

**BIRLA CENTRAL LIBRARY**

PILANI ( RAJASTHAN )

Class No. 570

Book No. W86F

Accession No. 35262





# Foundations of *Biology*



THE MACMILLAN COMPANY  
NEW YORK · BOSTON · CHICAGO · DALLAS  
ATLANTA · SAN FRANCISCO

MACMILLAN AND CO., LIMITED  
LONDON · BOMBAY · CALCUTTA · MADRAS  
MELBOURNE

THE MACMILLAN COMPANY  
OF CANADA, LIMITED  
TORONTO

## FROM PREFACE TO THE FOURTH EDITION

**A**cknowledgments are due to the authors and publishers of the following works, who generously have supplied some of the new illustrations included in this edition: Calkins' *Biology of the Protozoa* (Lea & Febiger); Chapman's *Handbook of the Birds of Eastern North America* (D. Appleton & Co.); Chandler's *Animal Parasites and Human Disease*, Curtis and Guthrie's *General Zoölogy* (John Wiley & Sons); Martin's *Human Body* (Henry Holt & Co.); Morgan's *Evolution and Genetics* (Princeton University Press); Metcalf and Flint's *Destructive and Useful Insects* (McGraw-Hill Book Co.); Lindsey's *Evolution and Genetics*, Newman's *General Zoölogy*, Smith, Overton, Gilbert, Denniston, Bryan, and Allen's *General Botany* (The Macmillan Co.); Rockefeller Foundation's *Annual Report*; and Thompson's *Concerning Evolution*, and Wilson's *Physical Basis of Life* (Yale University Press).

## FROM PREFACE TO THE FIRST EDITION

**T**he present volume brings together in brief form the fundamental principles of biology for the college student and the general reader.

It is well recognized that there is no adequate substitute for detailed laboratory work on the structure and physiology of representative organisms as a means of affording a first-hand knowledge of the facts and methods of biology. However, the author has realized with increasing force that the student's correlation of the laboratory data from day to day and accordingly his appreciation of the broader aspects of the subject are greatly enhanced by a synchronous

'running account' of the underlying principles. The material in this volume has proved to be of great value for this purpose in a course on General Biology elected each year by several hundred Yale undergraduates.

The large problems of life are common to both zoölogy and botany, and therefore both animals and plants have been drawn upon for illustration and discussion. This method of presentation accords with the author's conviction that the general biological viewpoint is the most favorable means of approach both to a broad knowledge of living phenomena as a part of a 'liberal' education, and to more advanced studies in zoölogy and botany which are prerequisite for medicine, forestry, etc. As is natural, however, the zoölogical aspect has been emphasized since it affords indispensable data for the interpretation of man himself. For courses in general zoölogy, therefore, the book will be found adequate in its treatment of animals, while the chapters on plants may readily be omitted without breaking the continuity of the discussion.

The author is indebted, of course, to innumerable sources for the facts and principles outlined. The content has grown by accessions year by year. Nearly all the standard treatises have been drawn upon, but those which have been most generally suggestive are listed in the bibliographies of the respective chapters.

The author has availed himself of the constructive criticism, generously given by Professor B. W. Kunkel of Lafayette College, Professor E. H. Cameron of the University of Illinois, and his colleagues at Yale, Professors R. G. Harrison, W. R. Coe, A. Petrunkevitch, F. P. Underhill, Henry Laurens, G. A. Baitzell, W. W. Swingle, and Dr. J. W. Buchanan, who have read the book either in manuscript or in the mimeographed form in which it has been used by the Yale classes. Finally, the author's indebtedness to the criticism and coöperation of his wife, Margaret Mitchell Woodruff, must not remain unmentioned, though it cannot be adequately expressed.

The original illustrations as well as those from other sources which have been modified or merely redrawn are, with a few exceptions, the work of Mr. R. E. Harrison, Yale, 1923. In most cases these figures have been selected because of their proved pedagogic value. Acknowledgments are due the authors and publishers of the following works, from which illustrations have been reproduced by permission: Coulter, Barnes, and Cowles' Textbook of Botany, Coulter's Plant Life and Plant Uses (American Book Co.); Kellicott's Social Direction of Human Evolution, Jordan and Kellogg's Evolution and Animal Life, Darwin's Life and Selected Letters, Huxley's Life and Letters (D. Appleton & Co.); Folsom's Entomology, Gager's Fundamentals of Botany (P. Blakiston's Sons & Co.); Jennings' Behavior of the Lower Organisms (Columbia University Press); Bergen's Foundations of Botany, Bergen and Caldwell's Practical Botany, Bergen and Davis' Principles of Botany, Densmore's General Botany, Hough and Sedgwick's The Human Mechanism, Linville and Kelly's General Zoölogy (Ginn & Co.); Kellicott's General Embryology, Sedgwick and Wilson's General Biology (Henry Holt & Co.); Morgan's Physical Basis of Heredity (J. P. Lippincott & Co.); Romanes' Darwin and After Darwin (Open Court Publishing Co.); Conklin's Heredity and Environment in the Development of Men (Princeton University Press); Conn and Budington's Physiology and Hygiene (Silver, Burdett & Co.); Coulter's Evolution of Sex in Plants (University of Chicago Press); Abbott's General Biology, Buchanan and Buchanan's Bacteriology, Campbell's University Textbook of Botany, Ganong's Textbook of Botany for Colleges, Hegner's College Zoölogy, and Introduction to Zoölogy, Holmes' Biology of the Frog, Huxley's Physiology, Lankester's Treatise on Zoölogy, Lull's Organic Evolution, Packard's Textbook of Entomology, Parker's The Elementary Nervous System, Parker and Haswell's Textbook of Zoölogy, Parker and Parker's Practical Zoölogy, Scott's The Theory of Evolution, Shipley and McBride's Zoölogy, Verworn's



General Physiology, Walter's Genetics, and The Human Skeleton, Wiedersheim's Comparative Anatomy of Vertebrates, Wilson's The Cell (The Macmillan Co.). To the Macmillan Company is also due the author's appreciation of the liberal attitude which they have assumed in all the arrangements attendant upon the publication of the book.

L. L. WOODRUFF

YALE UNIVERSITY  
May, 1922

# CONTENTS

CHAPTER	PAGE
I. THE SCOPE OF BIOLOGY . . . . .	1
A. Origin of Life Lore . . . . .	2
B. Biological Sciences . . . . .	3
C. Biology and Human Progress . . . . .	6
II. CELLULAR ORGANIZATION OF LIFE . . . . .	8
A. The Cell . . . . .	10
B. Cell Division . . . . .	13
III. THE PHYSICAL BASIS OF LIFE . . . . .	16
A. The Protoplasm Concept . . . . .	17
B. Unique Characteristics of Living Matter . . . . .	21
1. Organization . . . . .	21
2. Chemical Composition . . . . .	24
3. Metabolism . . . . .	28
4. Maintenance and Growth . . . . .	31
5. Reproduction . . . . .	32
6. Irritability and Adaptation . . . . .	32
IV. METABOLISM OF ORGANISMS . . . . .	36
A. Green Plants . . . . .	36
1. Protococcus . . . . .	37
2. Food Making . . . . .	38
3. Respiration . . . . .	40
B. Animals . . . . .	42
1. Amoeba . . . . .	42
2. Food Taking . . . . .	43
3. Respiration and Excretion . . . . .	44
C. Colorless Plants . . . . .	45
1. The Bacteria . . . . .	46
2. Cycle of the Elements in Nature . . . . .	48
D. The Hay Infusion Microcosm . . . . .	52
V. THE MULTICELLULAR ORGANISM . . . . .	56
VI. THE PLANT BODY . . . . .	64
A. Structure . . . . .	67
1. Types of Roots . . . . .	70
2. Histology of Roots . . . . .	74
3. Types of Stems . . . . .	76
4. Histology of Stems . . . . .	80
5. Types of Leaves . . . . .	85
6. Histology of Leaves . . . . .	88

CHAPTER	PAGE
B. Physiology . . . . .	91
1. Transpiration Stream . . . . .	92
2. Translocation . . . . .	94
3. Food Utilization . . . . .	96
4. Irritability and Adaptation . . . . .	97
VII. REPRODUCTION IN PLANTS . . . . .	101
A. Spore Formation . . . . .	102
B. Gamete Formation . . . . .	103
C. Sex Differentiation . . . . .	105
D. Reproductive Organs . . . . .	198
E. Alternation of Generations . . . . .	110
1. The Moss . . . . .	110
2. The Fern . . . . .	113
3. Water Ferns . . . . .	115
4. Seed Plants . . . . .	117
F. Seed and Fruit . . . . .	123
VIII. SURVEY OF THE PLANT KINGDOM . . . . .	128
A. Thallophytes . . . . .	129
1. Algae . . . . .	130
2. Fungi . . . . .	136
B. Bryophytes . . . . .	142
C. Tracheophytes . . . . .	145
1. Gymnosperms . . . . .	149
2. Angiosperms . . . . .	151
<i>a.</i> Dicotyledons . . . . .	154
<i>b.</i> Monocotyledons . . . . .	161
D. Plants of the Past . . . . .	165
E. Plant Distribution . . . . .	168
F. Synoptic Classification of Plants . . . . .	172
IX. THE ANIMAL BODY: INVERTEBRATE . . . . .	173
A. The Chief Groups of Animals . . . . .	174
B. Hydra . . . . .	175
C. Earthworm . . . . .	180
1. Body Plan . . . . .	180
2. Tissues and Organs . . . . .	182
3. Organ Systems . . . . .	186
D. Crayfish . . . . .	191
1. External Anatomy . . . . .	195
2. Internal Anatomy . . . . .	196
X. SURVEY OF THE ANIMAL KINGDOM: INVERTEBRATES . . . . .	202
A. Protozoa . . . . .	202
B. Sponges . . . . .	214

# CONTENTS

xiii

CHAPTER	PAGE
C. Coelenterates . . . . .	219
D. Flatworms . . . . .	226
E. Roundworms . . . . .	228
F. Rotifers, Bryozoans, and Brachiopods . . . . .	230
G. Annelids . . . . .	232
H. Molluscs . . . . .	235
I. Echinoderms . . . . .	241
J. Arthropods . . . . .	245
K. Synoptic Classification of Invertebrates . . . . .	254
XI. SURVEY OF THE ANIMAL KINGDOM: VERTEBRATES . . . . .	256
A. Fishes . . . . .	259
1. Cartilaginous Fishes . . . . .	260
2. Bony Fishes . . . . .	261
B. Amphibians . . . . .	265
1. Salamanders and Newts . . . . .	266
2. Toads and Frogs . . . . .	267
C. Reptiles . . . . .	268
1. Turtles and Tortoises . . . . .	269
2. Crocodiles and Alligators . . . . .	269
3. Lizards and Snakes . . . . .	271
D. Birds . . . . .	272
E. Mammals . . . . .	274
1. Monotremes . . . . .	274
2. Marsupials . . . . .	275
3. Placentals . . . . .	276
F. Synoptic Classification of Vertebrates . . . . .	280
XII. THE ANIMAL BODY: VERTEBRATE . . . . .	282
A. Body Plan . . . . .	282
B. Skin . . . . .	284
C. Muscles . . . . .	287
D. Skeleton . . . . .	290
E. The Human Body . . . . .	298
F. Distinctive Vertebrate Characters . . . . .	298
XIII. NUTRITION . . . . .	301
A. Buccal Cavity, Pharynx, and Esophagus . . . . .	307
B. Stomach . . . . .	308
C. Small Intestine . . . . .	308
1. Liver . . . . .	309
2. Pancreas . . . . .	310
3. Absorption . . . . .	312
4. Distribution . . . . .	313
D. Large Intestine . . . . .	314
E. Food Use . . . . .	314

CHAPTER	PAGE
F. Vitamins . . . . .	315
G. Ductless Glands . . . . .	317
XIV. CIRCULATION . . . . .	318
A. Circulation in the Lower Vertebrates . . . . .	321
B. Circulation in the Higher Vertebrates . . . . .	325
XV. RESPIRATION . . . . .	335
A. Lungs . . . . .	335
B. Respiratory Mechanism . . . . .	336
C. Respiratory Interchange . . . . .	338
XVI. EXCRETION . . . . .	341
A. Gills and Lungs . . . . .	342
B. Skin . . . . .	342
C. Liver . . . . .	343
D. Kidneys . . . . .	343
1. Urine . . . . .	345
2. Evolution of Kidneys . . . . .	346
XVII. REPRODUCTION . . . . .	350
A. Gonads . . . . .	350
B. Uterine Development . . . . .	352
C. Urogenital System . . . . .	356
XVIII. COÖRDINATION: ENDOCRINAL . . . . .	358
A. Pancreas . . . . .	359
B. Gonads . . . . .	359
C. Intestine . . . . .	360
D. Thyroid . . . . .	361
E. Parathyroids . . . . .	362
F. Adrenals . . . . .	362
G. Pituitary . . . . .	363
H. Pineal Body . . . . .	364
I. Thymus . . . . .	364
XIX. COÖRDINATION: NERVOUS . . . . .	366
A. Central Nervous System . . . . .	368
B. Craniospinal System . . . . .	373
C. Autonomic System . . . . .	378
D. Sense Organs . . . . .	379
1. Cutaneous and Internal Senses . . . . .	380
2. Sense of Taste . . . . .	381
3. Sense of Smell . . . . .	382
4. Ear . . . . .	382
5. Eye . . . . .	384
E. The Organism as a Whole . . . . .	388

# CONTENTS

xv

CHAPTER	PAGE
XX. ORIGIN OF LIFE . . . . .	390
A. Biogenesis and Abiogenesis . . . . .	390
B. Origin of Life on the Earth . . . . .	396
1. Cosmic Origin . . . . .	397
2. Terrestrial Origin . . . . .	399
XXI. CONTINUITY OF LIFE . . . . .	403
A. Reproduction . . . . .	403
B. Origin of the Germ Cells . . . . .	412
1. Mitosis . . . . .	414
2. Chromosomes of the Germ Cells . . . . .	417
3. Spermatogenesis . . . . .	420
4. Oögenesis . . . . .	422
5. Chromosome Cycle . . . . .	425
XXII. FERTILIZATION . . . . .	428
A. Gametes . . . . .	428
B. Union of Gametes . . . . .	431
1. Synkaryon . . . . .	432
2. Significance of Fertilization . . . . .	433
XXIII. DEVELOPMENT . . . . .	441
A. Embryology of the Earthworm . . . . .	442
B. Development of the Frog . . . . .	445
1. Germ Cell Formation and Spawning . . . . .	445
2. Fertilization and Embryo Formation . . . . .	446
3. Larval Stages and Metamorphosis . . . . .	450
C. Embryonic Membranes of the Higher Vertebrates . . . . .	452
D. Problems of Development . . . . .	457
1. Epigenesis versus Preformation . . . . .	457
2. Organizers . . . . .	463
3. Realization of Function . . . . .	466
XXIV. GENETICS . . . . .	468
A. Heritability of Variations . . . . .	469
1. Modifications . . . . .	471
2. Recombinations . . . . .	473
3. Mutations . . . . .	474
B. Galton's Studies . . . . .	474
C. Mendelian Principles . . . . .	476
1. Monohybrids . . . . .	477
2. Dihybrids . . . . .	481
3. Trihybrids . . . . .	485
4. Summary . . . . .	486
D. Alterations of Mendelian Ratios . . . . .	487

CHAPTER	PAGE
E. Mechanism of Inheritance . . . . .	493
1. Sex Determination . . . . .	496
2. Linkage . . . . .	499
3. Crossing Over . . . . .	501
4. Mutations . . . . .	503
F. Nature and Nurture . . . . .	508
<b>XXV. ORGANIC ADAPTATION . . . . .</b>	<b>512</b>
A. Adaptations to the Physical Environment . . . . .	513
1. Adaptations Essentially Functional . . . . .	513
2. Adaptations Essentially Structural . . . . .	520
B. Adaptations to the Living Environment . . . . .	537
1. Plant Associations . . . . .	539
2. Communal Associations . . . . .	539
3. Symbiosis . . . . .	541
4. Parasitism . . . . .	544
5. Immunity . . . . .	548
C. Individual Adaptability . . . . .	549
<b>XXVI. ORIGIN OF SPECIES . . . . .</b>	<b>556</b>
A. Evidences of Organic Evolution . . . . .	558
1. Classification . . . . .	559
2. Comparative Anatomy . . . . .	562
3. Paleontology . . . . .	566
4. Embryology . . . . .	573
5. Physiology . . . . .	577
6. Distribution . . . . .	579
B. Factors of Organic Evolution . . . . .	583
1. Lamarekism . . . . .	584
2. Darwinism . . . . .	585
3. Genetics and Evolution . . . . .	589
<b>XXVII. THE HUMAN BACKGROUND . . . . .</b>	<b>600</b>
A. The Prehuman Lineage . . . . .	600
B. Fossil Man . . . . .	608
1. Java Man . . . . .	608
2. Peking Man . . . . .	609
3. Piltdown Man . . . . .	610
4. Heidelberg Man . . . . .	611
5. Neanderthal Man . . . . .	611
6. Cro-Magnon Man . . . . .	612
7. Human Variability . . . . .	614
C. Cultural Development . . . . .	616
1. Paleolithic Culture . . . . .	617
2. Mesolithic Culture . . . . .	620
3. Neolithic Culture . . . . .	621
4. Age of Metals . . . . .	623

# CONTENTS

xvii

CHAPTER	PAGE
XXVIII. BIOLOGY AND HUMAN WELFARE . . . . .	627
A. Medicine . . . . .	628
1. Microorganisms and Disease . . . . .	629
2. Parasitic Worms . . . . .	636
3. Health and Wealth . . . . .	642
B. Biology and Agriculture . . . . .	644
1. Plant and Animal Food . . . . .	644
2. Insects Injurious to Animals . . . . .	646
3. Insects Injurious to Plants . . . . .	649
4. Beneficial Insects . . . . .	655
5. Plants Injurious to Plants . . . . .	659
C. Conservation of Natural Resources . . . . .	661
D. Constructive Biology . . . . .	664
1. Plants and Animals . . . . .	665
2. Man . . . . .	666
XXIX. BIOLOGICAL HISTORY . . . . .	671
A. Greek and Roman Science . . . . .	672
B. Medieval and Renaissance Science . . . . .	674
C. The Microscopists . . . . .	678
D. Development of the Subdivisions of Biology . . . . .	681
1. Classification . . . . .	682
2. Comparative Anatomy . . . . .	685
3. Physiology . . . . .	687
4. Histology . . . . .	692
5. Embryology . . . . .	694
6. Genetics . . . . .	698
7. Organic Evolution . . . . .	701
BIBLIOGRAPHY . . . . .	711
GLOSSARY . . . . .	726
INDEX . . . . .	751





# Foundations *of Biology*



## CHAPTER I

# THE SCOPE OF BIOLOGY

Science is, in its source, eternal; in its scope, unmeasurable; in its problem, endless; in its goal, unattainable. — *von Baer*.

**T**he oldest as well as the most obvious classification of the objects composing the world about us is into non-living and living; and the knowledge accumulated during many centuries in regard to the former is today represented in the physical sciences, while that of the latter comprises the content of BIOLOGY, the science of matter in the living state. Biology has as its ultimate object the description of its phenomena in terms of what may be regarded as basic concepts of science: matter and energy acting in time and space; but it is needless to say that the attainment of this object is not imminent in any department of knowledge, and least so in the science of living things. These exhibit energy relationships which transcend the classifications of physicist and chemist today — a condition which expresses in its highest manifestations what we call our 'life.'

Whether the 'riddle of life' will ultimately be solved is a question which everyone would like to answer but only the rash would attempt to predict. Suffice it to say that biologists who are on the firing line of progress today are directing their attention solely to the description and measurement of the phenomena exhibited by living things — those phenomena which distinguish life from lifeless — in an attempt to relate them to the familiar and more readily accessible phenomena of which we have some exact knowledge in the realm of the non-living. But this should by no means be taken to indicate that biologists do not recognize the stupendous problems they face, or do not appreciate to the

full—indeed more fully than others—the imposing gap that separates even the simplest forms of life from the inorganic world.

Our present interest, however, is not in discussing the theoretical goal of biology, but in drawing in bold strokes an outline picture of the present-day knowledge of the subject which represents the cumulative results of the application of the scientific method to problems of life. This method is not peculiar to science, but is merely a perfected concentration of our human resources of observation, experimentation, and reflection. Thus far this has been a most productive method and certainly has given no evidence that its usefulness is being exhausted. But, of course, “in ultimate analysis everything is incomprehensible, and the whole object of science is simply to reduce the fundamental incomprehensibilities to the smallest possible number.”

### A. ORIGIN OF LIFE LORE

The foundations of the scientific study of living nature were laid by Aristotle and Theophrastus over 2000 years ago. On the basis of collecting, dissecting, classifying, and pondering they reached generalizations, some of which have but recently been put on a firm basis of fact. Indeed, they precociously raised some of the broad questions which are fundamental today; but from the Greeks until about the fifteenth century there is little to record. There were many additions to the body of knowledge during this long slumber period, but fact and fancy were so intermingled that the truth was largely obscured. (Figs. 443, 444.)

The feeling that, though man is of nature, he is still apart, was expressed at the revival of learning, during the sixteenth century and later, in the broad classification of all knowledge as history of nature and history of man; the former recording the “history of such facts or effects of nature as have no dependence on man’s will, such as the histories of metals, plants, animals, regions, and the like”; the latter treating

of the voluntary actions of men in communities. Thus all record of facts was either NATURAL HISTORY or civil history. From this general field of natural history the present-day sciences of astronomy, physics, chemistry, geology, and biology became separated as relatively independent bodies of facts as each gained content, clearness, and individuality. Astronomy, physics, and chemistry were set apart first owing to the fact that their material was more readily susceptible to mathematical and experimental treatment, thus leaving the histories of the earth, animals, and plants, or so-called observational sciences, as the residue for natural history.

It remained, however, for Lamarck and Treviranus, during the opening years of the nineteenth century, to attain a vision of the unity of animal and plant life and to express it in the term BIOLOGY. But biology is something more than a union of plant science — BOTANY — and animal science — ZOÖLOGY — under one name; for it endeavors, in addition to describing the characteristics of plants and animals, to unfold the general principles underlying both. (Fig. 467.)

## B. BIOLOGICAL SCIENCES

Thus the biologist has as his field the study of living things — what they are, what they do, and how they do it. He asks, how this animal or that plant is constructed and how it works — and this he attempts to answer. He would like to ask, and often does ask, why it is so constructed and why it works the way it does. Aristotle realized that the essence of a living thing is not what it is made of nor what it does, but why it does it.

These queries of the biologist reflect the two primary viewpoints from which biological phenomena may be approached: the *morphological* in which interest centers upon the form and structure of living things; and the *physiological* in which attention is concentrated upon the functions performed — the mechanical and chemical engi-

neering of living machines. Clearly, however, it is impossible to draw a hard and fast distinction between morphology and physiology because in the final analysis structure must be interpreted in terms of function, and vice versa. But again, the fields of morphology and physiology naturally resolve themselves into special departments of study, depending on the level of analysis of structure or of function which is emphasized. Thus MORPHOLOGY stresses the general form of the animal or plant; ANATOMY, the gross structure of individual parts, or *organs*; HISTOLOGY, the microscopic structure of organs, or *tissues*; CYTOLOGY, the component elements of tissues, or *cells*, and the physical basis of life, or *protoplasm*. Similarly, PHYSIOLOGY investigates the activities of animals and plants, the functions of organs, the properties of tissues, the phases of cell life, and finally the physico-chemical characteristics of protoplasm. Furthermore, the development of the individual, or EMBRYOLOGY, the method of transmission of characters from parents to offspring, or GENETICS, and the origin of species, or ORGANIC EVOLUTION, are other wide fields which must be approached from both the structural and functional aspect if any real advance is to be made toward a comprehensive appreciation of life. (Fig. 1.)<sup>1</sup>

Thus, just as the various physical sciences have expanded and become specialized until they are beyond the grasp of a single man, so biology and its subdivisions, or the BIOLOGICAL SCIENCES, are now distributed among many specialists. Although specialization results in a narrowing and isolating of the fields of study, as deeper levels of investigation have been reached in all the sciences there has been a tendency for the basic phenomena to meet on the common ground of the fundamental sciences, physics and chemistry — for in the last analysis the biologist must assume, as a *working hypothesis*, that the properties of protoplasm are the resultant of the properties and interrelationships of the chemical elements which compose it. But he must not sup-

<sup>1</sup> In order not to interrupt the continuity of the narrative, formal definitions of technical terms are usually omitted from the text. See the GLOSSARY, Appendix II.

pose that physics and chemistry when added up fulfill the rôle of biology. Rather he must grip the cardinal fact that with new relations the properties of things change — the

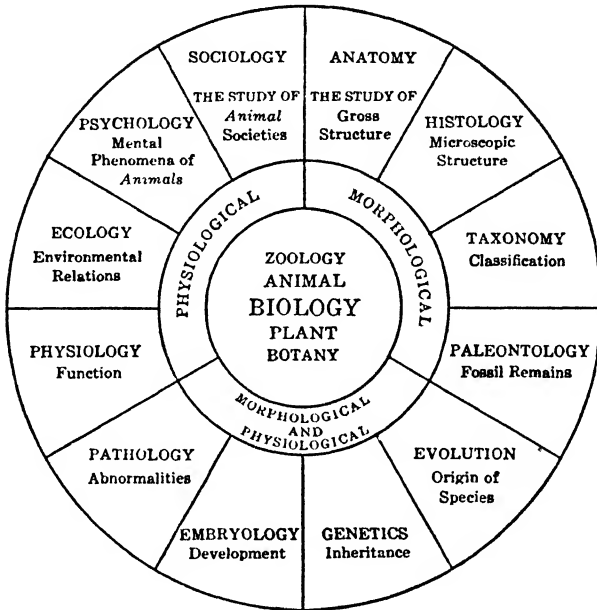

FIG. 1. The chief divisions of Biology.

properties of protoplasm depend on and emerge from those of its chemical constituents only when the latter are actually in the protoplasmic complex. (P. 39.)

Thus "in one direction, supported by chemistry and physics, biology becomes biochemistry and biophysics. In another direction it becomes the basis of the psychological sciences which relate to human nature, of psychology and sociology," etc. Indeed, it is not an exaggeration to regard all knowledge as really biological, since the process of knowing is a life process which is basal to every art and its practice, to every science and its application, and to every philosophy and its exposition.



### C. BIOLOGY AND HUMAN PROGRESS

Probably the value of a knowledge of biological principles, and of the order of nature in general, cannot be better emphasized than in the words of the founder of modern methods of biological teaching. Huxley wrote: "Suppose it were perfectly certain that the life and fortune of every one of us would, one day or other, depend upon his winning or losing a game of chess. Don't you think that we should all consider it to be a primary duty to learn at least the names and moves of the pieces; to have a notion of a gambit, and a keen eye for all the means of giving and getting out of check? Do you not think we should look with a disapprobation amounting to scorn, upon the father who allowed his child, or the state which allowed its members, to grow up without knowing a pawn from a knight? Yet it is a very plain and elementary truth, that the life, the fortune, and the happiness of every one of us, and, more or less, of those who are connected with us, do depend upon our knowing something of the rules of a game infinitely more difficult and complicated than chess. It is a game which has been played for untold ages, every man and woman of us being one of the two players in a game of his or her own. The chess-board is the world, the pieces are the phenomena of the universe, the rules of the game are what we call the laws of Nature. The player on the other side is hidden from us. We know that his play is always fair, just and patient. But also we know, to our cost, that he never overlooks a mistake, or makes the smallest allowance for ignorance. To the man who plays well, the highest stakes are paid, with that sort of overflowing generosity with which the strong shows delight in strength. And one who plays ill is checkmated — without haste, but without remorse." (Fig. 454.)

The contributions of the biological sciences to human welfare — the rules of the game of life — we shall consider more fully later. At this point it is merely necessary to emphasize that biology affords certain fundamental principles which

plants and animals, including man, are actually lineal descendants in unbroken series from the beginning of cellular life on the earth. Cells are the smallest units of living matter capable of continued independent life and growth. (Figs. 292, 293.)

### CHAPTER III

## THE PHYSICAL BASIS OF LIFE

Over the structure of the chemical molecule rises the structure of the living substance as a broader and higher kind of organization. — *Hertwig*.

**T**he realization that all animals and plants possess a fundamentally similar organization — the structural and physiological units, or cells — leads quite naturally to an intensive study of the material of which the cells are composed — the physical basis of life itself. Accordingly we must now consider more specifically the characteristics of this actual life-stuff — protoplasm.

The old saying that the materials forming the human body change completely every seven years is a tacit recognition that lifeless material, taken in the form of food, is gradually transformed into living matter under the influence of the body. Indeed, just as a geyser retains its individuality from moment to moment though it is at no two instants composed of the same molecules of water identically placed, so the living individual is a focus into which materials enter, play a part for a time, and then emerge to become dissipated in the environment. But here the analogy stops. For in the living organism the materials which enter as food, endowed with **POTENTIAL ENERGY**, are arranged and rearranged until specific molecular combinations result, which in turn are transformed into integral parts of the organization of life itself. However, to live is to work, and to work means expenditure — the transformation of the potential into **KINETIC ENERGY** — with the result that materials in relatively simple form and largely or entirely devoid of energy are returned to the realm of the non-living. And note, the

living organism must continuously utilize energy in order merely to maintain itself. Cessation is death.

Thus we reach a fact of prime importance: so far as we know, living matter — protoplasm — is merely ordinary matter that has assumed, for the time being, unique physico-chemical relationships that display the remarkable series of phenomena which we recognize as LIFE.

But non-living matter is always closely associated with living matter in the bodies of animals and plants. Indeed, the two are so intimately related that it is frequently difficult to distinguish sharply between them. Obviously, in the human body, for instance, the visible parts of hair and nails, a large part of bone, and the liquid part of blood are non-living material. But the non-living is not confined to gross structures, for the dead among the living is still revealed until the penetrating power of the microscope fails us. (Fig. 218.)

## A. THE PROTOPLASM CONCEPT

Although there is a continuous stream of matter and energy flowing through the living individual, nevertheless the physical and chemical study of living matter from whatever source we take it, from the lowest plant to man, reveals a striking similarity in its fundamental factors, and this is the basis of the protoplasm concept held by modern biologists.

As the finer structure of animals and plants came within the range of vision through improvements in microscope lenses, it was gradually recognized that the ultimate living part appeared to be a granular, viscid fluid. This started a long series of studies on the materials of the bodies of unicellular organisms similar to *Amoeba* and of the cellular elements of higher animals and plants, which finally led, about the middle of the last century, to the complete demonstration of the full morphological and physiological significance of protoplasm. There is, in truth, an essentially

similar, fundamental, living material of both animals and plants — a common physical basis of life. This reduction of all life phenomena to a common denominator laid the foundations for — indeed, actually established — the life-science, biology. (Figs. 6, 10; Pp. 692–694.)

Although we speak of a common 'physical basis of life,' it is important to bear in mind that the protoplasm of no two animals or plants or, indeed, of different parts of the same animal or plant is exactly the same. Identity of protoplasm would mean identity of structure and function — identity of life itself. The protoplasm concept merely emphasizes that, after allowances are made for all the variations, we still have the similarities far outnumbering the dissimilarities in the 'agent of vital manifestations.'

The physical chemists tell us that protoplasm consists of matter in the colloidal state — a condition of matter that chemists have long been familiar with in the inorganic world. A COLLOID may be described as matter divided into particles larger than one molecule and suspended in a medium of different matter. Therefore butter and cream are each colloids: the former consisting of water finely divided and suspended in oil, and the latter essentially of finely divided oil in water. But protoplasm is a stupendously more complex colloidal system. It comprises not two, but very many substances, some in simple and others in highly complex molecular form, so finely divided that they are invisible with the ordinary microscope.

Now colloidal systems in general are characterized by tremendous surface activity — the result of energy relations between the contact surfaces of the particles of the different component substances. This being so, and protoplasm being a colloid composed of very many different kinds of materials, the total surface area between suspended substances and suspending media is very great, and thus affords the requisite conditions for a highly complex system of energy relations. And when we add to this the fact that at such surfaces chemical changes, some involving changes in electrical po-

tential, occur; and also that mechanical changes are induced by precipitation, coagulation, and constant redistribution between the suspending media and the substances in suspension, we begin to get at least a glimpse of the exceedingly intricate and delicate *energy-transforming system* that protoplasm really is. To work out these intricacies is one of the imposing tasks still before the biologist, chemist, and physicist.

But the statement that protoplasm is a colloidal system — essentially a colloidal dispersion of proteins in water — leaves the reader without any clear conception of its appearance. As a matter of fact it is as difficult to describe the appearance of protoplasm as it is to define it. Protoplasm must be seen under the microscope to be appreciated. With a moderate magnification, it presents a fairly characteristic picture, appearing like a translucent, colorless, viscid fluid containing many minute granules as well as clear spaces or vacuoles. If it is examined in water it exhibits no tendency to mix with the surrounding medium, though investigations show that OSMOTIC interchanges are constantly going on. For this reason it is impossible to consider protoplasm except in connection with its surroundings, whatever they may be — variations in its environment and variations in its activities being reflected directly or indirectly in its appearance. (Fig. 6.)

Under the highest magnifications, not only does the finer structure of protoplasm differ in various specimens, but also in the same cell under slightly different physiological conditions. At one time it presents the appearance of a fairly definite honey-comb or net-like structure, or *reticulum*, the meshes of which enclose a more fluid substance; at another time, a foam-like, or *alveolar*, appearance due to a more liquid substance scattered or emulsified as spherical bodies in a less liquid medium. Again, at other times, the denser portion seems to take the form of minute threads, or *fibers*, or of tiny *granules* distributed in a somewhat fluid matrix. (Fig. 10.)

These appearances have given rise to various theories which emphasize one or another as the universal formula for the physical structure of protoplasm, from which the other

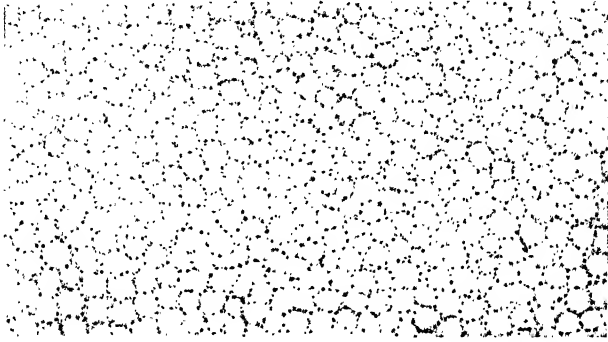

FIG. 10. Protoplasm of the living Starfish egg (very highly magnified), exhibiting alveolar, or foam-like, structure. This arises by the appearance, growth, and crowding together of minute bodies in a homogeneous ground substance. (From Wilson.)

appearances are merely secondarily derived. But the trend of recent work has been to indicate that although the general similarity of protoplasmic activity, wherever we find it, might lead us to expect to find also a visible fundamental structural basis, such does not exist within the range of magnifications at our command. Reticular, alveolar, and other structures which our microscopes reveal are, as it were, merely surface ripples from underlying physico-chemical changes in the colloidal system which, thus far, have proved unfathomable.

However, just as the invention of the compound microscope nearly three and a half centuries ago made possible the discovery of cells and the study of protoplasm, so today by means of new tools and techniques, the door to molecular biology, so called, has recently been opened. The ultramicroscope and the ultraviolet microscope have removed from magnification the old limits of the wave length of ordinary light, while the electron microscope affords magnifications far exceeding those of any optical system. Furthermore the ultracentrifuge is able to separate out minute

dispersed particles hitherto unmanageable. And the spectroscope is now showing the presence of traces of biologically important chemicals and aiding in the analysis of the chemical make-up of organic compounds, while the X-ray is affording almost infinitesimally fine measurements and patterns in the realm of living material.

So biology is off on new trails with the description and analysis of biological phenomena, not in terms of cells, but of important parts of cells and even in terms of molecular structure and forces. But "it should not be expected, of course, that continual fragmentation will of itself necessarily reveal the true inner meaning of life processes." A plant or animal may well be — apparently is — something more than the sum of its parts: the *organismal* point of view is being increasingly insisted upon by many biologists. Life is an expression of functional unity in which the parts coöperate for the maintenance of the whole in continuously changing surroundings. The various phenomena are manifestations of the whole and are elusive when it is resolved into elements whether these be physical, chemical, or morphological. The overwhelming problem in all nature is still the organism. (Pp. 29, 388.)

## B. UNIQUE CHARACTERISTICS OF LIVING MATTER

Since the phenomena of life are without exception the results of protoplasmic activity, it is obvious that we must look to protoplasm for the primary attributes of living matter. The properties which are absolutely characteristic of living matter are its specific *organization, chemical composition, metabolism* involving the power of *maintenance, growth, and reproduction*, and *irritability* resulting in the power of *adaptation*.

### 1. Organization

It has been emphasized that living things are not homogeneous, but possess structural and physiological ORGANIZATION. Animals and plants are made up of various parts



adapted for certain purposes. They exhibit 'a viable unity' and so stand in sharp contrast with objects comprising the inorganic world as, for instance, rocks and rivers. Accordingly animals and plants are referred to as ORGANISMS. Moreover, as we have seen, the organizational units of all living things are cells, and so it follows that cell structure is a direct or indirect expression of all the unique life characteristics that we are about to survey. A few of the details of cell structure are necessary for an appreciation of the organization of organisms.

It will be recalled that the protoplasm of all typical cells is differentiated into two chief parts: the *cytoplasm*, or general groundwork which makes up the bulk of the cell; and the *nucleus*, a more or less clearly defined spherical body, situated near the center of the cytoplasmic mass. (Pp. 10-13.)

**CYTOPLASM.** The cytoplasm may be considered the less specialized protoplasm of the cell, and its appearance and other characteristics are those which have been outlined in our discussion of protoplasm. With that in mind, for the sake of definiteness, we may consider its basis as consisting of a meshwork, composed of innumerable, minute granules which permeate an apparently homogeneous ground-substance, or **HYALOPLASM**. Distributed throughout the cytoplasm are usually various lifeless inclusions such as granules of food, droplets of water or oil, vacuoles of cell sap, crystals, etc., representing materials which are to be, or have been, a part of the living complex, or are by-products of the vital processes. This passive material is frequently referred to as **METAPLASM**, but it is quite evident that such a term stands for no essential morphological part of the cell, and we have no absolute criterion to distinguish between some granules which are regarded as metaplasmic in nature and others which are ordinarily considered active elements of the cytoplasm. But there are various bodies in the cytoplasm, in addition to the nucleus, which are undoubtedly active. Chief among these are the **CENTROSOME**, which plays an

essential part in cell reproduction, and the PLASTIDS, MITOCHONDRIA, and GOLGI BODIES which are involved in special physiological activities of the cell. (Fig. 11.)

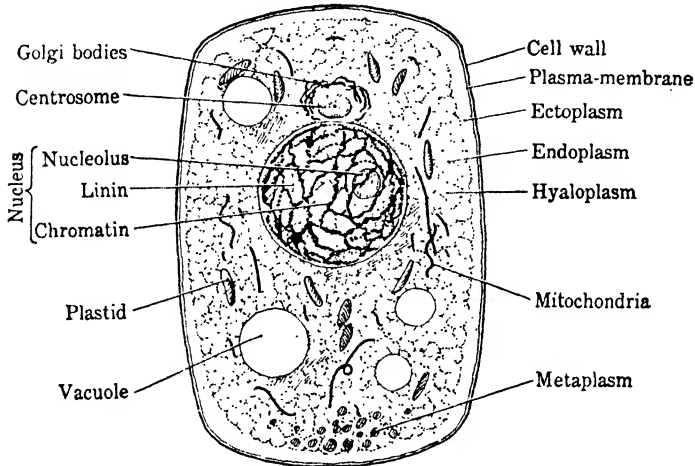

FIG. 11. Diagram of a cell.

The cytoplasm, since it forms the general groundwork, is that part of the cell which comes most closely into relations with the environment, and accordingly near the surface it is frequently modified somewhat in texture and consistency so that a definite outer region, or **ECTOPLASM**, may be distinguished from an inner, or **ENDOPLASM**. The ectoplasm is limited externally by a **PLASMA-MEMBRANE** just beneath the cell wall. The plasma-membrane is certainly a part of the living cytoplasm, while the cell wall must be regarded as non-living, though in many cases it is a direct transformation of the living material which grows and plays, in connection with the plasma-membrane, an important part in controlling the flow of matter and energy to and from the cell and its surroundings.

**NUCLEUS.** As already mentioned, within the cytoplasmic mass there is an area of clearly differentiated material which usually has a spherical form, bounded by a membrane, so that it appears as a definite body of protoplasm called the

nucleus. The structural basis of the nucleus consists of a homogeneous ground-substance, or KARYOLYMPH, which is permeated by a meshwork that usually appears to consist of two substances, LININ and CHROMATIN, which probably are chemically closely related. Chromatin is the highly characteristic nuclear material which takes various forms during different phases of cell activity but generally gives the appearance either of a network of tiny granules with one or more dense 'knots' of chromatin, or of a number of definite bodies known as CHROMOSOMES. Frequently there are one or more conspicuous, spherical bodies in the nucleus known as NUCLEOLI which apparently are reservoirs of nuclear materials. Later it will be necessary to describe some of the important changes in chromatin arrangement that occur during various phases of cell activity, especially during cell division, but it is sufficient at this moment to emphasize that the nucleus is a differentiated area of the cell protoplasm which is the arena of the chromatin. Indeed, the nucleus probably represents the highest type of organization in the organism. (Figs. 292, 293.)

## 2. Chemical Composition

It is impossible to make an analysis of living matter because the disturbance of its molecular organization by chemical reagents kills it. Therefore our knowledge of its chemical composition has of necessity been derived from a study of 'dead protoplasm.' However, since in the transformation from the living to the non-living state there is clearly no loss of weight, it follows that the complete material basis of life is still present for examination. In other words, the death of protoplasm is a result of *disorganization*.

Chemical analysis of protoplasm shows that it invariably comprises the elements OXYGEN, CARBON, HYDROGEN, NITROGEN, PHOSPHORUS, SULFUR, CALCIUM, MAGNESIUM, SODIUM, POTASSIUM, IRON, and CHLORINE. Probably other elements are always present; certainly some others are found normally

in the protoplasm of certain parts of various species of animals and plants. Thus in addition to the elements just mentioned which form by far the larger part of the human body, there are also present traces of several other elements, such as iodine, copper, manganese, and fluorine.

The average composition of the human body, including cellular and intercellular material, is about as follows:

Oxygen . . . . .	65.00%
Carbon . . . . .	18.00
Hydrogen . . . . .	10.00
Nitrogen . . . . .	3.00
Calcium . . . . .	2.00
Phosphorus . . . . .	1.00
Potassium . . . . .	0.35
Sulfur . . . . .	0.25
Sodium . . . . .	0.15
Chlorine . . . . .	0.15
Magnesium . . . . .	0.05
Iron . . . . .	0.004

At first glance there is nothing very striking about this list of elements. They are all common ones with which the chemist is familiar in the non-living world. The materials of a man's body are worth less than one dollar! Furthermore, quantitatively the most important compound is nothing more complex than WATER ( $H_2O$ ). It composes more than two-thirds of the human body. But there are *combinations* of the elements which are highly significant and characteristic, and result from the capacity of carbon, hydrogen, and oxygen, or carbon and hydrogen together, to form the numerous complex compounds which in turn supply the basis for intimate associations with other elements. As a matter of fact, the bulk of protoplasm is composed of carbon, oxygen, hydrogen, and nitrogen associated with each other in an apparently infinite series of relationships, in which the carbon seems to play the leading rôle — the indispensable bond that links all other elements in organic unity. Some of these compounds are relatively simple, but the majority consist of elaborate atomic arrangements and not a few

represent molecular complexes of hundreds and even thousands of atoms.

The COMPOUNDS OF CARBON which are characteristic of protoplasm fall into three chief groups: proteins, carbohydrates, and fats.

PROTEINS invariably consist of the elements carbon, oxygen, hydrogen, nitrogen, and usually sulfur, and frequently phosphorus, iron, etc. Examples are GLIADIN ( $C_{685}H_{1068}N_{196}O_{211}S_5$ ) of wheat, ALBUMIN of the white of egg, CASEIN of milk, and MYOSIN of lean meat. The *nitrogen* particularly distinguishes proteins from the other compounds of the living complex and, as we shall see later when considering the chemical processes in animals and plants, is largely responsible for their commanding position as the chemical pivot around which revolve a multitude of reactions characteristic of biological phenomena. Study of the relationship of nitrogen to the other chemical elements of proteins has revealed that the protein molecule is basically a huge complex of linked AMINO ACIDS — an amino acid being an organic acid in which one hydrogen atom is replaced by the amino group,  $NH_2$ . The amino acids are the nitrogenous units — the building blocks — with which organisms deal physiologically, rather than the proteins themselves. An animal, for example, with various proteins available in its food, chemically disrupts them into their amino acid constituents, and then takes an amino acid here and another there and constructs the specific proteins it demands. And again, if individual amino acids are supplied, the animal employs them.

Although there are less than two dozen different amino acids, the number of proteins is legion. Furthermore, besides the so-called simple proteins composed solely of amino acids, there are many which comprise in addition other radicals, such as the hemoglobins which contain hematin and the nucleoproteins with nucleic acid. Indeed, it seems highly probable that the specific structure of each animal and plant depends upon the chemical specificity of its proteins, but for

our purposes it is sufficient to recognize that the presence of proteins and the power of forming them is a prime chemical characteristic of living matter. Apparently these huge, complex molecules with their high lability and, therefore, tendency to chemical change are fundamentally associated with the plasticity and responsiveness of the protoplasmic system itself.

CARBOHYDRATES consist of various combinations of carbon, hydrogen, and oxygen, the latter elements typically being present in the proportion found in water ( $H_2O$ ). Though more simple in chemical structure than proteins, they range in complexity from the simple sugars, or monosaccharides such as GLUCOSE and FRUCTOSE, to polysaccharides such as STARCH, GLYCOGEN, and CELLULOSE. Cotton and filter paper are nearly pure cellulose.

FATS are composed of the same elements as the carbohydrates, but in quite different arrangements. The proportion of oxygen is always less, and therefore they are more oxidizable and richer in potential energy. Fats represent the union of an acid (fatty acid) and glycerol. Common examples are found in butter, cod liver oil, olive oil, etc. Various other lipids, closely related to but more complex than the true fats, are represented by the LECITHINS and CHOLESTEROL that are universally present in protoplasm.

Thus proteins, carbohydrates, and fats comprise large classes of substances which are distinctly characteristic of living matter, not being found in nature except as the result of protoplasmic activity; although biochemists now can artificially construct certain fats and carbohydrates as well as the amino acid constituents of some proteins. Proteins undoubtedly play the most important part in the organization of protoplasm, while the carbohydrates and fats contribute largely to the supply of available energy. However, it is impossible to draw a hard and fast distinction in regard to their respective contributions because, for example, as we shall see later, carbohydrates form the foundation upon which proteins are built by green plants. (Pp. 38-40.)

Proteins, carbohydrates, and fats are frequently referred to as the foodstuffs, but it will be recognized that while they constitute the chief groups, all the constituents of protoplasm must be available. Accordingly, inorganic salts, water, and free oxygen are really foodstuffs. Furthermore, recent investigation has disclosed another class of organic substances, known as VITAMINS, which are absolutely necessary. These accessory food substances are referred to as vitamin A, B, C, etc., though now the chemical constitution of many of them is known. An inadequate amount of a particular vitamin in the diet results in definite abnormalities and may lead to death if the deficiency is not corrected. Scurvy, for instance, is a disease induced by the lack of vitamin C which is also known as ascorbic acid. Finally, an immense group of organic catalyzers, called ENZYMES, must be mentioned. These are not food substances but special protein-like bodies formed in organisms where they play a major part in inducing and accelerating chemical processes. (Fig. 233; Pp. 315, 316.)

However, after all has been said, our knowledge of the chemical complexities of protoplasm offers only an inadequate conception of their relationship to life. Moreover, it appears that there is relatively little increase in chemical and physical complexity from the lowest to the highest organisms. Rather has evolution taken place in terms of organization.

### 3. *Metabolism*

We have emphasized that living matter is continually changing, and this fundamental fact is reflected in nearly all attempts to define life. Aristotle described life as "the assemblage of operations of nutrition, growth, and destruction"; deBlainville, as a "twofold internal movement of composition and decomposition"; and Spencer, as "the continuous adjustment of internal relations to external relations."

This interaction consists of chemical and physical processes in which combustion, or oxidation, plays the chief rôle. Over a century ago it was shown that animal heat results from a slow burning of the materials of the body, involving the intake of oxygen and the liberation of carbon dioxide; and further, that for a given consumption of oxygen and liberation of carbon dioxide, about the same amount of heat is produced by an animal as by a burning candle. In other words, the oxidation of the complex compounds which enter the body as food is definitely proportional to the amount of energy which the body gives out, just in the same way as the amount of work performed by a steam engine and the amount of heat it liberates bear a strict proportion to the consumption of fuel. "The symbol of the organism is the burning bush of old."

But the foundations for a MECHANISTIC interpretation of life are to date very fragmentary. The synthesis of physico-chemical facts about the parts of organisms cannot reconstruct for us the living being because the analytical method of investigation disregards and destroys organization, and organization is life. When only physical and chemical methods are employed, only physical and chemical facts are forthcoming. "The whole is not to be understood by an analysis of its parts any more than an architectural masterpiece can be comprehended by chemical and physical analysis of the stones of which it is built. The conception of the organism as a physico-chemical machine encounters the insuperable difficulties of explaining a machine which runs itself, repairs itself, alters itself to meet the exigencies of surrounding conditions, and reproduces itself; and what is still worse, attains its final form by developing from a simple beginning through an orderly sequence of forms and evolves through time into a succession of machines of ever-increasing complexity of construction."

One naturally asks whether metabolic processes involve a special form of energy — 'vital force' — which is quite different from chemical and physical energy, and which con-



trols form and development and directs activities. This is the philosophically important question of VITALISM. From the standpoint of biology we may say that no instrument ever devised has detected such energy, and until some unique vital energy can be made evident to one of the human senses, it does not fall within the scope of science — science can neither deny nor affirm its existence. Perhaps for the present it is sufficient to realize that unique phenomena may emerge from new relationships — relationships change the properties of things. The properties of molecules are those which the atoms have when they are in the molecule, and the phenomena of life depend on — emerge from — the physico-chemical constituents of protoplasm when, and only when, they are organized as protoplasm. A living cell exhibits “many unpredictable properties beyond those of the mere sum of its individual constituent molecules and compounds, or the additive resultants to be derived from any arrangement of them.” Biology is indeed committed to a thoroughgoing physico-chemical analysis of organic structure and function, but it is not committed to a reduction of its concepts to physico-chemical levels. (Pp. 21, 691, 692.)

However, it is important to note that many of the grosser phenomena of life are being gradually restated in terms of the physical sciences. So it appears clear that the organism is a system for transforming energy — transforming the potential energy stored in chemical complexes of its own substance into the various vital processes of living — into work performed. And it is in this transfer of energy from one form to another that we find exhibited the activities which are most distinctive of living things. In these processes of metabolism many complex substances rich in potential energy, which have entered as food and have been, in whole or part, added to the protoplasmic system, are reduced to simpler and simpler conditions and finally, with their energy content nearly or entirely exhausted, are eliminated as EXCRETIONS. Obviously, if life is to persist, this continual waste must be counter-balanced by a proportionate intake

of food in order to renew the supply of energy and to provide the materials which, after preliminary changes, are made into an integral part of the living organism.

#### 4. *Maintenance and Growth*

Thus the living animal or plant is partially consuming and rebuilding itself continually — metabolism is a dual process. When constructive metabolism, ANABOLISM, keeps pace with destructive metabolism, KATABOLISM, the individual remains essentially unchanged — it balances its account physiologically — and this MAINTENANCE is the normal condition of adult life. But one of the most obvious results of constructive metabolism is growth, or permanent increase in the size of the individual. As a rule growth is most rapid during the early part of the individual's existence, or youth. Indeed, at birth a child is about a billion times larger than the egg cell from which it has developed. Later in life, when maturity is attained, growth chiefly occurs in making good, in so far as may be, the wear and tear incidental to living, and in providing for reproduction.

Growth, as well as maintenance, means that the organism takes the materials which it receives in the form of food, transforms them and fits them into the protoplasmic organization here and there throughout as needed. This INTERSTITIAL GROWTH by chemical synthesis is in striking contrast to the growth, for example, of crystals that increase in size merely by the addition to the surface of new material of the same kind from the saturated solution, the mother liquid, in which they are suspended. 'Crystal growth is passive; organic growth is active.' Protoplasm, with materials and energy taken from its environment, constructs more protoplasm — endows the non-living with its own unique organization. It makes more life-stuff. And, if the available materials are adequate, the living substance tends to increase indefinitely, or until the specific limits of the cell or organism are attained. This protoplasmic growth, involving

growth of both cytoplasm and nucleus, is highly characteristic of living matter. It is cell growth and precedes reproduction.

### 5. *Reproduction*

So far as is known, living matter arises only by the activities of preëxisting living matter. We have seen that this transformation is continually going on in anabolic processes in the animal or plant, and brings about repair and growth of the individual; but it is in reproduction that what may be termed the overgrowth of the individual results in the production of a new one.

Thus reproduction and growth are phenomena which are intrinsically the same — both are the result of a preponderance of the constructive phase of metabolism. The single cell, whether a whole organism or a single unit of a complex body, increases in volume up to a certain limit and then divides. In the former case two new individuals replace the parent cell; in the latter, the complex body has been increased to the extent of one cell. In both cases cell division has resulted in cell reproduction. Thus cell division, preceded by growth of cytoplasm and nucleus, is always reproduction, though it is customary and convenient to restrict the term reproduction to cell divisions which result in the formation of new individuals — single cells or groups of cells which sooner or later separate from the parent organism. They are the new generation. This is a unique characteristic of living things which provides for the continuation of the race. (Figs. 9, 292, 293.)

### 6. *Irritability and Adaptation*

The discussion of metabolism has emphasized the close interrelationship between the living organism and its surroundings, and the dependence of life upon the interplay and interchange between protoplasm and its environment. As a matter of fact the plant or animal retains its individual-

ity — lives — solely by its powers of developing and maintaining exquisite adjustments, ADAPTATIONS, to its surroundings. This results from the IRRITABILITY of living substance: its inherent capacity of reacting to environmental changes by changes in the equilibrium of its matter and energy. The inciting changes, known as STIMULI, may be chemical, electrical, thermal, photic, or mechanical, but the nature of the response is determined rather by the fundamental character of protoplasm itself than by the nature of the stimulus. Muscle cells respond by contracting, regardless of the nature of the stimulus.

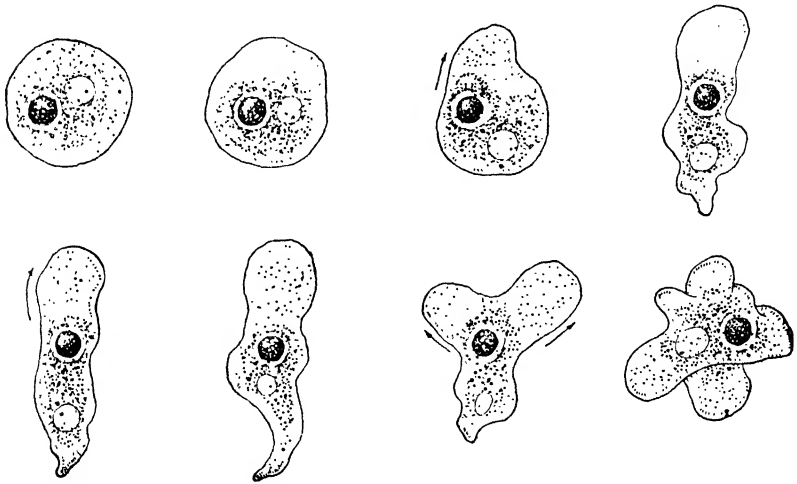

FIG. 12. Amoeboid movement. Successive changes in form assumed by an Amoeba. The clear ectoplasm flows forward, followed by the granular endoplasm with the nucleus (darker) and contractile vacuole (lighter). Highly magnified. See Fig. 6. (Modified, after Verworn.)

The reactions of organisms usually result in MOVEMENT, one of the most obvious manifestations of life. Movement depends in every instance upon tumultuous ultramicroscopic physico-chemical changes of protoplasm itself. Thus it is to these changes that, in the last analysis, we must turn for the energy which brings about the visible movements in animals and plants.

The obvious movement of the higher animals is, of course,

the result of the contraction (shortening and broadening) of the individual muscle cells forming the muscular system, but movements of other cells of the body occur as, for example, the flowing movement of the white blood cells which is similar to that of certain unicellular animals, the Amoebae, and so is known as AMOEBOID movement. The protoplasm of an active Amoeba is one of the most striking and beautiful sights under the microscope; the cell ceaselessly changing its form as one outflowing, or PSEUDOPodium, follows another and the whole cell advances in the direction of the main stream. When particles of food are met, the pseudopodia flow around them, and when they have been digested within the cell, the protoplasm moves onward leaving the waste material behind. In many other unicellular animals, such as Paramecium, an active, internal circulation, or CYCLOSIS, of the protoplasm is visible, and the cells of certain multicellular plants, such as Nitella and Tradescantia, afford remarkable exhibitions of rotation and circulation of protoplasm. (Figs. 12, 15.)

Moreover, locomotion in Paramecium and related Ciliates is effected by myriads of short, vibratile, thread-like prolongations of the cytoplasm, termed CILIA; while other unicellular forms, such as Euglena, move by long whip-like processes, or FLAGELLA. Finally, ciliated cells form membranes, or CILIATED EPITHELIA, that serve various purposes in the bodies of higher animals. Thus the food and respiratory currents of Molluscs, such as the Clam, are induced by ciliary action, and certain internal passages of the human body are provided with cilia for the transport of materials. (Figs. 6-8, 21, 140.)

These and all other reactions of living matter are results of its irritability and involve not only *response* to a stimulus but also *conduction* so that the cell, or group of cells, as a whole is directly or indirectly influenced — a condition which attains its fullest expression in the higher animals with a nervous system. Every organism responds as a coördinated unit — an individual. It adapts itself structurally and func-

tionally to the necessities of its existence. This power of adaptation, as exhibited in active adjustment between internal and external relations, overshadows every manifestation of life and contributes, more than any other factor, to the imposing gap that separates the organism from the inorganic world.

The characteristics which we have described — specific organization, chemical composition, metabolism involving the power of maintenance, growth, and reproduction, and irritability resulting in the power of adaptation — individually and collectively are characteristic of living matter. Any formal objections that may be raised to the diagnostic character of one or another only serve to emphasize the unique conditions which obtain in life.

In our discussion thus far, we have endeavored to describe the characteristics of life in terms of its organizational units — cells, and of its physical basis — protoplasm. But we have not attempted formally to define 'life' or 'protoplasm' because, since they are unique, it is impossible to resort to the trick of comparing them with something else; and because the expressions 'protoplasm' and 'life' are generalizations. The former indicates that all animals and plants have an essentially similar foundation, and the latter that they exhibit certain characteristic actions and reactions. The living organism exhibits a permanence and continuity of individuality correlated with specific behavior, and this it transmits to other matter which it makes a part of itself, and to its offspring at reproduction. "What is more impressive than the duration of frail living matter, showing a stability far greater than the physiographic features of the earth's surface, unless it be the richness of its evolution within the period of its duration." The organism regarded as a whole is, indeed, a unique phenomenon.

## CHAPTER IV

# METABOLISM OF ORGANISMS

Nature, which governs the whole, will soon change all things which thou seest, and out of their substance will make other things and again other things from the substance of them, in order that the world may be ever new. — *Marcus Aurelius*.

Life is known to us only in the form of individual organisms, so we turn now to concrete examples of unicellular plants and animals which present, in relatively simple form within the confines of a cell, the essentials of all the fundamental life processes, many of which we shall later have occasion to study in their complex expressions in the higher organisms. Our present interest in these simple forms is chiefly to illustrate the complex nutritional interdependence of three great groups of organisms — green plants, animals, and ‘colorless’ plants. At first glance it may appear that multicellular organisms, such as a tree or frog, would afford more suitable examples, but since the fundamental distinction between plants and animals is chiefly a question of metabolism, there are advantages in studying it in single cells, where one’s attention is not distracted by undue complexity of structure.

### A. GREEN PLANTS

Unicellular green plants are distributed all over the world and adapted to a great variety of conditions. We find them, for example, forming green coatings on the bark of trees, scums on puddles and ponds, or being blown about in dust by wind. Of the many hundreds of species we select *Protococcus vulgaris* because of the simplicity of its structure and life history, and because it is readily obtained for study. (Figs. 13, 84.)

## 1. *Protococcus*

A single *Protococcus* is invisible to the naked eye, but like many another microscopic form, it makes up in numbers for the small size of the individual, and frequently gives a greenish color to moist surfaces of rocks, tree trunks, fence posts, and flower pots.

Examined under the microscope, the organism is seen to consist of a spherical mass of protoplasm with a nucleus centrally located. Most of the cytoplasm surrounding the nucleus is specialized to form a PLASTID which contains green

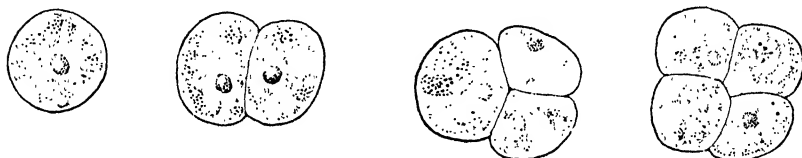

FIG. 13. *Protococcus vulgaris*, a unicellular green plant. Separate individual and temporary cell groups formed by cell division. Highly magnified.

pigments. The whole organism is enclosed within a distinct, rigid cell wall which has been secreted by the protoplasm and is composed of CELLULOSE, a carbohydrate especially characteristic of plants. It is evident that the organism is a single cell. (Fig. 13.)

Since *Protococcus* is a single cell, we find reproduction presented in its simplest terms: under favorable conditions the cell divides and the two resultant cells sooner or later separate. Sometimes, however, several divisions occur before the cells are separated and thus there is formed, as it were, a temporary multicellular body, but one without any physiological division of labor between the cells because all are independent in their vital activities. Moreover, this tendency to form temporary cell groups suggests the type of step which was taken during plant evolution when the multicellular body was established.

We may now turn our attention to the point *Protococcus* was chosen especially to illustrate — the characteristic life processes of green plants.



## 2. Food Making

Since *Protococcus* lives, grows, and multiplies in moisture exposed to sunlight, it is to this environment that we must look for the materials with which it constructs protoplasm, and the energy which it employs in the process. And, furthermore, since the organism is enclosed within a cell wall, its income and outgo must be materials in solution in order to pass through to the living protoplasm.

In short, *Protococcus* takes materials from its surroundings in the form of simple compounds, as carbon dioxide, water, and mineral salts, which are relatively stable and therefore practically devoid of available energy, and, through the radiant energy of sunlight, shifts and recombines their elements in such a way that products rich in potential energy result. *Protococcus* thus exhibits the prime distinguishing characteristic of green plants — the power to construct its own foodstuffs.

The key to this power of chemical synthesis by light — PHOTOSYNTHESIS — resides in a highly complex chemical substance called CHLOROPHYLL which consists of two very similar but distinct pigments. Chlorophyll is segregated in special cytoplasmic bodies, the plastids, and gives to *Protococcus* during its active phases and to the foliage of plants in general their characteristic green color. Plastids bearing chlorophyll grow and divide and are known as CHLOROPLASTS. The chlorophyll arrests and transforms a small part of the energy of the sunlight which reaches it, in such a way that the protoplasm can employ this energy for food synthesis.

The first great step in the constructive process is a combination of carbon with hydrogen and oxygen to form a carbohydrate. *Protococcus* gets these elements from carbon dioxide and water by a process of molecular disruption. We know that when charcoal, for instance, is burned, carbon and oxygen *unite* to form carbon dioxide, and energy in the form of light and heat is liberated. Obviously *Protococcus* must employ an equal amount of energy in separating the

carbon and oxygen of carbon dioxide; that is, in overcoming their chemical affinity. And this kinetic energy which the plant employs is then represented in the chemical potential which exists between the oxidizable carbon and free oxygen — it has become potential energy. Thus the plant in sunlight is continually separating the carbon from the oxygen of carbon dioxide. The oxygen is liberated as free oxygen, while the carbon which has been separated from the oxygen is combined with molecules of water to form a carbohydrate — grape sugar (glucose).

The conventional equation for this reaction is:

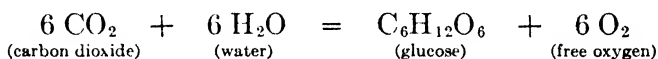

However, the processes involved are by no means as simple as is implied above. It is probable that a relatively simple compound, such as formaldehyde ( $\text{CH}_2\text{O}$ ), is first produced from carbon dioxide and water, and that molecules of this substance are then united to form glucose. Although there is little conclusive data in regard to the details of the intermediate stages, the equation stated affords a satisfactory expression of the end result of photosynthesis which is adequate for the present discussion.

The first great step in food synthesis, the formation of a *sugar*, having been accomplished, the green plant usually transforms the sugar and stores it as *starch* for future use as fuel or as the basis of further synthesis. Starch is the first visible product of photosynthesis.

We have seen that the chief characteristic of proteins as compared with carbohydrates (sugars, starches) is the presence of nitrogen, and this element must be added to the CHO basis already constructed as the next step toward protein synthesis. The green plant not only can, but must employ nitrogen in simple combinations, chiefly *nitrates*, and this is a fact of prime importance, for typically, as will appear later, animals and most colorless plants require nitrogen in more complex combinations. Thus by the addition of nitro-

gen to the carbohydrate basis relatively simple nitrogenous compounds, *amino acids*, are built, which in turn form the foundation for the synthesis of the immense variety of proteins. Little is known of the complex chemical processes involved in protein construction, and nothing about the actual incorporation of the proteins as an intrinsic part of the architecture of the living matter itself. But it is evident that synthesizing *enzymes* play a crucial rôle. These are special proteins which are known only as products of living protoplasm and are the activating agents (catalytic agents) for chemical transformations in which, however, they themselves take no integral part. How do these enzymes arise? Nobody knows.

Protococcus thus takes the raw elements, so to speak, of living matter and by the radiant energy of sunlight, which its chlorophyll traps, constructs carbohydrate, protein, protoplasm. In other words, the green plant is a synthesizing agent, building up highly complex and unstable molecular aggregates brimming over with the energy received from the sun. So the green plant, whether Protococcus or Elm, by this **AUTOTROPHIC** method manufactures its own food for itself as well as for the living world in general. And incidentally, as it were, replenishes the available supply of free oxygen without which plants and animals could not exist.

### 3. Respiration

As we have already stated, protoplasm is always at work — to live is to work — and this means expenditure of energy: the same energy that chlorophyll has secured for the plant and stored away in its food. Therefore the food must be oxidized — burned — in order to release the energy, and for this the plant must have available a supply of free oxygen. Protococcus obtains this oxygen dissolved in water and also, in sunlight, from that liberated through photosynthesis. The process involved in releasing this energy may be represented by the equation:

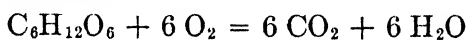

which, it will be noted, is the reverse of the equation for photosynthesis. This intake of free oxygen by the cell and outgo of carbon dioxide and water, the chief products of combustion, is known as RESPIRATION. It is essentially the securing of energy from food, involving the exchange of carbon dioxide for oxygen by protoplasm. And this interchange of gases between the living matter and its surroundings is not only characteristic of *Protococcus* and all green plants, but of all living things. Plants respire just as truly as animals, though the more active life and complex bodies of most of the latter require an elaborate respiratory apparatus in order that an adequate gaseous interchange may be effected with the necessary rapidity. (Fig. 247.)

Thus the green plant may be regarded as a chemical machine for the transformation of energy — the radiant energy from the sun — into lifework; the matter and energy which enter, form, and leave the organism obeying, to the best of our knowledge, the fundamental laws of matter and energy of the non-living world.

We have now obtained some idea of one living organism, *Protococcus*, a green plant reduced to the simplest terms — a single cell provided with chlorophyll. And we have seen that this chlorophyll is the key to the photosynthetic activity of the green plant. In other words, the expression 'green plant' does not refer specifically to the color of a plant (in some cases it may appear, for example, red or brown), but to the presence of chlorophyll by virtue of which the plant is a constructive agent in nature. It has the power to manufacture its own foodstuffs from relatively simple compounds largely devoid of energy and, in particular, is able to utilize nitrogen in the form of nitrates.

We pass now from the essentially constructive agents in nature to the destructive agents; from the collectors of energy to the energy dissipators; from the green plants to animals and then to so-called colorless plants.

## B. ANIMALS

There is probably no better introduction to the study of the biology of an animal than that afforded by an Amoeba such as *Amoeba proteus*, a common organism of ponds, ditches, and decaying vegetable infusions. Amoebae, frequently referred to as the simplest animals, are representatives of the great group of single-celled animals, or PROTOZOA. Paramecium is another common but much more complex protozoön. Members of this group are found in almost every niche in nature and, like the PROTOPHYTA, as the unicellular plants are sometimes called, are important because, although small in size, the number of individuals is inconceivably large. Collectively they produce profound changes in their environment. (Figs. 6, 12, 21, 149; Pp. 202-214.)

## 1. Amoeba

In order to study Amoeba it is necessary to magnify it several hundred times. This done, it appears as a more or less irregular mass of viscid granular material, rather slowly changing its shape and thereby moving along. As a matter of fact it is essentially a naked bit of protoplasm, without obviously specialized parts. However, careful study reveals that the organism really consists of a single protoplasmic unit differentiated into cytoplasm and nucleus — it is a cell: an animal. (Fig. 14.)

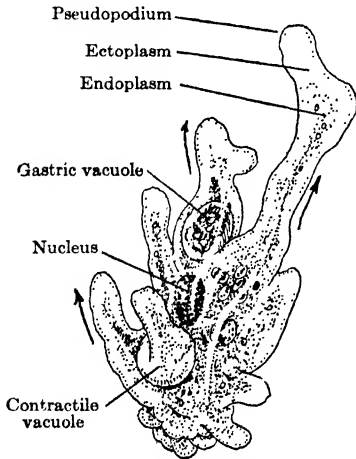

FIG. 14. *Amoeba proteus*.

But there are no specialized locomotor organs—merely now and again the clear outer

layer of protoplasm, or ECTOPLASM, flows out at one point, followed by the internal granular ENDOPLASM, so that a pro-

jection, or PSEUDOPODIUM, is formed. There is no permanent mouth, food being engulfed by the protoplasm flowing about it as opportunity offers. There is no permanent digestive or excretory apparatus. (P. 34.)

Amoeba, under favorable conditions, grows rapidly and, when it has attained the size limit characteristic of the species, cell division, here called BINARY FISSION, takes place, with the result that from the single large cell there are formed two smaller individuals which soon become complete in all respects. These, in turn, grow and repeat the process so that, as in the case of Protococcus, within a few days the original Amoeba has divided its individuality, so to speak, among a multitude of descendants. (Fig. 9.)

Clearly Amoeba performs all the essential vital functions that become an animal. Such being so, it is important to compare the metabolism of Amoeba, the animal, with that of Protococcus, the green plant.

## 2. Food Taking

The food of Amoeba is chiefly other microscopic animals and plants that it meets in its environment of pond water or vegetable infusion. Coming in contact with its prey, pseudopodia are extended about it and soon the prospective food material is enclosed within the endoplasm of its captor. Here the food is surrounded by a droplet of fluid, a GASTRIC VACUOLE, into which the endoplasm secretes chemical substances (enzymes, etc.) which gradually simplify — digest — the complex proteins, carbohydrates, etc., of the food. Finally, this material, which shortly before was the protoplasm of another organism, is incorporated into Amoeba protoplasm — matter and energy is supplied and the animal lives and grows. (Fig. 15.)

This HOLOZOIC method of nutrition is strikingly different from the autotrophic type which we have seen in Protococcus. In Amoeba solid particles of food — tiny animals and plants — are taken into the cell, and since the chief

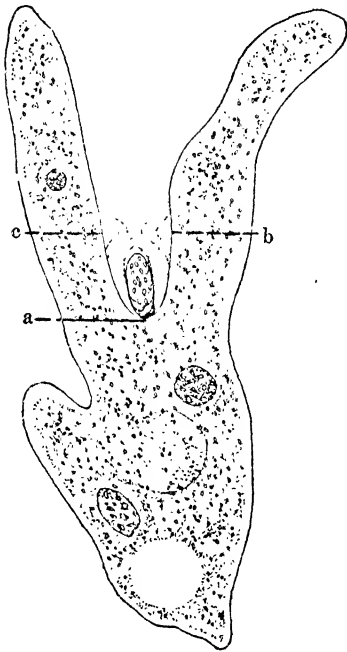

FIG. 15. *Amoeba proteus* ingesting a flagellate, *Chilomonas*. The flagellate touched at points a, b, and c. Pseudopodia were formed at b and c as indicated by the dotted lines; these fused enclosing it in a gastric vacuole. (From Kepner and Taliaferro.)

organic constituents of protoplasm are proteins, associated with carbohydrates and fats, it is clear that the income of the animal organism is, unlike that of the green plant, chiefly ready-made complex foodstuffs. In other words, *Amoeba*, like all animals, requires relatively complex chemical compounds rich in potential energy: proteins rich in potential energy: proteins, carbohydrates, and fats. Of these, proteins or their constituent amino acids are absolutely indispensable because it is only from this source that nitrogen is available for the animal. But the green plant, through its chlorophyll apparatus, is able to take materials largely devoid of energy and to rearrange them and endow them with potential energy which it has received in the kinetic form from sunlight.

### 3. Respiration and Excretion

Of course, *Amoeba*, like *Protococcus*, is continually breaking down its food and its own protoplasm by a process of combustion which involves an intake of free oxygen and the liberation of carbon dioxide and water. Nitrogenous wastes, chiefly URIC ACID or UREA, as well as inorganic salts are also excreted. This interchange takes place over the entire surface of the animal, aided by a CONTRACTILE VACUOLE that expels fluid from the cell. So the animal, like the plant, returns to its environment the elements in simple combina-

tions which are devoid or nearly devoid of energy. We have stated that green plants are essentially constructive and animals destructive agents in nature. It is apparent, of course, that green plants are both constructive and destructive, but the constructive processes of green plants are necessary and sufficient not only for themselves but for all living things. "Plants are manufacturers of munitions which they themselves and animals explode in the never-ending battle of life." Animals cannot exist without plants.

A little consideration of the income and outgo of green plants and animals will show that, although the animals are dependent on the plants for their complex foodstuffs, they do not return, for example, the nitrogen to the outer world in a form simple enough to be available for green plants. For example urea,  $(\text{NH}_2)_2\text{CO}$ , which still has a little energy left that the animal is unable to extract, must be transformed into nitrates.

Furthermore, since plants die, which are not consumed by animals, and animals die, which are not devoured by other animals, large stores of matter and energy are locked up in the complex compounds of their dead tissues. Clearly, there must be some way of completing the cycle of the elements, for if there were not, life, as we know it, could not have continued long on the earth. This gap is filled by the so-called COLORLESS PLANTS; that is, plants which, because chlorophyll is not present, lack the power of photosynthesis and so in most cases are dependent for food on more complex substances than green plants demand, though not so complex as animals require.

### C. COLORLESS PLANTS

As representative of the diverse types of colorless plants which, lacking chlorophyll, are without the power of photosynthesis, we select the vast group known as the BACTERIA. For reasons that will soon appear, it is not practical to focus attention on one particular species of Bacteria, as we have



just done in considering green plants and animals. Instead we shall discuss in very general terms the group as a whole, referring now and then to special kinds of Bacteria to illustrate particular points.

### 1. *The Bacteria*

The wide distribution of the Protozoa is exceeded by the Bacteria. Representatives are literally found everywhere: floating with dust particles in the air, in salt and fresh water, in the water of hot springs, frozen in ice, in the upper layers of the soil, and in the bodies of plants and animals. Bacteria have received a considerable notoriety under the names of 'microbes' and 'germs,' owing to the fact that certain types subsist within the human body as parasites and bring about disturbances, chiefly chemical, which we interpret as disease. But aside from these forms which, though all too many, are relatively few in number, human life and life in general on the earth could not long continue without their services. Indeed, the Bacteria have practically ruled the world since they first secured a foothold when the earth was young. It is this aspect of the Bacteria which concerns us at present.

Among the Bacteria are the smallest organisms known. Probably one one-thousandth of an inch is about the average length of rod-like forms, but some species are less than one fifty-thousandth of an inch in length and much less in breadth. None of the typical forms comes within the range of unaided vision, while some are revealed only by the highest powers of the microscope — indeed there is room and to spare for billions of Bacteria to live in a thimbleful of milk. The small size and similarity of structure of many of the Bacteria render their study particularly difficult, and accordingly they are grouped and classified largely on the basis of chemical changes which they produce in their surroundings, rather than on structural characteristics. However, there are three chief morphological types: the rod-like form or *BACILLUS*; the spherical form or *COCCUS*; and the spiral form or *SPIRILLUM*. Either bacilli or cocci may be associated in

linear, branching, or plate-like series, or grouped together in colonies. (Fig. 16.)

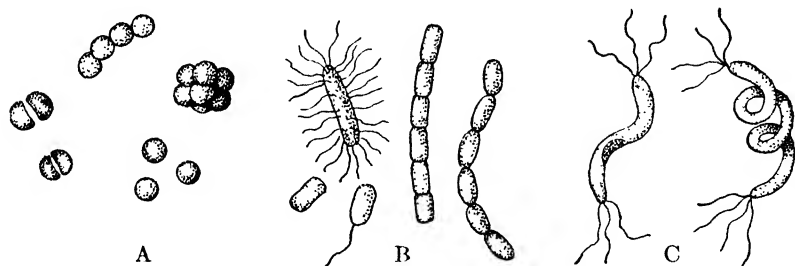

Fig. 16. Chief types of Bacteria. A, cocci; B, bacilli; C, spirilla. Very highly magnified.

The individual bacterium is regarded as a single cell, though in most species there is no definite nuclear body, the chromatin material being distributed in the form of granules throughout the cytoplasm which is enclosed within a cell wall. Some forms show active movements by means of thread-like prolongations of the cytoplasm, or flagella, as in the case of the common *Spirillum* of decaying vegetable infusions.

Reproduction is by a process of cell division which, under favorable conditions, may occur as often as every fifteen minutes. The vast multitude of cells thus produced before long exhaust the food supply and contaminate with excretion products the medium in which they are living, so that further growth is inhibited. In many species, under these circumstances the protoplasm within the cell wall assumes a spherical form and secretes a protecting coat about itself, and thus enters upon a resting state. In this spore form the Bacteria can withstand drying, variations in temperature, and other conditions — in certain cases even strong carbolic acid — to which in the active state they would readily succumb, and thereby the organisms tide over periods of unfavorable conditions and are ready to start active life again when the opportunity occurs. It is certainly fortunate for man that most disease-producing species are unable to form spores. (Fig. 344.)

## 2. Cycle of the Elements in Nature

We have seen that carbon dioxide is the source from which green plants derive the carbon which they synthesize into carbohydrates, fats, and proteins. Animals directly or indirectly feed on plants, so that the ultimate source of the carbon of animals is likewise the carbon dioxide of the atmosphere. Although both plants and animals by their respira-

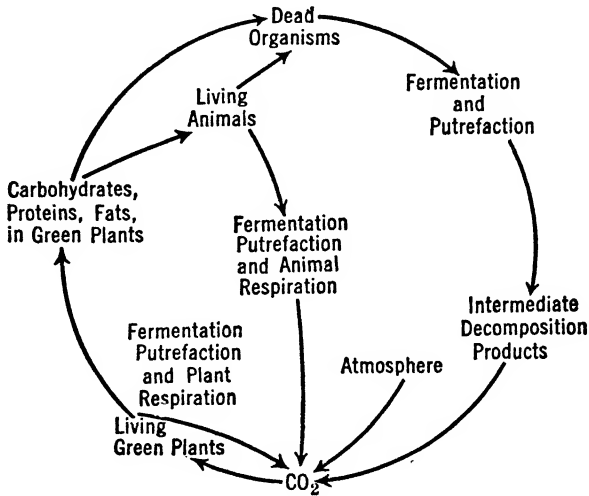

Fig. 17. The Carbon Cycle. A schematic representation of the circulation of carbon in nature.

tory process are continually returning to the outer world some of this carbon as carbon dioxide, it is evident that relatively enormous amounts of carbon are nevertheless being taken out of circulation and locked up in the bodies of the plants and animals. For example, it has been estimated that about one-half the weight of a dried tree trunk is contributed by carbon.

The same general segregation is going on in regard to nitrogen. The green plants take it in the form of nitrates, for instance, and store it away in the proteins; and again animals get their nitrogen from plant proteins, so that the ultimate source of the animal nitrogen is the same. In a

somewhat similar manner we might trace the fate of other chemical elements necessary for protoplasm, but that of carbon and nitrogen is crucial and illustrates the fact that although both green plants and animals are continually taking certain elements from and returning them to their environment, nevertheless the amount taken away is greater than is returned. (Figs. 17, 18.)

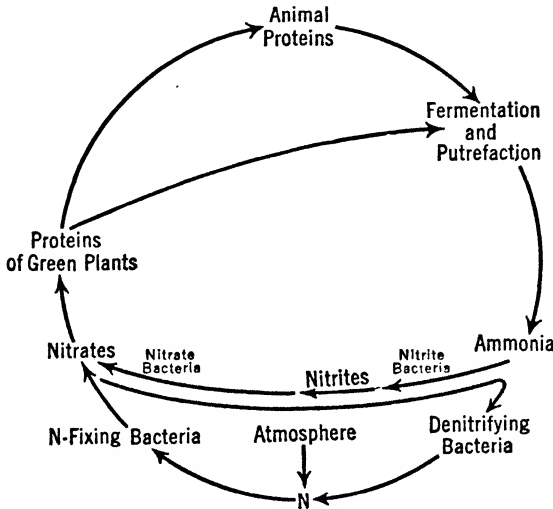

FIG. 18. The Nitrogen Cycle. A schematic representation of the circulation of nitrogen in nature.

The agents which restore to the inorganic world the elements removed by green plants and animals are the colorless plants, such as the Bacteria, Molds, Yeasts, etc. As we know, when an animal or plant dies, DECAY sets in almost immediately; that is, the complex chemical compounds are slowly but surely reduced to simpler and simpler forms until 'dust' remains. Although undoubtedly many of these compounds would automatically, so to speak, tend to simplify, nevertheless this is not only hastened, but chiefly carried out by organisms of decay such as the Bacteria. *Fermentation* and *putrefaction* occur through enzymes which they form. The carbohydrates and fats are resolved into carbon

dioxide and water, and the proteins are reduced to carbon dioxide, water, and ammonia ( $\text{NH}_3$ ) or free nitrogen, while the nitrogenous waste (urea, etc.) of animals is similarly broken down. (Figs. 89, 343.)

Practically all of these long series of chemical reactions are carried on by different kinds of Bacteria. Most green plants, however, take their nitrogen chiefly in the form of nitrates, and accordingly we find that another type of Bacteria (NITRITE BACTERIA) acts upon the ammonia and transforms it into nitrous acid ( $\text{HNO}_2$ ). After certain chemical reactions in the soil, forming, *e.g.*, potassium nitrite or ammonium nitrite, still another type (NITRATE BACTERIA) oxidizes the nitrites into nitrates, *e.g.*,  $\text{KNO}_3$  or  $\text{NH}_4\text{NO}_3$ , so that again this nitrogen is in a form which is available for green plants.

But, still confining our attention to the nitrogen, it is obvious that there is a leak from this cycle, since some of the nitrogen in the form of ammonia or free nitrogen escapes to the atmosphere. The greatest loss, however, is brought about by a group of DENITRIFYING BACTERIA whose activities are largely spent in changing nitrates into gaseous nitrogen which escapes into the air, and so is placed beyond the reach of green plants and animals. But fortunately there are many kinds of NITROGEN-FIXING BACTERIA which rescue the nitrogen from the atmosphere and return it to the cycle of elements in living nature. These organisms are widely distributed, some living freely in the soil and others symbiotically in tiny nodules which they produce on the rootlets of higher plants, such as Beans, Clover, and Alfalfa; and this accounts for the fact, long known but not understood, that these plants when plowed under are particularly efficient in enriching the soil. Incidentally, it is not clear whether the Bacteria fix the nitrogen under the conditions existing in the nodule, or whether the higher plant fixes the nitrogen in the presence of the Bacteria, or whether both share equally in the reaction. In any case, the end result is the same. (Fig. 19.)

In brief, there is a cycle of the elements in nature through green plants and animals and back again to the inorganic world through the Bacteria and other colorless plants. Such is the reciprocal nature of the nutritive processes of living organisms.

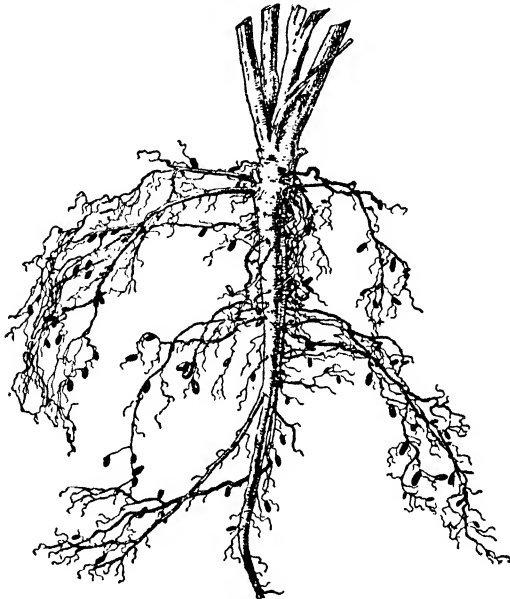

Fig. 19. Root nodules caused by symbiotic Nitrogen-fixing Bacteria. (From Bergen and Caldwell.)

Since the chemical changes produced by the Bacteria are either the direct results of, or are incidental to the process of nutrition in these organisms, it is evident that the material taken as food by certain groups is relatively complex: for example, by those which bring about the early putrefactive changes in proteins; while that employed by others is very simple since they find adequate chemical combinations less complex than those needed by green plants. Indeed, there are certain Bacteria that are able to utilize carbon dioxide and water as do green plants, but instead of obtaining energy for the synthesis from sunlight, these autotrophic forms derive it from chemical energy liberated by the oxidation of

inorganic substances in their environment. Such a process possibly represents the most primitive method of nutrition from which all the others have been derived in the evolution of life. (Pp. 166, 514.)

#### D. THE HAY INFUSION MICROCOSM

The importance of the complex nutritional interdependence of organisms in general as well as the cosmical function of green plants — the link they supply in the circulation of the elements in nature — may be emphasized and summarized by a brief description of a hay infusion. (Pp. 537–539.)

Probably nowhere is the ‘web of life’ more conveniently or convincingly exhibited than in the kaleidoscopic sequence of events — physical, chemical, and biological — that are initiated when a few wisps of hay are added to a beaker of water. Apparently the chief components of a hay infusion are hay and water, but these merely supply the matter and energy for the interplay of various forms of life. Most of these are beyond the scope of unaided vision though chiefly responsible for the obvious changes which occur from day to day in their environment.

Ordinarily tapwater, for instance, contains free oxygen and various inorganic salts in solution, and not infrequently different species of Bacteria, unicellular green plants, and Protozoa. The hay soaking in the water contributes soluble salts, carbohydrates, proteins, etc. It also supplies many microscopic animals and plants which have adhered to it in dormant form and are only awaiting suitable surroundings to assume active life again. (Fig. 20.)

A microscopical examination of an infusion when it is first made shows very few active organisms, but within a day or so, depending largely on the temperature, it reveals countless numbers of Bacteria which have arisen by division from the relatively small number of dormant and active specimens originally present. At first the Bacteria are fairly evenly

distributed in the infusion, but as conditions change, largely through the chemical and physical transformations which they themselves bring about, those species which can employ oxygen in combined form (that is, in chemical compounds)

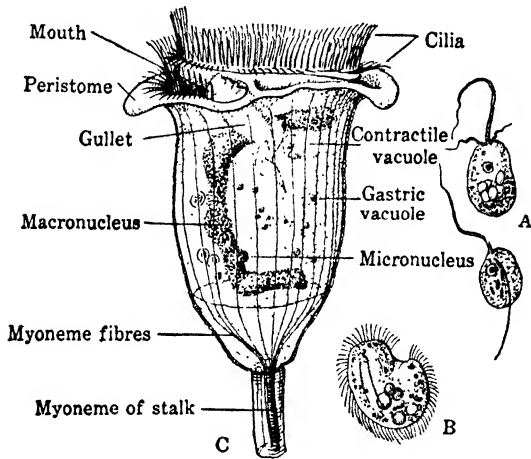

FIG. 20. Some types of Protozoa found in infusions. A, two species of flagellated Monads; B, Colpoda, a small Ciliate; C, Vorticella, one of the most complex Ciliates. All highly magnified.

find existence possible and competition less keen at the bottom of the beaker, while those species which are dependent upon free oxygen gather nearer the surface where the supply is being replenished constantly from the atmosphere.

Up to this point the life of the microcosm is largely bacterial — unicellular SAPROPHYTIC plants which employ as food the complex decomposition products of the proteins, etc., of the hay. The process is essentially destructive and the simplified products are represented in the relatively simple excretions of the Bacteria.

But during bacterial ascendancy another factor has been gradually intruding itself almost imperceptibly into the drama. This is the microscopic animal life which has been multiplying with increasing rapidity as conditions became more favorable, and forthwith assumes the dominant life phase in the infusion. Among the animal forms, the first



to appear are exceedingly minute flagellated Protozoa, known as Monads, many species of which absorb products of organic disintegration brought about by the Bacteria, while

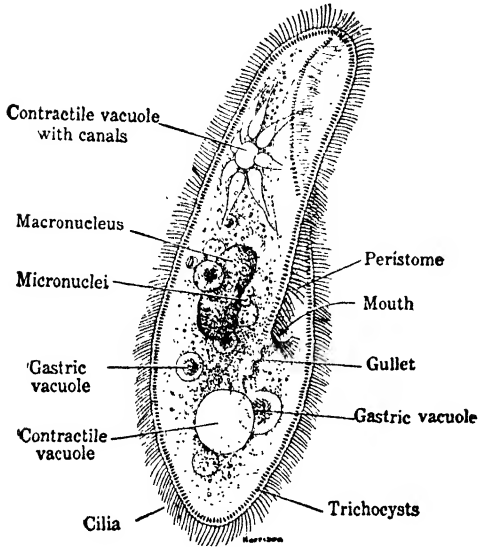

FIG. 21. *Paramecium aurelia*. One of the most common Protozoa in infusions made with pond water. Highly magnified. See Figs. 148-150.

others exhibit HOLOZOIC nutrition, ingest solid food — the Bacteria themselves. Then tiny ciliated Protozoa, probably Colpidium and Colpoda, close relatives of Paramecium, appear in untold numbers and feed upon the Bacteria. The dominance of these smaller ciliates is brought to an end after a few days by the ascendancy of larger ciliates which, though feeding to a certain extent upon the already greatly depleted bacterial population, obtain most of their food by eating the smaller ciliates. And so the cycle of life continues — saprophytic forms gradually being replaced in dominance by herbivorous and these in turn by carnivorous organisms. In truth, nothing lives or dies to itself. (Figs. 21, 141, 147.)

But obviously this chain of events must sooner or later come to an end through the dissipation of energy brought about by the metabolic processes of the colorless plants and animals. Sooner or later the supply of potential energy stored up in the chemical compounds of the hay will have become nearly or completely exhausted — transformed into the kinetic form and expressed in the life activities of the plant and animal population.

others exhibit HOLOZOIC nutrition, ingest solid food — the Bacteria themselves. Then tiny ciliated Protozoa, probably Colpidium and Colpoda, close relatives of Paramecium, appear in untold numbers and feed upon the Bacteria. The dominance of these smaller ciliates is brought to an end after a few days by the ascendancy of larger ciliates which, though feeding to a certain extent upon the

Thus, after a few weeks, the hay infusion world has reached a standstill — extermination faces the population and inevitably occurs unless microscopic green plants, close relatives of *Protococcus*, find opportunity to develop in the energy-exhausted environment and proceed to entrap the kinetic energy of sunlight, store it up in carbohydrates and proteins, and thus restore energy in the potential form to the hay infusion.

If such occurs, the hay infusion world is a microcosm indeed — green plants, colorless plants, and animals gradually become reciprocally adjusted so that a self-perpetuating condition of practically stable equilibrium is established; in other words, what is termed a 'balanced aquarium.' The rise and fall of teeming populations, made possible by the rapidly changing environmental conditions which the bringing together of hay and water initiated, is replaced by an apparently harmonious interdependence of organisms demanding different food conditions, such as we are familiar with in the world at large.

## CHAPTER V

# THE MULTICELLULAR ORGANISM

Over the structure of the cell rises the structure of higher plants and animals, which exhibit the yet more complicated, elaborate combinations of millions and billions of cells coördinated and differentiated in the most extremely different ways. — *Hertwig*.

It has been pointed out that all organisms consist either of one free-living cell or of many cells, and some idea has been gained of unicellular forms from *Protococcus*, *Amoeba*, and the *Bacteria* which were selected to illustrate various types of nutrition. We are now in a position to consider the origin and organization of the individual in the *METAZOA* and *METAPHYTA*, as the multicellular animals and plants are sometimes called.

Every individual, with exceptions to be noted later, begins its existence as a single cell which has been set free as a *SPORE* from the parent, or which has been formed by the fusion of two cells, or *GAMETES*, each typically derived from a separate parent individual: one *MALE*, the other *FEMALE*. The former method is known as *UNIPARENTAL*, or *ASEXUAL*, reproduction and the latter as *BIPARENTAL*, or *SEXUAL*, reproduction. The union of male and female gametes (*SPERM* and *EGG*) in sexual reproduction to form the *ZYGOTE* is termed *FERTILIZATION*. Both asexual and sexual methods are widespread among plants and animals, frequently alternating in regular sequence in the same species to give a life cycle with an *ALTERNATION OF GENERATIONS*. (Figs. 7, A–C; 8, A; 255.)

The most remarkable fact about a reproductive cell is its power to develop into an organism similar to the parent from which it has separated. Both the spore and the zygote

(fertilized egg) are set, one may say, to go through a series of changes which transforms an apparently simple cell into an obviously complex multicellular plant or animal with all the tissues and organs characteristic of the species. It is important, at this point, to review the typical method by which the development of the adult is accomplished.

Briefly, the general method of development is cell division accompanied by differentiation. The spore (asexual) or the zygote (sexual) by a succession of cell divisions, termed CLEAVAGE, passes from the single-cell stage to a two-cell stage and then, with more or less regularity, to four-cell, eight-cell, sixteen-cell stages, etc. If these cells separated after each division, the same general condition would occur here which has been seen in the Protophyta and Protozoa, where each organism is a complete free-living cell. Or again, if cleavage merely resulted in a group of so many exactly similar cells, there would arise a COLONY of unicellular individuals rather than a multicellular organism.

Such colonial forms are, in fact, numerous among the lower plants and animals, and show nearly all grades of complexity from simple associations of a few identical cells, as for example in Spondylomorum, to groups of many thousands of cells in which some of the individuals are specialized for certain functions. Volvox affords an instructive example of the latter condition. The majority of the cells, ten thousand or more, that form the relatively large spherical colony are flagellated individuals, each of which lives a practically independent existence in organic union with its fellows. The chief contribution of each of these cells to the economy of the whole results from the lashing of its flagella, which helps to propel the colony through the water. But, under certain conditions, some of the cells become specialized for reproduction, both asexual

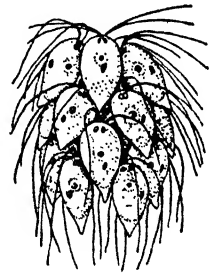

FIG. 22. A simple colony of unicellular organisms (*Spondylomorum*) each of which carries on all the functions of life, including reproduction.

and sexual, and form new colonies which sooner or later are set free. Thus we have a differentiation of reproductive (GERM) cells from body (SOMATIC) cells, and a foreshadowing of that further specialization and physiological division of labor between cells which is the most characteristic feature of the Metaphyta and Metazoa. (Figs. 13, 22, 23, 282.)

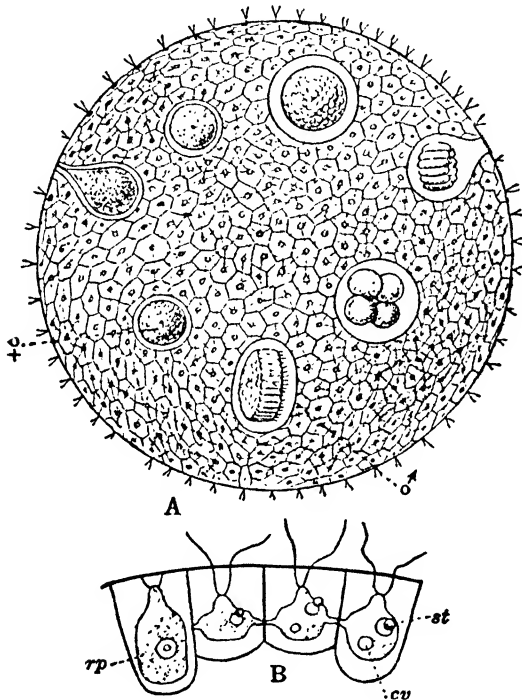

FIG. 23. *Volvox globator*, a large colony of flagellated unicellular organisms in which the various cells have become organically connected, and certain cells specialized for reproduction. A, mature colony (highly magnified) showing sperm, ♂, and eggs, ♀, in various stages of development; B, four cells (more highly magnified) showing the connections between three 'somatic' cells, and the early differentiation of a reproductive cell, *rp*. *cv*, contractile vacuole; *st*, 'eyespot' or stigma. (From Kölliker.)

Indeed, the complex bodies of multicellular organisms are made possible by cell differentiation and cell coöperation. All protoplasm possesses, for instance, the primary attribute of contractility, but in the muscle cells of animals we find the capacity for contraction very greatly developed, and to

a certain extent at the expense of other powers. But this differentiation would be ineffective were not innumerable similarly specialized cells grouped together — marshaled to perform a certain function. The power of a muscle results from the combined action of its component muscle cells. Differentiation without coöperation between cells we have seen in unicellular organisms. Paramecium has highly specialized parts; other Protozoa have still more — perhaps the limit of possibilities of the single cell. But the multicellular body solves the difficulty by removing the limit — by assigning special functions to groups of cells rather than to parts of one cell. (Figs. 21, 150.)

Thus cell division (cleavage) involving differentiation and its attendant physiological division of labor is the keynote of development in both the higher animals and plants. Taking animal development as an example, we find that the cells which arise from the cleaving egg (zygote) usually become arranged so that they form the surface of a hollow sphere of cells known as a **BLASTULA**. All the cells at first appear essentially similar, but soon those at one pole of the blastula become invaginated until the central cavity, termed the **BLASTOCOEL**, is largely obliterated. Accordingly there results the **GASTRULA** stage which may be roughly compared to a sac, with an opening to the exterior termed the **BLASTOPORE**, composed of two layers of cells. The outer layer is known as the **ECTODERM**, and the inner, which lines the gastrula cavity (**ENTERIC CAVITY**), as the **ENDODERM**. The ectoderm comprises cells which are already somewhat differentiated among themselves for special purposes, but which, as a whole, form a primary tissue with general functions of its own, chiefly sensory and locomotor. Similarly the endoderm consists of cells which, as a group, form the nutritive cells of the embryonic animal. (Fig. 24.)

In the gastrula stage of most animals, a third layer of cells arises typically from the endoderm and becomes disposed between the ectoderm and endoderm. This middle layer is the **MESODERM**. In this way the so-called three **PRIMARY**

GERM LAYERS are established which are characteristic of the developing animal, and from these are derived the specialized tissues which compose the various organs of the adult. For example, the ectoderm by cell division and differentiation

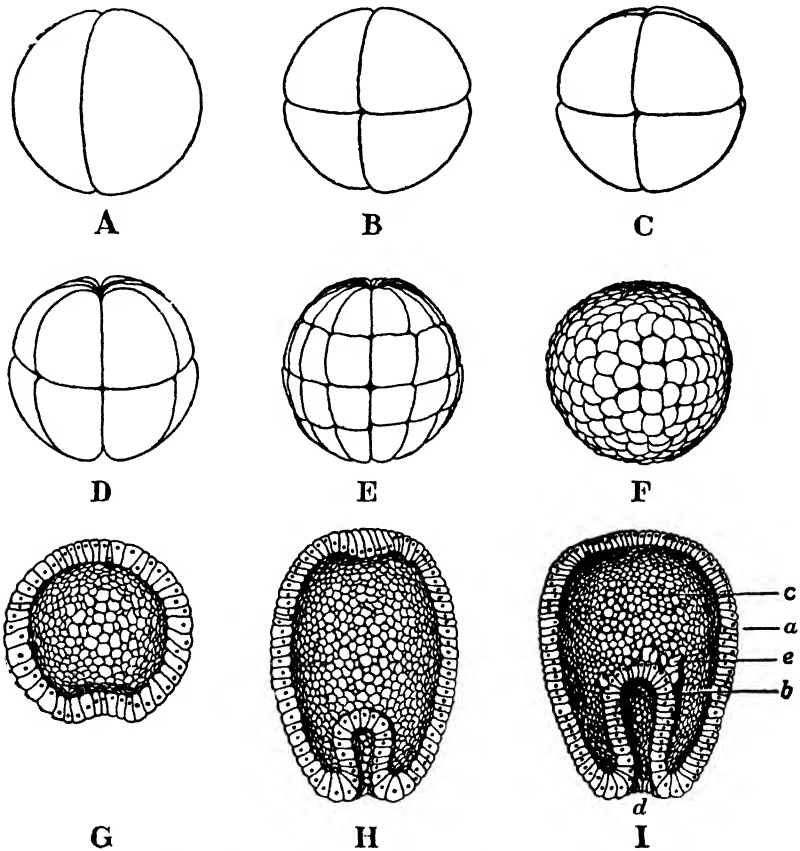

FIG. 24. Diagram of the general method of early development of an animal. A-F, cleavage and formation of the blastula; G, section of blastula showing the beginning of gastrulation; H-I, early and later gastrula stages. *a*, ectoderm; *b*, endoderm; *c*, blastocoel; *d*, blastopore, leading into the enteric cavity; *e*, cells arising from the endoderm, destined to form the mesoderm.

gives rise to the outer skin and central nervous system, the mesoderm to muscular and supporting tissues and the blood vascular system, while the endoderm forms the layer of cells which lines the alimentary canal of the adult organism.

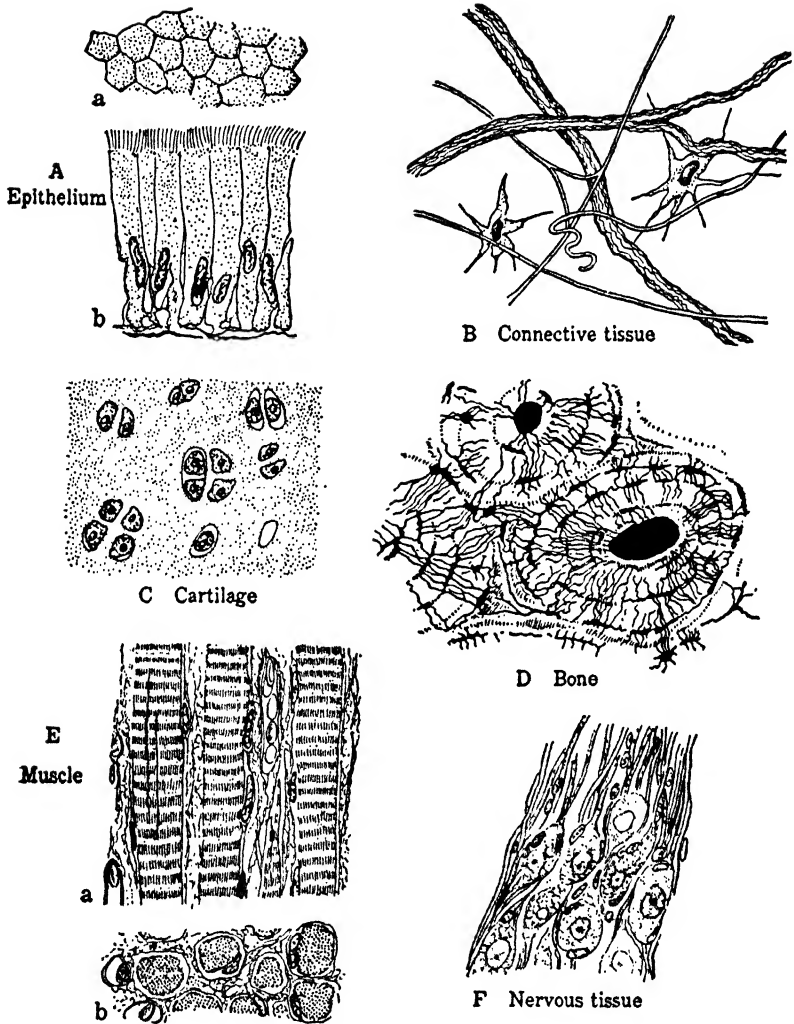

FIG. 25. Various animal tissues. A, epithelium (simple ciliated columnar) from human intestine : a, surface view ; b, longitudinal section ; B, connective tissue (subcutaneous) from Rabbit, showing cells and fibers (elastic and fibrillated) ; C, cartilage, showing cells in spaces in hyaline matrix ; D, bone : section of human humerus showing many spaces in matrix in which the bone cells lie ; E, muscle (striated) from Man : a, longitudinal section ; b, cross section ; F, nervous tissue : bipolar nerve cells from ganglion of auditory nerve of Cat. All highly magnified.



This grouping of more or less similar cells into functional systems, or **TISSUES**, is at the basis of the architecture of multicellular animals and plants, and thus we have now reached another level in the analysis of their structure. Although the unit of organization is the cell, these are associated in groups, or tissues, which represent a morphological unit of a higher order — a division of labor among the cells that makes possible the multicellular body with its attendant complexity. A tissue may be defined as a group of essentially similar cells specialized to perform a certain function. Examples are bone, muscle, and nerve in animals; and wood and pith in plants. (Figs. 25, 26, 230.)

Since the similar cell components of multicellular organisms are grouped to form tissues, it follows that the major working units, or **ORGANS**, of the animal or plant body as a whole are formed of tissues. In other words, an organ is a complex of tissues which has assumed a definite form for the performance of a certain function: for example, the human hand composed of bone, muscle, nerve, etc.; or the plant stem of wood, pith, etc.

As one would naturally expect, among the lowest *Metaphyta* and *Metazoa* there are forms in which the body is relatively simple, without highly specialized tissues and organs, but in most animals specialization is carried still another step forward by the grouping of organs devoted to the performance of some one general function into an **ORGAN SYSTEM**. An animal has many muscles, each of which is an organ but which collectively constitute a working unit, the muscular system; or it has stomach, intestine, liver, etc., forming the digestive system. On the other hand, even in the highest plants differentiation has proceeded neither in just the same way, nor so far, since the body is composed of tissue systems rather than organ systems. This point will be clear when the structure of the plant and animal body has been considered.

In truth, the multicellular plant or animal — the organism as a whole — is the resultant of the action and interaction

of many systems, organs, tissues, and, in the final analysis, of a multitude of coöperating protoplasmic units, or cells — upward of a hundred thousand billions in man. However, we must not overlook the whole which is greater than its

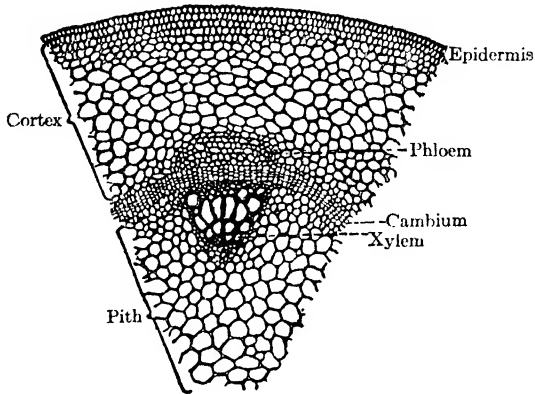

FIG. 26. Portion of a transverse section of a young plant stem to show cellular differentiation and tissues.

parts. The cells merge their individuality in that of the entire organism, and as long as they remain associated they are to be regarded, not as individuals, but as specialized centers of action and reaction of the living body itself, by means of which physiological division of labor is made possible. (Pp. 21, 29, 388.)

## CHAPTER VI

# THE PLANT BODY

The evidence seems to show beyond question that our present species of plants have descended by gradual evolution from simpler and fewer species which formerly existed — back, it is possible, to a single kind which thrived in remotest antiquity.

— *Ganong.*

Nearly all stages exist between the simplest unicellular plant body, such as is exhibited by *Protococcus*, and the highly complex multicellular body of the familiar flowering plants, or **SEED PLANTS**. A simple type is found among the

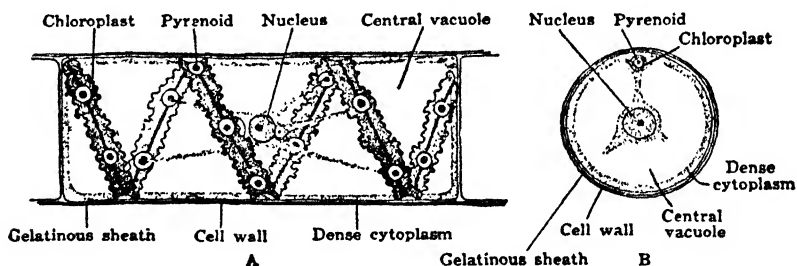

FIG. 27. Spirogyra. A, one cell of a filament; B, cross section of a cell through the nucleus. Highly magnified. (From Smith and others.)

thread-like, or filamentous, Green Algae commonly called pond scums. Thus in *Spirogyra* the body consists of a series of similar cells joined end to end and, therefore, from one point of view, may be looked upon as a colony of cells since the individual cells of the filament are essentially independent. Occasionally *Spirogyra* is attached instead of floating free, while in many other simple forms, such as *Ulothrix*, the filaments are anchored by specialized cells, or **HOLDFASTS**. (Figs. 27, 61.)

Still more common are plant bodies composed of branching filaments of cells. The branches may all be similar, or there may be a chief axis with lateral branches of different form. Frequently the branches, though still composed merely of filaments of cells placed end to end, may show, for example, much larger chloroplasts and be more active in photosynthesis. Thus even in so simple a plant is seen a physiological division of labor.

The next specialization is in regard to the character of the growth. Whereas in simple unbranched filamentous forms growth takes place, as a rule, by the division of all of the cells composing it, in the branched types this is usually restricted to one or more cells near the end of each filament. Thus, depending on the character of the growth from the apical cells, various complex forms of massive

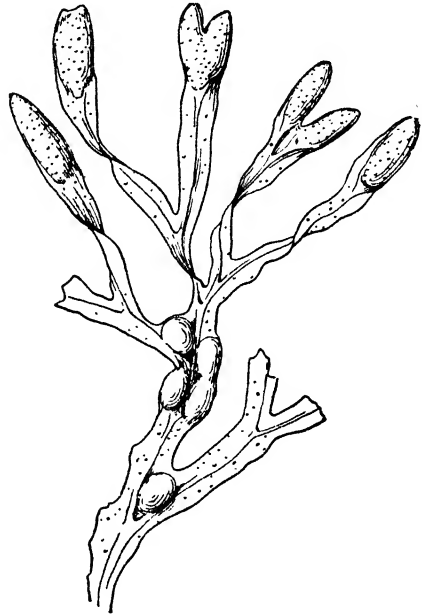

FIG. 28. The Rockweed (*Fucus*). A common seaweed, one of the Brown Algae, with a ribbon-like, forking thallus. (From Coulter.)

branching structures arise in seaweeds as, for instance, many of the Red Algae. The chloroplasts of these plants are chiefly developed in the cells on the surface; which again indicates the physiological division of labor referred to above and suggests that many, if not all of the modifications of the simple plant body, or THALLUS, thus far considered are provisions for bringing about the most favorable exposure to light of the photosynthetic apparatus. (Fig. 88.)

Another method of attaining the same object is found in other Algae. In the common Sea-lettuce (*Ulva*) the thallus

takes the form of a plate of cells, as a result of cell division occurring in two planes, and then this usually becomes thicker by division of the cells in a third plane also. Moreover, by further modifications of the thallus, the single attaching cell of the simple filamentous types is replaced in the larger Algae by massive holdfasts which anchor them

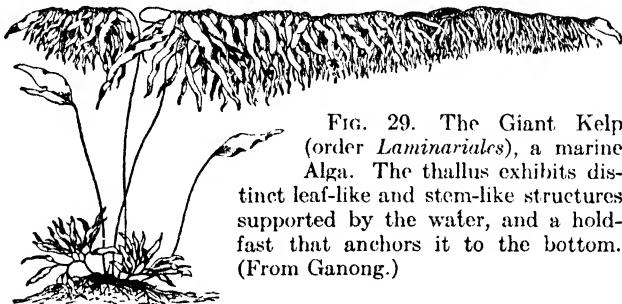

FIG. 29. The Giant Kelp (order *Laminariales*), a marine Alga. The thallus exhibits distinct leaf-like and stem-like structures supported by the water, and a holdfast that anchors it to the bottom. (From Ganong.)

securely to rocks. Still there is no marked differentiation in the cellular components of the holdfasts because they perform only this one function of the roots of higher forms; the absorption of water with salts in solution being carried on by the individual cells of the whole plant. Although among the most complex seaweeds, for example in the Rockweed, Gulfweed, and the Kelps, the form of the thallus is highly modified into parts which serve certain of the functions of root, stem, and leaf of higher plants, still in this division of labor none of the fundamental tissue differentiations so characteristic of the higher forms occur. Similarity of *function* has given rise to superficially similar, or ANALOGOUS, structures. (Figs. 28, 29, 87.)

The plants just considered are all ALGAE which, with the colorless plants, or FUNGI, form a major division of the plant kingdom known as the THALLOPHYTA. A further increase in complexity of plant body is exhibited by the MOSSES and their allies, or BRYOPHYTA. In a typical Moss, specialization of parts results in a body composed of an upright or creeping stem, provided with rhizoids for anchorage and absorption of materials, and leaves for photosynthesis. But there is

little cellular differentiation and no vascular, or conducting, tissues; this being reserved for the *vascular plants*, or TRACHEOPHYTES, comprising the FERNS and their allies, or Pteridophytes, and the SEED PLANTS, or Spermatophytes. (P. 172.)

As will be explained in detail later, most plants exhibit in their life history an alternation of generations: a sexual plant, or GAMETOPHYTE, bearing gametes gives rise to a non-sexual spore-bearing plant, or SPOROPHYTE, which in turn produces a gametophyte. In plants higher than the Thallophytes, these two generations are markedly different in size and structure. The sporophyte is the conspicuous and complex generation in the Tracheophytes — the generation which is recognized by everyone as a 'fern' or a 'seed plant,' and accordingly, for the present, attention will be directed to the sporophyte.

## A. STRUCTURE

The body of the sporophyte of a typical Seed Plant is clearly differentiated into two parts, ROOT and SHOOT. The root is an organ for attachment, as well as for the intake of water with the various materials in solution that are necessary for the life of the plant. The shoot consists of STEM and LEAVES. The stem is a supporting and conducting structure that forms the connecting link between the root and the photosynthetic apparatus of the leaf. The reproductive organs that produce the spores are usually developed on highly modified leaves which in the familiar Flowering Plants are grouped, with certain accessory structures, to form a FLOWER.

In order to obtain a mental picture of the essential working plan of the tissue distribution in these major parts of the body of a Seed Plant, we shall consider first an ideal vertical section of a representative of the commonest group of Flowering Plants, the DICOTYLEDONS. (Fig. 30; P. 154.)

The root and shoot system together constitute a continuous body, which may be regarded as forming a long narrow

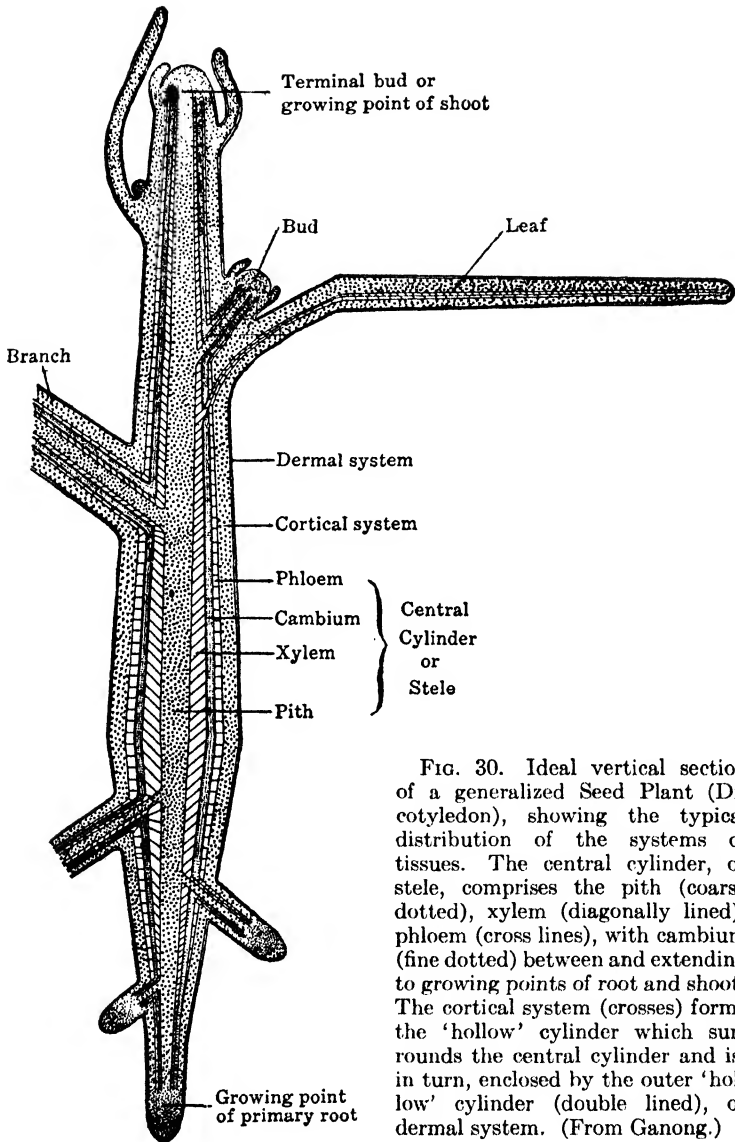

FIG. 30. Ideal vertical section of a generalized Seed Plant (Dicotyledon), showing the typical distribution of the systems of tissues. The central cylinder, or stele, comprises the pith (coarse dotted), xylem (diagonally lined), phloem (cross lines), with cambium (fine dotted) between and extending to growing points of root and shoot. The cortical system (crosses) forms the 'hollow' cylinder which surrounds the central cylinder and is, in turn, enclosed by the outer 'hollow' cylinder (double lined), or dermal system. (From Ganong.)

cylinder of cells, the bottom of which is the growing point of the primary root, and the top, the growing point of the shoot. This *primary cylinder*, in turn, is made up of a solid *central cylinder* of cells, surrounded by *two concentric 'hollow' cylinders*. The inner of these concentric hollow cylinders

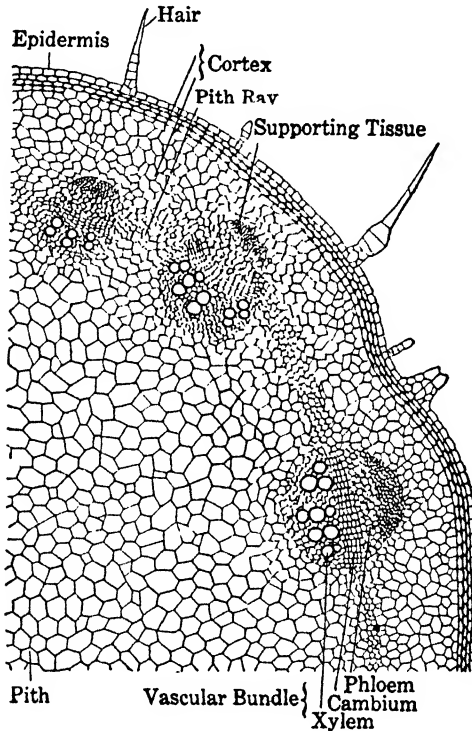

FIG. 31. Portion of a transverse section of a Sunflower stem. Magnified.  
(From Smith and others.)

surrounds the central cylinder, and in turn is surrounded by the outer cylinder. The latter forms the surface of the primary cylinder, or the outer layer of cells of the plant. These three cylinders comprise the **PRIMARY TISSUE SYSTEMS**.

The central cylinder, known as the **STELE**, runs continuously throughout root and stem. It provides the **PITH**, or primary axial tissue, and the **VASCULAR BUNDLES**. The latter include the food-conducting tissue or **PHLOEM**, the water-



conducting tissue or XYLEM, and between them the actively growing tissue or CAMBIUM. The cambium becomes continuous with the tissues at the growing points of stem and roots, and together these embryonic tissues, called MERISTEM, may be regarded as the GROWTH SYSTEM of the plant.

The hollow cylinder, immediately surrounding the solid central cylinder, comprises the CORTICAL SYSTEM which provides the chlorophyll-bearing tissue of the young stem and the CORTEX of bark and root.

The outside cylinder forms the DERMAL SYSTEM which supplies the hair layer of the surface of the young root and the protective EPIDERMIS covering the stem. (Fig. 31.)

The three cylinders plainly seen in the stem extend out into the leaf, where they form the veins, the chlorophyll-bearing tissue, and the epidermis.

Bearing in mind this diagrammatic plan of the root and shoot and of their component tissue systems, we are in a position to survey some of the common forms assumed by the root, stem, and leaf, and then to analyze their tissue systems by the study of transverse and longitudinal sections under the microscope.

### 1. Types of Roots

Roots are the plant organs which are in direct contact with the soil. Here they anchor the plant and perform their primary functions of absorption and conduction of water and solutes to the stem. The PRIMARY ROOT of a young plant, therefore, is usually a continuation downward from the shoot. It may persist throughout the life of the plant as the TAP ROOT and merely give off small, lateral, secondary roots. Tap roots are common in many herbs, as the Dandelion, and in young trees. More often the primary root is entirely replaced by SECONDARY ROOTS which radiate and branch in all directions from the main axis of the plant until they form a complex underground structure. This may equal in size the part of the plant body which is developed above the surface by the shoot system. (Figs. 32, 79.)

In plants which live through two years (**BIENNIALS**), often the first year is spent in storing up food. Sometimes this is

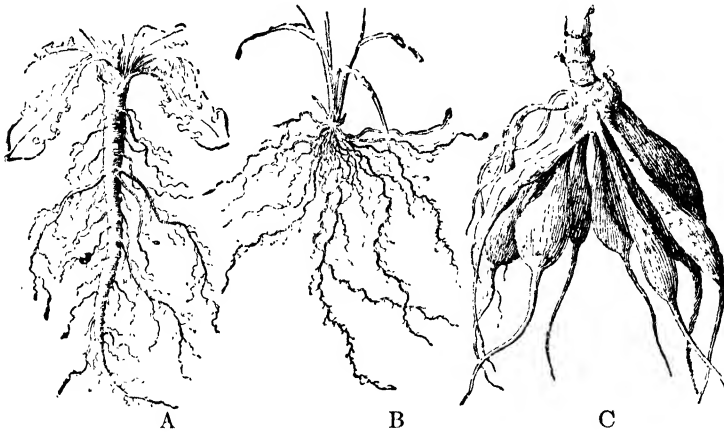

FIG. 32. A, tap root of the Dandelion; B, fibrous roots of a Grass; C, clustered and fleshy roots of the Dahlia. (From Bergen and Davis.)

in the roots, in which case they are greatly enlarged to form a reservoir of material, at the expense of which during the second season the plant rapidly develops flowers and seeds. These **STORAGE ROOTS** may be tap roots as in the Turnip, or lateral roots as in the Dahlia, Sweet Potato, and White Sweet Clover. (Figs. 32, 56.)

Although the contact of the plant with its environment through its roots is ordinarily underground, tropical plants in particular frequently develop **AËRIAL ROOTS** from the stem or its branches. Roots which rise from such unusual places are called **ADVENTITIOUS ROOTS**. In certain species the aërial roots hang free in the air and absorb moisture

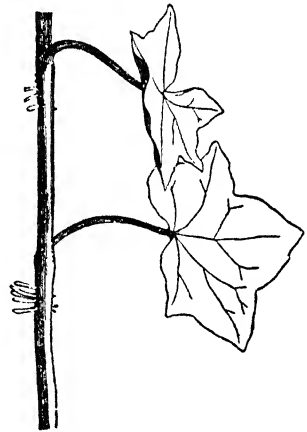

FIG. 33. English Ivy, showing the aërial roots which enable it to cling to walls. (From Ganong.)

from the atmosphere. In addition, such roots may develop chlorophyll and so perform the characteristic function of

leaves. Sometimes, as in the Banyan tree, aërial roots grow from the branches down to the earth where they become attached, eventually forming secondary supports which may



FIG. 34. Dodder, a parasitic Seed Plant, entwined about the stem of its host, a Golden Rod. A, part of a transverse section of stem of host to show penetration by Dodder roots (haustoria); B, several Dodder seedlings growing in the soil before attachment to a host. *l*, scale-like leaves; *r*, haustoria.

become stout trunks and function as stems. Comparable to these roots are the so-called PROP ROOTS of some Palms and of the familiar Indian Corn and the aërial CLINGING ROOTS of Ivy. (Fig. 33.)

Many plants depend chiefly or entirely on other plants for their food materials. The roots of such PARASITIC species

frequently grow into the tissues of their HOST, and become more or less modified into suckers, or HAUSTORIA. In the Dodder and Mistletoe, the haustoria enter the tissues of the stem of the host, while in many of the false Foxgloves (*Gerardia*) they enter the tissues of the roots. And in some aquatic and parasitic plants roots are absent, their function being taken over by the stem or leaves. (Fig. 34.)

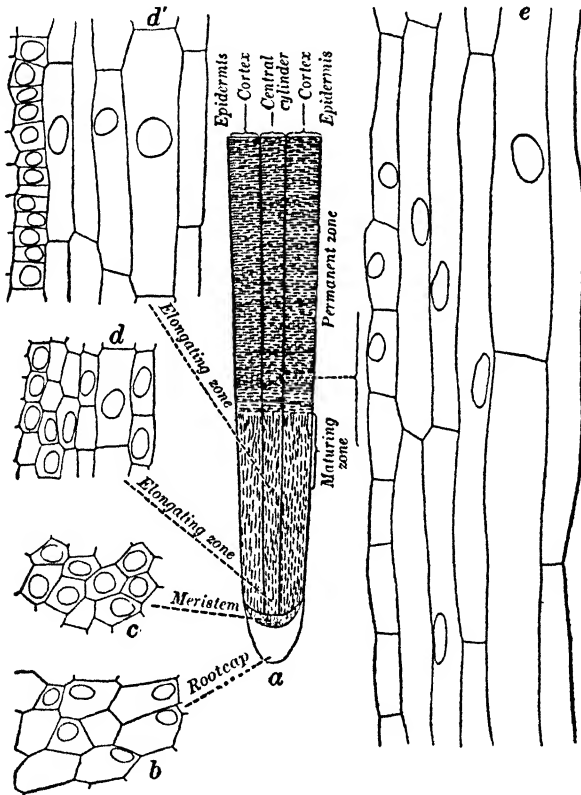

FIG. 35. Cell division and tissue differentiation in a growing root tip. Diagram of root (a) shaded to show the several regions from which the highly magnified sections (b, c, d, d', e) are taken. (From Densmore.)

Without multiplying examples, it is clear that the part of a plant which the botanist calls a root, and which typically anchors the plant to the earth and takes water with various materials in solution from the soil, frequently is highly modi-

fied and even assumes the duties of other organs in certain plants which are adapted for special places in the economy of nature.

## 2. Histology of Roots

An examination with the microscope of the tip of a root shows that it is covered with a large number of cells which form a protective **ROOT CAP**. These cells are gradually rubbed

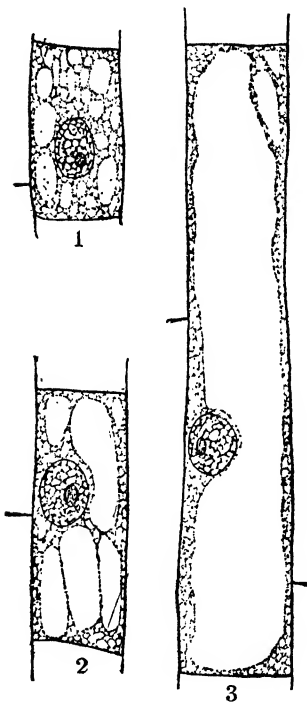

FIG. 36. Stages in the development of an embryonic cell to the mature condition. Highly magnified. (From Smith and others.)

away as the root works through the soil and continually replaced by new ones from the **GROWING POINT** which is immediately above. The numerous, small, densely-packed cells constituting the growing point represent the region of cell formation for the entire root tip, since near the center is a group of cells from which smaller cells are divided off, and these in turn absorb food materials and gradually attain the normal size. It will be recalled that the growing point is continuous with the cambium region above, and it thus represents the growth system, or meristem, at the root tip. (Fig. 35.)

Just above the growing point is the **ELONGATING ZONE** which includes cells recently formed by the tip in its growth downward. In this region the cells retain their relatively thin cell walls but enlarge rapidly, especially in length:

the force exerted by cell elongation driving the root tip through the soil. The cytoplasm of these cells, by the development and fusion of large vacuoles of **CELL SAP** — chiefly water with sugar, salts, and various other substances in

solution — soon forms merely a lining closely applied to the wall; a condition characteristic of many plant cells in contrast with those of animals. (Figs. 36, 37.)

As the elongating zone gradually merges above into the MATURING ZONE, there is seen on the surface the first evidence of the protective layer, or epidermis, and, just within, the cortex made up of several layers of cells. Still further toward the center of the root, the central cylinder, or stele, appears with differentiating vascular tissue.

Furthermore, conspicuous on the outer surface of the maturing zone are numerous ROOT HAIRS, each a modified epidermal cell. It has been emphasized above that the primary function of the root is the intake of water, with certain of the elements of food in solution, that forms a film about the soil particles. This function is performed almost entirely by OSMOSIS,<sup>1</sup> that is by *diffusion*

through the semi-permeable plasma-membranes of the innumerable root hairs. Accordingly cells of this type, continually dying and being replaced by new ones near the growing points of the young roots, form the vital point of contact between the root system and its environment. The root hairs exhibit the selective power of protoplasm to a

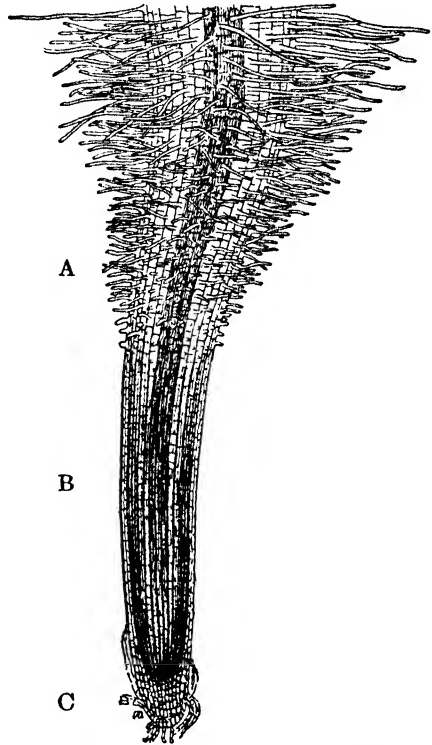

FIG. 37. Root tip of Radish. A, region of root hairs; B, region of elongation; C, root cap. Magnified. (From Ganong.)

<sup>1</sup> See: GLOSSARY.

remarkable degree. For illustration, Red Clover and Barley plants when burned yield about the same proportion of mineral matter as ash. But the barley ash contains

nearly twenty times as much silica as the clover, while the latter contains nearly six times as much lime as the barley. (Figs. 37, 38, 54.)

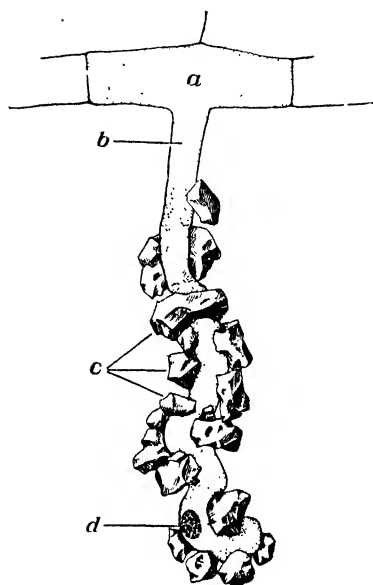

FIG. 38. Root hair showing its relation to adjoining cells of the root and to particles of the soil surrounded by a film of water. *a*, vacuole filled with cell sap; *b*, cytoplasm (dotted); *c*, soil particles; *d*, nucleus within the cytoplasm lining the cell membrane. Highly magnified.

In the maturing zone, but particularly just above in the so-called PERMANENT ZONE, the stele shows still more cellular specialization. The young vascular bundles are differentiated into the phloem tissue, characterized by its small angular tubes; while the developing xylem, with its large vessels, has nearly obliterated the primitive ground tissue, or pith. Between the xylem and the phloem appears the developing cambium, but this begins its characteristic growth contribution somewhat above. Indeed, as we pass upward the cellular structure becomes

more and more similar to that of the stem; the older woody roots of trees and shrubs being, from the standpoint of both structure and function, essentially stems, except that leaves are not formed on roots. (Figs. 30, 35.)

### 3. Types of Stems

The stem is the axis of the shoot and has two primary functions. First, to support and raise the photosynthetic organs, or leaves, into a position of vantage with respect to

light and to bear the reproductive organs and their products; and, second, to act as the medium of communication between the absorbing organs, or roots, and the leaves and reproductive organs.

Stems exhibit a wide range in form and external structure. Thus in HERBS, where the shoot dies down to the ground each winter or at the completion of a life cycle, the stem is relatively slender and soft in texture, while in SHRUBS and TREES the stem persists throughout the life of the plant, growing thicker annually to form a woody axis. Stems of shrubs are comparatively slender and short and usually give rise to branches near the ground, while those of trees grow stout and tall, forming a TRUNK. However, some species may be shrubs in one type of environment and trees in another.

In herbaceous stems the entire length usually bears leaves whereas in woody stems they are restricted to the growth of the last few years. Indeed in DECIDUOUS trees that lose their leaves in autumn, they are confined each summer to the current growth of the stem. The fall of the leaf is an entirely normal process — the leaf is cut off without injuring the stem by the development of a special layer of cells across the stalk of the leaf that seals the wound as the leaf falls. Leaf scars thus show the former positions of leaves. (Fig. 39.)

The points on a stem at which leaves arise are known as NODES and the por-

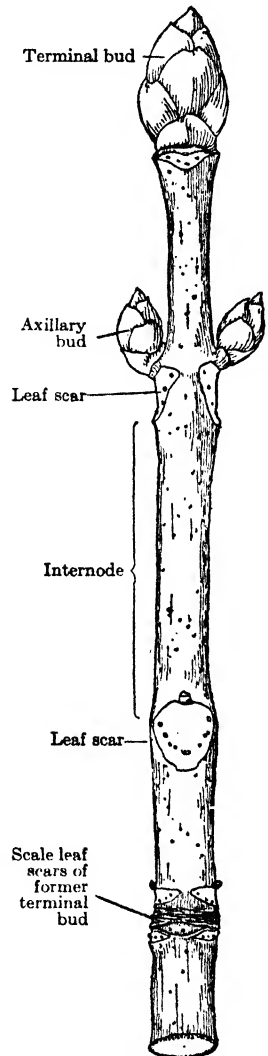

FIG. 39. A woody twig of the Horse Chestnut with winter buds enclose by scale leaves.



tion between two nodes is an INTERNODE. The former are centers of active growth where BUDS, and so lateral stems, or BRANCHES, arise. The disposition of the leaves at the nodes, or PHYLLOTAXY, follows characteristic patterns that insure the minimum amount of shading. Most common is a leaf at each node in an ascending spiral about the stem, but sometimes there are two or more leaves at each node.

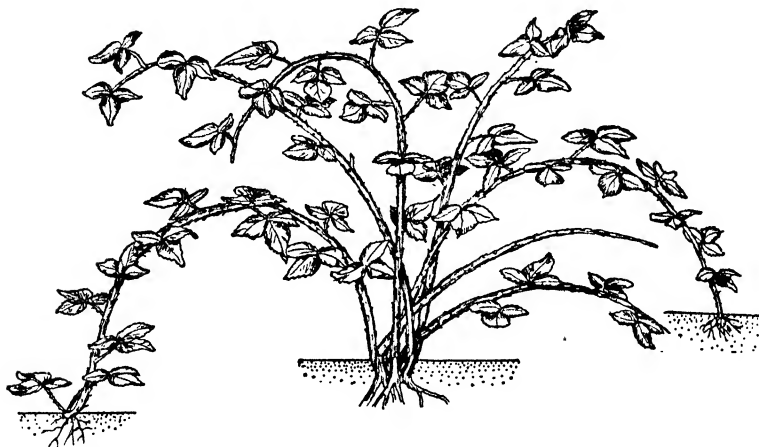

FIG. 40. Propagation of the Black Raspberry by branches. (From Densmore.)

Buds are the specialized growing points of the stem and may be TERMINAL and so determine the elongation of the stem, or LATERAL and give rise to branches. In a BRANCH BUD there is a tiny branch with leaves ready to grow, in a FLOWER BUD there are one or more flowers, and in a MIXED BUD, both leaves and flowers. Adventitious buds may occur on roots. (Fig. 39.)

Although photosynthesis is, of course, carried on chiefly by leaves, most young stems are green and so coöperate in this process, but in woody plants the stem surface becomes covered with BARK and chlorophyll is no longer present. However, small scattered areas of more porous bark, termed LENTICELS, make possible the interchange of gases between the inner tissues of the stem and the atmosphere.

The stem, like the root, may be modified and diverted from its typical structure and take over more or less of the functions of other parts. For the purpose of propagation, creeping stems occur, such as the surface RUNNERS of the Strawberry, and the underground RHIZOMES of many Sedges, Grasses, and common Ferns. Sometimes the stem to a large extent replaces the root system, but more often it acts as an underground reservoir in which food material is stored up during the short growth period for the rapid development of the flowering shoot.

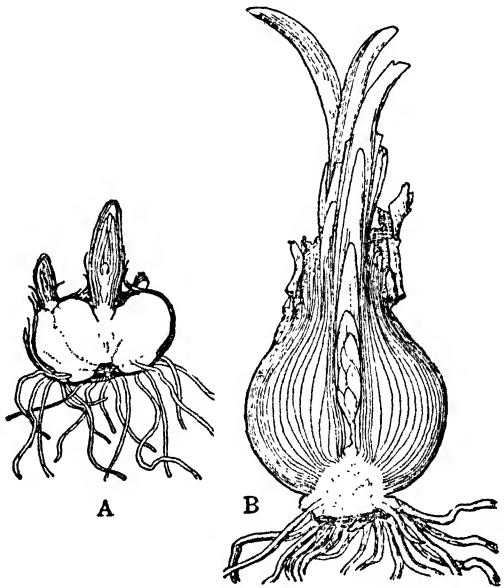

FIG. 41. A, underground stem (corm) of Crocus; B, underground bud (bulb) of Hyacinth. Vertical sections. (From Smith and others.)

This is well seen in some of the early spring plants such as the Bloodroot and Trillium, and reaches an extreme in the CORM of the Crocus. (Figs. 40, 41, 50.)

Extremely arid regions are characterized by plants, such as the Cacti, in which the leaves are completely suppressed to prevent rapid evaporation; their function being taken over by the stem which is provided with well-developed chlorophyll-bearing tissue. Sometimes the stem or branches may superficially resemble a leaf by being flattened or otherwise modified, as in certain Cacti such as the Prickly Pear, the apparent leaves of the so-called Smilax (*Myrsiphyllum*), and the filamentous 'leaves' of Asparagus. Finally, the versatility of the stem is illustrated by the THORNS of the Honey Locust, the twining TENDRILS of the Grape, and the TUBER

of the Potato which is essentially a 'concentrated rhizome.' (Figs. 42, 111, 114.)

#### 4. Histology of Stems

Just as cell division in the meristem tissue of the growing point of the root results, typically, in downward growth, so in the bud, a similar region at the growing point of the shoot, cell multiplication results in progress upward. In other words, from the region where root and shoot merge, the growth of the plant is in opposite directions.

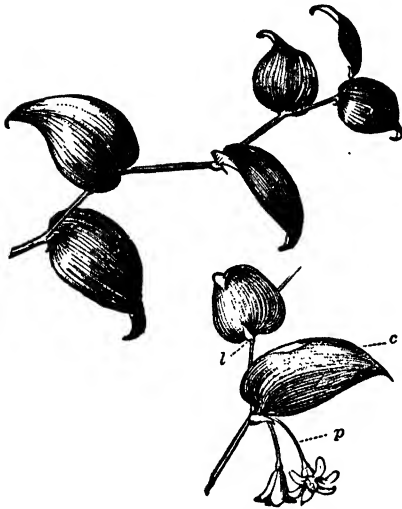

FIG. 42. Stem of *Myrsiphyllum*. *c*, leaf-like branch, or cladophyll, situated in the axil of a leaf; *l*, leaf; *p*, flower stalk.

The general character of the embryonic tissue is essentially the same in both the root and shoot regions, being composed of densely packed, more or less cubical cells which are completely filled with protoplasm. At this stage the cells have not become modified for special functions by the formation of

vacuoles of cell sap, or in other ways. But all the tissues of the stem are derived from the cells of the growing point, so that slightly below this region three areas are to be noted in which differentiations are in progress. These result in the formation of the outer cylinder — epidermis, the intermediate cylinder — cortex, and the central cylinder — stele, in which the ground tissue, or pith, is gradually surrounded by the developing vascular bundles. (Figs. 26, 31, 43, 44.)

The vascular bundles are much the same as in older roots. The tissues of the bundles are specialized for three chief

functions: the wood, or xylem, for the conduction of water, the phloem for the translocation of food, and fibers in each for mechanical support. Furthermore the cambium, when present, provides for the continuous growth of the stem. The vascular bundles are, of course, directly continuous with those of the root and leaf.

The disposition of the vascular bundles is quite different in the two great divisions of the Flowering Plants: the DICOTYLEDONS with two seed leaves and netted-veined leaves and the MONOCOTYLEDONS with one seed leaf and parallel-veined leaves. Dicotyledons are much the more numerous and com-

prise many small plants as well as all the common trees and shrubs. The most important Monocotyledons are the grasses, palms, lilies, and orchids. The structure of the vascular-bundle system will first be described in a typical dicotyledonous stem. (Figs. 103, 104.)

**DICOTYLEDONOUS STEM.** We have noted that the developing stem is soon differentiated into three chief regions: the epidermis, cortex, and stele. The epidermis, or outermost layer, consists of a single layer of cells whose outer walls are greatly thickened and impregnated in part with a waxy

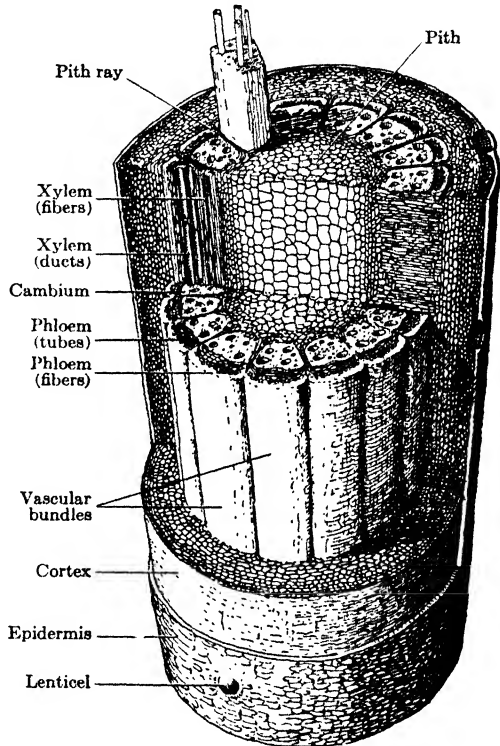

FIG. 43. Diagram of the structure of the woody stem of a vine, a Dicotyledon.

substance, or CUTIN, for protection and for conservation of water. Specialized pores, or STOMATA, characteristic of leaves, occur on the stems of herbs, but these are replaced by lenticels when bark is formed on woody stems. The cortex, just within the epidermis, usually comprises two cellular layers. First there is an outer COLLENCYMA layer of cells, some of which contain chloroplasts and so perform photosynthesis, that typically have the angles of their cellulose walls thickened for mechanical strength in the young stem while still allowing for the stretching and growth of the cells. Just beneath the collenchyma is the PARENCHYMA layer, composed of more or less generalized cells which usually develop chloroplasts in the young stem. And scattered in the parenchyma are groups of thick-walled dead cells which provide FIBERS for further rigidity. (Figs. 26, 31, 43.)

The stele, or central cylinder of the stem, comprises two general regions: the central pith surrounded by the vascular-bundle area. The pith is composed of thin-walled cells that compose the ground tissue.

The vascular bundles, as seen in a transverse section of the stem, exhibit the general form of a broken ring about the pith. Each bundle comprises three clearly differentiated parts: the thick-walled cells of the xylem nearest the center of the stem, the thin-walled cells of the phloem situated peripherally, and one or several layers of embryonic, or meristem, cells of the cambium between the xylem and phloem. The active division of the cells of the cambium layer forms phloem cells on the outer side and xylem cells on the inner side. Thus the vascular bundles increase in size and gradually replace the intervening cells, except those that remain as the so-called PITH RAYS and serve chiefly for the conduction of materials across the stem. And eventually the cambium of the various vascular bundles may become continuous so that it forms a closed cylinder of growing tissues. Cambium activity continuously increases the diameter of the stem and thus is forced to increase its own diameter. (Figs. 31, 43, 44.)

The xylem is composed of two chief types of cells: TRACHEAL or VESSEL cells and WOOD FIBERS. Tracheal cells are elongated dead cells, without protoplasm, that serve chiefly for conducting water. Ducts or vessels are formed of long rows of dead tracheal cells by the disappearance of the

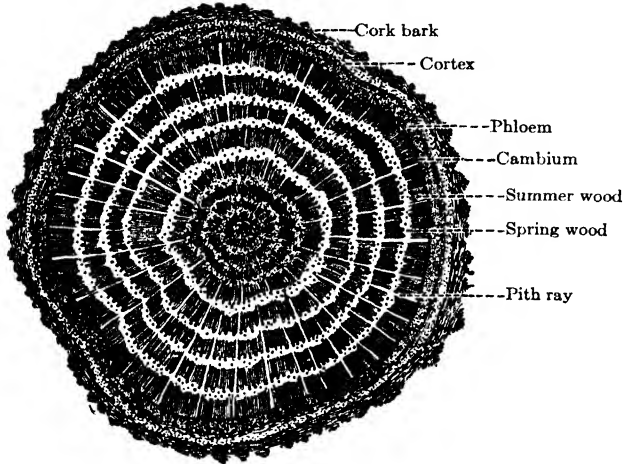

FIG. 44. Transverse section of an Oak stem eight years old. Diagrammatic. The central darker dotted portion is heartwood; the outer wood layers, with alternating light spring wood and dark summer wood, are sapwood. (From Densmore.)

contiguous walls, and so provide the chief water-conducting elements of the stem. Wood fibers are long, slender, pointed dead cells. Their thick walls give rigidity and strength to the stem and, with the tracheal cells, form most of the wood of trees.

The phloem consists of three chief types of cells, known as SIEVE TUBES, COMPANION CELLS, and PHLOEM FIBERS. The tubes are thin-walled, elongated, living cells without nuclei, the cavities of adjacent cells being in communication by tiny pores in the terminal walls, and serving primarily as food-conducting elements. The companion cells, as the name indicates, are closely associated with the sieve tubes — indeed, each is in communication by pores with its sister sieve tube cell and apparently coöperates with it. The phloem fibers afford mechanical protection for the sieve tubes.

Such is the general arrangement of the tissues of a typical dicotyledonous stem, but it will be understood, of course, that great variation in the details occurs in this immense plant group, in response to adaptations to diverse environmental conditions and modes of life.

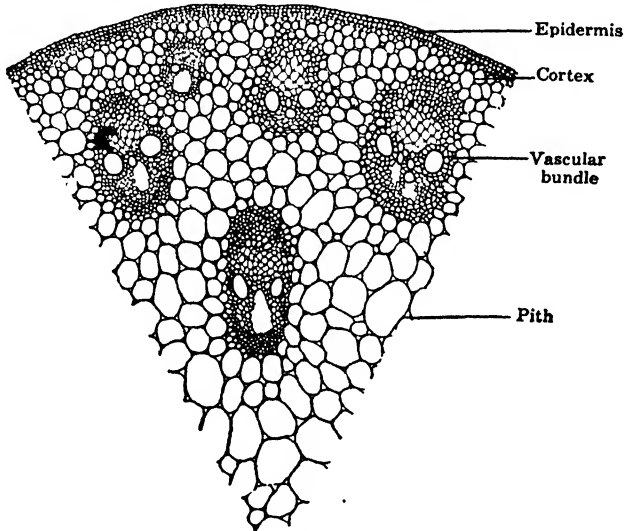

FIG. 45. Portion of a transverse section of a monocotyledonous stem. Magnified.

MONOCOTYLEDONOUS STEMS differ from those of the Dicotyledons chiefly in the arrangement and structure of the vascular bundles. Instead of being disposed in a cylinder, they are usually scattered throughout the stele. Sometimes, however, there are no vascular bundles in the center and the pith cells disappear so that a hollow stem is formed, as is the case in most grasses and the well-known bamboo. Furthermore, the vascular bundles differ from those of Dicotyledons by the absence of a cambium layer. Thus both the arrangement and the structure of the vascular bundles preclude the indefinite growth in diameter of the monocotyledonous stem and are directly or indirectly responsible for many of the characteristic differences exhibited by the two great divisions of the Flowering Plants. (Fig. 45.)

## 5. Type of Leaves

Leaves are lateral outgrowths from the stem, and, unlike most of the latter, are usually limited in growth — they attain a certain size and then stop. A branch of the stem typically arises in the axil of a leaf, or just above its point of attachment. (Fig. 39.)

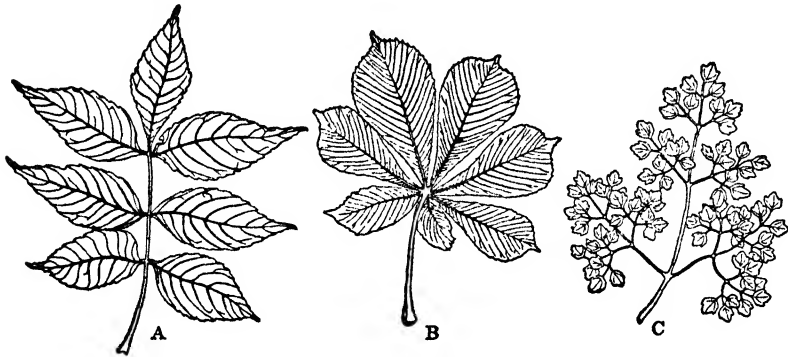

FIG. 46. Compound leaves. A, pinnately compound leaf of an Ash; B, palmately compound leaf of the Horse Chestnut; C, four-times-divided leaf of the Meadow Rue. (From Smith and others.)

Leaves and roots form the two chief points of contact between the plant and its surroundings. The fundamental functions of leaves are to expose to the sunlight the chlorophyll apparatus and to afford a surface for the interchange of gases. That work is performed by leaves is evident from the rough estimate that at least one gram of sugar per square meter of leaf surface is manufactured each hour on a bright summer day. Accordingly the principal part of a typical leaf is a broad **BLADE** which affords the optimum conditions for exposure. The blade is usually attached to the stem, or branch, by a stalk, or **PETIOLE**, which is somewhat modified at the point of union into a **LEAF BASE** from which may arise small, leaf-like appendages, or **STIPULES**. When the petiole is absent, the blade of such a sessile leaf appears to arise directly from the stem. (Figs. 46–48.)

Running through the center of most leaves is a large **VEIN**, the **MIDRIB**, which continues in the petiole. On either side of



the midrib are many smaller veins which in Dicotyledons form a conspicuous network permeating the blade, and in Monocotyledons run parallel to the midrib. In either case



FIG. 47. Banana plant, showing support by greatly elongated, clasping leaf-bases.

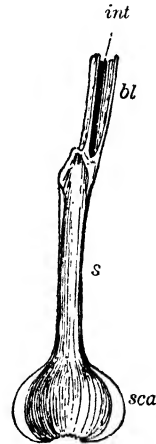

FIG. 48. Onion leaf, cut longitudinally. *bl*, blade; *int*, hollow interior of leaf; *s*, thin sheath of leaf; *sca*, thickened base of leaf. (After Sachs.)

they form a complex system of tubes, continuous with the vascular bundles of the stem, for the conduction of materials and for the support of the softer tissues of the blade. (Figs. 103, 104.)

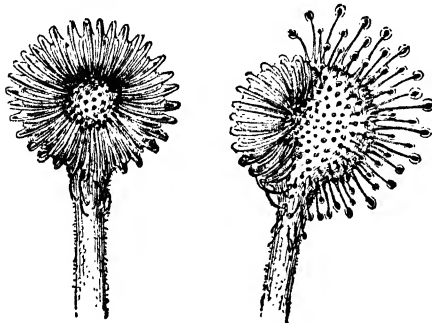

FIG. 49. Leaves of Sundew during digestion of captured prey. The one at the left has all the tentacles closed; the one at the right, only half of them closed over the prey.

The shape of leaf blades varies, of course, very greatly in different plants. Thus, for example, the blade may be divided into lobes which if they extend to the midrib or the base of the blade are termed **LEAFLETS** and the whole a **COMPOUND LEAF**, as those of the Ash, Rose, and Horse Chestnut.

Some plants have three or four times divided compound leaves. (Figs. 46, 107-122.)

The leaf, like the root and stem, exhibits numerous modifications — indeed, it may assume the function of these parts. Thus the leaf bases of the Banana grow so close together that they form the ‘trunk’ of the tree, while hairs on the leaves of certain plants of the Pineapple family absorb water and perform the functions of root hairs. The chlorophyll-bearing tissue may be nearly or completely suppressed, as in the SCALES which enclose WINTER BUDS in a protective case. These are conspicuously developed in the Horse Chestnut and the Hickory. Or the scale leaves, in addition to affording protection, may act as reservoirs in which food materials are stored, as in the BULB of the Hyacinth and Onion. In fact, all transitions between scale leaves and typical foliage leaves may frequently be seen in an unfolding leaf bud. Still more marked departures from the usual leaf-form are the TENDRILS of some climbing plants such as the Sweet Pea, the SPINES of the Barberry and the Thistle, the FLOATS of the Water Hyacinth.

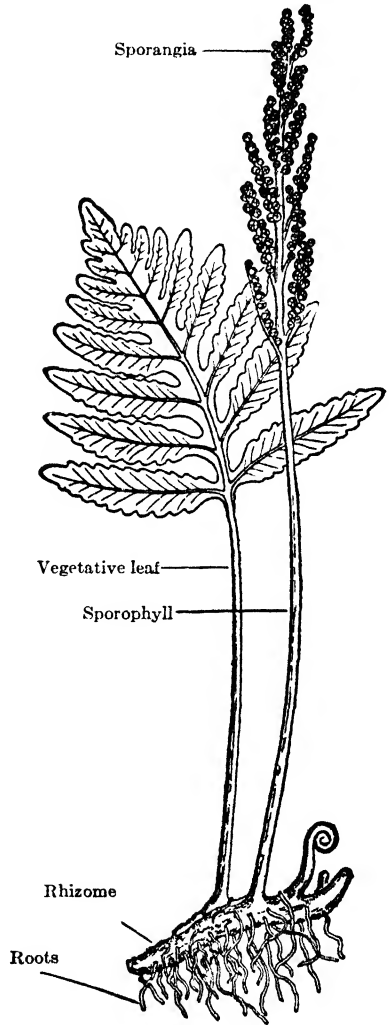

FIG. 50. The Sensitive Fern (*Onoclea sensibilis*), showing a vegetative leaf and a spore leaf, or sporophyll, arising from the rhizome. (From Bergen and Davis.)

cinth, and the INSECT TRAPS of truly carnivorous plants such as the Pitcher-plants and Sundews which capture small living animals. (Figs. 39, 41, 47-49.)

Leaf modification in another direction, for reproduction, occurs in the spore-bearing structures of Ferns and Seed Plants. In some Ferns the spore cases, or SPORANGIA, are borne upon typical leaves, and in others on special leaves with the chlorophyll-bearing tissue partly or completely sup-

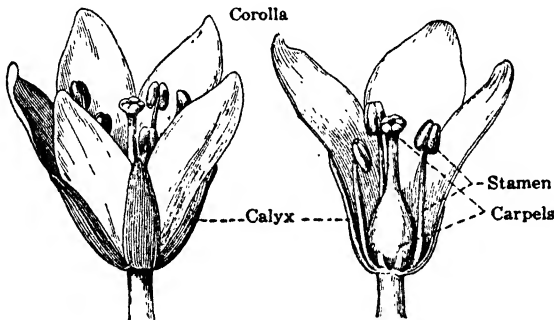

FIG. 51. The floral parts of the Alpine Azalea (*Loiseleuria*). Collectively the sepals constitute the calyx, and the petals, the corolla. The pistil represents several united carpels. (After Müller.)

pressed. Such leaves which are given over to the production of spores, as in the common Sensitive Fern, are known as SPOROPHYLLS. In the Flowering Plants, the flower is a group of sporophylls, known as CARPELS and STAMENS, associated in most cases with certain sterile leaf structures, termed SEPALs and PETALS, which afford protection to the sporophylls and offer attraction to insect visitors. We shall consider the structure of the flower in more detail when discussing reproduction in plants. (Figs. 50, 51, 72.)

## 6. Histology of Leaves

The embryonic cells forming the growing point, or bud, of the shoot comprise, as we have seen, the fundamentals of both stem and leaves; that is to say, stem and leaves arise together in buds. The method of their development is well seen in the buds of a common water plant, Elodea. Here

the rounded end of the stem is composed of the characteristic embryonic tissue. The rudiment of each individual leaf is first visible on the surface as an enlarged cell, which by division and differentiation gradually develops into a flat projection of special tissues constituting the fully formed leaf. (Fig. 52.)

The fundamental structure of a typical leaf is well illustrated by a section. The essential features consist of thin upper and lower limiting layers of cells, or epidermis, which are continuous at the edges of the blade, and thus enclose the supporting and conducting tissues consisting of vascular bundles, or veins, and the CHLORENCHYMA, or chlorophyll-bearing, cells that carry on the work of photosynthesis. (Fig. 53.)

The outer walls of the epidermal cells are usually thickened and cutinized so that they are impervious to water and gases. Accordingly the epidermis is perforated with tiny pores, or STOMATA, which lead to air spaces among the chlorenchyma cells. It is estimated that the number of stomata on the lower surface of typical leaves averages about 200 per square millimeter. Each stoma is enclosed by two specialized epidermal cells, termed GUARD CELLS, which change the size of the opening according to varying internal and external conditions, and so regulate the rate of exchange of oxygen and carbon dioxide between the internal cells of the leaf and its surroundings, and also the exit of water vapor.

The veins, as we know, form the framework of the leaf, as well as the complex network of highways for the transportation of materials between the blade as a whole and the stem. In transverse section the larger veins usually have the form of a ring or crescent, the upper part consisting of thick-walled xylem cells for conducting water and for strength,

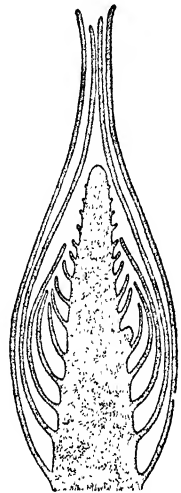

FIG. 52. Diagram of a section through a terminal naked bud of *Elodea*, showing the development of leaves, and, at right, a branch. (From Smith and others.)

and the lower comprising thin-walled phloem cells for the transport of food materials. And the whole may be strengthened by a surrounding sheath of cells. Thus veins are continuous with, and possess the essential features of the vascular bundles seen in the stem, lacking, however, the cambium. (Fig. 53.)

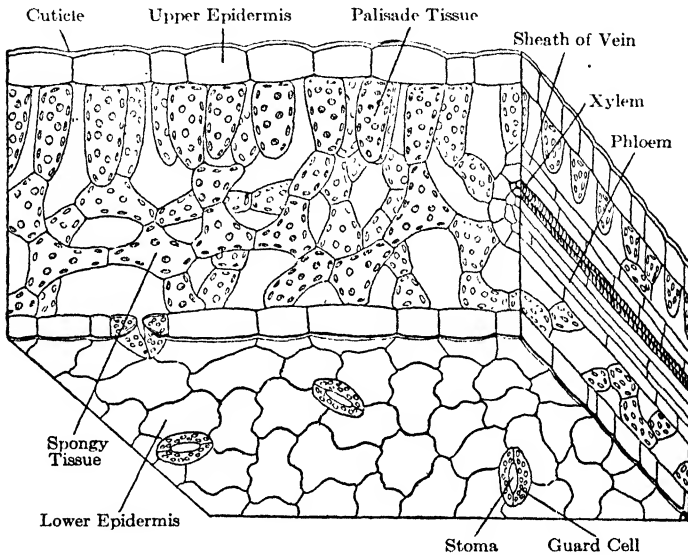

FIG. 53. Diagram of a portion of the blade of a leaf, showing the relations of the various tissues. (From Smith and others.)

The major tissues of the leaf consist of chlorenchyma cells. Immediately under the upper epidermis these are usually arranged in a definite layer known as the PALISADE tissue. Below this region the cells are less irregularly disposed so that there are more AIR SPACES between them. The spaces in this SPONGY tissue form a practically continuous system of passages throughout the leaf and thereby facilitate the interchange of oxygen, carbon dioxide, and water vapor between the leaf cells and the outer world by the stomata. (Figs. 53, 55.)

The cytoplasm within the thin walls of the chlorenchyma cells forms merely a lining in which are situated the nucleus

and numerous specialized, disk-shaped, cytoplasmic bodies, the chloroplasts, which contain chlorophyll and therefore appear green. These are, of course, the essential agents of photosynthesis. The center of the cell is occupied by a large VACUOLE filled with cell sap. This sap is usually under pressure, which accounts for the close application of the cytoplasm to the inside of the cell wall and produces the TURGOR characteristic not only of these cells, but also of many other types of plant cells. The wilting of the leaves and stems of cut plants is due chiefly to the escape of water from the cell vacuoles resulting in loss of turgor, and consequently of rigidity. (Fig. 36.)

## B. PHYSIOLOGY

We have now outlined the essential structure of a generalized Seed Plant, with the exception of the parts modified for reproduction. Before turning to this function which has to do with the race rather than the individual, it is important to consider the organism as a whole — how the various cells, tissues, and organs coöperate in the nutrition of the living plant. For nutrition, it will be recalled, is the function of primary importance to the individual.

The essentials of nutrition were readily described in the simple green plant *Protococcus*, because the whole organism comprises but a single cell which directly interchanges mat-

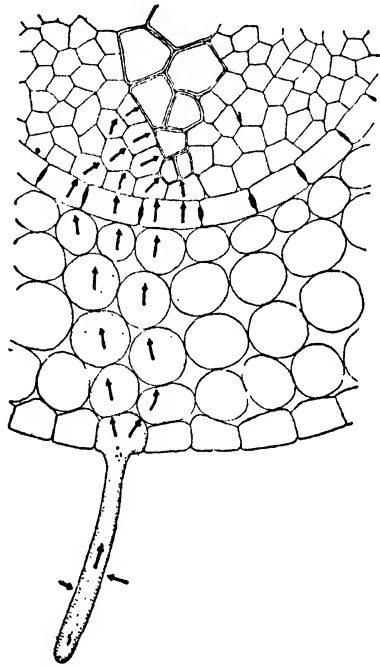

FIG. 54. Diagram of the path of water with solutes from the soil through a root hair and cortical cells of a root to the xylem. (From Smith and others.)

ter and energy with its environment. But with the establishment of the complex plant body, an organization of thousands or millions of highly specialized cells, the intricate interrelationship of the various parts to the nutrition of the whole becomes a problem in itself. (Fig. 13.)

The green plant, as we know, takes in the raw materials and builds them up into its foodstuffs. In the case of the higher plants, water in large amounts is taken in through the root hairs. Dissolved in this water are various substances — nitrates, phosphates, sulfates, etc., which supply most of the elements that are necessary for the make-up of protoplasm. The leaves admit carbon dioxide through the stomata. Thus the substances which are to be built up into foodstuffs typically enter at the opposite ends of the plant, and must be brought together in a chemical laboratory, as it were, in order that their union may be effected. The organ in which food construction takes place is chiefly the leaf, and, specifically, in the chloroplasts. Accordingly we must consider the forces involved and the highways which bring the raw materials from the root hairs to the leaves, and those which carry the finished products to the various parts of the plant for their use. (Fig. 54.)

### 1. *Transpiration Stream*

The water enters the root hairs, passes to the xylem, and is given a start up the stem by so-called **ROOT PRESSURE**: all the result of diffusion and osmotic phenomena in the multitude of root cells. Indeed, not only the absorption of soil water but also the entire process of circulation in the plant is largely due to osmotic phenomena, because solutes entering the root hairs, as well as dissolved substances in the cells throughout the body, pass from cell to cell by diffusion through their plasma-membranes. Each solute moves from regions of greater to those of lesser concentrations.

The water having ascended through the xylem of the root enters the similar region of the stem. Here, it will be recalled,

the conducting elements are tracheal cells that form a series of non-living tubes extending up the stem to the leaves, through which they are distributed in the veins. This is the

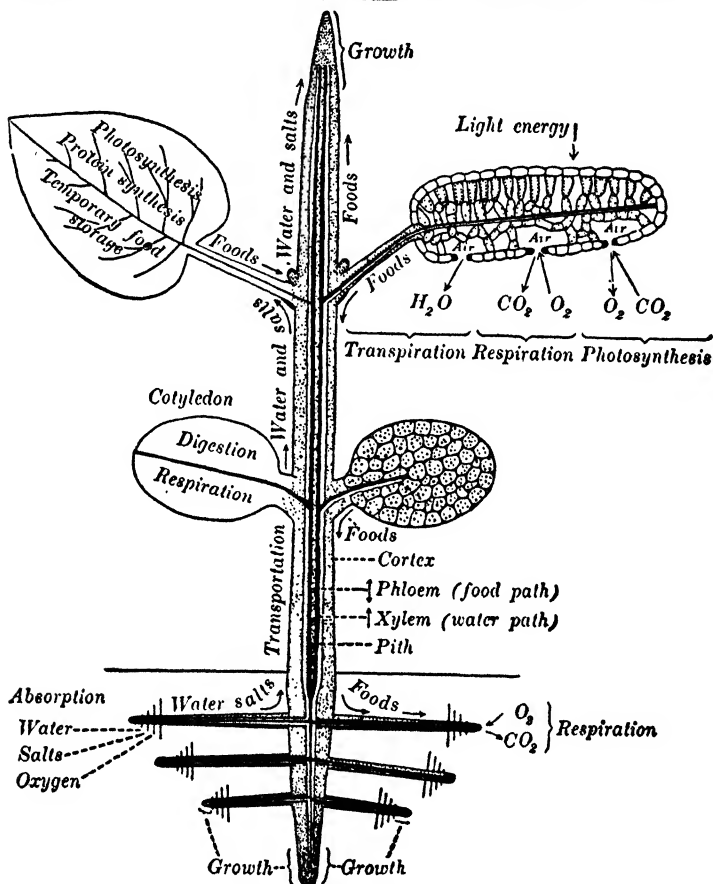

FIG. 55. Diagrammatic presentation of important physiological activities of a Seed Plant (Bean). The first leaves (seed leaves, or cotyledons) are richly stored with food and contribute only slightly to photosynthesis. (From Densmore.)

fluid-conducting highway from root to leaf. And it appears that an osmotic 'pull' in the leaves draws water from the vessels of the stem into the cells of the leaf. Involved in the dynamics of this rise of SAP is the interesting physical phenomenon that water when confined in tiny tubes, such as



those of plant stems, possesses remarkable tensile strength — “it is as strong as wire” — and evaporation at the upper end of the water column in the leaves serves to pull up the water. (Fig. 55.)

The outgo of water vapor through the stomata of the leaves by evaporation is termed TRANSPIRATION, and is brought about by heat energy secured both from the surrounding atmosphere and from a surplus of the energy of sunlight absorbed by the leaves during photosynthesis. In the last analysis, the energy of heat, resulting in evaporation from the leaves, is largely responsible for the movement of the column of water, or TRANSPIRATION STREAM, which is continually passing through the plant — entering the root with various substances in solution, passing up the xylem, and emerging, minus the solutes, through the stomata as water vapor. The fact that much more water usually is evaporated from a forest than from an equal area of a lake affords some conception of the part played by vegetation not only in returning water to the atmosphere but also in ‘consuming’ heat energy — cooling the summer air. It has been estimated that for each pound of tissue constructed, the plant transpires about forty gallons of water.

## 2. *Translocation*

The supply of carbon which the plant needs is obtained from carbon dioxide which enters the leaves through the stomata. The water, containing various salts in solution which has been taken in by the roots, meets the carbon dioxide in the chlorenchyma cells. As we know, through the radiant energy of light a complicated series of chemical reactions is initiated by which carbon, oxygen, and hydrogen are united to form a sugar. In this process, free oxygen is evolved which may be used in respiration or liberated through the stomata. Part of the sugar thus formed is directly utilized by the plant as fuel, and part is employed as the basis for the manufacture of proteins and the living

material itself by the addition of nitrogen and various other chemical elements. (Fig. 55; Pp. 38-40.)

Therefore the leaves are special organs in which certain materials of the inorganic world are assembled and arranged in new chemical compounds so that they can be utilized as building material for the plant body and as sources of energy for carrying on the vital functions. In other words, the new compounds are the food of the plant — and, incidentally, of the rest of the living world.

In every case the food built up in the leaves must be distributed, or **TRANSLOCATED**, to the organism as a whole. This occurs largely by diffusion and therefore insoluble food must be rendered soluble, **DIGESTED**, by special organic catalyzers, or enzymes, that induce or accelerate the process of chemical simplification. Then the material passes to the smallest veinlets and then on to larger and larger veins which finally lead to the stem.

In the stem, the course taken by the food depends upon the immediate needs of the plant. It may pass either up or down through the conducting vessels, or sieve tubes, formed by elongated living cells in the phloem, and some may be transferred to the xylem to afford materials for rapidly growing parts. When growth is not active, most of the food passes downward through the phloem in order that it may be stored, chiefly as starch, in stem and root. In brief, all the living cells of the plant directly or indirectly draw upon the supply of food translocated through the phloem, so we may look upon the phloem as primarily a food-distributing system from the leaf, just as we have seen that the xylem is the system for carrying water and solutes from root to leaf. Thus in a tree the raw materials pass up through the wood and the products pass down through the bark. (Fig. 56.)

The dynamics of translocation from leaf to shoot and root through the phloem again involves chiefly the movement of solutes from regions of greater to those of lower concentration. Thus if sugar is used up at a growing point, more flows automatically to that point. Or, if sugar is removed for

storage as starch, more sugar flows in. However, the plant is not entirely 'at the mercy' of osmosis and diffusion. The

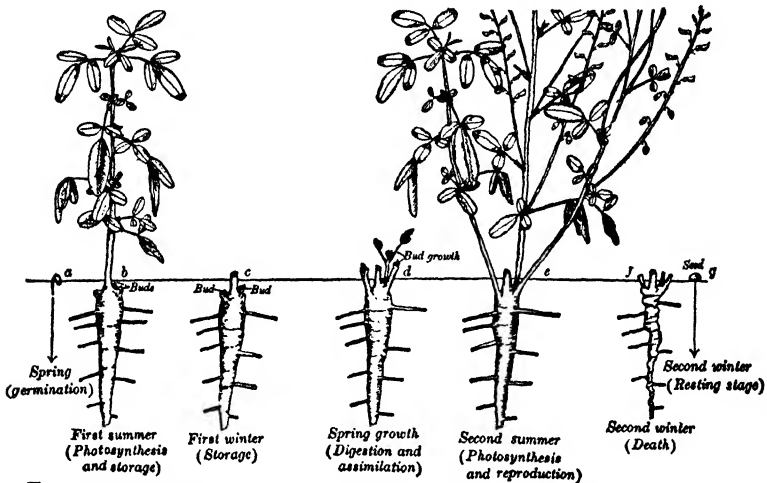

FIG. 56. The seasonal history of a biennial plant, White Sweet Clover. (From Densmore.)

cellular mechanism is highly sensitive. It coördinates these phenomena, in ways as yet unknown, for the welfare of the organism as a whole.

### 3. Food Utilization

The food which the plant has constructed and translocated to the various parts of its body must be employed by the individual cells in supplying the material and energy for their life processes. When the food stream reaches the cells, they select not only the materials essential for their individual life, but in addition those which they require for the performance of their particular part in the economy of the whole. They may employ these as received or elaborate from them by enzyme action the specific proteins, carbohydrates, or fats needed. But doing this implies work, and work means expenditure of energy — the same energy of sunlight which was stored in the food during its construction by the chlorenchyma cells. In order to release this energy

RESPIRATION must occur. Carbohydrates, fats, and proteins must be oxidized, that is, burned, and consequently free oxygen transmitted throughout the plant to the various cells, and carbon dioxide carried away. This is effected by an intercellular system of air spaces which ramifies throughout the plant and communicates with the surrounding atmosphere chiefly by way of the stomata, but also to some extent through the lenticels on the stem. (Figs. 43, 55.)

#### 4. Irritability and Adaptation

Finally, it is important not to lose sight of the unity of the organism as a whole which results from the coöperation of the various cellular elements comprising the plant body. The plant not only is adapted but is adaptable to its environment, both living and lifeless. The protoplasm responds to stimuli by its inherent power of irritability just as truly, though not so actively or so complexly, as do animals with a nervous system. The response is a change in either structure or function, or both, and usually is due to growth, so it appears chiefly in young, developing parts. However, the so-called "sleep movements" of some plants such as the well-known Sensitive Plant, *Mimosa*, are the result of rapid changes in the turgor of special cells. (Fig. 57.)

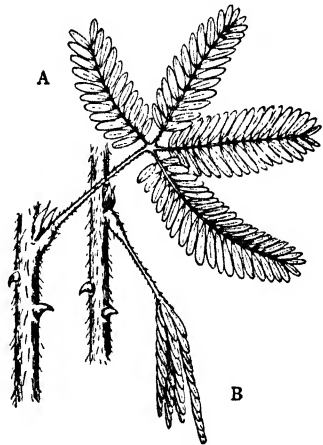

FIG. 57. Sensitive Plant, *Mimosa pudica*, showing A, leaf in typical position; and B, after mechanical stimulation.

Some stimuli effecting growth responses apparently arise within the plant, such as those which induce a constant rotation of the tips of developing stems, but the great majority are environmental changes, notably light, gravity, pressure, moisture, temperature, and various chemical substances, as well as other plants and animals.

The most obvious, because immediate, responses are growth movements in a direction that is determined by the direction of the stimulus, and are termed **TROPISMS**. Thus we are familiar with specific reactions to light, or **PHOTOTROPISM**, in which the root is *negatively* phototropic — it

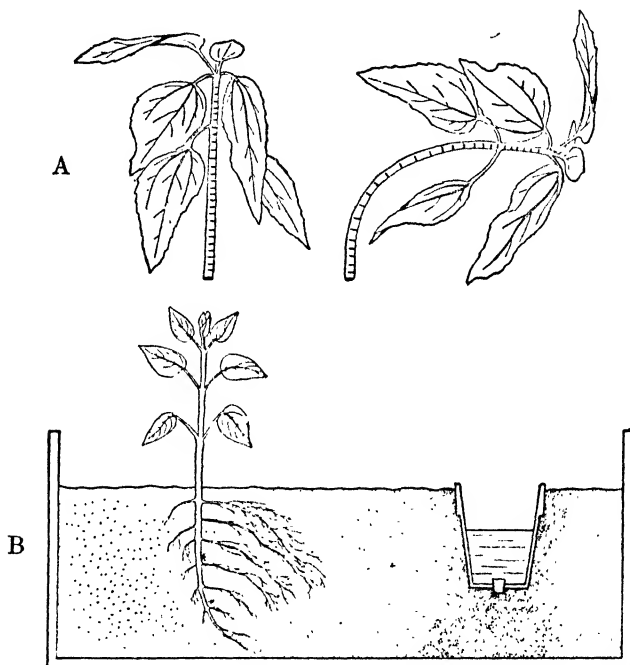

FIG. 58. A, Phototropism. Left, part of a Sunflower plant with its stem marked at equal intervals. Right, the same plant after exposure to a one-sided illumination. Bending occurs in the region of elongation. B, Hydrotropism. Section of a box containing sand, with a plant and a porous flower pot containing water. The unequal water content of the soil on different sides of the plant affects both the form and the direction of growth of the roots. (From Smith and others.)

grows away from the source of light, and the shoot is *positively* phototropic — it grows toward the light. Conversely, the response to gravity, or **GEOTROPISM**, of the root is positive and of the shoot is negative. Chemical substances, of course, have many and varied influences on growth and in some cases apparently determine its direction. Thus **CHEMOTROPISM** is exhibited by the growth of the pollen

tube down the stigma of the flower, to be described later. Furthermore, responses to mechanical stimuli, such as pressure, or **THIGMOTROPISM**, are well shown by the tendrils of climbing plants and the turgor reaction of the Sensitive Plant already mentioned. Roots, in particular, exhibit **HYDROTROPISM** in their growth through the soil. (Fig. 58; Pp. 119, 120.)

In fact, water is so crucial for plants — it forms over nine tenths of some plant tissues — that various species show inherited adaptations to greater or less moisture: characteristics that lead to their designation as **HYDROPHYTES**, or plants that live partly or completely submersed; **MESOPHYTES**, or the great majority of plants that require a moderate water supply; and **XEROPHYTES**, or drought-enduring species.

In brief, the plant is not static either as an individual or a species. To live it must react to its environment. Most of these reactions are growth responses which, in some cases at least, are brought about through the action of so-called **PHYTOHORMONES** — special chemical substances that are distributed hither and yon through the plant. (Fig. 59.)

Indeed there is a system of hormones whereby growth and other processes in one part are both stimulated and controlled from other parts of the body. Thus the **AUXINS** that promote root growth are formed in the tips of the growing shoots, and mature leaves manufacture hormones that influence the growth of younger leaves, and others that determine the development of flowers. The reactions of seedlings to light are brought about by auxins that induce an elongation of cells that are in the dark and consequently a

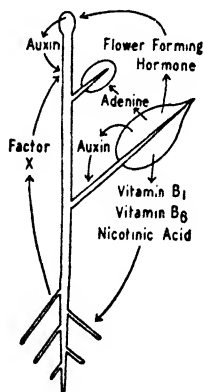

FIG. 59. Some hormone and hormone-like chemical interrelationships between the organs of a plant. Arrows extend from point of origin of a specific substance to where it is translocated for use. In upward sequence are shown: root, mature leaf and stem, growing leaf and stem, and apical bud. "The plant is a true democracy, one for all and all for one." (From Went.)

bending of the whole toward the light. Again so-called wound hormones stimulate cell division and so the development of a protective layer over the surface of wounds. And withal, biochemists recently have been able to artificially synthesize some growth-promoting substances with the result that it is now possible to induce greatly accelerated growth and to control certain processes, such as the induction of roots on cuttings otherwise non-rooting, the prevention of abnormal dropping of young fruit, and so on.

We have now surveyed the structure and functions of a typical higher plant as a whole and, in particular, have indicated how the organism is specialized for the chief function which primarily concerns the individual: that is, nutrition, or the transformation of matter and energy into life and work. Since, however, the duration of the existence of the individual is relatively limited, it is obvious that some provision must exist for the continuation of the race. In other words, new individuals must be formed. Reproduction occurs.

## CHAPTER VII

# REPRODUCTION IN PLANTS

The synthetic act by which the organism maintains itself is fundamentally of the same nature as that by which it repairs itself when it has undergone mutilation, and by which it multiplies and reproduces itself. — *Bernard.*

**W**e have considered the gradual increase in complexity of the plant body from the unicellular condition, through colonies of essentially similar cells and the thallus type, to that of some typical higher plants, placing emphasis on organs directly or indirectly associated with nutrition. It is necessary now to review in a similar manner the specializations of structure and function which exist in the plant kingdom for the multiplication of individuals.

As has been seen, in *Protococcus* all the life processes essential to the individual are exhibited in relative simplicity and without obviously complicated apparatus. Moreover, the continuation of the race is provided for by the individual cell dividing to form two new cells. Neglecting for the time being the mechanism of cell division, it is clear that reproduction in *Protococcus*, since it is not complicated by specialized organs for its performance, is a comparatively simple process. (Fig. 13.)

It may be well to reiterate here that reproduction and growth are phenomena which are intrinsically the same — both are the result of a preponderance of the constructive phase of metabolism. The single cell, whether a whole organism or a single unit of a complex body, increases in volume up to a certain limit and then divides. In the former case two new individuals replace the parent cell; in the latter, the complex body has been increased to the extent of one



cell. In both cases cell division has resulted in cell reproduction. Thus cell division is always reproduction, though it is customary and convenient to restrict the term reproduction to cell divisions which result in the formation of new individuals — single cells or groups of cells which sooner or later separate from the parent organism. (Pp. 14, 32.)

### A. SPORE FORMATION

That cell division in multicellular plants results in the growth of the single individual is well illustrated by the simpler Green Algae, such as *Spirogyra* and *Ulothrix*, in which the plant body consists of a series of similar cells placed end to end to form a long threadlike body. In such cases, cell division merely increases the length of the filament constituting the body, unless the newly formed cell becomes detached from the parent plant. As a matter of fact, in some species, under certain conditions the protoplasmic content, or **PROTOPLAST**, actually makes its escape from the cell wall and swims about in the surrounding water. This independent protoplast is a **SPORE**. (Figs. 7 C, 60, 61.)

Moreover, this spore now begins a series of cell divisions which result in a new filament, or individual. Therefore a spore is a cell, or the essential part of a cell, the protoplast, which has separated from one plant body and is capable of producing another plant body. This statement might seem to indicate that spore formation is restricted to plants with multicellular bodies, but, as a matter of fact, spore formation occurs in the life history of many unicellular plants as, for example, *Sphaerella*. It will be noted that the cell divisions which produce the spores do not involve the cell wall; merely the protoplast within divides and the daughter cells make their escape. (Fig. 60.)

Therefore spore formation is not a necessary result of the establishment of a multicellular body, but an inheritance from unicellular forms which makes possible one of the two effective types of asexual reproduction in the Metaphyta.

The other type is **FRAGMENTATION** which consists essentially in the separation from the body of larger or smaller parts which later reproduce the whole plant. It is a familiar fact that, under proper conditions, cuttings, buds, bulbs, and sometimes pieces of leaves may reproduce or, as it is sometimes stated, **REGENERATE** a complete plant. This is just an expression of the same power which the spore, though a single cell, exhibits. It regenerates, as it were, a plant body similar to the one from which it has separated.

## B. GAMETE FORMATION

During the life history of some unicellular plants, such as *Sphaerella*, under certain conditions a cell, instead of dividing to form a few spores, divides many times to form a considerable number of small cells. These are **GAMETES**. Then they fuse in pairs and it is this behavior of the gametes which particularly distinguishes them from spores. In a general way, from the standpoint of their origin, gametes may be regarded as spores which have developed the habit of fusing to form a **ZYGOTE**. Moreover, the origin of gametes is the origin of **SEX**, and the fusion of these sex cells is **FERTILIZATION**. (Figs. 7 A, B; 60-63.)

Another example will emphasize this point. The body of a filamentous Alga, *Ulothrix*, is composed of a linear series of cells all of which are essentially the same in structure and function. Under favorable conditions the cells divide and the plant grows in length. New individuals are not formed by this process, although the mechanical breaking, fragmentation, of the filament into two parts, owing to the simplicity of the body, gives two individuals. But under certain conditions some of the cells cease to contribute to the elongation of the filament. Instead, the protoplasts begin to divide within their cell walls, and thus each forms from 2 to 64 or more cells of different sizes, depending upon the number of divisions the parent protoplast undergoes. (Fig. 61.)

•

Now the behavior of the cells of different sizes is characteristic and significant. The largest and those of intermediate size are spores because they soon settle down and develop

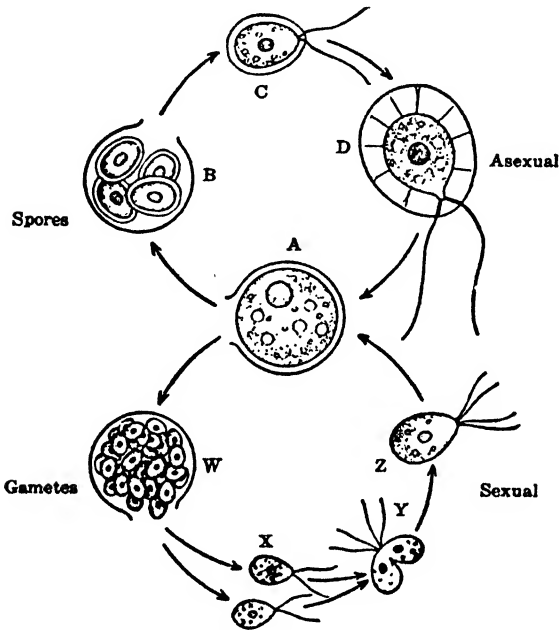

FIG. 60. General plan of the life history of certain unicellular plants, such as *Sphaerella*. A, B, C, D, asexual cycle; A, W, X, Y, Z, sexual cycle. A, dormant cell enclosed within a protective cyst wall which has ruptured to allow the enclosed protoplast to escape; B, division of the protoplast to form four spores (C) each of which grows, develops two flagella, and assumes the typical 'adult' free living form (D). This may reproduce many times, each time forming four cells within a cyst, but eventually each cell assumes the dormant form (A) again. Under other circumstances the protoplast from the dormant form may divide until many small cells (W) are formed. These make their escape and are gametes (X) since they fuse in pairs (Y). The composite cell resulting from fertilization is a zygote (Z) which soon forms a cyst wall and assumes the dormant phase.

into new filaments. On the other hand, the smallest cells unite in pairs, each pair fusing to form a large single cell. It is apparent that these cells by fusing, instead of germinating, behave sexually and therefore are gametes, while the product of this process is a zygote. So it appears that sexual reproduction arose when certain cells, apparently similar to

spores, assumed the habit of pairing to form a zygote before germination.

It should be noted that sexual reproduction is not a different kind of reproduction, but merely reproduction *preceded* by the formation of a zygote; a fact very readily

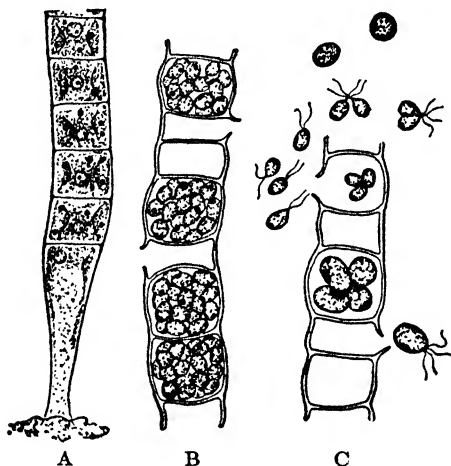

FIG. 61. *Ulothrix*, a filamentous Green Alga. Highly magnified. A, modified cell for attachment at the base of a filament; B, cells of a filament which have formed spores: from three cells the spores have been liberated; C, part of a filament liberating spores (below), and gametes (above) which pair to form zygotes. (From Coulter.)

lost sight of in the higher forms where accessory phenomena connected with sexuality obscure the essential features, but quite apparent in *Ulothrix* because here the zygote does not directly form a new filament. Instead, after passing a longer or shorter time in a dormant condition protected by a heavy wall, the protoplast (zygote) within divides to form a number of swimming spores, each of which then develops into a new individual.

### C. SEX DIFFERENTIATION

So far we have seen that sex cells, the gametes, arose with the establishment of the habit of cells uniting in pairs. This is obviously a statement of fact rather than an explanation

of sex. Although the two cells which fuse show no morphological characters by which they can be distinguished from each other, there is certainly a *physiological* basis of sex which induces them to swim toward each other, to become oriented so that fusion begins at the flagellated ends, and to

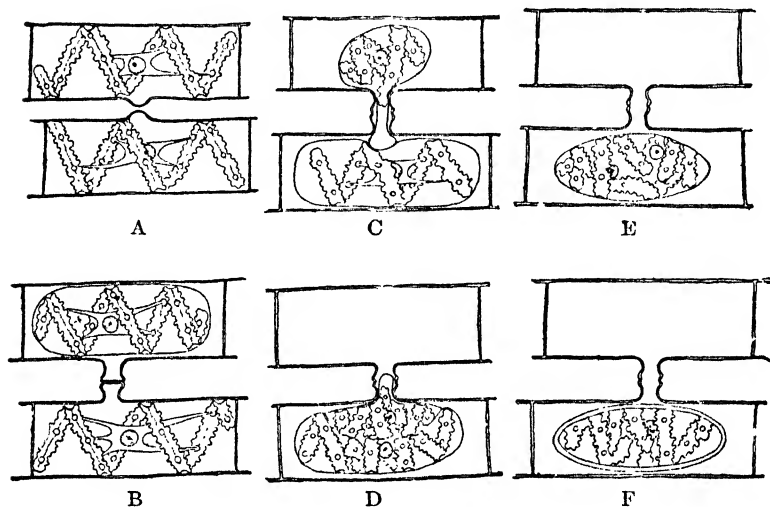

FIG. 62. Spirogyra. Stages in the union of gametes and the formation of the zygote. Highly magnified. See Fig. 27. (From Smith and others.)

melt into a single cell. This is a reorganized cell with the complicated structural and physiological equipment of the two cells which entered into its make-up. The zygote thus is a cell which *combines* the characteristics of both the contributing gametes, and to this significant fact must be attributed the chief importance of sex phenomena in the life history of plants as well as of animals. We shall return later to this subject. (Pp. 439, 440.)

Although sexuality is first evident as a physiological difference between gametes which leads to their characteristic behavior (zygote formation), even among the lower plants *structural* differentiations appear. In fact, a series of plants can be arranged showing the transition from gametes which appear morphologically identical to those which differ so

widely that they seem to have little in common. *Oedogonium*, another filamentous Alga, will suffice as an example since it affords an excellent illustration of gamete differentiation. One form of *Oedogonium* gamete, representing an entire protoplast of a greatly enlarged cell, is richly supplied with food materials and chloroplasts and remains motionless within the cell wall. The other type develops in pairs in small cells with greatly reduced chloroplasts and food content. Instead of being motionless, each cell is provided with a circle of cilia by which it leaves its place of origin, swims actively in the water and, entering a cleft in the wall surrounding a large gamete, fuses with it to form a zygote. (Figs. 63, 64.)

In short, one gamete, designated the EGG, is a large non-motile cell stored with food materials, while the other gamete, or SPERM, is a small active cell largely devoid of food. This is typical of the conditions which are at the foundation of gamete

differentiation throughout the plant and animal kingdoms — eggs and sperm expressing a physiological division of labor which entails structural specialization in opposite directions. (Figs. 7 A, B; 8 A; 255.)

In *Oedogonium* sexuality is apparent both in the behavior and in the structure of the gametes, so that it is possible to identify the sex cells as male gametes, or sperm, and female gametes, or eggs. It will be noted that this is not the origin

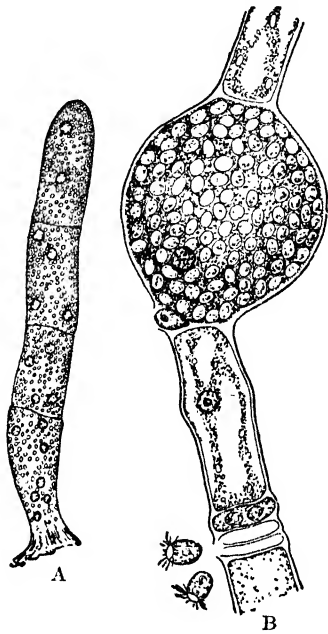

FIG. 63. *Oedogonium*, a filamentous Green Alga. A, young filament; B, portion of a filament forming gametes (egg and sperm). Below are two sperm which have just been liberated; above is a large egg with a sperm just coming into contact with it to form a zygote. Highly magnified. (From Coulter.)

of sex, for sex arose when certain cells by their behavior became gametes. In other words, sexuality is expressed by

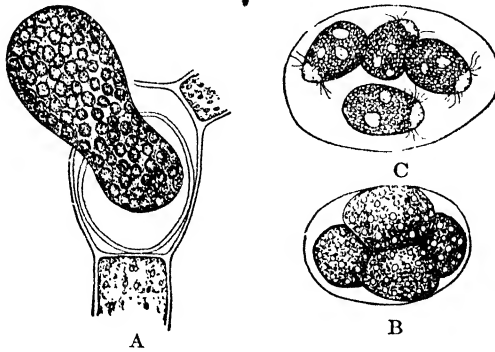

FIG. 64. Oedogonium. A, zygote emerging from cell of parent filament; B, division of zygote into four spores; C, mature spores ready to escape and develop into new filaments. Note that the zygote does not give rise directly to a filament, but to spores. Highly magnified. (From Coulter.)

the fusion of two cells which reorganize as a single cell; and all obvious modifications of these cells, which enable them to function as gametes, are secondary.

#### D. REPRODUCTIVE ORGANS

Hand in hand with the specialization of spores and gametes there is a progressive modification of the cells or groups of cells which produce them, until highly developed REPRODUCTIVE ORGANS arise. The asexual reproductive cells, or spores, are formed in SPORANGIA, which may be merely vegetative cells in which the protoplast becomes transformed into a spore, or elaborate multicellular structures set aside for this one function. Similarly, with the origin of sexuality, the sex cells, or gametes, arise in GAMETANGIA, which later are distinguished as ANTHERIDIA, or sperm-producing, and ARCHEGONIA, or egg-producing organs. Moreover, although the terms male and female are strictly applicable only to the sperm and eggs respectively, the antheridia and archegonia are called male and female organs; while a plant body which bears only male reproductive

organs is designated as a male plant and one which bears female reproductive organs is known as a female plant. In short, the sexuality of the gametes is reflected back, as it were, to the organs and then to the individual which bears them; although the gametes are the actual sex cells. If this is kept clearly in mind it will obviate confusion in considering the remarkably specialized secondary features which sexuality imposes on the bodies of higher plants and animals. (Fig. 65.)

We may now review the facts before proceeding to further complications. Reproduction, divested of its specialized features, is merely growth expressed in cell divisions. This primary potentiality of all cells may exist side by side with the development of cells specialized for asexual reproduction (spores) and sexual reproduction (gametes). In either case the products become separated from the parent body and develop new bodies. Furthermore, spores which in the lowest forms are developed from any of the vegetative cells of the plant body, in higher forms arise in asexual reproductive organs (sporangia), while gametes are produced in sexual reproductive organs (gametangia). With the morphological differentiation of gametes into sperm and eggs, a further specialization of the gamete-forming organs results in male and female reproductive organs (antheridia and archegonia). When sporangia and gametangia are borne by separate individuals, asexual plants (SPOROPHYTES) and sexual plants (GAMETOPHYTES) result.

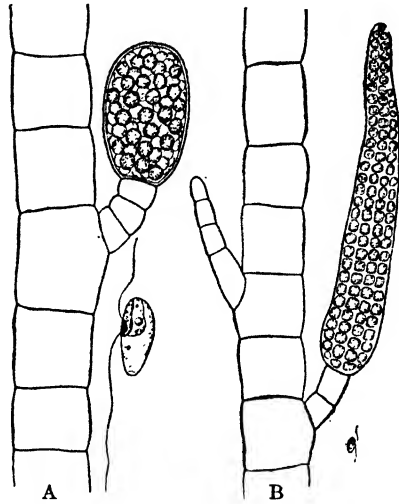

FIG. 65. A Brown Alga, *Ectocarpus*. A, portion of a filament with a sporangium and a liberated spore; B, portion with a gametangium and a liberated gamete. Highly magnified. (From Coulter.)



Finally, antheridia and archegonia may be borne on separate gametophytes, in which case male and female gametophytes result.

## E. ALTERNATION OF GENERATIONS

From the standpoint of the evolution of the higher plants a significant fact stated above is that sporangia and gametangia may be borne by separate individuals, for this involves an asexual, spore-bearing generation, or sporophyte, and a sexual, gamete-bearing generation, or gametophyte. We shall outline this ALTERNATION OF GENERATIONS in the life history of a typical Moss and Fern as an introduction to the problem of reproduction in the higher Seed Plants.

### 1. The Moss

The common Mosses are a relatively inconspicuous but nevertheless an important part of our flora, because they form heavy growths or carpets of vegetation which hold back much of the rainfall so that it sinks into the soil. Although there are about 14,000 species which botanists include in the class *Musci* of the BRYOPHYTA, a general description of a typical common Moss, such as *Polytrichum commune*, will suffice for the purpose at hand. (Pp. 142-145.)

The shoot of a moss plant is differentiated into a very short stem with an upright branch bearing leaves; all of simple structure in comparison with those of the seed plants we have studied. True roots are not present, but their function is in part performed by filamentous outgrowths called RHIZOIDS. At the top of the leafy moss plant, inconspicuous reproductive organs are developed. Some species bear both antheridia and archegonia on the same plant, while others have only one type. The leafy moss plant is thus a sexual individual, or gametophyte. When the reproductive organs are mature, sperm escape from the antheridia and, swimming about in moisture which has collected on the leaves, are attracted to the archegonia containing the

eggs by a chemical substance secreted within these organs. A single sperm which has made its way down into an archegonium fuses with the egg to form a zygote. The fertilized egg retains its position in the archegonium and germinates.

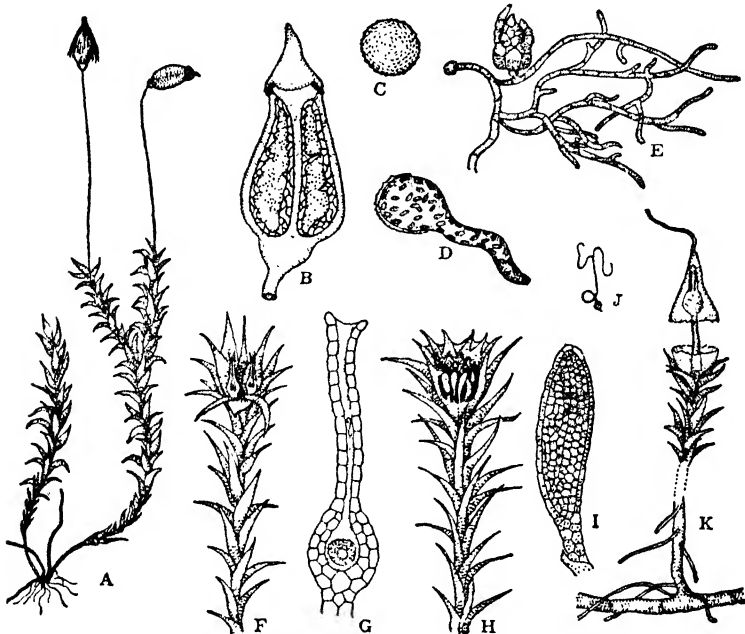

FIG. 66. The life history of a Moss, chiefly *Polytrichum*. A, the entire plant (gametophyte and sporophyte),  $\times \frac{1}{2}$ ; B, median vertical section of the capsule in which spores are formed,  $\times 6$ , with spore (C) and germinating spore (D),  $\times 300$ ; E, spore germinated to a protonema with a bud which forms leafy plant (gametophyte),  $\times 75$ ; F, tip of gametophyte with two archegonia,  $\times 2$ ; G, archegonium in section showing egg,  $\times 16$ ; H, tip of gametophyte with antheridia,  $\times 2$ ; I, antheridium,  $\times 16$ ; J, a single liberated sperm,  $\times 600$ ; K, gametophyte with sporophyte developing in enlarged and transformed archegonium. (After Ganong.)

The result is a rod-shaped embryo which grows not only upward through the archegonium and so out into the world, but also downward into the tissues of the gametophyte from which it secures practically all of its food materials. (Fig. 66.)

The essentially parasitic nature of the new individual renders the development of leaves superfluous, so it consists

of a simple upright stalk at the top of which the reproductive organ is borne. This spore-case, or CAPSULE, produces spores and accordingly the individual is a sporophyte. The ripe spores are liberated and, falling to the ground, each forms a filamentous outgrowth called a PROTONEMA. Soon a bud arises on the protonema which develops into a leafy moss plant. The cycle is complete. (Fig. 67.)

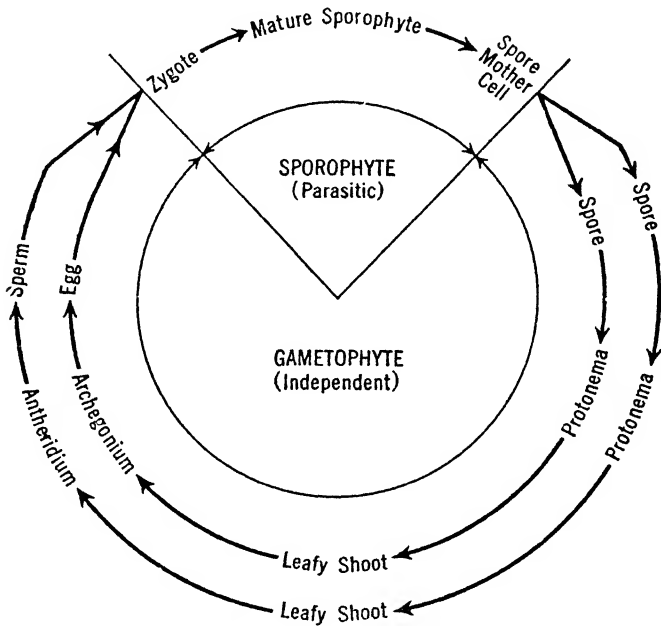

FIG. 67. Diagram of the life cycle of a Moss. (After Smith and others.)

A common Moss thus exhibits in its life history an alternation of sexual and asexual generations. The leafy moss plant, with antheridia and archegonia, produces gametes and is the gametophyte. The leafless generation, which develops from the fertilized egg in the archegonium, produces spores and is the sporophyte. So the gametophyte arises asexually, but is itself sexual; the sporophyte arises sexually but is itself asexual. The dominant generation from the viewpoint of both structure and nutrition — the plant one thinks of as a 'moss' — is the gametophyte.

## 2. The Fern

The common Ferns comprise a group of some 6,000 species, usually referred to as PTERIDOPHYTES. Although the forms of different species are remarkably varied, the ensemble of characters and in particular the foliage is quite distinctive, so that one would recognize practically any member of the group as a 'fern.' (Pp. 147, 148.)

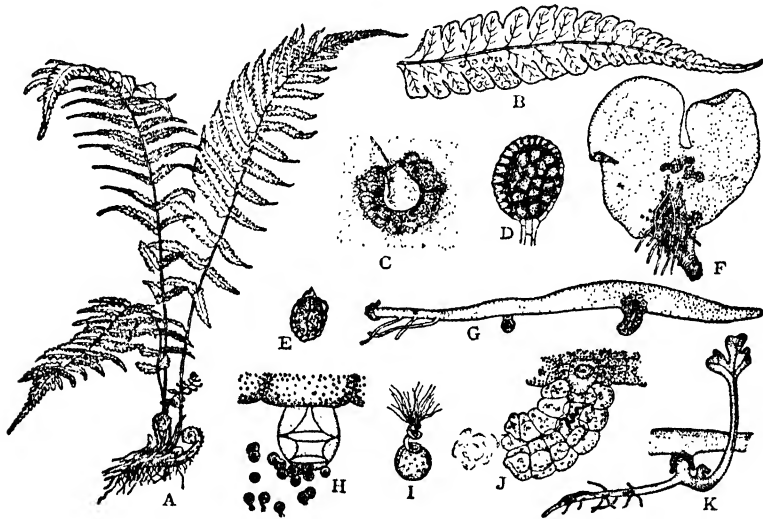

FIG. 68. The life history of a common Fern, chiefly *Aspidium*. A, the entire sporophyte,  $\times \frac{1}{10}$ ; B, portion of a leaf showing groups of sporangia (sori),  $\times \frac{1}{2}$ ; C, a sorus showing sporangia,  $\times 10$ ; D, a sporangium,  $\times 50$ ; E, a single spore,  $\times 100$ ; F, ventral view,  $\times 3$ , and G, a median section,  $\times 6$ , of a prothallus showing rhizoids, antheridia, and archegonia; H, antheridium liberating sperm,  $\times 120$ ; I, single sperm still attached to a remnant of 'mother cell,'  $\times 300$ ; J, open archegonium with sperm passing down to egg,  $\times 120$ ; K, young sporophyte developing from zygote in archegonium. (After Ganong.)

The stems may be short and close to the ground, or upright as in the Tree Ferns, though creeping and underground stems, or rhizomes, are more common. The leaves, known as FRONDS, either arise in clusters from the tip of the stem as in Tree Ferns and many common species, or in some cases are distributed along the rhizome. Roots bring the stem into intimate contact with the food materials of the soil,

though rhizomes function to a certain extent as roots. An examination of the cellular structure of a common Fern, such as *Aspidium marginale*, shows that it is much more complex than a Moss, the tissues of stem and leaves being essentially like those we have seen in the Seed Plants, and accordingly Ferns and their allies and Seed Plants are known as *vascular plants* or TRACHEOPHYTES. (Figs. 50, 99. P. 145.)

The fern plant bears, on certain of its leaves, reproductive organs which are sporangia. These, of course, produce spores and therefore the plant commonly recognized as a fern is a sporophyte. The spores when ripe are liberated from the sporangia and fall to the ground, where they germinate. From a spore arises a tiny body, about a quarter of an inch in diameter, called a PROTHALLUS, which is essentially a plate of chlorophyll-bearing cells with rhizoids attaching it to the ground. On its lower surface are developed reproductive organs, antheridia and archegonia, which form gametes. The prothallus therefore is a gametophyte. (Fig. 68.)

Sperm are liberated from the antheridia and swim in the moisture, from dew or rain, to the archegonia. A single sperm works its way down an archegonium and fuses with the egg to form a zygote. Then the zygote, which remains in the archegonium, proceeds to divide and forms at first a small plant with stem and leaf that grows upward and root that seeks the soil. During the process of root and shoot development the plant retains its attachment to the parent prothallus from which its food is secured. Later, when direct communication with the environment has been established by its own root and leaf, the new generation becomes entirely independent of the prothallus which then degenerates and dies. The young plant gradually grows into the typical asexual leafy plant, which itself in due time produces spores. The cycle is complete. (Fig. 69.)

It is clear that in the Fern, as in the Moss, there is an alternation of generations. The leafy fern plant (sporophyte) gives rise to the prothallus (gametophyte). The leafy fern arises sexually, but is itself asexual; the prothallus arises

asexually, but is itself sexual. The significant fact, however, is that the conspicuous leafy moss plant is a gametophyte, while the large leafy fern plant is a sporophyte; or, one may say, the 'moss' is a sexual plant and the 'fern' is an asexual

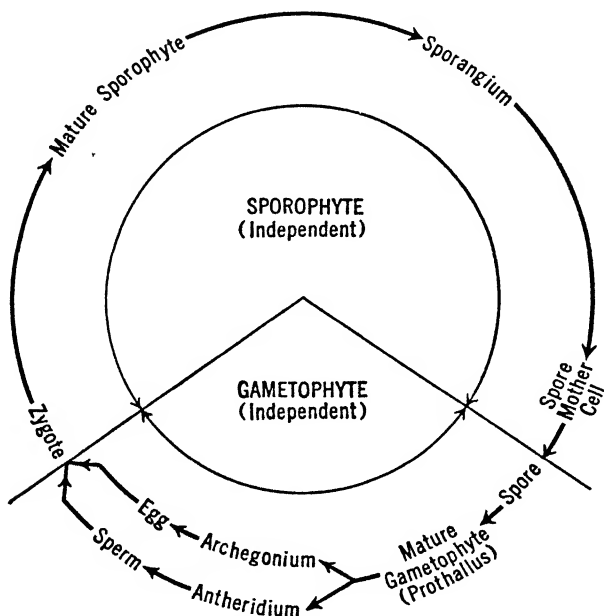

FIG. 69. Diagram of the life cycle of a Fern. See Fig. 67. (After Smith and others.)

plant. This ascendancy in dominance of the asexual and suppression of the sexual generation, which is so characteristic of the fern as compared with the moss life history, is carried still further in the higher Ferns and finally culminates in the Seed Plants.

### 3. Water Ferns

As we have seen, the sporophyte of the common Ferns produces spores on ordinary vegetative fronds or sometimes on more or less specialized sporophylls. In either case but one kind of spore is formed. However, in the Water Ferns,

and certain Fern allies, spores of two kinds occur which, since they differ greatly in size, are called MICROSPORES and MEGASPORES. The production of two kinds of spores is known as HETEROSPORY and leads to the differentiation of the sporophylls into MICROSPOROPHYLLS and MEGASPOROPHYLLS. The microspores on germination form microgametophytes which produce sperm, and therefore are called MALE GAMETOPHYTES, while the megaspores develop into megagametophytes bearing eggs, and accordingly are known as FEMALE GAMETOPHYTES. (Fig. 70.)

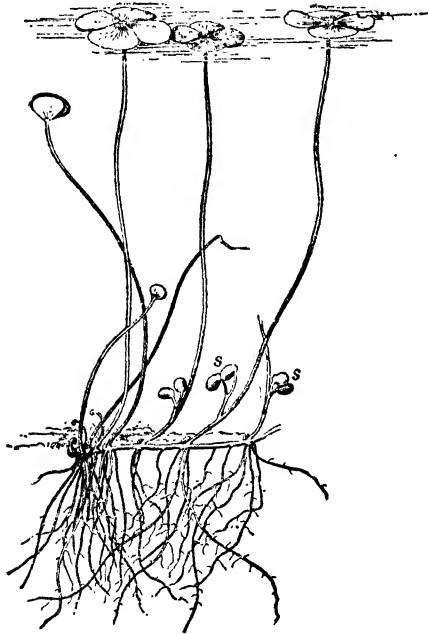

FIG. 70. The Clover-leaf Water Fern (*Marsilea*) showing special spore-bearing cases (s) in which are microsporangia and megasporangia. (From Bergen and Davis.)

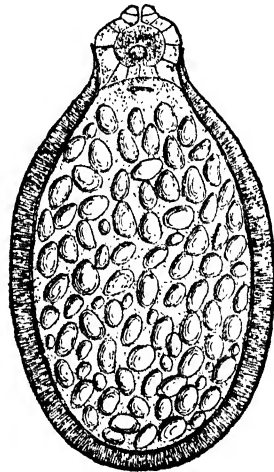

FIG. 71. Megaspore of *Marsilea*, enclosing food material (starch grains), and female gametophyte comprising a single archegonium (with egg) at one end of the spore.

Finally, in these heterosporous forms the gametophytes are no longer even small independent plants, such as the prothallus of the common Ferns, but both male and female gametophytes are so greatly reduced that they practically remain permanently in the parent microspore and megaspore,

respectively, which supply them with food. This, it will be noted, is just the reverse of the condition which exists in the Moss, where it is the sporophyte which is the dependent generation. (Fig. 71 ; P. 148.)

#### 4. Seed Plants

Passing to the higher Seed Plants, or Flowering Plants, we find that these are heterosporous sporophytes, and the FLOWER represents a greatly modified stem (branch), the leaves of which are specialized as sporophylls and accessory structures. In order to make this clear it is necessary to review the structure of a typical flower. (Figs. 51, 72.)

A complete flower consists of four whorls of modified leaves. These arise near together at the top of a RECEPTACLE, representing the enlarged tip of the floral branch, which connects the flower proper with the main tissue systems of the plant as a whole. The outermost and lowest circle of leaves (CALYX) is composed of several parts (SEPAL) which usually are green and retain a leaf-like appearance. Just within and above the calyx is the second circle (COROLLA) formed of larger leaves (PETALS) which are usually brightly colored. The calyx and corolla together form the PERIANTH, or floral envelope which surrounds the primary floral organs, the STAMENS and CARPELS.

The stamens represent the third circle of leaves, but are so highly modified that their leaf origin is not immediately apparent. Each consists of a slender FILAMENT at the apex of which is a small case known as the ANTHOR. Within the

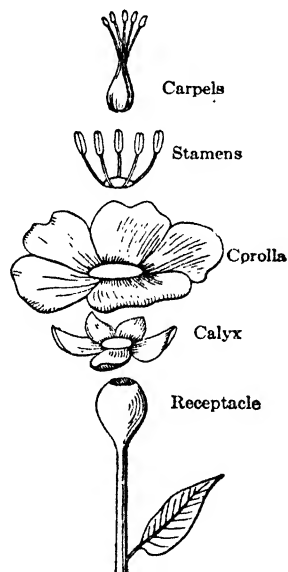

FIG. 72. Diagram of the parts of a typical flower. The pistil (compound) is formed of fused carpels.



anther POLLEN GRAINS are formed. The pollen grains arise from microspores and, therefore, the pollen sacs of the

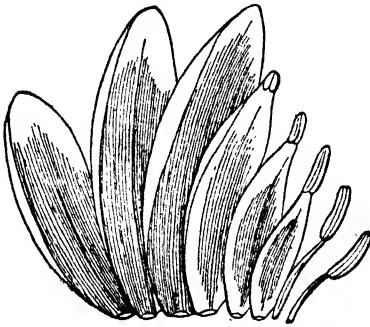

FIG. 73. Transition between petals and stamens in a Water Lily. (After Gray.)

anthers are MICROSPORANGIA and the stamens are microsporophylls. (Fig. 73.)

Finally, just within the circle of stamens is the fourth whorl of floral leaves, the carpels, in which specialization has gone so far that practically no suggestion of leaf structure remains. Each carpel consists of three parts: a lower, expanded portion termed the OVULE CASE, or 'ovary,' merging above into the elongated slender STYLE, the tip of which is the STIGMA. Such a fully-developed carpel is known as a PISTIL and when, as frequently happens, the various carpels fuse to form a composite structure, this is called a compound pistil. Within the ovule case are developed the reproductive bodies known as OVULES which are MEGASPORANGIA for within each is formed a megaspore. A carpel, therefore, is a megasporophyll. Incidentally, each ovule is a potential seed. (Figs. 72, 74.)

So far it is clear that a flower is a group of sporophylls which produce microspores and megaspores. Since, however, such reproductive bodies always form male and female gametophytes, their development must now be considered.

The first fact to have clearly in mind is that the megaspore is never liberated by the megasporangium; and further that the latter remains just where it arose in the ovule

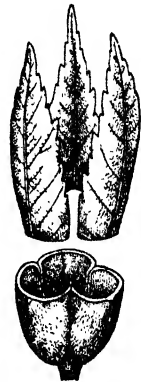

FIG. 74. Diagram to illustrate the method of union of three carpels (megasporophylls) to form the ovule case of a pistil (compound). The edges which unite form the point of attachment of the ovules. (After Gray.)

case of the pistil. Consequently the megaspore germinates within the pistil, and it forms there a female gametophyte composed of only a few cells, including the female gamete, or egg. Thus the female gametophyte generation of Seed Plants is invisible unless the contents of the pistil are examined with the microscope. (Fig. 75.)

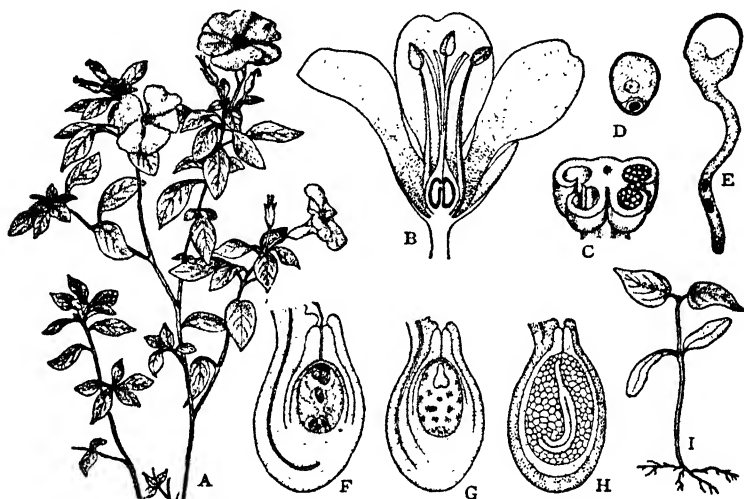

FIG. 75. The life history of a higher Seed Plant, from various species. A, shoot of a Flax with flowers,  $\times \frac{1}{3}$ ; B, vertical section of a flower,  $\times \frac{1}{3}$ ; C, an anther cut to show four microsporangia containing pollen grains (microspores),  $\times 6$ ; D, an ungerminated pollen grain, and one, E, which has formed tube (male gametophyte),  $\times 110$ ; F, longitudinal section of an ovule enclosing megaspore and its contents (female gametophyte),  $\times 20$ ; G, an ovule transformed into a seed with young embryo sporophyte and endosperm,  $\times 10$ ; H, a mature seed,  $\times 5$ ; I, young sporophyte from the germination of the seed,  $\times \frac{1}{2}$ . (After Ganong.)

The pollen grain develops from a typical microspore which is a single cell enclosed within a protective wall. While it is still in the anther its nucleus divides and two cells are formed, but further development does not occur until the pollen is transferred in some way, usually by insects or the wind, to the stigma of the pistil. The stigma secretes fluids suitable for the germination of the ripe pollen grain, which bursts its rigid wall and puts forth a cytoplasmic tube. This grows down through the tissues of the pistil until its tip

enters the ovule case, and carries with it the two nuclei, one of which divides again to form two nuclei which represent sperm. The pollen has now completed its development and thus the contents of the pollen grain plus the tube constitute a greatly reduced male gametophyte. (Figs. 7, 76.)

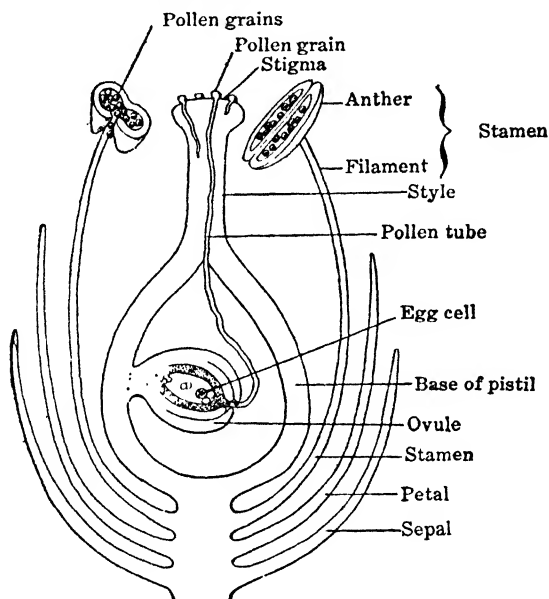

FIG. 76. Diagram of a flower, showing pollination and fertilization.

By the time the pollen tube reaches the ovule case, the megaspore within has formed, as already described, the female gametophyte with its egg. So the ovule case has indeed become an OVARY. One of the sperm nuclei unites with the egg and forms a zygote which remains just where it is, surrounded by the tissues of the ovule which is itself attached to the ovule case, and proceeds to divide to form an embryo sporophyte with rudimentary root, stem, and leaf. Concurrently, the ovary and associated tissues of the base of the pistil undergo more or less profound changes, or ripen, and become transformed into a FRUIT. The young sporophyte within, together with food material, or ENDOSPERM, for its further development, formed under the influ-

ence of the other sperm nucleus, is sealed by a seed coat into a special packet. It has become a SEED. In this form the new generation is prepared not only to leave the parent plant and withstand adverse conditions for a long time, but also to continue rapidly its development into an adult sporophyte when it falls upon favorable soil. (Figs. 77, 78.)

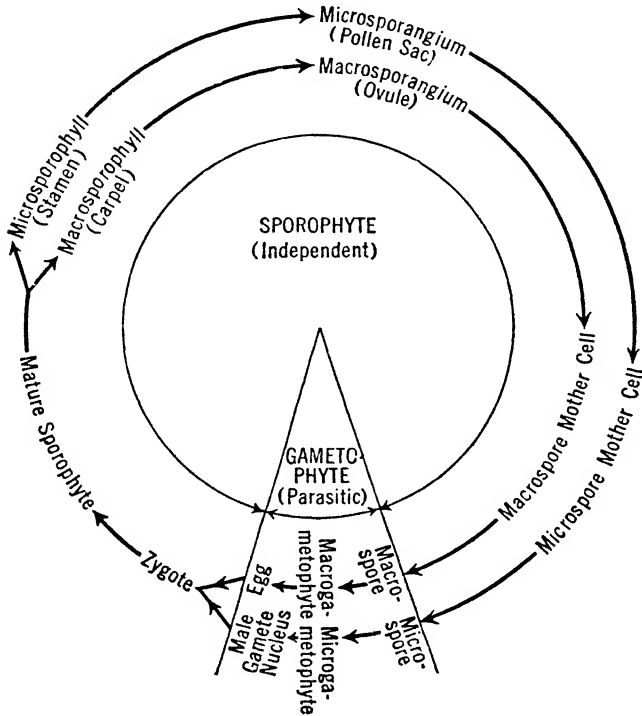

FIG. 77. Diagram of the life cycle of a higher Seed Plant. See Figs. 67, 69. (After Smith and others.)

Thus it is clear that the gametophyte generation of Seed Plants is reduced to its lowest terms—little more than sufficient to form the gametes. The whole generation is telescoped, as it were, within the flower of the previous sporophyte generation, so that sporophyte seems to produce sporophyte; whereas, as a matter of fact, three distinct generations contribute to the formation of the seed. The

seed coat comprises tissue from the megasporangium of the parent sporophyte bearing the flower, and the embryo is the young sporophyte derived from the intervening gametophyte generation. Indeed, in lower Seed Plants, such as the Conifers, etc., endosperm stored in the seed actually represents tissue of the female gametophyte. (Figs. 78, 102.)

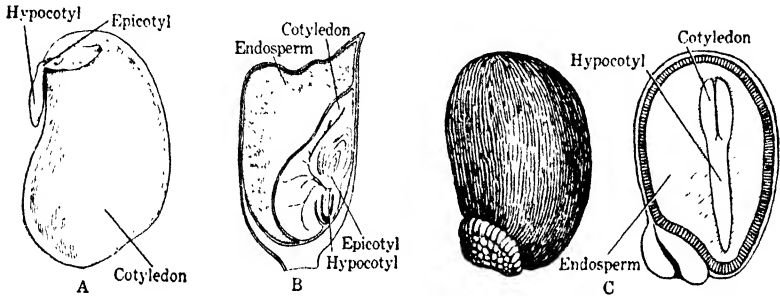

FIG. 78. Seeds. A, Bean with seed coats and one cotyledon removed; B, grain of Corn in longitudinal section; C, Violet showing hard seed coat, and longitudinal section of seed. (After Smith, and Coulter.)

The great reduction of the gametophyte generation in Seed Plants is accompanied by a transference of some of the phenomena associated with sexuality to the sporophyte, so that the latter, though intrinsically asexual, comes secondarily to exhibit certain sexual characters, chiefly in the flower. Thus, although both the stamens and carpels are actually sporophylls of the non-sexual generation, they are frequently referred to as the male and female organs of the flower, the ovule case of the pistil being called, from the first, the ovary. Likewise POLLINATION, or the transference of the pollen grains from anther to stigma, is often called the fertilization of the flower; whereas, as we have seen, it is merely a preliminary step which makes it possible for gametophytes to meet on common ground so that the sperm, which themselves have suffered reduction and lost their motility, can reach the egg and perform the act of fertilization. Frequently this sexual differentiation extends to the flower as a whole, since some flowers bear only stamens and others only carpels and are known as male and as female

flowers respectively. Moreover, male and female flowers may be borne on separate plants, in which case the plants themselves are called male and female. In brief, the terminology which strictly is applicable only to the sexual generation is, for convenience, transferred to the asexual generation, in consequence of the fact that accessory sexual functions are reflected back to it through the almost complete suppression of the actual sexual generation itself.

## F. SEED AND FRUIT

Before leaving the Seed Plants, still more emphasis must be placed on the seed which is their chief characteristic and apparently largely responsible for their dominance in the modern flora. The essential feature of the seed habit, it will be recalled, is the partial development of the young sporophyte within the tissues of the parent sporophyte, and its release, provided with food and protected by special coverings, as a seed. Obviously such a body has greater chances of wide dispersal and survival than a spore, and so contributes much more effectively to the perpetuation of the species.

The three chief parts of a seed are the embryo, endosperm, and seed coat, and each differs considerably in details in various plants. Thus, for example, the embryo in the Dicotyledons has two, nearly equal, laterally situated seed leaves or cotyledons, and between them a shoot, or EPICOTYL, above their point of origin, and a HYPOCOTYL, chiefly root, below. This is well shown in the Bean. In the Monocotyledons the embryo has one lateral cotyledon and an epicotyl and a hypocotyl, as in a grain of Indian Corn. (Figs. 78, 103, 104.)

The endosperm usually is present in seeds but this food-storage tissue may be quickly reduced by the food being absorbed and stored in the cotyledons, as in the Bean, or there may be a considerable amount of endosperm in the mature seed, as in the Corn and Violet.

The seed coat shows a scar, or HILUM, that marks its

former point of attachment in the ovary, and it is perforated by a **MICROPYLE** toward which the tip of the hypocotyl points.

Thus the new generation is tightly sealed in a case practically impervious to water and gases except through the micropyle; it is in a dormant condition, with the life processes reduced to a minimum, awaiting conditions favorable for

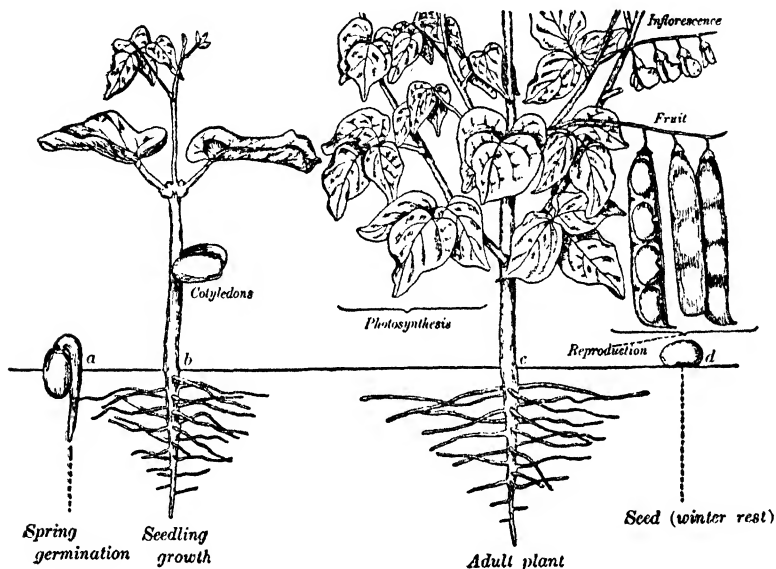

FIG. 79. The seasonal history of an annual plant, a Bean. See Fig. 56. (From Densmore.)

**GERMINATION.** Some seeds such as those of the Willows must germinate, if at all, within a few days, while others have to undergo a considerable period of so-called **AFTER-RIPENING** before development can occur. In addition to internal factors, germination is dependent upon various environmental factors, chiefly water, oxygen, and a proper temperature. The intake of water causes an internal swelling so that the seed coat ruptures, the hypocotyl protrudes — and the young plant is on its way. The length of time during which seeds remain capable of germination shows great variation. Tobacco seeds have germinated after twenty

years, but the statements that seeds have proved viable after a century or more may be questioned. (Fig. 79.)

During the process of seed development the ovule case surrounding the seed, often with other parts of the flower, becomes transformed into a fruit. So-called SIMPLE fruits are formed from one flower, AGGREGATE fruits from a group

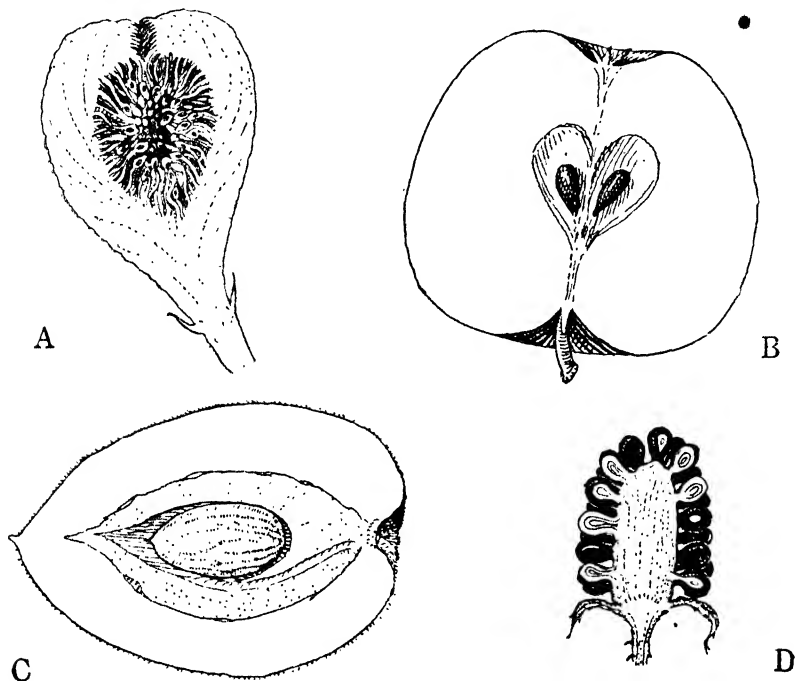

FIG. 80. Some types of fruits. A, 'fruit' of the Fig, comprising the hollow end of a branch enclosing a number of true fruits; B, Apple, pome type of fruit; C, stone fruit (drupe) of Peach, showing pit enclosing the seed; D, aggregate fruit of the Blackberry.

of adherent fruits in one flower, and MULTIPLE fruits from a close cluster of flowers. Under these three chief types the variations in fruit structure are legion. Among simple fruits are the various *dry fruits* such as the LEGUME or POD of the Pea and Bean, the CAPSULE of the Lily, the ACHENE of the Sunflower, the GRAIN of the Grasses, and the NUT of the Walnut; as well as *fleshy fruits* represented by the BERRY of



the Grape and Tomato, the DRUPE of the Peach, and the POME of the Apple. The Blackberry, Raspberry, and Strawberry are common aggregate fruits, while the Mulberry and Pineapple are multiple fruits. (Fig. 80.)

Such an array of fruits as accessories, as it were, of seeds, naturally raises the question of their significance, and the answer is that they apparently afford one of the chief agencies for seed, and therefore species, dispersal. Some seeds and

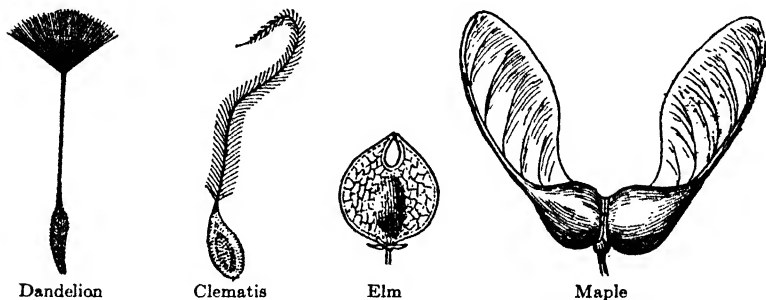

FIG. 81. Fruits and seeds dispersed by wind.

entire fruits are light and provided with long hairs or wings to facilitate distribution by wind. Others develop spines and hooks for attachment to the feet of birds or the fur of mammals. Fleshy fruits are eaten by birds and the indigestible seeds distributed. In still other cases their buoyancy allows them to be carried long distances by water. And so on, one adaptation after another — almost as many as are provided in flowers to facilitate a wide dissemination of the pollen for cross-fertilization. (Figs. 81, 82.)

A survey of the reproductive processes in plants impresses one with the fact that reproduction is, to a very large extent, asexual. The great masses of thallus vegetation, represented by the Algae and their allies, increase in bulk chiefly by vegetative cell division, and new individuals are formed in profusion by fragmentation and spore formation. In the Mosses, where the sexual generation is prominent, beds of moss are developed chiefly by the asexual budding of the

sexual plant, while spore formation holds a prominent place in the increase and dissemination of individuals. In the Ferns and Seed Plants, which are to all intents and purposes asexual plants, since the sexual phase is relegated to an increasingly obscure position in the life history, reproduction is not only by spores, but also in many cases by cuttings, bulbs, fragments of leaves, etc. In brief, reproduction, unaccompanied by sexual phenomena, is apparently amply sufficient for the propagation of plants. (Fig. 40.)

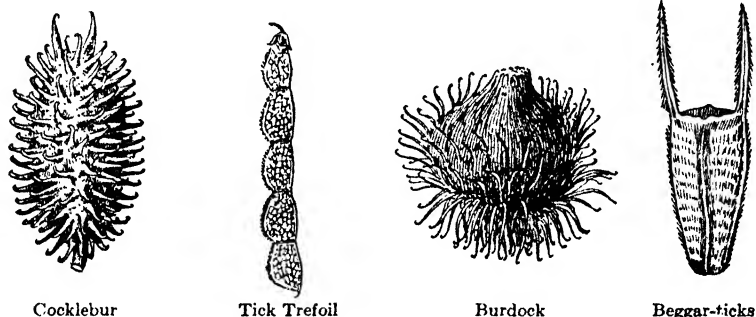

FIG. 82. Fruits and seeds dispersed by animals.

However, it will be noted that sexuality has persisted from its simple origin in gamete formation by unicellular plants. The gametophyte generation in the life history decreases in importance structurally as we proceed from the lower to the highest plants; but in spite of this fertilization is retained and greatly modifies all phases of a plant's life. Indeed, the interpolation of the sporophyte generation between gametophyte generations greatly multiplies the progeny of a single zygote: the zygote, instead of producing one new plant, gives rise indirectly through the sporophyte to a multitude of plants with whatever changes fertilization has conferred. Obviously important advantages must be gained in the long run by fertilization or such complex devices culminating in the flower would not have been evolved for its preservation. But the large problem of the significance of fertilization must be deferred until after sex in animals has been discussed. (Fig. 294, Pp. 439, 440.)

## CHAPTER VIII

# SURVEY OF THE PLANT KINGDOM

From so simple a beginning endless forms most beautiful and most wonderful have been, and are being evolved. -- *Darwin.*

**T**he world of life presents a varied pageant ranging from the simplest microscopic unicellular forms to the highly complex and often gigantic multicellular plants and animals — a multiplicity of types that is bewildering. So in any survey of organisms, first of all it is necessary to arrange the various kinds, or *SPECIES*, in some order — to classify them by placing near together those that are closely related in structure and function, and separating those that are less related. And if *relationship* is the basis of classification, we should know what the biologist means by relationship. The answer is: ‘blood relationship,’ descent with change from a common ancestor. But this large subject of species and their origin must be left until much later in our study; it may be merely stated now that although the object of a natural classification is to express the pedigrees of the organisms, most classifications are, at best, still very far from realizing this ideal.

The species is the unit in classification and, for the moment, may be broadly defined as a group of individuals which are alike in all of their essential characters, structural and physiological, and which produce similarly endowed individuals. The scientific name of a plant or animal consists of two words, written in italics, the first denoting the *GENUS* and the second the species. Thus all Sunflowers are members of the genus *Helianthus* and the common garden Sunflowers comprise the species *annuus*; the botanical name

of the garden Sunflower therefore is *Helianthus annuus*. (Pp. 559–562.)

One might wonder why it is necessary to employ unfamiliar Latin or Latinized names for organisms, until it is recalled that a plant or animal may have dozens of local names in one country, and, again, that the same name may be applied to different organisms in various countries. Witness the 'Loblolly Pine' (*Pinus taeda*) with over 30 local names in America; and the word *corn* which in England is applied to Wheat, in Scotland and Ireland to Oats, and in America to Maize, or Indian Corn, whereas the scientific name of Maize, *Zea mays*, means just one species to biologists the world over. (Fig. 118.)

For our purpose, classification can be reduced to a minimum — just enough to facilitate a synoptic view of the diversities of organisms. Thus in our immediate consideration of plants it will suffice initially to divide the Plant Kingdom, comprising about a quarter of a million known species, into three chief divisions, or PHYLA, in which structure and function apparently make the most, as it were, of new opportunities: the THALLOPHYTA, or Algae and Fungi; the BRYOPHYTA, or Mosses and kin; and the TRACHEOPHYTA, or Ferns and kin and Seed Plants. Most of the Seed Plants are commonly known as Flowering Plants. (P. 172.)

## A. THALLOPHYTES

The division Thallophyta comprises a number of widely divergent groups of plants, some unicellular and others with large multicellular bodies. The body, or thallus, of the latter takes many forms, filamentous, plate-like, etc., and considerable tissue differentiation occurs, but the typical root, stem, and leaf of higher plants are not developed. Some Thallophytes have an alternation of generations comparable to that which we are familiar with in higher plants. The Thallophyta is composed of two major series: the chlorophyll-bearing ALGAE and the FUNGI without this pigment.

1. *Algae*

The seaweeds and their fresh-water allies constitute the immense series of *Algae*: some of the simplest of them presumably similar to the green plants from which all the higher plants have been derived. Although all the *Algae* possess chlorophyll, in many the green color is masked by special pigments so that there are *BLUE-GREEN ALGAE* or *Myxophyceae*, *GREEN ALGAE* or *Chlorophyceae*, *BROWN ALGAE* or *Phaeophyceae*, and *RED ALGAE* or *Rhodophyceae*.

*BLUE-GREEN ALGAE*. Most of the *Blue-green Algae* form 'green-slimes' on wet rocks and soil, in ponds and puddles, which, when examined under the microscope, reveal single cells or chains and filaments of numerous associated cells. And the cells are so simple that there is no clearly differentiated nucleus, and the chlorophyll and other pigments are distributed in the cytoplasm and not confined to chloroplasts. Fur-

thermore, neither motile spores nor gametes are formed, so they are the lowest green plants. *Gloeocapsa*, a representative commonly found on damp rocks, consists of a single cell with a wall which swells to form a sticky jelly-like coat, so that cell division results in

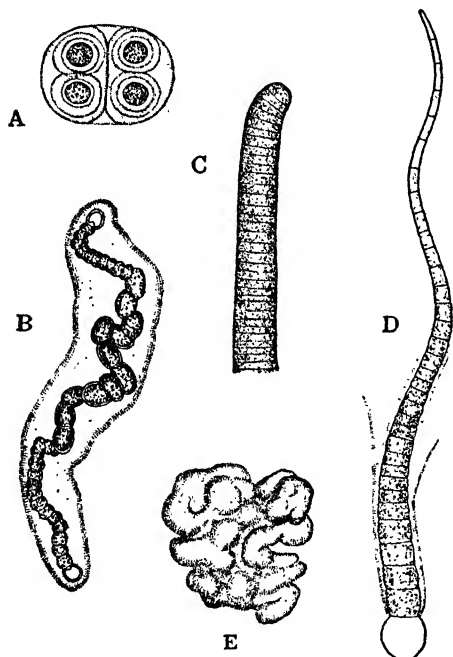

FIG. 83. Blue-green Algae. A, *Gloeocapsa*; B, *Nostoc*, single filament; C, *Oscillatoria*; D, *Rivularia*, single filament; E, *Rivularia*, colony. All highly magnified except E which is natural size. (After Engler and Prantl.)

thermore, neither motile spores nor gametes are formed, so they are the lowest green plants.

*Gloeocapsa*, a representative commonly found on damp rocks, consists of a single cell with a wall which swells to form a sticky jelly-like coat, so that cell division results in

temporary colonies. Apparently the presence of a gelatinous covering makes it possible for many Blue-green Algae to thrive in more dry situations than would otherwise be possible. (Fig. 83.)

Oscillatoria, living submerged in shallow water or on damp soil, serves to illustrate the common filamentous forms — merely a thread of disk-shaped cells. Thus, as each cell divides, it contributes to the elongation of the filament which sooner or later breaks into two. Strangely enough, the filaments have the power of movement — chiefly a feeble creeping or spiral swinging. Other common filamentous forms are Nostoc and Rivularia. (Fig. 83.)

Although most Blue-green Algae live in fresh water, Trichodesmium, which forms an additional reddish pigment, floats sometimes in immense numbers in marine waters, for instance, the Red Sea — hence the name.

**GREEN ALGAE.** The Green Algae comprise an immense and varied assemblage of forms inhabiting both salt and fresh waters; in the latter constituting the dominant algal flora. Some are attached while others are free, contributing a large portion to the floating population of microscopic plants and animals known as PLANKTON. In common with some Blue-green and Brown Algae, many species find reservoirs an especially favorable abode and so prove a nuisance in municipal water supplies. However, the moisture of damp soil, shaded rocks, and tree trunks suffices for some species, while others flourish in brine lakes and on the surface of snow. The plant body may be unicellular, filamentous, or a plate of cells. In every case the cells are more highly differentiated than in the Blue-green Algae, since a definite nucleus and one or more chloroplasts are present.

The Green Algae are believed to be near the main line of ascent of the higher plants and accordingly have been intensively studied. It will be recalled that we have considered several representatives — for example, the unicellular Proto-coccus and Sphaerella, and the filamentous Ulothrix, Oedogonium, and Spirogyra — not only to illustrate the es-

establishment of the simple thalloid plant body, but also the development of motile spores and the origin of gametes and sexual reproduction. Ulothrix and Oedogonium are commonly found as bright green films on stones in sluggish streams, ponds, and fountains; while Spirogyra ordinarily floats in tangled masses as 'pond scum,' buoyed by bubbles of gas, chiefly oxygen from photosynthesis. (Figs. 13, 22, 27, 60-64.)

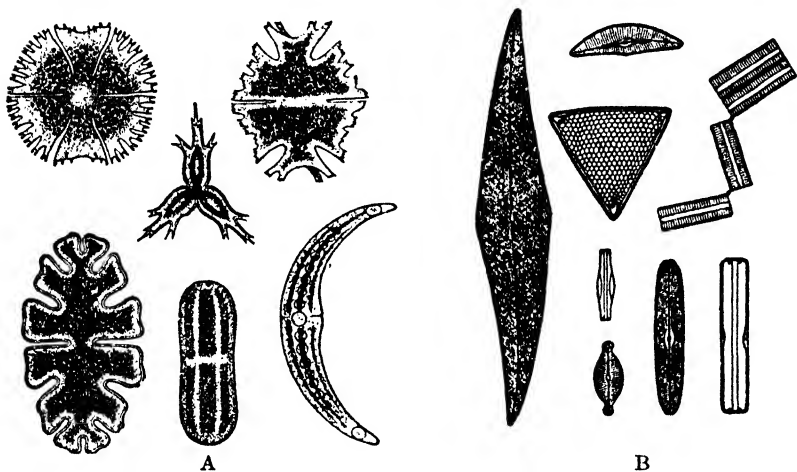

FIG. 84. Representative forms of Desmids (A) and Diatoms (B). Highly magnified. (After Kerner.)

The unique green DESMIDS are close kin of Spirogyra. They constitute an abundant group of somewhat specialized forms, typically unicellular, whose geometrically symmetrical bodies are objects of beauty under the microscope. (Fig. 84.)

Another interesting group is represented by Vaucheria, commonly known as the 'green felt,' because the branching filaments interlace to form a coarse mat in shallow waters or on wet ground, and even on damp flower pots. Each plant may be regarded as a single very large cell, sometimes several inches long, containing numerous nuclei and chloroplasts. Reproduction occurs by spores and gametes. (Fig. 85.)

Although their relationships to other Algae are obscure, at this point may be mentioned the Stoneworts, so called because some are rendered rough and brittle by incrustations of lime. Representa-

tatives are *Chara* and *Nitella* with slender, jointed, branching bodies that rise a foot or more from the bottom of ponds, and bear a superficial resemblance to higher plants. However, the cellular structure is simple, although some of the cells are an inch or more long and exhibit most strikingly protoplasmic streaming. Accordingly

*Nitella* is a favorite object of study in biological courses. (Fig. 86.)

**BROWN ALGAE.** The Brown Algae are typically marine forms that are conspicuously represented by the Kelps and Rockweeds of our coasts. They usually have tough, leathery, plate-like or ribbon-like thalloid bodies that are anchored by holdfasts and buoyed by air-bladders; but some are delicate as, for instance, *Ectocarpus*. The common Kelp, *Laminaria*, may be thirty feet long, while some 'Giant Kelps' attain a length of over 200 feet. Many are differentiated so that the parts of the thallus simulate the structures of higher plants. This occurs also in the Gulfweed, *Sargassum*, which forms huge floating masses, such as the so-called Sargasso Sea. Most species reproduce by both spores and gametes, but the Gulfweed and the common Rockweed, *Fucus*, reproduce only sexually. Rockweed consists of a forking, ribbon-like thallus buoyed by bladders; the swollen tips of the thallus containing small pits in which gametes are produced. Thus most of the Brown Algae show considerable tissue

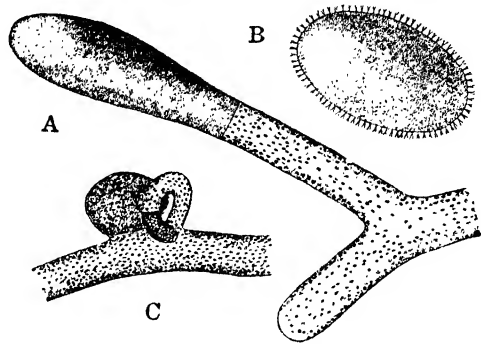

FIG. 85. *Vaucheria*. A, portion of a filament forming a spore; B, spore; C, filament with gamete-producing organs. (Magnified.)



differentiation and, in general, are more highly specialized than the Green Algae, but no higher forms appear to have arisen from them. (Figs. 28, 29, 65, 87.)

Finally, in passing, mention may be made of a group of unique unicellular forms, known as DIATOMS, whose relationships to other Algae are uncertain. They possess a brown pigment, and typically each is enclosed within a cellulose wall heavily impregnated with silica. Their beautiful glassy cases, in some species so regularly sculptured that they are employed to test the quality of microscope lenses, accumulate at the bottom of lakes and seas — such deposits during the geological past forming the 'diatomaceous earth' that is the basis of some commercial polishing powders. And though Diatoms are microscopic in size, their immense numbers make them of great importance in the synthesis of food for aquatic animal life. (Figs. 84, 367.)

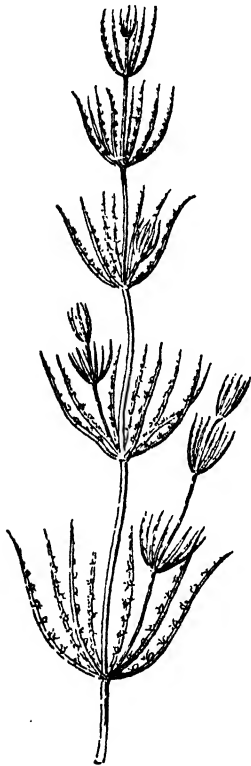

FIG. 86. *Chara*. End of a main shoot. (After Strasburger.)

RED ALGAE. The great majority of Red Algae are marine forms that are anchored by holdfasts; some species in the deepest waters that Algae inhabit. It is probable that their characteristic reddish pigment, which masks the chlorophyll, is an adaptation to the lower illumination available in their environment for photosynthesis, and their

typically graceful form and delicate texture to their usual abode below tide level. However, not all are red and some have a leaf-like or leathery thallus; indeed, it may become incrustated with lime and so contribute to the formation of coral reefs, atolls, etc. Well-known products of the Red Algae are agar-agar, extensively used as a culture medium



FIG. 87. Gulfweed (*Sargassum*) showing the 'stem,' 'leaves,' and the berry-like floats of the thallus. (From Coulter, Barnes, and Cowles.)



FIG. 88. A Red Alga, *Polysiphonia*. Portion of thallus with antheridia. (From Smith and others.)

in bacteriological work, and the so-called Irish moss of the North Sea and Atlantic Ocean which is collected in large quantities and used in the preparation of jelly. In fact some are extensively cultivated for food, such as *Porphyra* which forms the 'laver' of Japan, China, and Hawaii. (Fig. 88.)

Among the important characteristics of the Red Algae are the presence in most species of broad protoplasmic bridges between adjacent cells of the thallus, the absence of motile spores and gametes, and the development of a highly specialized type of sexual reproduction — features that make the origin of the class obscure.

So we leave the Algae, the great basic group of green plants, noting that it accomplishes the transition from the unicellular condition to the multicellular thalloid body, the beginnings of tissue differentiation, and the establishment of reproduction not only by motile spores but also by gametes, and so presents the origin of sex and alternation of generations in plants.

## 2. *Fungi*

The Thallophytes include also the *Fungi*, an immense and heterogeneous assemblage of so-called colorless plants which may be variously colored but since they lack chlorophyll are never leaf-green. And being without chlorophyll, of course they cannot manufacture their food but must secure it either as parasites from living plants or animals, or as saprophytes from the products of living or dead bodies. Some *Fungi* are either saprophytic or parasitic as occasion demands.

It is probable that most of the *Fungi* are descendants from Algae which have lost chlorophyll, while some have arisen from simple unknown forms without chlorophyll which are ancestral to all plants. Although the classification of the group is difficult, for practical purposes we may consider four subdivisions: the BACTERIA or Schizomycetes, the ALGA-LIKE

FUNGI or Phycomycetes, the SAC FUNGI or Ascomycetes, and the CLUB FUNGI or Basidiomycetes. (P. 172.)

BACTERIA. The Schizomycetes, or Bacteria, include the smallest unicellular organisms revealed by the microscope, but in spite of their size they apparently have ruled the world since it was young, and today their study constitutes the immensely important science of bacteriology. However, we may summarily dismiss the Bacteria at this point because they have already been considered from the stand-

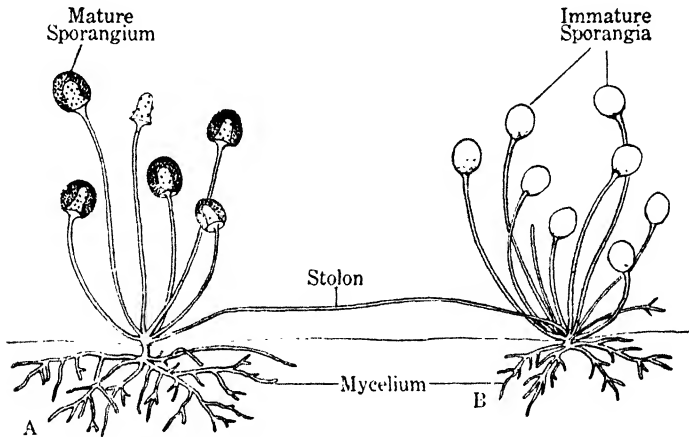

FIG. 89. Bread Mold, *Rhizopus*. Magnified. Older plant (A) has given rise to another plant (B). The mycelium permeates the bread.

point of the circulation of the elements in nature, and their relation to certain diseases of plants, animals, and man may be more appropriately discussed later. (Figs. 16, 19, 344; P. 629.)

ALGA-LIKE FUNGI. Common examples of the Alga-like Fungi, or Phycomycetes, are the Black Molds that form furry growths on damp bread, preserved fruit, etc., the Water Molds, and the Blights that cause very destructive plant diseases. The body consists of an extensive branching mass, or MYCELIUM, of colorless filaments, or HYPHAE, which permeate the nutritive material and function as digestive and absorbing organs. Certain specialized hyphae give rise to spores or gametes.

The Bread Mold (*Rhizopus*), one of the Black Molds, liberates clouds of non-motile spores that are widely distributed by air currents, as is attested by its almost universal presence. Also under certain conditions a non-motile gamete is

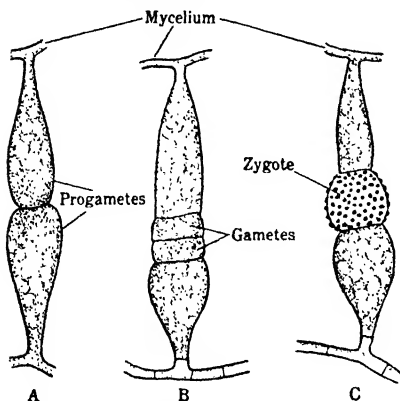

FIG. 90. *Rhizopus*. Formation of gametes and fertilization, after contact of hyphae of two strains. Highly magnified.

formed by a hypha when it comes in contact with one from another plant, presumably of the opposite sex. (Figs. 89, 90.)

Closely related to the Black Molds is *Empusa* that kills the House Fly — a halo of its hyphae often being seen in the autumn about dead flies on window panes. The mycelium of the common Water Mold, *Saprolegnia*, develops in the tissues of dead aquatic insects, though certain related species frequently cause serious depredations among fish in aquaria. Some Water Molds find sufficient moisture for their existence on dead organisms in the soil. Reproduction occurs by motile spores and by gametes.

Representative of the Blights are the Blister Blight of the Shepherd's Purse and Radish, the Potato Blight, and the Downy Mildew or Blight of the Grape. Each and all form extensive mycelial growths in the tissues of their hosts, and are propagated by externally produced spores known as CONIDIA. These are distributed by the wind, but become motile on reaching the moist surface of a prospective host. Gametes also arise and fertilization results in a resting zygote which forms motile spores ready to infect another host.

SAC FUNGI. Nearly everyone is familiar with the Blue, Green, and Yellow Molds so common on fruit, damp leather, and cheese. Indeed, the characteristic flavors of certain cheeses are due to particular molds. Also common are the

Powdery Mildews such as *Microsphaera* which is found on Lilac leaves. Dissemination is by conidia and by ASCOSPORES that develop in unique spore sacs, or asci: hence the name Ascomycetes. In many cases, at least, sexual phenomena precede the development of ascospores. (Fig. 91.)

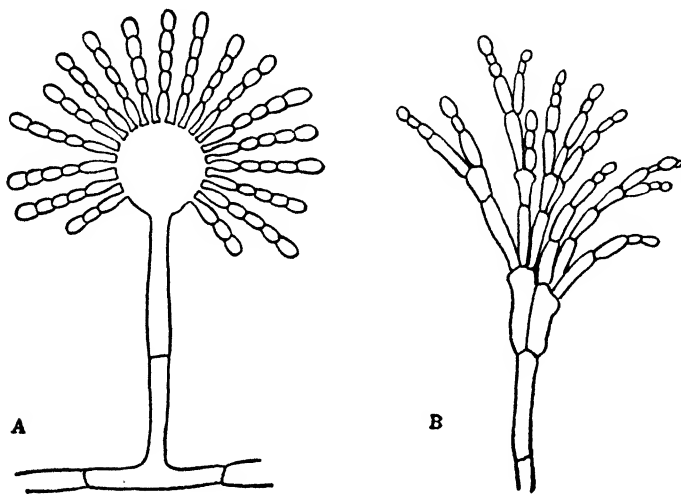

FIG. 91. A, *Aspergillus* (green or yellow mold); B, *Penicillium* (blue mold)—source of the drug penicillin. Hyphae bearing conidia. Highly magnified.

Other examples of Sac Fungi are the edible Truffles and Morels, and the various species that produce diseases known as the 'black-knot' of the Plum and Cherry, the 'ergot' of Rye, and the 'peach-curl.' And the Yeasts apparently should be included as specialized or degenerate forms that do not develop a mycelium. Yeast cells typically reproduce by budding but under adverse conditions resort to the formation of ascospores. The metabolism of Yeast will be considered later, especially in regard to alcoholic fermentation. (Fig. 343.)

**CLUB FUNGI.** Here we reach the most highly organized of the Fungi, constituting the Basidiomycetes: the Rusts and Smuts and the Mushrooms, or Toadstools. The former are chiefly parasitic plants, while the latter are for the most

part harmless saprophytes, though some are parasites. Reproduction is typically by **BASIDIOSPORES**, so called because they arise from a specialized reproductive structure, the **BASIDIUM**. Sexual processes are obscure.

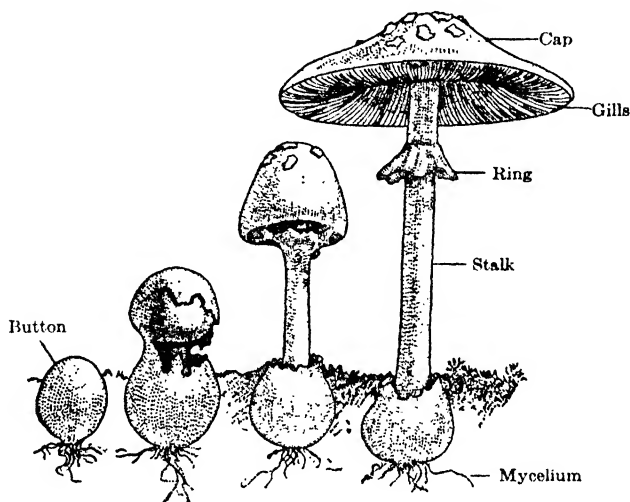

FIG. 92. A Mushroom, *Amanita* (poisonous), showing the development of the spore-bearing structure from the underground mycelium. (From Ganong, after Gibson.)

The Rusts and Smuts comprise a large group of very destructive parasites of higher plants. Well-known are the Cedar and Apple Rust, the Wheat and Barberry Rust, and the White Pine and Gooseberry Rust, each with an amazingly complex life history including several types of spores. The Smuts are particularly injurious to cereals, producing in Wheat, Barley, Corn, Oats, etc., the diseases known as smuts from the appearance of the masses of dark-colored spores. (Fig. 438.)

The common field Mushroom, *Psalliota campestris*, so widely cultivated for its edible qualities, is representative of the group, though many, such as various species of *Amanita*, are highly poisonous. The body consists of an extensive tangled mass of branching mycelial filaments that spreads through the substratum and gives rise to large, fleshy spore-

bearing structures, the conspicuous 'mushrooms.' The spores of *Psalliota* are formed on plate-like 'gills' on the under surface of the expanded cap of the mushroom, but in some genera they are developed in tiny pores. (Fig. 92.)

Closely related to the Mushrooms are the common parasitic Bracket fungi that form shell-like outgrowths on trees and stumps, the Coral fungi resembling branching Corals, the Puffballs, Earth-stars, etc. — all the large spore-bearing structures of invisible mycelia.

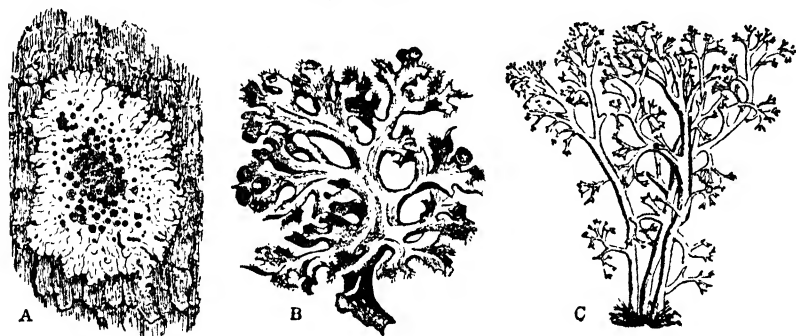

FIG. 93. Lichens. A, Crustose type, *Physcia*, on tree trunk; B, foliose type, *Cetraria*; C, fruticose type, *Cladonia*. See Fig. 371. (From Ganong.)

This completes our survey of the Fungi and also of the basic plant group, the Thallophytes; but, in passing, mention must be made of the Lichens which are composites of Algae and Fungi in SYMBIOTIC relationship: each contributes to the welfare of the other partner. The Fungus, usually one of the Sac Fungi, makes up the bulk of the body with its interwoven mycelium, and in this the unicellular Algae, either green or blue-green, are enmeshed. There are three chief types of lichen bodies: the CRUSTOSE in which the thallus forms an incrustation on trees, rocks, or soil; the FOLIOSE, comprising leaf-like lobes attached at one or more points to the substratum; and the FRUTICOSE with filamentous bodies, branching like shrubs, and either prostrate, pendent, or erect. (Fig. 93.)

Lichens are not only of particular interest for their exhibition of symbiosis, but also for their contributions to the



soil. Certain crustose forms dissolve and disintegrate rocks and so provide a footing for other plants. Moreover lichens such as the so-called Iceland-moss and Reindeer-moss are of some importance as animal food, the Rock-tripe may serve in an emergency as human food, and the Bread-of-heaven may well be the "manna" of the Israelites.

## B. BRYOPHYTES

The Mosses and their allies, or Bryophyta, form a relatively unimportant phylum of inconspicuous green plants which are somewhat intermediate between the Thallophytes and the Tracheophytes, but their relationships with these groups are not clear. Although a few Bryophytes are aquatic, most of them are land dwellers and afford a glimpse of a plant type which arose from the Algae and emerged from the water, but rather falteringly made the land its abode — the conquest of the land was reserved for the better adapted Tracheophytes. (Pp. 110–112, 172.)

The Bryophytes differ from their algal ancestors chiefly by usually possessing a more complex body and reproductive structures, in particular archegonia, and by the further specialization of the alternation of generations so that the sporophyte is dependent upon the gametophyte. It will be recalled that the gametophyte is the dominant generation in the life history of Bryophytes — the 'moss' is a gametophyte. (Figs. 66, 67.)

The Bryophytes include two classes: the relatively little-known LIVERWORTS, or Hepaticae, and the true MOSSES, or Musci, familiar to nearly everyone.

**LIVERWORTS.** The majority of the Liverworts are moisture-loving plants, some floating on the water but more growing on damp ground, rocks, or the bark of trees. The body of the gametophyte generation is a prostrate thallus that often has leaf-like structures similar to those of true mosses. The ventral surface is provided with rhizoids for attachment and perhaps for absorption, while the dorsal sur-

face exposes chlorophyll-bearing cells to the sunlight. Apparently there have been three main lines of Liverwort evolution, well represented by *Marchantia*, *Porella*, and *Anthoceros*. (Fig. 94.)

In *Marchantia* and its kin the body is essentially a remarkably complex thallus, due to a thickening and differentiation of its component cells into tissues. Reproduction occurs asexually by buds that develop in tiny cups on the dorsal surface and, sooner or later, fall off and form new plants; and also sexually by gametes that arise on characteristic upright structures known



FIG. 94. *Marchantia*. Thallus with a receptacle, bearing antheridia, and two bud cups. (From Ganong, after Kny.)

as male and female receptacles. Sperm discharged from the antheridia fertilize eggs in the archegonia, and then each

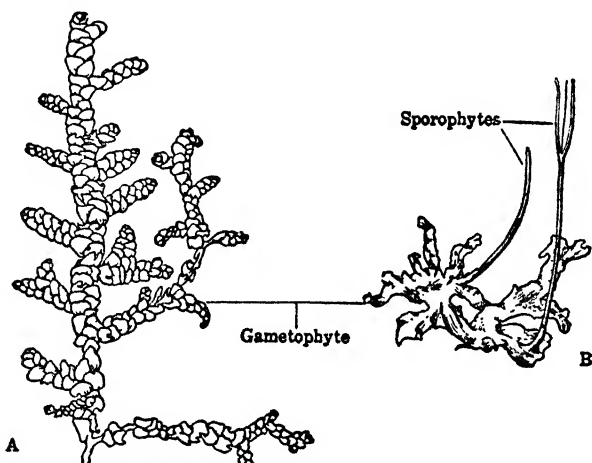

FIG. 95. A, *Porella*: gametophyte; B, *Anthoceros*: gametophyte bearing sporophytes. (From Smith and others.)

zygote, in situ, develops into a simple sporophyte. Subsequently the latter liberate spores that give rise to gametophytes, and so the alternation of generations is completed.

Porella and its allies constitute the greatest group of Liverworts. They are typically delicate plants growing



FIG. 96. Peat Moss, *Sphagnum*. Gametophyte with sporophytes at the tip. (From Bergen.)

either in damp situations or on rocks and tree trunks, and bear little resemblance to Marchantia. Commonly they are called Scale-mosses or Leafy-liverworts and are mistaken for true Mosses because the gametophyte body usually consists of a stem bearing three rows of small, simple leaves. (Fig. 95.)

Anthoceros forms are few and inconspicuous, but of particular interest because, in contrast to other Liverworts, the gametophyte is simple while the sporophyte is considerably more complex and bears chlorophyll. Thus, although it is dependent upon the gametophyte for water and solutes, it carries on photosynthesis and so is prophetic of the gradual ascendancy in prominence of the sporophyte as plant evolution progresses. (Fig. 95.)

**MOSSES.** The true Mosses, or Musci, are adapted to nearly all habitats from actual submergence to great dryness. Thus the Peat

Moss, *Sphagnum*, often fills ponds with a dense growth that flourishes above the surface and dies below, with the final result that in certain cases the lower layers become transformed

into peat, a low-grade fuel. Incidentally, the high absorptive capacity of *Sphagnum* commends it as an emergency surgical dressing and for packing live plants. (Fig. 96.)

But by far the most numerous and common Mosses form the typical carpet vegetation of the drier places of the earth, and presumably are relics of the original green plants which covered the uplands before the more successful Tracheophytes had arisen.

Since the general structure of the body, with simple upright branch and leaves, and the clear-cut alternation of generations exhibited by Mosses have already been considered, we can leave them, and the Bryophytes in general, at this point; merely emphasizing that the group has made significant advances upon the foundations afforded by the Thallophytes, even though they may not be the direct ancestors of higher plants. (Figs. 66, 67.)

### C. TRACHEOPHYTES

The immense assemblage of plants exhibiting a specialized system of vessels for the conduction of materials through the body is known as the Tracheophyta, and includes all the higher members of the Plant Kingdom: the Ferns and their kin and the Seed Plants. They are *vascular plants* in contrast with the non-vascular Thallophytes and Bryophytes. Indeed, the development of a vascular system in the independent sporophyte generation constituted an epoch in plant evolution because it made possible a larger and more complex body with highly differentiated tissue systems. So some of them found a free field and flourished as the first forests of the earth, notably during the Carboniferous period. (Fig. 382; Pp. 166, 172.)

Three great classes of the Tracheophytes are the CLUB MOSSES or Lycopsidea, the HORSETAILS or Sphenopsida, and the true FERNS and the SEED PLANTS or Pteropsida.

CLUB MOSSES. The best-known Club Mosses are the so-called Ground-pine and Running-cedar — the latter

widely used as Christmas greens. Both are members of the genus *Lycopodium* and have slender branches entirely covered with small, elongated leaves. Many of the erect branches terminate in a conspicuous STROBILUS which is a compact group of highly modified leaves (sporophylls) that bear

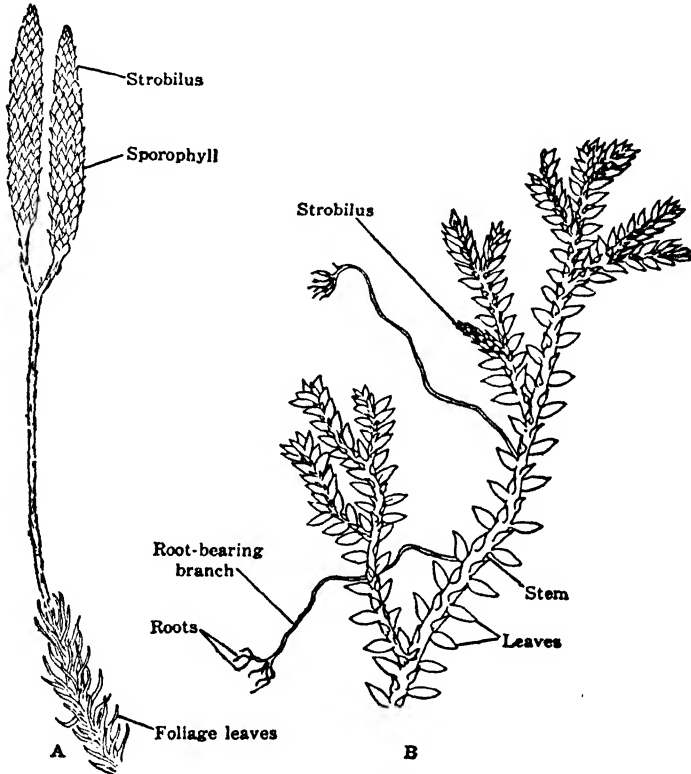

FIG. 97. A, *Lycopodium*; B, *Selaginella*. Portions of mature sporophytes. (From Smith and others.)

spores. A smaller Club Moss, *Selaginella*, is of particular interest because it produces two kinds of spores (heterospory) and, therefore, male and female gametophytes. These are dependent upon food stored in the spores and so upon the parent sporophyte generation — a complete reversal of the relations in the Bryophytes. In fact *Selaginella* closely approaches seed-formation. (Fig. 97.)

**HORSETAILS.** Some three dozen species of Horsetails, all members of the genus *Equisetum*, are relatively inconsequential relics of the geologic yesterday when Horsetails were trees. The sporophyte of *Equisetum* consists of a creeping stem from which arise green branches that are typically hollow, markedly jointed, and abundantly provided with silica — the latter suggesting their use for scouring and the name ‘scouring rush.’ At each joint of the branches there is a whorl of tiny scale-like leaves, but photosynthesis is chiefly performed by chlorophyll in the branches. Spore-bearing strobili develop either at the tips of the vegetative branches or of special ones devoid of chlorophyll. Existing Horsetails are homosporous, but some of the ancient species were heterosporous. (Fig. 98.)

**FERNS.** The true Ferns, or Filicineae, are today not only the most numerous but also the most representative of the group commonly called the Pteridophytes. Although they flourish in temperate regions, their fullest expression is reached in the tropics where they are a prominent feature of the vegetation, and vary from low forms, with either delicate and filmy or broad leaves, or *fronds*, to trees rising some forty feet and crowned with leaves thirty feet long. (Figs. 50, 68, 69, 99.)

The structure of Ferns suggests in many ways the anatomy of the Seed Plants. The fibro-vascular tissue of certain species forms a hollow cylinder of xylem and phloem which separates the basic tissue of the stem into an inner pith and

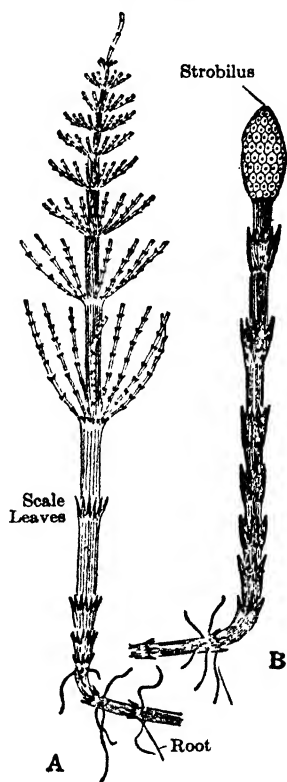

FIG. 98. Horsetail, *Equisetum*. Sterile (A) and fertile (B) aerial branches of sporophyte. (From Smith and others.)

outer cortex. In fact, in some of the larger Ferns there may be several concentric rings of vascular bundles. The spores of some species are formed on special leaves, or sporophylls.



FIG. 99. Tree Ferns (*Alsophila*) in the Federated Malay States. (From Campbell.)

Ferns have already been considered with particular reference to alternation of generations, so we may dismiss them with a passing reference to the small group of Water Ferns. They bear little superficial resemblance to the common Ferns, as is attested by Marsilea. This little Clover-leaf Fern is of much interest, not only because it is heterosporous, but also because the male and female gametophytes are so greatly reduced that they essentially consist of only reproductive structures (antheridia and archegonia) which develop within the respective spores — a reduction that is prophetic of the condition in higher plants.

Clearly the great group of Pteridophytes, with the development of a complex dominant sporophyte generation with vascular tissues, large foliage leaves, and, in some cases, sporophylls, heterospory, and attendant phenomena, carries on apace to the conditions found in the Seed Plants. However, it appears that the modern Ferns are not the ancestors of the Seed Plants. (Figs. 70, 71.)

**SEED PLANTS.** The Seed Plants, usually called Spermatophytes, are the modern plants that have successfully dominated the vegetable world, probably largely by virtue of the seed habit. And they are by far of most economic im-

portance. Indeed, to most people Seed Plants and botany are essentially synonymous, but, of course, any real understanding of their structure and life history is impossible without a knowledge of the lower plants. This is particularly true of their most characteristic feature, the seed habit: the partial development of the new sporophyte generation within the tissues of the previous sporophyte generation, and later its release, with a food supply and a protective coat, as a seed. (Figs. 30, 75, 77, 78.)

Since previously we have had occasion to survey the structure and life history of Seed Plants, and also the development and significance of flower and seed, at present attention

may be confined chiefly to an outline of their classification.

There are two remarkably independent lines of Seed Plants: the GYMNOSPERMS that bear seeds exposed on sporophylls arranged in the form of a strobilus, or CONE, and so are without flowers in the popular sense, and the ANGIOSPERMS that produce seeds enclosed within the base of a flower — the typical Flowering Plants.

### 1. Gymnosperms

The group of Gymnosperms includes the tropical CYCADS, the GINKGO, and the familiar CONIFERS commonly repre-

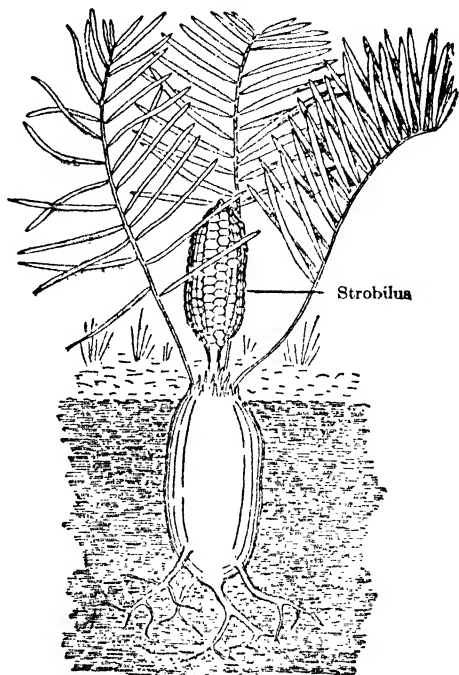

FIG. 100. A Cycad, *Zamia*. Mature sporophyte bearing a carpellate strobilus. (From Smith and others.)



sented by the Pines, Firs, Spruces, Hemlocks, Cedars, Redwoods, etc. About five hundred species are living today, but in the geological past they were the dominant Seed Plants and flourished in association with giant Club Mosses, Horsetails, and related forms.

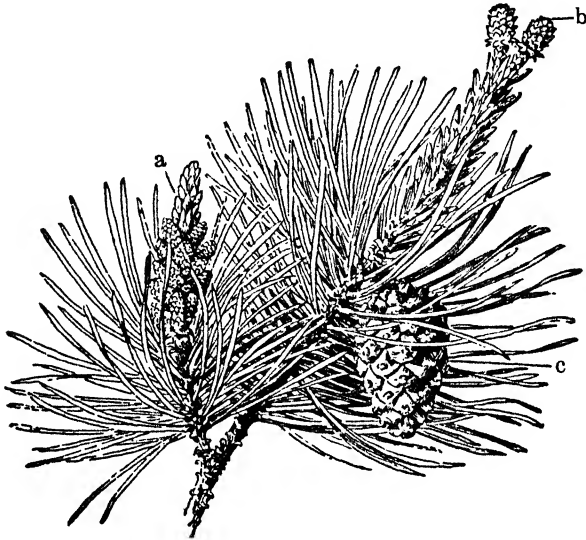

FIG. 101. Scotch Pine, *Pinus sylvestris*. Twig showing: a, staminate cones; b, young carpellate cones; c, mature carpellate cone. (From Bergen.)

**CYCADS.** The Cycads, a very small remnant of a once important group, bear a superficial resemblance to Ferns, and apparently have arisen from an ancient and now extinct group known as Seed-ferns. The stem is either a stout columnar shaft, or like a great tuber crowned with a rosette of large leaves as in the well-known *Zamia* of Florida. It is of much interest that the Cycads, and the related GINKGO, or Japanese Maidenhair tree, produce sperm that are motile, a power that has been lost by the male gametes of all other Seed Plants. (Fig. 100.)

**CONIFERS.** The representative Gymnosperms in temperate regions are the Conifers with their characteristic groups of sporophylls, or CONES, and scale or needle leaves: a leaf-form adapted to endure severe conditions. Conifers either

have no regular period of leaf-falling or shed their leaves every two years, and so are 'evergreen.' However, the Larch and Bald Cypress shed their leaves annually. (Figs. 101, 102.)

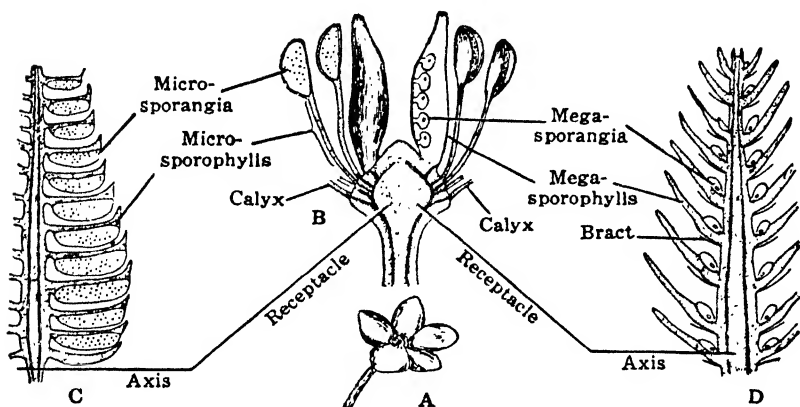

FIG. 102. Diagram to illustrate the corresponding parts of the strobili of the Spruce and the flower of the Marsh Marigold. A, flower of the Marigold; B, section of the flower; C, median longitudinal section of the staminate strobilus of the Spruce; D, similar section of the carpellate strobilus. (From Densmore.)

## 2. Angiosperms

The most numerous, conspicuous, and important group of the vegetable kingdom comprises the Angiosperms — a relatively modern array, apparently still in active evolution, that has gradually displaced the Gymnosperms in dominance. Angiosperms are also the familiar Flowering Plants, and the development of true flowers has involved the elaborate interrelationships with insects by which pollination is effected. It is true that some Angiosperms depend on the wind for pollen (microspore) distribution, as do all Conifers; nevertheless insects appear to be largely responsible for the great variety in floral structure. (Figs. 75, 102, 366.)

It will be recalled that the typical flower is a modified branch bearing sporophylls (carpels and stamens) and a perianth of sepals and petals. In the Club mosses, Horse-tails, and some Ferns, and in the Gymnosperms it is repre-

sented by a cluster of sporophylls, the strobilus or cone, but a perianth is absent. The diversities of floral structure, as well as the arrangement of the flowers (either singly or in different types of clusters, termed INFLORESCENCE), are

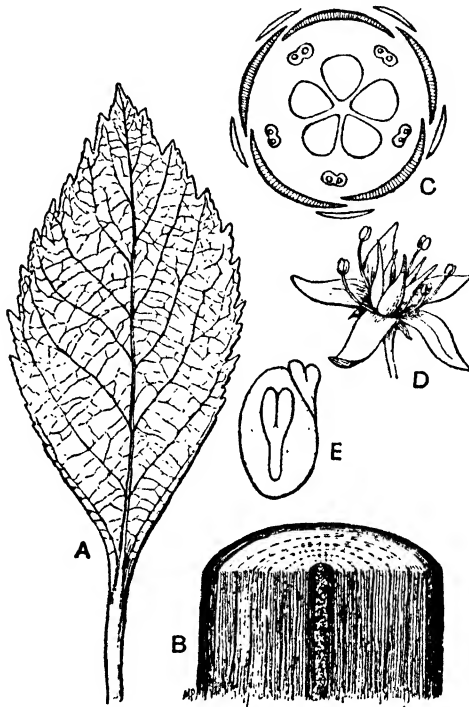

FIG. 103. Diagram of characteristic structures of Dicotyledonous Seed Plants. A, leaf, netted-veined; B, stem with vascular bundles arranged so that wood forms annual rings; C, flower with parts usually in 5's (transverse section); D, flower; E, seed having embryo with *two* cotyledons (section). See Fig. 104. (From Gager.)

usually departures from a more or less typical plan and thus afford the characteristics which are largely depended upon in the classification of Angiosperms. (Figs. 72-74, 105.)

There are two great classes of Angiosperms, quite distinct but somewhat parallel: the DICOTYLEDONS, represented by over 110,000 species, and the MONOCOTYLEDONS, by about 30,000 species. The typical contrasting characters of these groups are as follows:

Dicotyledons. — The embryo sporophyte in the seed has two lateral cotyledons (seed leaves); the vascular bundles of the stem usually have cambium and form a hollow cylinder, permitting an annual increase in diameter and in branching;

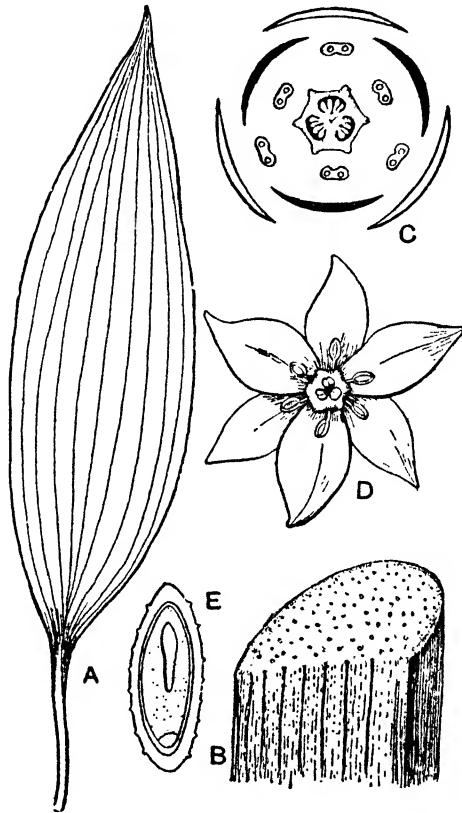

FIG. 104. Diagram of characteristic structures of Monocotyledonous Seed Plants. A, leaf, parallel-veined; B, stem with vascular bundles scattered through the pith; C, flower with parts in 3's (transverse section); D, flower; E, seed having embryo with *one* cotyledon (section). (From Gager.)

the veins of the leaves form a conspicuously netted system; and the floral parts are typically in multiples of five. (Figs. 43, 44, 103.)

Monocotyledons. — The embryo in the seed has a single lateral cotyledon; the vascular bundles of the stem are without cambium and are irregularly scattered so that usu-

ally no annual increase in diameter or extensive branching occurs; the veins of the leaves are parallel; and the floral parts are in multiples of three. (Figs. 45, 104.)

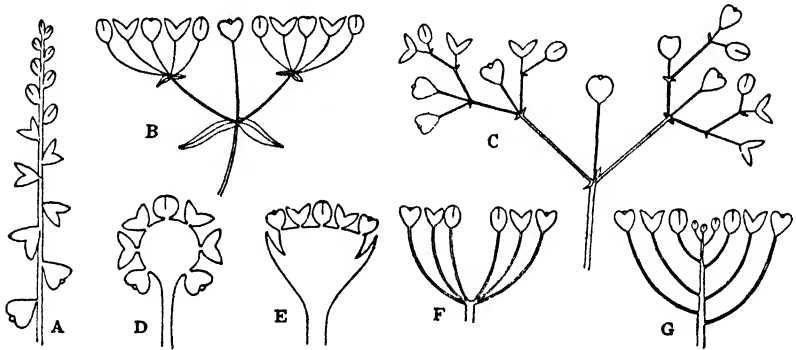

FIG. 105. Diagrams showing the arrangement of flowers in some common types of inflorescence. A, spike; B, cyme (compound); C, fascicle; D, head (clover type); E, head (composite type); F, umbel; G, corymb. (After Stevens.)

### a. Dicotyledons

The commanding position among the vegetation of the earth today is held by the Dicotyledons — herbs, shrubs, and trees displaying almost every conceivable variety in size, form, and habitat. There are about 8000 genera arranged in nearly 225 families, from which the following may be taken as representatives:

*Willow Family.* The Willows and Poplars, widely distributed woody shrubs or trees, are among the most primi-

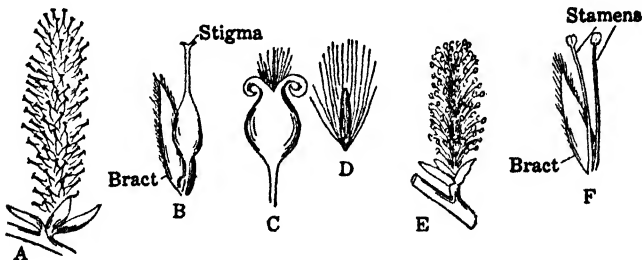

FIG. 106. Willow. A, carpellate catkin, or flower group; B, carpellate flower; C, fruit; D, seed; E, staminate catkin; F, staminate flower. (From Smith and others.)

tive Dicotyledons as is indicated by very simple flowers without sepals and petals. They are in clusters known as CATKINS which comprise either carpellate or staminate flowers that are borne on separate plants. The fuzzy catkins of the Pussy Willow are eagerly sought in early spring. Closely related families are represented by the Walnuts, Birches, Beeches, and Oaks. (Fig. 106.)



FIG. 107. A, Elm twig bearing flowers and fruit; B, inflorescence of Sweet William, a member of the Pink family. (From Smith and others.)

*Nettle Family.* This is a rather diversified group of herbs, shrubs, and trees with slightly more complex flowers possessing sepals. Most of the plants are tropical, but well known are the Elms, Mulberries, Figs, Hops, Hemps, and Nettles. Many members of the family contain a milky juice, or LATEX; that from certain species being used as a beverage or as a source of rubber. (Fig. 107.)

*Pink Family.* This family consists chiefly of herbs with relatively conspicuous flowers which are usually provided with both sepals and petals. Widely known are the Carnations, Sweet Williams, Chickweeds, and Bouncing Bets. (Fig. 107.)

*Buttercup Family.* The common Buttercup is fairly typical of this family which includes many species with showy flowers, due to prominent sepals or petals. Some of

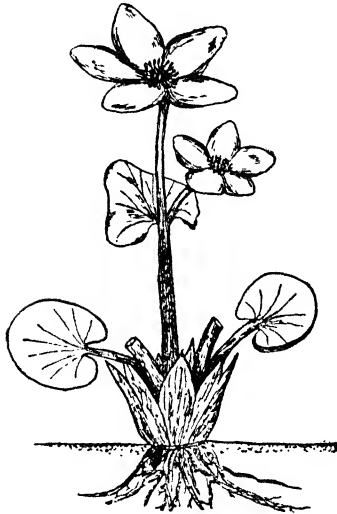

FIG. 108. Marsh Marigold.  
(From Densmore.)

the best-known near relatives of the Buttercup are the Anemones, Hepaticas, Marsh Marigolds, Peonies, and Columbines. (Fig. 108.)



FIG. 109. Shepherd's Purse; a plant and a raceme bearing flowers on its upper portion and fruits below. (From Smith and others.)

*Mustard Family.* Representative of this family is a large number of herbs, often with acrid substances such as the familiar Mustard. The flowers have a characteristic cross-shaped corolla and are arranged in a RACEME, as is well seen in the Shepherd's Purse. Other common examples are the Radish, Turnip, and Water Cress, as well as the variations of a species of Brassica such as the Cabbage, Brussels Sprouts, and Cauliflower. (Figs. 109, 425.)

*Rose Family.* This is a very large and diversified assemblage of herbs, shrubs, and trees which include many of the

most important economic and ornamental plants. Representatives of several sections of the family, each characterized by a special type of flower and fruit, are the Apple and Hawthorn, the Strawberry and Cinquefoil, the Raspberry and Blackberry, the Roses, and the Plum, Cherry, and Peach. (Figs. 40, 80, 110.)

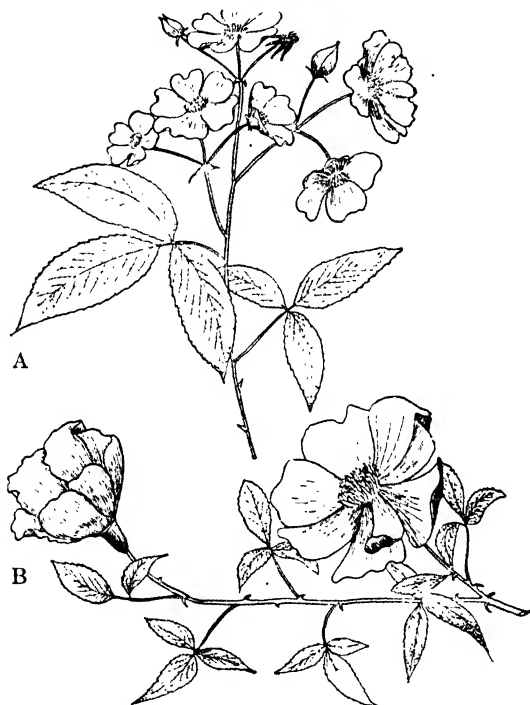

FIG. 110. A, Cherokee Rose; B, Tea Rose. (From Hylander.)

*Cactus Family.* The plants most highly adapted to withstand the merciless heat and dryness of desert areas are some thousand species of shrubs and trees that form the exclusively American Cactus Family. To conserve water most Cacti have dispensed with leaves, and the stem and branches have taken over the photosynthetic function. Spines are profusely developed and serve as a needed protection since succulent vegetation is rare in their typical habitat. In spite of their unorthodox body-form, most Cacti bear beautiful



cup-shaped or funnel-shaped flowers of variegated colors — sometimes only for a few hours, or one night as is the case of the famous Night Blooming Cereus. Common types of Cacti include the Prickly Pears (*Opuntia*), Barrel, Organ Pipe, Suharo, and Hedgehog Cactus. One species of Prickly Pear occurs sparingly in New England. (Fig. 111.)

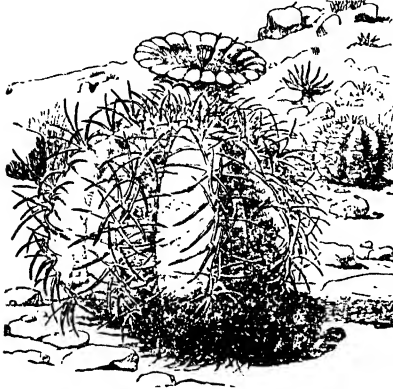

FIG. 111. Barrel Cactus. (From Bergen.)

*Pulse Family.* The Peas, Beans, and Peanuts are members of an immense family which is characterized, in general, by bilaterally symmetrical flowers, and fruit in the form of a pod, or

LEGUME. In the temperate zone a few are trees such as the Locusts, but in the tropics trees are abundant, supplying lumber, gums, drugs, and dyes. It will be recalled that certain plants of this family, such as Beans, Clovers, and Alfalfa, have symbiotic relations with nitrogen-fixing Bacteria, and so are important for the nitrogen supply of soils. (Figs. 79, 112.)



FIG. 112. Legumes: Soy Bean, Alfalfa, and Vetch. (From Hylander.)

*Parsley Family.* Characterized by small flowers arranged in an **UMBEL**, this family is commonly represented by herbs that secrete volatile, odorous substances. Parsley and Celery, Parsnip and Carrot are edible species and so quite unlike the Poison Hemlock and the Wild Carrot and Wild Parsnip. However, the production of volatile oils is even more characteristic of the large *Mint Family*, which includes the Peppermint, Spearmint, and Catnip. (Figs. 105, 113.)

*Nightshade Family.* Representatives of this group of herbaceous plants with radially symmetrical flowers are known to nearly everyone by the Tobacco, Potato, Tomato, and Red Pepper. Many of the fruits contain substances used as drugs; indeed, a potato is reputed to contain a trace of poison. (Fig. 114.)

*Gourd Family.* Strange to say, the flowers of this family are either staminate or carpellate as in the primitive Willow

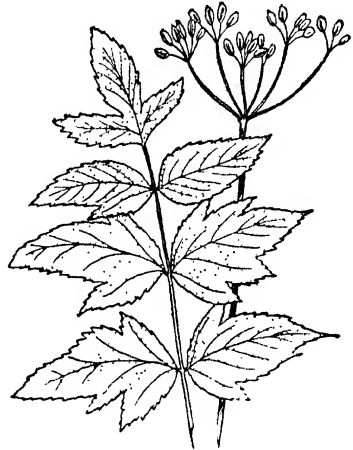

FIG. 113. Wild Parsnip. Compound umbel composed of several simple umbels. (From Hylander.)

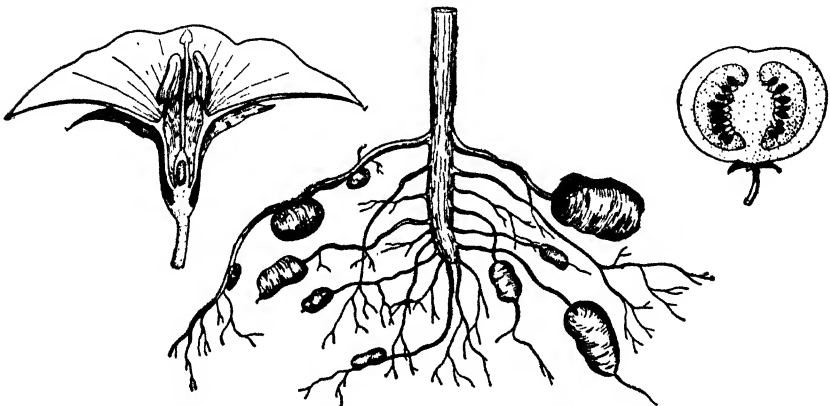

FIG. 114. Potato. Flower section, tubers, and fruit section. (From Hylander.)

Family, though otherwise they show characteristics that justify their advanced position among the Dicotyledons. Most species are natives of tropical or semitropical regions but many, such as the Squash, Muskmelon, Pumpkin,

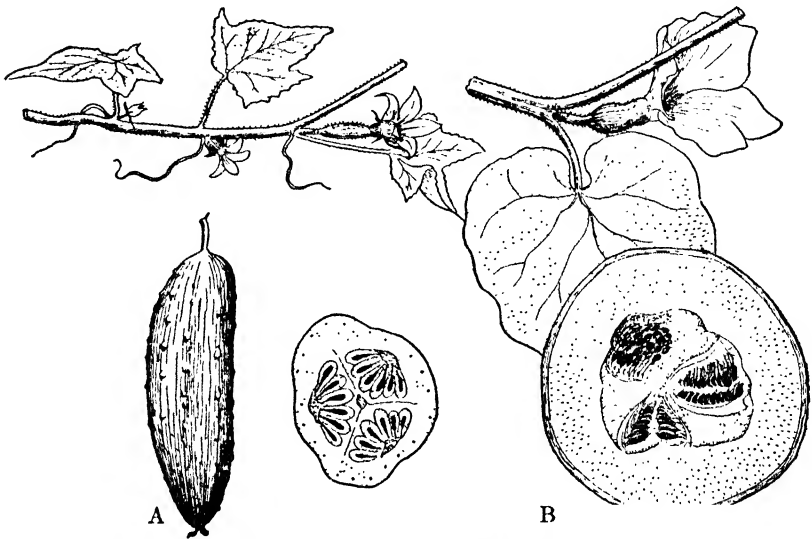

FIG. 115. Flowers and fruit of A, Cucumber; B, Muskmelon. (From Hylander.)

Cucumber, Watermelon, and Gourds, prosper under cultivation farther north. (Fig. 115.)

*Composite Family.* The Dicotyledons culminate in the great Composite family which alone comprises about 20,000 species, nearly one-sixth of all Seed Plants, and has an

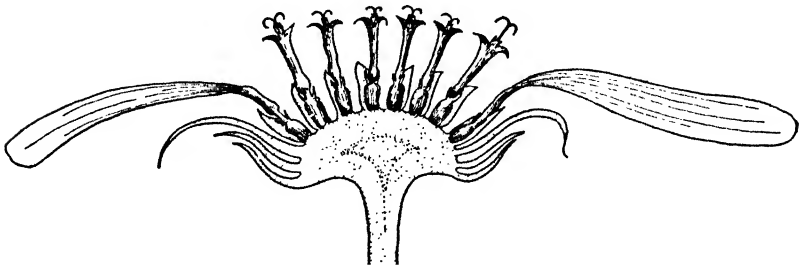

FIG. 116. Vertical section of flower head of the Sunflower, showing bracts, two ray flowers, and six disk flowers. (From Hylander.)

immense geographical distribution due largely to the many devices by which its seeds are widely disseminated. The most notable feature of the family, well represented by the Daisy, is the characteristic composite head, or flower cluster, in which the numerous individual flowers are usually differentiated into showy RAY flowers about the edge of the head and relatively inconspicuous DISK flowers within. Thus the individual flowers are subordinated to the cluster which superficially has the appearance of a single flower. Practically all composites are herbs, some of economic and many of ornamental value, but there are plenty of weeds. Chrysanthemums, Asters, Sunflowers, Goldenrods, Yarrows, Dandelions, Ragweeds, Thistles, Sagebrush, and Burdock are other Composites typical of this most successful plant group. (Figs. 105, 116.)

### b. Monocotyledons

The Monocotyledons apparently had their origin in a very primitive dicotyledonous stock and then independently evolved complexities of floral structure along lines broadly parallel. They are mostly herbaceous plants, distributed in some 1200 genera and 42 families. Conspicuous among the latter are the following:

*Cat-tail Family.* This is one of the most primitive families and is well represented by the common Cat-tails of marshes with their long-lived branching stem in the mud and annual aerial branches ensheathed with long leaves. The tiny

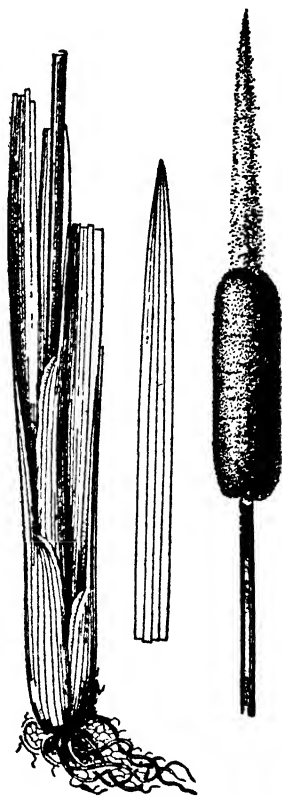

FIG. 117. Cat-tail. An aerial branch, a single leaf, and a spike, or flower cluster. (From Smith and others.)

flowers are without sepals and petals, and so remind one of the condition in the Willow family, the simplest of the Dicotyledons. The flowers are closely grouped in a cylin-

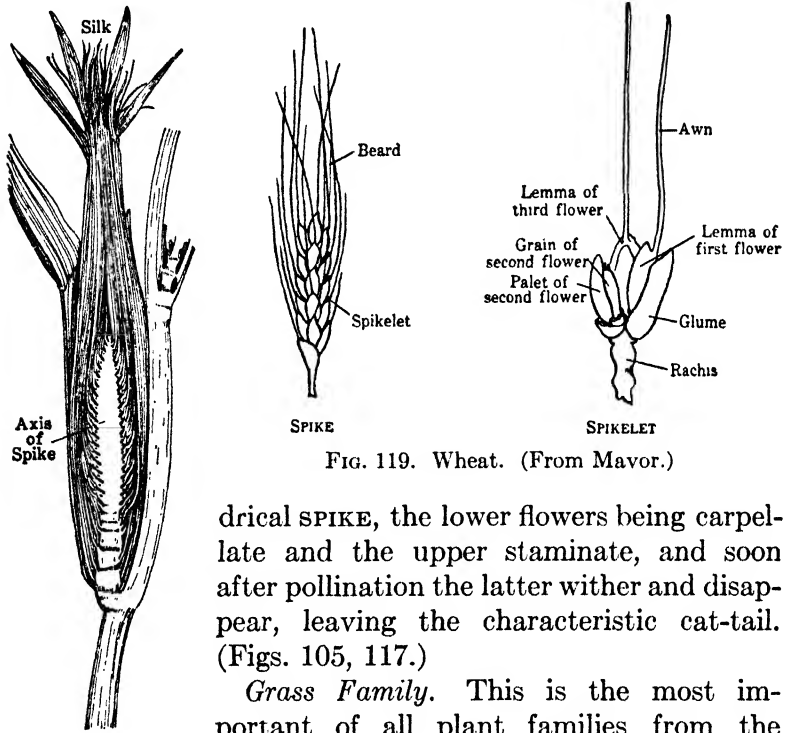

FIG. 119. Wheat. (From Mavor.)

drical SPIKE, the lower flowers being carpelate and the upper staminate, and soon after pollination the latter wither and disappear, leaving the characteristic cat-tail. (Figs. 105, 117.)

*Grass Family.* This is the most important of all plant families from the standpoint of usefulness to Man. It constitutes a large, rather sharply defined group with simple, small flowers that lack a typical calyx and corolla and are usually arranged in a more or less compact head or spike above the leaves, as in Wheat. Sometimes stamens and carpels are in separate flowers as, for instance, in Indian corn where the ear is a carpelate flower cluster and the tassel a staminate cluster. The stem typically is jointed, and by interlacing rootstocks may produce annual shoots, forming a turf. Other examples are the Grasses of our lawns, Oats and Barley, as well as

FIG. 118. Indian Corn. A carpelate flower cluster, or ear, before fertilization. The axis of the spike is the cob, and the tips of the silk are stigmas. (After Sargent.)

Bamboo and Sugar Cane. Closely related to the Grasses are the Sedges: so-called Rushes and Marsh-grasses. (Figs. 118, 119.)

*Palm Family.* Palms afford a conspicuous display in tropical vegetation, with their columnar stems crowned by im-



FIG. 120. Coco Palm. The upper flower cluster is at an early stage, with the staminate flowers still present. The lower cluster has lost the staminate flowers and the young coconuts have enlarged considerably. (From Bergen and Caldwell, after Freeman and Chandler.)

mense leaves. Unlike most other Monocotyledons, they usually have woody stems, and some are trees. The flowers are arranged in spike-like clusters and possess a very simple perianth. Well-known representatives are the Coco and Date Palms. The Rattan Palm is a climbing plant. (Fig. 120.)

*Lily Family.* This familiar assemblage comprises chiefly perennial herbs with well-developed bulbs or rootstocks and beautiful flowers. Usually the leaves of the calyx and corolla are similar in color, and often united at the base to form a tube. Many are garden favorites, such as the Lilies, Tulips, Hyacinths, and so on to Asparagus, Onion, and Garlic. Common wild forms are the Trilliums and Solomon's Seals. (Figs. 41, 48, 121.)



FIG. 121. Turk's Cap Lily. (From Hylander.)

*Orchid Family.* The Orchids form not only the largest — over fifteen thousand species — but also the most specialized group of Monocotyledons,

with characteristic bilaterally symmetrical flowers exhibiting bizarre variations of sepals, petals, and other floral parts in adaptation to insect visitors that ensure cross-pollination.



FIG. 122. Orchids: Whorled Pogonia, Wild Pink, and Grass Pink. (From Hylander.)

Curiously enough, many of the flowers have a fanciful resemblance to "insects and their relatives, with spidery petals and sepals and variegated 'bodies' which are the lips of the flowers." Orchids are chiefly tropical plants, many of them growing high up in trees as epiphytes and some without chlorophyll living as saprophytes, but none as parasites. And it is an interesting fact that intimate mycorrhizal and similar relationships are particularly well illustrated in the Orchids. Apparently they do not thrive in the absence of symbiotic association with the mycelial filaments of Fungi, and their microscopic seeds even fail to germinate unless they are in relation with a specific Fungus. Few Orchids are of economic value, except the widely-cultivated climbing *Vanilla* which supplies the vanilla bean, but their beauty and their rarity in temperate regions give them an aesthetic attraction for all plant lovers, as is attested by the well-known *Lady's Slippers*. (Figs. 122, 366; Pp. 543, 544.)

Thus we complete our systematic survey of the plant kingdom. The Monocotyledons culminate in the Orchids as do the Dicotyledons in the Composites; the two groups representing the present acme of plant evolution — a long way from the simple unicellular Algae near the beginning of the pageant of plant life. (P. 172.)

#### D. PLANTS OF THE PAST

The plants that we have considered are evidently only a small remnant of those which flourished and became extinct during the immensely long past of geologic history. This much we know from fossil plants that have been discovered, though of course there are great gaps in our knowledge, in part owing to the necessarily incomplete fossil record. Even so, certain facts stand out so that with reasonable assuredness we can picture in bold strokes some of the most significant progressive steps in the evolution of the Plant Kingdom.



Although the first plants are completely unknown, it seems certain that they must have been aquatic forms that were able to synthesize their food from inorganic materials by some simpler means than the chlorophyll apparatus of today; probably by one somewhat similar to the autotrophic method of nutrition of the Sulfur Bacteria. Doubtless these earliest organic synthesizers were below cellular grade, without the protoplasmic physiological division of labor represented by nucleus and cytoplasm. Then came cellular complexity, followed by the multicellular body with its attendant differentiation of tissues and organs. And probably very early in this evolution sexual phenomena and alternation of generations were established. (P. 514.)

All this and more came to pass before the fossil record is of much assistance. The earliest fossils show Bacteria and Blue-green Algae in the Proterozoic era and all of the great groups of Algae on the shores of the early Paleozoic seas. Thus plant life undoubtedly began in the sea, and the Thallophytes with unicellular or thalloid bodies are well-adapted for an aquatic habitat. But invasion of the land presented new problems and a wide field for the successful pioneer. On dry land it is necessary to form an attachment (root) with the source of water, and at the same time an extensive surface (leaf) for photosynthesis, adequately waterproofed to prevent unduly rapid evaporation. Moreover, the leaves must be advantageously exposed to light — separated from one another on a mechanically strengthened axis (stem). And since the points of intake and outgo of water are now far apart, the stem must be provided with a conducting system (vascular bundles).

So the most highly successful land invaders were the Vascular Plants, or Tracheophytes, that forsook, as it were, the thalloid body and developed true root, stem, and leaf in Devonian time. The earliest known and most primitive Vascular Plants are the Psilophytales which probably evolved from an Anthoceros-like ancestor, and not through the Bryophytes proper which, without a vascular system, some-

what falteringly essayed a land-habit. The Psilophytales are small forms with erect stems arising from a creeping or underground rhizome and terminating in cone-like clusters of sporangia. And from this group of plants probably arose by different lines of descent the Ferns and the Seed Plants of today. (Figs. 95, 123.)

The first known Seed Plants appear late in the Devonian period and are represented by the most primitive order of the Gymnosperms, the Cycadofilicales or Seed-ferns, now long since extinct. Angiosperms are not known before the Cretaceous period and thenceforth they rose relatively rapidly to the position of supremacy that they still maintain. (Fig. 382.)

The Seed Plants constitute the dominant element in the modern flora, largely, it is believed, by virtue of the 'seed habit.' This eliminates many of the disadvantages attendant upon the method of spore distribution exhibited in lower plants, abolishes the delicate, free-living gametophyte, removes the water hazards of free-swimming sperm by developing pollination, provides with greater surety for the protection and nourishment of the embryo within the parent tissues, and then distributes this endowed embryo as a seed. No wonder Seed Plants today hold the place they do in the sun. (Figs. 76, 78, 81, 82.)

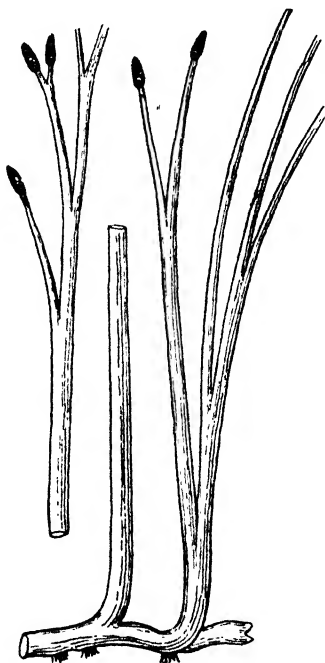

FIG. 123. *Rhynia major*, one of the Psilophytales, with aerial, leafless branches, tipped with sporangia, arising from a rhizome. (After Kidston and Lang.)

## E. PLANT DISTRIBUTION

The review of the plant kingdom has necessarily neglected the interrelationships of the plants with their organic and inorganic surroundings as illustrated by their distribution. There are, of course, plant COMMUNITIES characteristic of relatively local physical features, and also of the wider geographical areas of continents. (Pp. 537-539.)

Many complex problems are involved in the distribution of vegetation, including factors that are in part hereditary and in part environmental. The latter are the more obvious and consist of moisture, temperature, and other factors that determine the CLIMATE, and the chemical and physical composition of the SOIL.

Although the heritage of some plants, such as the well-known Dandelion, Ragweed, and Goldenrod, is sufficiently versatile so that they thrive from low to high altitudes and under wide variations in soil, the great majority are confined to a more restricted habitat — in many cases a single factor rendering a region untenable or favorable. Thus Cranberries are adapted to acid bogs, Cacti to arid wastes, Hemlock seedlings to deep shade, Poplar seedlings to high illumination, Palms to above-freezing temperatures, Redwoods to foggy mountain slopes, and Edelweiss to Alpine meadows. Many plants are found only on limestone soils, while others are characteristic of serpentine areas.

Such factors and many more present a complex of interacting elements that in the final analysis determine the FLORA of a region. This may be illustrated broadly by the general regions of vegetation in North America — the forests, grasslands, deserts, and tundra. (Fig. 124.)

The great FORESTS of the continent are designated the Northern, the Southern, and the Western evergreen forests, the deciduous forest, and the tropical forest.

The *Northern evergreen forest* extends across the continent from ocean to ocean, its northern boundary being a transitional area to the treeless arctic regions, and its southern,

in general, the northern tier of States northwestward to the Rocky Mountains and to Alaska. It broadly follows

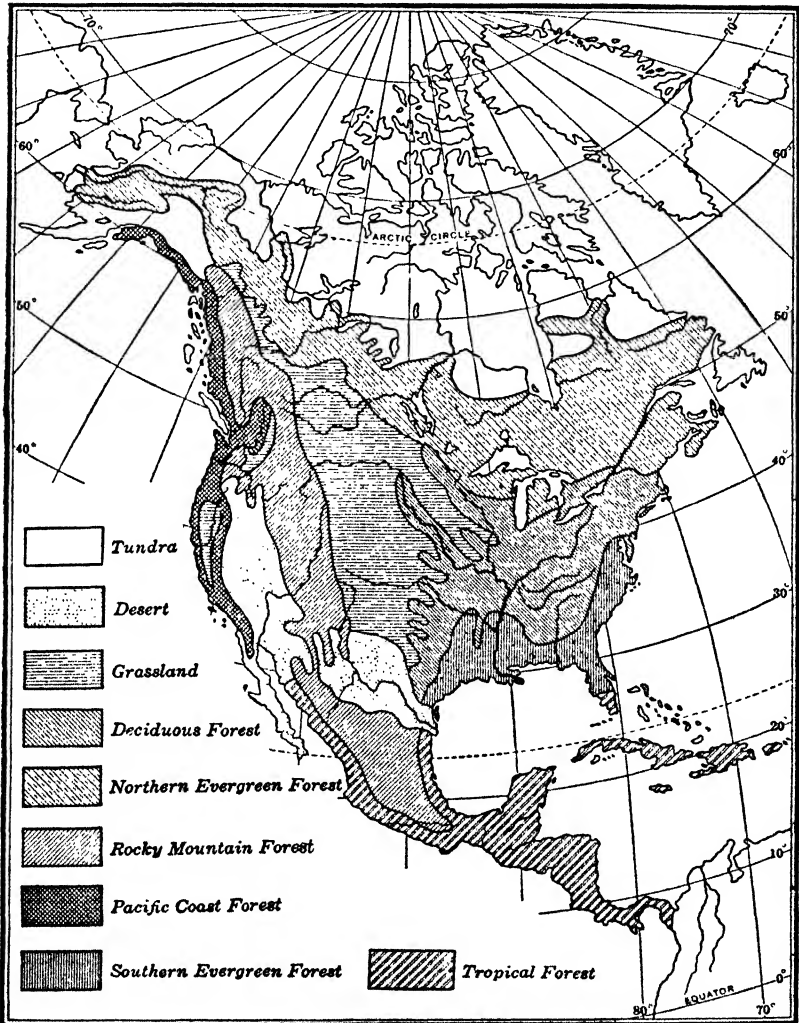

FIG. 124. General regions of vegetation in North America. (After Smith.)

glaciation, being mostly north of the ancient glacial limits. As the name indicates, the predominant trees are evergreens, chiefly conifers, such as Spruces, Firs, Hemlocks, and Pines.

Another large tree belt, the *Southern evergreen forest*, extends over the coastal plain from eastern Virginia to Texas and comprises such well-known species as the Georgia Pine, short-leaf Yellow Pine, and Cypress.

And again on the Pacific coast there is the great *Western evergreen forest*, extending from Alaska to southern Mexico. This comprises the so-called Rocky Mountain forest extending along the slopes of the Rockies from northern British Columbia to southern Mexico, and the Pacific Coast forest covering the slopes of the coastal mountains from southern Alaska through California. The former is characterized by the Western Yellow Pine and Lodgepole Pine, and the latter by the Sitka Spruce and Douglas Fir and a narrow belt of the famous giant Redwoods, or Sequoia.

Thus evergreen trees form the dominant stands over an immense part of North America and are of enormous economic importance.

The great *deciduous forest*, composed of trees that annually shed their leaves, merges on the northeast with the northern evergreen forest and extends from central New York along the Appalachian Mountains to Texas. Its boundary on the west passes from Wisconsin to eastern Oklahoma. The most characteristic development of this forest is in the southern Appalachians with stands of such trees as Oaks, Maples, Hickories, Birches, Walnuts, Ashes, and Elms.

The *tropical forest* region comprises southern Florida, the coastal plain of Mexico, and all of Central America as well as the West Indies. A tropical forest in full development as seen in certain parts of Central America is an astounding display of vegetation. Under the canopy formed by tall trees there is usually a dense undergrowth, favored by moisture and warmth, while the trunks and branches of the trees are entwined with woody vines, or LIANAS, which afford a place in the sun for a profusion of lichens, mosses, ferns, orchids, and other EPIPHYTES. And the fauna of such a forest canopy is a world in itself. Indeed, an experience never to be forgotten is a visit to the tropical rain forest

encompassing the Barro Colorado Island Biological Station in the Canal Zone.

Turning from the forests, we find the GRASSLANDS of the continent covering an immense area with its eastern boundary extending approximately from Manitoba to the middle of Texas, and its western border among the approaches to the Rockies from Alberta to New Mexico. The eastern portion is the so-called PRAIRIE, while the more western is the GREAT PLAINS; both apparently the result of a light annual rainfall and high evaporation that is unfavorable for the growth of tree seedlings.

From grassland to DESERT the transition may not be abrupt. Large desert areas include most of Nevada and Arizona, parts of southern California, New Mexico, Texas, and northern Mexico, as well as a considerable portion of Lower California. The so-called Great Basin between the Rockies and the Sierras, characterized by Sagebrush and other shrubs of similar appearance, except for rapidly maturing herbs after the seasonal rains, merges toward the south into a region of intense heat and drought which is remarkable for many XEROPHYTIC plants — Cacti, Yuccas, Agaves, and the leafless Creosote adapted to aridity.

Quite different conditions, though no less rigorous for vegetation, obtain along the northern border of the continent from Labrador to Alaska. Here, forming the TUNDRA, are only the most hardy plants — chiefly Lichens, Mosses, Grasses, and certain low shrubs that withstand the intensely cold, dry air, strong winds, and soil that, in general, thaws to a depth of only a few inches. Many of the herbaceous species make the most of this favorable period to display masses of conspicuous flowers.

Such a synoptic view of the several great regions of vegetation in North America can, of course, do little more than suggest the interest and importance of the immense field of plant geography, an aspect of ecology. "One must not lose sight of the woods for the trees."

## F. SYNOPTIC CLASSIFICATION OF PLANTS

(With representative examples and approximate number of known species)

Phylum 1. THALLOPHYTA: Thallus plants.

Series of the *ALGAE*. (20,000 species.)

Class I. MYXOPHYCEAE: Blue-green Algae. Gloeocapsa, Oscillatoria.

Class II. CHLOROPHYCEAE: Green Algae. Protococcus, Sphaerella, Ulothrix, Oedogonium, Ulva, Spirogyra, Desmidiids.

Class III. PHAEOPHYCEAE: Brown Algae. Kelps and Rockweeds. Laminaria, Fucus, Ectocarpus, Sargassum.

Class IV. RHODOPHYCEAE: Red Algae. Polysiphonia.

Series of the *FUNGI*. (60,000 species.)

Class I. SCHIZOMYCETES: Bacteria.

Class II. PHYCOMYCETES: Alga-like Fungi. Black Molds, Blights.

Class III. ASCOMYCETES: Sac Fungi. Blue Molds, Powdery Mildews, Yeasts.

Class IV. BASIDIOMYCETES: Club Fungi. Smuts, Rusts, Mushroom rooms.

Phylum 2. BRYOPHYTA: Liverworts and Mosses. (20,000 species.)

Class I. HEPATICAE: Liverworts. Marchantia, Porella, Anthoceros

Class II. MUSCI: Mosses. Sphagnum, Polytrichum.

Phylum 3. TRACHEOPHYTA: Vascular Plants.

Class I. LYCOPSIDA: Club mosses. Lycopodium, Selaginella.

Class II. SPHENOPSIDA: Horsetails. Equisetum.

Class III. PTEROPSIDA: Ferns and Seed Plants.

A. Pteridophytes: Ferns. (6000 species.)

B. Spermatophytes: Seed Plants.

1. Gymnosperms: Cycads and Conifers. (600 species.)

2. Angiosperms: Flowering Plants.

a. Dicotyledons: Willows, Nettles, Pinks, Buttercups, Roses, Beans, Sunflowers. (110,000 species.)

b. Monocotyledons: Grasses, Palms, Lilies, Orchids. (30,000 species.)

## CHAPTER IX

# THE ANIMAL BODY: INVERTEBRATE

Animals are always attempting the next to the impossible and achieving it. — *Goethe*.

**T**he most obvious characteristic which distinguishes familiar plants from animals is the power of locomotion of the latter. This criterion, however, fails among the lowest forms; for example, *Sphaerella* swims as actively as *Paramecium*. Moreover, among multicellular animals there are innumerable permanently attached forms, such as the typical stages of the Sponges, Hydroids, Barnacles, etc. Although the power of locomotion is not a diagnostic character of animals as compared with plants — this, as has been explained, being chiefly a matter of metabolism — it is a fact that the great dissimilarity between the bodies of multicellular plants and animals is a direct or indirect result of the loss by plants and the development by animals of the primitive power of locomotion which most unicellular organisms possess.

At the basis of this difference is probably the fact that plants, in general, manufacture their food from readily available elements whereas most animals must actively seek it. Therefore early in the evolution of plants comparatively rigid cell walls of cellulose were established, which directed the development of the body along relatively fixed lines. On the other hand, animal cells, unhampered by the limitations imposed by rigid, confining walls, were free to respond in more ways to environmental conditions, and this made possible the extremely diverse forms of mobile bodies characteristic of the animal kingdom. (Figs. 21, 60, 151, 153.)



## A. THE CHIEF GROUPS OF ANIMALS

The animal kingdom may be divided from the standpoint of cellular organization into two groups: on the one hand, the unicellular animals, or **PROTOZOA**, comprising about twenty thousand known species, nearly all of which are microscopic, such as Amoeba, Paramecium, and their allies; and on the other hand, multicellular forms, or **METAZOA**. The latter division includes animals ranging in size from those which are so small that hundreds can sport in a drop of water, to the giant Whales of today and the Dinosaurs of the geologic past. (Figs. 199, 208.)

Although the actual stages in the transition from the Protozoa to the Metazoa are unknown, among the more complex colonial flagellated Protozoa there are forms, as already noted, in which the various cells become organically connected so that a primitive type of multicellular body results, and, furthermore, certain cells are set aside for reproduction. In other words, coöperation involving a physiological division of labor takes place between the individuals of a group of cells, and this results in the establishment of an individual body of somatic cells associated with germ cells. (Figs. 23, 282.)

Considered from another standpoint, all animals may be divided into two groups known as **INVERTEBRATES** and **VERTEBRATES**. The former group, frequently referred to as the lower animals, comprises nearly a million known species and exhibits an enormous variety of form and complexity of structure ranging from the Protozoa and Sponges to the Molluscs, Crustaceans, and Insects. On the other hand, the Vertebrates, or higher animals, form a relatively homogeneous group of about sixty thousand species, including the Fishes, Amphibians, Reptiles, Birds, and Mammals. The Birds and Mammals in contrast with all other animals are referred to as warm-blooded, because their body temperature is practically constant and usually above that of their surroundings. (Pp. 254, 255, 280, 281.)

The highly complicated and varied organization of animals renders it impossible to present a concise and adequate plan of a typical animal body, and it is therefore necessary to select one group of animals as the basis of study and then to compare with this, in so far as comparisons are possible without confusion, some of the most significant morphological and physiological variations presented by other groups. We naturally select the group of Vertebrates for chief consideration not only because its relative homogeneity renders it the most available, but also because it includes Man. However, even before we focus attention on the Vertebrates, it is necessary to study certain morphological principles as exhibited among the Invertebrates, first selecting as basic types the Hydra, Earthworm, and Crayfish.

## B. HYDRA

In discussing the development of animals, it was pointed out that the dividing egg typically forms first a blastula which, in turn, becomes transformed into the gastrula stage. The gastrula is essentially a sac composed of two layers of cells: an outer, or ectoderm, and an inner, or endoderm, layer. Although no adult animals retain this simple gastrula form, those composing the group, or phylum, known as the COELENTERATES are to all intents and purposes permanent gastrulae since their bodies are built on the plan of a two-layered sac. This is well exhibited in the various species of Hydra which are almost microscopic, fresh-water Coelenterates commonly found attached to submerged vegetation or stones in brooks and ponds. (Fig. 125; Pp. 59, 60.)

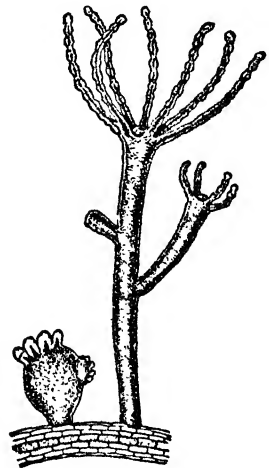

FIG. 125. Hydra. Two specimens with buds, one contracted. Considerably magnified. (After Pfurtscheller.)

The body of Hydra somewhat resembles a long narrow sac: the flat, closed end constituting the **BASAL DISK**, and the conical open end, the **HYPOSTOME**. The opening is the

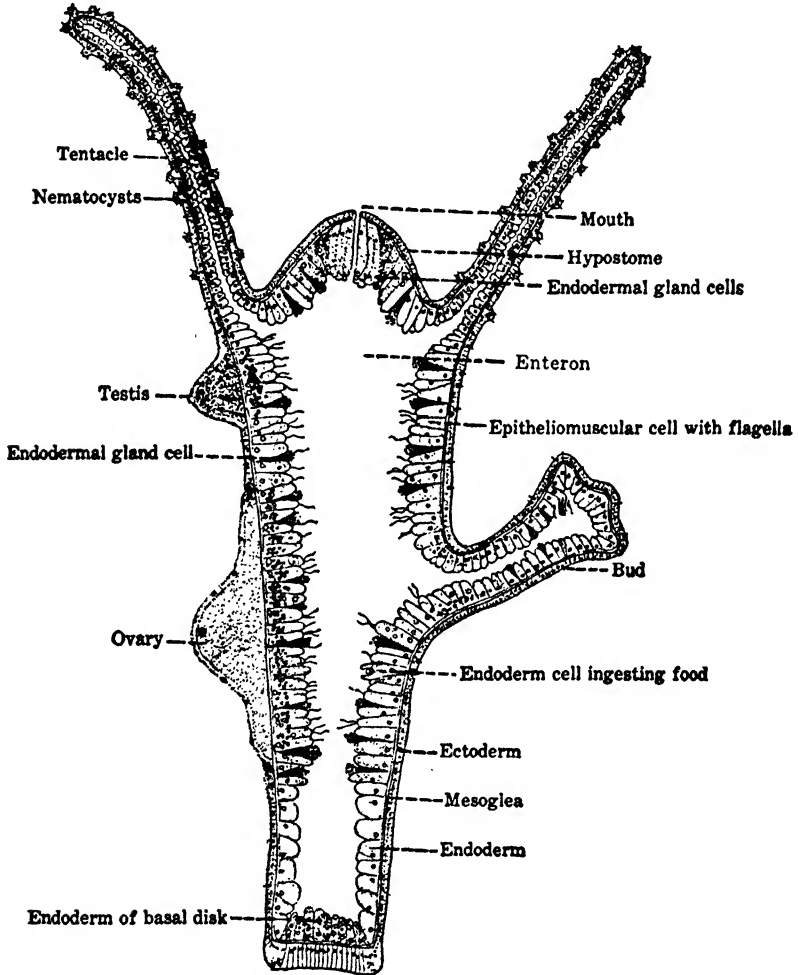

FIG. 126. Hydra. Longitudinal section. (After Kepner and Miller.)

**MOUTH** which is surrounded by a circle of five or more slender outpocketings of the body termed **TENTACLES**. The main axis of the body extends from the basal disc to the mouth, and every plane passing through this axis divides the body

into symmetrical halves. In other words, the parts of the body are symmetrically disposed about, or radiate from, the main axis, and so Hydra affords an example of RADIAL SYMMETRY. (Fig. 126.)

The body wall, including the tentacles, is composed of two distinct cell layers, ectoderm and endoderm, separated by a very thin space filled with a non-cellular jelly-like material, known as MESOGLEA, secreted by the cells of both ectoderm and endoderm. The entire surface, except the basal disc, is covered with a thin, transparent, non-cellular CUTICLE.

Hydra thus illustrates a very simple type of metazoan structure in which but two primary tissues exist; such specializations as are necessary for the performance of the essential life

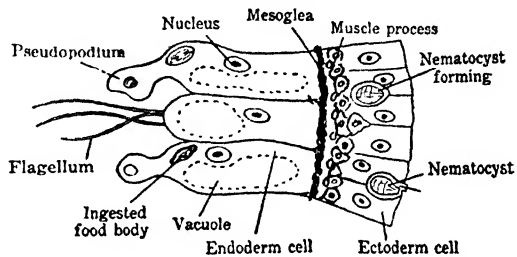

FIG. 127. Hydra. Transverse section of body wall. Highly magnified. (After Parker.)

functions being confined to the various cells that compose these layers. Many of the cells of the endoderm which line the ENTERON are concerned with the digestion of solid food taken in through the mouth, while those of the ectoderm are variously modified for protection and the other relations of the individual to its surroundings, as well as for reproduction. (Figs. 4, 127.)

The *ectoderm* comprises several chief types of cells. The elongated EPITHELIO-MUSCULAR CELLS have broad bases with contractile fibrils which, together with those of certain cells of the endoderm, are responsible for the animal's remarkable powers of expansion and contraction. The SENSORY CELLS act as external receptors of stimuli, and the NERVE CELLS form a sort of net for the conduction of nerve impulses. Between the bases of the epithelio-muscular cells are wedged INTERSTITIAL CELLS which give rise to GERM CELLS and to CNIDOBLAST CELLS. The latter form stinging capsules, or

NEMATOCYSTS, which are widely distributed over the surface but are most numerous on the tentacles. Each of the four kinds of nematocysts encloses a coiled tube which is ejected when the nematocyst explodes under proper stimulation, and new nematocysts are continually being developed to replace those expended. That they are effective weapons is evident from the fact that tiny animals are quickly paralyzed and often killed by a poison injected by the tubes of the nematocysts. (Fig. 262.)

The ectoderm of the basal disc is without nematocysts and functions chiefly for attachment, and for locomotion which is effected by a sort of gliding. It also secretes mucus, and a gas bubble within the mucus may serve to buoy the animal to the surface of the water. But the disc is not the sole agency in locomotion. Sometimes the animal attaches itself alternately by basal disc and by tentacles and tumbles along; at other times it 'walks' inverted on its tentacles.

The *endoderm* forms considerably more than half of the body wall and consists of several types of cells. These are elongated epithelio-muscular cells, with broad bases, which function both in digestion and contraction; small GLANDULAR CELLS that are secretory in function; still smaller interstitial cells situated at the bases of the larger types of cells; and finally, NERVE CELLS. (Fig. 127.)

A Hydra attached by its basal disc, with body and tentacles fully extended, commands a relatively large area. Protozoa, tiny Crustaceans, etc., that come in contact with the nematocysts in the tentacles are paralyzed and held; and then the victims are conveyed by the tentacles to the mouth, which expands and engulfs them. Once within the enteron the glandular cells of the endoderm secrete enzymes which are churned about with the food by contractions of the body and by vibratile flagella that project into the enteron from many of the endoderm cells. The digested material is then absorbed by endoderm cells. Furthermore, particles of food are engulfed by these cells and digested intracellularly. Waste material is ejected through the mouth.

Most species of Hydra are grayish in color but exceptions are the two cosmopolitan species: the Brown Hydra, *Pelmatohydra oligactis*, and the Green Hydra, *Chlorohydra viridissima*. The latter is green because innumerable unicellular Algae, *Chlorella vulgaris*, enjoy an abode within the endoderm cells — a mutually beneficial symbiotic relationship. (P. 541.)

Reproduction in Hydra is both *asexual* and *sexual*. Now and again outpocketings, or BUDS, grow from the body wall, gradually develop into tiny animals, and then drop off as new individuals. Sometimes Hydra undergoes transverse or longitudinal fission but probably only as a sequel to atypical conditions. The processes involved in such asexual reproduction are not very different from those involved in the replacement, or REGENERATION, of parts lost by mutilations — a power possessed to a very high degree by Hydra. (Figs. 125, 126, 283, 285.)

Most species of Hydra are DIOECIOUS, the sexes being separate; but some are HERMAPHRODITIC, each individual producing both eggs and sperm. The testis and ovary are temporary conical elevations of the ectoderm within which the gametes are formed from interstitial cells — a multitude of sperm in the testis and a single egg in the ovary. The sperm are set free into the water and after one fertilizes a ripe egg protruding from the ovary, the zygote is liberated and develops into a young animal.

Hydra thus exemplifies the large phylum of two-layered, or DIPLOBLASTIC, animals, the Coelenterates, all of which are basically similar in body plan though many are markedly different in superficial features. The *primary tissues*, ectoderm and endoderm, are not differentiated during development into *secondary tissues* (muscular tissue, nervous tissue, etc.) for one function or another — the simple life processes of the animals being adequately provided for by the specialization of isolated cells or small groups of cells within the ectoderm and endoderm. (Pp. 219–226.)

### C. EARTHWORM

The bodies of all animals above the Coelenterates are built of three primary tissues which, as development of the individual proceeds, give rise to the secondary tissues and thereby form a relatively complex body. This third primary tissue layer, the MESODERM, typically is developed, as we have described earlier, from the endoderm and comes to occupy the position held by the mesoglea of Hydra; that is, between the ectoderm and the endoderm.

The development of the mesoderm is largely the key to the advance in body organization of higher animals, because it makes possible a radical change in plan that involves the establishment of a body cavity, or COELOM, in which are disposed many of the chief organs. Accordingly the Coelenterates, since they lack the coelom, are often referred to as ACOELOMATES, and animals above the Coelenterates, since they possess a coelom, are known as COELOMATES. The difference in structure can best be made clear by considering the anatomy of a somewhat higher Invertebrate, such as one of the many species of Earthworms, members of the phylum Annelida. (Pp. 232-235.)

#### 1. *Body Plan*

Whereas the Hydra body is essentially a sac composed of two layers of cells surrounding the enteric cavity, the body of the Earthworm is built on the plan of a tube within a tube — the outer tube forming the BODY WALL, and the inner, the wall of the digestive tract, or ALIMENTARY CANAL. The walls of these tubes merge into each other at both ends, and thus together they enclose a space, the coelom. The alimentary canal opens to the exterior at either end, forming the MOUTH and ANUS. (Figs. 128, 132.)

The coelom of the Earthworm is divided by a large number of transverse partitions, called SEPTA, which extend from the inner surface of the body wall to the outer surface of the

alimentary canal. The result is that the worm's body cavity is not a continuous space running from one end of the animal to the other, but consists of a linear series of chambers through the center of which runs the alimentary canal. The limits of these chambers are indicated on the outside of the worm by a series of grooves which encircle the body wall.

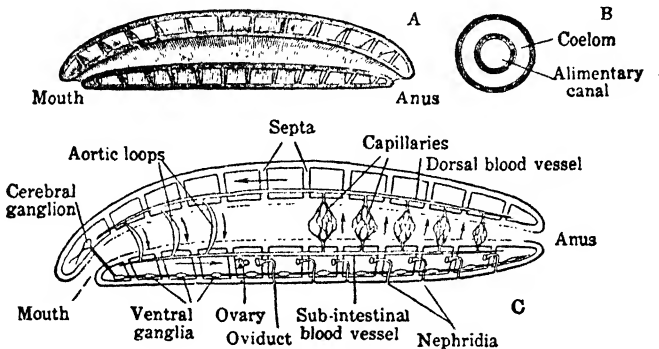

FIG. 128. Diagrams of the general body plan of the Earthworm. A and C, longitudinal sections; B, transverse section. (From Sedgwick and Wilson.)

In short, the body is made up of a series of essentially similar units known as **SEGMENTS**, and thus is a simple example of **SEGMENTATION** which affords further opportunities for division of labor between the various parts of the body. It is a characteristic expressed in varying degree in nearly all higher animals.

Many of the chief parts, or organs, of the Earthworm are symmetrically arranged with respect to the long axis of the body which passes from mouth to anus, so there may be passed through the main axis a single plane that divides the body into symmetrical halves, each of which is a 'mirror image' of the other. The main axis, therefore, extends from the mouth (**ANTERIOR END**) to the anus (**POSTERIOR END**), and the plane that divides the body into right and left sides passes through the upper (**DORSAL**) and lower (**VENTRAL**) side: the body exhibits **BILATERAL SYMMETRY** — a characteristic of higher animals. (Fig. 131.)



## 2. *Tissues and Organs*

Definitive organs are highly developed in the Earthworm, and these demand a much greater differentiation of tissues than occurs in Hydra where local modifications of ectoderm and endoderm serve the purposes of its relatively simple organization. Accordingly in the Earthworm and in all higher forms the mesoderm is added to the two primary cell layers, and from these three there is developed a great variety of special tissues. It is convenient to distinguish six main groups of tissues: epithelial, supporting, muscular, nervous, circulating, and germinal. (Fig. 25.)

The importance of EPITHELIAL TISSUES is evident from the fact that the body is covered and lined with these cellular membranes so they form the point of contact between the organism and its environment. For example, food before it is really inside the body must pass through an epithelium lining the digestive tract, and before it can do that it must be digested by enzymes secreted by epithelial cells. Furthermore, the waste products of metabolism must be excreted and pass from the body through epithelial membranes. Specialization for secretion and excretion leads to GLAND formation. Glands may be unicellular and scattered here and there in the surface of the cellular membrane, or they may be grouped at certain points of vantage. Just as often, however, many cells combine to form multicellular glands, which sink, as it were, below the surface as simple or complex tubes or sacs of secreting cells, and thus amplify manyfold the effective surface within a given space. And finally, specialized epithelial cells form important elements of sense organs — the outposts of the nervous system. (Figs. 129, 130.)

Obviously the larger and more complex the organism, the greater is the necessity for sustaining and binding material; and therefore as we ascend the animal scale we find, in general, an increase in SUPPORTING TISSUE. Whereas in epithelia the cells themselves form the major part of the tissue, in supporting tissues it is direct or indirect products of the cells,

known as intercellular material, or matrix, that gives character to the tissue. Thus the function of **CONNECTIVE TISSUE** is performed chiefly by intercellular bundles of fibers, and the same principle is true for the *cartilage* and *bone* forming the internal skeletons of higher animals.

**MUSCULAR TISSUE** is responsible for the power of motion and locomotion so characteristic of most animals, and also for the necessary movements performed by the internal organs in carrying on the various life processes. Muscle cells have in a highly developed and specialized form a fundamental property of all protoplasm, contractility, which they exhibit by shortening and broadening when stimulated by impulses coming

chiefly through the nervous system. A muscle is a coöperating group of muscle cells, bound together by connective tissue elements and richly supplied with blood vessels and nerves. (Figs. 8, 25, 131, 216, 217.)

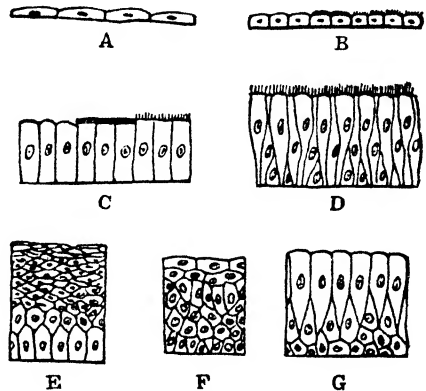

FIG. 129. Epithelial tissues. A, one-layered flat epithelium; B, one-layered cubical epithelium, two cells with cuticle and four with cilia; C, cylindrical epithelium, three cells with cuticle and three with cilia; D, ciliated epithelium; E, many-layered epithelium; F, transitional epithelium; G, stratified epithelium. (From Walter.)

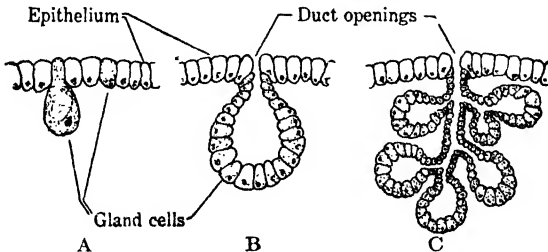

FIG. 130. Diagrams of glands: specialized epithelial cells which elaborate materials and secrete them for the use of the organism. A, unicellular; B, C, multicellular.

All protoplasm is irritable — it responds to stimuli — but obviously the larger and more complex the body becomes, the more necessary it is that stimuli be available to its various parts and that the actions and reactions of its component cells be instantly coordinated so that the parts act as a whole — an organism. This function is performed

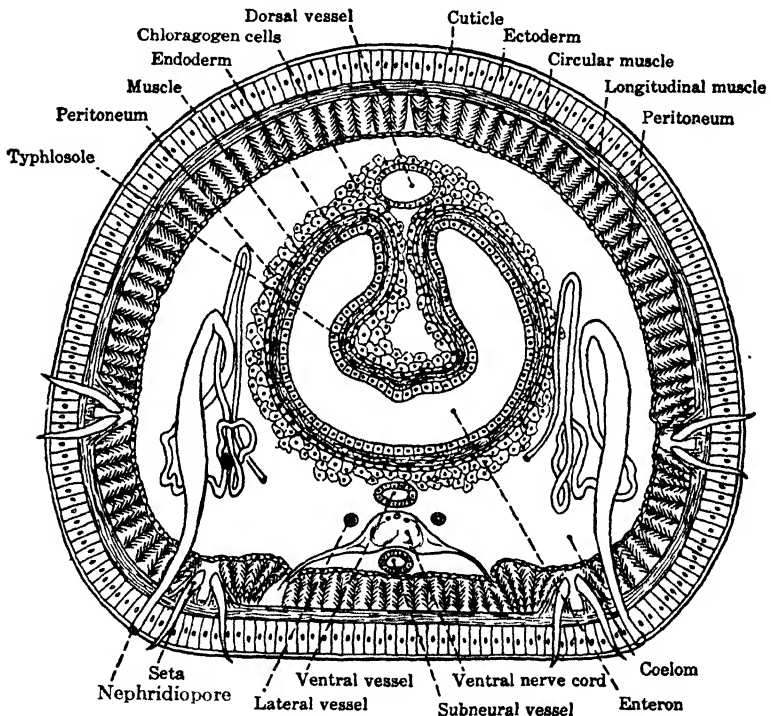

FIG. 131. Transverse section through the middle region of the body of an Earthworm. (From Hegner.)

by NERVOUS TISSUE which transmits nerve impulses when sensory cells are stimulated. (Figs. 265, 266.)

One seldom thinks of BLOOD, LYMPH, and TISSUE FLUID that transport materials in the body, as tissues, but in truth they must be regarded as CIRCULATING TISSUE in which the living cells are suspended in a fluid matrix, the PLASMA. Circulating tissues minister to, and are in intimate contact with, every tissue and cell of the organism. (Figs. 242, 243.)

And finally, within the body — though perhaps not of the body — is the **GERMINAL TISSUE** destined to contribute to the propagation of the race during reproduction. (Figs. 291, 302.)

So the Earthworm and higher animals present a great advance over the two-layer body plan exhibited by Hydra, involving the coöperation of various tissues to form organs, and the coöperation of organs to form **ORGAN SYSTEMS**, each of which plays a particular part in the economy of the whole.

### 3. Organ Systems

The organ systems of the Earthworm and all higher animals may be classified as the **INTEGUMENTARY** and **SUPPORTING SYSTEMS** which constitute the covering and the framework of the individual; the **ALIMENTARY**, **CIRCULATORY**, **RESPIRATORY**, and **EXCRETORY SYSTEMS** that directly or indirectly are concerned with nutrition; the **NERVOUS SYSTEM** which in coöperation with the various **SENSE ORGANS**, the **MUSCULAR SYSTEM**, etc., not only coördinates the various parts of the individual but also orients the whole with respect to its environment; and, finally, the **REPRODUCTIVE SYSTEM** that makes possible the continuation of the race. The fundamental life processes for which these systems provide must be carried on by all animals, and the chief differences in the structure of animals, from the lowest to the highest, is a resultant of the means adopted to serve these essential functions under different conditions imposed by the environment and mode of life.

*Integumentary and Supporting Systems.* The body of the Earthworm, as we have seen, is a long cylindrical tube with an opening at each end, the mouth and anus. The surface is covered by a transparent non-cellular cuticle which is perforated by numerous tiny pores for respiration and the exit of secretions, by a series of **DORSAL PORES** leading into the body cavity, and by the outlets of the excretory and reproductive systems. Furthermore, four pairs of very small,

chitinous bristles, or **SETAE**, protrude through the ventral surface of nearly every segment. (Fig. 132.)

Immediately under the cuticle is a layer of cells which constitutes the outermost cellular layer, or **EPIDERMIS**. Beneath this is a layer of **CIRCULAR MUSCLE**, and then one of

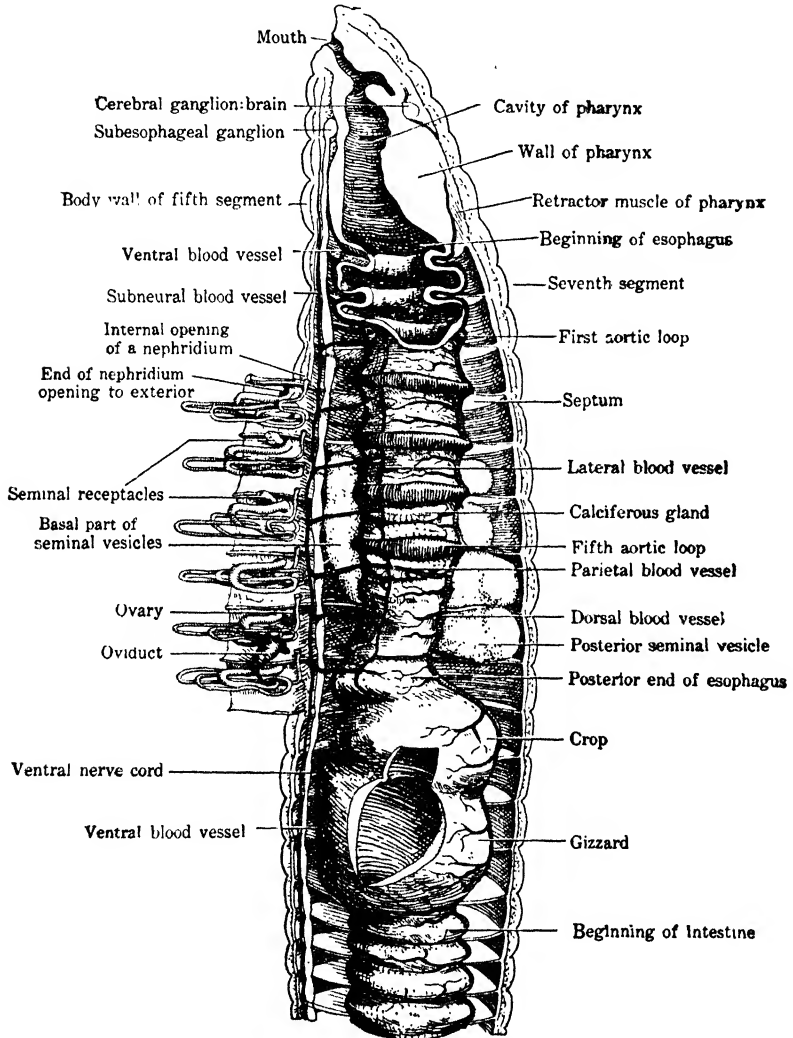

FIG. 132. Earthworm. Diagram of a dissection, lateral view. (Modified, after Linville and Kelly.)

LONGITUDINAL MUSCLE, and finally the PERITONEAL EPITHELIUM which lines the body cavity. Thus the integumentary and supporting systems of the Earthworm consist of the 'skin,' or epidermis, and layers of muscle; a true skeleton, such as occurs in higher animals, not being present. (Fig. 131.)

*Alimentary System.* Dissection of an Earthworm reveals, within and extending the entire length of the body, an inner tube known as the ALIMENTARY CANAL. The space between the two tubes is the coelom, which is divided transversely by thin membranes, or septa, into a series of compartments, or segments. Indeed the septa essentially suspend the alimentary canal in the coelom, which is filled with a colorless COELOMIC FLUID that is irregularly forced about from one segment to another as the worm contracts. The wall of the canal, in general, consists of an outer peritoneal epithelium of so-called CHLORAGOGEN CELLS, and this layer forms the intestinal part of the coelomic lining. Internal to this is a thin layer of longitudinal muscles, then a similar one of circular muscles, and finally, a layer of ciliated epithelium, endodermal in origin, which lines the lumen of the canal.

The alimentary canal is a straight tube that shows various specializations for extracting and digesting the food which consists of particles of organic matter, chiefly pieces of leaves and humus in general. Food particles are sucked through the mouth into the BUCCAL POUCH and passed to the muscular PHARYNX. After the addition of secretions from the PHARYNGEAL GLANDS, the food traverses the long, narrow ESOPHAGUS, where CALCIFEROUS GLANDS contribute an acid-neutralizing secretion. Then the food enters the CROP where it is temporarily stored until passed to the GIZZARD to be rolled and squeezed into small fragments. And now the ingested material is ready to go on to the INTESTINE proper, extending from the gizzard to the anus, where digestion and absorption chiefly occur. To increase the surface area for these functions there is a deep glandular infolding of the dorsal wall of the intestine that extends its entire length and is known as the TYPHLOSOLE. (Figs. 131, 132.)

The process of digestion does not differ fundamentally from that in higher animals to be considered later. The food runs the gantlet of a series of chemical substances, chiefly enzymes which reduce complex molecules of the food to simpler ones that can be absorbed and so actually taken into the body. And the waste, indigestible material, or *FECES*, is evacuated through the anus. (Fig. 233.)

*Circulatory System.* For the distribution of material to the various parts of the body of the Earthworm, a circulatory system is demanded. This comprises a series of tubes, or *VESSELS*, in which is circulated a fluid tissue, or blood. The

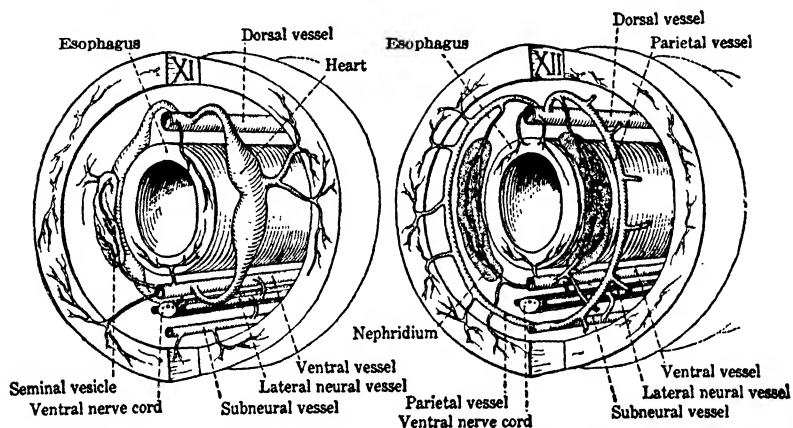

FIG. 133. Diagrams of the circulatory system in segments XI and XII of the Earthworm. (From Hegner.)

latter is composed of a liquid plasma, red in color owing to a dissolved pigment, and of suspended colorless *BLOOD CELLS*. In Vertebrates the closely related respiratory pigment, hemoglobin, is in blood cells and not in the plasma.

The blood vessels consist chiefly of five relatively large longitudinal trunks, one of which runs just above and nearly the entire length of the alimentary canal. This *DORSAL VESSEL* induces the blood flow by waves of contractions, or *PERISTALSIS*, of its muscular walls. The successive waves pass forward and force the blood before them until the five pairs of *AORTIC LOOPS*, or so-called hearts, are reached. Here

the blood is similarly forced through the loops into the VENTRAL VESSEL which is just beneath the alimentary canal. In the ventral vessel some of the blood proceeds anteriorly and some posteriorly, and in both cases eventually through smaller and smaller vessels, or CAPILLARIES, until it reaches the body wall and various organs. The return current is by the LATERAL-NEURAL VESSELS and by the SUBNEURAL VESSEL and then up to the dorsal vessel by the PARIETAL VESSELS. Thus the blood *circulates*, carrying food and oxygen to the tissues, and waste material, including carbon dioxide, away; and so functions not only in nutrition but also in respiration and excretion. (Figs. 132, 133.)

*Respiratory System.* The relatively simple body and inactive life of the Earthworm renders unnecessary an elaborate respiratory system such as is present in many higher animals. Accordingly it consists merely of the network of capillaries which permeate to the surface of the body wall and there allow the blood to exchange carbon dioxide for oxygen through the moist membrane.

*Excretory System.* Most of the waste products of metabolism leave the body by a series of tiny coiled tubes, or NEPHRIDIA, one pair being present in nearly every segment. A nephridium is a ciliated tube with a funnel in one segment and the major portion of the coiled tube in the next posterior segment, where it leads out of the body by a NEPHRIDIOPORE on the ventral surface. Ciliary action draws solid particles from the coelomic fluid into the tube to be passed out the pore, while gland cells in the coiled portion remove waste products from the blood to be similarly disposed of. (Figs. 128, 131, 253.)

*Nervous System.* Coördination of the activities of the individual, both external and internal, is the function of the nervous system and sense organs. The chief nervous center of the Earthworm is a bilobed mass of tissue, the brain or CEREBRAL GANGLION, lying on the dorsal surface of the pharynx. From each lobe there passes ventrally a CIRCUM-ESOPHAGEAL COMMISSURE which merges into the SUB-



ESOPHAGEAL GANGLION just beneath the pharynx. From this ganglion the VENTRAL NERVE CORD (actually two closely united cords) extends in the midventral line to the posterior end of the worm. (Fig. 139.)

In each segment, except the first three, the cord enlarges into a ganglion from which arise three pairs of nerves. The latter are either EFFERENT OR AFFERENT NERVES. Efferent nerves consist of MOTOR NERVE FIBERS which are delicate prolongations of nerve cells, or NEURONS, in the ganglia, and carry motor nerve impulses to the muscles, glands, and other organs. On the other hand, afferent or SENSORY NERVE FIBERS arise from SENSORY CELLS, or RECEPTORS, chiefly on the surface of the body, and carry sensory nerve impulses to the ventral nerve cord which, in turn, may relay them to the brain. Or the sensory impulse may be immediately transformed in the nerve cord into a motor impulse and pass by motor fibers to a muscle or other EFFECTOR. In this event a simple REFLEX ARC is established and a reflex action occurs. The groups of sensory cells constitute the simple SENSE ORGANS of the worm which enable it to respond to light, contact, and other stimuli. (Figs. 128, 131, 132, 265, 266.)

*Reproductive System.* The Earthworm is hermaphroditic since both male and female reproductive organs are present in each individual. The male system consists of two pairs of TESTES, a pair of SPERM DUCTS leading to the surface, and three pairs of SEMINAL VESICLES. The female system comprises a pair of OVARIES, a pair of OVIDUCTS which start as an open funnel in one segment and then enlarge into an egg sac in the next posterior segment before opening to the exterior, and finally, two pairs of SEMINAL RECEPTACLES. (Figs. 128, 132.)

Cross-fertilization occurs because, during copulation, sperm from each individual pass into the seminal receptacles of the other where they are stored until egg-laying occurs. Then the enlarged glandular CLITELLUM on the body surface, which aids in holding the animals in copulation, secretes a

band-like tube which, as it is moved forward, receives eggs and sperm. Soon this 'cocoon' is passed off the anterior end of the worm, and then it closes to form the capsule in which the fertilized eggs develop into tiny worms. (Fig. 302.)

Thus it is clear that the body plan of the Earthworm is radically different from that of Hydra, exhibiting as it does such essential new features as mesoderm, coelom, bilateral symmetry, segmentation, specialized tissues, definitive organs, and complex organ systems. The persistence and development of this basic plan from Earthworm to Man is interpreted as evidence of evolution.

#### D. CRAYFISH

Bearing in mind the general plan of the body of the Earthworm, next may be considered the main principle underlying the changes in this plan which give rise to many of the diverse forms among the higher animals. This principle appears to be chiefly a specialization of the individual segments so that the body, instead of consisting of a large number of essentially similar segments, is formed of a complex series of them, many of which are quite different from the rest. Moreover, by the partial or complete fusion of two or more segments and the suppression of segmentation, definite regions of the body are marked off. This principle is well illustrated by members of the phylum ARTHROPODA, or 'jointed-foot' Invertebrates, such as Lobsters, Insects, and Spiders. There are over half a million living species of Arthropods. (Pp. 245-252, 255.)

The body of a primitive Arthropod differs from that of the Earthworm chiefly in the reduction of the number of segments and the development of paired jointed APPENDAGES as outgrowths from the body in each segment. From such a primitive type all the multitude of diverse forms of arthropod bodies can be derived. For instance, in the Crayfish,

which is essentially a fresh-water Lobster, the body consists of twenty-one segments, but by the union or complete fusion of certain segments, the body is divided into three more or less distinct regions — HEAD, THORAX, and ABDOMEN.

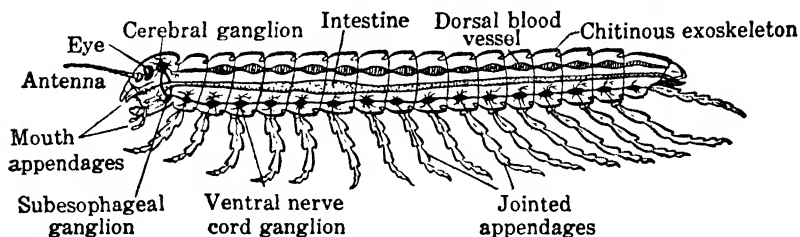

FIG. 134. Diagrammatic representation of the structure of an ideal primitive Arthropod in which very little specialization of the segments has occurred. (After Schmeil.)

Furthermore, the primitive locomotor appendages of the respective segments are modified into organs for the performance of widely different functions: those of the head, as sensory organs, jaws, etc.; those of the thorax, as organs for grasping, offense, defense, and walking; and those of the abdomen for swimming, etc. Thus change in structure has gone on hand in hand with change in function so that, although there is no obvious resemblance between the jaws of the Crayfish and the legs employed for swimming, nevertheless a study of their development shows beyond doubt that they owe their origin to modifications of one primary type. Accordingly the various appendages of the series are said to be **HOMOLOGOUS** — they exhibit **SERIAL HOMOMLOGY** — signifying a fundamental similarity of structure based on descent from a common antecedent form. One of the tasks of the division of biology known as **COMPARATIVE ANATOMY** is to determine the various parts of animals or of plants which are homologous and to study the adaptive changes which are associated with change of function. (Figs. 134–137.)

The principle of specialization and fusion of the segments of the higher Arthropods also results in profound modifications of the internal organs. In the first place, the partitions between the various segments in the Earthworm have disap-

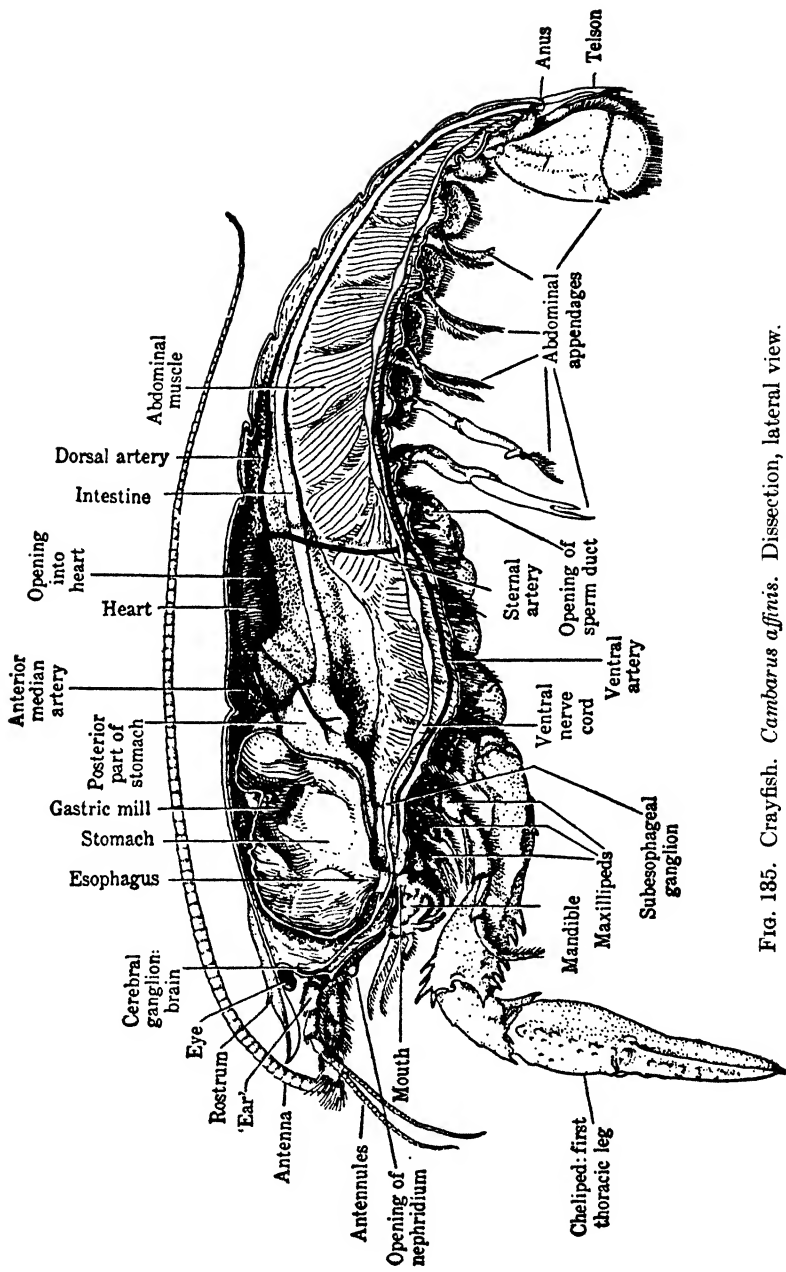

Fig. 185. Crayfish. *Cambarus affinis*. Dissection, lateral view.

peared in the Crayfish. Again, the alimentary canal of the Earthworm is a nearly straight tube extending through the body, with relatively slight modifications in certain segments for the elaboration of the food material as it passes along from mouth to anus; while in the Crayfish there is an accentuation of such modified regions, and the development of large outpocketings, or glands, which are specialized for the formation of chemical substances to digest the food.

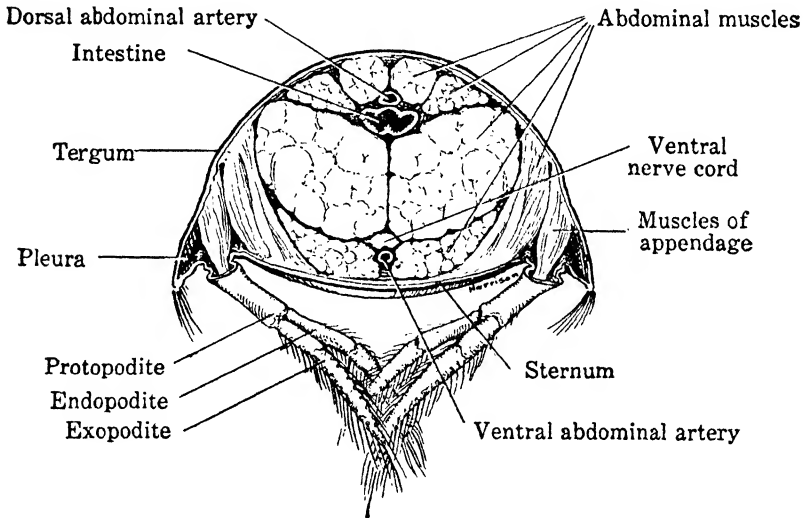

FIG. 136. Crayfish. Transverse section of the fifth abdominal segment.

As a final illustration we may take the nervous system. In both the Earthworm and the Crayfish it exhibits the same general plan, but certain modifications have been brought about in the latter by the uniting of segments in the region of the head and thorax. This process has resulted in the fusion of the segmental ganglia into larger ganglionic masses. For example, the cerebral ganglion of the Crayfish comprises the primitive ganglia of the segments which have united to form the head. (Fig. 139.)

With this summary view of the chief contrasting features of the Earthworm and Crayfish as types, we turn to a more specific consideration of the structure of the latter.

## 1. External Anatomy

*Integumentary and Supporting Systems.* The entire body of the Crayfish is covered with a non-living EXOSKELETON, composed of a chitinous CUTICLE impregnated with

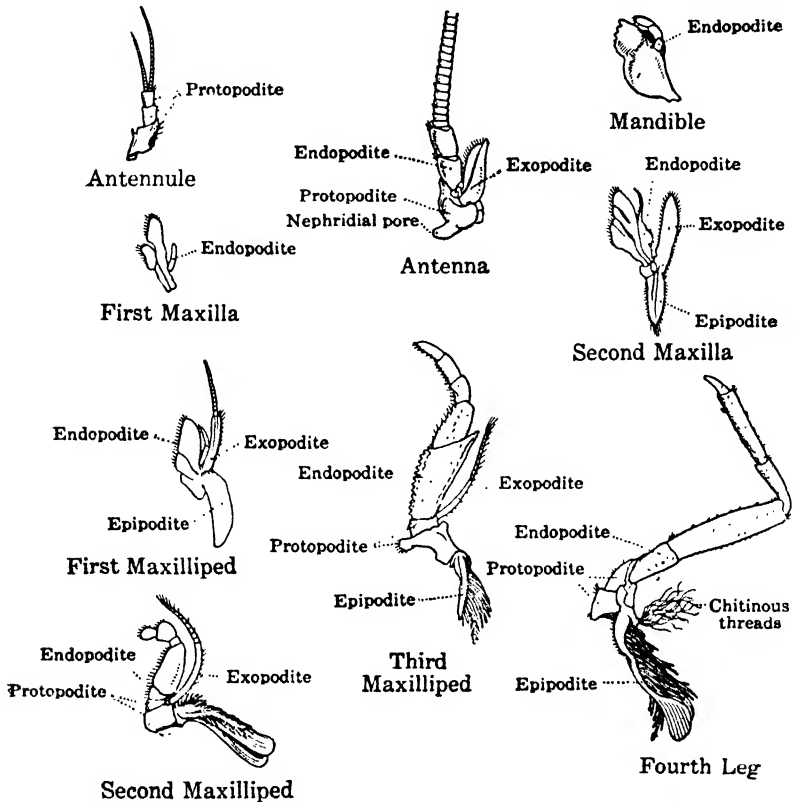

FIG. 137. Typical appendages of a Crayfish. Protopodite, endopodite, and exopodite are homologous throughout the series. (After Kerr.)

lime, which is extremely resistant except at the joints to allow movement. And since growth of the exoskeleton cannot occur as the animal increases in size, it must be shed periodically and a new one secreted — a process known as **MOLTING, OR ECDYSIS**.

The body is segmented but this is not everywhere apparent because there is a rigid anterior portion, or **CEPHALOTHORAX**,

covered dorsally and laterally by a shield-like CARAPACE. Across the carapace runs a groove which demarks the head from the thoracic region. An anterior, pointed extension of the carapace, called the ROSTRUM, is just above the pair of stalked eyes. The cephalothorax is composed of six head and eight thoracic segments and is followed by the abdomen of seven movable segments. An extension, or TELSON, of the terminal abdominal segment bears the anus. (Fig. 135.)

A typical segment of the abdomen comprises externally a dorsal plate or TERGUM, lateral plates or PLEURA, and a ventral transverse bar or STERNUM. Every segment bears a pair of jointed appendages; each, as already emphasized, a variant of a common, primitive type consisting of a basal segment, or PROPODITE, which bears two branches, an outer EXOPODITE and an inner ENDOPODITE. In certain cases the modifications result in appendages which are FOLIACEOUS, as the second maxillae; or BIRAMOUS, as the swimmerets on the abdomen; or UNIRAMOUS, as the walking legs. (Figs. 136, 137.)

## 2. Internal Anatomy

The coelom of the Crayfish, in comparison with that of the Earthworm, is very greatly reduced; the conspicuous spaces, or SINUSES, between the organs in the body being filled with blood and so constituting a HEMOCOEL. A large part of the body cavity is filled with muscle tissue. The largest muscles are in the abdomen to flex and extend this region, but other large muscles are in the thorax and the pincers, or CHELIPEDS, while smaller ones motivate the other appendages, etc. Rigid segmental arrangement of the internal organs of the Earthworm is largely absent in the Crayfish, though still obvious in the structure of the nervous system. (Figs. 135, 139.)

*Alimentary System.* The mouth is situated on the ventral surface of the head, just between the jaws, or MANDIBLES, and leads into the initial part of the alimentary canal, or

esophagus. From here the food, consisting largely of living and dead animal tissues which have been manipulated by the mandibles and other appendages about the mouth, is passed to the stomach for further treatment. In the anterior, or **CARDIAC CHAMBER** of the stomach there is a group of chitinous bodies, known as the **GASTRIC MILL**, which are moved by powerful muscles and grind the food. Sometimes there are also present two hard bodies, or **GASTROLITHS**, which probably represent stored calcareous material for use in forming the exoskeleton during ecdysis.

The ground-up food is forced through a **STRAINER** to the **PYLORIC CHAMBER** of the stomach into which open the **HEPATIC DUCTS** that deliver the secretions from two large **DIGESTIVE GLANDS**, the so-called liver. After this combined mechanical and chemical treatment the products of digestion are absorbed and then the residue is carried through the long, straight intestine to the anus. (Fig. 135.)

*Circulatory System.* The absorbed food passes to the circulatory system, which consists of a heart, a series of blood vessels, and a number of sinuses, all containing blood. The latter is a nearly colorless fluid containing the respiratory pigment and numerous amoeboid blood cells. The heart is a muscular-walled sac suspended in the **PERICARDIAL SINUS** in the median dorsal part of the thorax. Blood in the sinus enters the heart through six valvular apertures, or **OSTIA**. (Figs. 135, 138.)

Five arteries arise from the anterior part of the heart. They are the **ANTERIOR MEDIAN ARTERY** passing forward above the stomach and supplying the cardiac part of the stomach, the esophagus, and head; two **ANTENNARY ARTERIES**, one on either side of the anterior median artery, passing forward and downward and by branches supplying part of the stomach, antennae, excretory organs, muscles, etc.; and two **HEPATIC ARTERIES** arising below the antennary arteries and proceeding to the digestive glands. Proceeding posteriorly from the ventral part of the heart is the **DORSAL ARTERY** which supplies the upper part of the abdomen, while



a branch gives rise to the **STERNAL ARTERY** leading downward and passing between the nerve cords connecting certain ganglia. Here, below the nervous system, it forms the **VENTRAL ARTERY** which supplies this region.

Under the impetus of the rhythmical contractions of the heart, the blood circulates throughout this series of arteries

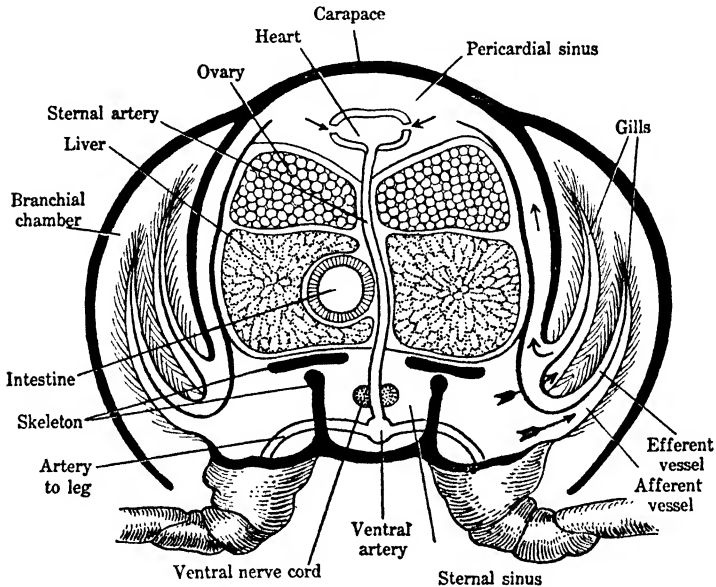

FIG. 138. Diagrammatic transverse section of the thorax of the Crayfish, showing the gills and some of the internal organs. (After Hegner.)

which finally terminate as capillaries in the tissues. Here the blood escapes from the vessels into small tissue spaces and sooner or later reaches the large **STERNAL SINUS** from which it passes through the respiratory organs. From thence it returns to the heart by way of the **BRANCHIO-CARDIAC SINUSES** and the **PERICARDIAL SINUS**.

*Respiratory System.* Delicate, finger-like outpocketings of the body wall, or **GILLS**, effect a large exposure of blood-bearing tissue to the surrounding water so that the respiratory interchange may be effected. The gills are arranged in two rows, near the bases of certain appendages, in the

BRANCHIAL CHAMBER which is beneath the pleura of the carapace. A current of water bathes the gills, chiefly by the activity of the plate-like exopodite of the **SECOND MAXILLA**: the so-called bailer, or **SCAPHOGNATHITE**. (Figs. 137, 138.)

*Excretory System.* The nephridia of the Crayfish comprise a single pair of relatively large bodies known as **GREEN GLANDS**. Each is composed of a glandular part and a thin-walled bladder with a short duct leading to the surface on the basal segment of the **ANTENNA**. (Fig. 135.)

*Nervous System.* The general plan of the nervous system, as already stated, is similar to that of the Earthworm. The cerebral ganglion is larger and sends nerves to the eyes, antennules, and antennae. Circumesophageal commissures from the brain pass ventrally to a relatively large subesophageal ganglion formed by the fusion of the ventral ganglia of several segments. It supplies nerves to the **MANDIBLES**, **MAXILLAE**, and first and second **MAXILLIPEDS**. Smaller ganglia of the ventral cord occur in each of the posterior segments and supply the surrounding regions. In addition, the Crayfish is provided with a complex of nerves arising from the brain and commissures to supply the walls of the stomach. (Figs. 135, 139.)

*Sense Organs.* The chief receptors of the Crayfish are a pair of highly complex eyes. Each eye is on the tip of a movable stalk on either side of the head, and consists of more than 2000 long, slender visual units, or **OMMATIDIA**, whose four-sided outer tips appear, as **FACETS**, through the transparent **CORNEA** covering the surface. Such a **COMPOUND**

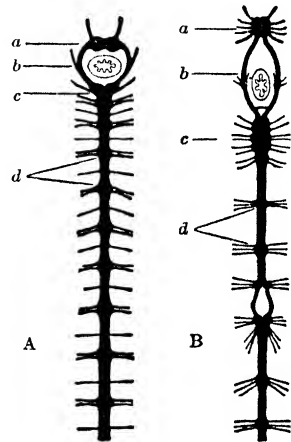

FIG. 139. Diagram of the anterior portion of the central nervous system of an Earthworm (A) and a Crayfish (B). *a*, brain (cerebral, or supraesophageal, ganglion); *b*, nerve commissures encircling the pharynx (shown in section); *c*, subesophageal ganglion; *d*, ganglia of the ventral nerve cord, with nerves emerging.

EYE produces MOSAIC VISION; the image resulting from as many points of light as there are ommatidia. This apparently is well suited to detect motion because changes in position of a comparatively large object will affect all of the ommatidia.

The Crayfish is provided with STATOCYSTS, one in the basal segment of each antennule, which are organs of equilibration and perhaps may function also as auditory organs. Each is a chitinous sac enclosing some two hundred sensory hairs and a number of sand grains, or STATOLITHS. The contact of the latter with the hairs, changing by gravity as the animal moves, determines the orientation, or equilibrium, of the body. If iron filings are substituted for sand grains, the animal's equilibrium can be upset by a magnet!

In addition to eyes and statocysts the Crayfish has receptors for other stimuli. Thus the entire body responds to touch, though plumed TACTILE HAIRS on certain of the appendages are especially sensitive. Similarly, receptors for the so-called CHEMICAL SENSE, which probably includes both taste and smell, are widely distributed.

*Reproductive System.* Unlike the Earthworm, the Crayfish is dioecious, each individual being either male or female. The male organs consist of a testis, just beneath the pericardial sinus, and two long, coiled sperm ducts that lead from the testis to the surface through the GENITAL PORES on the protopodites of the fifth pair of walking legs. The ovary of the female is similar in size and position, the oviducts opening through a pore on the protopodites of the third pair of walking legs. The sperm are transferred at copulation to a seminal receptacle on the ventral surface of the abdomen of the female, where they are available to fertilize the eggs when laid some months later. The fertilized eggs are attached to the appendages of the abdomen and their development proceeds until as free-swimming larvae they are able to shift for themselves.

*Regeneration.* In Hydra and the Earthworm the power of regeneration is so highly developed that it is essentially a

method of asexual reproduction. In the Crayfish, the power is much more limited, though the various appendages, including the eyes, are replaced when lost. Sometimes, however, the new appendage differs in structure and function from the original. Furthermore each of the walking legs is provided with a special breaking point near its base where the muscles contract to prevent loss of blood when a leg is severed. Or an injured leg may be discarded at this point by the action of certain muscles; a process called AUTOTOMY. In either case regeneration occurs at the stump.

We have now considered Hydra, Earthworm, and Crayfish, chiefly to afford a background for an understanding of the body structure of higher animals. It will be recalled that Hydra exhibits radial symmetry and the simple two-layered condition which is a transient phase in the early development of higher forms. The Earthworm illustrates bilateral symmetry, and the addition of the mesoderm, an alimentary canal opening to the exterior by an anterior mouth and a posterior anus, segmentation, coelom, definite organs, and organ systems. The Crayfish shows, in simple form, certain general principles underlying the modification of the earthworm type, which involve the specialization of various regions of the body in connection with the change of functions of the parts to fulfill more complex life-conditions.

It should be emphasized, however, that we have selected from the groups of Invertebrates certain types which illustrate several fundamental structural principles, but that there are other invertebrate groups that exhibit body plans which, superficially at least, depart very widely from the types described. However, it is believed that these forms do not break the general evolutionary relationships of the Invertebrates as a whole. We now turn to their consideration.

## CHAPTER X

# SURVEY OF THE ANIMAL KINGDOM: INVERTEBRATES

It seems as if Nature had essayed one after the other every possible manner of living and moving, as if she had taken advantage of every permission granted by matter and its laws. --- *Gide*.

**W**ide as are the diversities in structure exhibited by plants, they are exceeded many-fold by animals, so zoölogists have still more difficulties than do botanists in their attempts to give a natural classification. Indeed, there is considerable difference of opinion even in regard to the number of main divisions, or phyla, and, in some cases, to the sequence in which they should be arranged. In our survey, however, it is necessary to emphasize only the chief phyla and, of course, to take them up serially — but the series must not be regarded as invariably indicating their genetic relationships. To attempt to express the latter it would be necessary to resort to a branching 'phylogenetic tree,' but the details of such a scheme would show considerable variation if made by different zoölogists. Thus forewarned in regard to some of the uncertainties of present-day classifications, we may proceed to a synoptic view of the Animal Kingdom. (Fig. 183; Pp. 254, 255, 559-562.)

### A. PROTOZOA

The first great phylum is the Protozoa which comprises the most primitive forms of animal life, each individual being, as we know, typically a single unit of living matter. But it does not follow that the Protozoa are devoid of complex organization. In fact, some exhibit a complexity of

structure within the confines of a cell that probably is not exceeded in the cells of higher animals. The Protozoa are the simplest, but by no means simple animals, and their study forms the science of PROTOZOÖLOGY. And there are plenty of kinds of Protozoa. Although about 20,000 species

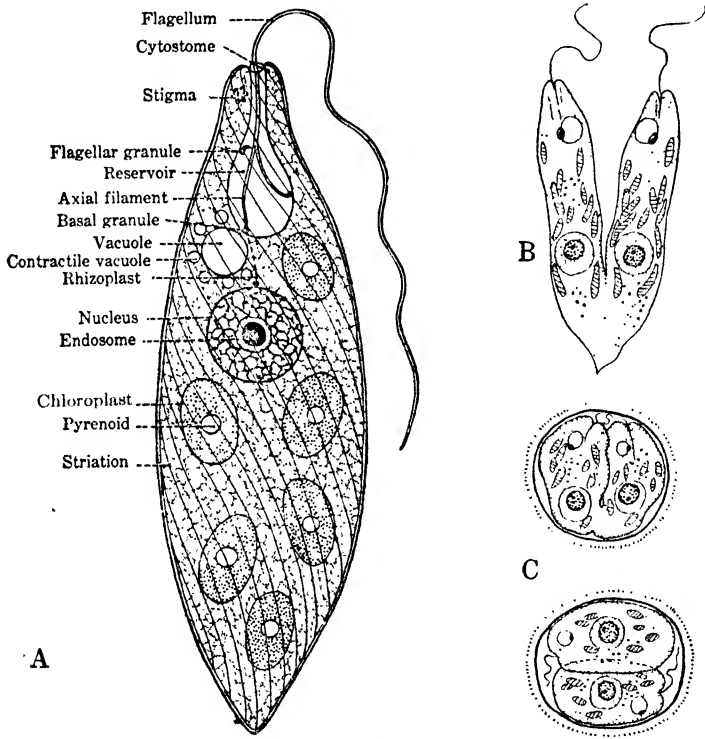

FIG. 140. *Euglena*. A, free-swimming individual showing details of structure (From Hegner); B, reproduction by longitudinal binary fission; C, two stages of fission within a cyst. Variously magnified.

have been described, undoubtedly there are more species than in all the rest of the animal world. Every higher animal that has been carefully studied has been found to harbor at least one species of Protozoa specialized to live in it. (Fig. 420.)

The Protozoa, since they are single cells, demand for active life a more or less fluid medium, and so are aquatic animals. However, different species exhibit all gradations

of adaptation to variations in moisture from those that thrive in oceans and lakes, or pools and puddles, to those which find sufficient the dew on soil or grass blade, or the fluids within the tissues and cells of higher plants and animals.

The phylum Protozoa is divided, largely on the basis of the locomotor organs, into four CLASSES: the Flagellata, Rhizopoda, Sporozoa, and Ciliata. In general, we may regard the FLAGELLATA as cells with flagella as locomotive organs, such as *Euglena*; the RHIZOPODA as forms like *Amoeba* that move about by means of pseudopodia; and the CILIATA as organisms like *Paramecium* that swim by cilia. The SPOROZOA, all of which are parasitic, such as the organisms causing malaria, possess no characteristic type of organ for locomotion though all are motile at some stage in their life history. (Figs. 12, 14, 21, 140, 146.)

FLAGELLATA. The great class of flagellate Protozoa, sometimes called the Mastigophora, comprises the most primitive animals. But no hard and fast line can be drawn between the plant and animal kingdoms: one merges into the

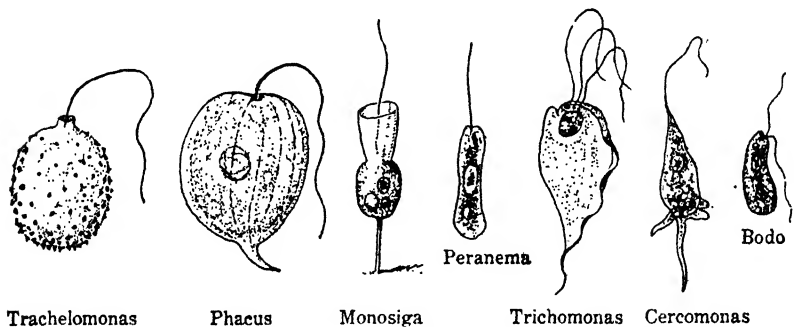

FIG. 141. Common flagellated Protozoa. Highly magnified.

other when the simplest forms of life are approached. Indeed botanists, with considerable justice, claim some of the Flagellates chiefly because they possess chlorophyll and are able to manufacture their own food. But in the absence of sunlight many chlorophyll-bearing forms, such as *Euglena*, are able to utilize food material in solution and are similar in structure to other species without chlorophyll that are

typically holozoic. Moreover it is not possible to draw a sharp line between the Flagellates and the Rhizopods because certain organisms possess both flagella and pseudopodia during various phases of their life. (Figs. 140, 141.)

The Flagellates are very widely distributed in sea, pond, and infusions of organic matter. An immense order, the DINOFLAGELLATA, constitutes not a small part of the microscopic life of the sea, competing with certain Rhizopods and microscopic plants in variety of species and number of individuals—numbers so immense that wide areas of the sea may become discolored or appear phosphorescent. Many others have invaded the field of parasitism, living in the digestive tract and blood stream of higher animals: the TRYPANOSOMES being among the most destructive blood parasites of man and beast in certain tropical regions. (Figs. 142, 374.)

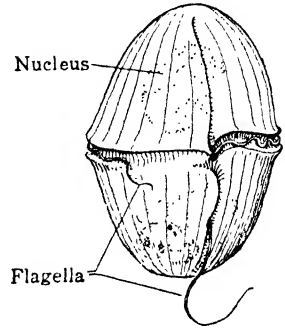

FIG. 142. A Dinoflagellate, *Gymnodinium*. Highly magnified.

The versatility of the Flagellates in mode of life and nutrition apparently implies a high potential of adaptation and evolution. Indeed, it is among them and some unicellular Algae that certain interesting associations, or COLONIES, of individuals occur that suggest a possible method of origin of the multicellular body. (Figs. 22, 23.)

RHIZOPODA. Amoeba, which we have already studied, may be visualized as the type of the Rhizopods since all members of this class are, broadly speaking, 'amoebae,' but there are numerous species of the genus *Amoeba* itself. The common, relatively large fresh-water species, *Amoeba proteus* and *Amoeba dubia*, have as associates many other fresh-water and salt-water species. Again, numerous species, such as those comprising the genus *Endamoeba*, live within the bodies of man and other animals. Furthermore, there are many common fresh-water genera, such as *Arcella* and



Diffugia, that have resistant protective coverings, or shells. The shells have an opening through which the pseudopodia are protruded so that locomotion, securing of food, etc., can be performed. But all of these animals, whether free-living or parasitic, naked or provided with a shell, are

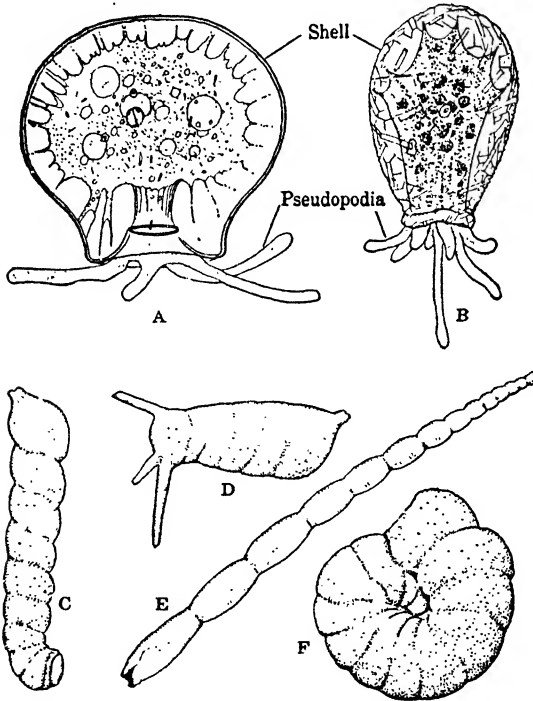

FIG. 143. A, *Arcella* showing the protoplasm through the transparent shell and also protruding as pseudopodia; B, *Diffugia* showing the same; C, D, E, F, shells of four species of Foraminifera. Various magnified.

creeping cells with more or less broad or blunt finger-form pseudopodia and comprise a group of the Rhizopods usually known as the LOBOSA. (Figs. 143, 414; Pp. 42-45.)

An immense group of chiefly marine Rhizopods is the FORAMINIFERA. Most species have quite complex shells of calcium carbonate, with one or many openings through which thread-like pseudopodia emerge, branch, and flow together so that the shell becomes essentially an internal

structure. The almost incalculable number of Foraminifera constitutes an important source of marine food for small animals which, in turn, are the food of economically important fishes. The more resistant shells of the Foraminifera sink to the sea-bottom and cover vast areas totaling, perhaps, one third of all the sea-bottom and more than that of the North Atlantic Ocean. This so-called Globigerina ooze is reported to be accumulating at the rate of about one tenth of an inch a year on submarine telegraph cables. Similar deposits during the geological past are represented today by limestone thousands of feet thick. The Pyramids and the Sphinx are built of foraminiferous rock. (Figs. 143, 144.)

Two other groups of the Rhizopoda, known as the HELIOZOA and RADIO-LARIA, typically have unbranched, radiating pseudopodia, each supported by a core of more dense protoplasm. Most species are floating, spherical forms, and the pseudopodia, protruding from the entire surface of the cell, give the appearance of the conventional figure of the sun. Accordingly the fresh-water forms are commonly called Sun Animalcules, or Heliozoa. The Radiolaria are all marine and are more complex than the Heliozoa; the proto-

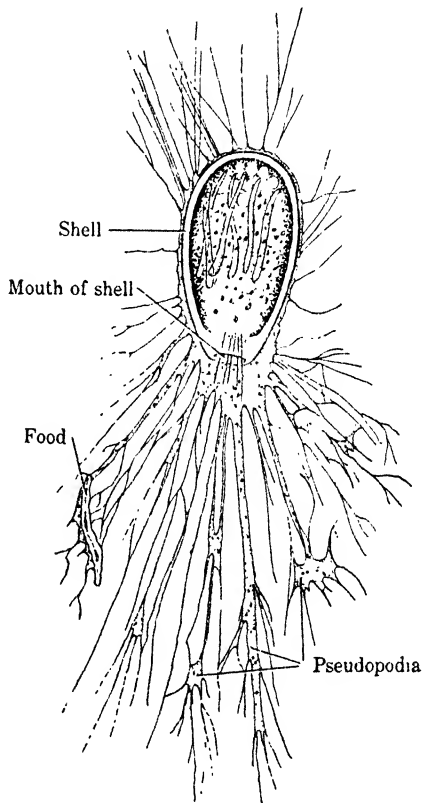

FIG. 144. *Allogromia*, one of the few fresh-water Foraminifera. Note the pseudopodial mass emerging from, and surrounding the shell. Highly magnified. (After Cambridge Natural History.)

plasm being differentiated into several layers, enclosing a dense, perforated CENTRAL CAPSULE, and usually supported by an elaborate skeleton of silica. The Radiolaria vie in numbers and importance with the Foraminifera in the economy of the sea; the deposits of their silicious skeletons forming the Radiolarian ooze, widely distributed in the tropical Pacific

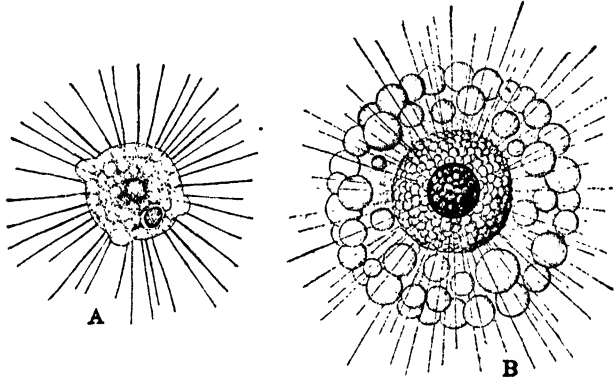

FIG. 145. A, Heliozoön, *Actinophrys sol*; B, Radiolarian, *Thalassicolla nucleata*. Highly magnified. (From Kudo.)

and Indian Oceans. Certain immense rock strata are contributions to the earth's surface made by the Radiolaria during bygone ages. (Fig. 145.)

SPOROZOA. Although parasitic species are found in all four classes of Protozoa, the Sporozoa have the distinction of living solely at the expense of other organisms, their HOSTS, in which they create disturbances of more or less severity which frequently result in disease. The parasite's ability to get a living with little expenditure of energy has in the Sporozoa, as elsewhere in the animal kingdom, resulted in a degeneration of structures necessary for a free life, and in an elaboration of the reproductive processes to ensure that the parasite secures access to the proper host. For, in general, each Sporozoön is adapted to live in one (or two) particular species of animal — indeed probably every species of higher animal has at least one Sporozoön specially fitted to live in it.

Monocystis is a common Sporozoön that spends its entire life in the body of an Earthworm. The 'adult' Monocystis is an elongated cell living in the seminal vesicles and securing

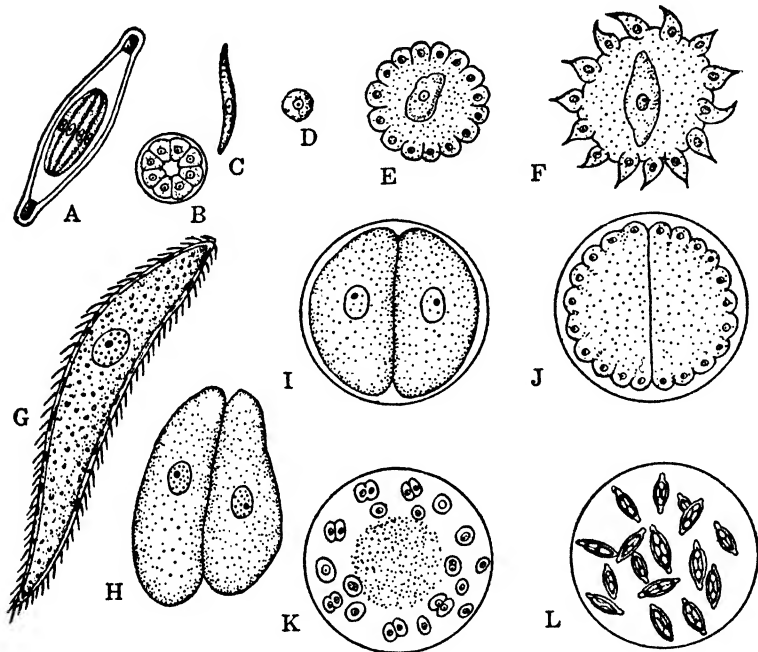

FIG. 146. Life cycle of a Sporozoön, *Monocystis*. A, spore consisting of a spore case enclosing eight sporozoites; B, transverse section of same; C and D, liberated sporozoites; E, sporozoite after entering 'sperm-sphere' of Earthworm; F and G, growth until fully developed trophozoite is formed surrounded by the degenerate remains of sperm-sphere with flagella of sperm; H, two trophozoites that have become free from degenerate sperm-sphere and united as gametocytes; I, encystment of gametocytes; J, division of nuclei and cytoplasm to form gametes; K, union of the gametes to form zygotes, residual cytoplasm of gametocytes in center of cyst; L, cyst containing many spores formed by secretion of a spindle-shaped spore case around each zygote which then divides to form eight sporozoites. These become arranged as in A and are ready to be transferred to another host. All highly magnified. (From Curtis and Guthrie.)

its nourishment from the developing germ cells of the worm. Here food is plentiful, and accordingly much is stored for use during the complex reproductive changes which terminate in the production of resistant SPORES. These eventually are discharged from the body of the worm and trust to

chance that entrance may be gained to the body of another worm in order that the life cycle may be repeated. (Fig. 146.)

Malaria is transmitted to man solely by diseased female mosquitoes that inoculate into the blood stream a Sporozoön of the genus *Plasmodium*. Once in the human blood, the

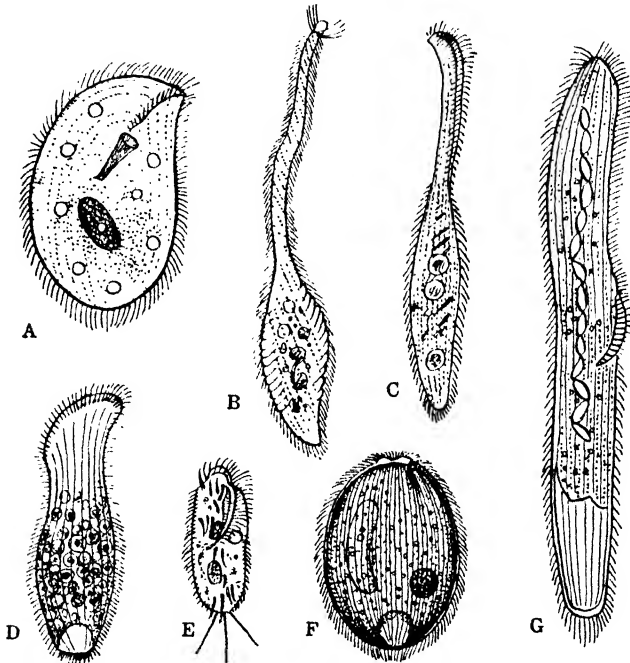

FIG. 147. Some common Ciliata from fresh water. A, *Chilodonella*; B, *Lacrymaria*; C, *Lionotus*; D, *Spathidium*; E, *Stylonychia*; F, *Prorodon*; G, *Spirostomum*. Variesly magnified.

parasite enters a red blood cell and begins its complicated life history. Multiplication of the parasite until millions of red cells are infected and destroyed results in the periodic liberation of poisonous material in the blood which produces the alternate chills and fever. In order to complete its life history the parasite must again be taken into the body of a mosquito by the latter biting an infected person. (Figs. 373, 415-417.)

**CILIATA.** The ciliated Protozoa, constituting the class Ciliata, probably represent the most complex development

of the unicellular plan of animal structure. Ciliates have afforded ready material for the study of various physiological problems, not only because some of the species are relatively large, but also because, in general, they lend themselves readily to experiment. Most of the Ciliates are free-living in fresh and salt water, though not a few are parasitic. There is a highly complex fauna in the digestive tract of sheep and cattle, and man is not immune.

The organization of the group may be illustrated by *Paramecium*, a giant among the Protozoa, that is just visible to the naked eye as a

whitish speck if the water in which it is swimming is properly illuminated. When magnified several hundred times it appears as a more or less slipper-shaped organism which one would not consider, at first glance, a single cell because it shows such highly specialized parts. (Figs. 21, 147, 148.)

The nuclear material in *Paramecium*, instead of forming a single body as it does in most cells, is distributed in two parts: a large MACRONUCLEUS, and one or more small MICRONUCLEI. Strictly speaking, the macronucleus and micronuclei together constitute the nucleus of the cell, and represent a sort of physiological division of labor of the chromatin complex which is characteristic of the Ciliata.

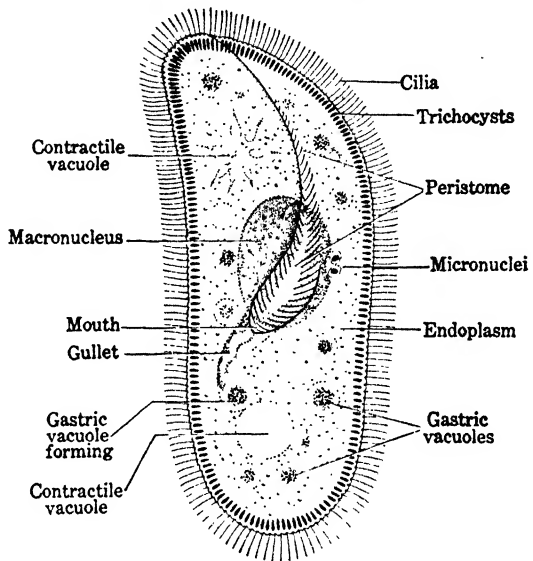

FIG. 148. *Paramecium calkinsi*. Highly magnified.

But it is in the cytoplasm that specialization is most conspicuous. Not only are there general differentiations into ectoplasm and endoplasm, but these regions also have local specializations such as thousands of hair-like, vibratile CILIA for locomotion and securing food, TRICHO CYSTS for defense, PERISTOME, MOUTH, and GULLET for the intake of solid food, GASTRIC VACUOLES for digestion, and CONTRACTILE

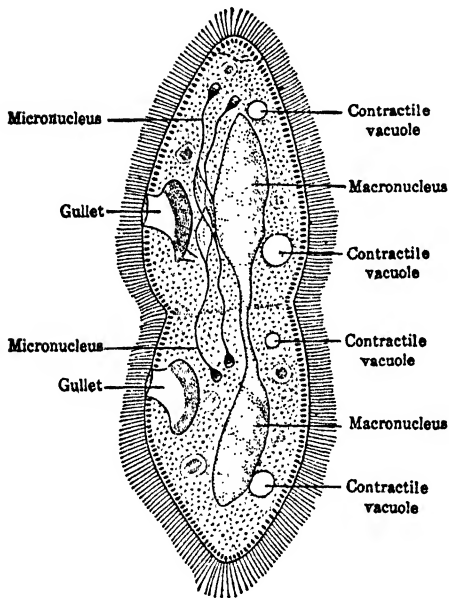

FIG. 149. *Paramecium aurelia* in process of division. Highly magnified. (From Lang.)

VACUOLES for excretion. And withal, the various parts of the cell are coordinated by a NEUROMOTOR system. (Figs. 149, 150, 375, 376.)

Paramecium, under normal conditions, grows rapidly and, when it has attained the size limit characteristic of the species, cell division takes place — a process of reproduction that can continue indefinitely if the environment is favorable. But periodically Paramecium undergoes an internal nuclear reorganization

process (ENDOMIXIS). Also now and then individuals temporarily fuse in pairs and interchange nuclear material (CONJUGATION) — an expression of fundamental sex phenomena, involving fertilization. And in certain cases, self-fertilization (AUTOGAMY) takes place. (Figs. 300, 301.)

Indeed the Ciliates seem, so to speak, to have made the most of their unicellular plan of structure, for Paramecium is fairly representative: it is not the most simple nor yet the most complex. Specialization of one part and another of the cell has produced in the Ciliata a group of animals that,

judged by distribution and numbers, is highly successful in the microscopic world of life.

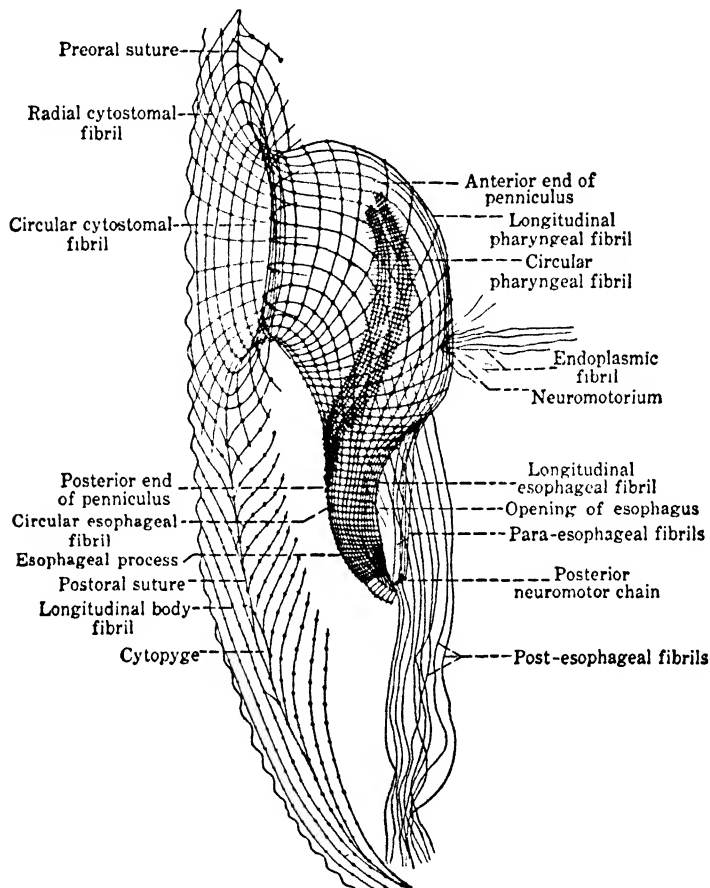

FIG. 150. Diagram of a part of the neuromotor system in the region of the peristome and gullet of *Paramecium multimicronucleatum*, to afford an idea of the structural complexity attained by some Protozoa. Very highly magnified. (After Lund.)

In this necessarily cursory survey of the Protozoa, at least one major point must be forced upon our attention — the versatility of form and function exhibited by these unicellular animals — their ADAPTATION to many and varied modes of life in the most diverse environmental conditions. But their unicellular plan of structure, permitting only



cytological differentiation, has obvious inherent limitations which adaptation cannot surmount, while the multicellular type of organization characteristic of all other animals affords opportunities almost transcending imagination. It makes possible both cytological and histological — tissue — differentiation. However, the potential of evolution of the protozoan type *was* expressed, it is believed, when it gave rise in the geological past to the stock from which the higher animals have developed. This allowed the powers of adaptation pent up, so to say, in the single cell to find expression in specialization and coöperation in the individual of another and higher order which multicellular animals, or Metazoa, represent. (Fig. 183 ; P. 254.)

### METAZOA

The multicellular animals constituting the Invertebrates present a bewildering array of forms adapted to nearly every conceivable environment. Some are smaller than many of the Protozoa and others much larger than certain Vertebrates. Some are aquatic, others are terrestrial, and still others spend most of their life in the air. The majority possess the power of locomotion, but many are fixed, or sessile, and not a few are obligatory parasites in or on the bodies of other animals.

The fact that there are nearly a million known species, and probably twice as many yet to be discovered, at once suggests that our survey must be confined to a relatively few representatives from each of the major invertebrate phyla; just enough to place the three forms selected for special study — Hydra, Earthworm, and Crayfish — in proper perspective. (Figs. 125, 132, 135.)

### B. SPONGES

It is not surprising that the Sponges, which constitute the PORIFERA, the lowest phylum of multicellular animals, show certain relationships with the Protozoa. Specialization of

cells and physiological division of labor, though carried far beyond that shown by the most complex colonial Protozoa, nevertheless have not suppressed the individualities of the coöperating cells to the extent that occurs in most higher forms. Witness the fact that when certain Sponges are gently squeezed through the meshes of fine silk cloth, so that the tissues are resolved into separate cells, these cells will gather together in small groups and each group will grow into a Sponge. And if the disassociated cells of different species are intermingled, they will sort themselves into their respective species - a remarkable example of the power of regulation so generally exhibited by living organisms. In brief, the Sponge is an individual animal, but its organization is loose and the dependence of one part upon another is relatively slight.

From casual observation one would not recognize a Sponge as an animal at all - in fact it was only during the past century that their animal nature was demonstrated. Thus the common *Leucosolenia* of the New England coast is a tiny tube permanently attached at the base to a rock, or other support, just below low-tide mark. It is without the power of locomotion and does not visibly respond in any way when touched. However, if it is examined under a lens, it will be found that the whole surface of the sac-like body is dotted with innumerable tiny pores, or *OSTIA*, through which water is being drawn into the central *GASTRAL CAVITY* and passed on out through a large opening, or *OSCULUM*, at the top. The ostia and the osculum are surrounded by contractile cells which regulate the size of the openings, but no differentiated nervous tissue is present so the contractile cells apparently respond to direct stimulation - the genesis of a *NEURO-MUSCULAR* mechanism. The name of the phylum, *Porifera*, refers to the pores on the surface. (Fig. 151.)

A section of the body wall of *Leucosolenia* shows that it is supported by a skeleton, composed of a network of three-pronged *SPICULES* of calcium carbonate, embedded in the tissue. The latter consists of two fairly definite layers of

cells: an outer, or DERMAL EPITHELIUM, and an inner, or GASTRAL EPITHELIUM, separated by a jelly-like mesoglea with many amoeboid wandering cells and germ cells.

The gastral epithelium is of particular interest because it consists chiefly of a layer of COLLAR CELLS, each provided

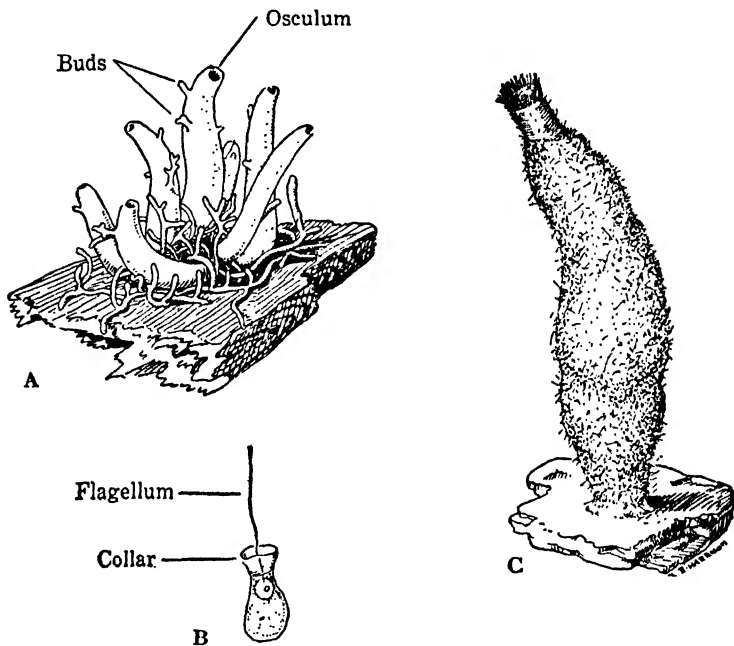

FIG. 151. A, small colony of *Leucosolenia*; B, a collar cell; C, *Sycon*. Various magnifications.

with a flagellum, and resembling certain flagellated Protozoa from which it is probable that the Sponges have descended. It is the constant lashing of the flagella that creates the current of water, laden with food and oxygen, through the pores into the gastral cavity, and on out through the osculum, bearing waste materials. Thus although Sponges are static there is seething activity within — it has been estimated that some five gallons of water may be drawn through the canal system of a 10 cm. sponge during a single day. It is also the collar cells that capture, engulf, and digest particles of food in typical unicellular fashion (intracellular digestion)

and pass the products on to the other cells. Apparently the amoeboid wandering cells also ingest and store food. Similarly, respiration and excretion are carried on by the individual cells.

Such is the essential plan of structure of a simple Sponge, but there are more complex forms which, in general, can be derived from this so-called ASCON type by a thickening of the body wall, and then either the restriction of the collar cells to canals embedded in it in close proximity to the gastral cavity (SYCON type), or their segregation in tiny

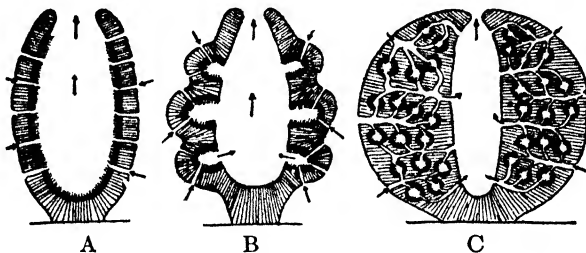

FIG. 152. Types of canal systems of Sponges. A, ascon type (*Leucosolenia*); B, sycon type (*Grantia*, *Sycon*); C, leucon type (*Spongilla*, *Euspongia*). The arrows indicate the direction of the current of water. Solid black represents the gastral layer with collar cells. (After Johnson and Snook.)

cavities more remotely situated in the tissues but still in communication with the gastral cavity by long canals (LEUCON type). In either case the functioning surface of both the dermal and gastral epithelium is enormously increased. Obviously the elaboration of canals makes possible the massive types of sponges, since it serves, in general, the purpose of a circulatory system. The sycon type is represented by *Sycon* and the leucon type by the common Fresh-water Sponge, *Spongilla*, and the Bath Sponge, *Euspongia*. (Fig. 152.)

But one must not gain the idea that all Sponges are quite similar in appearance. Some are no larger than a pin head, others are six feet or more tall. Some are branched, fan-shaped, or cup-shaped. Most are white or gray though many contribute brilliant colors to the picture presented by the sea floor.

Among all this variety of Sponges, however, certain species, chiefly of the genus *Euspongia*, stand out as of high economic importance because their flexible, fibrous skeleton of SPONGIN, when cleaned and dried, is the familiar bath sponge of commerce. These Sponges, long gathered by diving, are now also farmed with some success. Live Sponges are cut into very small pieces, wired to cement plates and then sunk to places favorable for sponge growth. Several years later the pieces have matured sufficiently to produce a marketable sponge crop.

Sponges reproduce asexually and sexually. Asexual reproduction is by BUDS which may remain attached and form a colony as in *Leucosolenia*, or become separated as distinct individuals; and also in many cases by the liberation of groups of cells, called GEMMULES, possessing the power to form new individuals. Some species under adverse conditions collapse and disintegrate into rounded cell masses which later regenerate to normal form. Sexual reproduction is by egg and sperm—both being formed in the same hermaphroditic individual. The zygote develops into a tiny ciliated embryo which, after a short free-swimming existence effecting the dissemination of the species, settles down, becomes permanently attached, and soon attains the adult structure.

The relationship of the Porifera to other Invertebrates raises an interesting problem. The tissues of Sponges are, as we have seen, not only too complex to be considered colonies of Protozoa, but they also are much less complex than those of the higher multicellular animals. And they are organized in a radically different way as well—without organs and organ systems, without mouth and enteron, and with an apparent reversal of the two primary cell layers which are not homologous with the ectoderm and endoderm of higher animals. All considered, Sponges probably represent a side branch of the animal kingdom that went up, so to say, an evolutionary blind alley, and remained only Sponges! (Fig. 183.)

### C. COELENTERATES

With the large group of aquatic animals comprising the COELENTERATA — the Polyps, Jellyfish, Sea Anemones, and Corals — we reach a basic phylum of the Invertebrates because, with ectoderm and endoderm definitely established, with a mouth opening into a digestive cavity, and with specialized body parts coordinated by a simple nervous system, they institute a plan of structure that proves to be fruitful for the derivation of certain features exhibited in higher animals. Our review of the phylum will merely serve to indicate some of the chief forms assumed by the POLYP type of individual, already studied in Hydra, in the highly diversified classes known as Hydrozoa, Scyphozoa, and Anthozoa. (Pp. 175–179.)

HYDROZOA. One of the few Coelenterates inhabiting fresh water is the common polyp, Hydra. However, the life history of Hydra is not representative of the many kinds of marine Hydrozoa that commonly grow on submerged objects, such as the piles of piers, because most of them consist of large colonies of hydra-like individuals organically connected; somewhat as though a Hydra formed many buds that remained attached. Moreover, the colony is only one phase of the life history of a hydroid, for it develops special buds, known as MEDUSAE, which become separated from the colony as independent free-swimming individuals. At first glance a medusa bears little resemblance to a polyp, though it is essentially a sexual polyp that has been produced on the colony by budding and then liberated. Accordingly the complete life history of a typical hydroid involves an ALTERNATION OF GENERATIONS consisting of the asexual colony and the sexual medusae that swim away and disseminate the species. Hydra is apparently a specialized form in which the medusa generation is suppressed. (Figs. 153, 154.)

The hydroid colonies exhibit some interesting examples of physiological division of labor between the component individuals. Thus in *Bougainvillea* there are two kinds of

polyps: the typical feeding polyps, or HYDRANTHS, and the MEDUSOID polyps which later, with some structural changes, are set free. Again in *Obelia*, another common hydroid, there are also highly modified individuals, or GONANGIA,

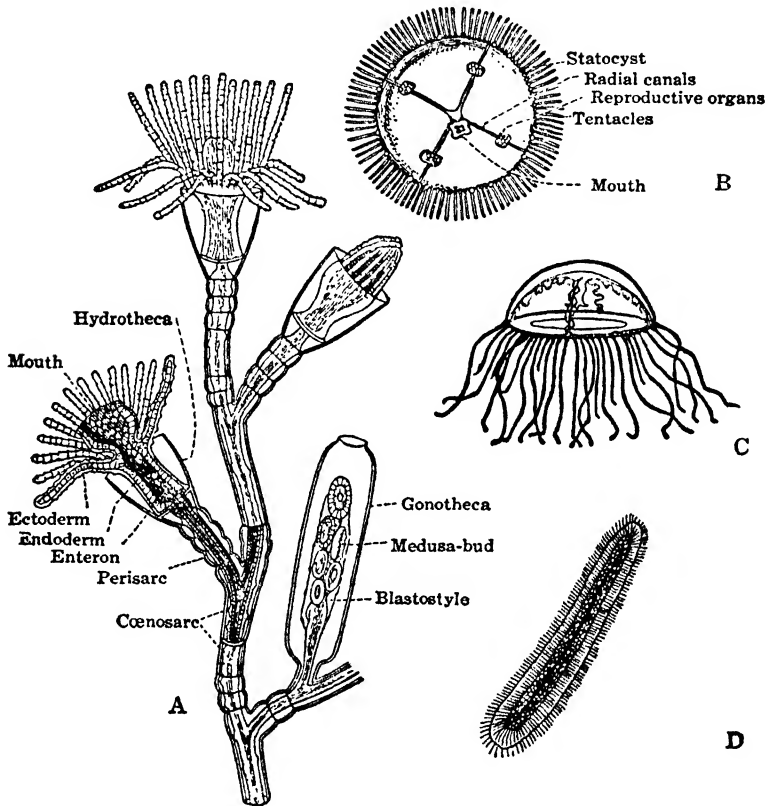

FIG. 153. Life history of a Hydroid, *Obelia*. A, portion of the asexual colony, showing three hydranths (one in longitudinal section) and a gonangium; B, free-swimming sexual medusa, oral view; C, medusa, side view; D, ciliated larva. (C and D of closely related species.) Various magnifications. (After Allman and Hargitt.)

specialized to produce the medusa generation by budding. In still other Hydrozoa this POLYMORPHISM is carried even further. Thus *Physalia*, the Portuguese Man-of-War, is a floating hydroid colony consisting of an air-filled bag, or float, with a sail-like crest, from which are suspended a

large number of polyps. These individuals are very diverse: some are nutritive, others are tactile, and still others bear batteries of nematocysts. Furthermore, there are male reproductive polyps and others that give rise to egg-producing

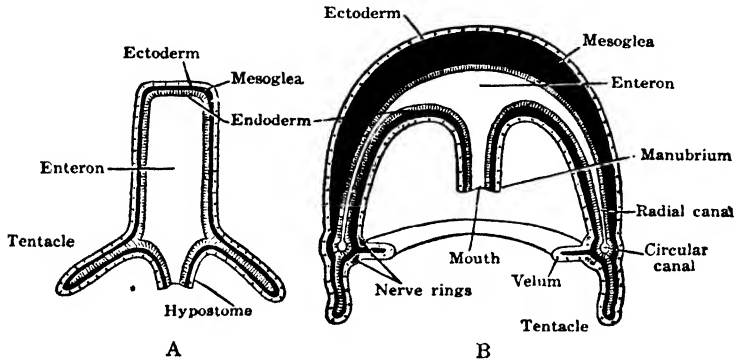

FIG. 154. Diagram showing the fundamentally similar structure of *Hydra* or a hydranth of *Obelia* (A) and of a medusa (B). (From Parker.)

medusae. Obviously an animal such as *Physalia* suggests that in many of the lower forms the individual is not so sharply defined, and is more difficult to define, than in the higher animals.

**SCYPHOZOA.** The second great class of the Coelenterates comprises chiefly large medusae, such as the common saucer-shaped *Aurelia* of the Atlantic coastal waters or its giant relative, *Cyanea*, which may attain a diameter of eight feet; each and all well-called jellyfish since their soft tissues are more than 96 per cent water.

The structure of *Aurelia* is basically the same as that of the medusa generation of the Hydroids; the most obvious difference being an excessive development of the mesoglea between ectoderm and endoderm so that the body wall is relatively thick. The mouth is in the center of the under (oral) surface and opens into a large enteron. The latter branches into RADIAL CANALS that run to the circumference, or 'rim,' where they merge into a CIRCULAR CANAL. Thus digested food is carried directly to all parts of the animal without the necessity of a special circulatory system. Sur-



rounding the mouth are four ribbon-like **ORAL ARMS** which, together with the fringe of tentacles about the rim of the animal and certain filaments in the radial canals, are well supplied with nematocysts for stinging the prey. (Fig. 155.)

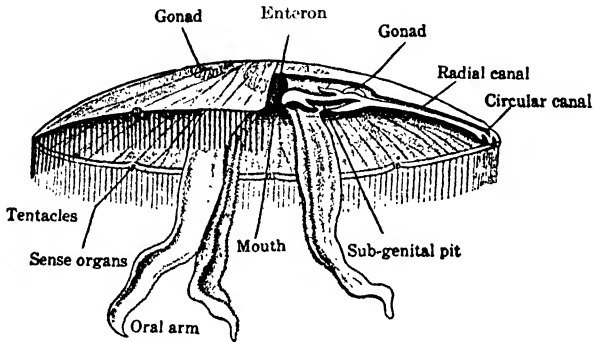

FIG. 155. *Aurelia*, lateral view; one quadrant shown in section. (After Parker and Haswell.)

Among the tentacles on the rim are small rounded **SENSE ORGANS** which control, through the underlying nerve cells and muscle bands, the movements of the animal. Contraction of the rim of the bell, slowly and rhythmically, presses the water within the bell against that without and so forces the animal along. But *Aurelia* is largely at the mercy of wind and wave — few being destined to reproduce before dissolution and none to survive the winter.

The reproductive organs of *Aurelia* consist of four large U-shaped **GONADS** which shed their products, either eggs or sperm, into the radial canals and so to the outer world through the mouth. Fertilization takes place in the open water and forms a zygote that develops into a free-swimming larva. This soon settles to the bottom, becomes attached, and assumes a polyp-like form which feeds and buds and is comparable to the hydroid generation of the Hydrozoa. During the winter this fixed individual, now known as a **STROBILA**, becomes, as it were, sliced in orderly fashion into a series of saucer-like embryo medusae, called **EPHYRAE**, which separate, one by one, and swim away to eventually

attain the form of the adult sexual Aurelia. The remaining part of the strobila again assumes the typical polyp form and, after feeding and budding, may strobilate anew the following winter. (Fig. 156.)

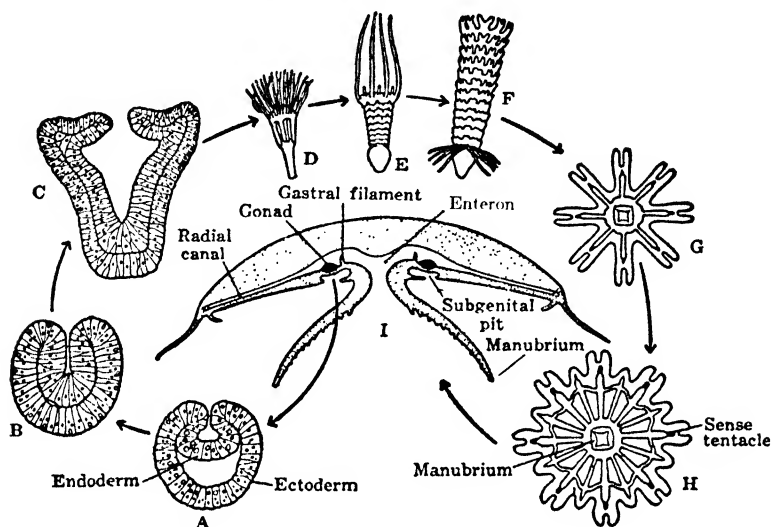

FIG. 156. *Aurelia*, life history. A, B, C, longitudinal sections through gastrula stages; D, scyphistoma; E, F, strobila; G, H, ephyra, I, vertical section through adult. A, B, and C are more highly magnified than the other figures. (From Hegner, after Kerr.)

**ANTHOZOA.** The final class of the Coelenterates, the Anthozoa, presents another array of polyp-like animals, comprising the Sea Anemones and the Corals.

Metridium, a well-known Sea Anemone of the North Atlantic coast, is common in tide pools or attached to piers of wharves; its slight powers of creeping being seldom exerted. It is a ruggedly built polyp, nearly cylindrical in form, with the upper end disclosing the mouth in the midst of a crown of numerous tentacles. The mouth opens into a large gullet which leads down into the enteron. The latter is quite complex because its walls give rise to several series of vertical, radially arranged partitions (MESENTERIES), thereby increasing the functional digestive and respiratory surface. Pores, or OSTIA, make possible the passage of water

through the mesenteries. Also within the enteric cavity are long, coiled, nematocyst-bearing filaments that can be protruded in profusion through both the mouth and numerous pores in the body wall, and so are efficient offensive and defensive weapons. Furthermore, the solid tentacles of *Metridium* are not only well supplied with nematocysts, but also with a coat of cilia that plays a crucial part in the ingestion of food. Once the prey has been paralyzed by the discharge of the nematocysts, the tentacles bend inward

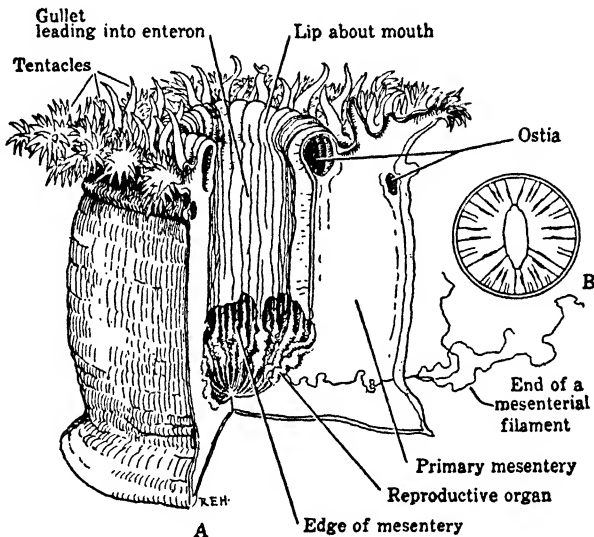

FIG. 157. Sea Anemone, *Metridium marginatum*. A, View of polyp with one quadrant removed; B, Diagram of transverse section showing mesenteries.

and over so that ciliary action sweeps the food slowly but surely toward the mouth. Here other cilia, in particular those in two or more long grooves known as SIPHONOGLYPHS, aided by muscular contractions, carry it on down into the enteron. (Fig. 157.)

*Metridium* typically reproduces sexually, though asexual reproduction by budding may also occur. The reproductive organs are located within the enteron where, in the case of females, the eggs are fertilized, and the embryos develop

into ciliated larvae before making their exit to settle down and assume the adult characters.

Metridium, then, may serve to illustrate the general type of polyp structure exhibited by the Anthozoa, and it is only necessary to relate this to the Corals which are essentially Metridium-like polyps that secrete, under and about themselves, more or less complex skeletons, chiefly of carbonate of lime.

As the polyp continues to secrete the coral, it actually pushes itself farther and farther away from the surface to which it became attached. This growth process, together with multiplication by budding, gradually builds up considerable masses of coral about larger and larger colonies of polyps — the arrangement of the polyps and the disposition of the coral being

characteristically different in the numerous species of Coral animals. Certain kinds of Corals, acting through long periods of time, are responsible for building not only atolls and islands but also fringing reefs and barrier reefs; the Great Barrier Reef of Australia is over a thousand miles long and fifty broad. (Fig. 158.)

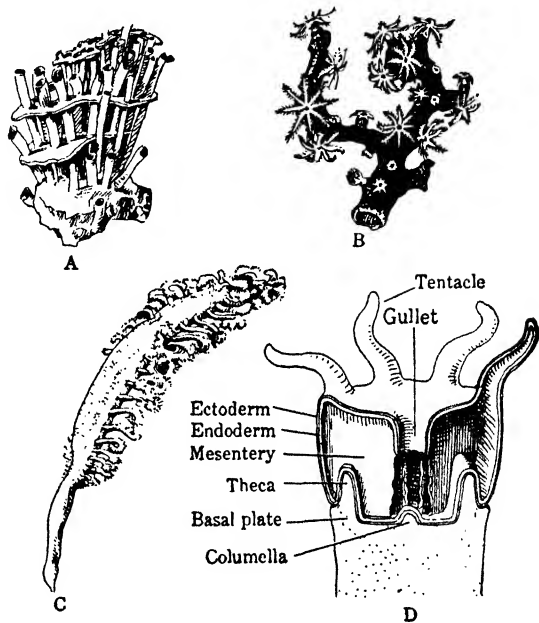

FIG. 158. Corals. A, Skeleton of a young colony of Organ-pipe Coral, *Tubipora musica*; B, small branch of Red Coral, *Corallium rubrum*, showing living polyps; C, Sea Pen, *Pennatula phosphorea*; D, diagrammatic section of a single coral polyp. Various magnifications.

So the polyp type of individual obviously is successful in its way, but our present interest lies chiefly in the fact that it is the stem, or near the stem, from which higher forms started along their main path of ascent. (Fig. 183.)

#### D. FLATWORMS

Passing over a small phylum of marine Coelenterate-like animals, the CTENOPHORA, popularly called Sea-walnuts and

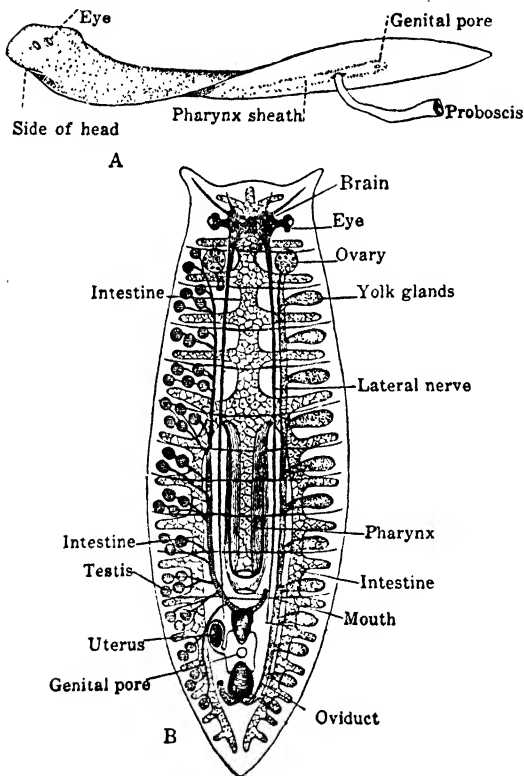

FIG. 159. A, *Planaria polychora*, a fresh-water Flatworm; B, diagram of internal organs of a Flatworm. Magnified. (After Shipley and MacBride, and von Graff.)

Comb-jellies, that have made a somewhat abortive attempt to establish a body on the three primary layer plan, we come directly to the first great group of TRIPLOBLASTIC animals, the Flatworms, constituting the phylum PLATYHELMINTHES. (Fig. 159.)

On the lower surface of submerged stones near the edges of ponds are often to be found tiny black, gray, or white Flatworms, creeping by cilia, known as Planaria. They are obviously radically different in

structure from a polyp since they exhibit bilateral symmetry: they have a broader anterior end with simple eyes and brain,

and a narrower posterior end, and so have right and left sides. Strange to say, however, the mouth is situated not in the 'head,' but behind the middle of the ventral surface of the body, and functions both for the intake of food and the exit of waste. And instead of opening into a sac-like enteron, the mouth leads into a long, protrusible pharynx and this, in turn, into an extremely branched intestine which extends throughout the body. Somewhat similarly extend the excretory system, the male and female reproductive systems, as well as the weblike nervous system; each and all embedded in a continuous mass of tissue, called **MESENCHYME**, which is derived from a third primary germ layer, the mesoderm. Thus the organ systems do not actually lie in a definite body cavity. Since nearly every organ system extends throughout the body, no special circulatory system is required, and apparently oxygen sufficient for the animal's need can diffuse through the tissues. (Figs. 160, 284, 286, 287.)

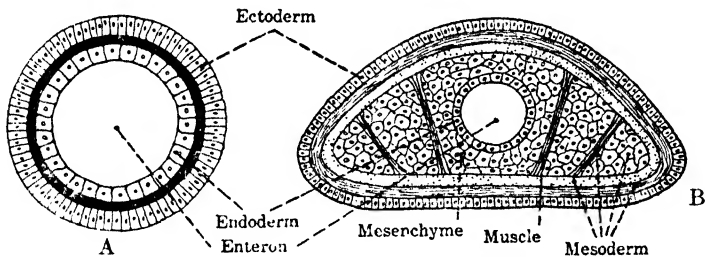

FIG. 160. Diagram of cross sections of the body of a Coelenterate (A) and a Flatworm (B). Note the mesoderm between the ectoderm and endoderm in the latter. The mesenchyme here occupies the coelomic cavity of higher forms. (From Hegner.)

The genus *Planaria* is a member of the first class of the phylum, known as the **TURBELLARIA**, the other classes being the **TREMATODA**, or Flukes, and the **CESTODA**, or Tapeworms. Both of the latter have departed superficially somewhat widely in structure from the free-living Planarians and also have developed extraordinarily complex life histories, involving alternation of generations, in becoming adapted to various parasitic modes of life. The study of Flukes and

Tapeworms, as well as of the Roundworms considered below, constitutes an important part of the science of PARASITOLOGY because many species inhabit man and beast and produce various important diseases. Accordingly we shall study their life histories when discussing the relations of biology to human welfare. (Figs. 420-422.)

## E. ROUNDWORMS

If either number of species or number of individuals were the sole criterion of a phylum's importance, unquestionably the lowly NEMATHELMINTHES, or Roundworms, most of which are members of the class Nematoda, would rank high in the animal kingdom. They live literally everywhere from hot springs to Arctic ice, from desert sand to bottom mud of lakes and seas, from the roots of plants to the blood of man. A thimbleful of soil may contain hundreds, even thousands, of individuals. "If all the matter in the universe except the nematodes were swept away, our world would

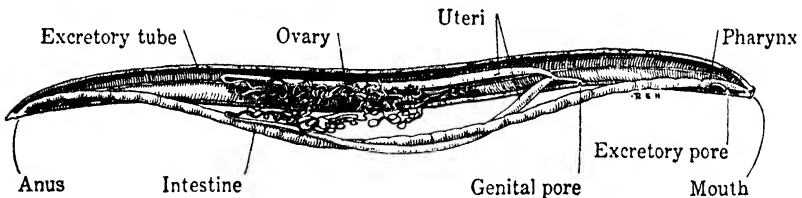

FIG. 161. Roundworm, *Ascaris lumbricoides*. Diagram of dissection from right side. Reduced.

still be dimly recognizable, and if, as disembodied spirits, we could then investigate it, we should find its mountains, hills, vales, rivers, lakes, and oceans represented by a film of nematodes. The location of towns would be decipherable, since for every massing of human beings there would be a corresponding massing of certain nematodes. Trees would still stand in ghostly rows representing our streets and highways. The location of the various plants and animals would still be decipherable, and, had we sufficient knowledge, in many cases even their species could be determined by an examination of their erstwhile nematode parasites." (Cobb.)

The Roundworms are slender, cylindrical worms as is indicated by other common names, such as Threadworms, Hairworms, and Eelworms. The Vinegar Eel, found in cider vinegar, is a form readily available for study at any season of the year. The nematode body plan shows considerable advance over that of the Flatworms because the simple intestine has two openings to the exterior, mouth and anus;

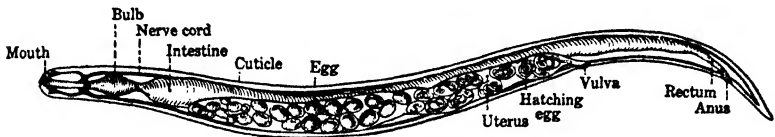

FIG. 162. Vinegar Eel, *Turbatrix aceti*. Diagram of a female showing parts of the nervous, digestive, and reproductive systems. Magnified. (From Hegner.)

the nervous system consists of a ring around the pharynx which sends large nerves throughout the length of the body; the excretory system is well developed; and the male and female reproductive systems are usually in separate individuals. Furthermore the various organs lie in a spacious body cavity. However, there are no special circulatory or respiratory systems. (Figs. 161, 162.)

Naturally the Roundworms that have been most studied are parasites of man and domestic animals. The Guinea worm, probably the "fiery serpent" of Moses, is sometimes more than three feet long and spends its adult life just under the human skin and its youth in a water-flea, Cyclops. The various species of *Ascaris* are relatively large intestinal worms, the females attaining a length of more than a foot and producing some fifteen thousand eggs a day. Two of the most dreaded parasites are the tiny *Trichinella*, the cause of the often fatal TRICHINOSIS contracted by eating infected pork, and *Necator*, notorious as the Hookworm. The common Gall worm which infects most of our crop plants is one of the worst pests known to agriculture. All considered, the Roundworms are hardly second to the Flatworms from the standpoint of medical zoölogy and, like



them, tax the ingenuity of biologists in ferreting out their complex reproductive processes and life histories which have been evolved to ensure entrance to the proper host. (Figs. 423, 424.)

## F. ROTIFERS, BRYOZOANS, AND BRACHIOPODS

At this point a passing glance may be taken at representatives of three small phyla that contribute relatively little of theoretical or practical importance.

The ROTIFERA, or Wheel-animalcules, constitute a group of tiny animals commonly found in fresh and salt water, in association with the Protozoa. Although Rotifers are the smallest Metazoa, they possess a highly complex series of internal organs, in spite of which some species can withstand slow drying in mud. In this desiccated condition they may be blown about until moisture is again encountered, whereupon they gradually 'swell up'

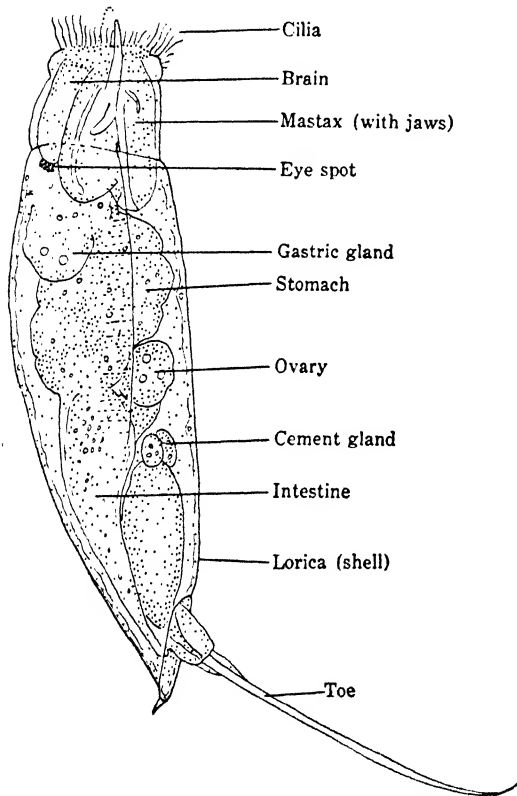

FIG. 163. A Rotifer, *Trichocerca rosea*. Highly magnified. (From Edmondson.)

and assume active life and reproduction. (Fig. 163.)

The BRYOZOA are frequently referred to as Moss-animals because most of them form mat-like fixed colonies growing

on submerged objects in sea or pond. A superficial examination of the common fresh-water *Plumatella*, for example, might suggest that it is a Hydroid, but closer scrutiny reveals a very different structural plan, including complex internal organs. In addition to reproducing sexually and by typical budding, *Plumatella* develops peculiar internal buds, or STATOBLASTS, each enclosed in a chitinous shell. In the event that the pond dries up or the colony is frozen, the resistant statoblasts survive to start a new colony upon the return of favorable conditions. (Fig. 164.)

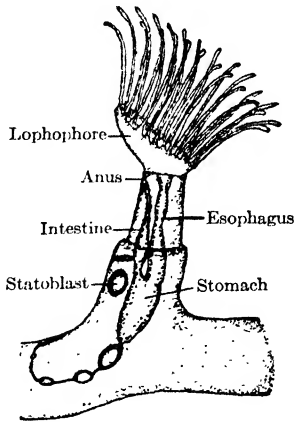

FIG. 164. A single individual of a colony of *Plumatella*. Highly magnified. (After Brown.)

The BRACHIOPODA, or Lampshells, at first glance look like Clams, and so bear no obvious resemblance to the colonial Bryozoa. However, Brachiopods possibly are related to the Bryozoa, because their internal structure resembles in certain ways that of *Plumatella*. Brachiopods represent one of the older marine groups, their shells constituting conspicuous and characteristic fossils in the more ancient rock strata.

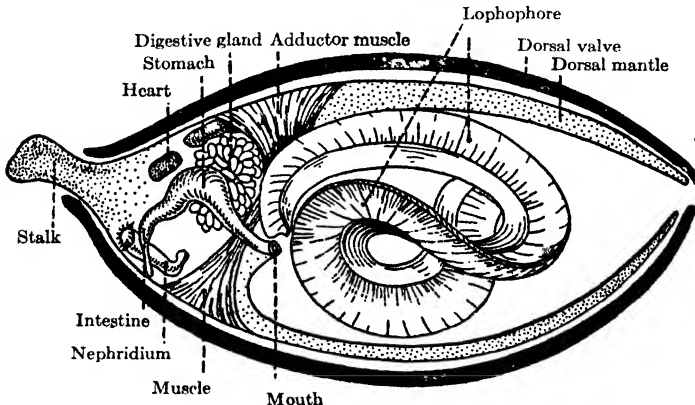

FIG. 165. Brachiopod. Diagram of a vertical section. (From Hegner.)

Those living today are merely little-changed survivors of a successful group of yesterday — perhaps nearly a billion years ago in the early Paleozoic seas. “The everlasting hills are the type of venerable antiquity, but the genus *Lingula* has seen continents grow up, and has maintained its integrity unmoved by the convulsions which have given the crust of the earth its present form.” (Fig. 165.)

### G. ANNELIDS

The Segmented Worms constitute a relatively straightforward phylum, the ANNELIDA, which carries us on apace in the development of the more complex animal body: conspicuously by definitely introducing the principle of segmentation. Well-known representatives are the marine Sandworms of the class POLYCHAETA; the Earthworms of the OLIGOCHAETA; and the Leeches of the HIRUDINEA. (Figs. 131, 132, 166.)

The principle of segmentation, as already emphasized in the Earthworm, is probably the most significant advance

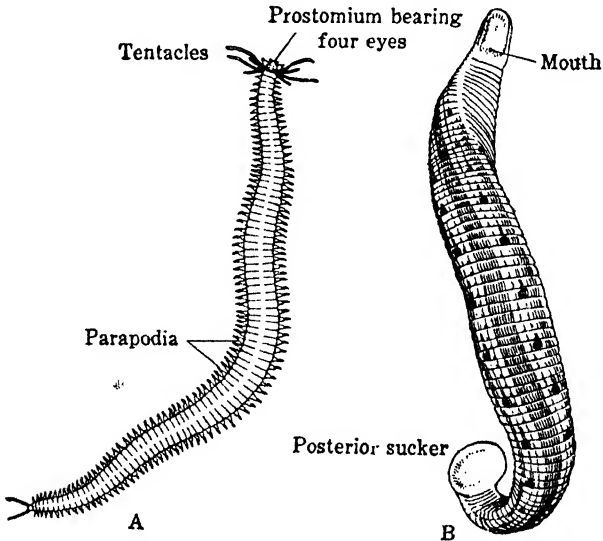

FIG. 166. A, Sandworm, *Nereis virens*; B, Medicinal Leech, *Hirudo medicinalis*.

made by the phylum. At all events, it is the plan exemplified by the most successful of the higher groups — the Arthropods and Vertebrates. Apparently the segment is an adaptable unit of organization that makes possible local specialization. Moreover in Annelids the coelom first attains high structural significance and affords ample space for more elaborate organ systems. With these facts and the general anatomy of the Earthworm in mind, the three most important classes of Annelids may be considered. (Pp. 180–191, 254.)

**POLYCHAETA.** This class comprises a large number of species of marine worms, most of which burrow in sand or mud at tide-level and so are often called Sandworms. A common and representative genus is *Nereis*, although marked modifications

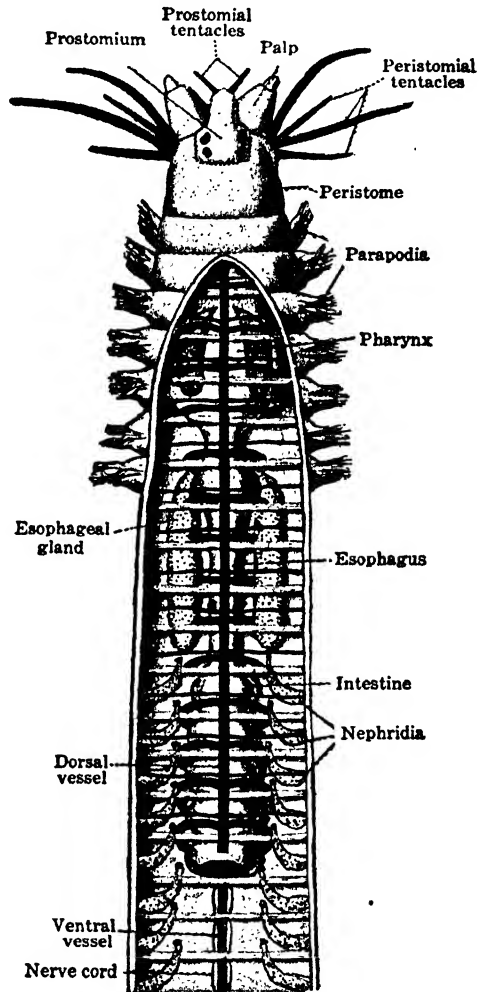

FIG. 167. *Nereis*. Anterior end of the body with dorsal body wall removed. (After Parker and Haswell.)

of the external features of the body of *Nereis* are exhibited by many other genera, such as the Tubeworms that are permanently sedentary in specially constructed tubes.

The body of *Nereis* consists of a linear series of some fifty segments and may attain a foot in length. Several of the anterior segments form a head with mouth, chitinous jaws, and sense organs — notably rather complex eyes; while most of the remaining segments are provided with paddle-like, bristled appendages, or **PARAPODIA**, that act both as respiratory and locomotor organs. The general plan of the internal organs, with the exception of the reproductive system, is the same as in the Earthworm. (Fig. 167.)

The sexes are separate in *Nereis*, and from the fertilized egg arises a free-swimming larval stage, the **TROCHOPHORE**, which finally develops into the adult worm. A trochophore, or similar larva, occurs in the development of members of several other phyla of Invertebrates, for example the Mollusca, and therefore some zoölogists believe this indicates that the phyla involved have all descended from a common ancestor. (Figs. 168, 183.)

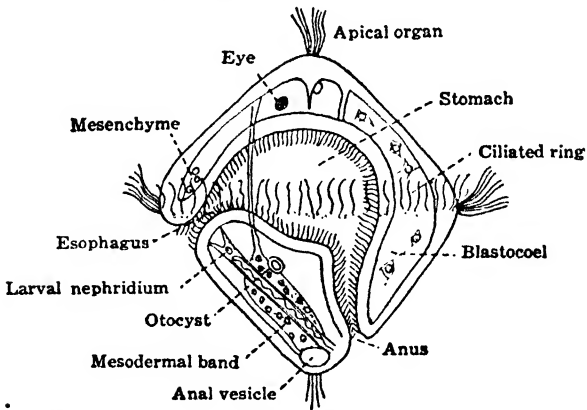

FIG. 168. Diagram of the trochophore larva of a Polychaete worm. Side view. (From Hegner, after Shearer.)

**OLIGOCHAETA.** The Earthworms and closely related freshwater worms constitute the second great class of Annelids. Earthworms show a simplification of the external structures exhibited by *Nereis* because the head is greatly reduced and attendant specialized sense organs are absent. Furthermore, the setae are all that represent the parapodia. Ap

parently the sluggish, underground life of Earthworms renders highly developed locomotor, respiratory, and sense organs unnecessary. However, in some of the more active fresh-water Oligochaetes, projections of the body serve as gills, and simple eyes are present. It will be recalled that Earthworms are hermaphroditic and that the zygote develops directly into a small worm without an intervening larval form as in the Polychaetes. (P. 190.)

Some idea of the importance of the many species and enormous numbers of Earthworms may be gathered from Darwin's estimate that in many soils they annually bring to the surface some eighteen tons of earth per acre. Thus these worms, unseen and unheard, gradually effect radical transformations of the surface soil, and so play a significant part in loosening and aërating the soil.

HIRUDINEA. The best known member of the class is the Medicinal Leech, *Hirudo medicinalis*, so popular when blood-letting was in vogue that physicians were dubbed 'leeches.' This species is about four inches in length, but is capable of great change in form. The body is somewhat flattened and comprises about thirty segments. There are two suckers, one at either end of the animal, but no setae or parapodia and the coelom is greatly reduced. The chief food of most leeches is the blood of Vertebrates, which is sucked into an immense branched dilation of the alimentary canal where it is stored without clotting. Then during a period of several months, it is gradually passed to the stomach for digestion. (Fig. 166.)

Leeches are hermaphroditic and the reproductive process is similar to that in the Earthworms. Although the Medicinal Leech is a fresh-water form, many species are marine and more are terrestrial.

## H. MOLLUSCS

The important phylum MOLLUSCA, which includes not only such well-known edible 'shell-fish' as the Clams, Oysters, Scallops, and Snails, but also the Cuttle-fish, Devil-fish, Nautili, etc., presents a considerable departure in bodily

plan from that exhibited by the Segmented Worms and constitutes another large branch of the Invertebrate 'tree.' However, from certain structural features exhibited by the lowest class, the AMPHINEURA represented by Chiton, and particularly the developmental stages, such as the trochophore, of various Molluscs, it appears clear that they have arisen from a worm-like ancestral type which, instead of adopting segmentation, became otherwise specialized to form a unique and highly successful group. (Fig. 169.)

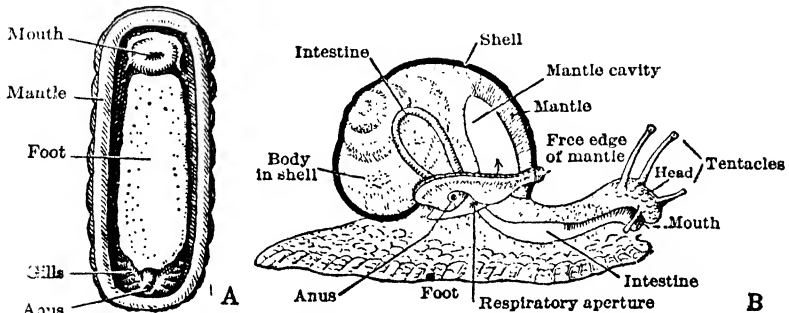

FIG. 169. A, Chiton, ventral view; B, Snail, diagrammatic side view.

The most characteristic structures of Molluscs are an external skeleton, or SHELL; a fleshy muscular organ, the FOOT, typically for locomotion; and a MANTLE CAVITY between the main body and an enclosing envelope, the MANTLE that lines the shell. Among the five classes of Molluscs only three are of sufficient general interest to command attention here: the Gastropoda, Pelecypoda, and Cephalopoda. (Pp. 253, 254.)

**GASTROPODA.** One usually thinks of Molluscs as sea-dwelling animals but among the some sixteen thousand species of Snails, Slugs, and other similar Gastropods, more than one-third are terrestrial. Everyone is familiar with the spirally coiled snail's shell into which the animal can completely retire when disturbed, but many close relatives, such as the Limpets, commonly represented by the Boat-shells (*Crepidula*) and the Abalones, have shells that are relatively simple, flattened cones, while most of the Slugs have no shell

at all. The shell when present is secreted by the inconspicuous mantle. The common Snails and Slugs glide along on a path of slime by muscular contractions of the foot which forms the entire ventral part of the body, but some of the marine species actively swim by means of delicate, undulating expansions of the foot.

Snails and their allies have a well-developed head with tentacles, eyes, and a mouth supplied with a rasping tongue-like organ, the *RADULA*. The mouth leads into a complicated digestive tract. Add to the digestive organs the complex blood vascular system, excretory system, nervous system, and reproductive system, and it becomes evident that even the lowly Garden Slug belies its soft, slimy body. (Figs. 169, 384.)

*PELECYPODA*. The Mollusca is a phylum of surprises, for the Pelecypoda is a class of headless animals that for the most part have taken to a sedentary life within a shell composed of two *VALVES* hinged together: they are bivalves. The adult Oysters are permanently attached and therefore footless; the Clams and Mussels are sluggish, sand-burrowing creatures; the Shipworms riddle wharves with their tunnels, while the Scallops swim about by rapidly opening and clapping together the valves of the shell. (Fig. 170.)

The most distinctive feature of the bivalves, aside from the shell, is their peculiar method of securing food from a current of water that is kept in motion by the activity of cilia on the gills, mantle surface, and *LABIAL PALPS* about the mouth. In brief, water laden with oxygen and microscopic animals and plants is drawn through an opening, the *INHALENT SIPHON*, into the lower part of the mantle cavity, known as the *INFRABRANCHIAL CHAMBER*, where the sieve-like gills are suspended. As it passes through the gills, the food is carried by ciliary action to the mouth, while at the same time the blood in the gills is aerated. From the gills the water current passes into the *SUPRABRANCHIAL CHAMBER* and then on out through the *EXHALENT SIPHON*, carrying with it various waste products.



The mouth leads through the esophagus to the stomach which is provided with two large digestive glands, or liver. Strange to say, the long, coiled intestine passes through the

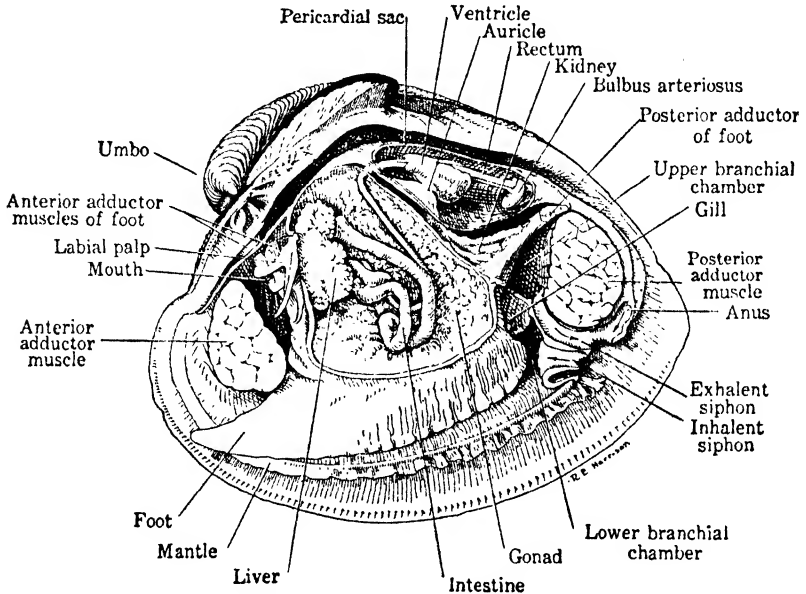

FIG. 170. Hard-shell Clam, Little-neck Clam, or Quahog, *Venus mercenaria*. Dissection showing structures visible when left valve, mantle, and gills are removed.

heart before it proceeds above the POSTERIOR ADDUCTOR muscle to discharge through the anus into the exhalant siphon. (Fig. 170.)

The circulatory system comprises a heart, dorsally situated in the PERICARDIAL SAC, and a system of blood vessels and spaces, or sinuses, that deliver the blood throughout the body. The nervous system is rather complex and consists chiefly of three pairs of large ganglia and nerves connecting them. Several types of simple sense organs occur; the sensory cells on the edge of the mantle probably being responsive to light and contact.

The reproductive process varies considerably in different bivalves. In most species the sexes are separate but some

are hermaphroditic and exhibit a periodical change in sex. Oysters spawn in the spring, liberating the sperm and eggs, and the zygotes develop into microscopic free-swimming SPAT. Within a week these sink to the bottom and become attached to whatever object they happen to touch and, if fortunate, gradually develop into adult Oysters. Fortunate, because it is estimated that a larva has less than one chance in a million of surviving to attain maturity and the qualities that appeal to the human palate. But one individual may liberate nearly half a billion eggs.

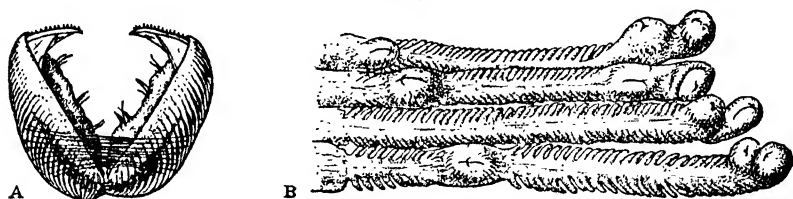

FIG. 171. A, Glochidium of a fresh-water Mussel; B, gill filaments of a fresh-water Fish with many embedded parasitic glochidia. (After Lefevre and Curtis.)

The eggs of the fresh-water Clams, or Mussels, are fertilized by sperm entering the mantle cavity with the inhaled water current, and the larvae develop in the gills which act as temporary brood-pouches. Eventually as tiny clams, known as GLOCHIDIA, they escape, settle on the bottom of the pond or river, and die unless they come into contact with a fish. In this event each glochidium becomes attached to a fish and as a parasite obtains free food and transportation for several weeks until it has developed sufficiently to drop off, settle to the bottom, and shift for itself. (Fig. 171.)

The economic importance of the Bivalves hardly need be mentioned. Oyster-farms in America alone produce an annual crop valued at many millions of dollars; fresh-water Mussels are the basis of the pearl button industry of the Mississippi Valley; and pearls produced by the irritated mantle tissue of several species of bivalves are perhaps the most highly prized and priced jewels.

**CEPHALOPODA.** The Squids, Cuttle-fish, Devil-fish or Octopi, and Nautili present in many ways a marked contrast to the rest of the Molluscs, being relatively active, aggressive marine animals which have achieved a highly specialized head by combining head and foot — hence the name Cephalopoda. Most of the present-day Cephalopods are shell-less or have merely an internal remnant such as the horny ‘pen’ of the Squid, or the Cuttle-fish ‘bone’ favored by caged Canary-birds. Many depend upon their activity or the emission of a cloud of ink, or both, in order to escape an enemy. This is the source of the original ‘India ink.’ However, the Pearly, or Chambered, Nautilus is without an ink sac, and lives in the largest and terminal chamber of a typical shell coiled in a flat spiral. (Fig. 172.)

The head of Cephalopods, surrounded by actively motile tentacles, is provided not only with parrot-like beak and rasping tongue, but also with a rather large brain, and efficient eyes that superficially are very like those of fishes. As

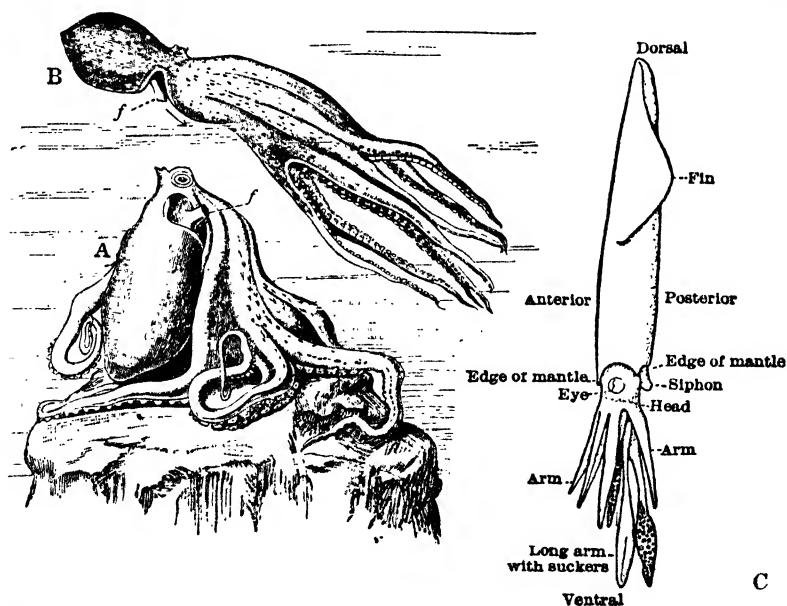

**FIG. 172.** A, B, Octopus, at rest and in motion. *f*, siphon. C, Squid, side view. (From Hegner, after Mercuriano and Williams.)

a matter of fact a few of the Cephalopods are in many respects more capable than some of the lower Vertebrates. They apparently exhaust the possibilities of the molluscan body plan both in complexity and in size. Indeed the Giant Squid is the largest Invertebrate, for when measured to the tip of the extended arms it exceeds in length any living Vertebrate except the largest Whales.

## I. ECHINODERMS

Everyone who has spent a summer at the seashore certainly is familiar with the Starfish and Sea Urchin, common examples of the marine phylum of spiny-skinned animals, the ECHINODERMATA. All members of the group have radially symmetrical bodies — a condition not seen since we left the Coelenterata. However, the symmetry indicates no direct relationship with the Coelenterates, because during early embryonic life an Echinoderm is actually bilaterally symmetrical and the radial form is only secondarily assumed — it masks the basic structure. Indeed “Nature’s pentagonal experiment” has produced a series of bizarre forms that

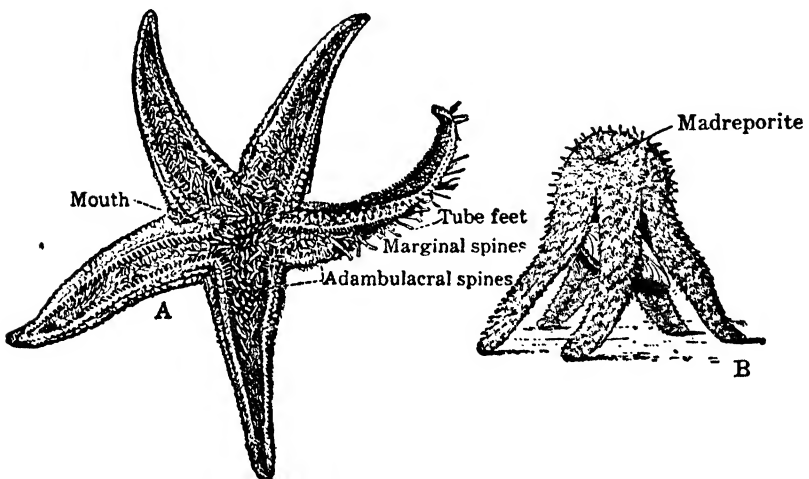

FIG. 173. Starfish, *Asterias*. A, oral view; B, devouring a Clam. (From Cambridge Natural History.)

have been successful from early geologic time to the present, though they bear little resemblance to other animals. Witness the structure of a common Starfish. (Fig. 173.)

The body of the Starfish consists of a **CENTRAL DISK** from which radiate five or more **ARMS**. The entire animal is protected by an exoskeleton consisting of calcareous plates embedded in the tissue and of short blunt spines. Surrounding

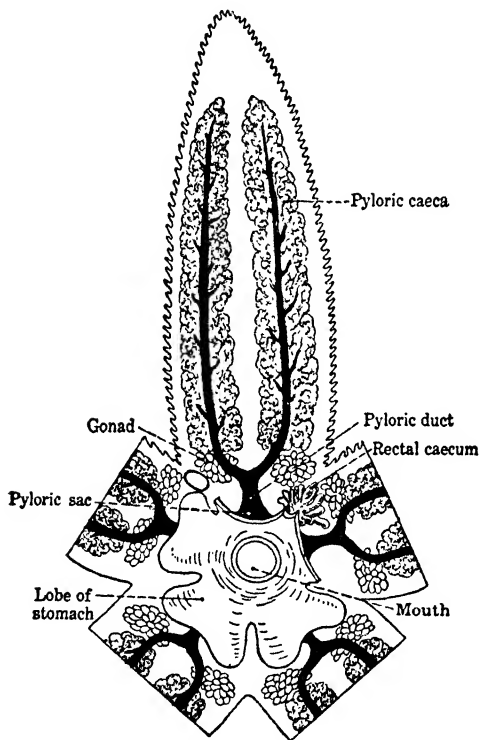

FIG. 174. Starfish. Diagram of internal anatomy from oral side. Four arms have been cut off. (After Hegner.)

of **TUBE FEET**: the unique hydraulic locomotor and food-capturing organs. (Fig. 174.)

The mouth opens into a large stomach that leads into the **PYLORIC SAC** from which large, glandular **PYLORIC CAECA** extend into each arm. Above the stomach is a small rectum

the bases of the latter are many specialized spines, or **PEDICELLARIAE**, which are tiny pincers moved by muscles. They serve to keep the surface of the animal free from debris and protect the delicate, protruding **DERMAL BRANCHIAE**. The mouth is situated in the disk on the surface that is ventral as the animal crawls along, while the anus is on the opposite surface. Near the latter is a small porous plate, the **MADREPORITE**, which admits water to a series of tubes, the **WATER-VASCULAR SYSTEM**, terminating in myriads

that passes to the aboral surface, but waste materials are ejected through the mouth. The nervous system is essentially a nerve ring encircling the mouth, with a branch extending into each arm, but there is no central, dominating nerve mass that is comparable to a brain, and only the simplest sense organs, the tube feet acting largely in the latter capacity. The functions of a circulatory and respiratory system are carried on by the coelomic fluid — mostly sea-water in which amoeboid cells float — that fills the large body cavity, or coelom, circulates through the dermal branchiae, and bathes all the organs, including the male or female reproductive organs.

The Starfish is a member of the first class (ASTEROIDEA) of the phylum, and serves to give some idea of the fundamental anatomical plan of the other classes. True, members of the other classes bear little obvious resemblance to the Starfish. Most similar are the Brittle Stars (class OPHUROIDEA) with flattened central disk and long, slender arms, sometimes branched, which are fragile and readily discarded when injured. Tube feet serve solely as tactile and respiratory organs since locomotion is effected by contractions of the arms. But the Sea Urchins and Sand Dollars (class ECHINOIDEA) are without arms; the more or less spherical body being enclosed within a hard shell composed of a multitude of closely fitting calcareous plates and covered with a forest of spines for protection, while the protruding tube feet serve for locomotion. Then the Sea Cucumbers (class HOLOTHUROIDEA) are essentially elongated, flexible, muscular sacs with contractile tentacles about the mouth, representing modified tube feet. The animals seem to be little inconvenienced if they eject most of their internal organs, because a period of rest suffices for their regeneration. Finally, the Sea Lilies (class CRINOIDEA), apparently the antithesis of the Sea Cucumbers, are usually temporarily or permanently attached by a jointed stalk from which extend their much-branched arms in plume-like fashion, and so some are called Feather Stars. (Fig. 175.)

Still, with all this diversified array of Echinoderms, it is, we repeat, true that all are basically similar in structure and development — they have almost surely been derived in a round-about way from a primitive worm-like ancestor. Many zoölogists place them as the final phylum of Invertebrates and regard them as nearest to the stem from which the Vertebrates arose. (Fig. 183.)

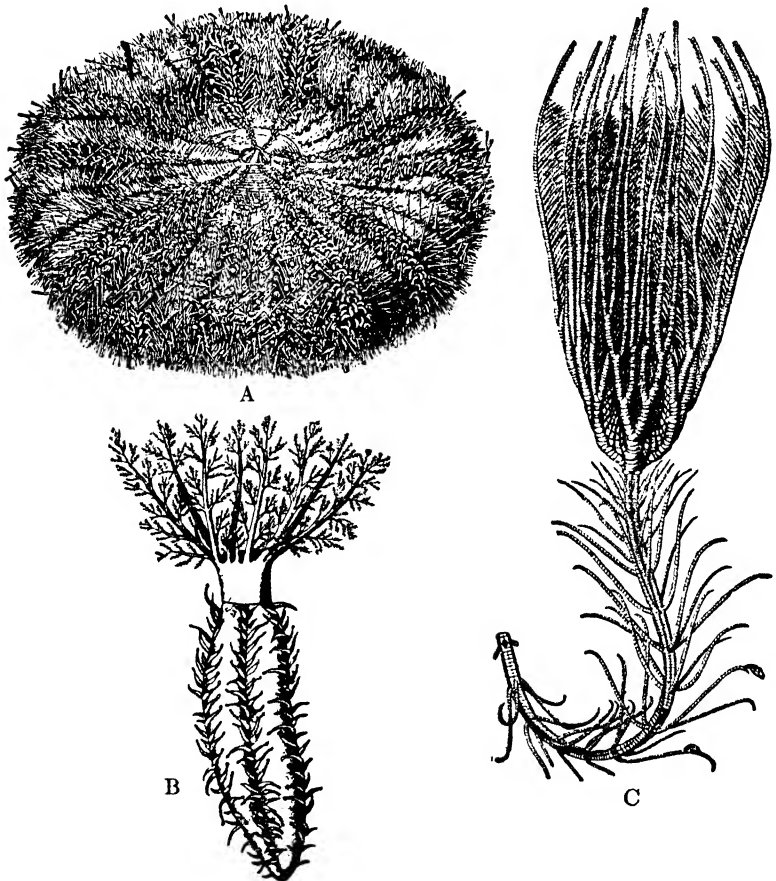

FIG. 175. A, Sea Urchin, *Asthenosoma*, oral view; B, Sea Cucumber, *Cucumaria*; C, Sea Lily, *Metacrinus*. (From Thomson, Ludvig, and Carpenter.)

## J. ARTHROPODS

We now turn to the more orthodox — because dominant — phylum of segmented Invertebrates with jointed appendages, the ARTHROPODA. The most important classes are the Crustacea, Myriapoda, Insecta, and Arachnida — the first chiefly aquatic and breathing by means of GILLS, and the rest typically terrestrial with TRACHEAE or equivalent air-breathing organs. (Fig. 245.)

The Arthropod body, as already indicated in our study of the Crayfish, is built on the plan of a chain of segments; several of the anterior segments constituting the head, with the mouth, and the posterior one containing the anus. In the simplest Arthropods there is relatively little differentiation between either the segments or the characteristic pair of jointed appendages that each bears; but proceeding to more complex forms, one finds a progressive union and specialization of segments in certain regions of the body and a shifting and transformation of their appendages for one function or another. As a matter of fact, it seems that all the possible changes are rung on the pervading segmental chain. (Figs. 134, 135; Pp. 191–201.)

Another conspicuous feature of the phylum is the presence of a hard, unyielding, external armor, or exoskeleton, with flexible joints, moved by attached muscles. This skeleton hampers the increase in size of the inhabitant, so periodically it is shed — the animal molts. Seizing the opportunity, so to speak, the animal rapidly increases in size at the expense of material stored for this purpose, and also secretes a new skeleton. A 'soft-shelled' Crab is one which has recently molted and has been taken at a disadvantage before the newly secreted skeleton has had time to harden.

The life history of many of the Arthropods is surprisingly complex and involves radical form changes that constitute a METAMORPHOSIS. Thus the embryo of certain Crustacea leaves the egg as an unsegmented larva, then after molting



assumes a segmented larval form, and so on until the adult state is attained. In other Crustacea one or more of these stages may be briefly summarized, as it were, in the egg before hatching. Finally, animals like the Crayfish hatch with essentially the adult form. And this series of metamorphic stages in the development of the higher Crustacea is of considerable theoretical interest because they are very similar to the larval or adult forms of certain other Crustacea

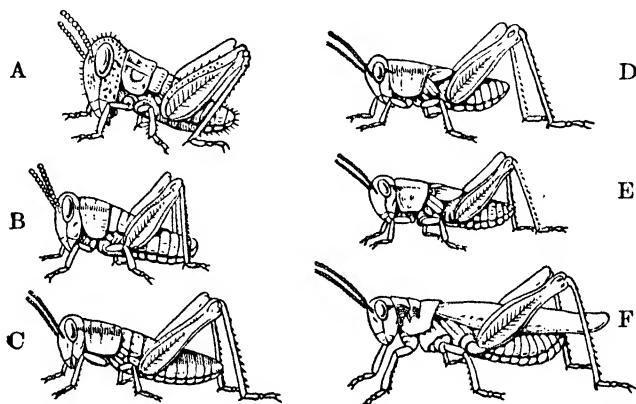

FIG. 176. Partial, or incomplete metamorphosis of a Locust, showing the five nymph stages (A-F), and the adult (F). Not drawn to scale. Note the gradual growth of the wings which are first visible in C. (After Packard.)

that are regarded as more primitive in organization. Thus it would seem that individual development in the higher Crustacea briefly and very broadly and incompletely summarizes — RECAPITULATES — their ancestral, or evolutionary, history.

However, metamorphosis is probably called to our attention more prominently in the Insects. It is common knowledge that caterpillars are the larval, worm-like, feeding forms of Butterflies and Moths. The winged adult condition is attained by a final molt that takes place while the larva is in a 'resting' condition, the PUPA, made necessary by the great structural changes which are involved. In many other insects there is a similar metamorphosis, but in some it is less radical. Thus the young Locust, or Grasshopper, is

similar in form to the adult, but after each molt it is larger than before, and finally is a fully-winged adult. Such a transformation not involving a pupal stage is frequently referred to as incomplete metamorphosis. (Figs. 176, 426-430.)

With these general facts in mind we pass in review representative types of Arthropods.

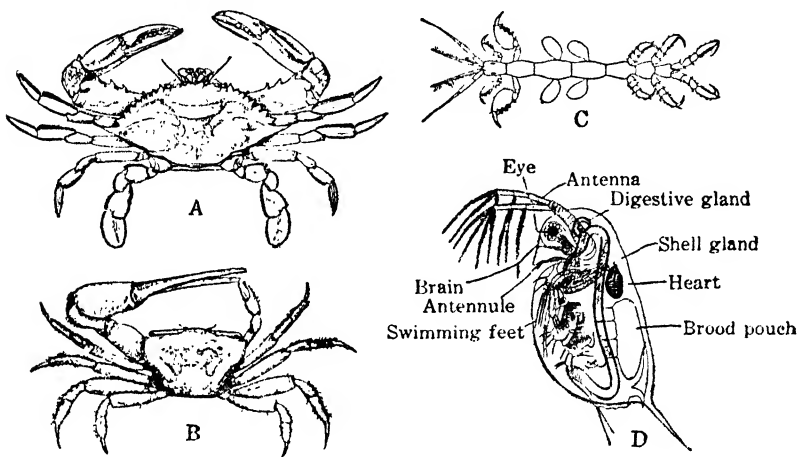

FIG. 177. Crustaceans. A, edible Blue Crab, *Callinectes*; B, Fiddler Crab, *Gelasimus*; C, Caprella; D, *Daphnia*, a Water-flea. Not drawn to scale. (From Paulmier, and Claus.)

**CRUSTACEA.** A varied multitude of marine and a somewhat smaller number of fresh-water animals constitute the class Crustacea. Among its approximately twenty thousand species, probably the best known, because they are among the largest and some are edible, are the Lobsters, Crayfishes, and Crabs. The latter appear unique because the abdomen is permanently bent forward under the cephalothorax. Then at the other extreme, as it were, are the little-known Woodlice, or Pill-bugs, that live in damp places, even in our gardens. All of these and their many close relatives form one of the two Crustacean subclasses, the MALACOSTRACA. The other great subclass, the ENTOMOSTRACA, includes even greater diversity of structure. There are the Cirripedes, or Barnacles, that early in their life settle down permanently to a sedentary existence and thereby foul the hulls of ships

and encrust driftwood and stones on the seashore. Then unrecognized by other than specialists are the many kinds of microscopic crustaceans, such as *Daphnia*, *Cyclops*, and their allies. These so-called water-fleas vie in numbers with the Protozoa and microscopic plants in the vastness of open seas as well as in many lakes. Thus they form a crucial part of the food of larger animals, including fishes, and so indirectly of man. (Figs. 135, 137, 177, 345 ; Pp. 191-201.)

MYRIAPODA. Passing to the Myriapoda we reach the terrestrial Arthropods with long serpentine bodies, such as the

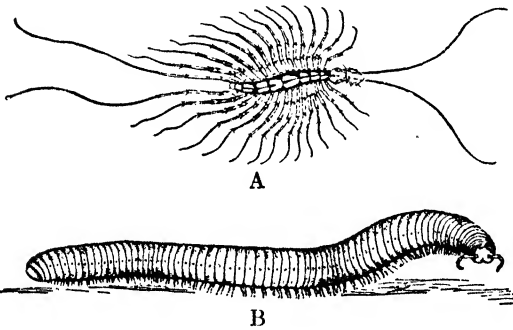

FIG. 178. A, Centipede, *Scutigera forceps*; B, Millipede, *Julus virgatus*.

more or less flattened Centipedes, or Chilopods, and the rounded Millipedes, or Diplopods; the latter with the body segments united in pairs so that there seem to be four legs on each segment. But, as their names indicate, legs are

plentiful, in some Millipedes reaching nearly two hundred. Centipedes are swift-moving carnivorous forms with poisonous jaws, represented, for example, by members of the genus *Scolopendra* of the tropics, which may be nearly a foot in length and sometimes dangerous to man. The common house centipede, *Scutigera forceps*, feeds on insects but is harmless to man. Millipedes, on the other hand, are slow-moving vegetarians which, in many cases, are highly destructive to plants. (Fig. 178.)

INSECTA. Everyone knows various members of the Insecta, familiarly represented by that most domestic of animals, the House Fly, but probably few realize that the species of insects outnumber all the other species of animals except the Protozoa. (Figs. 179, 428 ; P. 255.)

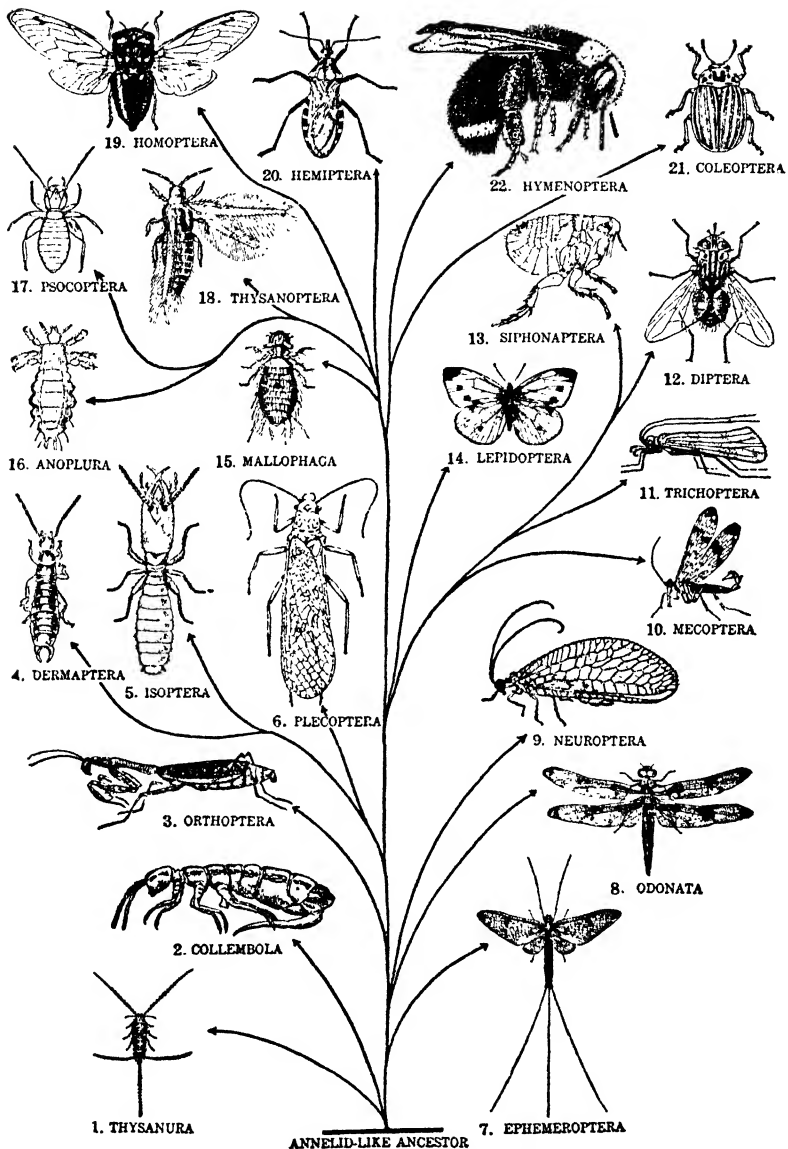

FIG. 179. General relationships of the chief orders of the class Insecta. 1, Silverfish; 2, Springtail; 3, Praying mantis; 4, Earwig; 5, Termite; 6, Stonefly; 7, Mayfly; 8, Dragonfly; 9, Lacewing-fly; 10, Scorpion-fly; 11, Caddice-fly; 12, Stable fly; 13, Flea; 14, Butterfly; 15, Bird louse; 16, Cootie; 17, Book louse; 18, Thrips; 19, Cicada; 20, Triatoma bug; 21, Potato beetle; 22, Bumble bee. In general, the classification is based on the presence or absence of wings, structure of mouth parts, and the life history. (From Hegner.)

A typical insect is characterized by a body divided into three major parts: head, thorax, and abdomen. The head bears a pair of compound eyes, usually one to three simple eyes, or OCELLI, a pair of 'feelers,' or ANTENNAE, and the mouth parts: the LABRUM, MANDIBLES, MAXILLAE, and LABIUM. (Figs. 180, 245, 362.)

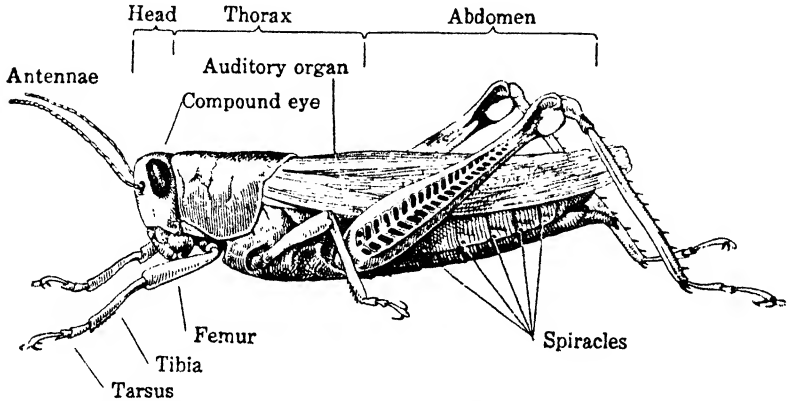

FIG. 180. Grasshopper, or Locust, *Melanoplus differentialis*.

The thorax is composed of three segments, each of which typically bears a pair of legs. The legs of insects in most cases perform many functions in addition to locomotion: they are really a set of tools. Witness the legs of the Honey Bee. (Fig. 363.)

Usually two of the three thoracic segments each bear a pair of wings, but the House Fly, of course, has but one pair and the Flea none at all, though the fly's 'balancers' are remnants of its missing pair. The wings of insects are entirely dissimilar in origin and structure from the legs and therefore bear no relation to the paired appendages of other Arthropods. They are new structures that confer upon insects the honor of being the only Invertebrates to conquer the air. Indeed, their adaptive radiation to all sorts of habitats and modes of life exhibits a versatility that somewhat parallels that of the highest Vertebrates, the Mammals. (Figs. 346, 352.)

Furthermore, certain insects excel all the rest of the living world, excepting man, in the remarkable development of communal organization. This involves specialization of individuals for definite contributions to the economy of the social unit, such as the ant nest or the bee hive. (Figs. 426-437; Pp. 531-537.)

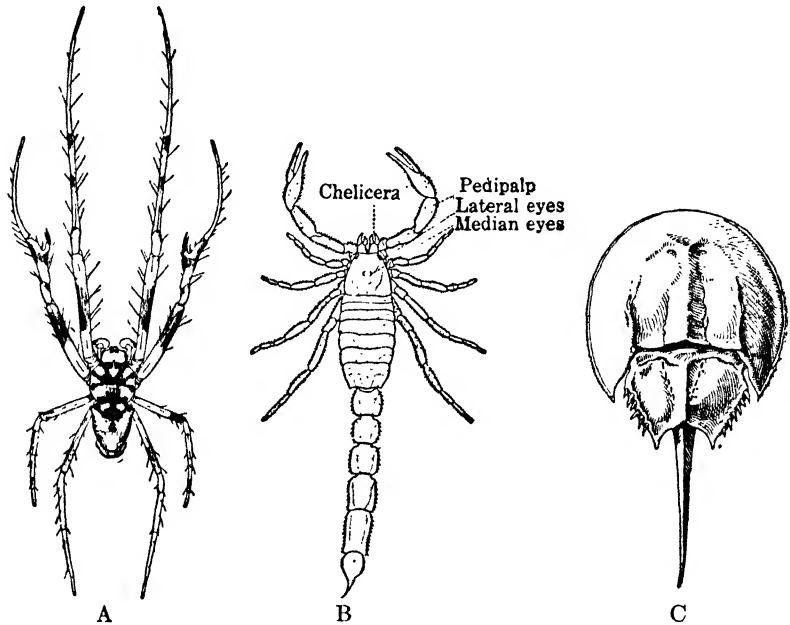

FIG. 181. A, Spider, *Epeira verrucosa* (from Emerton); B, Scorpion, *Buthus occitanus* (from Krapelin); C, King-crab, *Limulus polyphemus*.

ARACHNIDA. We conclude the Arthropod phylum with the class Arachnida, which comprises the Spiders, Ticks, Mites, Scorpions, and their close relatives. These are frequently confused with Insects, but the more common forms, such as the Spiders and Ticks, are readily distinguished by the possession of eight legs. (Fig. 181.)

Spiders are carnivorous animals that capture their prey by elaborately constructed webs, or by stalking and pouncing upon it. Some Spiders are poisonous and their reputation has served to malign many harmless relatives. But the

Scorpions in general are poisonous, and the Mites and Ticks are injurious to Man in many ways. Some bite and others burrow into our bodies and those of our domestic animals; the common Rabbit frequently harbors several thousand Ticks. Even our garden crops and forests suffer. Unfortunately certain species infect their hosts with various Bacteria and Protozoa and so produce serious diseases. But there are many harmless forms, represented by the well-known red Harvest Mites.

And then appended to the Arachnida is the peculiar marine King or Horseshoe Crab, *Limulus polyphemus*, of our Atlantic coast. It is of considerable theoretical interest to students of evolution because it shows certain resemblances to the great group of extinct Arthropods known as Trilobites. (Fig. 181.)

Finally, mention should be made of a unique group, the Onychophora, that is usually regarded as a class of Arthropods. It comprises only a few genera and species, commonly called Peripatus, whose sole importance is that they seem to



FIG. 182. Peripatus, *Peripatopsis capensis*. About natural size. (From Sedgwick.)

link the Arthropods with the Annelids by exhibiting characters of both phyla. The chief organ systems are, in general, like those of Annelids, but jaws, paired appendages, tracheae, and a hemocoel are present. The animals, now found in widely separated parts of the earth, probably are the remnant of a population, once continuous, that has departed but little from the arthropod stem. (Fig. 182.)

The Arthropods, judged by the stupendous number of species and individuals, or by variety of form, or by sheer success in competition with other animals in air, water, and on the ground, are "Nature's most successful invertebrate

experiment." The segmental plan begun in a small way in some of the lower forms, is definitely established in the Annelids, and is made the most of in the Arthropods. (Fig. 182.)

However, Arthropods are hampered by inherent structural limitations. The hard, dead, external skeleton imparts

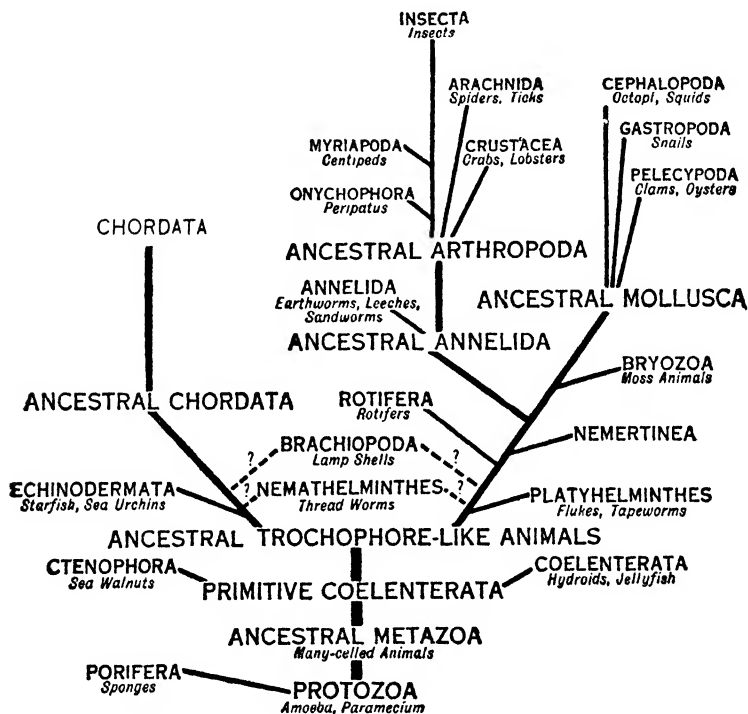

FIG. 183. Genealogical tree showing the probable relationships of the principal groups of Invertebrates. (From Newman, after Sigerfoos and Allee.)

certain mechanical restrictions on size and freedom of action that are removed in Vertebrates by an internal living skeleton. And small size precludes a constant body temperature greater than the surroundings, so they cannot achieve the constancy of living possible to the warm-blooded Birds and Mammals. Nevertheless it has been suggested as not beyond the range of possibility that Insects may yet dominate the earth! (Fig. 183; Pp. 646-659.)



K. SYNOPTIC CLASSIFICATION OF INVERTEBRATES<sup>1</sup>

(With representative examples and the approximate number of known species)

Phylum PROTOZOA. (20,000 species.)

Class I. FLAGELLATA: Flagellates. Euglena, Monads, Trypanosomes.

Class II. RHIZOPODA: Amoeba, Foraminifera, Heliozoa, Radiolaria.

Class III. SPOROZOA: Plasmodium, Monocystis.

Class IV. CILIATA: Ciliates. Paramecium, Vorticella, Stentor.

Phylum PORIFERA: Sponges. (3000 species.) Leucosolenia, Sycon, Grantia, Euspongia.

Phylum COELENTERATA. (10,000 species.)

Class I. HYDROZOA: Hydra, Obelia, Gonionemus.

Class II. SCYPHOZOA: Aurelia.

Class III. ANTHOZOA: Sea Anemones, Corals.

Phylum CTENOPHORA: Sea-walnuts. (100 species.)

Phylum PLATYHELMINTHES: Flatworms. (7000 species.)

Class I. TURBELLARIA: Planaria.

Class II. TREMATODA: Liver Flukes.

Class III. CESTODA: Tapeworms.

Class IV. NEMERTINEA: Nemertean.

Phylum NEMATHELMINTHES: Roundworms. (3000 species.)

Class I. NEMATODA: Ascaris, Trichinella, Hookworm.

Class II. NEMATOMORPHA: Gordius.

Class III. ACANTHOCEPHALA: Echinorhynchus.

Phylum ANNELIDA: Segmented Worms. (7000 species.)

Class I. ARCHANNELIDA: Polygordius.

Class II. POLYCHAETA: Sandworms, Tubeworms. Nereis.

Class III. OLIGOCHAETA: Earthworms, Nais.

Class IV. GEPHYREA: Sipunculus.

Class V. HIRUDINEA: Leeches.

Phylum ROTIFERA: Rotifers. (1800 species.)

Phylum BRYOZOA: Bryozoans. (3000 species.)

Phylum BRACHIOPODA: Brachiopods. (130 species.)

Phylum MOLLUSCA. (75,000 species.)

Class I. AMPHINEURA: Chiton.

Class II. SCAPHOPODA: Dentalium.

Class III. GASTROPODA: Snails, Slugs.

Class IV. PELECYPODA: Oysters, Clams, Scallops, Shipworm.

Class V. CEPHALOPODA: Squid, Octopus, Nautilus.

<sup>1</sup> See p. 280 for the classification of Vertebrates.

Phylum ECHINODERMATA. (5000 species.)

Class I. ASTEROIDEA: Starfishes.

Class II. OPHIUROIDEA: Brittle Stars.

Class III. ECHINOIDEA: Sea Urchins.

Class IV. HOLOTHUROIDEA: Sea Cucumbers.

Class V. CRINOIDEA: Sea Lilies, Feather Stars.

Phylum ARTHROPODA. (700,000 species.)

Class I. CRUSTACEA.

Subclass 1. *Entomostraca*: Daphnia, Cyclops, Barnacles.

Subclass 2. *Malacostraca*: Crayfish, Lobsters, Crabs, Pill-bugs.

Class II. ONYCHOPHORA: Peripatus.

Class III. MYRIAPODA: Centipedes, Millipedes.

Class IV. INSECTA: Insects.

Commonly accepted orders are:

- |   |   |
|---|---|
| 1. <i>Thysanura</i> : Silverfish, etc.                          | 13. <i>Anoplura</i> : Sucking Lice.                             |
| 2. <i>Collembola</i> : Springtails.                             | 14. <i>Hemiptera</i> : Bugs.                                    |
| 3. <i>Orthoptera</i> : Grasshoppers,<br>Crickets, Roaches, etc. | 15. <i>Homoptera</i> : Plant-lice, etc.                         |
| 4. <i>Isoptera</i> : Termites.                                  | 16. <i>Dermoptera</i> : Earwigs.                                |
| 5. <i>Neuroptera</i> : Ant-lions, Lace-<br>wings, etc.          | 17. <i>Coleoptera</i> : Beetles.                                |
| 6. <i>Ephemeroptera</i> : Mayflies.                             | 18. <i>Strepsiptera</i> : Stylopids.                            |
| 7. <i>Odonata</i> : Dragonflies.                                | 19. <i>Mecoptera</i> : Scorpion-flies, etc.                     |
| 8. <i>Plecoptera</i> : Stoneflies.                              | 20. <i>Trichoptera</i> : Caddice-flies.                         |
| 9. <i>Psocoptera</i> : Book-lice, etc.                          | 21. <i>Lepidoptera</i> : Moths and<br>Butterflies.              |
| 10. <i>Mallophaga</i> : Bird-lice.                              | 22. <i>Diptera</i> : Flies, Mosquitoes.                         |
| 11. <i>Embiopoda</i> : Embiids                                  | 23. <i>Siphonaptera</i> : Fleas.                                |
| 12. <i>Thysanoptera</i> : Thrips.                               | 24. <i>Hymenoptera</i> : Bees, Wasps,<br>Ants, Ichneumons, etc. |
- Class V. ARACHNIDA: Scorpions, Spiders, Mites.

## CHAPTER XI

# SURVEY OF THE ANIMAL KINGDOM: VERTEBRATES

In the course of the age-long struggle for existence, Nature has discovered the mechanisms most apt for each species to meet the conditions of survival. — *Lillie*.

**T**he important phyla of the Invertebrates having been described, it remains to survey the highest and concluding phylum of the animal world, technically known as the CHORDATA which for all practical purposes is synonymous with the VERTEBRATA. The only Chordates that are not Vertebrates, or BACKBONED animals, are a few lowly creatures, the so-called Protochordates, apparently having Invertebrate and certainly Vertebrate affinities; the latter chiefly evidenced by the presence of a NOTOCHORD which is the forerunner of the backbone, a dorsal NERVE TUBE, and GILL SLITS for respiration. (Figs. 184, 185; 212, 213.)

The PROTOCHORDATES comprise three quite distinct types, each of subphylum rank, the Hemichorda, Urochorda, and Cephalochorda. In the HEMICHORDA, well represented by the worm-shaped Dolichoglossus, the notochord is a short rod of cells above the anterior end of the alimentary canal which is perforated by small gill slits, and a short section of the dorsal nerve cord is tubular. In the UROCHORDA, which includes the Tunicates, or Sea Squirts, a clear-cut notochord and nerve tube, both confined to the tadpole-like larval stages, is accompanied by a large pharynx, perforated by a multitude of gill slits, which persists in the sessile adult. And in the CEPHALOCHORDA all of the three chief chordate characteristics attain full development. The little sand-

burrowing *Amphioxus* is of especial interest because it epitomizes the general type from which all higher forms probably have been derived. In addition to the notochord, gill slits, and dorsal nerve tube, *Amphioxus* exhibits a segmental

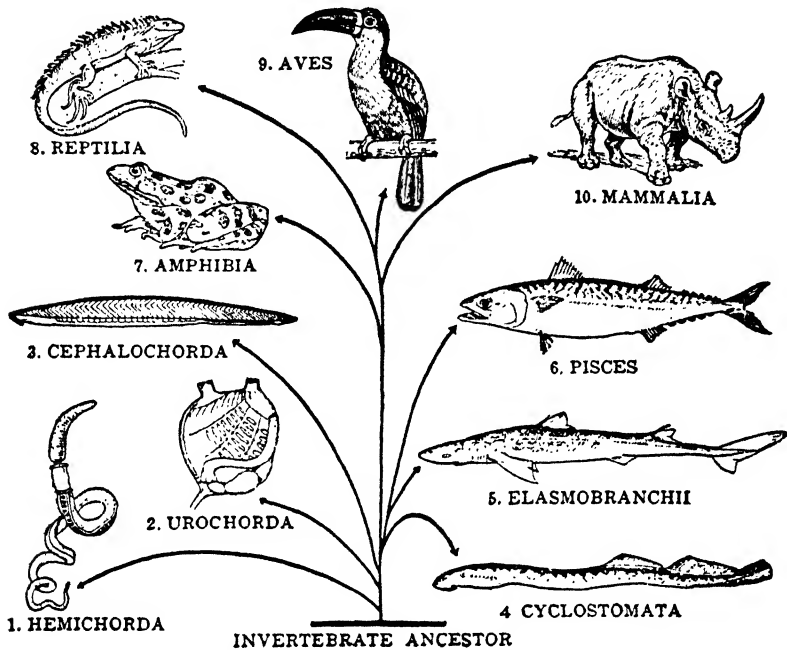

FIG. 184. General relationships of the chief divisions of the phylum Chordata. 1, Dolichoglossus; 2, Sea Squirt; 3, *Amphioxus*; 4, Lamprey; 5, Shark; 6, Mackerel; 7, Frog; 8, Iguana; 9, Toucan; 10, Rhinoceros. Not drawn to scale. See Fig. 183. (After Hegner.)

arrangement of the muscles, a circulatory system with the blood flowing posteriorly in the dorsal vessel and anteriorly in the ventral vessel, and a liver-like diverticulum of the alimentary canal — all prophetic of the condition in the Vertebrates. (Fig. 185.)

We may now proceed to the rest of the Chordates — the Vertebrates — and since emphasis is later to be placed on the anatomy and physiology of the vertebrate body because Man is a Vertebrate, our immediate attention can be largely confined to their classification. (Fig. 186.)

The Vertebrates include all the larger and more familiar animals — Fishes, Amphibians, Reptiles, Birds, and Mammals — so that in the popular mind the words animal and Vertebrate are essentially synonymous. A fish, as everyone knows, is an aquatic backboned animal which breathes by

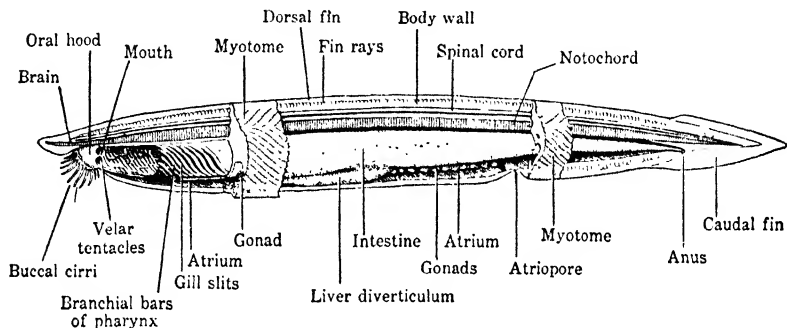

FIG. 185. The general anatomy of a primitive Chordate, *Amphioxus* (*Branchiostoma lanceolatus*), a near relative of the lowest Vertebrates. Lateral view with most of the left body wall removed. Nearly twice natural size.

means of gills and swims by fins. An Amphibian, such as a frog, may, in a general way, be thought of as a fish that early in life — at the end of the tadpole stage — discards its gills, develops lungs, substitutes five-toed limbs for fins, and takes up a terrestrial existence. Similarly, a Reptile,

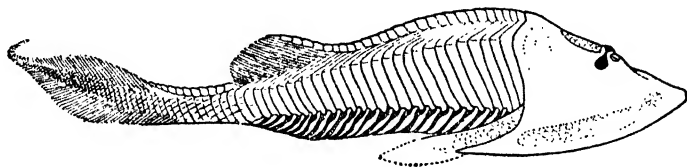

FIG. 186. *Cephalaspis*, one of the Ostracoderms — the oldest known Vertebrates. Extinct. (From Newman, after Patten.)

say a lizard, may be pictured as an Amphibian which has relegated, as it were, the tadpole stage to the egg, and therefore emerges with limbs and lungs. Birds and Mammals may be regarded as separate derivatives of the reptilian stock which have transformed the scales of the Reptile into feathers and hair respectively, and have developed a special

care for their young: the Birds by incubation of the eggs and the Mammals by retention of the young essentially as parasites within the body of the female until birth occurs. (Figs. 257, 306, 307.)

It will be appreciated, of course, that other important characteristics — many of which will be apparent as we proceed — delineate these chief Vertebrate groups; but, in fact, the Vertebrates as a whole are remarkably homogeneous both structurally and functionally, the most obvious external differences to the contrary. Some of the *outstanding characters* typical of Vertebrates, in addition to the unique notochord, living endoskeleton, dorsal nerve tube (spinal cord), and gill slits are: bilateral symmetry, traces of segmentation, coelom, red blood cells, brain encased in a skull, paired appendages (fins or limbs), and a tail. (Figs. 212, 213.)

Vertebrates are *the* modern animals: the “athletes of the Animal Kingdom.” They have parceled out, as it were, the available environment amongst themselves. The Fishes dominate the water, the Birds, the air, and the Mammals, the land. To be sure, the Amphibians waver between water and land, and the Reptiles are chiefly terrestrial; but both are minor groups to-day: the supremacy of the Reptiles passed to the Mammals in the geological yesterday. Man is a Mammal. (Pp. 280, 281.)

## A. FISHES

Living as they do in an aquatic environment, Fishes find at least two problems of large-bodied, active, terrestrial animals considerably simplified. In the first place, the density of water makes less necessary either supports to raise the body or sturdy muscles to move them. Thus the paired appendages, FINS, and the tail of Fishes are adapted chiefly for propulsion and steering. However, it requires greater expenditure of energy to propel a body through water than through air, and this is typically met by ‘stream-lining’ so that some fishes are capable of speeds that compare favorably with those of terrestrial animals. In the second

place, although an efficient respiratory apparatus is required, no special provision is needed to keep the respiratory membranes moist. The water merely passes into the mouth, over the gills, and then out through the gill slits. (Fig. 246.)

Fishes are cold-blooded since they possess no mechanism to maintain a constant body temperature — a character they share with the Amphibians and Reptiles. Most species are OVIPAROUS — the eggs are shed; but some, such as the well-known Guppy, are VIVIPAROUS — the eggs develop within the mother's body and the young are born.

If we neglect the primitive fish-like creatures devoid of true jaws and paired fins, known as CYCLOSTOMES, and turn at once to the true Fishes, or PISCES, they fall into two main

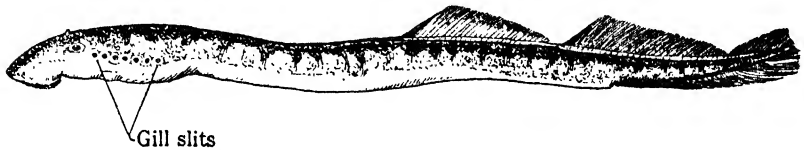

FIG. 187. A Cyclostome. Lamprey, *Petromyzon marinus*.  
(Redrawn, after Dean.)

groups: the ELASMOBRANCHS with an internal skeleton of gristle, or CARTILAGE, and the OSTEICHTHYES in which the cartilaginous skeleton is largely replaced by one of BONE. (Fig. 187.)

### 1. Cartilaginous Fishes

The most primitive of the true fishes are the Sharks and Rays, or Elasmobranchs: a small remnant of a once dominant group of Vertebrates. They differ from higher fishes chiefly by a cartilaginous skeleton, by gills communicating directly with the body surface by several gill slits, and by a skin roughened by small tooth-like projections, or PLACOID SCALES. (P. 286.)

Sharks are confined to marine waters and are most abundant in the tropics. The most common species off our coasts are the small Dogfish Sharks, notorious pests to fishermen but favorites for dissection in zoölogical laboratories. (Figs. 188, 236.)

Whereas the Sharks have the typical stream-line body of swift swimmers, the Rays, or Skates, are bottom-dwellers, and have a greatly flattened body with eyes on the dorsal, and mouth and gill slits on the ventral surface. The most famous of the Rays are the Torpedoes, so called because they are able to give a severe electric shock. (Fig. 189.)

## 2. Bony Fishes

All of the fresh-water fishes, as well as the great majority of those dwelling in the sea — the dominant fish population of the earth today — have a skeleton of bone, and usually a body-covering of scales. They are Bony Fishes or Osteichthyes. And with few exceptions — such as the more

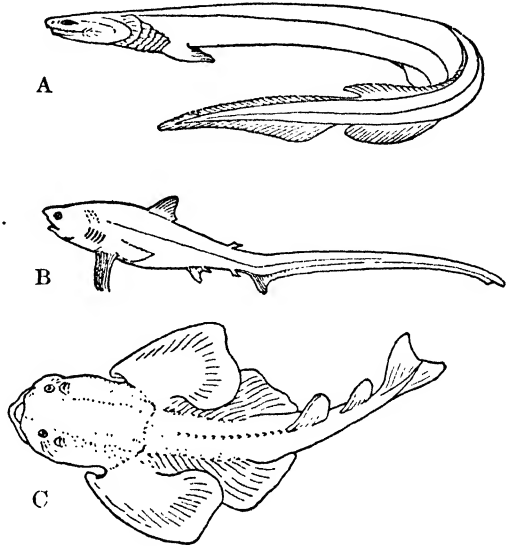

FIG. 188. Sharks. A, Frilled Shark, *Chlameidoselachus anguineus*; B, Thresher Shark, *Alopias vulpes*; C, Angel Shark, *Rhina squatina*. (From Newman.)

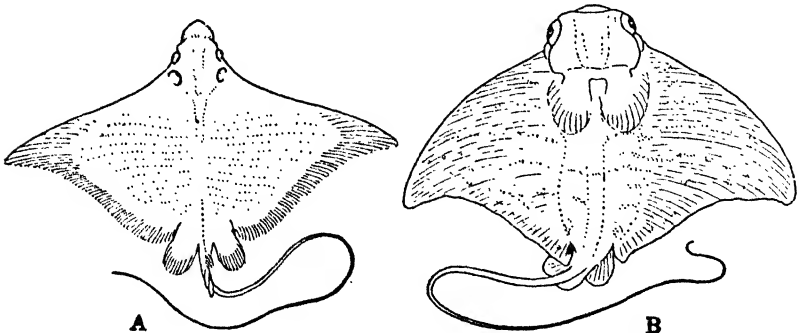

FIG. 189. A, Sting Ray, *Stoasodon narinari*; B, Eagle Ray, *Myliobatis aquila* (From Newman, after Jordan and Evermann, and Bridges.)



primitive Lobe-finned Fishes, Lung-fishes, Sturgeons, and Garpikes which have partially cartilaginous skeletons and bony plates instead of scales — all are members of the great subgroup of TELEOSTS. (P. 280.)

Teleosts typically have the external openings of the gill slits covered by a protecting flap, or OPERCULUM, so that water bathing the gills leaves the body by a single opening at the posterior edge of the operculum on either side of the head. They are usually provided with an AIR BLADDER which

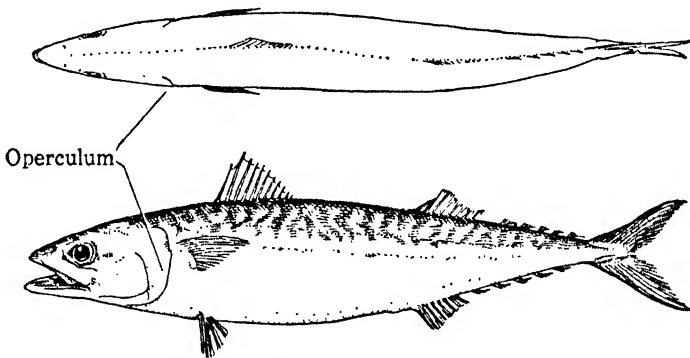

FIG. 190. Mackerel, *Scomber scombrus*.

arises as a sac-like out-pocketing of the alimentary canal and functions chiefly as a hydrostatic organ, but in some cases acts as an accessory respiratory organ, or primitive lung. (Figs. 190, 219, 225.)

Modifications of the typical fish-like form of swift-swimming fishes that have been assumed by various species in adaptation to different habitats and modes of life are legion. One immediately thinks of the snake-like body of the Eels, the grotesque form of the Sea-horses, and the compressed body of the Flat-fishes such as the Flounders and Halibuts. But Flat-fishes are hatched with typical fish form, and it is only as the animals settle down on one side that the 'under' eye gradually moves so both are on top. Even the bizarre form exhibited by the Flying-fishes that jump and sail above the water is exceeded by the denizens of the ocean's deepest

reaches where sunlight never penetrates, the pressure is tremendous, and the temperature is only slightly above the freezing point. In such surroundings some possess luminous organs, some have immense eyes to make the most of little light, some are blind and so depend upon tactile organs, some have an immense mouth and an enormous stomach capable of digesting a fish nearly their own size, and so on and on — adaptations seemingly endless. And least is a Goby one-third of an inch long — the smallest known Vertebrate. (Figs. 191–193.)

Finally we must revert to the Lung-fishes, or Dipnoans, represented today by only five fresh-water species — a mere remnant of a flourishing population in the geological past. They are of special interest because the air bladder opens into the pharynx and regularly functions as a lung. This is of advantage to the fish when water is lacking during a drought. Lung-fishes have been regarded as intermediate between Fishes and Amphibians, but recent evidence indicates that

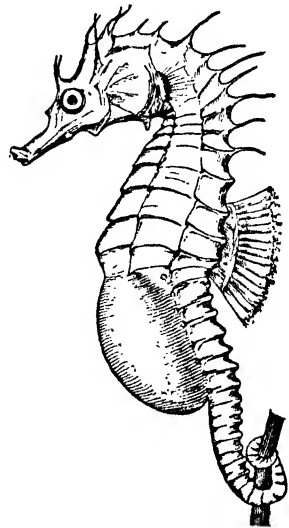

FIG. 191. Sea-horse, *Hippocampus antiquorum*. Male showing brood pouch formed from combined pelvic fins. See Fig. 359. (From Doflein.)

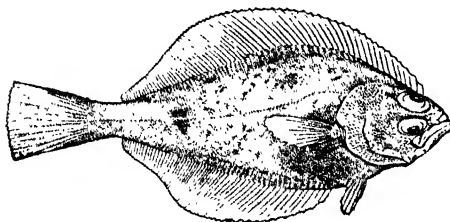

FIG. 192. A Flat-fish.

both are descended from a very primitive stock, known as Lobe-finned Fishes, which had already begun the development of adaptations for land life — in particular, air bladders for air breathing and

fin-lobes that are prophetic of Amphibian limbs. (Figs. 194, 195.)

There is some reason to believe that all fishes originated in fresh water and that the ancestral fresh-water forms gave rise to modern marine fishes and to the land Vertebrates. Strange to say, the modern fresh-water Teleosts apparently represent a relatively recent re-migration from the sea.

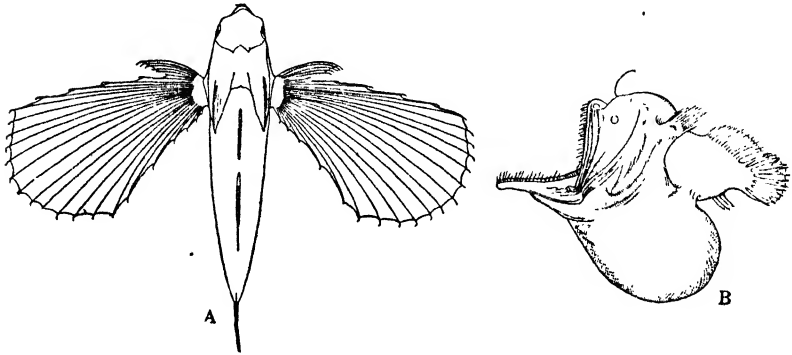

FIG. 193. A, a Flying-fish; B, a deep-sea Fish. (From Gunther, and Lull.)

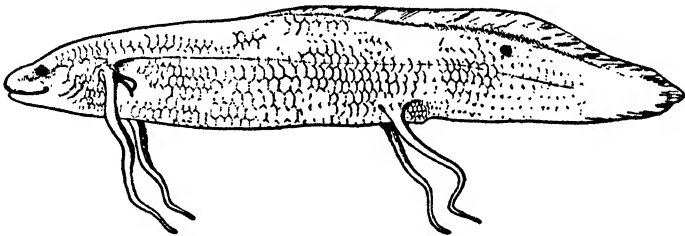

FIG. 194. African Lung-fish, *Protopterus annectens*. (From Dean.)

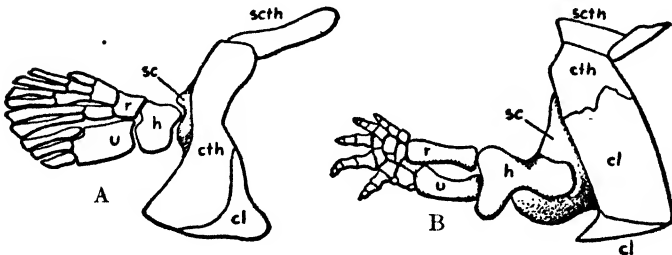

FIG. 195. Comparison of the skeleton of the right pectoral limb and shoulder region of a Lobe-finned Fish (A) and of a primitive Amphibian (B). Homologous bones are similarly lettered. (From Newman, after Romer.)

Fishes are of such great economic value that the governments of progressive countries spend large sums for their study, protection, and propagation. The important food and game fishes are almost without exception Teleosts — relatively modern forms that did not exist during the Age of fishes, when Fishes were the only Vertebrates, but appeared later during the Age of Reptiles. (Fig. 383.)

## B. AMPHIBIANS

The members of the class AMPHIBIA, commonly represented by the Frogs and Salamanders, made a great forward step in vertebrate evolution by adopting — if somewhat falteringly — the land-habit. This opened up to them a vast environment closed to fishes and demanded efficient lungs and supporting limbs as well as innumerable other structural and physiological adaptations to the new conditions. Apparently the limbs were derived from the fin-lobes of the paired fins of fishes and built on the PENTADACTYL plan which persists in all the higher Vertebrates. (Figs. 195, 221, 222.)

Amphibians are cold-blooded, slimy-skinned animals that spend the early part of their life with median fins, tail, and gills, and only substitute, or add, limbs and lungs when finally they emerge on dry land. During this metamorphosis from the larval to the adult form they apparently recapitulate broadly their evolutionary history. (Figs. 304, 306.)

Nearly all Amphibians return to water to breed, and many spend the cold months in a dormant condition buried in mud at the bottom of ponds and streams. During this HIBERNATION period the metabolic processes are greatly reduced, and the temperature is little above the surroundings. However, Frogs cannot survive being actually frozen although they may remain alive when embedded in a solid block of ice.

The Amphibians that retain the tail throughout adult life constitute the order CAUDATA, and those deprived of this structure during metamorphosis, the order SALIENTIA.

## 1. Salamanders and Newts

The tailed Amphibians, commonly known as Urodeles, such as the Salamanders and Newts, though hatched as aquatic larvae, or TADPOLES, undergo a relatively incon-

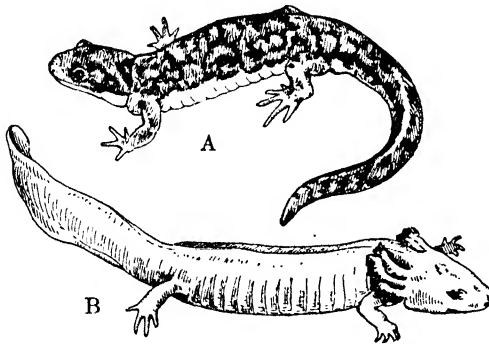

FIG. 196. A, *Amblystoma*, *Amblystoma tigrinum*;  
B, *Necturus*, *Necturus marulosus*.

spicuous metamorphosis that varies considerably in different species. Thus some retain their gills throughout life, though functional lungs are developed; others resorb the gills but retain the gill slits; and still others lose all traces of both gills and gill

slits. In fact, some even go to the extreme and lose their lungs, thus depending solely upon the moist skin to act as a respiratory membrane. Obviously the lung-breathing method is not consistently adopted.

Common tailed Amphibians are *Necturus* (Mud-puppy), *Cryptobranchus* (Hell-bender), *Amblystoma* (Blunt-nosed and Tiger Salamanders), and *Triturus* (the Newts). Several species have recently proved a boon to biologists interested in fundamental problems of growth. From tadpole to adult they possess remarkable powers of regeneration: they repair minor and major mutilations, restoring excised eyes and amputated limbs and even appropriating the limbs of other species when they are grafted on them. (Figs. 196, 197, 314.)

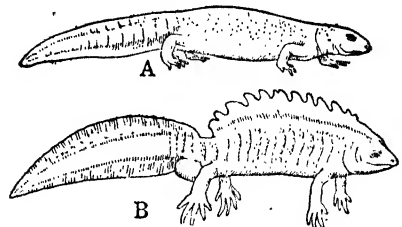

FIG. 197. A Newt, *Triturus cristata*.  
A, female; B, male during the breeding season. (From Gadow.)

## 2. Toads and Frogs

The majority of Amphibians, some nine hundred species, are without tails in the adult condition and so are called Anurans. They are the Toads and Frogs with a relatively clear-cut metamorphosis from tadpole to limbed, lung-breathing, tailless adult. The common Toads, such as *Bufo americanus*, hop about chiefly after dusk devouring worms, snails, and insects and so render a considerable service. In fact, someone has estimated that the gardener owes a toad on his premises nearly twenty dollars at the end of the season. (Fig. 198.)

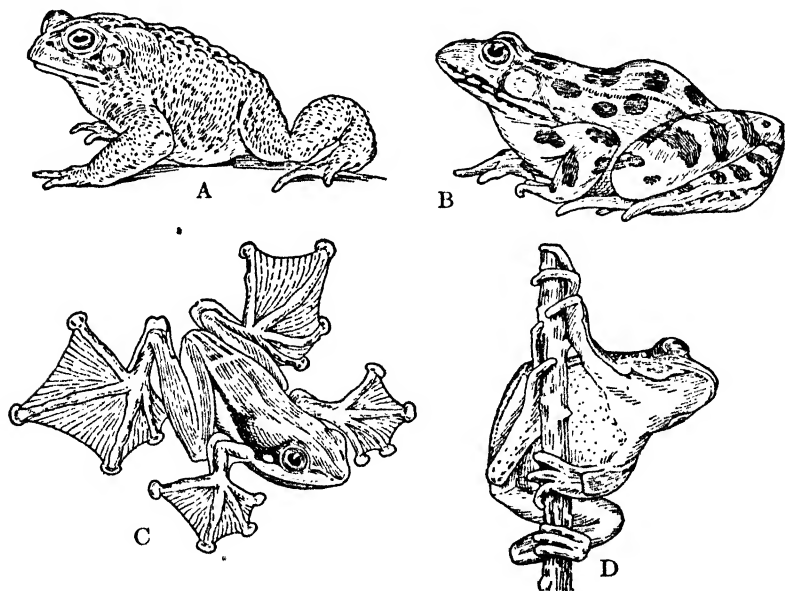

FIG. 198. A, Toad, *Bufo americanus*, stalking prey; B, Leopard Frog, *Rana pipiens*; C, Javan Flying Frog, *Rhacophorus pardalis*; D, Tree Toad, *Hyla versicolor*. (From Newman, after Dickerson and Lydekker.)

Tree Frogs and Tree Toads are tiny arboreal forms with soft, adhesive pads on the toe tips. Many of them, such as the common Tree Toad, *Hyla versicolor*, are able to change their color through various shades of gray, brown, and green, and so are rendered inconspicuous in their natural surroundings.

The true Frogs are represented by several well-known species in the United States: among them the Leopard Frog (*Rana pipiens*), the Bull Frog (*Rana catesbeiana*), and the Green Frog (*Rana clamitans*). More need not be said about frogs at this point because they are in many ways ideal subjects for anatomical and physiological investigations so that we shall have occasion to refer to them later. (Figs. 216, 222, 226.)

### C. REPTILES

Apparently descended from primitive Amphibians, the Reptiles met new and more favorable land conditions with progressive structural and physiological features: for ex-

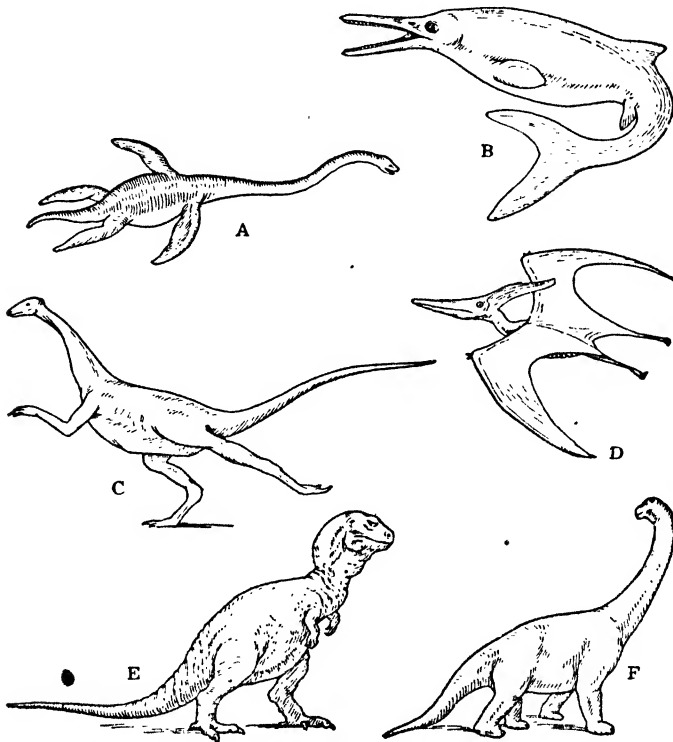

FIG. 199. Reptiles of the past. A, Plesiosaur, *Elasmosaurus*; B, Ichthyosaurus, *Baptonodon*; C, Ostrich Dinosaur, *Struthiomimus*; D, Pterosaur, *Pteranodon*; E, carnivorous Dinosaur, *Tyrannosaurus*; F, herbivorous Dinosaur, *Brachiosaurus*, about 80 feet long. (After Osborn.)

ample, they skipped metamorphosis and started out from the egg with functional lungs and on four feet. So the Reptiles very soon, geologically speaking, became the dominant Vertebrates on the earth, flourishing both in number of individuals and variety of species adapted to all sorts of land and swamp conditions, and even, secondarily, to aquatic and aërial life. Probably the best-known representatives of the extinct population of the Age of Reptiles are some of the giant Dinosaurs. (Figs. 199, 382, 383.)

Although the supremacy of the Reptiles eventually passed to the Mammals, there are still some five thousand species living today. These are arranged in three chief orders: the CHELONIA, CROCODILIA, and SQUAMATA, represented by the Turtles and Tortoises, the Crocodiles and Alligators, and the Lizards and Snakes, respectively.

### 1. *Turtles and Tortoises*

Typically encased in a shell composed of bony plates firmly fixed to the backbone and to the ribs, the Turtles and Tortoises — some land-dwellers, others aquatic — depend upon this rather than speed for protection. In fact a few, like the Box Turtle, can completely seal themselves up, as it were, between the dorsal CARAPACE and the ventral PLASTRON. The tortoise-shell of commerce is the horny outer layer of the carapace of the Hawk's bill, or Tortoise-shell Turtle. Probably the protective shell also, in part, accounts for the fact that the jaws of turtles and tortoises are toothless. Nevertheless, many can inflict severe wounds — witness the beaked jaws of the Snapping Turtle. (Fig. 200.)

### 2. *Crocodiles and Alligators*

Predatory inhabitants of tropical rivers, Crocodiles and Alligators are lizard-like in form with long, gaping jaws well armed with teeth, and with a thick, leathery skin covered with horny scales. Alligator skin has long been popular for the manufacture of 'leather goods.'



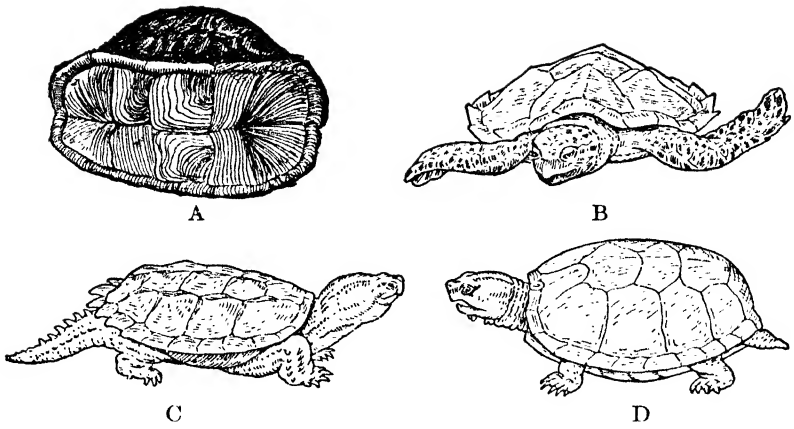

FIG. 200. Turtles. A, Box Turtle enclosed within carapace and plastron; B, Tortoise-shell Turtle, *Eretnochelys imbricata*; C, Snapping Turtle, *Chelydra serpentina*; D, Mud Turtle, *Cinosternum pennsylvanicum*. (A from Bamford; B, C, D after Lydekker.)

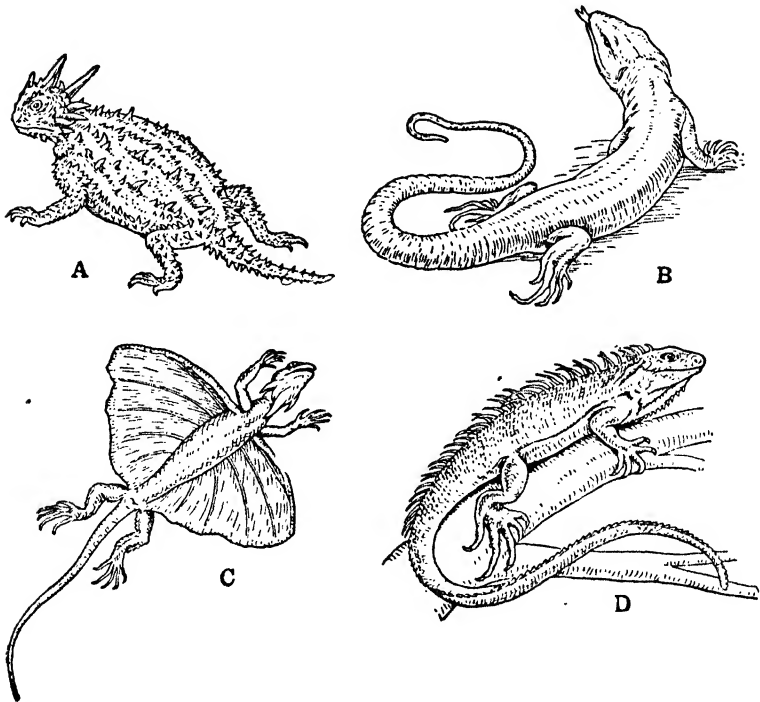

FIG. 201. Lizards. A, Horned-toad, *Phrynosoma cornutum*; B, European Lizard, *Lacerta viridis*; C, Flying Dragon, *Draco volans*; D, Iguana, *Iguana tuberculata*. (From Newman, after Gadov and Lydekker.)

### 3. Lizards and Snakes

The Lizards form a highly diversified group of the Squamata, typically with scaly skin and well-developed limbs and long tail. Representatives are the common Iguana, the Gila-monster, and the Horned 'toad.' Closely related to the true Lizards are the Chameleons, famous for their ability to change color rapidly in response to various stimuli. (Fig. 201.)

Snakes, constituting the other great division of the Squamata, are the most recent product, geologically speaking, of evolution among the Reptiles, and without them the class

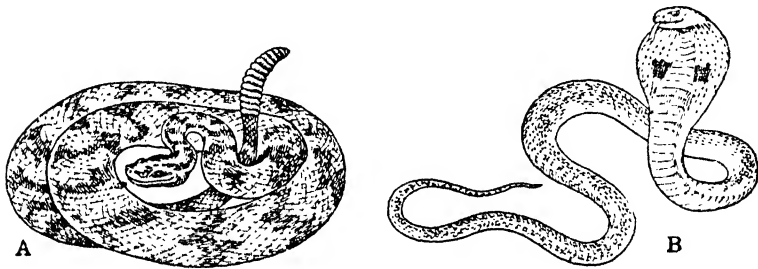

FIG. 202. A, Rattlesnake, *Crotalis durissus*; B, Cobra, *Naja tripudians* (From Newman, after Lydekker.)

today would be poorly represented. Snakes are essentially limbless lizards in which even the internal supporting structures of the limbs have in most instances disappeared. But apparently snakes should not be regarded as degenerate forms, because their chief characteristics — absence of limbs, greatly elongated body, and loosely articulated jaws — are all highly specialized adaptations for swallowing whole and digesting large prey. (Figs. 202, 380.)

Most species of snakes, in common with the great majority of Vertebrates, except the Mammals, are oviparous, but a few are viviparous. And it is hardly necessary to say that a few have poison glands associated with special teeth, or fangs. The Rattlesnakes, Copperheads, Moccasins, and Cobras are among the most notorious in this respect. How-

ever, many species crush their prey by constriction as do the Boa-constrictors and Pythons. (Fig. 381.)

#### D. BIRDS

The Birds, constituting the class AVES, are the warm-blooded (HOMOTHERMAL) animals that have made the air their own by the development of fore limbs into wings, scales into an insulating blanket of feathers, and other bodily adaptations. And not the least of their progress is perhaps due to instinctive care of their eggs and young. That Birds are an offshoot from the Reptilian stock, probably the Dinosaurs, is attested by the fossil remains of a bird, known as *Archaeornis*, with characteristic feathers but lizard-like tail and teeth. (Figs. 383, 385.)

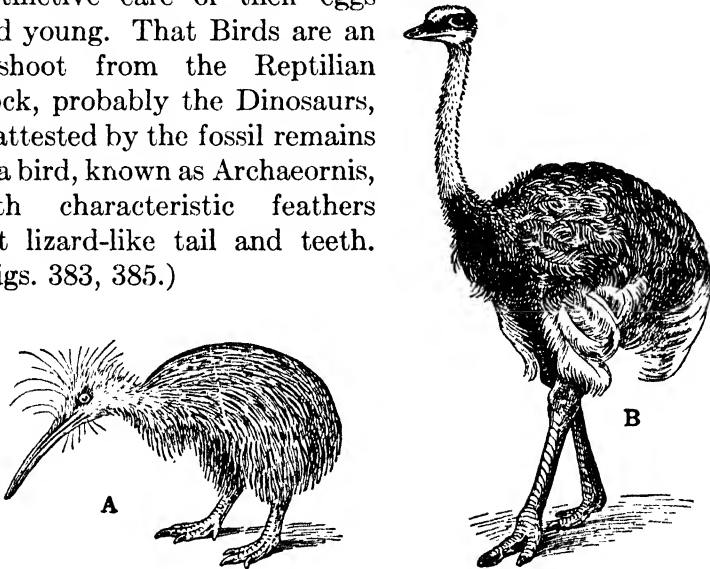

FIG. 203. A, Kiwi, *Apteryx australis*; B, Ostrich, *Struthio camelus*.  
(From Newman, after Evans.)

The Birds to-day form a remarkably homogeneous group, probably due to restrictions imposed by the mechanical problems involved in flight. Sustained exercise in the air necessitates an exceptionally efficient heart to rush supplies to the various parts of the body, and coöperating lungs that communicate with a system of air spaces among the viscera and in the hollow bones. Withal, the plumage not only provides an efficient heat-retaining coat, but the feathers of

wings and tail also are well adapted for propulsion and steering. Minimum weight with maximum strength characterizes these living heavier-than-air flying machines.

Birds usually are arranged in two very unequal divisions, the RATITAE and CARINATAE. The first includes a few species without a keel-like breast bone to support strong wing muscles, as illustrated by the flightless *Apteryx* and

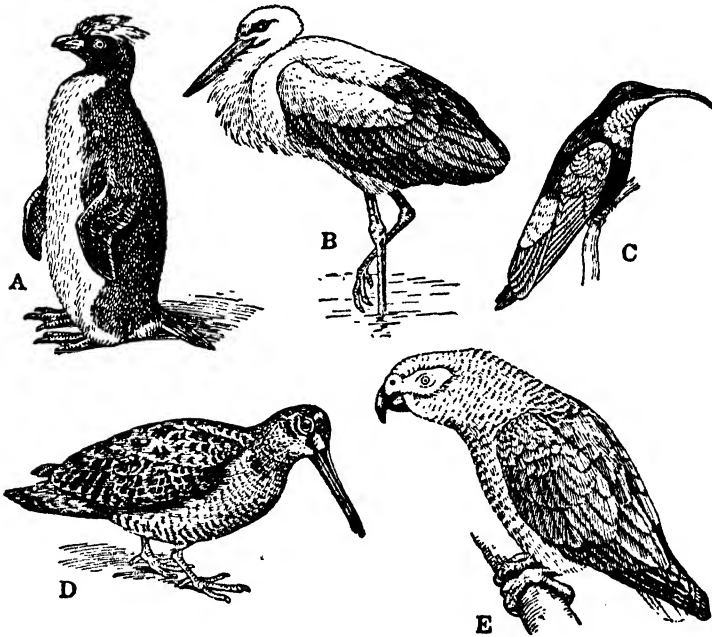

FIG. 204. Carinate Birds. A, Penguin, *Eudyptes chrysocoma*; B, Stork, *Ciconia alba*; C, Hummingbird, *Eulampis jugularis*; D, Woodcock, *Scolopax rusticula*; E, Parrot, *Psittacus erithacus*. (After Lydekker and Evans.)

Ostriches; and the second division comprises those with the 'keel,' which is all the rest of the bird population — about fifteen thousand species. These are differentiated by relatively minor anatomical variations, particularly in regard to wings, feet, and horny beaks ensheathing toothless jaws, in adaptation to various habitats and ways of life. (Figs. 203, 204, 353.)

A consideration of the classification of the Carinatae would carry us too far into details, but ORNITHOLOGY is of very high interest and of great economic value. Birds contribute in large measure, both directly and indirectly, to the human food supply: directly as domestic and game birds, and indirectly because they make successful agriculture possible by eating almost inconceivable numbers of destructive insects and weed seeds. (Figs. 388, 389, 391; Pp. 663, 664.)

## E. MAMMALS

With the class MAMMALIA we reach the highest forms of life on the earth, culminating in Man, so here naturally our interest is chiefly focussed. But since considerable attention is to be given to their anatomy and physiology with special reference to the human body, only the essential mammalian characters and classification are now in point.

In brief, Mammals are warm-blooded, lung-breathing, hairy Vertebrates. The young of all but the very lowest develop before birth at the expense of food derived from the mother's blood. All are nourished after birth by milk from special MAMMARY GLANDS. On the basis of their methods of reproduction, the Mammals are divided into three subclasses: the PROTOTHERIA, or the primitive oviparous Monotremes; the METATHERIA, or pouched forms, the Marsupials; and the EUTHERIA, or those with a typical placenta, commonly called the Placentals. (P. 280.)

### 1. Monotremes

The primitive egg-laying Monotremes quite evidently point to a reptilian ancestry for the class. Although they are oviparous, the young when hatched are nourished by milk. There are only three species, each about the size of a rabbit: the Duckbill (*Ornithorhynchus*) and the Spiny Ant-eaters: Echidna (*Tachyglossus*) and Proechidna (*Zaglossus*) found in Australia, Tasmania, and New Guinea. (Fig. 205.)

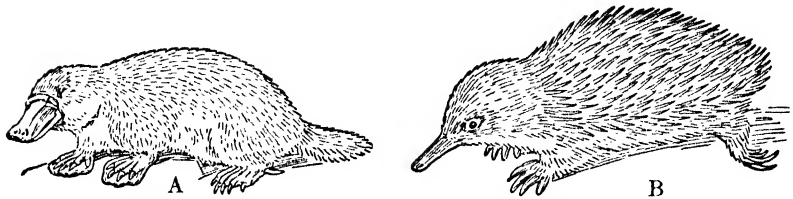

FIG. 205. Monotremes. A, Duckbill, *Ornithorhynchus anatinus*; B, Echidna, *Tachyglossus aculeatus*. (From Newman.)

## 2. Marsupials

The pouched Mammals, or Marsupials, occur chiefly in Australia and neighboring islands, where they are the characteristic mammalian fauna: a primitive one that has flourished there isolated from keen competition, but is now rapidly dying out since the higher Mammals have been imported. The Kangaroos and Wallabies are the best-known examples of the Australian Marsupials, and the Virginia Opossum is one of the few scattered survivors in America of a group once widely distributed over the earth. (Figs. 206, 351.)

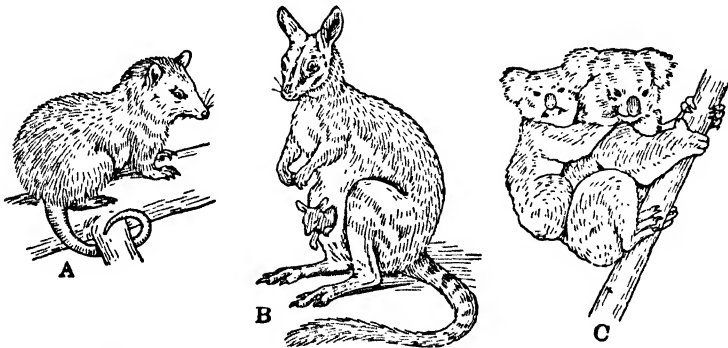

FIG. 206. Marsupials. A, Virginia Opossum, *Didelphys virginiana*; B, Wallaby, *Petrogale xanthopus*; C, Koala, *Phascolarctos cinereus*. B and C carrying young. (After Vogt and Specht, and Brehm.)

The method of reproduction of the Marsupials is unique. The eggs hatch, as it were, within the mother's body where development proceeds for a short time, nourishment being provided through an atypical or very simple placenta. Then

the young are born in an exceedingly immature condition and make their way to a pouch on the abdomen of the mother. Here they attach themselves to the teats of the mammary glands and are nourished by milk. Even after the young are well developed the pouch serves as a refuge.

### 3. Placentals

The PLACENTALIA, or Eutheria, comprises all the rest of the Mammals from the lowly Insectivora, such as *Gymnura* and Hedgehog, to the Primates, including Man. All nourish their young before birth by means of a highly complex placenta that makes possible the protracted development of the embryo under ideal conditions for nutrition and protection

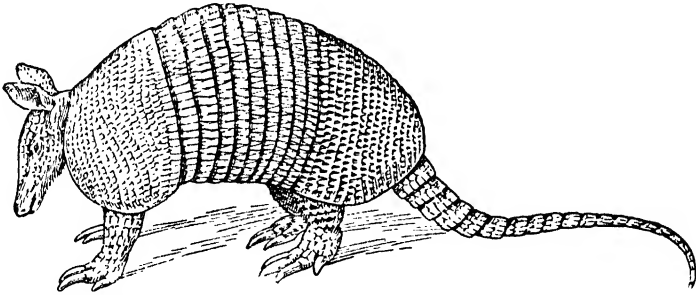

FIG. 207. An Edentate. Texas Nine-banded Armadillo, *Dasypus novemcinctus texanus*. (From Newman.)

within the mother's body: conditions necessary for the establishment of niceties of structure and function. Thus it is fair to say that the placenta and associated embryonic membranes are in no small degree responsible for the commanding position of the group in competition with other forms of life. (Fig. 257; Pp. 452-456.)

The adaptive radiation of Placentals to nearly all types of environments and modes of life — from whales to bats, and moles to men — is an expression of their success which elsewhere in the animal world is not reached even by the insects. But it makes their classification a difficult problem.

However, for our purpose they may conveniently be grouped in four great LEGIONS, chiefly on the basis of the structure and function of their limbs and teeth. (Fig. 346.)

The first is the immense assemblage of clawed mammals, or UNGUICULATES. This is represented by the INSECTIVORES,

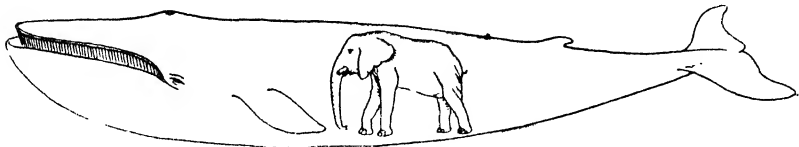

FIG. 208. Sulfur-bottom Whale, *Sibbaldus musculus*, and African Elephant, *Loxodonta africana*, drawn to scale. (Modified, after Lull.)

or insect-eating mammals — such as Gymnura, the Hedgehogs, and Moles (Figs. 346, 349); the EDENTATES, or toothless mammals — Sloths, Anteaters, and Armadillos (Figs. 207, 346); the CHIROPTERA, or flying mammals — the



FIG. 209. Florida Sea-cow, *Trichechus manatus*.

Bats (Figs. 346, 348, 377); the RODENTS, or gnawing mammals — Squirrels, Rabbits, Guinea-pigs, Rats, Mice, Porcupines, and Beavers (Figs. 227, 324, 346); and finally the CARNIVORES, or beasts of prey — Cats, Dogs, Bears, Seals, etc. (Figs. 223, 346.)

Another legion includes the completely aquatic CETA-CEANS — Whales, Porpoises, and Dolphins. (Figs. 208, 346, 350, 377.)



The hoofed mammals, or UNGULATES, form a great legion of herbivorous animals: important subdivisions being the ARTIODACTYLS, or even-toed Pigs, Hippopotami, Camels, Oxen, Sheep, Deer, Giraffes, etc.; the PERISSODACTYLS, or

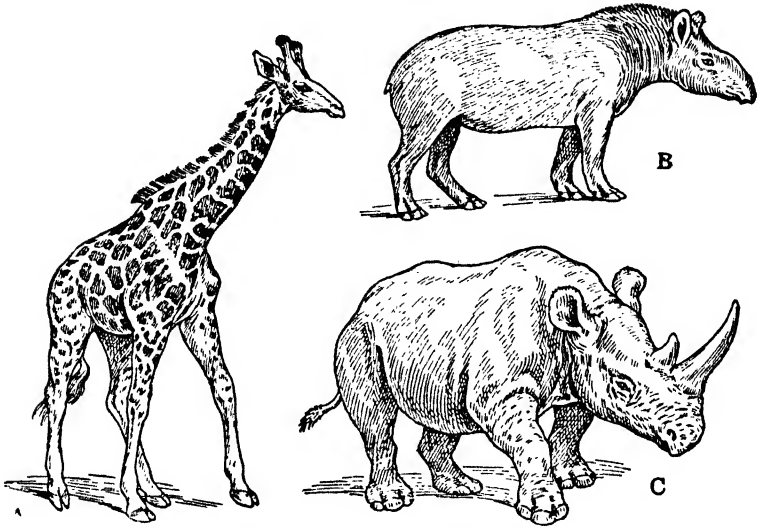

FIG. 210. Ungulates. A, Giraffe, *Giraffa camelopardalis*; B, American Tapir, *Tapirus terrestris*; C, African Rhinoceros, *Rhinoceros bicornis*. (From Newman, after Beddard and Lydekker.)

odd-toed Horses, Tapirs, and Rhinoceroses; and the PROBOSCIDIANS, or Elephants. Closely related are the aquatic SIRENIANS, or Sea-cows. (Figs. 209, 210, 346, 377, 386, 387.)

The PRIMATES form the concluding legion and include Lemurs, Tarsiers, Monkeys, Apes, and Men. They are predominant chiefly by virtue of their mobile, grasping hands, and their intelligence. Quite appropriately Primates have been called "the inquisitive mammals." (Figs. 211, 378; Pp. 298, 600-616.)

So is completed our glance at the chief types — phyla — in the varied panorama of animal life from Protozoön to Mammal. Necessarily brief, it is adequate for our purpose

if we are impressed with certain outstanding facts, not the least significant being the versatility and prodigality of life. Nature has tried, as it were, one experiment after another: some phyla have prospered and then waned; some have gone up blind alleys and stayed there; some have met the conditions of life to the full and have flourished: two in outstanding fashion — Arthropods and Vertebrates. Only some,

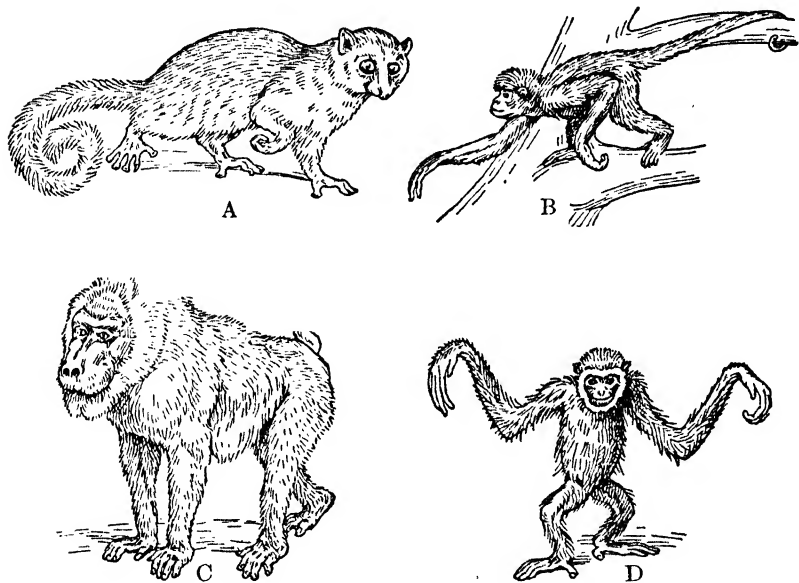

FIG. 211. Primates. A, Dwarf Lemur, *Microcebus smithii*; B, Spider Monkey, *Ateles ater*; C, Mandrill, *Papio leucophoeus*; D, Gibbon, *Hylobates lar*. (From Newman, after Beddard and Lydekker.)

then, and not all have made a real contribution, but this has been tenaciously conserved and appears again and again in 'higher' phyla. So there is a trace of structural and physiological continuity—unity in diversity—woven in the picture of animal life that is interpreted as evidence of descent with change.' The appreciation of this unity in diversity will contribute toward the proper perspective for a more detailed consideration of the vertebrate body and of certain general biological principles. (Figs. 183, 184, 397.)

## F. SYNOPTIC CLASSIFICATION OF VERTEBRATES (CHORDATES)<sup>1</sup>

(With representative examples and the approximate numbers of known species)

Phylum CHORDATA. (70,000 species.)

Subphylum A. *HEMICHORDA*: Dolichoglossus.

Subphylum B. *UROCHORDA*: Tunicates, Sea-squirts. Styela.

Subphylum C. *CEPHALOCHORDA*: Lancelets. Amphioxus.

Subphylum D. *VERTEBRATA*

Class I. *CYCLOSTOMATA*: Hagfish, Lamprey.

Class II. *PISCES*

Subclass 1. *ELASMOBRANCHII*: Cartilaginous Fishes. Sharks and Rays. Dogfish.

Subclass 2. *OSTEICHTHYES*: Bony Fishes.

Order 1. *Dipnoi*: Lung-fishes.

Order 2. *Teleostei*: Teleosts. Mackerel, Trout, Cod, Perch, Goldfish, Guppy.

Class III. *AMPHIBIA*. (2000 species.)

Order 1. *Apoda*: Coecilians.

Order 2. *Caudata*: Urodeles. Necturus, Salamander, Cryptobranchus, Amblystoma.

Order 3. *Salientia*: Anurans. Frogs, Toads.

Class IV. *REPTILIA*. (6000 species.)

Order 1. *Chelonia*: Turtles, Tortoises.

Order 2. *Rhynchocephalia*: Sphenodon.

Order 3. *Crocodylia*: Crocodiles, Alligators.

Order 4. *Squamata*: Chameleons, Lizards, Snakes.

Class V. *AVES*: Birds. (15,000 species.)

Division A. *Ratitae*: Apteryx, Ostrich.

Division B. *Carinatae*: All familiar Birds.

Class VI. *MAMMALIA*. (10,000 species.)

Subclass 1. *Prototheria*: Monotremes. Duck-bill, Echidna.

Subclass 2. *Metatheria*: Marsupials. Opossums, Kangaroos.

Subclass 3. *Eutheria*: Placentals. All familiar Mammals.

Order 1. *Insectivora*: Moles, Shrews, Hedgehogs, Gymnura.

Order 2. *Edentata*: Sloths, Anteaters, and Armadillos.

Order 3. *Chiroptera*: Bats.

Order 4. *Rodentia*: Rats, Mice, Rabbits, Squirrels, Beavers, Porcupines, Guinea-pig.

Order 5. *Carnivora*: Cats, Dogs, Bears, Seals, Walruses.

<sup>1</sup> See p. 254 for the classification of Invertebrates.

Order 6. *Cetacea*: Whales, Porpoises, Dolphins.

Order 7. *Ungulata*: Horses, Tapirs, Rhinoceroses, Camels, Oxen, Antelopes, Giraffes, Pigs, Hippopotami, Elephants.

Order 8. *Sirenia*: Sea-cow.

Order 9. *Primates*.

Suborder 1. *Lemuroidea*: Lemurs.

Suborder 2. *Tarsioides*: Tarsiers.

Suborder 3. *Anthropoidea*: Monkeys, Apes, Men.

Series 1. *Platyrrhini*: New World Monkeys.

Family 1. *Cebidae*: Capuchins, Howler Monkeys, Spider Monkeys, etc.

Family 2. *Hapalidae*: Marmosets.

Series 2. *Catarrhini*: Old World Monkeys, Apes, Men.

Family 3. *Cercopithecidae*: Macaques, Baboons, Mandrills, etc.

Family 4. *Hylobatidae*: Gibbons.

Family 5. *Pongidae*: Orangutans, Chimpanzees, Gorillas.

Family 6. *Hominidae*: Men.

## CHAPTER XII

# THE ANIMAL BODY: VERTEBRATE

If we contemplate the method of Nature, we see that everywhere vast results are brought about by accumulating minute actions. — *Spencer*.

**T**he Vertebrates, it will be recalled, form one of the most clearly defined divisions of the animal kingdom and include the Fishes, Amphibians, Reptiles, Birds, and Mammals. Together with a few very primitive forms, such as *Amphioxus*, they constitute the culminating phylum of the animal world, the Chordata. There is, in fact, less diversity in structure among the Vertebrates as a whole than is present, for example, in the one subdivision of the Arthropods, the Crustacea, of which the Crayfish is a member. Accordingly we shall confine our attention largely to a description of the structure and physiology of an 'ideal' Vertebrate, and mention incidentally some of the chief modifications of general significance which appear in the different groups, and specifically in Man. (Fig. 184.)

### A. BODY PLAN

The ideal vertebrate body is more or less cylindrical in form, and is essentially bilaterally symmetrical with respect to a plane passed vertically through the main axis which extends from the anterior to the posterior end. Three regions of the body may be distinguished, head, trunk, and tail. Frequently there is a narrow neck between the head and trunk. (Figs. 212, 213.)

The head forms the anterior end and contains the brain, eyes, ears, and nostrils, or ANTERIOR NARES, as well as the mouth and throat, or PHARYNX. On either side of the head,

behind the mouth, is a series of openings, or **GILL SLITS**, leading into the pharynx, which, however, in air-breathing Vertebrates disappear before the adult condition is attained.

The trunk forms the body proper and contains the coelom, and the major part of the alimentary canal leading posteriorly to the exterior by the anus, as well as the chief circulatory, excretory, and reproductive organs.

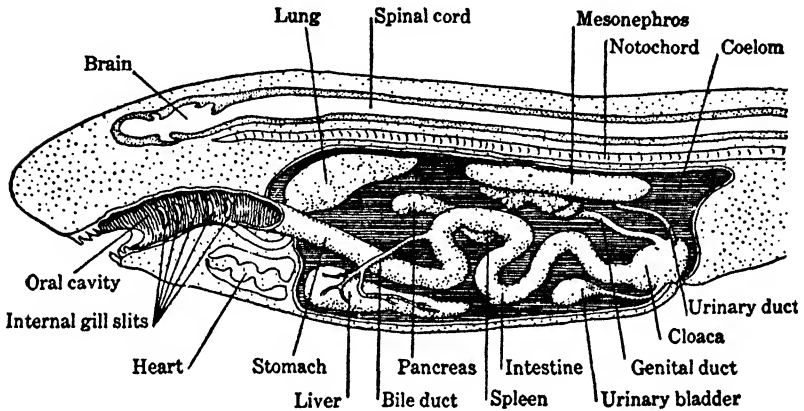

FIG. 212. Body plan of an ideal Vertebrate. Longitudinal section.

In most aquatic Vertebrates the trunk very gradually merges into a large muscular **TAIL**: the region posterior to the coelom and anus. Thus the vertebrate tail is a unique structure — the tail of Invertebrates terminating with a segment bearing the anus. In many terrestrial Vertebrates the tail has become practically an inconsequential unpaired appendage.

The vertebrate coelom comprises two chief parts — a large **ABDOMINAL** chamber and a small anterior chamber. The latter constitutes the **PERICARDIAL** chamber in Fishes but in higher forms it is divided into two parts, one (pericardial) investing the heart and the other (pleural) investing the lungs. The lining membrane of the coelom, known as the **PERITONEUM**, forms the innermost layer of the body wall, covers the organs, and in certain regions forms broad folds, or **MESENTERIES**, in which they are suspended. In the Mam-

mals the organs of the chest, or **THORAX**, are separated from those of the abdomen by a muscular partition, or **DIAPHRAGM**. (Figs. 225-228.)

In aquatic forms thin extensions from the trunk and tail form median fins. Paired fins, developed from the trunk, comprise the **PECTORAL** fins, situated near the junction of

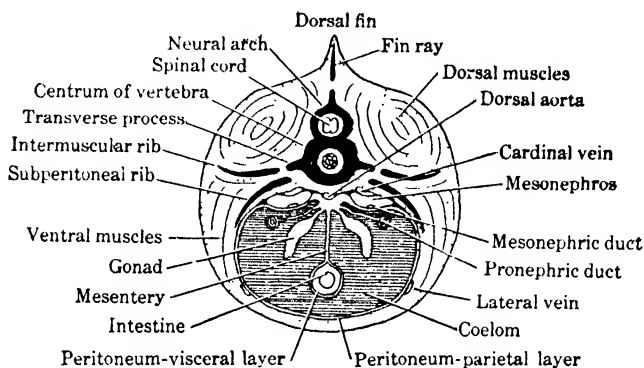

FIG. 213. Body plan of an ideal Vertebrate. Transverse section.

head and trunk, and the **PELVIC** fins, primitively just lateral to the anus. The pectoral and pelvic fins, or the fore limbs and hind limbs which replace them in all forms above the Fishes, are the only lateral appendages typically found in Vertebrates.

## B. SKIN

The surface of the body that comes in direct contact with the environment is covered by an integument, or skin, which, though primarily protective and sensory in function, takes part to a greater or less degree in respiration, excretion, and secretion. The skin varies considerably in thickness over different parts of the body, being thinnest over the exposed part of the eyeball. Scales, feathers, claws, horns, hoofs, nails, teeth, etc., are derivatives of the skin. Unlike the simple skin of Invertebrates, that of Vertebrates is formed of two chief layers: an outer epithelial tissue, the **EPIDERMIS**, derived from the ectoderm; and an inner **DERMIS** from the mesoderm of the embryo. (Figs. 129, 214.)

The epidermis itself always consists of several layers of cells: the lower, known as the **MALPIGHIAN LAYER**, comprising actively dividing cells whose products gradually are moved up to form the superficial layers of flattened, horny, dead cells. Thus this layer is not directly converted into the cuticle as is the case, for example, in the Arthropods. The outermost dead cells are constantly sloughed off individually, or in groups when the human skin 'peels' after sunburn or a snake 'sheds its skin.' As a rule, blood vessels do not

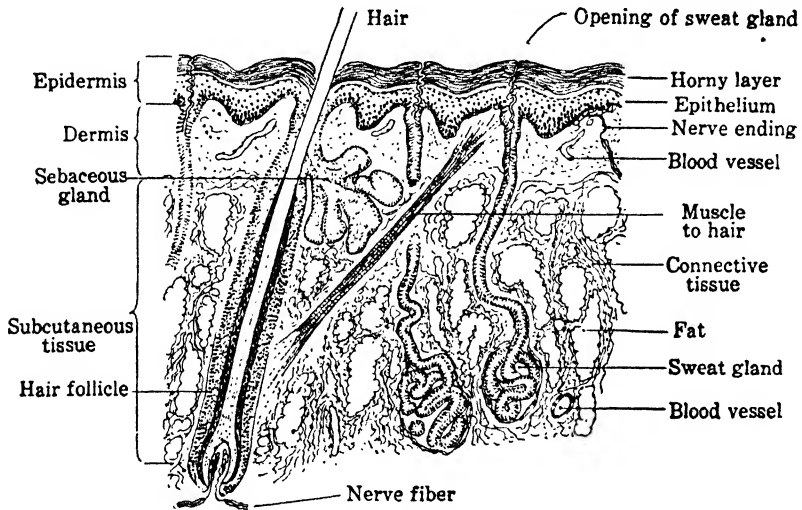

FIG. 214. Human skin. Vertical section highly magnified.

permeate the epidermis, which in part accounts for the fact that a former Malpighian cell becomes more and more 'dead' the further it is pushed toward the surface.

The dermis is the characteristic part of the vertebrate skin and comprises a felted meshwork of connective tissue fibers and cells which underlies the relatively thin epidermis. Within this meshwork are embedded blood and lymph vessels, pigment cells, sense organs, nerve endings, muscle fibers, sweat and sebaceous glands, hairs, deposits of fats, etc. The lower part of the dermis is transitional with the so-called subcutaneous tissue where fat cells are usually more abun-



dant and the weave of the connective tissue fibers is looser. Some of the fibers interlace with those of the sheaths of the underlying muscles and so aid in anchoring the skin.

Perhaps the most interesting among the derivatives of the skin are teeth which occur in nearly all Vertebrates, except Birds, and are homologous throughout the series. It is clear that originally they were PLACOID SCALES, such as occur in

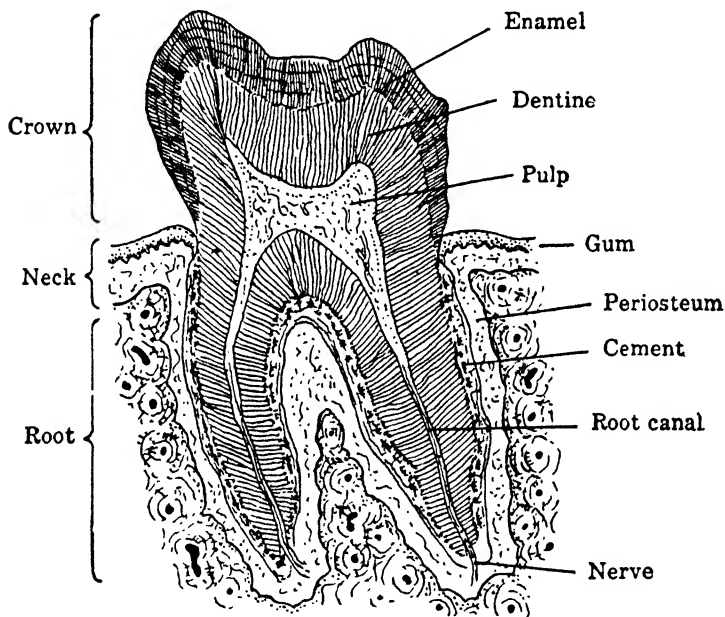

FIG. 215. Human tooth. Vertical section.

the skin of present-day Sharks, which have been modified in form and function in and about the mouth. Both placoid scales and teeth consist of a basis of DENTINE, or so-called ivory, formed by the dermis and overlaid, in part, by ENAMEL from the epidermis. A typical mammalian tooth consists of the ROOT surrounded by cement and embedded in a socket in the jaw, and the NECK which is transitional to the CROWN that protrudes above the gums. Inside the tooth is the pulp cavity which is supplied with nerves and blood vessels from the tissues below. (Fig. 215.)

The teeth of Fishes, Reptiles, and Amphibians are usually all similar in form, while in Mammals there are usually four kinds in each jaw. In most Mammals, including man, two sets of teeth are developed: the first, deciduous or milk teeth, and the second, permanent. In the human dentition, the first set comprises ten teeth in each jaw: four incisors, two canine, and four molars; and the second set, sixteen in each jaw: four incisors, two canine, four premolars, and six molars.

### C. MUSCLES

The body wall proper, just beneath the skin, is chiefly composed of muscular tissue, commonly spoken of as flesh, which varies in thickness in different parts of the body. In the mid-dorsal region it surrounds the brain and spinal cord and the axial supporting structure, or notochord, while ventrally it forms the wall of the coelom. In the lower Vertebrates and the embryonic stages of higher forms the muscular layer is composed of segments known as MYOTOMES. But in the adult stage of the latter this evidence of vertebrate segmentation largely disappears, since the muscular tissue for the most part assumes the form of highly complex longitudinal bands, extensions from which pass into the paired appendages. (Figs. 212, 213.)

Muscles, such as those attached to the bones, in which contraction can be brought about at will are termed VOLUNTARY muscles, while those which cause most of the movements of the viscera are known as INVOLUNTARY muscles. From the standpoint of their microscopic structure, muscle cells are of three kinds. Voluntary muscles consist of STRIATED muscle cells, or fibers, and involuntary muscles, except those of the heart, are composed of SMOOTH muscle cells. The cells of the heart approach somewhat in structure those of voluntary muscles and are known as CARDIAC muscle cells. Smooth and cardiac types are associated with other tissues in the organs and organ systems, whereas the striated muscle cells typically form definitive organs that are usually thought of as 'the muscular system.' (Figs. 8, 25, 216, 217.)

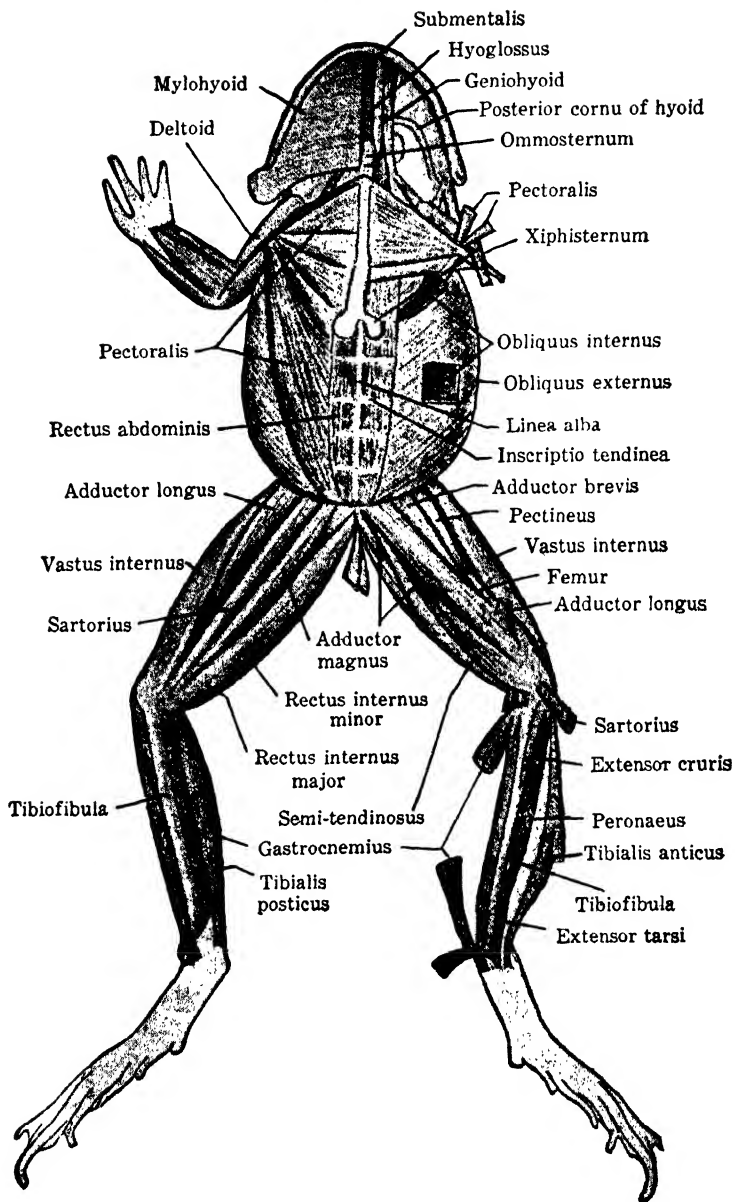

FIG. 216. Muscles of the Frog. Ventral view. (After Parker and Haswell.)

A single muscle consists of a large number of striated muscle fibers extending lengthwise and held by connective tissue in bundles, or FASCICULI. The latter, in turn, are grouped in larger bundles and these in still larger aggrega-

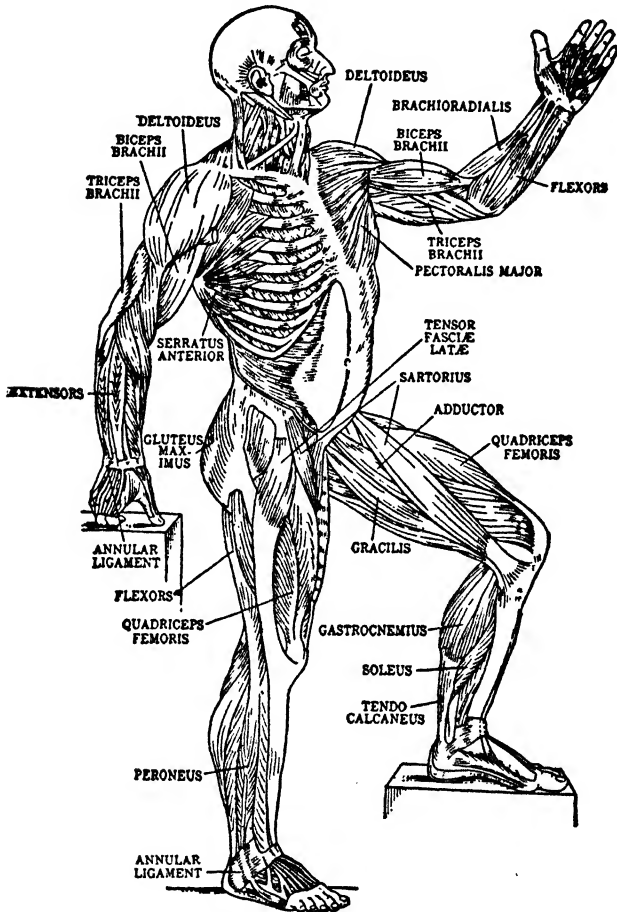

FIG. 217. Some of the muscles of Man. (From William Wood and Co.)

tions, the muscles. The connective tissue sheath which encloses the whole muscle is essentially continuous as a TENDON with a similar sheath covering a bone, and so muscle and bone become a working unit. Blood vessels and nerve fibers permeate the whole to each muscle cell.

## D. SKELETON

The form of the vertebrate body is maintained by a system of supporting and protecting structures, termed the **SKEL-ETON**. Although various outgrowths of the skin, such as scales, feathers, and hair, form a part of the skeletal system known as the **EXOSKELETON** which is comparable to the protective coverings of the Invertebrates, it is a bony **ENDO-SKELETON** which is characteristic of the higher animals. This living internal skeleton, largely mesodermal in origin, exhibits such great diversity and complexity that its study, known as **OSTEOLOGY**, forms an important subdivision of comparative anatomy.

In the lower Fishes the endoskeleton is composed of a firm elastic tissue, **CARTILAGE**, or gristle, but from the higher Fishes to Man most of the cartilage becomes **OSSIFIED**, or transformed into **BONE**. The human skeleton is formed of about 200 separate bones, but the number varies at different periods of life, because some bones which at first are distinct later become fused. (Figs. 218-224.)

While it is true that the bones constitute the main supporting framework of the body, they are entirely inadequate to knit together the organism into a working unit. We find therefore various kinds of connective tissue interwoven between the integral parts of the body. These tissues form sheaths about most of the organs and also supply the connecting links between muscle and muscle, muscle and bone — **TENDONS**; and bone and bone — **LIGAMENTS**.

Supporting tissues, of which bone, cartilage, and connective tissue form the chief groups, are characterized by the development of large amounts of resistant non-living material in or between the component cells themselves; the character of the tissue being determined chiefly by the nature of this matrix. Thus connective tissues are of several kinds depending chiefly upon the nature of the intercellular fibers which largely obscure the cells themselves. In some cases **WHITE** fibers are loosely, and in others closely, felted. Or, they

may be arranged in bundles. Where elasticity is necessary, ELASTIC fibers are interspersed with the white fibers, or even replace the latter almost entirely. (Fig. 25.)

Cartilage cells live in spaces, or LACUNAE, in the matrix. In HYALINE cartilage, the matrix is clear and translucent, usually without fibers; in ELASTIC cartilage there are elastic fibers embedded in the matrix; and in FIBRO-CARTILAGE interwoven bundles of white fibers largely take the place of the hyaline matrix. (Fig. 25.)

Most bones are preformed in cartilage. Certain specialized cells replace the cartilaginous scaffolding by a complex series of events including the deposition of lime salts which give

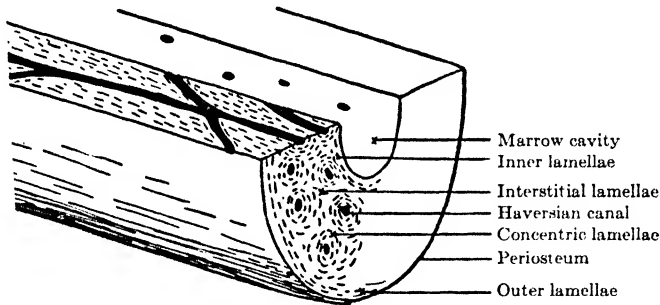

FIG. 218. Diagram of the structure of a bone. Haversian canals and lacunae in black, leaving the bony lamellae white. (From Walter.)

the matrix the characteristic rigidity of bone. The living bone cells lie in spaces, or lacunae, in the matrix and are arranged in concentric circles, or LAMELLAE, about a central cavity, or HAVERSIAN CANAL. Tiny tubes, or CANALICULI, keep the cells in communication with each other and with the Haversian canals through which blood and lymph vessels and nerves reach them, chiefly from the central MARROW CAVITY. Thus a structure, at once rigid and modifiable, results. (Figs. 25, 218.)

The primitive axis of the skeleton consists of a cylindrical cord or rod of cells, or notochord, which lies in the mid-dorsal line of the body wall just below the brain and spinal cord and above the coelom. In most Vertebrates, however, the

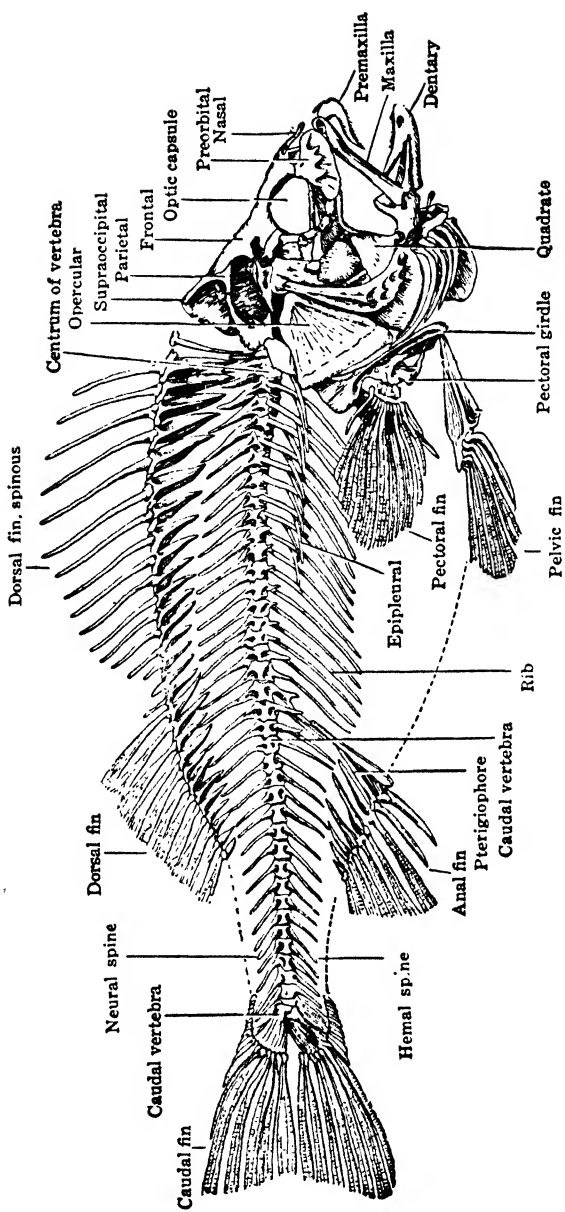

FIG. 219. Skeleton of a Bony Fish, the Perch.

notochord in its original form is only a temporary structure, being partially or completely replaced during later development by a linear series of cartilaginous or bony elements, known as VERTEBRAE, which form the VERTEBRAL COLUMN, or backbone. This is one of the most characteristic structures of Vertebrates as compared with Invertebrates, or backboneless animals. (Figs. 212, 213.)

A typical vertebra of the higher animals consists of a basal portion, known as the CENTRUM, and a NEURAL ARCH which it supports. These form a protecting ring of bone about the spinal cord. From various parts of the vertebra as a whole arise PROCESSES for movable articulation with its neighbors, the attachment of muscles, etc. Between the vertebrae of the Mammals are cushions of cartilage which absorb shock. (Fig. 220.)

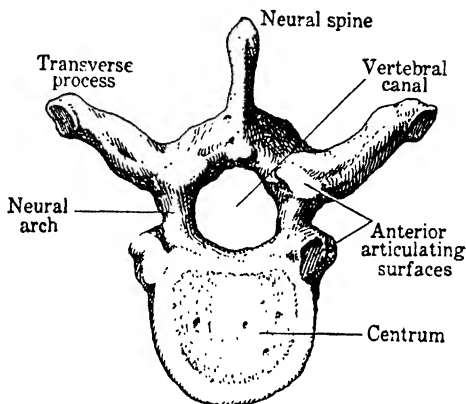

FIG. 220. Typical human vertebra (tenth thoracic).

In some forms, RIBS are attached to the transverse processes of certain vertebrae. These extend outward and downward within the body wall, and usually are attached in the ventral line to the breast bone (STERNUM). Thus, in the adult of the higher Vertebrates, the series of centra of the vertebrae come to occupy the position formerly held by the notochord; while above, the neural arches form the VERTEBRAL CANAL containing the spinal cord; and below, the transverse processes, ribs, and sternum surround the anterior portion of the coelom. (Figs. 213, 220, 224.)

The vertebrate head, containing the anterior openings of the alimentary canal and respiratory passages and also the brain and chief sense organs, is protected in the lower



Fishes by a cartilaginous case, and in higher forms by a bony case, or **SKULL**, which articulates with the first vertebra of the backbone. Attached to the skull are **JAWS** that serve as supporting structures for the mouth.

The skull and vertebral column form the main **SKELETAL AXIS** from which is suspended the **APPENDICULAR SKELETON**, or bony framework of the paired appendages (**FINS** or **LIMBS**)

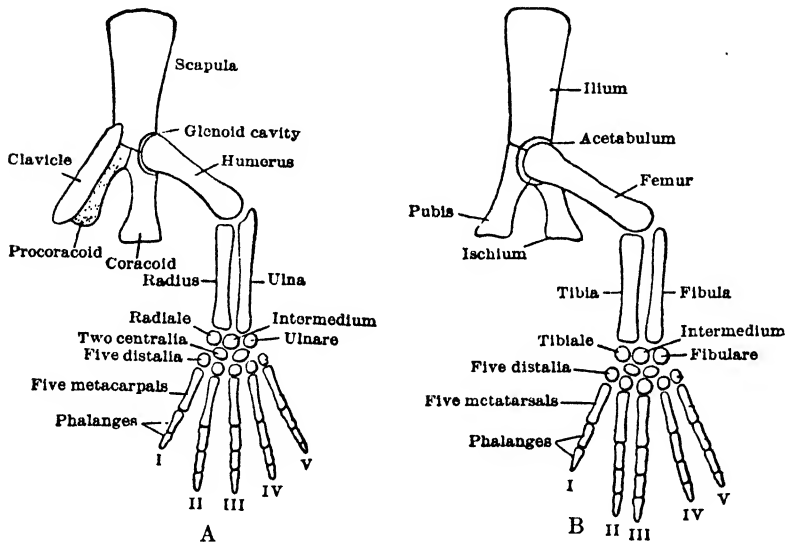

FIG. 221. Plan of the Vertebrate limbs. A, fore limb and pectoral girdle; B, hind limb and pelvic girdle. (After Parker and Haswell.)

and their supporting structures (**GIRDLES**). This is relatively simple in the anterior (pectoral) and posterior (pelvic) paired fins of Fishes, which merely act as paddles; but when these are modified into paired limbs for progression on land, the mechanical problems involve the development of complex limb skeletons to support the body, and to act as levers for the limb muscles to move in locomotion. In response to this need an elaborate series of bones is developed that in all cases, however greatly modified in adaptation to different environments and modes of life, may be referred to a common plan. This is known as the **PENTADACTYL**

LIMB in allusion to the five digits (FINGERS and TOES) in which it usually terminates. The limbs are attached directly or indirectly to the vertebral column by groups of bones that form respectively the PECTORAL and PELVIC GIRDLES. (Figs. 221, 224, 377, 378.)

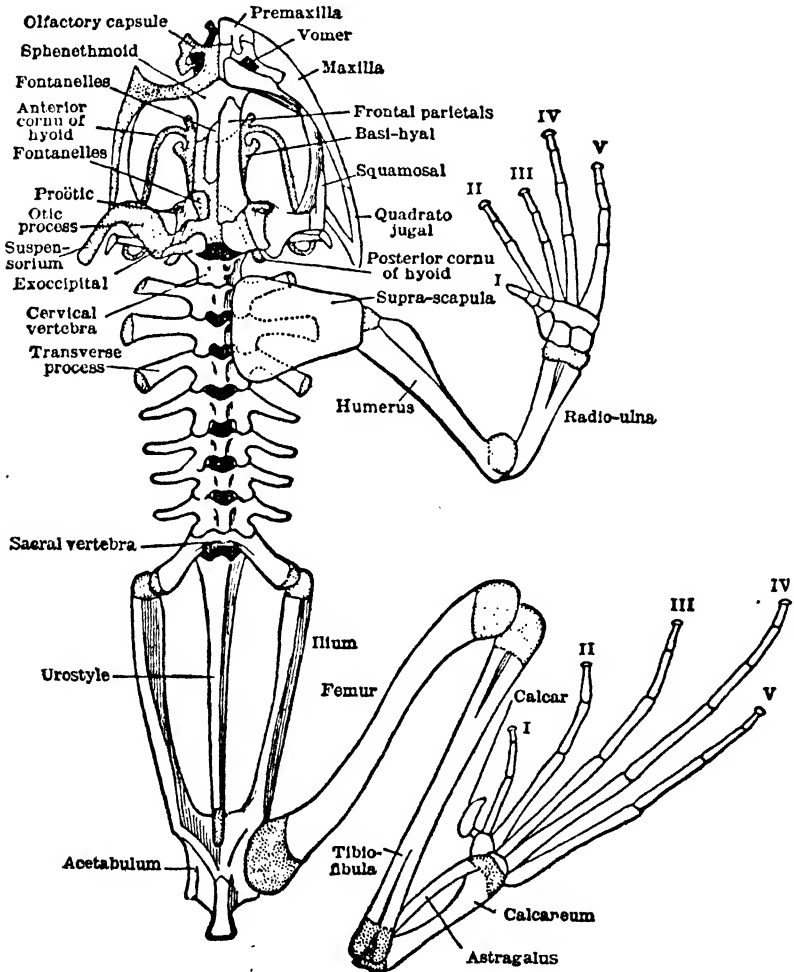

FIG. 222. Skeleton of the Frog. Dorsal aspect; the left half of the shoulder girdle and the left fore and hind limbs are removed, as also are the membrane bones on the left side of the skull. Permanently cartilaginous parts dotted. (After Howes, slightly altered.)

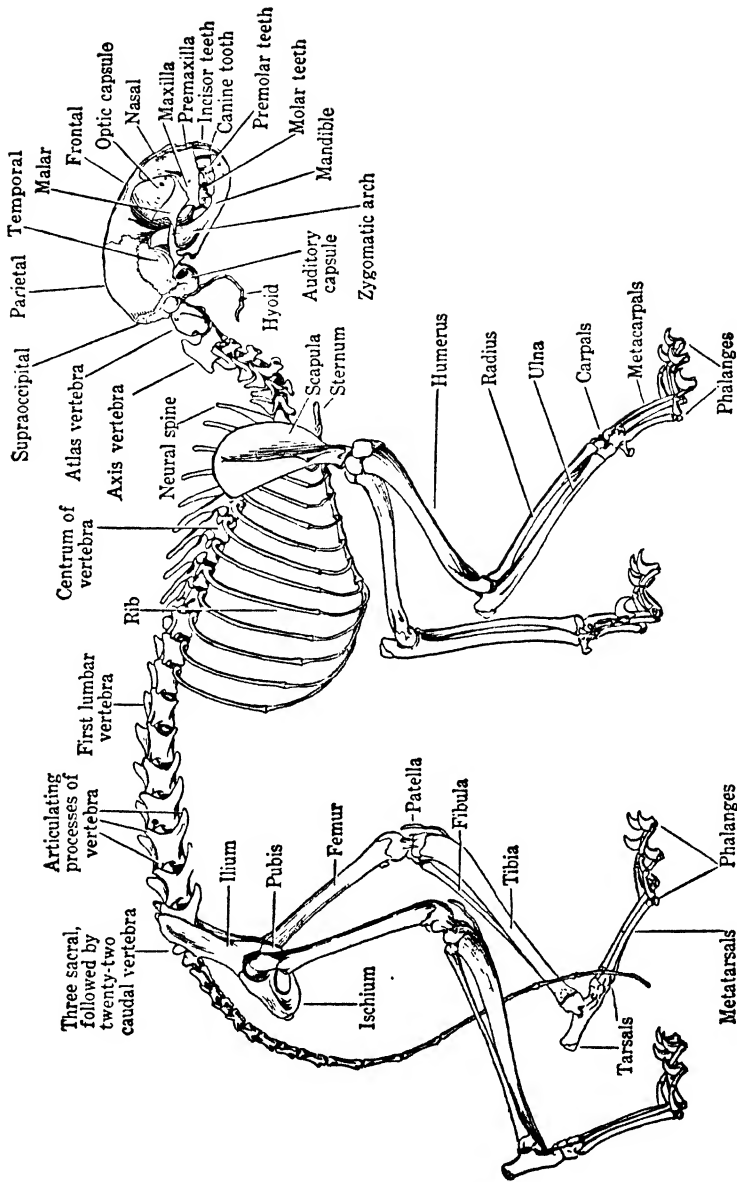

FIG. 223. Skeleton of Cat.

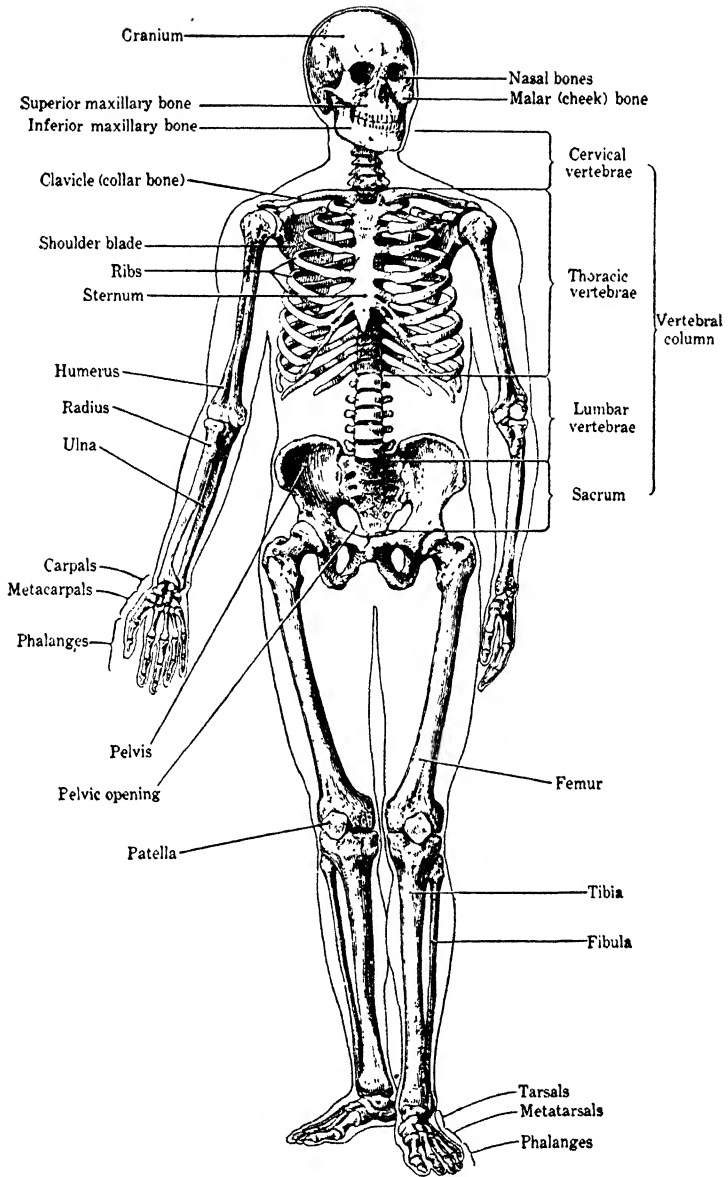

FIG. 224. Skeleton of Man.

### E. THE HUMAN BODY

Considering specifically the human body, we find that its outstanding characters are largely the result of man's erect posture. True it is that the body is not perfectly adapted to its upright position, but this is more than compensated for by the complete division of labor between the upper and lower limbs that liberated the former from contributing to locomotion and gave the opportunity for the pentadactyl plan to attain its highest development in the human HAND. With its completely opposable thumb, the hand is directly or indirectly responsible for more of man's unique characters than one usually realizes. It is an efficient grasping organ — a battery of tools that makes possible the use of artificial tools which, in a way, may be regarded as accessory organs, devised by the brain and appropriated or discarded at will.

But the hand is also a delicate 'sense organ' since touch is "the great confirmatory sense" underlying many of our sensory experiences with the world about us. "Tactile fingers are continually learning." Indeed, it is upon a basis of conscious and subconscious tactile sensations that much of the superstructure of the higher mental processes is reared. It seems clear that the erect posture and the facile hand have contributed in no small way to the supremacy of the brain and so to man's outstanding position above the beasts. (Figs. 224, 243; Pp. 605-607.)

### F. DISTINCTIVE VERTEBRATE CHARACTERS

As a summary of this general outline of the structure of the vertebrate body, we may emphasize three characters which are of prime diagnostic importance.

In the first place, whereas the skeletal structures of Invertebrates typically consist, as in the Crayfish, of an exoskeleton of hard, non-living materials deposited on the surface of the body, the chief function of which is protection, the vertebrate skeleton is primarily a living endoskeleton. It is an organic part of the organism which, although it affords protection

for delicate parts, provides adequately for support and supplies muscle levers, and thus makes practicable the relatively large bodies of the higher animals. The notochord is at once the foundation and axis of the vertebrate internal skeleton and either persists throughout life as such, or simply long enough to function as a scaffolding about which the vertebral column is built. It is in recognition of the prime importance of the notochord that the Vertebrates and their nearest allies, such as *Amphioxus*, are known as Chordates. (Fig. 185.)

In the second place, it will be recalled that the central nervous system of the Earthworm and Crayfish consists of a nerve cord running along in the body cavity below the digestive tract, except at the anterior end where it encircles the pharynx to form a dorsal brain. The position of the vertebrate brain is similar, though the spinal cord is not a 'cord' but a nerve tube which lies in the vertebral canal embedded in the muscles of the body wall *above* the digestive tract and, of course, outside of the coelom. Thus the spinal cord itself and its location are highly characteristic.

The third fundamental characteristic is a series of perforations or slits through the throat and body wall. In the lower forms the gill slits provide an exit for the current of water entering by the mouth and, being richly supplied with blood, afford the chief means of respiratory interchange between the animal and the surrounding medium. In the higher Vertebrates the gill slits are present merely during a transient phase in the development of the individual, since the function of aërating the blood is taken over by the lungs. (Figs. 212, 246, 388.)

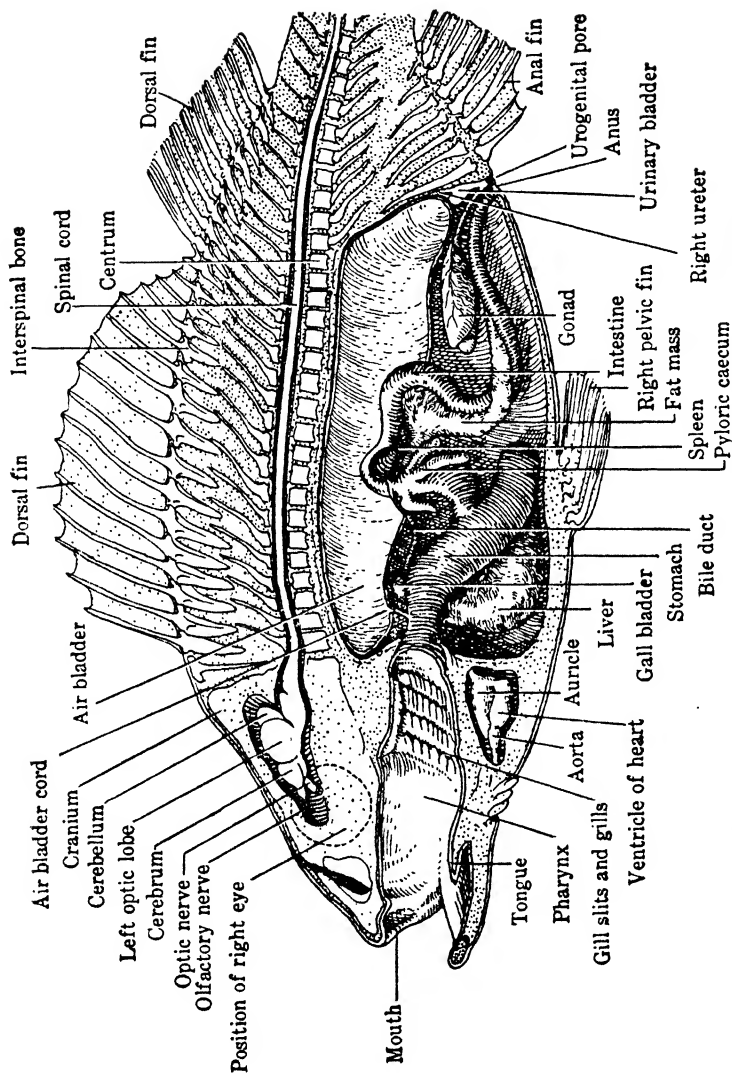

FIG. 225. Dissection of a Bony Fish, the Yellow Perch, *Perca flavescens*.

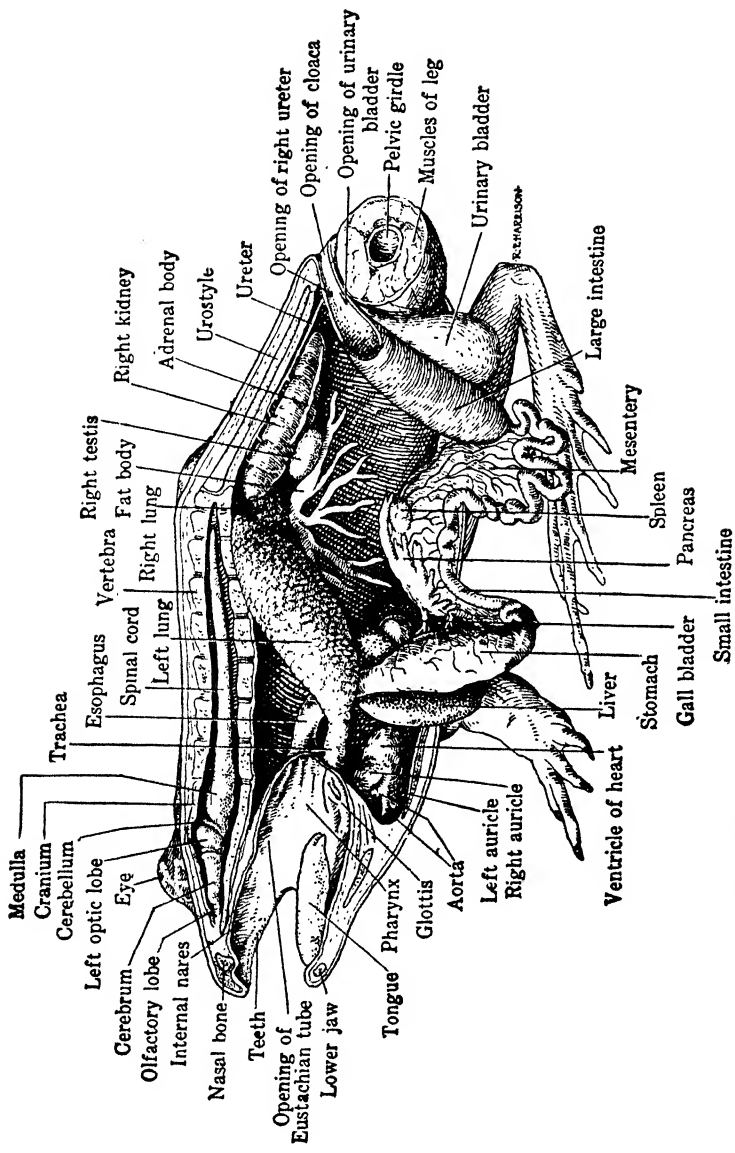

Fig. 226. Dissection of an Amphibian, the Frog, *Rana clamitans*.



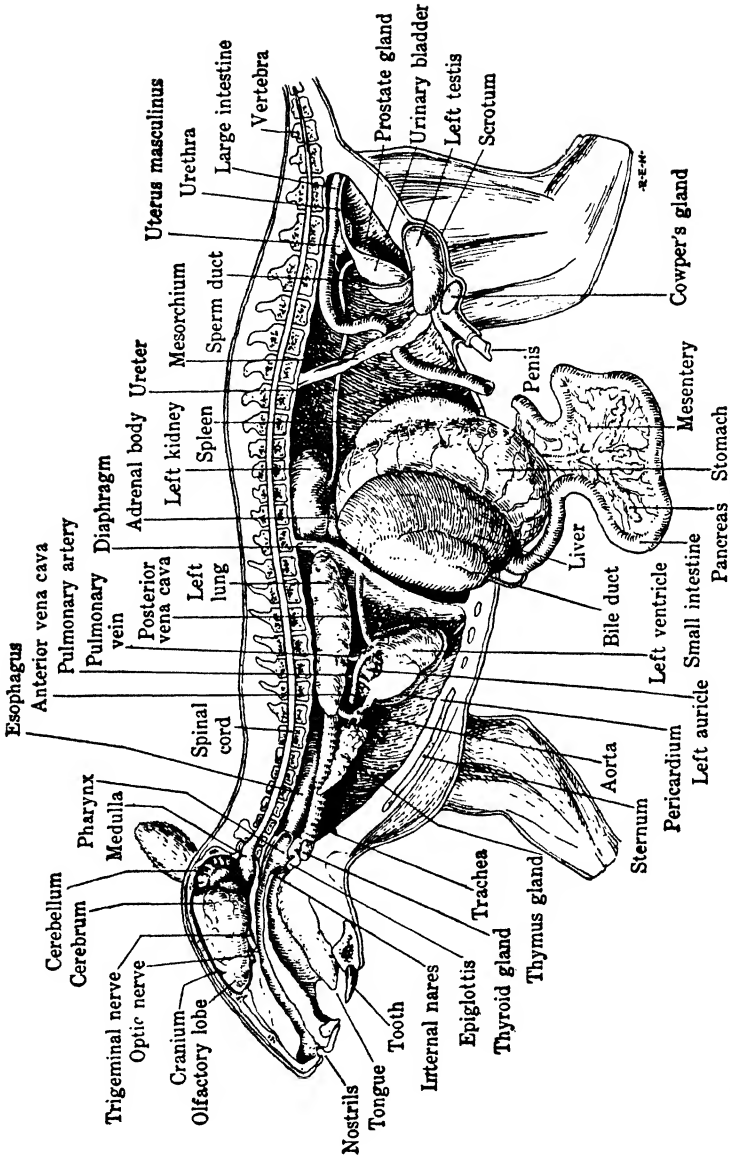

FIG. 227. Dissection of a Mammal, the Gray Squirrel, *Sciurus carolinensis*. (Modified, after Linville and Kelly.)

## CHAPTER XIII

# NUTRITION

It is a great satisfaction for me to know when regaling on my humble fare that I am putting in motion the most beautiful machinery with which we have any acquaintance. — *Dickens*.

**A**mong the single-celled animals, such as Amoeba, nutrition is reduced to its simplest terms. The food material enters the cell and is acted upon by substances formed by the protoplasm in its vicinity: the food is chemically changed, or digested, so that it becomes available for the use of the cell. In Hydra a special layer of cells, the endoderm, is largely devoted to digestion. Although some of the endoderm cells actually engulf small particles of food and digest them within the cell (INTRACELLULAR DIGESTION), the major part of digestion is brought about within the enteron by secretions from the endoderm cells. Digestion of the latter type (EXTRACELLULAR) is characteristic of the Earthworm and all higher animals. (Figs. 15, 127.)

We have considered the form and supporting structures of the body wall of a typical Vertebrate — the outer tube which surrounds and contains the viscera — and therefore we recall that through this outer tube, just as in the case of the Earthworm and Crayfish, there runs from mouth to anus a second or inner tube, the digestive tract, or alimentary canal. (Figs. 128, 212, 213.)

The alimentary canal is essentially a tubular chemical laboratory which passes the food on by its own muscular activity from one part to another. Each of these regions, in turn, supplies the chemical reagents which it uses both for changing the food into a soluble form so that it can pass through the walls and be distributed to the cells of the organ-

ism as a whole, and also for making it suitable for use by these cells. Indeed, the complex food materials which enter the human mouth run the gantlet of a whole series of digestive fluids.

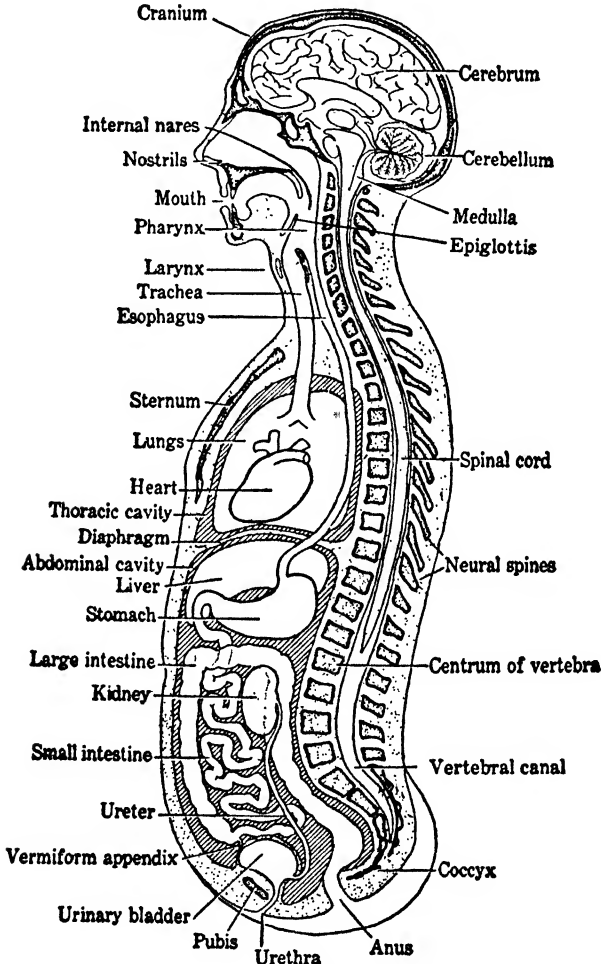

FIG. 228. Diagrammatic section of the human body.

Although the various kinds of food eaten by animals differ widely in their chemical composition, nevertheless the process of digestion is basically similar in nearly every case: it is a process of **HYDROLYSIS**. This is a chemical reaction

in which a molecule of the substance to be digested combines with a molecule of water to form a new compound. Then this splits into two or more simpler molecules and, by repeated hydrolyses, exceedingly complex food substances become relatively simple ones. Hydrolyses are brought

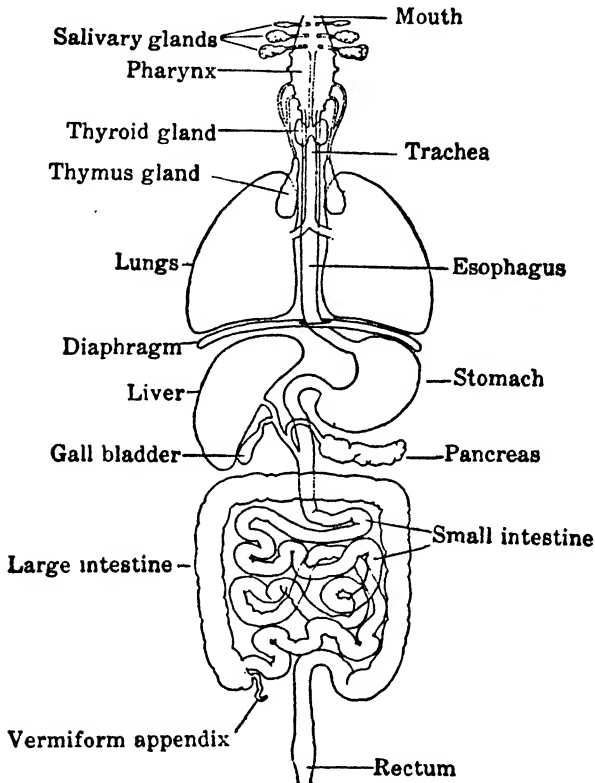

FIG. 229. Diagram of the human alimentary canal and its derivatives. The pharynx shows the embryonic position of five pairs of gill pouches, the second pair probably giving rise to the tonsils, and the third and fourth to the thymus glands.

about through the activities of special catalytic agents, the ferments, or **ENZYMES** — a special enzyme for each kind of chemical reaction being supplied by the alimentary canal. Moreover, the diverse digestive enzymes, carrying out chemical simplification of various foodstuffs, finally produce,

by hydrolysis, just a few relatively simple substances: AMINO ACIDS from proteins, FATTY ACIDS and GLYCEROL from fats, and SIMPLE SUGARS from more complex carbohydrates. (Fig. 233.)

The wall of the alimentary canal consists of several cellular layers: a lining epithelium, a connective tissue layer, two muscular layers, and an outer membrane, the peritoneal

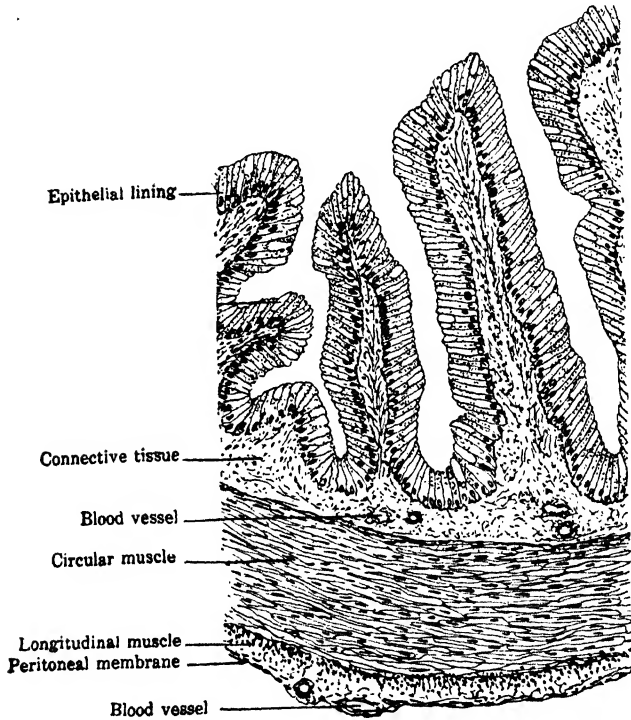

FIG. 230. Portion of a transverse section of the small intestine of the Frog. Highly magnified.

epithelium. The epithelium which lines the alimentary canal and its derivatives, certain glands, is the digestive tract proper in the sense that it is of basic functional importance in secreting the digestive fluids and in absorbing the products of digestion. The other layers perform accessory functions such as support, conduction of blood vessels and nerves, and movements of the canal. (Fig. 230.)

## A. BUCCAL CAVITY, PHARYNX, AND ESOPHAGUS

The entrance to the alimentary canal is, of course, the mouth: a transverse aperture in the head that leads into the mouth-chamber, or **BUCCAL CAVITY**, supported by the jaws. The buccal cavity gradually merges into the throat, or **PHARYNX**, which in the Vertebrates acts as a passage both for the food and the respiratory gases. The respiratory current of water in aquatic forms soon passes to the exterior by a series of perforations, the **GILL SLITS**, through the pharynx and body wall; while the respiratory current of air in higher forms enters the **LUNGS**. On the other hand, in all Vertebrates the preparation of the food for its passage through the alimentary canal starts in the buccal cavity. (Figs. 228, 229, 246.)

The human buccal cavity is lined with a membrane, continuous at the lips with the outer skin, which is provided with unicellular **MUCOUS GLANDS** that secrete **MUCIN**. This secretion together with those from three pairs of large **SALIVARY GLANDS** constitute the **SALIVA** which lubricates the food so that it may be more readily moved about by the **TONGUE** for mastication by the teeth and then passed on toward the esophagus. Furthermore, saliva contributes to the digestion of starches by two enzymes, **PTYALIN** and **MALTASE**. However, only a small portion of the starch is digested during the rapid passage of food through the mouth region, and the activity of the enzymes probably ceases after the food has been in the stomach for awhile where the reaction is acid. (Fig. 233.)

So the mouthful of food, masticated, moistened, and with the starch partially digested, is rolled by the tongue and passed along the pharynx into the esophagus. Henceforth it is beyond voluntary recovery, because it is pushed along by involuntary rhythmical contractions, **PERISTALSIS**, of the digestive tract wall. The esophagus is a muscular tube which passes through the thorax and rapidly delivers the food without further digestion to the **STOMACH**.

## B. STOMACH

The stomach, really the first stopping place of food that has been swallowed, is a thick-walled sac situated just below the diaphragm in Mammals. In common with most of the viscera, the stomach is suspended in the abdominal cavity by a broad membranous fold, or mesentery, which is continuous with the peritoneal membrane lining the cavity. Within the mesentery, blood vessels, nerves, etc., pass to the stomach. (Figs. 225–229.)

Here the work of the digestive tract actively progresses by the action of specific chemical substances present in the **GASTRIC JUICE** which is secreted by innumerable **GASTRIC GLANDS**. The latter are tiny pits in the stomach wall lined with special glandular cells. Human gastric juice is a complex fluid comprising over 99 per cent of water; hydrochloric acid, **HCl**; a protein-splitting enzyme, **PEPSIN**, which has a milk-curdling activity similar to **RENNIN**; common salt, **NaCl**; and mucus. This array of components of gastric juice softens the food mass, gives it an acid reaction and simplifies the various proteins — transforms the average meal, in the course of a few hours, with the assistance of the slow churning movements of the stomach wall, into **CHYME** which gradually passes through the **PYLORIC VALVE** into the intestine. Apparently little or no absorption occurs in the stomach.

## C. SMALL INTESTINE

The human intestine is a much coiled tube, about twenty-six feet in length, that extends from the stomach to the anus, and it is in the upper part, known as the **SMALL INTESTINE**, that not only the most radical changes in the food take place — digestion is essentially completed; but also most of the products of digestion pass through its walls into the body proper — absorption occurs. Accordingly we find various kinds of glands to elaborate and secrete the digestive fluids. Some of these are unicellular or simple multicellular tubular glands embedded in the intestinal wall; others are highly

complex and far removed from the intestine into which they pour their products through long ducts. But, as we know, even in the latter case the glands are really derivatives of the intestine—cellular areas sunk, as it were, below the membrane to which they really belong—because they arise during development as outpocketings of its wall: the ducts being the sole remaining connection with the point of origin. (Figs. 130, 231.)

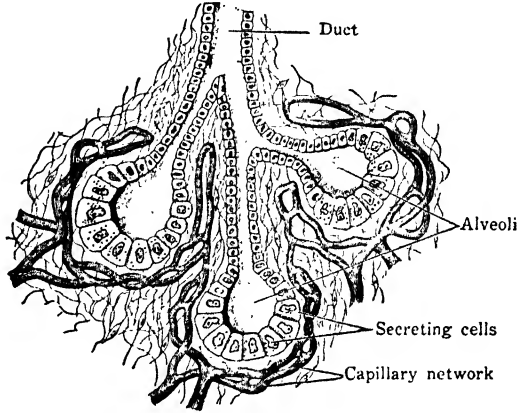

FIG. 231. Diagram of a gland (compound sacular) in section, together with the surrounding tissues. Highly magnified. (From Hough and Sedgwick.)

## 1. Liver

The largest gland in the body, the LIVER, pours its secretions into ducts which unite to form a single BILE DUCT. This carries the secretions to the upper part of the small intestine. The product of the liver, termed BILE, which is constantly formed (about 1000 cc. per day in man) but may be temporarily stored in the GALL BLADDER, is a highly complex, alkaline mixture of substances. Some of them, the bile pigments, etc., are excretions on their way out of the body through the intestines, while others are secretions which contribute to digestion by coöperating with an enzyme from another gland, the pancreas. Thus bile salts aid in the emulsification of fats and the absorption of fatty acids. (Fig. 232.)

Incidentally, it should be emphasized that the liver is perhaps the most versatile organ in the body. Among its functions, in addition to those of a digestive gland, may be



mentioned its role in protein and carbohydrate metabolism; the storage of various substances, including vitamins, necessary for the body; the regulation, in part, of the fluid balance of the body; the formation of substances necessary for blood clotting; and the removal from the blood of toxic substances absorbed from the intestine.

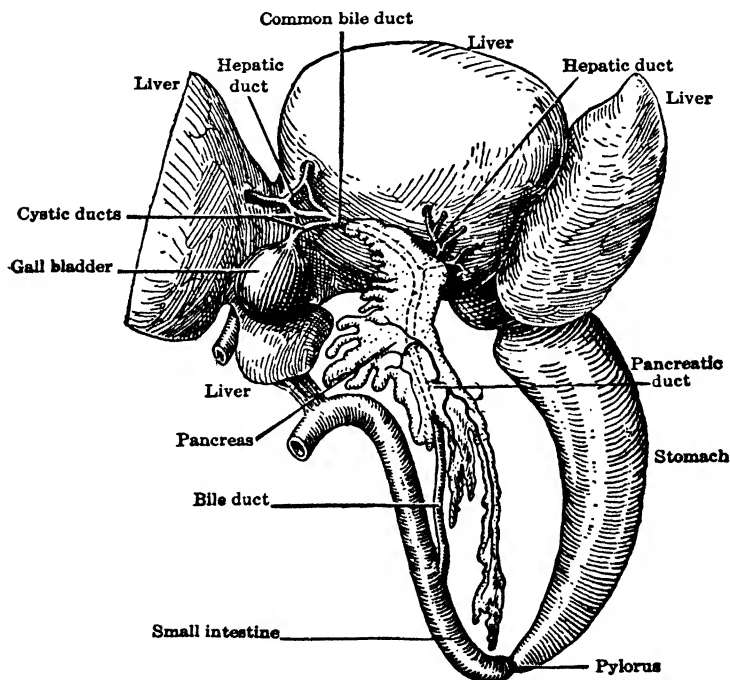

FIG. 232. Liver and pancreas of the Frog, showing their ducts. Lobes of liver turned forward. The cystic ducts unite with hepatic ducts and finally lead into the common bile duct. The latter passes through the pancreas, receives further hepatic ducts and the pancreatic duct and leaves the pancreas, opening into the upper part of small intestine.

## 2. Pancreas

The PANCREAS may be regarded as the chief digestive gland in the vertebrate body though it also performs additional functions. It lies just below the stomach in man and each day secretes into the small intestine, through the bile duct into which the pancreatic duct leads, about 1200 cc.

of strongly alkaline PANCREATIC JUICE. This contains several chief types of enzymes — the TRYPSIN group acting on proteins, AMYLASE on starches, and LIPASE on fats. (Figs. 232, 233.)

LOCATION	SECRETIONS	ENZYMES	SUBSTANCES CHANGED	INTER-MEDIATE PRODUCTS	PRODUCTS READY FOR ABSORPTION
Mouth	Saliva	Ptyalin Maltase	Starch Maltose	Maltose	Simple sugars
Stomach	Gastric juice	Pepsin	Proteins	Proteoses Peptones Paracasein	
Small intestine	Pancreatic juice	Trypsin group	Proteins Proteoses Peptones	Polypeptides Dipeptides	Amino acids
		Amylase	Starch	Maltose	
		Lipase	Fats		Fatty acids Glycerol
	Intestinal juice	Erepsin group	Polypeptides Dipeptides		Amino acids
		Maltase Invertase Lactase	Maltose Cane sugar Lactose		Simple sugars

FIG. 233. — Chief chemical activities of the human digestive tract.

Thus food that has been subjected to the enzymes of the upper digestive tract is now attacked by the pancreatic juice. But this is not all ; the process of progressive chemical simplification of the food is carried on by the secretions of innumerable minute glands embedded in the intestinal wall. This so-called INTESTINAL JUICE supplies several enzymes — the EREPSIN group to change the protein products into amino acids, and the others to convert complex sugars into simple sugars. And, as in the stomach, digestion is facilitated by muscular contractions of the intestinal wall. There are slow swayings of entire loops of the intestine; there are local

'segmentation' contractions; and finally there are peristaltic waves that pass the material along for absorption or elimination.

One naturally wonders how it is that the living tissues of the digestive tract, and especially of the glands themselves, withstand the digestive activities of their own enzymes, although the stomach or intestine of an animal killed during active digestion will begin self-digestion. A partial explanation of immunity during life appears to be that the enzymes are not in an active form while they are within the glands, but are later chemically changed by specific enzyme activating substances, coenzymes, etc., that they meet in the digestive tract when food is actually present.

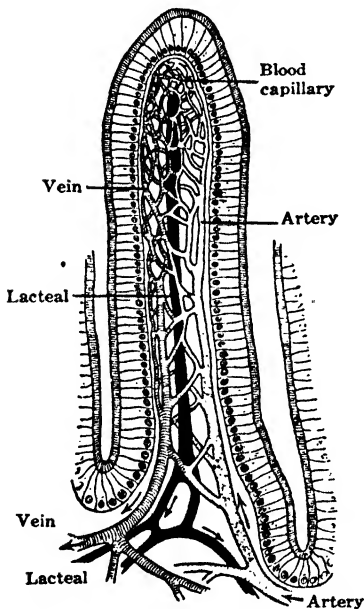

FIG. 234. Diagram of a section through a villus. Very highly magnified. (From Peabody and Hunt.)

### 3. Absorption

The purpose of digestion is, first, to make the food soluble so that it may enter the body proper: pass through the epithelium lining the digestive tract wall; and, second, to put it into a chemical form that can be used by the cells. The passage into the body, or **ABSORPTION**, occurs chiefly in the small intestine, the walls of which are lined with millions of minute projections, or **VILLI**, that bring tiny vessels into intimate contact with the absorptive membrane while greatly increasing the effective absorptive surface. Apparently absorption is not only the result of simple physical processes, such as diffusion and osmosis, but is largely the function of the actual living cells forming the epithelium of the villi. (Figs. 234, 272.)

#### 4. Distribution

The transportation system of vessels in the villi consists of BLOOD vessels which take up the absorbed products of protein and carbohydrate digestion, and LYMPH vessels, here called LACTEALS, which receive the derivatives of the fats. Both also take absorbed water and salts.

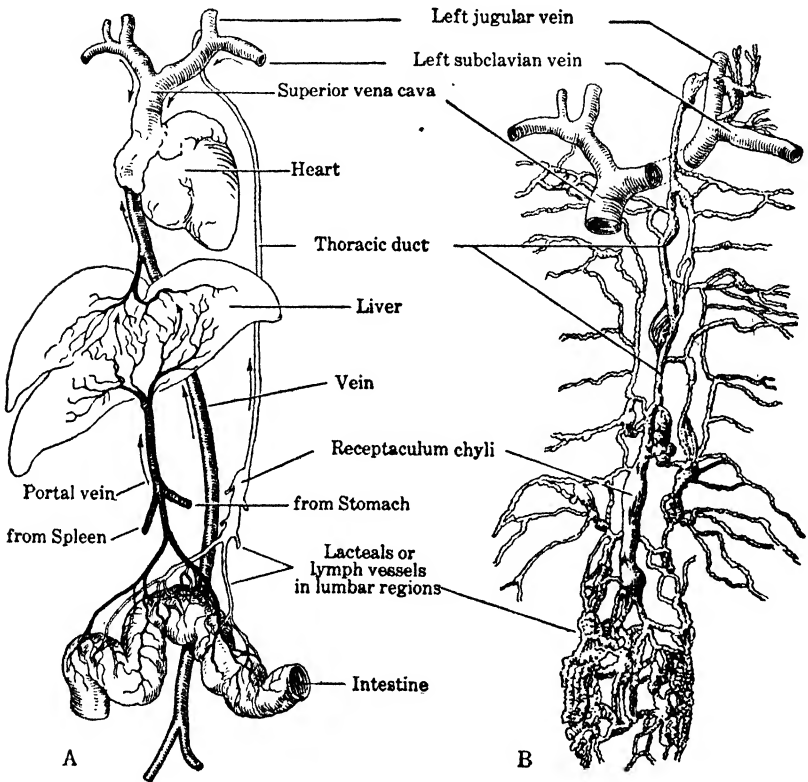

FIG. 235. A, diagram of paths of absorbed food from the human digestive tract. Proteins and carbohydrates by veins; fats by lymphatics. B, plan of distribution of the chief lymphatic vessels in the human body.

Accordingly the path through which the digested proteins and carbohydrates are transported differs from that of the fats. The blood vessels returning blood from the digestive organs finally merge to form a large vessel, the PORTAL VEIN, which proceeds to the liver to allow that organ to regulate

certain of the blood constituents — in particular to store up sugar, in the form of GLYCOGEN, after a meal and later dole it out to the blood as conditions demand. On the other hand, the lacteals merge into larger and larger lymph vessels and finally into the THORACIC DUCT which empties into the blood vascular system — the fats being switched, as it were, around the liver so that they do not directly enter the blood supply to that organ. (Fig. 235.)

#### D. LARGE INTESTINE

During the passage of food through the small intestine, digestion is practically completed and absorption has progressed far. The remaining material is carried through a constriction into the LARGE INTESTINE, or COLON, where the enzymes already present continue their digestive activity and the products are absorbed. Also, the activities of Bacteria are more evident than in the small intestine and bring about various chemical changes, apparently of no positive benefit and largely incidental to the slow passage of the residue, except in the case of certain strictly herbivorous animals, such as the cow, where they make possible the utilization of cellulose. Furthermore, water that up to this point has been necessary to keep the materials fluid to facilitate digestion is now gradually absorbed. Then the useless undigested materials, or FECES, are carried to the exterior either through a terminal cavity, the CLOACA, into which also open the urogenital ducts, or directly out through the anus as in most Mammals.

#### E. FOOD USE

Digestion, absorption, and distribution completed, the actual food supplying matter and energy is at the disposal of the various cells for carrying on the essential metabolic processes. Since the daily energy output of the average man not carrying on heavy physical labor is about 3000 calories, and the energy yield per gram for proteins and carbohydrates

is about 4.1 calories, and for fats about 9.3 calories, it is not difficult to determine from these fuel values how much of each foodstuff, or mixture of them, is required to supply the necessary energy.

But, of course, provision must also be made for tissue maintenance and this draws upon the proteins with their nitrogen constituent. In general it may be said that, since carbohydrates and fats adequately supply the energy demands, protein consumption apparently need not greatly exceed the nitrogen required for tissue maintenance. However, excess protein derivatives, the amino acids, are put to good use. Reaching the liver by the portal vein, the amino groups are removed and the deaminized amino acids converted into glycogen, so-called animal starch. Thus this highly important function of the liver makes it possible for the body to use protein to supply energy for the body when it is not needed to build tissue.

## F. VITAMINS

The body also requires small amounts of certain so-called accessory food substances, or VITAMINS, which are usually present in sufficient quantity in a normal mixed diet. Vitamins are organic substances, not related chemically to one another, that do not supply energy or structural material, and do not act as enzymes, but are necessary for cell metabolism. Their exact mode of action is not yet determined and in some cases their exact chemical constitution is unknown. At present at least six vitamins are recognized as of outstanding importance.

VITAMIN A — the growth-promoting vitamin — is essential for developmental processes, in particular for glandular structures, and so has a profound effect on the vigor and general health of the body, including resistance to infections. It is chemically closely related to the yellow pigment, carotene, and is widely distributed in foods. Important sources are butter, cream, egg-yolk, liver, cod-liver oil, leafy vegetables, and carrots.

VITAMIN B<sub>1</sub>—the antineuritic vitamin, or THIAMIN—has a special relation to the metabolism of nerves, and its deficiency is followed by a loss of appetite, certain types of neuritis, and in extreme cases by the disease known as BERIBERI which involves, among other symptoms, paralysis. Excellent sources for thiamin are whole-grain cereals, leafy vegetables, fruit, nuts, yeast, and liver.

VITAMIN B COMPLEX—Closely associated with thiamin in the so-called *vitamin B complex* are several other vitamins, notably NIACIN and RIBOFLAVIN. Inadequate amounts of niacin result in growth deficiencies and the disease called PELLEGRA, characteristic symptoms being brown pigmentation of the skin, nervous disorders, and digestive disturbances. The last may also be evidence of riboflavin deficiency. The sources of these vitamins are, in general, the same as for thiamin.

VITAMIN C—the antiscorbutic vitamin, or ASCORBIC ACID—when included in adequate amounts in the diet prevents SCURVY, a disease evidenced by hemorrhagic conditions of the skin, teeth, gums, and joints, and if not arrested leading to progressive weakness and death. Vitamin C is present in most fresh foods, especially vegetables and fruit. Oranges, lemons, and tomatoes are ready sources.

VITAMIN D—the antirachitic vitamin—regulates chiefly the concentration of calcium and phosphorus in the blood and the process of calcification of the bones and teeth. Deficiency of the vitamin results in the disease known as RICKETS, characterized by various skeletal deformities. Although it is not generally distributed in significant amounts in our usual foods, rich sources are available in oil from the liver of the cod and halibut, and action of ultraviolet rays on certain sterols produces the vitamin, so that exposure of the human body to sunlight, within limits, is beneficial.

VITAMIN E—The antisterility vitamin—has been studied particularly in rats where it affects the reproductive functions, insufficient amounts resulting in sterility. It is widely distributed in foods and appears to be an alcohol.

## G. DUCTLESS GLANDS

Finally, we must not overlook certain accessories of the alimentary canal which lose all direct connection with it as development proceeds—really glands that have carried, as it were, the process of outpocketing from the digestive tract to the breaking point and become DUCTLESS GLANDS. Such, for instance, are the THYROID and THYMUS glands near the anterior end of the esophagus. The human thymus regresses during childhood and is of doubtful function, but the thyroid delivers its important product directly into the blood stream which therefore is an INTERNAL, OR ENDOCRINE SECRETION. We shall have occasion later to discuss the coördinating functions carried out by HORMONES secreted by ductless glands and other endocrine organs. At the moment it may be remarked that the pancreas is stimulated to secrete its digestive enzymes by a hormone, known as SECRETIN, brought to it by the blood. Secretin is liberated into the blood by special gland cells in the wall of the small intestine, when food enters from the stomach. (Figs. 229, 260, 261.)

Certainly, at first glance, the complicated digestive system of the Vertebrate may seem to have little in common with that of the Earthworm, but as a matter of fact the fundamental plan is the same. The differences which are present are chiefly the result of an increase of the working area of the alimentary canal, not only to afford greater secretive and absorptive surface and a larger variety and amount of digestive substances, but also to prolong the length of time the food is subjected to treatment. This increase in area has been effected by folds and elevations of the inner surface of the tract; by outpushings of limited areas of the tube to form large glands which in most cases contribute their products to their point of origin through ducts; and by increasing the length of the inner tube as compared with the outer tube, or body wall, which results in throwing the intestine into various convolutions within the body cavity. Thus is met the complex nutritional demands of the higher animals.



## CHAPTER XIV

# CIRCULATION

I finally saw that the blood, forced by the action of the left ventricle into the arteries, was distributed to the body at large, and its several parts, in the same manner as it is sent through the lungs, impelled by the right ventricle into the pulmonary artery, and that it then passed through the veins and along the vena cava, and so round to the left ventricle . . . which motion we may be allowed to call circular. — *Harvey*, 1628.

**T**he transport of materials to and from the various parts of the organism is obviously a simple problem in the Protozoa and many of the lowest Metazoa compared to that presented by animals with deeply-hidden tissues, each and every cell of which must be served. Indeed a complex body is impossible without a complex circulatory system. This has been outlined in the Earthworm and Crayfish and we now proceed to its further development in the Vertebrates. (Figs. 132, 133, 135.)

The crucial points of contact between the higher animal and its environment, in so far as the intake of matter and energy is concerned, are the membranes which line the alimentary canal and its derivatives, the gills or lungs. Through the lining of the alimentary canal must pass all the materials which are to be assembled as integral parts of the organism and the fuel which is to supply the energy for the vital processes, while through the membranes of the gills or lungs must pass the oxygen which is to release this energy. Only when these membranes have been passed are the materials really within the body and at its disposal for distribution by the circulatory system to the individual cells of the various organs which are to use them.

In addition to carrying the fuel and the oxygen, the circu-

latory system must remove the waste products of metabolism from the cells and deliver them to the proper excretory organs, such as the lungs or kidneys, to be passed to the outside world. The circulatory system is therefore the essential connecting link between the points of intake, utilization, and outgo of materials. (Fig. 244.)

And furthermore, the circulatory system is a coördinating agent of crucial importance because it distributes hormones from the various endocrine glands to the particular tissue or organ where their regulatory influence is to be effected. So the circulatory system is a distributing system which not only maintains a suitable environment for the myriads of cells of the body, but also, in coöperation with the nervous system, unifies the organs into an organism. (Fig. 261.)

Various stages in the development of a circulatory system can be traced in the Invertebrates. In some it consists merely of a single cavity or several connected cavities filled with a fluid containing various types of cells, while in others more and more of the spaces, or sinuses, are replaced by definite tubes, or **VESSELS**, for the conduction of the fluid. With the establishment of closed vessels, the contractions of various organs and the movements of the body as a whole can no longer be entirely depended on for the movement of the fluid, and accordingly, in certain regions, a muscular layer is developed in the walls of the vessels, which by rhythmic pulsation forces the fluid along. Thus it will be recalled that in the Earthworm there is the coelomic fluid within the body cavity, which is forced about by the movements of the worm and bathes most of the internal organs; and also a system of vessels, the vascular system, a part of which contracts rhythmically and distributes the blood to the individual cells. Again, in the Crayfish the blood circulates through sinuses and vessels. (Figs. 128, 132, 133.)

In the Vertebrates circulation is effected by two systems, the **BLOOD VASCULAR** and the **LYMPHATIC** systems. The blood vascular system consists of vessels that distribute the blood composed of a liquid plasma, in which float various

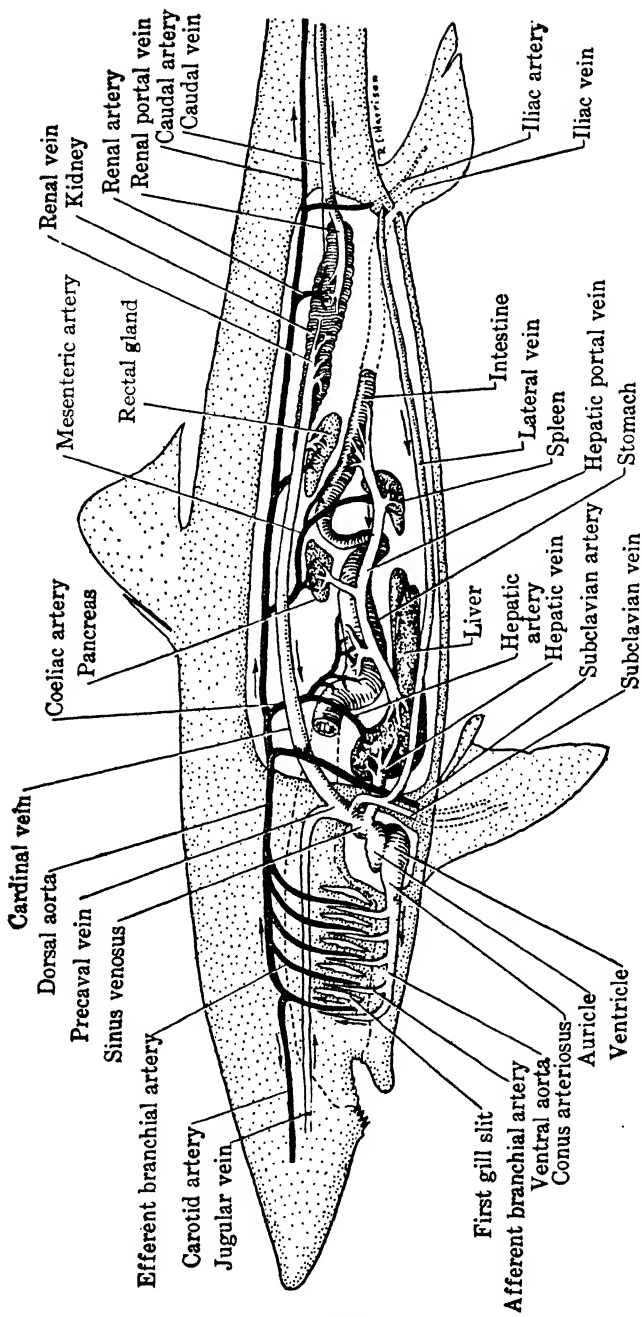

FIG. 236. Diagrammatic lateral view of the vascular system of a Shark (Dogfish). Vessels carrying oxygenated ('pure') blood shown in black; non-oxygenated ('impure'), in white. Arrows indicate direction of blood flow.

formed elements, chiefly RED and WHITE cells. The lymphatic system comprises spaces, channels, and vessels in the lower Vertebrates, but in the Mammals, including Man, it is essentially a network of vessels so that in higher animals the so-called closed circulatory system has replaced the predominantly open circulatory system of lower forms. The lymphatics carry LYMPH which consists of a liquid plasma with white cells. Both systems are closely associated, but the lymphatic plays a relatively passive role, so it is the blood vascular system that one ordinarily has in mind when speaking of the circulatory system. (Figs. 234-236, 240, 242, 243.)

The essential elements of the blood vascular system are, first, a muscular organ for propulsion of the blood, the HEART, which lies near the mid-ventral line in the anterior part of the coelom; and, second, tubes which convey the blood to the heart, the VEINS, and away from the heart, the ARTERIES. The arteries divide and subdivide to form smaller and smaller arteries which finally merge into exceedingly delicate tubes, or CAPILLARIES, that permeate the tissues of the body. The capillaries, in turn, deliver the blood to tiny VEINS which pass it on through larger and larger veins to the heart. Consequently the blood flows, regulated by VALVES, in a circle from heart around to heart again, through a closed system of vessels. Indeed, in the meshes of a network of blood streams all the life of our bodies goes on. About one-twentieth of the weight of the normal human body is blood. (Figs. 236, 242.)

### A. CIRCULATION IN THE LOWER VERTEBRATES

The heart represents that part of the vascular system in which the power of rhythmic contraction is concentrated, and it can be regarded as a blood vessel whose walls have become highly modified by an excessive development of muscular tissue. In the lowest Vertebrates and in embryonic stages of higher forms the heart consists typically of two chief chambers, an AURICLE and a VENTRICLE, with muscular

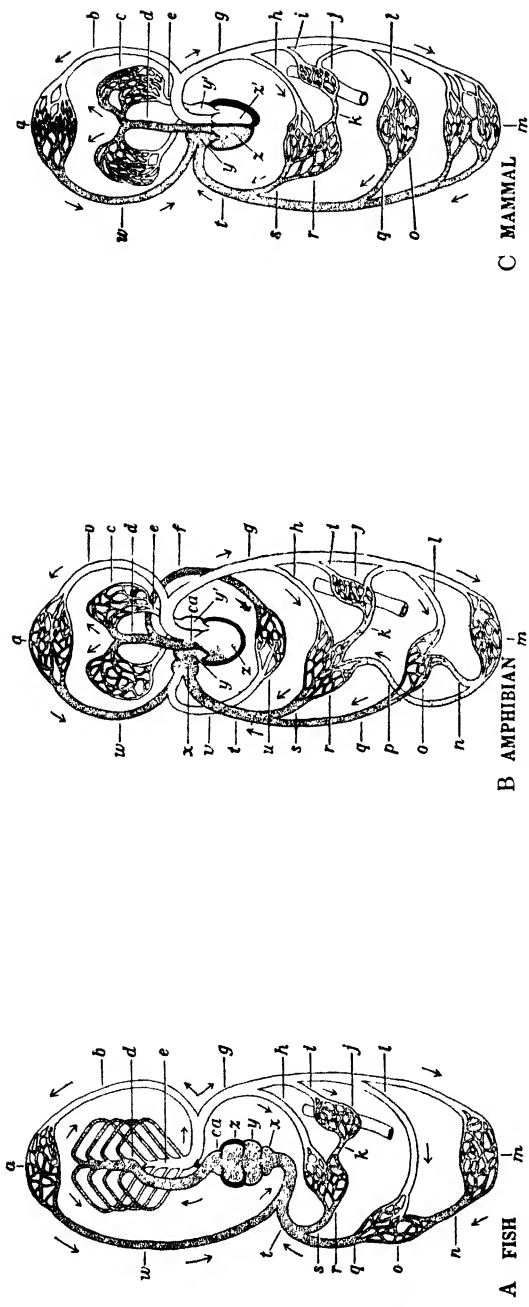

FIG. 237. Plan of the vascular system of a Fish, Amphibian, and Mammal. 'Pure' blood, unshaded; 'impure' blood, shaded. *a*, capillaries of head region; *b*, chief arteries leading to head region; *c*, capillaries of lungs; *ca*, conus arteriosus; *d* (in A), vessel from heart dividing up into the afferent branchial arteries of gills; *d* (in B and C), pulmonary artery to lungs; *e* (in A), artery from gills formed by union of afferent branchial arteries (capillaries of gills, connecting afferent and efferent branchial arteries, not shown); *e* (in B and C), pulmonary vein to left auricle; *f*, artery from ventricle to skin; *g*, chief artery (dorsal aorta) to posterior parts of body; *h*, hepatic artery to liver; *i*, arterial blood supply to stomach, intestine, etc.; *j*, capillaries of stomach, intestine, etc.; *k*, portal vein; *l*, blood supply to kidneys by renal arteries; *m*, capillaries of posterior extremities; *n*, renal portal vein; *o*, capillaries of the kidneys; *p*, abdominal vein; *q*, renal veins; *r*, capillaries of liver; *s*, hepatic vein; *t*, main venous current from posterior parts of body to heart; *u*, capillaries of skin; *v*, cutaneous vein; *w*, return venous current from the head region; *x*, sinus venosus; *y*, auricle in A, right auricle in B and C; *y*, left auricle; *z*, ventricle in A and B, right ventricle in C; *z*, left ventricle. Arrows indicate direction of blood flow.

flaps, or valves, which allow the blood to flow in one direction only; that is, from auricle to ventricle. An enlargement, the SINUS VENOSUS, connects the veins (VENOUS SYSTEM) with the auricle, and there is frequently another, called the CONUS ARTERIOSUS, in a similar position at the arterial end. The heart is thus essentially a linear series of chambers. The sinus venosus and auricle function mainly as reservoirs to fill rapidly the especially muscular ventricle. The latter, acting both as a suction and force pump, passes the blood on to the conus arteriosus and from there to the ARTERIAL SYSTEM as a whole. For our purposes, however, we may consider the heart in the lowest Vertebrates (Fishes) as composed of the two chambers, auricle and ventricle. (Fig. 237.)

The arterial system is the distributing system of vessels which carries the blood to all regions of the body. Soon after its origin at the heart, the circuit in the aquatic forms is temporarily interrupted to allow the blood to pass through the GILLS and exchange carbon dioxide for a supply of oxygen. To facilitate this gaseous interchange, the arteries (AFFERENT BRANCHIAL) as they enter the membranes about the gill slits break up into smaller and smaller vessels which finally are of microscopic caliber and consist of but a single layer of cells. These capillaries, in turn, merge into larger vessels (EFFERENT BRANCHIAL ARTERIES) which finally lead into the chief artery of the body, the DORSAL AORTA. This extends along the median dorsal line of the body, just below the vertebral column, and sends branches to the various organs.

The branches of the dorsal aorta, on reaching the location which they supply with arterial blood, break up into capillaries similar to those in the gills, so the blood can deliver food, oxygen, etc., to the tissues. The blood receives in return various waste products of metabolism, including carbon dioxide and, in certain cases, absorbed food materials from the intestine, and special secretions chiefly from endocrine glands. The fine capillaries lead into veinlets and these into veins of constantly increasing caliber which sooner



resolves into capillaries to allow that organ to regulate certain of the blood constituents. From the capillaries the blood then passes into the HEPATIC VEIN which conveys it toward the heart. Thus the liver receives blood from two sources: an artery providing blood primarily for the use of the organ itself, and a vein (portal vein) delivering blood, containing a large amount of food material, solely to receive special treatment before being sent back to the heart and then all over the body. This special arrangement for a venous blood supply to the liver is known as the HEPATIC PORTAL SYSTEM. (Figs. 232, 235, 236, 240.)

Moreover, in Vertebrates lower than the Birds, the venous blood from the posterior part of the body makes a detour through the capillaries in the kidneys on its way back to the heart. This constitutes what is termed the RENAL PORTAL SYSTEM. Therefore in these forms the kidneys as well as the liver receive blood from two sources, an artery and a vein. It will be noted that both the hepatic portal vein and the renal portal vein arise in capillaries and terminate in capillaries. (Figs. 236-238.)

Such is the general plan of the blood vascular system of the lower Vertebrates. The modifications of this which occur in higher forms are related chiefly to changes in the respiratory mechanism necessitated by abandoning an aquatic for a terrestrial mode of life, with consequent dependence on the free oxygen of the atmosphere instead of that dissolved in the water.

## B. CIRCULATION IN THE HIGHER VERTEBRATES

We may now note some of the far-reaching changes that the blood vascular system undergoes as a result of the substitution of lungs for gills. In the first place the series of paired branchial arteries, which formerly supplied the gills, no longer break up into capillaries, but instead lead directly into the dorsal aorta, and accordingly are termed AORTIC ARCHES. Thus Fishes bequeath, as it were, to higher forms a series of pairs of aortic arches which, though they are no



longer of use in their former capacity, appear in the developmental stages. Some disappear at that time and others are modified and diverted to various uses in the adult. (Fig. 239.)

For our purpose it is sufficient to emphasize that in man's body one aortic arch continues to carry blood directly from the heart to the dorsal aorta, while parts of another deliver blood from the heart to the lungs and back again to the

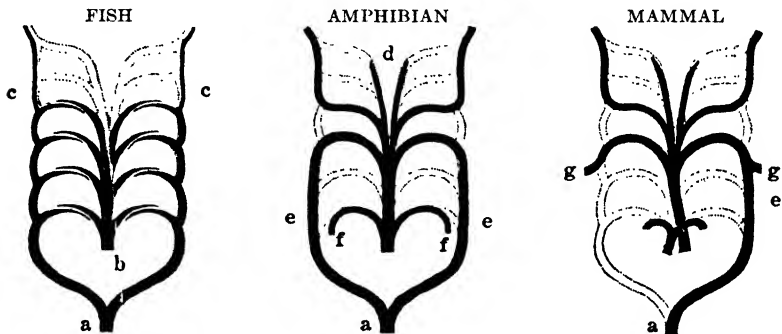

FIG. 239. Diagram to show some of the transformations of the six pairs of primitive gill arteries (aortic arches). Dotted lines indicate portions of the arches that have disappeared. a, dorsal aorta; b, ventral artery from heart (not shown); c, internal carotids; d, external carotids; e, aortic arch; f, pulmonary arteries; g, subclavian arteries to fore limbs.

heart. Thus there is established a second current of blood through the heart, which necessitates a median partition in both the auricle and ventricle in order to keep the two currents separate.

In this way a four-chambered heart arises which consists of right and left auricles and ventricles. The **RIGHT AURICLE** receives blood from the venous system of the body and passes it through the **TRICUSPID VALVE** into the **RIGHT VENTRICLE** to be pumped through the **PULMONARY ARTERY** to the lungs. After traversing the capillaries of the lungs, the blood is returned by the **PULMONARY VEIN** to the **LEFT AURICLE**, thence through the **MITRAL VALVE** into the **LEFT VENTRICLE** which forces it into the **AORTA** and so on its way about the body as a whole. To all intents and purposes, the higher Vertebrates have two hearts which act in unison —

a right, or pulmonary, heart receiving non-aërated blood from the entire body and pumping it to the lungs, and a left,

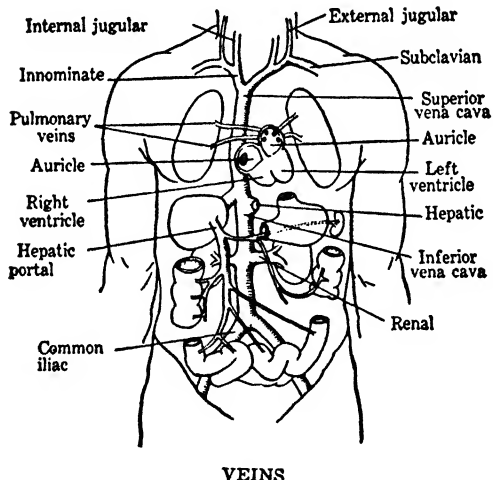
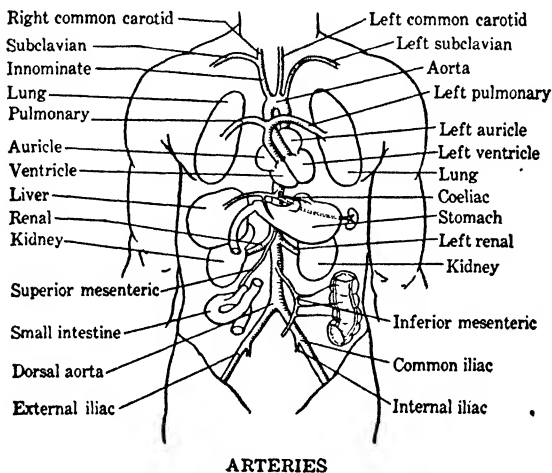

FIG. 240. Diagrams of the chief vessels of the arterial and venous systems of Man. (From Mavor.)

or systemic, heart receiving aërated blood from the lungs and delivering it to the body as a whole. Thus the blood vessels of the primitive aquatic respiratory apparatus are

transformed by gradual additions and subtractions into the PULMONARY SYSTEM of the higher Vertebrates. (Figs. 237, 240, 241.)

The vascular system is, in truth, a highly efficient apparatus. Day in and day out throughout life the human heart,

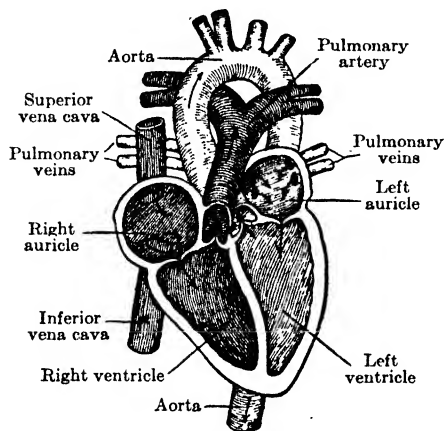

FIG. 241. Diagram of human heart and associated blood vessels. The direction of blood flow is indicated by arrows.

beating rhythmically at an average rate of 70 times per minute, does about 300,000 foot-pounds of work. This power is expended in moving the weight of the blood, in imparting to it the velocity of its motion, and in maintaining pressure in the aorta and pulmonary artery and so throughout the vascular system. The PULSE is the alternate expansion and contraction

of a vessel, in particular an artery, due to changes in pressure that result from a heart beat.

The VELOCITY is greatest when the blood leaves the heart and gradually diminishes until, in the capillaries of both the pulmonary and systemic systems, it is reduced to a minimum. On the return trip from the capillaries through the veins the velocity gradually increases, though it reënters the heart at a velocity lower than the one at which it departed. Thus of the 23 seconds which it takes a unit of blood to make the complete circuit in man, about two seconds are spent in the capillaries — a relatively long time when it is realized that the average length of the capillary path is about one-fiftieth of an inch. The chief factor underlying the change in velocity is simple. The blood, driven throughout its course by the same force — the heart beat — varies in velocity with the width of the bed through which it is

flowing. Although the area afforded individually by the arteries and veins is greater than that by any single capillary, nevertheless the total area afforded by the capillary system is enormously greater than that by either the arterial or venous system. The total surface of the capillaries of a man has been stated to be about equal to the area of a city block.

Moreover, since a liquid in a closed system of tubes must flow from a region of high to one of low pressure, the blood **PRESSURE** continuously diminishes from heart back to heart again. Resistance to flow in the capillaries and other tiny vessels, known as **PERIPHERAL RESISTANCE**, is due to their small size and the great total area of their internal surface; and this accounts for the fact that pressure of the blood in the arteries is much higher than in the veins. Although the pressure in the capillaries of any region as a whole is less than the arteries which supply them and is greater than in the veins which they supply, nevertheless the pressure in a single capillary is very low, as is demanded by its delicate wall.

Thus in the capillaries the blood moves very

slowly under low pressure and here the blood does its work — contributes to the **TISSUE FLUID** and interchanges materials with it. All the rest of the vascular system — heart, arteries, and veins — is arranged to give the blood just this opportunity in the capillaries. (Fig. 242.)

The tissue fluid is essentially some of the blood plasma that has passed through the walls of the capillaries, carrying along food materials, oxygen, etc., to be exchanged for the various waste products of metabolism of the cells which it bathes. Thus there is a continuous drainage of fluid from the capillaries into intercellular spaces. Some of this tissue

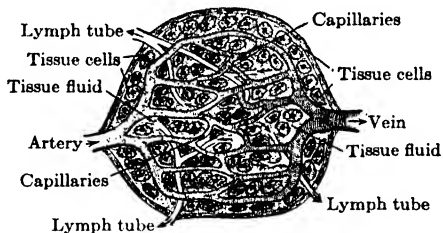

FIG. 242. Diagram of the intimate relations between capillaries, lymphatics, and tissue cells.

fluid, with waste products, etc., passes immediately into the capillaries again, but the excess passes into small LYMPH VESSELS. The filtration is, of course, from a region of higher to one of lower osmotic pressure with regard to each diffusible substance. (Fig. 243.)

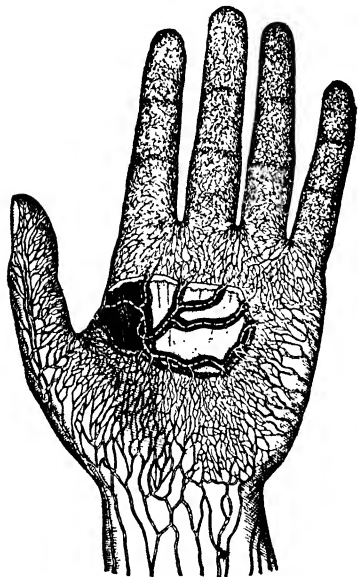

FIG. 243. The superficial and some of the deeper lymphatics of the human hand. (From Hough and Sedgwick.)

Lymph is essentially excess tissue fluid with many white cells, chiefly LYMPHOCYTES from lymph glands, etc., which passes through larger and larger lymphatic vessels until it is finally delivered to veins in the region of the neck, and the materials are restored to the blood. The flow of lymph from regions of high pressure in the lymphatics of the tissues to those of lower pressure where they enter the venous system is furthered by various muscular movements of the body. (Fig. 235.)

With such a marvelously complex transportation system, clearly some provision must exist for regulating the blood flow in order to meet the varying local demands of the organs of the body under different physiological conditions. This is attended to chiefly by nerve impulses which are conducted by a system of VASOMOTOR NERVES and bring about the dilation or contraction of the smaller arteries leading to an organ. Since the total volume of blood in the body is practically constant, an extra supply to one part necessitates a slightly reduced supply to another. So it happens, for instance, that after a hearty meal more blood is sent to points where digestion is going on, leaving less for other organs — the reduced supply to the brain probably resulting in the proverbial drowsiness at such times.

Moreover, of course, the blood itself undergoes various changes during its course through the body as it receives or delivers food substances, secretions, and excretions. And furthermore, for instance, its supply of red blood cells is replenished from the bone marrow and apparently stabilized, in part, by a vascular organ, the SPLEEN, which is situated in the abdomen behind the stomach. (Figs. 225-227, 244.)

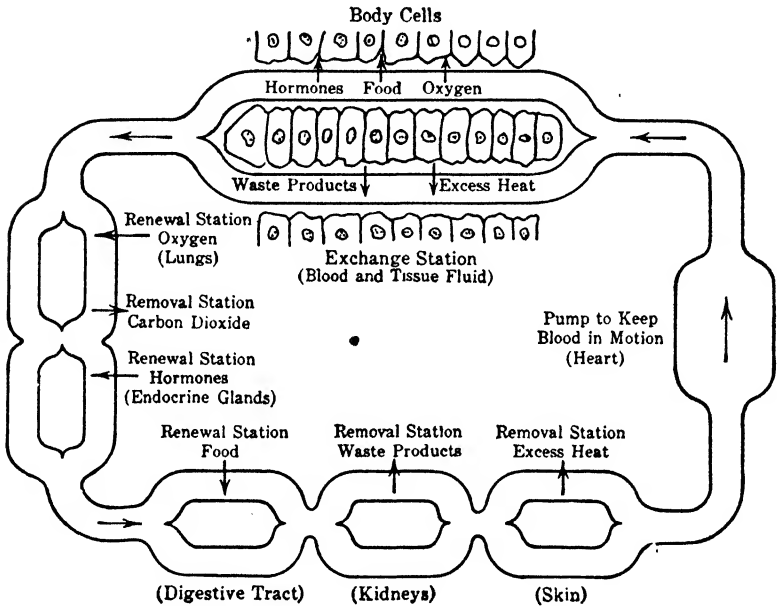

FIG. 244. Diagram illustrating how a suitable environment is maintained by the flow of blood. (After Martin.)

The elaborate mechanism in homothermal animals (Birds and Mammals) that maintains a practically constant body temperature is largely dependent upon heat distribution, heat loss, and heat conservation by the blood vascular system. At rest, a gentle stream of blood flows through the capillaries of a man's muscles; in violent exercise, a great torrent, impelled by increased heart action, brings food and oxygen and carries away waste products and heat. This superfluous heat is carried by the blood to the lungs and skin for elimination. The skin becomes flushed by the dis-

tension of its blood vessels and heat is radiated, always aided by perspiration. Thus the body is losing heat, but we 'feel warm' because the sense organs that make us aware of temperature are situated in the skin. We 'feel cold' when blood is withdrawn from the skin to the internal organs and heat is being conserved. This makes clear the apparent paradox — one is apt to 'feel warm when catching cold.'

So much for the paths and duties of the blood and lymph that circulate through the body — just enough, perhaps, to emphasize that with increase in size and complexity of the animal body there goes hand in hand an elaboration of the transportation system. It is gradually transformed to meet the new demands made upon it, and thus leaves in higher animals evidence of their origin.

## CHAPTER XV

# RESPIRATION

The living body is the theatre of many chemical and physical operations in line with those of the inorganic domain. —*Thomson.*

**A**s we have seen, the essential factor of respiration is an interchange of gases between protoplasm and the environment: an intake of free oxygen for combustion, and an outgo of the waste products, chiefly carbon dioxide and water. In the unicellular organisms, such as *Protococcus* and *Amoeba*, and in simple multicellular animals like *Hydra*, this is a relatively direct process since an elaborate mechanism is not necessary to facilitate the interchange. But with the establishment of a highly differentiated multicellular body, fewer and fewer cells are in immediate contact with the aërating medium and so various provisions are necessary to transfer the gases to and from the outer world and the individual cells themselves. (Figs. 13, 14, 125.)

In all forms the *SKIN* functions to some extent; in the *Earthworm*, in fact, it acts as the chief respiratory membrane since a profuse supply of blood vessels to the moist surface of the body effects a sufficiently rapid gaseous interchange for the relatively inactive life of the organism. The *Crayfish* meets the problem of respiration by finger-form outpocketings of the body wall, the *GILLS*: a method of bathing a large area of the respiratory membrane in the respiratory medium,

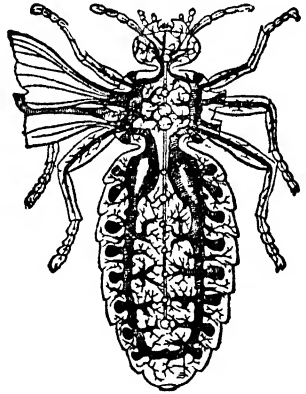

FIG. 245. Diagram of the respiratory (tracheal) system of an Insect. The other internal organs are omitted.



the surrounding water. Insects, however, instead of bringing the blood to the surface, develop a network of tubes, or TRACHEAE, which ramify throughout the body tissues and conduct air directly to the cells. (Figs. 138, 245.)

Among all the Vertebrates, as has been indicated, the anterior end of the digestive tract functions as a common food and respiratory passage. In Fishes, the respiratory water current which enters the mouth makes its exit by way of the gill pouches and gill slits; the lining of the pouches — outpocketings of the lining of the alimentary canal — functioning as the respiratory membrane. (Fig. 246; P. 307.)

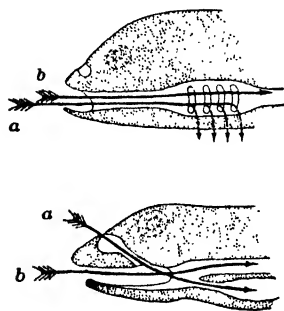

FIG. 246. Diagram of a vertical section through the head region of Fish (above) and higher Vertebrate (below) to show paths of the respiratory currents (a) and food (b). See Fig. 228.

Among the air-breathing Vertebrates there are the added problems of protecting and keeping moist the greatly increased respiratory surface which their more active metabolism — proportionally greater energy requirements — demands. The respiratory membrane must be kept moist because even in terrestrial animals the process remains essentially aquatic. Diffusion of oxygen and carbon dioxide takes place through

a watery film covering the respiratory membrane. In terrestrial Vertebrates the gill slits persist merely as transient embryonic reminders of evolutionary history; the function of the gill pouches being taken over by a huge, moist, membranous outpocketing of the ventral wall of the pharynx into the anterior portion of the body cavity, which constitutes the LUNGS. Thus, even in man, the respiratory membrane which lines the lungs is, from the standpoint of development, a specialized part of the epithelium of the alimentary canal. Furthermore, the establishment of lungs entails, in turn, a complex respiratory mechanism so that the air within them may be renewed at frequent intervals. The operation

of this mechanism is often called **EXTERNAL RESPIRATION**, in contrast with **INTERNAL RESPIRATION** — the actual cell respiration. (Fig. 388.)

## A. LUNGS

In the human respiratory process, air after entering the nostrils, **ANTERIOR NARES**, passes along the nasal passages and out the **POSTERIOR NARES** into the lower part of the pharynx. Air may also enter through the mouth. From the

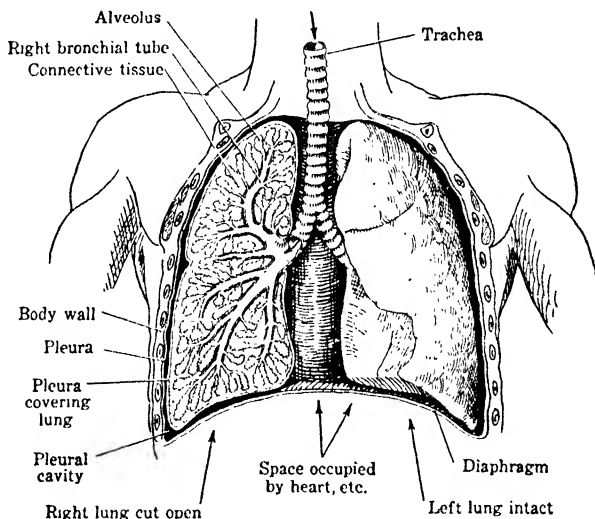

FIG. 247. Diagram of a vertical section through the human thorax, showing the lungs.

pharynx it passes over the **EPIGLOTTIS**, and through the slit-like **GLOTTIS** into the **LARYNX**, or so-called Adam's apple, and then down the windpipe, or **TRACHEA**. Within the larynx are the **VOCAL CORDS** which vibrate in response to air currents; the amplitude of the vibrations and the tension of the cords being responsible for the **VOICE**. The mouth, pharynx, and nasal cavities act as resonating chambers. (Fig. 228.)

As the lower end of the trachea enters the chest, or **THORAX**, it divides into right and left branches, or **BRONCHI**, which in

turn branch into numerous BRONCHIAL TUBES within the lungs, each of which is a bag of elastic, spongy tissue. Here the bronchial tubes divide into smaller and again smaller branches, until finally they form microscopic twigs, each ending in one or more tiny air sacs, or ALVEOLI. Thus there are many thousands of alveoli in the human lungs, every one in direct communication with the air. Furthermore, each alveolus is profusely supplied with capillaries through which flows blood sent by the heart and soon to return to the heart so that it may be distributed to every part of the body. It is while the blood is in the capillaries of the alveoli that it gives up to the air in the alveoli carbon dioxide, water, and heat taken from the tissues, and at the same time receives

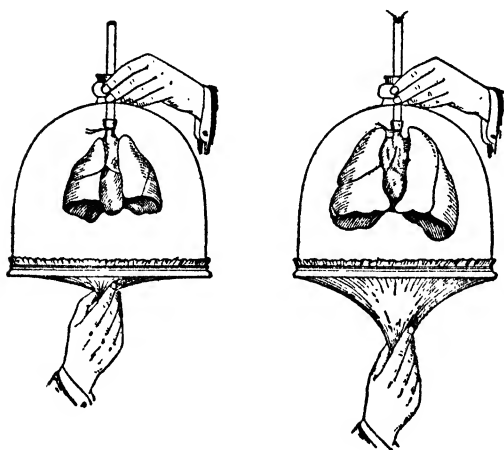

FIG. 248. Diagram to illustrate the mechanism of diaphragm breathing. The lungs of a Mammal are enclosed in a bell-jar. As the rubber membrane below (representing the diaphragm) is pulled down, enlarging the cavity, air enters through the tube (trachea) and expands the lungs. (From Conn and Budington, after Tigerstedt.)

oxygen. This is effected through the delicate walls of the capillaries and alveoli. So the alveoli are really the effective surface of the lungs. (Fig. 247.)

## B. RESPIRATORY MECHANISM

In order for the lungs to play their part in respiration, it is evident that the air within them must be periodically renewed, and this rhythmical process

of INSPIRATION and EXPIRATION is what one usually refers to as breathing. The complex mechanism involved and its method of operation may be briefly outlined.

The lungs are cone-shaped, elastic sacs suspended in an air-tight cavity, the thorax, which can be enlarged by

raising the RIBS and lowering the DIAPHRAGM, a muscular partition between the thoracic and abdominal cavities. The sole entrance to the lungs is through the trachea, and accordingly an atmospheric pressure of approximately fifteen pounds to the square inch is exerted down through the trachea on the inner walls of the lungs and keeps them constantly in close contact with the walls of the thoracic cavity — otherwise there would be a vacuum between the lungs and the thoracic wall. Therefore when the thoracic cavity is enlarged by contraction of the muscles of the ribs and diaphragm, the elastic lungs expand in maintaining contact

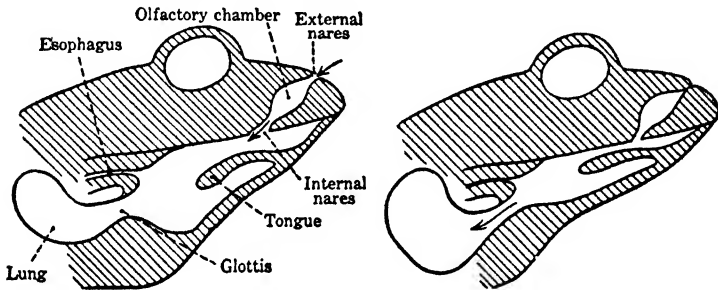

FIG. 249. Diagram to illustrate the respiratory movements of the Frog. At left, the external nares are open and air enters the buccal cavity. At right, the external nares are closed and the floor of the buccal cavity raised, forcing air into the lungs. Note that absence of diaphragm and air-tight thoracic cavity necessitates an entirely different mechanism from that in Mammals. (From Hegner.)

with its walls — inspiration takes place; and when the thoracic cavity is decreased, by relaxation of the same muscles, expiration occurs. The lungs play an entirely passive part in the process. Of course, if through injury the thorax is punctured, then there is equal atmospheric pressure on both sides of the walls of the lungs and they collapse. (Figs. 248, 249.)

Since the rhythmical respiratory movements are due to the contractions of muscles, it follows that stimuli reach the muscles from the nervous system; because muscles, excepting those of the heart, do not contract automatically. Nerve impulses arise in the RESPIRATORY CENTER in the lower part of the brain, just before it merges into the spinal

cord, and pass by nerves to the muscles involved. Although the respiratory center is essentially automatic, the carbon dioxide content of the blood reaching the center determines the rate of the respiratory movements which it induces; an increase in carbon dioxide (a lowering of the pH) resulting in acceleration. Moreover there are nerves from the lungs which carry nerve impulses that contribute to the rhythm of breathing, apparently by holding in check the activities of the center itself.

Indeed, the center can be influenced by stimuli from nearly any part of the body: witness the effect of a cold plunge on breathing. Although the action of the center is chiefly involuntary, since we breathe when we are asleep, obviously it can be controlled to a considerable extent by the will because we can 'hold the breath' for some time by sending impulses to the respiratory center which inhibit its discharge. If this center is destroyed or the nerves are severed, respiratory movements immediately and permanently cease.

### C. RESPIRATORY INTERCHANGE

The respiratory mechanism has attained its objective when air and blood are brought into such close relationship in the lungs that gaseous interchange can occur and heat be transferred. Inhaled air varies very widely in temperature but in our homes is perhaps most frequently about 20° C. (68° F.). Exhaled air is about 36° C., or very nearly the same as that of the human body. Thus under usual circumstances the exhaled air is warmer than when it entered the lungs — the blood has lost heat. Again, the amount of water in the inhaled air is variable, being low on a dry day and high on a wet day; but the exhaled air is practically saturated with water vapor — the blood has lost water. Furthermore the inhaled air contains merely a trace of carbon dioxide, while when it leaves the lungs it bears a little more than 4 per cent — the blood has given up carbon dioxide. Finally, air entering the lungs contains approximately 21 per

cent oxygen, while when exhaled there is only about 16 per cent — the blood has received oxygen. In short, the blood by its traffic with the air in the lungs gives up heat, moisture, and carbon dioxide, and takes up oxygen.

One naturally is interested to know how the blood while passing through the lungs acquires the oxygen, since this is the element demanded by every cell in its life processes. At least two phenomena are involved. In the first place, the air contains a considerable amount of oxygen under relatively high tension and therefore oxygen passes into the liquid plasma of the blood where the oxygen conditions are just the opposite. It follows the physical laws of the diffusion of gases through permeable membranes, the walls of the alveoli and the capillaries. Thereupon most of the oxygen is appropriated by the red blood cells of which there are many trillions in the human body. They carry a complex chemical substance, HEMOGLOBIN, which has a high chemical affinity for free oxygen: it is oxygenated to form an unstable chemical compound, OXYHEMOGLOBIN. Accordingly the red blood cells leave the lungs with the oxygen affinity of the hemoglobin satisfied and return to the heart to be distributed throughout the body.

The oxygen is actually delivered to the tissue cells, through the mediation of the tissue fluid, by the capillaries in the tissues where the oxygen tension is low — just the opposite of the condition in the lungs — because the various tissue cells use the oxygen nearly as rapidly as it is received. So the red cells give up most of their oxygen — oxyhemoglobin is reduced to hemoglobin — and the blood receives in exchange, as it were, carbon dioxide (because the  $\text{CO}_2$  tension is lower in the blood), and also water and heat resulting from oxidation processes in the tissue cells. Nearly half of the carbon dioxide is carried by the red blood cells and the rest by the blood plasma, chiefly in the form of an alkaline bicarbonate. Since carbon dioxide is acidic it is buffered during its passage in order to avoid serious changes in the pH (acidity) of the blood.

And now the blood, after its passage — lasting about two seconds — through the capillaries, proceeds on its way back to the heart which sends it to the lungs so that it can transfer carbon dioxide, water, and heat to the air in the alveoli. The carbon dioxide passes to the air largely because it is under higher tension in the blood than in the air. The respiratory cycle is complete.

It should be noted that the blood does not give up all of its carbon dioxide in the lungs nor all of its oxygen in the tissues. Residual amounts of both are essential for life. Moreover VENTILATION, under ordinary living conditions, is unnecessary for maintaining the chemical purity of the air in a room. There is no danger of health or comfort being jeopardized by reduction in oxygen or increase of carbon dioxide or by the accumulation of expired poisons. The most important factors are the temperature and moisture of the air.

Such, in brief, is the elaborate apparatus present in the higher animals and man to provide for the new conditions arising because of the removal of many of their component cells further and further from the source of oxygen, and the demand for more and more facilities for securing it as their life processes increased in activity. We have already considered the attendant changes in the blood vessels; so now it is only necessary to be sure that the mechanism does not obscure its object — to reiterate that, although one ordinarily thinks of the movements involved in the renewal of the air in lungs as respiration, it is neither inspiration or expiration, nor the interchange of gases between blood and air or between blood and tissue cells. The essential feature of respiration is the same here as it is in unicellular plants and animals: the protoplasm of each and every cell of the body securing energy from food by combustion, involving the appropriation of oxygen and the liberation of carbon dioxide. All else is accessory — though necessary.

## CHAPTER XVI

# EXCRETION

The mathematically accurate end-reaction of a chain of known and unknown causes and effects. — *Noyes*.

**P**rovisions for eliminating from the organism the waste products of metabolism are not less important than those for supplying the matter and energy by which the vital processes are carried on. In many of the unicellular forms the whole surface of the organism functions as an excretory organ, but it will be recalled that even in some of these, such as *Amoeba* and *Paramecium*, contractile vacuoles facilitate the removal of useless metabolic products. Indeed, in all but a few of the lowest Metazoa there are highly specialized organs for excretion. In the Vertebrates we find the **KIDNEYS** and the **GILLS** or the **LUNGS** devoted largely to excretion, and the **SKIN** and **LIVER** acting in subsidiary capacities. Each receives a profuse blood-supply from which it takes the waste products that are to leave the body as an excretion. (Figs. 6, 21, 246.)

There is an essential distinction between an excretion, which represents chemical waste from the vital processes, and the major part of the material that is ejected from the digestive tract as feces. The latter is almost entirely indigestible material taken in with the food which has not directly contributed to the metabolic processes of the organism, though some of it may have acted temporarily in an accessory capacity. Accordingly the digestive tract is not included in the list of excretory organs, though it will be recalled that certain waste products excreted by the liver reach the outside world with the feces.

The nature and amount of the material eliminated by the excretory organs is, of course, determined by what is brought



to them by the blood, and this, in final analysis, is dependent upon the food — the fuel that has been burned — and the disintegration of protoplasm from the wear and tear of life. Carbohydrates and fats yield carbon dioxide and water, while proteins give in addition UREA, URIC ACID, CREATININE, AMMONIA, etc., the products of nitrogenous metabolism. And there are also various inorganic salts.

### A. GILLS AND LUNGS

We have already emphasized the elimination of carbon dioxide by the gills or the lungs. Here the cells of the respiratory membranes play essentially a passive rôle in excretion, since the carbon dioxide, which is under higher tension in the blood than in the water or air, follows the physical laws of diffusion of gases and passes from the blood. In addition to carbon dioxide, the blood of homothermal animals loses a large amount of water and heat; the amount depending on the moisture and temperature of the air which enters the lungs. When the air is exhaled, its temperature is very nearly that of the body and it is saturated with water vapor. About one-third of the water eliminated by the human body is excreted by the lungs. (Fig. 247 ; P. 338.)

### B. SKIN

The skin of some of the lower Vertebrates, for instance the frog, is an exceedingly important excretory organ, because more carbon dioxide is eliminated through it than through the lungs; but in most of the higher forms, including man, excretion by the skin is confined to the SWEAT GLANDS. There are about two millions of these simple tubular glands, with a total length of several miles, opening on the surface of the human body. They take from the blood, in addition to large quantities of water, traces of nitrogenous waste or urea, fatty acids, and inorganic salts, chiefly sodium chloride, which form a residue on the surface of the skin when the

PERSPIRATION evaporates. However, most of the water may be regarded as a secretion rather than an excretion because it is of use to the body, being employed in regulating the body temperature. Everyone knows that evaporation of perspiration accelerates the loss of heat by the skin. In addition to sweat glands, the skin is provided with SEBACEOUS GLANDS which open, as a rule, at the base of hairs and deliver a true secretion — a lubricant for hair and skin, and a conserver of body heat. (Figs. 214, 250.)

### C. LIVER

The liver, in addition to its various other functions, aids in no small way in excretion. It removes deleterious compounds of nitrogen from the blood and converts them into urea. Then it secretes the urea into the blood from which it is later removed by the kidneys and passed from the body in the URINE. Other waste products collected from the blood form a part of the bile and so reach the intestine for elimination in the feces. (Fig. 232 ; Pp. 309, 310.)

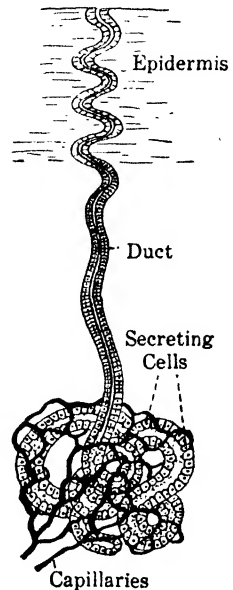

FIG. 250. Diagram of a sweat gland. Highly magnified.

### D. KIDNEYS

The kidneys are two bean-shaped, compound tubular glands which, in coöperation with the liver, constitute the chief excretory organs of Vertebrates. Any serious interference with their activity rapidly leads to a poisoning of the body with its own waste products. However, the removal of such materials is but one aspect of the function of the kidneys — they act as a blood-regulator to maintain a proper balance of the normal chemical constituents of the blood plasma. (Fig. 251.)

The functional units of a kidney are several million tiny **RENAL TUBULES**. Each begins in the **CORTEX** with a cup-shaped enlargement, known as a **BOWMAN'S CAPSULE**, which surrounds a tuft of capillaries, or **GLOMERULUS**, supplied by the renal artery. The tubules continue from the capsule

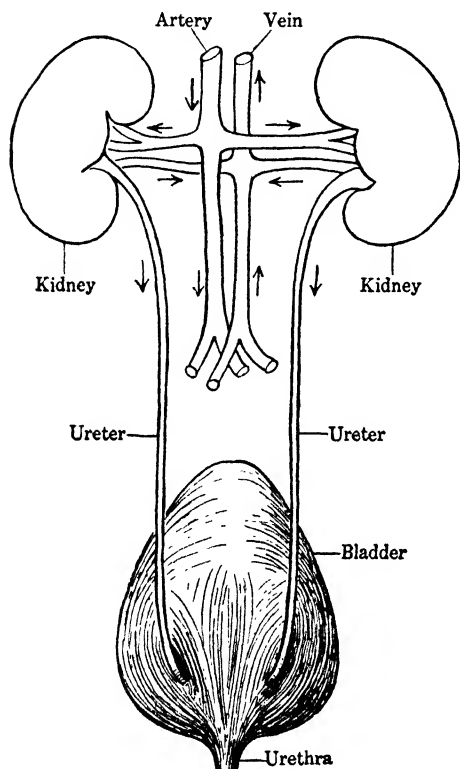

FIG. 251. Diagram of the human urinary system, posterior view.

by an intricate course through the **MEDULLARY REGION** of the kidney to open at the tip of a **PYRAMID**. In the medullary region they are enmeshed in capillaries extending from the glomerulus. Thus each renal tubule has two regions supplied with capillaries—the capsule and the tubular part proper. (Fig. 252.)

As the blood passes through the glomerulus, water, sugar, various salts, urea, etc., filter from the capillaries and pass down the tubule. Here much of the water, all of the sugar, and other substances of value are reabsorbed—the absorption being

selective and regulated by the immediate needs of the body. Then the residue reaches the end of the tubule, passes through its opening on a pyramid in the **PELVIS** of the kidney, and so on its way down the **URETER** and eventually out of the body. About 90 per cent of the nitrogenous waste is eliminated from the human body in the form of urea. (Figs. 225-227.)

## 1. Urine

The excretion of the kidneys, known as urine, is a highly complex watery solution of organic and inorganic substances which flows continuously from the kidneys through the ureters to the URINARY BLADDER. Here it is stored temporarily until passed to the exterior through the URETHRA. Since urine comprises not only nearly all the normal products of katabolism, but also the majority of abnormal substances that may enter or be formed by the organism, one of the

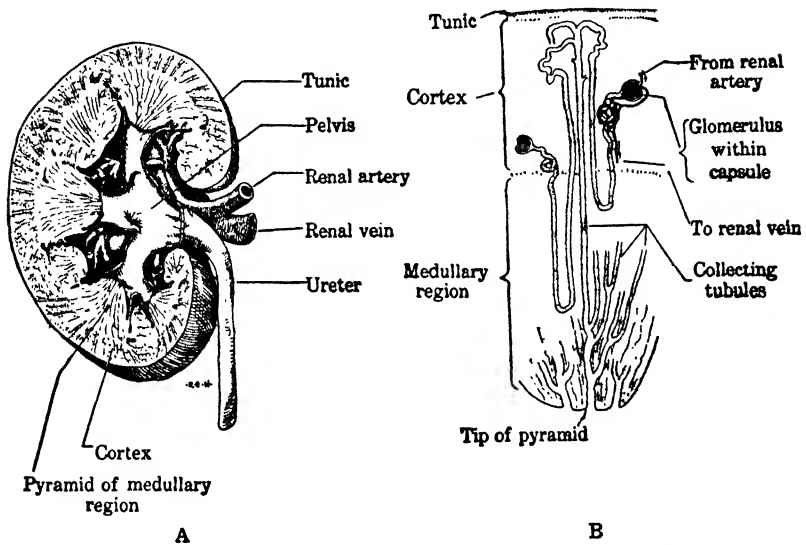

FIG. 252. Human kidney. A, longitudinal section; B, diagram of the course of the tubules in the kidney. The cortex is the region in which the tubules come into functional association with the capillaries. Tubules extend through the medullary region to open on the tips of the pyramids.

best indications of the general metabolic condition of the human body is afforded by a chemical and microscopical analysis of the urine. Thus in Bright's disease protein appears; in diabetes, excess sugar and water are found; while in gout uric acid is present in abnormal quantity in the urine.

However, the interpretation of the analysis is of first importance in every case because the urine rapidly reflects

normal changes in the physiological condition as well as those that are abnormal; even the nervous tension of an examination may well be evidenced by the appearance of glucose. Again, the amount of urine excreted depends upon many factors. Under normal conditions with a given intake of water, the volume of urine varies chiefly with the temperature and moisture of the atmosphere. For instance, when the atmosphere is hot and dry, a relatively large amount of water is eliminated as perspiration. Accordingly the intake of water should be greater in order to carry off readily the waste products of metabolism through the kidneys. One is apt to think of the kidneys as essentially passive organs that merely drain materials from the blood. But, as a matter of fact, a milligram of kidney tissue consumes, on the average, more oxygen per unit of time than the same weight of the beating heart. The kidneys work.

## 2. *Evolution of the Kidneys*

Aside from their functional importance, the kidneys are of considerable interest to the comparative anatomist because of their complicated evolutionary history throughout the vertebrate series. Indeed the basic elements of the vertebrate kidney may be most readily interpreted with the excretory system of the Earthworm in mind. (Figs. 128, 131, 253.)

It will be recalled that the chief excretory organs of the Earthworm consist of pairs of coiled tubes, or NEPHRIDIA, segmentally arranged in the coelom on either side of the alimentary canal. Each nephridium begins as an open funnel in the coelom of one segment, passes through the partition to the next posterior segment and there, after coiling, passes to the ventral surface and opens to the exterior by a pore. Thus, reduced to its simplest terms, a nephridium is a tube communicating between the coelom and the outer world, and affording a path of egress for the waste matter in the coelomic fluid. But, in addition, the blood vascular system carries nitrogenous waste, inorganic salts in solution,

etc., to the coiled part of the nephridial tube where special cells take them from the blood and deliver them to the interior of the tube to be passed out of the body. Thus the nephridia of the Earthworm remove waste material from both the coelomic fluid and the blood.

Although the primitive segmentation of the coelom has disappeared in the Vertebrates, nevertheless segmentally arranged nephridia are the basis of the essential excretory elements of the kidneys. Thus in the lowest of this group the primitive type of kidney, or **PRONEPHROS** as it is called, consists of a series of nephridia in the dorsal part of the anterior end of the coelom. These, however, instead of opening independently to the exterior, discharge their products into a common tube (**PRONEPHRIC DUCT**) which passes them to the outside. In higher forms the pronephros disappears, and its function is taken over by another series of nephridia which appears in the coelom posterior to the pronephros. This series constitutes the **MESONEPHROS** and opens into the pronephric duct which accordingly now is called the **MESONEPHRIC DUCT**. Finally, in still higher Vertebrates this second urinary organ is replaced by a third, the kidney proper (**METANEPHROS**) and its special duct, the ureter. (Fig. 254.)

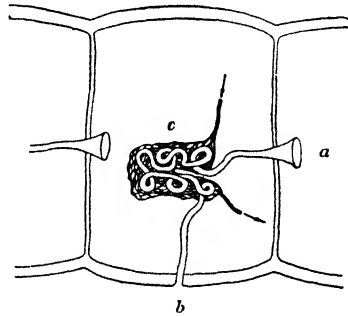

FIG. 253. Diagram to show the general structural plan of a nephridium of an Earthworm, anterior end toward the right. *a*, internal opening (nephrostome) of nephridium; *b*, external opening (nephridiopore); *c*, capillary network about the coiled, glandular portion in the coelom.

Thus as we ascend the vertebrate series three distinct kidney systems appear, in each case by the development and grouping of nephridium-like elements into a definitive organ. In this process the primitive communication of the individual nephridia with the body cavity is lost and the functions of the tubular portion increased, until, in the higher forms, all

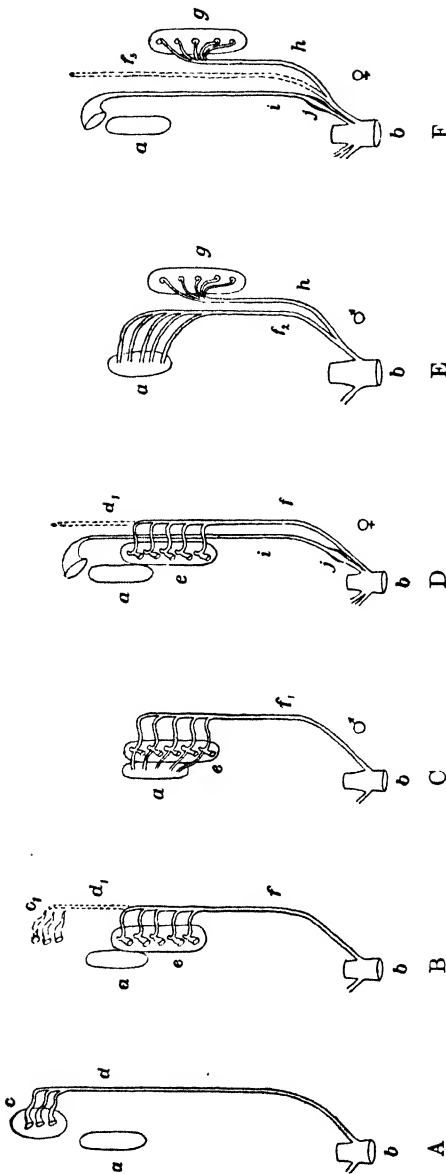

FIG. 254. Diagram of the fundamental plan of the urogenital system of Vertebrates. A, Pronephric system — primitive and early embryonic type in all Vertebrates; functional in the Frog tadpole. B, Mesonephric system — embryonic type in all Vertebrates, and adult type in the lowest Vertebrates (Cyclostomes). C, Mesonephric system and the male (♂) reproductive system in adult Fishes and Amphibians (Frog). D, the same, female (♀). E, Metanephric system, and male (♂) reproductive system in adult Reptiles, Birds, and Mammals. F, the same, female (♀). a, gonad; d, pronephric duct; d<sub>1</sub>, the same, vestigial; e, mesonephros; f, mesonephric duct (originally posterior portion of pronephric duct); f<sub>1</sub>, mesonephric duct acting also as sperm duct; f<sub>2</sub>, mesonephric duct acting solely as sperm duct; f<sub>3</sub>, mesonephric duct, vestigial; g, metanephros; h, metanephric duct; i, oviduct; j, uterus. See Figs. 225–228.

the waste products are taken solely and directly from the blood. It is therefore apparent that each of the relatively large, compact kidneys of the higher Vertebrates consists essentially of an enormous number of nephridium-like elements, the renal tubules, bound together by connective tissue and covered with a protective coat. The tubules within the kidney deliver the materials taken from the blood, the urine, to the pelvis of the kidney, from which it passes down the ureter into the urinary bladder, and finally to the exterior. (Figs. 251, 252.)

Such, in broad outline, is the historical viewpoint from which the human kidneys must be interpreted. As a matter of fact, however, the evolutionary transformation is still further complicated by anatomical, though not physiological, relations with the reproductive system. As will be pointed out later, this neighboring system now and again foists, as it were, some of its accessory responsibilities upon parts of the excretory (urinary) system, and even takes over portions and makes them integral parts of its own when they have been permanently abandoned by the urinary system in its development.



## CHAPTER XVII

# REPRODUCTION

**R**eproduction, as we know, is in the final analysis cell division, whether it is binary fission in unicellular forms such as *Protococcus* and *Amoeba*, or the setting free by the multicellular organism of cells with the power of going through a complex series of changes by which they rapidly become transformed into the individual similar to the parent. In most animals this process is complicated at the start by sexual phenomena: the fusion of two germ cells, the male and female gametes, to form the fertilized egg, or zygote. Indeed, sex is fundamentally a physiological difference between gametes, which, however, usually so profoundly influences the body that we recognize it as male or female. (Figs. 63, 255; Pp. 439, 440.)

Disregarding for the time being the actual origin of the germ cells in the body, we find in the Metazoa special organs in which the germ cells reside and undergo changes preparatory to their liberation. Such reproductive organs, or GONADS, ordinarily contain germ cells of one kind, and therefore are either ovaries or testes.

### A. GONADS

In many of the simpler animals, the gonads are merely temporary structures that appear during certain seasons of the year when conditions favor sexual reproduction. In some species the same individual produces both eggs and sperm, in which case the sexuality of the germ cells is not reflected back, so to speak, to the organism as a whole, which accordingly is known as a hermaphrodite. It will be recalled that such frequently is the condition in *Hydra* where the

testis and ovary appear as groups of ectoderm cells which in one case give rise to many sperm and in the other to a single egg. Thus in *Hydra* there is no complicated apparatus for sexual reproduction; merely now and again the temporary development of the primary sex organs. (Fig. 126.)

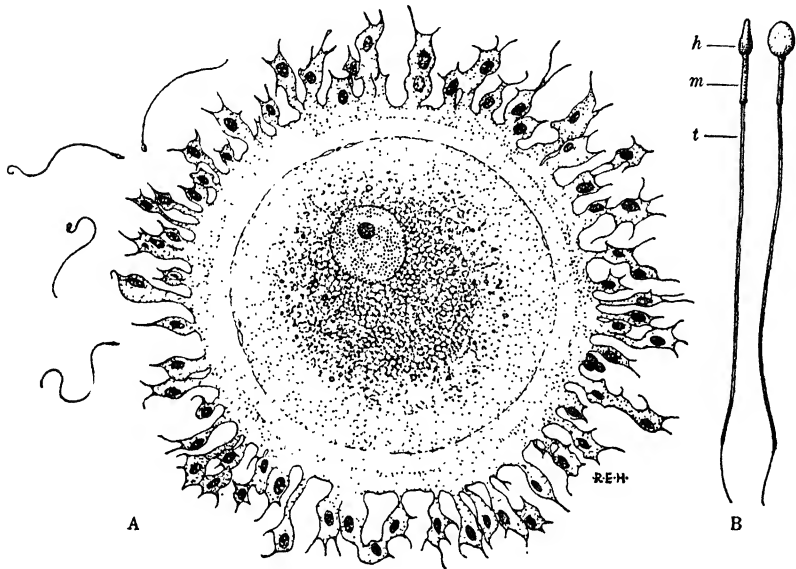

FIG. 255. Human egg and sperm. A, four sperm (left); and egg (right) just removed from the ovary, surrounded by follicle cells of the ovary and a clear membrane. The central part of the egg contains metaplasmic bodies and the large nucleus. Superficially there is a clear ectoplasmic region. Magnified about 400 times. B, two views of the human sperm, *h*, head consisting of the nucleus surrounded by a cytoplasmic envelope; *m*, middle piece; *t*, tail or flagellum. Magnified about 2000 times.

The complex bodies of most animals, however, demand more or less permanent gonads, as well as means for transferring the gametes directly or indirectly to the exterior. This is brought about by the fact that in coelomate animals the gonads come to lie, not on the outside of the body, but in the body cavity. In the Earthworm, which also is hermaphroditic, the testes and ovaries are permanent organs attached to the partitions between certain segments. The sexual products are set free in the coelom where they are

taken up by sperm ducts and oviducts and carried to the outside. (Figs. 128, 132.)

Throughout all the chief vertebrate groups the sexes are distinct, although in rare instances hermaphroditic individuals occur. The definitive primordial germ cells first appear as localized areas of the epithelium lining the coelom, on either side of the vertebral column. As the germ cells develop they become associated with connective tissue, blood vessels, and nerves and form the paired gonads. In the most primitive Vertebrates a condition more simple than in the Earthworm is found, for both male and female gametes merely break out of the gonads and find their way to the exterior by a pair of minute ABDOMINAL PORES. In higher forms, however, special sperm ducts and oviducts are developed in close relationship with the urinary system. (Fig. 255.)

In some aquatic and most terrestrial Vertebrates fertilization occurs while the eggs are still within the oviducts; the copulatory organ transferring the sperm directly to the terminal portion of the ducts through which they make their way up to meet the descending eggs. After fertilization the zygote may soon pass to the exterior; usually, as in the case of the familiar hen's egg, after being wrapped up in nutritive and protective coats secreted about it during its passage down the oviduct. Or, as is the case rarely among lower forms and the rule among all Mammals except the Monotremes, the zygote on reaching the lower part of the oviduct becomes attached to the wall of an enlargement of the oviduct or of a chamber formed by the union of the two oviducts, called the UTERUS. Here the embryo proceeds far along in development before birth occurs. (Figs. 256, 257, 299.)

## B. UTERINE DEVELOPMENT

In the human body, the attachment of the fertilized egg in the uterus is followed by the very rapid development of what may be regarded as a new uterine lining, profusely

supplied with blood vessels. This soon surrounds the embryo and, as pregnancy proceeds, the embryo protected by EMBRYONIC MEMBRANES projects into, and finally completely fills the gradually increasing uterine cavity. As the uterus

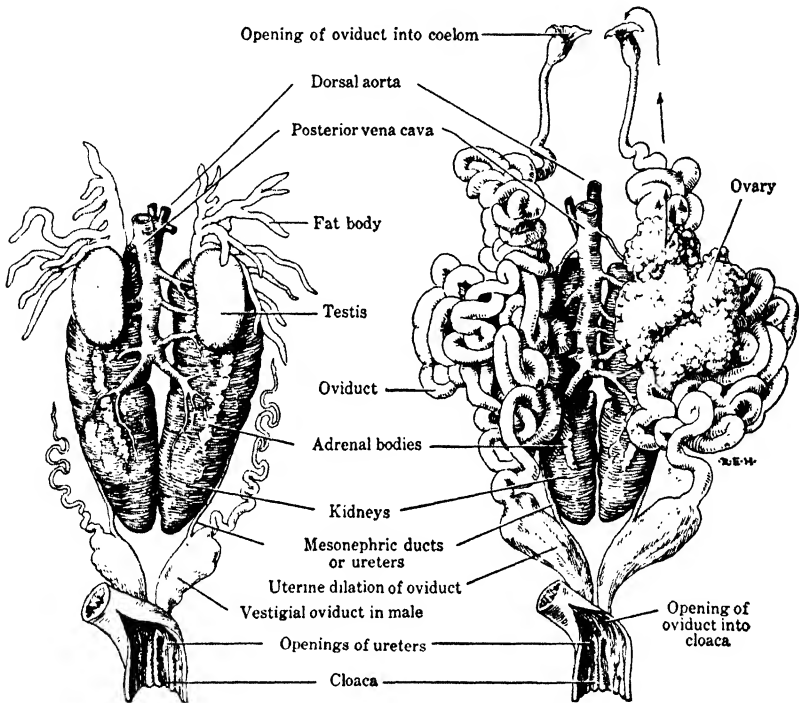

FIG. 256. Urogenital organs of the Frog.

enlarges, it exerts increasing pressure on the adjacent organs, and later shifts higher up in the abdominal cavity where the flexible body wall more readily accommodates it. Throughout the entire period of pregnancy the embryo leads essentially a parasitic existence at the expense of the mother's body which supplies it with food and oxygen, and removes carbon dioxide, urea, and other metabolic wastes. This, of course, imposes a considerable amount of extra work on the various maternal organs, especially the lungs, kidneys, and digestive system, and therefore special provisions must be

made for this intimate interchange of materials between the blood vascular systems of mother and offspring. (Fig. 257.)

The embryo at first is nourished by materials absorbed from the rich blood supply of the uterine wall, but soon this proves inadequate for the rapidly increasing demands of the growing

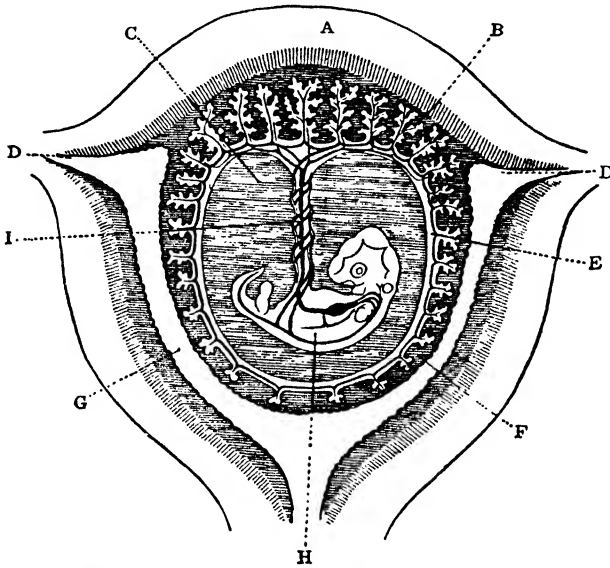

FIG. 257. Diagrammatic section of the human uterus with developing embryo. The embryo (H) is suspended in a fluid-filled cavity (C) surrounded by embryonic membranes (E) and by tissue (F) from the uterus itself. The sole path of communication between embryo and mother is by blood in vessels passing up through the umbilical cord (I), spreading out into capillaries in the placenta (B) and there coming into close relations with the maternal blood supply. The openings of the oviducts (D) into the uterus become closed during the development of the embryo. A, dorsal wall of uterus; B, placenta; C, fluid-filled cavity of amnion; D, openings of oviducts (Fallopian tubes); E, embryonic membranes; F, uterine tissue; G, uterine cavity; H, embryo; I, umbilical cord.

embryo, and a new structure, the **PLACENTA**, is formed jointly by the tissues of the uterus and embryo to meet the need. The connection of the embryonic body with the placenta is by the **UMBILICAL CORD**. The blood of the embryo passes by its arteries through the umbilical cord to capillaries in the placenta, and after exchanging various waste products for food and oxygen by diffusion with the

maternal blood supply, returns by veins to the embryo. Accordingly there is no direct intermixture of maternal and embryonic blood: the embryo from the beginning is a separate organism whose blood supply merely interchanges materials with that of the mother through the placenta. This temporary dependence is terminated when the child is expelled from the uterus, the umbilical cord is severed, and the offspring is born. A little later the so-called afterbirth, consisting of the placenta and embryonic membranes, is expelled. (P. 456.)

Thus, except in the simplest animals, there is a special reproductive system: a series of organs connected with the reproductive function. But it must be emphasized that the essential organs are the gonads themselves and all the rest are accessory. Furthermore, in relation to the sexual differentiation of male and female individuals, many so-called

SECONDARY SEXUAL CHARACTERS arise which are not directly connected with the reproductive organs, but nevertheless depend very largely for their development upon HORMONES liberated by the gonads. For example, early castration of the Stag inhibits the growth of a distinctive male secondary sexual character, the antlers; while if performed later when the antlers are full grown, they are shed and abnormal ones take their place. In fact, the sexual life of most animals, including man, is largely conditioned by hormonal activity, as will appear beyond. (Fig. 261.)

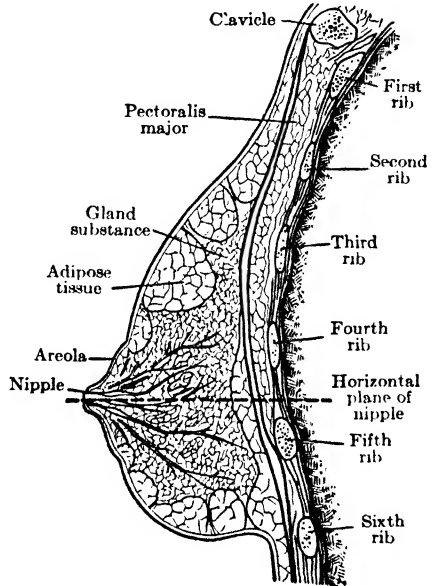

FIG. 258. Diagram of a mammary gland, human. (After Gerrish.)

## C. THE UROGENITAL SYSTEM

We must now outline the structural interrelations of the urinary and reproductive organs forming the UROGENITAL SYSTEM. It has been pointed out that the nephridia, which combine to form the kidneys in some of the lower Vertebrates, retain their funnel-like openings into the coelom and therefore afford a direct exit for waste material in the coelomic fluid. It is some of these nephridia that are employed in the lower Fishes for the transfer of the germ cells to the outside. The testes of the male, which lie close to the kidneys, become connected with the nephridia (mesonephros) by a series of short delicate tubes. Through these tubes the SPERMATIC FLUID, containing the sperm from the testes, is transferred to the nephridia and by them to the kidney (mesonephric) ducts and so to the exterior with the urinary waste. In this way, during the period of sexual activity of the male, the kidney tubules satisfactorily perform two functions, and the mesonephric ducts become UROGENITAL CANALS. (Fig. 254, C.)

Turning to the female, we find that the ovaries, which are situated in about the same position with relation to the kidneys as the testes in the male, do not enter into communication with a set of nephridia of the kidneys (mesonephros); probably because the eggs are too large to pass through the tubules. Instead, what appears to be the coelomic opening of a single nephridium-like structure on either side (which fails, so to speak, to enter the kidney complex) enlarges and becomes the funnel which connects up with a new duct opening into the cloaca. Thus there arises from the female urinary system a pair of entirely distinct oviducts. An egg, liberated from the ovary into the coelom, finds its way into one of the oviducts and descends directly to the outside, or into an enlargement (uterus) of the terminal portion of the duct where development proceeds until birth occurs. (Figs. 254, D; 256.)

The female reproductive system, though derived from the

mesonephric system, has become entirely independent of it. Accordingly the disappearance of the mesonephros and duct in higher Vertebrates, when it is replaced by the metanephros and the ureter as the functional urinary system, has little effect on the female reproductive system. As a matter of fact, the abandoned mesonephros and duct degenerate and disappear in the female, while in the male the mesonephric duct remains and becomes completely appropriated by the reproductive system. The sperm now pass directly into the former mesonephric duct, which thereby becomes solely a sperm duct. (Figs. 254, E, F; 259.)

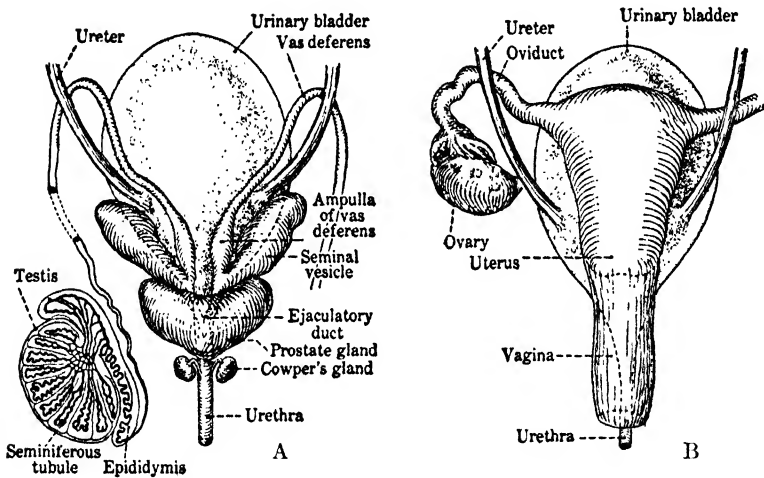

FIG. 259. Diagrams of the human urogenital organs. Posterior view. A, male; B, female. (From Hegner.)

Such is the historical origin of the foundations of the reproductive system as it occurs in the Reptiles, Birds, and Mammals. Each of these groups, building on this foundation, has developed modifications and additions demanded by its special lines of evolution. It appears again that, whenever possible, structures at hand are employed to construct what is to be, and thus there is woven in the woof and warp of higher forms a partial record of their ancestry.



## CHAPTER XVIII

# COÖRDINATION: ENDOCRINAL.

Nature is more subtle than any argument. — *Francis Bacon.*

**S**ince a primary attribute of protoplasm is irritability — the power of responding to environmental changes by variations in the equilibrium of its own matter and energy — it is not strange that the cells of an organism mutually influence each other's activities and reciprocal interrelationships have been established during their long evolutionary history. In fact the various cells, tissues, organs, and organ systems of animals, Invertebrate and Vertebrate, are unified into an organism by the ENDOCRINE SYSTEM, or chemical interplay between its various parts, which is made possible by the facilities for distribution afforded by the circulatory system; and also by the NERVOUS SYSTEM which supplies a central station with lines for instantaneous intercommunication with every part of the body.

It is only with the recent increase in knowledge of the general problem of metabolism that the far-reaching importance of the chemical control and integration of bodily processes has gradually been brought to the fore. Although we may properly think of the various chemical regulators, or HORMONES, as forming a coördinating system in so far as their collective action has such a result, in the present stage of our knowledge it is possible to do little more than cite the specific action of individual hormones as examples of the general method of chemical regulation which their study, ENDOCRINOLOGY, is revealing. It will be recalled that somewhat similar chemical agents, often called PHYTOHORMONES, occur in plants. (Fig. 59.)

Certain hormones in Vertebrates are elaborated by special secretory cells embedded in organs devoted partly to other functions, notably in the pancreas, gonads, and intestine; while others are formed by glandular organs devoted solely to their production, such as the thyroid, parathyroids, and pituitary. In every case the hormones are specific chemical substances which are liberated into the circulatory system for transport to the place where they are to exert their influence. Since the glandular cells secrete their products directly into the blood or lymph, they are known as **DUCTLESS GLANDS**, and their products are **INTERNAL SECRETIONS**. (Fig. 260; P. 317.)

### A. PANCREAS

Groups of special gland cells in the Pancreas, called **ISLETS OF LANGERHANS**, secrete the hormone, chemically isolated as **INSULIN**, which enables the body to oxidize dextrose and to store glycogen in the liver. (Figs. 229, 232.)

**DIABETES** has long been known to be the result of a deficiency in pancreatic function leading to the incoördination of the chemical processes by which the body utilizes carbohydrates which supply energy. Evidence of the disease is chiefly an increase in the sugar content of the blood and the presence of sugar in the urine. The body cannot use the sugar and must resort to proteins and fats for energy. Now we know that a close approach to the normal metabolic condition can be attained by administering to diabetics insulin extracted from the pancreas of sheep or other animals. Insulin thus takes the place of the secretion which the diabetic pancreas fails to provide and so removes the pall of hopelessness from many cases of diabetes.

### B. GONADS

As already stated, the male and female reproductive organs exert various endocrinal effects. This is evidenced, in particular, by the influence of castration on the development of secondary sexual characters. (Fig. 259; P. 355.)

The male sex hormone, or **TESTOSTERONE**, is secreted by cells between the tubules which produce sperm. When injected in castrated animals it corrects the deficiencies caused by testis removal. Furthermore, hormones from the pituitary gland are necessary for the normal development of the testes.

Several hormones are secreted by ovarian tissue. One, known as **ESTRIN**, is apparently produced in the egg follicles. It is associated with the development of secondary sex

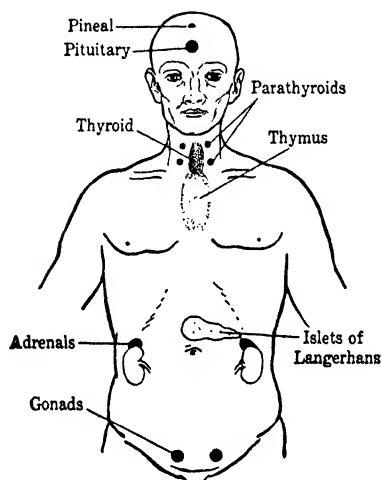

FIG. 260. Approximate position of some of the endocrine glands in Man.

characters and certain uterine changes, including those of the menstrual cycle. Another hormone, called **LUTEIN**, is secreted by the **CORPUS LUTEUM** which fills the follicle when the egg has been liberated. It inhibits ovulation, stimulates the growth of the uterus, sensitizes it for the implantation of the embryo, and induces other changes in the uterus during pregnancy. As in the case of the testis, the development of the ovary itself is dependent upon a hormone from the pituitary

gland. Thus it is becoming increasingly clear that the sex life and the behavior of the higher animals is to a considerable extent conditioned by a complex of hormonal relationships. (Fig. 261.)

### C. INTESTINE

Some of the cells lining the small intestine secrete hormones; in particular, one known as **SECRETIN**. The acidity of the chyle, or the food coming from the stomach, stimulates the cells to secrete the hormone which then passes by the blood stream to the pancreas and stimulates it to perform its digestive functions.

## D. THYROID

Turning now to glands devoted solely to the secretion of hormones, first may be considered the thyroid which arises as an outpocketing of the digestive tract in the neck region and finally loses all connection with its point of origin and becomes a ductless gland. (Fig. 229.)

The general effect of the thyroid hormone, THYROXINE, on metabolism is a regulation of the rate of oxidation in the body to meet changing physiological demands. An excess of thyroxine induces such vigorous fuel consumption that no surplus remains in the body to be stored as fat, while a deficiency in the glandular secretion results in a tendency toward fat formation. The administration of thyroid extract or thyroxine is often an efficient though dangerous means of reducing fat by increasing the oxidative processes of the

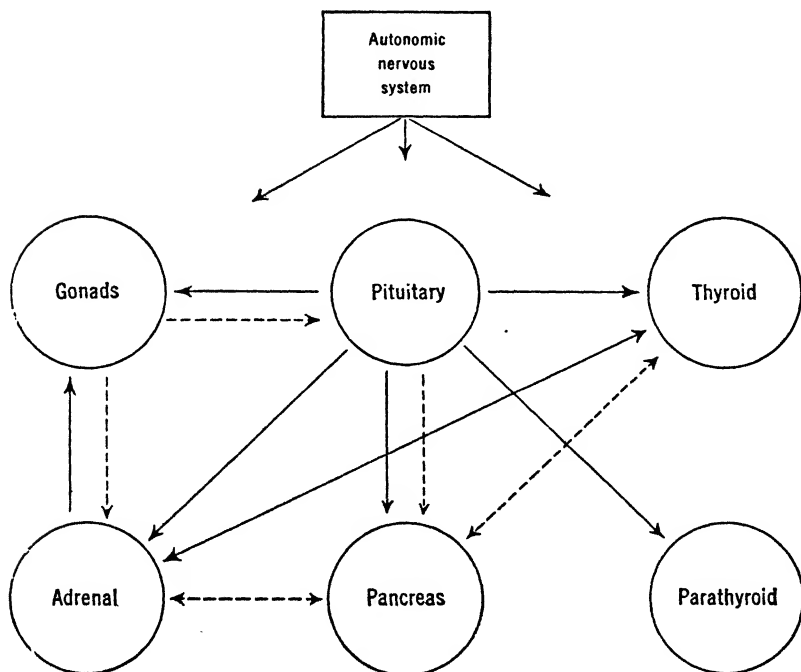

FIG. 261. Diagram to illustrate some of the chief lines of interplay between coördinating elements of the animal body. Stimulation —, inhibition - - -.

body. A deficiency of the hormone during adult life frequently results in a pathological condition called MYXEDEMA. Children in whom the development of the thyroid is suppressed become dwarfish idiots known as CRETINS, while overdevelopment of the gland induces increased nervous activity and mental disorders. Feeding with thyroid material prevents or retards the development of cretinism and cures myxedema, while a surgical removal of part of the gland may cure the nervous instability and other symptoms due to an excessive amount of the hormone. GOITER is a pathological enlargement of the thyroid due to a deficiency in iodine needed to manufacture its iodine-containing thyroxine.

### E. PARATHYROIDS

The PARATHYROIDS, usually four in number, are small glands closely associated with the thyroid but performing a distinct function: the regulation of the calcium-phosphorus balance in the blood by a hormone known as PARATHORMONE. Removal of the glands is followed by a sharp decrease in calcium which results in convulsions, tetany, and death, unless controlled by the intake of calcium or the injection of the hormone. (Fig. 260.)

### F. ADRENALS

The ADRENAL GLANDS, one situated in close proximity to each of the kidneys, are endocrine organs of high significance that secrete at least two hormones. One, known as EPINEPHRIN, is poured into the blood when the glands are stimulated by the nervous system. Epinephrin has its most marked effect when muscular exertion is at a premium: it accelerates heart action, increases blood pressure, reduces muscular fatigue, stimulates the liver to release its stored glycogen, retards the activities of the alimentary canal, dilates the eyes, etc. It appears to act as a chemical whip which makes various organs play their part in the general mobilization. (Fig. 256.)

Another hormone, CORTIN, has a regulating influence on carbohydrate metabolism. The destruction of the cortex of the glands which secrete the hormone is followed by muscular weakness, convulsions, and other symptoms characteristic of the rare ADDISON'S DISEASE. Administration of cortin relieves the symptoms.

## G. PITUITARY

The pituitary gland, or hypophysis, is sometimes referred to as "the master gland" because of the wide range of its hormonal influence. It comprises two chief lobes of diverse origin: the anterior from the roof of the pharynx, and the posterior from the infundibulum on the ventral surface of the brain. (Fig. 267.)

The anterior lobe supplies at least ten hormones, many of which exert specific control over other endocrine organs or over the production of other hormones. Representative examples may be cited:

The SOMATROPIC hormone controls growth and development. A deficiency results in DWARFISM and an excess, GIGANTISM. In adult life an excess of the hormone produces ACROMEGALY, characterized by abnormal enlargement of the bones, particularly of the face, hands, and feet.

PROLAN exerts a controlling effect on the development of the male and female gametes, in particular on the ovarian follicles and therefore on their own hormonal influences.

PROLACTIN initiates and maintains lactation after the mammary glands have matured under the influence of other hormones.

The ADRENOTROPIC hormone (or factor) regulates the development of the adrenal cortex and therefore the production of its hormone.

The PANCREATOTROPIC hormone controls the islets of Langerhans and regulates insulin production.

The THYROTROPIC hormone regulates the secretion of thyroxine.

The DIABETOGENIC hormone has an antagonistic action toward insulin in the control of blood sugar, perhaps by acting on nerve centers which influence carbohydrate metabolism.

The functions of the posterior lobe of the pituitary gland have not been clearly determined. Extracts of it afford a material called PITUITRIN which, when injected, increases blood pressure, reduces urine secretion, and induces contraction of the uterus. But whether this is secreted into the blood under normal conditions is uncertain. The presence of the posterior lobe apparently is not essential for health. (Figs. 261, 267.)

## H. PINEAL BODY

A small cone-shaped outgrowth of the dorsal surface of the midbrain, known as the pineal body, apparently is the remnant of a median eye which was present in some fossil forms and appears in one genus of living lizards. It may be recalled that over three centuries ago Descartes identified it as "the seat of the soul." Now it is generally accorded an endocrinal function but neither the nature of the secretion nor its effects are as yet clear. It is possible that it influences a hormone from the pituitary which, in turn, affects the gonads. (Figs. 267, 268.)

## I. THYMUS

The thymus gland usually consists of two lobes joined across the front of the neck. In man it reaches its greatest development in childhood and then decreases markedly after puberty. The hormone of the thymus, sometimes called THYMOCRESCIN, has been claimed to accelerate cell growth and division and therefore to influence the growth rate during early life. (Fig. 229.)

Enough perhaps has been said to emphasize that the recent development of our knowledge of hormones and their interrelations has already given impressive evidence of their

importance in the economy of the organism. It may well be that each and every tissue liberates specific chemical substances that are hormonal-like in action. And when we add the influence of stimuli from the nervous system on the complex of the endocrinal glands, in particular on the pituitary, the maze of action and interaction that integrates the organs into an organism is astounding. (Fig. 261 ; P. 388.)

The almost uncanny potency of some of these chemical agents is evidenced, for example, by the fact that as little as one milligram of thyroxine is sufficient to induce a two per cent increase in the total oxidation of the resting human body. And the amount of this hormone required by the body during a whole year is probably about  $2\frac{1}{2}$  grams, while that in use at any one time is approximately two tenths of a gram. "But this pinch of material spells all the difference between complete imbecility and normal health." So close is the "physiological sympathy of the parts in the commonwealth of the body, that it is perhaps justifiable to regard the mind as a function of the whole organism" — a thought that must give pause not only to the biologist but also to the sociologist. Chemical coördination is indeed a fact.



## COÖRDINATION: NERVOUS

It seems that Nature, after elaborating mechanisms to meet particular vicissitudes, has lumped all other vicissitudes into one and made a means of meeting them all. — *Mathews*.

**A**lthough hormones are indispensable as a means for regulating many of the functions of both animals and plants, they are entirely inadequate for the instantaneous correlation of diverse parts of animals and also for the adjustment of the whole animal to its surroundings. This need

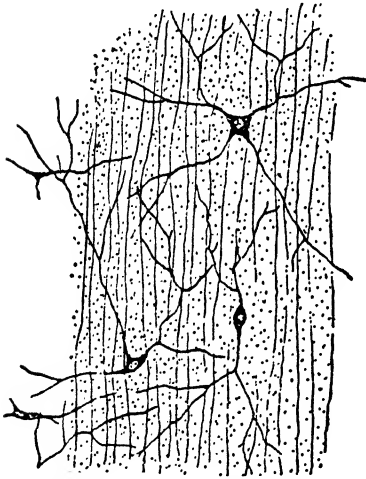

FIG. 262. Nerve cells in the ectoderm of *Hydra*. Highly magnified. The parallel lines represent muscle fibers. (After Schneider.)

is supplied by the **NERVOUS SYSTEM**: a complicated arrangement of cellular elements in which irritability and conduction are highly developed. The study of the nervous system constitutes the science of **NEUROLOGY**.

Even in some unicellular organisms certain portions of the protoplasm are especially differentiated for receiving and conducting stimuli, and others for making effective such stimuli by contractions of the whole or parts of the cell. Indeed, *Paramecium* and other *Ciliates* possess a **NEUROMOTOR SYSTEM** which apparently consists of a coördinating center, or **MOTORIUM**, from which conductile paths extend through the cell to the cilia, etc. But it is in the lower **Metazoa**, such as *Hydra* and its allies, that we find the

establishment of definite NERVE CELLS, some of which are specialized for receiving stimuli and others for conducting the excitation to cells specialized for contracting (muscle cells), etc. Thus a simple RECEPTOR-EFFECTOR system arises which may be regarded as the basis for the development of the elaborate NEURO-MUSCULAR MECHANISM of higher forms. Although from the functional point of view it is difficult to differentiate the receptors, conductors, and effectors in the economy of the organism, from the standpoint of anatomy the conductors constitute a definite entity, the nervous system proper. (Figs. 150, 262-264, 272, 273.)

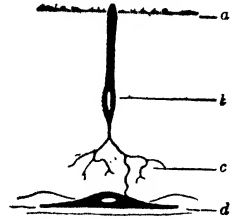

FIG. 263. Diagram of a simple type of receptor-effector system found in some Hydra-like animals. It comprises receptors (*b*), or sense cells, reaching to the body surface (*a*), with basal nerve net (*c*) connecting with muscle cells (*d*). (Slightly modified, after Parker.)

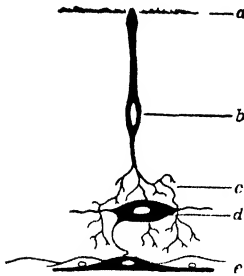

FIG. 264. Diagram of a more complex type of receptor-effector system, found in some Hydra-like animals. It comprises, in addition to the receptor (*b*) with nerve net (*c*) and the muscle cells (*e*), another nerve (ganglion) cell (*d*) interpolated in the nerve net. (*a*) body surface. (From Parker.)

The structural elements of the nervous system of all animals consist of cells known as nerve

cells, or NEURONS. In the lower forms these cells are united so that they form NERVE NETS which surround and permeate the tissues which they stimulate to action. In more highly developed animals the net arrangement is relegated to the control of relatively minor functions, while the main nervous system consists of numerous neurons arranged in groups, or GANGLIA, and prolongations of the neurons, or NERVE FIBERS, bound together into cables, or NERVES. The neurons, which are embedded in protective sheaths of connective tissue in the ganglia, are in physiological continuity one with another by 'transmitting contacts,' or SYNAPSES; but each neuron, it is believed, remains structurally distinct. (Figs. 265, 266, 271.)

continuity one with another by 'transmitting contacts,' or SYNAPSES; but each neuron, it is believed, remains structurally distinct. (Figs. 265, 266, 271.)

A. CENTRAL NERVOUS SYSTEM

It will be recalled that the first great differentiation during the development of a multicellular animal establishes an outer ectoderm and inner endoderm, and thus separates the functions of protection and general reactions to the environ-

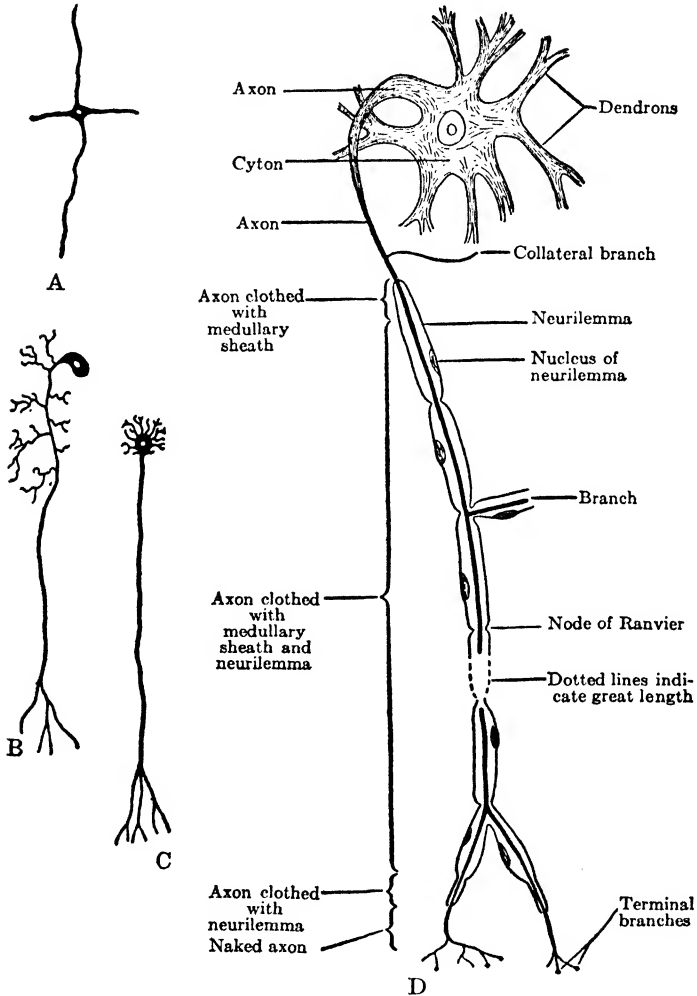

FIG. 265. Neurons. Stages in the differentiation of nerve cells. A, primitive neuron from the nerve net of Hydra-like animals; B, motor neuron of the Earthworm; C, D, primary motor neurons of a Vertebrate. (D from Kimber, Gray and Stackpole.)

ment from that of nutrition. It is natural therefore that the ectoderm should become the seat of those specializations which have evolved into the nervous system and sense organs. Such is the case in all forms from the lowest to the highest, and thus the development and comparative anatomy of the nervous system of Vertebrates, in particular, affords evidence of the genetic continuity of the whole series.

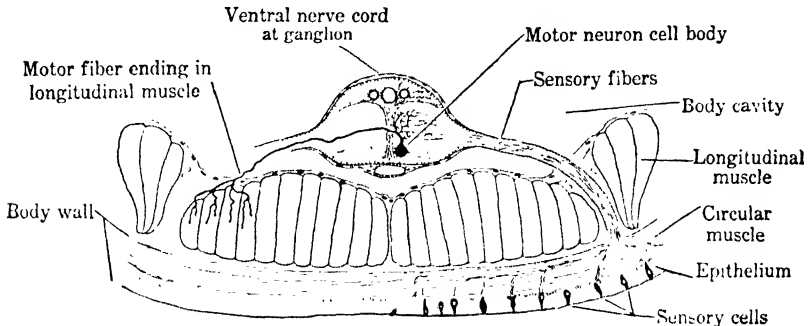

FIG. 266. Diagram of primary sensory and motor neurons of the ventral nerve cord of an Earthworm, showing their connections with the skin and the muscles to form a simple reflex arc. Highly magnified. See Fig. 131.

In the development of a Vertebrate, the first indication of the nervous system is a **MEDULLARY PLATE** in the ectoderm along the dorsal surface, which soon becomes converted into a tube by the apposition and, finally, the fusion of its edges. This **NEURAL TUBE** then becomes separated from, and sinks below the surface ectoderm, and in time forms the **CENTRAL nervous system** consisting of the **BRAIN** and **SPINAL CORD**. As development proceeds, outgrowths from the central nervous system establish the **CRANIOSPINAL** and the **AUTONOMIC** systems, so that structurally as well as physiologically the whole nervous system represents a unit; a single organ, as it were, which secondarily becomes closely identified here and there with sense organ, muscle, or gland, as the case may be. (Figs. 269, 304.)

The first marked structural modifications in the developing central nervous system of Vertebrates are two constrictions of the enlarged anterior end of the neural tube, which estab-

lish the three primary brain vesicles: FORE-BRAIN, MID-BRAIN, and HIND-BRAIN. Thus very early in embryonic development, one end of the neural tube is molded into the brain, leaving the rest to become the spinal cord. (Fig. 267.)

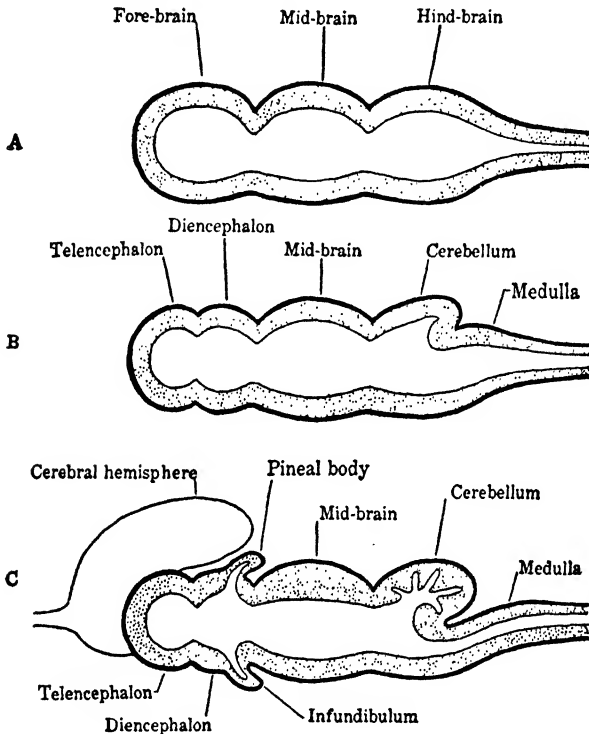

FIG. 267. Diagrams to illustrate the general method of transformation of the anterior end of the neural tube into the brain. Median vertical sections.

The three-vesicle brain now becomes transformed into one of five vesicles by a hollow outpocketing from the anterior end of the fore-brain and a dorsal outpocketing from the hind-brain. In the lowest forms the brain throughout life consists essentially of these divisions, known as TELENCYPHALON, DIENCEPHALON, MID-BRAIN, CEREBELLUM, and MEDULLA OBLONGATA—the last merging into the spinal cord. The telencephalon usually gives rise to a pair of CEREBRAL HEMISPHERES which, in higher forms, are destined

gradually to overshadow in size and significance, all the other parts of the brain. Finally, the development of a pair of **OLFACTORY LOBES** from the telencephalon — or its derivatives, the cerebral hemispheres — completes the establishment of the chief brain chambers.

The further changes which transform the more or less linear series of vesicles into the increasingly complex and compact brain of higher forms are due to bendings, or **FLEXURES**, and to unequal thickenings and outgrowths of the chamber walls. For instance, the upper and lower surfaces of the diencephalon give rise to the **PINEAL BODY** and the **INFUNDIBULUM** respectively, while from similar regions of the mid-brain are developed the **OPTIC LOBES** and **CRURA CEREBRI**. Hand in hand with these changes the primary cavities of the chambers undergo a gradual restriction, but throughout all there persists at least a remnant of the original tubular cavity which is continuous with that of the spinal cord. (Figs. 228, 268.)

The **CEREBRUM**, or cerebral hemispheres, is considerably the largest and most important part of the human brain since it is the center of perceiving, thinking, voluntary motion, and even consciousness — the seat of the higher mental life in general. These primary activities are performed by neurons, the cell bodies being located in the **CORTEX**, the outer layer of **GRAY MATTER**, while the nerve fibers of the neurons extend deeper to form the inner **WHITE MATTER**. These fibers transmit nerve impulses to and from the cell bodies in the cortex.

Next in importance is the cerebellum which, of course, also consists of neurons. Their functions are subsidiary to those of the cerebrum since initiative resides in the cerebrum, but messages from this director are coördinated by the cerebellum on their way to various parts of the body. Thus, one may consciously extend an arm, but the various compensating movements of other parts of the body that are necessary to maintain equilibrium are attended to by the cerebellum. It is discriminating but not conscious.

Finally, in the medulla, nerve fibers are in the ascendancy since all nerve impulses to and from the cerebrum and cerebellum and the spinal cord are transmitted through the medulla. The crura cerebri are large bundles of fibers extending from the medulla to the cerebrum. However, nerve cells

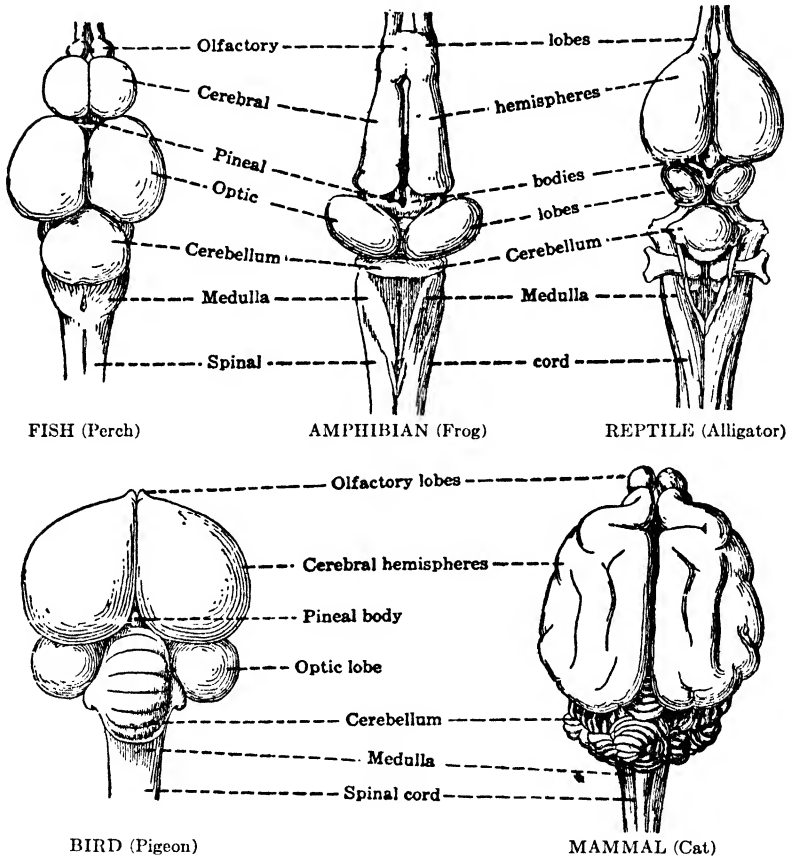

FIG. 268. Diagrams of the dorsal surface of the brain of five types of Vertebrates to show the relative development of the various parts.

are also prominent in the medulla: some of them give rise to nerves, and some form functional groups, or centers of action for regulating the respiratory and circulatory organs, known as the **RESPIRATORY CENTER**, **VASOMOTOR CENTER**, etc.

## B. CRANIOSPINAL SYSTEM

The brain and spinal cord are, as we know, protected and isolated by a cartilaginous or bony case formed by the skull and the neural arches of the vertebrae which are embedded in the muscles forming the dorsal part of the body wall.

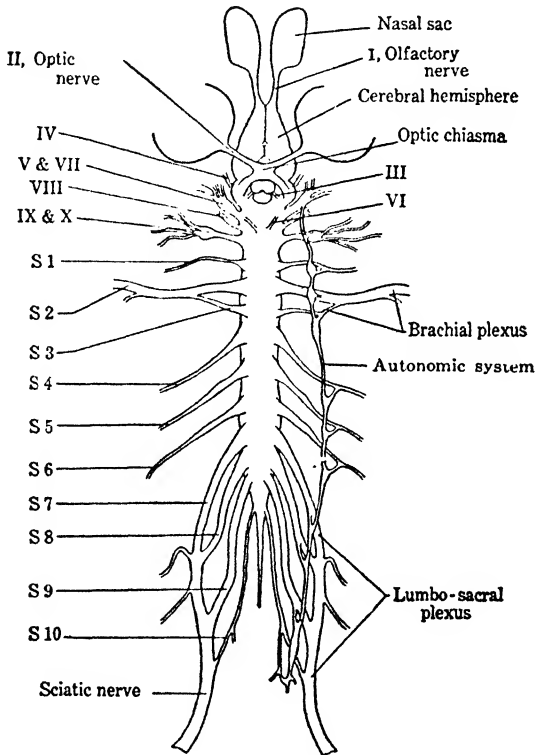

FIG. 269. Ventral view of the central nervous system of the Frog, showing the origins of the cranial and spinal nerves, and the autonomic system of one side. I-X, the ten cranial nerves; S1-S10, the ten spinal nerves. (After Mavor.)

The sole paths of nervous communication between the central system and the rest of the organism and its surroundings are a series of pairs of CRANIAL and SPINAL NERVES. These arise at fairly regular intervals from one end of the brain and cord to the other, and pass out through openings



in the skull and between or through the vertebrae to constitute the craniospinal system. (Figs. 228, 269, 270.)

It is usually considered that the primitive segmental condition of the vertebrate body is well exhibited in the arrangement of the cranial and spinal nerves, and that the origin of the cranial nerves from the brain affords a partial index to the primary series of segments which have been merged to form the vertebrate head. Conditions as they exist at the present time can perhaps be most readily understood by imagining a simple, ancestral, segmented worm-like form in which the dorsal neural tube gives off a pair of nerves to each segment of the body. As the result of a gradual shifting forward, union, and finally complete fusion of certain segments near the anterior end, there is formed a head region with its brain, battery of sense organs, and skull, more or less distinct from a trunk region with its spinal cord, vertebral column, paired limbs, etc. This **CEPHALIZATION** naturally involves a corresponding shifting and modification of the primitive condition of the paired nerves; especially since the innervation of a group of cells in normal development is apparently rarely changed — a nerve following the part which it originally supplied through many of the transformations and even migrations of the latter.

If this point of view is accepted, the cranial and spinal nerves are, historically considered, similar structures. But the former, synchronously with the changes in the head region, have departed somewhat widely from their ancestral condition and have even been augmented by nerves of diverse origin. The spinal nerves, on the other hand, continue to issue from the cord at about equal intervals and in segmental arrangement as indicated by muscle segments and skeletal structures, although those of certain regions unite in the body cavity to form groups, or **PLEXUSES**, to afford an adequate nerve supply to the appendages. (Figs. 269, 270.)

From the standpoint of function the nerves are of three classes: **SENSORY**, **MOTOR**, and **MIXED**. Sensory nerves are

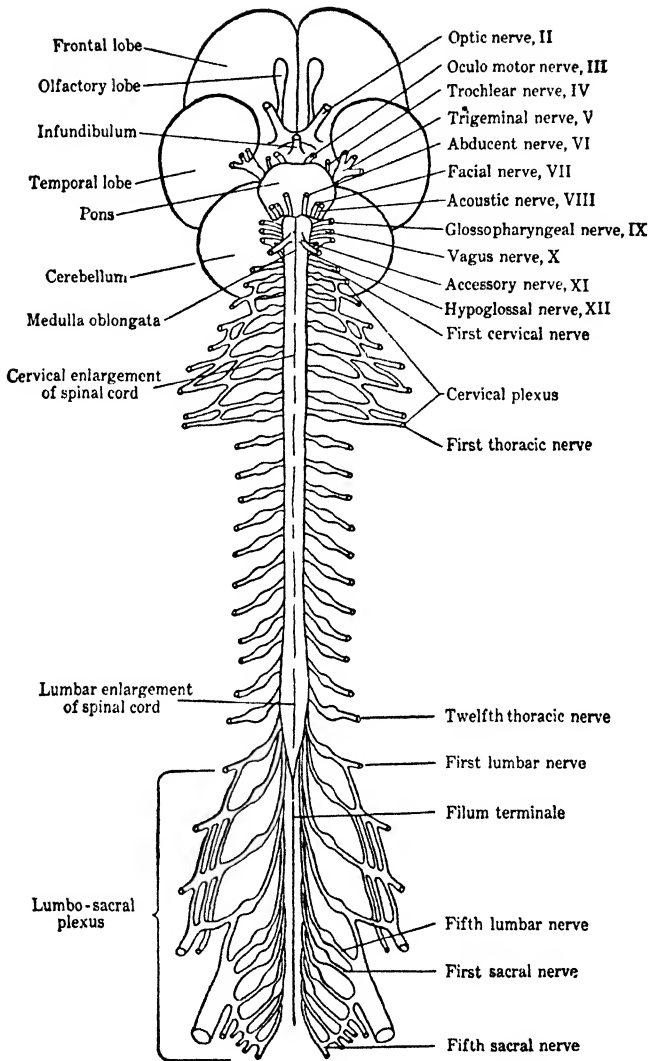

FIG. 270. Ventral view of the central nervous system of Man, showing the origins of the cranial and spinal nerves and the nerve plexuses. The term 'cervical plexus' is used to include the cervical plexus proper, composed of the first four cervical nerves, and the brachial plexus which includes the last four cervical nerves and the first thoracic nerve; the term 'lumbo-sacral plexus' is used to include the lumbar plexus, composed of the first four lumbar nerves, and the sacral plexus which includes the fifth lumbar, the sacral, and the coccygeal nerves. The autonomic system is not shown. (From Mavor.)

the paths over which excitations, or NERVE IMPULSES, due to stimuli are conducted to the cord and brain, while motor nerves are the paths for distributing impulses from the brain and cord to muscle cells, gland cells, etc., and thus induce the response of the organism. The great majority, however, are mixed nerves which afford paths not only for sensory but also for motor impulses and so perform both functions.

The nature of a nerve impulse has not been determined, although it is clear that both chemical and electrical changes are associated with its conduction through a nerve fiber. It appears that nerve impulses, in many cases at least, are not transmitted directly to the cell stimulated, but by means of chemical substances that are liberated from the nerve endings into the tissue fluid surrounding the cells. This is referred to as HUMORAL TRANSMISSION.

It is important to note that a nerve is actually a bundle of nerve fibers; the fibers themselves in turn being prolongations of nerve cells, the cell bodies of which are usually in groups, or ganglia. Moreover, a nerve impulse is not transmitted by a nerve as a whole, but by one component cell process, a nerve fiber; that is, by way of a definite cell path through the nerve. The same is equally true of the cord and the brain which differ from nerves largely in that they comprise more cell processes and also the cell bodies themselves. In other words, the brain and cord comprise the elements of both ganglia and nerves.

A mixed nerve conducts impulses both to and from the central organ because it contains both sensory and motor cell paths, or fibers. All cranial and spinal nerves are primarily mixed nerves, because typically they arise by two roots from the central organ; the DORSAL ROOT containing only sensory (afferent) fibers and the VENTRAL ROOT only motor (efferent) fibers. This condition is preserved by the spinal nerves of higher forms since each arises by two roots. But some of the cranial nerves, in response to the profound modifications that have been wrought in the head region, have only one root, and so are either solely sensory, as those

to the sense organs, or only motor, as those innervating the muscles which move the eye. (Fig. 271.)

Many nerve impulses set up by sensory stimuli are, in part, shunted directly from sensory to motor nerve paths in the spinal cord itself. One removes his finger from the

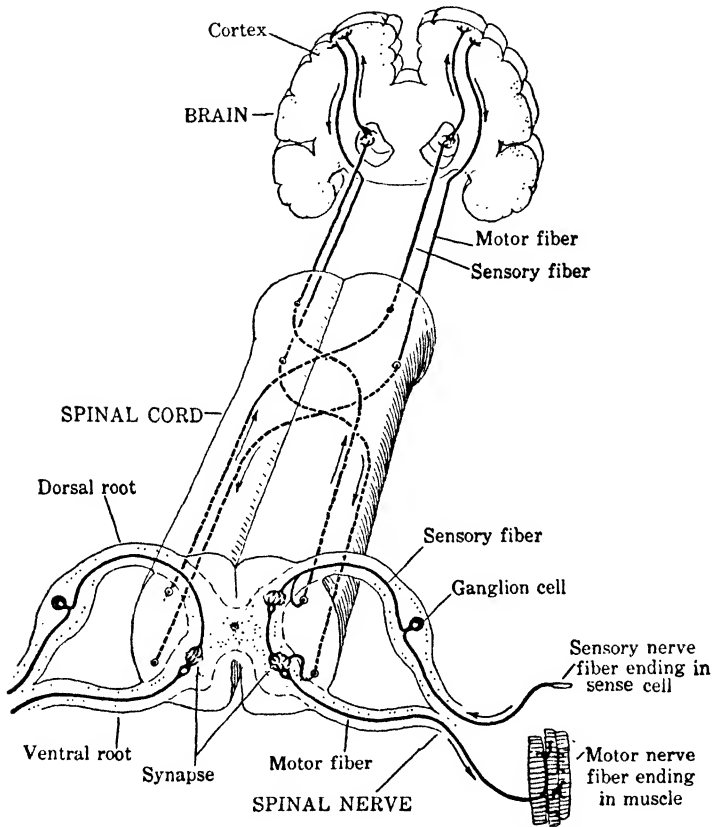

FIG. 271. Diagram of the paths of sensory and motor nerve fibers. A reflex arc from sense cell via spinal cord to muscle cell is shown at lower right.

pin-point before he is conscious of the prick. Thus so-called **REFLEX ARCS** bring about the multitude of **REFLEXES** which relieve the brain of much unnecessary labor, and are the basis of the behavior of animals. Many reflexes apparently are inherited, but others, known as **CONDITIONED REFLEXES**, are established as the result of experience. (Figs. 266, 271.)

## C. AUTONOMIC SYSTEM

So far we have considered the central system — the brain and spinal cord, and its lines of communication with the

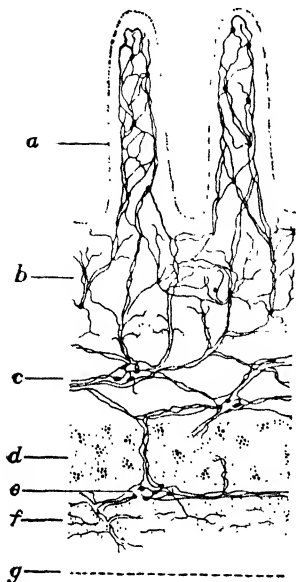

FIG. 272. Diagram of a section (highly magnified) of the wall of the intestine of a Vertebrate to show its intrinsic nervous organization which brings about the movements of the tube. The two plexuses consist essentially of simple neurons arranged as nerve nets. *a*, food absorbing surface of the intestine; *b*, mucous layer; *c*, plexus of neurons (submucous); *d*, circular muscle; *e*, plexus of neurons (myenteric); *f*, longitudinal muscle; *g*, serous layer. See Fig. 234. (From Parker, after Lewis.)

body as a whole — the cranial and spinal nerves. But it must be emphasized that this craniospinal system gives rise to a highly complex auxiliary series of ganglia and nerves which is charged with the regulation of practically all of the functions of the body that are not under voluntary control, such as those of the circulatory system and alimentary canal. This AUTONOMIC SYSTEM in the higher Vertebrates consists essentially of a double nerve chain, situated chiefly in the body cavity just ventral to the vertebral column, from which branches proceed to innervate the nearby organs. It communicates with the central system by way of the sensory roots of the spinal and some of the cranial nerves. (Figs. 269, 272.)

Such, in essence, is the distribution throughout the body of the nervous system which, although it arises as an infolding of the ectoderm and therefore is primarily external, comes to be internal and so chiefly dependent upon more or less isolated groups of SENSORY cells for the reception of stimuli. Some of these, termed EXTERNAL RECEPTORS, remain at the surface to receive stimuli from the outer world, while others, known as INTERNAL RECEPTORS, are situated within the body for the

reception of stimuli arising there. The external receptors are what one ordinarily thinks of as sense organs. But whatever the source of the stimulus or the location of the sense organ, all sensations are 'felt' and interpreted in the brain. This is somewhat obscured by our habit of projecting sensations to the part stimulated. The brain sees and hears.

#### D. SENSE ORGANS

Although among some of the Protozoa certain regions of the cell are specialized so that they are more sensitive to one or another kind of stimulation, the great majority show no trace of sense organs. Nevertheless all forms, in common with all protoplasm, possess the power of receiving and responding to environmental changes. Thus Amoeba and Paramecium react to mechanical, thermal, chemical, and electrical stimulation: the entire surface of the cell is sensitive to stimuli, and the excitations are conducted from one part to another essentially by the protoplasm as a whole, aided in Paramecium and its allies by the neuromotor system. (Fig. 150.)

In some Invertebrates, such as Hydra and the Earthworm, the entire surface of the body is still depended upon as a receiving organ for all kinds of stimuli, and only simple sense cells are developed. In the majority of animals, however, although all the cells, of course, retain their power of irritability, environmental changes exert their influence chiefly upon complex receptors which are specialized to respond most readily to particular forms of energy. The energy, for example, of heat or light, is transformed by appropriate

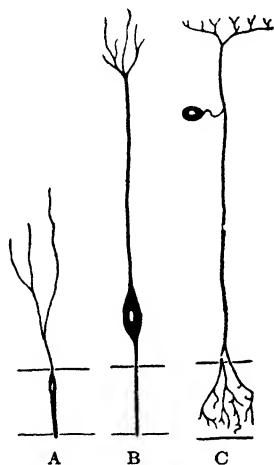

FIG. 273. Diagram of stages in the differentiation of sense cells. A, primitive sensory neuron of Hydra-like animals; B, sensory neuron of a Mollusc; C, primary sensory neuron of a Vertebrate. In each case the sensory surface is represented below, and therefore the nerve impulse passes upward. (From Parker.)

mechanisms into the energy of a nerve impulse, and accordingly the sense organs constitute the outposts of the nervous system. (Figs. 262-264, 266, 273, 274.)

Since we necessarily gain our knowledge of the outside world solely through the data afforded by our sense organs, it follows that we judge the capacity of the sense organs of other animals merely by comparing them with our own. This is a safe procedure only in the case of sense organs that more or less correspond in structure to those which we possess. In the Crayfish, for example, we find complex sense organs which, without doubt, are eyes, and others which are ears, or at least perform one of the functions of our ears, equilibration; while some of the head appendages are particularly adapted to receive sensations of touch. The senses of smell and taste are also probably present, but here we are on less sure ground. It is, indeed, almost certain that environmental changes which are without effect on the sense organs of the human body, and so play no recognizable part in the 'world' of man, may stimulate receptors in lower organisms. But human ingenuity has in certain cases devised apparatus to minimize his limitations: witness the radio receiver. (Figs. 135, 180; Pp. 199, 200.)

The simplest form of sense organ in Vertebrates is a single epithelial cell for the reception of stimuli, connected with a nerve fiber for the conduction of the nerve impulse to a sensory center. Usually, however, many associated cells are arranged to respond and are aided by accessory structures for intensifying the stimulus, protection, etc., so that the whole forms a highly complex sense organ. (Figs. 273, 278.)

### 1. *Cutaneous and Internal Senses*

Confining our attention to the Vertebrates, we find that practically the entire surface of the body constitutes a sense organ, because the skin is permeated with a network of sensory nerves. Certain regions are supplied with special PRESSURE RECEPTORS which may take the form of a regular

system of sense organs, such as the LATERAL LINE ORGANS of fishes and amphibians, or of groups of TACTILE CORPUSCLES as in man. In addition to pressure receptors, most of the surface of the human body is provided with PAIN, HEAT, and COLD SENSE SPOTS, either singly or in clusters. Thus it has been estimated that there are nearly four million pain spots and about sixteen thousand heat spots.

The surfaces within the body, such as the muscles, etc., are also provided with sensory nerves. The so-called muscular sensibility, hunger, and thirst are examples.

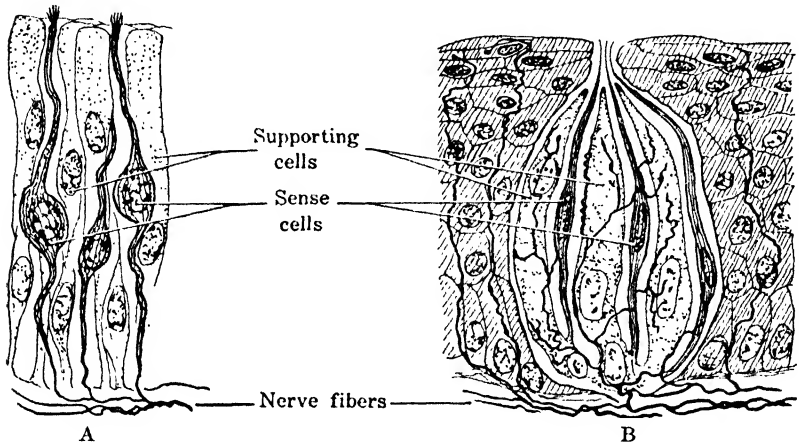

FIG. 274. A, cells of olfactory epithelium from human nose. B, cells of a taste bud in epithelium of tongue. The sensory cells terminate externally in hair-like processes which are activated by the chemical stimuli that produce odor or taste.

## 2. Sense of Taste

In the higher Vertebrates the sense of taste is restricted to the cavity of the mouth, particularly to the tongue, where special receptors known as TASTE BUDS are in communication with the brain by two of the cranial nerves; but in some Fishes similar organs are scattered quite generally over the surface of the body. In Man taste sensations are numerous but apparently are the result of combinations of four fundamental sensations — sweet, bitter, acid, and salt — and also sensations of smell. (Fig. 274.)



### 3. Sense of Smell

The special sense organs of smell, or **OLFACTORY CELLS**, reside in the membrane which lines a pair of invaginations of the anterior end of the head, termed **OLFACTORY POUCHES**. The cells are in communication with the brain by the olfactory, or first pair of cranial nerves. The pouches constitute relatively simple sacs in the lower Vertebrates, but in the air-breathing forms, and especially in the Mammals, the walls of the pouches are thrown into folds, ridges, and secondary pouches. This is necessitated by the concentration of the olfactory surface to the air passages in the upper part of the **NOSE** which lead through the posterior nares to the pharynx. However, the human olfactory apparatus has

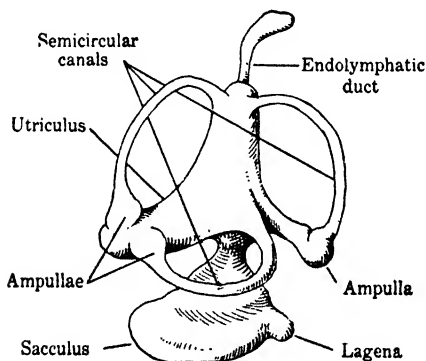

FIG. 275. Diagram of the left membranous labyrinth of a lower Vertebrate, showing the sacculus, utriculus, and the three semicircular canals. The lagena is a derivative of the sacculus which becomes the cochlea in higher Vertebrates.

fallen somewhat from the complexity which is attained in the lower Mammals, as is attested not only by its structure in the adult but also by transient remnants in the human embryo. (Fig. 274.)

above the lower Fishes, loses its connection with the exterior and forms the so-called **INNER EAR**, or **LABYRINTH**. This becomes divided into two chief parts, the **SACculus** and the **UTRICULUS**, from which are developed three **SEMI-CIRCULAR CANALS**, one in each plane of space. The sacculus is largely devoted to the reception of vibrations of the surrounding medium, that is to hearing in the usual sense

### 4. The Ear

The ear, or organ of hearing and equilibration, arises as a depression of the ectoderm of the head, which, in all Vertebrates

of the word. Accordingly the sacculus becomes progressively differentiated as we ascend the vertebrate scale—a complex derivative in the mammalian ear being the COCHLEA. (Figs. 275, 276.)

On the other hand, the utriculus and the semicircular canals provide for sensations of loss of equilibrium, or orientation of the body in space, and show far less change. It is probable that equilibration is the chief function of the

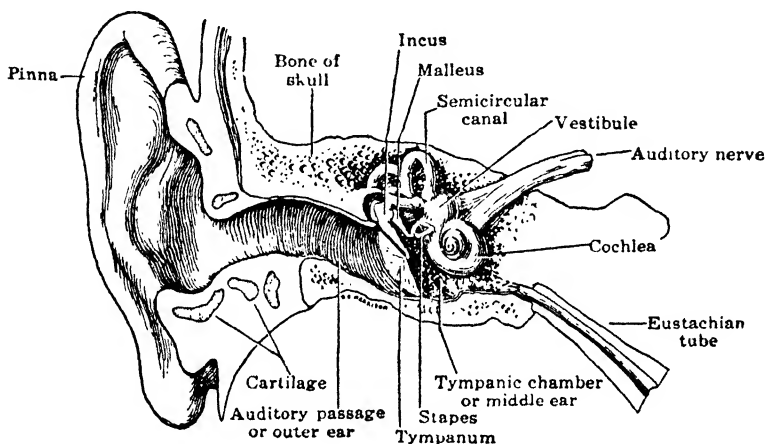

FIG. 276. Front view of a vertical section of the human ear, right side. Note the transmitting mechanism of three bones: malleus, incus, and stapes.

entire labyrinth in Fishes, as it is of the so-called auditory organs of many Invertebrates, such as the Crayfish. With the progressive specialization of the labyrinth, the essential sensory cells, which are in communication with the brain by the eighth, or AUDITORY NERVE, become limited to a few definite areas. These sensory cells are provided with auditory hairs which project into the cavity of the labyrinth and so are stimulated by movements of the fluid which fills it.

The ears of Fishes lie immediately below the skull roof where they are readily accessible to vibrations transmitted by the water. But with the substitution of air for water as the surrounding medium, there arises the necessity of a more delicate method for conducting and also for collecting

and augmenting the sound waves. The result is that, in ascending the vertebrate series, we find the ear proper receding farther and farther below the surface.

Soon, between the labyrinth, or inner ear, and the surface of the head, a simple resonating chamber is added which is provided with a vibrating membrane, the **TYMPANUM** or **EAR DRUM**, situated just under the skin. Then this is improved by the development of a bony transmitting mechanism between the tympanic membrane and the inner ear. This consists of a single bone until we reach the Mammals, when two more bones are added by being diverted from their earlier function of articulating the jaws with the skull. Finally, the resonating (tympanic) chamber recedes farther below the surface and becomes the **MIDDLE EAR** to which sound waves are conducted through a tubular passage, the **OUTER EAR**. In some forms the latter is provided with an external funnel-like expansion, the **PINNA**. Apparently much is accomplished by accumulating minute changes during the ages. (Fig. 276.)

## 5. The Eye

The organs of sight are the most complex sense organs of animals and reach a very high degree of specialization even in some of the Invertebrates. Among the latter the essential sensory element (**RETINA**) of the eye usually arises by the

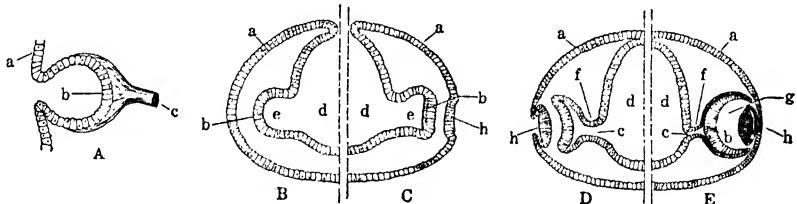

FIG. 277. Diagrams illustrating the method of formation of the eye of an Invertebrate (A) and a Vertebrate (B, C, D, E—successive stages). Note that the opposite surface of the retinal cells is exposed to the light rays in the Vertebrate as compared with the Invertebrate eye. *a*, ectoderm; *b*, retinal area; *c*, future position of optic nerve; *d*, cavity of the diencephalon; *e*, optic vesicle; *f*, stalk of optic vesicle, later replaced by the optic nerve; *g*, vitreous chamber within optic cup; *h*, developing lens.

invagination of a limited area of ectoderm, the cells of which become differentiated for receiving the photic stimuli that produce nerve impulses to be transmitted to the central nervous system. Among Vertebrates the sensory cells are also of ectodermic origin, but only secondarily so, since the OPTIC VESICLES arise as outpocketings directly from the sides of the diencephalon. (Fig. 277.)

A retina alone, such as exists in some of the lower Invertebrates, can afford no visual sensations other than light and darkness, and perhaps in some cases the ability to distinguish

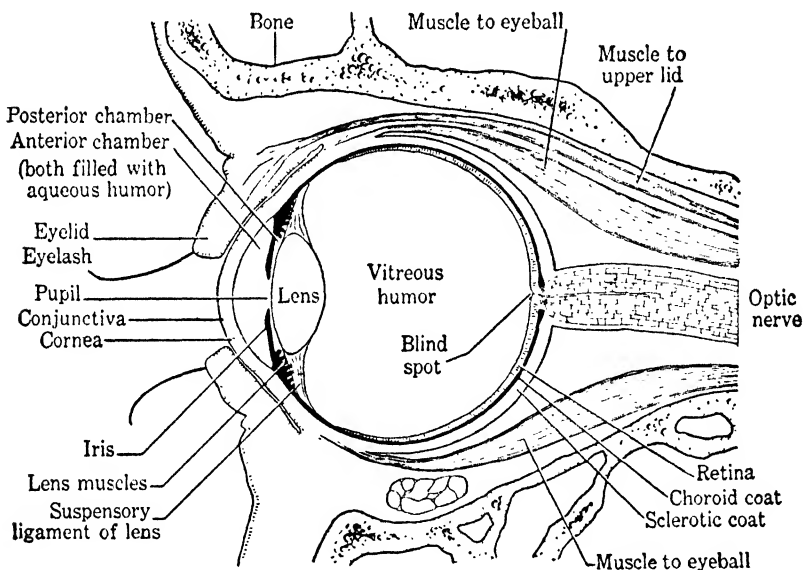

FIG. 278. Vertical section of the human eye and associated structures.

light of one color from that of another. In order that not merely degrees of the intensity of light may be perceived, but that objects may be seen, many of the higher Invertebrates have developed various kinds of complicated apparatus for bringing the rays from a given point to a focus at one point on the retina. These culminate, on the one hand, in the compound eye of the Arthropods; and on the other, in the 'camera' eye of certain Molluscs such as the Squid.

In the latter case the mechanism is very much like that found in the Vertebrates, but since it occurs in Molluscs which cannot be considered in the direct evolutionary line of the Vertebrates, it affords an example of similar responses of different organisms to similar needs giving rise to *analogous* structures. (Figs. 172, 278.)

The wall of the vertebrate eye, or **EYEBALL**, forms a more or less hollow sphere which can be rotated by several relatively large muscles. The anterior exposed part of the eyeball consists of two transparent layers: the delicate **CONJUNCTIVA**, continuous with the inner lining of the eyelid, and the rigid **CORNEA** beneath. The sides and posterior part are also composed of two layers, the outer **SCLEROTIC** coat and the inner **CHOROID** coat. Suspended within the eyeball is the **LENS** which divides the cavity into two chief parts; the one posterior to the lens, known as the **VITREOUS CHAMBER**, being lined by the retina whose nerve cells supply the nerve fibers forming the **OPTIC**, or second cranial, nerve.

The vertebrate eye is an optical apparatus that may be compared roughly with a camera, but a camera is focussed by altering the distance between the lens and the film, whereas the eye of Vertebrates, except the Fishes, is focussed by changing the curvature of the lens. Thus light waves passing through the conjunctiva, cornea, and an opening (**PUPIL**) in a regulating diaphragm (**IRIS**) reach the lens and are focussed on the retina. This contains two groups of light receptors, the **RODS** and **CONES**. The former are concerned with vision in dim light and the latter in bright light and also with color vision. Both transmit their excitations through the optic nerve, and eventually to the cerebral cortex of the brain. The brain itself interprets the nerve impulses and composes — sees — the picture. How this is done, nobody knows. (Fig. 279.)

A broad survey of the sense organs of Vertebrates from the lowest to the highest impresses one with the fact that, taken by and large, the improvements, though considerable, are

not so marked as one might expect when the great development of the nervous system, particularly the brain, is considered. The brain increases enormously in volume and complexity from fish to man. In many fishes it seems to be little more than a slight modification of the anterior end of the spinal cord, while in the frog the brain and cord weigh

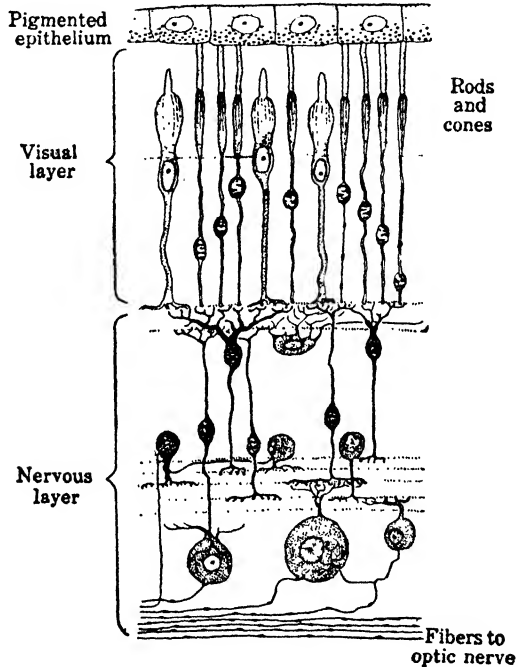

FIG. 279. Diagram of a vertical section of the Vertebrate retina (human). The pigmented epithelium is the retinal layer farthest from the vitreous chamber, and in contact with the choroid coat.

about the same. But the human brain weighs about three pounds, nearly fifty times as much as the cord, and comprises many billions of nerve cells. So apparently we must look to the general influence of the sensory stimuli themselves for the underlying factors in the development of the brain during its long evolutionary history — the brain, in turn, being enabled to make more out of the same stimuli and create in man the higher mental life with all that it implies.

It is, indeed, an appalling thought that all human mental states are represented by a few thimblefuls of cells constituting the cerebral cortex.

### E. THE ORGANISM AS A WHOLE

From the synoptic view just taken of the methods of correlation in the animal body, certain principles may be emphasized.

In the first place it is clear that the organism as a whole is greater than the sum of its parts. The body is functionally a unit. Furthermore, this unit is adaptable — it is plastic within considerable limits. Removal of any part changes to some extent the behavior of other parts and so of the whole. Thus removal of one portion of the nervous system affects other parts of the system but also induces changes in other organs which are dependent upon the nervous system for their normal functioning. Again, the various endocrine glands are largely interdependent so that the suppression of the activities of one gland may alter the activities of others. And, of course, both endocrinal and nervous systems mutually influence each other. (Fig. 261; P. 365.)

Another aspect of the coördination problem is exemplified by various so-called **COMPENSATORY MECHANISMS**. For instance, compensation for the removal of part of an organ may be met in several ways: by regeneration of the remnant, as when destruction of a part of the liver is followed by the regeneration of essentially all that was lost; or by increased activity of the remaining part of an organ so that normal equilibrium is restored, as when one kidney is removed, the other assumes its functions; or by some other organ taking upon itself the function of the lost organ, as when the stomach is removed, the remainder of the alimentary canal takes over many of its functions. (Figs. 286–289.)

All of these examples of regulatory phenomena involving compensation are correlated with the general maintenance of a so-called steady state, or **HOMEOSTASIS**, in the body. The

internal environment is maintained in a relatively constant condition by a complex series of mechanisms such as those for preventing marked changes in the volume or composition of the blood, in the temperature of the body, in the normal sugar and salt content of the blood, and so on.

Probably in every case both nervous and endocrinal influences are involved, and withal there is a FACTOR OF SAFETY because, for instance, most of the pancreas or half of the lungs may be removed with little apparent change in the ability of the body to carry out its functions. Truly we are "fearfully and wonderfully made."



## CHAPTER XX

# ORIGIN OF LIFE

The mystery of life will always remain. Science is not the death, but the birth of mystery, awe, and reverence. — *Donnan*.

**A** general background of biological facts and principles has now been established, and we are therefore in a position to take up from an advantageous viewpoint some of the broad questions raised by the science. For its antiquity as well as its universal interest, the problem of the origin of life takes precedence.

### A. BIOGENESIS AND ABIOGENESIS

It seems strange, with some of the complexities of organisms before us, that the best minds up to the seventeenth century saw nothing very remarkable in the spontaneous origin of plants and animals of all kinds from mud and decaying substances. As a matter of fact, we find that even Aristotle, who laid such broad foundations for the science and philosophy of the organism, believed that certain of the Vertebrates, such as eels, arose spontaneously.

Similar ideas are voiced repeatedly through more than twenty centuries by scientists and philosophers, poets and theologians. Van Helmont, one of the founders of chemical physiology during the seventeenth century, gives particularly specific directions for the experimental production of scorpions and mice; while Kircher actually figures animals that he states arose under his own eyes through the influence of water on the stems of plants. The following ironical reflections, aroused by Sir Thomas Browne's doubts in regard to mice arising by putrefaction, are quite typical of opinion of the time: "So we may doubt whether, in cheese

and timber, worms are generated or if beetles and wasps in cow dung, or if butterflies, shellfish, eels, and such life be procreated of putrefied matter. To question this is to question reason, sense, and experience. If he doubts this, let him go to Egypt, and there he will find the fields swarming with mice begot of the mud of the Nile, to the great calamity of the inhabitants."

Naturally, with the gradual increase in knowledge of the complexity of organisms, the idea of **ABIOTENESIS**, or **SPONTANEOUS GENERATION**, was restricted more and more to the lower forms. It remained, however, for Francesco Redi during the latter part of the seventeenth century to question seriously the general proposition, and to substitute direct experimentation for discussion and hearsay. By the simple expedient — it seems simple today — of protecting decaying meat from contamination by flies, he demonstrated that these insects are not developed from the flesh and that the apparent transformations of meat into maggots is due solely to the development of the eggs deposited thereon by flies.

One may imagine that the practical man of affairs scoffed at Redi toiling under the Italian sun with meat and maggots to satisfy a scientific curiosity, and little dreamed that the practical results which germinated from this study would be among the most important factors in twentieth-century civilization. Indeed, it is difficult to overestimate the importance of Redi's conclusion from either the theoretical or practical viewpoint, for with it was definitely formulated the theory that matter does not assume the living state, at the present time at least, except from preëxisting living matter.

The influence of this work gradually became evident in scholarly literature. One author during the next century states that "spontaneous generation is a doctrine so generally exploded that I shall not undertake to disprove it. It is so evident that all animals, yea and vegetables, too, owe their production to parent animals and vegetables, that I have often admired the sloth and prejudices of philosophers

in taking abiogenesis upon trust." Another writes that he "would as soon say that rocks and woods engender stags and elephants as affirm that a piece of cheese generates mites."

But it is not to be supposed that the time-honored doctrine of spontaneous generation actually had been so easily relegated to the myths of the past, Redi's work and these eighteenth-century opinions to the contrary. Indeed, the history of the establishment of BIOGENESIS — all life from life — extends down almost to the present time, for no sooner had experiment apparently disposed of spontaneous generation than it arose again with fresh vigor in a slightly different form demanding further investigation.

The difficulties came from two chief sources. In the first place, Redi himself had been baffled by the presence of parasites within certain internal organs of higher animals, such as the brains of sheep. How did they get there if not by spontaneous generation? The answer to this had to await the working out of the marvelously complex life histories of the parasitic worms and allied forms which showed that they all arise from parents like themselves. In the second place, improvements in microscope lenses contributed to the discovery of smaller and smaller living creatures. Countless numbers and myriads of kinds of 'animalcules' appearing almost overnight in decaying organic infusions aroused widespread interest and amazement, and proved to be the chief riddle. The plausible explanation seemed to be spontaneous generation. (Figs. 16, 20, 421, 422.)

Among others, Needham studied the problem and believed that he had demonstrated the spontaneous origin of minute organisms in infusions that he had boiled and sealed in flasks. His results attracted considerable attention because the famous French naturalist, Buffon, found in them support for his theory that the bodies of all organisms are composed of indestructible living units, which upon the death of the individual are scattered in nature and later brought together again to form the units of new generations. (Fig. 465.)

Needham's and similar results, however, were shown by Spallanzani and others to be inconclusive because they were obtained by insufficient sterilization and sealing of the flasks containing the infusions. But at this point objections came from another source: the chemists who had recently discovered the important part played by free oxygen for life processes and for the putrefaction and fermentation of organic substances. They argued that the treatment to which Spallanzani and other experimenters subjected the infusions might well have changed the organic matter, excluded oxygen, etc., so that it was impossible for life to be produced.

This objection was met by a long series of experiments by various investigators during the first half of the last century, which showed conclusively that thoroughly sterilized infusions never developed living organisms even when air was admitted, provided the latter had been rendered sterile by heat or by having all suspended 'dust' particles removed. Thus the chemists were answered — the infusions possessed all the conditions necessary to support life — but life did not arise. The biologist who contributed most to the establishment of this conclusion was Pasteur. His masterly and comprehensive work was not only convincing and final, but it also demonstrated the source of the life that so rapidly appeared in infusions that are exposed to the air. It is the air. A considerable part of so-called dust is made up of microorganisms in a dormant state ready to resume active life when moisture and other suitable conditions are encountered. Furthermore, these organisms are not the result, but

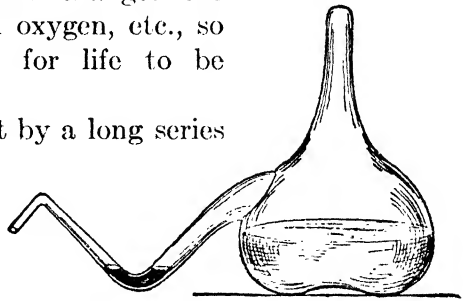

FIG. 280. Flask used by Pasteur in his experiments on spontaneous generation. After the contents were poured in, the top of the flask was sealed. The opening at the end was sealed against the entrance of germs, but not oxygen, etc., by the water of condensation that accumulated at the bend. Life did not develop in the flask.

rendered sterile by heat or by having all suspended 'dust' particles removed. Thus the chemists were answered — the infusions possessed all the conditions necessary to support life — but life did not arise. The biologist who contributed most to the establishment of this conclusion was Pasteur. His masterly and comprehensive work was not only convincing and final, but it also demonstrated the source of the life that so rapidly appeared in infusions that are exposed to the air. It is the air. A considerable part of so-called dust is made up of microorganisms in a dormant state ready to resume active life when moisture and other suitable conditions are encountered. Furthermore, these organisms are not the result, but

the cause of decay — their own activities bring about chemical changes: putrefaction, fermentation, and, in the bodies of higher organisms, disease. And this is amply attested by the methods now universally used in food preservation and aseptic surgery — to mention but two of the innumerable basic contributions to civilization that have directly followed. (Figs. 280, 281, 450.)

Although highly improbable, it is of course not impossible that simple life is even at the present time arising spontaneously under special environmental conditions, perhaps in the ocean depths, though unable to come to fruition in competition with existing highly specialized protoplasm of ancient pedigree. If such living matter is arising, it must be very simple compared with protoplasm as we know it today; so simple, in fact, that we would not recognize it as such, because the protoplasm of even the simplest organisms has had a long evolutionary history.

Indeed, when the lowest reaches of 'life' are studied they seem to descend almost to the realm of the inorganic. Some of the so-called **FILTERABLE VIRUSES** are smaller than certain protein molecules. Although the virus particles are referred to as filter-passing, their size can be measured with a considerable degree of accuracy by the use of ultrafiltration through collodion membranes, the size of whose pores have been previously determined. Thus the virus of yellow fever, which is carried by a mosquito, is approximately 22 millimicrons while the rabies virus is about 125 millimicrons in diameter. (Fig. 418.)

We may well ask, What are these almost infinitesimally small things which fall between the orthodox realms of the Bacteria and Protozoa? Here is revealed a vast array of an immensely important group of bodies which tax our ingenuity in trying to draw a line between the living and non-living. Recent work seems to show that at least one, known as the tobacco virus, is chemically a single protein molecule. One must ponder on that fact. The behavior of this molecule leads some to regard it as a very primitive type of organism,

so primitive, in fact, that it has exhibited, so far, only one of the usually recognized basic functions of life. The viruses in general multiply when in the tissues of the host, in this case in the tobacco plant. A certain amount of virus is put in and more appears. Are the extra particles the direct

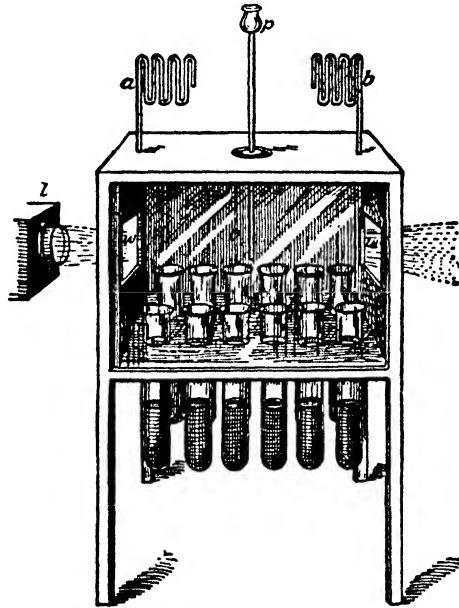

FIG. 281. Apparatus used by Tyndall in his experiments on spontaneous generation. The front and side windows (*w*, *w*) of the cabinet are made of glass. Air can enter through the two tubes (*a*, *b*). The optical test for the purity of the atmosphere within the cabinet was made by passing a powerful beam of light from the lamp (*l*) through the side windows. When the atmosphere contained no suspended 'dust' particles, the tubes (*c*) within were filled, through the pipet (*p*), with sterile culture medium suitable for the growth of germs, but none developed. (After Tyndall.)

descendants of the original ones as in recognized organisms? Or is their genesis merely conditioned by the presence of the original leaven? Is a virus a living thing which has dispensed with all that is necessary for its own nutrition and reproduction, but when implanted in the protoplasm of a living cell uses the energy and nutrition of the host to propagate itself?

The answers to these and many other questions raised by the viruses obviously are of the utmost theoretical and practical import. They are of the future, though probably not a distant one. Today this much seems certain. Our well-worn, and well-liked, antithesis between the inorganic and the organic does not exhaust the possibilities. The molecular unit of the non-living world threatens to approach the cellular unit of the living, and it is conceivable that an intermediate microcosm, represented by the viruses, will in part bridge the imposing gap between the quick and the dead, and possibly afford a glimpse of life's origin.

Although the borderline between lifeless and living may prove to be intangible, so far as human observation and experiment go no form of life arises today except by reproduction from preëxisting life. The evidence from innumerable sources converges overwhelmingly to the support of biogenesis. There is no evidence in support of abiogenesis.

## B. ORIGIN OF LIFE ON THE EARTH

If we accept the testimony of astronomer and geologist, the earth was at one time in a condition in which life could not exist, and so we are face to face with the problem of how it came to be established on the earth in the past -- the remote past, since the geological record affords convincing proof that life has existed continuously on the Earth for many hundreds of millions of years.

Accordingly, unless one is willing to ascribe life's origin to SPECIAL CREATION — which at once removes it from the sphere of science and so beyond the present discussion — we have the following alternative: either life came to this planet from some other part of the universe, or it arose spontaneously from non-living matter at one period at least in the past as a natural result of the evolution of the earth and its elements. With these in mind, a review may be made of the present state of the problem. It is nearly, if not quite, as important to define our area of ignorance as to extend our area of knowledge.

## 1. Cosmic Origin

The establishment of biogenesis and the dawning realization of the unique complexity of the structure of matter in the living state have led several scientists to suggest that life has never arisen *de novo* on the earth but has been carried hither from elsewhere in the universe — the so-called COSMOZOA theory.

On the assumption that some of the heavenly bodies have always been the abode of life, and from the fact that small solid particles, which presumably have been a part of such bodies, are moving everywhere in space, these particles have been pictured as the vehicles which disseminate the simplest forms of life through interstellar space to find lodgment and development upon such planets as afford a suitable environment. Clearly, from this point of view, life may be as old as the universe itself.

The plausibility of the cosmozoa theory depends on two assumptions: that life exists elsewhere in the universe, and that life can be maintained during the interstellar voyage. Neither assumption has, of course, any foundation of established fact, though the second offers at least something tangible for discussion.

As we know, many of the Bacteria and Protozoa, especially when under the influence of unfavorable surroundings, have the power of developing protective coverings about themselves and of assuming a dormant condition in which all the metabolic activities are reduced to the lowest ebb. In this spore or encysted state they can endure extremes of temperature and dryness which would quickly prove fatal during active life. For instance, it seems clear that the spores of certain kinds of Bacteria can survive a temperature approaching that below which no chemical reactions are known to occur, and others can endure at least as high as 140° C. for a short time. The cysts of some relatively highly specialized Protozoa can retain their vitality for at least half a century, while the seeds of some plants have been found to retain the



power of germination for nearly a century; though statements that grain from ancient Egyptian tombs still maintains its power of growth has been positively disproved. (Pp. 515, 516.)

But the hardships to which living matter would be exposed when started on its interstellar journey are not to be minimized. Meteors in their fall through the earth's atmosphere become heated to incandescence and, if they are the vehicle of transfer, it would only be conceivable for life to survive far below their surface where the temperature is lower. To avoid this and other difficulties it has been suggested that the radiant pressure of light is sufficient to overcome the attraction of gravitation for particles of the extraordinary minuteness of some of the lower forms of life, and that isolated germs might make the journey to the earth. But on the assumption that an organism were forced out into space by the mechanical pressure of light waves from the sun of the nearest solar system, it would require many thousand years for it to reach the earth. However, certain scientists believe that, owing to the exceedingly low temperature and absence of water vapor which must prevail in cosmic space, there is no reason why spores should lose appreciably more of their germinating power in ten thousand years than in six months. But now ultraviolet and cosmic rays loom as the chief stumbling-block. Apparently everywhere in cosmic space living matter would be exposed to so great an intensity of these radiations that there would be hardly any possibility of its survival.

Without further discussion, it is apparent that the cosmozoa theory is one which cannot be proved or disproved. It removes the origin of life to a "conveniently inaccessible corner of the universe where its solution is impossible." So most biologists would agree that, "knowing what we know, and believing what we believe, as to the part played by evolution in the development of terrestrial matter, we are, without denying the possibility of the existence of life in other parts of the universe, justified in regarding cosmic

theories as inherently improbable." Accordingly we may turn to ideas regarding the evolutionary origin of life from the inorganic upon the earth.

## 2. *Terrestrial Origin*

It is of first importance to define as clearly as possible the probable physical conditions under which the birth of living organisms may have happened, for by this we provide some ground for rational speculation. Of peculiar significance are the questions relating to the available energy sources of the first organisms and the state of the major biological elements, particularly carbon and nitrogen, at the beginning of the earth's history.

At present it is, of course, the sun that turns the wheels of living machinery. Some authorities insist that solar energy, particularly the ultraviolet light, which is now absorbed by the ozone layer of our modern oxygen-rich atmosphere, initially supplied the energy for the building up of organic compounds. According to this view, life has been from the beginning dependent on a photosynthetic process, though at first this process would involve the production of some simple compound, like formaldehyde, by the action of ultraviolet light on water and carbon dioxide, rather than the elaborate utilization of visible light by the chloroplast that we know today.

It would appear that some relevant information can be obtained from the planet Venus, because it has a well-developed atmosphere of carbon dioxide (no oxygen or water vapor are present) which is entirely filled with a white mist or dust which gives the planet its marked reflecting power. Since it is almost inconceivable that a little water vapor was not initially there, it has been suggested that ultraviolet light has caused the whole meager supply of water to combine with carbon dioxide to produce formaldehyde, a substance which is not stable and indeed cannot be detected in the present atmosphere of the planet. If it ever

has been present, it would almost certainly have polymerized, the molecules uniting together to form a white fluffy material known as polyhydroxymethylene hydrate. If this is correct, the brilliance of the 'evening star' is due to reflection from an atmosphere filled with a snow-like dust of a substance not very unlike starch or glycogen.

It is tempting, then, to regard Venus as a planet on which the evolution of organic matter has proceeded, by two relatively simple steps, to a stage somewhat comparable with the polysaccharides. And since there is no reason to think Venus more favorably situated than the earth for the development of a carbon dioxide atmosphere, it is reasonable to suppose that carbon existed on the original surface of the earth in the form of  $\text{CO}_2$ . Until we know whether free oxygen was also originally present, we cannot tell whether the first step, the formation of formaldehyde photochemically, could take place or not. Balancing all the available evidence, it would seem slightly more probable that oxygen was absent, and the earth's surface therefore was freely irradiated with ultraviolet.

Less information exists as to the original state of nitrogen than of carbon. Ammonia, however, appears to exist in igneous rocks, so that even if most of the nitrogen of the earth were initially in the atmosphere in a rather inert form, as it is today, enough ammonia might accumulate in the sea, as the result of erosion and volcanic activity, to provide a more active compound to initiate the synthesis of nitrogenous organic compounds. The possibility of cyanogen  $(\text{CN})_2$  having played a part, as Pflüger long ago supposed, must not be entirely dismissed; but cyanogen, though cosmically abundant, is unstable in the presence of water and is hardly known in the earth's crust or atmosphere.

Whatever may have been the origin of the first organic compounds, their subsequent history in the presence of water, and probably of metallic compounds acting as catalysts, would be diversified. It has recently been suggested that once a large supply of simple organic compounds

existed in the sea, colloidal matter would ultimately be formed by polymerization, and that finally the separation of droplets of colloidal concentrate from the more dilute medium would occur. If so, such droplets may have been the systems from which the first organisms evolved.

The facts and ideas that have been briefly presented hardly do more than indicate possible lines of approach to the problem of the origin of life. They do, however, indicate that we can begin to replace the verbal prestidigitation of earlier writers on this subject with some concrete information that defines the field and permits the more probable hypotheses to be sorted, with some assurance, from the less probable.

It will be noted that the various suggestions, except the cosmozoa theory, have one assumption in common — the 'chance' assemblage of the various elements of protoplasm: an assumption regarded by some as not unreasonable when the stupendous duration of time and the almost infinite variations in conditions that were at the disposal of nature are appreciated. According to the statistical theory of probability, if we wait long enough anything that is possible, no matter how improbable, will happen — a thought which led Swift to remark that the attempt to advance knowledge by turning a crank has so far failed to produce a single learned treatise! And it must be emphasized that many modern biologists and physicists insist that the marvelous 'order of nature' cannot be thought of as emerging from the fortuitous.

And so we may profitably turn to a consideration of the present-day manifestations of life, and dismiss the problem of the origin of life on the earth with the conservative statement penned more than half a century ago by Huxley:

"Looking back through the prodigious vista of the past, I find no record of the commencement of life, and therefore I am devoid of any means of forming a definite conclusion as to the conditions of its appearance. Belief, in the scientific

sense of the word, is a serious matter, and needs strong foundations. To say, therefore, in the admitted absence of evidence, that I have any belief as to the mode in which existing forms of life have originated, would be using words in a wrong sense. But expectation is permissible where belief is not; and if it were given to me to look beyond the abyss of geologically recorded time to the still more remote period when the earth was passing through physical and chemical conditions, which it can no more see again than a man can recall his infancy, I should expect to be a witness of the evolution of living protoplasm from not living matter. . . . That is the expectation to which analogical reasoning leads me; but I beg you once more to recollect that I have no right to call my opinion anything but an act of philosophical faith." (Fig. 454.)

## CHAPTER XXI

# THE CONTINUITY OF LIFE

Owing to the imperfection of language the offspring is termed a new animal, but is in truth a branch or elongation of the parent.

— *Erasmus Darwin.*

**S**ince so far as is known all life now arises from preëxisting life and has done so since matter first assumed the living state, it apparently follows that the stream of life is continuous from the remote geological past to the present and that all organisms of today have an ancient pedigree. It is to the establishment of this as the reasonable conclusion from the data accumulated during recent years, that from now on our attention is somewhat more particularly directed; and accordingly it is necessary first of all to consider in some detail the relation of parent to offspring in present-day forms as exhibited by reproduction.

### A. REPRODUCTION

The power of producing new individuals specifically similar to the parent is, as has been seen, one of the most important characteristics of living in contrast with lifeless matter. Furthermore, reproduction is typically cell division. This is quite evident in unicellular plants and animals, but by no means so obvious in higher organisms where, as we know, special gonads and highly complex accessory organs are developed in furtherance of reproduction.

It will be recalled that in *Protococcus* and *Amoeba*, for example, the nucleus and cytoplasm divide into two parts, so that by cell division, here called **BINARY FISSION**, the identity of the parent organism is merged into the two new cells. Simple as this seems, fission actually involves consider-

ably more than the halving of the original cell, because each half must *reorganize* into a complete new individual with all parts characteristic of the parent. This is more obvious in some of the highly specialized Protozoa, such as Paramecium. (Figs. 6, 9, 148, 149.)

Among some unicellular plants and animals, notably in the group of Protozoa known as the Sporozoa, the parent cell, instead of merely forming two cells by binary fission, becomes resolved into many cells by a series of practically simultaneous divisions known as MULTIPLE FISSION, or SPORULATION. This is usually preceded by growth of the parent cell and its enclosure in a protective covering, or CYST, which ruptures to liberate the spores. Other unicellular forms, such as the Yeasts — colorless plants chiefly responsible for alcoholic fermentation — exhibit a modified form of fission in which the parent cell forms one or several outgrowths, or BUDS, that gradually assume the characteristic adult form and sooner or later become detached as complete similar individuals. (Figs. 343, 373; Pp. 208–210.)

In a considerable number of instances, however, the cells arising by multiple fission or budding remain closely associated or organically connected so that they form a COLONY. In some colonial organisms the component cells are all alike and each retains its individuality, while in others certain cells are restricted more or less in their functions, so that a physiological division of labor is established which involves the shifting of individuality from the cells to the colony as a whole. This specialization is exhibited chiefly with regard to reproduction and reaches its highest expression among colonial PROTISTA (Protozoa and Protophyta) in Volvox, where among ten thousand or so cells, perhaps a score are specialized for reproduction and the rest are somatic. Usually each of the reproductive cells (germ cells) divides to form a group which is set free as a miniature colony, but in certain cases some of the reproductive cells become transformed into male and others into female gametes. After fertilization of the eggs, usually by sperm from another colony, the

zygotes develop into new colonies which eventually are liberated from the parent colony. (Figs. 22, 23.)

As has been previously suggested, the physiological division of labor in the colonial Protista, involving, as it does, a segregation of reproductive from somatic structures, affords a logical transition from the unicellular condition to that characteristic of the multicellular forms. From one point of view these may be considered highly complex colonies of cells in which specialization, no longer confined merely to demarking germinal and somatic regions, has transformed the latter into a complex of tissues and organs, the body (SOMA) of the individual, while the germinal tissue (GERM) is confined to the essential reproductive organs.

It is customary, therefore, to draw a more or less sharp distinction between the soma and germ — to consider the soma the individual which harbors, as it were, the germ destined to continue the race. This theory of GERMINAL CONTINUITY, which is chiefly associated with the name of Weismann, recognizes that the germ contains living material which has come down in unbroken continuity ever since the origin of life and which is destined to persist in some form as long as life itself. On the other hand, the soma may be said to arise anew in each generation as a derivative or offshoot of the germ, and, after playing its part for a while as the vehicle of the germ, to pass the germ on at reproduction, and then die. "A hen is only an egg's way of making another egg." The germinal continuity concept has altered the attitude of biologists toward certain fundamental questions in heredity and evolution, as will be apparent when these subjects have been considered. (Figs. 282, 290, 315, 462.)

Though *Volvox* and other colonial forms afford a glimpse of the conditions which probably prevailed when the evolutionary bridge from unicellular to multicellular organisms was crossed, the varied methods of reproduction of the latter by no means indicate the early establishment of a hard and fast boundary between soma and germ. The con-



## A. Paramecium.

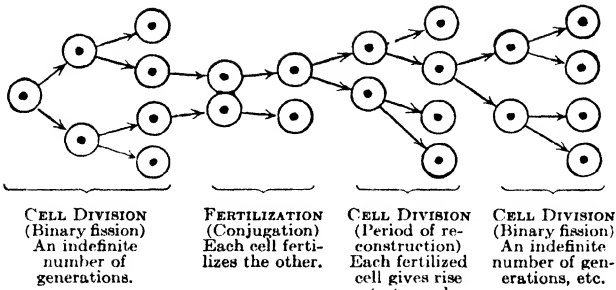

## B. Volvox.

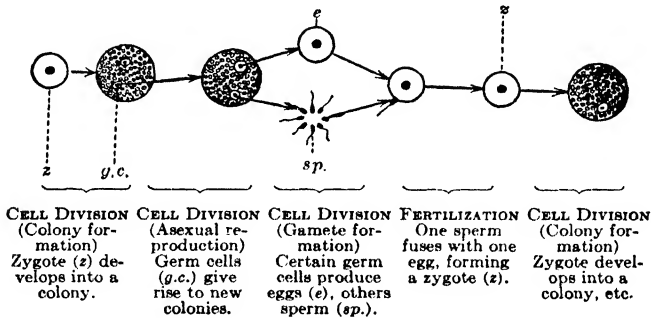

## C. Hydra.

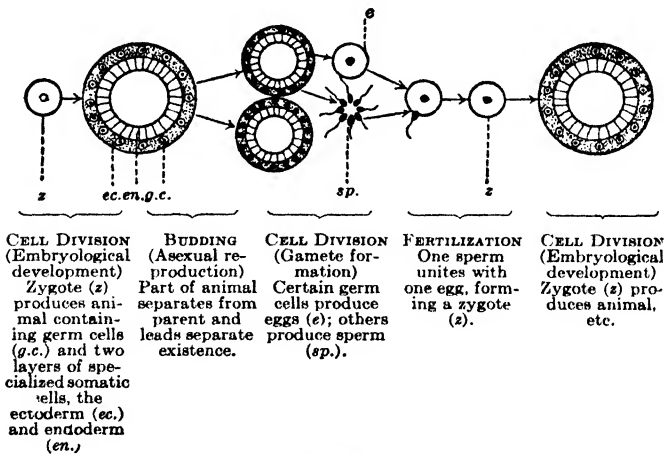

## D. Earthworm.

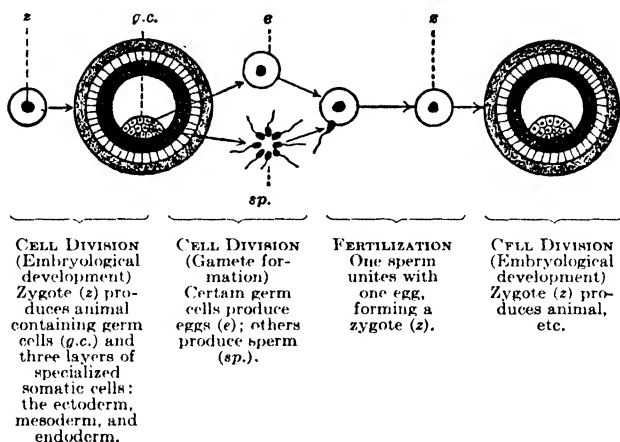

FIG. 282. Diagrams to illustrate the general reproductive cell cycle in A, a unicellular organism (*Paramecium*); B, a colony of cells (*Volvox*); C, a simple Metazoön (*Hydra*); and D, a more complex Metazoön (*Earthworm*). (Modified, from Hegner.)

ception of special germ cells early set aside, as it were, from the somatic cells must not be taken too literally. (Figs. 283, 284, 286.)

Thus, as we know, many kinds of plants reproduce normally by fragmentation — each of the pieces REGENERATING the whole — and essentially the same is true of some of the lower animals which reproduce by fission, budding, etc. Again most plants and many animals regenerate parts lost by mutilations of one sort or another. Among plants, pieces of the root, stem, or, in special cases, of the leaf may give rise to individuals complete in every respect.

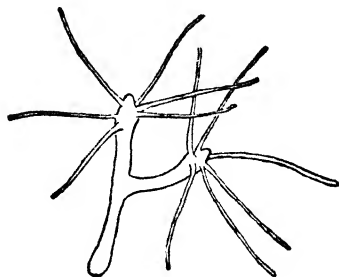

FIG. 283. Hydra reproducing asexually by fission. (From Koelitz.)

Until the middle of the eighteenth century this power of regeneration was considered a property peculiar to plants,

and soon after Hydra was discovered experiments were made to determine whether the organism was a plant or an animal. Specimens were cut into several pieces and it was found that each piece developed into a complete Hydra. This result, from the ideas of the time, should have led to the conclusion that Hydra is a plant, but additional characteristics were observed which outweighed all other considerations. Accordingly Hydra was recognized as an animal with the power of replacing lost parts. (Fig. 285.)



FIG. 284.  
A Flatworm,  
*Planaria*, in  
the process of  
fission. (From  
Child.)

Since the classic work on Hydra the power of regeneration has come to be recognized as a fundamental property of all animals. It is exhibited to the greatest degree among the lower animals, while in the higher Vertebrates it is confined chiefly to wound healing and to the replacement of cells which especially suffer from wear and tear, such as those forming the outer layers of the skin. Regeneration is one phase of a fundamental property of protoplasm, namely growth, whether it consists in restoring a part of a Paramecium, transforming a bit of a Flatworm into a complete animal, or replacing half of an Earthworm, the head of a Snail, the claw of a

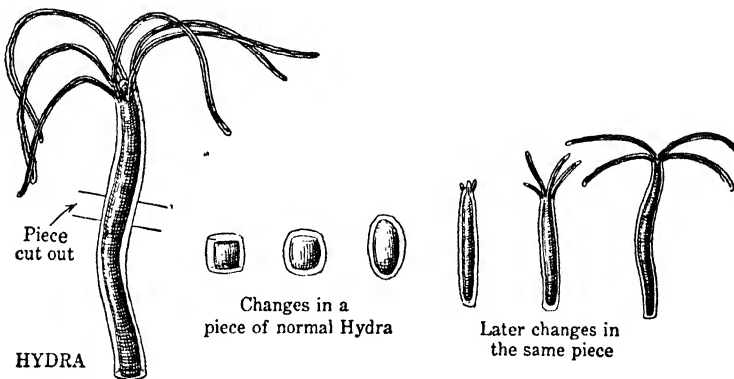

FIG. 285. Regeneration in Hydra.

Crayfish, or the leg of a Salamander. But it will be recognized that associated with growth there are complex processes of simplification (dedifferentiation) of tissues and organs, and later a rebuilding (differentiation) in order that a part may become again a normally organized whole. Witness

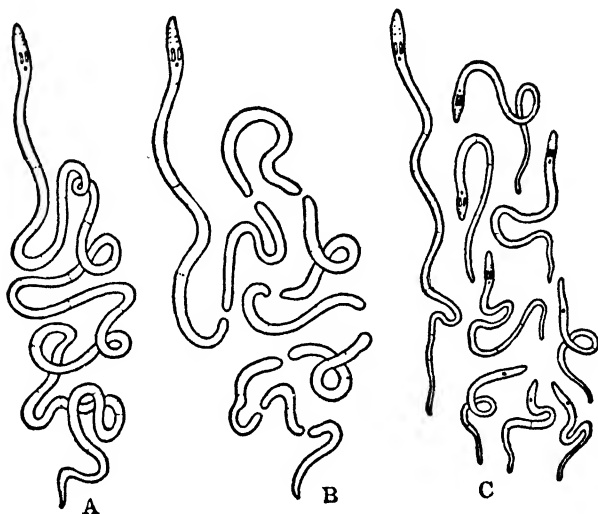

FIG. 286. Reproduction of a Flatworm, *Lincois socialis*, by fission. A, mature worm; B, same, in nine parts; C, regeneration of each resulting in normal smaller worms. (From Coe.)

certain marine Flatworms that can be cut down to less than one two-hundred-thousandth of their original size and still become miniature worms like the original. (Figs. 286, 287.)

The experimental study of regeneration phenomena has opened up a new vista of the regulatory powers of living things from Protozoön to Vertebrate and from egg to adult, and has afforded a means of approach to some fundamental biological problems. And withal it has a practical value. The surgeon now knows more about the regeneration of tissues in general and of nerves in particular in wound healing, and the oysterman knows — or should know — that his attempt to destroy Starfish by tearing them up and throwing the pieces overboard may serve merely to increase

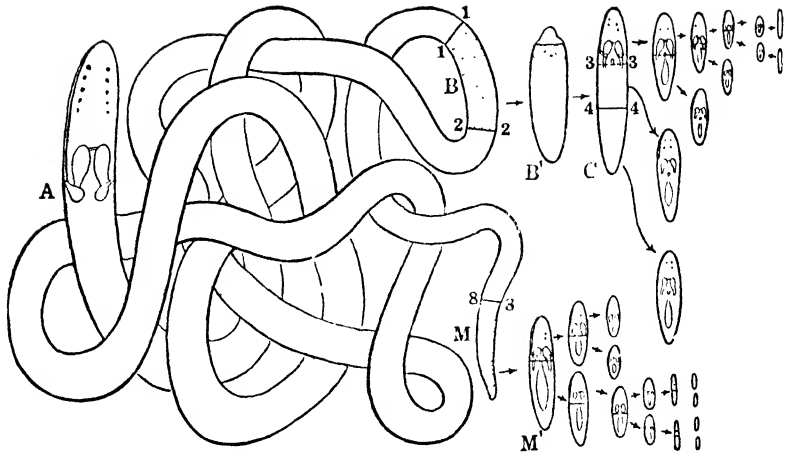

FIG. 287. Regeneration in a Flatworm, *Lineus socialis*. A, normal worm; B, B', section cut from body and its appearance after twelve days; C, same after thirty days, cut in planes 3-3 and 4-4. Successive cuttings and regenerations indicated by arrows. M, M', similar experiments and results on posterior end of body. (From Coe.)

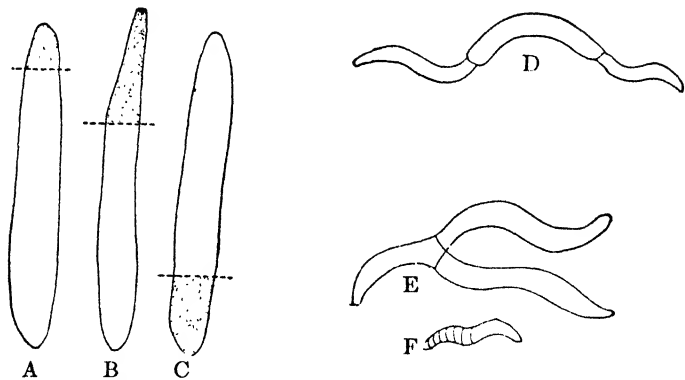

FIG. 288. Regeneration and grafting in the Earthworm. A, regeneration of removed anterior segments by the posterior piece. B, regeneration of posterior segments by the posterior part, so that the worm has a 'tail' at either end. C, regeneration of removed posterior end by the anterior piece. D, three pieces grafted together to make a long worm; E, two pieces grafted together to form a worm with two 'tails'; F, short anterior and posterior pieces grafted together. Regenerated portions are dotted. (From Morgan.)

this enemy of the Oyster. Indeed, the Starfish *Linkia* is able to regenerate a whole organism from an arm segment only one-thirtieth part of the original animal. (Figs. 173, 287, 289.)

The power of fragments of distinctively somatic tissue in many lower animals and plants to form a complete organism, including the reproductive organs and germ cells, indicates

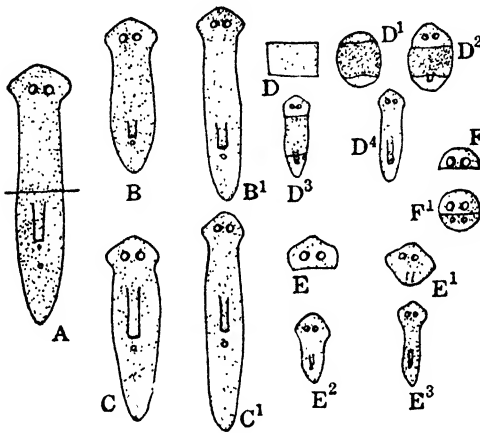

FIG. 289. Regeneration of a Flatworm, *Planaria maculata*. A, normal worm; cut across at line indicated. B, B<sup>1</sup>, and C, C<sup>1</sup>, regeneration of anterior and posterior parts of A to form complete worms. D, piece cut from a worm; D<sup>1</sup>, D<sup>2</sup>, D<sup>3</sup>, D<sup>4</sup>, successive stages in the regeneration of D. E, 'head' from which rest of animal has been cut off. E<sup>1</sup>, E<sup>2</sup>, E<sup>3</sup>, successive stages in the regeneration by E of a complete body. F, similar experiment to E, but a new 'head' in reversed position is regenerated instead of a body, F<sup>1</sup>. See Fig. 159. (From Morgan.)

that we must postulate at least a potential supply of the germ residing in the somatic tissue, which can make good the definitive germ cells when they are lost. At first glance this may seem to be a far cry to save an idea, but it is a fact that there is a continuity of the *nuclear* complex (GERM PLASM) whether the germ cells are set aside early in individual development, or later by the transformation of relatively undifferentiated somatic cells. That this is really the crux of the question will be appreciated after the details of cell division have been discussed.

## B. ORIGIN OF THE GERM CELLS

Among the Vertebrates, as previously described, the germ cells reside during adult life in definite organs, the ovaries and testes, and upon these cells the power of reproduction of the individual is solely dependent. It seems clear, however, that the primary germ cells do not arise as such by

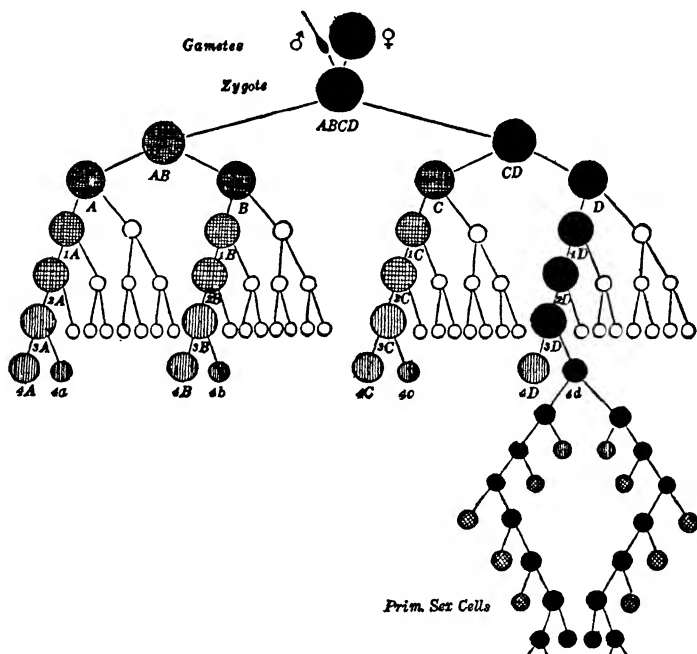
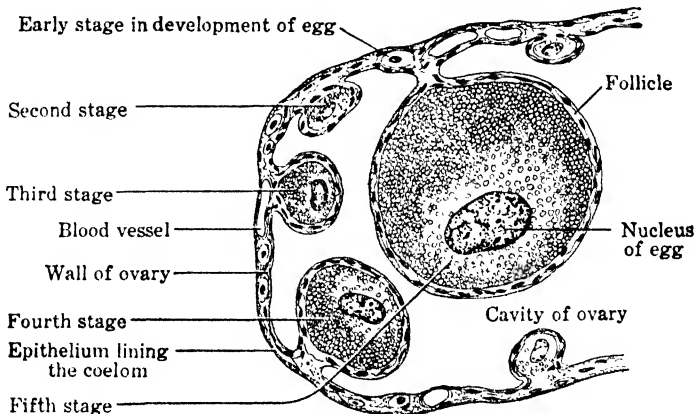

FIG. 290. Diagram of the lineage of the body cells and germ cells in a Worm or Mollusc. Lineage of germ cells shown in black, of ectoderm in white, and of endoderm and mesoderm in shaded circles. (From Conklin.)

division in the tissues which during development form the ovaries and testes. Just when the germ cells are set aside in Vertebrates is uncertain, but it seems to occur very early in embryonic life, perhaps during the cleavage of the egg as is the case in certain Invertebrates. Then by shiftings of the tissues during growth, and possibly also by amoeboid movements of the germ cells themselves, they finally reach definite positions in the epithelium lining the dorsal wall of the coelom which becomes a part of the gonads. (Fig. 290.)

With regard to the fate of the PRIMORDIAL GERM CELLS, once they have reached testis or ovary, we are on surer ground and can trace with considerable exactness their divisions and transformations which give rise to the sperm and eggs. In the first place the primordial germ cells proceed to divide in the testis and ovary so that they produce a large number of germ cells known as SPERMATOGONIA and OÖGONIA respectively. (Fig. 295.)

Thus, for instance, the ovary of an adult female frog shows oögonia in various stages of development. The eggs of the next breeding season are the largest cells; those of intermediate size represent approximately those of the following year; and many smaller cells are the oögonia from which the eggs of later years will arise. Furthermore there are other cells that form a matrix of supporting and nutritive tissue (FOLLICLE CELLS, etc.) in which the germ cells are embedded. The mammalian ovary presents a similar picture, except that since fewer eggs are produced at each breeding period, the supply of oögonia is not so large. Nevertheless, even in the human ovary there are potentially many thousands of eggs. The testis shows a similar condition, but since so many more sperm than eggs are produced, the spermatogonia divide much more actively. (Figs. 256, 291.)



**FIG. 291.** Diagrammatic section through a lobe of the ovary of a Frog, showing several stages in egg development. Magnified.



## 1. Mitosis

Before taking up the origin of the gametes by division from the spermatogonia and oögonia, it will be necessary to describe in some detail the complicated internal process involved in all typical cell divisions, known as MITOSIS, which was dismissed when considering the origin of cells until the reader would be in a position to appreciate its full significance. (Fig. 11.)

Reduced to its simplest terms, a typical resting cell, that is one which is not dividing, consists of a mass of CYTOPLASM surrounding a NUCLEUS; the latter with its chromatin distributed so that it presents a net-like appearance. In addition to the nucleus, it will be recalled that there is present another important cell organ, the CENTROSOME, which appears like a tiny body enclosing a granule and is situated in the cytoplasm near the nucleus of the resting cell. For all practical purposes we may consider the cytoplasm as the arena in which mitosis takes place, the centrosome as the dynamic agent, and the nucleus, or more specifically its CHROMATIN, as the essential element which the complicated process is to distribute with exactness to the daughter cells that are in process of formation. With this in mind we may proceed to an outline of the chief stages of mitosis, though it should be emphasized that variations in the details are as numerous as the different types of cells in plants and animals, and that any general account can do no more than present the fundamental plan of operations.

Broadly speaking, mitosis can be divided into four chief stages: prophase, metaphase, anaphase, and telophase, during each of which characteristic changes take place in the nucleus, cytoplasm, and centrosome. (Fig. 292.)

At the beginning of the PROPHASE, or earlier, the centrosome divides to form two, each of which becomes surrounded by what appears to be a halo (ASTER) of radiating fibers. The centrosomes and asters now proceed to move apart, take up positions at opposite sides of the nucleus, and, as the

nuclear membrane disappears, there arises between them the CENTRAL SPINDLE which is composed of fibers in direct relation to the chromatin elements of the nucleus. While

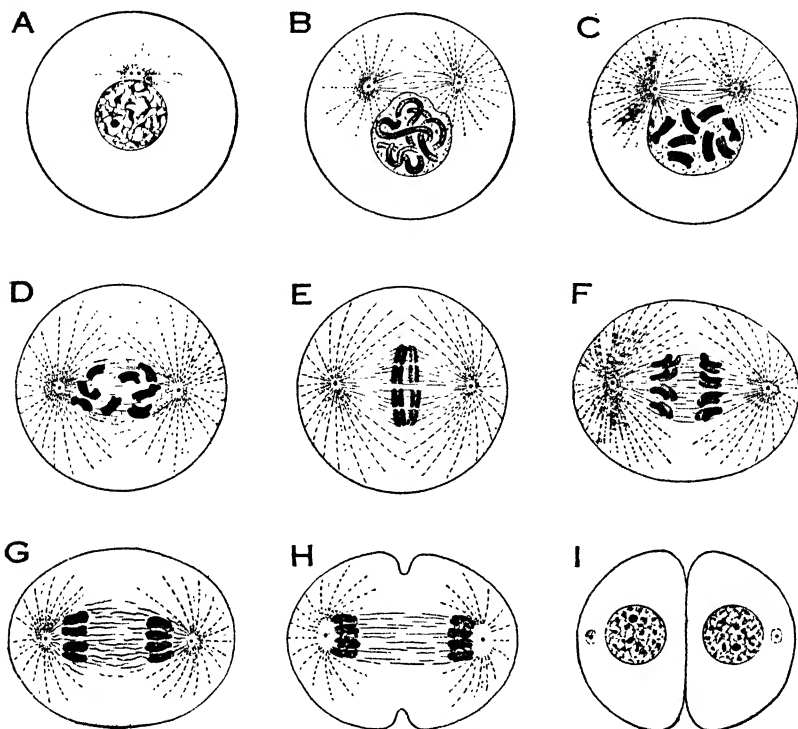

FIG. 292. Typical stages of mitosis (somatic) in which the chromosome number is assumed to be eight. A, prophase (start) : chromatin still exhibiting net-like appearance, centrosome divided and surrounded by aster ; B, prophase (early) : chromosomes visible as long split threads of chromatin, centrosomes moving apart and spindle arising between ; C and D, prophase (later) : nuclear membrane disappearing, chromosomes shorter and thicker ; E and F, metaphase and anaphase (early) : chromosomes arranged in equatorial plate and each separating into two along the longitudinal split ; G, anaphase (later) : a set of eight chromosomes approaching each aster ; H, telophase : gradual loss of visibility of distinct chromosomes, asters and spindle disappearing, division of cytoplasm beginning ; I, mitosis completed, two cells.

these changes are going on, the chromatin is not inactive. The chromatin, originally presenting the appearance of a network of granules, now becomes visibly resolved into a number of split threads of chromatin, termed CHROMOSOMES,

which by chromatin concentration gradually become shorter and thicker and so distinctly individual. The number of chromosomes varies greatly in different species, but is typically an even number and the same for all the cells of a given species.

When the chromosomes have assumed a visibly definite form, the preliminary events which constitute the prophase of mitosis merge into those of the METAPHASE. The chromosomes become arranged in a plane at right angles to the long axis of the central spindle, midway between the two centrosomes, to form the EQUATORIAL PLATE.

And now the stage is set for what is apparently the climax of mitosis, designated the ANAPHASE. Each of the chromosomes separates into two parts, along the line of the *longitudinal* split already present, in such a manner that each of the thousands of chromatin granules which make up a chromosome is equally divided. Two sets of similar daughter chromosomes are thus formed, and then one set moves to each end of the spindle. In this way each centrosome becomes associated with one set of daughter chromosomes.

The last stage, or TELOPHASE, is one of nuclear reconstruction and division of the cytoplasm. The chromosomes become indistinct as they spin out to form the net-like arrangement of the chromatin in the nucleus of each daughter cell, a nuclear membrane arises, and the nucleus again assumes the form of a definite spherical body characteristic of the resting cell. It must be emphasized, however, that although the chromosomes usually disappear from view as definitive entities in the resting nucleus, nevertheless the individuality of each persists and the same chromosomes emerge from the nuclear complex at the next division period.

Simultaneously with these nuclear changes, and before the spindle and asters — the machinery of mitosis — disappear, the division of the cytoplasm is initiated as indicated by an indentation of the cell wall, encircling the cell at the equator. This becomes deeper as it gradually extends through the

cytoplasm in the same plane which the equatorial plate formerly occupied, until the cytoplasm is cut into two separate masses, each containing one of the daughter nuclei and centrosomes. Thus one cell has merged its individuality into two daughter cells by mitotic division. Cell division — reproduction — has occurred.

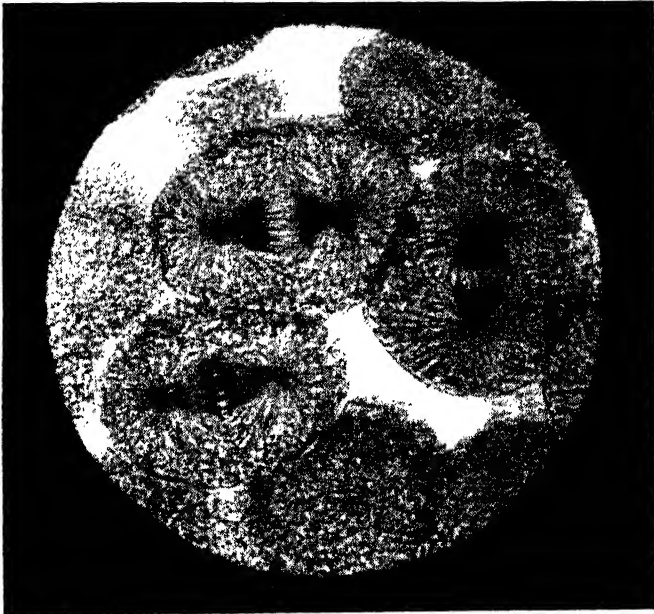

FIG. 293. Photograph of mitosis in cells of the blastula of the Whitefish. Early and late anaphases. Highly magnified. (From the General Biological Supply House.)

What is the main thought that we carry away from this brief view of a phenomenon that is going on in various cells of our own bodies this very instant? Surely it seems that whereas the mitotic process results in essentially a mass division of the cytoplasm, the chromatin material is rearranged and distributed in a manner which makes it possible for each cell to receive a very definite share. Each daughter cell receives the same number of chromosomes, although in many cases there is a very great difference in the size of

the resulting cells. Indeed, exactness of chromatin distribution appears to be the primary object of mitosis.

The significance of the nicety of chromatin distribution lies in the fact that not only are the various chromosomes qualitatively different but also each chromosome is qualitatively different from one end to the other, and these different parts of the chromosomes, known as GENES, are the determiners of characters which are handed on from cell to cell. And since cell division is reproduction, the chromosomes are the chief agents in the transmission of characters from parent to offspring in inheritance. We shall consider these important problems when heredity is discussed, but now we must return to the origin of the gametes.

## 2. Chromosomes of the Germ Cells

It is clear that the spermatogonia and oögonia in the gonads, together with all the cells forming the body proper, are direct descendants by mitotic cell division from the fertilized egg which gave rise to the individual organism. This, we have just seen, is equally true of the chromosomes and, therefore, every cell of the animal body has the same number of chromosomes as the fertilized egg. Furthermore, since fertilization always consists in the fusion of two gametes — a fusion of nucleus with nucleus and cytoplasm with cytoplasm to form a zygote — one of two things must happen. Either the zygote, which is one cell reconstructed from two, must have double the chromosome number, that is, a set contributed by both egg and sperm; or some method must exist by which the chromosomes of the gametes are reduced in number to one-half that characteristic of the somatic cells.

As a matter of fact, a reduction in the number of chromosomes always does take place sometime during the life history. In plants, such as the Ferns and Seed Plants, it occurs at the formation of the spores. Thus it follows that the cells of the gametophyte contain half as many chromosomes as the sporophyte, and the sporophyte number is restored by

the union of the gametes. It must be borne in mind, however, that the familiar plants are sporophytes which, for all practical purposes, directly produce sporophytes because the gametophyte is reduced almost to the vanishing point.

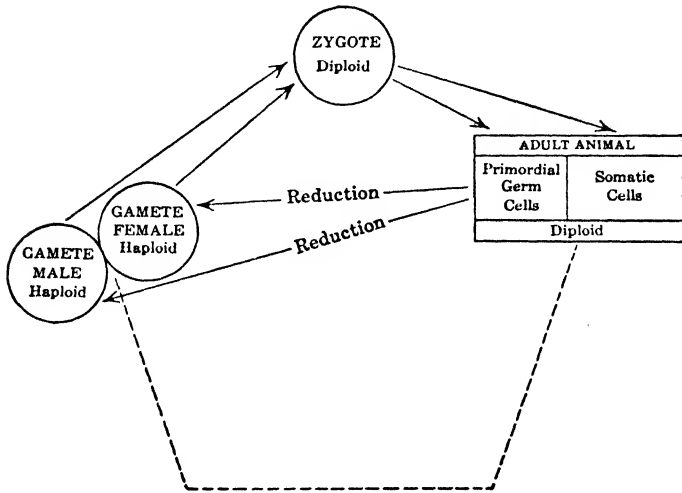

A

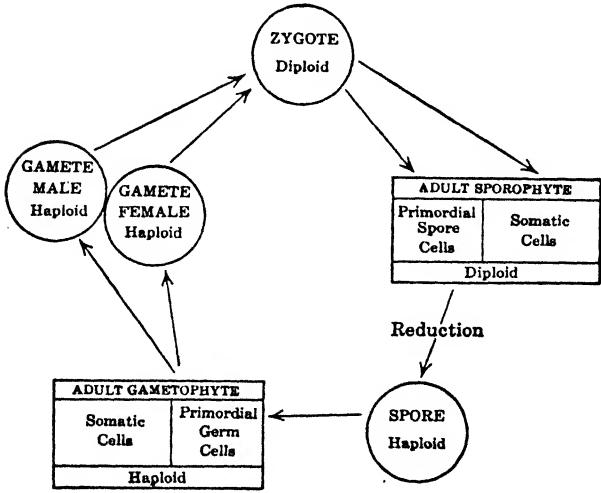

B

FIG. 294. Schematic representation of the life history of an animal (A) and of a plant, *e.g.*, Fern, (B) from the standpoint of the diploid and haploid condition of the chromosomes.

The chromosome number in the cells of the parent sporophyte and the sporophyte in the seed is the same. However, attention must be concentrated on the conditions as they exist in animals, in which the somatic number (DIPLOID NUMBER) of chromosomes is reduced to one-half (HAPLOID NUMBER) at the formation of the gametes. From the standpoint of chromosome number, the sporophyte is comparable to the animal soma and the gametophyte is represented essentially only by the gametes in animals. (Figs. 77, 294.)

The MATURATION or 'ripening' of the germ cells of animals involves two cell divisions by which each spermatogonium gives rise to four sperm, and each oögonium to one functional egg and three tiny, abortive cells known as polar bodies or POLOCYTES; each and all with one-half the number of chromosomes of the somatic cells and of the germ cells up to this point in their development. Consequently these two divisions, termed MATURATION DIVISIONS, or MEIOSIS, must be examined in some detail if we are to appreciate the nicety of the process by which the chromosome number is reduced one-half without impairing the chromatin heritage from cell to cell. We shall describe first the origin of the sperm, or SPERMATOGENESIS, and then proceed to the fundamentally similar origin of the egg, or OÖGENESIS.

### 3. Spermatogenesis

A given SPERMATOGONIUM, with the diploid number of chromosomes characteristic of the body cells of the species, proceeds to increase in size preparatory to the first meiotic mitosis and is designated a PRIMARY SPERMATOCYTE. At the close of this growth period, when the cell is in process of division, the chromosomes join in pairs, that is, undergo SYNAPSIS. Then the chromosomes of each pair split lengthwise so that each synaptic pair now forms a synaptic group of four chromosomes known as a TETRAD. The tetrads are then arranged in the equator of the spindle exactly as the single chromosomes are in ordinary mitosis. But in the early

anaphase each tetrad is resolved into two DYADS each consisting of two chromosomes, so that one dyad of each tetrad passes to each pole of the spindle and so to the arising cells, or SECONDARY SPERMATOCYTES. (Fig. 295.)

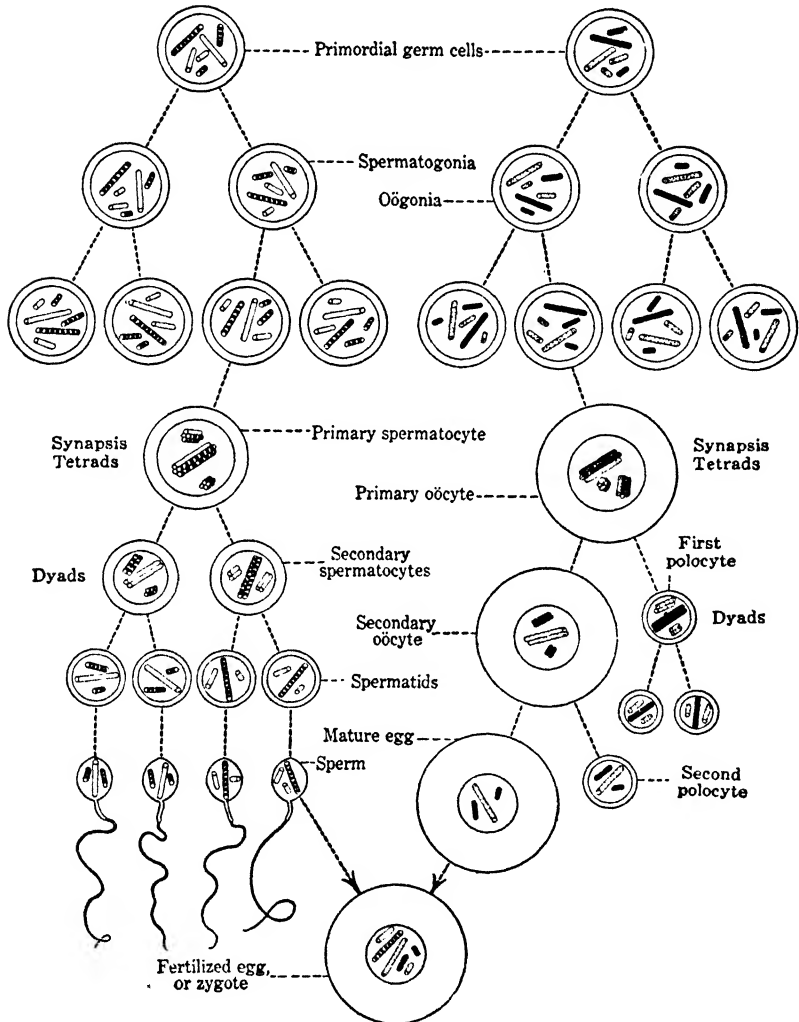

FIG. 295. The general plan of spermatogenesis and oögenesis in animals. Male at left; female at right. The somatic, or diploid, number of chromosomes is assumed to be six. Homologous chromosomes are of equal length. (After Hegner.)



Now the second and final meiotic division takes place by the division of the secondary spermatocytes. In each the dyads are arranged in the equator of the spindle and then, as cell division proceeds, one chromosome of each dyad passes to each of the daughter cells, or SPERMATIDS.

Thus by two meiotic divisions there arise from each spermatogonium four spermatids. But since only *one* chromosomal division takes place during the *two* meiotic cell divisions (in the other, synaptic mates are disjoined), the chromosome number in the spermatids is one-half that in the spermatogonia and in the body cells. The spermatids presently are transformed into sperm and therefore each spermatogonium with the diploid number of chromosomes gives rise to four sperm each with the haploid number. Chromosome REDUCTION is accomplished. (Fig. 295.)

In brief, the meiotic divisions distribute the component chromosomes of the tetrads to separate cells so that at the conclusion of meiosis each of the four resulting cells has a haploid set of chromosomes composed of a longitudinal half of one member of each of the original synaptic mates. Reduction thus involves the SEGREGATION of synaptic mates into separate cells, the gametes.

#### 4. Oögenesis

The maturation of the egg, as already intimated, follows the same plan as that of the sperm, and the reduction of the chromosomes is the same. Such modifications as occur are related to the fact that the egg is always a relatively large, passive cell stored with nutritive materials for use during the developmental process, while the sperm is among the smallest of cells — essentially a nucleus surrounded with a delicate envelope of cytoplasm. Accordingly it is only necessary to emphasize that the growth period of egg formation, in which the OÖGONIUM becomes transformed into the PRIMARY OÖCYTE, is characterized by a much greater increase in size than is the case in the corresponding period in sperma-

togenesis; and that the following two maturation divisions involve very unequal divisions of the cytoplasm. Thus one SECONDARY OÖCYTE is very large, while the other is a tiny cell termed the FIRST POLOCYTE.

Moreover, the large secondary oöcyte and first polocyte now divide again; the former giving rise to a large cell, the mature EGG, and a tiny SECOND POLOCYTE; while the first polocyte divides equally to form two polocytes. In this way arise the four cells, comparable to the four sperm in spermatogenesis, each with the haploid number of chromosomes. But only one of these, the egg, functions as a gamete. The three polocytes, although possessing a similar chromosome complex, are sacrificed in providing one cell, the egg, with its special cytoplasmic equipment. The polocytes get just enough cytoplasm to be regarded as cells, and soon degenerate and disappear. (Figs. 295, 296.)

Such is the outline of the essentials of spermatogenesis and oögenesis in animals; processes which involve a modification of ordinary somatic mitosis to give each gamete half the somatic number of chromosomes characteristic of the species. It is clear that this is not merely a mass reduction of chromatin material, but is a separation and *segregation* after synapsis of definite chromatin entities, the chromosomes, so that each of the gametes receives the reduced number.

Throughout the animal and plant kingdoms, wherever sexual reproduction occurs, phenomena which can be interpreted as nuclear reduction have been observed. In some of the Protozoa this seems to be merely an extrusion of a certain amount of chromatin, but since whenever chromosomes can be observed and counted the process has been found to follow in principle essentially the same lines described above, we have every reason to believe that it is never a haphazard mass reduction, and that the ripe gametes emerge with a definite chromatin heritage, relatively simple as this may be in the lowest forms.

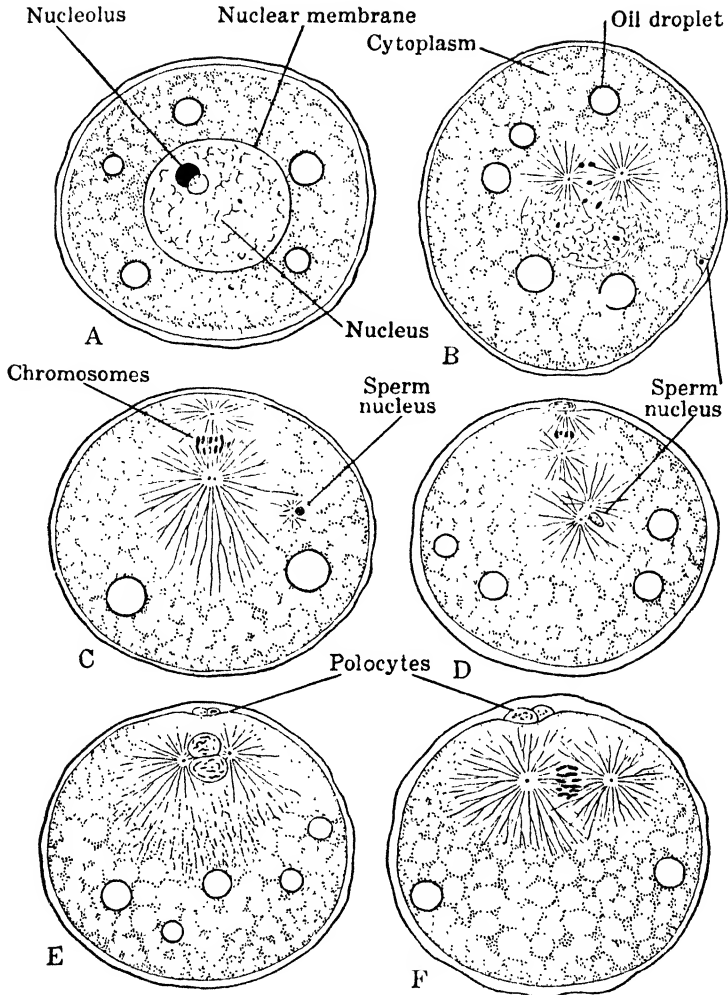

FIG. 296. Maturation and fertilization of the egg of the Sandworm, *Nereis*. A, egg (oöcyte) before start of maturation; B, first polocyte spindle forming, sperm just entering; C, first polocyte spindle established; D, first polocyte formed, second polocyte spindle near; spindle with sperm nucleus; E, second polocyte formed, union of egg and sperm nucleus; F, spindle for first division of fertilized egg. Note that in *Nereis*, as in many other animals, maturation of the egg is deferred until the time of fertilization. (From Wilson.)

## 5. The Chromosome Cycle

We have now surveyed the *germ cell cycle* from the fertilized egg through the germ plasm in the adult to the gametes again, but before proceeding to consider the details of the fusion of egg and sperm — the fertilization process — it may clarify matters to glance back to the *chromosome* condition in the fertilized egg at the *beginning* of the cycle that has just been considered.

Obviously this fertilized egg (zygote) contained two groups of chromosomes, one of which belonged to the egg and therefore may be termed MATERNAL, and one which was derived from the sperm and thus is PATERNAL. When the zygote divided by mitosis to form the body and germ, every cell received two groups of chromosomes directly derived from these two original groups in the zygote. It logically follows, and all observations indicate, that each and every cell, both of the body and of the germinal tissue, possesses two groups of chromosomes, one of maternal and one of paternal origin — in other words, direct lineal descendants of the combined set formed at fertilization.

So it happens that each body cell really has two complete sets (diploid number) of chromosomes, and the same is true of the germ cells until maturation. Then at synapsis corresponding (HOMOLOGOUS) maternal and paternal chromosomes pair and after the maturation divisions the gametes have a single set (haploid number). (Figs. 295, 297.)

Thus far we have emphasized chromosome reduction as the main result of the complicated maturation phenomena. The question now arises: Is this chromatin distributed so that all the gametes receive the same heritage?

As already stated, the evidence indicates not only that chromosomes differ qualitatively one from another, but also that the various parts of each chromosome are qualitatively distinct. And further that these qualitative differences are the physical basis of inheritance — the determiners (genes) of characters which will be realized in the individual or the

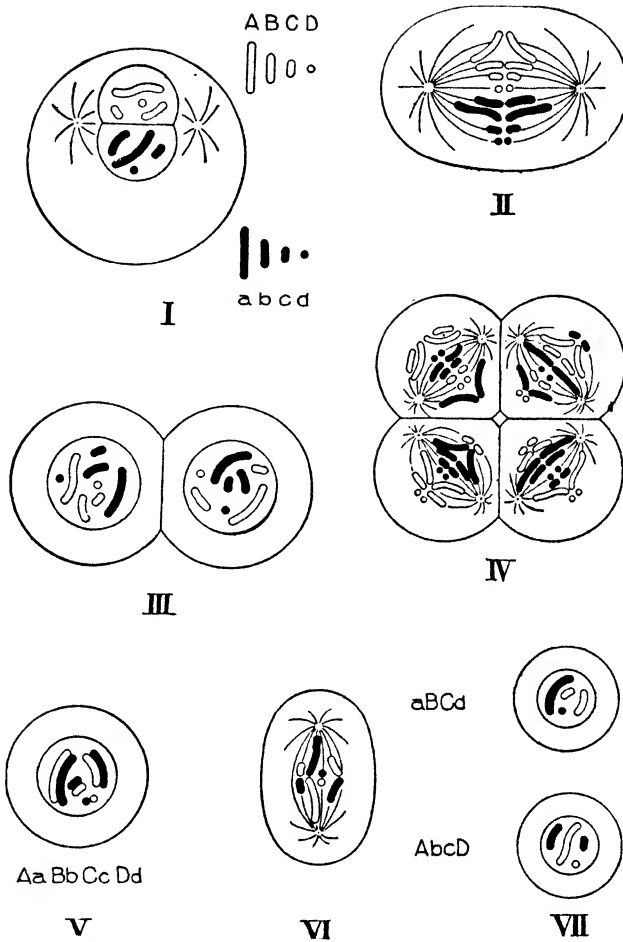

FIG. 297. Diagram of the chromosome cycle of an animal. Somatic (diploid) chromosome number assumed to be eight. Paternal chromosomes (from sperm) = A B C D; maternal (from egg) = a b c d. I, union of nuclei of gametes, each with the haploid number of chromosomes, in the zygote at fertilization to give the diploid number of chromosomes. II, III, IV, somatic divisions or divisions of germ cells before maturation (diploid number of chromosomes). V, synapsis, involving pairing of homologous paternal and maternal chromosomes to give the haploid number of paired chromosomes. (Tetrad formation disregarded.) VI, a maturation division — separation of pairs into single chromosomes again. VII, two gametes, with the haploid number of chromosomes; there are 14 more possible combinations of the chromosomes, or types of gametes, which are not shown. See Fig. 329. (After Wilson, slightly modified.)

race to which the cell containing them contributes. Such being the case, the chromosomal complex of each of the nuclei which arises after synapsis — the nuclei of the gametes — depends on how the various chromosomes happen to be distributed during the two meiotic divisions. As a matter of fact, all the chromosomal combinations occur that are mathematically possible with the available number of chromosomes in a given species, but with one limitation: every cell must receive a derivative of one member of each synaptic pair of chromosomes, so that each and every gamete receives a complete haploid group of chromosomes, but rarely the same group (maternal or paternal) which existed before maturation. For example, if the somatic (diploid) number of chromosomes is eight, sixteen different types of gametes are possible. In man with 48 somatic chromosomes, and after synapsis 24 pairs of paternal and maternal chromosomes, there are  $2^{24}$ , or about seventeen million possible types of gametes in each sex; and since these combine at random at fertilization, the possible number of different types of zygotes from one parental pair mounts far up in the trillions from chromosomal combinations alone. No wonder the children of a family differ — there is variation! (Fig. 332.)

In a way, therefore, fertilization is not consummated, so far as its influence on the race is concerned, until the maturation of the gametes in the new generation to which it has given rise. We must defer until later the consideration of the significance of these facts in BIPARENTAL inheritance, and merely emphasize again that the continuity of life implies not only the continuity of cells but also of their nuclear elements, the chromosomes — the genes.

## CHAPTER XXII

# FERTILIZATION

The entire organism may be compared to a web of which the warp is derived from the female and the wool from the male.

— *Huxley*.

**N**ow that we are familiar with the method of gamete formation and its contribution to the continuity of life, it is in order to consider some important details of the structure of the gametes themselves, and the significance of the complex series of phenomena that they initiate at fertilization. The biological importance of fertilization and the part it plays in the life of the individual organism and the race has aroused the interest of philosophers and scientists since the time of Aristotle, but it is only within the past half-century that at least a partial answer has been forthcoming from a critical analysis of the gametes and their product, the zygote.

### A. GAMETES

The gametes, while exhibiting in certain cases peculiar adaptations to special conditions, are remarkably similar in general structure throughout the animal series. The same is true for most plants until we reach the special conditions, involving pollination, in the Seed Plants. It will be recalled that it is possible to arrange a series of lower forms which shows various stages in sex differentiation. Beginning with those in which both gametes are structurally similar, we pass by slow gradations to others in which the egg is a relatively large, passive, food-laden cell and the sperm a minute, active, flagellated cell. (Figs. 60, 63, 298, 373.)

As a matter of fact, the egg is subject to much more variation in size and general appearance than the sperm, for after

fertilization it must be adapted to meet the special conditions of development peculiar to the species. Thus, for instance, the actual size of the egg in animals is determined chiefly by whether the developing embryo is in the main

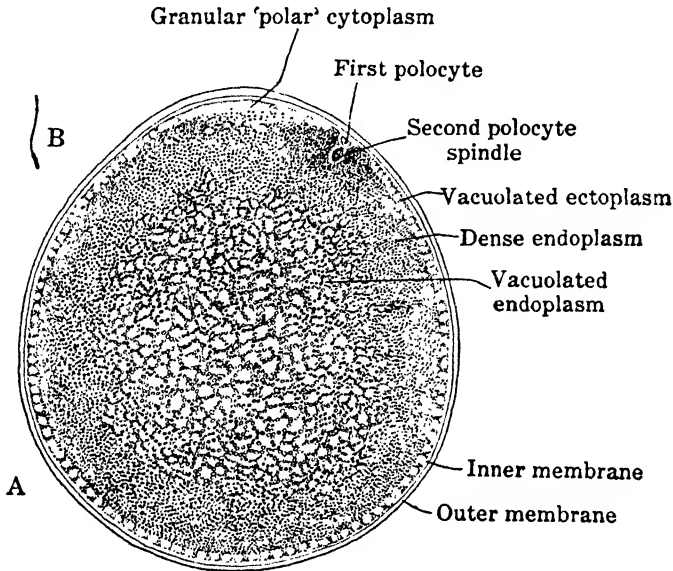

FIG. 298. A, section through the egg of a primitive Vertebrate, the Lamprey; B, sperm of the same species, drawn to scale. Highly magnified. (From Kellicott, after Herfort.)

dependent upon food stored in the cytoplasm of the egg itself, or upon some outside source, such as the sea water in which it floats, or the tissues of the parent. The first case is well illustrated by a bird's egg in which the so-called YOLK is the egg cell proper, hugely distended by stored food and surrounded by nutritive and protective envelopes. These are the 'white of the egg,' shell membranes, and shell which are formed by secretion from the walls of the oviduct during the passage of the egg to the exterior. On the other hand, the eggs of Mammals, for instance of the rabbit and man, are very small—the human egg being less than  $1/125$  of an inch in diameter—since their essentially parasitic



method of development in the uterus renders superfluous the storage of food material in the egg cytoplasm. (Figs. 255, 299, 309.)

With the specialization of the egg along lines which render it non-motile, it has devolved upon the sperm to assume the function of seeking out the egg for fertilization. It does this in most cases by active lashing of its flagellum. This necessitates a fluid medium in which the sperm can swim, and such

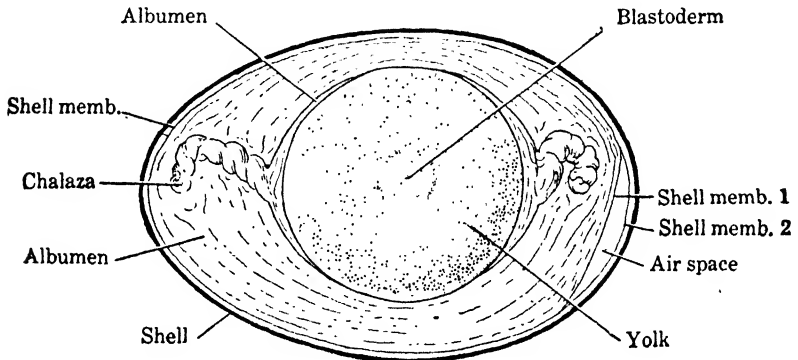

FIG. 299. Egg of the domestic Fowl, before incubation. Dorsal view. See Fig. 307.

is provided by the environment in which the organism lives or, in the case of most higher animals, where fertilization takes place within the oviduct, by special fluids secreted for the purpose.

A question of much interest is how the actual meeting of the gametes is brought about. In many cases it is undoubtedly merely by chance: the random swimming of the sperm sooner or later bringing one in contact with an egg. In other cases the movements of the sperm indicate a definite attraction by the egg. Thus the sperm of certain Mosses seem to approach the egg in the archegonium under the influence of chemicals secreted there, and those of some of the lower animals apparently are attracted by substances liberated by the egg at maturation. In all such instances there can be but little doubt that stimulation of the sperm by specific

substances plays a part in bringing the gametes together and is a chemical link between egg and sperm in normal fertilization. This is an example of CHEMOTROPISM: a phenomenon of considerable importance, especially in the behavior of many kinds of free-living cells.

## B. UNION OF GAMETES

Once a single sperm has come into functional contact with the egg, it initiates a chain of events which constitutes fertilization. Although, as might be expected, the variations in details are legion, they do not obscure the main facts. The first reaction on the part of the egg is to prevent the entrance of other sperm and thereby to ensure a free field for the operations of the first arrival. Frequently a jelly-like layer is formed about the egg, or if a membrane is already present this may be rendered impermeable or still another formed. In cases where the egg is surrounded originally by a dense and resistant wall, the tiny opening provided for the entrance of the sperm is closed. However, the accessory wrappings about certain eggs, such as those of birds, have no relation to the present subject since they are secreted, not by the egg itself, but by glands in the wall of the oviduct, some time after fertilization has occurred, when the egg is passing down. (Fig. 299.)

The reactions of the egg cytoplasm that exclude accessory sperm are overshadowed in importance by others which upset the stable equilibrium of the egg and render its surface permeable, so that extensive osmotic interchanges take place between the cytoplasm of the egg and its surroundings. Most often this is visible merely in a shrinkage of the cytoplasm due to loss of water, but sometimes contractions, amoeboid movements, or flowing of special cytoplasmic materials to definite regions of the egg are visible. In any event it is certain that profound changes occur in the cytoplasm — its organization as a gamete soon gives place to a reorganization that establishes the general outlines of its subsequent development as a new individual. (Figs. 296, 312.)

## 1. *Synkaryon*

Turning now to the nuclei, known as male and female GAMETIC NUCLEI, the union of which to form the single nucleus (SYNKARYON) of the zygote is the climax of fertilization. Disregarding the flagellum of the sperm, which disappears as it enters the egg, we find that the sperm nucleus moves through a quite definite path toward the center of the egg where it is met by the egg nucleus. Both the gametic nuclei now become resolved into chromosomes which lie free in the cytoplasm, while two centrosomes, each surrounded by an aster, appear and take up positions on either side of the chromosomes to form a typical mitotic figure. The two sets of chromosomes form an equatorial plate at the center of the spindle, thus establishing at once not only the mitotic apparatus for the first division of the egg, but also the intimate association on equal terms of chromosomes, with their potentialities from the two parents, to form a common structure — the nuclear complex of the new individual. (Figs. 296; 297, I, II; 303.)

Such are the outstanding facts of fertilization which a host of investigators have brought to light chiefly within the past seventy years. It was not until 1839 that Schwann, with the establishment of the cell theory, recognized the egg as a cell, and twenty-six years more before the sperm was similarly understood; while the first realization that fertilization is an orderly fusion of two cells to form one came during the seventies of the last century. Then it became evident that in sexual reproduction each individual contributes to the formation of the offspring a single cell in which must be sought the solution of the problems of sex, fertilization, development, and inheritance. However, the concentration of attention on the cell has not simplified the solution of these fundamental problems, but rather it has contributed to an ever-increasing appreciation of the complexities of cell phenomena and the difficulties of formulating them in general terms. (Fig. 458.)

## 2. *Significance of Fertilization*

Quite naturally the original view was that fertilization fundamentally is reproduction — the mature egg pauses in development and usually comes to naught unless a sperm enters. However, as we know, reproduction is cell division or the detachment of a portion of a living organism to form another, whereas fertilization is the union of two cells to form one cell. The erroneous idea that fertilization is reproduction is due to the fact that in higher organisms, if fertilization is to occur at all, it must take place at the period in the life history when the individual is but a single cell detached from the parent — that is, at the time of reproduction. With this point clear, we may briefly discuss the significance of fertilization, first on the basis of evidence derived from the unicellular animals.

**PROTOZOA.** The life histories of most of the Protozoa that have been carefully studied include a period in which fertilization occurs. Under favorable environmental conditions, *Paramecium*, for instance, reproduces by binary fission two or three times a day so that in a remarkably short period the one cell is replaced by a host of descendants. Sooner or later, however, the individuals exhibit a tendency to unite temporarily in pairs, or **CONJUGATE**. Usually the conjugants are of diverse descent and different 'mating types.' During conjugation complicated changes take place in the nuclei of the cells, involving chromosome reduction and the formation of two gametic nuclei in each individual of the pair of conjugants. Then one of the gametic nuclei in each conjugant migrates over and fuses with the stationary gametic nucleus of the other to form a synkaryon in each cell. After this the two *Paramecia* separate, reconstruct their characteristic vegetative nuclear apparatus, and proceed to reproduce by division as before. (Figs. 21, 149, 282, 300.)

This is fertilization in *Paramecium*, and on the assumption that the primary significance of synkaryon formation should be most evident in unicellular forms, a large amount

of experimental breeding has been carried out on *Paramecium* and its allies. The earlier results seem to demonstrate that *Paramecium* can divide only a limited number of times, say a couple of hundred, after which the cells die from ex-

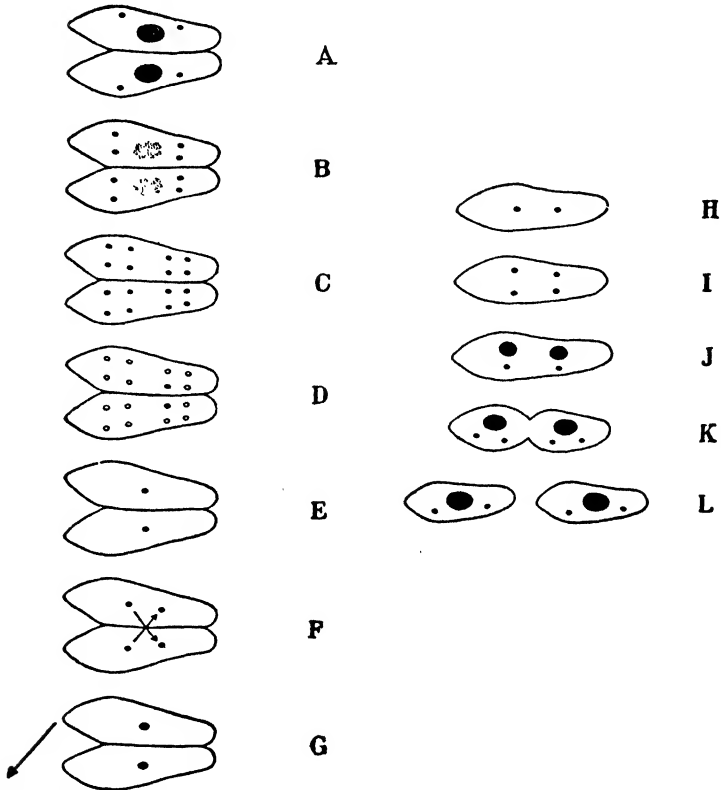

FIG. 300. Diagram of the nuclear changes during fertilization (conjugation) in *Paramecium aurelia*. A, union of two individuals along the peristomal region; B, degeneration of macronucleus and first division of the micronuclei; C, second division of micronuclei; D, seven of the eight micronuclei in each conjugant degenerate (indicated by circles) and disappear; E, each conjugant with a single remaining micronucleus; F, this nucleus divides into a stationary micronucleus and a migratory micronucleus — the gametic nuclei. The migratory micronuclei are exchanged by the conjugants and fuse with the respective stationary micronuclei to form the synkaryon. This is fertilization. G, conjugants, with synkaryon, separate (only one is followed from this point); H, first division of synkaryon to form two micronuclei; I, second reconstruction division; J, transformation of two micronuclei into macronuclei; K, division of micronuclei accompanied by cell division; L, typical nuclear condition restored, as in A. Two micronuclei are characteristic of *P. aurelia*.

haustion or SENILE DEGENERATION unless fertilization takes place. In other words, it was believed that periodic REJUVENATION by fertilization is a necessity for the continuance of the life of the race. And therefore, so the conclusion ran, protoplasm is unable to grow indefinitely: there is an inherent tendency for katabolism to gain ascendancy over anabolism, and fertilization serves to maintain or restore the youthful condition and secure the continuance of the race.

In this connection, the life history of Paramecium from one period of fertilization to the next is often compared to the life of a multicellular organism from its origin as the fertilized egg, through youth and adult life to old age. The striking difference is that, in the case of Paramecium, the products of division of an animal which has conjugated (EXCONJUGANT) separate as so many independent cells which in later generations are capable of fertilization; while all the products of division of the fertilized egg of multicellular forms remain together as a unit and become differentiated for particular functions in the individual, except a few, the germ cells, which retain the power of forming new individuals. Pushing this comparison a little further, it is stated that after fertilization in Paramecium there is the period of greatest cell vigor, or youth, followed by maturity when the cells are ripe for fertilization again, and in the absence of fertilization — and only then — the onset of old age, and death. Thus death has no normal place in the life history of Paramecium, for all the cells at the period of maturity are capable of fertilization. On the other hand, in multicellular forms only some of the cells, the germ cells, retain this power — the somatic cells have paid the penalty of specialization and must die. Thus death of the individual except by accident does not occur among unicellular forms because fertilization 'rejuvenates' the cell, and the cell and the individual are one and the same. With the origin of multicellular forms, involving the segregation of soma from germ, death became possible, and was established — it is the 'price paid for the body.' (Figs. 282, 315.)

Suggestive as is this comparison and contrast — and it is not without some justification — the cardinal fact remains that recent work has demonstrated that *Paramecium* and some closely related forms, when bred under favorable environmental conditions, can continue reproduction indefinitely, at least in one case for more than thirty years and some twenty thousand generations, without fertilization and without any signs of degeneration. Moreover in many unicellular forms fertilization has never been observed and probably does not occur in the life history. In other words, fertilization is not a necessary antidote for inherent senescence, and this, taken in connection with other data which point in the same direction, such as the unlimited reproduction of many plants by asexual processes, and the recent discovery that certain tissue cells removed from the vertebrate body will live, grow, and divide apparently indefinitely if given favorable conditions, renders it safe to make the general statement that senescence is not inherent in protoplasm — the need of fertilization is not a primary attribute of living matter. Reproduction and fertilization are intrinsically separate processes which, however, have become closely associated, especially in higher forms.

So far our conclusion is entirely negative — fertilization is not reproduction and is not intrinsically necessary for reproduction. What then is its significance? Though fertilization may not be necessary in the life of simple organisms under favorable conditions, this does not indicate that it may not be a stimulus to protoplasmic activity when it does occur — perhaps a very important factor under special environmental conditions. Indeed it appears certain that conjugation in many cases directly results in stimulating the vital processes of the cell, including reproduction. But it would seem that the essential factor in this stimulation is not the essence of fertilization, which is synkaryon formation. In certain Ciliates, including some species of *Paramecium*, an internal nuclear reorganization process known as **ENDOMIXIS** occurs periodically. This is carried on by each

individual, without a nuclear contribution from another and without synkaryon formation. Nevertheless it frequently effects a physiological stimulation similar to that which follows synkaryon formation during fertilization. Accordingly the factor common to both fertilization and endomixis, that is general nuclear reorganization, apparently is responsible for the 'dynamic' effects. (Fig. 301.)

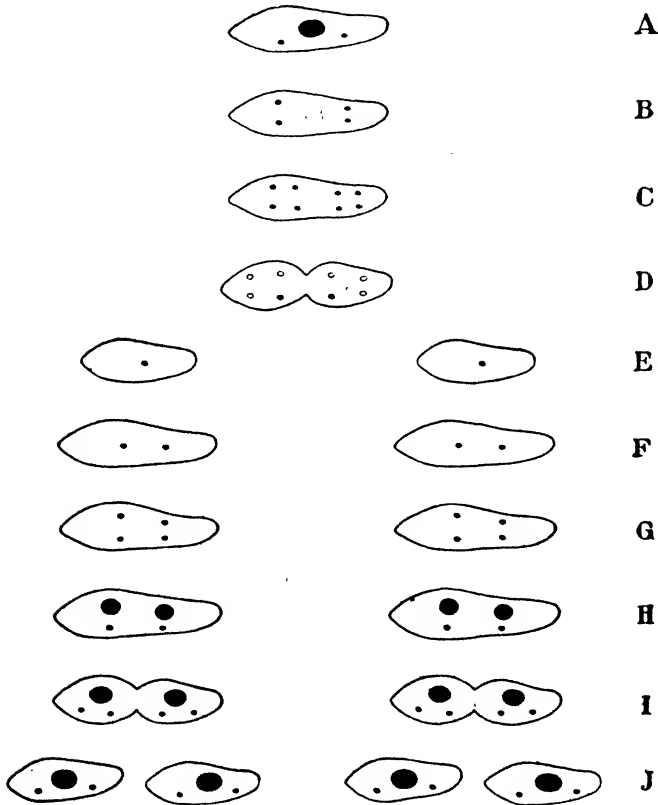

FIG. 301. Diagram of the nuclear changes during endomixis in *Paramecium aurelia*. A, typical nuclear condition; B, degeneration of macronucleus and first division of micronuclei; C, second division of micronuclei; D, degeneration of six of the eight micronuclei; E, division of the cell; F, first reconstruction micronuclear division; G, second reconstruction micronuclear division; H, transformation of two micronuclei into macronuclei; I, micronuclear and cell division; J, typical nuclear condition restored, as in A.



**METAZOA.** We may now consider other evidence among higher forms in regard to the dynamic influence of fertilization. Although fertilization is usually necessary for the resumption of the series of cell divisions which paused after the maturation divisions, and which are to transform egg into adult, there are many exceptional but entirely normal cases where the egg proceeds to divide of its own accord. Such **PARTHENOGENETIC** eggs are formed like other eggs, though sometimes without chromosome reduction. Thus the eggs of the Honey Bee, to cite the most interesting case, develop either with or without fertilization — fertilized eggs forming females and unfertilized eggs, males. Certain species of Rotifers and Roundworms apparently reproduce solely by parthenogenesis, males not being known. Leaving out of the question the effect on the chromosome complex, the fact that an egg divides without the influence of a sperm indicates clearly that, in such cases at least, neither structural additions nor physiological influences of the sperm are necessary to initiate development.

It may be urged, however, that such cases of normal parthenogenesis are special adaptations to peculiar conditions in which the egg has usurped, as it were, the usual sperm function, and that therefore the evidence is of little weight in determining the primary significance of fertilization. Accordingly the data from so-called **ARTIFICIAL PARTHENOGENESIS** are particularly cogent. It has been found that the eggs of a considerable number of animals from the lower Invertebrates to Mammals, which normally require fertilization, can be induced to start development parthenogenetically by various artificial means such as subjection to certain chemicals, unusual temperature changes, shaking, or the prick of a needle — the effective stimulus varying with different species.

Just what happens in the egg as a result of such treatment is open to discussion, but for our purpose it is sufficient to know that the egg begins to divide in normal fashion. This shows conclusively that even eggs which normally require

fertilization are intrinsically self-sufficient not only to start to develop but in certain cases to attain the adult state, and therefore this strongly indicates that an incidental and not the main function of fertilization is to stimulate cell division.

Restating the evidence in its bearings on the meaning of fertilization, we may say that fertilization is not fundamentally an indispensable event in the life history of many unicellular organisms living under favorable environmental conditions. Certain species have been bred for thousands of generations without conjugation, and, indeed, without endomixis. Again, in some other species it has never been observed and probably does not occur. Similarly in the Metazoa, both normal and artificial parthenogenesis indicate that the egg itself comprises a mechanism which is capable of initiating and carrying on development. From this viewpoint, fertilization may be satisfactorily interpreted as a means of ensuring under special or unfavorable environmental conditions in unicellular organisms, and under usual conditions in the eggs of multicellular forms, a suitable stimulus which otherwise might be unavailable at the proper time.

Granting then that fertilization may afford a stimulus to development, is this its chief significance? Many lines of evidence surely converge toward the view that the opportunities which fertilization affords for changes in the complex of the germ are of paramount importance. Fertilization establishes new diploid groups of hereditary characters by combining diverse haploid groups from the two gametes. It makes possible the shuffling of germinal variations so that they are presented in new combinations. It is the pooling of the germinal changes of two lines of descent. Some of the new combinations may more effectually meet — be better adapted to — the exigencies of the environment, and so have a survival value for the organism in the struggle for existence. So whatever the primary meaning of fertilization may be, its importance in establishing the essentially dual nature of

every sexually produced organism is settled beyond dispute, and it is the cardinal fact of heredity. No wonder is it that usually in the lowest and always in the highest organisms provisions are made for a process which multiplies many-fold the opportunities for descent with change. (Fig. 329.)

In passing, it should be emphasized that provisions to ensure fertilization have had a profound influence on the morphology and physiology of organisms. Sex of the gametes and sex of the individual body are, of course, radically different, although the latter is indirectly an outcome of the former. The evolution of the gametes themselves is relatively simple: from those alike so far as structure is concerned, though physiologically different, to those in which one sex is smaller and more motile and the other larger and usually non-motile. But the sexual evolution of the individual body in the Metazoa presents amazing phenomena. Witness the biological and physiological contrast of individuals that bear sperm and eggs respectively. Sex, indeed, becomes largely a dominating factor in the life of the lower animals, and even of man, where the primary function of somatic sexual differentiation to ensure fertilization appears to become largely submerged. "It is as though variety and beauty had become ends in themselves in the evolution of secondary sex characters, as exemplified in the plumage of birds, and in the strife and amenities of human social relations." (Figs. 63, 255.)

## CHAPTER XXIII

# DEVELOPMENT

The student of Nature wonders the more and is astonished the less, the more conversant he becomes with her operations; but of all the perennial miracles she offers to his inspection, perhaps the most worthy of admiration is the development of a plant or animal from its embryo. — *Huxley*.

**T**he new individual, established by the orderly merging of a cell detached from each parent in sexually reproducing plants and animals, has before it the problem of assuming the adult form by a complicated developmental process. Its heritage provided in the zygote must be realized. As we have seen, this involves, first, the cleavage of the egg, followed, in the Metazoa, by blastula and gastrula stages during which the primary germ layers are established — the fundament out of which the definitive form, organs, and organ systems of the adult are evolved. The description and comparison of these processes in different organisms constitute the content of one aspect of EMBRYOLOGY. (Figs. 24, 303, 461.)

It is unnecessary — indeed, it is impossible — to survey the immense field included under embryology. Attention must be confined to the development of animals. And we must be satisfied with the realization that their development, though it varies widely in producing the immensely diverse body forms, exhibits throughout a thread of similarity in its fundamental features. This may be gained by concrete examples — first the embryological development of the Earthworm from the zygote to the establishment of the general body plan.

### A. EMBRYOLOGY OF THE EARTHWORM

The egg of the Earthworm, after fertilization, proceeds to divide first into two cells, then four cells, eight cells, and so on, with more or less regularity, until a condition is attained in which many relatively small cells are arranged about a central cavity. This stage of the embryo will be recognized as the blastula. (Pp. 59, 60, 190.)

The various cells of the blastula appear essentially the same except that those at one end are somewhat larger than at the other. The larger cells now sink into and nearly obliterate the central cavity of the blastula, thus forming a typical gastrula stage composed of two layers of cells, ectoderm on the outside and endoderm on the inside. The infolded enteric pouch, or enteron, enclosing the enteric cavity, eventually becomes the main part of the alimentary canal of the worm; its present opening to the exterior, or blastopore, forming the mouth. So the developing worm has now reached a transient state which is broadly comparable to the permanent adult condition of Hydra. (Fig. 302.)

While these two primary germ layers are being established, the developing embryo shows the rudiments of the third primary germ layer (mesoderm) in the form of two **MESOBLAST CELLS** which leave their original position in the wall of the embryo and take up a place between the ectoderm and endoderm; that is, in the remnant of the cavity of the blastula which the invagination process during gastrulation has not completely obliterated. Here the mesoblast cells, by division, form on either side of the enteric pouch a linear series, or band, of mesoderm cells. These mesoderm bands gradually increase in size and spread out until finally they unite above and below, that is encircle, the enteric pouch. Thus they form a continuous mesoderm layer between ectoderm and endoderm. Simultaneously with the growth of the mesoderm bands to form a definite middle layer, a linear series of spaces appears in each band which presages the future segmentation of the worm's body. These cavities increase

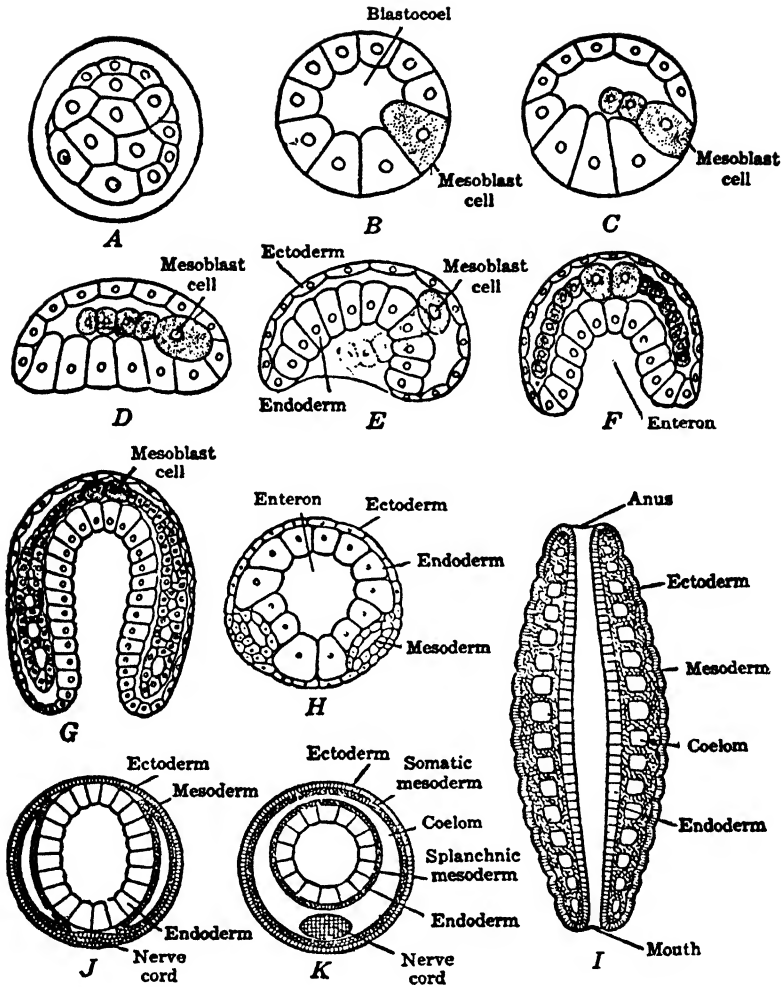

FIG. 302. Diagrams of stages in the development of the Earthworm. A, blastula (surrounded by a membrane); B, section of a blastula showing blastocoel and one of the primary cells (mesoblast cells) of the mesoderm; C, later blastula with developing mesoderm bands; D, start of gastrulation; E, lateral view of gastrula showing invagination which as it proceeds leaves the mesoderm bands on either side of the body as indicated by the cells represented with dotted outline; F, section of E to show mesoblast cells, mesoderm bands, and enteric cavity. G, later stage showing cavities in the mesoderm bands; H, the same (G) in transverse section; I, diagram of a longitudinal section of a young worm after formation of mouth and anus; J, the same in cross section; K, later stage in transverse section. (After Sedgwick and Wilson.)

in size and, when the bands unite around the enteric pouch, the corresponding cavities of each band also become continuous in the same regions. (Fig. 302, C-H.)

In this way the mesoderm itself becomes divided into what are essentially two cellular layers, an outer, or **SOMATIC LAYER**, next to the ectoderm, and an inner, or **SPLANCHNIC LAYER**, in contact with the endoderm. The space between these layers of the mesoderm is the body cavity, or coelom. The coelom, however, is not a continuous cavity from one end of the embryo to the other, because the mesodermal cells which separate the linear series of cavities in the respective mesodermal bands persist. These cells form a regular series of connecting sheets of tissue between the somatic and splanchnic mesoderm layers and thus divide the body of the worm into a series of essentially similar segments, the limits of which are indicated on the outside by a series of grooves that encircle the worm's body. (Fig. 302, I, J.)

While these processes are transforming the two-layered gastrula into an embryo composed of three primary layers, and exhibiting segmentation, coelom, etc. — in short, the 'tube within a tube' body plan characteristic of higher forms — the embryo is gradually increasing in size and elongating. The mouth, representing the blastopore, remains at one end, which is therefore designated as anterior, while growth is chiefly in the opposite direction or toward the posterior. At this end (the blind end of the enteric pouch formed at gastrulation) an opening to the exterior, the anus, is formed so that the enteric pouch now communicates with the exterior at both ends and becomes the alimentary canal. Thus antero-posterior differentiation is clearly established.

A transverse section perpendicular to the main axis of the developing worm at this stage presents the appearance of a circle within a circle. The smaller circle surrounds the enteric cavity and is the wall of the alimentary canal. It is separated by a space, the coelom, from the larger circle, or body wall. Moreover, each of these circles is composed of two tissue layers: the alimentary canal, formed internally

of endoderm and externally of splanchnic mesoderm; and the body wall, internally of somatic mesoderm and externally of ectoderm. Thus the coelomic cavity is entirely enclosed by mesoderm. (Fig. 302, K.)

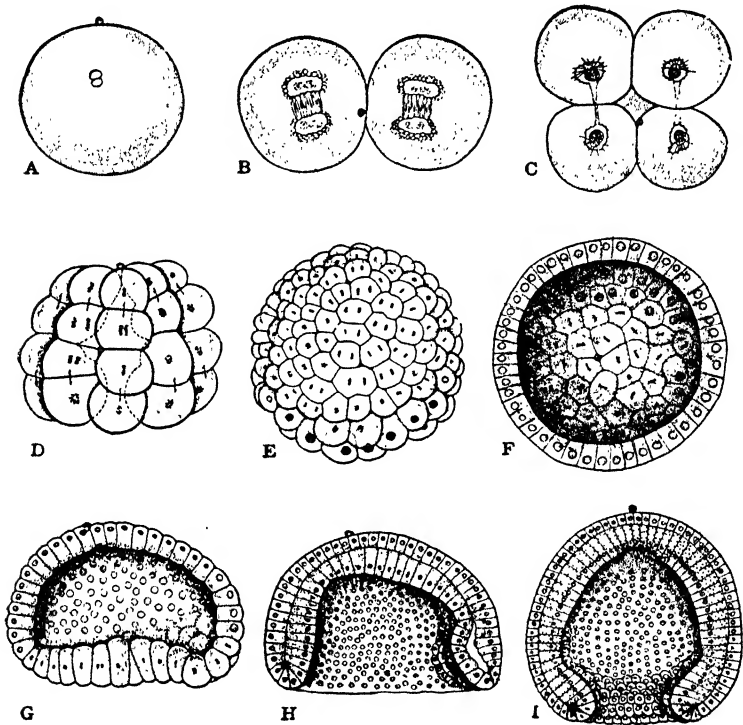

FIG. 303. General plan of the early development of the egg of a primitive Chordate, *Amphioxus*. A, egg with maternal and paternal nuclei fusing, polarocyte at top; B, two-cell stage with nuclei in mitosis; C, four-cell stage; D, thirty-two-cell stage; E, blastula; F, section of blastula showing the blastocoel; G-I, invagination of blastula to form gastrula, obliterating the blastocoel and forming another cavity, the enteron. (After Conklin.)

It is from these three primary layers of cells (ectoderm, somatic and splanchnic mesoderm, and endoderm) that all of the tissues and organs of the adult worm arise through later differentiation, thickenings, foldings, outgrowths, etc. For example, the nervous system is formed by the ingrowth of a thickened region of the ectoderm, the blood vascular system develops by a specialization of cells throughout the



mesoderm, while the reproductive system first appears as thickenings of the somatic mesoderm which, as development proceeds, become largely separated from it as independent organs in the coelom. (Figs. 131, 132.)

## B. DEVELOPMENT OF THE FROG

As an example of vertebrate development we may take that of the Frog, though it must be borne in mind that just as other Invertebrates differ in their embryology from the Earthworm, so the embryology of other Vertebrates departs widely from that of the Frog — chiefly fundamental and highly significant similarities persisting. This 'similarity in dissimilarity' may be readily visualized by comparing the early developmental stages of the Earthworm, Amphioxus — a primitive Chordate, and the Frog as figured herewith. (Figs. 302-304.)

For descriptive purposes the development of the Frog may be divided into three periods: germ cell formation and spawning, fertilization and embryo formation, and larval stages and metamorphosis.

### 1. *Germ Cell Formation and Spawning*

Spermatogenesis and oögenesis, involving the maturation of the gametes, follow the typical process. The first polocyte is formed as the egg passes down the oviduct and the second at the time of fertilization. The eggs are covered with a continuous, gelatinous layer, secreted by the walls of the oviducts, so that when they are shed they adhere in strings; and later, as the jelly swells in the water, they are embedded in a large gelatinous mass which absorbs heat and affords protection. (Figs. 291, 295.)

### 2. *Fertilization and Embryo Formation*

Fertilization occurs just as the eggs leave the body of the female. The sperm pass through the jelly, and a single

are developed which make it necessary for the tadpole to come to the surface of the water for air. Finally, the young frog transfers its abode largely to land, and grows. (Fig. 306, I-L.)

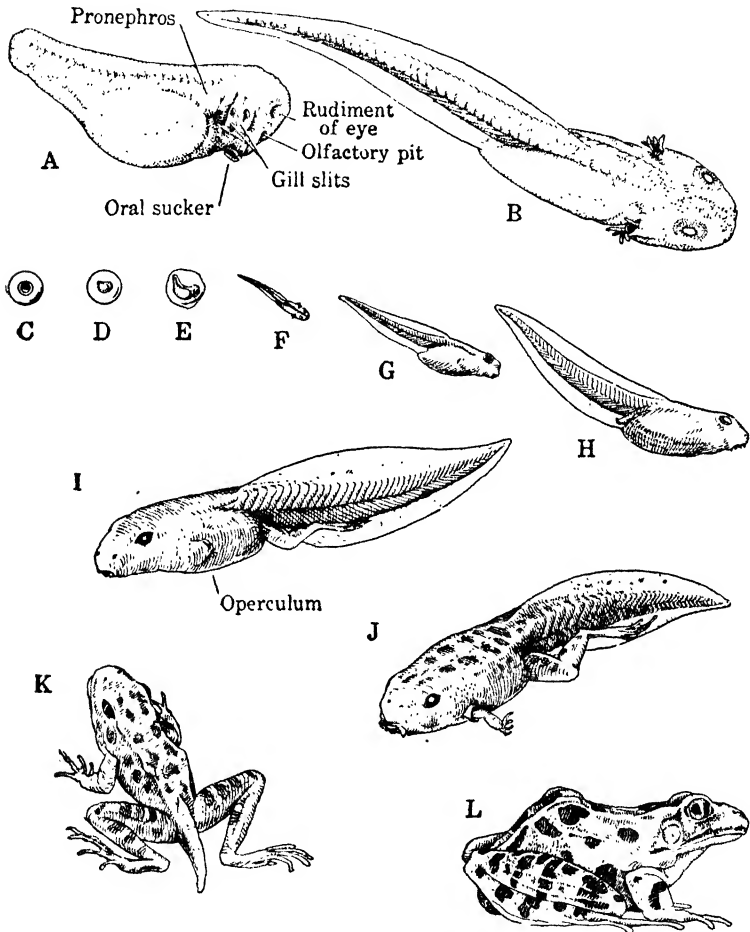

FIG. 306. Development and metamorphosis of the Frog. A, B, stages closely following K in Fig. 304; C-L, stages from egg to adult drawn to scale.

The process of metamorphosis varies in length from a few weeks to several years in different species of Frogs. In all cases it is some time after metamorphosis before sexual maturity arises. Preceding the first breeding season, the gonads

develop rapidly, their ducts become fully differentiated, and adult male and female individuals are established. (Figs. 256, 291.)

### C. EMBRYONIC MEMBRANES OF THE HIGHER VERTEBRATES

The embryonic development of the higher Vertebrates departs rather widely in many ways from that of the Earthworm and Frog. Thus the eggs of Reptiles and Birds contain much more yolk, with consequently a still greater obscuring, though not obliteration, of the characteristic blastula, gastrula, etc. The first obvious result of the great amount of yolk is that complete division of the egg is impossible, so the egg really consists of two parts: the inert

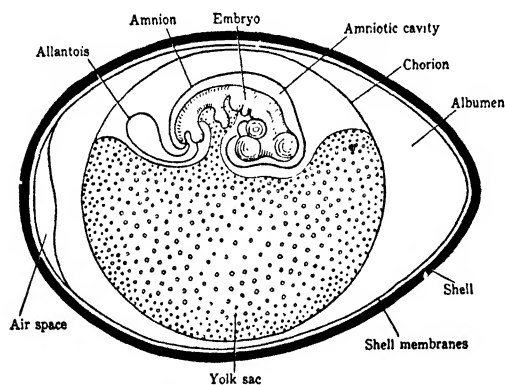

FIG. 307. Diagram of a vertical section of a hen's egg after five days of incubation. The embryo, which naturally lies on its right side, has been raised to show its form. See Fig. 299.

yolk and the protoplasmic region in which cell division occurs and eventually forms the embryo proper and the EMBRYONIC MEMBRANES. (Fig. 299.)

In the bird's egg the cleaving protoplasm consists of a tiny disc, or BLASTODERM, which floats on the upper surface of the mass of yolk.

Thus the embryo during its early stages is crowded upward and forms essentially a plate of tissues spread out on the surface of the spherical yolk, while embryonic membranous tissue is growing around the yolk to form the YOLK SAC. As development continues the embryo itself is gradually raised above and, as it were, partly pinched off from the yolk, until only a narrow connection with the yolk sac persists. (Fig. 307.)

The most characteristic embryonic membranes are the AMNION, CHORION, and ALLANTOIS. The amnion and chorion arise from a crescentic fold of extraembryonic tissue which finally completely surrounds the embryo and yolk sac with two membranous layers. The inner membrane, or amnion, encloses a fluid-filled space, the amniotic cavity, in which the embryo lives. Thus the amniotic fluid affords, as it were, a 'private pond'—a substitute in terrestrial eggs for the aquatic environment of their ancestors.

The outer membrane, or chorion, which arises from the amniotic fold, forms the external surface through which the interchange with the outer world takes place. This is made

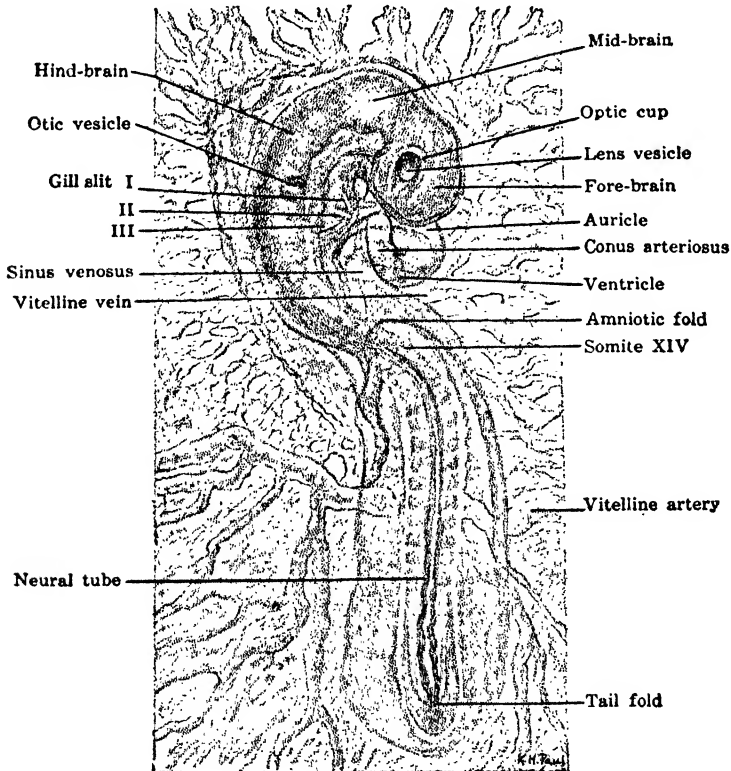

FIG. 308. Two-day chick embryo. Transparent preparation, dorsal view (head from right side). Magnified. (From Shumway.)

possible by the allantois which arises as a membranous out-pocketing of the intestinal region of the embryo that gradually intrudes itself between the amnion and chorion. The allantois acts as a urinary bladder and, after the development of blood vessels in its walls, serves for respiratory interchange through the investing chorion and the porous shell. (Fig. 308.)

Although the embryonic membranes — yolk sac, amnion, chorion, and allantois — develop from the egg they do not constitute an actual part of the embryo. After performing their several functions they are discarded at the time of hatching. Such are the conditions in Reptiles and Birds and they make understandable those in the placental Mammals.

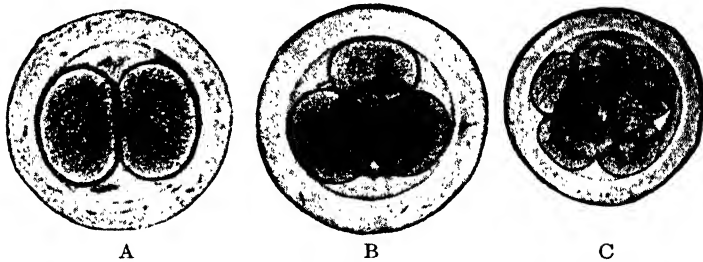

FIG. 309. Photographs of early stages in the development of the egg of the Rabbit. A, two-cell stage, 24 hours after fertilization, in thick surrounding membrane (zona pellucida); B, four-cell stage, 29 hours; C, eight-cell stage, 32 hours. Highly magnified. (After Streeter.)

Although the mammalian egg is very small, contains practically no yolk, and undergoes total cleavage, yet many of the developmental stages obviously are reminiscent of a condition when a large supply of yolk existed — food material no longer needed because a parasitic relationship is soon established with the mother. (Fig. 309.)

The embryonic membranes are still present in Mammals though they differ in many ways from those in Reptiles and Birds where food is supplied by the yolk sac. Since all the income of the mammalian embryo is derived from the mother, the chorion and allantois are modified to contribute

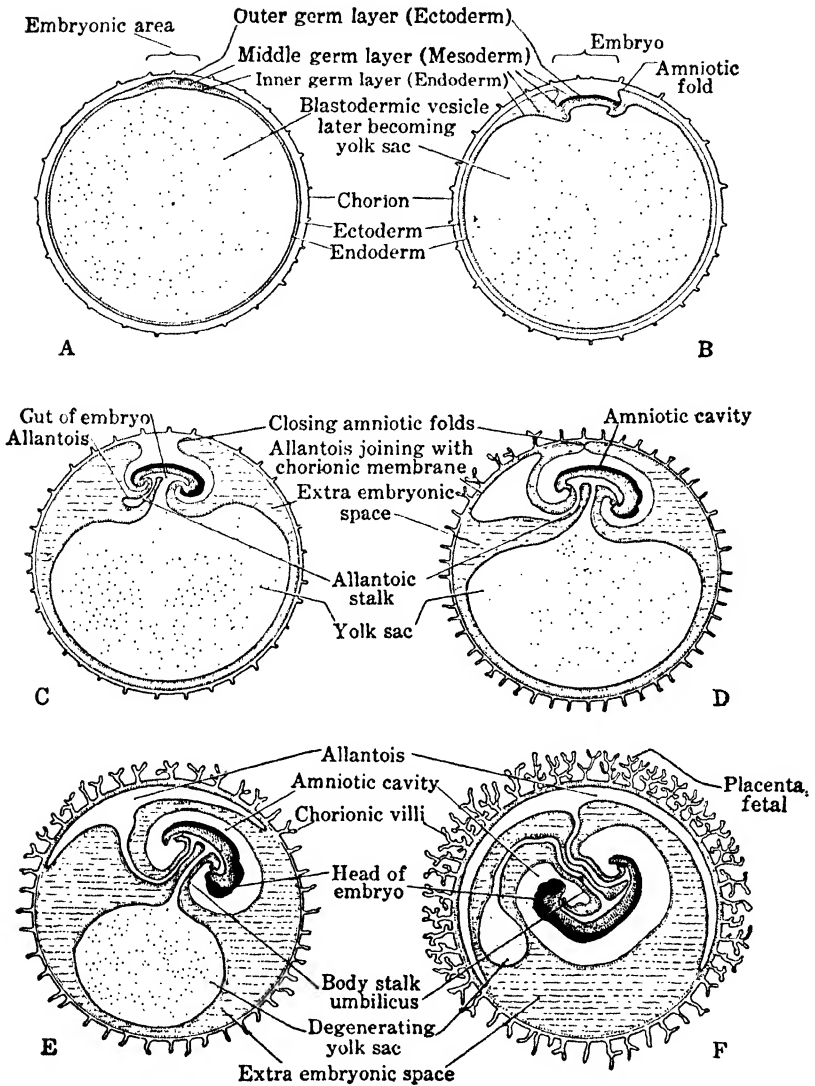

FIG. 310. Diagrammatic sections showing the development of the egg and embryonic membranes of a Mammal. A, early stage showing rudiment of embryo at top, before the appearance of the amnion; B, embryo outlined, with developing amnion and yolk sac; C, embryo with amnion further developed and allantois appearing; D, embryo with amnion closing, and allantois joining with outer membrane, or chorion; E, F, embryos in which the vascular layer of the allantois is applied to the chorion and growing into the villi of the latter to form the fetal placenta; yolk sac reduced; amniotic cavity increasing; mouth and anus established.

to the organ that makes this possible, the PLACENTA. (Fig. 310; P. 276.)

In placental Mammals the allantois and chorion form an intimate union. The chorion, in turn, forms a close union with the membrane lining the maternal uterus and thus constitutes the essential part of the fetal placenta. The area of attachment of the processes from the chorion, or CHORIONIC VILLI, with the uterine wall varies in different Mammals.

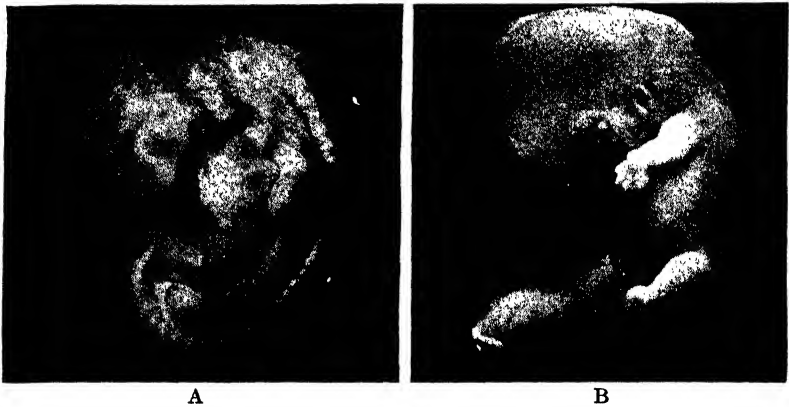

FIG. 311. Human embryos. A, one month old (6.7 mm.), showing arm and leg buds, caudal end, umbilical cord, heart, gill slits, olfactory pit, and eye; B, six weeks old (19 mm.), showing developing hands and feet, elbow and knee, nose, eye, and ear. See Fig. 388. (From Hegner, after Streeter.)

For example, in the Horse and Whale the villi cover the whole surface of the chorion, while in Man they are restricted to a single discoidal area. The latter accounts for the name 'placenta' — a round, flat cake. It appears that the dominant position of the Mammalia in the world of life is in no small part due to the protection and nourishment made possible for their offspring by the establishment of intrauterine development — and this by the diversion of the chief embryonic membranes of their ancestors to placental use. (Figs. 257, 311.)

With this outline of some of the chief features of the embryology of representative animals before us, it is possible

to gain some appreciation of the complexity of the processes involved, as well as of the similarity of the basic method of development — cleavage, blastula, gastrula, primary germ layers, etc. Furthermore, for example, it will be recalled that typically the ectoderm forms the outer skin and nervous system; the endoderm supplies the lining membrane of the major part of the alimentary tract; while the mesoderm contributes muscles, blood vessels, reproductive organs, the membrane lining the coelom, etc. This similarity in origin of the organ systems from the primary germ layers, throughout the animal series above the Coelenterates, is of the highest significance because it indicates a fundamental structural similarity in the body plan of all these forms. It is exhibited in the developmental process in each generation, even though the adult body in the various groups differs widely in form and arrangement of organs. Such a state of affairs clearly suggests an hereditary relationship throughout the animal series. (Figs. 302-304.)

#### D. PROBLEMS OF DEVELOPMENT

Embryology is something more than the description of the kaleidoscopic series of stages which seem to melt one into the other as development progresses. It attempts, especially at the present time, to look below and beyond structure to the physiological processes involved, and to determine how the sequence of events is brought about. This is but a repetition of the stages of progress in all science: a passage from the descriptive to the experimental. The results thus far secured have raised many, and answered some problems of development that are of great practical importance and theoretical interest. Outlines of three broad problems must suffice as examples.

##### 1. *Epigenesis versus Preformation*

From what the pioneer students of embryology during the seventeenth and eighteenth centuries saw, or thought they saw, with simple lens and newly invented compound micro-



scope, there were gradually formulated two opposing views of development which, though long since swept aside in their original form as a result of the increase of knowledge, raised a problem that is still before the embryologist today.

In brief, one view virtually denied development by maintaining that the adult organism is nearly or completely formed within the germ, either in the egg or the sperm, which merely by expansion, unfolding, and growth gives rise to the new generation. In this first crude form the **PREFORMATION** theory demanded the 'encasement' of all future generations one within another in the germ of existing organisms, so that when it was computed that the progenitor of the human race must have contained some two hundred million homunculi (a conservative estimate, to say the least) the *reductio ad absurdum* was irresistible.

The other view was reached by careful studies on the transformation of the hen's egg into the chick, which soon made it clear that the chick is not preformed in the egg. The embryo arises by a gradual process of progressive differentiation from an apparently simple fundament — it is a true process of development, or **EPIGENESIS**. But the upholders of epigenesis were before long beyond their depth and in danger of attempting to get something out of nothing — lost in the miraculous.

A statement in such succinct form tends to accentuate the crudities of these two conflicting views — "preformation explaining development by denying it and epigenesis explaining development by reaffirming it" — and it may be well to remark that the early embryologists with the means at their command faced a stupendous task of which only recent work has brought a full appreciation.

The path to progress cleared by the realization that adult structures are not preformed as such in the egg, and that development is not an expansion but the formation — the 'becoming' — by an orderly sequence of events of structures of great complexity out of apparent simplicity, the problem of the embryologist was to determine what the egg structure

actually is, and how it is related to that of the adult. To trace the development of these studies would involve the history of embryology since the formulation of the cell theory. We must confine ourselves to the bare statement of the new guise in which the old theories of preformation and epigenesis confront us today as a result of recent research.

The reader already recognizes the fertilized egg as a cell, with its nucleus comprising a complex of quite definite elements — the chromosomes — contributed jointly by the two gametes. To this extent, then, the nucleus and therefore the egg exhibit a ready-formed structural basis which (as we have already suggested, and will have occasion to elaborate later) is definitely related to characters which appear in the offspring. (Pp. 425–427.)

Turning to the egg cytoplasm, we are confronted with conditions which are not so uniform but nevertheless highly suggestive. In the first place, before fertilization the egg possesses a definite POLARITY, expressed, for example, by the position of the nucleus and the distribution of yolk, pigment granules, and vacuoles. This polarity is traceable, in part at least, to the polarity of the oögonia, and through them to the germinal epithelium. In brief, the egg as a whole is *organized*; the invisible organization of the fundamental matrix of the cytoplasm being revealed, in part, by the disposition of various elements of the cell. Now this cytoplasmic organization undergoes more or less profound changes in establishing that of the new individual. In some cases the reorganization occurs at fertilization, while in others it is somewhat deferred. And herein, apparently, is to be sought the explanation of the difference in behavior — in potentialities — of various types of eggs during cleavage stages. Two contrasting examples will serve to bring the main facts before us. (Figs. 296, 312.)

The first type is well illustrated by the egg of a Mollusc, *Dentalium*, and a primitive Chordate, *Styela*. The egg of the latter shows at the first division five clearly differentiated cytoplasmic regions. For the sake of simplicity these may

be described as white, light and dark gray, and light and dark yellow. As cleavage proceeds, these substances are distributed with great regularity to definite cell groups which in turn form special organs or organ systems of the animal. Thus cells which receive the white region form the ectoderm; those which receive the dark gray, the endoderm; while the cells with light or dark yellow form mesodermal structures,

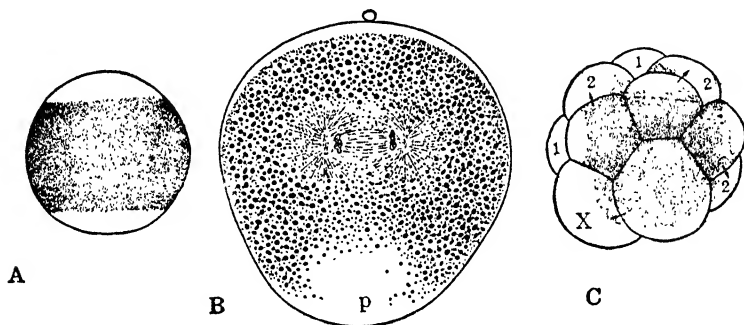

FIG. 312. Egg of a Mollusc (*Dentalium*), showing cytoplasmic differentiation. A, egg, shortly after being extruded and before maturation is completed, showing three differentiated regions; B, section through an egg after fertilization, showing cytoplasmic rearrangement involving the segregation of clear polar lobe at p; C, normal sixteen-cell stage, with materials of polar lobe now in cell X. Removal of the polar lobe results in an abnormal embryo. (After Wilson.)

and so on. And further, the experimental removal of a cell or cell group in which a certain substance is segregated results in an embryo deficient in the very structures which this normally forms. In other words, the egg cytoplasm seems to be a mosaic of organ-forming substances which possibly themselves directly, but probably through more fundamental conditions of which they are but the visible expression, have a causal relation to definite adult structures. Just in so far as this is true, the adult is *predelineated* in bold lines, though not actually preformed, in the egg. (Fig. 312.)

Passing now to the second type, represented, for example, by the eggs of some Sea Urchins, the results obtained seem to be diametrically opposite. Although more or less clearly differentiated cytoplasmic regions appear to exist, frequently

the removal of a part of the egg before division, or the separation of the cells at the two-cell stage, and sometimes even at the four-cell stage, has no permanent effect on the structural integrity of the developing embryo. Each of the cells has the power to develop into an embryo complete in every respect, but smaller than the normal. Or, to put it another way: a single cell of the four-cell stage, which normally forms one-fourth of the embryo, if isolated with one other cell, may form one-half of a normal embryo and, if isolated with two other cells may form one-third. And apparently the same phenomenon occurs in the case of human identical twins. The egg becomes separated into two parts during early development and results in two individuals with identical hereditary basis. Identical quintuplets, all from one zygote, have become famous. In all such cases one may ask: what has become of the egg organization?

At first glance the behavior of these two classes of eggs seems to afford results which are irreconcilable — the former supporting the doctrine of preformation in a refined form, and the latter its antithesis, epigenesis. But an explanation is not far to seek. The difference apparently depends, as already suggested, upon the time when chemical differentiation of the egg cytoplasm occurs and the products are localized in special regions. If this occurs before or at fertilization, so that the early divisions give rise to dissimilarly organized cells, then each of the cells is not *TOTIPOTENT* and the mosaic type of development results. But if the initial differentiation and localization is delayed until later, or is relatively slight so that all the cells of the early stages are essentially similar, then during this period each cell is totipotent — the whole forms an *EQUIPOTENTIAL SYSTEM* — as exhibited by some of the early stages of the Sea Urchin. Thus we may bring under one viewpoint the apparently contradictory behavior of the two classes of eggs, for it turns out to be reducible to a common factor: the time of chemodifferentiation and localization of the products. In one case this has progressed further than in the other during the early

stages. In both cases, therefore, development is epigenetic in its obvious features. (Figs. 312, 313.)

However, since cytoplasmic differentiation is a fact whether it appears early or late, we have merely pushed the solution of the problem further back and the question becomes: Is there a primary differentiation and, if so, where?

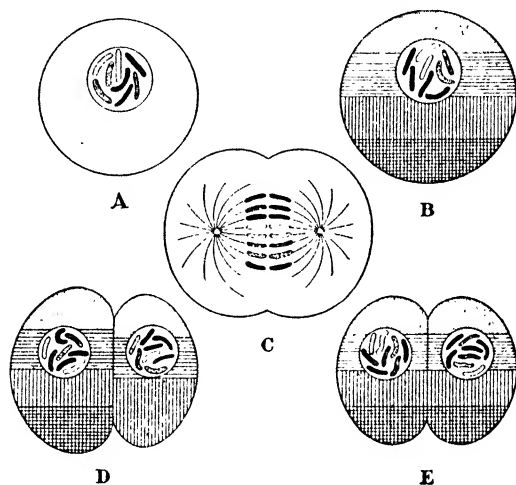

FIG. 313. Diagram to illustrate how the character of the first division of an egg may influence the distribution of the products of cytoplasmic differentiation and therefore the potentialities of the resulting cells. A, immature egg, assumed to have no definite segregation of cytoplasmic stuffs; B, mature egg, with cytoplasmic zones established; C, first division of egg; D and E, two types of two-cell stages; D, type with one cytoplasmic zone entirely distributed to one of the cells, and therefore each of the two cells, if separated, gives rise to an abnormal larva; E, type with equal distribution of the zones to both cells, and therefore, if separated, each of the two cells gives rise to a normal larva. (From Wilson.)

It is not possible to present here the specific evidence on this point, but the reader's knowledge of the nucleus, and particularly its definite chromosomal architecture, will lead him to anticipate that modern research tends more and more to emphasize the gene as representing a material configuration — probably a protein molecule — which is transmitted, in a way, 'preformed' from generation to generation and determines the cytoplasmic characteristics of the cells. As to how the specific physical basis of inheritance, the genes constitut-

ing the chromosomes, is related to cytoplasmic organization and to characters which arise later, we can offer no satisfactory explanation or even guess. We must be content with a discussion, in the next chapter, of some of the facts of heredity which show that certain chromosomes — genes — are causally related to the inheritance of certain characters.

But in so far as the nucleus possesses an organization which is definitely related to differentiations of the cytoplasm, organ-forming substances, or characters of embryo and adult, we may look upon the chromatin to this extent as representing a sort of primary preformation which is realized by a process of building up — epigenesis — as one character after another becomes established in the development of the individual. This is the guise in which the old problem of preformation versus epigenesis faces the biologist today.

So the early embryologists were right when, studying the egg of the frog or hen, they maintained that development *is* development and not merely the unfolding of an organism already fashioned in more or less definite adult form. But it took two centuries of research to reveal the fact that, below and beyond its superficial aspects, there is a germ of truth in the principle of preformation hidden in the nuclear architecture, the enormously complex physico-chemical structure of the genetic basis, so that the origin of the individual, though obviously through epigenesis, is fundamentally from a sort of preformed basis. We no longer bother ourselves with the old conundrum as to which is more complex, the egg or the adult, but recognize that each is complex in its way — the simplicity of the egg being more apparent than real, as is attested by every endeavor to analyze cytoplasm, nucleus, chromosomes, genes, and beyond.

## 2. Organizers

It has been known for some time that the various regions of an embryo exert upon one another during their development highly important formative influences, but extensive

experiments, in particular on amphibian embryos, have revealed a complexity of the problem that hardly would have been anticipated and have opened up a new approach to the problem of differentiation. This has been brought to the fore by the discovery of so-called ORGANIZERS: substances of undetermined chemical constitution which play a fundamental role in the differentiation of tissues and organs during the development of both Vertebrates and Invertebrates.

It appears, for example, that a stimulus emanates from the material (chorda-mesoderm) invaginated at the dorsal lip of the blastopore in the gray crescent region of the developing frog's egg. This stimulus induces in normal development the formation of a medullary plate and tube, the fundament of the nervous system and the primary axis of the future adult. When the dorsal lip is removed from an embryo and transplanted into another, the transplant continues characteristic gastrulation movements in its new environment and transforms the surrounding host material into so-called organ fields such as normally occur about the dorsal lip of the blastopore in its original position. (Figs. 304, 314.)

Thus the grafted dorsal lip organizes about itself a new, secondary embryo which is entirely independent of the normal embryo organized about the host's dorsal lip. The grafted dorsal lip itself becomes the notochord and mesoderm of the musculature of the second embryo while it organizes the medullary plate, eyes, ears, heart, etc., from the tissue of the host. And in the process, the integrity of the germ layers is violated because the organizer induces, for instance, ectoderm to form mesoderm and mesoderm to form ectoderm.

Furthermore, in addition to these so-called primary organizers, there appear to be secondary inductive agents. An example is the ability of the eye cup to form a lens out of presumptive skin. And still again, the efficacy of an organizer, primary or secondary, is not confined to embryos of the same or even closely related species because, for instance,

the organizer from a frog (an Anuran) will induce a secondary embryo in a newt (a Urodele).

What organizers are and how they act is perhaps the problem of the moment in so-called CHEMICAL EMBRYOLOGY. It

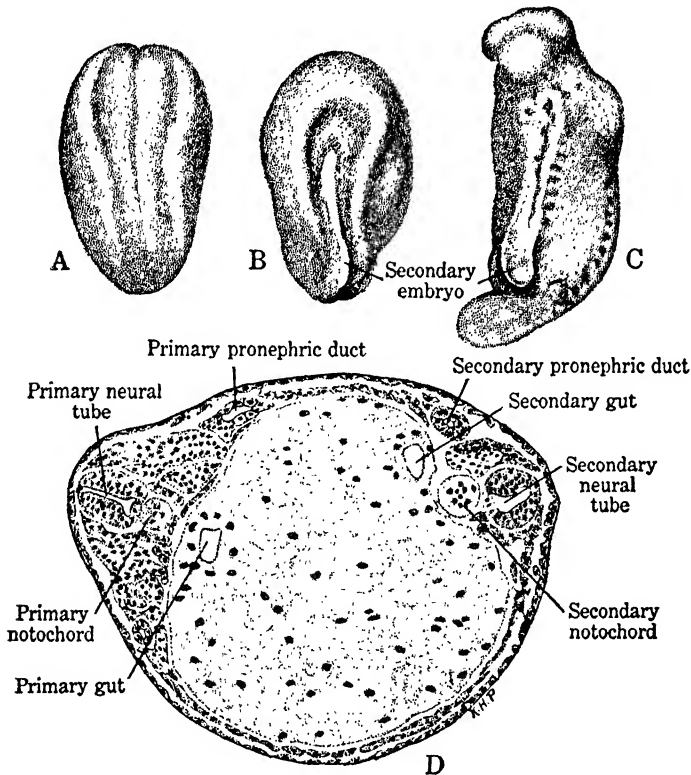

FIG. 314. Effect of transplanting organizer. A, dorsal view of host (*Triton taeniatus*) in 'neurula' stage; B, right side view at same stage with secondary medullary plate induced by organizer (dorsal lip region) of the donor (*Triton cristatus*) shown in white; C, later stage showing primary embryo in side view and secondary embryo in dorsal view; D, transverse section through C. (From Shumway, after Spemann and Mangold.)

appears that the organizers are chemical entities because the organizer tissue, such as the dorsal lip of the blastopore just considered, still retains its inducing influence when it has been crushed, dried, or boiled. Or it may impart its organizing power to inert material such as a bit of agar. More-



over, chemical substances which have inducing ability have been isolated from embryonic (and adult) tissues. But more than mere chemical stimulation is involved in the process of morphogenesis, for there seems to be an interaction between stimulating and stimulated tissues which is necessary for 'normal' development. In other words, the stimulus to differentiation is controlled and modified, in as yet unknown ways, by the tissues in which the morphogenetic changes occur: action of stimulus plus reaction of tissue equals differentiation.

The fact that many adult tissues of Invertebrates and Vertebrates possess the power of inducing neural tube formation suggests that such influences may be responsible for certain puzzling pathological formations known as TERATOMATA. Indeed, it appears that organizer-action phenomena merge into those of the general hormonal regulation and co-ordination of the organism. It is possible that even gene action will prove to be explainable by a somewhat similar chemico-physical mechanism.

### 3. Realization of Function

One must not lose sight of the fact that although embryologists are, of necessity, largely restricted to the study of the development of form, interwoven with this is the basic problem of the realization of function. For instance, as emphasized by Conklin, 'mental' development begins in the germ cells that contain not only the elements out of which the body is formed but also those which give rise to mental behavior. Among these germinal elements of mental activity are *differential sensitivity* or the capacity of responding differently to different stimuli; *organic memory* or the retention of the effects of previous stimuli in the general protoplasm or in special organs; *tropisms* and *reflexes* or inherited methods of response to stimuli; *instincts* or chains of reflexes, usually adaptive; and *conditioned reflexes* and *habits* which are established by oft-repeated stimuli and responses. As

development progresses differential sensitivity gives rise to special senses; reflexes and tropisms to instinctive behavior and habits; organic memory to associative memory and the ability to learn. Seeking satisfaction by the process of trial and error, together with associative memory, leads to intelligent responses; and conflicting stimuli and selective responses, to inhibition and choice or voluntary action.

Throughout the whole of this complicated process of physical and psychical development we find that every step is a response of the individual to stimuli. In general it is a gradual progression from the relatively simple to the more complex, but there are certain critical stages when it seems to jump from a lower to a higher level. One of the most striking of these is when the egg or embryo becomes free-living, in Mammals the period of birth. Another is when organic memory becomes associative memory and learning becomes possible. Another is when intelligent reactions to specific things lead to generalizations and reasoning, which apparently are limited to human beings. Still another level is reached when intelligence and reason become factors in shaping purposive behavior. And finally the highest level of human development is attained when purposive behavior, joined to social emotions, training, and habits, shape behavior not only for personal but also for social satisfactions with all their ethical implications.

It is a far cry from the structures and functions of the egg to those of the fully developed human being, from the tropisms and reflexes of embryos to the behavior of men and women, from the conditioned reflexes of infants to the habits and ideals of truth, freedom, love — but it is one continuous road. However, it should be noted that while “all these stages and processes of development are according to nature there is here no explanation of nature.” (P. 553.)

## CHAPTER XXIV

# GENETICS

So careful of the type . . .

So careless of the single life. — *Tennyson.*

**T**he old adage that 'like begets like' expresses the general fact of heredity. Everyone recognizes that parent and offspring agree in their fundamental characteristics: they 'belong to the same species.' And everyone realizes that the resemblance may be strikingly exact even in details of form or behavior. Family traits reappear. The mere statement of striking resemblances among the individuals of a family is a tacit admission that no two individuals are exactly alike; in other words, HEREDITY is organic *resemblance* based on descent — inheritance of the characters exhibited by the parents is not complete, there is VARIATION. Indeed "variation is the most invariable thing in nature," but one must guard against the impression that there is an antithesis between heredity and variation. "Living beings do not exhibit unity and diversity, but unity in diversity. Inheritance and variation are not two things, but two imperfect views of a single process."

We may now consider the problems of heredity and variation which are at the basis not only of what organisms have been in the past and are at the present, but also of whatever the future may have in store for them. Variations are the raw materials of evolutionary progression or regression. From a broad point of view, the origin of species and the origin of individuals are essentially the same question. If we can solve the relations of parent and offspring, the origin of species will largely take care of itself. As a matter of fact, historically the question of species origin was approached

first, and through the work of Darwin became of paramount interest in the latter half of the nineteenth century. The twentieth century finds the individual — the hereditary relation of parent and offspring — the center of investigation, and it forms the science of GENETICS. ORGANIC EVOLUTION attempts to establish the general fact that all organisms are related by descent; genetics attempts to show how specific individuals are related.

Even further has the pendulum swung from the general to the particular. Today investigation is centered not on the heritage of the individual as a whole, but on particular characters of the individual. Experimental work has shown that, for practical purposes, the individual may be regarded as an aggregate of essentially separate characters, both structural and physiological, that are relatively stable and may be inherited more or less as units. But the analysis does not stop even at this level. Each character is regarded as represented in the chromosomes of the germ cells by one or more determining factors, or GENES; and whether or not a given character will be present in a tree or a man depends on whether the genes for this particular character entered into the nuclear complex of the fertilized egg which formed the individual. Therefore, geneticists are now studying the relative positions which the genes occupy on certain chromosomes; how they may cross over from one chromosome to the other of a synaptic pair; how they mutually influence one another, and so on.

During recent years there have been great advances in knowledge of the underlying factors of heredity, and the data accumulated are so vast that we can do little more than indicate the character and promise of the principles already discovered.

## A. HERITABILITY OF VARIATIONS

In the Protista the problems of heredity confront us in their simplest, though by no means simple form. Proto-

coccus or Amoeba, as we know, divides into two cells which through growth and reorganization soon are to all intents and purposes exactly similar to the parent cell. The parent has become offspring. Thus stated, one does not wonder

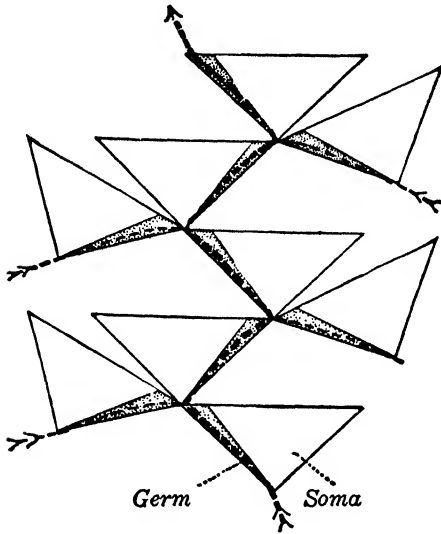

FIG. 315. Scheme to illustrate the continuity of the germ. Each triangle represents an individual composed of germ (dotted) and soma (clear). The beginning of the life cycle of each individual is at the apex of the triangle where both germ and soma are present. In biparental (sexual) reproduction the germ cells of two individuals become associated in a common stream which is the germ and gives rise to the soma and germ of the new generation. This continuity is indicated by the heavy broken line and the collateral contributions at each succeeding generation by light broken lines. (From Walter.)

that parent and offspring are alike — each is composed of essentially the same protoplasm. But when we come to multicellular forms in which reproduction is restricted to special germ cells which involve fertilization, confusion is apt to arise unless one keeps clearly in mind — and perhaps exaggerates for the sake of concreteness — the distinction between germ and soma that has been previously discussed. Since in higher forms, to which brevity demands that our attention be confined, the sole connection between parent and offspring is through the germ cells, it follows that they must be the sole path of inheritance. In other words, whatever

characters the body actually *inherits* must have been represented by genes in the fertilized egg from which it arose; and furthermore, any characters that the individual can transmit must be represented in its germ cells. (Figs. 9, 13, 315; Pp. 405–411.)

## 1. Modifications

Every individual organism — a man, for instance — is a composite not only of inherited characters, but also of MODIFICATIONS of the soma produced by external conditions during embryonic development or later. The individual's environment, food, friends, enemies, the world as he finds it, as well as his education, work, and general reactions to this environment, all have their influence on body and mind and determine to a considerable extent the realization of the possibilities derived from the germ — what he makes of his endowment. He acquires, let us say, the strong arm of the blacksmith, the sensitive fingers of the violinist, or the command of higher mathematics. In other words, what he *is* depends on his heritage and what he does with it. Now, if he does develop an inherited capacity, can he transmit to his offspring this talent in a more highly developed form than he himself received it? Or must his children begin at the same rung of the ladder at which he started and make their own way up in the world? This is the old question of the inheritance of modifications, or so-called ACQUIRED CHARACTERS. (Fig. 341.)

Is the great length of the Giraffe's neck, to take a classic though crude example, due to a stretching toward the branches of trees during many successive generations, with the result that a slightly longer neck has been gained in each generation and inherited by the following? If so, it is a result of the inheritance of modifications because the changes were somatic in origin. Or is the length of the neck the result of the survival in each generation of those individuals which 'happened to be born' with longer necks and accordingly were better adapted to foliage conditions than those which varied toward shorter necks? If so, it is not a result of modifications but of changes having their origin in the germ cells. (Fig. 210.)

Today biologists almost unanimously deny the former and accept the latter interpretation — the consensus of opinion

is certainly that modifications, or changes in the individual body due to nurture, use, disuse, or mutilations, are not transmitted as such. This conclusion is held chiefly because there is no positive evidence of the inheritance of modifications while there is much negative evidence; and also because there is no known mechanism by which a specific modification of the soma can so influence the germ complex that this modification will be reproduced as such or in any representative degree. However, it should be emphasized that biologists clearly recognize the potent influence of environment and the organism's reactions to the environment on the destinies of the race, even though they see, at present, no grounds for a belief that any specific modification can enter the heritage and so be reproduced. (Fig. 342.)

In this connection the question of the inheritance of disease will undoubtedly arise in the reader's mind. But this is really not a special case. If the disease is the result of a defect in the germinal constitution, it may be inherited just as any other character, physiological or morphological, that has a germinal basis. But if the disease is a disturbance set up in the body by some accident of life or through infection by specific microorganisms, before birth or later, it is a modification and inheritance does not occur. Of course, the well-known fact that susceptibility or immunity to disease-producing organisms — the 'soil' for their development — may be inherited is not an exception to this statement. It may, however, be suggested in passing that from the standpoint of the individual born malformed, structurally or mentally, as a result of parental alcoholism, syphilis, or other obliquities, it probably will not appear of the first moment that the sins have been visited otherwise than by actual inheritance. (Fig. 419.)

The whole question of the non-heritability of modifications, or acquired characters, is a relatively new point of view which has been fostered by the elusiveness of crucial experimental evidence, by an ever-increasing knowledge of the

details of the chromosome mechanism of inheritance, and by the general influence of Weismann's contrast of the soma and germ. Indeed, Lamarck a century ago did not question the inheritance of acquired characters and made it the corner-stone of his theory of evolution, while some have even gone so far as to say that either there has been inheritance of acquired characters, or there has been no evolution. However, the question is not so serious as that, as will be seen later on; though obviously it is profoundly important from many viewpoints, biological, educational, and sociological. Incidentally, it may be mentioned for those who would like to believe that acquired characters are inherited, that if desirable modifications were inheritable, undesirable ones would be also. Perhaps Nature is merciful! (Figs. 462, 467.)



FIG. 316. Effect of crossing two varieties of wheat, one 'bearded' and the other 'beardless.' The parents are shown on either side and the hybrid offspring in the middle. A case of so-called intermediate inheritance.

## 2. Recombinations

Turning from modifications, which obviously are useless to the geneticist, we find that the most common inherited differences which appear in offspring are RECOMBINATIONS that owe their origin to new groupings of the germinal factors, or genes.

Everyone is familiar with some of the more obvious hereditary differences following fertilization which are the result of recombinations of parental characters represented in the egg and sperm: that is, cases in which nothing is apparent which is not clearly related to the conditions expressed in the ancestors. For example, the offspring may exhibit a character of one parent to the exclusion of that of the other



— the character appearing unmodified. This is termed *ALTERNATIVE* inheritance. Or the character in the offspring may appear *INTERMEDIATE* between those of the parents. Or, again, it may be a sort of *MOSAIC* of the parental characters, each parent contributing a certain character but not to the exclusion of that of the other. Sometimes the parental traits seem to fuse, or *BLEND*. And as a final example, characters of grandparents or more remote ancestors may crop out, and constitute *REVERSION*. (Fig. 316.)

### 3. *Mutations*

But quite different results now and then occur. Characters which have no place in the ancestry appear and are transmitted to the descendants. Sometimes these new heritable variations, or *MUTATIONS*, are only slight departures from the parental condition, while in other instances they are quite abrupt. But the significant fact is that mutations result from relatively radical alterations in the gene complex and so afford new opportunities for variation.

Thus recombinations and mutations contrast sharply with modifications which are not transmitted to the offspring and are the results of enviroing conditions on the soma during embryonic development or later. The importance of this distinction can hardly be overemphasized because it makes comprehensible many of the inconsistencies of earlier work on genetics, as will immediately appear. (Fig. 340.)

## B. GALTON'S STUDIES

The statistical treatment of biological data as a method of studying inheritance was first brought prominently to the attention of biologists by the work of Galton, a cousin of Darwin, during the closing decades of the last century and started the widespread investigation of genetic problems. In particular, his work on the inheritance of characters in man, such as stature and intellectual capacity, is a biological classic judged by the discussion it evoked. As a result of

these studies, Galton formulated two principles of heredity which may be briefly stated as follows:

*Ancestral Inheritance.* The two parents contribute between them, on the average, one-half of each inherited faculty; each of them contributing one-quarter of it. The four grandparents contribute between them one-quarter, or each of them one-sixteenth, and so on.

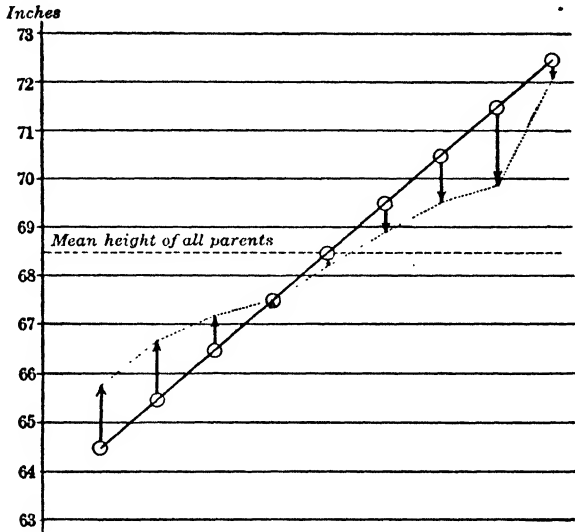

FIG. 317. Scheme illustrating Galton's law of filial regression, as shown in the stature of parents and children. The circles represent the height of graded groups of parents and the arrow heads show the average heights of their children. The length of the arrows indicates the amount of 'regression' toward mediocrity. (From Walter.)

*Filial Regression.* On the average any deviation of the parents from the racial type is transmitted to the progeny in a diminished degree; the deviation from the racial mean being two-thirds as great as that of the parents. (Figs. 317, 394.)

These so-called laws, taken by and large, undoubtedly express general truths — offspring inherit much more from their immediate than from their remote ancestors; and offspring of gifted or deficient parents, judged by the average standard of a mixed population, regress toward mediocrity:

that is, toward the population average. But the 'laws' are not particularly helpful in arriving at the fundamental principles involved in heredity because the data upon which they are founded include indiscriminately both heritable variations and modifications. The individual's somatic characters, which form the data, belie in many cases the underlying germinal constitution — what will be transmitted to the progeny. Thus, for instance, experiments on plants and animals show that when the *germinal* make-up of all the members of a group is the same with regard to a character in question, the regression is complete, no matter how far the particular parents may diverge *somatically* from the group average. The somatic divergence represents modifications which are not inherited. Conversely, when the divergence of the parents from the population average is due to characters which represent expressions of their germinal constitution, then there is no regression.

### C. MENDELIAN PRINCIPLES

It was reserved for Gregor Mendel to apply statistical methods to facts observed in the progeny derived from carefully controlled experiments in breeding. In other words, to substitute for 'ancestral generations,' controlled pedigrees — to look forward as well as backward and thus largely to remove the unknown and unknowable quantity which rendered the conclusions of Galton somewhat delusive. Mendel's studies that founded the modern science of genetics actually were made a score of years before Galton's, but failed to reach the attention of the biological world engrossed in the evolution theory; in fact were not known by Darwin to whom they would have meant so much in his work to secure experimental data on heredity. We can with advantage introduce the survey of genetic principles by a study of examples from Mendel's own work. (Fig. 463.)

Mendel chose seven pairs of ALTERNATIVE characters which he found were constant in certain varieties of edible Peas, such as the form and color of the seeds, whether round

or wrinkled, yellow or green; and the length of the stem, whether tall or short: and these he studied in the HYBRIDS. One ordinarily thinks of a hybrid as a cross between two species or, at least, two characteristically distinct varieties of animals or plants; but as a matter of fact the offspring of all sexually reproducing organisms are really hybrids because two parents seldom, if ever, are exactly the same in all of their germinal characters. Consequently the offspring are hybrids with respect to all the characters in which the parents differ; but in the following exposition the terms hybrid and pure are used solely in regard to the particular characters under analysis.

## 1. *Monohybrids*

Mendel found, in crossing pure tall and short varieties of Peas, that all of the progeny of this PARENTAL (P) generation, in the FIRST FILIAL ( $F_1$ ) generation, were tall like one parent, there being no visible evidence of their actual hybrid character. Accordingly tallness was designated a DOMINANT (T) and shortness a RECESSIVE (t) character.

Mendel's next step was to follow the behavior of these characters in succeeding generations. Therefore the tall hybrids ( $F_1$ ) were inbred (self-fertilized) and their offspring, the SECOND FILIAL ( $F_2$ ) generation, were found to be tall and short in the ratio of three to one (3 T:1 t), or 75 per cent dominant to 25 per cent recessive individuals. But, of course, in dealing with a small number of individuals this ratio is merely approximate; the greater the number of offspring, the closer it is approached. In this particular case Mendel obtained 787 dominant and 277 recessive individuals: a ratio approximating 3:1. (Fig. 318.)

Continuing the work, Mendel found that the short plants (recessives) when inbred gave only recessives generation after generation, and accordingly were pure. On the other hand, the tall plants (dominants) when inbred proved to be of two kinds: one-third pure dominants which bred true

indefinitely, and two-thirds hybrids like their parents, giving when inbred the same ratio of three dominants to one recessive in the THIRD FILIAL ( $F_3$ ) generation.

Aside from his masterly foresight in realizing that success depended on simplifying the problem by dealing with

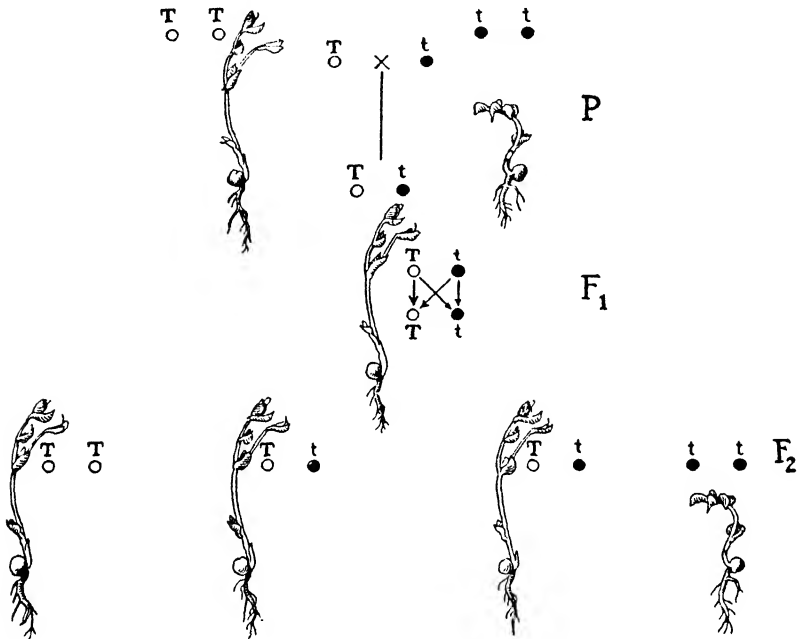

FIG. 318. Inheritance of size in a cross between a tall (T) and a short (t) race of the garden Pea. The small circles represent the genes involved.

definite alternative characters, Mendel's claim to fame lies chiefly in his discovery of a simple principle by which the results may be explained. Since the hybrids when inbred always give rise to hybrids and also to each of the parental types in a *pure* form, it must be that the factors (genes) which determine the characters in question are sorted out, or SEGREGATED, in the ripe germ cells, or gametes. Assuming for illustrative purposes that a single gene determines a given character, it follows that after segregation the genes are distributed so that some gametes bear the gene for one character and other gametes bear the gene for the other

character, but *no gamete ever bears the genes for both characters*. This is referred to as the *purity of the gametes*. If the gametes of the original tall parent contain the gene for tallness (T), and those of the short parent the gene for shortness (t) — then the hybrids will arise from a zygote which combines both genes (Tt), and since tallness is dominant over shortness all will be tall. Further, when the germ cells of this hybrid (Tt) mature, and these genes are segregated so that *half of the gametes bear T and half bear t*, then when such plants, each with this germinal constitution, are inbred there will be equal chances for gametes bearing the same and for gametes bearing different genes to meet in fertilization — hence three types of zygotes are formed.

The zygotes are 1 TT:2 Tt:1 tt. But, since T is dominant, the offspring produced will be in the ratio of 3 tall to 1 short, which is the now widely established 3:1 ratio of dominants to recessives in the F<sub>2</sub> generation of a monohybrid in both plants and animals. The important point, however, is that these tall plants, although they all *appear* alike and therefore belong to the same PHENOTYPE, are actually of two kinds with respect to their germinal constitution; because one-third bear gametes all of which contain the gene T, and two-thirds bear gametes half of which

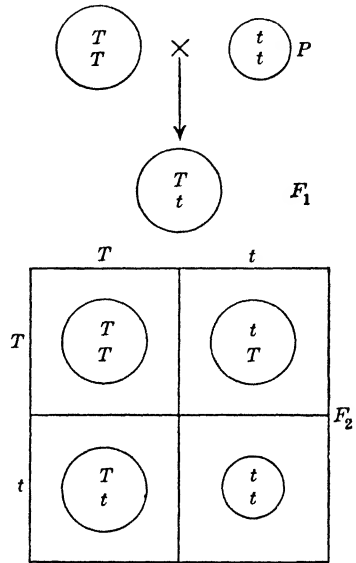

FIG. 319. Monohybrid. Results of crossing tall (T) and short (t) Pea plants. The circles represent the zygotes and the characters of the soma (phenotype); the letters within the circles, the germinal constitution (genotype). The letters outside the recombination square represent the gametes. Note that each of the parents (P) represents a different phenotype and genotype; all the F<sub>1</sub> (one shown) belong to the same phenotype and genotype; while the F<sub>2</sub> represent two phenotypes and three genotypes. The relative number of individuals composing the F<sub>2</sub> phenotypes is 3:1, and genotype is 1:2:1.

contain T and the other half t. Consequently the tall phenotype is composed of two GENOTYPES which are distinguishable only by what they *produce*. (Figs. 318–320.)

It is thus apparent why the pure tall plants, when inbred, always breed true, and why the dwarfs, necessarily pure, do the same — all the gametes of one bear T and those of the other, t. The pure plants are HOMOZYGOUS with respect to the characters in question. It is also clear why the hybrids

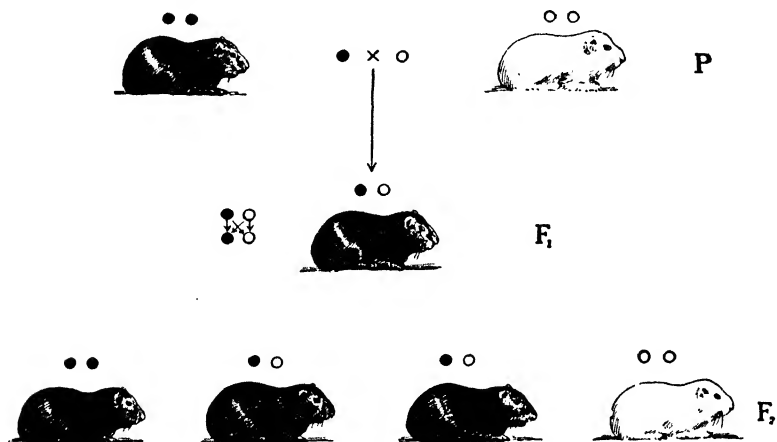
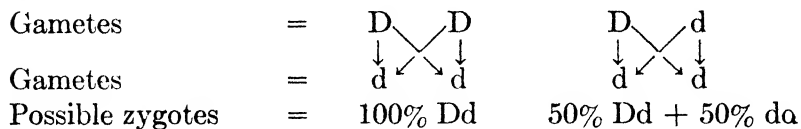

FIG. 320. Inheritance of color in a cross between pure pigmented (black) and white (albino) Guinea-pigs. The small circles represent the genes involved.

when inbred give rise to hybrids and pure dominants and recessives — half of their gametes bear T, and half bear t. The hybrid plants are HETEROZYGOUS.

The real difference then between the F<sub>2</sub> hybrids (Tt) and the pure dominants (TT) is that the former are heterozygous and the latter are homozygous with respect to the character in question. In order to tell which is which, since they are phenotypically the same, it is necessary to breed them. When self-fertilization can be practiced, as in the case of most plants, we get the result directly; that is an individual's progeny are either all dominants or dominants and recessives in 3:1 ratio, and thus the gametic constitution of the parent is immediately known. However, in the case of animals, where

self-fertilization is impossible, the determination can be made by mating the dominants with recessives; for a homozygous (pure) dominant then will give all dominants, while a heterozygous (hybrid) dominant will give half dominants and half recessives. Thus:



So far we have considered inheritance in MONOHYBRIDS, that is cases involving one pair of alternative characters that can be interpreted as the resultant of one pair of genes termed allelomorphs or ALLELES, but now we proceed to cases where two, three, or more pairs of genes are involved, known as DIHYBRIDS, TRIHYBRIDS, etc.

## 2. Dihybrids

Mendel investigated inheritance in dihybrids by crossing, for example, a pea producing yellow round seeds with one producing green wrinkled seeds. The plants in the F<sub>1</sub> generations bear only yellow round seeds, and therefore yellow and round are each dominant characters when paired with green and wrinkled. After self-fertilization such hybrid plants produce offspring (F<sub>2</sub>) with seeds showing all the possible combinations of the four characters (that is, not only yellow round and green wrinkled, but also two *new* combinations, yellow wrinkled and green round), and in the ratio of 9 yellow round to 3 yellow wrinkled to 3 green round to 1 green wrinkled. (Figs. 321, 322.)

These results can be interpreted only as indicating that one of the original parent plants bore gametes all containing the genes for yellow and for round peas (YR), while the other parent plant bore gametes all containing the genes for green and for wrinkled (yr). Such being the case, the resulting zygote contains the genes YRyr, and the hybrid which it forms develops gametes with all the possible combinations



of these genes (except, of course,  $Yy$  and  $Rr$ ) which are  $YR$ ,  $Yr$ ,  $yR$ , and  $yr$  — there is an INDEPENDENT ASSORTMENT of the genes as evidenced by the new combinations  $Yr$  and  $yR$ . Now, in turn, at fertilization there are sixteen possible combinations of gametes, since there are four different kinds

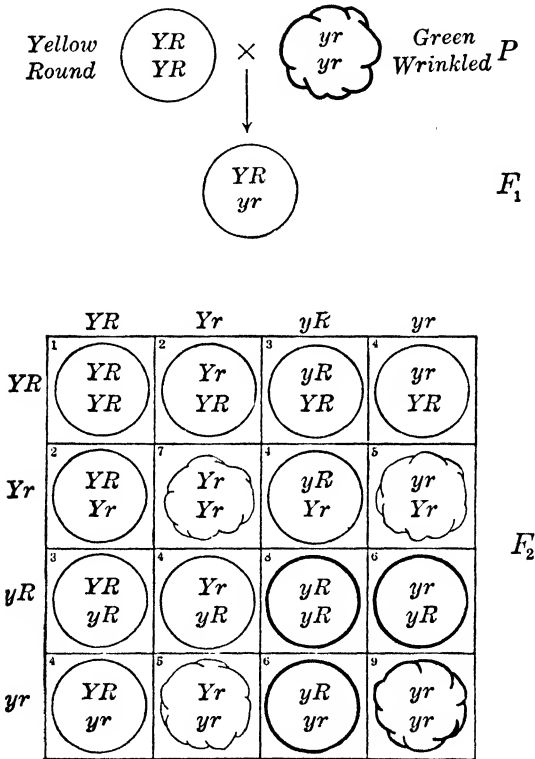

FIG. 321. Dihybrid. Results of crossing pure yellow round seeded ( $YR$ ) Peas with green wrinkled seeded ( $yr$ ). The circles represent the zygotes and the characters of the soma (phenotype); the letters within the circles, the germinal constitution (genotype). The letter groups outside the recombination square represent gametes. The hybrids of the  $F_1$  generation are all yellow round seeded since green and wrinkled are recessive. The  $F_1$  plants form four types of gametes giving sixteen possible combinations, or zygotes, representing four phenotypes (shown graphically) and nine genotypes (numbered). There is one pure dominant (1) and one pure recessive (9). The zygotes numbered 4 are identical with the  $F_1$  generation. Four are homozygotes (1, 7, 8, 9) and the rest are heterozygotes. The relative number of individuals composing the phenotypes is 9:3:3:1. Those numbered 7 and 8 are new homozygous combinations resulting from independent assortment.

of sperm and four different kinds of eggs with respect to the characters in question. Accordingly the  $F_2$  generation, which is produced by the union of these gametes, is represented by one pure dominant (YRYR), one pure recessive (yr yr), four homozygotes including the two just mentioned, and twelve heterozygotes. These sixteen individuals form nine

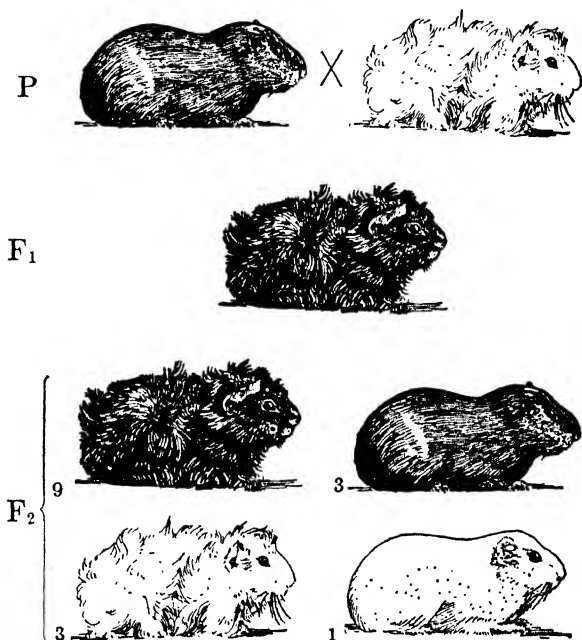

FIG. 322. Results of crossing pure smooth pigmented (black) with rough white Guinea-pigs. Rough and pigmented are dominant. Note that each parent (P) bears both a dominant and a recessive character. The  $F_2$  illustrates the principle of independent assortment.

genotypes but, since only the dominant character is expressed when dominant and recessive genes combine, they are resolvable into four phenotypes (YR, Yr, yR, yr) in the ratio 9 YR:3 Yr:3 yR:1 yr. Thus the 9:3:3:1 ratio for two pairs of alternative characters is merely the monohybrid 3:1 expanded. Both rest on the same fundamental assumption that the genes for alternative characters are segregated during gamete formation — both members of a pair of alleles never occur in the same gamete — the gametes are pure.

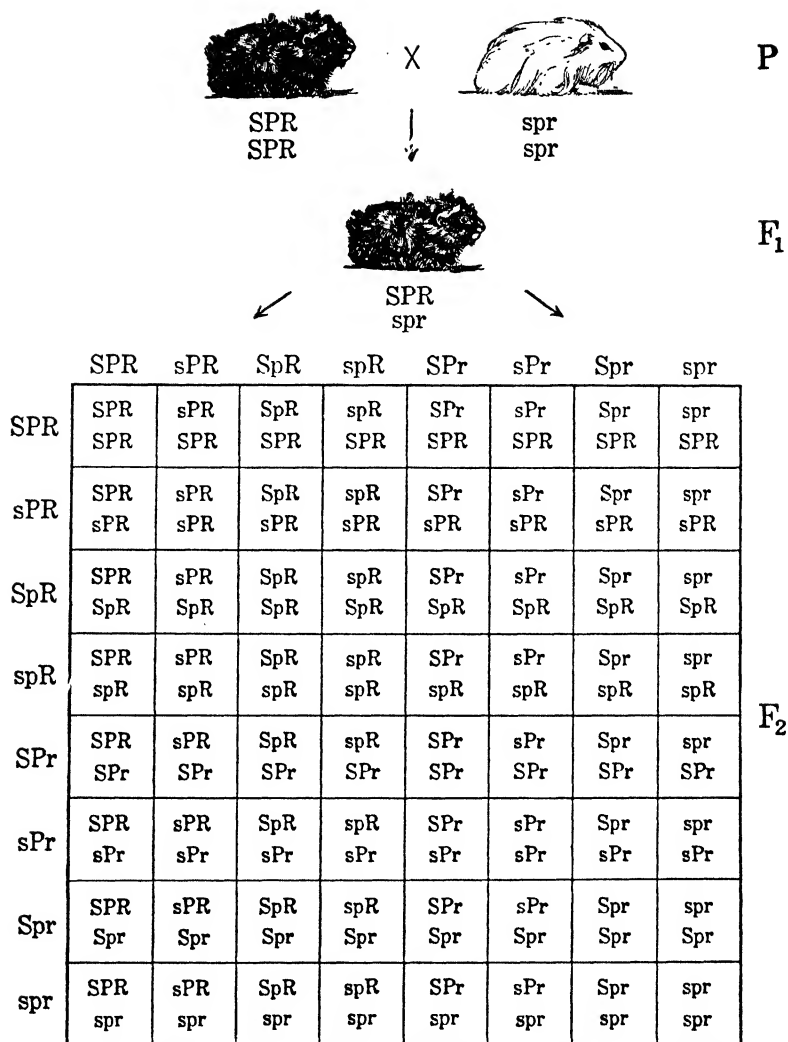

FIG. 323. Diagram of a trihybrid. Results of crossing pure Guinea-pigs having short, rough, pigmented (black) hair with pure individuals having long, smooth, white hair. The letter groups outside the recombination square represent the gametes and those within, the zygotes. The F<sub>1</sub> hybrids form eight types of gametes, giving sixty-four possible combinations, or zygotes, representing eight phenotypes and twenty-seven genotypes. There is one pure dominant (in upper left corner) and one recessive (in lower right corner). Eight are homozygotes (diagonal from upper left to lower right corner) and the rest are heterozygotes. The zygotes in the diagonal from upper right to lower left are identical with the F<sub>1</sub> generation. The relative number of individuals composing the phenotypes is 27:9:9:9:3:3:3:1. (See Fig. 324.)

### 3. Trihybrids

Similarly in trihybrids, for example Mendel's cross between pure tall peas bearing yellow round seeds and short bearing green wrinkled seeds, or the cross between pure Guinea-pigs with short, rough, black hair and those with long, smooth, light hair, give in the  $F_2$  generation 27 genotypes and 8 phenotypes; the number of individuals in the phenotypes being in the ratio 27:9:9:9:3:3:3:1. Of course, in nature there are few instances in which parents and offspring differ by only

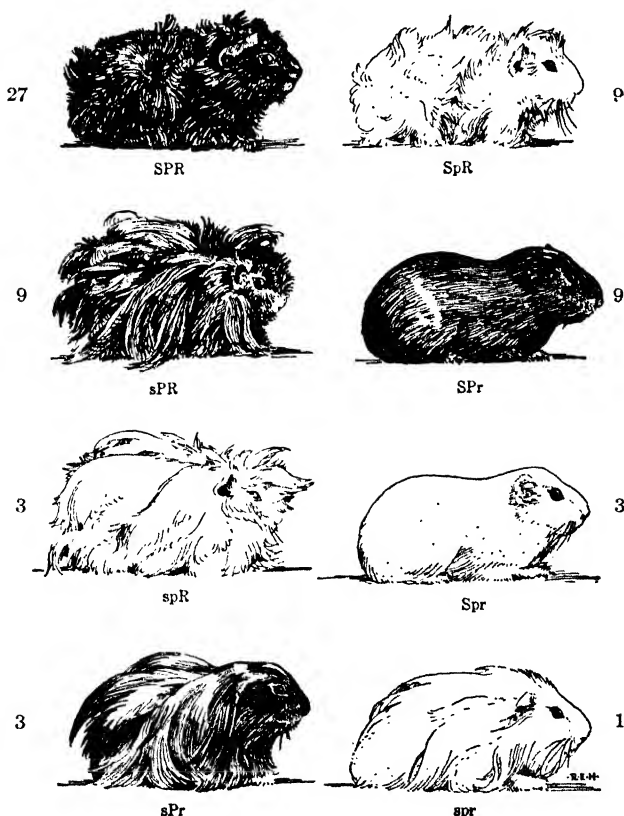

FIG. 324. The eight phenotypically different kinds of Guinea-pigs in the  $F_2$  generation of a trihybrid. S = short hair, s = long hair, P = pigmented coat, p = non-pigmented coat or albino, R = rough coat, r = smooth coat. The hybrid parents ( $F_1$ ) were phenotypically SPR. (After Castle.)

one, two, or three characters, but since characters arising from each pair of alleles can usually be treated singly, convenience demands that the analysis be made with respect to one or two pairs at a time, which therefore is the usual method of procedure. (Figs. 323, 324.)

#### 4. Summary

Before passing to certain extensions of these established hereditary principles, it may serve to clarify the subject if we restate it in slightly different form and thus emphasize the essential facts thus far discussed chiefly on the basis of Mendel's own work.

Every cell of the body, or soma, of an individual may be regarded as bearing a pair of genes for each alternative character (*e.g.*, size in the case of the pea), one member of each pair having been derived from each gamete which at fertilization contributed to the individual's make-up. When both genes of a pair are identical (*e.g.*, either TT or tt) they are expressed in the soma (*e.g.*, the plant is tall or short). The individual is homozygous with respect to size. But when the two genes are not identical (*e.g.*, Tt), one, the dominant (T), is expressed in the soma (the plant is tall), while the other, the recessive (t), is not expressed. The individual is heterozygous with respect to the character in question (*e.g.*, size).

It will be recalled that after synopsis of the chromosomes, during spermatogenesis and oögenesis, *segregation* of the chromosomes (genes) occurs with the result that each gamete receives only one gene for each character — the so-called purity of the mature germ cells. Thus the gametes of homozygous individuals are all alike with respect to the gene in question (*e.g.*, all bear either T or t), while the gametes of heterozygous individuals are of two numerically equal classes (*e.g.*, 50 per cent bear T and 50 per cent bear t). (Figs. 295, 297; P. 422.)

Finally, there is an *independent assortment* of the genes for

different characters, as evidenced by new combinations of characters in the progeny of dihybrids, etc. For example, size and color are independently inherited. This depends, as we shall see later, upon the genes involved being in different pairs of chromosomes. (P. 495.)

The principles of segregation and independent assortment are usually known as Mendel's laws.

#### D. ALTERATIONS OF MENDELIAN RATIOS

The immense amount of experimental breeding that has been carried on since Mendel's time has accentuated the significance of the principles of segregation and independent assortment, but has revealed that dominance is by no means universal. A few examples will bring the main facts before us.

All the pairs of alternative characters in peas which Mendel studied showed essentially complete dominance of one character in each pair, but we now know a great many cases in which the hybrid ( $F_1$ ) shows a different condition from either of the parents. For instance, on crossing homozygous *red* and *white* races of the Four-o'clock, all the progeny in the heterozygous ( $F_1$ ) generation bear *pink* flowers or, we may say, flowers intermediate in color between the two parents. Neither red nor white is dominant: the result is INTERMEDIATE. But inbreeding the hybrids gives three types of individuals in the  $F_2$  in the ratio of 1 red:2 pink:1 white. Thus the typical 3:1 ratio is, so to speak, automatically resolved into the 1:2:1 ratio which, when one character is dominant, is evident only on further breeding. Segregation actually occurs as usual, because the homozygous progeny of the hybrid exhibit the original parental characters unmodified. (Fig. 325.)

In certain other cases, the hybrids, instead of being true intermediates, really exhibit the characters of *both* parents: neither character is recessive. Thus in Shorthorn cattle, red and white when mated give roan, a color effect resulting from a close intermingling, or MOSAIC, of red and white

hairs in the coat. Accordingly roan Shorthorns are always heterozygous, but their offspring give the expected ratio of 1 red:2 roan:1 white which is clear evidence of segregation. Another example is the well-known blue Andalusian fowl.

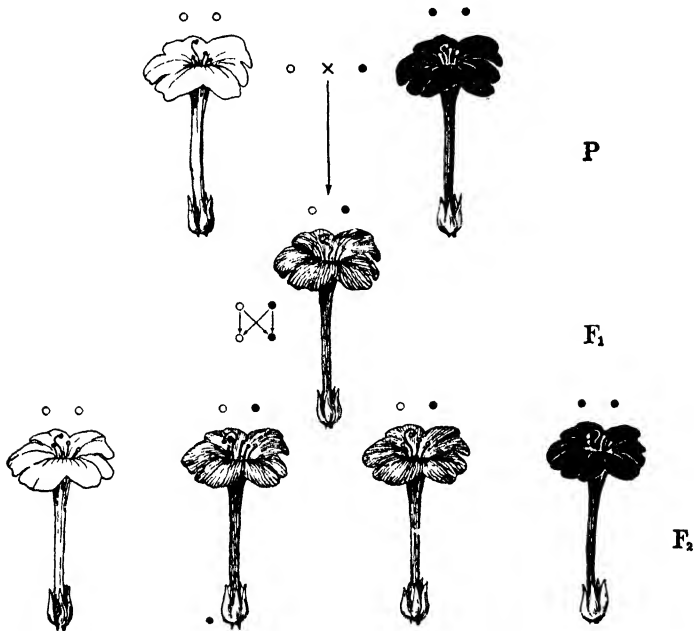

FIG. 325. Results from crossing white and red flowered races of Four-o'clocks (*Mirabilis jalapa*). The somatic condition (phenotype) is shown graphically; the small circles represent the genes which are involved.

This will not breed true — it is a hybrid in which the characters of both parents are exhibited, apparently without blending though giving a somewhat intermediate effect. Its offspring show the ratio of 1 black:2 blue Andalusian:1 white-splashed-with-blue. In order to obtain all blue Andalusians — the type recognized by poultrymen — it is necessary to mate black with white-splashed-with-blue birds. So again it is clear that segregation is involved, as it is in innumerable instances where no sharp distinction can be made between *complete* and *incomplete* dominance. (Fig. 326.)

Illustrations of some of the complications are afforded by cases of so-called BLENDING inheritance that result from the *cumulative* action of several pairs of genes (MULTIPLE GENES) as in the cross of white and black human races. The

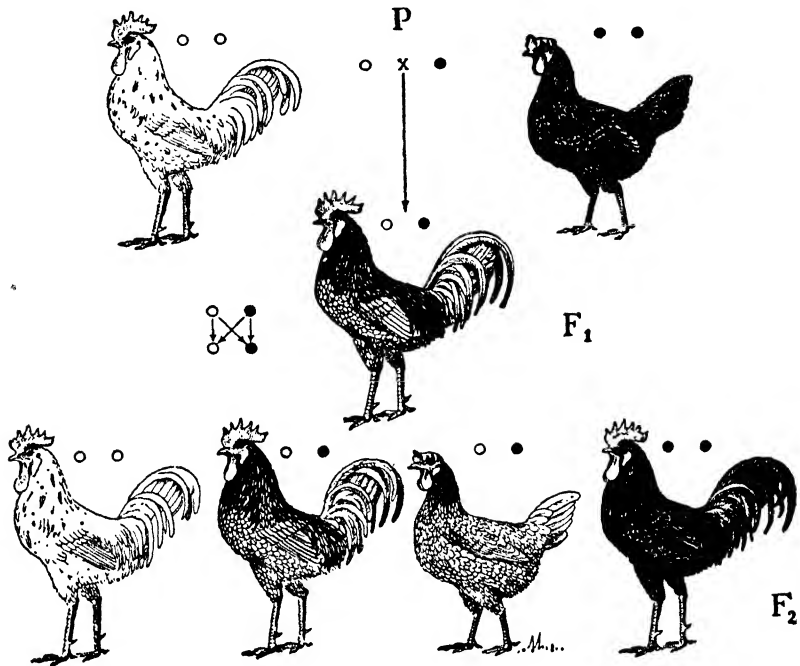

FIG. 326. Cross of white-splashed-with-blue and black fowls, giving in the  $F_1$  all blue Andalusians, and in the  $F_2$  one white-splashed-with-blue to two blue Andalusians to one black.

mulatto ( $F_1$ ), from a cross between an individual homozygous for white and an individual homozygous for black, is intermediate in skin color between the parental types, and in the  $F_2$  and later generations gives a series of gradations between white and black but rarely pure white or black offspring. Assuming that three pairs of genes for *color* are involved, the genetic constitution of the black race may be represented by AABBCc and that of the white race by aabbcc. Accordingly the hybrid, or mulatto, has the genetic constitution AaBbCc and is intermediate in color since



only half of the genes for black pigmentation are present. Furthermore, the progeny ( $F_2$ ) of mulattoes show different degrees of color ranging from pure white to pure black owing

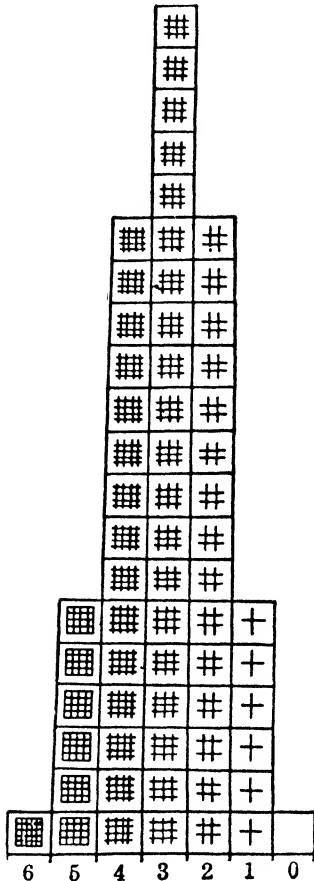

FIG. 327. The distribution of the sixty-four possible recombinations in the  $F_2$  generation when three pairs of similar genes, cumulative in action, produce a character; e.g., the offspring of mulattoes. The figures indicate the number of genes (e.g., for black) present in the individuals represented by the column above. (From Walter.)

to the sixty-four possible recombinations of genes according to the trihybrid formula: the more 'black' genes present, the darker the pigmentation of the skin. The infrequent appearance of pure whites or blacks in the  $F_2$  generation is because the chances are slight that, through segregation and independent assortment, all the separate genes for black or white will be brought together in a single gamete and, further, that such a gamete at fertilization will meet another similarly endowed. Incidentally, it should be noted that in the event that this should happen, the resultant black or white individual would be pure only with respect to skin color. The chances are almost infinitely small that he would also be pure in regard to all the numerous other characters of either the negroid or white race of his grandparents. (Fig. 327.)

The genes so far considered have been able, in various combinations, to express themselves in viable individuals. But many genes are known which produce such harmful effects that offspring which receive them from both parents usually die at an early

stage of development. Such **LETHAL GENES** obviously disturb the typical Mendelian ratios. For instance, there is a breed of chickens known as Creepers because the birds have abnormally short legs and wings. Creepers are always heterozygous but when they are mated the ratio is 2:1 instead of the typical 3:1. The explanation is that the missing creeper offspring die during early development in the shell. Homozygous creepers are unable to survive. (Fig. 328.)

Parents	Creeper × Creeper			
	Cc		Cc	
Gametes	C	c	C	c
		C	c	
Offspring	C	CC dies	Cc Creeper	
	c	Cc Creeper	cc normal	

FIG. 328. Change of typical ratios due to lethal genes in the domestic Fowl.

Lethals of various kinds are found in many plants and animals, including man. It is possible for lethals to be effective as early as the gametes or as late as adult life. In the latter case, of course, it has a greatly deferred, and usually unrecognized, effect on the expected ratios. It is probable that future intensive study of lethals in man will prove of considerable importance in medicine.

From these few examples, selected almost at random from the wealth of data at hand, it is apparent that the various types of inheritance can be satisfactorily interpreted on the fundamental principles of segregation and independent assortment. It is merely necessary to bear in mind that it is the genes which determine the development of characters, and not the characters themselves that behave as units; for now we know that most characters are determined by many genes, and that even in cases where one gene seems to produce a character, other **MODIFYING GENES** may affect its development.

Within the past few years geneticists have been able by the multiple gene, modifying gene, and similar concepts to bring the inheritance of a large number of characters into line with the principles presented. Thus stature, proportions of the various parts of the body, as well as nearly all of the physiological and mental characteristics in man are evidently dependent upon many genes. In certain fruit flies (*Drosophila*) eye color may be influenced by more than fifty pairs of genes and the wing characters by upward of a hundred. Thus it is becoming increasingly clear that what a given gene will produce is determined by the constitution of the gene plus its interaction with many, if not all, of the other genes of the complex. However, as we have seen, the single gene pair in many or most cases does have its most conspicuous effect on a certain character of the organism.

Furthermore, what the gene complex will produce may bear an intimate relationship to the environment. For instance, in *Drosophila* the abnormal condition of extra legs is inherited in typical Mendelian manner when the flies are reared at a low temperature; whereas supernumerary legs do not appear in flies with the *same* gene heritage when bred at a higher temperature. Or again, the so-called sun-red color of the kernels of Indian corn is a heritable character that develops only when the kernels themselves are exposed to light by the removal of the husk. In short, the environment, in certain cases at least, may act as a differential intensifying or diminishing gene action, and thus influence the realization of the potentialities of the heritage. (Fig. 342; Pp. 509, 510.)

So it happens, as is usually the case, the more a problem is studied the more complex it appears to become. Suffice it to say that although our knowledge of inheritance is today very much broader than Mendel conceived on the basis of his classic experiments, it is evident that he supplied us with basic principles which are affording a common denominator for an ever-increasing number of facts in genetics.

## E. MECHANISM OF INHERITANCE

With this general outline of genetic principles before us, it is now necessary to bring them into relation with the facts so far discovered in regard to the structure of the germ cells. In other words, we have assumed, on the basis of the experimental results derived from breeding plants and animals, the existence of genes, the occurrence of segregation, etc., but has the actual study of cells (CYTOLOGY) by means of the microscope given evidence of the physical basis of genes and of a segregating mechanism? The reader will at once answer this in the affirmative from our discussion of the origin and structure of the germ cells and their behavior in fertilization. Accordingly the essential facts may now be restated from this viewpoint. (Fig. 295.)

The egg and sperm each carry a definite haploid number of chromosomes and consequently after fertilization the zygote contains a double, or diploid, set. For each chromosome contributed by the sperm there is a corresponding, or HOMOLOGOUS, chromosome contributed by the egg. In other words, there are two chromosomes of each kind which may be considered as pairs. When division of the zygote takes place each chromosome splits into two chromosomes, so that each daughter cell receives a daughter chromosome derived from each of the original ones. Since all the cells of the organism are lineal descendants by similar mitotic cell divisions, all of its cells contain two sets of chromosomes — one paternal and the other maternal; and since the primordial germ cells have a similar origin, they also have two sets of chromosomes. But during the maturation process synapsis occurs: that is, homologous chromosomes of paternal and maternal origin unite in pairs — the process of fertilization which gave rise to the individual being consummated in the ripening of its own germ cells. But this union is only temporary; during the maturation process the maternal and paternal chromosomes of each synaptic pair are separated and one of each (though very rarely all of the same maternal or

paternal set) passes to the daughter cells — segregation occurs. Thus each mature germ cell, or gamete, contains one member of every chromosome pair and the number of chromosomes is reduced one-half, that is to one complete set. (Figs. 297, 329.)

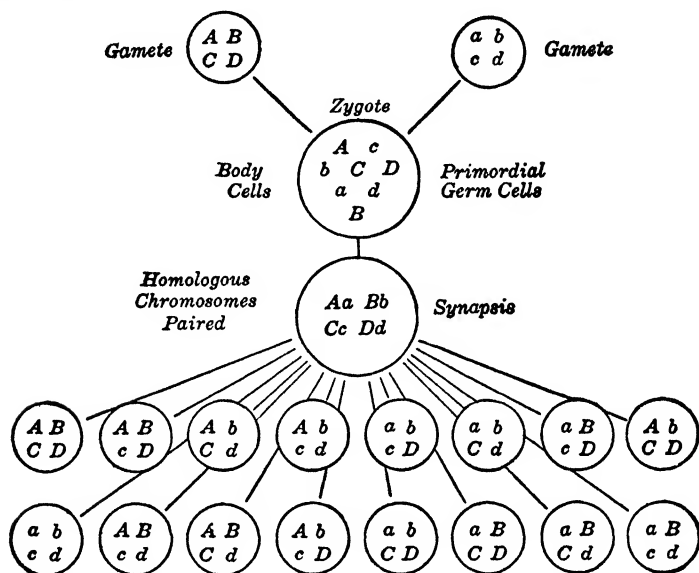

FIG. 329. Diagram to show the union of haploid groups of either the chromosomes or of the genes of the gametes to form the diploid condition of the zygote, body cells, and primordial germ cells. Finally their pairing at synapsis, segregation, and independent assortment in the gametes. With four pairs of chromosomes or of genes ( $Aa$ ,  $Bb$ ,  $Cc$ ,  $Dd$ ) there are sixteen possible types of gametes.

It has been assumed that the genes for alternative characters segregate in the formation of the gametes of hybrids so that a single gamete bears one and not both genes of a pair of alleles. That is the genes, which come together in the zygote that forms the hybrid, separate again in the formation of its own gametes. This is just what cytological studies show. Chromosome behavior exactly parallels the typical behavior of the 'Mendelian' gene, because after synapsis, during spermatogenesis and oögenesis, each chromosome of paternal origin separates from the corresponding chromosome of maternal origin. Therefore it is clear that the genes are

in the chromosomes. Moreover, since the genes similarly situated in homologous maternal and paternal chromosomes are HOMOLOGOUS GENES, or alleles, it follows that homologous genes are *segregated* in separate gametes during maturation—the two members of a pair of alleles pass to different gametes. This is the basis of the so-called purity of the gametes.

Furthermore, in considering dihybrids we found, for instance, that genes for yellow and round and for green and wrinkled seeds were inherited in a fashion which indicated that yellow and round are distributed independently of each other—there is an *independent assortment* because all possible combinations with green and wrinkled occur. This clearly is fully accounted for, provided the genes for color and the genes for form are not in the same pair of chromosomes. Moreover, following synapsis the gametes secure one of each pair of homologous chromosomes (a haploid group), but not necessarily—indeed very rarely—all of maternal or paternal origin. (Figs. 321, 322, 329.)

In short, when two gametes unite, each contributes to the zygote a homologous haploid group of genes with the result that the offspring is of diploid gene constitution. Similarly, each gamete contributes a homologous haploid chromosome group so that the zygote is of diploid chromosome constitution. Thus both the *chromosomes* and the *genes* (characters) are in the haploid condition in the gametes and the diploid in the zygote. This close parallelism of character and chromosome behavior, first pointed out in detail by a young American cytologist, Sutton, in 1903, affords further proof that the chromosomes through their constituent genes determine the physical basis of inheritance, and that segregation and related phenomena are highly significant facts. For all practical purposes, A, B, C, D, and a, b, c, d, in Figures 297 and 329 may be interpreted either as chromosomes or as genes (characters).

Turning now to the inheritance of characters whose genes are borne by the *same* chromosome: these would seem to be indissolvably linked together. And since the chromosome

number is usually not large — there are twenty-four pairs of chromosomes in man — compared with that of heritable characters, we would expect frequently to find characters linked together. That is, not separately inherited, or independently assorted, as are yellow and round in our example. In reality many cases are known in which characters are usually inherited together. The inheritance of sex and sex-linked characters will make the main point clear, and at the same time serve to bring before us the essential facts in regard to the determination of sex.

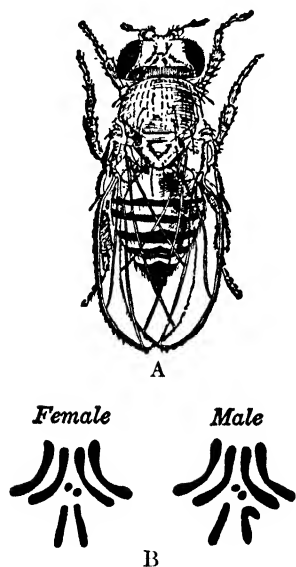

FIG. 330. A, Fruit Fly, *Drosophila*; B, chromosomes: the lower pair in the female is the X-X, and in the male is the X-Y. (From Bridges.)

### 1. Sex Determination

Intensive studies of the chromosomes in the somatic cells and in the germ cells before the maturation divisions have shown that in one of the sexes, usually in male animals, the two members of a certain pair of homologous chromosomes (synaptic mates) differ recognizably from each other in size or form or both. For example, one member, referred to as the X chromosome, may be similar to the other chromosomes, while its mate, called the Y chromosome, may be atypical in form or much smaller or, indeed, not present at all in certain species. Furthermore, if this is the condition in males, it has been found that in corresponding cells of *females* there are two X chromosomes. Thus the chromosome groups of males possess an X-Y pair, and those of females, an X-X pair. This difference between the chromosomes of the sexes naturally suggests that the X chromosome bears essential determiners for sex, and this proves to be the case. (Fig. 330.)

During spermatogenesis the maturation divisions following synapsis segregate the synaptic mates (X-Y) in the regular way, so that two classes of sperm result: half the sperm bear the X chromosome and half the Y chromosome. Furthermore, in oögenesis the maturation divisions distribute an X chromosome (from the X-X pair) to each cell, and accordingly every egg bears an X chromosome. Thus, in man the somatic number of chromosomes is 48; males having 46 plus an X-Y pair, and females 46 plus an X-X pair. Half the sperm bear 23 plus X, and half bear 23 plus Y; while all the eggs bear 23 plus X. Males are heterozygous and females are homozygous for 'sex.' (Fig. 331.)

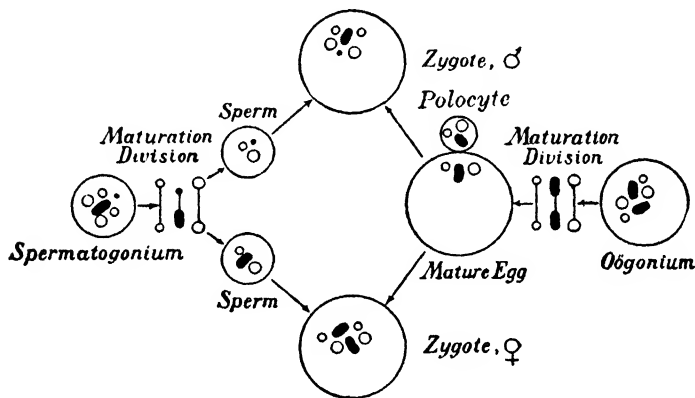

FIG. 331. Diagram to show the relation of the two classes of sperm in fertilization. Somatic chromosome number assumed to be six. The formation of gametes in the male is shown at the left, in the female at the right; fertilization, producing the male or female zygote, in the center. X chromosome (large) and Y chromosome (small) in black. (After Wilson.)

Since there are equal numbers of sperm with and without the X chromosome, as many eggs on the average will be fertilized by one class of sperm as the other, with the result that half of the zygotes will contain one X and half two X chromosomes. The former will develop into males and the latter into females, since the somatic cells of males have one X chromosome and similar cells of females have two. (Fig. 332.)



So it seems clear that sex is typically determined in many animals, including man, and in some plants at the time of fertilization by the same fundamental mechanism that controls inheritance in general. Moreover, many genes are

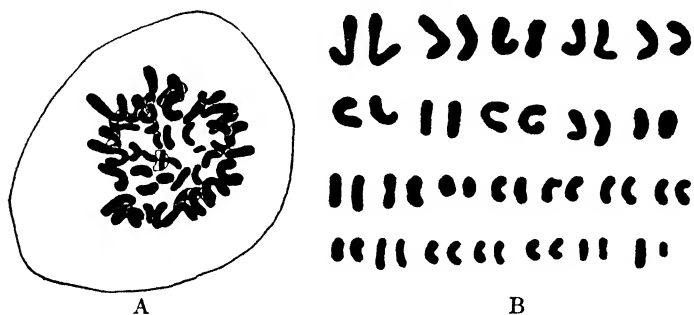

FIG. 332. A, human spermatogonium with 48 chromosomes; B, chromosomes arranged to show the 24 pairs of synaptic mates. The X-Y pair is at lower right. Very highly magnified. (From Painter.)

involved. The decision is given by certain genes in the X chromosomes, acting in connection with genes in other chromosomes. The genes in the X chromosomes turn the balance under the usual conditions of development so that a series of processes is initiated, involving the action and

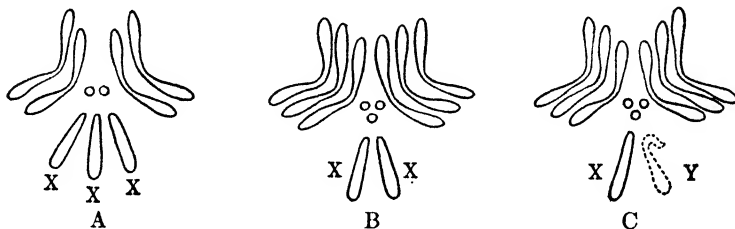

FIG. 333. Influence of the balance between X chromosomes and the other chromosomes on sex in *Drosophila*. A, 'super female'; B, 'intersex'; C, 'super male.' (See Fig. 330.)

interaction of hormones, nutritional factors, and various environmental conditions, that lead to the sex *differentiation* of the adult.

But many unusual cases, some normal and others abnormal, occur particularly among the lower animals. Thus it has been found that INTERSEXES, individuals exhibiting

varying degrees of male and female characters, may result from abnormal sets of chromosomes in which the balance between the X and the other chromosomes is upset, as is well illustrated by studies on *Drosophila*. Or hormones may have a modifying influence. Thus in cattle a male twin usually renders abnormal the development of its female twin

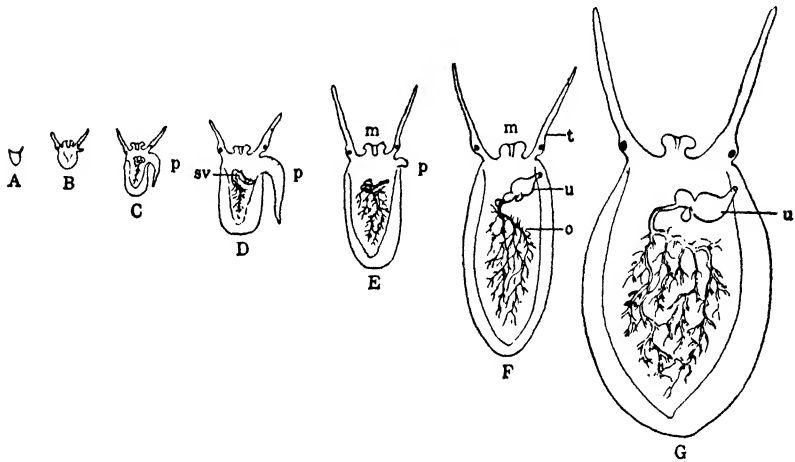

FIG. 334. Successive sexual phases in a Mollusc, *Crepidula nummaria*, showing the development and reorganization of the male reproductive system preceding the female phase. A, recently hatched young; B, early male phase; C, young functional male; D, mated male; E, transition phase; F, G, female phases; m, mouth; o, ovary; p, penis; sv, seminal vesicle; t, tentacle; u, uterus and seminal receptacle. (From Coe.)

in the uterus, so that a sterile 'free-martin' results. Or still again, SEX REVERSAL may occur through environmental factors acting on the early embryo, as in the case of the Frog. And finally, the sex of the adult may change, sometimes periodically as in the Oyster. Such marked departures from typical sex differentiation serve to emphasize that the final establishment of sex is indeed a resultant of many complex factors. (Figs. 333, 334.)

## 2. Linkage

Since the basic mechanism that regulates sex is the same as that which determines the distribution of other characters

in inheritance, it might be supposed that the genes of other characters as well are carried in the X chromosome. As a matter of fact the behavior in inheritance of certain characters is such that it can only reasonably be explained on this assumption. Accordingly such characters are known as **SEX-LINKED**. This brings us again to the point at which we digressed to consider sex — the discussion of genes associated in the same chromosome.

The best-known examples of sex-linked characters in man are **COLOR-BLINDNESS** in which the affected individual is unable to distinguish red from green, and **HEMOPHILIA** in which the individual's blood has so little tendency to clot that bleeding from even a slight wound may be serious. Both abnormalities have long been known to be inheritable, and in the same peculiar criss-cross way. Thus color-blindness is usually transmitted from a color-blind man through his daughters, who are normal, to half of his grandsons; and from a color-blind woman to all of her sons and none of her daughters. When both parents are color-blind, all the children show the defect. This behavior is readily accounted for if we assume that the gene for color-blindness when present is associated with those for sex on the X chromosome, and that color-blindness develops in males when it is received from one parent, and develops in females when it is received from both parents. Thus a color-blind man is always heterozygous for the character, while a color-blind woman is homozygous. A woman who is heterozygous has normal vision, but is a 'carrier,' that is, produces gametes half of which carry the gene for color-blindness. It is obvious why color-blindness is very much less frequent in women than in men. Incidentally, it also clearly shows that whatever characters are borne by the X chromosome are not transmitted by a father to his sons, and so perhaps minimizes, from the standpoint of heredity, the importance usually ascribed to descent in the direct male line. (Fig. 335.)

Color-blindness and hemophilia thus serve to illustrate the association of genes of different characters in the same

chromosome and the association later of their respective characters in the adult — independent assortment does not occur. This 'exception' to the principle of independent assortment 'proves the rule.' And it offers still further evidence, if such is needed, that the genes are in the chromosomes — the chromosomes are merely linkage groups of genes. The number of chromosomes and the number of linkage groups is the same.

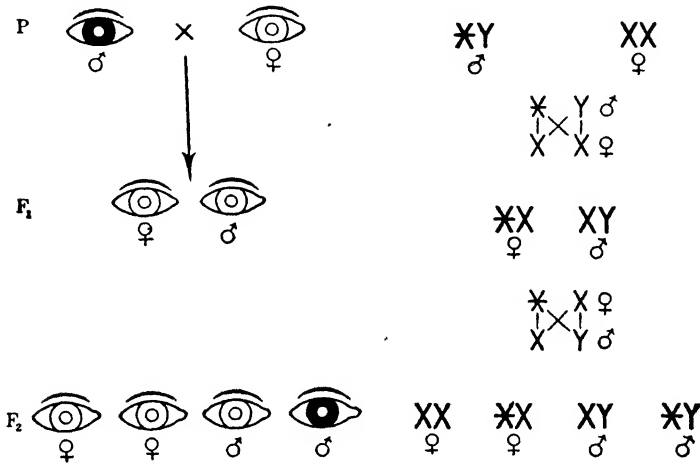

FIG. 335. Diagram to show the inheritance of color-blindness from the male. A color-blind man (shown in black) transmits the character through his daughters (carriers) to half of his grandsons. \* indicates the X chromosome with the gene for color-blindness.

### 3. Crossing Over

However, the presence of associated genes in the same chromosome by no means indicates that these genes must *always* be distributed together. Thus during synapsis homologous genes (alleles) often reciprocally **CROSS OVER** from one synaptic mate to the other, and so become separated from their former gene associates in the same chromosome. When such occurs the exchanged genes are segregated independently of their former associates in the same chromosome — they pass to different gametes and therefore to different individuals. Thus *gene recombination* is added to *chromosome*

*recombination* with the result that a greatly increased flexibility is afforded the genetic mechanism. Variation, indeed, is still further provided.

In addition to its great importance in bringing about genetic change, crossing over affords the geneticist an opportunity to determine the relative positions of different genes

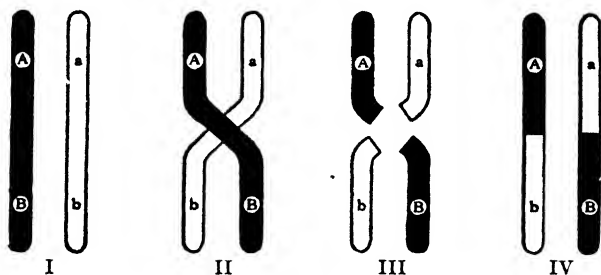

FIG. 336. Diagram of crossing over during synapsis of homologous paternal and maternal chromosomes. The letters indicate the linear arrangement of the genes (or gene groups) with alleles opposite each other. I, pair of chromosomes; II, chromosomes winding about each other at synapsis; III, separation of these chromosomes, involving breaking at the points of crossing; IV, their emergence from synapsis with the members of the pairs of alleles interchanged. (From Lindsey.)

in a chromosome. It has been found that the frequency of crossing over between two genes in a chromosome is, in general, proportional to the distance between the genes, and therefore it is possible to estimate the distances between the genes by determining the amount of crossing over that occurs between them. Furthermore, it so happens that the chromosomes in the cells of the salivary glands of *Drosophila* are relatively huge so that it is possible to observe differentiated regions representing the positions of various genes. And these giant chromosomes are typically in pairs — so-called somatic synapsis — with identifiable homologous gene regions in apposition. Thus with data from very extensive breeding experiments and from microscopic studies of details of the chromosomes it is possible to construct **CYTO-GENETIC MAPS** showing the relative positions of the various genes in the chromosomes. In *Drosophila* the genes for more than

six hundred characters have already been mapped, and estimates indicate that this fly has not less than 5,000 genes. (Fig. 337.)

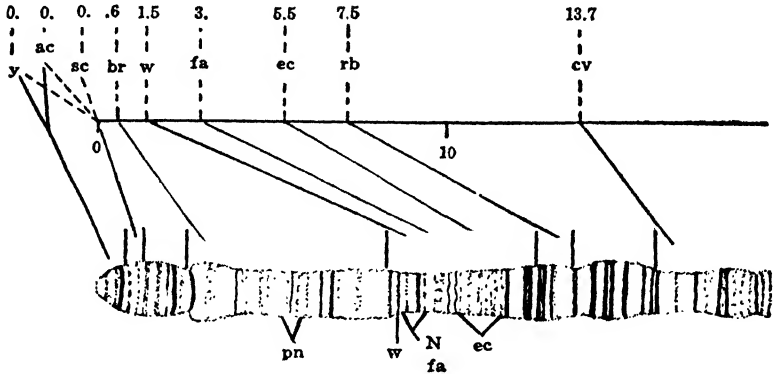

FIG. 337. Cyto-genetic map. Terminal portion of the X chromosome from the salivary gland of *Drosophila*, with the locations of some of the genes indicated. ac, achaete; br, broad; cv, cross-veinless; ec, echinus; fa, facet; N, notch; pn, prune; rb, ruby; sc, scute; w, white; y, yellow. (After Painter.)

#### 4. Mutations

But the possibilities of genetic change are not necessarily limited by the typical chromosome groups or to crossing over that usually afford the material for recombinations. Not infrequently relatively radical alterations, or **MUTATIONS**, occur, often just before or during the maturation of the germ cells, which thereupon are at the disposal of the regular genetic mechanism for segregation, etc. (P. 474.)

Mutations may be broadly classified as chromosomal aberrations and intrinsic changes in the individual gene. Indeed some geneticists restrict the term mutation to gene changes. A few illustrations from the wealth of available data must suffice.

**CHROMOSOMAL ABERRATIONS** consist of departures from the normal number and arrangement of the chromosomes, and of their parts. Thus many cases are known in which the normal chromosome complement (diploid number) has been reduced to the haploid number or increased to some

multiple of the haploid number. In the former case it is called **HAPLOIDY**; and in the latter, **POLYPLOIDY** or, more specifically, **TRIPLOIDY**, **TETRAPLOIDY**, etc. Such symmetrical changes in the chromosome groups appear to be more frequent in plants than in animals. Thus the haploid sets of three well-known varieties of Wheat consist of 7, 14, and 21 chromosomes respectively. (Fig. 338.)

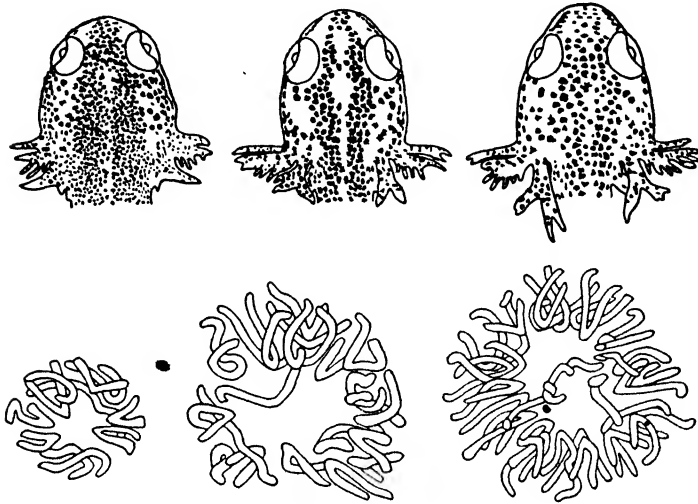

FIG. 338. Haploid, diploid, and triploid larvae of a Newt, *Triturus viridescens*. Upper row, pigment pattern of the head; lower, the chromosomes (11, 22, 33) of the epidermal cells. (From Fankhauser and Griffiths.)

Some marked instances of the origin of new types have recently been observed in the Jimson weed (*Datura*). In one case the plants differ in size and several other characters that clearly are attributable to the doubling of the diploid number of chromosomes. They have 24 pairs of chromosomes instead of the typical 12 pairs. Equally interesting are certain observations on *Drosophila* which typically has 4 pairs of chromosomes. Individuals have appeared that differ markedly from the normal flies and possess 12 chromosomes as a result of the addition of another haploid set.

Another type of chromosome mutation, known as **HETERO-PLOIDY**, involves only one, or rarely two, chromosomes and

not an entire set. Thus again in *Drosophila*, the failure of the X chromosomes to separate after synapsis (NON-DISJUNCTION) gives rise to individuals with nine chromosomes, including one Y and two X chromosomes. This may be regarded as a 'male' complement of chromosomes plus another X chromosome, with the result that flies so endowed are females with a visibly altered heredity. Many other atypical combinations occur. (Fig. 333.)

Still other irregularities may involve only a portion of one chromosome. Thus part of a chromosome may be lost, or duplicated, or attached to another chromosome. For example, a race of *Drosophila* has been obtained in which a part of the Y chromosome has become transferred (TRANSLOCATED) to the end of an X chromosome; and another race in which one of the X chromosomes has been broken into two nearly equal parts — one part being united to one of the other chromosomes.

Moreover, recent work emphasizes the significance of the order of arrangement of the genes in a chromosome; alterations of the usual order resulting in hereditary changes referred to as POSITION EFFECTS. Indeed the activity of a gene is determined by three internal factors: the chemical constitution of the gene itself, the genetic constitution of the gene system in which it acts, and the position of the gene in the gene system. And external factors in the environment may play a part in genic expression.

All chromosomal aberrations, rare and radical as most of them are, may be regarded, in a way, as a broad extension of the principle of recombination. They exert their influence by new relations and proportions of the genetic material, and offer new hereditary possibilities in the event that they are not lethal.

GENE MUTATIONS apparently involve intrinsic alterations in the individual genes themselves or even the origin of new genes, and probably are the most significant changes in the hereditary complex. They presumably are a result of an alteration in the physico-chemical constitution of the



gene. It appears that usually only one of a pair of homologous genes mutates at a given time so the change is extremely localized, and most frequently takes place just before or during maturation. Although gene mutations occur relatively rarely, about a thousand have been identified in *Drosophila*, chiefly by the elaborate studies of Morgan and his collaborators — studies involving upward of 25 million fruit flies. These experiments have made this tiny insect the greatest contributor to our knowledge of genetics since Mendel's experiments with peas. (Fig. 464.)

Perhaps the best-known example of gene mutation in carefully pedigreed animals is the sudden appearance, at



FIG. 339. A series of nine alleles of the gene affecting flower color in the Snapdragon, from typical red (upper left) through pale shades to red-striped. (From Sinnott and Dunn, after Baur.)

long intervals, of a single white-eyed *Drosophila* in a true-breeding red-eyed stock. The white-eyed mutant breeds true from its origin, and the genetic data indicate that a specific point on one chromosome — it has been mapped — suddenly changed so that the developmental processes that formerly gave rise to the usual red eyes thereafter produced white eyes.

Sometimes a series of relatively small mutations may occur at the *same* point, or locus, in a chromosome. Thus, again in *Drosophila*, more than a dozen point changes or mutations at the same locus have occurred, forming a series of gradations between red and white eyes, ranging through

so-called wine and coral to pearl and ivory. Thus the gene for red eyes of the wild type (instead of being, as is typical, homologous with one other gene, or allele, to form a pair of alleles) is homologous with a series of alleles, or **MULTIPLE ALLELES**, any one of which may be present as its definitive allele, or as alleles of each other, in a given individual. The homozygotes form the graded series from red eyes which is dominant to each of the others. Many similar series occur in plants and animals. In Man the well-known **BLOOD GROUPS** result from multiple alleles affecting the property of the red cells by which they respond to specific components of the blood serum. Knowledge of the blood groups is, of course, of first importance when transfusions are to be made. (Fig. 339.)

Such are a few of the types of mutations in the nuclear complex of the germ cells that we now know give rise to genetic variations. Chromosomal aberrations afford new relations and proportions of their constituent genes, whereas gene mutations actually determine the nature of the chromosomal elements themselves. In many instances, probably the majority, mutations produce lethal combinations in the gametes or zygotes — the altered hereditary constitution renders development or survival impossible. In other cases, individuals with the mutant characters become established and produce offspring with these new characters and so supply the material for descent with change.

Finally, in passing, it should be mentioned that mutations may also occur in somatic cells. Such **SOMATIC MUTATIONS** give rise to changes in the individual body which, of course, cannot be transmitted by the germ cells, but may be perpetuated by vegetative reproduction. Thus many desirable types of fruit are produced solely by tissue, descended from the original plants in which the mutations occurred, that has been grafted on other plants.

Important as is the recently acquired knowledge of some of the nuclear changes at the basis of mutations, we still

do not know the fundamental factors underlying their origin. However, recent experiments have afforded a most valuable clue. It has been found possible to induce mutations in certain animals and plants by subjecting their germ cells to unusual conditions — the most effective so far employed



FIG. 340. Mutation in Sheep. An Ancon ewe (left) with her heterozygous (normal-legged) mother. (From Landauer.)

being irradiations (X-rays, etc.) and certain temperature changes. As yet, desired specific mutations cannot be induced but since random mutations are provoked by controlled and measured external agents, the way seems to be opening for an experimental attack on the problem of the origin of mutations in nature which apparently is the basis of organic evolution.

## F. NATURE AND NURTURE

Even after making due allowance for the possibilities of genetic change involved in mutations, the individual still may be considered as a composite of very many characters which usually behave in a definite way in inheritance. Expressed somewhat fancifully, individuals may be regarded as temporary kaleidoscopic combinations of the genetic factors belonging to the species; the act of reproduction, especially the maturation divisions involving segregation, and subse-

quent fertilization, providing the new turn of the kaleidoscope.

But since the life of an organism is one continuous series of reactions with its surroundings, it follows that nurture plays an immensely important part in molding the individual on the basis of its heritage. Indeed we are apt to overlook the fact, already mentioned, that every character is a



FIG. 341. Corn of a single variety (Leaming dent): at the left, grown well spaced; at the right, badly crowded. The heredity of each plot of corn is the same; the striking differences in growth are therefore solely due to environment. They are modifications. (From Blakeslee.)

product both of factors of the heritage and of the environment and can be reproduced only when both are present. Those characters that appear regularly in successive generations are those whose development depends upon factors always present in the normal surroundings. Other characters, potentially present, do not become realized unless the unusual environmental conditions necessary for their

development happen to be met. Witness the examples, already mentioned, of supernumerary legs in *Drosophila*, and sun-red in Indian corn. (P. 492.)

To disentangle the closely interwoven influences of heredity and environment is one of the most important and perplexing problems of the science of genetics. This is especially true in the case of man. Development is a form of behavior, and how a child develops physically and mentally is determined not by its heritage alone nor by its environing conditions alone, but by both in intricate combination. Heredity

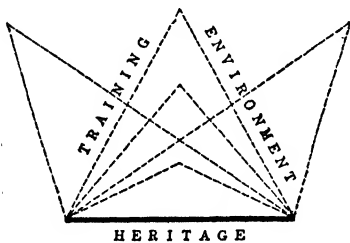

FIG. 342. Scheme to illustrate the contributions of nature and nurture to the make-up of the individual. The triangles represent various types of individuals which may be produced by the same germ cells (heritage) if environment and training are variable. The foundation of the 'triangle of life' is heritage. (After Conklin.)

and environment are collaborating artists with different rôles to play as molders of the individual. (Fig. 341.)

Although apparently we do not inherit the effects on our forebears of their surroundings and training, nevertheless we are the heirs to their customs — each generation builds upon the intellectual and material foundations of all of its predecessors — and this entails added responsibilities as well as opportunities for each succeeding generation. Already in certain

fields the applications of science to human affairs tax the ability of man to use them wisely. Thus 'social heredity' bids fair to outstrip our conservative and essentially unchanging inherited nature. The EUTHENIST emphasizes nurture, the EUGENIST emphasizes nature. As is so often the case, however, when doctrines are opposed, the truth combines both; though we cannot doubt, knowing what we know of the genetic constitution of organisms, that from the standpoint of permanent advance — racial rather than individual — the path to progress is chiefly through eugenics, the science of being well-born. (Fig. 342.)

This distinction between heritage and acquirements leaves a fatalistic impression in many minds, which to a slight extent is justified. We cannot get away from inheritance. On the other hand, although the organism changes slowly in its heritable organization, it is very modifiable individually; and this is man's particular secret — to correct his internal organic inheritance by what we may call his external heritage of material and spiritual influences. It is therefore clear that the problem of human improvement has two aspects: in the first place, the effects of culture on the individual which, though not inherited, are cumulative from generation to generation through training; and secondly, racial betterment through breeding the best. (Pp. 666–670.)

Summarizing our survey of genetics, in the first place, it is evident that the basis of inheritance is in the germinal rather than in the somatic constitution of the individual. A character to be inherited must be represented by one or more genes in the germ cells, although the environment is not unimportant in the development of the character from the gene complex. Secondly, there is no satisfactory evidence that modifications of the body, acquired characters, can be transferred from the body to the germ complex and so be inherited. And thirdly, the germinal basis of characters, genes, may be dealt with essentially as units. The chromosomes — linkage groups of genes — undergo segregation and independent assortment during the development of the gametes of an individual, so that paternal and maternal contributions may be readjusted in all the possible combinations. Finally, mutations afford still further changes in the gene complex for distribution by the genetic mechanism, and so provide crucial opportunities for variation — for descent with change. (Pp. 589–599.)

## ORGANIC ADAPTATION

Every creature is a bundle of adaptations. Indeed, when we take away the adaptations, what have we left? — *Thomson and Geddes.*

**S**ince organisms are dependent for their life processes upon energy liberated by physico-chemical processes in protoplasm, any and all influences which induce changes in the structure or functions of an organism must initially modify the underlying metabolic phenomena. In other words, organic response is a problem of metabolism. Although it is highly important that this cardinal fact be clearly grasped, the science of biology today is not in a position to interpret the responses of organisms in these fundamental terms. Accordingly we can present merely some representative instances to illustrate the fact that the response of organisms, as exhibited in active adjustment — ADAPTATION — of internal and external relations, overshadows in uniqueness all other characteristics of life and at one stroke differentiates even the simplest organism from the inorganic.

Overwhelmingly striking as is the fitness of organisms to their physical surroundings, we must not lose sight of the fact that the environment itself presents a reciprocal fitness. This apparently results from the "unique or nearly unique properties of water, carbonic acid, the compounds of carbon, hydrogen, and oxygen. . . . No other environment consisting of primary constituents made up of other known elements, or lacking water and carbonic acid, could possess a like number of fit characteristics, or in any manner such great fitness to promote complexity, durability, and active metabolism in the organic mechanism which we call life." (Henderson.)

## A. ADAPTATIONS TO THE PHYSICAL ENVIRONMENT

In any consideration of the reciprocal relations which must exist between organisms and their surroundings, of first importance is the inconstancy of the latter. Uncertainty is the one certainty in nature and accordingly the response of living things — their adaptability to environmental change — is at once the most striking and indispensable adaptation.

### 1. *Adaptations Essentially Functional*

Although the changes of the environment are almost inconceivably complex — witness the kaleidoscopic series of events exhibited in the hay infusion microcosm — there are certain general conditions that every environment must supply, and without which life cannot exist. These are food, including water and oxygen, and certain limits of temperature and pressure. (Fig. 20.)

**Food.** As we know, food represents the stream of matter and energy that is demanded for the metabolic processes of living matter. And each and every element which forms an integral part of protoplasm must be available. Since all protoplasm consists chiefly of a dozen chemical elements, these, of course, must be present; and further, since protoplasm is a colloidal complex in which water plays a fundamental rôle, life processes without water are impossible. But the old adage that what is food for one is another's poison has a broader significance than is immediately apparent. Although it is true there are general 'food-elements' which all life demands, it is equally true that the combinations in which these elements must be presented to the organism, in order to be available for its metabolic processes, are subject to the widest variation. (Pp. 24-28.)

We have emphasized and contrasted the nutrition of a typical animal, green plant, and colorless plant, and have seen the reciprocal part which they play in the circulation of the elements in nature; so it is necessary, with these facts in mind, only to cite special cases in order to illustrate the



adaptation of certain groups of organisms to special conditions of existence. The demands of the Sulfur Bacteria and the Yeasts are in point. (Figs. 17, 18.)

The Sulfur Bacteria, representatives of a relatively small group known as AUTOTROPHIC Bacteria, have the power to manufacture their own food with energy derived from inorganic substances and without the aid of the energy of sunlight. The Sulfur Bacteria live in water containing hydrogen sulfide, from which, by oxidation, they obtain energy and store up within the protoplasm free sulfur in the form of tiny globules. And then by further oxidation they transform the sulfur into sulfuric acid which immediately becomes a sulfate and is excreted. Thus a gas which is poisonous to nearly all organisms is for the Sulfur Bacteria a necessary life-condition.

The Yeasts include a host of microscopic colorless plants which play an important part in the simplification of organic compounds. An ounce of 'brewers' yeast' contains about five billion cells. Since they are devoid of chlorophyll, yeast cells, of course, lack photosynthetic powers, though like many other colorless plants they are not dependent upon proteins for nitrogen but obtain it in less complex form. But the essential fact of interest at present is the chemical changes associated with yeast metabolism — the transformation of a large proportion of the sugar content of the medium in which they live into alcohol and carbon dioxide. This process of ALCOHOLIC FERMENTATION may be approximately expressed by the formula:



The explanation is not far to seek. When deprived of an adequate supply of air, yeast resorts to the energy released when, with the decomposition of the sugar, the carbon and oxygen unite as  $\text{CO}_2$ . The formation of alcohol by the remnants of the sugar molecules is, from the standpoint of the plant, a mere incidental factor which is, so to speak, unavoidable. On the other hand, from the broad viewpoint, the waste products of the action of the yeast plant's enzymes

represent an important phase in the general simplification of organic compounds in nature. And man turns to account in numerous ways both products of the plant's destructive powers — the alcohol and the carbon dioxide. (Fig. 343.)

Thus the Yeasts are practically independent of free oxygen and in this they agree with many kinds of Bacteria as well as some animals, chiefly parasitic forms, which are able to secure the necessary energy by the rearrangement of the atoms within, or the disruption of, molecules containing oxygen. Indeed, certain species of Bacteria not only do not

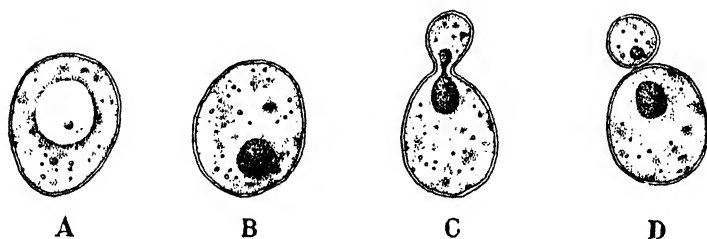

FIG. 343. Yeast cells, very highly magnified. A, cell showing granular cytoplasm and a large vacuole; B, showing nucleus; C, cell budding; D, mother cell and bud after division is completed.

need free oxygen at all, but are killed when it is present in any considerable amount. All such organisms are termed ANAËROBES. An important example is *Clostridium tetani*, commonly known as the bacillus tetani, which inhabits garden soil and street dust and produces TETANUS, or lockjaw, in man and certain domesticated animals when it gains entrance and develops in the tissues.

TEMPERATURE. Although protoplasmic activity is restricted to ranges of temperature which do not seriously interfere with the chemico-physical processes involved, it is a commonplace that various species are adapted to different degrees of temperature. Each has its optimum at which it thrives best and its maximum and minimum beyond which life ceases. The great majority of organisms find their optimum temperature between 20° C. and 40° C., though species inhabiting the polar and tropical regions show adaptations to the temperature extremes of their surroundings.

As a matter of fact, it is not possible to state the upper and lower limits beyond which all active life ceases, but some Protozoa are known to multiply in the water of hot springs, certainly at temperatures slightly higher than  $50^{\circ}\text{C}$ ., and others in water until freezing actually occurs.

But many of the lower forms of life, such as the Bacteria and Protozoa, have the power of developing, particularly under unfavorable surroundings, protective coverings of various sorts about themselves and of assuming a resting

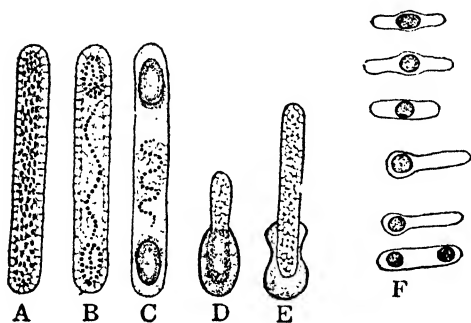

FIG. 344. A-E, *Bacillus bütschlii*: A, cell structure; B, C, spore-formation; D, E, germination of a spore. F, various types of spore-formation occurring among bacilli. Very highly magnified. (From Smith and others; A-E after Schaudinn.)

condition in which all the metabolic processes characteristic of active life are reduced to the lowest terms. In this spore or encysted state they are immune to extremes of temperature and of dryness to which they readily succumb during active life.

Thus some types of Bacteria can successfully withstand a temperature of nearly —

$200^{\circ}\text{C}$ . for six months, and about  $-270^{\circ}\text{C}$ . for shorter periods, while others can endure a temperature at least as high as  $140^{\circ}\text{C}$ . for a short time. And some organisms survive rapid freezing in liquid air though they succumb when slowly frozen at only  $-2^{\circ}\text{C}$ . (Fig. 344.)

It is clear that the great majority of organisms are at the mercy of environmental temperatures. This is true of all except the 'warm-blooded' animals, the Birds and Mammals. It is significant that these homothermal animals possess a highly complex mechanism which maintains their body temperature practically constant — in Man at  $37^{\circ}\text{C}$ . ( $98.6^{\circ}\text{F}$ .) — and any considerable departure from this temperature results in death.

The heat regulatory mechanism represents, so to speak, the final result of the assembling and elaborating, throughout vertebrate evolution, of various elements, the origin of which is found among the Fishes. In the Mammals it comprises insulating material in the skin, a closed blood vascular system, power of rapid oxidation, endocrinal and other glandular products, evaporation surface of the lungs and skin, 'trophic' and 'temperature' nerves, coördinating centers, etc., — the whole complex rendering its possessors largely independent of the surrounding temperature and making possible a carrying on of the various bodily functions with such nicety as the life of these forms demands. Indeed, this mechanism makes it entirely possible for a man to stay in a hot dry chamber sufficiently long to see a chop actually cooked. It is hardly probable that the human brain, for instance, could have developed to function as it does if its cells were subject to wide temperature variations such as are those of a fish or frog.

**PRESSURE.** The metabolism of organisms, in common with chemical processes in general, is influenced by the surrounding mechanical pressure. Therefore it is evident that the pressure of either the water or air plays an important part in the operation of the life functions. We find many organisms adapted to even the greatest depths of the ocean where the pressure is several tons to the square inch — so great that some forms burst when rapidly brought to the surface. Indeed, keeping within a zone of tolerable pressure is a real problem for sea animals — the problem of falling neither downward nor upward being met in various ways, as by gas bladders, oil droplets, and so-called flotation processes. However, a noteworthy fact is that many marine organisms have a remarkable capacity for rapid adaptation to great changes in pressure. This is unusually conspicuous in Whales that are able to dive rapidly to a depth of nearly a mile without untoward effects — the pressure increasing one atmosphere (15 pounds per square inch) for every thirty-three feet of depth. (Fig. 345.)

Terrestrial organisms have a much simpler though by no means insignificant problem, since the greatest difference in pressure to which they can be exposed is considerably less than one atmosphere. Some, of course, are adapted to live

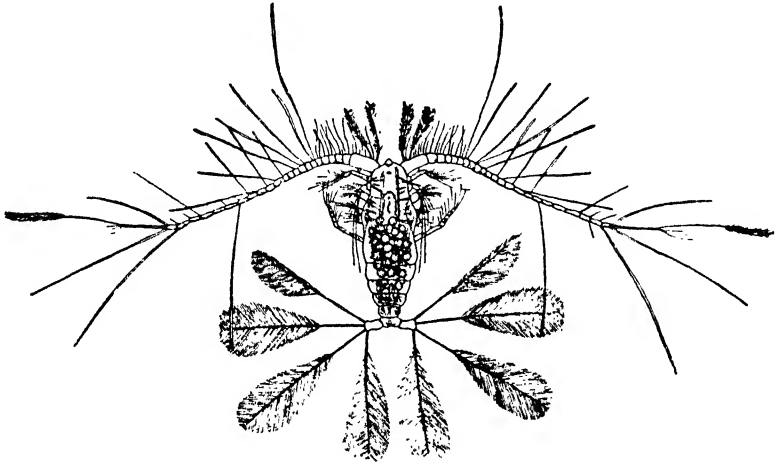

FIG. 345. A tiny marine Crustacean, a Copepod, showing extreme development of setae as so-called flotation processes. Magnified. (After Giesbrecht.)

at high altitudes and to soar still higher where the air pressure is relatively low. And again, many of the terrestrial Vertebrates present an adaptive mechanism which renders them less dependent on a constant atmospheric pressure.

**SEA TO LAND.** These examples suffice to emphasize the general environmental conditions which are necessary for life, and to suggest that within these broad limits organisms are adapted to special environmental conditions so that there is scarcely a niche in nature untenanted. However, the reciprocal integration of the organism and its surroundings may be further shown by reference to some of the physico-chemical adaptations of life, generally believed to have had its origin in the sea, as it invaded progressively fresh water and dry land in its evolutionary development.

Apparently the fundamental physico-chemical conditions under which life is possible have remained essentially the

same since its origin in the sea, and therefore the evolution of different forms of life has necessitated the development of mechanisms for maintaining within the animal an environment similar to the original conditions. Protoplasm, as we know, is adjusted to, and dependent upon the properties of the surrounding solution and accordingly transfer to fresh water necessitated the development of mechanisms to keep the salt content of the body fluids independent of, and higher than, the surrounding water. The sea contains about 100 times more salts than fresh water and probably this is the chief hurdle that organisms surmounted in colonizing the latter.

The blood of different animals today shows very great similarity, and it could not be otherwise since slight variations in osmotic pressure produce such profound changes in cells. Osmotic independence had to be attained and, in general, this was done by semi-permeable boundary membranes of limited area, and by excretory organs capable of secreting a hypotonic urine and therefore doing osmotic work to maintain the osmotic gradient between the external and internal environments. Thus the composition of the blood has remained the same not by a static process — it has been actively maintained as life became adapted to new habitats.

Adjustment to a terrestrial habitat involves, of course, still other adaptations. Much lower viscosity and more abundant oxygen make possible a general speeding up of the vital processes, but now provision also is necessary for the conservation of water which is so essential for all the functions of life. This is met in part, for example, by waterproof coverings and by certain changes in the kidneys and rectum which enable them to reabsorb water otherwise destined to be lost. And since fats, as compared with proteins and carbohydrates, afford a larger percentage of metabolic water, animals in danger of undergoing desiccation emphasize the oxidation of fats.

In general the characteristic nitrogenous waste product of primitive aquatic animals is ammonia because it can readily

diffuse into their environment. But, necessarily, in amphibious animals ammonia is replaced by urea because it is non-toxic in relatively high concentrations and so can be temporarily retained by the body without deleterious effects. Thus urea formation may be regarded as an adaptation to water shortage and as such might be expected to persist in truly terrestrial forms. However, this is the case only in the Mammals, since most strictly terrestrial Reptiles and the Birds find special conditions imposed by their early development in eggs protected by shells, and so instead of converting ammonia into urea which is not easily eliminated, they change it into uric acid which can be precipitated without disturbing the osmotic balance and discarded with the embryonic membranes at hatching.

In short, it seems reasonable to believe that the primary needs of protoplasm are basically the same today as they were when it had its origin in the sea, and that, with the evolution of complex bodies adapted to changed surroundings, the problem of adaptation was met in part by the blood — at first probably little different from sea water — maintaining an *internal* environment approaching that of the parental sea.

## 2. Adaptations Essentially Structural

We may now broaden our view of the plasticity of organisms by a consideration of adaptations which are essentially structural. But here as elsewhere it is absolutely impossible to distinguish sharply between structure and function which, obviously, are only reciprocal aspects of the fitness of living creatures.

ADAPTIVE RADIATION OF MAMMALS. In the group of Mammals, forms are to be found which are extraordinarily modified in adaptation to the most diverse environmental conditions. From a more or less primitive type, or focus, there radiate, as it were, types which are specialized for very different habitats and modes of life. We may select from the placental Mammals a small Malayan insectivorous ani-

mal known as *Gymnura*, which is allied to the Hedgehogs, as most similar among living Mammals to the generalized or focal type of terrestrial Mammal. *Gymnura* has relatively short pentadactyl limbs with the entire palms and soles

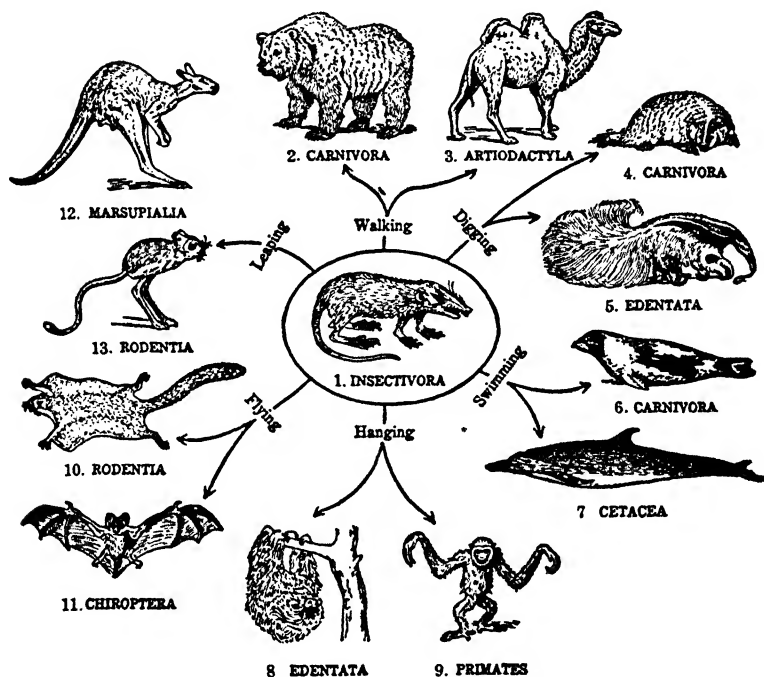

FIG. 346. Diagram of parallelism in evolution and adaptive radiation in Mammals. 1, *Gymnura*; 2, Bear; 3, Camel; 4, Badger; 5, Anteater; 6, Seal; 7, Dolphin; 8, Sloth; 9, Gibbon; 10, 'Flying' Squirrel; 11, Bat; 12, Kangaroo; 13, Jerboa. (From Hegner, after Newman and others.)

resting flat upon the ground (PLANTIGRADE) and therefore essentially adapted for comparatively slow progression. (Fig. 346.)

Radiating from this focus, adaptations for rapid running (CURSORIAL adaptations) are chiefly evident in a lengthening of the limbs. Thus, for example, in the Dogs, Foxes, and Wolves, the effective limb length is increased by raising the wrist and heel from the ground and walking merely upon the digits (DIGITIGRADE); while in Antelopes, Horses, and hoofed



runners in general, the chief limb bones themselves are lengthened, subsidiary ones are suppressed, and the wrist and ankle are raised still further from the ground, so that merely the tips of one or two digits of each limb support the animal (UNGULIGRADE). Thus the typical cursorial forms represent the culmination of mammalian adaptation to plains and steppes; regions in which long distances must frequently be traversed in quest of food, and safety is to the swift. (Fig. 347.)

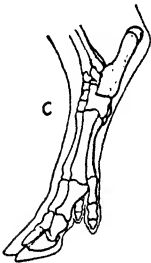
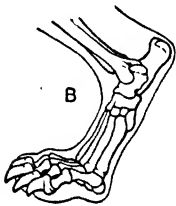
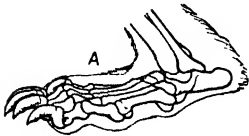

FIG. 347. Foot postures of Mammals. A, plantigrade; B, digitigrade; C, unguligrade. (From Lull.)

Another line of adaptive radiation is presented by the tree dwellers: ARBOREAL forms which make their own the world of foliage high above the ground. Such are, for instance, the Sloths which are really tree climbers that walk and sleep upside down suspended from branches; the tailless Apes that swing among the boughs chiefly by their arms; and the Squirrels that scamper along the branches. Some Squirrels and the so-called Flying Lemurs take long soaring leaps supported by wide folds of skin between the sides of the body and the extended limbs. But the Mammals have not left the air untenanted, for truly VOLANT forms are represented by the

Bats in which the fore limbs with greatly elongated fingers form the framework of true wings. (Fig. 348.)

Passing below the surface of the earth, FOSSORIAL Mammals are found, such as the Woodchucks, Gophers, and especially the Moles, which are adapted to a subterranean existence by bodily modifications that facilitate digging. Furthermore, the gap between terrestrial and aquatic Mammals is bridged by the Muskrats, Beavers, Otters, and Seals

which are more or less equally at home on land and in the water. (Fig. 349.)

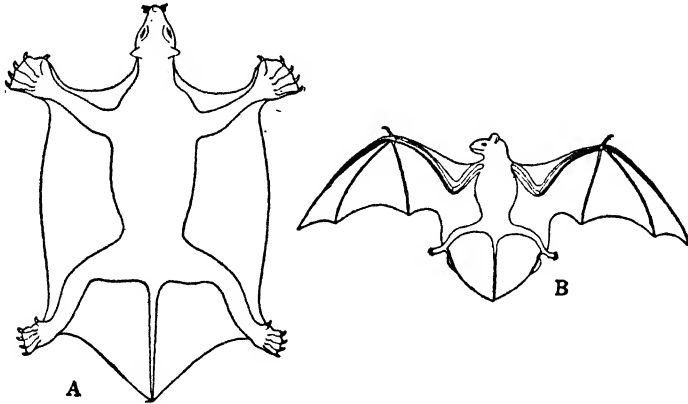

FIG. 348. A, 'Flying Lemur,' *Galeopithecus volans*; B, Bat, *Vespertilio noctula*. (From Lull.)

The truly AQUATIC Mammals, such as the Porpoises and Whales, have completely abandoned the land of their ancestors of the geological past and today approach, in adapta-

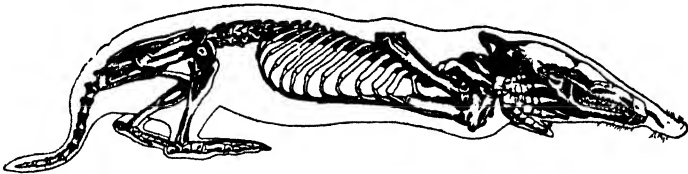

FIG. 349. Skeleton of a Mole, *Talpa europaea*. (From Pander and D'Alton.)

tions to a marine life, the general contour of the primitively adapted aquatic Vertebrates, the Fishes. (Figs. 208, 209, 350.)

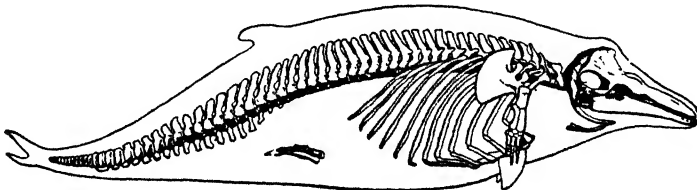

FIG. 350. Skeleton of a Porpoise. The vestigial pelvic bones are shown imbedded in the flesh. (From Pander and D'Alton.)

Thus the various lines of adaptive radiation of the placental Mammals from a generalized terrestrial type, such as *Gymnura*, have provided forms fitted for all sorts and conditions of the environment — representatives are competing with members of other groups beneath, on, and above the earth and in the water.

In brief, every organism is in a state of equilibrium with its environment; it is adjusted to meet the demands made upon it, with the greatest possible efficiency that its heredity allows. And a disturbance of this equilibrium due to changes in habits or environment must result in readjustments to

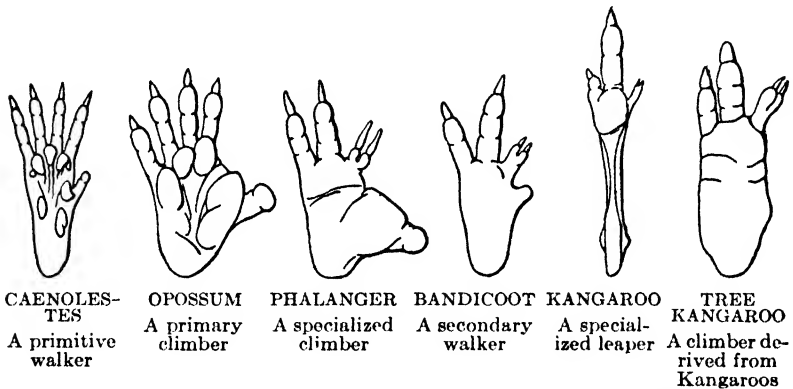

FIG. 351. Hind feet of a series of marsupial Mammals, showing the history of the feet of the Tree Kangaroo, *Dendrolagus*. (From Davis.)

meet the new conditions, if the organism is to survive. One more example, this time from the marsupial Mammals, will serve to emphasize such problems in adaptation. (P. 275.)

“When we unravel the entire history of the Tree Kangaroos, we find that they have gone through an amazing series of changes of habits. Their original ancestors, like all primitive Mammals, no doubt were structurally adapted to walking on the ground. Then they took to living in trees, and their feet adjusted themselves to grasping branches. Then they descended to the ground again, and their grasping feet were readjusted to walking. In the course of time these walking animals developed into leaping animals like the

true Kangaroos, and their feet became extremely highly specialized structures. When these leaping animals finally took to living in trees once again their feet had become so highly specialized for leaping that they could no longer re-adjust themselves into grasping organs, and so the existing Tree Kangaroos climb by bracing their feet against the trunk of a tree, as Bears do. Most of the steps in this series of transformations are represented by existing Marsupials that have gone no farther than one or another of the stages in the series." (Fig. 351.)

Somewhat similar problems in adaptation are, of course, exhibited throughout the living world, especially among the

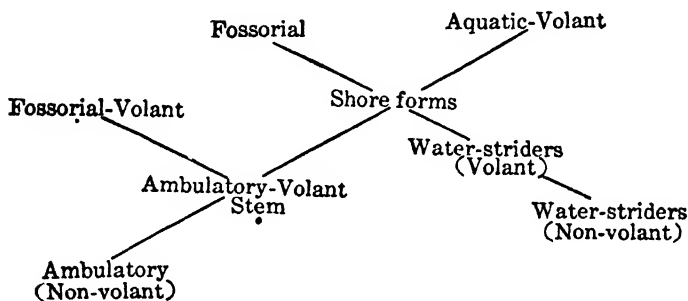

FIG. 352. Diagram of the adaptive radiation of a group of Insects, the Hemiptera, or Bugs. (From Lindsey.)

Insects, though there seems no doubt that the adaptability of the mammalian stock — its potential of evolution — is in no small degree responsible for the dominant position which the Mammals hold in the world of today. (Figs. 352, 353.)

**ANIMAL COLORATION.** Perhaps the most generally striking characteristic of organisms is their color and color pattern. Among plants this applies chiefly to the flowers and fruit of the higher forms, though here and there throughout the plant series the typical green color is replaced or rendered inconspicuous by others. But the absence of photosynthetic pigments in animals and their relatively active life have permitted more latitude in body color, and accordingly it is in the animal world that color adaptations are more numer-

ous and varied. Some colors and color patterns are, of course, merely incidental to the chemical composition of the whole or parts of the body. Others, however, irresistibly arouse our interest and seem to demand a less simple explanation because they are apparently of special service to their

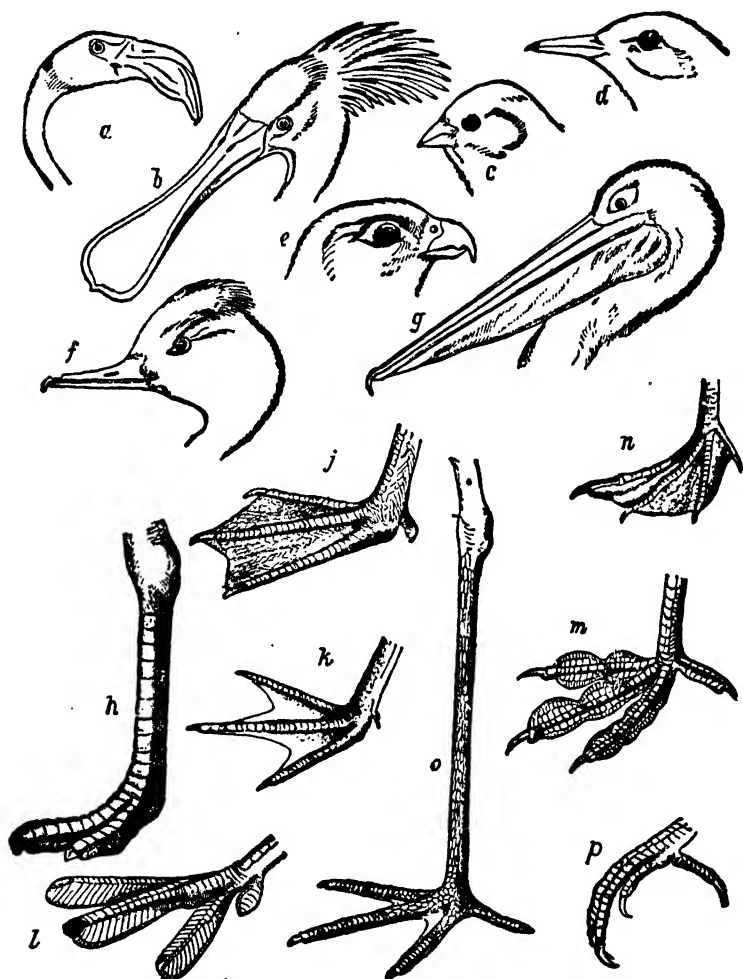

FIG. 353. Representative adaptations of the beaks and feet of Birds. *a*, Flamingo; *b*, Spoonbill; *c*, Bunting; *d*, Thrush; *e*, Falcon; *f*, Duck; *g*, Pelican; *h*, Ostrich (running); *j*, Duck (swimming); *k*, Avocet (wading); *l*, Grebe (diving); *m*, Coot (wading); *n*, Tropic Bird (swimming); *o*, Stork (wading); *p*, Kingfisher (grasping). (From Hegner, after several authors.)

possessors. A few examples will serve to bring the problem before us and indicate the class of facts involved.

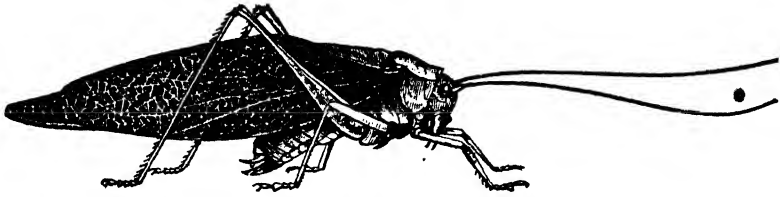

FIG. 354. The common green Katydid, *Microcentrum*. (From Riley.)

The color and color patterns of many animals are such that they harmonize or fuse with the usual surroundings of the creatures and render them practically indistinguishable from their immediate environment. Every frequenter of the open knows innumerable instances. The song of the green Katydid readily guides one to its immediate vicinity, but it is quite another matter to distinguish its leaf-green wings among the foliage of its retreat. Again, one is attracted by the striking colors of an Underwing Moth while in flight, but is at a loss to find the insect when scarlet or orange is obscured by the overlapping, grayish-mottled fore wings blending with the tree trunk where it has come to rest. (Figs. 354, 355.)

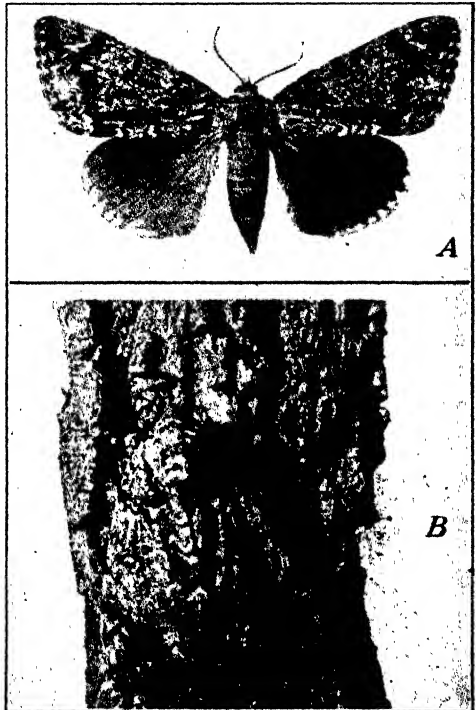

FIG. 355. Underwing Moth. A, wings expanded, exposing the highly colored hind wings; B, resting on bark. (From Folsom.)

The white of the Foxes, Hares, and Owls of alpine and arctic regions; the green color of foliage-dwelling Toads and Frogs; the tendency toward fawn and gray of desert Insects, Reptiles, Birds, and Mammals; the olive upper surface of the bodies of brook Fishes; the steel gray above and white below of sea Birds that harmonize with sea and sky when

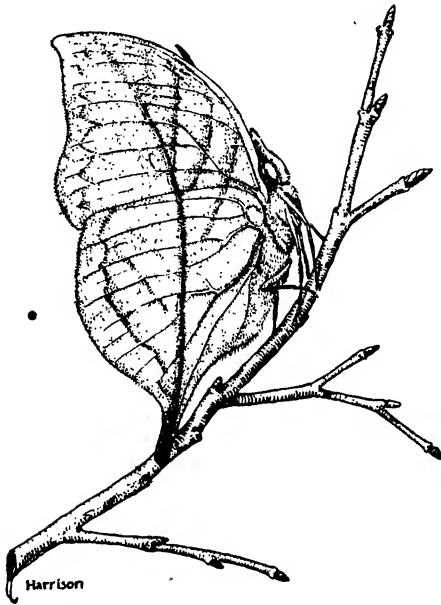

Fig. 356. Leaf Butterfly, *Kallima*.

viewed from above and below respectively — the number of such cases is legion. Gazelles living on the lava fields of volcanic regions are dark gray, while those of the great stretches of sand plains are white — the same species exhibiting regional variations in color which blend with the surroundings. Furthermore, the same individual may vary in color with the seasonal changes in its environment, or present different color schemes in different localities. Thus the summer coat colors

of the Arctic Fox and the Weasel harmonize with the browns of rocks; and the winter coat of white, with snow-clad nature. And the Chameleons are by no means unique in their ability to change color very rapidly so that self-effacement often results.

But confusion is worse confounded when to harmonizing color is added harmonizing form, striking examples of which are the Leaf Butterflies of the East Indian region, the familiar Walking-sticks, and the caterpillars ('inch-worms') of Geometrid Moths. (Figs. 356, 357, 359.)

Although the general tendency in nature is for *sympathetic*

coloration — indeed, it is frequently possible to infer from the color of an animal its habitat — there are numerous cases in which the colors and color schemes seem to be in striking contrast with the animal's usual background. Sometimes, however, the contrast which is so striking with the bird in the hand, proves to be *obliterative* with the bird in the bush — a conspicuous color pattern, expressing gradations of light and shadow, and counter shading, fuses with a background of light and shadow afforded by the background. (Fig. 358.)

But examples of color patterns which by the most liberal stretch of the imagination cannot be interpreted as harmonious with the animal's usual surroundings are not far to seek. Brilliant yellows and reds render, for instance, many Wasps, Bees, Butterflies, and various species of Snakes actually conspicuous. And it is suggestive that very many of these forms are provided with special means of defense, such as poison glands and formidable jaws, or special secretions which render them unpalatable. Moreover,

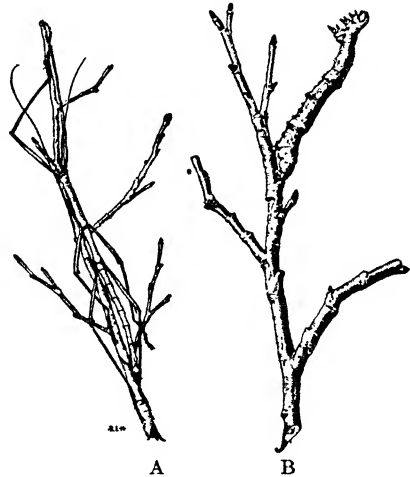

FIG. 357. A, Walking-stick Insect on a twig; B, larva of a Geometrid Moth resting extended from a twig. (Modified, after Jordan and Kellogg.)

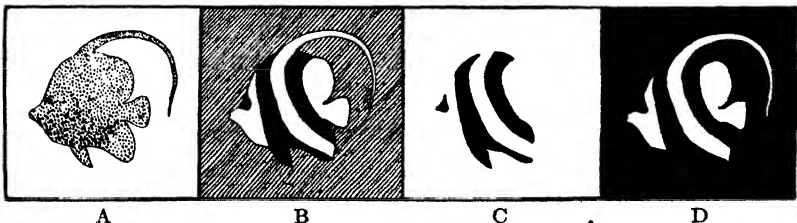

FIG. 358. Diagrams of a Fish to show differential blending. A, seen as a self-colored object without pattern; B, C, D, with a disruptive pattern against different backgrounds. (From Cott.)



what is still more interesting, many animals possessing this 'protective conspicuousness,' which renders them easily identified and advertises that they are to be avoided by their foes,

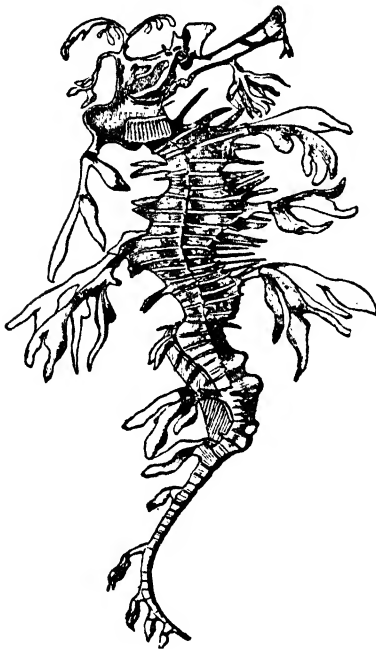

FIG. 359. Sea-horse, *Phyllopteryx eques*, which lives on Sargassum and resembles the latter. See Fig. 191. (After Boulenger.)

are frequently 'mimicked' in color pattern and form by defenseless creatures. Thus commonly associating with the various species of Bees hovering about flowers are defenseless Flies which are so bee-like in appearance that they are usually mistaken for Bees, and avoided accordingly by human, and presumably by other enemies also. (Figs. 360, 365.)

Now, what is the significance of such phenomena of animal coloration and form? This problem has attracted much attention and appears by no means so simple today as it did a generation ago. Biologists at present are not

so ready to interpret individual cases as 'protective,' 'aggressive,' 'alluring,' 'confusing,' or 'mimetic.' But it must be

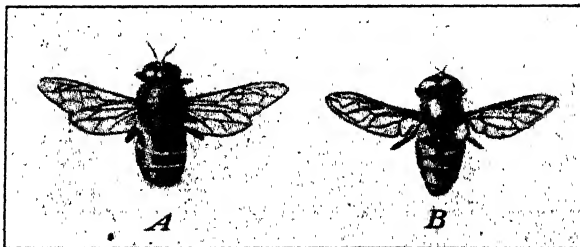

FIG. 360. 'Protective mimicry.' A, drone Honey Bee; B, a Bee-fly, *Eristalis tenax*. (From Folsom.)

admitted that nowhere else is the plasticity — adaptability — of organisms better illustrated, and that, taken by and large, many such adaptations are of crucial importance in the life and strife of species. Apparently the origin of such adaptive variations must be sought in mutations — the unadaptive mutations being eliminated in the struggle for existence.

**THE LEGS OF THE HONEY BEE.** From time immemorial the Honey Bee (*Apis mellifera*) has been the subject of wonder and study, and today there is no more interesting example of adaptation than that exhibited by bees in relation to the specialized community life of the hive. (Fig. 361.)

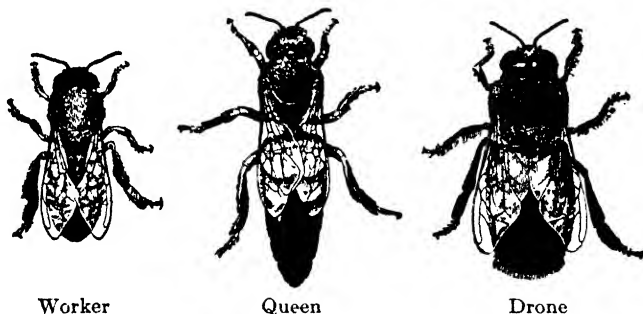

FIG. 361. The Honey Bee, *Apis mellifera*. (From Bureau of Entomology.)

An average hive comprises some 65,000 bees of which one is a **QUEEN**, several hundred are **DRONES**, and the rest **WORKERS**. The queen is the only fertile female and accordingly she is the mother of nearly all the other members of the hive. Throughout her life of a few years she is tended and fed by her numerous offspring. The drones, or males, contribute nothing to the work of the hive but, after the old queen departs at the *swarming*, one of them during the nuptial flight mates with a virgin queen which then becomes the new queen of the hive. Thus the queen and the drones represent an adaptation of the colony to communal life — a physiological division of labor in the hive which involves a specialization of members solely for reproduction, while the daily work and strife of the colony devolves upon the

workers. The latter are sexually undeveloped females which do not lay eggs but spend their time carrying water, collecting nectar and pollen, secreting wax, building the comb, preparing food, tending the young, and cleaning, airing, and defending the hive.

The worker is a 'bundle of adaptations' for its varied duties. The primitive insect appendages have become

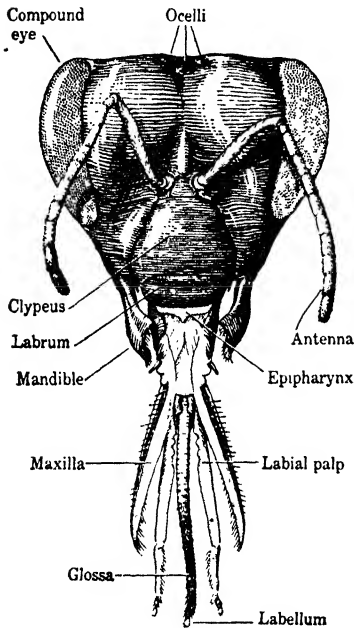
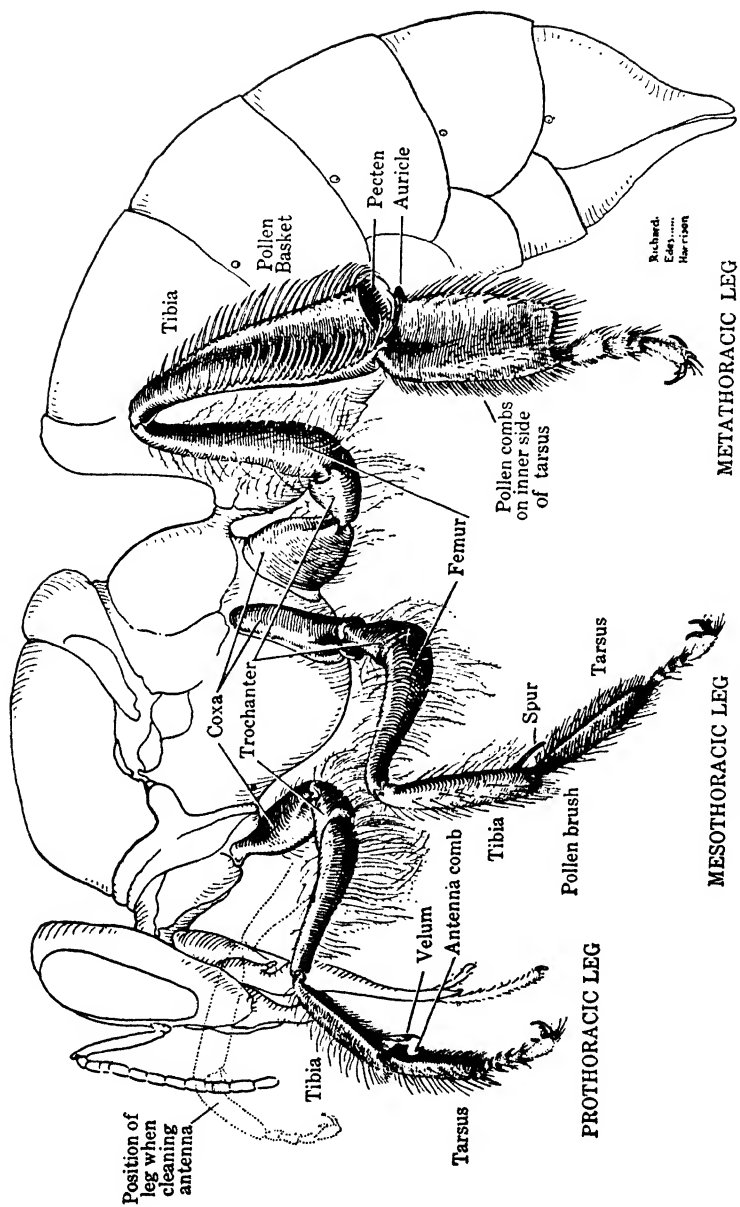

FIG. 362. Head of a worker Honey Bee.

specialized in the worker bee so that collectively they constitute a battery of tools adapted with great nicety to the uses for which they are employed. This applies to all of the appendages of the insect's body, but we shall neglect those of the head and consider only the specializations of the three pairs of legs. These, as in all insects, arise from the THORAX: the anterior pair from the first segment of the thorax (prothorax), the second, or middle, pair from the second thoracic segment (mesothorax), and the posterior pair from the third, or last, thoracic segment (metathorax). A typical insect leg consists of several parts: the COXA, which forms the junction

with the body, followed in order by the TROCHANTER, FEMUR, TIBIA, and five-jointed TARSUS, or foot. (Figs. 362, 363.)

The worker bee's PROTHORACIC LEGS show the following specializations. The femur and tibia are covered with long, branched FEATHERY HAIRS which aid in gathering pollen when the bee visits flowers. The tibia, near its junction with the tarsus, bears a group of stiff bristles (POLLEN BRUSH) which is used to brush together the pollen grains that have



METATHORACIC LEG

MESOTHORACIC LEG

PROTHORACIC LEG

Fig. 363. Legs of the worker Honey Bee.

been dislodged by the hairs of the upper leg-segments. On the opposite side of the leg is a composite structure, the ANTENNA CLEANER, formed by a movable plate-like process (VELUM) of the tibia which fits over a circular notch in the upper end of the tarsus. The notch is provided with a series of bristles that form the teeth of the ANTENNA COMB. The ANTENNAE, or 'feelers,' which are important sense organs of the head, are cleaned by being placed in the toothed notch and, after the velum is closed down, drawn between the bristles and the edge of the velum. On the anterior face of the first segment (metatarsus) of the tarsus is a series of bristles, or EYE BRUSH, which is used to remove pollen and other particles adhering to the hairs on the head about the large compound eyes and interfering with their operation.

The terminal segment of the tarsus of each leg is provided with a pair of notched CLAWS, a sticky pad (PULVILLUS), and a group of TACTILE HAIRS. When the bee is walking up a rough surface, the points of the claws catch and the pulvillus

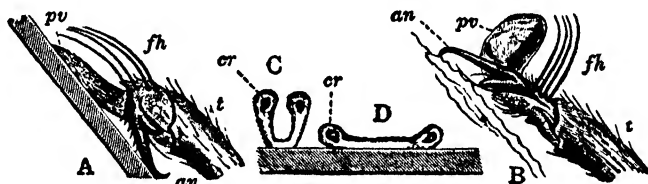

FIG. 364. Foot of the Honey Bee in the act of climbing, showing the 'automatic' action of the pulvillus. A, position of foot on a slippery surface; B, position of foot in climbing on a rough surface; C, section of a pulvillus just touching a flat surface; D, the same applied to the surface. *an*, claw; *cr*, curved rod; *fh*, tactile hairs; *pv*, pulvillus; *t*, last segment of tarsus. (From Packard, after Cheshire.)

does not touch, but when the surface is smooth, so that the claws do not grip, they are drawn beneath the foot. This change of position applies the pulvillus, and it clings to the smooth surface. Thus the character of the surface automatically determines whether claw or pulvillus shall be used. But there is another adaptation equally remarkable. "The pulvillus is carried folded in the middle, but opens out when applied to a surface; for it has at its upper part an elastic

and curved rod which straightens as the pulvillus is pressed down. The flattened-out pulvillus thus holds strongly while pulled along the surface by the weight of the bee, but comes up at once if lifted and rolled off from its opposite sides, just as we should pull a wet postage stamp from an envelope. The bee, then, is held securely till it attempts to lift the leg, when it is freed at once; and, by this exquisite yet simple plan, it can fix and release each foot at least twenty times per second." (Fig. 364.)

The characteristic structures of the middle (MESOTHORACIC) legs of the bee are a small POLLEN BRUSH and a long spine, or POLLEN SPUR.

The METATHORACIC LEGS exhibit four remarkable adaptations to the needs of the insect, known as the POLLEN COMBS, PECTEN, AURICLE, and POLLEN BASKET. The pollen combs comprise a series of rows of bristle-like hairs on the inner surface of the first segment of the tarsus; the pecten is a series of spines on the distal end of the tibia which is opposed by a concavity, the auricle, on the proximal end of the tarsal segment; while the pollen basket is formed by a depression on the outer surface of the tibia which is arched over by rows of long curved bristles arising from its edges.

Thus the worker is fully equipped. Flying from flower to flower, the bee brushes against the anthers laden with pollen, some of which adheres to the hairs on its body and legs. While still in the field, the pollen combs are first brought

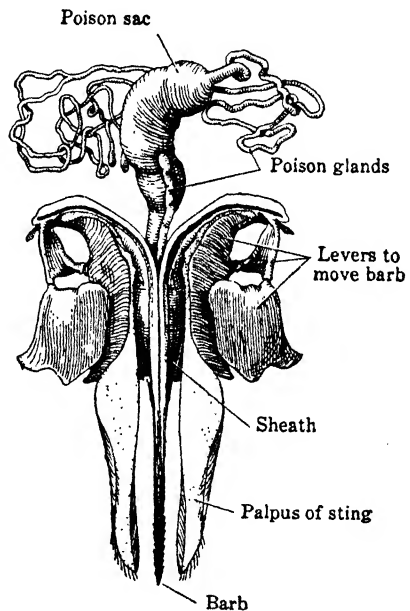

FIG. 365. Sting of a worker Honey Bee.

into play to comb the pollen from the hairs, while the pectens scrape the pollen from the combs. Then the auricles are manipulated so that the accumulating mass of pollen is pushed up into the bristle-covered pollen baskets. This process is repeated until the baskets are full and then the

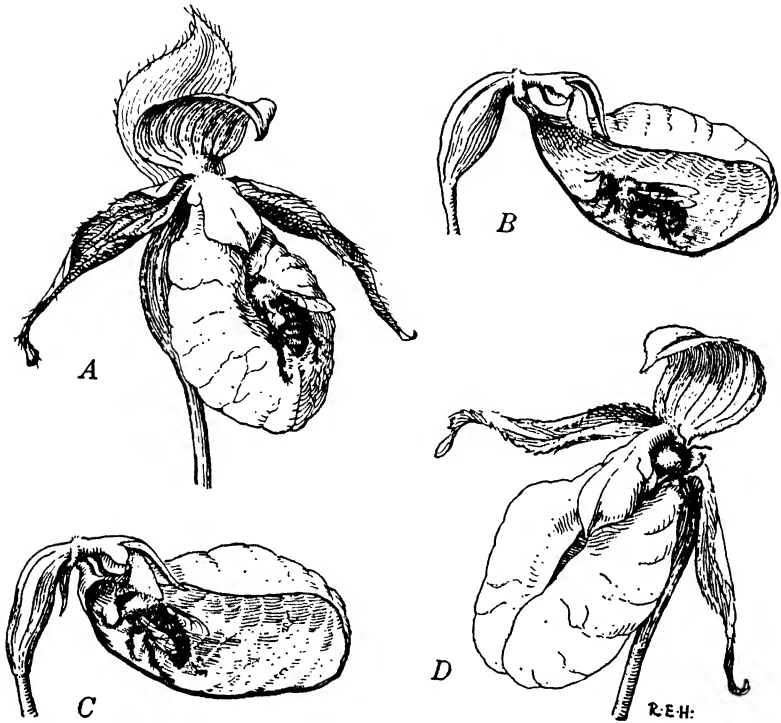

FIG. 366. Pollination of an Orchid, a Lady's Slipper (*Cypripedium*), by a Bumble Bee. *A*, Bee forcing its way into the flower; *B*, Bee obtaining nectar in the flower; *C*, Bee starting to escape brushes pollen upon the stigma of the flower; *D*, before finally escaping the Bee receives another load of pollen from the anther.

insect returns to the hive where the contents of the pollen baskets are removed by the aid of the spurs with which the mesothoracic legs are provided. (Figs. 365, 366.)

Moreover, the structural adaptations of the worker bee are but one aspect of a reciprocal fitness. Many of the flowers which the bee visits show remarkable adaptations for the reception of the bee and for dusting it with pollen, because

bees are effective agents in transferring pollen from flower to flower and thus ensuring cross-fertilization. And so the bee which has been given as our final example of adaptation to the physical environment, serves also as an introduction to the consideration of adaptation to the living environment. No better proof could be asked of the futility of attempting to classify the adaptations of organisms — the organism is a unit: a complex of adaptations to any and all of its surroundings, inanimate and animate, otherwise it could not exist.

## B. ADAPTATIONS TO THE LIVING ENVIRONMENT

We now turn more specifically to some striking interrelations of organism with organism, in order to make possible an appreciation of the devious means to which they have

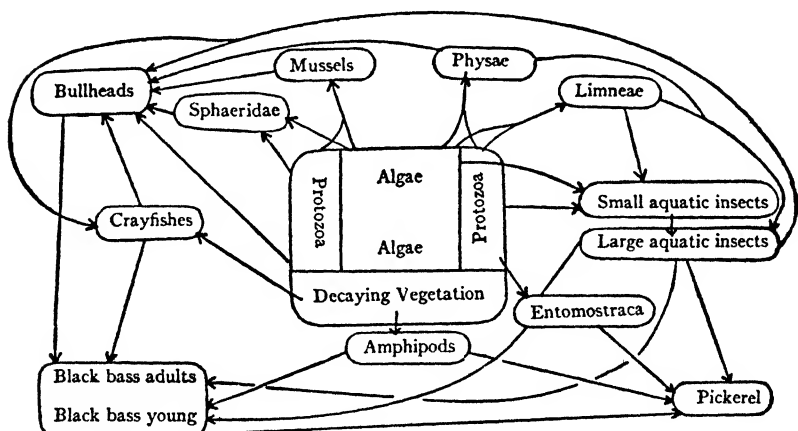

FIG. 367. Diagram of the web of life and the equilibrium of nature, as illustrated by the food relations in a pond community. Arrows point from the organisms eaten to those doing the eating. The task of ecology is to decipher the patterns of the web of life. (From Shelford.)

recourse — to what extent the strands of the web of life become entangled — in the competition for a livelihood.

The mutual biological interdependence of organisms is, in the final analysis, the result of the primary demands of all creatures — proper food, habitat, reproduction, defense



against enemies and the forces of nature. The web of life is an expression of the coöperation, jostling, and strife of individual with individual, and species with species for these primary needs; and the activities which follow from them form the foundations of life in the lowest as well as the highest. A little patch of meadow soil two feet square has revealed, within about an inch from the surface, over a thousand animals and three thousand plants. There is a struggle for existence. (Figs. 367, 368, 436.)

Take a single example. A common food fish, the Squeteague, captures the Butter-fish or the Squid, which in turn has fed on young fish, which in their turn have fed on small

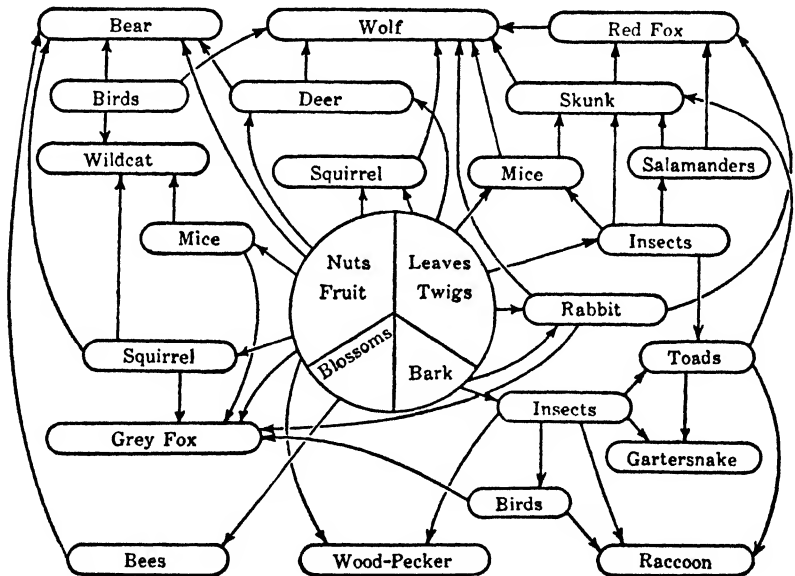

FIG. 368. Diagram to show equilibrium in food relations in a forest community. Arrows point from plant or animal eaten to animal which eats it. (From Shelford.)

Crustacea, which themselves have utilized microscopic Algae and Protozoa as food. Thus the food of the Squeteague is actually a complex of all these factors, and such a *nutritional chain* is no stronger than its single links. Circumstances that modify or suppress the food and thereby reduce the

abundance of the Algae and Protozoa of the sea are reflected in correlative changes in the abundance of economically important food fishes. And this same principle is true throughout living nature, though only occasionally is it possible to trace it. Nature is a vast assemblage of linkages.

### 1. *Plant Associations*

Easily recognizable associations of different species of plants occur as a result of adaptation to similar environ-

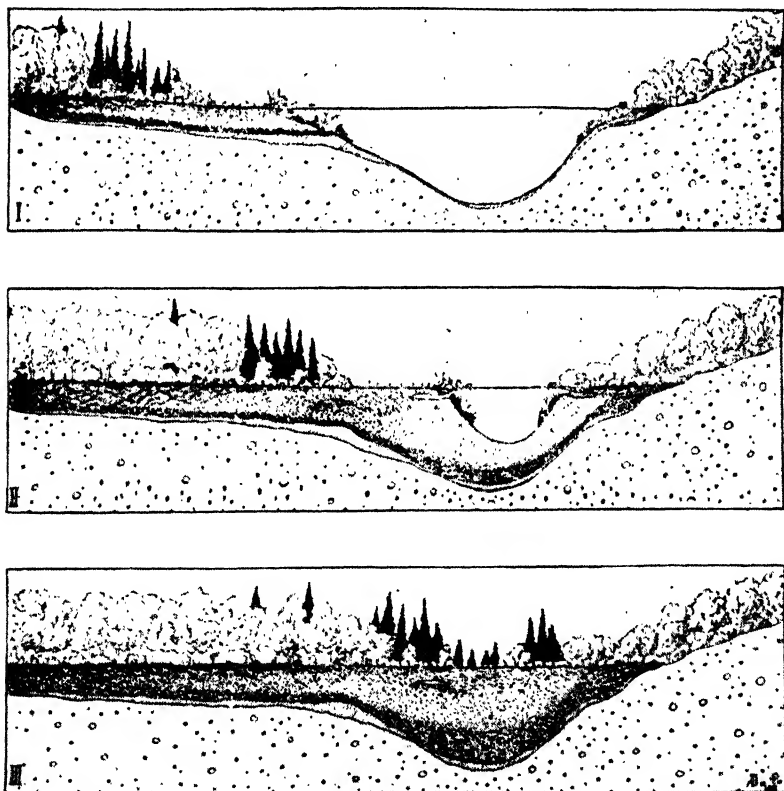

FIG. 369. Plant succession. Three stages in the filling of a lake with a deposit of peat which is finally covered by forest. Stages in the succession are aquatic plants, bog plants, shrubs, coniferous forest, and deciduous forest, the last being the climax vegetation. (From Geological Survey of Ohio, after Dachnowski.)

mental conditions, inorganic and organic, and so the plants become to some extent mutually dependent upon each other. Such a plant community of sea beach or swamp, woods or desert, and so on, may comprise plants that are very different in size, structure, and kind, though each includes certain species or groups of species that are characteristic and give them their names, such as Sedge-Cattail swamp association or Beech-Maple forest association. (Pp. 168-171.)

Although all plant communities appear static, most of them slowly but surely change. Thus they may extend their range until all the available suitable environment has been taken over; and in doing this their very presence brings about other changes — they may encroach upon the domains of other plant communities. All this and more results in a SUCCESSION of plants or plant communities as time goes on, until stability is reached by the appearance of species that are practically permanent for the particular region — the so-called CLIMAX association. Obviously the innumerable adaptations involved in such communities form an important aspect of plant ECOLOGY. (Fig. 369.)

## 2. Communal Associations

Perhaps the simplest associations of animals are represented by GREGARIOUS species, such as Wolves which hunt in packs, and Buffaloes and Horses which herd for protection. Here the association is more or less temporary and there is no division of labor between the members, other than leadership by one animal.

COMMUNAL animals, however, exhibit highly complex associations in which the members merge, as it were, their individuality in that of the community. This is well exhibited, for example, among the Ants, in which all of the various species, about 5000 in number, are communal, and the Wasps and Bees, in which all gradations exist from solitary to hive-dwelling species. In the case of the Bees, and still more in the Ants, the division of labor has developed to the extent

that structural differentiations have given rise to classes of individuals specially adapted for the performance of certain functions in the economy of the community.

But the differentiations of various members of a colony of Ants or Bees are limited to their bodies and are practically fixed and irreversible, while in human society, differentiations are no longer confined to the bodies of individuals. Man's ingenuity has devised what are to all intents and purposes artificial, accessory organs — tools and machines. Accordingly it is here that we find the highest expression of communal coöperation, because increased intelligence, in particular, makes flexible the stereotyped life as exhibited in the lower forms — the human individual is adaptable to the various community tasks. (Pp. 616, 624.)

### 3. Symbiosis

Associations of different species are by no means always an expression of coöperative adaptations. All gradations occur from those which are mutually beneficial to the parties in the pact, to those in which one member secures all the advantage at the expense of the other.

A simple type of association in which both members profit is represented by the relation that occurs between Ants and plant lice, or Aphids. The defenseless Aphids are protected, herded, and 'milked' by the Ants to supply their demand for honeydew, a secretion of the Aphids which they greedily devour. (Fig. 370.)

The most intimate associations in which the organisms involved are mutually benefited, if not absolutely necessary for each other's existence, are termed SYMBIOTIC. A familiar case is the common green Hydra (*Chlorohydra viridissima*) that owes its color to the presence of a large number of unicellular green plants which live in its endoderm cells. The products of the photosynthetic activity of the plant cells are at the disposal of the Hydra, and the latter in return affords a favorable abode and the material necessary for the life of

the plants. An essentially similar type of relationship exists between herbivorous animals, such as cattle, and certain Bacteria that dwell in the alimentary canal, digest the cellulose, and so make it available for the animals.



FIG. 370. Rose Aphids visited by Ants.

A more striking example of symbiosis is afforded by Lichens which represent intimate combinations of various species of colorless plants (Fungi) and simple green plants (Algae). In each case the Fungus supplies attachment, protection, and the raw materials of food, while the Alga performs photosynthesis. Each can live independently under favorable conditions, but in partnership they are superior to hardships with which many other plants cannot cope, and thus some Lichens become the vanguard of vegetation in repopulating rocky, devastated areas. (Fig. 371.)

From the practical standpoint of agriculture the symbiotic nitrogen-fixing Bacteria are of first importance. It will be recalled that these Bacteria form small nodules on the rootlets of higher plants and make atmospheric nitrogen available to the latter. Again, there are symbiotic relationships

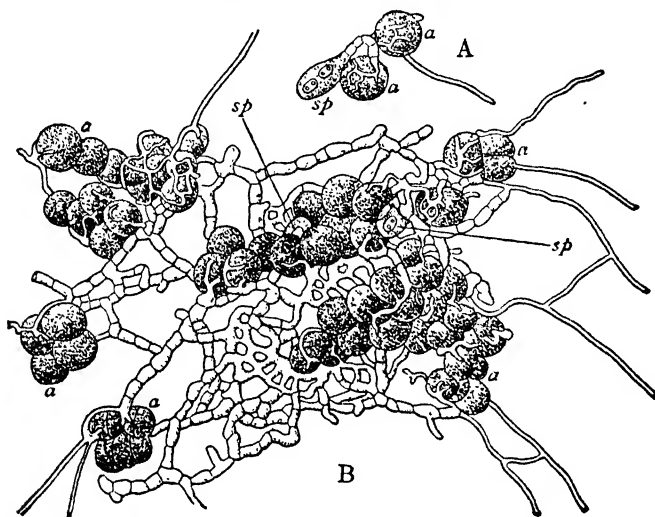

FIG. 371. The formation of a Lichen, *Physcia paratina*, by the combination of an Alga and a Fungus. A, germination of a Fungus spore (*sp*), whose filaments are surrounding two cells (*a*) of the unicellular Alga, *Cystococcus humicola*. B, later stage in which spores have formed a web of filaments (mycelium) enveloping many algal cells. Highly magnified. See Fig. 93. (From Bonnier.)

between the mycelial filaments of various species of Fungi and the roots of higher plants. The filaments, or MYCORRHIZA, surround the roots, enter the outer region of the root tissue, and apparently facilitate the intake of materials by the roots by acting essentially as accessory root hairs. Indeed, there is a wide range of similar symbiotic relations. For instance, certain seeds are unable to germinate without an association with a Fungus. Moreover, in some cases, the associations merge into parasitism. (Figs. 18, 19, 372.)

Finally, it is often difficult to distinguish between symbiosis and relationships such as exist when two species are so associated that one profits without the other either profit-

ing or suffering. An instance of such COMMENSALISM is shown by the tiny Crabs that share an Oyster's shell without apparently inconveniencing the Oyster, while partaking of superfluous food and enjoying protection.

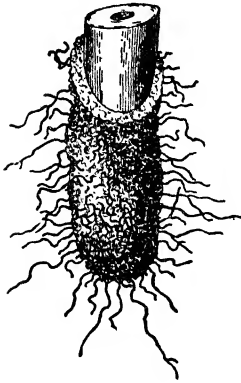

FIG. 372. Root tip of a Beech coated with mycelial filaments, or mycorrhiza. (After Pfeffer.)

#### 4. Parasitism

Associations in which one organism, the PARASITE, secures the sole advantage and at the expense of the helpless second party, the HOST, are most numerous—it has been estimated that more than half the animal kingdom are parasites. And these justly receive considerable notoriety because many human diseases are the result of man's unwilling part in such associations.

In fact, PARASITOLOGY has become an important subdivision of biology, both practical and theoretical. Practical, as a corner-stone of public health; and theoretical, because many of the most remarkable functional and structural adaptations are exhibited by parasites in becoming fitted for this apparently highly successful method of gaining a livelihood, and by the hosts in bearing the burden with the least outlay. Generally speaking, the effect on the parasite consists in a simplification of the various organs of the body devoted to food-getting, locomotion, etc., since their duties are performed by the host; while the organs and methods of reproduction are highly specialized and elaborated, owing to the necessity of producing enough offspring to compensate for the hazards involved in reaching a proper host. For in the majority of cases a parasite is adapted to live in a specific host, and death ensues if this is not attained at the proper time. (Figs. 146, 421.)

Probably the most generally interesting example of parasitism is the cause of the disease known as MALARIA. Man

is subject to at least three types of malaria, each the result of infection by a different malarial organism. The malarial parasites are all unicellular animals, Protozoa, with complicated life histories which are adaptations to the specific demands of their parasitic existence. One part of the life history, the asexual, is passed in the human red blood cells; while the other, the sexual, occurs in the digestive tract of certain species of Mosquitoes. A single parasite inoculated

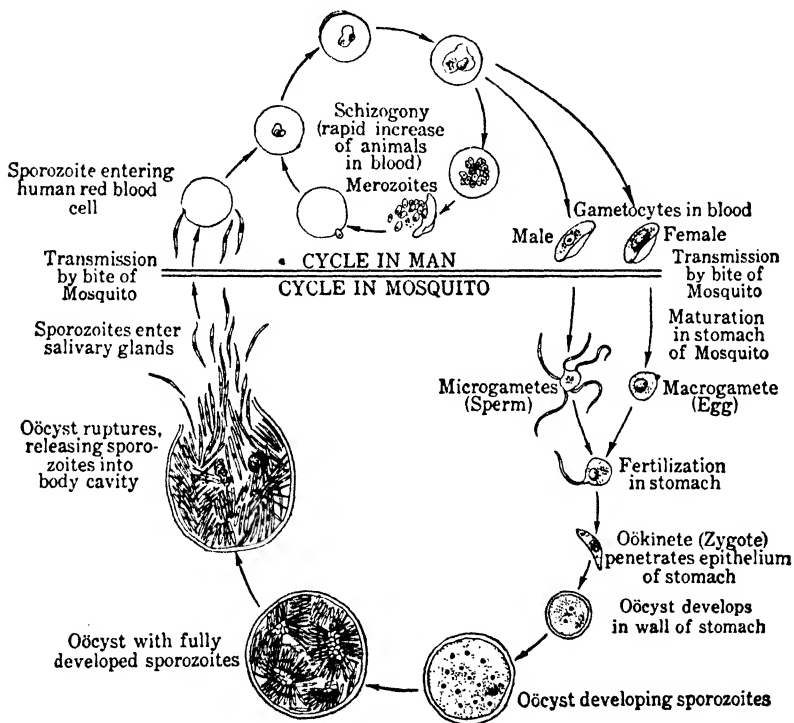

FIG. 373. Life history of a Malarial Parasite, *Plasmodium*.

into the human vascular system by the bite of an infected mosquito enters a red blood cell and multiplies. The progeny, liberated from the destroyed cell, similarly attack other cells and multiply, repeating the process until an immense number of blood cells are parasitized. And poisonous products of the life processes of the parasites provoke the chills



and fever characteristic of the disease when, say, a hundred million red blood cells are destroyed at one time. (Fig. 373.)

But the parasites must make their escape before the human host successfully combats the toxic substances, kills the parasites by taking quinine, or succumbs to them. Some trillions of malarial parasites perish when a human patient dies. The getaway is accomplished, if at all, by a mosquito biting the host and taking with the blood certain sexual stages of the parasite which can develop in the cold-blooded insect. Certainly not more than one out of untold millions of mosquitoes finds an infected person. But this hazard overcome, the Mosquito is the host. In its stomach the sexual phase of the life history of the malarial parasite takes place, fertilization occurs, and finally the numerous products of the zygote work their way to the mouth parts of the insect where they await an opportunity to enter the human blood.

The life history of malarial parasites exhibits a continuous series of adaptations to parasitic life: the nicety of the adjustment being especially well illustrated at the transfer from man to mosquito, since all the parasites which enter the stomach of the latter are digested except those sexual forms which are ready to initiate the sexual part of the cycle in the new host. (Pp. 631-633.)

But the acme of parasitic associations is attained only when the adaptations of parasite and host have become so complete that the latter 'pays the price' without ill effects. Serious disturbance or death of the host is disadvantageous to the parasite, so during the course of evolution those parasites which "do not trifle with their luck, but live in harmony with their host succeed in the struggle for existence, and those which bite the hand that feeds them are doomed to destruction." Thus the Antelopes and similar Mammals of certain regions of Africa harbor in their blood various species of Protozoan parasites, known as **TRYPANOSOMES**, without any apparent discomfort. But if the intermediate hosts, which are biting Flies, transfer certain species of Trypano-

somes to the blood of imported Horses or Cattle, or of Man, serious diseases result which are usually fatal. Indeed, the opening up of large regions of Africa has been greatly retarded by the ravages of Trypanosomes in new hosts to which they are not adapted. Generally speaking, pathogenic

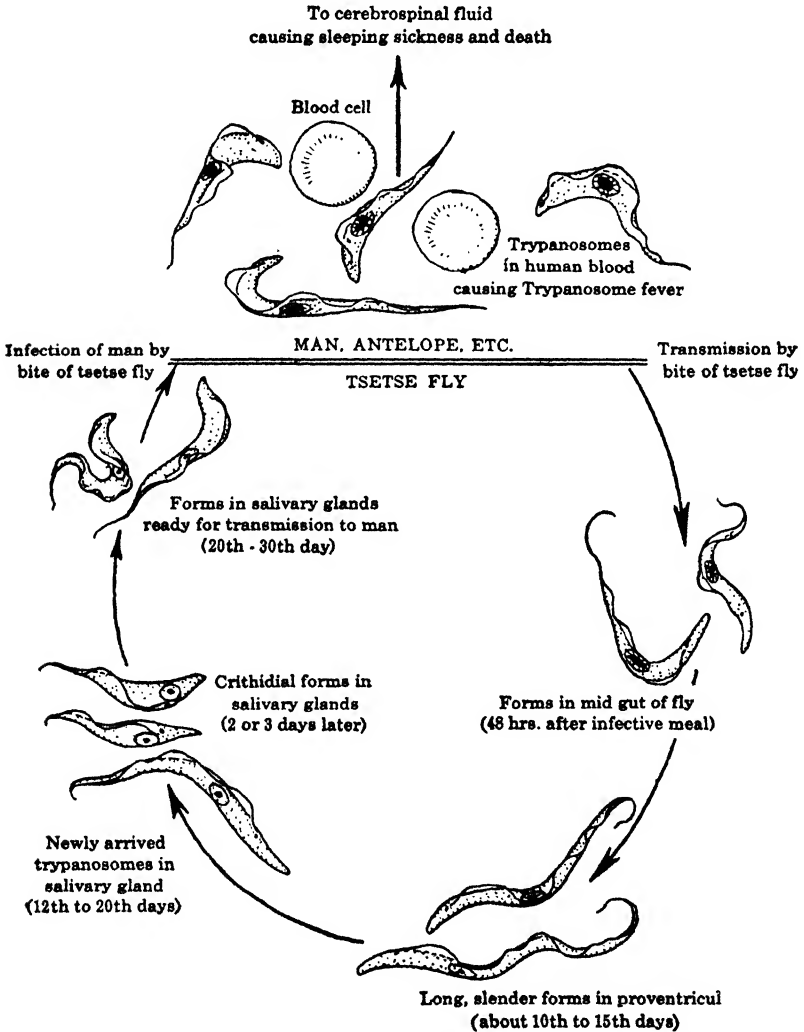

FIG. 374. Life history of the Trypanosome, *Trypanosoma gambiense*, that produces African sleeping sickness in Man. Magnified about 1500 times. (Modified, after Chandler.)

species may be regarded as aberrant forms which are not yet adapted to their hosts or are not in their normal hosts. And these are the parasites which are especially forced upon our attention, though there are no organisms without their specially adapted parasites — the parasites themselves not excepted. Thus a Frog may harbor in its rectum a ciliated Protozoön, *Opalina*, whose cytoplasm is infested by an *Endamoeba* which, in turn, is invaded by the spores of a lower plant. Verily, “big Fleas have little Fleas” — technically called **HYPERPARASITISM**. (Figs. 374, 414 ; Pp. 634–643.)

### 5. Immunity

At best the part played by the host cannot be regarded as ideal, and devious types of adaptations against parasites exist which, in so far as they are effective, bring about **IMMUNITY**. Usually among the higher animals, including Man, immunity to the ravages of pathogenic microorganisms seems to depend chiefly upon the activities of the white blood cells and upon specific chemical substances in the blood, termed **ANTIBODIES**.

The white blood cells have been called the policemen of the body because, under the influence of invading organisms, some of them make their way through the walls of the capillaries in the region of the infection and, in amoeboid fashion, engulf and digest the intruders. When acting in this capacity they are referred to as **PHAGOCYTES**. Cells specialized for phagocytosis are also found as integral elements of various parts of the body, such as lymph nodes, spleen, and bone marrow. They are strategically located to remove bacteria and other harmful invaders.

The antibodies may be classified, in general, according to their method of action. Thus the **ANTITOXINS** neutralize the poisonous products (toxins) of certain bacteria; the **PRECIPITINS** precipitate foreign proteins of bacterial or other origin, at least *in vitro*; the **AGGLUTININS** clump bacteria; the **LYSINS** actually destroy foreign cells; and the **OPSONINS** in some way render bacteria vulnerable to phagocytic action.

The antibodies are produced in response to ANTIGENS, usually specific proteins, from the parasites themselves. Thus the individual may acquire immunity by undergoing the disease, either in its usual form, or in a mild form by the artificial inoculation of a weakened strain of virus, dead bacteria, or their toxins, as in VACCINATION. In any case a defense mechanism is established in the body so that it is prepared to produce the specific antibodies in the event of a later infection. In certain cases, such as tetanus, temporary immunity may be afforded by the inoculation of the antibodies themselves, instead of the antigens.

Indeed, the subject of immunity has become a science in itself (IMMUNOLOGY) within the past few years — a science which has as its fundamental basis the investigation of the marvelous power of adaptation of protoplasm as exemplified in coping with disease-producing parasites, and even with those ultramicroscopic agents of disease, the so-called FILTERABLE VIRUSES, such as produce yellow fever, small-pox, measles, and rabies. It will be recalled that the viruses are so small that they pass through porcelain filters and, in one case at least, consist of a single protein molecule. But they have the power to multiply when in the protoplasm of host cells and so exhibit one fundamental characteristic of life. Their further study is certain to be of immense practical and theoretical importance. (Fig. 418; Pp. 394-396.)

### C. INDIVIDUAL ADAPTABILITY

We may now turn to a survey of the highest expression of adaptation evolved by Nature, which appears as TROPISMS and other elements of BEHAVIOR in the lower organisms, gains definiteness and content as we ascend the animal series, and becomes the basis of INTELLIGENCE and all that the human mental life involves. It is the adaptation which renders Man essentially superior to adaptation — enables him to a large extent to control, instead of being controlled by his environment. "It seems that Nature, after elaborating mechanisms to meet particular vicissitudes, has lumped

all other vicissitudes into one and made a means of meeting them all" — the nervous mechanism.

That organisms respond to environmental changes, we are well aware. Life itself is the result of — in fact, is — a continuous flow of physico-chemical actions, interactions, and reactions with the surroundings. "That which above all else characterizes organisms is organization and the regulations and correlations, both internal and external, which condition their wholeness and their capacity to survive in the struggle for existence through appropriate behavior." By behavior we refer specifically to the reactions of the organism as a unit, rather than to the internal processes in the economy of its life. And surveyed from a broad viewpoint, there is discernible in the behavior of animals, just as in

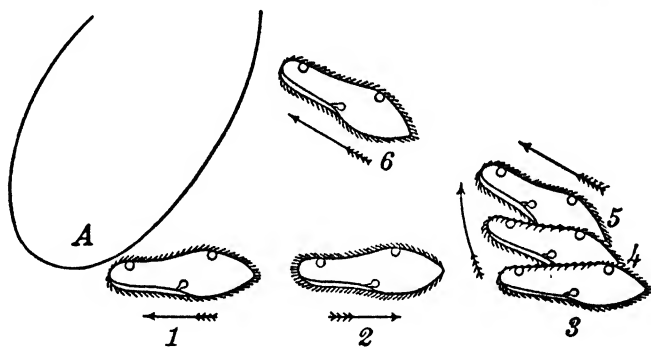

FIG. 375. Diagram to show the avoiding reaction of *Paramecium*. *A*, a solid object or other source of stimulation. 1-6, successive positions taken by the animal. The rotation on its long axis is not indicated. (From Jennings.)

their structure in general and in their nervous system in particular, from the lowest to the highest, a great though gradual increase in complexity. The behavior of *Amoeba* and *Paramecium* is an expression of the primary attributes of protoplasm — irritability, conductivity, and contractility. So is the behavior of *Hydra* and *Earthworm* in which special cells constitute a definite coördinating, or nervous system. And so is the complex behavior of the higher animals, including *Man*, with their elaborate series of sense organs and highly developed sensorium, or brain.

“Let us now try to form a picture of the behavior of Paramecium in its daily life under natural conditions. An individual is swimming freely in a pool, parallel with the surface and some distance below it. No other stimulus acting, it begins to respond to the changes in distribution of its internal contents due to the fact that it is not in line with gravity. It tries various new positions until its anterior end is directed upward, and continues in that direction. It thus reaches the surface film. To this it responds by the avoiding reaction (Figs. 21, 375), finding a new position and swimming along near the surface of the water. . . . Swimming forward here, it approaches a region where the sun has been shining strongly into the pool, heating the water. The Paramecium receives some of this heated water in the current passing from the anterior end down the oral groove. (Fig. 376.) Thereupon it pauses, swings its anterior end about in a circle, and finding that the water coming from one of the directions thus tried is not heated, it proceeds forward in that direction. This course leads it perhaps into the region of a fresh plant stem which has lately been crushed and has fallen into the water. The plant juice, oozing out, alters markedly the chemical constitution of the water. The Paramecium soon receives some of this altered water in its ciliary current. Again it pauses, or if the chemical is strong, swims backward a distance. Then it again swings the

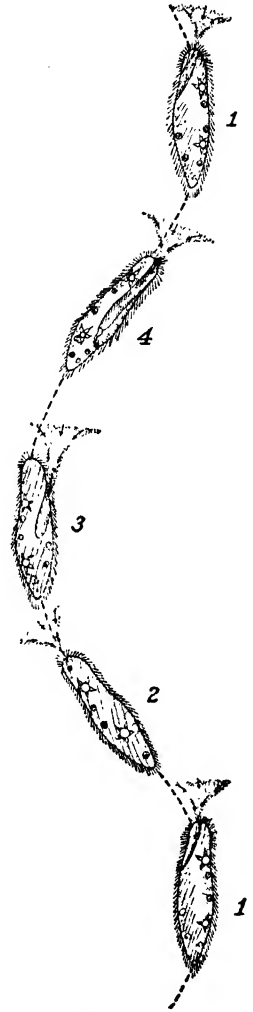

FIG. 376. Diagram to show the rotation on the long axis, and the spiral path of Paramecium. 1-4, successive positions assumed. The dotted areas with small arrows represent the currents of water drawn from in front. (From Jennings.)

anterior end around in a circle till it finds a direction from which it receives no more of this chemical; in this direction it swims forward. . . .

“In this way the daily life of the animal continues. It constantly feels its way about, trying in a systematic way all sorts of conditions, and retiring from those that are harmful. Its behavior is in principle much like that of a blind and deaf person, or one that feels his way about in the dark. It is a continual process of proving all things and holding to that which is good.” (Jennings.)

The behavior of *Paramecium* leaves one with the impression that the animal is largely at the mercy of its surroundings — that the environment rather than the organism itself is the dominant factor, and this is true to a considerable degree. But *Paramecium* is not merely an automaton. Its behavior is modifiable and, in the long run, is adapted to the usual changes of its surroundings. It forms immense aggregations where food and other conditions are favorable. That the reactions are adequate for the simple life and methods of reproduction of *Paramecium* is attested by its success — it is one of the most common and widely distributed animals.

In such simple MOTOR RESPONSES and TROPISMS, which result from DIFFERENTIAL SENSITIVITY or the power of responding differently to different stimuli, must be sought the largely automatic responses of animals such as REFLEXES, INSTINCTS or chains of reflexes, and ORGANIC MEMORY or the retention of the effects of previous stimuli. All apparently are chiefly the result of inherited nervous structure and therefore may be regarded as inherited behavior. And increase in the complexity of life processes has involved at the same time an increase in the number and complexity of reflexes and instincts. The primitive reflexes and instincts lead *Hydra* to seize small organisms within reach of its tentacles and pass them to its mouth, the Earthworm to swallow decaying leaves as it burrows through the soil, the Crayfish to grasp its prey with its large claws, tear it into

pieces by means of certain appendages about the mouth which are adapted just for the purpose — and so on to the higher Vertebrates where the feeding instincts reach their maximum of complexity. The remarkable behavior of Ants and Bees is essentially a complex of instincts. Moreover, instincts of fear, self-defense, play, care of the young, etc., render a considerable part of the behavior of even the higher organisms more automatic than is perhaps, at first thought, apparent. (Figs. 266, 271.)

But just as the behavior of *Paramecium* and its allies is modifiable, so reflexes and instincts which seem the most fixed show at least a slight degree of adaptability to unusual conditions. Indeed new reflexes, known as **CONDITIONED** reflexes, may be established as the result of experience during the life of the individual. And it is this ever-present power of modifiability, which is in man called 'choice,' that leavens the whole and becomes the dominant factor in the behavior of the highest animals; while reflex action and instinct are relegated to a subsidiary though by no means unimportant rôle. A large part of human education consists in establishing other fixed adaptive responses called **HABITS** which join the earlier reflexes and instincts in relieving the conscious life of innumerable simple factors of behavior, and leave it more or less free for the higher intellectual processes. The cerebrum, regarded as the organ of the **MIND**, is superimposed upon the system of automatic, machine-like responses of the reflex centers. It is the executive that reacts to the state of affairs as a whole and coördinates or alters responses when the routine responses are inadequate. The progress of modifiability toward conscious choice-responses to external conditions constitutes a gradual and ill-defined transition from instincts to **ASSOCIATIVE MEMORY**, or newly conditioned responses, to learning and the highest intellectual processes. (Pp. 466, 467.)

Although it is necessary to emphasize that mind and intelligence, in the biological sense, are expressions for that integration of nervous states and actions which makes pos-



sible a nicety of adaptation of behavior to environmental conditions that otherwise would be impossible — that it is the chief means of adaptation; it is a serious mistake to minimize the importance of the vast gulf between human nature and that of the most highly developed lower animals. In no respect are these differences more marked than in the various forms of learning which collectively form the means of education. While associative memory, or conditioning, will account for the various non-instinctive actions of man's animal associates, human racial history and the individual's experience contain much which baffles explanation in such terms. Indeed, in the highest reaches of conscious life we appreciate that it is able to form strange conceptions; that it has not only memory of the past, but also anticipation of the future. We can brood and meditate and understand in part. We are guided by the past, present, and future in making adaptations. "The largest fact in the story of evolution is the growing dominance of the mental aspect of life." (Pp. 616, 624-626.)

Thus it is clear that, with all the variations in structure and function, organisms all possess irritability in common: they all exhibit adaptive responses which enable them to exist in spite of surrounding changes. "Adaptability appears to be the touchstone with which Nature has tested each kind of organism evolved; it has been the yard-stick with which she has measured each animal type; it has been the counter-weight against which she has balanced each of her productions. However well adapted to a specific environment a type might be, did it lack ever so little of its possibilities in this direction it was sooner or later relegated to the scrap heap. Some forms, to be sure, persisted in special environments where they were protected from competition, or where the conditions were fairly constant, but the general course of evolution has been always in the direction of increasing adaptability or increasing perfection of irritability." And now at the summit is Man consciously trying to carry on

what Nature has been unconsciously attempting these millions of years — trying to secure mastery of his environment. The individual's heritage is, in fact, the cumulative result of the adaptations of the race — including adaptability.

## CHAPTER XXVI

# ORIGIN OF SPECIES

The process of evolution has its outcome in personalities who have discerned its magnificent sweep. — *Thomson.*

**F**rom the time of the Greek natural philosophers there always have been men who have sought a naturalistic explanation of the origin of the diverse forms of animals and plants, and who have suggested that the present ones arose from earlier forms by a long process of descent with change, or **EVOLUTION**. But with the revival of natural history studies after the Middle Ages, the prevailing ideas in regard to creation led the majority, perhaps almost unconsciously, to assume that there is merely a limited number of kinds of organisms, all of which were established at one time. And this is not so strange as might at first glance appear, when one considers that nearly all of the important facts which we have reviewed in the preceding pages were yet to be discovered, and that the number of known kinds of animals totalled but a thousand or so instead of about a million as today.

The pioneer work of the early Renaissance naturalists consisted principally of collecting and describing animals and plants. This involved making a catalog of the different kinds — classifying them in some way — and consequently some basis of **CLASSIFICATION** was sought. This attention was more definitely focussed on the kinds, or **SPECIES**, and for practical, if for no other reasons, the species assumed a prominence which overshadowed the individuals which composed it. (Pp. 128, 129, 202.)

Indeed, today biologists are hard put to it to define a species. Of course everyone recognizes not only that there

are many kinds of animals and plants, but also that many individuals are essentially the same. Groups may be formed of individuals which differ less among themselves in the sum of their characters than they do from the members of any other group of individuals. And further, the members of a group produce other individuals which are essentially similar. It is such a group of individuals that is regarded by the biologist as a species. But it is difficult to formulate a satisfactory brief definition of a species, unless perhaps it be "a group of individuals that do not differ from one another in excess of the limits of 'individual diversity,' actual or assumed." So with but slight exaggeration it may be said that a species is largely a concept of the human mind: it is a time concept — "a cross-section at a given moment through a gradually changing and genetically connected series of life forms." The real unit in nature is the individual animal or plant, and an understanding of the differences between individuals should give us the key to the differences between species. In the final analysis, the problem of the origin of species is a problem in genetics. (Figs. 389, 391.)

This seemingly obvious point of view has but relatively recently been clearly grasped by biologists, and the species rather than the individual has loomed large in the discussions of how plants and animals came to be what they are today. As a matter of fact, during the eighteenth century the greatest student of plant and animal classification, Linnaeus, emphasized the idea that each species represents a distinct thought of the Creator, and that the object of classification is to arrange species in the order of the Creator's consecutive thoughts. This viewpoint is somewhat whimsically expressed by the old naturalist who found a beetle which did not seem to agree exactly with any species in his collection and solved the difficulty by crushing the unorthodox individual under his foot. His credulity surely would have been strained by the estimate of a modern entomologist that if all the species of insects were known they would total some three million. (Fig. 451.)

We may consider, then, that the consensus of opinion up to the middle of the last century was overwhelmingly on the side of SPECIAL CREATION and FIXITY OF SPECIES, and therefore against the idea occasionally advanced by men, as it now appears, ahead of their times, that DESCENT WITH CHANGE is the true explanation of the origin of the diverse forms of plants and animals. But, as nearly everyone knows, a complete reversal of opinion has occurred since 1859 — today professional scientists and most educated laymen accept ORGANIC EVOLUTION; accept the view that all living things are one by birth and the system of living nature is historically a unit, a consistent whole and not a collection of isolated and independent species. And we have accepted it in the preceding sections of this work; but if this appears to have been prejudging the question, the explanation is that the genetic connection of organisms is the guiding principle of all modern biology. The mere fact that an unbiased presentation of the data seems to prejudice the question is the most cogent presumptive evidence for evolution. It is true that there are differences of opinion among biologists in regard to the *factors* which have brought about the evolutionary change — but there are none in regard to the *fact* of evolution itself. It will be convenient, therefore, first to summarize a few of the *evidences* of evolution, and then to present certain modern views in regard to the *methods* of evolution. (Pp. 701–707.)

### A. EVIDENCES OF ORGANIC EVOLUTION

To one who has thoughtfully followed the preceding pages there must immediately occur many facts which are readily and reasonably interpreted from the point of view of descent of one species from another, but which are entirely obscure from that of the special creation of species. For instance, one will recall the cellular structure of all organisms; the method of origin and the fate of the germ layers in animals; the interrelationship of the urinary and reproductive systems in the Vertebrates; the comparative anatomy of the

vascular and skeletal systems of Vertebrates; the similarity of the physical basis of inheritance in animals and plants; the gradual reduction of the gametophyte generation in the life history of the higher plants: in brief — the ‘unity in diversity’ that pervades the world of living things. (Figs. 237, 239, 254, 268, 377.)

In general, such are the types of data which support the evolution theory. Although the evidence, from the nature of the case, must be indirect, it is none the less impressive, chiefly because the facts for evolution are from such diverse sources and all converge toward the same conclusion. The theory of evolution reaches the highest degree of probability, since in every branch of botany and zoölogy all the data are most simply and reasonably explained on the basis of descent with change. It is a cardinal principle of science to accept the simplest conception which will embrace all the facts.

Assuming the reader’s familiarity with the contents of this volume up to the present point, it is now necessary to summarize some of the most important evidence from various subdivisions of biology. But, as will soon appear, it is impossible to arrange the facts in natural groups because the evidence from one merges into that from another — the evidence interlocks.

## 1. Classification

When the serious study of biological classification was well under way, biologists found increasing evidence of the similarity, or affinity, of various species of animals and plants. Not only is it possible to arrange organisms in essentially ascending series of increasingly complex forms, but also in many cases it is difficult or impossible to decide just where one species ends and the next begins. That is, the most divergent individuals within a given species frequently approach those of a closely similar species. There are *intergrades*. (Fig. 389.)

Furthermore it is found that species themselves can be naturally arranged in more comprehensive groups to which the name GENUS is applied. For example, the common Gray Squirrel represents the species *carolinensis*, and the Red Squirrel, the species *hudsonicus*. Both are obviously Squirrels, and therefore both species are grouped under the genus *Sciurus*. Accordingly, each animal is given a name composed of two words: the first, generic and the second, specific. The Gray Squirrel is *Sciurus carolinensis* and the Red Squirrel is *Sciurus hudsonicus*. Thus to give a scientific name to an animal or plant is really to classify it, because the first word of the name indicates that it possesses some fundamental characteristics in common with the other species of the genus — in fact, is more like them than it is like any other group of organisms.

But again, the members of the genus *Sciurus* have many characteristics in common with other animals which obviously are not true squirrels. The Chipmunks, or Ground Squirrels, for instance, differ not only in certain obvious features, but in the possession of internal cheek pouches, etc. This dissimilarity and similarity is expressed by placing them in a different genus, *Tamias*, but in the same FAMILY, *Sciuridae*. The familiar eastern Chipmunk is *Tamias striatus*.

Moreover, while the Beaver (*Castor canadensis*) differs still more from the Squirrels than do the Chipmunks, and therefore is placed in a distinct family, the *Castoridae*, it nevertheless agrees with both in many fundamental ways so that it is placed in the ORDER *Rodentia*, which also includes the Squirrels and Chipmunks, as well as many other families and genera. Other orders, such as the *Ungulata* (Horses, Cattle, etc.), the *Carnivora* (Cats, Dogs, Bears, etc.), and the *Primates* (Monkeys, Apes, Man), while they differ widely from the Rodents, still agree with them in possessing hair, and milk glands for suckling the young. This basic likeness is expressed by including all under the CLASS *Mammalia*.

The Mammals in turn are readily distinguished from Birds, Reptiles, Amphibians, and Fishes (each of which forms a

separate class), but nevertheless are constructed on the same basic plan, comprising a dorsal central nervous system surrounded by skeletal elements forming the skull and vertebral column. Therefore, all are comprehended in the larger group *Vertebrata* which, with certain minor groups, comprises the PHYLUM *Chordata* and stands in contrast with all the Invertebrate phyla which include Hydra, Earth-worm, Crayfish, etc. The classification of the Gray Squirrel, *Sciurus carolinensis* (Fig. 227), may be outlined as follows:

KINGDOM — Animalia  
SUBKINGDOM — Metazoa  
PHYLUM — Chordata  
SUBPHYLUM — Vertebrata  
CLASS — Mammalia  
ORDER — Rodentia  
FAMILY — Sciuridae  
GENUS — *Sciurus*  
SPECIES — *carolinensis*.

This classification of the Gray Squirrel, although it incidentally serves to illustrate the general method of classification of all organisms, is important because it places concretely before us the fact that organisms show such fundamental similarities with obvious dissimilarities. In short, the mere fact that animals and plants naturally arrange themselves, as it were, in classes, orders, families, genera, species, etc., raises the question of the origin of species. Is special creation implying fixity of species, or is descent with change the more plausible explanation? (Pp. 682-685.)

The unavoidable answer is descent with change — evolution — because the principle in accordance with which the groups of increasing comprehensiveness are formed is solely the greater or less similarity in the structural features of the organisms. It is much more reasonable to assume that the thread of fundamental similarity which runs, for instance, through all the Vertebrates is the result of inheritance, while the differences of orders, families, genera, etc., are due to



changes brought about under different unknown conditions, than it is to assume that each is the result of a special creative act. Especially so when we realize that in a very large number of cases it is difficult or impossible to decide the limits of a species, owing to variations among the individuals comprising it, and it is necessary to resort to SUBSPECIES and VARIETIES in classification. Again, among genera, intergrading forms demand SUBGENERA; among orders, SUBORDERS; among classes, SUBCLASSES; and so on. If we admit the origin by descent with change of the subspecies and varieties, there is no logical reason for denying the same origin of species, orders, and higher groups. The difference is one of degree and not of kind. Before the recognition of evolution, classification was a groping after an elusive ideal arrangement which naturalists felt but were unable to express except in artificial form and in transcendental terms. Under the influence of the evolution theory, classification became the natural expression of biological pedigrees. (Figs. 183, 389, 391; Pp. 172, 280, 281.)

## 2. *Comparative Anatomy*

The evidence from classification is, as has just been seen, really evidence from comparative anatomy, since modern classifications are based chiefly on anatomical characters. The various groups — classes, orders, families, genera, species, etc. — are founded not on a single difference, nor on several differences, but chiefly on a large number of similarities. For instance, the differences exhibited throughout the five classes of the Vertebrates are relatively slight in comparison with the basic resemblances. This similarity in dissimilarity is brought out by the science of comparative anatomy. A few concrete examples, some of which we are already familiar with, will serve to bring the main facts clearly before us. (Pp. 685–687.)

The fore legs of Frogs and Lizards, the wings of Birds, the fore legs of the Horse, and the arms of Man are built on the

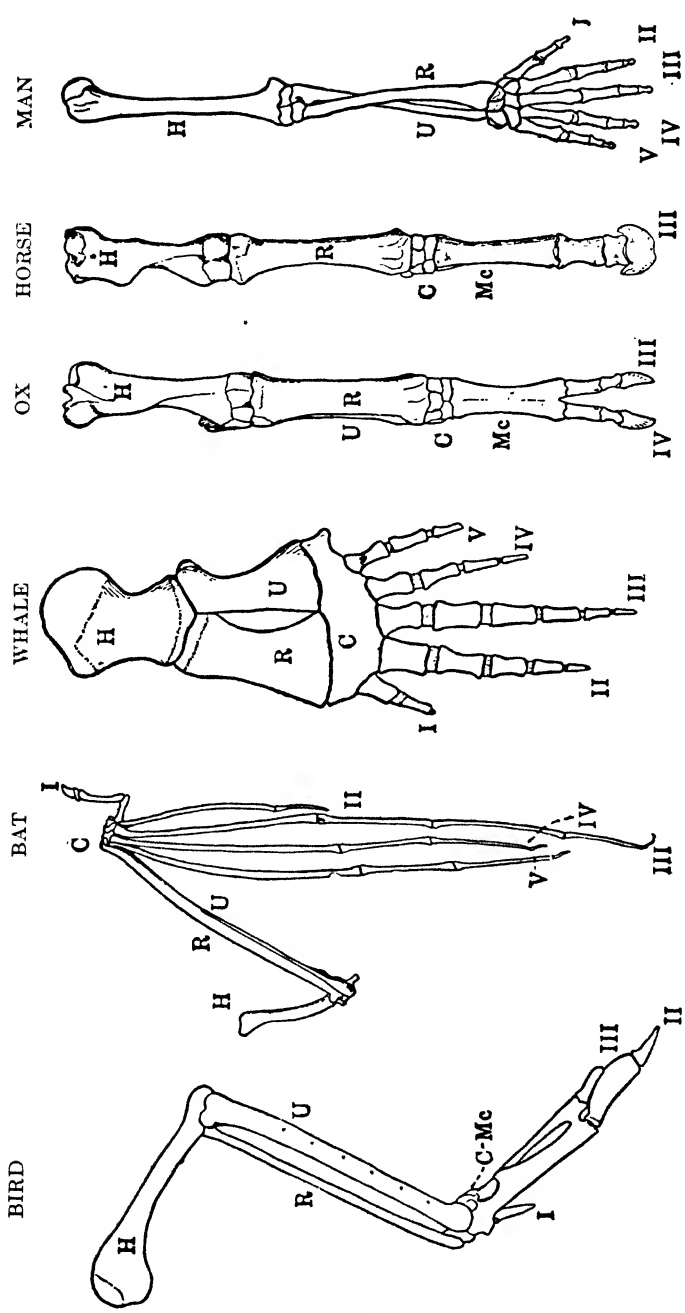

FIG. 377. Vertebrate fore limbs to show homologous skeletal structures. Bird, left wing; Bat, right wing; Whale, left flipper; Ox; right fore leg; Horse, right fore leg; Man, right arm. C, carpals; H, humerus; Mc, metacarpals; R, radius; U, ulna; I-V, digits. (After Scott.)

same basic plan. The same is true of the hind limbs. Clearly all are HOMOLOGOUS structures, such variations as exist being brought about chiefly by the transformation or absence of one part or another. In short, all the chief parts of both the fore limbs and the hind limbs are homologous

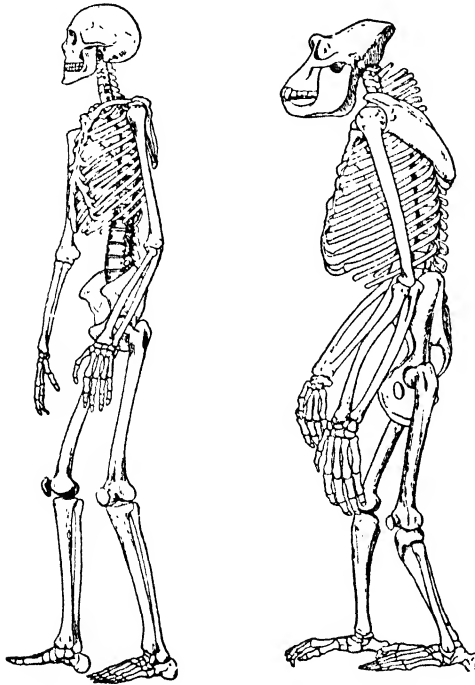

FIG. 378. Skeletons of Man and Gorilla.  
(From Lull.)

throughout the series.

All are composed of the same fundamental materials disposed in practically the same way — nearly all the bones, muscles, blood vessels, and nerves are homologous. Or compare the digestive systems of the same forms, or the excretory and reproductive systems. One has but to recall that, on an earlier page, it was possible to describe in general terms these systems as they exist throughout the vertebrate series — in forms as obviously different as a fish and a man. They are all

fundamentally the same. (Figs. 221, 237, 254, 268, 377, 378, 401.)

Turning to the Invertebrates, we may remind the reader that all the appendages of the Crayfish are built on the same simple plan as exhibited in the swimming legs (swimmerets) of the abdomen. The highly specialized walking legs, great claws, jaws, and feelers (antennae and antennules) are all reducible to modifications of the simple swimmeret type. In short, all are homologous structures, though differing

widely in function. This is a most striking example of SERIAL HOMOLOGY, though we have seen the same principle exhibited in the Vertebrates where the fore limbs and the hind limbs of each animal are homologous. Moreover, the appendages of the Crayfish are not only serially homologous among themselves, but are also homologous with the appendages of all the other members of the class Crustacea — just as the limbs of one Vertebrate are homologous with those of all other Vertebrates. (Figs. 136, 137, 377.)

Another class of facts presented by comparative anatomy is derived from VESTIGIAL organs. In the human body there are nearly a hundred structures which apparently are useless and sometimes are harmful. One thinks at once of the VERMIFORM APPENDIX of the large intestine, apparently

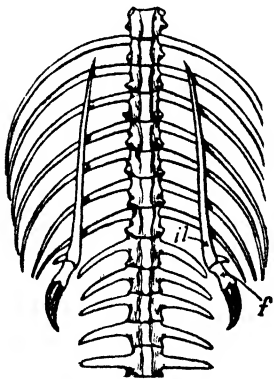

FIG. 380. Vestigial hind limbs of a Snake, *Python*. *f*, femur; *il*, ilium. (From Romanes.)

a remnant of part of the caecum that serves a useful purpose in certain herbivorous Mammals. But equally suggestive are the muscles of the ear, which in some individuals are sufficiently developed to move the external ear; or the so-called third eyelid at the inner angle of the eye which corresponds to the lid (NICITATING MEMBRANE) that moves laterally across the eye of Reptiles and Birds; or the terminal vertebrae (COCCYX) of the human spinal column. Other animals likewise possess many such structures. Porpoises have vestiges of hind limbs enclosed within the body, and certain species of Snakes bear tiny useless hind legs. The splint bones of the Horse are remnants of lost toes. (Figs. 228, 350, 379, 380.)

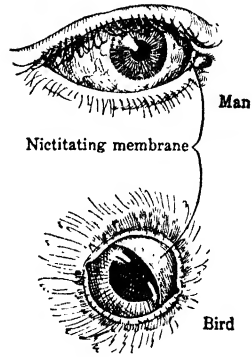

FIG. 379. The nictitating membrane, or third eyelid.

In another class of cases, the organs or remnants of organs of a lower form are altered or completely made over, as it were, into new organs of the higher form. The milk glands of Mammals are transformed sweat glands of the skin, while the poison glands of Snakes are specialized salivary glands. During the embryonic life of Vertebrates there are gill slits, all of which vanish in higher forms except one

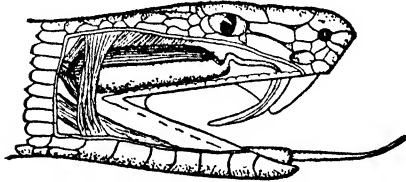

FIG. 381. Head of a Rattlesnake, with the skin and part of the muscles removed. The long oval mass in the upper jaw, which is connected by a duct with the curved tooth, or fang, is the poison gland. (From Smallwood.)

pair which remains as passages (EUSTACHIAN TUBES) connecting each middle ear with the pharynx. Gill arches, which function as supports for the gills in the aquatic Vertebrates, persist in highly modified form as skeletal structures associated with the jaws and tongue and entrance to the

lungs (LARYNX) in terrestrial forms. Finally, in this connection the reader will recall the transformations of the blood vessels in the Vertebrates which occur with the substitution of lungs for gills, and also the variations and interrelationships of the excretory and reproductive systems in the ascending series of vertebrate classes. (Figs. 237, 239, 254, 381, 388.)

One may, of course, conclude from all these facts that the various species of Vertebrates have each been independently created according to the same preconceived plan — and likewise all the great numbers of orders, families, genera, species, etc., of each of the five classes that these forms represent. Or one may conclude that all have arisen by descent with change from a primitive vertebrate organism which possessed the fundamental similarities exhibited in the series. The latter is the conclusion accepted by biologists today.

### 3. Paleontology

Huxley once said that if zoölogists and embryologists had not put forward the theory of evolution, it would have been

necessary for paleontologists to invent it. What then are the main facts offered by PALEONTOLOGY, the study of the FOSSIL remains of extinct animals and plants?

In the first place it must be made clear that geologists are able to determine, with remarkable accuracy in most cases, the sequence in time, or CHRONOLOGICAL SUCCESSION, of the rock strata composing the earth's surface. The main outline of this scheme of geological chronology was understood before the evolution of organisms was a crucial question, so we may consider the evidence which it affords of the chronological succession of the fossil remains exhibited by the various strata, as impartial testimony to the order of appearance on the earth of the different types of animals and plants. (Figs. 382, 383, 397.)

ERAS	PERIODS OR EPOCHS	DOMINANT ANIMAL TYPES	DOMINANT PLANT TYPES
Cenozoic	Recent Pleistocene	Man	Flowering plants
	Pliocene Miocene Oligocene Eocene	Mammals	
Mesozoic	Cretaceous Jurassic Triassic	Reptiles	Gymnosperms (Conifers and kin)
Paleozoic	Permian Carboniferous	Amphibians	Spore-plants (Mosses, Ferns, and kin)
	Devonian	Fishes	
	Silurian Ordovician Cambrian	Shell-bearing marine animals	Algae
Proterozoic		Shell-less Invertebrates	Bluc-green Algae
Archeozoic		Simplest animals (inferred)	Simplest plants (inferred)

FIG. 382. — Correlation of geological time and dominant types of organisms. See Fig. 383.

The geological time-table briefly summarizes the panoramic succession of life as it is seen by the paleontologist. It is of little value to attempt to discuss the absolute duration of geologic time because estimates vary so greatly, though there are fairly reliable data in regard to the relative length of the various eras. Perhaps the conservative estimate of

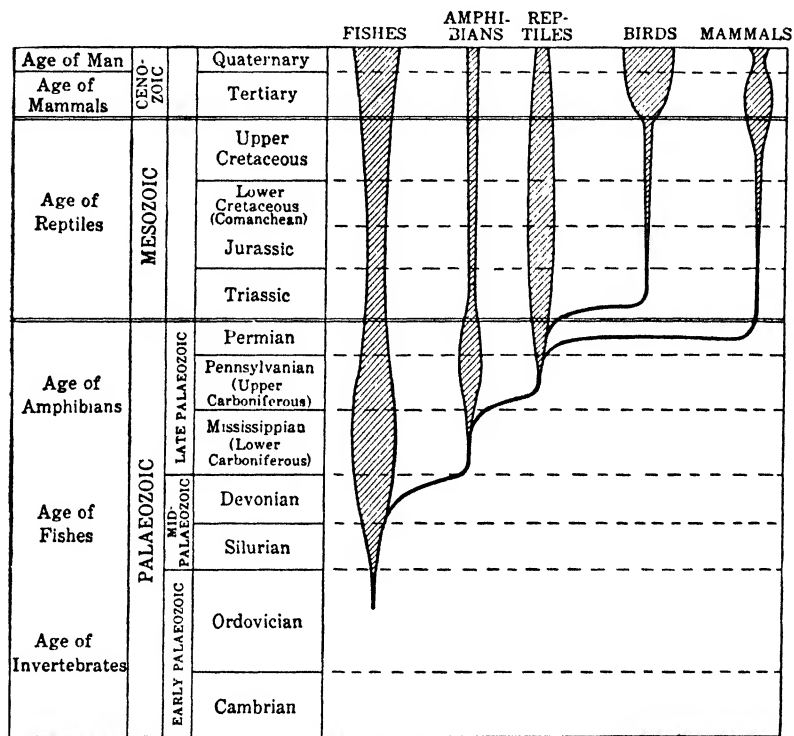

FIG. 383. Correlation of the origin and development of Vertebrate classes with geological time. Each higher class arises from less specialized members at the base of the lower class. (After Osborn.)

two billion years, much more than half of which was before the Paleozoic era, will serve to spell the earth's unfathomable past and to afford some idea of the immensity of time available for evolutionary changes. Ten thousand years are but as yesterday in the history of species.

Even a casual survey of this history — natural history —

of the earth and its inhabitants cannot but impress one with the fact that, taken all in all, there has been a continuous, though not always a uniform, advance in the complexity of organisms from the most ancient times, and that the older types seem gradually to melt into modern forms as the remoter geological eras merge into the more recent.

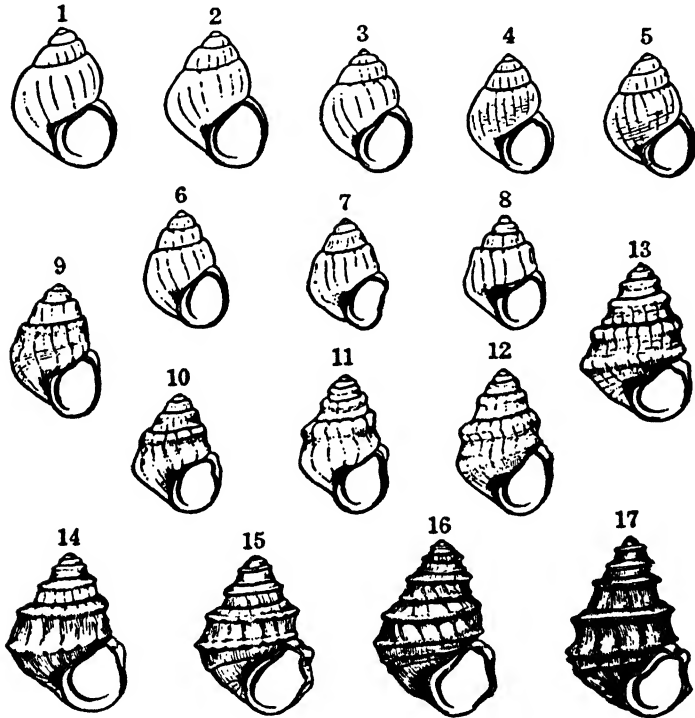

FIG. 384. Successive forms of a Snail, *Paludina*, from the Tertiary deposits of Slavonia. (After Neumayr.)

“Only the shortness of human life allows us to speak of species as permanent entities.” Invertebrates appear in the Proterozoic era; Fishes, Amphibians, and Reptiles in the Paleozoic; Birds and primitive Mammals in the Mesozoic; higher Mammals and Man in the Cenozoic. Mosses and Ferns arise before Conifers and the latter before the familiar Flowering Plants. Just in proportion to the completeness



of the geological record is the unequivocal character of its testimony to the truth of the evolution theory. For the sake of concreteness we may select two examples from the wealth of material offered by the paleontologist. (Fig. 384.)

At first glance there seems to be little but contrasts between a typical Reptile and a typical Bird; between a cold-blooded, scaly-skinned Lizard, let us say, and a warm-blooded,

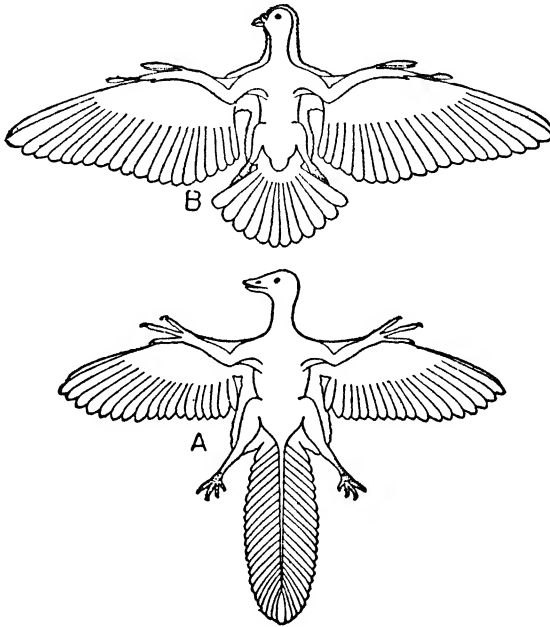

FIG. 385. Reptilian Bird, *Archaeornis* (A), compared with Pigeon, *Columba livia* (B). (From Lull.)

feathered Pigeon. And yet the zoölogist\* is convinced that Birds have evolved from a reptilian stock, because, in spite of superficial dissimilarities, there are fundamental structural resemblances not only between adult Reptiles and Birds, but also between their embryological stages. And further, because the fossil remains of very primitive Birds, *Archaeornis* and *Archaeopteryx*, have been found which form, in many ways, connecting links between the Reptiles and Birds as we know them today. (Fig. 385.)

Archaeornis was undoubtedly a bird about the size of a Pigeon, but one with jaws supplied with many small teeth; with a long lizard-like tail formed of many vertebrae, each bearing a pair of quill feathers; with a free-fingered reptilian hand; and so on. In brief, just such a creature as the imagination of an evolutionist would picture for a primitive bird has been actually discovered in the lithographic stone quarries of Bavaria, representing the later Jurassic period.

The ancestry of the modern Horse has been the most impressive fossil pedigree, ever since Professor Marsh collected the famous series of fossil skeletons from the western United States and arranged them in the Yale University Museum. They have been referred to as the "first documentary record of the evolution of a race." Huxley studied this collection and regarded it as conclusive evidence of evolution.

The essential facts of the evolution of the horse are these. Horse-like animals probably arose from an extinct group, similar to the *Condylarthra*, which had five toes on each foot and a large part of the sole resting on the ground. However, the first unquestionable horse-like forms found in North America are little animals about a foot in height, known as *Eohippus*, from rocks of the EOCENE epoch. The fore foot of *Eohippus* has four complete toes (digits 2, 3, 4, and 5) but no trace of the inner digit, or thumb, while the hind foot has three complete digits (2, 3, and 4) with vestigial remains, or *splints*, of the first and fifth. Later in the Eocene appears *Orohippus* showing a somewhat larger central digit in the fore foot and the disappearance of the splints in the hind foot. Passing up to the OLIGOCENE epoch, *Mesohippus*, an animal about the size of a wolf, occurs with fore and hind feet three-toed, but with the side toes much smaller than the central one, and just a trace of the fifth digit in the fore foot as a splint. Then *Merychippus* appears in the MIOCENE epoch, with still shorter side toes (digits 2 and 4) so that they do not reach the ground, and the weight is borne solely on the hoofed tip of the third digit. This same general reduction

# THE EVOLUTION OF THE HORSE.

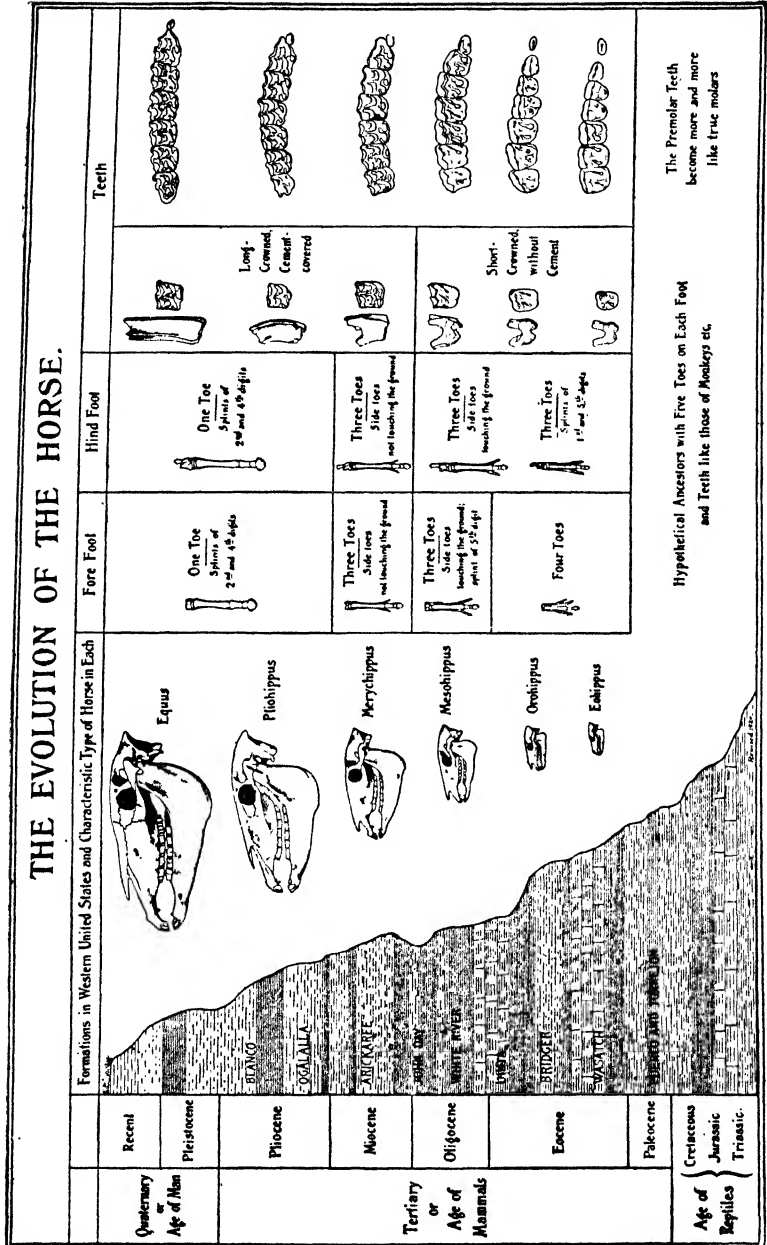

Hypothetical Ancestors with Five Toes on Each Foot and Teeth like those of Monkeys etc.

FIG. 386. Graphic presentation of the evolution of the Horse. (From Matthew.)

of the lateral digits and advance in size and functional importance of the middle digit is carried further during the Pliocene epoch in *Pliohippus*, which is usually regarded as the first type of 'one-toed' horse, and leads finally to the genus *Equus* which has continued from the Pleistocene epoch to the present. This genus includes the modern Horse, *Equus caballus*, with one functional digit on each foot and vestiges of two more (digits 2 and 4) as the splint bones. (Fig. 386.)

In this outline of what must be interpreted as the fossil ancestors of the horse of today, we have merely selected several representative forms to emphasize changes in foot structure. But, of course, many other equally significant changes were involved in the transformation — during perhaps ten million generations — of an *Eohippus* type into that of *Equus*. This much appears certain to the biologist: "In early Eocene times there lived small five-toed hoofed quadrupeds of generalized type, that the descendants of these were gradually specialized throughout long ages along similar but by and by divergent lines, that they lost toe after toe till only the third remained, that they became taller and swifter, that they gained longer necks, more complex teeth, and larger brains. So from the short-legged splay-footed plodders of the Eocene marshes there were evolved light-footed horses running on tiptoe on the dry plains."

Truly, the stupendous and ever-increasing record of ancient forms of life is not that of a disordered multitude. Newly discovered fossil remains, one after another, fall into the scheme of a common tree of descent — descent with change. (Figs. 384, 387.)

#### 4. Embryology

If evolution is a fact, one would expect to find evidences of the genetic relationships of organisms in their embryological development from egg to adult. Under former headings we have incidentally mentioned embryological

data which point toward evolution, so that now attention may be confined to an attempt to make clear a fact of importance — the history of the individual frequently corresponds

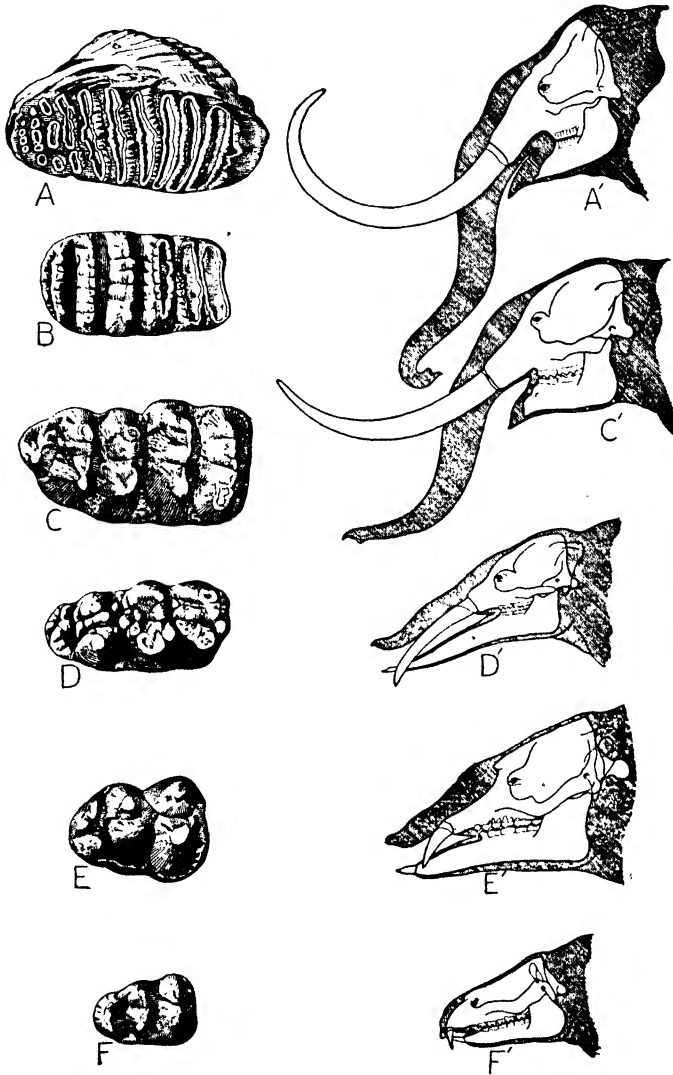

FIG. 387. Evolution of the head and molar teeth of Elephants. A, A', *Elephas*, Pleistocene; B, *Stegodon*, Pliocene; C, C', *Mastodon*, Pleistocene; D, D', *Trilophodon*, Miocene; E, E', *Palaeomastodon*, Oligocene; F, F', *Moeritherium*, Eocene. (From Lull.)

in broad outlines to the history of the race as indicated by evidence from comparative anatomy, etc. If we have in mind the earlier discussion of vertebrate anatomy, just a few typical examples will suffice to suggest the type of evidence which supports this so-called RECAPITULATION THEORY, OF BIOGENETIC LAW. (P. 246.)

Lower Vertebrates, such as the Fishes, have a heart composed of two chief chambers: an auricle which receives blood from the body as a whole and a ventricle which pumps it to the gills on its way to supply all parts of the body. Among the members of the next higher group, the Amphibia (Frogs, Toads, etc.), the auricle is divided into two parts, while the ventricle remains as before. Thus these forms have a three-chambered heart. Passing to the Reptiles, we find that most of the Lizards, Snakes, and Turtles have the ventricle partially divided into two chambers, while the more specialized Crocodiles and Alligators have a complete partition and therefore a four-chambered heart. This is the condition in all adult Birds and Mammals, but the significant fact is that, in the development of the heart of the individual Bird and Mammal, embryonic stages succeed each other which parallel in a general though remarkable way this sequence from a two-chambered to a four-chambered condition as exhibited in the adults of the lower Vertebrates. (Figs. 237, 241.)

Or take the development of the brain in the Vertebrate series. Even in the human embryo the fundament of the brain arises by simple transformations of the anterior end of the neural tube, which at first are nearly indistinguishable from the conditions that exist in the lowest Vertebrates. Then the changes become progressively more complex along lines broadly similar to those occurring from Fish to Mammal, until finally the complex human brain is formed. (Figs. 267, 268.)

The same picture is presented by a study of the development of the excretory system, the reproductive system, the skull, and so on. One cannot avoid the fact that the organs

of higher animals during development pass through stages which correspond with the larval or adult condition of similar organs in lower forms. The correspondence is far from exact — to be sure, there are gaps and blurs — but it is not an exaggeration to say that embryological development is parallel to that which anatomical study leads us to expect.

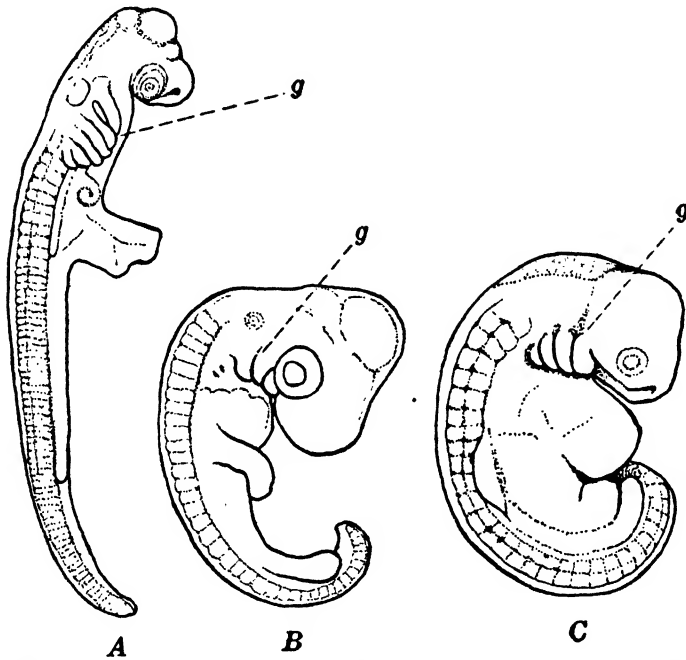

FIG. 388. Embryos in corresponding stages of development. A, Fish (Shark); B, Bird; C, Man. *g*, gill slits. See Fig. 311. (From Scott.)

A knowledge of the anatomy of an animal actually gives a sound basis of facts from which to predict in broad outlines its embryological development. (Figs. 254, 388.)

What are the bearings of these facts on the evolution theory? It is perfectly logical to conclude that it is an architectural necessity, let us say, for the four-chambered heart to arise from a two- and three-chambered condition — and undoubtedly if this were the only example of 'ontogeny repeating phylogeny' the conclusion would be justified. But

when one considers the widespread general correspondence of the developmental stages in higher forms with conditions as they exist in the adults of lower forms, the facts almost overwhelmingly force us to go further and conclude that the similarity has its basis in inheritance, in actual blood relationship between the higher and lower forms — in descent with change. (Pp. 694–698.)

### 5. *Physiology*

Fundamental structural similarities throughout a series of organisms imply fundamental physiological similarities — structure and function go hand in hand, each being an expression of the other. Function alone gives permanence to structure — and this is strikingly corroborated by the data accumulated which show that species are characterized not only by morphological attributes, but by their specific biochemical constitution and reactions as well.

Reverting to the recapitulation theory which has just been discussed, it is interesting to add that the developing chick embryo “recapitulates in a chemical sense.” At first, in general, it behaves like an aquatic organism and excretes ammonia, then after a few days it excretes urea like an amphibian, and finally the chief end-product of nitrogenous metabolism is uric acid. (Pp. 518–520.)

Again, it is significant that certain tissues of Invertebrates, with one exception, have arginine phosphate, and those of Vertebrates have creatine phosphate, while the tissues of an ‘intermediate’ form, the protochordate *Dolichoglossus*, have *both* of these phosphates. And the tissues of the one exception among the Invertebrates, the Echinoids which show embryological similarities to certain Protochordates, also have both phosphates. (Figs. 183, 184.)

It will be recalled that chemical control by hormones plays an important part in the coördination of the animal body into a working unit, especially in the case of such functions as digestion, growth, and reproduction. Now it is significant that the hormones seem to be largely if not com-



pletely interchangeable from one species of Vertebrate to another. Thus a deficiency in the insulin hormone in the human body may be supplied from the pancreas of a fish or a sheep. Obviously this strongly suggests that at least certain of the chemical regulators have been common factors from a remote ancestral period. (P. 359.)

But chemical differences as significant as anatomical ones have been revealed by the type of crystals formed by the hemoglobin of the blood. When orders, families, genera, or species are clearly separated by anatomical criteria, the crystals are correspondingly markedly differentiated. Thus from crystal form it is evident that the common White Rat is the albino of the Norway Rat (*Mus norvegicus*) and not of the Black Rat (*Mus rattus*); and that Bears are more nearly related to the Seals than they are to Dogs.

Again, there are other important chemical differences, not determinable by ordinary chemical analysis, between the blood even of closely related species, long known by the fact that the TRANSFUSION of the blood of one species into another is usually attended by physiological disturbances and often by death. It has been found by innumerable transfusions and also by so-called PRECIPITIN TESTS of the blood *in vitro*, that is outside the body, that the degree of the reaction is in many cases proportional to the degree of relationship of the species involved, as indicated by their classification on the basis of anatomical structure.

Thus, as one would expect, human blood shows by the precipitin test closer chemical relationships with the blood of the highest Apes than it does with that of the Old World Monkeys; closer relationships with the blood of the latter than it does with that of the New World Monkeys; and closer with the blood of these than with that of the Lemurs; and so on. Or, descending to the Reptiles: paleontology indicates that there is a close relationship between Lizards and Snakes and also between Turtles and Crocodiles, while the reptilian ancestor of the Birds was probably more closely allied with the latter than the former groups. These same

relationships are indicated by blood tests. Thus chemical characteristics may soon prove to be a necessary criterion in the classification of organisms. It appears that all the data warrant the conclusion that the chemical characteristics of the blood are almost as constant as structural similarities of the blood vessels. In fact, the inorganic salts present in the various circulating fluids of animals correspond in nature and relative amounts to what we have good reason to believe was the composition of the ocean some hundreds of millions of years ago. So in evolutionary terms, a common property has persisted in the bloods of animals throughout the ages which have elapsed during their evolution from a common ancestor; of all the systems, the blood perhaps is the most conservative in retaining its ancestral condition. Blood relationship is a fact. (Pp. 518-520.)

## 6. *Distribution*

Everyone recognizes, and we have already mentioned, that there are wide variations in the fauna and flora of different parts of the earth. There is a characteristic life on mountain, plain, and seashore, and in the sea — as well as in pond and puddle — and also in arctic, temperate, and tropical regions. Furthermore, it will be recalled that the study of plant and animal distribution involves the investigation of both the relations of the various organisms to the general environing conditions and the interrelations of the species with each other. Confining attention merely to the geographical distribution of organisms, we may take some clear-cut examples and see whether or no evolution offers a reasonable explanation of the facts. (Figs. 367, 368, 389; Pp. 168-171, 512, 539.)

Various species of Walnuts, members of the genus *Juglans*, now have a discontinuous distribution over limited areas of the Eastern and Western Hemispheres, whereas during the geological past, from the Cretaceous to the Pliocene epochs, these trees flourished over immensely wider regions. So it

appears clear that the discontinuous distribution of modern species represents merely the segregated remnant of the past. (Fig. 390.)

Again, a characteristic genus of Mammals, the Tapirs, is represented today by distinct species in two widely sepa-

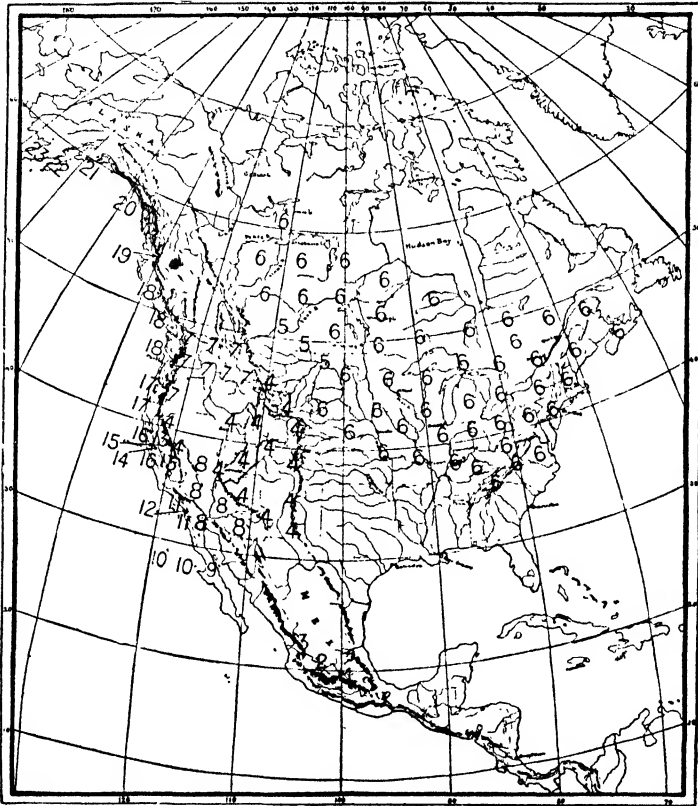

FIG. 389. Geographical distribution of twenty-three of the twenty-nine subspecies of Song Sparrows. Each different number indicates a subspecies. "We find complete intergradation in color and in size. Nowhere can one draw the line. As the climatic conditions under which the birds live change, the birds keep pace. Here we have a species in flower, as it were, a single Song Sparrow stalk with its twenty-nine blossoms, any one of which might make an independent growth as a species if it were separated from the parent stem. Doubtless some day the separation will come, when we shall have several species, each with its groups of races, but at present we have only one species, divided into some twenty-nine subspecies, or species in process of formation." (Chapman.)

rated regions: Central and South America and southern Asia and adjacent islands. But distribution in the past proves to be the key to the present distribution. Paleontological studies show that in the Pliocene epoch Tapirs were distributed over nearly all of North America, Europe, and northern Asia, and thereafter gradually became extinct so that by the close of the Pleistocene epoch the remnants were distributed as we find them today. (Fig. 210.)

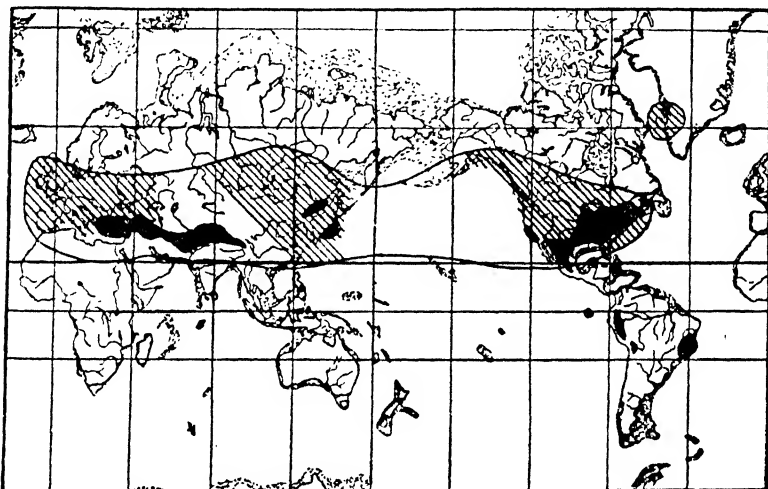

FIG. 390. Present range of the Walnuts (solid black) and area (lined) which they are known to have occupied during the geologic past. (From Berry.)

In brief, the present *discontinuous* distribution represents the remnants of world-wide Walnut and Tapir populations, and the differences between the existing species are such as one might expect to find among the members of a genus long isolated in different environments by geographical barriers. We know, for example, that a litter of European Rabbits was introduced on the small island of Porto Santo during the fifteenth century and by the middle of the last century its descendants had become so distinct from the parent form that they were described as a new species.

Indeed it was the characteristic fauna and flora of islands that impressed Darwin with the need of some interpretation

of their origin other than by special creation. During his famous three years' voyage around the world on the "Beagle," he stopped at the Galapagos Islands, situated about 600 miles off the west coast of South America, and was astonished to find that although the fauna as a whole resembled fairly closely that of the mainland, nevertheless the species for the most part not only were different, but even those of the separate islands were distinct — the islands nearest to each other having species most similar. Darwin wrote, "My attention was first thoroughly aroused by comparing together the numerous specimens, shot by myself and several others on board, of Mocking Thrushes, when, to my astonishment, I discovered that all those from Charles Island belonged to one species (*Mimus trifasciatus*); all from Albemarle Island to *M. parvulus*; and all from James and Chatham Islands (between which two other islands are situated as connecting links) belonged to *M. melanotis*." And again, "We have the truly wonderful fact that, on James Island, of the thirty-eight Galapageian plants found in no other part of the world, thirty are exclusively confined to this one island."

Darwin's observations of such facts as these have been corroborated in the Galapagos and extended to isolated island faunas and floras all over the world. For instance, half of the species of Insects and four-fifths of the species of Seed Plants that occur on St. Helena are found nowhere else. And further, Darwin's explanation of the phenomena is the most plausible extant. Continental islands secure their life from the mainland before they are cut off, and oceanic islands after their formation by volcanic action alone or aided by coral growth. In either event the organisms inhabiting islands are isolated from the main stock of the species, and they diverge, in proportion to the length of time and the degree of isolation, until they constitute separate races and species. Isolation promotes divergence apparently to a considerable extent by preventing new types from being swamped by interbreeding with the old, and by allowing many mutations to become established

that would not have survived in a more competitive field. Furthermore, new conditions may afford new problems to be met by mutations. We see evolution as a response of life to its environment. Each species peculiar to each isolated island can reasonably be interpreted as having arisen by descent with change. (P. 593.)

We have now summarized a few concrete examples of the chief types of evidence that organisms — species — have come to be what they are today through a long process of descent with change. This evidence, taken with that presented, so to speak, on and between the lines throughout this book, should place the reader in a position to form a more or less independent judgment of the question. It is only necessary to remind him again that, although the evidence, from the nature of the case, must inevitably be indirect, its force is tremendously increased by its amount. And the reader, with only a very limited amount of the data before him, cannot appreciate the overwhelming impressiveness of all the concordant evidence for organic evolution.

## B. FACTORS OF ORGANIC EVOLUTION

Taking for granted the fact of evolution, what are the factors which have brought about evolution? This is quite a different question, but one which has often brought confusion to the popular mind. Although biologists are in general agreement on the basic factors involved, there is much debate in regard to their relative importance and method of operation. And the layman frequently has mistaken the questioning of one factor or another for a questioning of the fact.

No purpose will be served at this point by an historical account of the origin of the present-day point of view. Suffice it to say that the evolution idea is a generalization which has crept from science to science — from astronomy to geology, from geology to biology, thereupon becoming

ORGANIC evolution. The idea in one form or another is as old as history, but for all practical purposes the biologist Lamarck, during the early part of the nineteenth century, formulated the first consistently worked out theory of organic evolution. (Fig. 467.)

### 1. *Lamarckism*

The evidence for organic evolution offered by Lamarck was necessarily limited in amount, and in some cases neither happily selected nor convincingly presented, so it was laughed out of court by biologists and laymen alike. His evolution factor was essentially the change of the organisms through the use and disuse of parts; the physiological response of the organism to new needs offered by new conditions of life. And these changes, somatic in origin, he believed were transmitted to the progeny. His first statement in 1809, freely translated, is as follows:

“First Law: In every animal which has not exceeded the term of its development, the more frequent and sustained use of any organ gradually strengthens this organ, develops, and enlarges it, and gives it a strength proportioned to the length of time of such use, while the constant lack of use of such an organ imperceptibly weakens it, causing it to become reduced, progressively diminishes its faculties, and ends in its disappearance.

“Second Law: Everything which nature has caused individuals to acquire or lose by the influence of the circumstances to which their race may be for a long time exposed, and consequently by the influence of the predominant use of such an organ, or by that of the constant lack of use of such part, it preserves by heredity and passes on to the new individuals which are produced, provided that the changes thus acquired are common to both sexes, or to those which have given origin to these new individuals.”

Lamarck's first law is, in general, sound, but the second — the inheritance of acquired characters — is highly question-

able to say the least, because, as we have seen, there is no evidence that modifications are heritable. But this weak point was not the one which caused the rejection of the theory by Lamarck's contemporaries. The various antagonistic influences can be summed up by saying: the time was not ripe for evolution.

## 4. Darwinism

Then a generation later appeared Charles Darwin in England. With a better background prepared for him, in part through the headway being made by the evolution theory in geology, he did two things in his *Origin of Species* which was published in 1859. He presented an overwhelming mass of *facts* that could be explained most reasonably by assuming the origin of existing species by descent with change from other species. And he offered as an explanation of the origin of species the *theory* of "NATURAL SELECTION, or the preservation of favoured races in the struggle for life." It was the *combination* of the facts and the theory to account for the facts that won the thinking world to organic evolution — a common height from which we view the whole world of living beings. (Fig. 469; Pp. 705-707.)

What, in brief, was the theory? In the first place, without attempting to determine the cause of variations, Darwin showed the great amount of VARIATION in nature. And any and all kinds of heritable variations were, broadly speaking, important — though he questioned the Lamarckian idea of the inheritance of acquired characters.

The universality of variations established, Darwin emphasized the fact that the POWER OF REPRODUCTION of organisms far exceeds space for the offspring to live in and food for them to eat. Some recent data will illustrate this point. A microscopic Paramecium possesses the power to eat, grow, and reproduce — to transform the materials of its environment into Paramecium protoplasm — at the rate of 3000 generations in five years. And all the descendants



(if they actually existed) would equal 2 raised to the 3000th power, or a volume of protoplasm approximately equal to  $10^{1000}$  times the volume of the earth! The Plant Lice, or Aphids, may produce a dozen generations in a year. The final brood, assuming the average number of young produced by each female to be one hundred and that every individual produced its full complement of young, would consist of ten sextillion individuals — a procession if it could be marshalled, that “would extend from the earth out into space far beyond the furthest star that has ever been discerned by the telescope.” The common House Fly under favorable conditions may lay as many as six batches of eggs, of about one hundred and forty eggs each, during its short life of approximately three weeks. Assuming that all the progeny survived and multiplied at the same rate, “the progeny of a single pair, if pressed together into a single mass, would occupy something like a quarter of a million cubic feet, allowing 200,000 flies to a cubic foot.” And the all too familiar Mosquito may have nearly two hundred billion descendants during one summer. Indeed, the common Rat will afford astounding figures. (Figs. 370, 415, 428.)

The number of individual organisms on the earth is essentially infinite. If it is assumed that the average life span of an individual is a year — a day would probably be nearer the truth — then one must grip the fact that this infinitude of individuals is each year wiped out, and replaced by reproduction. Such “almost explosive expansion of a population” under favorable conditions is appalling, though true, and serves to afford an appreciation of the enormous realized and unrealized potentialities of living matter to make more living matter — to reproduce. “The problem of organic evolution is that of the evolution of an organic mass consisting of an infinitude of individuals reproduced during an infinitude of generations.”

Something must — does — suppress the inherent power of each species to overpopulate the earth, and Darwin emphasized the STRUGGLE FOR EXISTENCE between the

individuals of species. Thus "a plant which annually produces a thousand seeds, of which on an average only one comes to maturity, may be said to struggle with the plants of the same and other kinds which already clothe the ground. . . . Battle within battle must be continually recurring with varying success; and yet in the long run the forces are so nicely balanced that the face of nature remains for long periods of time uniform, though assuredly the merest trifle would give the victory to one organic being over another." In other words, the struggle is so keen that a variation, however slight, which better fits — adapts — an individual to its surroundings than its neighbors are adapted, will more often than not give its possessor an advantage in the struggle, and accordingly the latter will tend to survive and to pass on the favorable variation to its progeny. Thus by NATURAL SELECTION is brought about THE SURVIVAL OF THE FITTEST — the survival of those individuals, and therefore species, which are best adapted to the peculiar conditions of their environment and mode of life. And note, this offers an explanation of the fact of *adaptation* itself.

This is all so simple from one point of view and so complex from others, that it may well be restated in Darwin's own words: "As many more individuals of each species are born than can possibly survive, and as, consequently, there is a frequently recurring struggle for existence, it follows that any being, if it vary however slightly in any manner profitable to itself, under the complex and sometimes varying conditions of life, will have a better chance of surviving, and thus be naturally selected. From the strong principle of inheritance any selected variety will tend to propagate its new and modified form."

Nothing succeeds like success, and once started Darwin's theory gradually swept nearly all opposition away. Indeed, some of its advocates in their enthusiasm extended Darwin's theory to a point not justified by his own conservative statements. Then, as was to be expected, the reaction came. One objection after another was raised as the problem was

studied from nearly every standpoint by biologists the world over. But it is unnecessary to obscure the main issue by entering into these controversies. What is the status of the theory of natural selection today? The answer must be sought in the light of genetics. (Figs. 389, 391, 396.)

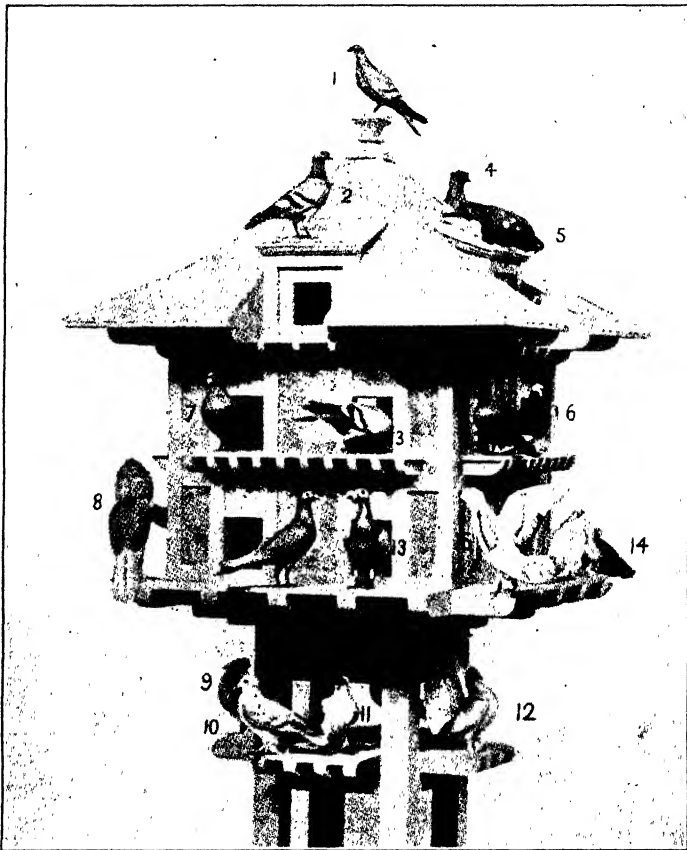

FIG. 391. A few varieties of domestic Pigeons. Over one hundred and fifty different breeds have been derived by selection from the wild Blue-rock Pigeon, some of which "differ fully as much from each other in external characters as do the most distinct natural genera." (Darwin.) 1, Blue-rock Pigeon, *Columba livia*, ancestral form; 2, homing; 3, common mongrel; 4, archangel; 5, tumbler; 6, bald-headed tumbler; 7, barb; 8, pouter; 9, Russian trumpeter; 10, fairy swallow; 11, black-winged swallow; 12, fantail; 13, carrier; 14, 15, bluetts. (From photograph of an exhibit in the United States National Museum.)

### 3. *Genetics and Evolution*

Evolution is not a closed book — an event which has been completed in the past — but a process which is actively going on now. It may well be an accelerating process that is gaining momentum. Perhaps it is even today but little beyond the beginning of its revelations. “Nothing endures save the flow of energy and the rational order that pervades it.” And there is every reason to believe that the factors involved in present evolution are essentially the same as those which have operated in the past. We now realize that organic evolution is a bird’s-eye view of the results of heredity since the origin of life — the facts of inheritance hold the key to the factors of evolution. Therefore we shall consider the relations of recent discoveries in genetics to the evolution problem — to the origin of the fitness of organisms. (Pp. 486, 511, 698–701.)

**SELECTION.** The process of selection has long been successfully practiced by man to establish desirable types of domestic animals and plants, and, as we know, Darwin assumed that a somewhat similar but automatic selective process determines the survival of the better adapted wild forms in nature. Darwin clearly recognized that selection in itself can produce nothing — its efficacy depends on the materials afforded by variation. But he did not and, of course, could not make the modern sharp distinction between modifications, recombinations, and mutations. In general he accepted all variations as at the disposal of selection, but emphasized the importance of small, finely-graded, fluctuating variations in gradually producing, through many generations, a cumulative effect in the direction of selection — variations that today we know are, in part, modifications.

The modern approach to the critical analysis of significant variations was opened by the work of two botanists, deVries and Johannsen. DeVries laid stress on the importance of discontinuous variations which he called **MUTATIONS** — a class of variations that we have already discussed; while

Johannsen made clear that in a homozygous germ complex, or PURE LINE, selection is ineffective, as will appear beyond.

Some of the problems of selection will be clear from an example. Take, say, a quart of beans and sort them into groups according to the weight of each bean. Then put each group into a separate cylinder and arrange the cylinders in a series according to the weight of the enclosed beans. Now if we imagine a line connecting the tops of the bean piles in the cylinders, it takes the form of a normal curve of probability, or variability curve.

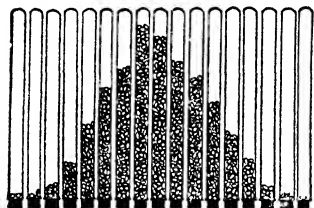

FIG. 392. Diagram to illustrate a quart (population) of beans assorted according to weight.

A similar figure would be obtained by the statistical treatment of nearly all fluctuating characters among the members of any large group of organisms, or of the size of the grains in a handful of sand, or the devia-

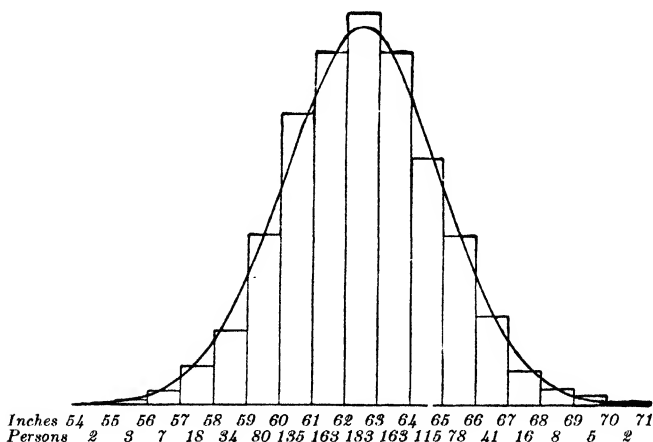

FIG. 393. Normal variability curve plotted from measurements of the height of 1052 women (population.) The height of each rectangle is proportional to the number of individuals of each given height. (After Pearson.)

tions of shots from the bull's-eye in a shooting match. Therefore the variations with respect to a given character very closely approximate the expectation from the mathe-

mathematical theory of probability, or chance, and the reasonable conclusion is that such finely-graded fluctuating variations are a resultant of a large number of factors, each of which contributes its slight and variable quota to the expression in a given individual. (Figs. 392, 393.)

The question is, what results are obtained by breeding from individuals which exhibit such a fluctuating variation to, let us say, a greater degree than that of the mean of a mixed POPULATION? With Galton's principle of filial regression in mind, one will naturally expect, and rightly, that the offspring usually will exhibit the character to a less

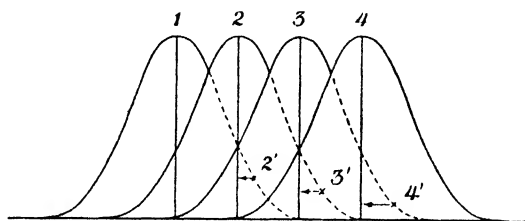

FIG. 394. Schematic representation of the effect of selection from the viewpoint of Galton's 'law of filial regression.' 1, mode before selection; 2, 3, 4, new (successive) modes, the results of selections of individuals at 2', 3', 4'. The mode has been shifted in the direction of selection (toward the right); but each time there has been the amount of regression indicated by the length of an arrow. See Fig. 317.

degree than the parents but to a greater degree than the population. The top (mode) of the curve will have moved, so to speak, slightly in the direction of selection. Now, by continuing generation after generation to select as parents the extreme individuals, is it possible, with due allowance for some regression, to take one step after another indefinitely, or until the character in question is expressed to a degree which did not exist previously? The experience of practical breeders gives a partial answer, since the continual selection of the best animals for mating and the best plants for seed has been a profitable procedure. But it has long been known that after a certain amount of selection has been practiced it may cease to be effective, and thenceforth serves chiefly to keep the character at the higher level attained. (Fig. 394.)

The crux of the matter is in regard to exactly what the variations are. Both modifications and recombinations are usually included, and this mixture of non-heritable and

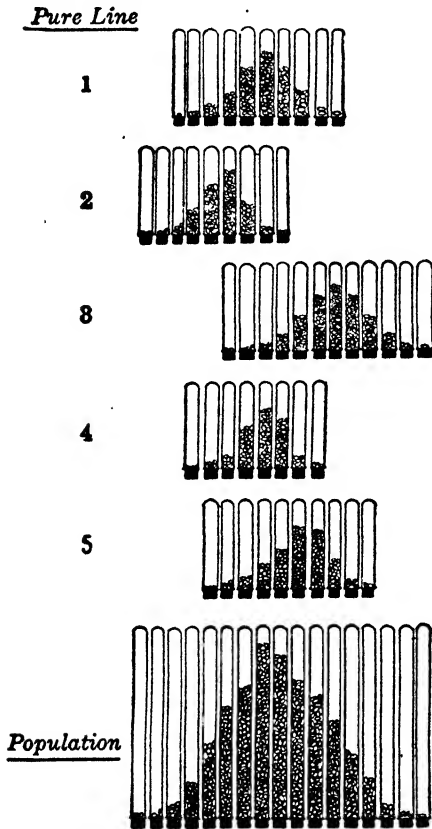

FIG. 395. Diagram to illustrate a population of beans and its five component pure lines. The beans are assorted according to weight. Tubes containing beans of the same weight are placed in the same vertical row. See Fig. 392. (From Walter, after Johannsen.)

heritable variations is what makes confusion. If we rule out recombinations by inbreeding or by self-fertilization of homozygous individuals, soon we establish PURE LINES. Then the variations are all modifications and selection is ineffectual with characters which are not inherited.

The importance of this point was discovered by Johannsen in careful experiments on the inheritance of characters in single pure lines of a brown variety of the common garden Bean. For example, by keeping the progeny of each individual bean separate from that of all the rest, he was able to isolate a number of pure lines which differed in regard to the average weight of the beans. Thus selection resolved the bean

population with which he began into its constituent 'weight types,' or lines, each of which exhibited a characteristic variability curve of its own with a mode departing more or less from that of the population. But when Johannsen se-

lected *within* a pure line (ruled out recombinations) nothing at all resulted; he was unable to shift the mode because he was dealing with non-heritable characters. In other words, selection sorts our preëxisting pure lines (lines with homogeneous germinal constitution) from a population and then stops. Thereafter a mutation must occur in the pure line for selection to be effective — but by the mutation the single pure line becomes two. Some of the best varieties of cotton, wheat, and other commercially valuable plants are pure lines, in some cases tracing their origin back to a single seed. (Fig. 395.)

The pure line concept has served to clarify our ideas in regard to selection by focussing attention on the actual nature of the variations being dealt with. It discriminates sharply between modifications, which are a result of environmental influences, often recurrent in each generation and so *seemingly* inherited, and variations which are heritable because they are the result of changes in the germ plasm.

However, it will be recognized at once that, in general, the animal breeder, as well as Nature, deals with hybrid stock, heterozygous in regard to many characters, rather than with pure lines. Even pure lines may not stay pure — mutations may occur. Here selection has ample material at its disposal so it can and does segregate new combinations and accumulate mutations in the direction of selection. If it is carried on sufficiently long — aided by various ISOLATING FACTORS such as geographical barriers, seasonal variations in the reproductive period, physiological incompatibility, sterility of hybrids, etc. — the extent of the change may be very great: a more or less steady change in the direction of selection when mutations are available. (P. 582.)

Although selection is not 'creative,' it is effective: the appreciation of its limitations has but accentuated its possibilities. NATURAL SELECTION may automatically act as a 'sieve' and sort out the new combinations and mutations presented — retain the fit and discard the unfit — and so afford a natural explanation of adaptation. It seems



to be a strictly scientific explanation of the fitness of living things, in spite of the fact that it does not explain — and does not attempt to explain — the *origin* of fitness. “If peas are rolled down an inclined plane, the largest go fastest, the smallest slowest, and the round ones go straight to the bottom, while the irregular ones deviate toward the sides.

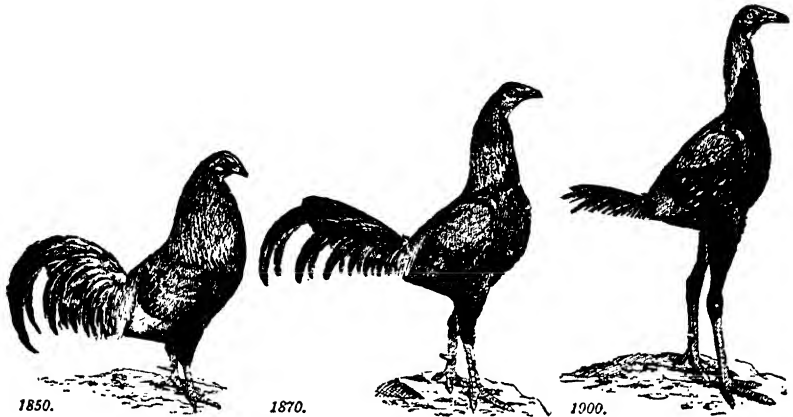

FIG. 396. The evolution of the Game Cock. Results produced largely by selection before our present knowledge of the mechanism of inheritance. (From Metcalf, after Wright.)

This may be an efficient means of sorting peas, although the origin of the differences in the peas is unknown.” (Figs. 391, 396.)

**METHOD OF EVOLUTION.** A synoptic view of some of the essential facts, presented from a different angle, may serve to clarify our view of evolution as fundamentally a complex problem in genetics.

In the first place, we have seen that though variations are the rule and not the exception, some are of importance for evolution and some are not. All the evidence indicates that the effective variations are germinal and not somatic. Changes arising in the soma — modifications — are unable to attain representation in the germ plasm so that they are ‘born again,’ although modifications impressed anew on the soma in each generation may enable a race to survive until

appropriate recombinations or mutations appear. Evolution must be brought about by changes in the germinal complex — by the evolution of the germ plasm itself. Accordingly selection must operate to eliminate the unfit germ plasm (genotype) rather than the unfit soma (phenotype), though as a matter of fact the fitness of an individual is determined largely by its somatic characters. Dominant genes are directly within the reach of natural selection, whereas recessive genes may slip by because they are frequently concealed by dominants. The latter is a much more select, and selected, group: recessives may be the “skeleton in the nuclear cupboard of the race.” We know that INBREEDING, *e.g.*, cousin-marriages in man, often reveals recessives because relatives are likely to carry the same recessives and so afford more chance for them to meet and become expressed in the offspring. Conversely, OUTBREEDING brings forth in the offspring the dominants of both parents, which probably accounts, in part, for so-called HYBRID VIGOR. It provides new combinations not only of established germinal factors but also of such mutations as occur, and so affords opportunity for relatively rapid germinal change. (Figs. 297, 329.)

All this presents a complication of the mental picture of the operations of selection which did not exist before our modern concept of phenotype and genotype. Since individuals frequently belie their genotypic condition — what they can pass on to their progeny — natural selection has, so to speak, a more devious though not less sure path. (Fig. 320.)

Secondly, how does the germ plasm change? True, germinal alterations result from the usual processes of chromosome recombination and gene recombination (crossing over), as well as from the more radical mutations — chromosomal aberrations and intrinsic gene changes. But what is the nature of the intrinsic gene changes? No one has ever knowingly seen a gene. They are known by their works. Thus we already have a biochemical account of some thirty-five genes concerned in the production of the

chief blue, purple, and red water-soluble sap-pigments that produce variations in flower color of more than a dozen species of plants. All the pigments prove to be derivatives of one substance, pelargonidin, through the action of specific dominant genes that insert various chemical side-chains in this basic pigment molecule. (Fig. 336.)

So it appears that single genes control simple biochemical differences. But the genes themselves are not simple. Their properties probably are dependent to a large extent upon their molecular structure; probably huge protein molecules with side-chains that may change in number and position to give gene mutations. Presumably multiple alleles, such as we have seen in the eye color of *Drosophila*, represent a series of mutations of one gene. And the fact that graded *series* of mutations (in *Drosophila*, from red to white eyes) occur, suggests progressive, or directional, changes in the chemical structure of the gene. Indeed it may possibly offer an explanation of the fact that evolution in many cases seems to show definite directional trends, referred to as ORTHOGENESIS. Obviously, all these changes afford a wealth of opportunities for alterations in the germ plasm and so for the appearance of new characters in organisms. (Fig. 339.)

True it is that mutations seem to be infrequent in comparison with non-inheritable changes of somatic origin, nevertheless it must be borne in mind not only that somatic changes are more readily apparent, but also that the majority of the mutations which occur lead to a decrease in vitality or even to death. This is to be expected, for an apparently random change in a highly complicated 'mechanism' such as a living organism, which has long survived in a severely competitive environment, is far more apt to upset than to improve the nicety of its internal and external adaptation; natural selection is conservative unless a changing environment is presenting new conditions to be met. In general, natural selection hews to the line and tends to keep wild types within specific bounds. (Fig. 340.)

Relatively little information is available in regard to the basic factors that induce mutations, but we have seen that recent experimental work indicates that environmental factors, such as irradiation, etc., acting directly on the genetic complex are not without influence — mutations have been produced. Therefore it seems probable that both external and internal environmental conditions, particularly the new cellular environment of the genes following hybridization, are potential inducers of mutations and so of new variations at the disposal of natural selection. However, when all is said, we are far from any appreciation of the physico-chemical changes in the germinal material itself that are responsible for the new characters. And characters may emerge that cannot be recognized as the computable or additive result of newly associated genes — the expressions of the genes may change, new properties may emerge from new relations — “emergent evolution.” Witness the properties of water that emerge from a certain association of hydrogen and oxygen. (Pp. 503–508.)

One may well inquire whether geneticists in their extensive experiments during the past two decades have succeeded in ‘creating’ a new species. And the answer is largely determined by one’s concept of a species — a problem we have already discussed. It is fair to say that some biologists hold that new species have been ‘created,’ while others who are more conservative prefer to consider the new forms as ‘artificial species.’ Certainly the new forms have distinctive characters, breed true, and are sterile with the parental forms, as a result of the chromosomal aberrations and other alterations in the genetic complex. Probably all would agree that some of the new types would be regarded as true species were their origin not actually known! Many of the chromosomal aberrations studied in pedigreed strains in the laboratory are also found in wild populations and often distinguish recognized races and species. The question, however, is not as important as it may appear at first glance. The essential fact is that we now understand, at least to a

considerable extent, the mechanism of inheritance and variation that is at the basis of similarity and dissimilarity of individuals, parents and offspring — the mechanism that surely is crucially involved in the differentiation of groups of similar individuals, or species. (Pp. 128, 559–562.)

To epitomize — these facts from genetics, taken in connection with the wealth of data from geographical distribution, the succession of types in the geologic past, and so on, give us the modern background for attempting to form an opinion of the method of evolution. The opinion of most biologists is that natural selection in general is a guiding principle underlying the establishment of the adaptive complexes of organisms. Evolution is the result of mutations, germinal variations, largely, though not entirely, independent of environing conditions. Many of these variations give rise to characters which neither increase nor decrease the adaptation of the organism, and consequently are neutral from the standpoint of its survival. With regard to such characters natural selection is essentially inoperative. Other germinal changes occur, some of which produce adaptive and others unadaptive characters, and here natural selection is effective. It may eliminate the unadaptive and leave the adaptive variations and so make possible the survival value of the latter in the struggle for existence. The germ plasm never ceases to experiment, or natural selection to discover. Variability affording opportunity for adaptability is expressed in 'evolvability,' a profoundly significant characteristic of life.

So, it will be noted, this is essentially a clarified view of Darwin's idea of natural selection that has been made possible by recent intensive studies of the intrinsic nature and the origin of variations. Natural selection still affords the most satisfactory explanation of that coördinated adaptation which pervades every form of life: it shows how nature can be self-regulating in establishing adaptations. But it is probable — indeed, positive — that there are more factors involved than are dreamt of in our biology. (Pp. 701–707.)

In the words of Thomson: "The process of evolution from invisible animalcules has a magnificence that cannot be exaggerated. It has been a process in which the time required has been, as it were, of no consideration, in which for many millions of years there has been neither rest nor haste, in which broad foundations have been laid so that a splendid superstructure has been secured, in which, in spite of the disappearance of many masterpieces, there has been a conservation of great gains. It has its outcome in personalities who have discerned its magnificent sweep, who are seeking to understand its factors, who are learning some of its lessons, who cannot cease trying to interpret it. It looks as if Nature were Nature for a purpose" — indeed Aristotle, in effect, emphasized that the essence of a living being is not protoplasm, but purpose. However, this thought carries us beyond the accepted sphere of science into the great fields of philosophy and theology.

## CHAPTER XXVII

# THE HUMAN BACKGROUND

Thoughtful men will find in the lowly stock whence Man has sprung, the best evidence of the splendor of his capacities; and will discern in his long progress through the past, a reasonable ground of faith in his attainment of a nobler future. — *Huxley*.

**A**s the culmination of our survey of the continuity of life, it is important to consider briefly what is known in regard to human origins — to bring Man more specifically into relationship with the evolutionary process and to appreciate his affiliations as evidenced by the ancestral strands that persist in his fabric.

Primitive man everywhere recognizes his kinship with other animals and even endows them with many human attributes, but sophisticated man has been less generous. Indeed, the general recognition of Man's place in nature has but recently been attained, although more than two thousand years ago Aristotle placed him at the summit of animal creation, emphasizing his God-like nature, but withal regarding him as only the highest point of the Scale of Nature. Linnaeus, the founder of our modern method of classification, during the middle of the eighteenth century placed Man in the order PRIMATES of the class Mammalia, a position he has since held. (Figs. 443, 451.)

### A. THE PREHUMAN LINEAGE

The order Primates to-day comprises three suborders: the LEMUROIDEA, or Lemurs; the TARSIOIDEA, or Tarsiers; and the ANTHROPOIDEA, or Monkeys, Apes, and Man. Most of the characters which distinguish them from the other groups of Mammals represent adaptations to a tree-dwelling life:

adaptations for climbing, for subsisting on a simple and plentiful food supply, and for taking advantage of changing

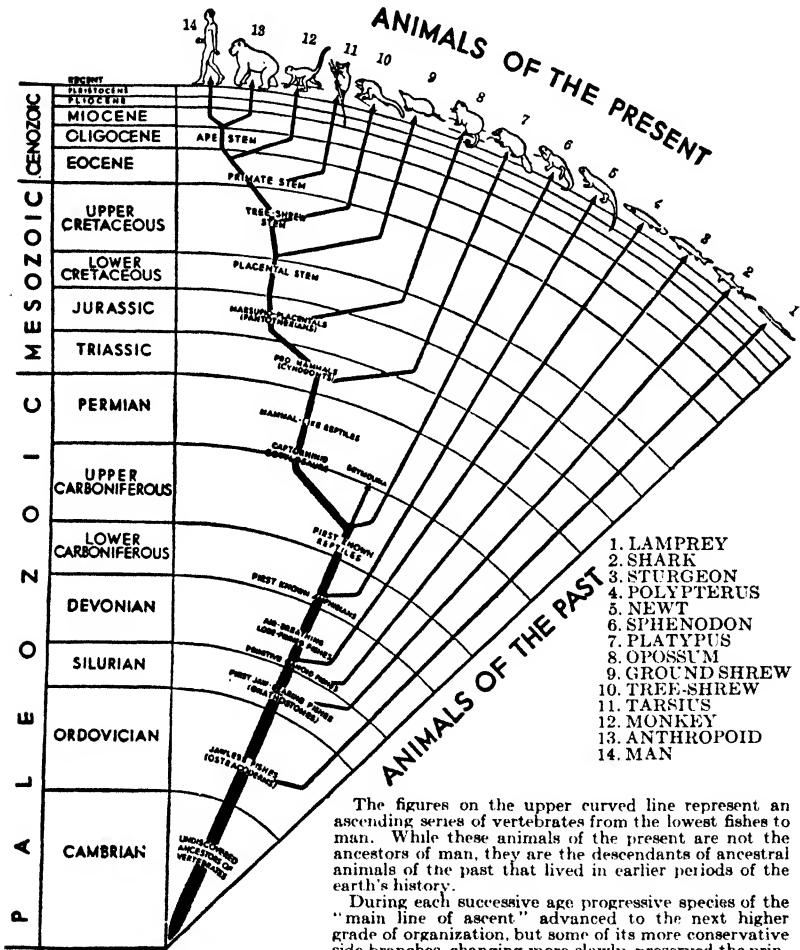

Fig. 397. Phylogenetic tree of vertebrate evolution, especially emphasizing the ancestral history of Man. (From Gregory.)

environmental conditions by a bigger and better brain. (Figs. 211, 397, 398.)

The Anthropoidea, in which our interest centers, are widely distributed throughout the tropical regions of both



hemispheres, and although those of the Eastern and Western Hemispheres doubtless were derived from the same original stock, they have followed somewhat different though, in general, parallel evolutionary paths since their origin more

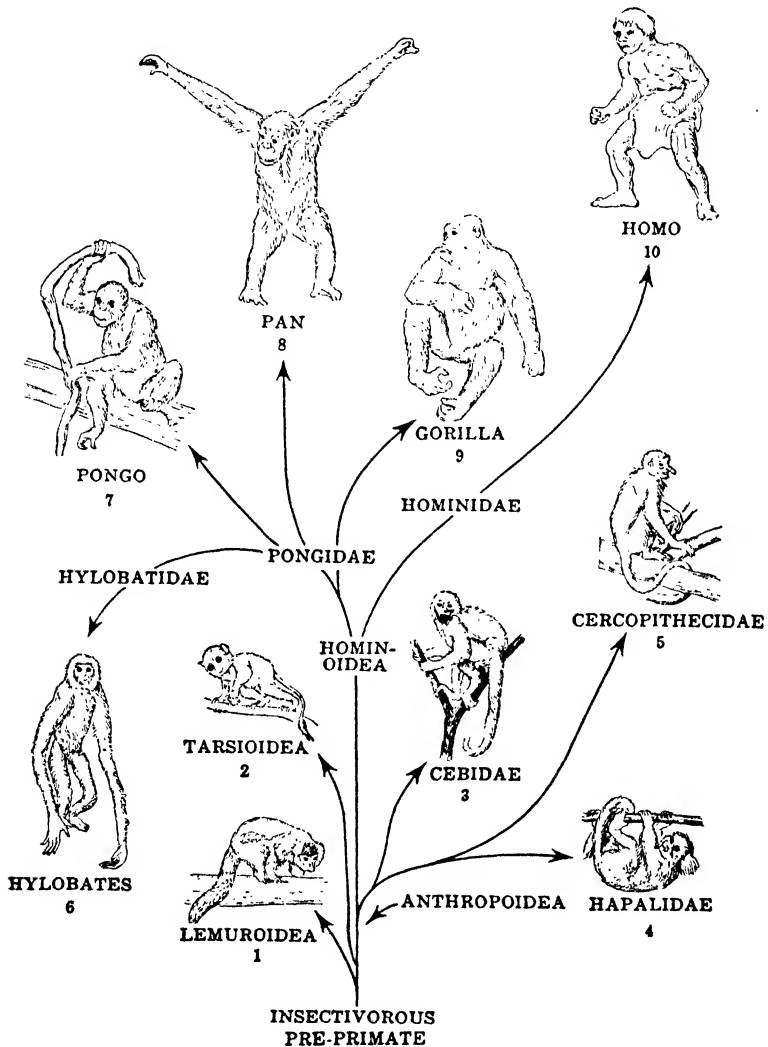

FIG. 398. General relationships of the Primates. 1, Lemur; 2, Tarsius; 3, New World Monkey; 4, Marmoset; 5, Old World Monkey; 6, Gibbon; 7, Orangutan; 8, Chimpanzee; 9, Gorilla; 10, Neanderthal Man. See p. 281.

than fifty million years ago, early in the Age of Mammals. (Fig. 382.)

The Old World branch of the Anthropeida is of especial importance because it is dignified by the inclusion of Man. It comprises three families higher in rank than the Monkeys. These are the HYLOBATIDAE, or Gibbons; the PONGIDAE, or Orangutans, Chimpanzees, and Gorillas; and the HOMINIDAE, or Men. The Hylobatidae and Pongidae are known as the man-like, or ANTHROPOID APES. However, all are not agreed that this separation of the anthropoid apes from Man is justified, for, as one states it: "between the Gorilla and Man, barring for the moment the mental and spiritual distinctions, there is hardly more difference than there is between the horse and the ass, and the degree of consanguinity is much the same." And another assigns the separation to the prejudices of "that self-conscious prig who calls himself *Homo sapiens* and is fond of acting like a viceroy of God." Perhaps all may be satisfied by grouping the Anthropoid Apes and Man in a single Superfamily, the HOMINOIDEA. (P. 281.)

At all events, the inevitable inference is that these various forms have evolved from a common stock, though it should be emphasized that no living species represents the direct human ancestor. The chimpanzee-gorilla group is regarded as the nearest to Man, but these apes have evolved along different lines since the divergence of the human lineage in the geologic past. Apparently the common ancestor was a rather large animal with a mode of life more similar to the present-day Gibbons than to either the Chimpanzees or the Gorillas, although anatomically the Gibbons to-day differ more markedly from Man than do any of the other anthropoid apes. Gibbons are relatively small active animals with such very long arms that the knuckles reach the ground even when the body is erect. But they are strictly arboreal forms whose amazing adaptations for progression through the foliage of trees have been suggested as of prime importance in the development of their mentality; and so possibly it was with the prehuman ancestors. (Figs. 211, 399, 400.)

Receding still further into the past, there were antecedent to the common ancestor of the anthropoid apes and Man more and more primitive forms — Tarsioids or Lemuroids — and so back, and still further back to an insectivorous



FIG. 399. Chimpanzee, *Pan troglodytes*. Note large ears, long lips, ridge above eyes, long arms, nails on fingers and toes, and hand resting on back of fingers. Height  $4\frac{1}{2}$  feet; weight of male, 160 pounds. (Drawn by Horsfall.)

stem from which the Primates originally emerged. It is perhaps somewhat in deference to Man that the Primates are usually placed as the culminating order of Mammals and so of the Vertebrate series, because in spite of their larger brain — and the use they make of it — the Primates retain many primitive characters that elsewhere are found only in the lowly order INSECTIVORA. (Fig. 346.)

No useful purpose will be served at the present time by

delving further into the geologic past for still earlier antecedent forms, because behind the Insectivores the actual record becomes increasingly obscure. However, it seems certain that the latter were evolved from still more primitive Mammals during the Mesozoic Age — the Age of Reptiles; the earliest Mammals arising from the reptilian stock.



FIG. 400. Gorilla, *Gorilla gorilla*. Note large head, small ears, short lips, large canine teeth, ridges above eyes, and absence of a chin. The gorilla walks on the backs of its fingers. Height about 5½ feet, weight 500 pounds. (Drawn by Horsfall.)

Returning to Man as a Primate and his relationships with the anthropoid apes, we are on more firm ground. This relationship is supported by many independent but interlocking lines of evidence, such as the similarities in structure of the brain and viscera, of the musculature and the skeleton in general, and of the hands and feet in particular. The differences are almost entirely in proportions. Thus Man has a larger brain and brain-case as compared with the facial portion of the skull, smaller development of the canine

teeth, complete adaptation of the structure of the vertebral column to the upright position, greater length of the legs as compared with the arms, and greater length of the great toe with almost the complete loss of the power of bringing it in opposition to the other toes. This latter characteristic and the small size of the canine teeth are probably "the most marked and easily defined distinction that can be drawn between Man and the anthropoid apes." (Fig. 401.)

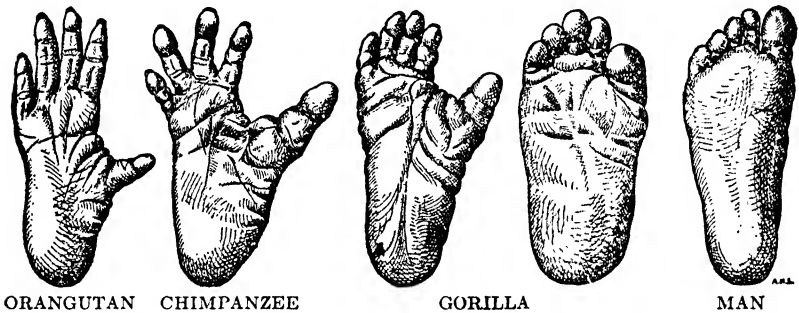

FIG. 401. Feet of Anthropoid Apes and Man. (From Schultz.)

But, in general, the structures are almost identical. Indeed, even the ridges on the palms and soles, and the chemical properties of the blood indicate affinity. And not the least important evidence is the structure of the premolar and molar teeth, because those of Man are very unlike those of any other animals except the great apes. Therefore the teeth, especially since they withstand well the ravages of geologic time, afford excellent clues in the search for the fossil anthropoids at the root of the human family tree. (Figs. 378, 397, 398.)

Numerous fossil remains have been found that give evidence in regard to the origin of the anthropoids. Back in the Eocene epoch are various Tarsioids and a monkey which bridge the gap to higher Primates, and in the Oligocene epoch are several monkeys and anthropoid apes that are near to the main line of ascent. And then in the Miocene epoch appears *Dryopithecus* which leads in the Pliocene epoch — perhaps ten million years ago — to *Ramapithecus* with teeth directly

foreshadowing those of Man. *Australopithecus* is even closer to Man, but, since this genus and its kin do not appear until the Pleistocene, it is a contemporary of early Man, and not his ancestor. However, our immediate anthropoid forebear must have been very similar to this genus. The number and arrangement of the teeth, the bicuspid pattern of the premolars, as well as various characters of the incisors, canine, and the milk dentition, are prophetic of the human dentition to-day, particularly in certain primitive races. It appears that the differences shown by the human teeth are to a considerable extent the results of an omnivorous diet, and of changes in the proportions of the jaws, following the great expansion of the cranium in providing for the enlarging brain.

So it seems reasonably clear that the prehuman ancestors arose through or near the *Ramapithecus* stem, and that the human status was attained through a long-continued and profound morphological evolution during the Pliocene and Early Pleistocene epochs. The ancestral stem was adapted to live in the vast forests of the Old World; an arboreal habitat being the only one in which the fore-limb could become a true hand and the sense of sight gain the ascendancy over that of smell. But as geologic time progressed, geologic, topographic, and climatic changes occurred, the forests became restricted, and we may assume that the Primates which had not already made a retreat were impelled to renounce, in part, the arboreal for a terrestrial habitat.

Thus the precursors of Man made the next great necessary step — to the ground: an environment which was provocative of many adaptations, in particular the erect body with hind limbs supporting the entire weight. This necessitated considerable mechanical readjustment, including the alternating curvature of the vertebral column for the nicer balance of the larger cranium. Moreover, the development of the brain, furthered by the emancipation of the hands from their part in locomotion and by changes in the vocal organs leading to speech, eventually paved the way to the

emergence of culture from the biosocial foundations of pre-man — to invention, communication, and social habituation. In the course of the ages Man arrived. (Figs. 224, 228.)

## B. FOSSIL MAN

The evolution of Man, unlike that of other organisms, presents two clear-cut aspects: the physical and the mental. His physical evolution was exceedingly slow, but his cultural development, once started, proceeded with increasing momentum. Both can be traced with some assurance from the actual fossil remains of prehistoric Man and the relics of his handiwork.

When one realizes how slight are the chances for the remains of prehistoric Man to become fossilized and, if preserved, to be unearthed to-day, and, furthermore, how short is the time that interest has centered in the problem, it seems remarkable that the record is no more fragmentary than it actually is. Some of the important fossil forms are of the greatest significance, though experts are by no means unanimous in regard to the interpretation of details. At present it is premature to attempt to reach a decision in regard to the specific Early Pleistocene ancestors of modern Man, but there is reasonable assurance that the problem will eventually be solved. Man probably developed from different centers, each branch taking its own course, more or less independently of the others. At all events his emergence is essentially a Pleistocene story. Some representative 'fossil men' may be reviewed.

### 1. *Java Man*

In deposits of the Middle Pleistocene of Java, some half a million years old, there have been discovered during the last fifty years various skeletal fragments which possess many of the attributes of 'missing links.' The bones found probably represent several species. The first discovered and most famous actually consists merely of a skull-cap, since the

associated bones proved to be unrelated, but more recently portions of three other skulls have been unearthed. With these fragments as a guide, experts have attempted to restore the chief features of this so-called JAVA MAN, *Pithecanthropus erectus*. However, the much vaunted Java man has become overshadowed in importance by newer discoveries in regard to the similar Peking man, who actually preceded him. (Fig. 402.)

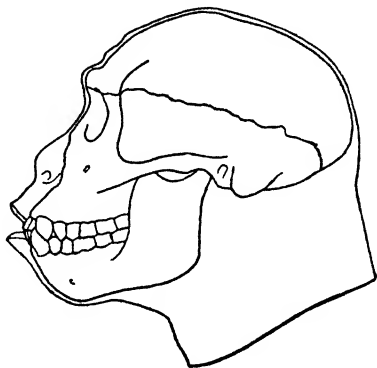

FIG. 402. Skull and face of the Java Man, *Pithecanthropus erectus*. Portion below irregular line restored. (From Lull, adapted from McGregor.)

## 2. Peking Man

At various times during the past thirty-five years many fragments of fossil man have been found near Peiping, China, in deposits of Early Pleistocene age, perhaps a million years old, and careful research on these fossils has established their authenticity. From the

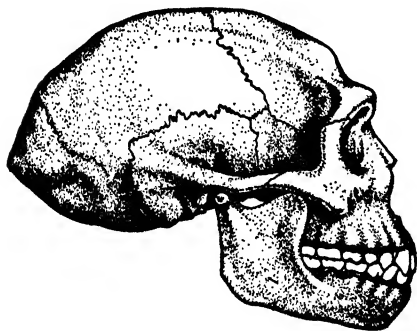

FIG. 403. Peking Man, *Sinanthropus*. The face and jaws are mainly restored. (From Romer, after Weinert.)

fragments discovered — skulls, jaws, teeth, etc. — it appears that the PEKING MAN, *Sinanthropus pekinensis*, had very thick cranial walls but surprisingly large cranial capacity. The brain was loftier but narrower than in the Java man, and the mastoid region of the temporal bone is suggestive of that in the adult anthropoid apes and

the human infant. The teeth are somewhat primitive although essentially human. The Peking man obviously represents a very primitive type in the general line of advance,



which seems to be very closely, but not directly related to the Java man. Moreover, there is some evidence of the dawn of culture with this early man. Abundance of carbonized material indicates the use of fire, and pieces of crudely chipped stones suggest the use of tools, while split bones make it reasonably certain that cannibalism was indulged in. (Fig. 403.)

### 3. Piltdown Man

Significant discoveries were made near Piltdown Common in Sussex, England, from 1911 to 1913, that included parts

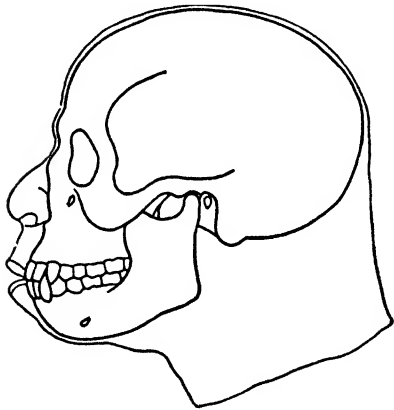

FIG. 404. Skull and face of Piltdown Man, *Eoanthropus dawsoni*. (From Lull, adapted from McGregor.)

of two crania and a lower jaw, nasal bones, and several teeth. The enormously thick cranial walls of this PILTDOWN MAN, *Eoanthropus dawsoni*, resemble those of the Peking man, but the forehead and vault of the skull approach nearer to that of modern man. However, the jaw and canine tooth are more ape-like than in the man of Peking, and probably do not belong to the same skeleton.

In fact, some believe that they represent a fossil Chimpanzee, just as a fossil Orangutan is now known to make up part of the original "Java Man"! Thus, these important relics are not completely understood as yet, and it is hoped that future finds will fill in the gaps in our knowledge of them. Although practically geological contemporaries, it is difficult from the scanty data to bring the relatively large-brained Piltdown man into relationship with the Java and Peking men. (Fig. 404.)

#### 4. Heidelberg Man

A second species of early Man, of definitely known geologic occurrence, is represented merely by a lower jaw found during 1907 in a sand deposit of Early Pleistocene age near Heidelberg, Germany. The quite massive jaw is of a primitive type, but the teeth are essentially human both in relative size and general appearance.

Accordingly, the HEIDELBERG MAN is included in the same genus with modern man, as *Homo heidelbergensis*. However, the relationships of Heidelberg man are obscure, though possibly he is an ancestor of the men of Neanderthal, his successors. (Fig. 405.)

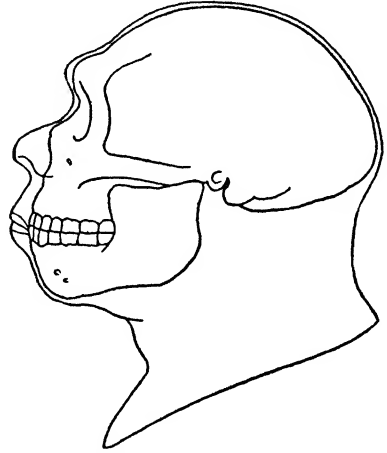

FIG. 405. Skull and face of Heidelberg Man, *Homo heidelbergensis*, based upon McGregor's restoration of the skull, only the lower jaw being known. (From Lull.)

#### 5. Neanderthal Man

The remains of NEANDERTHAL MAN, *Homo neanderthalensis*, appear in the caverns or rock shelters of Europe

several hundred thousand years after the Heidelberg man. The history of Man during the vast interim has not yet been revealed, but we must suppose that he persisted precariously through the intermittent periods of glaciation during the great ice ages. Indeed, the Neanderthal race may have diverged early in the Pleistocene, but it flourished in the last interglacial and the early part of the last glacial epoch. It appears to have sprung from an earlier stock of which the Java and Peking men were members. (Fig. 398.)

Neanderthal man is known to us from many skeletons, one of the earliest in point of discovery being found in the Neander Valley, near Düsseldorf, Germany, in 1857, and

one of the most recent in the Cave of Robbers near Jerusalem. The men of Neanderthal averaged about five feet, four inches in height and were stocky and powerful. They probably walked with a shuffling, slouching gait since curved thigh bones and imperfect curvatures of the spine

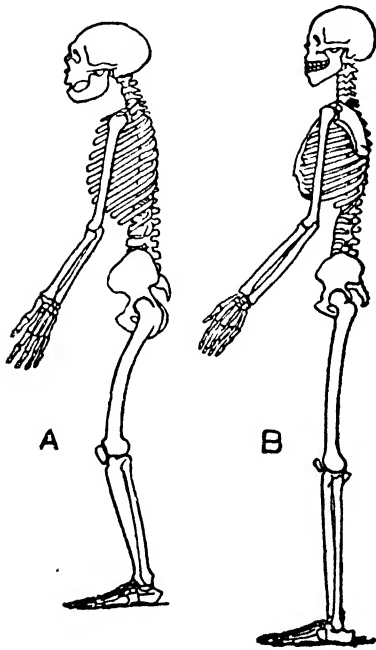

FIG. 406. Skeleton of Neanderthal Man (A), *Homo neanderthalensis*, compared with that of a living native Australian (B), *Homo sapiens*; the latter the lowest existing race. (After Woodward.)

show that the limbs were habitually bent at hip and knee. A large head with heavy jaws was supported by powerful neck muscles. (Fig. 406.)

The skull is notable for its size but the cranium is low and the forehead retreats from a continuous brow-ridge that is distinctive of the race. The large brain is relatively simple compared with that of modern man, especially in the regions devoted to the higher mental activities. However, that these cave men were not without ability is attested by the well-wrought stone hunting implements found associated with their remains. But bestiality outweighed human features, according to modern standards, though it seems

that some higher human traits lurked in their make-up because in certain instances there is evidence of reverential burial, with all that it implies. (Figs. 407, 409.)

## 6. Cro-Magnon Man

Sometime in the last glacial epoch the supremacy of Neanderthal man was challenged by a superior race — the first that is recognized as of the same species, *Homo sapiens*, to

which modern Man is assigned. This invading race of CRO-MAGNON MEN seems to be of different immediate stock from the Neanderthal men of Europe and, in large part at least, to be responsible for their extinction. Apparently Cro-Magnon man came from an Asiatic source about fifty thousand years before the dawn of history, after an antecedent evolution of many more thousands of years from a *Sinanthropus*-like stem. If this is true, modern man may be, so to speak, Neanderthal man's progressive nephew, though not his direct descendant.

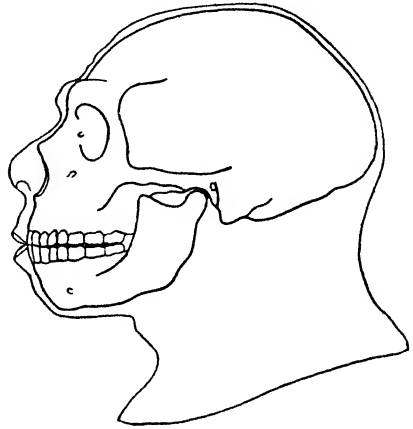

FIG. 407. Skull and face of Neanderthal Man, *Homo neanderthalensis*. (From Lull, adapted from McGregor and Boule.)

Although numerous remains of the Cro-Magnon race have been discovered, those from a rock-shelter of Cro-Magnon in western France represent the type. The men

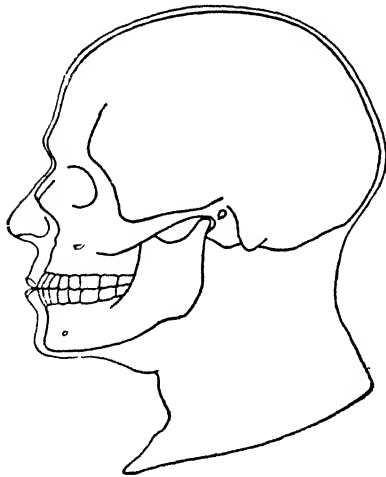

FIG. 408. Skull and face of Cro-Magnon Man, *Homo sapiens*. (From Lull, adapted in part from McGregor.)

were of large stature, averaging at least six feet in height, while the women were much smaller. The posture was entirely erect with the characteristically alternating curves of the human spine, and straight limbs. The cranium was of very large capacity with high, vertical forehead and no brow-ridges. The face was broad in comparison with the cranium, and the somewhat prominent chin, narrow and pointed. (Figs. 408, 409.)

The Cro-Magnons were a splendid race physically, and the remarkable Paleolithic art that still survives in certain caverns of France and Spain attests their mental equipment. Thus from both aspects they meet the standard of the species *Homo sapiens*, and differ in no great degree from their successors, the so-called Mesolithic and Neolithic races which, in turn, closely approach the present-day races of Man.

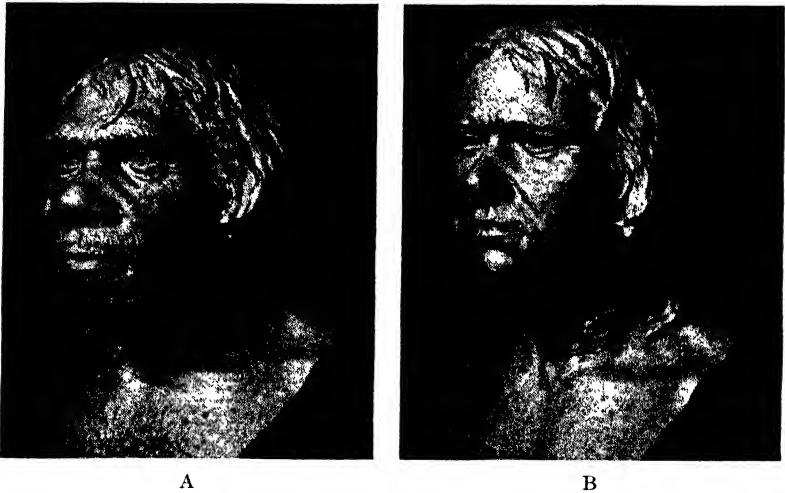

FIG. 409. A, Neanderthal Man; B, Cro-Magnon Man. Original models by Professor J. H. McGregor, in the American Museum of Natural History.

### 7. Human Variability

It is generally agreed that Man is represented today by one species comprising several races. The four commonly recognized are the Australoid, Negroid, Mongoloid, and Causcasoid. Their typical characteristics may be summarized.

**AUSTRALOID RACE:** brown skin; long skull; prominent eyebrows; large teeth; long, black, wooly hair; and long limbs. Habitat: Australia, and scattered regions in India and Ceylon.

**NEGROID RACE:** brown or black skin and eyes; long skull; round forehead; flattened nose; sloping teeth; and short,

black, woolly hair. Habitat: Madagascar and Africa from the Sahara Desert southward.

**MONGOLOID RACE:** golden-brown skin; broad and short skull; flat nose; small, oblique eyes; and coarse, straight, black hair. Habitat: east of a line from Lapland to Siam. Chinese, Tartars, Japanese, Malays, Eskimos, and American Indians.

**CAUCASOID RACE:** usually considered to comprise three varieties: *Mediterranean* — long-headed, short and slender with brown to black hair and eyes; *Alpine* — round-headed, medium height, stocky build, with brown to black hair and eyes; and *Nordic* — long-headed, tall, with flaxen, red, or light brown hair, and blue, gray, or green eyes.

The Caucasoid race shows great variation which apparently is due to the intermingling of the varieties, etc., and includes, in addition to the native peoples of western Europe and their widely scattered descendants, the Moors, Berbers, Egyptians, Persians, Afghans, Kurds, Hindus, Turks, Jews, and Armenians.

Since the early Pleistocene, Man has evolved and multiplied; he has eliminated many competing types and has domesticated others, and he has considerably modified not only the biological but also the physical conditions of his environment. In brief, he has become the first organism in the history of life that can with some justice be dubbed the Lord of Creation.

Approached from any standpoint and conservatively stated, this is a unique phenomenon with unique results. From the strictly biological aspect it is significant that *Homo sapiens* probably is the most variable Vertebrate and this variety has been achieved within the limits of a single species; not as in other successful types by expanding into scores of distinct species. And superimposed upon the intrinsic biological variability is the immense variability due to nurture in the broadest sense — upbringing, profession, etc., which results in a final variability that would astound were

it not so familiar. "This enormous range of individual variation often leads to misunderstanding and even mutual incomprehensibility; but it also provides the necessary basis for fruitful division of labor in human society." All men are born equal only in the sight of the law.

### C. CULTURAL DEVELOPMENT

The obviously unique characteristics that set Man apart from the rest of the Animal Kingdom are the capacity for CONCEPTUAL THOUGHT which is synonymous with true speech, the development of CUMULATIVE TRADITION, and its chief consequence, the continuous development of TOOLS. These are mutually interdependent and collectively are responsible for the dominance of Man on the earth. His position above the beasts is based largely upon the fact that he alone possesses a genuine culture. He domesticated himself — Man created culture, and culture created Man. But, of course, the biological basis constitutes the foundations upon which the cultural superstructure rests — Man cannot get away from Nature. Various culture patterns are impressed upon the individual as habits of thought and action and this social conditioning demands a complex organism with the ability to make environmental adaptations.

Animals in general exhibit various BIOSOCIAL reactions, such as the group life of Bees and Ants or the simple family life of the anthropoid Apes, that are inherited from generation to generation and are the outcome of evolution. But upon the hereditary biosocial endowment of actions and reactions, Man has superimposed processes of a cultural order that are acquired in each generation by the continuity of so-called group conditioning; *i.e.*, habits of body and mind are impressed upon the young by the elders and cumulative tradition results. Although these cultural processes are an addition to, and are dependent upon the hereditary biosocial endowment, they are something more than merely an elaboration of it. They are essentially untrammelled by the limitations of the slow process of organic evolution that is depend-

ent upon germinal variations and natural selection. Thus the cultural aspect of human nature can and does forge ahead in so far as the physical and mental heritage is adequate to meet the emergency.

### 1. *Paleolithic Culture*

Most of the specimens of prehistoric man have been found in Europe and this holds true also for the evidences of his culture, so our attention may be confined to this region where the chronology has been worked out most thoroughly.

The first artifacts appear in the Pliocene period or very early in the Pleistocene epoch of periodic glaciation, and consist of pebbles that obviously have been chipped by man. This culture is evidence of the exceedingly slow dawning of human mental life because it persisted with little improvement for not less than several hundred thousand years. It apparently represents the cultural scale of the Peking and Piltdown men and possibly also of Heidelberg man. However, as time passes we find that the artifacts increase in variety of form and nicety of manufacture, and the so-called PALEOLITHIC culture emerges. There are cleavers, axes, scrapers, drills, etc., some of them apparently shaped for convenience in grasping, and eventually we reach the work of Neanderthal man — the first Paleolithic culture that can be assigned to a definite race of OLD STONE AGE MEN.

The relics of Neanderthal man, unlike those of his precursors, are found typically in rock shelters and caverns. The chief source has been in western France, although a similar culture is widespread in other suitable regions of Europe, and in Palestine and Mongolia. The most famous cavern, at Le Moustier in France, is believed to have served as a human abode for more than fifty thousand years, and accordingly the culture of the Neanderthals is known as MOUSTERIAN. (Fig. 410.)

The stone implements of the Neanderthals show technical improvements in the methods of chipping as well as a greater variety of form. In addition to the point and the scraper



there are saws, hammers, drills, and skinning implements. Also tools of bone were used for dressing hides, but there is no evidence of implements for sewing so it is assumed that clothing, such as it was, consisted of single skins. And it may be emphasized, in passing, that the invention of clothing, whenever it occurred, was a primary step in human progress,

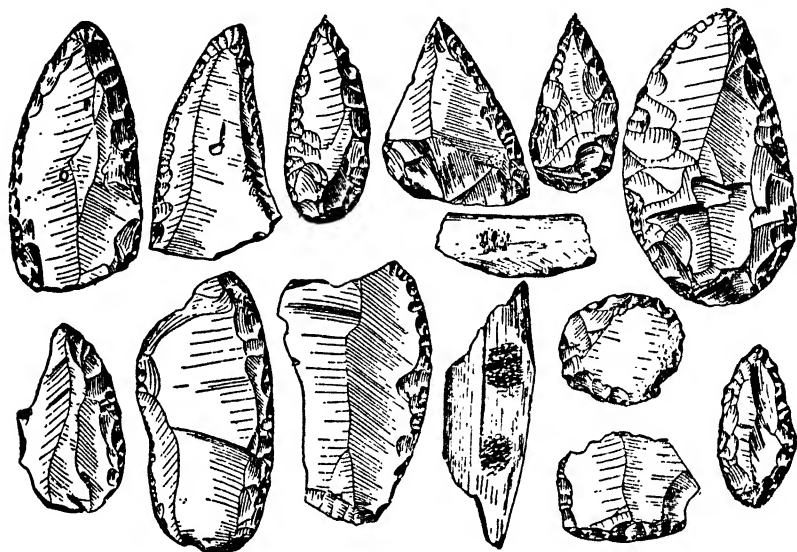

FIG. 410. Mousterian implements. Flint scrapers and points, and two bone compressors from a rock shelter of La Ferrassie (Dordogne), France. Middle Paleolithic Period. (From MacCurdy, after Capitan and Peyrony.)

because it largely removed the limitations imposed by climate and so opened up new regions for human development.

The use of fire was known to Neanderthal man, and burial of the dead was practiced, but even the simplest pictorial art was not developed. Apparently chipping flint tools and hunting demanded all the energy and ability of the Neanderthals until they were superseded by the Cro-Magnons.

It is believed that a wave of migration from Asia brought the Cro-Magnons to western Europe where they met and to some extent mingled with the Neanderthals, but to the eventual extinction of the latter. Clearly it was the survival

of the fit for the Cro-Magnon was essentially like modern man both physically and mentally, and "the characters of their crania reflect their moral and spiritual potentialities." It was a race of hunters and warriors, of sculptors and painters that lived at the close of the long glacial epoch, some fifty thousand years ago.

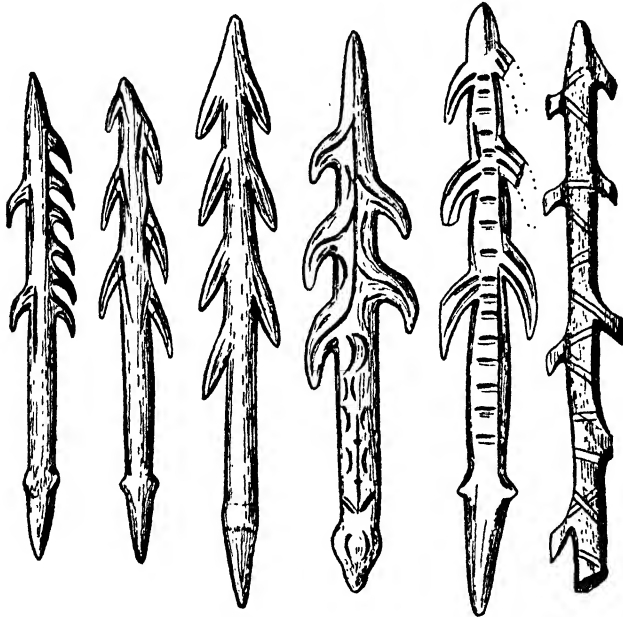

FIG. 411. Harpoons of reindeer horn from France and Switzerland. Late Paleolithic Period. (From MacCurdy, after Breuil.)

The marked line of cleavage between the Neanderthal and Cro-Magnon cultures is attested by a newly developed kit of tools. No longer are the implements confined to such as can be fashioned merely by chipping, but include, for example, the harpoon of reindeer horn, the flat bone point with cleft base, the needle of bone or ivory, the dart thrower, and the flint scratchers, knives, and gravers. The latter were used both for cutting bone, horn, and ivory and also for engraving and sculpturing. Indeed the Cro-Magnon artist not only modeled in clay, but also was skillful with

colors, first simple, later blended, as is still attested by the drawings and frescoes on the walls and ceilings of his caverns. However, the art that depicted the Woolly Rhinoceros and the Mammoth was to fade as the diminishing ice sheets forced these animals north to eventual extinction. The cause of this flowering of artistic ability and its passing remains an enigma. It was not exhibited by the immediate successors of Paleolithic man, though comparable art flourished at a very much later period among the Bushmen of South Africa. (Figs. 411, 412.)

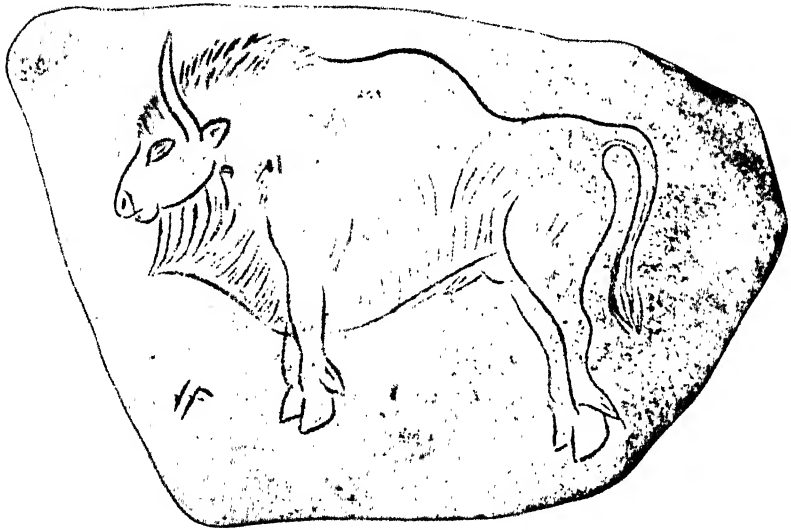

FIG. 412. Bison incised on limestone. Rock shelter of Laugerie-Basse (Dordogne), France. Late Paleolithic Period. (From MacCurdy.)

## 2. Mesolithic Culture

The so-called MESOLITHIC culture succeeded the Paleolithic and represents, as it were, the Dark Ages of the prehistoric era. Characteristic of the period are the huge shell heaps — refuse piles that throw considerable light on the food habits and implements of the people. These are found in Europe, Asia, and America. Usually they were situated near water as is evidenced by the great abundance of oyster

and mussel shells, and of the bones of the duck, goose, gull, and swan. Mammals are represented by bones of the stag, boar, wolf, bear, beaver, etc. It is significant that remains of domesticated animals are not present, except possibly of the dog — the earliest companion of man. Among the implements are arrow points, axes, adzes, and blade-like flints, while remnants of pottery show that at least crudely fashioned bowls and jars were employed.

Other interesting accessions of the period are the curious painted pebbles that are found in stream beds. The pebbles bear symbols of various kinds, some of them crudely resembling modern letters. In fact it has been seriously suggested that these symbols represent a mode of writing and that some of them have had their influence on our own alphabet.

### 3. Neolithic Culture

The culture of the NEOLITHIC, or NEW STONE AGE, is essentially that of modern men who have deserted cavern life and taken to the open. The animal life is also modern since no 'prehistoric' animals persisted and none have since become naturally extinct. The human population appears to have been increasing in numbers, and the division of labor between individuals and communities to have become more significant. Thus the Mesolithic hunter and fisherman gave place to the Neolithic husbandman who, to some extent at least, controlled his food supply and so made possible the development of community life. From a mere food gatherer, Man became a food producer.

Almost surely the relatively rapid transformation of the primitive civilization was the outcome of the cultivation of plants — such as wheat, barley, rye, flax, grape, apple, and pear; the domestication of animals — for example the dog, ox, sheep, and goat; and the development of the art of making pottery and textiles. Moreover pottery and textiles afforded an outlet for artistic ability and this is also evidenced, for instance, in the beautifully chipped flint pon-

iards and knives. The shaping and finishing of stone tools and weapons by a process of polishing appears for the first time in the Neolithic period which accordingly is frequently referred to as the age of polished stone implements. (Fig. 413.)

Transportation on water by means of dugouts began in Neolithic times, and the custom was developed of erecting habitations on piles in rivers, lakes, and swamps. Such

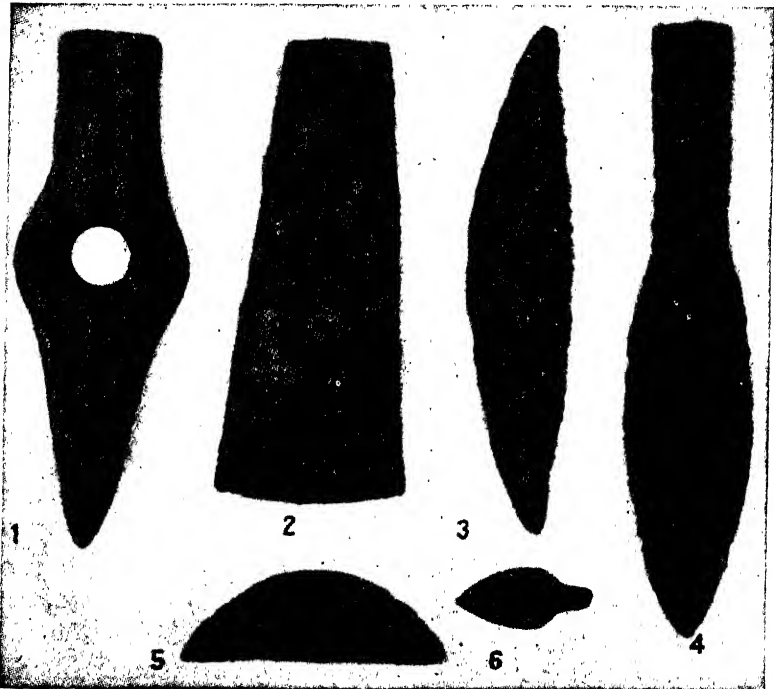

FIG. 413. Implements typical of the Neolithic Period. 1, ax-hammer; 2, ax; 3, saw; 4, dagger; 5, knife; 6, arrow point. (From American Museum of Natural History.)

PILE VILLAGES, serving both sanitation and safety, were widely distributed in Europe during the later Neolithic and survived into the following age. The best known representatives are the Swiss Lake Dwellings.

Transportation by dugout apparently antedates the invention of the wheel, but Neolithic man employed at least crude

wheels made from sections of logs, and the significance of this advance can hardly be overestimated. The wheel is so inextricably woven into the fabric of modern civilization that one is inconceivable without the other — probably nine-tenths of all the energy used by man is spent turning wheels. "Take away fire and the wheel and the world would suddenly revert to sub-Neolithic level."

Although burial of the dead extends further into the past, it reaches ceremonial significance with Neolithic man. Numerous so-called MEGALITHIC monuments still remain — some of them memorials to the dead, and others of unknown symbolic import. Probably the most celebrated is the Stonehenge on Salisbury Plain in England. And finally, to his other accomplishments, Neolithic man developed some surgical skill as evidenced, in particular, by skulls showing trepanation. So culture moved on apace to the Age of Metals.

#### 4. *Age of Metals*

The gradual transition from the Stone Age — Paleolithic, Mesolithic, and Neolithic — to the AGE OF METALS effected perhaps the most important step in the history of human culture. It meant a release from the restrictions inherent in the very nature of stone and the opening up of the almost infinite possibilities of metals in the fabrication of newer and better instruments and utensils. Invention was stimulated.

Each step in the progress of invention toward security of life and property for early Man gave further impetus to community living, and this forced a growing respect for simple mutual interests. However, it was only after the stimulus for making inventions had resulted in an easier life with regard to security, food, and shelter, and also had released to individuals more time for physical ease, that growing ethical relations between man and man and tribe and tribe became strongly evident, and community living became smoother. The early aims of each human being

seem to have included security for self and family, such as characterize the objectives of most Mammals. Then Man gradually came to desire the permanent establishment of health, recreation, and contentment as part of his place in the sun.

This turning point in culture was fostered by the development of the art of extracting metals from their ores and of melting and casting them. Copper was the first employed, probably because it was available in its native condition, and led to a transition period, the so-called AGE OF COPPER. This later gave place to the great BRONZE AGE, with the discovery of the many advantages of this alloy of copper and tin. The Bronze Age extended approximately from 3500 to 1000 B.C. and shows gradual progression in the variety and nicety of fabrication of tools, utensils, ornaments, etc., as well as concomitant progress in many other aspects of human culture. Life in the late Bronze Age is depicted in Homer's *Iliad* and *Odyssey* — Achilles' shield was of bronze. The Bronze Age gradually merged into the IRON AGE which bridges the transition between prehistoric and historic times.

So Man has travelled far since culture emerged from the mere biosocial pattern. He has gained an increment in each generation and passed it on by so-called 'social heredity' until the cumulative result is monumental. The individual is what he is, and has the significance that he has, not so much by virtue of his individuality, but rather as a member of a great human society. Witness the high order of endeavor and social integration that has led Man not only to modern science and art, but has created within him the aspirations and ideals that make him unique in the world of life. It spells modern civilization that, ideally at least, ministers to the health, wealth, and happiness of mankind. And it is one of "the justifiable prides of science that what it has gained it seldom loses. Great wars, barbarian invasions, can halt progress and delay scientific advance for decades

## THE HUMAN BACKGROUND

or centuries, but when they pass Man takes up the chain pretty much where his ancestors were halted."

It is important to note that although cultural evolution has given to humanity greatly increased powers, the hereditary physical basis apparently has remained essentially the same since the origin of *Homo sapiens*. Increased cultural complexity has depended upon the intelligent use of structures and capacities already present and not upon the evolution of new ones. Indeed, the relatively static character of Man's nature may possibly constitute a crucial handicap to indefinite human progress. One may be a confirmed optimist and still admit that the increasing momentum of the stupendous cultural advance during the past century is today taxing the adjustment capacity — the adaptability — of the human biological heritage. Surely, Man must study himself more intensively.

And so we may appropriately reiterate what was stated on an early page: the most pregnant thought from the study of biology in general and Man's past in particular is the unity of nature — the oneness of life — based on the ever-increasing background of knowledge which "robs life of none of its mystery but rather serves to link it securely with the larger mystery of the universe and the Infinite back of it all." Man becomes more intelligible, and therefore more controllable, when he recognizes his affiliations and the ancestral strands that linger in his fabric. It is encouraging to know that he has behind him not a descent, but an ascent, and that there is some appreciable momentum in the right direction. "By means of his conscious reason and its chief offspring, science, Man has the power of substituting less dilatory, less wasteful, and less cruel methods of effective progressive change than those of natural selection, which alone are available to lower organisms. And by means of his conscious purpose and his set of values, he has the power of substituting new and higher standards for change than those of mere survival and adaptation to immediate circumstances, which alone are inherent in pre-human evolution. To put the matter in



another way, progress has hitherto been a rare and fitful by-product of evolution. Man has the possibility of making it the main feature of his own future evolution, and of guiding its course in relation to a deliberate aim."

In brief, Man though one with all living beings has the unique and all-important power consciously to study the ways, to direct the forces of nature, and to adapt himself to them. The knowledge of Man's physical development through the ages in no wise minimizes the other aspects of his nature on whose origin biology is silent, and which constitute the enormous gap that separates him from the beasts. Man alone has the capacity to know what is good and the freedom of will to strive for it. When the grandeur of this view of life to which biology leads is appreciated to the full, no reassurance is necessary of Man's commanding position — his opportunities and his responsibilities.

## CHAPTER XXVIII

# BIOLOGY AND HUMAN WELFARE

Man is part of a web of life which he continues to fashion, and the success of his weaving depends upon his understanding.

— *Thomson.*

**N**ow that we have made a general survey of the foundations of biology, it is important to consider some of the outstanding contributions of biology to human welfare — contributions made, for the most part, within a century, but already so interwoven with our everyday life that they have become indispensable.

Indeed, some of the great biological generalizations have in daily affairs a profound practical significance which is easily overlooked. For example, the cellular structure of all living things — implying the existence of a fundamental similarity in organization throughout the living world. Again, the basically similar life-stuff, protoplasm — demonstrating that all living nature is united by a common bond not only of cellular organization but also of protoplasmic basis to which all life phenomena are referable. Still again, the transformation by protoplasm of non-living material into living material — proving that living matter is ordinary matter uniquely organized. And finally, organic evolution. All nature is one.

These and other great biological truths have a far-reaching import to everyone, because collectively they unmistakably lead to the grand conclusion that human life must be interpreted in terms of all life. Man must conform to the general order of living nature of which he is an integral but dominant part. Remove one of the essentials of life and he

perishes like the beasts. But he differs in capacity to understand and to take advantage of circumstances. Human welfare, therefore, demands that man 'control' nature by consciously adapting himself to it. Indeed, the chief purpose of education is the adaptation of the individual and the promotion of adaptability — adjustment to the basic internal and external conditions of life without a loss of plasticity. Thus biology affords the natural foundation of the science and art of right living which human welfare demands.

### A. MEDICINE

Health — the adaptation supreme — is a priceless possession whether it be estimated from the standpoint of the well-being of the individual or in terms of national wealth. Accordingly, medicine, in the broadest sense of the word, is without doubt the most important aspect of applied biology. Human anatomy and physiology, on which the foundations of medicine rest, are merely special parts of the general sciences of anatomy and physiology of all organisms. In fact the interpretation of human anatomy is impossible except in the light of the comparative anatomy of Vertebrates, while human physiology owes its present state of development to the fundamental principles derived from experimentation on the lower animals. And hope for further advance is chiefly dependent upon similar investigations on animals which have been rendered insensible to pain by anesthetics. To mention one example: experimental surgery practiced on animals has demonstrated the possibility of innumerable operations which no conscientious surgeon would have ventured to perform for the first time on man. In the words of Darwin who gave up the sport of hunting on account of his great sympathy with the suffering of animals: "Physiology can make no progress if experiments on living animals are suppressed, and I have an intimate conviction that to retard the progress of physiology is to commit a crime against humanity."

## 1. *Microorganisms and Disease*

No one will gainsay that discoveries in preventive and curative medicine rank amongst the most important contributions of scientific research to civilization, and nearly all have as their foundation studies by generations of biologists. Though Pasteur's first investigations were in chemistry, his subsequent work, which pointed out the way of preventing and eradicating diseases due to microorganisms, followed naturally from his discovery that the souring of wine and milk is the result of the activities of organisms from the air which induce chemical changes. Injure the skin of a grape, and organisms from the atmosphere enter and fermentation begins. Exclude air or sterilize it, and fermentation is prevented. Lister immediately saw the importance of this for surgery, and modern aseptic surgery — one of the greatest blessings of mankind — was born. (Figs. 280, 450.)

Proceeding on the theory that since fermentation is the result of the activities of microorganisms, certain diseases of plants and animals are likewise caused by the invasion of the body by similar germs, Pasteur turned to the study of cholera in French fowls and anthrax in sheep and cattle. The treatment he employed so greatly reduced the death rate of the animals that it is estimated to have saved the French nation in twenty years not less than the amount of the war indemnity of 1871. Then Pasteur devised the treatment that is now universally employed for rabies, a disease which man usually contracts by infection from the bite of a 'mad' dog.

During the past half-century a host of investigators, following the lead of Pasteur, have secured undreamed-of results in discovering preventive measures and curative treatments for a long series of diseases of man, domestic animals, and plants. One thinks immediately of diphtheria, tuberculosis, bubonic plague, typhoid fever, pneumonia, malaria, syphilis, amoebic dysentery, and African sleeping sickness — all the results of the infection of man by microorganisms. It is hard

to realize that so recently as 1884, Koch, probably the greatest successor of Pasteur, proved that tuberculosis is caused by a specific type of Bacteria, and thereby revolutionized the treatment of this disease which has been estimated to cause about one-seventh of all the deaths in the world each year. (Figs. 374, 414.)

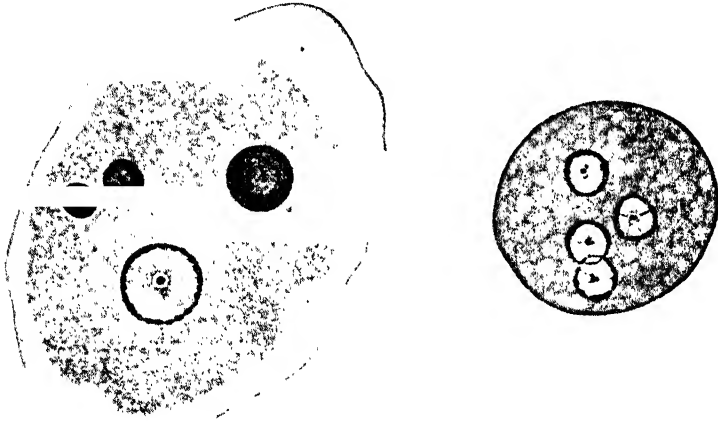

FIG. 414. *Entamoeba histolytica*, a parasitic Amoeba of the human intestine, which gives rise to amoebic dysentery. A, active Amoeba showing nucleus and three ingested human red blood cells; B, encysted Amoeba with four nuclei, preparatory to division into four individuals. It is estimated that nearly ten per cent of the people of the United States are infected, most of them being 'carriers' who show no symptoms. But a single carrier in one day may discharge some 30,000,000 cysts to menace the health of others less resistant. (After Dobell.)

Only second in importance to the prevention of human diseases that are due to microorganisms, is the suppression of diseases of domestic animals. For example, the Chief of the Bureau of Animal Industry estimates that the Bacteria which produce infectious abortion in cattle are responsible for an animal loss of approximately fifty million dollars each year in the United States. And the study of this disease is proving of increasing significance from the recognition that undulant fever in man is caused by a member of the same group of Bacteria — an excellent instance of how knowledge leads to further knowledge.

Indeed, the way interlocking data from several biological fields are frequently necessary to determine the causative agent of a disease can, perhaps, be best illustrated by a brief outline of the development of our knowledge of malaria, yellow fever, and syphilis.

**MALARIA.** From ancient times malaria, as the name indicates, was supposed to be due to foul air, especially from swampy regions, but the first step toward the correct explanation was made in 1880 when Laveran found certain micro-

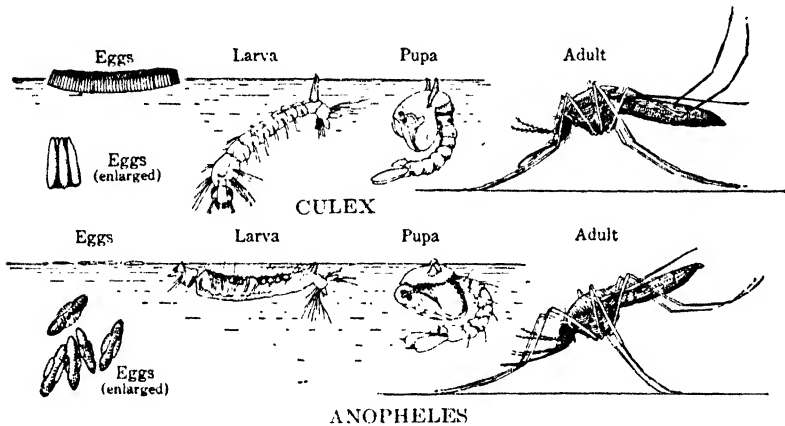

FIG. 415. Mosquito life histories. Mosquitoes of the genus *Anopheles*, which transmit malarial parasites, differ from the common *Culex* in every stage. When at rest the adult *Culex* holds its body parallel to the surface, whereas *Anopheles* holds it nearly perpendicular.

scopic parasites always present in the blood of malarial patients. Nearly two decades later Ross demonstrated similar parasites in the body of a Mosquito, and then a long series of studies by various investigators, among whom Grassi stands foremost, showed that when a female mosquito of the genus *Anopheles* bites a malarial patient, it secures with the blood some of the parasites such as Laveran had discovered, and thereupon the mosquito becomes the host of the Malarial organism. Within the mosquito, the parasite undergoes a complicated series of changes, including rapid reproduction. This finally results in myriads of parasites

located in the salivary glands of the insect, ready to be injected into the blood of the next individual bitten and to begin the other phase of its life history in man. (Figs. 373, 415; Pp. 544-546.)

So stated, it appears simple enough, but years of study by specialists on Insects (ENTOMOLOGISTS), by specialists on

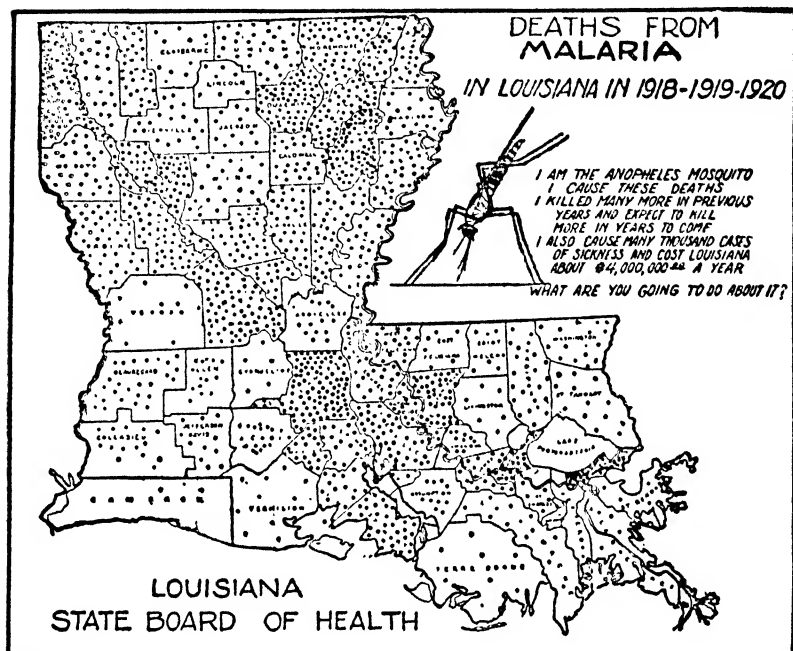

FIG. 416. Map used in anti-malaria campaign in Louisiana. Each dot represents a death from malaria. The public health importance of malaria, however, is more accurately measured by the sickness rate and the loss of efficiency than by the loss of life. It has been estimated that for each death 2000 to 4000 days of sickness must be included in the total burden of loss and suffering.

Protozoa (PROTOZOÖLOGISTS), and by physicians highly trained in general medical zoölogy are behind the scenes in making clear the way to eradicate a disease which, it is estimated, each year costs the United States not less than one hundred million dollars and the British Empire three times that amount. In India alone it is responsible for a death list of about two million people annually while some

one hundred million suffer from the malady. In the United States deaths from malaria have decreased more than sixty per cent since the turn of the century, but the disease is still a serious problem. However, present conditions in the Canal Zone and the Pontine Marshes of central Italy show what heroic measures of eradication will accomplish. (Fig. 416.)

But it must not be overlooked that the difficulties of control of malaria (as well as similar diseases and pests) are

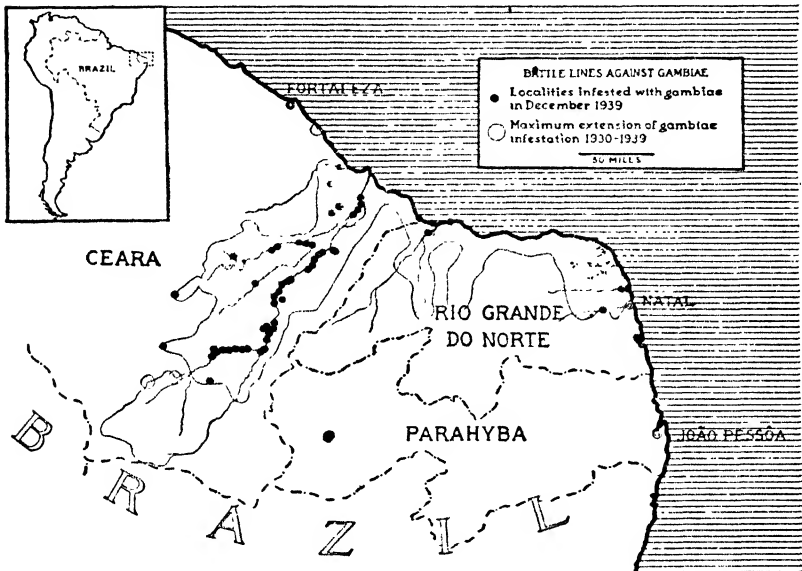

FIG. 417. The invasion by *Anopheles gambiae*. (From the Rockefeller Foundation.)

being increased by modern means of rapid transportation. Apparently the aeroplane is responsible for the recent invasion of Brazil by *Anopheles gambiae* from equatorial Africa. In the new environment the gambiae-carried malaria is working havoc, with the mortality in certain districts estimated at ten per cent. A distinguished malariologist has recently said that "this invasion of gambiae threatens the Americas with a catastrophe in comparison with which ordinary pestilence, conflagration, and even war are but small and temporary calamities." (Fig. 417.)



**YELLOW FEVER.** Proof that malaria is due to a Protozoön which can be transmitted to Man only by members of a certain genus of mosquitoes, was largely the work of English, French, and Italian biologists; but the demonstration that another kind of mosquito, *Aedes aegypti*, is responsible for the transmission of the parasite which causes yellow fever is due to Reed, Lazear, and other members of the United

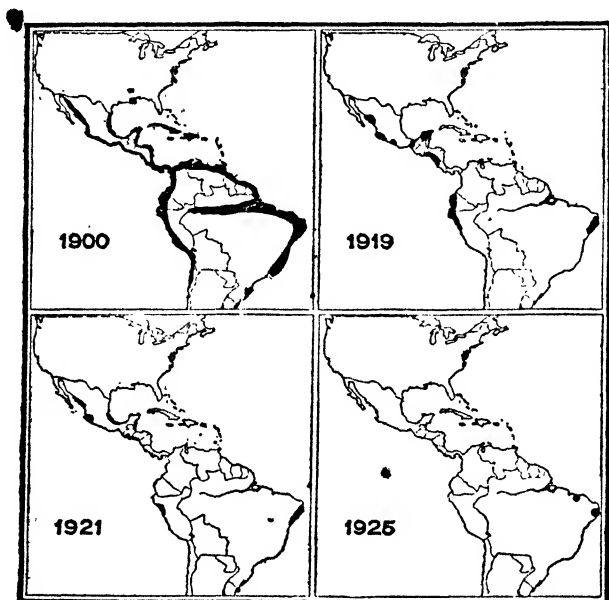

FIG. 418. Results of a quarter-century of yellow fever control as it appeared up to 1925. In 1928 an outbreak of so-called jungle yellow fever in Brazil somewhat changed the picture. (From the Rockefeller Foundation.)

States Yellow Fever Commission working in Cuba in 1900. This discovery was followed by an intensive campaign with the result that Havana was rendered free from yellow fever in just eighty days — for the first time in 400 years. And the Panama Canal became possible — the earlier attempt by France was unsuccessful largely on account of yellow fever. (Fig. 418.)

Now we even have to be reminded that half a million cases of yellow fever occurred in the United States during

the past century: the epidemic of 1793 took a total of one-tenth of the population of Philadelphia, and that of 1878 killed more than thirteen thousand in the Mississippi Valley alone. However, while this and more is true, the recent discovery in the jungles of Brazil of new sources of infection, involving unknown vectors and other hosts than man, has made the problem much more complex and the complete control of the fever less certain than it appeared to be a decade ago; although it is important to note that today one

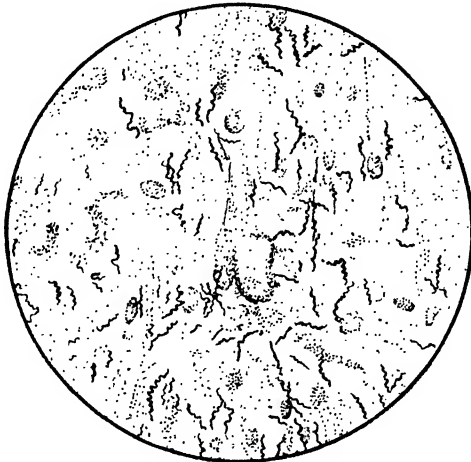

FIG. 419. *Treponema pallidum* (the spiral bodies) in liver of child with congenital syphilis. Highly magnified.

may be vaccinated with a weak virus of yellow fever and probably rendered immune for a year. In 1938 over a million persons were inoculated.

**SYPHILIS.** The brilliant investigations of the protozoölogist Schaudinn, in collaboration with Hoffmann, in 1905 revealed the unicellular parasite, *Treponema pallidum*, that is the cause of syphilis — one of the greatest scourges of mankind since it became widespread during the sixteenth century. The ravages of the parasite produce many symptoms — frequently a type of general paralysis with a gradual loss of the mental faculties and death. The discovery of the parasite has made possible intensive studies of therapeutic

measures to combat it, and the test of upward of a thousand chemical substances has resulted in the discovery of certain organic arsenic compounds of great specific value. While syphilis, of course, is not inherited, much of it in the world today is due to the infection of infants before or at the time of birth. (Fig. 419.)

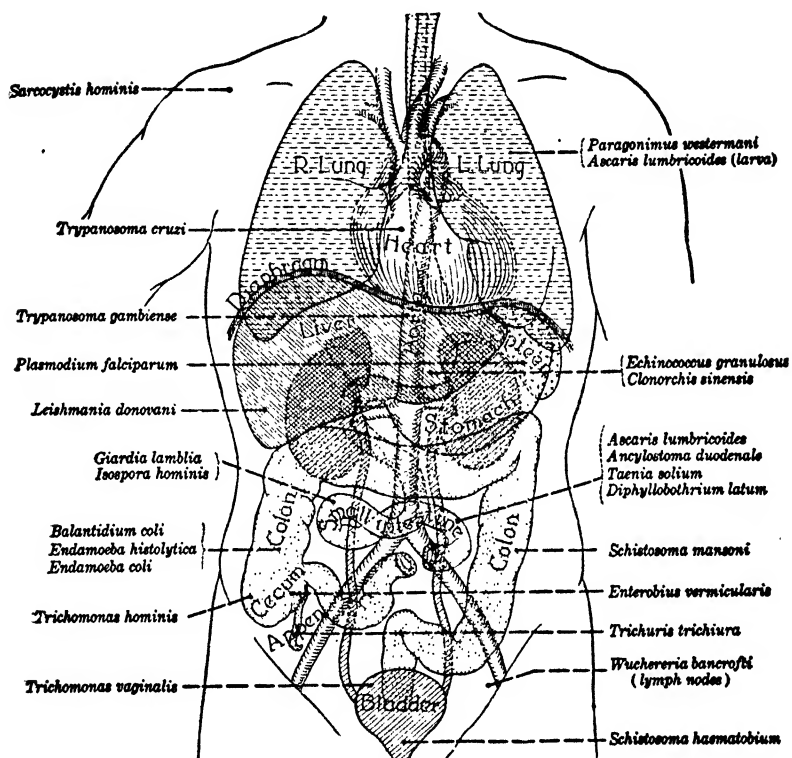

FIG. 420. The chief points of localization of some of the parasites in the organs of the human body. At the left are Protozoa; at the right, Worms. (After Hegner.)

## 2. Parasitic Worms

Thus far we have been considering causative agents of disease which are popularly called microbes, and we now turn from this "world of the infinitely little" to somewhat larger organisms which form a most important part of

medical zoölogy. This field may be illustrated by the various kinds of parasitic worms.

**TREMATODES.** There are many parasitic Flatworms, related to the free-living Planaria, that comprise the group **TREMATODA**. Parasitic species usually exhibit complicated life histories whose unravelling taxed the patience and ingenuity of biologists. Among the numerous species, the Liver Fluke is perhaps of most interest. (Figs. 159, 284, 420.)

The adult **LIVER FLUKE** is a worm about an inch long which lives in the bile ducts of the liver of sheep, cattle, pigs, etc., and occasionally of man. It is hermaphroditic, and in its isolated position is almost continually producing fertilized eggs. In fact, one fluke may liberate over five hundred thousand eggs which pass down the bile ducts of the host (sheep) into the intestine and finally leave the body with the feces. An egg that happens to reach moisture develops into a ciliated larva, or **MIRACIDIUM**, which escapes from the egg-shell and swims about. For further development to occur the larva must encounter within a few hours a certain species of fresh-water Snail, otherwise death results. But once it has bored into a snail's body, the parasite receives a new lease of life involving a series of changes. After about two weeks it has become a sac-like creature, or **SPORO CYST**, which in turn proceeds to develop within itself a brood of another larval stage, the **REDIA**. Each redia liberated from a ruptured sporocyst usually gives rise to one or more generations of rediae, and the final generation of these produces a third kind of larva, known as a **CERCARIA**. (Fig. 421.)

All these stages arise in the snail's body, but now the swarm of cercariae emerges from the snail, and each swims about in the water and finally encysts on a blade of grass. Here again the life of the parasite hangs in the balance, for death follows unless the grass with the cyst is eaten by a sheep and the cyst reaches the animal's intestine. This location successfully attained, the cercaria escapes from the cyst, and makes its way to the bile ducts where it soon

develops into a mature fluke, the cause of liver-rot in sheep. The life history is completed.

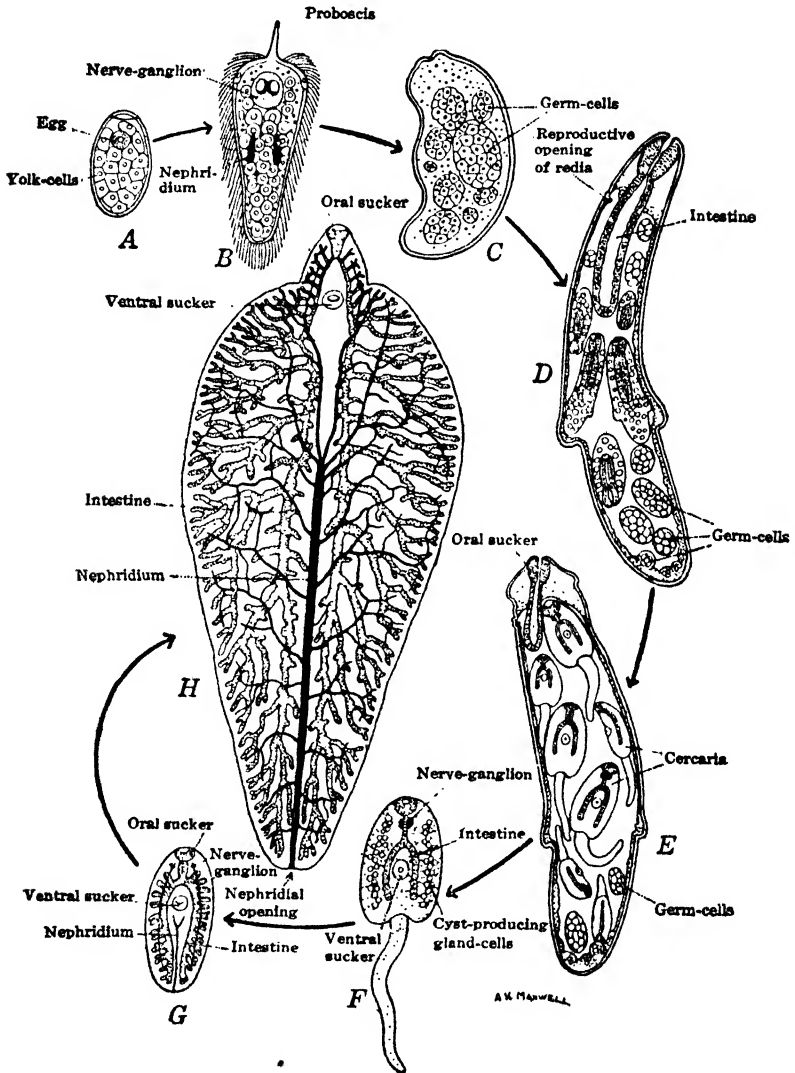

FIG. 421. Life history of the Liver Fluke, *Fasciola hepatica*. A, 'egg'; B, miracidium; C, sporocyst; D, E, rediae; F, cercaria; G, encysted stage; H, adult (nervous and reproductive systems omitted). (From Hegner, after Kerr.)

The large number of eggs produced by a single fluke increases the chances of a ciliated larva meeting the proper kind of snail, while the various generations within the snail multiply manifold the number of cercariae from a single egg, and just to that extent increase the opportunities for at least one to reach another sheep. This life history, while remarkable, is by no means unique, and is presented as a type which is broadly representative of a large group of parasitic Flatworms. No wonder that years of study are required by specialists in different branches of zoölogy to discover the various stages of the different species and determine their relationships.

**CESTODES.** The group of Flatworms known as the CESTODA comprises the numerous species of TAPEWORMS which infest the lower animals and man. The best-known species are *Taenia solium* and *Taenia saginata*, both living as adults in the human digestive tract, while the larvae of the former infest pigs, and those of the latter, cattle. (P. 227.)

*Taenia* is a long ribbon-like worm comprising a small knob-like head, or SCOLEX, which is an organ for attachment to the lining of the human digestive tract, and a large number of similar segments, or PROGLOTTIDS. These are formed by growth just behind the scolex so that the oldest and largest proglottids are at the posterior end of the animal. (Fig. 422.)

The adult tapeworm is hermaphroditic and each of the older proglottids contains both male and female reproductive organs, while the terminal 'ripe' ones are almost completely filled with eggs which have already developed into embryos. One by one the ripe proglottids become detached from the worm and pass from the host with the feces. For development to proceed further an embryo must be swallowed by a pig, whereupon it bores through the walls of the animal's intestine, passes to the voluntary muscles and there encysts. In this position it develops into the BLADDER WORM, or CYSTICERCUS, stage. To complete the life history, infected meat, insufficiently cooked, must be eaten by man. If this transfer is successfully accomplished, upon attaining

the human digestive tract the parasite gradually assumes the adult form, the scolex becomes attached, and a series of proglottids begins to develop.

Since tapeworms which live as adults in man and the higher animals secure their food by absorbing that of their host, they seriously interfere with nutrition, but larval stages

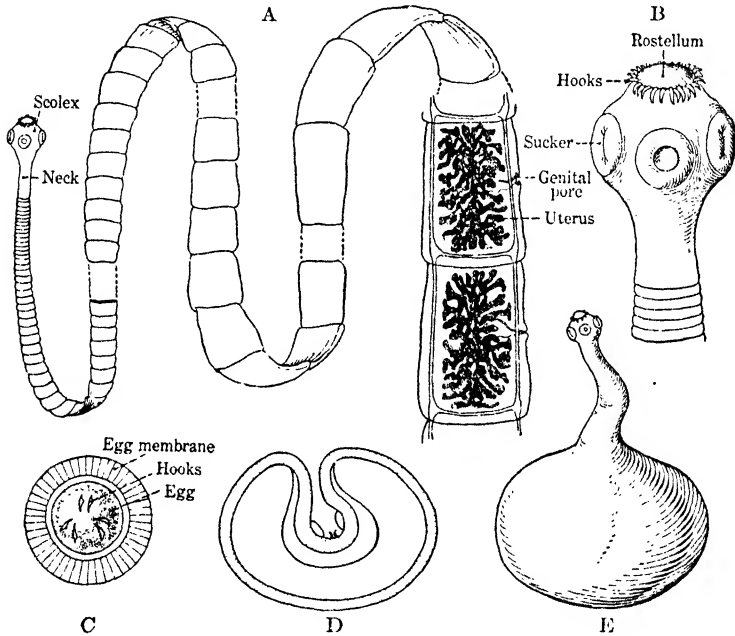

FIG. 422. Tapeworm, *Taenia solium*. A, anterior and posterior parts of a specimen about 8 feet long comprising some 900 proglottids. Uteri filled with eggs are shown in the last two proglottids. B, Scolex more highly magnified. C, egg with embryo. D, Bladder worm (cysticercus) before head (scolex) is protruded. E, same after protrusion. (From Hegner.)

are still more dangerous. Thus, the larvae of a tapeworm (*Echinococcus*), which lives as an adult in the intestine of the dog and other carnivores, form in the brain, liver, etc., of man, pig, and sheep large vesicles, or HYDATIDS, usually with fatal results. Such larvae in the brains of sheep were a stumbling-block for the early exponents of biogenesis, since, with the life history unknown, they could not account for the larvae except on the theory of spontaneous generation.

NEMATODES. Passing now to the NEMATODA, or ROUNDWORMS, we come to a group which, from the standpoint of medical zoölogy, is of as much importance as the Flatworms. Free-living forms are found literally everywhere in water, soil, and air, and blown about by the wind. Most nematodes are harmless, but some are of great economic interest because of their injury to the roots and other parts of plants. Thus the destructive 'spring dwarf' disease of the cultivated strawberry results from the activities of a microscopic nematode; sometimes there may be ten thousand in an

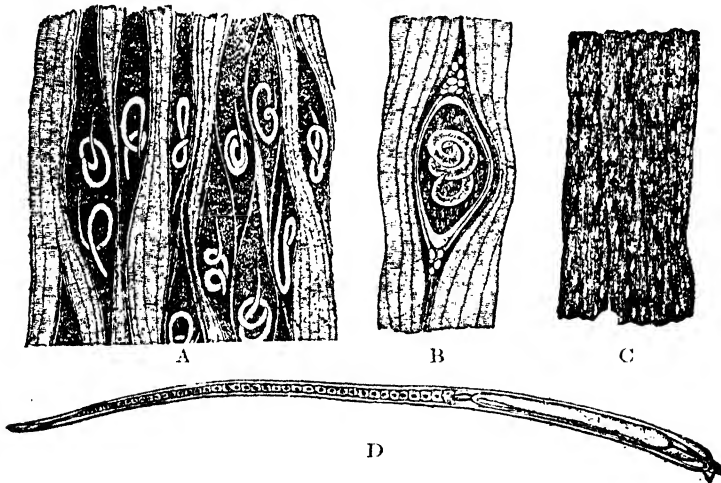

FIG. 423. *Trichinella spiralis*. A, larvae free among muscle fibers; B, a single larva encysted among fibers; C, piece of pork containing many encysted worms, natural size; D, adult worm, magnified. (From Leuckart.)

infected bud. Among the nematodes parasitic in man and the higher animals, *Trichinella* and the Hookworm will serve as examples. (Figs. 161, 162.)

TRICHINELLA is the cause of a serious disease in man, pigs, and rats known as TRICHINOSIS. Man becomes parasitized by eating infected pork, insufficiently cooked, and pigs contract the disease by eating offal or infected rats. The larvae from the meat quickly mature in the wall of the human intestine, and each female worm produces nearly ten thousand larvae. These pass by the lymphatics and



blood vessels to all parts of the body, localize in the voluntary muscles, and there encyst to await a possible getaway from the body at death. Since thousands of cysts which retain viability for several years may occur in a single gram of muscle, the riddling of the tissues is not only very serious, but may be fatal. (Fig. 423.)

The widespread distribution of the several species of HOOKWORMS and their insidious effects make them also of great practical importance. The tiny worms, just visible to the naked eye as whitish threads, are hatched in a warm

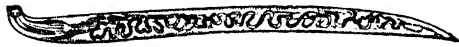

FIG. 424. The American Hookworm, *Necator americanus*, magnified.

moist soil, make their way through the skin of the human foot, enter the circulatory system, are carried to the lungs, and finally work to the intestine. Here, as adults, they become attached, feed upon the blood of their host and liberate eggs. These pass out with the host's feces to become the source of infection for others. The spread of knowledge of the essential facts and of vermifuges to expel the parasites has been an important contribution of the International Health Board which has carried on a campaign in over fifty countries. It has been estimated that not less than two million persons in the United States are afflicted with the disease, but the recently acquired facts in regard to the parasite should result eventually in its almost complete eradication. (Fig. 424.)

### 3. Health and Wealth

It has been aptly said that health and wealth are essentially synonymous, and this is amply shown by the fact that medical progress is reputed to have added at least twenty years to the average human life span during the past century — mainly years of the highest efficiency from the age of thirty-five to fifty-five years. It is conservative to say that the increase in longevity has effected a saving of more money

than has ever been expended in support of every kind of scientific investigation, and this without taking into account the economic value of the lives or the immensely greater factor of human happiness which follows from healthful and unbroken family life.

The same can also be said for the leading rôle which medical zoölogy has played in rendering vast regions of the tropics almost as safe for human habitation as the temperate regions of the earth — regions which must offer an outlet for the rapidly increasing human population. Statistics make clear that the population of the world has more than doubled during the last century; what it will do during the next century experts in vital statistics are actively computing. But this much is certain: it is merely a matter of time before regions now untenanted by civilized man must be encroached upon more and more, not only for food and other materials but also for a place of abode; and the first step necessary to make this possible is the survey of the innumerable biological competitors in the form of parasites, etc., which man must encounter in adjusting himself to this environment.

Again, knowledge is power — the best investment from the standpoint of health and wealth is in support of research. It is easy to forget that studies on the life history of micro-organisms, fleas, rats, and the rest have made impossible today such epidemics as have many times in the past swept over the world. During the Christian era more people have succumbed to the Plague than constitute the total population of the earth today. It is easy to forget that the biological forces of disease are costing the United States nearly four billion dollars annually — a loss largely preventable by an efficient dissemination of knowledge and an efficient application of biological principles already well established. Civilizations in the past have succumbed to the onslaughts of pestilences, and the hope of our immensely more complex community life depends upon the development of knowledge of these living agents of disease.

## B. BIOLOGY AND AGRICULTURE

True it is that man cannot live by bread alone, but it is equally true that the fundamental urge of all living things to secure food and to multiply is, in the final analysis, at the basis of human endeavor. Modern agriculture represents the body of knowledge accumulated by mankind during its slow progress toward civilization, involving increasingly exacting food demands as community life became more and more complex. Agriculture is, of course, dependent upon many fundamental biological sciences — indeed, agriculture is one aspect of applied biology — but merely a few examples must suffice to bring the most significant points before us.

### 1. *Plant and Animal Food*

As we know, all animals, including man, are absolutely dependent for their food upon the photosynthetic activities of plants. Green plants must manufacture enough food for themselves, and to spare for the rest of the living world as well. Animals must have ready-made food which, after they have used it, is useless both for animals and for green plants. Here, it will be recalled, the Bacteria and other colorless plants come in and make possible the completion of the biological cycle of the elements in nature: put the materials in a condition in which they are again available to green plants. (Figs. 17–20.)

This intimate food interrelationship of all living organisms, which has been demonstrated by interlocking data accumulated by thousands of biochemical studies, is not only of profound theoretical interest, but also of incalculable practical importance in all problems of soil fertility, including soil composition and maintenance, crop rotation, etc. To coax greater productivity from the soil — civilization rests upon the soil — is a problem of no mean importance. One of its most crucial factors is the demand for the economical production of food for plants themselves; in particular, for

an adequate supply of nitrogen in a form readily available for the use of cultivated plants.

A natural source of nitrogenous plant food is, of course, the nitrogen of the atmosphere, trapped by Nitrogen-fixing Bacteria; but the artificial conversion of this gaseous element into solid forms suitable for fertilizers has taxed to the utmost the ingenuity of chemists. Finally after years of intensive

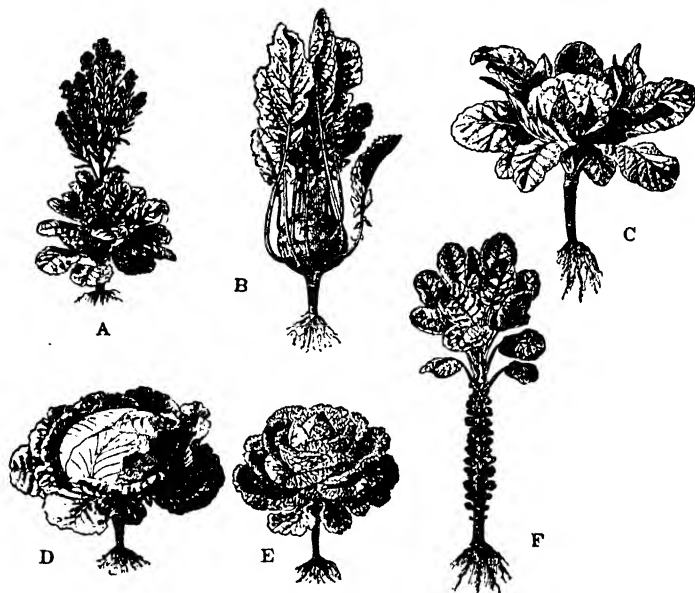

FIG. 425. A, the wild *Brassica oleracea* from which the following cultivated plants have been derived: B, Kohlrabi; C, Cauliflower; D, Cabbage; E, Welsh Cabbage; F, Brussels Sprouts. (After Smalian.)

laboratory study and experimentation, they have succeeded in developing industrial processes for accomplishing this result, which have created an enormous industry of world-wide extent and supplied agriculture with a cheaper source of this indispensable nitrogenous food for plants. (Fig. 19.)

Soil investigations involving the coöperation of chemist and biologist lay the foundations for studies on seed planting, germination, and growth, which in turn lead to others on transplanting, grafting, and pruning, and on pollination, hybridizing, and developing new varieties of plants. Nearly

every cultivated plant that is important for food or other purposes has been improved. The great body of practical information which the human race has accumulated from centuries of toil has been multiplied a hundred fold within the past generation, through the intensive work of investigators at agricultural experiment stations, colleges, and universities throughout the world. (Fig. 425.)

## 2. *Insects Injurious to Animals*

A former Chief of the United States Bureau of Entomology informs us that insects alone in this country continually nullify the labor of a million men, in spite of the annual expenditure of between two and three hundred million dollars in fighting insects, and if human beings are to continue to exist they must first win the war. This can be accomplished only by the labors of an army of patient and skilled investigators, and will occupy very many years, possibly all time to come. This is not only because the insect complex is enormous — there are possibly three million species of which only about six hundred thousand have been described — but also because insects achieved an important place on this globe many millions of years before man came into existence, and today are probably the most perfectly adapted of all creatures to live under all sorts of environmental conditions. If this statement appears extreme, the following examples will serve to make clear some of the cardinal facts which are necessary for an appreciation of the stupendous problems involved. (Fig. 179.)

Among this teeming insect population, probably the Botflies, Blowflies, Fleas, and Lice stand preëminent as parasites of man and beast. Botflies of various kinds infest domesticated animals but rarely human beings. The most common HORSE BOTFLY attaches its eggs to the horse's hair in a position where the eggs can be licked off and swallowed. Then the larvae spend nearly a year attached to the lining of the stomach, and if present in considerable numbers cause

irritation and serious digestive disturbances. When full grown the larvae pass out with the feces, pupate in the ground, and emerge as adult botflies.

Again, the common Ox Botfly deposits its eggs chiefly on the legs of cattle, but when the larvae, or 'cattle grubs,' emerge they penetrate the hide, and then wander through the tissues until the following spring. Finally they come to rest just under the hide of their host, which they puncture

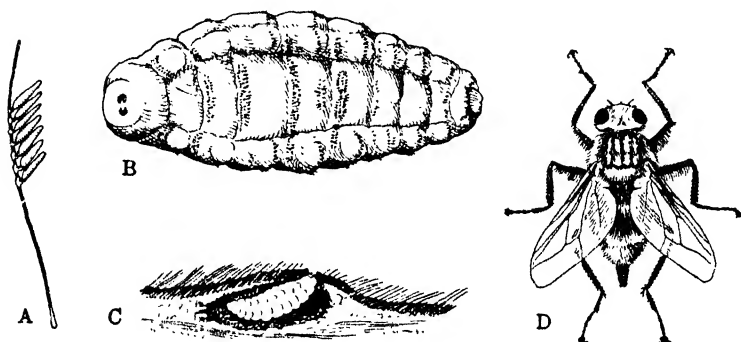

FIG. 426. Ox Botfly, *Hypoderma lineata*. A, eggs attached to hair; B, larva; C, larva just beneath air-hole in skin of Ox; D, adult.

to get air. When the larvae are ready to assume the pupal state they burrow out, drop to the ground and there complete their life history. It is estimated that the monetary loss from the Ox Botfly alone in the United States is about one hundred million dollars annually. (Fig. 426.)

Fleas and Lice of various species are common parasites of the higher animals throughout most of the world. The JIGGER FLEA of warmer climates is frequently a serious human pest because the female flea burrows into the skin when ready to deposit eggs. The Cat Flea, Dog Flea, and House Flea we usually consider merely a nuisance, but they are potential carriers of disease-producing microorganisms. One might think that a life devoted to the study of fleas and lice could be more profitably spent, until we recall that expert knowledge of these animals was essential to discover that Trench fever in the World War was transmitted by

lice; was essential to make clear that Bubonic plague, or 'Black Death,' is carried by fleas. (Fig. 427.)

It was long known that rats die in great numbers during a plague epidemic, and accordingly biologists set out to determine whether there is any relation between the disease of the rat and of man, and found that man is infected with the plague bacillus, *Bacillus pestis*, by being bitten by a flea from an infected rat. Extermination of rats and fleas means the practical eradication of the disease, but in California the Ground Squirrels have become infected with the

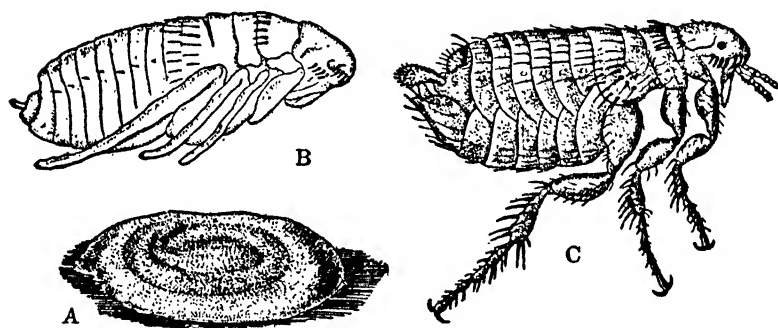

FIG. 427. Dog Flea, *Ctenocephalus canis*. A, larva in cocoon; B, pupa; C, adult. (From Howard.)

bacillus so the problem has become somewhat greater. Bubonic plague is doomed, though it has already taken an incalculable toll of human lives: even during the first four years of the present century it destroyed about two million people in India. Still more recently San Francisco had an outbreak of the plague that not long ago probably would have developed into a national calamity; but it was immediately stamped out with the loss of very few lives.

In brief, numerous parasitic insects not only actually develop at the expense of animal tissue, but others act as the transmitting agents of Bacteria, Protozoa, etc., which are the actual parasites, as we have already seen in the case of malaria, yellow fever, and African sleeping sickness. And last, but not least, we know that HOUSE FLIES, which we

tolerate as uninvited guests at our tables, have been shown to carry the germs of typhoid fever, tuberculosis, dysentery, and several other scourges. (Figs. 373, 374, 428.)

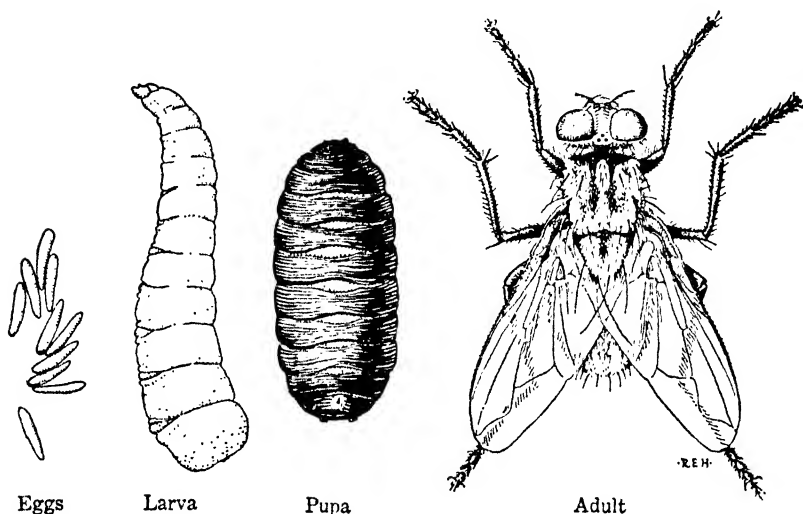

FIG. 428. Life history of the House Fly, *Musca domestica*.

### 3. *Insects Injurious to Plants*

It has been stated, and truly, that it costs the American farmer more to feed his insect foes than to educate his children: in fact, more than is expended for all the educational institutions in the United States, and more than twice the loss by fire. And we all pay the bill. Every kind of plant supports many species of insects, although usually certain ones are especially destructive. Thus Oak trees are attacked by no less than a thousand kinds of insect pests, Apple trees by about four hundred, and Clover and Corn by some two hundred insect enemies. A few random examples obviously must suffice for our view of the field.

The ARMY-WORM is the larva of a brown moth which sometimes becomes so numerous in regions east of the Rocky Mountains that the caterpillars have to migrate in search of food. Immense armies crawl along totally destroying



the crops over large areas. Fortunately, the pest has its own insect enemies, the chief being certain *Tachina* flies which lay their eggs on the caterpillars, and the larvae of the flies burrow into their bodies and finally destroy them. (Fig. 436.)

Of equal interest is the CABBAGE BUTTERFLY which was accidentally introduced from Europe into Canada in 1868, and has gradually made the whole of the United States its field, even ousting a related native species. Many of the

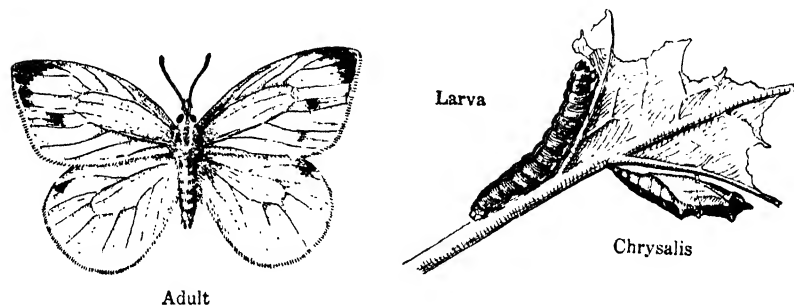

FIG. 429. Life history of the Cabbage Butterfly, *Pieris rapae*.

caterpillars of the Cabbage butterfly are destroyed by parasites; one being a Braconid fly which was imported from its old home in Europe by entomologists for this special purpose. (Fig. 429.)

The POTATO BEETLE first began to attract attention about ninety years ago when it transferred its activities from certain weeds in the Colorado region to the recently introduced Potato plant, and since that time it has spread all over the United States and has emigrated to Europe to become one of the serious insect pests. Large masses of yellow eggs are deposited by the beetles on the under surface of potato leaves which serve as food for the caterpillars until they are full grown and ready to pupate in the ground. Two broods of adults are usually produced annually to carry on the depredation. (Fig. 179.)

Among the most destructive parasites of Wheat, Rye, and Barley, nearly the world over, is the HESSIAN FLY which was

introduced into America toward the end of the eighteenth century. The life history is especially adapted to the growth of wheat, and two or three broods of the insect develop in one year. Fortunately it has numerous parasites of its own that hold it somewhat in check, though in certain regions it is necessary to regulate the planting of wheat according to so-called fly-free dates.

The EUROPEAN CORN BORER has long been distributed over a large part of the Old World but only recently has reached America. Starting in New England, it has slowly moved westward and may well before long infest the entire corn-raising area of the continent. The destructive stage, of course, is the caterpillar which, throughout most of the insect's range, spends the winter in the stem of its food plant and gives rise to the adult moth early the following summer. Unfortunately, however, in New England there are two generations annually, one of which winters in the larval state. It is estimated that this pest caused a loss of nearly four million dollars during 1939 in the northeastern States.

The JAPANESE BEETLE was accidentally introduced into New Jersey from Japan about twenty years ago and since has spread rapidly through many of the eastern States, defoliating trees and shrubs and destroying lawns and golf greens. The larva spends the winter underground and the adult emerges the following summer.

It seems safe to say that the destruction wrought by the COTTON BOLL WEEVIL exceeds even its notoriety. During the first thirty-five years after its invasion of the United States from Mexico, it had to its account a wastage of upward of three billion dollars, not to mention other immense financial losses due to depreciated land values, etc. Probably each person in the United States pays annually ten dollars more for cotton fabrics than he would if this weevil did not exist — it is one of Nature's methods of reducing the cotton crop. The injury to the cotton plant is caused by both the adults and larvae: the former by feeding and boring holes for their eggs, and the latter by injuring the developing

flowers so that they either fail to bloom, or produce seeds with few cotton fibers. (Fig. 430.)

While SCALE-INSECTS are so small and obscure that they are only a name to all except specialists, they constitute economically one of the most important groups of the entire

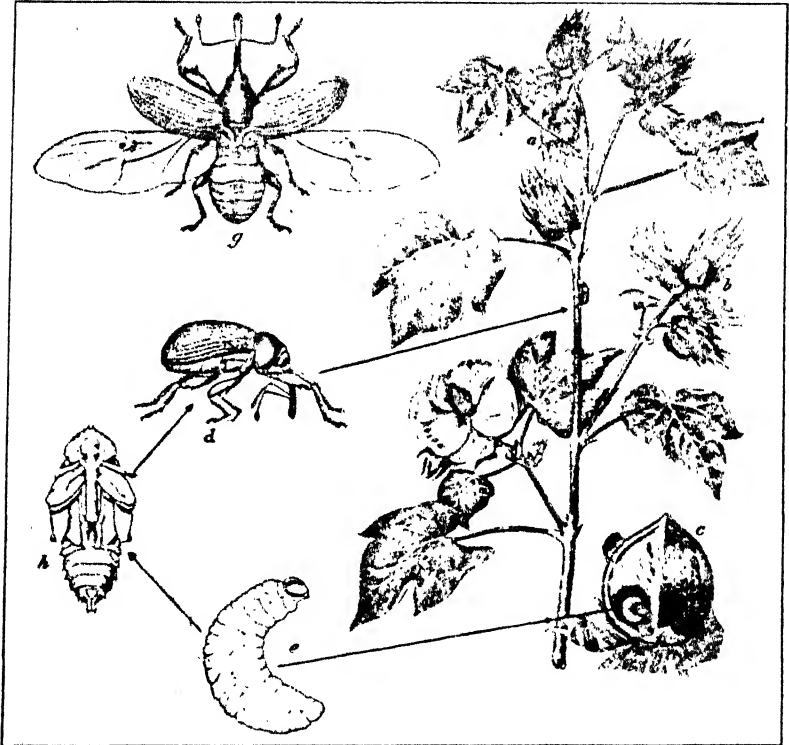

FIG. 430. Life history of the Cotton Boll Weevil, *Anthonomus grandis*. On the right, a Cotton plant attacked by the Weevil, showing *a*, a dry infested 'square'; *b*, a 'flared square' with punctures; *c*, a cotton boll sectioned to show attacking Weevil and larva in its cell; *d*, adult viewed from the side; *e*, larva; *g*, adult female with wings spread as in flight; *h*, pupa, ventral view. (From Metcalf and Flint, after U. S. Department of Agriculture.)

insect world. Scale-insects infest almost all kinds of trees and shrubs; in some cases doing merely temporary damage and in others actually killing the hosts. Among the myriads of species, the SAN JOSÉ SCALE is probably the most important, and since being brought to California from China has

spread all over the United States. The adult female insect lies permanently attached by its beak to the bark, underneath a tiny, waxy scale which it secretes. Here eyes, legs, and antennae are lost and the sac-like creature sucks the plant sap and reproduces. It is estimated that the progeny of a single individual during one season would number thirty million if all were to survive. (Fig. 434.)

About forty-five years ago the vineyards of France, and later those of California, appeared to be doomed to destruction by the attacks of a species of minute plant louse, or APHID. The French government offered a large reward for an effective remedy, and many entomologists and botanists devoted all their time to the study of the problem. Eventually it was discovered that certain American wild grapes were naturally immune to the pest. Accordingly by grafting the cultivated grape upon the resistant wild stock a combination was effected which saved the vineyards of both countries. (Figs. 370, 435.)

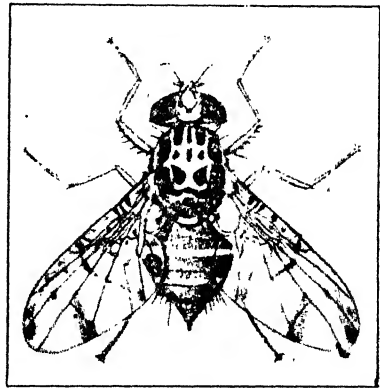

FIG. 431. Mediterranean Fruit Fly, *Ceratitis capitata*. (From U. S. Department of Agriculture.)

The MEDITERRANEAN FRUIT FLY, long the bane of fruit growers in many parts of the world, appeared a few years ago in certain Florida orchards, but the invasion apparently has been repulsed by the Bureau of Entomology and Plant Quarantine. A defense is also maintained on the Rio Grande against the Mexican fruit fly, and throughout the country against our many native species, though the latter are held in check to some extent by their own insect enemies. However, various species of the genus *DROSOPHILA* have contributed more to our knowledge of genetics than any other animal. Its sole diet is Yeast and it is guided to its food by the odor of alcohol liberated by the yeast cells. (Figs. 330, 431.)

Another great problem is the preservation of forest and shade trees from native and also imported pests. The enormosity of the loss attributed to this army of silent tree-killers is staggering. They destroy more of the nation's wealth each year than do forest fires — timber equal to one-fifth of the wood produced annually in the United States. So

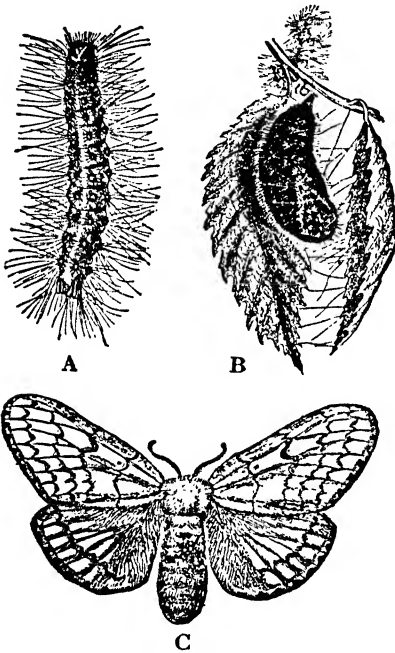

FIG. 432. Gypsy Moth, *Porthetria dispar*. A, larva; B, pupa; C, adult female. (From Howard.)

far their march has met relatively little resistance, but resistance is not easy when we recall that some insects may travel hundreds of miles on the wings of the wind — aviators have trapped them more than two miles aloft. Moreover, aeroplanes themselves may inadvertently transport noxious insects and other pests.

The MOUNTAIN PINE BARK BEETLE, not content with its invasion of the vast forests of the Northwest, now is threatening those of the Yellowstone National Park. The GYPSY MOTH, accidentally introduced near Boston, has spread throughout a large part of southern New England, crossed the New York State line, and even started a colony in Pennsylvania. Entomologists have made intensive studies of its European enemies, left behind when it came to America, and the introduction of some of these into New England gives some hope that it may eventually be conquered. In one year alone nearly three million enemies, representing eight species, were liberated. These two examples may stand as representative of the legions of destructive forest insects. (Fig. 432.)

Finally we should be reminded, if necessary, that our households are not immune to insect marauders that take an immense aggregate toll each year. CARPET BEETLES and CLOTHES MOTHS are all too familiar examples. (Fig. 433.)

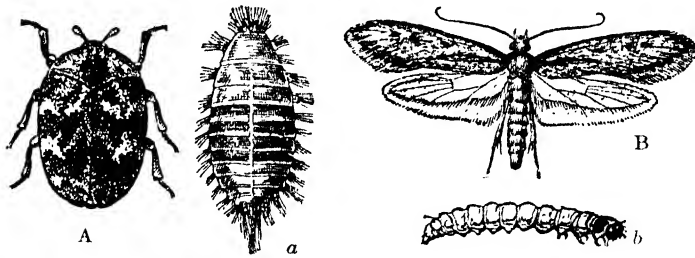

FIG. 433. A, Carpet Beetle, *Anthrenus scrophulariac*; a, larva of Carpet Beetle; B, Clothes Moth, *Tinea pellionella*; b, larva of Clothes Moth. (From Riley.)

#### 4. Beneficial Insects

Although we have mentioned incidentally the part played by certain insects in suppressing other noxious kinds, it would be unfair to the insect world not to emphasize the existence of members which are serviceable to man: those thousands which prey upon our enemies or supply us with materials. The principal enemies of insects are other insects, and "if they should quit fighting among themselves, they would overwhelm all vertebrate animals"; though sometimes long biological investigations are necessary to keep them fighting when we have upset the natural conditions; e.g., moved them to a new

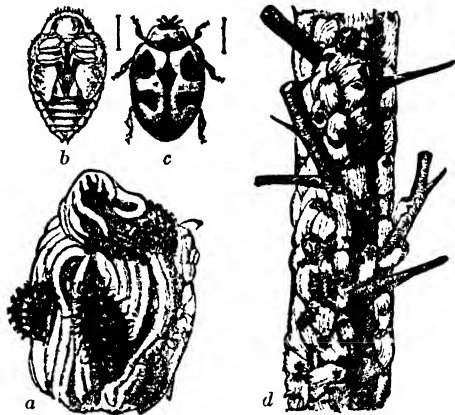

FIG. 434. Australian Ladybird Beetle, *Rodolia cardinalis*, and Cottony Cushion Scale, *Icerya purchasi*. a, larvae of beetle feeding on scale; b, pupa of beetle; c, adult beetle; d, Orange twig showing scales and beetles. (From Marlatt.)

environment away from their natural enemies. Thus *Acacia* plants brought from Australia introduced the COTTONY CUSHION SCALE which soon spread to the great California orange and lemon groves, and entailed enormous losses. The fruit growers finally sent an expert entomologist to study in Australia the native enemies of the insect. As a result some Ladybird beetles were eventually discovered which offered hope of meeting the needs, and these were sent to California and carefully reared until they could be colonized in the infected groves. Here they multiplied and ever since have held the Scale in check. (Figs. 434-436.)

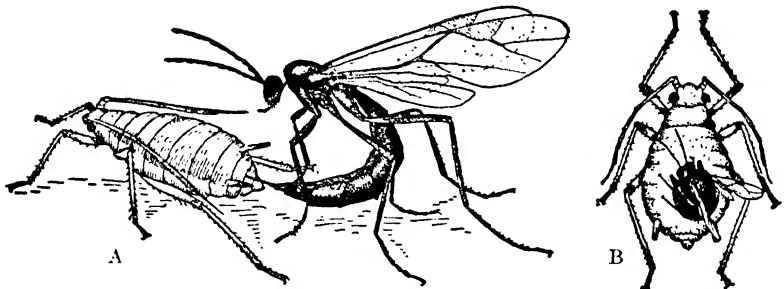

FIG. 435. A, an Ichneumon Fly inserting egg in an Aphid; B, emergence of the parasite that has developed from the egg. (From Webster.)

When insects destroy weeds or noxious plants we, of course, regard them as beneficial. An impressive example is afforded by the PRICKLY-PEAR (*Opuntia*) scourge in Australia. This Cactus was accidentally introduced from America and soon became an enormous economic problem by rendering useless some sixty million acres. Cultural, mechanical, and chemical methods of eradication proved impractical, but the study of the insect enemies of the Prickly-pear led to the introduction of the ARGENTINE MOTH-BORER, *Cactoblastis cactorum*, with the result that the menace was under complete control within a decade.

Furthermore we must not forget that such insects as the SILKWORM MOTH and the HONEY BEE are really domesticated animals; each is at the basis of an enormous world industry. One of Pasteur's most important studies was on the PEBRINE

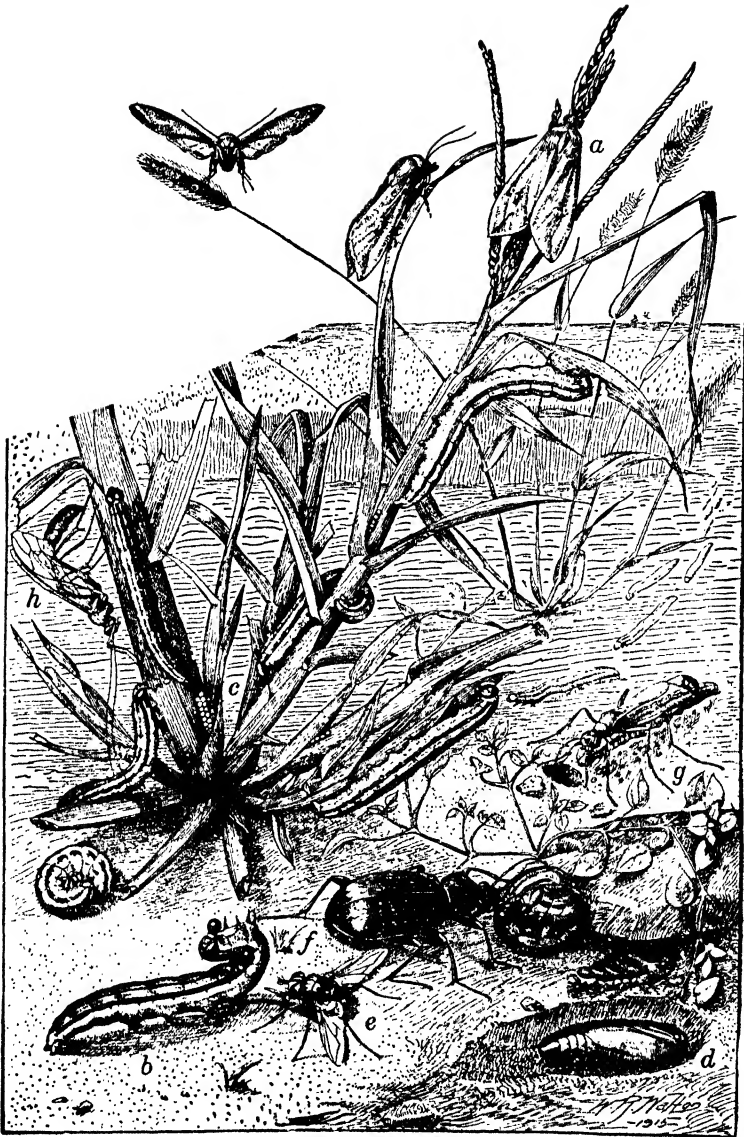

FIG. 436. Army-worm Moth, *Cirphis unipuncta*, and its ecological relationships with other Insects. *a*, adult Moth; *b*, full-grown larva; *c*, eggs; *d*, pupa in soil; *e*, parasitic Fly, *Winthemia*, laying eggs on an Army-worm; *f*, Ground Beetle, *Calosoma*, preying upon an Army-worm, and, at right, *Calosoma* larva emerging from burrow; *g*, a Digger Wasp, *Sphex*, carrying an Army-worm to its burrow; *h*, a wasp-like parasite of the Army-worm. (From U. S. Department of Agriculture.)



disease of silkworms, which not only saved the silk industry of France, but also paved the way for the study of infectious diseases in higher animals and man. The cause of pebrine proved to be a Protozoan parasite, *Nosema bombycis*. (Figs. 361, 437.)

The dependence of many plants upon insects for pollination is well illustrated by the difficulties in establishing the SMYRNA FIG in California. The fruit would not mature, and studies by botanists and entomologists showed that in the

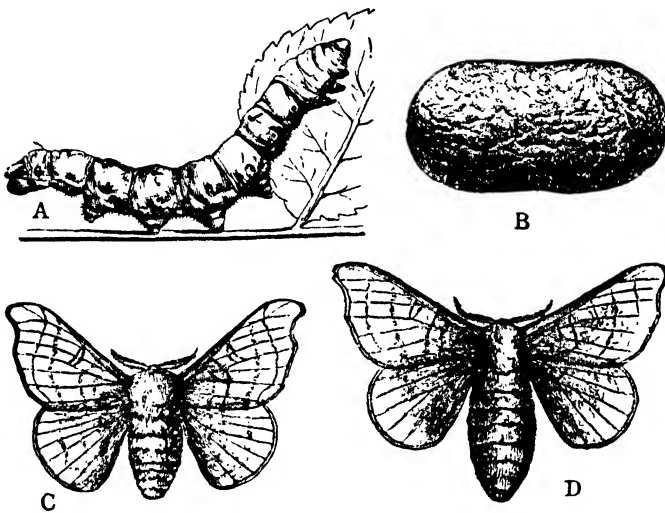

FIG. 437. Silkworm Moth, *Bombyx mori*. A, caterpillar; B, cocoon; C, male moth; D, female moth. (From Shipley and MacBride.)

plant's native land pollination was effected by a certain tiny insect. Importation and establishment of the insect carrier in California created there the immense fig-growing industry. (Fig. 366.)

As a matter of fact an amazing number of plants that we most highly prize would be unable to reproduce were it not for pollination by insects; for instance, there would be no pears, apples, peaches, plums, oranges, or strawberries. So it is perhaps not unreasonable that an entomologist has asked whether insect depredations may not be regarded as

a 20 per cent commission we pay for the invaluable services that 'friendly insects' render. It may, but it is economical, if not generous, to reduce the tax to the lowest limit!

Insects touch human affairs in other vital but less direct ways. It will be recalled that Darwin emphasized the importance of Earthworms in aerating and plowing the soil; but various insects probably contribute at least as greatly to this indispensable work. Ground-burrowing insects are still more widely distributed than Earthworms and in most regions they are more numerous and more active. Moreover, not only do they carry decaying leaves beneath the soil, but also rich nitrogenous plant food such as manure and the dead bodies of animals. (Fig. 436.)

Finally, it is entirely reasonable to wonder how land plants could have arisen without the direct or indirect services of insects. Indeed geological history indicates that land plants did not flourish and flowering plants did not exist before insects became a well-established part of the earth's fauna. (Pp. 267, 567-569.)

### 5. *Plants Injurious to Plants*

Plants would seem to have enough animal enemies without having to contend with parasitic plants, but as a matter of fact the science of plant diseases, PHYTOPATHOLOGY, is largely devoted to the destructive activities of colorless plants, the Bacteria and higher Fungi. The life histories of many of the SMUTS, RUSTS, and related parasitic fungi are so complicated that hundreds of specialists are continually employed in ferreting them out in order to preserve the products of farm and forest. Perhaps the WHITE PINE BLISTER RUST, another accidental importation from Europe that threatens our forests, is sufficiently typical to present some of the difficulties involved. (Fig. 438; P. 140.)

This species lives during one stage of its life on the White Pine and during another on the leaves of the Currant or the Gooseberry. In common with most of the Fungi, it produces spores which are distributed by the wind. When the spores

(type one) of a certain stage in the life history fall upon white pine leaves, they enter the stomata, develop, and grow through the tissues. Finally, after several years, the bark

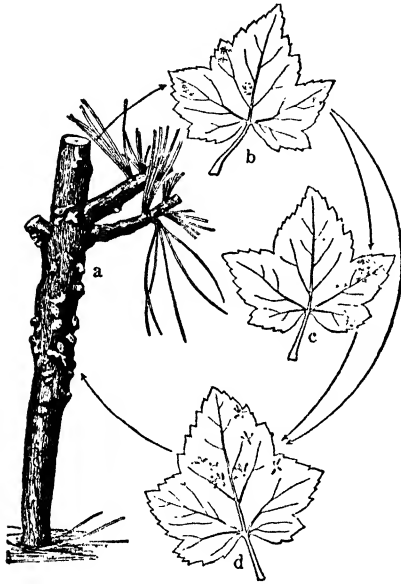

FIG. 438. Diagram of the life history of the White Pine Blister Rust. *a*, blisters on Pine in spring, from which the disease spreads to Currant or Gooseberry leaves and produces the early summer stage, *b*, thence it may spread to another Currant leaf and produce there a second crop of the early summer stage, *c*, or it may at once produce the late summer stage, *d*. In the fall it infects the neighboring White Pines. (From Smallwood, after Spaulding.)

swells at the points of infection and sporangia are protruded which liberate myriads of a second type of spores in the form of a bright yellow powder. For further development, one or more of these spores must be carried by the wind to the leaf of a currant or gooseberry bush. Established here the spore germinates, grows down into the leaf tissue, and in a couple of weeks this new stage in the life history is itself forming spores. Masses of this third type of spore appear as tiny specks of orange powder on the leaf surface.

The third type of spore also develops on the currant or gooseberry and soon another lot of similar spores are produced. Such repeating infection may continue every two weeks until autumn when the leaves fall. Then spores of type one appear which can develop only on a white pine. If this transfer is successfully accomplished, the life cycle is completed. Since either the currant or gooseberry acts as the intermediate host, they afford a hazard for White Pine forests in the vicinity. This life history involving two hosts recalls that of certain animal parasites, such as the Malarial organisms.

Enough, perhaps, has been said to indicate the struggle for knowledge which man must maintain in order to cope with the biological forces that would rob him, are robbing him, of what he considers his heritage. But it is only fair to add that some biologists who have given the most thought to the problem are by no means certain that the struggle will eventually be successfully terminated; it is possible that insects and allied enemies will gain the upper hand in the warfare for food when the human population has increased beyond a certain limit. This seems incredible, though it is a conservative statement by men who are specialists and not pessimists. In any event, it is clear that the most urgent need today is more knowledge of the life habits of insects and other destructive organisms. Generous Federal and State appropriations must be made so that through research effective methods of control may be developed. Experience has shown that the research dollar is not only invested in a gilt-edge security, but one at the same time producing a national dividend almost beyond computation.

### C. CONSERVATION OF NATURAL RESOURCES

We are slowly awakening to the fact that we have been very shortsighted. Conservation of natural resources has, until recently, given very little concern, although it is one of the greatest problems which biologists of the present generation face, and it must be solved now or it will be too late. What happened in America is being repeated in many other parts of the world. Our forefathers came to a land of fertile soil covered with primeval forests, abounding with large and small birds and mammals, and with waters richly supplied with fish. These they necessarily and rightly drew upon for their livelihood. It was their wealth — Nature's generous bonus.

But the apparently inexhaustible supply has already become alarmingly reduced and conservation must be the watchword, as was recognized many years ago by President Theodore Roosevelt, who considered it "the weightiest

problem now before the nation, as nobody can deny the fact that the natural resources of the United States are in danger of exhaustion, if the old wasteful methods of exploiting them are permitted longer to continue." Yet in spite of this, the conditions are still such that a prominent legislator is justified in stating that "it is time that the national conscience be awakened to the necessity of preserving what is left of the outdoor heritage of our fathers, and of restoring some of that which has been destroyed and defiled."

Only about one-eighth of the virgin forest of the United States remains today. It seems incredible for a civilized nation — but is only too true. Approximately one-half of this is held by the Government but the rest is being destroyed far more rapidly than unaided nature can restore it. And there is nowhere in the world a sufficient supply of the kinds of timber we use to take their place. We have continuously treated our forests, except those under public control, not as a farm on which to produce crops, but as a mine whose useful product is to be gathered once for all. The axe has held almost unregulated sway, but with ideas of conservation becoming increasingly widespread it appears that hope for a better future for our forests is well founded.

It seems hardly necessary to state that forests are of inestimable value in many ways entirely aside from the lumber they supply. We are, perhaps, prone to forget that under nature's stabilizers of forests, shrubbery, and grass the blowing and washing away of the soil progresses but slowly, while with their removal by man this erosion is increased tremendously. Witness the great dust storms during recent years in the Southwest. The devastating floods that swept down the Mississippi in 1927, the Yangtze in 1931, and the Ohio River in 1937 are in no small part attributable to deforestation. China's affliction is the product of millenniums, ours of little more than a century. Scientific forestry is crucial for our future. (Fig. 439.)

Many of the larger animals have been exterminated and some of the smaller ones are fast approaching the same fate.

For instance, the Bison is extinct in the United States except for the few preserved in reservations; the Elk is restricted in numbers and range; the Elephant Seal remains only in one small colony; the two species of Right Whales are threatened with extermination; and the Beaver has disappeared from most of its former haunts. The demand for furs is estimated to be responsible for the destruction of

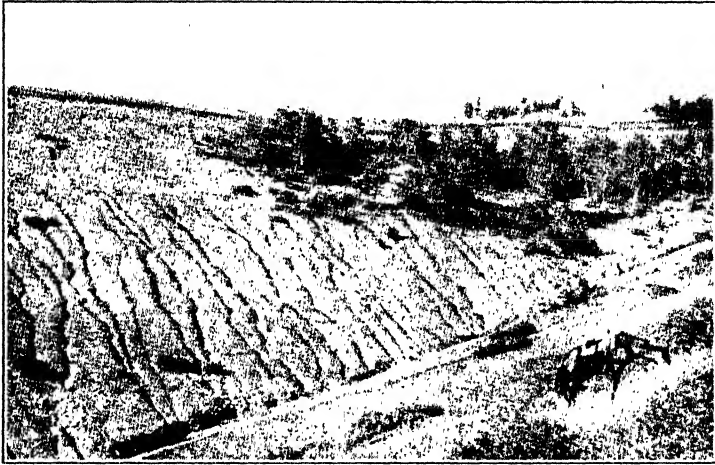

FIG. 439. Soil erosion due to removal of all the trees. (From U. S. Forest Service.)

thirty million mammals throughout the world each year, and this number is nearly doubled if all the wild mammals destroyed for commercial purposes are included. While there is life there is hope, but unless immediate steps are taken to reduce the slaughter, the fur-bearing animals of the world at large are doomed.

Birds are now faring somewhat better owing to the heroic efforts started a generation ago by the Audubon Societies, so that a partial restoration of our former bird population seems probable. Of what use are the birds? Even if usefulness were the only question involved, the answer would still be clear. Experts tell us that without the services of insect-eating and seed-eating birds, successful agriculture would soon be impossible, and the destruction of the greater part

of our vegetation would also result. One caterpillar during its lifetime of less than two months can consume three-quarters of a pound of leaves, or nearly ninety thousand times its original weight. Birds are "the winged wardens of our farms." Their help is needed in the struggle.

Finally, stream pollution has become an urgent problem. Under normal conditions, Protozoa, Bacteria, and other small organisms bring about the so-called self-purification of standing and running water. These biological workmen, unseen and unheard, keep our waters unpolluted, and most modern methods of sewage treatment depend to a considerable extent upon their activities. The wide application of our present knowledge of the various factors — biological, chemical, and physical — may even yet return some of our waterways to their pristine purity with their balanced aquatic life.

In truth, it is dangerous to upset the intricate balance of the economy of nature by the reckless destruction of plant or animal without taking thought for the morrow — without intensive study of the far-reaching consequences which may follow from the breaking of one link in the chain of the interrelationships of organisms. The destruction even of certain Protozoa and other microscopic life may seal the fate of animals of great economic value. (Figs. 84, 142, 367, 368, 436.)

#### D. CONSTRUCTIVE BIOLOGY

The great living heritage which we have received will be permanently impaired for posterity, even though useless waste is stopped, unless the highly complex problem of conservation is attacked constructively in the light of modern biological knowledge. Merely to hold Nature's bonus unimpaired, crucial as that is, will not adequately meet the requirements of increasing populations with the attendant demands of complex civilized life. Few seem to realize that the whole of our business life takes root in nature. All of our progress and prosperity is predicated on the abundance

of our natural resources and the manner in which we develop them. Methods of raising crops and domestic animals which were sufficient for primitive communities are entirely inadequate to satisfy modern conditions.

### 1. *Plants and Animals*

Man's conquest of the plant kingdom has hardly begun, because the number of species already brought into his service is insignificant in comparison with the wealth of available kinds. Relatively few of the nearly two hundred thousand known species of higher plants are cultivated, and most of these in merely an incidental way. There is every reason to believe that many plants not as yet employed possess intrinsic value at least equal to those under cultivation — "some neglected weed in the hands of a skilled botanist may one day revolutionize agriculture." Furthermore, the botanist must develop varieties of important plants which not only afford the largest yield, but also are most resistant to unfavorable climatic conditions and to disease; the forester must develop timberland both for the materials it supplies and the indirect effect it has on soil erosion and on water conservation for agricultural and other purposes; the entomologist and plant pathologist must devise means for holding in check destructive insects, as well as bacterial and related microscopic parasites of plants. All of these and others must cooperate. For what does it profit us if we are robbed of our crops? (Fig. 439.)

Indeed, the state of civilization of a people is closely related to its success in developing plants and animals for particular needs. One hears of new 'creations,' but often fails to recall that man can merely direct the laws of inheritance, and this he can do only by intensive investigations of the principles underlying heredity. Certainly the most important recent contribution of biology is the discovery of the general method of transmission of characters from generation to generation, common to all living things, which



has established the new biological science, genetics. Today, as we have seen, biologists the world over are developing and applying these principles in plant and animal breeding. What was impossible a few years ago is now being accomplished almost as a mere matter of routine work in many biological laboratories. (Pp. 486, 511.)

## 2. *Man*

Important as the application of these principles is in the mastery of agricultural problems, a far more profound power remains to be realized when, as nations, mankind becomes awake to the fact that these same basic principles apply equally to human inheritance. If it be true that the human race has not improved in bodily and mental characteristics since the time of the ancient Greeks, the responsibility rests with man himself. He has studied and applied selective breeding of animals and plants. He has in general kept the best for his purposes that nature offered and eliminated the rest. He has depended chiefly on the stock and only secondarily on the environment for permanent improvement. But it has been otherwise with himself. Much of the worst human stock has continued to survive and multiply, and disproportionately so as civilization has advanced. Reliance has been placed almost solely on the improvement of the conditions of life and not on breeding from the best. We may fairly say that humanity is what it is today in spite of the continual violation of many of the biological principles which would improve the race. (Figs. 391, 396, 440.)

This, of course, is merely a statement of fact; not a reproach. Man could not have done otherwise until it had been demonstrated that he is a part of, and not apart from, the rest of living nature — the most profoundly important fact that biology has contributed to human welfare. With this fully grasped, new import is given to the study of general biological principles and no plant or animal is too insignificant to throw light on life problems. And this has

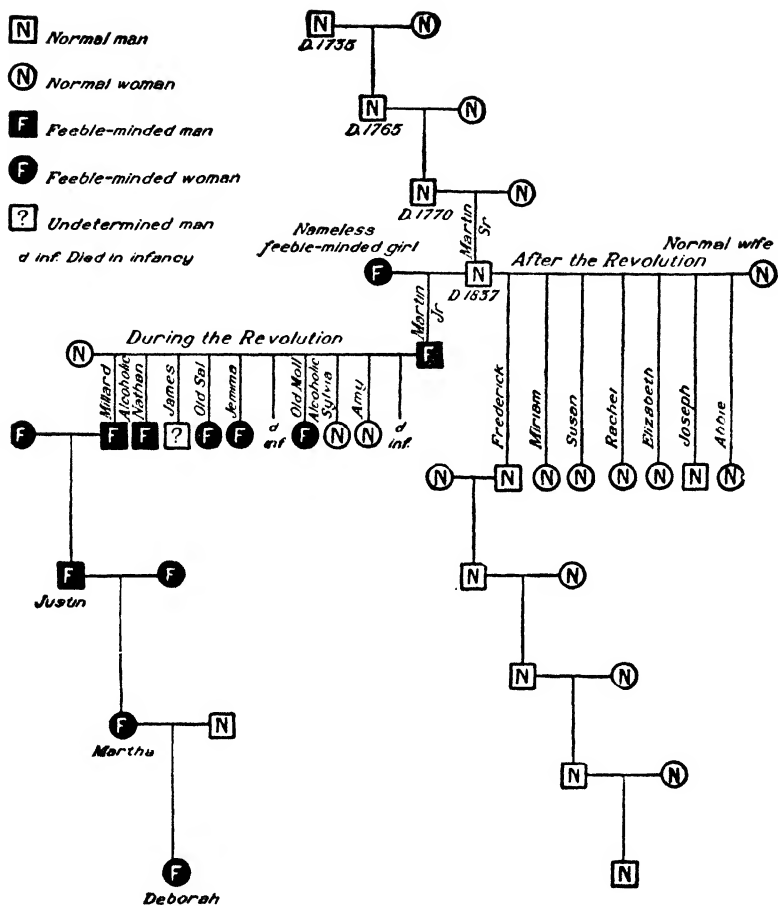

FIG. 440. The Kallikak family.

Of the 480 descendants, in five generations, of this branch, 143 are known to have been feeble-minded, 36 illegitimate, 33 sexually immoral — mostly prostitutes, 24 alcoholic, 3 epileptic, and 3 criminal. 82 died in infancy.

Of the 496 descendants, in five generations, of this branch, none were feeble-minded, and all but 2 were normal mentally. 2 were alcoholic and 15 died in infancy. Thus nearly all were good citizens. Among them were educators, physicians, lawyers, judges, traders, landowners — men and women prominent in every phase of social life. (After Goddard.)

been the chief source of the stupendous potential for biological control which has within less than a century come to mankind. Potential for control, we say, because years of research by generations of investigators is still necessary before we shall be prepared to solve the problems we now face and which the increasing human population will immensely augment. (Figs. 327, 335, 441, 442.)

The natural method of securing a healthy — adapted — race is, of course, the gradual process of adjustment throughout the ages in response to environmental changes. But

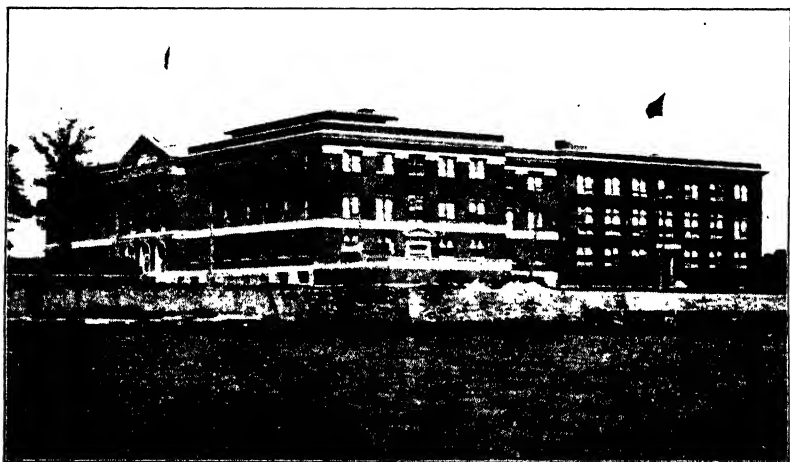

FIG. 441. The Marine Biological Laboratory, Woods Hole, Massachusetts. One of the laboratories where biologists spend the summer in research covering many branches of the science.

mankind has the power, which we believe is denied to the lower animate beings, of conscious response — of choice. Human volition and action can retard or accelerate nature's response. Human volition may not only decide, within limits, the response to surrounding conditions, but also not infrequently may directly change the conditions so as to render unnecessary individual or racial adaptation to them. Thoughts such as these make plain the enormous complexity of the situation and reveal the possibility of danger lurking where it may be least expected — danger lest in acting as

we think humane from the point of view of particular individuals, we may be rendering a disservice to the race.

The complex problems of eugenics, the science of being well-born, are problems in genetics so intricately interwoven with those of all the other sciences of human life and relationships, in particular sociology and psychology, that propaganda in eugenics not fundamentally grounded in basic interlocking data from these sciences is not only premature,

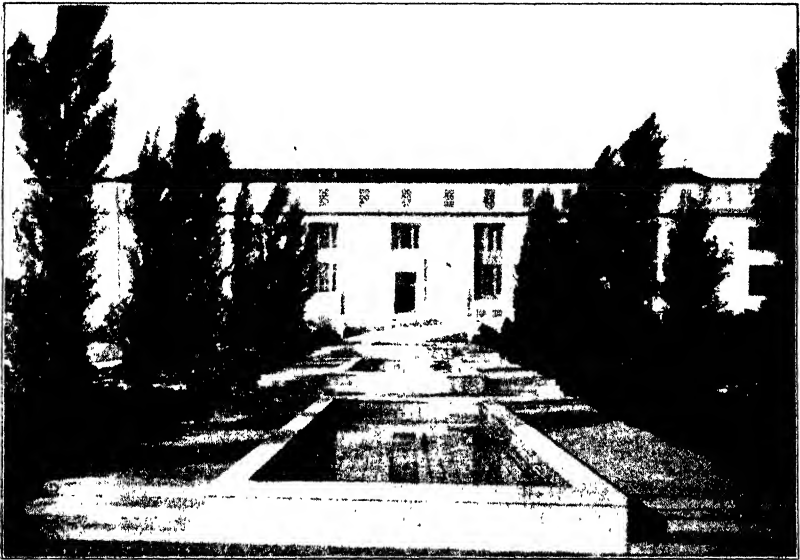

FIG. 442. Home of the National Academy of Sciences and the National Research Council of the United States, in Washington, D. C. The focus of American scientific research.

but fraught with insidious possibilities. Eugenics seeks improvement through nature, euthenics seeks improvement through nurture. Each is a partial view and before significant progress can be made the proper balance between these two aspects of one problem must be grasped. Organism and environment are one and inseparable. (Pp. 508-511.)

The urgent need of the present is for more and still more knowledge which is secured in the laboratory rather than on the lecture platform. When we realize that if the infants

Darwin and Lincoln, who were both born on the same day, had been exchanged by their parents, almost certainly neither would have produced epoch-making contributions to science or civilization, it gives us pause. The Danes have a proverb that it does no harm to be born in a duckyard if you are laid in a swan's egg — thus emphasizing heredity, though heredity implies not a repetition in kind, but in possibilities. We cannot hope to be born equal, but we may ask to be born with an equal opportunity to develop what is in us. At least we can say at present, without fear of contradiction, that man owes it to himself not to be less mindful of his own stock than he is of that of his domestic animals.

From every standpoint the mere pittance man casts to biological research returns to him many-fold in health and wealth, in comfort and power, and most of all in a broader and more appreciative outlook on a congenial world. The walls of ignorance that hem us in may be high, but they can be scaled as generation after generation cuts its niches and gives sure footing to its successor. Far from depriving life of its mystery, biology affords a sublime picture of the interrelatedness of living things and still more inextricably interweaves human life with that of all nature. (Pp. 6, 7, 624-626.)

## CHAPTER XXIX

# BIOLOGICAL HISTORY

History must convey the sense not only of succession but also of evolution. — *New York Times*.

**T**he story of man's slow emergence from a condition in which he was completely at the mercy of his environment, to his relatively masterful position as exhibited in our present civilization, is the inspiring history of science — the intellectual development of the race. Indeed, as we have seen, knowledge spells power — power to direct and become adapted to the forces of nature, and this knowledge has been acquired after much labor and safely treasured with great pains as a result of scientific study. Truly “the succession of men during the course of many centuries should be considered as one and the same man who exists always and learns continuously”; but we, for the most part, forget the past whose heirs we are — “the present is vocal and urging, the past silent and patient.” Let us for the moment turn to the works of some of the outstanding contributors to biological history.

Some knowledge of hunting, agriculture, and husbandry was one of the early acquirements of prehistoric man. In their rock shelters, over 50,000 years ago, the Cro-Magnons of France made spirited records of animals which probably were inspired by the chase but display an imaginative interest beyond mere physical necessities. And at the dawn of history, nearly 6000 years ago, systems of agriculture and medicine apparently found a place in Egyptian and Babylonian civilizations. So, on the practical side, biology has a very ancient beginning. But biology as the science of life in which emphasis is placed on the study of vital phenomena for their own sake really begins with the Greeks. (Fig. 412.)

## A. GREEK AND ROMAN SCIENCE

Science reaching Greece from the South and East fell upon fertile soil, and in the hands of the Hellenic natural philosophers was transformed into coherent systems through the realization that nature works by fixed laws — a conception foreign to the Oriental mind but the corner-stone of all future scientific investigation. It is not an exaggeration to say that



FIG. 443. Aristotle.

to all intents and purposes the Greeks laid the foundations of the chief subdivisions of natural science and, specifically, created biology.

ARISTOTLE (384-322 B.C.), the most famous pupil of Plato and dissenter from his School, represents the highwater mark of the Greek students of nature and is justly called the Father of Natural History. Although Aristotle's contributions to biology are numerous, perhaps of most significance is the fact that he took a broad survey of the existing data and welded them into a science. He did this by relying, to a considerable extent, on the direct study of organisms and by insisting that the only true path of advance lies in accurate observation and description. The observational method and its very modern development, the laboratory

method of biological study, find their first great exponent in Aristotle. But mere observation without interpretation is not science. Aristotle's generalizations based on the facts accumulated and his elaboration of broad philosophical conceptions of organisms give to his biological works their lasting significance. (Fig. 443.)

While Aristotle's biological investigations were devoted chiefly to animals, his pupil and co-worker, THEOPHRASTUS



FIG. 444. Theophrastus of Eresus.

(370–286 B.C.), made profound studies on plants. Theophrastus not only laid the foundations but also gave suggestions of much of the superstructure of botany; an achievement which entitles him to rank as the first great student of plant science. (Fig. 444.)

Before leaving the Greeks we must mention HIPPOCRATES (460–370 B.C.), the Father of Medicine. Writing a generation before Aristotle, at the height of the Age of Pericles, Hippocrates crystallized the knowledge of medicine into a science and gave to physicians a high moral inspiration. And so it is fair to say that more than two thousand years ago the Greeks delineated the major subdivisions, the philosophical implications, and the social significance of biological science.



The history of medicine and of biology as a so-called pure science are so closely interwoven that consideration of the one involves that of the other. Indeed the physicians form the chief bond of continuity in biological history between Greece and Rome. The interest of the Romans lay largely in practical affairs so it would seem that the advantages to be gained from medicine should have led them to make important contributions. As it happened, however, two Greek physicians were destined to have the most influence: Dioscorides, an army surgeon under Nero, and Galen, physician to the Emperor Marcus Aurelius.

DIOSCORIDES wrote the first important treatise on applied botany. This was really a work on the identification of plants for medicinal purposes but, gaining authority with age and being variously transformed, it became the standard 'botany' for fifteen centuries.

GALEN (131–201) was the most famous physician of the Roman Empire and his voluminous works represent both a repository for the anatomical and physiological knowledge of his predecessors, improved and worked over into a system, and also a large amount of original investigation. Galen was at once a practical anatomist and also an experimental physiologist, inasmuch as he described from dissections and insisted on the importance of vivisection and experiment. Galen gave to medicine its standard 'anatomy' and 'physiology' for fifteen centuries.

Any consideration of the biological science of Rome would be incomplete without a reference to the vast compilation of mingled fact and fancy made by PLINY the Elder (23–79). It was aside from the path of biological advance, but long the recognized *Natural History*, passing through some eighty editions after the invention of printing.

## B. MEDIEVAL AND RENAISSANCE SCIENCE

For all practical purposes we may consider that biology at the decline of the Roman Empire was represented by the works of Aristotle, Theophrastus, Dioscorides, Galen, and

Pliny. Even these exerted little influence during the Middle Ages. Dioscorides, Galen, and Pliny were available to the scholars, but in so far as science reached the people in general it was chiefly by collections of quotations from corrupt texts of these authors interspersed with anecdotes and fables. Quite characteristic of the times is the oft-quoted *PHYSIOLOGUS*, found in many forms and languages — a collection of grotesque natural history stories in which, for instance, the centaur and phoenix take their place with the frog and the crow in affording crude illustrations of theological texts and in pointing out far-fetched morals.

In fact, science was submerged to such an extent that the scientific Renaissance owes its origin largely to the revival of classical learning; in particular to the translation of Aristotle and Theophrastus, and renewed study of Dioscorides and Galen. Their works were so superior to the current science that, in accord with the spirit of the times, to question their authority became almost sacrilegious. The first studies were merely commentaries on the writings of these authors, but as time went on more and more new observations were interspersed with the old. In short, the climax of the scientific Renaissance involved a turning away from the authority of Aristotle and the past, and an adoption of the Aristotelian method of observation and induction.

Botany was the first to give visible signs of the awakening, probably because of the dependence of medicine on plant products. "All physicians professed to be botanists and every botanist was thought fit to practice medicine." In the *HERBALS* published in Germany during the sixteenth century we can trace the growth of plant description and classification from mere annotations on the text of Dioscorides to well-illustrated manuals of the plants of western Europe.

Meanwhile zoölogy began to emerge as a distinct science, but the less obvious immediate utility of the subject, combined with the greater difficulty of collecting and preserving animals, and therefore the necessity of more dependence on travelers' tales, contributed to retard its advance. One

group of naturalists, the ENCYCLOPEDISTS, so called from their endeavor to gather all the available information about living things, attempted the impossible. However, this gleaning from the ancients and adding such material as could be gathered led to the publication of huge volumes of fact and fiction, which served to popularize zoölogy and afforded the necessary survey which must precede constructive work. Gesner's great *History of Animals* had the most influence.



FIG. 445. Andreas Vesalius.

Although GESNER (1516–1565) of Switzerland was without doubt the most learned naturalist of the period and probably the best zoölogist who had appeared since Aristotle, the direct path to progress was blazed by men whose plans were less ambitious. Contemporaries of Gesner, who confined their treatises to special groups of organisms which they themselves investigated, really instituted the biological MONOGRAPH that has proved to be an effective method of scientific publication.

While the herbalists, encyclopedists, and monographers at work in natural history were making earnest endeavors to develop the powers of independent judgment, long suppressed during the Middle Ages, the chief emancipator of

biology from the traditions of the past appeared in the Belgian anatomist, VESALIUS (1514–1564). Not content with the anatomy of the time, which consisted almost solely in interpreting the works of Galen by reference to crude dissections made by barbers' assistants, Vesalius attempted to place human anatomy on the firm basis of exact observation. The publication of his great work *On the Structure of the Human Body* made the year 1543 the dividing line between



FIG. 446. William Harvey.

ancient and modern anatomy, and thenceforth anatomical as well as biological investigation in general broke away from the yoke of authority, and men began to trust and use their own powers of observation. (Fig. 445.)

The work of Vesalius was on anatomy, and physiology was treated somewhat incidentally. The complementary work on the functional side came in 1628 with the publication of the epoch-making monograph *On the Motion of the Heart and Blood in Animals* by HARVEY (1578–1657) of London. No rational conception of the economy of the animal organism was possible under the influence of Galenic physiology, and it remained for Harvey to demonstrate by a series of

experiments, logically planned and ingeniously executed, that the blood flows "in a circle" from heart back to heart again, and thus to supply the background for a proper understanding of the physiology of the organism as a whole. With the work of Vesalius and Harvey, biologists had again laid hold of the great scientific tools — observation, experiment, and induction — which since then have not slipped from their grasp. (Figs. 237, 446.)

### C. THE MICROSCOPISTS

During this revival period, when collections and accurate descriptions of plants and animals were being made and the study of anatomy and physiology was going rapidly forward, optical inventions occurred which were destined to make possible modern biology. First came the development of the SIMPLE MICROSCOPE, through an adaptation of the principles of spectacles, during the sixteenth century; then the combination of lenses to form the COMPOUND MICROSCOPE, first effectively employed by Galileo in 1610; and by the middle of the century simple and compound microscopes were being made by opticians in the leading centers of Europe. Significant of the times is the clear appreciation of the importance of studying nature with instruments which increase the powers of the senses in general and of vision in particular, expressed by HOOKE (1635–1703) of London in a remarkable book, the *Micrographia*, published in 1665. Using his improved compound microscope, Hooke clearly observed and figured for the first time the "little boxes or cells" of organic structure, and his use of the word cell is responsible for its application to the units of modern biology. (Figs. 5, 447.)

Microscopical work was a mere incident among the varied interests of Hooke, while LEEUWENHOEK (1632–1723) of Holland spent a long life studying nearly everything which he could bring within the scope of his simple lenses. With an unexplored field before him, all of his observations were discoveries. Bacteria, Protozoa, Hydra, and many other organisms were first revealed by his lenses. But Leeuwen-

hoek's discovery of the sperm of animals created the most astonishment. His imagination, however, outstripped his observations for he thought that the next generation must be preformed within the sperm and so regarded it as the com-

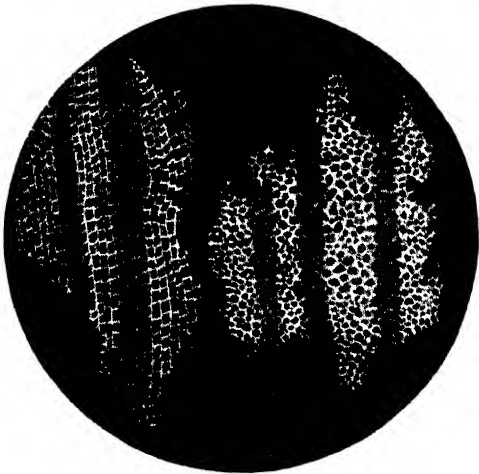
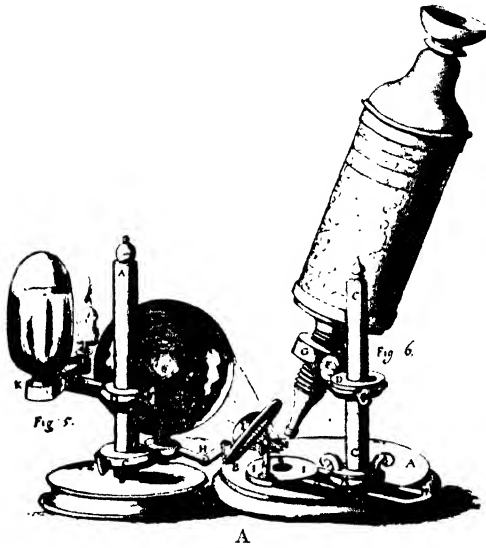

FIG. 447. Hooke's microscope (A), and the "little boxes or cells" (B) he observed in cork. (From Hooke's *Micrographia*. 1665.)

plete germ which had only to be hatched by the female. (Frontispiece; Fig. 448.)

The patience and ingenuity of Leeuwenhoek were equalled in studies on insect anatomy by SWAMMERDAM (1637-1680) of Holland. Inspired largely by the desire to refute the current notion that insects and similar lower animals are without complicated internal organs, Swammerdam spent

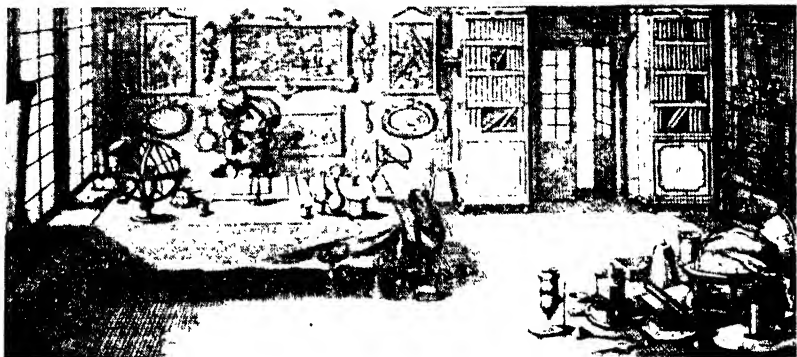

FIG. 448. An early eighteenth century biological laboratory. (From Joblot, 1718.)

his life in studies on their structure and life histories. Revealing, as he did, by the most delicate technique in dissection, the finest details observable with his lenses, Swammerdam not only set a standard for minute anatomy which was unsurpassed for a century, but also dissipated for all time the conception of simplicity of structure in the lower animals. He thus, quite naturally, added one more argument to those of the Italian REDI (1626-1698) and others against spontaneous generation — an erroneous theory that survived until the work of Pasteur (1822-1895) in the nineteenth century. (Fig. 450; Pp. 391-394.)

Malpighi of Bologna and Grew of London, contemporaries of Hooke, Leeuwenhoek, and Swammerdam, may be considered as the pioneer histologists. GREW (1641-1712) devoted all his attention to plant structure, while MALPIGHI (1628-1694), in addition to botanical studies which paralleled Grew's, made elaborate investigations on animals. The

versatility as well as the genius of Malpighi is shown by his studies on the anatomy of plants, the function of leaves, the development of the plant embryo, the embryology of the chick, the anatomy of the silkworm, and the structure of glands. Skilled in anatomy but with prime interest in physiology, his lasting contribution lies in his dependence upon the microscope for the solution of problems where



FIG. 449. Marcello Malpighi.

structure and function, so to speak, merge. This is well illustrated by his ocular demonstration of the capillary circulation in the lungs, which is probably his greatest discovery and the first of prime importance ever made with a microscope, since it completed Harvey's work on the circulation of the blood. (Fig. 449.)

#### D. DEVELOPMENT OF THE SUBDIVISIONS OF BIOLOGY

The microscopists taken collectively created an epoch in the history of biology, so important is the lens for the advancement of the science. Broadly speaking, we find that its development along many lines during the eighteenth and particularly the nineteenth century went hand in hand



with improvements in the compound microscope itself and in microscopical technique. Again, the microscopists in general and Malpighi in particular opened up so many new paths of advance that from this period on it is not possible, even in the most general survey, to discuss the development of biology as a whole. The composite picture must be



FIG. 450. Louis Pasteur.

formed by emphasizing and piecing together various lines of work, such as classification, comparative anatomy of animals, embryology, physiology of plants and animals, genetics, and evolution.

### 1. *Classification*

Classification has as its object the bringing together of organisms which are alike and the separating of those which are unlike; a problem of no mean proportions when a conservative estimate today shows nearly a million known species of animals and a quarter of a million plants—leaving out of account the myriads of forms represented only by fossil remains.

Naturally the earliest classifications were utilitarian or more or less physiological — fowl of the air, beasts of the field; edible, poisonous, etc. But as knowledge increased emphasis was shifted to the anatomical criterion of specific differences, and thenceforth classification became an important aspect of natural history — a central thread both

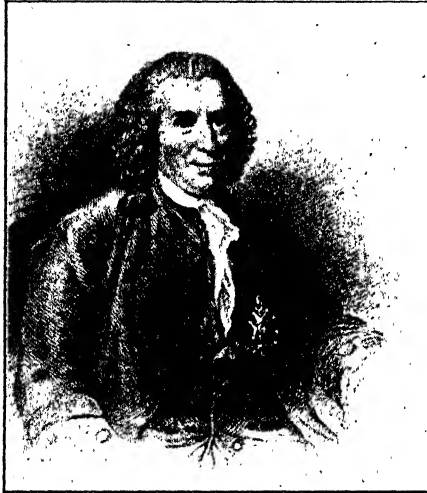

FIG. 451. Carolus Linnaeus.

practical and theoretical. Practical, in that it involved the arranging of living forms so that a working catalog was made which required nice anatomical discrimination, and therefore the amassing of a large body of facts concerning animals and plants. Theoretical, because in this process zoölogists and botanists were impressed, almost unconsciously at first, with the 'affinities' of various types of animals and of plants, and so were led to problems of their origin. (Fig. 183.)

From Aristotle, who emphasized the grouping of organisms on the basis of structural similarities, we must pass over some seventeen centuries, in which the chief work of interest was done by the herbalists and encyclopedists, to the time of RAY (1628–1705) of England and LINNAEUS (1707–1778)

of Sweden. Previous to Ray the term species was used somewhat indefinitely, and his significant contribution was to make the word more concrete by applying it solely to groups of similar individuals which seem to exhibit constant characters from generation to generation. This paved the way for the great taxonomist, Linnaeus. (Fig. 451.)

First and foremost a botanist, Linnaeus published a practical classification of flowering plants which afforded a great impetus to plant study, particularly because he insisted

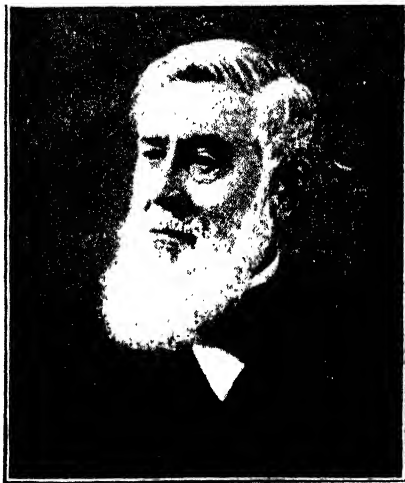

FIG. 452. Asa Gray (1810-1888). The foremost American botanist of the nineteenth century.

on brief descriptions and the scheme of giving each species a name of two words, generic and specific, thereby establishing the system of BINOMIAL NOMENCLATURE. Linnaeus' success with botanical taxonomy led him to extend the principles to animals and even to the so-called mineral kingdom: the latter showing at a glance his lack of appreciation of any genetic relationship between species. Although Linnaeus believed that species, genera, and even higher groups represented distinct acts of creation, nevertheless his greatest works, the *Species Plantarum* and *Systema Naturae*, are of

outstanding importance in biological history and by common consent the base line of priority in botanical and zoölogical nomenclature. (Fig. 452; P. 561.)

## 2. Comparative Anatomy

Owing to the less marked structural differentiation of plants in comparison with animals, plant anatomy lends itself less readily to descriptive analysis, so that an epoch in the study of comparative anatomy is not so well defined in botany as in the sister science, zoölogy.



FIG. 453. Georges Cuvier.

Comparative anatomy as a really important aspect of zoölogical work, in fact as a science in itself, was the result of the lifework of CUVIER (1769–1832) of Paris. It is true that some of his predecessors had reached a broad viewpoint in anatomical study, but Cuvier's claim to fame rests on the remarkable breadth of his investigations — his survey of the comparative anatomy of the whole series of animal forms. And not content merely with the living, he made himself the first real master of the anatomy of fossil Vertebrates, as his contemporary LAMARCK was of fossil Invertebrates. (Figs. 382, 453, 467.)

Cuvier's grasp of anatomy was due to his emphasizing, as Aristotle had done before him, the functional unity of the organism: that the interdependence of organs results from the interdependence of function — structure and function are two aspects of the living machine which go hand in hand. Cuvier's famous principle of correlation — "Give me a



FIG. 454. Thomas Henry Huxley.

tooth," said he, "and I will construct the whole animal" — is really an outcome of this viewpoint. Every change of function involves a change in structure and, therefore, given extensive knowledge of function and of the interdependence of function and structure, it is possible to infer from the form of one organ that of most of the other organs of an animal. But Cuvier undoubtedly allowed himself to exaggerate his guiding principle until it exceeded the bounds of fact.

Among Cuvier's immediate successors, OWEN (1804–1892) of London perhaps demands special mention. He spent a long life dissecting with untiring patience and skill a remarkable series of animal types, as well as reconstructing extinct forms from fossil remains. Aside from the facts accumulated, probably his greatest contribution was making concrete the distinction between homologous and analogous

structures. This has been of the first importance in working out the pedigrees of plants as well as of animals; though Owen himself took an enigmatical position in regard to organic evolution — not unlike that of the great teacher and investigator of zoölogy in America, Agassiz (1807–1873), but

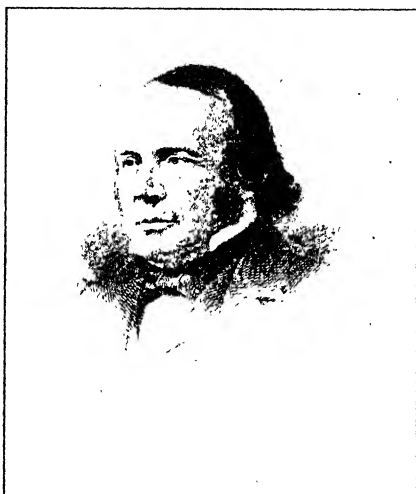

FIG. 455. Louis Agassiz.

quite different from that of HUXLEY (1825–1895), his famous contemporary English comparative anatomist. (Figs. 377, 387, 454, 455.)

### 3. *Physiology*

The functions of organisms were discussed by Aristotle with his usual insight, though with less happy results, since, as might be expected, physiology is more dependent than anatomy upon progress in other branches of science. Similarly Galen was hampered in his attempt to make physiology a distinct department of learning, based on a thorough study of anatomy, and the corner-stone of medicine; though fate foisted upon uncritical generations through fifteen centuries his system of human physiology.

Neither Vesalius nor his contemporaries attempted to explain the workings of the body by appeal to physical

and chemical laws; and for good reason. Chemistry had not yet thrown off the shackles of alchemy and taken its legitimate place among the elect sciences, while during Harvey's lifetime, under the influence of Galileo, the new physics was born. But by the end of the seventeenth century both physics and chemistry had forced their way into physiology and split it into two schools. The physical school was founded by BORELLI (1608-1679) of Italy, who, employing incisive physical methods, attacked a series of problems with brilliant results; while the chemical school developed from the influence of FRANCISCUS SYLVIVS (1614-1672) of Holland as a teacher rather than as an investigator.

This awakening brought a host of workers into the field and the harvest of the century was garnered and enriched by HALLER (1708-1777) of Geneva. In a comprehensive treatise which at once indicated the breadth of view and critical judgment of its author, Haller established physiology as a distinct and important branch of biological science. It was no longer a mere adjunct of medicine. Perhaps the most significant advance in Haller's century consisted in setting the physiology of nutrition and of respiration — both of which awaited the work of the chemists — well upon the way toward their modern form.

REAUMUR (1683-1757) of Paris, SPALLANZANI (1729-1799) of Pavia, and BEAUMONT (1785-1853) of Connecticut may be singled out for their exact studies on gastric digestion, which showed 'solution' of the food to be the main factor in digestion; although it was not clear how these changes differ from ordinary chemical ones. It was left for their successors during the latter half of the nineteenth century to establish the fact that food in passing along the digestive tract runs the gantlet of a series of complex enzyme reactions, each of which has its part to play in putting the various constituents of the food into such form that they can pass to the various cells of the body where they are actually used. (Fig. 233.)

On the side of respiration, an earlier approach was made

toward a true understanding of the process. In France LAVOISIER (1743–1794) demonstrated that the chemical changes taking place in respiration involve essentially a process of combustion, and it chiefly remained for later work to show that this takes place in the tissues rather than in the lungs. (Fig. 247.)

Most of the firm foundation on which the physiology of animals rests today has been built up by the work on Vertebrates. But since the middle of the nineteenth century, when the versatile MÜLLER (1801–1858) of Germany emphasized the value of studying the physiology of higher and lower animals alike, there has been an ever-increasing tendency to focus evidence, in so far as possible, from all forms of life on general problems of function. This has culminated in the science of COMPARATIVE PHYSIOLOGY.

The less obvious structural and functional differentiation of plants retarded progress in plant physiology as it did in plant anatomy. Probably of most historical, and certainly of most general interest is the development of our knowledge of the nutrition of green plants. Aristotle's notion that the plant's food is prepared for it in the ground was still prevalent during the seventeenth century when Malpighi, from his studies on plant histology, gave the first hint of supreme importance — the crude 'sap' enters by the roots and is carried to the leaves where, by the action of sunlight, evaporation, and some sort of a 'fermentation,' it is elaborated and distributed as food to the plant as a whole. (Fig. 449.)

It is HALES (1667–1761) of England, however, to whom the botanist looks as the Harvey of plant physiology, because in his *Vegetable Staticks* (1727) he laid the foundations of the physiology of plants by making plants speak for themselves through his incisive experiments. For the first time it became clear that green plants derive a considerable part of their food from the atmosphere, and also that the leaves play an active rôle in the movements of fluids up the stem and in eliminating superfluous water by evaporation. Still the picture was incomplete, and so remained until the



biologist had recourse to further data from the chemist. (Fig. 456.)

In 1779, PRIESTLEY (1733–1804) of England, the discoverer of oxygen, showed that this gas under certain conditions is liberated by plants. This fact was seized upon by a native of Holland, INGENHOUSZ (1730–1799), who demonstrated that carbon dioxide from the air is reduced



FIG. 456. Stephen Hales.

to its component elements in the leaf during exposure to sunlight. The plant retains the carbon and returns the oxygen — this process of carbon-getting being quite distinct from that of respiration in which carbon dioxide is eliminated. It remained then for DE SAUSSURE (1767–1845) in Geneva to show that, in addition to the fixation of carbon, the elements of water are also employed, while from the soil various salts, including combinations of nitrogen, are obtained. But it was nearly the middle of the last century before the influence and work of LIEBIG (1803–1873) at Giessen led to a clear realization of the fundamental part played by the chlorophyll of the green leaf in making certain chemical elements available to animals. The establishment of the cosmical function

of green plants — the link they supply in the circulation of the elements in nature — is an epoch in biological progress. (Figs. 17, 18, 55.)

Enough perhaps has been said to indicate the trend of physiology away from the maze of Galenic 'spirits' in which science lost itself, toward the modern viewpoint of science which assumes as its *working hypothesis* that life phenomena are an expression of a complex interaction of physico-chemical laws which do not differ fundamentally from the so-called laws operating in the inorganic world, and that the economy of the organism is in accord with the law of the conservation of energy.

However, it is important to emphasize that VITALISM — the conception that life phenomena are, in part at least, the resultant of manifestations of matter and energy which transcend and differ intrinsically in kind from those displayed in the inorganic world — has arisen many times in the development of biological thought. This has been either as a reaction against premature conclusions of the rapidly growing science, or from an overwhelming appreciation of the staggering complexity of life phenomena. Vitalism attained perhaps its most concrete formulation as a doctrine during the early part of the eighteenth century, in opposition to the obviously inadequate explanations which chemistry and physics could offer for the phenomena of irritability of living matter then prominently engaging the attention of biologists. The vitalists of that period abandoned almost completely all attempts to explain life processes on a physico-chemical basis, and assumed that an all-controlling, unknown, mystical, hyper-mechanical force was responsible for all living processes. It is apparent that such an assumption in such a form is a negation of the scientific method, and at once removes the problem from the realm of scientific investigation.

Of course, no biologist at the present time subscribes to vitalism in this form; some uphold vitalism — if it must still be called vitalism — in its considerably limited modern

form; while undoubtedly all will admit that we are at the present time utterly unable to give an adequate explanation of the fundamental life processes in terms of physics and chemistry. "The physical and chemical mechanisms, which we are increasingly learning to know, to understand and to apply in experiment, are to be regarded as mechanisms of control of structure and function on the biological level. Their rôle has not up to the present been shown to transcend this range. It is therefore fallacious to conclude that the organism is nothing more than a 'physical-chemical-mechanical conglomerate.'" Certainly the twentieth century finds few biologists who really expect a scientific explanation of life ever to be attained or who expect that protoplasm will ever be artificially synthesized. However, this much is positive: during the past fifty years some biologists have now and then thought they were on the verge of artificially creating life in the test tube, only to leave the problem, like the alchemists of old, with more respect for the complexities of protoplasmic organization and the imposing gap which separates even the simplest forms of life from the inorganic world. (Pp. 29, 30, 35, 388, 389.)

#### 4. *Histology*

Studies on the physiology of plants and animals naturally involved the progressive analysis of the physical basis of the phenomena under consideration, but the Aristotelian classification of the materials of the body as unorganized substance, homogeneous parts or tissues, and heterogeneous parts or organs, practically represented the level of analysis until the beginning of the eighteenth century. In fact it was not until the revival of interest in embryology early in the last century that the cell became a particular object of study, and attention began gradually to shift from more or less superficial details to cell organization. This culminated in the investigations of two German biologists, the botanist SCHLEIDEN (1804-1881) and the zoölogist SCHWANN (1810-

1882), published in 1838 and 1839. Together these studies convinced biologists that all organisms are composed of units, or cells, which are at once structural entities and the centers of physiological activities. And soon it became clear that the development of animals and plants consists in the multiplication of an initial cell to form the multitude of different kinds which constitute the adult. (Figs. 293, 457, 458.)



FIG. 457. Matthias Jacob Schleiden.

Unquestionably the cell concept represents one of the greatest generalizations in biology, and it only needed for its consummation the full realization that the viscid, granular material which zoölogists interpreted as the true living matter of animals, and the quite similar material which botanists considered the true living part of plants are practically identical. This viewpoint was crystallized about 1865, chiefly by SCHULTZE (1825-1874) of Germany, in the formulation of the protoplasm concept, and thenceforth not only morphological elements — cells — but also the material of which they are composed — protoplasm — were recognized as fundamentally the same in all living beings. Indeed, the realization of a common physical basis of life in both plants and animals — a common denominator to which all

vital phenomena are reducible — gave content to the term biology and created the science of life in its modern form. (Figs. 10, 459.)

### 5. Embryology

The cell theory resulted, as we have seen, from combined studies on the adult structure and on the development of plants and animals, and accordingly implies that the science



FIG. 458. Theodor Schwann.

of embryology has a history of its own. As a matter of fact, Aristotle discussed the wonder of the beating heart in the hen's egg after three days' incubation, but there the subject practically rested until FABRICIUS (1537–1619) at Padua, early in the seventeenth century, published a treatise which illustrated the obvious sequence of events within the hen's egg to the time of hatching. This beginning was built upon by a pupil of Fabricius, the celebrated Harvey, who added many details of interest, though little progress in embryology was possible without the microscope.

The microscope was first turned on embryological problems by the versatile MALPIGHI in two treatises published in 1672, and at one step animal development was placed upon

a plane so advanced that for over a century it was unappreciated. One conclusion of Malpighi, however, was seized upon by contemporary biologists. Apparently, unbeknown to him, some of the eggs which he studied were slightly incubated, so that he thought traces of the future organism were preformed in the egg. This error contributed to the formulation of the preformation theory, which gradually became the dominant question in embryology.



FIG. 459. Max Schultze.

As a matter of fact the time was not ripe for theories of development. The preformationists were wrong, but so were Aristotle, Harvey, and later supporters of epigenesis who went to the opposite extreme and denied all egg organization and therefore tried to get something out of nothing. It remained, as we know, for embryologists of the immediate past and present to work out many of the details of the origin and organization of the germ cells, and to reach a level of analysis deep enough to suggest how "the whole future organism is potentially and materially implicit in the fer-

tilized egg cell" and thus that "the preformationist doctrine had a well-concealed kernel of truth within its thick husk of error." (Fig. 460; P. 457-463.)

Another great advance came in the accurate and comprehensive studies of the Russian, VON BAER (1792-1876), published in the thirties of the last century. Taking his material from all the chief groups of higher animals, von Baer founded

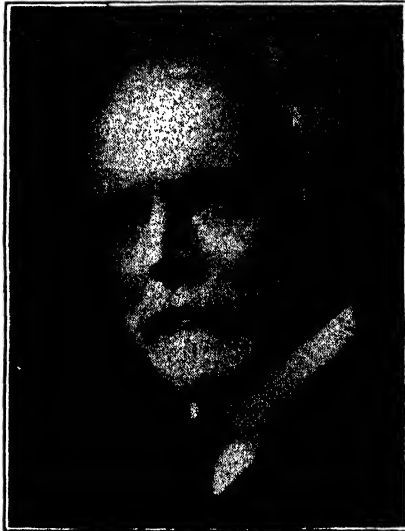

FIG. 460. Edmund Beecher Wilson (1856-1939). The foremost American cytologist of the early twentieth century.

COMPARATIVE EMBRYOLOGY. Among his achievements may be mentioned: the clear discrimination of the chief developmental stages, such as cleavage of the egg, germ layer formation, tissue and organ differentiation; the insistence on the importance of the facts of development for classification; and the discovery of the egg of Mammals. His observations on the origin and development of the germ layers, which afforded the key to many general problems of the origin of the body form, and his emphasis on the resemblance of certain embryonic stages of higher and lower animals, were made by his successors, under the influence of the evolution theory, the point of departure for the development of the GERM

LAYER THEORY and RECAPITULATION THEORY. Both were of importance in stimulating research, and although the present generation has not inherited its forebears' implicit faith in the theories, it has profited immensely by the facts they accumulated. (Fig. 461 ; Pp. 246, 573-577.)

From every point of view von Baer created an epoch in embryology just when the cell theory began to exert its influence on biological research, and thenceforth it became



FIG. 461. Karl Ernst von Baer.

the problem of the embryologist to interpret development in terms of the cell. It is unnecessary to follow historically the establishment of the fact that the egg and the sperm are really single nucleated cells; that fertilization consists in the fusion of egg and sperm and the orderly arrangement of their chief nuclear contents, or chromosomes; that the new generation *is* the fertilized egg, since every cell of the body as well as every chromosome in every cell is a lineal descendant by division from the zygote, and so from the gametes which united at fertilization to form it. Such, however, are the chief results of cytological study since von Baer. But embryologists have not been content to employ merely the



descriptive method, and the dominant note of the most modern research is physiological — the experimental study of the significance of fertilization, the dynamics of cell division, the basis of differentiation, the influence of environmental stimuli, and so on. CHEMICAL EMBRYOLOGY has emerged. (Figs. 290, 292, 312; Pp. 465, 466.)

## 6. Genetics

The study of inheritance could be little more than a groping in the dark until embryology, under the influence of the cell theory, afforded a body of facts which clearly indicated

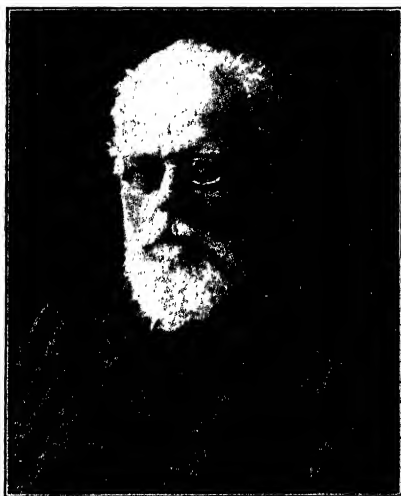

FIG. 462. August Weismann.

that typically the fertilized egg is the sole bridge of continuity between successive generations. Indeed, the present science of genetics has a history largely confined to this century.

Although clearly intimated by a number of workers, the conception of the continuity of the germ plasm was first forced upon the attention of biologists and given greater precision by WEISMANN (1834–1914) of Germany in a series of essays culminating in 1892 in his volume entitled *The Germ Plasm*. He identified the chromatin material which constitutes the chromosomes of the cell nucleus as the specific

bearer of hereditary characters, and emphasized a sharp distinction between germ cells and somatic cells. (Figs. 315, 462.)

While this viewpoint had been gradually gaining content and precision, the science of genetics had been advancing not only by exact studies on the structure and physiology of the germ cells, but also by statistical studies of the results of heredity — the various characters of animals and plants as exhibited in parents and offspring. The studies of this type which first attracted the attention of biologists were made by GALTON (1822–1911) of England. In the eighties



FIG. 463. Gregor Johann Mendel.

and nineties of the last century, he amassed a great volume of data concerning, for example, the stature of children with reference to that of their parents, and derived his well-known 'laws' of inheritance. (Figs. 317, 394.)

But the work which eventually created the science of genetics was that of MENDEL (1822–1884) of Brünn, Austria. Mendel combined in a masterly manner the experimental breeding of pedigreed strains of plants and the statistical treatment of the data thus secured in regard to the inheritance of certain characters, such as the form and color of the

seeds in peas. His work was published in 1865 in an obscure natural history periodical, and he abandoned teaching and research to become the Abbot of his monastery. Thus terminated prematurely the scientific career of one of the epoch-makers of biology, and the now famous Mendelian laws of

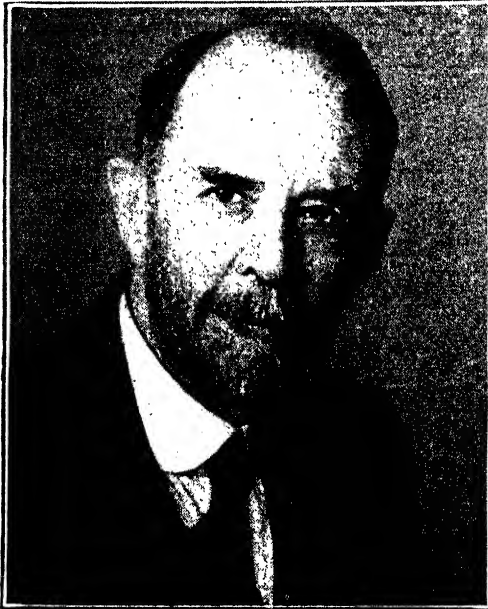

FIG. 464. Thomas Hunt Morgan (1866-1945).

inheritance were unknown to science until 1900, when other biologists, coming to similar results, unearthed his thirty-five-year-old paper. (Figs. 318, 463.)

We have already seen that the fundamental principle of the segregation of the genes during the development of the gametes, which Mendel's work indicated, has been extended to other plants and to animals, and that instead of being, as at first thought, a principle of rather limited application, appears from the investigations of a host of workers, in particular Morgan and his school, to be the basis of all inheritance. And the present results are extremely convincing because cytological studies on the architecture of the chromo-

some complex of the germ cells keep pace with, and afford a picture of the physical basis of inheritance — the mechanism by which the segregation and independent assortment of characters by the Mendelian formula takes place. Such is the deeply hidden element of truth in the old preformation theories. (Figs. 297, 337, 464.)

## 7. *Organic Evolution*

A question which has interested and perplexed thinking men of all times is how things came to be as they are today. The historian of human affairs attempts to trace the sequence and relationship of events from the remote past to the present. Similarly, the geologist endeavors to formulate the history of the earth; and the biologist, the history of plants and animals on the earth. All recognize that the present is the child of the past and the parent of the future, and that past, present, and future, though causally related, are never the same. It was the Greek natural philosophers who introduced this idea of history into science and attempted to give a naturalistic explanation of the earth and its inhabitants, and thus started the uniformitarian trend of thought which culminated in the establishment of organic evolution during the past century.

Aristotle says, in substance: Although the line of demarcation is broadly defined, yet nature passes by ascending steps from one to the other. The first step is that of plants; which, compared with animals, seem inanimate. The second step nature takes is from plants to plant-animals, the zoöphytes. The third step is the development of animals, which arise from an increased activity of the vital principle, resulting in sensibility; and with sensibility, desire; and with desire, locomotion. Man is the head of animal creation. To him belongs the God-like nature. He is preëminent by thought and volition. But although all are dwarf-like and incomplete in comparison with man, he is only the highest point of one continuous ascent. (Fig. 397.)

Aristotle specifically implies the *scala naturae* concept which attained its highest development during the eighteenth century at the hands of Linnæus. But whether or no Aristotle saw a genetic connection between the terms of the series — which Linnæus and his contemporaries did not — has been widely debated. If Aristotle were alive today probably he would disclaim having had such an idea, but be pleased to have it ascribed to him.



FIG. 465. Comte de Buffon.

The thread of continuity in uniformitarian thought is not broken from the Greeks to the present, but from the strictly biological viewpoint two Frenchmen, Buffon and Lamarck, and two Englishmen, Erasmus Darwin and his grandson, Charles Darwin, stand preëminent.

BUFFON (1707–1788) was a peculiarly happy combination of entertainer and scientist who found expression in each new volume of his great *Natural History*. And it was largely, so to speak, between the lines of this work that Buffon's evolutionary ideas were advanced; apparently beyond the reach of the censor and dilettante. It is not strange, therefore, that it is often difficult to decide just how much weight

is to be placed on some of his statements; though certainly it is not exaggerating to ascribe to him not only the recognition of the factors of geographical isolation, struggle for existence, artificial and natural selection in the origin of species, but also the propounding of a theory of the origin of variations—that the direct action of the environment brings about modifications in the structure of animals and plants and these are transmitted to the offspring. (Fig. 465.)



FIG. 466. Erasmus Darwin.

When Buffon's influence had passed its height, ERASMUS DARWIN (1731–1802), grandfather of Charles Darwin, expressed consistent views on the evolution of organisms, in several volumes of prose and poetry, which lead biologists today to recognize him as the anticipator of the Lamarckian doctrine that somatic variations arise through the reaction of the organism to environmental conditions. "All animals undergo transformations which are in part by their own exertions, in response to pleasures and pain, and many of these acquired forms or propensities are transmitted to their posterity." (Fig. 466.)

LAMARCK (1744–1829) developed with great care the first complete and logical theory of organic evolution and is the

one outstanding figure in biological uniformitarian thought between Aristotle and Charles Darwin. "For nature," he writes, "time is nothing. For all the evolution of the earth and of living beings, nature needs but three elements, space, time, and matter." In regard to the factors of evolution, Lamarck put emphasis on the indirect action of the environment in the case of animals, and the direct action in the case of plants. The former are induced to react and so adapt them-

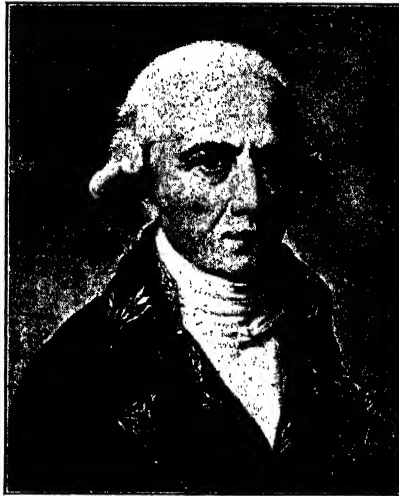

FIG. 467. Chevalier de Lamarck.

selves, as it were; while the latter, without a nervous system, are molded directly by their surroundings. And, so Lamarck believed, such changes, somatic in origin — acquired characters — are transmitted to the next generation and bring about the evolution of organisms. (Fig. 467; P. 584.)

Through the relative weakness of Lamarck's successors the French school of evolutionists dwindled to practical extinction; while in Germany, GOETHE (1749-1832), the greatest poet of evolution, and TREVIRANUS (1776-1837) "brilliantly carried the argument without carrying conviction," for the man and the moment must agree. Then in England the uniformitarian ideas elaborated by LYELL (1797-1875) in

his *Principles of Geology* established evolution in geology and the way was paved for CHARLES DARWIN (1809–1882) to do the same for the organic world. (Fig. 469.)

True, “the idea of development saturated the intellectual atmosphere — nevertheless the elaborate and toilsome labor of thinking it through for the endless realm of nature was to be done” and Darwin did it in his *Origin of Species* which appeared in 1859. By his brilliant, scholarly, open-minded,



FIG. 468. Alfred Russel Wallace.

and cautious marshaling of the facts pointing toward the universality of variations and the mutability of species; and by the theory of natural selection on the basis of slight adaptive variations resulting in the survival of the fittest in the struggle for existence — which, strange to say, Darwin and WALLACE (1822–1913) reached simultaneously and independently — Darwin made the old idea current intellectual coin, and indicated the setting of the evolutionary drama with cosmic breadth of vision. (Figs. 183, 389, 397, 468; Pp. 585–588.)

Today, of course, no representative biologist questions the fact of evolution — “evolution knows only one heresy,



the denial of continuity" — though in regard to the relative importance of the various factors involved, there is much difference of opinion. It is possible, of course, that we shall have reason to depart somewhat from Darwin's interpretation of the effective principles at work in the origin of species, but withal this will have little influence on his position in the history of biology. The great value which he placed upon facts was exceeded only by his demonstration that

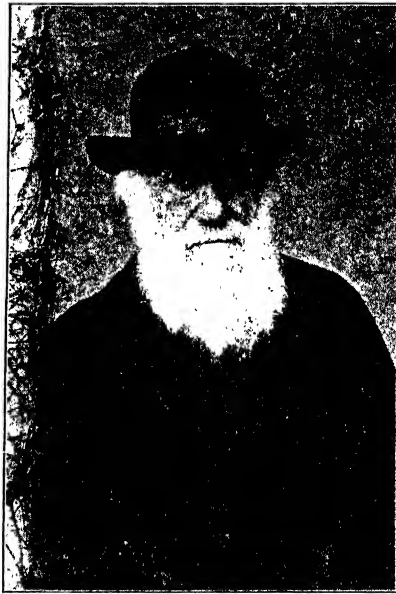

FIG. 469. Charles Darwin.

this "value is due to their power of guiding the mind to a further discovery of principles." The *Origin of Species* brought biology into line with the other inductive sciences, recast practically all of its problems, and instituted new ones. Darwin beautifully and conservatively expressed this new outlook on nature in the historically important concluding paragraph of his epoch-making work :

"It is interesting to contemplate a tangled bank, clothed with many plants of many kinds, with birds singing on the bushes, with various insects flitting about, and with worms

crawling through the damp earth, and to reflect that these elaborately constructed forms, so different from each other, and dependent upon each other in so complex a manner, have all been produced by laws acting around us. These laws, taken in the largest sense, being Growth with Reproduction; Inheritance which is almost implied by reproduction; Variability from the indirect and direct action of the conditions of life, and from use and disuse: a Ratio of Increase so high as to lead to a Struggle for Life, and as a consequence to Natural Selection, entailing Divergence of Character and the Extinction of less-improved forms. Thus, from the war of nature, from famine and death, the most exalted object which we are capable of conceiving, namely, the production of the higher animals, directly follows. There is grandeur in this view of life, with its several powers, having been originally breathed by the Creator into a few forms or into one; and that, whilst this planet has gone cycling on according to the fixed law of gravity, from so simple a beginning endless forms most beautiful and most wonderful have been, and are being evolved."



## APPENDIX



## I. BIBLIOGRAPHY

Some easily available works which are suitable for reference and collateral reading.

BAITSELL, G. A. *Manual of Biology*. 6th edition. The Macmillan Co., 1941. Detailed descriptions of the structure and life processes of a number of representative animals and plants, together with directions for their study in the laboratory. Written especially to accompany WOODRUFF's *Foundations of Biology*, 6th edition.

### CHAPTER I.—THE SCOPE OF BIOLOGY

- Biological Abstracts* of the World's Literature in Biology. Issued monthly. Vol. 15, 1941. Philadelphia.
- CATTELL, J. McK. (editor). *American Men of Science*. A Biographical Dictionary. 7th edition. Science Press, 1941.
- DAMPIER-WHETHAM, W. C. D. *A History of Science*. Cambridge, 1930.
- DORLAND, W. A. N. *Medical Dictionary*. 18th edition. Saunders, 1938.
- GREGORY, R. A. *Discovery, or the Spirit and Service of Science*. Macmillan, 1916.
- HALDANE, J. S. *The Philosophical Basis of Biology*. Doubleday, Doran, 1931.
- HENDERSON, I. F., and HENDERSON, W. D. *A Dictionary of Scientific Terms: Pronunciation, Derivation, and Definition of Terms in Biology, Botany, Zoology, Anatomy, Cytology, Embryology, Physiology*. 3d edition. Van Nostrand, 1939.
- HUXLEY, T. H. *Educational Value of the Natural History Sciences*. 1854. *Collected Essays*, Vol. *Science and Education*. Appleton.
- HUXLEY, T. H. *On Our Knowledge of the Causes of the Phenomena of Organic Nature*. 1863. *Collected Essays*, Vol. *Darwiniana*.
- HUXLEY, T. H. *On the Study of Biology*. 1876. *Collected Essays*, Vol. *Science and Education*.
- JAEGER, E. C. *A Dictionary of Greek and Latin Combining Forms Used in Zoological Names*. Thomas, 1930.
- MELANDER, A. L. *Source Book of Biological Terms*. New York, 1937.
- THOMSON, J. A. *An Introduction to Science*. Holt, 1911.
- WELLS, H. G., HUXLEY, J. S., and WELLS, G. P. *The Science of Life*. Doubleday, Doran, 1931.

- WESTAWAY, F. W. *Scientific Method*. 3d edition. Blackie & Son, 1923.  
 WHEELER, W. M. *Essays in Phitosophical Biology*. Harvard, 1939.  
 WHITEHEAD, A. N. *Science and the Modern World*. Macmillan, 1925.

## CHAPTER II. — CELLULAR ORGANIZATION OF LIFE<sup>1</sup>

- COWDRY, E. V. (editor). *General Cytology*. Chicago, 1924.  
 COWDRY, E. V. (editor). *Special Cytology*. 2d edition. Hoeber, 1932.  
 DARLINGTON, C. D. *Recent Advances in Cytology*. 2d edition. Blakiston, 1937.  
 GRAY, J. *Text Book of Experimental Cytology*. Macmillan, 1931.  
 SHARP, L. W. *Introduction to Cytology*. 3d edition. McGraw-Hill, 1934.  
 THOMPSON, D'ARCY W. *On Growth and Form*. Cambridge, 1917.  
 WILSON, E. B. *The Cell in Development and Heredity*. 3d edition. Macmillan, 1925.

## CHAPTER III. — THE PHYSICAL BASIS OF LIFE

- BARNES, T. C. *Textbook of General Physiology*. Blakiston, 1937.  
 HEILBRUNN, L. V. *Colloidal Chemistry of Protoplasm*. Borntraeger, 1928.  
 HEILBRUNN, L. V. *General Physiology*. Saunders, 1937.  
 HUXLEY, T. H. *On the Physical Basis of Life*. 1868. *Collected Essays*, Vol. *Method and Results*. Appleton.  
 KERMAK, W. O., and EGGLESTON, P. *The Stuff We're Made Of*. Longmans, Green, 1938.  
 LOEB, JACQUES. *The Dynamics of Living Matter*. Columbia, 1906.  
 MITCHELL, P. H., *Text Book of General Physiology*. 3rd edition. McGraw-Hill, 1938.  
 NEEDHAM, J., and GREEN, D. E. (editors). *Perspectives in Biochemistry*. Cambridge, 1937.  
 PARSONS, T. R. *The Materials of Life*. Norton, 1930.  
 PHILIP, J. C. *Physical Chemistry: Its Bearing on Biology and Medicine*. Longmans, Green, 1925.  
 SEIFRIZ, W. *Protoplasm*. McGraw-Hill, 1936.  
 SHERMAN, H. C. *Chemistry of Food and Nutrition*. 5th edition. Macmillan, 1937.  
 WILSON, E. B. *The Physical Basis of Life*. Yale, 1923.

## CHAPTER IV. — METABOLISM OF ORGANISMS

- BALDWIN, E. *An Introduction to Comparative Biochemistry*. Cambridge, 1937.  
 BLISS, S. *Introductory Guide to Biochemistry*. Saunders, 1939.

<sup>1</sup> Also see Bibliography for Chapter V.

- BUCHANAN, E. D., and BUCHANAN, R. E. *Bacteriology*. 4th edition. Macmillan, 1938.
- GORTNER, R. A. *Outlines of Biochemistry*. 2d edition. Wiley, 1938.
- GRAEVES, J. E., and GRAEVES, E. O. *Elementary Bacteriology*. 3d edition. Saunders, 1936.
- HOLMES, E. *The Metabolism of Living Tissues*. Cambridge, 1937.
- HUXLEY, T. H. *On the Border Territory between the Animal and Vegetable Kingdoms*. 1876. *Collected Essays*, Vol. *Discourses Biological and Geological*. Appleton.
- JORDAN, E. O. *Bacteriology*. 12th edition. Saunders, 1938.
- LUTMAN, B. F. *Microbiology*. McGraw-Hill, 1930.
- PLUNKETT, C. R. *Outlines of Modern Biology*. Holt, 1930.
- SINNOTT, E. W. *Botany: Principles and Problems*. 3d edition. McGraw-Hill, 1935.
- WAKSMAN, S. A. *Principles of Soil Microbiology*. Williams & Wilkins, 1927.
- WAKSMAN, S. A., and STARKEY, R. L. *The Soil and the Microbe*. Wiley, 1931.
- WOODRUFF, L. L. *The Origin and Sequence of the Protozoan Fauna of Hay Infusions*. *Journal of Experimental Zoölogy*. Vol. 12, 1912.

#### CHAPTER V. — THE MULTICELLULAR ORGANISM<sup>1</sup>

- BENSLEY, R. R., and BENSLEY, S. H. *Handbook of Histological and Cytological Technique*. Chicago, 1938.
- BREMER, J. L. *Histology*. 5th edition. Blakiston, 1936.
- DAHLGREN, ULRIC, and KEPNER, W. A. *Principles of Animal Histology*. Macmillan, 1908.
- EAMES, A. J., and MACDANIELS, L. H. *Introduction to Plant Anatomy*. McGraw-Hill, 1925.
- GAGE, S. H. *The Microscope*. 16th edition. Comstock, 1936.
- GUYER, M. F. *Animal Micrology. Practical Exercises in Zoölogical Microtechnique*. 4th edition. Chicago, 1936.
- JOHANSEN, D. A. *Plant Microtechnique*. McGraw-Hill, 1940.
- KELLICOTT, W. E. *General Embryology*. Holt, 1913.
- KENDALL, J. I. *Microscopic Anatomy of Vertebrates*. 2d edition. Lea and Febiger, 1940.
- KINGSBURY, B. F., and JOHANNSEN, O. A. *Histological Technique*. Wiley, 1936.
- LAMBERT, A. E. *Introduction and Guide to the Study of Histology*. Blakiston, 1938.
- LEE, A. B. *The Microtome's Vade Mecum*. 10th edition. Blakiston, 1937.

<sup>1</sup> Also see Bibliography for Chapter II.



- McCLUNG, C. E. (editor). *Microscopical Technique*. 2d edition. Hoeber, 1937.
- MAXIMOW, A. A., and BLOOM, W. *Textbook of Histology*. 3d edition. Saunders, 1938.
- SASS, J. E. *Elements of Botanical Microtechnique*. McGraw-Hill, 1940.
- SCHÄFER, E. A. *Essentials of Histology*. Revised by H. M. Carleton. Lea and Febiger, 1939.
- SCOTT, G. G., and KENDALL, J. I. *The Microscopic Anatomy of Vertebrates*. Lea and Febiger, 1939.

### CHAPTERS VI-VIII. — PLANTS

- BAILEY, L. H. *Manual of Cultivated Plants*. Macmillan, 1924.
- BOWER, F. O. *Primitive Land Plants*. Macmillan, 1935.
- BRITTON, N. L. *Manual of the Flora of the Northern States and Canada*. 2d edition. Holt, 1905.
- BROWN, H. P. *Trees of Northeastern United States*. 2d edition. Christopher, 1938.
- BROWN, W. H. *The Plant Kingdom*. Ginn, 1935.
- COULTER, J. M. *The Evolution of Sex in Plants*. Chicago, 1914.
- COULTER, J. M., BARNES, C. R., and COWLES, H. C. *Textbook of Botany*. 2d edition. American Book Co., 1931.
- COULTER, M. C. *The Story of the Plant Kingdom*. Chicago, 1938.
- GRAY, ASA. *Manual of Botany*. 7th edition. American Book Co., 1908.
- HASKIN, L. L. *Wild Flowers of the Pacific Coast*. Metropolitan, 1934.
- HAYWARD, H. E. *The Structure of Economic Plants*. Macmillan, 1938.
- HITCHCOCK, A. S. *Methods of Descriptive Systematic Botany*. Wiley, 1925.
- HOLMAN, R. M., and ROBBINS, W. W. *Textbook of General Botany*. 4th edition. Wiley, 1938.
- HYLANDER, C. J. *The World of Plant Life*. Macmillan, 1939.
- JOHNSON, A. M. *Taxonomy of the Flowering Plants*. Century, 1931.
- LONGYEAR, B. O. *Trees and Shrubs of the Rocky Mountain Region*. Putnam, 1927.
- MAXIMOV, N. A. *Plant Physiology*. 2d English edition. McGraw-Hill, 1938.
- MEDSGER, O. P. *Edible Wild Plants*. Macmillan, 1939.
- MEUNSCHER, W. C. *Poisonous Plants of the United States*. Macmillan, 1939.
- MILLER, E. C. *Plant Physiology*. 2d edition. McGraw-Hill, 1938.
- MUNZ, P. A. *Manual of Southern California Botany*. Stacey, 1935.
- REHDER, A. *Manual of Cultivated Trees and Shrubs*. 2d edition. Macmillan, 1940.
- ROBBINS, W. J., and RICKETT, H. W. *Botany*. 3d edition. Van Nostrand, 1939.

- ROBBINS, W. W. *Principles of Plant Growth*. Wiley, 1936.
- RYDBERG, P. A. *Flora of the Prairies and the Plains of Central North America*. New York Botanical Garden, 1932.
- SEIFRIZ, W. *The Physiology of Plants*. Wiley, 1938.
- SEWARD, A. C. *Plant Life Through the Ages*. 2d edition. Macmillan, 1933.
- SINNOTT, E. W. *Botany: Principles and Problems*. 3d edition. McGraw-Hill, 1935.
- SKENE, M. *Biology of Flowering Plants*. Macmillan, 1924.
- SMALL, J. K. *Manual of the Southeastern Flora*. Science Press, 1935.
- SMITH, G. M., OVERTON, J. B., GILBERT, E. M., DENNISTON, R. H., BRYAN, G. S., and ALLEN, C. E. *General Botany*. 3d edition. Macmillan, 1935.
- STEVENS, G. T. *Illustrated Guide to the Flowering Plants of the Middle Atlantic and New England States*. Dodd, Mead, 1910.
- STRASBURGER, E. *Textbook of Botany*. 6th English edition. Macmillan, 1930.
- WENT, F. W. *Regulation of Plant Growth*, in *Science in Progress*, 2d series. G. A. Baitsell (editor), Yale, 1940.

#### CHAPTERS IX-X. — INVERTEBRATES

- BEDDARD, F. E. *Earthworms and Their Allies*. Cambridge, 1901.
- BORRADAILE, L. A., and POTTS, F. A. *The Invertebrata*. 2d edition, Macmillan, 1935.
- BOULENGER, E. G. *World Natural History*. Scribner, 1938.
- BUCHSBAUM, R. *Animals Without Backbones*. Chicago, 1938.
- CARPENTER, G. H. *Biology of Insects*. Sidgwick and Jackson, 1928.
- CALKINS, G. N. *Biology of the Protozoa*. 2d edition. Lea and Febiger, 1933.
- CALKINS, G. N. (editor). *Protozoa in Biological Research*. Columbia, 1941.
- CARTER, G. S. *Introduction to Invertebrate Zoology*. Macmillan, 1940.
- DREW, G. A. *Invertebrate Zoology*. 5th edition. Saunders, 1936.
- FOLSOM, J. W., and WARDLE, R. A. *Entomology*. 4th edition. Blakiston, 1934.
- HARMER, S. F., and SHIPLEY, A. E. (editors). *The Cambridge Natural History*. Ten volumes, Macmillan, 1895.
- HEGNER, R. W. *College Zoology*. 5th edition. Macmillan, 1941.
- HEGNER, R. W. *Invertebrate Zoology*. Macmillan, 1933.
- HEGNER, R. W. *Parade of the Animal Kingdom*. Macmillan, 1935.
- HEGNER, R. W., and TALIAFERRO, W. H. *Human Protozoology*. Macmillan, 1924.
- HUXLEY, T. H. *The Crayfish*. 1880.
- HYMAN, L. H. *Hydras of North America*. *Trans. Amer. Micr. Society*, Vol. 50, 1931.

- HYMAN, L. H. *The Invertebrates: Protozoa through Ctenophora*. McGraw-Hill, 1940.
- JENNINGS, H. S. *Genetics of the Protozoa*. Nijhoff, 1929.
- JOHNSON, M. E., and SNOOK, J. J. *Seashore Animals of the Pacific Coast*. Macmillan, 1936.
- KUDO, R. R. *Protozoology*. 2d edition. Thomas, 1939.
- LANKESTER, E. R. (editor). *Treatise on Zoology*. Eight volumes. Macmillan.
- METCALF, C. L., and FLINT, W. P. *Fundamentals of Insect Life*. McGraw-Hill, 1932.
- NEEDHAM, J. G. *Guide to the Study of Fresh-water Biology*. 2d edition. Thomas, 1930.
- NEEDHAM, J. G. (editor). *Culture Methods for Invertebrate Animals*. Cornell, 1937.
- PARKER, T. J., and HASWELL, W. A. *Textbook of Zoology*. 6th edition. Macmillan, 1940.
- PRATT, H. W. *A Manual of the Common Invertebrate Animals, Exclusive of Insects*. 2d edition. Blakiston, 1935.
- RICKETTS, E. F., and CALVIN, J. *Between Pacific Tides*. Stanford, 1939.
- SHIPLEY, A. E. *Hunting under the Microscope*. Macmillan, 1928.
- WARD, H. B., and WHIPPLE, G. C. *Fresh-water Biology*. Wiley, 1918.
- WENRICH, D. H. *Eight Well-defined Species of Paramecium*. Trans. Amer. Microscopical Society, Vol. 47, 1928.
- WENYON, C. M. *Protozoology*. William Wood, 1926.

#### CHAPTERS XI-XIX. — VERTEBRATES

- ADAMS, L. A. *Introduction to the Vertebrates*. 2d edition. Wiley, 1938.
- BAINBRIDGE, F. A., and MENZIES, J. A. *Essentials of Physiology*. 7th edition. Longmans, Green, 1932.
- BAITSELL, G. A. *Human Biology*. McGraw-Hill, 1940.
- BOULENGER, E. G. *World Natural History*. Scribner, 1938.
- CANNON, W. B. *The Wisdom of the Body*. 2d edition. Norton, 1939.
- CARLSON, A. J., and JOHNSON, V. *The Machinery of the Body*. Chicago, 1937.
- CRANDALL, L. A. *An Introduction to Human Physiology*. 2d edition. Saunders, 1938.
- HEGNER, R. W. *College Zoology*. 5th edition. Macmillan, 1941.
- HEGNER, R. W. *Parade of the Animal Kingdom*. Macmillan, 1935.
- HILL, A. V. *Living Machinery*. Harcourt, Brace, 1927.
- HOLMES, S. J. *Biology of the Frog*. 4th edition. Macmillan, 1927.
- HOSKINS, R. G. *The Tides of Life*. Norton, 1933.
- HOWELL, W. H. *Textbook of Physiology*. 14th edition. Saunders, 1940.

- HYMAN, L. H. *A Laboratory Manual for Comparative Vertebrate Anatomy*, Chicago, 1922.
- KEITH, ARTHUR. *The Engines of the Human Body*. 2d edition. Lippincott, 1926.
- MARSHALL, A. M. *The Frog*. An Introduction to Anatomy, Histology, and Embryology. 12th edition. Macmillan, 1928.
- MARSHALL, C. S. *Introduction to Human Anatomy*. 2d edition. Saunders, 1939.
- MARTIN, H. N. *The Human Body*. 12th edition. Holt, 1934.
- MESSER, H. M. *Introduction to Vertebrate Anatomy*. Macmillan, 1938.
- MITCHELL, P. H. *Text Book of General Physiology*. 3d edition. McGraw-Hill, 1938.
- MORGAN, A. H. *Field Book of Ponds and Streams*. Putnam, 1930.
- MORGAN, A. H. *Field Book of Animals in Winter*. Putnam, 1940.
- NEAL, H. V., and RAND, H. W. *Chordate Anatomy*. Blakiston, 1939.
- NEWMAN, H. H. *The Phylum Chordata*. Macmillan, 1939.
- NORMAN, J. R. *History of Fishes*. Benn, 1931.
- PARKER, T. J., and HASWELL, W. A. *Textbook of Zoölogy*. 6th edition. Macmillan, 1940.
- PRATT, H. S. *Vertebrate Zoölogy*. 3d edition. Ginn, 1938.
- PRATT, H. S. *A Manual of Land and Fresh Water Vertebrate Animals of the United States, Exclusive of Birds*. 2d edition. Blakiston, 1935.
- ROGERS, C. G. *Comparative Physiology*. 2d edition. McGraw-Hill, 1938.
- SHERMAN, H. C., and LANFORD, C. S. *Essentials of Nutrition*. Macmillan, 1940.
- STARLING, E. H. *Principles of Human Physiology*. 6th edition. Lea and Febiger, 1933.
- WALTER, H. E. *Biology of the Vertebrates*. 2d edition. Macmillan, 1939.
- WALTER, H. E. *The Human Skeleton*. Macmillan, 1918.
- WIGGERS, C. J. *Physiology in Health and Disease*. Lea and Febiger, 1939.
- WILLIAMS, J. F. *Anatomy and Physiology*. 6th edition. Saunders, 1940.
- WINTON, F. R., and BAYLISS, L. E. *Human Physiology*. 2d edition. Blakiston, 1935.

## CHAPTER XX.—ORIGIN OF LIFE

- BENTNER, R. *Life's Beginning on Earth*. Williams and Wilkins, 1938.
- HUXLEY, T. H. *Biogenesis and Abiogenesis*. 1870. *Collected Essays*. Vol. *Discourses Biological and Geological*.
- MOORE, B. *The Origin and Nature of Life*. Holt, 1912.
- NEWMAN, H. H. (editor). *The Nature of the World and Man*. Chicago, 1926.
- OPARIN, A. J. *The Origin of Life*. Macmillan, 1938.

- OSBORN, H. F. *The Origin and Evolution of Life upon the Earth*. Scribner, 1917.
- SCHÄFER, E. A. *Life: Its Nature, Origin and Maintenance*. Science, Vol. 36, 1912.
- SMITH, K. M. *The Virus*. Cambridge, 1940.
- TROLAND, L. T. *The Chemical Origin and Regulation of Life*. The Monist, Vol. 24, 1914.
- VERWORN, M. *General Physiology*. 2d edition. Macmillan, 1899.
- WOODRUFF, L. L. *The Origin of Life*, in *Evolution of Earth and Man*. Yale, 1930.

### CHAPTERS XXI-XXIII. — CONTINUITY OF LIFE, FERTILIZATION, AND DEVELOPMENT

- CHILD, C. M. *Senescence and Rejuvenescence*. Chicago, 1915.
- DAVENPORT, C. B. *How We Came by Our Bodies*. Holt, 1936.
- DODDS, G. S. *Essentials of Human Embryology*. 2d edition. Wiley, 1938.
- DRIESCH, HANS. *Science and Philosophy of the Organism*. 1907-08. Black.
- GEDDES, P., and THOMSON, J. A. *Sex*. Holt, 1914.
- GRAY, J. *A Textbook of Experimental Cytology*. Macmillan, 1931.
- HEGNER, R. W. *The Germ-cell Cycle in Animals*. Macmillan, 1914.
- HUXLEY, J. S., and DEBEER, G. R. *The Elements of Experimental Embryology*. Macmillan, 1934.
- JENNINGS, H. S. *Life and Death, Heredity and Evolution in Unicellular Organisms*. Gorham, 1920.
- KELICOTT, W. E. *Chordate Development*. Holt, 1913.
- LILLIE, F. R. *Problems of Fertilization*. Chicago, 1919.
- MORGAN, T. H. *Experimental Embryology*. Columbia, 1927.
- NEEDHAM, J. *Chemical Embryology*. Cambridge, 1931.
- NEEDHAM, J. *Order and Life*. Yale, 1936.
- RICHARDS, A. *Outline of Comparative Embryology*. Wiley, 1937.
- SHUMWAY, W. *Vertebrate Embryology*. 3d edition. Wiley, 1935.
- WADDINGTON, C. H. *Organizers and Genes*. Macmillan, 1940.
- WEISMANN, AUGUST. *The Germ Plasm*. Scribner, 1892.
- WEISS, P. *Principles of Development*. Holt, 1939.
- WIEMAN, H. L. *An Introduction to Vertebrate Embryology*. McGraw-Hill, 1930.
- WILSON, E. B. *The Cell in Development and Heredity*. 3d edition. Macmillan, 1925.
- WOODRUFF, L. L. *Endomixis*, in *Protozoa in Biological Research*. Columbia, 1941.

## CHAPTER XXIV. — GENETICS

- ALLEN, EDGAR (editor). *Sex and Internal Secretions*. Williams & Wilkins, 1932.
- BAUR, E., FISCHER, E., and LENZ, F. *Human Heredity*. Macmillan, 1931.
- CASTLE, W. E. *Genetics and Eugenics*. 4th edition. Harvard, 1930.
- CASTLE, W. E. *Mammalian Genetics*. Harvard, 1940.
- CONKLIN, E. G. *Heredity and Environment in the Development of Men*. 7th edition. Princeton, 1927.
- CRANE, M. B., and LAWRENCE, W. J. C. *The Genetics of Garden Plants*. 2d edition. Macmillan, 1939.
- GALTON, FRANCIS. *Natural Inheritance*. 1889.
- GATES, R. R. *Heredity in Man*. Macmillan, 1929.
- GOLDSCHMIDT, R. *Physiological Genetics*. McGraw-Hill, 1938.
- GUYER, M. F. *Being Well-born*. 2d edition. Bobbs-Merrill, 1927.
- JENNINGS, H. S. *Genetics*. Norton, 1935.
- JENNINGS, H. S. *Genetics of the Protozoa*. Nijhoff, 1929.
- JENNINGS, H. S. *The Biological Basis of Human Nature*. Norton, 1930.
- MORGAN, T. H. *The Theory of the Gene*. 2d edition. Yale, 1929.
- RUSSELL, E. S. *The Interpretation of Development and Heredity*. Oxford, 1930.
- SHULL, A. F. *Heredity*. 3d edition. McGraw-Hill, 1938.
- SINNOTT, E. W., and DUNN, L. C. *Principles of Genetics*. 3d edition. McGraw-Hill, 1939.
- SNYDER, L. H. *The Principles of Heredity*. 2d edition. Heath, 1940.
- STADLER, L. J. *Experimental Alteration of Heredity*, in *Science in Progress*, 2d series. G. A. Baitsell (editor), Yale, 1940.
- STOCKARD, C. R. *The Physical Basis of Personality*. Norton, 1931.
- STURTEVANT, A. H., and BEADLE, G. W. *Introduction to Genetics*. Saunders, 1939.
- WADDINGTON, C. H. *Introduction to Modern Genetics*. Macmillan, 1939.
- WALTER, H. E. *Genetics*. 4th edition. Macmillan, 1938.
- WINTERS, L. M. *Animal Breeding*. 2d edition. Wiley, 1930.

## CHAPTER XXV. — ORGANIC ADAPTATION

- ALLEE, W. C. *Animal Aggregations*. Chicago, 1931.
- ALLEE, W. C. *The Social Life of Animals*. Norton, 1938.
- ALVERDES, F. *Social Life in the Animal World*. Harcourt, Brace, 1927.
- BRAUN-BLANQUET, J., FULLER, G. D., and CONRAD, H. S. *Plant Sociology*. McGraw-Hill, 1932.
- CHILD, C. M. *Physiological Foundation of Behavior*. Holt, 1924.
- CLEMENTS, F. E., and SHELFORD, V. E. *Bio-ecology*. Wiley, 1939.
- COTT, H. B. *Adaptive Coloration in Animals*. Methuen, 1940. ,

- CRILE, G. W. *Man — An Adaptive Mechanism*. Macmillan, 1916.
- DARWIN, CHARLES. *The Fertilization of Orchids. The Various Contrivances by Which Orchids Are Fertilized by Insects*. London, 1862.
- HALDANE, J. S. *Organism and Environment*. Yale, 1917.
- HENDERSON, L. J. *The Fitness of the Environment*. Macmillan, 1913.
- HESSE, R., ALLEE, W. C., and SCHMIDT, K. P. *Ecological Animal Geography*. Wiley, 1937.
- HINGSTON, R. W. G. *Instinct and Intelligence*. Macmillan, 1929.
- HOLMES, S. J. *The Evolution of Animal Intelligence*. Holt, 1911.
- JENNINGS, H. S. *Behavior of the Lower Organisms*. Columbia, 1906.
- LLOYD, R. E. *What Is Adaptation?* Longmans, Green, 1914.
- LOEB, JACQUES. *Forced Movements, Tropisms, and Animal Conduct*. Lippincott, 1918.
- NEEDHAM, J. G., and LLOYD, J. T. *The Life of Inland Waters*. Cornell, 1937.
- PEARSE, A. S. *Animal Ecology*. 2d edition. McGraw-Hill, 1939.
- PEARSE, A. S. *Environment and Life*. Thomas, 1930.
- PHILLIPS, E. F. *Beekeeping*. 2d edition. Macmillan, 1928.
- PUNNETT, R. C. *Mimicry in Butterflies*. Cambridge, 1915.
- ROOSEVELT, THEODORE. *Revealing and Concealing Coloration in the Birds and Mammals*. Bull. Amer. Museum Nat. Hist., Vol. 30, 1911.
- SHELFORD, V. E. *Laboratory and Field Ecology*. Williams & Wilkins, 1929.
- SNODGRASS, R. E. *The Anatomy and Physiology of the Honey Bee*. McGraw-Hill, 1925.
- Symposium on Adaptation*. Papers by M. M. Metcalf, B. E. Livingston, G. H. Parker, P. A. Mathews, and L. J. Henderson. American Naturalist, Vol. 47, 1913.
- TALIAFERRO, W. H. *The Immunology of Parasitic Infections*. Century, 1930.
- THAYER, G. H. *Concealing Coloration in the Animal Kingdom*. Macmillan, 1909.
- THOMPSON, J. A. *The System of Animate Nature*. Holt, 1920.
- THOMPSON, J. A. *Biology for Everyman*. Dutton, 1935.
- WASHBURN, M. F. *The Animal Mind. A Textbook of Comparative Psychology*. 4th edition. Macmillan, 1937.
- WEAVER, J. E., and CLEMENTS, F. E. *Plant Ecology*. 2d edition. McGraw-Hill, 1938.
- WELCH, P. S. *Limnology*. McGraw-Hill, 1935.
- WOODRUFF, L. L. *The Protozoa and the Problem of Adaptation, in Organic Adaptation to Environment*. Yale, 1924.
- WOODWORTH, R. S. *Psychology*. 4th edition. Holt, 1940.
- ZINSSER, H., ENDERS, J. F., and FOTHERGILL, L. D. *Immunity*. 5th edition. Macmillan, 1939.

## CHAPTER XXVI. — ORIGIN OF SPECIES

- BERGSON, HENRI. *Creative Evolution*. English translation, 1911.
- BERRY, E. W. *Paleontology*. McGraw-Hill, 1929.
- BERRY, E. W. *Tree Ancestors*. Williams and Wilkins, 1923.
- BROOKS, W. K. *The Foundations of Zoology*. Columbia, 1899.
- Creation by Evolution*. A consensus of present-day knowledge as set forth by twenty-five scientists. Macmillan, 1923.
- DARLINGTON, C. D. *The Evolution of Genetic Systems*. Cambridge, 1939.
- DARWIN, CHARLES. *Voyage of the Beagle*. (A Naturalist's Voyage.) 1839.
- DARWIN, CHARLES. *The Origin of Species*. 1859. 6th edition, 1880.
- DARWIN, CHARLES. *Variation in Animals and Plants under Domestication*. 1868.
- DOBZHANSKY, T. *Genetics and the Origin of Species*. Columbia, 1937.
- FISHER, R. A. *The Genetical Theory of Natural Selection*. Oxford, 1930.
- GOLDSCHMIDT, R. *The Material Basis of Evolution*. Yale, 1940.
- HALDANE, J. B. S. *The Causes of Evolution*. Harper, 1932.
- HUXLEY, J. (editor). *The New Systematics*. Oxford, 1940.
- LINDSEY, A. W. *Problems of Evolution*. Macmillan, 1931.
- LULL, R. S. *Organic Evolution*. 2d edition. Macmillan, 1929.
- MORGAN, T. H. *The Scientific Basis of Evolution*. 2d edition. Norton, 1935.
- OSBORN, H. F. *The Origin and Evolution of Life*. Scribner, 1917.
- PARKER, G. H. *What Evolution Is*. Harvard, 1925.
- RAYMOND, P. E. *Prehistoric Life*. Harvard, 1939.
- REICHERT, E. T., and BROWN, A. P. *The Differentiation and Specificity of Corresponding Proteins and Other Vital Substances in Relation to Biological Classification and Organic Evolution*. Carnegie Institution, 1909.
- SCHENK, E. T., and McMASTERS, J. H. *Procedure in Taxonomy*. Stanford, 1936.
- SCHUCHERT, C., and DUNBAR, C. O. *Outlines of Historical Geology*. 3d edition. Wiley, 1938.
- SHULL, A. F. *Evolution*. McGraw-Hill, 1936.
- THOMSON, J. A. *Concerning Evolution*. Yale, 1925.
- DE VRIES, H. *Species and Varieties. Their Origin by Mutation*. 3d edition. Open Court, 1912.
- WALLACE, A. R. *Darwinism*. 3d edition. Macmillan, 1905.
- WALLACE, A. R. *The Geographical Distribution of Animals*. London, 1876.
- WARD, HENSHAW. *Evolution for John Doe*. Bobbs-Merrill, 1925.
- WELLS, H. G. *The Evidence Furnished by Biochemistry and Immunology on Biologic Evolution*. Archives of Pathology, Vol. 9, 1930.



## CHAPTER XXVII. — THE HUMAN BACKGROUND

- ALVERDES, F. *Social Life in the Animal World*. Harcourt, Brace, 1927.
- BAITSELL, G. A. (editor). *The Evolution of Earth and Man*. Yale, 1929.
- CLARK, W. E. LE G. *Early Forerunners of Man*. Ballière, Tindall, and Cox, 1934.
- CONKLIN, E. G. *The Direction of Human Evolution*. Scribner, 1921.
- COLE, F. C. *The Long Road*. Reynal & Hitchcock, 1933.
- COON, C. S. *The Races of Europe*. Macmillan, 1939.
- DARWIN, C. *The Descent of Man*. London, 1871.
- DARWIN, C. *The Expression of the Emotions in Man and Animals*. London, 1872.
- GREGORY, W. K. *Man's Place among the Anthropoids*. Oxford, 1934.
- JENNINGS, H. S. *The Biological Basis of Human Nature*. Norton, 1930.
- HOOTON, E. A. *Crime and the Man*. Harvard, 1938.
- HOOTON, E. A. *Why Men Behave Like Apes and Vice Versa*. Princeton, 1940.
- HUNTINGTON, E. *Principles of Human Geography*. 5th edition. Wiley, 1940.
- HUXLEY, J. S. *The Uniqueness of Man*. Yale Review, Vol. 28, 1939.
- KABERRY, P. M. *Aboriginal Woman*. Blakiston, 1940.
- DELAGUNA, G. A. *Speech*. Yale, 1927.
- LUQUET, G.-H. *The Art and Religion of Fossil Man*. Yale, 1930.
- MACCURDY, G. G. *Human Origins*. Appleton, 1924.
- MACCURDY, G. G. (editor). *Early Man*. Lippincott, 1937.
- OSBORN, H. F. *Men of the Old Stone Age*. Scribner, 1915.
- OSBORN, H. F. *Man Rises to Parnassus*. Princeton, 1928.
- PEAKE, H., and FLEURE, H. J. *The Corridors of Time*. Vols. 1-3. Yale, 1927.
- ROMER, A. S. *Man and the Vertebrates*. Chicago, 1933.
- SMITH, G. E. *The Evolution of Man*. Oxford, 1924.
- SOLLAS, W. J. *Ancient Hunters*. 3d edition. Macmillan, 1924.
- TILNEY, F. *The Brain from Ape to Man*. Hoeber, 1929.
- WALKER, C. C. *The Biology of Civilization*. Macmillan, 1930.
- WARDEN, C. J. *The Evolution of Human Behavior*. Macmillan, 1932.
- WARDEN, C. J. *The Emergence of Human Culture*. Macmillan, 1936.
- YERKES, R. M., and YERKES, A. W. *The Great Apes*. Yale, 1929.

CHAPTER XXVIII. — BIOLOGY AND HUMAN WELFARE<sup>1</sup>

- BIGGER, J. W. *Man Against Microbe*. Macmillan, 1939.
- BURDON, K. L. *Medical Microbiology*. Macmillan, 1939.

<sup>1</sup> Also see Bibliography for Chapter XXIV.

- BURLINGAME, L. L. *Heredity and Social Problems*. McGraw-Hill, 1940.
- CHANDLER, A. C. *Introduction to Parasitology*. 6th edition. Wiley, 1940.
- COWDRY, E. V. (editor). *Human Biology and Racial Welfare*. Hoeber, 1930.
- DARWIN, L. *What Is Eugenics?* Galton, 1930.
- EAST, E. M. (editor). *Biology in Human Affairs*. McGraw-Hill, 1931.
- FERNALD, H. T. *Applied Entomology*. 3d edition. McGraw-Hill, 1935.
- GODDARD, H. H. *The Kallikak Family. A Study in the Heredity of Feeble-mindedness*. Macmillan, 1912.
- GUSTAFSON, A. F., RIES, H., GUISE, C. H., and HAMILTON, W. J. *Conservation in the United States*. Comstock, 1940.
- HEGNER, R. W. *Little Fleas Have Lesser Fleas*. Williams and Wilkins, 1938.
- HEGNER, R. W., ROOT, F. M., AUGUSTINE, D. L., and HUFF, C. G. *Parasitology*. Appleton, 1938.
- HENDERSON, J. *The Practical Value of Birds*. Macmillan, 1927.
- HILL, A. F. *Economic Botany*. McGraw-Hill, 1937.
- HJORT, J. *Human Value of Biology*. Harvard, 1938.
- HOBGEN, L. *Genetic Principles in Medicine and the Social Sciences*. Knopf, 1932.
- HOLMES, S. J. *Human Genetics and Its Social Import*. McGraw-Hill, 1936.
- HOWARD, L. O. *The Insect Menace*. Century, 1931.
- KEEN, W. W. *Animal Experimentation and Medical Progress*. Houghton Mifflin, 1914.
- KOFOID, C. A. *The Human Values of Biology*. Texas, 1925.
- DEKRUIF, P. *Microbe Hunters*. Harcourt, Brace, 1925.
- DEKRUIF, P. *Hunger Fighters*. Harcourt, Brace, 1928.
- DEKRUIF, P. *The Fight for Life*. Harcourt, Brace, 1938.
- LONG, W. B., and GOLDBERG, J. A. *Social Hygiene*. Lea and Febiger, 1938.
- MARVIN, F. S. (editor). *Science and Civilization*. Oxford, 1923.
- METCALF, C. L., and FLINT, W. P. *Destructive and Useful Insects*. 2d edition. McGraw-Hill, 1939.
- MOHR, O. L. *Heredity and Disease*. Norton, 1934.
- NEWSHOLME, A. *Evolution of Preventive Medicine*. Williams and Wilkins, 1927.
- OSBORN, F. *Preface to Eugenics*. Harpers, 1940.
- PACK, C., and GILL, T. *Forests and Mankind*. Macmillan, 1930.
- PARKINS, A. E. (editor). *Our National Resources and Their Conservation*. 2d edition, 1939.
- POPENOE, P., and JOHNSON, R. H. *Applied Eugenics*. 2d edition. Macmillan, 1933.
- PRESCOTT, S. C., and DUNN, C. G. *Industrial Microbiology*. McGraw-Hill, 1940.

- RILEY, W. A., and JOHANNSEN, O. A. *Medical Entomology*. McGraw-Hill, 1932.
- ROBBINS, W. W., and RAMALEY, F. *Plants Useful to Man*. 2d edition. Blakiston, 1937.
- SMITH, T. *Parasitism and Disease*. Princeton, 1934.
- SWEETMAN, H. L. *The Biological Control of Insects*. Comstock, 1936.
- VEDDER, E. B. *Medicine: Its Contribution to Civilization*. Williams and Wilkins, 1929.
- WALKER, C. C. *The Biology of Civilization*. Macmillan, 1930.
- WHIPPLE, G. C. *Microscopy of Drinking Water*. 4th edition. Wiley, 1927.
- WRIEDT, C. *Heredity in Live Stock*. Macmillan, 1930.

### CHAPTER XXIX. — BIOLOGICAL HISTORY

- BERNARD, C. *An Introduction to the Study of Experimental Medicine*. Trans. by H. C. Green. Macmillan, 1927.
- BULLOCH, W. *The History of Bacteriology*. Oxford, 1938.
- COLE, F. C. *The History of Protozoölogy*. University of London, 1926.
- DANA, E. S., and others. *A Century of Science in America*. Yale, 1918.
- DARWIN, C. *Life and Letters, Including a Biographical Chapter*. Edited by Francis Darwin. Appleton, 1887.
- FOSTER, M. *History of Physiology during the 16th, 17th and 18th Centuries*. Cambridge, 1901.
- GARRISON, F. H. *History of Medicine*. 4th edition. Saunders, 1929.
- GREEN, J. R. *History of Botany, 1860-1900*. Oxford, 1909.
- HUXLEY, T. H. *The Progress of Science, 1837-1887. Collected Essays*. Vol. *Methods and Results*. Appleton.
- HUXLEY, T. H. *Life and Letters*. Edited by L. Huxley. Appleton, 1901.
- JUDD, J. W. *The Coming of Evolution*. Cambridge, 1910.
- LOCY, W. A. *Biology and Its Makers*. 3d edition. Holt, 1915.
- LOCY, W. A. *The Growth of Biology*. Holt, 1925.
- MEYER, A. W. *The Rise of Embryology*. Stanford, 1939.
- MIALL, L. C. *The Early Naturalists, Their Lives and Works*. Macmillan, 1912.
- NATIONAL ACADEMY. *History of the National Academy of Sciences of the United States of America, 1913*.
- NORDENSKIÖLD, E. *History of Biology*. Knopf, 1928.
- OLIVER, F. W. (editor). *Makers of British Botany*. Cambridge, 1913.
- OSBORN, H. F. *From the Greeks to Darwin. An Outline of the Development of the Evolution Idea*. 2d edition. Scribner, 1929.
- VON SACHS, J. *History of Botany, 1530-1860*. Oxford, 1890.
- SEWARD, A. C. (editor). *Darwin and Modern Science*. Cambridge, 1909.
- SINGER, C. *Short History of Medicine*. Oxford, 1928.

- SINGER, C. *The Story of Living Things*. Harper, 1931.
- SNYDER, E. E. *Biology in the Making*. McGraw-Hill, 1940.
- WEST, G. *Charles Darwin: A Portrait*. Yale, 1938.
- WOODRUFF, L. L. *Microscopy Before the Nineteenth Century*. American Naturalist, 1939.
- WOODRUFF, L. L. (editor). *The Development of the Sciences*. 2d series. Yale, 1941.
- YOUNG, R. T. *Biology in America*. Gorham, 1922.

## II. GLOSSARY

- ABIogenesis.** The abandoned idea that living matter may arise at the present time from non-living matter without the influence of the former. *See* Biogenesis.
- ABSORPTION.** The passage of nutritive and other fluids into living cells.
- ACOELOMATE.** Not possessing a coelom, or body cavity; *e.g.*, Hydra.
- ACQUIRED CHARACTER.** A modification of the body which arises during individual life as a result of environmental influences.
- ADAPTATION.** The reciprocal fitness of organism and environment; a structure or reaction fitted for a special environment; the process by which an organism becomes fitted to its surroundings.
- ADRENAL GLANDS.** Ductless glands situated near the kidneys. Secretion supplies the hormones adrenaline and cortin.
- ADVENTITIOUS.** Not in the usual position; *e.g.*, aërial roots.
- AËROBE.** An organism requiring free oxygen. *See* Anaërobe.
- AFFERENT ROOT.** Dorsal, or posterior, root of certain cranial and all spinal nerves through which sensory nerve impulses enter the brain and spinal cord. *See* Efferent Root.
- ALBINO.** An individual lacking normal pigmentation; *e.g.*, a white rat. Albinism in the rat and man is a typical Mendelian recessive character.
- ALGÆ.** A heterogeneous group of lower plants in which the body is unicellular or consists of a thallus; *e.g.*, Protococcus, Spirogyra, Seaweeds.
- ALLANTOIS.** An embryonic membrane of higher Vertebrates, chiefly respiratory in function.
- ALLELES.** Homologous genes, similarly situated on homologous chromosomes. Allelomorphs.
- ALTERNATION OF GENERATIONS.** Typically the alternate succession of a sexual and an asexual generation in the life history; *e.g.*, Moss, Obelia.
- ALTERNATIVE INHERITANCE.** *See* Dominant Character.
- AMINO ACID.** Components of proteins. Organic acids in which one hydrogen atom is replaced by the amino group ( $\text{NH}_2$ ).
- AMNION.** A delicate membrane enclosing the developing embryos of Reptiles, Birds, and Mammals.
- AMOEBOID.** Usually applied to the flowing movements of a cell, as in Amoeba and white blood cells.
- AMPHIMIXIS.** The mingling of the germ plasma of two gametes in the zygote.
- ANABOLISM.** The constructive phase of metabolism. *See* Katabolism.

- ANAEROBE.** An organism not requiring free oxygen; *e.g.*, certain Bacteria and parasitic Worms. *See* Aërobe.
- ANALOGY.** Structural resemblance, usually superficial, due to similarity of functions; *e.g.*, wing of Butterfly and Bird. *See* Homology.
- ANAPHASE.** Period in mitosis involving the separation of the halves of the longitudinal split chromosomes, and the migration of the daughter chromosomes toward the respective centrosomes. *See* Telophase.
- ANATOMY.** The structure of organisms, especially as revealed by dissection. *See* Morphology.
- ANTENNAE.** A pair of appendages of the Arthropod head, sensory in function.
- ANTHER.** The part of the stamen which contains the pollen sacs (microsporangia) in Flowering Plants.
- ANTHERIDIUM.** The organ in plants, such as Mosses and Ferns, in which the sperm arise.
- ANUS.** Terminal orifice of the alimentary canal. Opening of the large intestine either on the surface of the body (Man) or into the cloaca (Frog).
- AORTA.** A great trunk artery. *See* Dorsal Aorta.
- AORTIC ARCHES.** Arteries arising from the ventral aorta and supplying the gills in aquatic Vertebrates. Undergo many modifications in the ascending series of air-breathing Vertebrates.
- APHIDS.** Small sucking Insects; *e.g.*, the green Plant Lice of garden shrubs.
- ARCHEGONIUM.** The organ in plants, such as the Mosses and Ferns, in which the egg arises.
- ARTERY.** A blood vessel carrying blood away from the heart.
- ASSOCIATIVE MEMORY.** Representative cerebral activity of the higher animals and Man, exclusive of reason which presumably is confined to the latter.
- ASTER.** Radiations surrounding the centrosome during cell division.
- AUTOGAMY.** Origin and union of gametic nuclei in one and the same cell. A type of self-fertilization; *e.g.*, in Paramecium. *See* Endomixis.
- AUTONOMIC SYSTEM.** System of outlying ganglia and nerves which communicates with the central nervous system through the spinal and cranial nerves. Regulates nearly all the involuntary functions of the body. Sympathetic nervous system.
- AUTOTROPHIC.** Power to synthesize food from inorganic substances. Green plants secure the necessary energy from light, and certain Bacteria by the oxidation of inorganic substances. *See* Holozoic.
- AXON.** A nerve fiber conducting impulses away from the cell body. Dendrons conduct toward the nerve cell body, or cyton. *See* Neuron.
- BIENNIAL.** A plant which completes its life history in two years, usually reproducing in the second.

- BILE DUCT.** Tube which conveys the secretions (bile) of the liver to the small intestine. Usually unites with the pancreatic duct to form a common duct which enters the intestine.
- BINARY FISSION.** The division of a cell, especially a unicellular organism, into two daughter cells; *e.g.*, in Paramecium.
- BINOMIAL NOMENCLATURE.** Scientific method of designating organisms by two Latin or Latinized words, the first indicating the genus and the other, the species; *e.g.*, the Dog, *Canis familiaris*; Man, *Homo sapiens*.
- BIOGENESIS.** The established doctrine that all life arises from preëxisting living matter. *See* Abiogenesis.
- BIOGENETIC LAW.** *See* Recapitulation Theory.
- BIOLOGY.** Study of matter in the living state, and its manifestations.
- BIPARENTAL.** Involving two progenitors, male and female.
- BIRAMOUS.** Comprising two branching parts; *e.g.*, abdominal appendages (swimmerets) of the Crayfish.
- BLASTOCOEL.** The cavity within the blastula. Segmentation cavity.
- BLASTOPORE.** The opening to the exterior from the enteric pouch of a gastrula.
- BLASTOSTYLE.** Central axis of an individual (gonangium) of a Hydroid colony that buds medusae; *e.g.*, in Obelia.
- BLASTULA.** The stage following cleavage when the cells are arranged in a single layer to form a hollow sphere.
- BLENDING INHERITANCE.** Apparent fusion of parental characters in the offspring; *e.g.*, skin color of mulattoes.
- BLOOD CELLS.** Detached cells present in the fluid plasma of the blood. Two principal kinds in Vertebrates, red and white. Blood corpuscles.
- BUCCAL CAVITY.** Mouth cavity.
- BUD.** Growing point of shoot. An undeveloped branch. Branch buds form stem and leaves; mixed buds, both leaves and flowers; flower buds, flowers only.
- BULB.** An underground, storage leaf bud. *See* Corm.
- CALCIFEROUS GLANDS.** Glands opening into the esophagus of the Earthworm and secreting calcium carbonate, probably to neutralize acidity of food.
- CALORIE.** The unit of heat energy, and therefore largely of food value. Heat required to raise 1000 grams of water 1° C. Large calorie.
- CALYX.** The outer whorl of modified leaves composing a typical flower. Usually green. The sepals collectively.
- CAMBium.** Actively dividing cells usually situated between xylem and phloem of vascular bundles.
- CARBOHYDRATES.** Compounds of carbon with hydrogen and oxygen, the hydrogen and oxygen typically in the same proportion as in water.

- CARDINAL VEINS.** Pair of large veins returning blood from posterior part of body; *e.g.*, in the Dogfish.
- CARPEL.** One of the innermost whorl of floral leaves which bear the megasporangia. A megasporophyll. Composed of ovule case ('ovary'), style, and stigma. A simple pistil or one element of a compound pistil.
- CARPELLATE.** Having carpels. Commonly refers to a flower without stamens. Pistillate. See Staminate.
- CASTRATION.** Removal of the gonads, especially of the male.
- CATALYSIS.** The inducing or accelerating of a chemical reaction by a substance (*e.g.*, an enzyme) which itself remains unchanged.
- CELL.** A structural and physiological unit mass of protoplasm, differentiated into cytoplasm and nucleus. The smallest unit of protoplasm capable of continued independent life.
- CELL SAP.** Water, with solutes, usually under pressure in a large vacuole in the cytoplasm of certain types of plant cells. Effects cell turgor.
- CELLULOSE.** A carbohydrate which characteristically forms the walls of plant cells.
- CENTROSOME.** A body, enclosing a minute granule, or centriole, situated in the center of the aster and active during cell division.
- CHELIPEDS.** The first thoracic appendages, or walking-legs, of the Crayfish and its allies. The pincers.
- CHEMOTROPISM.** A simple orienting response, either positive or negative, to chemical stimuli; *e.g.*, of Paramecium or sperm. Chemotaxis.
- CHLORAGOGEN CELLS.** Outer layer of intestine of Earthworm. Probably excretory in function.
- CHLORENCYMA.** Chlorophyll-bearing tissue, chiefly of the leaf.
- CHLOROPHYLL.** The characteristic green coloring matter of plants, by which photosynthesis takes place. Comprises two similar but distinct pigments.
- CHLOROPLASTS.** The special cytoplasmic bodies containing chlorophyll.
- CHOLESTEROL.** A complex monohydric alcohol of the lipid series. Closely related to vitamin D, certain hormones, and experimental cancer-producing substances. See Lipids.
- CHORDATE.** An animal whose primary axial skeleton consists temporarily or permanently of a notochord. All Vertebrates are Chordates, but the lowest Chordates are not Vertebrates.
- CHORION.** Outer embryonic membrane of Reptiles, Birds, and Mammals.
- CHROMATIN.** A deeply staining substance containing nucleic acid, characteristic of the nucleus and forming chromosomes, etc. See Germ Plasm.
- CHROMOSOME.** One of the deeply staining bodies into which the chromatin of the nucleus becomes visibly resolved during mitosis. A linkage group of genes. See Germ Plasm.



- CILIA.** Delicate protoplasmic projections from a cell, which lash in unison and propel the cell in the water (*e.g.*, Paramecium), or move particles over the cell surface; *e.g.*, cells lining various tubes in multicellular forms.
- CLASS.** In classification, a main subdivision of a phylum. *See* Order.
- CLEAVAGE.** Cell divisions which transform the egg into the blastula stage during development.
- CLOACA.** A cavity at the posterior end of the Vertebrate body, into which the intestine, urinary, and reproductive ducts open. Not present in most Mammals.
- COCHLEA.** The portion of the ear, in communication with the sacculus, which is the essential organ of hearing in the higher Vertebrates.
- COELOM.** The body cavity, enclosed by tissue of mesodermal origin.
- COELOMATE.** Possessing a coelom, or body cavity, as in animals above the Coelenterates.
- COELOMIC EPITHELIUM.** *See* Peritoneum.
- COENOSARC.** Tissue of the tubular branches of a Hydroid; *e.g.*, Obelia.
- COLLAR CELLS.** Cells with cytoplasmic flange, or collar, surrounding the base of the flagellum. Represented by certain Protozoa, and in the gastral epithelium of Sponges.
- COLLOID.** A state of matter in which a substance is finely divided into particles larger than one molecule and suspended in another substance.
- COLONY.** An aggregation, or intimate association of several or many individuals to form a superior unit; *e.g.*, Volvox, Obelia, Bee hive.
- COMPOUND EYE.** One composed of numerous facets, or separate visual elements. Affords mosaic vision; *e.g.*, eye of Crayfish and Locust.
- CONJUGATION.** Union (usually temporary) of two cells, resulting in fertilization; *e.g.*, in Paramecium. *See* Endomixis and Autogamy.
- CONSERVATION OF ENERGY.** The 'law' that the total energy of the universe is constant, none being created or destroyed but merely transformed from one form to another.
- CONTRACTILE VACUOLE.** A reservoir in unicellular organisms (*e.g.*, Paramecium) in which water and waste products of metabolism collect and are periodically expelled to the exterior.
- CORM.** A solid bulb-like expansion of a plant stem below the surface of the ground, for food storage. *See* Bulb.
- COROLLA.** The whorl of modified leaves immediately within the calyx of a flower. The petals collectively.
- CORTEX.** The cylinder between the outer and central cylinders in root and stem of the higher plants. Part of the Vertebrate brain.
- COTYLEDON.** A seed leaf. The first leaf (in Monocotyledons) or pair of leaves (in Dicotyledons) of the young sporophyte within the seed.
- COWPER'S GLAND.** Small ovoid body associated with the prostate gland and urethra in male Mammals.

- CRANIAL NERVES. Nerves which arise from the brain.
- CRANIUM. The protective case enclosing the brain.
- CREATININE. A nitrogenous waste product. Present in small quantity in human urine.
- CRETIN. A defective individual, due to a deficiency of thyroid secretion.
- CROSSING OVER. The exchange of homologous genes during synapsis of chromosomes. See Alleles.
- CRURA CEREBRI. Thickenings of ventral surface of mid-brain.
- CRYPTOGAMS. Plants without flowers; *e.g.*, Thallophytes, Mosses, and Ferns. See Phanerogams.
- CUTANEOUS. Pertaining to the skin.
- CUTICLE. The outermost lifeless layer of organisms. See Epidermis.
- CYST. A resistant envelope formed about an organism (*e.g.*, many Protozoa) during unfavorable conditions or reproduction.
- CYTOLOGY. The science of cell structure and function.
- CYTON. Cell body of a nerve cell or neuron.
- CYTOPLASM. Protoplasm of a cell exclusive of nucleus. Cytosome.
- DARWINISM. Charles Darwin's theory of Natural Selection. Erroneously used as synonymous with organic evolution.
- DECAY. Chemical decomposition involving putrefaction or fermentation. See Putrefaction.
- DENDRON. See Axon.
- DENTRIFYING BACTERIA. Types of Bacteria which break down compounds of nitrogen and set free the nitrogen to the atmosphere.
- DERMAL. Pertaining to the skin. The dermis is the inner layer of the vertebrate skin. See Epidermis.
- DICOTYLEDONS. One of the two great groups of the familiar flowering plants, a characteristic of which is the presence of two seed leaves, or cotyledons. Contrasted with the Monocotyledons having one seed leaf. See Cotyledon.
- DIFFERENTIATION. A transformation from relative homogeneity to heterogeneity, involving the production of specific substances or parts from a general substance or part. Specialization.
- DIFFUSION. Intermingling of two substances due to migration of their molecules. Pressure exerted by molecules diffusing through a semi-permeable membrane is osmotic pressure. See Osmosis.
- DIGESTION. Chemical simplification of food so that it can be absorbed and utilized.
- DIHYBRID. Progeny of parents differing in two given characters.
- DIOECIOUS. Bearing either male or female gonads. See Hermaphrodite.
- DIPLOBLASTIC. Composed of two primary layers: ectoderm and endoderm; *e.g.*, Hydra. See Triploblastic.

- DIPLOID.** Having two complete sets of homologous chromosomes. Typical somatic number in animals and the sporophyte generation of plants. *See* Haploid.
- DIVISION OF LABOR.** Allocation of special functions to special parts which cooperate toward the unity of the whole.
- DOMINANT CHARACTER.** One of a pair of alternative characters, represented by homologous genes, which appears in the phenotype to the exclusion of the other (recessive) character when both are present in the genotype.
- DORSAL AORTA.** Chief artery distributing pure blood to the body. Ventral aorta carries blood from heart to gill arteries in Fishes.
- DUCTLESS GLAND.** An organ whose function is to elaborate and secrete a hormone directly into the blood. An endocrine gland.
- ECOLOGY.** The study of the relations of the organism to environing conditions, organic and inorganic.
- ECTODERM.** The primary tissue comprising the surface layer of cells in the gastrula. *See* Germ Layer.
- ECTOPLASM.** Modified surface layer of cytoplasm of a cell. *See* Endoplasm.
- EFFERENT ROOT.** Ventral, or anterior, root of certain cranial and all spinal nerves through which motor nerve impulses leave the brain and spinal cord. *See* Afferent Root.
- EMBRYOLOGY.** Study of the early developmental stages, or embryos, of organisms.
- ENCYSTMENT.** The formation of a resistant covering, or cyst wall, about an organism; *e.g.*, *Euglena*. *See* Cyst.
- ENDOCRINE GLAND.** One which secretes a hormone. *See* Ductless Gland.
- ENDODERM.** The primary tissue comprising the inner layer of cells in the gastrula, and in subsequent stages forming the lining of the essential parts of the digestive tract and its derivatives. *See* Germ Layer.
- ENDOMIXIS.** A nuclear reorganization process in some Protozoa (*e.g.*, *Paramecium*) which does not involve the cooperation of two cells (as in conjugation) or synkaryon formation (as in both conjugation and autogamy).
- ENDOPLASM.** The inner cytoplasm surrounding the nucleus; *e.g.*, in *Amoeba*, *Paramecium*. *See* Ectoplasm.
- ENDOPODITE.** The inner of the two distal parts of the typical biramous Crustacean appendage. *See* Protopodite and Exopodite.
- ENDOSKELETON.** An internal living skeleton affording support and protection, as well as levers for the attachment of muscles. Characteristic of Vertebrates.
- ENDOSPERM.** A tissue, containing food materials, within a seed.
- ENERGY.** *See* Kinetic Energy and Potential Energy.

- ENTERON.** Digestive, or enteric, cavity lined with endoderm, also the enteric pouch forming its wall. *E.g.*, in Hydra.
- ENZYMES.** Special proteins which bring about by catalytic action many of the chemical processes of the body; *e.g.*, digestion. *See* Catalysis.
- EPIDERMIS.** The outer layer; *e.g.*, of skin or leaf.
- EPIGENESIS.** Development from absolute or relative simplicity to complexity. *See* Preformation.
- EPITHELIUM.** A layer of cells covering an external or internal surface, including the essential secreting cells of glands.
- EQUATORIAL PLATE.** The equator of the spindle with its group of chromosomes during the metaphase and early anaphase of mitosis. *See* Metaphase.
- ESOPHAGUS.** Tubular passage from pharynx to stomach.
- EUGENICS.** The system of improving the human race by breeding the best. "The science of being well born." *See* Euthenics.
- EUSTACHIAN TUBE.** Passage connecting the vertebrate middle ear with the pharynx. Remnant of the most anterior gill slit, represented in present-day Sharks by the 'blow-hole,' or spiracle.
- EUTHENICS.** The system of improving the human race by good environment. *See* Eugenics.
- EVOLUTION, ORGANIC.** Present-day organisms are the result of descent with change from those of the past.
- EXCRETION.** The elimination of waste products of metabolism. A waste product. *See* Secretion.
- EXOPODITE.** The outer of the two distal parts of the typical, biramous, Crustacean appendage. *See* Protopodite and Endopodite.
- EXOSKELETON.** A non-living external skeleton chiefly for protection. The characteristic skeleton of Invertebrates; *e.g.*, Crayfish. *See* Endoskeleton.
- EXTERNAL RECEPTORS.** Sense organs upon the surface of the body. *See* Internal Receptors.
- EXTRACELLULAR DIGESTION.** Digestion by the secretion of enzymes into a digestive cavity; *e.g.*, in Earthworm and Man. *See* Intracellular Digestion.
- FAMILY.** In classification, a main subdivision of an order. *See* Genus.
- FATS.** One of the chief groups of foodstuffs. Compounds (esters) of glycerol with a fatty acid; *e.g.*, mutton tallow is chiefly the fat stearin ( $C_{57}H_{110}O_6$ ) = glycerol plus stearic acid. More oxidizable than carbohydrates. *See* Lipids.
- FERMENTATION.** The transformation of carbohydrates by the activity of ferments, or enzymes, derived from living organisms. *See* Putrefaction.

- FERTILIZATION.** The union of male and female gametes, especially their nuclei, by which the chromatin complex of each is arranged to form the composite nucleus (synkaryon) of the zygote.
- FETUS.** An embryo of a Vertebrate, in egg or uterus.
- FLAGELLUM.** A whip-like prolongation of the cytoplasm, the movements of which usually effect the locomotion of the cell; *e.g.*, in Euglena.
- FLOWER.** A group of sporophylls and accessory structures.
- FLUCTUATIONS.** Relatively slight variations, usually forming a finely graded series, always found in organisms; may be either modifications or recombinations, but usually the former.
- FROND.** Fern leaf, usually both vegetative and spore-producing.
- FRUIT.** The ripened ovule case ('ovary') and contents, together with any structures which by adhesion become an integral part of it.
- FUNGI.** Colorless plants; *e.g.*, Bacteria, Yeast, Mushrooms.
- GALL BLADDER.** Receptacle near the liver for the temporary storage of bile.
- GAMETANGIUM.** A gamete-producing organ, especially in the lower plants.
- GAMETE.** A cell which unites with another at fertilization to form a zygote. Egg or sperm.
- GAMETIC NUCLEI.** Nuclei of gametes that unite to form the synkaryon, or nucleus of the zygote.
- GAMETOPHYTE.** The sexual, gamete-bearing generation in plants.
- GANGLION.** A group of nerve cells, chiefly the cell bodies, with supporting cells.
- GASTRIC VACUOLE.** A droplet of fluid enclosing ingested food, in which digestion occurs; *e.g.*, in Amoeba and Paramecium.
- GASTROLITHS.** Calcareous bodies found at certain times in the lateral walls of the stomach of the Crayfish. Probably represent the storage of material for the exoskeleton.
- GASTRULA.** A stage in animal development in which the embryo consists of a two-layered sac, ectoderm and endoderm, enclosing the enteric cavity which opens to the exterior by the blastopore.
- GEMMULE.** An asexual reproductive body liberated by certain Sponges.
- GENE.** Independently inheritable factor or element in the chromosomes which influences the development of one or more characters of the organism. Presumably a protein molecule.
- GENETICS.** The science of heredity.
- GENOTYPE.** The fundamental hereditary constitution, or gene complex, of an organism or group of organisms. *See* Phenotype.
- GENUS.** In classification, a main subdivision of a family. *See* Species.
- GERM.** *See* Germ Plasm.

- GERMINAL CONTINUITY.** The concept of an unbroken stream of germ plasm from the beginning of life, from which each generation is derived.
- GERM LAYER.** A primary tissue (ectoderm, endoderm, or mesoderm) in the embryo from which the tissues and organs of the adult animal develop by further differentiation.
- GERM LAYER THEORY.** The doctrine that the germ layers are fundamentally similar throughout the Metazoa and that homologous structures in various animals are derived during development from the same germ layer.
- GERM PLASM.** The physical basis of inheritance. The chromatin (genes) which forms the specific bond of continuity between parent and offspring. Contrasted with soma or somatoplasm. Germ.
- GILL SLITS.** Paired lateral openings leading from the anterior end of the alimentary canal to the exterior for the exit of the respiratory current of water. Permanent or embryonic characters of Vertebrates. Branchial clefts.
- GLAND.** One cell or a group of many epithelial cells which elaborate materials and secrete the product for the use of the organism.
- GLOCHIDIUM.** A bivalved larva of certain fresh-water Mussels (Clams), that lives temporarily as a parasite on a Fish.
- GLOTTIS.** The opening from the pharynx into the tube (trachea) leading to the lungs.
- GLYCOGEN.** So-called animal starch. Sugar is stored as glycogen in liver and muscle cells.
- GOLGI BODIES.** Formed elements in the cytoplasm; apparently active chemically.
- GONAD.** Ovary or testis.
- GONOTHECA.** Transparent sheath, or exoskeleton, of the reproductive individuals (gonangia) of a Hydroid colony; *e.g.*, Obelia.
- GRAY CRESCENT.** Localized pigment granules below the organizer region in the egg of the Frog. *See* Organizer.
- GUSTATORY.** Relating to the sense of taste.
- HAPLOID.** The reduced (one-half) number of chromosomes. A complete single set of chromosomes. *See* Diploid.
- HEMOGLOBIN.** Complex chemical compound, in the red blood cells, which enters into a loose combination with oxygen, becoming oxyhemoglobin.
- HEPATIC PORTAL SYSTEM.** Non-oxygenated but food-laden blood from digestive tract passes to the liver by the hepatic portal vein. Oxygenated blood reaches liver by the hepatic artery. Both leave by hepatic vein. Thus there is a double blood supply to liver in all Vertebrates.
- HEREDITY.** The transmission of characters from parent to offspring by the germ cells.

- HERMAPHRODITE.** An organism bearing both male and female reproductive organs; *e.g.*, Earthworm. Monoecious. *See* Dioecious.
- HETEROSPORY.** The condition of producing two kinds of spores, megaspores and microspores, as in the higher plants.
- HETEROZYGOUS.** Hybrid. Formed by gametes dissimilar in regard to a given character, or characters, and producing gametes dissimilar in regard to the character, or characters, in question. *See* Homozygous.
- HISTOLOGY.** The science of animal and plant tissues. Microscopic anatomy.
- HOLOZOIC.** Type of nutrition involving the ingestion of solid food. Characteristic of animals. *See* Autotrophic and Saprophytic.
- HOMOLOGOUS CHROMOSOMES.** The members of a pair of chromosomes of a diploid group, one paternal and the other maternal in origin, which comprise homologous genes. *See* Synaptic Mates.
- HOMOLOGOUS GENES.** Genes similarly situated on homologous chromosomes and contributing to the same expression or different expressions of a character. Alleles.
- HOMOLOGY.** Fundamental structural similarity, regardless of function, due to descent from a common form; *e.g.*, wing of Bird and fore leg of Dog.
- HOMOTHERMAL.** Provided with a mechanism which maintains the body at a practically constant temperature, usually higher than that of the environment; *i.e.*, the 'warm-blooded' animals, or Birds and Mammals.
- HOMOZYGOUS.** Pure. Formed by gametes the same in regard to a given character, or characters, and producing gametes all the same in regard to the character, or characters, in question. *See* Heterozygous.
- HORMONE.** An internal secretion, usually from a ductless gland. Secreted directly into the blood which distributes it throughout the body where it selectively influences tissues and organs.
- HOST.** An organism in or on which a parasite subsists.
- HYALOPLASM.** The clear ground-substance of protoplasm.
- HYBRID.** The progeny of parents which differ in regard to one or more characters. A heterozygote.
- HYDRANTH.** A feeding polyp of a Hydroid colony; *e.g.*, Obelia.
- HYDROIDS.** A group of animals (Coelenterates) exhibiting alternation of generations; *e.g.*, Obelia.
- HYDROLYSIS.** Decomposition of a chemical compound by reaction with water; *e.g.*, in digestion.
- HYDROSTATIC ORGAN.** Organ for regulating the specific gravity of an organism in relation to that of water; *e.g.*, the air-bladder of certain Fishes.
- HYDROTHECA.** Vase-like expansion of the exoskeleton, or perisarc, about a hydranth; *e.g.*, of Obelia.

- IMMUNITY.** Resistance of the body to infection by disease-producing organisms. Exemption from disease.
- INDEPENDENT ASSORTMENT.** Genes located in different pairs of chromosomes are segregated independently. *See* Linkage.
- INFUNDIBULUM.** A funnel-like outgrowth from the ventral wall of the diencephalon, forming the posterior lobe of the pituitary gland. *See* Pituitary Gland.
- INTERNAL RECEPTORS.** Sense organs within the body. *See* External Receptors.
- INTERNAL SECRETION.** *See* Hormone and Ductless Gland.
- INTESTINE.** Portion of the alimentary canal. In higher forms, portion from pyloric end of stomach to cloaca or anus. Usually divided into small and large intestine.
- INTRACELLULAR DIGESTION.** Digestion of food within the cell itself; *e.g.*, in Paramecium and to some extent in the endoderm cells of Hydra. *See* Extracellular Digestion.
- INVAGINATION.** Sinking or growing in of a portion of the surface; *e.g.*, during transformation of blastula into gastrula.
- INVERTEBRATE.** Animal without a notochord or a vertebral column.
- IRRITABILITY.** The power of responding to stimuli, exhibited by all protoplasm.
- KARYOLYMPH.** The more fluid material of the nucleus in contrast with the linin and chromatin.
- KATABOLISM.** The destructive phase of metabolism. *See* Anabolism.
- KINETIC ENERGY.** Energy possessed by virtue of motion; *e.g.*, union of C with O<sub>2</sub> transforms chemical potential energy into kinetic energy; *i.e.*, heat, etc. *See* Potential Energy.
- LACTEALS.** Lymphatic vessels of the small intestine.
- LAMARCKISM.** Essentially the doctrine of the inheritance of modifications, or acquired characters, as a factor in evolution.
- LARVA.** An immature stage in the life history of certain animals, usually active and differing widely in appearance from the adult; *e.g.*, caterpillar of Butterfly, tadpole of Frog.
- LENTICELS.** Stem structures that provide for the entrance and exit of gases.
- LININ.** Non-stainable portion of the nuclear reticulum, closely related chemically to chromatin.
- LINKAGE.** The inheritance together of characters represented by genes in the same chromosome. Independent assortment does not occur.
- LIPIDS.** Fatty substances including the true fats and such compounds as cholesterol (C<sub>27</sub>H<sub>46</sub>OH) and the lecithins containing also phosphorus and nitrogen. *See* Fats and Cholesterol.



- LYMPH.** Essentially excess tissue fluid, with numerous white cells, passing through vessels on its way back to the blood vascular system. *See* Tissue Fluid.
- MACRONUCLEUS.** The large 'somatic' nucleus in the Ciliates with dimorphic nuclei; *e.g.*, in Paramecium. *See* Micronucleus.
- MADREPORITE.** A small perforated plate on the aboral surface of certain Echinoderms (*e.g.*, the Starfish) that allows the passage of water to the water-vascular system.
- MALTOSE.** A double sugar derived from starch by hydrolysis during digestion.
- MANDIBLES.** Jaws.
- MANTLE.** Outer fold of tissue that lines the shell in Molluscs.
- MATURATION.** *See* Reduction.
- MAXILLIPEDS.** The three anterior pairs of appendages of the thorax of the Crayfish.
- MECHANISM.** The doctrine that the phenomena of life are wholly interpretable in terms of the laws of matter and energy which hold in the realm of the non-living. *See* Vitalism.
- MEDUSA.** Sexual, gonad-bearing generation of Hydroids, and some other Coelenterates.
- MEGASPORE.** The large spore, developed in a megasporangium, which in heterosporous plants forms a female gametophyte.
- MEGASPOROPHYLL.** A modified leaf of a heterosporous sporophyte which produces megaspores. A carpel.
- MEIOSIS.** *See* Reduction.
- MENDEL'S LAWS.** Segregation and independent assortment.
- MERISTEM.** Formative (embryonic) tissue with rapidly dividing cells, as in cambium and growing points of higher plants.
- MESODERM.** A primary tissue, or germ layer, of animals which develops between the ectoderm and endoderm. *See* Germ Layer.
- MESOGLEA.** The non-cellular layer between ectoderm and endoderm in Hydra and other Coelenterates.
- MESORCHUM.** Mesentery-like membrane supporting the testes.
- METABOLISM.** The sum of the physico-chemical processes in organisms, involving the building up, maintenance, and breaking down of the living matter and its constituents. *See* Anabolism and Katabolism.
- METAMORPHOSIS.** A more or less abrupt transition from one developmental stage to another; *e.g.*, transformation of larva into adult during the life history of a Butterfly or Frog.
- METAPHASE.** Stage in mitosis involving the arrangement of the chromosomes in the equatorial plate. *See* Anaphase.
- METAPHYTA.** Multicellular plants.

- METAPLASM.** Lifeless inclusions in cytoplasm; *e.g.*, yolk granules, etc.
- METAZOA.** Multicellular animals.
- MICRONUCLEUS.** The small 'germinal' nucleus in the Ciliates with dimorphic nuclei; *e.g.*, *Paramecium caudatum* has one, *P. aurelia* and *P. calkinsi* have two, and *P. woodruffi* and *P. polycaryum* have several micronuclei. *See* Macronucleus.
- MICROSPORANGIUM.** A sporangium which bears microspores; *e.g.*, pollen sac in anther of stamen.
- MICROSPORE.** The small spore, of heterosporous plants, which forms a male gametophyte. Essentially a pollen grain.
- MICROSPOROPHYLL.** A modified leaf, of a heterosporous sporophyte, which produces microspores. A stamen.
- MITOCHONDRIA.** Bodies in the cytoplasm which apparently contribute to specific chemical processes.
- MITOSIS.** The typical process of cell division.
- MODIFICATION.** *See* Acquired Characters.
- MOLT.** To cast off the outer covering; *e.g.*, the exoskeleton of Arthropods. Ecdysis.
- MONOCOTYLEDON.** *See* Dicotyledon.
- MONOHYBRID.** The progeny of parents differing in regard to one given character.
- MORPHOGENESIS.** The development of the form and structure of an organism.
- MORPHOLOGY.** The science of the form of animals and plants.
- MOZAIC INHERITANCE.** Inheritance of a character in part from each parent but without blending.
- MUTATION.** A heritable variation due to a change in the constitution of the chromosome (gene) complex, independent of segregation and crossing over. Chromosomal aberrations and intrinsic gene changes.
- MYONEMES.** Contractile fibrils of certain Protozoa; *e.g.*, *Vorticella*.
- MYOTOMES.** Muscle segments in body wall of lower Vertebrates and embryos of higher forms.
- NATURAL SELECTION.** The processes occurring in nature which result in the "survival of the fittest" individuals and the elimination of those less adapted to the conditions imposed by their environment and mode of life. Essence of the Darwinian theory of evolution.
- NEMATOCYST.** A nettle or stinging organ developed within an ectoderm cell; *e.g.*, in *Hydra*.
- NEPHRIDIOSTOME.** Funnel-like opening of a nephridium into the coelom.
- NEPHRIDIUM.** A tubular excretory organ; *e.g.*, in Earthworm.
- NERVE.** Essentially a group or cable of parallel nerve fibers bound together. *See* Axon.

- NEURAL TUBE.** A tube derived from the ectoderm and forming the brain and spinal cord in Vertebrates.
- NEURENTERIC CANAL.** Temporary passage between cavity of enteron and neural tube in Vertebrate embryos.
- NEURON.** A nerve cell, comprising cell body and cytoplasmic processes. *See* Axon, Cyton.
- NITRIFYING BACTERIA.** Nitrite Bacteria which, in the process of their nutrition, change ammonia ( $\text{NH}_3$ ) into compounds with the  $\text{NO}_2$  radical (nitrites), and Nitrate Bacteria which change nitrites into compounds with the  $\text{NO}_3$  radical (nitrates).
- NITROGEN-FIXING BACTERIA.** Types of Bacteria which take free atmospheric nitrogen and combine it with oxygen so that nitrates available for green plants are formed. Found in the soil and in tubercles on rootlets of various leguminous plants; *e.g.*, Beans, Clover, Alfalfa.
- NON-DISJUNCTION.** Failure of homologous chromosomes to separate after synapsis. Therefore they are not independently segregated during maturation — both pass to the same gamete.
- NOTOCHORD.** An axial cord of cells, characteristic of Chordates, about which the vertebral column is formed in Vertebrates.
- NUCLEOLUS.** A spherical, deeply-staining body within the nucleus, which apparently is a reservoir of nuclear material.
- NUCLEUS.** A specialized protoplasmic body in all typical cells. Most characteristic element is chromatin. The seat of the gene complex. *See* Cytoplasm and Gene.
- OCELLUS.** Sense organ responsive to light, especially the simple eye of Insects. *See* Compound Eye.
- OLFACTORY.** Relating to the sense of smell.
- ONTOGENY.** The developmental history of the individual. *See* Phylogeny.
- OÖCYST.** Encysted zygote; *e.g.*, of the malarial parasite, Plasmodium.
- OÖCYTE.** The ovarian egg before maturation.
- OÖGENESIS.** The development of the mature egg from a primordial germ cell.
- OPTIC LOBES.** Thickenings of the dorsal surface of the mid-brain.
- ORDER.** In classification, a main subdivision of a class. *See* Family.
- ORGAN.** A complex of tissues for the performance of a certain function; *e.g.*, the heart.
- ORGANIZER.** A region (or substance in a region) capable of self-differentiation and of inducing organization in neighboring regions; *e.g.*, the dorsal lip of the blastopore in Amphibians.
- ORTHOGENESIS.** Variation, and therefore evolution, in a definite direction as a result of intrinsic causes.

- OSMOSIS.** Diffusion of dissolved substances through a semi-permeable membrane. Osmotic pressure may be considered as a result of the inhibited power of diffusion of a dissolved substance — inhibited because the membrane is *semi*-permeable, *i.e.*, permitting water but not the substance in solution to pass through. The physical phenomena of diffusion and osmosis are complicated in living cells by the fact that their limiting membranes undergo changes in permeability. *See* Diffusion.
- OSTEOLOGY.** The study of the Vertebrate skeleton.
- OSTIUM.** In Sponges, the opening from the gastral cavity to the exterior.
- OVIPAROUS.** Egg-laying. *See* Viviparous.
- OVULE.** The body which after fertilization of the egg becomes a seed. The megasporangium.
- OVULE CASE.** The swollen base of a carpel or pistil in which ovules arise. 'Ovary.'
- OVUM.** Egg. Female gamete.
- OXIDATION.** The combination of any substance or its constituent parts with oxygen. Combustion.
- PALEONTOLOGY.** The science of extinct animals and plants represented by fossil remains.
- PARAPODIUM.** Locomotor and respiratory organ of marine worms; *e.g.*, Nereis.
- PARASITE.** An organism which secures its livelihood directly at the expense of another living organism on or in whose body it lives.
- PARENCHYMA.** Plant tissue composed of little-specialized cells, each usually with thin wall and large vacuole, serving for food storage, etc.
- PARTHENOGENESIS.** Development of an egg without fertilization.
- PATHOGENIC.** Disease-producing, especially in regard to the relation of a parasite to its host.
- PENTADACTYL.** Having five fingers or toes; typical vertebrate limb.
- PERIANTH.** Calyx or corolla, or both when present.
- PERICARDIUM.** Peritoneum lining the pericardial cavity containing the heart.
- PERISTALSIS.** Rhythmical contractions of the wall of the alimentary canal which force the food along.
- PERITONEUM.** Membrane lining coelom of Vertebrates. Consists of an outer layer of connective tissue next to the muscles of body wall and an inner layer of coelomic epithelium which forms the innermost layer of body wall. Mesodermal in origin.
- PHANEROGAMS.** Flowering or Seed Plants. *See* Cryptogams.
- PHARYNX.** Region of alimentary canal between buccal cavity, or mouth, and esophagus. Throat.

- PHENOTYPE.** The somatic, or expressed, characters of an organism or group of organisms irrespective of those potential in the germ cells. *See* Genotype.
- PHLOEM.** Portion of a vascular bundle in higher plants, forming the system for translocation of food.
- PHOTOSYNTHESIS.** Process by which complex compounds are built up from simple elements through the energy of sunlight absorbed by chlorophyll.
- PHYLOGENY.** The ancestral history of the race. *See* Ontogeny.
- PHYLUM.** In classification, a main subdivision of the animal or plant kingdom. *See* Class.
- PHYSIOLOGY.** The study of the functions of animals and plants. The mechanical and chemical engineering of organisms.
- PINEAL BODY.** An outgrowth from the upper wall of the diencephalon. The vestige of an additional eye possessed by the ancestors of existing Vertebrates. Possibly functions as an endocrine gland in Mammals. Brow-spot of Frog.
- PISTIL.** *See* Carpel.
- PITH.** Middle part of the central cylinder of a vascular plant shoot. Functions largely for the storage of water and food.
- PITH RAYS.** Extensions of the pith that radiate between the vascular bundles toward the bark. Medullary rays.
- PITUITARY GLAND.** A glandular body under the brain, formed of tissue from the nervous system (infundibulum) and from the alimentary canal (hypophysis). Secretes several hormones. The 'master' endocrine gland.
- PLACENTA.** A Mammalian organ for the interchange of all nutritive, respiratory, and excretory materials between the embryo (fetus) and mother. It also serves as an organ of attachment. In the higher Mammals it is composed of both fetal and maternal tissues. *See* Umbilical Cord.
- PLASMA.** Liquid portion of the blood, lymph, and tissue fluid.
- PLASMA-MEMBRANE.** Living cell membrane, as distinguished from the cell wall which may also be present.
- PLASTID.** A specialized cytoplasmic body. *See* Chloroplast.
- PLEXUS.** Intercommunication of fibers from one nerve with those of another to form a network; *e.g.*, sciatic plexus.
- POLAR BODIES.** *See* Polocytes.
- POLLEN.** Essentially the microspores of Seed Plants. Arise by one division of a microspore.
- POLLINATION.** The transference of pollen to the stigma of the pistil in Seed Plants. Eventuates in fertilization.
- POLOCYTES.** Tiny cells arising by division from the egg during maturation. Polar bodies.

- POLYMORPHISM.** Occurrence of several types of individuals during the life history, or composing a colony; *e.g.*, *Obelia*, Bee.
- POLYP.** Hydra, or a hydra-like individual of Hydroids, Corals, and other Coelenterates.
- POME.** Fleshy fruit with a core; *e.g.*, apple, pear.
- POPULATION.** Entire group of individuals from which samples are taken for genetical study. Usually comprises several pure lines.
- POTENTIAL ENERGY.** Energy possessed by virtue of stresses; *i.e.*, two forces in equilibrium. Criterion is work done against any restoring force; *e.g.*, kinetic energy of sunlight through agency of chlorophyll separates  $\text{CO}_2$  into C and  $\text{O}_2$  and thereupon is represented by an equal amount of chemical potential energy. Restoring force is here chemical affinity. Similarly a raised weight possesses gravitational potential energy in amount equal to kinetic energy expended in raising it. *See* Kinetic Energy and Conservation of Energy.
- PREFORMATION.** The abandoned doctrine that development is essentially an unfolding of an individual ready-formed in the germ. *See* Epigenesis.
- PRONEPHROS.** Primitive kidney of Vertebrates.
- PROPHASÉ.** Preparatory changes during mitosis leading toward the disposition of the chromosomes in the center of the cell (equatorial plate). *See* Metaphase.
- PROSTATE GLAND.** An accessory male genital gland in Mammals.
- PROSTOMIUM.** A lobe which projects from the first segment of the body of the Earthworm and forms an upper lip.
- PROTEIN.** A class of complex chemical molecules, containing nitrogen, which form the chief characteristic constituent of protoplasm.
- PROTHALLUS.** The gametophyte of Ferns.
- PROTISTA.** Protophyta and Protozoa; all unicellular organisms.
- PROTONEMA.** A filamentous growth from a Moss spore which gives rise to the leafy Moss gametophyte.
- PROTOPHYTA.** Unicellular plants. *See* Protista.
- PROTOPLASM.** The physical basis of life. Matter in the living state.
- PROTOPLAST.** The cell exclusive of the cell wall, especially in plants.
- PROPODITE.** The basal portion of the typical Crustacean appendage from which arise the endopodite and exopodite.
- PROTOZOA.** Unicellular animals. *See* Protista and Metazoa.
- PROTOZOÖLOGY.** The science of unicellular animals, or Protozoa.
- PSEUDPODIUM.** A temporary protoplasmic projection for locomotion, feeding, etc., as in *Amoeba*.
- PUPATION.** Assumption of a quiescent stage (pupa), in the life history of Insects with a 'complete' metamorphosis, during which the larva is reorganized as an adult; *e.g.*, chrysalis of a Butterfly and in cocoon of a Moth.

- PURE LINE.** A group of individuals bearing identical genes, derived from a common homozygous ancestor.
- PUTREFACTION.** The simplification of nitrogenous compounds, such as proteins, chiefly through the action of enzymes of living organisms. *See* Fermentation and Decay.
- PYLORIC VALVE.** Muscular constriction between stomach and small intestine.
- PYRENOID.** Portion of chloroplast specialized for starch formation.
- RECAPITULATION THEORY.** Doctrine that individual embryonic development (ontogeny) repeats in greatly abbreviated and modified form the development of the race (phylogeny). Biogenetic law.
- RECESSIVE CHARACTER.** *See* Dominant Character.
- RECOMBINATION.** Heritable variation due to the typical reassortment of the chromosomes during maturation and fertilization. Crossing over of genes is referred to as gene recombination.
- REDUCTION.** The process in maturation which separates synaptic mates and reduces the chromosome number one-half. Meiosis. The mechanism of segregation.
- REFLEX.** Relatively simple and essentially automatic response resulting from the transmission of a sensory impulse to a nerve center and its immediate reflection as a motor impulse, independent of volition. A conditioned reflex is one established by training.
- REGENERATION.** The replacement of parts which have been lost through mutilations or otherwise.
- RENAL PORTAL SYSTEM.** Blood ('impure') passes from posterior part of the body to kidneys by the renal portal vein; oxygenated blood to kidneys by the renal artery. Thus in animals with the renal portal system there is a double blood supply to the kidneys. Present in Fishes, Amphibians, and Reptiles; vestigial in Birds; absent in Mammals.
- REPRODUCTION.** Essentially protoplasmic growth resulting in cell division.
- RESPIRATION.** Essentially the securing of energy from food by oxidation, involving the exchange of carbon dioxide for oxygen by protoplasm.
- RESPONSE.** Any change in the activity of protoplasm, and therefore of an organism as a whole, as the result of a stimulus. *See* Irritability.
- RESTING CELL.** One which is not undergoing mitosis.
- RETINA.** Percipient part of the eye by virtue of a sensory layer which is stimulated by light rays.
- REVERSION.** The appearance of an ancestral character in an offspring, after it has been 'latent' for one or many generations. Atavism.
- RHIZOID.** A root-like filament in lower plants; *e.g.*, in Mosses and the prothallus of Ferns.

- RHIZOME.** Prostrate underground stem; *e.g.*, in sporophyte of common Ferns.
- ROOT HAIRS.** Prolongations of epidermal cells just above the growing point of roots which afford surface for intake of water and solutes.
- ROTIFERA.** Microscopic, aquatic, multicellular animals. Wheel animalcules.
- SACCULUS.** The anterior sac of the labyrinth of the ear, a derivative of which becomes the cochlea in higher Vertebrates.
- SAPROPHYTIC.** Type of nutrition involving the absorption of complex products of organic decomposition; *e.g.*, in many groups of Bacteria and other Fungi, as well as various species of lower animals (saprozoic). *See* Holozoic and Autotrophic.
- SEBACEOUS GLANDS.** Glands which elaborate a fatty substance (sebum) and secrete it into the hair follicles. Oil glands.
- SECONDARY SEXUAL CHARACTERS.** Differences between the sexes, other than those of the gonads and related organs.
- SECRETION.** A substance elaborated by glandular epithelium; or the process involved. *See* Gland and Excretion.
- SEED.** An embryo sporophyte supplied with food and protective envelopes.
- SEGREGATION.** The distribution of homologous chromosomes, and therefore of homologous genes (alleles), to separate cells during the formation of the gametes. The chief factor of Mendelian inheritance. *See* Reduction.
- SEMICIRCULAR CANALS.** Portion of the vertebrate ear devoted to the maintenance of equilibrium.
- SEMINAL RECEPTACLES.** Sacs within the body cavity of certain animals (*e.g.*, Earthworm), which receive sperm from another individual and retain them until fertilization is to occur.
- SEPAL.** A leaf of the calyx of a flower.
- SEPTA.** The partitions which divide the coelom of the Earthworm into a series of chambers, or segments.
- SERIAL HOMOLOGY.** Homology of a structure of an organism with another of the same organism; *e.g.*, appendages of the Crayfish, fore limbs and hind limbs of a Vertebrate.
- SESSILE.** Attached, sedentary; *e.g.*, Sponges.
- SETAE.** Bristle-like structures which protrude from the body and aid in locomotion; *e.g.*, in Earthworm and Nereis.
- SEX-LINKED CHARACTERS.** Characters represented by genes in the X chromosome.
- SHOOT.** Stem and leaves as contrasted with the root.
- SOMA.** Body tissue (somatoplasm) in contrast with germinal tissue (germ plasm).



- SPECIAL CREATION.** Doctrine that each species was specially created. Implies fixity of species. *See* Evolution.
- SPECIES.** In classification, the main subdivision of a genus. A group of individuals which do not differ from one another in excess of the limits of 'individual diversity,' actual or assumed.
- SPERM.** Male gamete. Spermatozoön.
- SPERMATID.** Male germ cells after the final maturation division but before assuming the typical form of the ripe sperm.
- SPERMATOCYTES.** Cells arising from the spermatogonia. Primary spermatocyte arises by growth from the last generation of spermatogonia. Primary divides to form two secondary spermatocytes.
- SPERMATOGENESIS.** The development of the sperm from a primordial germ cell.
- SPERMATOPHYTE.** Plant bearing seeds. Seed Plants, including the familiar flowering plants.
- SPINDLE.** The fiber-like apparatus between the centrosomes during mitosis.
- SPIRACLES.** Openings on the body surface leading into the tracheal system of Insects. Also branchial opening in tadpoles and certain other Vertebrates.
- SPLEEN.** A vascular ductless organ of most Vertebrates, usually situated near the stomach. Its definitive functions undetermined. Apparently acts as a stabilizer of the supply of red blood cells.
- SPONGIN.** A horny material, chemically allied to silk, forming the fibers of the skeleton of certain Sponges; *e.g.*, the Bath sponge.
- SPONTANEOUS GENERATION.** *See* Abiogenesis.
- SPORANGIUM.** A spore-producing structure in plants.
- SPORE.** A cell, liberated from the parent, which gives rise without fertilization to a new individual; *e.g.*, in Mosses. Also the resistant phase assumed by certain unicellular organisms; *e.g.*, Bacteria, Sporozoa.
- SPOROPHYLL.** A leaf which bears sporangia.
- SPOROPHYTE.** Spore-bearing (asexual) generation in plants exhibiting alternation of generations.
- SPORULATION.** Occurrence of several simultaneous divisions by which a unicellular organism is resolved into many smaller cells; *e.g.*, in Sporozoa.
- STAMEN.** The pollen-bearing organ in Seed Plants. A microsporophyll. *See* Anther.
- STAMINATE.** Usually applied to flowers possessing stamens but no carpels. *See* Carpellate.
- STATOCYSTS.** Organs of equilibrium; *e.g.*, in medusae.
- STELE.** The central cylinder of root and stem, formed of pith and united vascular bundles, in dicotyledonous Seed Plants.

- STIGMA.** The tip of a carpel (pistil) adapted to receive the pollen and provide for its germination. The 'eye spot' of *Euglena*.
- STIMULUS.** Any condition which calls forth a response from living matter. *See* Irritability.
- STOMATA.** Openings through the epidermis of a leaf for the interchange of gases and exit of water vapor. The stomatal apparatus comprises the stoma and its guard cells.
- SYMBIOSIS.** The association of two species in a practically obligatory and mutually advantageous partnership; *e.g.*, Lichens.
- SYMPATHETIC NERVOUS SYSTEM.** *See* Autonomic System.
- SYNAPSE.** The contact of one nerve cell with another, which makes possible the conduction of a nervous impulse from cell to cell.
- SYNAPSIS.** The pairing of homologous chromosomes during maturation of the germ cells.
- SYNAPTIC MATES.** Homologous chromosomes of maternal and paternal origin that pair during synapsis.
- SYNKARYON.** The composite nucleus formed by the union of the nuclei of two gametes. Male and female gametic nuclei united in the zygote. *See* Zygote.
- TAXONOMY.** The science of classification.
- TELOPHASE.** Final phase of mitosis during which the two daughter nuclei are reformed and cytoplasmic division is completed. *See* Prophase.
- TERATOMA.** A tumor consisting of a heterogeneous mixture of tissues, sometimes showing incipient organs.
- TETRAD.** Group of four chromosomes formed by a precocious division of synaptic mates in the primary spermatocyte and oöcyte.
- THALUS.** A relatively simple plant body, not differentiated into true root, stem, and leaf; *e.g.*, in Seaweeds and other Algae.
- THORAX.** Portion of the trunk in Mammals, containing esophagus, lungs, heart, and large vessels. The middle portion of the body in the Arthropoda; *e.g.*, in all Insects. In the Crayfish the head and thorax are fused to form the cephalothorax.
- THYMUS.** A glandular structure in the pharyngeal region of Vertebrates. Regresses during early life in Man. Function obscure.
- THYROID GLAND.** An endocrine or ductless gland in the pharyngeal region of Vertebrates.
- TISSUE.** An aggregation of similar cells for the performance of a certain function. *See* Organ.
- TISSUE FLUID.** Essentially plasma which has passed through the capillary walls to supply the milieu of the tissue cells. Intercellular fluid. *See* Lymph.

- TRACHEAL SYSTEM.** Series of tubes that convey air throughout the tissues of certain Arthropods; *e.g.*, Insects.
- TRACHEIDS.** Elongated cells which form water-conducting vessels in the vascular bundles of higher plants.
- TRACHEOPHYTES.** Vascular plants. Pteridophytes and Spermatophytes.
- TRANSPIRATION.** The exhalation of water vapor, particularly through the stomata of the leaf.
- TRICHOCYSTS.** Minute bodies, arranged in the outer part of the ectoplasm of certain Ciliates (*e.g.*, Paramecium), each of which upon proper stimulation is transformed into a thread-like process protruding from the cell surface. Apparently defensive structures.
- TRIHYBRID.** The progeny of parents differing in regard to three given characters.
- TRIPLOBLASTIC.** Consisting of three primary germ layers: ectoderm, endoderm, and mesoderm.
- TROPHOZOITE.** Growing and feeding form developed from a Sporozoite; *e.g.*, in Malarial Parasite.
- TROPISM.** Element of behavior of organisms. Inherent, directive response, of movement or growth, to an external stimulus; *e.g.*, chemotropism.
- TURGOR.** Pressure within a cell, largely due to the absorption of water, which distends or holds rigid the cell wall. *See* Cell Sap.
- TYPHLOSOLE.** A median dorsal invagination along the entire length of the intestine of the Earthworm which increases the area of the digestive and absorptive surface.
- UMBILICAL CORD.** A tubular structure, commonly called the navel cord, by which the embryo is attached to the placenta in Mammals. The blood vessels from the embryo to the placenta pass through it. *See* Placenta.
- UNGUICULATE.** Provided with claws.
- UNIFORMITARIAN DOCTRINE.** An interpretation of the present condition of the earth on the assumption of similarity of factors at work during past ages and today.
- UNIPARENTAL.** Derived from a single progenitor; *e.g.*, in asexual reproduction. *See* Biparental.
- UREA.** Nitrogenous waste product of animal metabolism. Formed as such in the liver, removed from the blood by the kidneys and eliminated from the body chiefly in urine.  $\text{CO}(\text{NH}_2)_2$ . A major part of the nitrogen is excreted in this form in human urine. *See* Creatinine and Uric Acid.
- URETER.** A tube carrying urine from kidney to the cloaca or to the urinary bladder.
- URIC ACID.** A nitrogenous waste product. Present in small quantity in the urine of Man.

- UROGENITAL.** Relating to the urinary and reproductive systems.
- UROSTYLE.** Terminal rod-like bone of the vertebral column of the Frog.
- UTERUS.** Lower portion of the oviduct (or oviducts) modified for the retention of the eggs, temporarily or during development.
- UTERUS MASCULINUS.** Remnant of the pronephric ducts in some male Mammals. †
- UTRICULUS.** The posterior sac of the labyrinth of the ear into which the semicircular canals open.
- VAGINA.** Passage leading from the uterus to the exterior.
- VASCULAR BUNDLE.** Essentially a system of supporting elements, and of tubes for conducting water and food. A fibro-vascular bundle. Characteristic of Vascular Plants, or Tracheophytes. *See* Stele.
- VASO-MOTOR NERVES.** Nerves which regulate the caliber of small arteries by bringing about relaxation or contraction of the muscular layer of their walls.
- VERMIFORM APPENDIX.** Blind outpocketing of the large intestine near its origin from the small intestine. Vestigial end of the caecum. Found only in Apes and Man.
- VERTEBRA.** One of the series of elements forming the backbone, or vertebral column.
- VERTEBRATE.** An animal with a backbone, or vertebral column. *See* Chordate.
- VITALISM.** The doctrine which attributes at least some of the phenomena of life to an interplay of matter and energy which transcends the so-called laws operable in the inorganic world. *See* Mechanism.
- VITAMINS.** Indispensable accessory food substances.
- VIVIPAROUS.** Producing young that have developed to a relatively advanced stage in the uterus; *e.g.*, most Mammals. *See* Oviparous.
- WORKING HYPOTHESIS.** A basic assumption to guide the study of a subject, and to be proved or disproved by facts accumulated.
- X CHROMOSOME.** The so-called sex chromosome.
- XYLEM.** The woody part with water-conducting vessels of a vascular bundle.
- Y CHROMOSOME.** When present, the synaptic mate of the X chromosome.
- YEAST.** A group of unicellular colorless plants (Fungi) which are chiefly responsible for alcoholic fermentation.
- YOLK.** Food material stored within the cytoplasm of an egg. *See* Metaplasm.

**YOLK SAC.** When a great quantity of yolk is present in an egg, the endoderm gradually grows over it to form the yolk sac which is usually of enormous size in comparison with the embryo proper; *e.g.*, in hen's egg. Its presence in the essentially yolkless egg of Mammals is reminiscent of their ancestry.

**ZOÖGEOGRAPHY.** The science of the geographical distribution of animals.

**ZYGOTE.** The composite cell formed by the union of male and female gametes. Fertilized egg. *See* Synkaryon.

# INDEX

[Figures in italics designate pages on which illustrations occur.]

- Abalone, 236  
Abdomen, 192, 193, 283  
Abiogenesis, 390-396  
Absorption, 312, 313  
Achene, 125  
Acoelomate, 180  
Acquired character, 471-473, 584, 585, 704; *See: Modifications*  
Acromegaly, 363  
Actinophrys, 208  
Adaptation, 7, 32-34, 97-100, 213, 214, 512-555, 587, 598, 628, 646  
Adaptive radiation, 276, 520-525  
Addison's disease, 362  
Adrenal gland, 302, 353, 360, 362, 364  
Aedes, 634  
Aërobe, 515  
Aeroplane, 654  
Afferent nerve, 190, 369, 377  
African sleeping sickness, 546, 547, 629, 648  
Afterbirth, 355  
After-ripening, 124  
Agar-agar, 134  
Agassiz, 687  
Agave, 171  
Agglutinin, 548  
Agriculture, 7, 621, 644-661, 665, 671  
Air bladder, 262, 263, 300  
Albino, 480, 483-485, 578  
Alchemy, 688, 692  
Alcoholic fermentation, 514, 515  
Alcoholism, 472, 667  
Alfalfa, 158  
Algae, 66, 129-136, 141, 537, 567  
Alga-like fungi, 137, 138  
Alimentary canal, 187, 196, 300-314  
Allantois, 452-455  
Allele, 481, 486, 501, 506, 507, 596  
Alligator, 269, 575  
Alphabet, 621  
Alsophila, 148  
Alternation of generations, 56, 110-123, 219, 220  
Alternative inheritance, 474, 476  
Alveolus, 335, 336  
Amanita, 140  
Amblystoma, 266  
Amino acid, 26, 40, 311, 315  
Ammonia, 49, 50, 342, 400, 519, 520, 577  
Amnion, 452-456  
Amoeba, 11, 14, 42-45, 205  
Amoebic dysentery, 629, 630  
Amoeboid movement, 11, 33, 34, 548  
Amphibia, 257, 258, 264-268, 280, 326, 567-569, 575; *See: Frog*  
Amphineura, 236  
Amphioxus, 257, 258, 280, 445  
Amylase, 311  
Anabolism, 31; *See: Metabolism*  
Anaërobe, 515  
Analogy, 686, 687  
Anaphase, 415, 416, 418  
Anatomy, 3-5, 677, 685-687  
Ancon sheep, 508  
Andalusian fowl, 488, 489  
Anemone, 156  
Angiosperm, 151-165  
Animal, body, 173, 282-300; classification, 253-255, 280, 281; coloration, 525-530; communities, 168; metabolism, 42-45, 301-317  
Annelida, 180, 232-235, 253, 254; *See: Earthworm*  
Annual ring, 152  
Anopheles, 631-633; *See: Mosquito*  
Ant, 540-542, 553, 616  
Antelope, 521  
Antenna, 192, 193, 250, 533, 534  
Anther, 117-120  
Antheridium, 108-120, 135, 143  
Anthoceros, 143, 144, 166  
Anthozoa, 223  
Anthrax, 629  
Anthropoids, 281, 600-607  
Antibody, 548, 549  
Antigen, 549

- Antitoxin, 548  
 Anus, 180, 181  
 Aorta, 320, 326. *See:* Circulation  
 Aortic arch, 325, 326  
 Ape, 281, 578, 600-607, 616  
 Aphid, 541, 542, 586, 653, 656  
 Apis, 530  
 Appendages of crayfish, 191, 194, 195  
 Apple, 125, 126, 157, 649  
 Apteryx, 272, 273  
 Arachnida, 251, 252  
 Arcella, 206  
 Archaeopteryx, 570  
 Archaeornis, 272, 570, 571  
 Archegonium, 108-116  
 Argentine moth borer, 656  
 Aristotle, 2, 3, 28, 599, 600, 687, 689,  
     672, 675, 683, 695, 701, 702, 704  
 Armadillo, 276, 277  
 Army-worm moth 649, 650, 657  
 Art, 614  
 Artery, 138, 193, 194, 197, 320, 321  
 Arthropoda, 191, 245-253, 255, 279  
 Artificial parthenogenesis, 438  
 Artiodactyl, 278  
 Ascaris, 228, 229, 636  
 Ascomycete, 137-139  
 Ascon, 217  
 Ascospore, 139  
 Ascorbic acid, 316  
 Asexual reproduction, 56, 126, 127;  
     *See:* Budding, Regeneration, and  
     Schizogony  
 Asparagus, 79, 163  
 Aspergillus, 139  
 Aspidium, 113, 114  
 Associative memory, 553, 554  
 Aster, 161, 414, 415  
 Asterias, 241-243  
 Auditory nerve, 375, 383  
 Audubon Societies, 663  
 Aurelia, 222, 223  
 Auricle, 320-322, 324, 326-328; *See:*  
     Heart  
 Australoid, 614  
 Australopithecus, 607  
 Autogamy, 212  
 Autonomic system, 369, 373, 378, 379  
 Autotomy, 201  
 Autotrophic, 40, 51, 514  
 Auxin, 99, 100  
 Aves, 272, 280  
 Avoiding reaction, 550  
 Awn, 162  
 Axon, 368  
 Azalea, 88  
 Babylonia, 671  
 Bacillus, 46, 47; *See:* Bacteria  
 Bacteria, 44-55, 136, 137, 166, 314,  
     397, 398, 514-516, 542, 543, 548,  
     629, 630, 648, 664, 678; autotro-  
     phic, 514; denitrifying, 49, 50;  
     nitrite, 49, 50; nitrogen-fixing,  
     49-51, 158, 543, 644; sulfur, 166,  
     514  
 von Baer, 1, 696, 697  
 Balanced aquarium, 55; *See:* Web of  
     life  
 Bald cypress, 151  
 Bamboo, 162  
 Banana, 86, 87  
 Bandicoot, 524  
 Barberry, 87  
 Bark, 83  
 Barnacle, 247  
 Barrel cactus, 158  
 Barro Colorado, 171  
 Basal disk, 176  
 Basidiomycete, 137, 139-141  
 Basidiospore, 140  
 Basidium, 140  
 Bat, 277, 521-523, 563  
 Bath sponge, 217, 218  
 Beagle, voyage of, 582  
 Beak, 526  
 Bean, 93, 122, 124, 158  
 Bear, 521  
 Beaumont, 688  
 Beaver, 277, 663  
 Bee, 531-537, 540, 553, 616  
 Beech, 155  
 Bee-fly, 530  
 Behavior, 466, 467, 549-555  
 Beri-beri, 316  
 Bernard, 101  
 Berry, 125, 126  
 Bibliography, 711-725  
 Biennial plant, 71, 96  
 Bilateral symmetry, 181, 201  
 Bile, 309  
 Binary fission, 43, 203, 212, 403  
 Binomial nomenclature, 684  
 Biogenesis, 390-396, 640  
 Biogenetic law, 575  
 Biological sciences, 4

- Biology, origin of, 1-5, 18; history of, 1-5, 671-707
- Biosocial, 608, 616
- Biparental, 56, 427; *See*: Inheritance
- Birch, 155, 170
- Bird, 257-259, 272-274, 280, 563, 570, 571, 575, 576, 578, 663, 664
- Bison, 620, 663
- Bivalve, 237, 239
- Blackberry, 125
- Black death, 648; *See*: Plague
- Black knot, 139
- Black mold, 138
- Bladder, air, 262, 263; urinary, 344, 345
- Bladderworm, 639, 640
- de Blainville, 28
- Blastocoel, 59, 60, 443, 445, 448
- Blastoderm, 430, 455
- Blastopore, 59, 60, 448
- Blastostyle, 220
- Blastula, 59, 60, 175, 443, 445
- Blending inheritance, 474, 489, 490
- Blight, 138
- Blister blight, 138
- Blood, 184, 188, 197, 319-332, 677, 678, 681; cells, 13, 321, 339, 548; crystals, 578; pressure, 329; relationship, 578, 579; types, 507; velocity, 328
- Bloodroot, 79
- Blue-green algae, 130, 131, 567
- Blue Mold, 139
- Boa-constrictor, 272
- Bodo, 204
- Boll weevil, 651, 652
- Bone, 61, 290, 291; *See*: Skeleton
- Bony fish, 261-264, 292
- Borelli, 688
- Botany, 3, 5, 673, 675, 683, 684, 689, 690; *See*: Plant
- Botfly, 646, 647
- Bougainvillea, 219
- Bouncing Bet, 155
- Bowman's capsule, 344
- Box turtle, 270
- Brachiopod, 230, 231, 253, 254
- Bracket fungus, 141
- Bract, 154
- Brain, 182, 189, 199, 299, 370-377, 517, 575, 605, 607
- Branchial artery, 236; *See*: Gill slits
- Branchiostoma, 258; *See*: Amphioxus
- Brassica, 156, 645.
- Brazil, 633
- Bread-of-heaven, 142
- Bread mold, 137, 138
- Bright's disease, 345
- Brittle star, 243
- Bronchial tubes, 335, 336
- Bronze age, 624
- Brown algae, 65, 109, 133-136
- Browne, 390
- Brussels sprouts, 156, 645
- Bryophyta, 66, 110, 129, 142-145; *See*: Moss
- Bryozoa, 230, 231, 253, 254
- Bubonic plague, 629, 643, 648
- Buccal cavity, 307
- Bud, 68, 77, 78, 89
- Budding, 175, 176, 179, 515
- Buffon, 392, 702
- Bufo, 267
- Bug, 525
- Bulb, 79
- Bumble bee, 249
- Burdock, 161
- Bushman, 620
- Buttercup, 156
- Butterfly, 246, 249, 650
- Cabbage, 156, 645
- Cabbage butterfly, 249, 650
- Cactoblastis, 656
- Cactus, 79, 157, 158, 168, 171, 656
- Caecum, 565
- Calciferous gland, 186, 187
- Calorie, 314, 315
- Calyx, 88, 117
- Cambium, 63, 68-70, 76, 81-83
- Camel, 278
- Canal Zone, 171, 633, 634
- Capillaries, 321, 328, 329, 681
- Caprella, 247
- Carapace, 196, 198, 269, 270
- Carbohydrate, 27, 315
- Carbon, 26, 48, 399, 400; cycle, 48; dioxide, 38-41, 48, 93, 331, 338-340, 400
- Cardiac muscle, 287
- Carinatae, 273
- Carnation, 155
- Carnivora, 277
- Carotene, 315
- Carpel, 88, 162
- Carpet beetle, 655



- Cartilage, 61, 260, 290, 291  
 Casein, 26  
 Castration, 355  
 Cat, 296, 372  
 Catalysis, 305  
 Caterpillar, 246, 650, 654-658  
 Catkin, 154  
 Catnip, 159  
 Cat-tail, 161, 162, 539  
 Caucasoid, 615  
 Caudata, 265, 266  
 Cauliflower, 156  
 Cell, 4, 8, 12, 13, 15, 32, 678, 679, 692-694; division, 4, 8, 13-15, 32, 37, 414-417; lineage, 412; plant, 12, 74-76, 80-84, 89-92; sap, 74, 76; theory, 693; wall, 11, 23, 64, 173; *See: Tissues*  
 Cellulose, 27, 37, 314  
 Cenozoic era, 567-569  
 Centipede, 248  
 Centrosome, 22, 23, 414, 415  
 Centrum, 293  
 Cephalaspis, 258  
 Cephalization, 374  
 Cephalochorda, 256-258, 280  
 Cephalopoda, 240, 241  
 Cephalothorax, 193, 195, 196  
 Cercaria, 637, 638  
 Cercomonas, 204  
 Cerebellum, 370, 372  
 Cerebral ganglion, 186, 189, 199  
 Cerebral hemispheres, 370-373; *See: Brain*  
 Cestode, 227, 639, 640  
 Cetacea, 277  
 Cetraria, 141  
 Chambered nautilus, 240  
 Chameleon, 271, 528  
 Chapman, 580  
 Chara, 133, 134  
 Cheliped, 193, 196  
 Chelonia, 269, 270  
 Chemical coordination, 358-365; *See: Hormone*  
 Chemical embryology, 465, 698  
 Chemical sense, 200  
 Chemotropism, 98, 431  
 Cherry, 157  
 Chess, 6  
 Chick, 430, 452, 453  
 Chilodonella, 210  
 Chilomonas, 44  
 Chilopod, 248  
 Chimpanzee, 281, 601-606  
 China, 609, 662  
 Chipmunk, 560  
 Chiton, 236  
 Chlorella, 179  
 Chlorenchyma, 89, 90  
 Chloragogen cells, 184, 187  
 Chlorohydra, 179  
 Chlorophyceae, 130; *See: Green algae*  
 Chlorophyll, 9, 38-41, 89-94, 399  
 Chloroplast, 38, 64, 203  
 Choice, 553  
 Cholera, 629  
 Cholesterol, 27  
 Chordate, 256-281; *See: Vertebrate*  
 Chorion, 453-455  
 Christmas greens, 146  
 Chromatin, 23, 24, 414-418; *See: Nucleus and Chromosome*  
 Chromosome, 415-427, 493, 504, 697; aberrations, 503-505, 595, 597; cycle, 425-427; map, 503; reduction, 418-423; *See: Gene*  
 Chrysalis, 650  
 Chrysanthemum, 161  
 Chyme, 308  
 Cilia, 34, 183; *See: Paramecium*  
 Ciliate, 53, 54, 210-214; *See: Paramecium*  
 Cinquefoil, 157  
 Circulation of elements in nature, 48-55, 513, 691  
 Circulatory system, 188, 189, 197, 198, 318-332; *See: Blood and Lymph*  
 Cirripede, 247  
 Cladonia, 141  
 Cladophyll, 80  
 Clam, 238  
 Class, 561  
 Classification, 128, 129, 172, 174, 202, 254, 255, 280, 281, 556-562, 682-685  
 Cleavage, 57-60, 443, 445, 448  
 Clematis, 126  
 Clitellum, 190  
 Cloaca, 283, 301, 314, 352  
 Clostridium, 515  
 Clothes moth, 655  
 Clothing, 618  
 Clover, 96, 158, 649  
 Clover-leaf fern, 116, 148

- Club fungi, 139-141  
 Club moss, 145, 146  
 Cnidoblast, 177  
 Cobra, 271  
 Coccus, 46, 47  
 Coccyx, 304, 565  
 Cochlea, 382, 383  
 Cocoon, 658  
 Coco palm, 163  
 Coelenterate, 175, 179, 219-226, 253, 254; *See*: Hydra  
 Coelom, 180, 181, 184, 201, 283, 284  
 Coelomate, 180  
 Coelomic fluid, 187, 319  
 Coenzyme, 312  
 Cold sense spots, 381  
 Collar cell, 216  
 Collenchyma, 82  
 Colloid, 18, 401  
 Colony, 37, 57, 58, 174, 205, 531  
 Coloration of animals, 525-530  
 Color-blindness, 500, 501  
 Colorless plants, 45-55, 136-142; *See*: Bacteria and Fungus  
 Colpoda, 53  
 Columbine, 156  
 Commensalism, 544  
 Communal associations, 539-541  
 Companion cell, 83  
 Comparative anatomy, 192, 562-566, 685-687  
 Compensatory mechanism, 388  
 Composite family, 160, 161  
 Compound, eye, 199, 200, 250, 385, 532; leaf, 85, 86  
 Conditioned reflex, 377, 466, 553  
 Condylarthra, 571  
 Cone, 150-152  
 Conidium, 138, 139  
 Conifer, 122, 149-151, 567, 569  
 Conjugation, 212, 406, 434-436; *See*: Fertilization  
 Conklin, 466  
 Connective tissue, 61, 184, 290, 291, 306  
 Consciousness, 554, 625  
 Conservation of natural resources, 661-664  
 Continuity of life, 403-427, 270; *See*: Cell division and Germ plasm  
 Contractile vacuole, 11, 42, 44, 211, 212  
 Contractility, 33, 34; *See*: Muscle  
 Conus arteriosus, 320, 323, 453  
 Coördination, 29, 34, 35, 358-389, 550-555; *See*: Hormone and Nervous system  
 Copepod, 518  
 Copper, 624  
 Copperhead, 271  
 Coral, 223, 225  
 Coral fungus, 141  
 Cork, 678, 679  
 Corm, 79  
 Corn, 122, 129, 162, 492, 509, 649  
 Corn borer, 651  
 Cornea, 199  
 Corolla, 88, 117  
 Corpus luteum, 360  
 Cortex, of brain, 371, 377; of stem, 63, 69, 70, 81, 84  
 Cortin, 362  
 Corymb, 154  
 Cosmic rays, 398  
 Cosmozoa theory, 397-399  
 Cotton boll weevil, 651, 652  
 Cottony cushion scale, 656  
 Cotyledon, 93, 122, 123, 152, 153  
 Cousin-marriage, 595  
 Cowper's gland, 302, 357  
 Crab, 245, 247, 544  
 Cranial nerve, 373-375  
 Craniospinal system, 369, 373-377  
 Crayfish, 191-201, 245-247, 255, 380, 537, 564, 565  
 Creatinine, 342  
 Creeper fowl, 491  
 Creosote plant, 171  
 Crepidula, 236, 499  
 Cretin, 361  
 Crinoidea, 243  
 Crocodile, 269, 575, 578  
 Crocus, 79  
 Cro-Magnon, 612-614, 618-620, 671  
 Cross fertilization, 537  
 Crossing over, 501-503, 595  
 Crura cerebri, 371  
 Crustacea, 245-248, 253, 254; *See*: Crayfish  
 Cryptobranchus, 266  
 Ctenophora, 226  
 Cucumber, 160  
 Culex, 631  
 Culture, 608, 616-626  
 Currant, 659, 660  
 Cutaneous senses, 380

- Cuticle, 177, 195  
 Cutin, 82  
 Cuttlefish, 240  
 Cuvier, 685, 686  
 Cyanea, 221  
 Cyanogen, 400  
 Cycad, 149, 150  
 Cycadofilicales, 167  
 Cyclops, 229, 248  
 Cyclosis, 34  
 Cyclostome, 260, 280  
 Cyme, 154  
 Cypress, 151  
 Cyst, 104, 203, 209, 397, 630, 638  
 Cystic duct, 310  
 Cysticercus, 639, 640  
 Cytogenetic map, 503  
 Cytology, 4, 214, 493, 696, 697  
 Cyton, 368, 731  
 Cytoplasm, 12, 13, 22, 23; *See*:  
   Protoplasm  
 Cytoplasmic organization, 459-463  
 Cytostome, 203
- Dahlia, 71  
 Daisy, 161  
 Dandelion, 71, 126, 161, 168  
 Daphnia, 247, 248  
 Darwin, Charles, 128, 581, 582, 585-  
   589, 599, 628, 659, 670, 702-707  
 Darwin, Erasmus, 403, 703, 704  
 Darwinism, 585-588  
 Date palm, 163  
 Datura, 504  
 Dead-leaf butterfly, 528  
 Death, 24, 435  
 Decay, 49; *See*: Fermentation and  
   Putrefaction  
 Deciduous, 77; forest, 169, 170  
 Dedifferentiation, 409  
 Dendron, 368  
 Denitrifying bacteria, 49, 50  
 Dentalium, 459, 460  
 Dentine, 286  
 Dermis, 284, 285  
 Descartes, 363  
 Descent with change, 511, 556, 558;  
   *See*: Evolution  
 Desert, 169, 171  
 Desmid, 12, 132  
 Development, 59, 60, 441-467; *See*:  
   Embryology  
 Devil-fish, 240
- Diabetes, 345, 359  
 Diaphragm, 302, 304, 305, 335-337  
 Diatom, 132, 134  
 Dickens, 303  
 Dicotyledon, 67, 81, 123, 152, 154-  
   161  
 Diencephalon, 370  
 Differentiation, 59, 214, 409  
 Diffugia, 206  
 Diffusion, 75, 96, 731  
 Digestion, 93, 95, 96, 178, 303-316,  
   688, 689  
 Digitigrade, 521, 522  
 Dihybrid, 481-484  
 Dioecious, 179  
 Dinoflagellate, 205  
 Dinosaur, 268, 269, 272  
 Dioscorides, 674, 675  
 Diphtheria, 629  
 Diploblastic, 179  
 Diploid, 248, 419, 420, 493, 494  
 Dipnoan, 263, 264  
 Disease, 7, 472, 628-643  
 Disk flower, 160, 161  
 Dispersal of seeds, 126, 127, 167  
 Distribution, 168-171, 579-583  
 Dodder, 72  
 Dog, 277, 302, 521, 578, 621, 629  
 Dogfish, 260, 320  
 Dolichoglossus, 256, 257, 577  
 Dolphin, 521  
 Dominant character, 477, 487, 488,  
   595  
 Dorsal nerve root, 376, 377  
 Dorsal pore, 185  
 Douglas fir, 170  
 Downy mildew, 138  
 Dragonfly, 249  
 Drone, 531  
 Drosophila, 492, 496, 502, 503-506,  
   596, 653  
 Drupe, 125, 126  
 Dryopithecus, 606  
 Duck, 526  
 Duckbill, 275  
 Ductless gland, 317, 359  
 Dust storm, 662  
 Dwarfism, 363  
 Dyad, 421  
 Dysentery, 649
- Ear, 200, 382-384  
 Earth-star, 141

- Earthworm, 180-191, 209, 232, 234, 235, 253, 254, 319, 346, 351, 368, 407, 410, 442-444; embryology, 442-444; regeneration and grafting, 408, 410
- Ecdysis, 195
- Echidna, 275
- Echinococcus, 640
- Echinoderm, 241-244, 253, 255; *See*: Sea urchin
- Ecology, 5, 537-539, 657; *See*: Web of life
- Ectocarpus, 109, 133
- Ectoderm, 9, 59, 60, 175-177, 179, 220, 221, 227; *See*: Germ layers
- Ectoplasm, 11, 23, 33, 42
- Edelweiss, 168
- Edentate, 276, 277
- Education, 6, 553, 628
- Eel, 262
- Eelworm, 229
- Efferent nerve, 190; *See*: Nerve
- Egg, 12, 13, 56, 107, 351-353, 429-432, 441-452, 696, 697; bird, 430, 452; frog, 413, 445-451; human, 429; mammal, 429, 696; organization, 458-466
- Egypt, 671
- Elasmobranch, 257, 260, 261, 280
- Elements, cycle of, 48-55
- Elephant, 277, 278, 574
- Elk, 663
- Elm, 126, 155, 170
- Elodea, 89
- Elongating zone, 73, 74
- Embryology, 4, 5, 60, 441-467, 573-577, 694-698
- Embryonic membrane, 353, 354, 452-456, 520
- Emergent evolution, 597
- Empusa, 138
- Encyclopedists, 676, 683
- Endamoeba, 205, 548, 630, 636
- Endocrine, 317, 358-365, 388; *See*: Ductless gland and Hormone
- Endoderm, 9, 59, 60, 175-179, 220, 221, 227; *See*: Germ layer
- Endolymphatic duct, 382
- Endomixis, 212, 436, 437
- Endoplasm, 11, 23, 33, 42
- Endopodite, 194-195
- Endoskeleton, 290, 298; *See*: Skeleton
- Endosome, 203
- Endosperm, 120, 122
- Energy, 16, 39, 44, 314, 315, 737, 743
- Enteric cavity, 9, 59, 60; *See*: Enteron
- Enteron, 176, 184, 220-224, 227; *See*: Enteric cavity
- Entomology, 632; *See*: Insect
- Entomostraca, 247, 632, 646-659
- Environment, 32-35, 508-555, 579-583, 666-670; *See*: Adaptation
- Enzyme, 28, 40, 305-315, 688
- Euanthropus, 610
- Eocene epoch, 567, 571, 572
- Eohippus, 571-573
- Ephyra, 222, 223
- Epicotyl, 122, 123
- Epidermis, 9, 69, 70, 73, 81, 84, 90, 284, 285
- Epigenesis, 457-463, 695
- Epiglottis, 335
- Epinephrin, 362
- Epiphyte, 170
- Epithelio-muscular cell, 176, 177
- Epithelium, 13, 61, 182, 183, 306
- Eprepsin, 311
- Equatorial plate, 415, 416
- Equilibration, sense of, 200, 383
- Equipotential system, 461
- Equisetum, 147
- Equus, 572, 573; *See*: Horse
- Erepsin, 311
- Ergot, 139
- Esophagus, 182, 187, 193, 197, 304-307
- Estrin, 360
- Eugenics, 510, 669
- Euglena, 203, 204
- Euspongia, 217, 218
- Eustachian tube, 383, 566
- Euthenics, 510, 669
- Eutheria, 274, 280, 281
- Evaporation, 94, 95, 166
- Evergreen forest, 169, 170
- Evergreens, 151
- Evolution, 4, 5, 128, 469, 554-599, 616, 617, 625, 701-707
- Excretion, 30, 44, 45, 189, 199, 341-349, 519, 520, 575
- Exopodite, 194-196
- Exoskeleton, 195, 245, 290
- Eye, 199, 200, 384-388, 565
- Fabricius, 694

- Family, 561  
 Fascicle, 154  
 Fat body, 301, 353  
 Fats, 27, 311, 315, 519, 733  
 Fatty acid, 27, 306, 311  
 Feather, 284  
 Feather star, 243  
 Feces, 188, 314  
 Feeble-minded, 667  
 Female, 56, 107; *See*: Gamete and Sex  
 Fermentation, 48, 49, 87, 88, 394, 514  
 Fern, 67, 113-115, 129, 147, 148, 419, 567, 569  
 Fertilization, 56, 103-105, 120, 126, 127, 200, 428-440, 493, 494, 545, 697; significance of, 127, 427, 433-440, 494  
 Fiber, of plant, 83  
 Fibro-vascular bundle, 147, 148; *See*: Vascular bundle  
 Fiddler crab, 247  
 Fig, 125, 155, 658  
 Filial regression, 475, 591  
 Filicinae, 147  
 Filterable virus, 394-396, 549, 635  
 Fin, 259-265, 284, 292, 300  
 Fir, 150  
 Fire, 623  
 Fish, 257-265, 292, 300, 326, 334, 372, 530, 567-569, 575, 576  
 Fission, 179, 203, 212; *See*: Binary fission  
 Fixity of species, 558; *See*: Evolution  
 Flagellates, 204, 205; *See*: Euglena  
 Flagellum, 34, 203, 204, 216  
 Flamingo, 526  
 Flat-fish, 262, 263  
 Flatworm, 226-228, 254, 408-411, 637-640  
 Flea, 249, 250, 647, 648  
 Flotation, 517, 518  
 Flower, 67, 78, 88, 117-120, 151-164  
 Flowering plants, 67, 117-127, 151-164, 567, 569, 659, 684; *See*: Seed plants  
 Flying fish, 262, 264  
 Flying lemur, 522, 523  
 Follicle, 413  
 Food, 16, 28, 96, 97, 513-515, 644-661; *See*: Metabolism and Nutrition  
 Foot, 522, 526, 606; *See*: Skeleton  
 Foraminifera, 206, 207  
 Forest, 168-170, 538; conservation, 662, 663  
 Fossils, 165, 166, 608-616, 685, 686; *See*: Paleontology  
 Four-o'clock, 487, 488  
 Fox, 528  
 Fragmentation, 103, 127  
 Free-martin, 499  
 Frog, 265-268, 280, 295, 301, 306, 324, 337, 372, 373, 413, 445-451, 548, 575; brain, 372, 373, 387; circulation, 324; embryology, 446-451; intestine, 301, 306; muscles, 288; pancreas and liver, 310; respiration, 337; skeleton, 295; urogenital system, 348, 353  
 Frond, 113, 147, 148  
 Fructose, 27  
 Fruit, 120, 123-126  
 Fruit fly, 653; *See*: *Drosophila*  
 Fucus, 65  
 Fungus, 66, 129, 136-142, 165, 542-544, 659-661; *See*: Bacteria, Mold, etc.  
 Galapagos Islands, 582  
 Galen, 674, 675, 687  
 Galileo, 678, 688  
 Gall bladder, 305, 309, 310  
 Galton, 474-476, 591, 699  
 Game cock, 594  
 Gametangium, 108, 109  
 Gamete, 56, 103-105, 138, 209, 406, 428-431, 545; *See*: Egg and Sperm  
 Gametophyte, 67, 109-121, 127, 142-144, 419  
 Ganglion, 181-184, 189, 190, 192, 193, 199, 367, 369, 377  
 Ganong, 64  
 Garlic, 163  
 Garpike, 262  
 Gastral cavity, 215  
 Gastric, glands, 308; juice, 308, 311; mill, 193, 197; vacuole, 11, 42-44, 211, 212  
 Gastrolith, 197  
 Gastropod, 236, 237  
 Gastrula, 59, 60, 175, 215, 223, 443, 445, 448, 665-670, 698-701  
 Gemmule, 218  
 Gene, 418, 463, 466, 491-495, 503, 505-508, 595-598; recombinations, 501, 502

- Genetics, 4, 5, 468-511, 589-599, 653  
 Genotype, 479, 480, 595  
 Genus, 128, 561  
 Geographical distribution, 168-171, 579-583  
 Geological time, 567, 568, 572  
 Geology, 567, 701  
 Geometrid moth, 529  
 Geotropism, 98  
 Germ, cells, 56-59, 102-120, 133, 138, 150, 176, 179, 184, 190, 200, 351, 405, 412-432; layers, 60, 448, 455, 457, 464, 697; plasm, 405-412, 476, 595, 598  
 Germinal continuity; *See*: Germ plasm  
 Germination, 124, 543  
 Gesner, 576  
 Geyser, 16  
 Gibbon, 279, 601, 603  
 Gide, 202  
 Gigantism, 363  
 Gila-monster, 271  
 Gill, 198, 266, 318, 323, 325, 333, 334, 342, 575; slit, 256-261, 283, 299, 300, 305, 307, 320, 566, 576  
 Ginkgo, 149, 150  
 Giraffe, 278, 471  
 Girdle, limb, 294; *See*: Skeleton  
 Gizzard, 186, 187  
 Gland, 178, 183, 307-312, 317, 343  
 Gliadin, 26  
 Globigerina, 207  
 Glochidium, 239  
 Gloeocapsa, 130  
 Glomerulus, 344, 345  
 Glottis, 337  
 Glucose, 27, 39  
 Glume, 162  
 Glycerol, 27, 306, 311, 314, 315  
 Glycogen, 27, 400  
 Goby, 263  
 Goethe, 173, 704  
 Goiter, 361  
 Golden rod, 72, 161, 168  
 Golgi body, 23  
 Gonad, 222, 284, 350-353, 359, 360; *See*: Ovary and Testis  
 Gonangium, 220  
 Gonotheca, 220  
 Gooseberry, 659, 660  
 Gorilla, 281, 564, 601-606  
 Gourd family, 159, 160  
 Gout, 345  
 Grafting, 410, 465, 507, 653  
 Grain, 125  
 Grantia, 216, 217  
 Grape, 79, 629, 653  
 Grass, 71, 125, 162, 169, 171  
 Grasshopper, 246, 250  
 Grassi, 631  
 Gray, 684  
 Gray crescent, 448, 464  
 Great Barrier Reef, 225  
 Greeks, 2, 556, 672-674, 701, 702  
 Green algae, 64, 108, 131-133; *See*: Algae  
 Green gland, 199  
 Green plant, 36-41; *See*: Plant  
 Grew, 680, 681  
 Ground-pine, 145  
 Growing point, 73-75  
 Growth, 31; *See*: Metabolism  
 Guard cell, 89, 90  
 Guinea-pig, 277, 480, 483-485  
 Guinea-worm, 229  
 Gulfweed, 133, 135  
 Guppy, 260  
 Gymnodinium, 205  
 Gymnosperm, 149-151  
 Gymnura, 276, 277, 280, 521, 524  
 Gypsy moth, 654  
 Habit, 466, 553, 616  
 Hair, 284, 285  
 Hairworm, 229  
 Hales, 689, 690  
 Halibut, 262  
 Haller, 688  
 Hand, 278, 297, 298, 606, 607  
 Haploid, 419, 420, 493, 494, 504  
 Harvest mite, 252  
 Harvey, 677, 678, 681, 694, 695  
 Haustoria, 72, 73  
 Havana, 634  
 Haversian canal, 291  
 Hay infusion, 52-55, 513  
 Health, 6, 7, 472, 628-643; *See*: Human welfare  
 Heart, 188, 193, 197, 198, 320-322, 575, 677, 678  
 Heartwood, 83  
 Heat, animal; *See*: Homothermal  
 Heat sense spots, 381  
 Hedgehog, 276, 277  
 Heidelberg man, 611, 617  
 Helianthus, 128, 129

- Heliozoa, 207, 208  
 van Helmont, 390  
 Hematin, 26  
 Hemichorda, 256, 257, 280  
 Hemiptera, 525  
 Hemlock, 150, 168  
 Hemoglobin, 26, 339; *See*: Blood  
 Hemophilia, 500  
 Hemp, 155  
 Henderson, 512  
 Hepatic portal system, 320, 325; *See*:  
   Liver  
 Hepatica, 156  
 Hepaticae, 142  
 Herb, 77  
 Herbal, 675, 683  
 Heredity, 468-511; *See*: Genetics  
 Hermaphrodite, 179, 190, 350, 637  
 Hertwig, 16, 56  
 Hessian fly, 650  
 Heteroploidy, 504, 505  
 Heterospory, 116, 148  
 Heterozygous, 480; *See*: Hybrid  
 Hibernation, 265  
 Hickory, 87, 170  
 Hilum, 123  
 Hippocrates, 673  
 Hippopotamus, 278  
 Hirudinea, 232, 235  
 Histology, 4, 5, 74, 80-83, 88-91,  
   182-186, 214, 284, 285, 291, 306,  
   680, 692-694; *See*: Tissues  
 History of biology, 2, 3, 671-707  
 Hive, 531  
 Holdfast, 64, 66  
 Holothuroidea, 343, 344  
 Holozoic, 43, 54  
 Homeostasis, 388  
 Homer, 624  
 Hominidae, 281, 602, 603  
 Homologous chromosomes, 425, 493,  
   494; genes, 495  
 Homology, 192, 195, 563, 564, 686,  
   687  
*Homo sapiens*, 612-616; *See*: Man  
 Homospory, 147  
 Homothermal, 272, 331, 516; *See*:  
   Temperature  
 Homozygous, 480  
 Honey bee, 438, 531-537, 540, 553,  
   616, 656  
 Honey locust, 79  
 Hoof, 278  
 Hooke, 678, 679  
 Hookworm, 229, 642  
 Hop, 155  
 Hormone, 99, 100, 317, 355, 358-365,  
   498, 577, 578  
 Horn, 284  
 Horned-toad, 270  
 Horse, 278, 521, 563, 571-573  
 Horse botfly, 646  
 Horse chestnut, 77, 87  
 Horsetail, 145, 147  
 Host, 73; *See*: Parasite  
 House fly, 248, 250, 586, 649  
 Human body, 297, 298, 304, 305:  
   brain, 304, 375, 387, 605; circula-  
   tion, 327; ear, 383; egg, 351; em-  
   bryo, 354, 456; endocrines, 359  
   365; eye, 385; evolution, 624-626;  
   hand, 298, 330, 607; kidneys, 344;  
   lungs, 335; muscles, 289; skeleton,  
   297, 612; skin, 285; variability,  
   614-616; welfare, 6, 7, 627-670;  
   *See*: Man  
 Hummingbird, 273  
 Humoral transmission, 376  
 Husbandry, 621  
 Huxley, 6, 401, 402, 441, 600, 686, 687  
 Hyacinth, 79, 163  
 Hyaloplasm, 22, 23  
 Hybrid, 316, 477, 480, 593, 595, 597  
 Hybrid vigor, 595  
 Hydatid, 640  
 Hydra, 9, 175-179, 219-221, 253, 254,  
   351, 366-368, 406-408, 541, 678  
 Hydrolysis, 304-306  
 Hydrophyte, 99  
 Hydrotropism, 98  
 Hydrozoa, 219-221  
 Hyla, 267  
 Hylobatidae, 602, 603  
 Hyperparasitism, 548  
 Hyoid, 296  
 Hypha, 137, 139  
 Hypocotyl, 122, 123  
 Hypostome, 176  
 Iceland-moss, 142  
 Ichneumon fly, 656  
 Iguana, 257, 270  
 Iliad, 624  
 Ilium, 296  
 Immunity, 472, 548, 549  
 Implements, 617-624

- Inbreeding, 595  
 Incomplete dominance, 488  
 Incus, 383  
 Independent assortment, 482-487,  
   491, 511, 701  
 India ink, 240  
 Individual adaptability, 549-555  
 Inflorescence, 152, 154; *See: Flower*  
 Infundibulum, 370, 371  
 Ingenhousz, 690  
 Inheritance, 468-511; *See: Genetics*  
   and *Heredity*  
 Insect, 164, 165, 246, 248-251, 253,  
   255, 333, 525, 527-536, 646-659;  
   adaptive radiation, 525, beneficial,  
   655-659; injurious, 646-655  
 Insectivora, 276, 277, 521, 602, 604  
 Insect trap, 86, 88  
 Instinct, 553  
 Insulin, 359, 363, 578  
 Integument, 185, 284, 285  
 Intelligence, 549  
 Intermediate inheritance, 473, 487,  
   488  
 Internal secretion, 317; *See: Hor-*  
   *monone*  
 Internal senses, 380  
 Internode, 77, 78  
 Intersex, 498  
 Interstitial cell, 177-179  
 Interstitial growth, 31  
 Intestinal juice, 311  
 Intestine, 187, 197, 283, 304, 305,  
   308-314, 360  
 Invention, 608  
 Invertebrates, 173-175, 201, 202,  
   214-255, 567, 568; *See: Hydra,*  
   *Earthworm,* and *Crayfish*  
 Iris, 385, 386  
 Irish moss, 136  
 Iron age, 624  
 Irradiation, 508  
 Irritability, 21, 32-34, 97-100; *See:*  
   *Nervous system*  
 Ischium, 296  
 Islands, 582  
 Islets of Langerhans, 359, 360, 363  
 Isolation, 582, 583, 592  
 Ivory, 286  
 Ivery, 71  
  
 Japanese beetle, 651  
 Java man, 608-610  
  
 Jellyfish, 219, 222, 223  
 Jennings, 552  
 Jigger flea, 647  
 Jimson weed, 504  
 Joblot, 680  
 Johannsen, 589, 590  
 Julus, 248  
 Jurassic period, 567, 568, 571  
  
 Kallikak family, 667  
 Kallima, 528  
 Kangaroo, 275, 521, 524  
 Karyolymph, 24  
 Katabolism, 31; *See: Metabolism*  
 Katydid, 527  
 Kelp, 66, 133  
 Kidney, 343-349, 353; *See: Nephrid-*  
   *ium*  
 Kinetic energy, 16, 39, 44, 737; *See:*  
   *Energy*  
 King crab, 251, 252  
 Kingdom, 561  
 Kircher, 390  
 Kiwi, 272  
 Koala, 275  
 Koch, 630  
 Kohlrabi, 645  
  
 Labium, 250  
 Labrum, 250  
 Labyrinth, 382  
 Lacrymaria, 210  
 Lacteal, 312, 313  
 Ladybird beetle, 655, 656  
 Lady's slipper, 164, 536  
 Lamarck, 3, 8, 473, 584, 585, 685, 702-  
   704  
 Laminaria, 133  
 Lamprey, 257, 360, 429  
 Land-habit, 167, 265, 518-520  
 Larch, 150  
 Large intestine, 314; *See: Intestine*  
 Larva, 450, 451, 631  
 Larynx, 335, 565  
 Lateral, line, 381  
 Latex, 155  
 Laver, 136  
 Laveran, 631  
 Lavoisier, 689  
 Lazear, 634  
 Leaf, 9, 67, 68, 77; *histology,* 9, 88-91,  
   *types,* 85-88  
 Leaf-butterfly, 528



- Leafy-liverwort, 144  
 Lecithin, 27  
 Leech, 232, 235  
 Leeuwenhoek, (Frontispiece), 678-680  
 Legume, 124, 125, 158  
 Leishmania, 636  
 Lemma, 162  
 Lemur, 278, 279, 521-523, 578, 600-604  
 Lens, 384-386  
 Lenticel, 78, 81, 82  
 Lepidoptera, 249, 255  
 Lethal gene, 491  
 Leucon, 217  
 Leucosolenia, 215, 216  
 Liana, 170  
 Lichen, 141, 142, 171, 542, 543  
 Liebig, 690  
 Life, 1, 21, 35; origin, 390-402  
 Ligament, 290  
 Lily, 163, 164  
 Limb, 294, 295, 563  
 Limpet, 236  
 Limulus, 251, 252  
 Lincoln, 670  
 Lingula, 232  
 Linin, 23, 24  
 Linkage, 495, 496, 499-501  
 Linnaeus, 600, 683, 702  
 Lionotus, 210  
 Lipase, 311  
 Lipid, 27, 737  
 Lister, 629  
 Liver, 283, 309, 310, 313, 315, 388  
 Liver fluke, 227, 637-639  
 Liverwort, 142-144  
 Lizard, 270, 271, 570, 575  
 Lobe-finned fish, 262-264  
 Loblolly pine, 129  
 Lobosa, 206  
 Lobster, 191  
 Lockjaw, 515  
 Locomotion, 33, 34, 173  
 Locust, 246, 250  
 Lodgepole pine, 170  
 Loiseleuria, 88  
 Louse, 647; *See: Aphid*  
 Lumbricus, *See: Earthworm*  
 Lung, 266, 307, 318, 334-340, 342  
 Lung-fish, 262-264  
 Lutein, 360  
 Lycopodium, 146  
 Lycopsidea, 145  
 Lyell, 704  
 Lymph, 184, 313, 319, 321, 329-331  
 Lymphocyte, 330  
 Lysin, 548  
 Mackerel, 262  
 Macronucleus, 54, 211, 212, 434, 437  
 Madreporite, 241, 242  
 Maidenhair tree, 150  
 Maintenance, 31  
 Malacostraca, 247  
 Malaria, 210, 545, 546, 629, 631-633, 648  
 Male, 56, 107; *See: Gamete and Sperm*  
 Malleus, 383  
 Malpighi, 680, 681, 689, 695, 696  
 Malpighian layer, 285  
 Maltase, 307, 311  
 Mammal, 257-259, 274-281, 326-328, 454-456, 520-525, 567, 569, 575, 696; adaptive radiation, 520-525; destruction of, 663; *See: Man.*  
 Mammary gland, 274, 276, 355  
 Mammoth, 620  
 Man, 6, 25, 281, 297, 327-331, 563, 564, 567, 569, 576, 600-626, 666-670; *See: Human body and Vertebrate*  
 Mandible, 250, 296  
 Mandrill, 279  
 Manna, 142  
 Mantle, 236  
 Maple, 126, 170  
 Marchantia, 143  
 Marigold, 156  
 Marsh, 571  
 Marsilea, 116, 148  
 Marsupial, 275, 276, 280, 524, 525  
 Mastax, 230  
 Mastodon, 576  
 Mating types, 433  
 Maturation, 420-423, 497  
 Maturing Zone, 73, 75  
 Maxilliped, 193, 195  
 Mechanism, 29, 692  
 Medicine, 7, 628-643, 671, 673, 674  
 Mediterranean fruit fly, 653  
 Medulla, 370, 372  
 Medullary plate, 369, 449  
 Medusa, 219-221  
 Megagametophyte, 116, 121  
 Megalith, 623

- Megasporangium, 116-119  
 Megaspore, 116-121  
 Megasporophyll, 116  
 Meiosis, 420-423, 497  
 Membrane bone, 295  
 Memory, 466, 467, 554  
 Mendelian inheritance, 476, 486, 487, 699, 700 *See: Genetics*  
 Mendel's laws, 486, 487  
 Meristem, 70  
 Merozoite, 545  
 Merychippus, 571, 572  
 Mesenchyme, 227  
 Mesentery, 283, 284, 301, 302  
 Mesoblast, 444  
 Mesoderm, 59, 60, 180, 201, 227, 444, 449  
 Mesoglea, 9, 176, 177, 220, 221  
 Meshippus, 571, 572  
 Mesolithic, 614, 620, 621  
 Mesonephros, 283, 284, 347, 348, 353, 356, 357  
 Mesozoic era, 567-569  
 Metabolism, 28-30, 35-55, 512; *See: Anabolism, Katabolism, and Nutrition*  
 Metal, age of, 623, 624  
 Metamorphosis, 245, 246, 265, 450, 451  
 Metanephros, 347, 348  
 Metaphase, 415, 416  
 Metaphyta, 56  
 Metaplast, 22, 23  
 Metatheria, 274, 280  
 Metazoa, 56, 174, 214  
 Meteor, 397, 398  
 Metridium, 223, 224  
 Microcosm, 52-55; *See: Web of life*  
 Microgametophyte, 116, 121  
 Micrographia, 678, 679  
 Micronucleus, 54, 211, 212, 434, 437  
 Microorganisms and disease, 629-636; *See: Bacteria and Protozoa*  
 Micropyle, 124  
 Microscope, 20, 678-681  
 Microsphaera, 139  
 Microspore, 116-121, 152  
 Microsporophyll, 116  
 Mildew, 139  
 Millipede, 248  
 Mimicry, 529-531  
 Mimosa, 97  
 Mind, 466, 467, 553  
 Mint family, 159  
 Miocene epoch, 567, 571, 572  
 Miracidium, 637, 638  
 Mistletoe, 73  
 Mite, 251, 252  
 Mitochondria, 23  
 Mitosis, 14, 414-418  
 Mitral valve, 326; *See: Heart*  
 Mixed nerve, 374, 375  
 Modifications, 471-473, 509, 510, 584, 585, 592-594, 703, 704  
 Modifying gene, 491, 492  
 Mold, 137-139  
 Mole, 277, 522, 523  
 Molecular biology, 20  
 Mollusc, 235-241, 253, 254  
 Molt, 195, 245  
 Monad, 53  
 Mongoloid, 615  
 Monkey, 278, 279, 281, 578, 600-603  
 Monocotyledon, 81, 84, 123, 153, 161-164  
 Monocystis, 209  
 Monohybrid, 477-481  
 Monosaccharide, 27  
 Monosiga, 204  
 Monotreme, 274, 275, 280, 352  
 Morel, 139  
 Morgan, 506, 700  
 Morphology, 3-5; *See: Anatomy*  
 Mosaic inheritance, 474, 487, 488  
 Mosaic vision, 200  
 Mosquito, 210, 545, 546, 586, 631-633  
 Moss, 66, 110-112, 129, 142-145, 567, 569  
 Moth, 246, 527, 654, 655-658  
 Motor nerve, 190, 374-377  
 Motor response, 552  
 Mouse, 277  
 Mousterian, 617, 618  
 Mouth, 180, 181  
 Movement, 33, 173; *See: Irritability*  
 Mulatto, 489, 490  
 Mulberry, 126, 155  
 Müller, 689  
 Multicellular organism, 9, 56-63; *See: Metazoa*  
 Multiple alleles, 506, 507, 596; genes, 489-491  
 Musci, 142, 144, 145  
 Muscle, 184, 185, 287-289; cells, 13, 61, 184, 185  
 Mushroom, 139-141

- Muskmelon, 160  
 Mussel, 237, 239  
 Mustard family, 156  
 Mutation, 474, 503-508, 589, 590, 595-598  
 Mycelium, 137-140  
 Mycorrhiza, 165, 543, 544  
 Myoneme, 53  
 Myosin, 26  
 Myotome, 258, 287, 449  
 Myriapoda, 248  
 Myxedema, 361  
 Myxophyceae, 130
- Nail, 284  
 Nares, 282, 335, 337  
 National Academy of Sciences, 669  
 Natural history, 3  
 Natural resources, 661-664  
 Natural selection, 583-599, 611, 612, 617, 625, 703, 705-707; *See: Selection*  
 Nautilus, 240  
 Neanderthal man, 611-614, 617, 618  
 Necator, 229  
 Necturus, 266  
 Needham, 392  
 Negro, 489, 490, 614  
 Nematelminthes, 228, 253, 254, 637  
 Nematocyst, 176-178, 221, 222, 224  
 Nematode, 228, 637, 641, 642  
 Neolithic, 614, 621-623  
 Nephridium, 184, 186, 189, 193, 199, 233, 234, 346-349, 356  
 Nereis, 232-234, 424  
 Nerve, 190; cell, 13, 61, 366-369; cord, 184, 186, 190, 192, 193, 199; fiber, 190; impulse, 376; net, 366, 367; tube, 299; vasomotor, 330  
 Nervous system, 189, 190, 199, 366-389; *See: Nerve*  
 Nettle family, 155  
 Neural arch, 293; tube, 299, 369, 448, 449  
 Neurenteric canal, 448  
 Neurology, 366  
 Neuromotor system of Protozoa, 212, 213, 366, 379  
 Neuro-muscular mechanism, 215, 367  
 Neuron, 13, 190, 367, 368; *See: Nerve cell*  
 Newt, 266, 504  
 Nictitating membrane, 565
- Night blooming cereus, 158  
 Nightshade family, 159  
 Nitella, 34, 133  
 Nitrate bacteria, 49, 50  
 Nitrates, 39, 49, 50  
 Nitrogen, 26, 40, 615, cycle, 49-51  
 Nitrogen-fixing bacteria, 49-51, 158, 543, 644  
 Node, 77  
 Non-disjunction, 505  
 Nordic, 615  
 Nose, 381  
 Nosema, 658  
 Nostoc, 130  
 Nostril, 282; *See: Nares*  
 Notochord, 256, 283, 284, 291, 299, 448, 449, 464  
 Noyes, 341  
 Nucleic acid, 26  
 Nucleolus, 23, 24  
 Nucleoprotein, 26  
 Nucleus, 12, 13, 23, 24, 64, 414-417; *See: Chromosome*  
 Nurture, 508-511  
 Nut, 125  
 Nutrition, 303-317, 688, 689; *See: Metabolism*  
 Nutritional chain, 537, 538  
 Nymph, 246
- Oak, 83, 155, 170, 649  
 Obelia, 220, 221  
 Ocellus, 250, 532  
 Octopus, 240  
 Odyssey, 624  
 Oedogonium, 107, 108, 131  
 Olfactory lobe, 371-373, 382, 383  
 Oligocene epoch, 567, 571, 572  
 Oligochaeta, 232, 234, 235  
 Ommatidium, 199  
 Onion, 86, 163  
 Ontogeny, 576; *See: Embryology*  
 Oöcyst, 545  
 Oögenesis, 421-423, 494  
 Oögonium, 413, 417, 421  
 Oökinete, 545  
 Opalina, 548  
 Operculum, 262, 450, 451  
 Ophiuroidea, 243  
 Opossum, 275, 524  
 Oposonin, 548  
 Optic lobe, 371, 372  
 Opuntia, 656

- Orangutan, 281, 601-606  
 Orchid, 164, 165, 536  
 Order, 561  
 Organ, 4, 62, 185; systems, 62, 185-190  
 Organ-forming substance, 459-463  
 Organic evolution, 419; *See*: Evolution  
 Organismal concept, 21, 35, 63, 388, 389; *See*: Organization.  
 Organization, 21, 22, 24, 28, 29, 35, 388, 389; of egg, 458-463  
 Organizer, 463-466  
 Origin, of life, 390-402; of species, 556-599  
 Ornithology, 274  
 Ornithorhynchus, 275  
 Orohippus, 571, 572  
 Orthogenesis, 596  
 Oscillatoria, 130  
 Osculum, 216  
 Osmosis, 75, 92, 96, 519, 741  
 Osteichthyes, 260, 261, 280  
 Osteology, 290; *See*: Skeleton  
 Ostracoderm, 258  
 Ostrich, 272, 273, 526  
 Otter, 522  
 Outbreeding, 595  
 Ovary, animal, 176, 190, 200, 351-353, 413; plant, 118-120  
 Oviduct, 190, 200, 353, 354  
 Oviparous, 260  
 Ovule, 118-120; case, 118-120  
 Owen, 686  
 Owl, 563  
 Ox botfly, 647  
 Oxygen, 29, 513-515; *See*: Photosynthesis and Respiration  
 Oxyhemoglobin, 339  
 Oyster, 237-239, 499, 544
- Pain sense spots, 381  
 Paleolithic, 614, 617-620  
 Paleontology, 5, 566-573  
 Paleozoic era, 567-569  
 Palet, 162  
 Palisade tissue, 90  
 Palm, 163, 168  
 Panama canal, 633, 634  
 Pancreas, 283, 302, 305, 310-312, 317, 359-364  
 Pancreatic juice, 311  
 Paramecium, 34, 211-213, 253, 254, 406, 433-437, 550-553, 585, 586; behavior, 550-553; conjugation, 212, 433, 434; endomixis, 212, 436, 437; reproductive power, 436, 585, 586; structure and life history, 211-213  
 Parapodium, 232-234  
 Parasite, 46, 72, 210, 228, 230, 544-548, 629-660  
 Parathyroid, 360, 361  
 Parazoa, 218  
 Parrot, 273  
 Parsley, 159  
 Parsnip, 159  
 Parthenogenesis, 438  
 Pasteur, 393, 629, 630, 656, 682  
 Patella, 297  
 Pathology, 5, 659  
 Pea, 87, 125; inheritance, 478-482  
 Peach, 125, 126, 157  
 Peach-curl, 139  
 Peanut, 158  
 Pearl, 239  
 Pearly nautilus, 240  
 Peat moss, 144  
 Pebrine, 656, 657  
 Pecten, 531, 535  
 Pectoral girdle, 264  
 Pedicellaria, 242  
 Pedigreed race of Paramecium, 436, 585  
 Peking man, 610, 617  
 Pelecypoda, 237-239  
 Pellagra, 316  
 Pelmatohydra, 179  
 Pelvic girdle, 297  
 Penguin, 273  
 Penicillium, 139  
 Pentadactyl limb, 265, 294, 295, 298  
 Pepper, 159  
 Peppermint, 159  
 Pepsin, 308, 311  
 Peptone, 311  
 Peranema, 204  
 Perch, 292, 300  
 Perianth, 117, 152  
 Pericardial chamber, 283  
 Periosteum, 291  
 Peripatus, 252  
 Peripheral resistance, 329  
 Perissodactyl, 278  
 Peristalsis, 188, 307  
 Peristome, 53, 54

- Peritoneum, 184, 186, 283, 284, 306  
 Permanent zone, 73, 76  
 Perspiration, 343  
 Petal, 88, 117-119, 152, 153, 163  
 Petiole, 83  
 Petromyzon, 260  
 Pflüger, 400  
 Phacus, 204  
 Phaeophyceae, 130  
 Phagocyte, 548  
 Phalanges, 294-297  
 Pharynx, 187, 282, 307  
 Phenotype, 479, 577, 595  
 Philosophy, 5, 599  
 Phloem, 63, 68-70, 76, 81-83, 90, 93, 147  
 Photosynthesis, 38-41, 93, 96, 399, 690  
 Phototropism, 98  
 Phycomyces, 137, 138  
 Phyllotaxy, 78  
 Phylogenetic tree, 202  
 Phylum, 129, 561  
 Physalia, 220  
 Physcia, 141, 543  
 Physical basis of life, 16-35, 691-694;  
*See: Protoplasm*  
 Physiological division of labor, 12, 58, 174, 211  
 Physiologist, 675  
 Physiology, 3-5, 91-100, 577-579, 687-692  
 Phytohormone, 99, 358  
 Phytopathology, 659  
 Pig, 639, 641  
 Pigeon, 372, 570, 588  
 Pigment cell, 13  
 Pile village, 622  
 Pill-bug, 247  
 Piltown man, 610, 617  
 Pineal body, 360, 364, 370, 371  
 Pineapple, 126  
 Pink family, 155  
 Pisces, 280  
 Pistil, 88, 117, 120  
 Pitcher-plant, 88  
 Pith, 63, 68, 69, 81; ray, 69, 81, 83  
 Pithecanthropus, 609  
 Pituitary gland, 360, 362, 363  
 Placenta, 274-279, 354, 455, 456  
 Placentals, 280, 281  
 Placoid scale, 260, 286  
 Plague, 629, 643, 648  
 Plains, 171  
 Planaria, 226, 408, 411; *See: Flatworm*  
 Plankton, 131  
 Plant, 8, 36-42, 46-52, 128-167;  
 associations, 539, 540; body, 64-75,  
 173; classification, 128, 204; distri-  
 bution, 168-171; fossil, 165-167;  
 nutrition, 38-40, 46-52, 91-97,  
 689-691; reproduction, 101-127;  
 review of, 128-167; *See: Bacteria*  
 and Seed plants  
 Plantigrade, 521, 522  
 Plasma, 184  
 Plasma-membrane, 23, 75  
 Plasmodium, 210, 545; *See: Malaria*  
 Plastid, 23, 38; *See: Chloroplast*  
 Plastron, 269, 270  
 Platyhelminthes, 226, 253, 254; *See:*  
*Flatworm*  
 Pleistocene epoch, 567, 572, 573, 608-  
 615  
 Plesiosaur, 268  
 Pleura, 335  
 Plexus, 373-375  
 Pliny, 674, 675  
 Pliocene epoch, 567, 572, 573, 617  
 Plihippus, 572, 573  
 Plum, 157  
 Plumatella, 231  
 Pneumonia, 629  
 Point changes, 506  
 Polar body; *See: Polocyte*  
 Pollen, 12, 118-120, 122, 126, 532-537  
 Pollen tube, 119, 120  
 Pollination, 119, 120, 122, 126, 152,  
 536, 537, 658  
 Polocyte, 420-424, 497  
 Polychaeta, 232-234  
 Polymorphism, 220  
 Polyp, 219-221, 223, 224, 226; *See:*  
*Hydra*  
 Polyploidy, 504  
 Polysaccharide, 27  
 Polysiphonia, 135  
 Polytrichum, 110, 111  
 Pome, 125, 126  
 Pond community, 537  
 Pond scum, 132  
 Pongidae, 602, 603  
 Poplar, 154, 168  
 Population, 590-592  
 Porcupine, 277

- Porella, 143, 144  
 Porifera, 214, 253, 254  
 Porphyra, 134  
 Porpoise, 277, 523, 565  
 Portal vein, 313, 324  
 Porto Santo rabbit, 581  
 Portuguese man-of-war, 220  
 Position effect, 505  
 Potato, 80, 159  
 Potato beetle, 249, 650  
 Potato blight, 138  
 Potential energy, 16, 39, 44, 743; *See:*  
   Energy  
 Pottery, 621  
 Powdery mildew, 139  
 Prairie, 171  
 Precipitin, 548, 578  
 Preformation, 457-463, 695, 701  
 Pressure, 517, 518; receptor, 380  
 Prickly-pear, 79, 158, 656  
 Priestley, 690  
 Primary tissues, 179  
 Primate, 276-279, 281, 600-626  
 Primordial germ cells, 412, 413, 419-423  
 Probability, 401, 590-592  
 Proglottid, 639, 640  
 Prolactin, 363  
 Pronephros, 347, 348  
 Prophase, 414, 415  
 Prorodon, 210  
 Prostate gland, 302, 357  
 Protein, 26, 311, 315  
 Prothallus, 113-115  
 Protheria, 280  
 Protista, 404  
 Protochordate, 256-258, 577  
 Protococcus, 36-41, 101, 131  
 Protonema, 111, 112  
 Protophyta, 42, 404  
 Protoplasm, 4, 9, 16-35, 693  
 Protoplast, 102  
 Protopodite, 194-196  
 Prototheria, 274  
 Protozoa, 42, 174, 202-214, 253, 254, 394, 397, 398, 404, 407, 433-437, 470, 516, 537, 538, 545-548, 629, 630, 636, 638, 648, 664, 678; *See:*  
   Amoeba and Paramecium  
 Protozoology, 203, 632; *See:* Protozoa  
 Psalliota, 140, 141  
 Pseudopodium, 11, 33, 34, 42, 43, 206, 207  
 Psilophytales, 166, 167  
 Psychology, 5, 467, 554, 555  
 Pteridophyte, 67, 113, 147, 148; *See:*  
   Fern  
 Pteropsida, 145  
 Pterosaur, 268  
 Ptyalin, 307, 311  
 Pubis, 296  
 Puffball, 141  
 Pulmonary circulation, 326-328  
 Pulse, 328  
 Pulse family, 158  
 Pulvillus, 534  
 Pumpkin, 160  
 Pupa, 246, 631  
 Pure line, 590-593  
 Purpose in Nature, 599, 625  
 Pussy willow, 155  
 Putrefaction, 48, 49, 394  
 Pyloric valve, 308  
 Pyramids, 207  
 Pyrenoid, 64, 203  
 Python, 272, 565  
 Quahog, 238  
 Queen bee, 531  
 Quintuplets, 461  
 Rabbit, 454, 581  
 Rabies, 629  
 Raceme, 156  
 Radial symmetry, 177, 201, 241  
 Radio, 380  
 Radiolaria, 207, 208  
 Radish, 75, 156  
 Radula, 237  
 Ragweed, 161, 168  
 Ramapithecus, 606, 607  
 Rana, 267, 268; *See:* Frog  
 Raspberry, 78, 126, 157  
 Rat, 277, 578, 586, 641, 648  
 Ratitae, 273  
 Rattlesnake, 271, 566  
 Ray, 260, 261  
 Ray flower, 160, 161  
 Ray, J., 683, 684  
 Reaumur, 688  
 Recapitulation, 246, 265, 575, 577, 697  
 Receptacle, 117  
 Receptor, 177, 190, 199, 367-369, 378-389  
 Recessive character, 477, 487, 595

- Recombinations, 473, 474, 501, 502, 592, 593  
 Red algae, 134-136  
 Red blood cells, 321; *See*: Blood  
 Redi, 391, 392  
 Redia, 637, 638  
 Reduction of chromosomes, 419-423  
 Red Sea, 131  
 Redwood, 150, 168, 170  
 Reed, 634  
 Reflex action, 190, 369, 377, 466, 552  
 Regeneration, 103, 179, 200, 201, 388, 407-411  
 Reindeer moss, 142  
 Renaissance science, 2, 674-678  
 Renal portal system, 320, 325  
 Rennin, 308  
 Reproduction, 14, 32, 101-110, 190, 350-357, 403-411, 575; *power of*, 436, 585, 586  
 Reptile, 257-259, 268-272, 280, 567-571, 575, 605  
 Research, 6, 7, 643, 645, 646, 653, 655, 661, 665, 666, 670  
 Respiration, 40, 41, 93, 97, 189, 198, 199, 307, 333-340, 688-690  
 Respiratory, center, 337, 372; *interchange*, 338-340; *mechanism*, 336-338  
 Retina, 384-387  
 Reversion, 474  
 Rhinoceros, 278, 620  
 Rhizoid, 110, 113, 114  
 Rhizome, 87, 113, 167  
 Rhizoplast, 203  
 Rhizopoda, 205-208; *See*: Amoeba  
 Rhizopus, 137, 138  
 Rhodophyceae, 130, 133  
 Rib, 284, 296, 297  
 Rickets, 316  
 Rivularia, 130  
 Roan cattle, 488  
 Rock-tripe, 142  
 Rockweed, 65, 133  
 Rodent, 277  
 Rods and cones, 386, 387  
 Roman science, 674  
 Roosevelt, T., 661  
 Root, 70; *cap*, 73-75; *hair*, 75, 76, 91; *histology*, 74-76; *pressure*, 92; *types*, 67, 68, 70-74  
 Rose, 156, 157  
 Ross, 631  
 Rotifer, 230, 253, 254  
 Roundworm, 228-230, 641, 642  
 Runners, 79  
 Running cedar, 145  
 Rush, 162  
 Rust, 139, 140, 659, 660  
 Sacculus, 382, 383  
 Sac fungi, 138, 139  
 Sacrum, 297  
 Safety factor, 389  
 Sagebrush, 161, 171  
 St. Helena, 582  
 Salamander, 265, 266, 409  
 Salientia, 265, 266  
 Salivary gland, 305, 307, 311, 566  
 Sand dollar, 243  
 Sandworm, 232, 233  
 San José scale, 653  
 Sap, 93  
 Saprolegnia, 138  
 Saprophyte, 53  
 Sap wood, 83  
 Sargasso Sea, 133  
 Sargassum, 133, 135  
 de Saussure, 690  
 Scale insect, 652, 653, 655, 656  
 Scale-moss, 144  
 Scallop, 237  
 Scaphognathite, 199  
 Schaudinn, 635  
 Schizogony, 545  
 Schizomycetes, 136; *See*: Bacteria  
 Schleiden, 692, 693  
 Schultze, 693, 695  
 Schwann, 692-694  
 Scolex, 639, 640  
 Scorpion, 251, 252  
 Scrotum, 302  
 Scurvy, 28, 316  
 Scutigera, 248  
 Scyphistoma, 223  
 Scyphozoa, 221  
 Sea anemone, 223, 224  
 Sea-cow, 277, 278  
 Sea cucumber, 243, 244  
 Sea-horse, 262, 263, 529  
 Seal, 277, 578, 663  
 Sea lettuce, 65  
 Sea lily, 243, 244  
 Sea pen, 225  
 Sea to land, 518-520  
 Sea urchin, 241, 243, 244, 460, 461

- Sea walnut, 226  
 Seaweed, 130  
 Sebaceous gland, 285, 343  
 Secondary sexual characters, 355, 440  
 Secretin, 317  
 Secretion, 183; *See*: Gland  
 Sedge, 162  
 Seed, 121-127, 167  
 Seed-fern, 150, 167  
 Seed plant, 64, 67, 117-127, 129, 145, 148-165, 167, 582  
 Segmented worm, 232-235; *See*: Earthworm  
 Segregation, 422, 423, 478, 486, 487, 491, 493-495, 501, 511  
 Selaginella, 146  
 Selection, 589-594, 703-707; *See*: Natural selection  
 Self-digestion, 312  
 Semicircular canal, 382, 383  
 Seminal, receptacle, 186, 190, 200; vesicle, 186, 190, 357  
 Seminiferous tubule, 357  
 Senile degeneration, 435  
 Sense organ, 190, 200  
 Sensitive fern, 87, 88  
 Sensitive plant, 97  
 Sensory cell, 177; *See*: Receptor  
 Sensory nerve, 190, 374-377  
 Sepal, 88, 117-119, 152, 153, 163  
 Sequoia, 170  
 Serial homology, 192, 565; *See*: Homology  
 Seta, 184  
 Sewage, 664  
 Sex, 56, 103-108, 127; determination, 496-499; differentiation, 105-107, 440; linked, 500, 501; origin, 103-108; reversal, 499; *See*: Fertilization  
 Shark, 260, 261, 320  
 Sheep, 637  
 Shepherd's purse, 156  
 Shipworm, 237  
 Shorthorn cattle, 487, 488  
 Shrub, 77  
 Sieve tube, 83  
 Silkworm, 656, 658  
 Sinanthropus, 609  
 Sinus, 196, 198  
 Sinus venosus, 320, 323, 453  
 Siphonoglyph, 224  
 Sirenia, 278  
 Sitka spruce, 170  
 Skate, 261  
 Skeleton, 290-297, 563, 564  
 Skin, 284-286, 333, 342  
 Skull, 294; *See*: Skeleton  
 Sleep of plants, 97  
 Sloth, 521, 522  
 Slug, 236, 237  
 Small intestine, 308, 309  
 Smell, sense of, 200, 381, 382  
 Smilax, 79  
 Smuts, 139, 140, 659  
 Snail, 236, 237, 569, 637  
 Snake, 271, 272, 565, 575, 578  
 Snapdragon, 506  
 Social heredity, 510, 616, 624, 625  
 Sociology, 5  
 Soil, 663  
 Solomon's seal, 163  
 Somatic, cells, 58, 174, 404-407, 411, 412, 435, 470, 699; mutations, 507  
 Song sparrow, distribution, 580  
 Sorus, 113  
 Soy bean, 158  
 Spallanzani, 393, 688  
 Spathidium, 210  
 Spawn, 239  
 Spearmint, 159  
 Special creation, 396, 558  
 Species, 128, 556-562, 597, 598, 646, 684  
 Speech, 607, 608  
 Spencer, 28, 282  
 Sperm, 12, 13, 56, 107, 351, 428-432, 679, 697  
 Spermatid, 421, 422  
 Spermatocyte, 420-422  
 Spermatogenesis, 420-422, 494  
 Spermatogonium, 413, 417, 421  
 Spermatophyte, 67, 148; *See*: Seed plant  
 Sperm duct, 190, 200  
 Sphaerella, 104, 131  
 Sphagnum, 144  
 Sphenopsida, 145  
 Sphinx, 207  
 Spicule, 215  
 Spider, 251, 252  
 Spike, 154, 161, 162  
 Spikelet, 162  
 Spinal, cord, 283, 284, 369-377; nerve, 373-375  
 Spiracle, frog, 450; insect, 250  
 Spirillum, 46, 47



- Spirogyra, 64, 102, 106, 131  
 Spirostomum, 210  
 Spleen, 283, 300, 302, 320, 331  
 Splint bone, 571, 572  
 Spondylomorum, 57  
 Sponge, 214-218, 253, 254  
 Spongilla, 217  
 Spongy tissue, 90  
 Spontaneous generation, 391-394, 680  
 Sporangium, 87, 88, 108-121, 137  
 Spore, 12, 56, 102, 103, 108, 127, 659, 660; of Bacteria, 47, 516; of Protozoa, 209  
 Sporocyst, 637, 638  
 Sporophyll, 87, 88, 146, 148  
 Sporophyte, 67, 109-123, 127, 142-144, 419  
 Sporozoa, 208-210, 404  
 Sporozoite, 209, 545  
 Sporulation, 209, 404  
 Spruce, 150, 151  
 Squash, 160  
 Squeteague, 538  
 Squid, 240  
 Squirrel, 277, 302, 560, 561  
 Stag, 355  
 Stamen, 88, 117-120, 154, 162  
 Stapes, 383  
 Starch, 27, 39, 311  
 Starfish, 241-243, 409, 411  
 Statoblast, 231  
 Statocyst, 200  
 Statolith, 200  
 Stele, 68, 82  
 Stem, 63, 67, 68, 69; histology, 80-83; types, 76-79  
 Sternum, 293  
 Stigma, 58, 118, 120, 154  
 Stimulus, 33, 97-100; *See*: Sense organ  
 Sting of bee, 535  
 Stipule, 85  
 Stolon, 137  
 Stoma, 82, 89, 90  
 Stomach, 283, 307, 308, 311  
 Stonehenge, 623  
 Stonewort, 133, 134  
 Stork, 273, 526  
 Strawberry, 79, 126, 157, 641  
 Stream pollution, 664  
 Striated muscle, 287  
 Strobila, 222, 223  
 Strobilus, 146-152  
 Struggle for existence, 439, 586, 587, 705  
 Sturgeon, 262  
 Styela, 459, 460  
 Style, 118, 120  
 Stylonychia, 210  
 Subesophageal ganglion, 186, 189, 192, 193  
 Subspecies, 562, 580  
 Sugar, 27, 39, 95, 306, 307, 311  
 Sugar cane, 162  
 Suharo, 158  
 Sulfur bacteria, 166, 515  
 Sundew, 86, 88  
 Sunflower, 125, 128, 129, 160  
 Sun-red, 492  
 Surgery, 394, 628, 629  
 Survival of the fittest, 587, 705  
     *See*: Natural selection  
 Sutton, 495  
 Swammerdam, 680  
 Sweat gland, 285, 343  
 Sweet william, 155  
 Swift, 401  
 Swiss lake dwellings, 622  
 Sycon, 217; *See*: Grantia  
 Sylvius, 688  
 Symbiosis, 51, 141, 142, 165, 179, 541-544  
 Symmetry, bilateral, 181, 201, 241; radial, 177, 201, 241  
 Synapse, 377  
 Synapsis, 420, 421, 493, 494  
 Synkaryon, 432, 433; *See*: Zygote  
 Syphilis, 472, 629, 631, 635, 636  
 Tachina fly, 650, 657  
 Tactile corpuscle, 381  
 Tadpole, 266, 450, 451  
 Taenia, 639, 640  
 Tail, 283  
 Tapeworm, 227, 639, 640  
 Tapir, 278, 580, 581  
 Tarsius, 278, 600-604  
 Taste buds, 381  
 Taxonomy, 5, 172; *See*: Classification  
 Teleost, 262-265, 280  
 Telophase, 415, 416  
 Telson, 193  
 Temperature, 397, 398, 515-517; body, 272, 331, 338, 515-517  
 Tendon, 290  
 Tendril, 79, 87

- Tennyson, 468  
 Tentacle, 176, 222  
 Termite, 249  
 Testis, 176, 190, 200, 351-353, 357, 360, 413  
 Testosterone, 360  
 Tetanus, 515  
 Tetrad, 420, 421  
 Tetraploidy, 504  
 Thalassicolla, 208  
 Thallophyta, 66, 129-142; *See: Algae and Fungi*  
 Thallus, 65, 66, 135, 166  
 Theophrastus, 2, 673, 675  
 Thiamin, 316  
 Thistle, 87  
 Thomson, 512, 556, 599, 627  
 Thoracic duct, 313, 314  
 Thorax, 192, 284, 335, 336  
 Thorn, 79  
 Thought, 616  
 Threadworm, 229  
 Thrush, 526, 582  
 Thymocrescin, 364  
 Thymus gland, 302, 305, 317, 360, 364  
 Thyroid gland, 302, 305, 317, 360, 361, 364  
 Thyroxine, 361, 363, 365  
 Tick, 252, 253  
 Tin, 624  
 Tissue, 4, 61-63, 179, 182-184; fluid, 184, 329  
 Toad, 267, 575  
 Toadstool, 139  
 Tobacco, 124, 159  
 Tomato, 159  
 Tongue, 307, 381  
 Tonsil, 305  
 Tools, 617-624  
 Tooth, 286, 576, 607  
 Tortoise, 269, 270  
 Totipotent, 461  
 Touch sense, 380, 381  
 Toxin, 548, 549  
 Trachea, 335  
 Tracheal cell, 83  
 Tracheal system, 245, 333, 334  
 Trachelomonas, 204  
 Tracheophyta, 67, 114, 129, 142, 145-166  
 Tradescantia, 34  
 Tradition, cumulative, 510, 616, 624  
 Transfusion of blood, 578  
 Translocation, 94-96, 505  
 Transpiration, 92-94  
 Tree fern, 113  
 Tree toad, 267  
 Trematode, 227  
 Trench fever, 647  
 Treponema, 635  
 Treviranus, 3, 704  
 Trial and error, 552  
 Triassic period, 567, 568  
 Trichinella, 229, 254, 641  
 Trichinosis, 229, 641  
 Trichocyst, 54, 211  
 Trichodesmium, 131  
 Trichomonas, 204, 636  
 Trihybrid, 485  
 Trillium, 79  
 Trilobite, 252  
 Triploblastic, 226  
 Triploidy, 504  
 Triturus, 266  
 Trochophore, 234  
 Trophozoite, 209  
 Tropism, 98, 466, 467, 549, 552  
 Truffle, 139  
 Trypanosome, 205, 546-548, 636  
 Trypsin, 311  
 Tsetse fly, 547  
 Tube feet, 241-243  
 Tuber, 79, 159  
 Tuberculosis, 629, 649  
 Tubeworm, 233  
 Tundra, 109, 171  
 Tunicate, 256, 257  
 Turbellaria, 227  
 Turgor, 91, 97  
 Turnip, 156  
 Turtle, 269, 270, 575, 578  
 Tympanic membrane, 383, 384  
 Tyndall, 395  
 Typhlosole, 184, 187  
 Typhoid, 629, 649  
 Twin, 461  
 Ulothrix, 64, 102, 105, 131  
 Ultramicroscope, 20  
 Ulva, 65  
 Umbel, 154, 159  
 Umbilical cord, 354, 455, 456  
 Underwing moth, 527  
 Undulant fever, 631  
 Unguiculate, 277  
 Ungulate, 278

- Unguligrade, 522  
 Unicellular, 9; *See: Protozoa and Protophyta*  
 Uniformitarian doctrine, 701  
 Uniparental, 56  
 Unity of life, 3, 14, 15, 279, 625-627, 693  
 Urea, 45, 342, 343, 519, 520, 577, 748  
 Ureter, 344, 345, 353, 357  
 Urethra, 344, 345, 357  
 Uric acid, 342, 345, 577  
 Urinary bladder, 344, 345, 357  
 Urine, 343, 345, 346, 519  
 Urochorda, 256, 257, 280  
 Urodele, 266  
 Urogenital system, 356, 357  
 Urostyle, 295  
 Uterus, 352-354  
 Utricle, 382, 383  
  
 Vaccination, 549  
 Vacuole, 23, 64, 76, 91  
 Vagina, 357  
 Vagus nerve, 375  
 Vanilla, 164  
 Variability curve, 590-592  
 Variation, 427, 468-476, 511, 527, 562, 585, 588  
 Vascular bundle, 69, 81, 84, 147, 148, 152, 153  
 Vascular plants, 67, 114, 145, 166  
 Vascular system, *See: Circulatory system*  
 Vas deferens, 357  
 Vasomotor, center, 372; nerve, 330  
 Vaucheria, 132, 133  
 Vein, 320, 321; of leaf, 89, 90  
 Ventilation, 340  
 Ventral nerve root, 376, 377  
 Ventricle, 320-322, 324, 326-328  
 Venus, 399, 400  
 Vermiform appendix, 304, 305, 565  
 Vertebra, 284, 293-297  
 Vertebral canal, 293  
 Vertebrate, 174, 256-300, 567, 568; body plan, 282-284; characters, 298, 299; circulation, 318-332; classification, 256, 257, 280, 281; coelom, 283; endocrine system, 358-365; limb plan, 294, 295, 563; nervous system, 366-388; respiration, 333-340; skeleton, 290-297; urogenital system, 341-357  
 Vesalius, 676, 677  
 Vestigial organs, 565, 566  
 Vetch, 158  
 Villus, 312, 378  
 Vinegar eel, 229  
 Violet, 122  
 Virus, 394-396, 549, 635  
 Vitalism, 29, 30, 691, 692  
 Vitamin, 28, 99, 310, 315, 316  
 Viviparous, 260  
 Vivisection, 628  
 Vocal cords, 335  
 Voluntary muscle, 287  
 Volvox, 57, 58, 404-406  
 Vorticella, 53  
 de Vries, 589  
  
 Walking-stick insect, 528, 529  
 Wallaby, 275  
 Wallace, 705  
 Walnut, 125, 155, 170, 579-581  
 Wasp, 529  
 Water cress, 156  
 Water ferns, 115, 116, 148  
 Water flea, 247, 248  
 Water in protoplasm, 25, 513, 519  
 Water lily, 118  
 Watermelon, 160  
 Water mold, 137, 138  
 Water-vascular system, 242  
 Wealth, 642-644  
 Web of life, 52-55, 537-539, 664  
 Weismann, 405, 473, 698  
 Whale, 277, 517, 523, 563, 663  
 Wheat, 162, 473  
 Wheel, 623  
 Wheel animalcule, 230  
 White pine blister rust, 659, 660  
 Willow family, 154, 155  
 Wilson, 696  
 Wood, 83; *See: Xylem*  
 Woodchuck, 522  
 Woodcock, 273  
 Wood, fiber, 81, 83; louse, 247  
 Woods Hole Marine Biological Laboratory, 663  
 Working hypothesis, 4, 691  
 Worm, 636-642; *See: Earthworm, Flatworm, etc.*  
  
 X chromosome, 496-501, 505  
 Xerophyte, 99, 171  
 Xylem, 63, 68-70, 76, 81-83, 90, 91, 93, 147

- Yale University, 571  
Yarrow, 161  
Y chromosome, 496-501, 505  
Yeast, 49, 139, 404, 514 515, 653  
Yellow fever, 394, 634, 635  
Yellow pine, 170  
Yolk, 429, 430, 447, 448  
Yolk sac, 452-455, 750  
Yucca, 171  
Zamia, 149  
Zea, 129; *See*: Corn  
Zona pellucida, 454  
Zoögeography, 579-583  
Zoölogy, 3-5  
Zygomatic arch, 296  
Zygote, 56, 103-108, 120, 350, 419,  
421, 424, 432, 479, 494, 497, 697



