

Birta Central Library

PILANI (Jaipur State)

Class No. - 545

Book No. - W684A

Accession No. - 33968

In the manufacture of this book, the publishers have observed the recommendations of the War Production Board and any variation from previous printings of the same book is the result of this effort to conserve paper and other critical materials as an aid to war effort.

ADVANCED QUANTITATIVE ANALYSIS

A Companion Volume to

ELEMENTARY QUANTITATIVE ANALYSIS

by HOBART H. WILLARD and N. HOWELL FURMAN

BY

HOBART H. WILLARD, P.H.D.

Professor of Chemistry, University of Michigan

AND

HARVEY DIEHL, P.H.D.

Associate Professor of Chemistry, Iowa State College

SECOND PRINTING



NEW YORK

D. VAN NOSTRAND COMPANY, INC.

250 FOURTH AVENUE

Copyright, 1943, by
D. VAN NOSTRAND COMPANY, INC.

All Rights Reserved

*This book or any part thereof may not
be reproduced in any form without
written permission from the publishers.*

First Published September 1943

Reprinted April 1944

ACKNOWLEDGMENT

The authors wish to express their appreciation to those whose valuable assistance forwarded the composition of this book: Mr. Park Gerald, Mr. Lawrence Liggett and Mr. Gerald Watson of Iowa State College, Professors B. A. Soule and R. K. McAlpine of the University of Michigan, Professor M. G. Mellon of Purdue University, Professor G. F. Smith of the University of Illinois, Mr. Arba Thomas of the American Rolling Mill Company, Mr. T. R. Cunningham of the Union Carbide and Carbon Research Laboratories, and Mr. T. A. Lancaster of the General Chemical Company.

PREFACE

The graduate training of chemists should involve advanced work in each of the fundamental fields of chemistry: inorganic, physical, organic, and analytical. This advanced analytical chemistry should be divided about equally between chemical methods of analysis and physico-chemical or instrumental methods of analysis.

This book has been written as a text for that part of the work dealing with chemical methods of analysis and the emphasis has been placed upon chemistry. The book is largely devoid of physico-chemical theory but it is rich in the factual inorganic chemistry useful to the practicing chemist and essential to the development of chemical intuition in the embryonic chemist. The authors feel that nowhere else can so thorough a knowledge of inorganic chemistry be acquired as by an extensive study of the analytical chemistry of the elements.

This text has been designed as a companion volume to Willard and Furman, *Elementary Quantitative Analysis*. As such, the treatment of certain subjects has been deliberately made supplementary in nature rather than complete. This may occasionally cause the reader some inconvenience but a considerable saving in the size and cost of the book has been effected by eliminating extensive duplication of the material found in the elementary book; and this may be remembered in a few cases where it may be necessary to consult the beginning book for background material. Page references are given to the third edition of Willard and Furman; these will assist in correlating the information of the two texts.

The first third of the book is devoted to a discussion of the general methods of chemical analysis; the topics are taken up in the order in which they are met in the course of an analysis, the problems of sampling, the methods of decomposing and dissolving materials, the methods of concentrating small amounts of materials, the various methods of separating the elements, and so on through to the methods of reporting the results. The second third of the text is devoted to the analysis of iron ore, steel, and silicate rock, and has sections devoted to the analytical chemistry of each of the elements encountered. Directions for laboratory work accompany

this portion of the book. The last third of the book is a discussion of the analytical chemistry of each of the elements not studied earlier; the common and most of the rarer elements are treated. The order in which the elements are discussed is that of the periodic table, and sufficient information is given to supply the student with the basic information needed for solving the problems involved in the analysis of complex inorganic mixtures. A large number of references to the original literature have been included with sufficient information to make possible a decision as to the adaptability of a specific method to a particular case. The methods included are the result of a rather critical examination of a large number which have been proposed.

A discussion of the methods of determining the atomic weights of the elements has been included. The fundamental nature of this subject demands that the student be at least familiar with the principal aspects of the problem, and a knowledge of the care and refinement of technic requisite to attaining atomic weight precision and accuracy cannot fail to have a wholesome effect on the attitude of the student toward the results of his own laboratory work.

Although directed primarily toward the teaching of quantitative analysis at the graduate level, the book may also find use by the more advanced undergraduate students, particularly perhaps by those interested in metallurgical analysis.

The observing reader will not fail to note that the majority of the literature references given are to the *Analytical Edition of Industrial and Engineering Chemistry*. This is neither accident nor narrow nationalism. Analytical Chemistry in America has expanded and matured, and in its fifteen years, the *Analytical Edition* has kept pace, faithfully sifted and recorded the results, and accepted the responsibilities of the dominant journal in the field. At the same time there has emerged in this country a professionally conscious group of analytical chemists and teachers of analytical chemistry, its nucleus being the Division of Analytical and Micro Chemistry of the American Chemical Society. To a certain extent the references cited in this text mirror the progress of this group and it is sincerely hoped that this progress will continue unabated and the science and profession of analytical chemistry be further strengthened and developed.

HOBART H. WILLARD
HARVEY DIEHL

CONTENTS

CHAPTER	PAGE
I. NOTES TO STUDENTS	1
Attitude and Approach to Laboratory Work	1
The Use of the Literature	2
Outline of Laboratory Work	3
The Keeping of Records	5
The Use and Care of Platinum Ware	6
The Use of Perchloric Acid	8
II. THE GENERAL OPERATIONS OF QUANTITATIVE ANALYSIS	11
Factors Which Affect the Speed and Accuracy of Analytical Methods	11
The Problems of Sampling	16
The Preparation and Weighing of Samples	23
Methods of Dissolving the Sample	28
Preliminary Considerations	28
Solvents for Metals	30
Solvents for Oxides	32
Decomposition of Silicates	32
Decomposition of Sulfides	33
Decomposition of Phosphates	34
Decomposition of Carbonates	34
Decomposition of Sulfates	34
Decomposition of Ferro Alloys	34
Decomposition of Chromite and Other Very Refractory Minerals	35
Concentration Methods for the Separation of Very Small Amounts of One Substance from Very Large Amounts of Another	35
Direct Precipitation of the Desired Minor Constituent	36
Fractional Precipitation of the Desired Minor Constituent	36
Extraction with an Immiscible Solvent	37
Distillation or Sublimation	37
Crystallization or Deposition of the Major Constituent	37
Precipitation with a Gathering Agent	38
Methods of Effecting Separations	39
Preliminary Considerations	39
The Acid Insoluble Group. Dehydration	41
The Insoluble Chloride Group	42
The Hydrogen Sulfide Group	42
The Ammonia Precipitate. The Separation of Weak Bases and Basic Salts from Stronger Bases	44

CHAPTER		PAGE
	Precipitation with Sodium Hydroxide. Fusions with Sodium Carbonate and Sodium Peroxide	48
	Distillation	49
	Extraction Methods. The Ether Extraction of Iron	51
	Electrodeposition	57
	Constant Current and Controlled Cathode Potential Methods	57
	The Mercury Cathode	58
	Internal Electrolysis	60
	Chemical Reduction to Metal	63
	The Use of Organic Precipitants	64
	Theoretical Considerations	64
	Dimethylglyoxime	71
	Cupferron	73
	8-Hydroxyquinoline (Oxine)	74
	α -Nitroso- β -naphthol	81
	α -Benzoinoxime (Cupron)	82
	Salicylaldoxime	83
	The Arsonic Acids	84
	Tetraphenylarsonium Chloride	85
	Nitron	86
	Diphenylthiocarbazone (Dithizone)	87
	Methods of Concluding the Determination	89
	Preliminary Note	89
	Absorbents for Water and Carbon Dioxide	90
	The Standardization of Potassium Permanganate Solutions	95
	The Silver Reductor	97
	The Lead Reductor	99
	The Potentiometric Determination of the End-Point	99
	Colorimetry	110
	Catalytic Methods for the Determination of Small Amounts of Materials	126
	The Methods of Reporting Analytical Results	127
III.	THE ANALYSIS OF IRON ORE, IRON, AND STEEL	130
	Suggestions Regarding the Analysis of Iron Ore, Iron, and Steel	131
	The Determination of Loss on Ignition of Iron Ore	134
	The Determination of Iron	134
	The Determination of Aluminum	142
	The Determination of Titanium	154
	The Determination of Manganese	162
	The Determination of Silica and Silicon	180
	The Determination of Sulfur	188
	The Determination of Phosphorus	196
	The Determination of Carbon in Steel	209
IV.	THE ANALYSIS OF ALLOY STEELS	215
	The Determination of Tungsten	216

CONTENTS

xi

CHAPTER	PAGE
The Determination of Molybdenum	222
The Determination of Chromium	228
The Determination of Vanadium	238
V. THE DETERMINATION OF ALKALI METALS	252
The Determination of Potassium	254
The Determination of Sodium	262
The Determination of Lithium	265
The Separation of Potassium, Rubidium, and Cesium	265
The Decomposition of Insoluble Silicates for the Determination of the Alkali Metals	266
VI. THE DETERMINATION OF THE ELEMENTS	278
Periodic Group I	280
Periodic Group II	290
Periodic Group III	308
Periodic Group IV	315
Periodic Group V	337
Periodic Group VI	358
Periodic Group VII	367
Periodic Group VIII	378
Summary of the Principal Methods for the Separation and Gravimetric Determination of the Elements	389
Summary of the Principal Methods for the Volumetric Determinations of the Elements	398
Problems Involving the Separation and Determination of the Various Elements	403
VII. THE DETERMINATION OF ATOMIC WEIGHTS	409
The Historical Development of Atomic Weights	409
The Chemical Methods of Determining Atomic Weights	411
Gas Density Methods	419
The Mass Spectrograph	419
The Constancy and Importance of Atomic Weights	420
AUTHOR INDEX	423
SUBJECT INDEX	433

CHAPTER I

NOTES TO STUDENTS

ATTITUDE AND APPROACH TO LABORATORY WORK

So we have two classes of workers in the analytical field, the determinators and the analysts. The determinators, who are by far the more numerous, may in turn be divided into two general classes: first, the common determinators who follow a method explicitly, without knowledge or concern as to the reactions involved; and second, the educated determinators who can handle systems containing one or perhaps two variables, or who, like determinators of pH , are chiefly interested in group effects and make no effort to go beyond this. The first are the laborers. They need not be chemists, and they require constant supervision. The second are the white-collar workers who exhibit the usual extremes of workers in this classification. The determinator's salvation lies in the development of truly selective methods of analysis, and his final resting place will be a heaven in which he has a shelf containing 92 reagents, one for each element, where No. 13 is the infallible specific for aluminum, No. 26 the sure shot for iron, No. 39 the unfailing relief for yttrium and so on to uranium.

As for the analyst, he is a comparatively rare bird and is often referred to as a disappearing species, like the old family practitioner who does the best he can, guided by theory and experience, of which the most comforting is experience. It must be admitted that one of the reasons for the gradual disappearance of the analyst is the anomaly that, in spite of the fact that he works entirely with material things, his reward is chiefly spiritual. Who ever heard of a consulting analyst, or of an analyst who patented a new method of analysis or incorporated a company to promote its use? Other reasons for the scarcity of the analysts are perhaps the peculiar characteristics, some inherent and some acquired, that he must possess. He must have the inquisitive habit of a detective, for oftentimes the composition of the material under test is absolutely unknown. He must be an expert manufacturer of pure chemicals, for on this ability the success of his gravimetric determinations depends. He must be an efficient dispenser of liquids of which he knows the exact effect. And, above all, he must serve a long apprenticeship, and keep in constant practice.—LUNDELL.¹

¹ From "The Chemical Analysis of Things as They Are," *Ind. Eng. Chem., Anal. Ed.*, 5, 221 (1933); recommended reading for all who would be chemists.

It is of the greatest importance that before beginning work the analyst should have a thorough understanding of the entire method of the analysis projected and should know the chemistry involved, the sources of error, the presence or absence of interfering materials, and the reasons for the order pursued and the mechanical details adopted. A worker who blindly follows a written procedure may develop skill in manipulation but will never become a chemist. The methods of analysis used in the courses for which this text is designed are typical ones which illustrate general principles and techniques. These may be applied to other cases than the ones studied, but this requires a complete knowledge of the reactions and principles involved. Therefore, in the recitation work, special emphasis will be laid upon the theory, general principles, chemical reactions, applications, and errors of the various methods, and little attention will be paid to manipulative details. Skill in manipulation is judged by the accuracy of the analyses, but a knowledge of the subject, which is of more importance, is judged by the ability to apply it to new problems and to familiar substances under new conditions and to detect errors and to devise possible improvements in old processes.

The greatest problem of laboratory work is the efficient use of the time available. Laboratory work should be planned ahead and arrangements made for carrying on simultaneously as many operations as possible. When long evaporations are required, the time should be filled in with other work; and long, preliminary operations should be started early enough so that they will be finished by the time they are wanted. Idle moments can be filled in with minor jobs such as cleaning glassware, marking and igniting crucibles, and so on. With proper planning there will be no waste of time and the effort of looking ahead will be amply rewarded.

The Use of the Literature. Acquiring a familiarity with the chemical literature is of fundamental importance in the training of a chemist. In schools where a special course in the use of the chemical library is given, this may be more or less compulsory; in other places it is largely a matter of individual effort. Next to actually having the knowledge itself, a knowledge of where to find information is most important. The details of the multitudinous methods which may be drawn upon are beyond the memory of any one chemist, and frequent reference to the literature is not only a remunerative method of avoiding mistakes but also a stimulating source of new ideas.

The methods of analyzing most commercially important materials have been largely standardized by the various societies such as The American Society for Testing Materials, The American Public Health Association, The Association of Official Agricultural Chemists, The United States Pharmacopoeial Convention, and others. The publications of these societies contain detailed directions for the analysis of many materials and together with the standard reference books of various subfields constitute the first literature to be consulted. An extensive bibliography of the chief texts in the various fields of analysis is given in Willard and Furman, 3rd Ed., pp. 480-492.

In the case of minerals, and to a lesser extent, alloys, it is not likely that there will be found in the literature a method of analysis of a particular subject, but the relevant material will probably be found under the elements composing the substance. Many of the best analytical separations are to be found only in the various chemical journals, and have not yet found their way into any of the books on the subject. In a science where so many new discoveries are constantly being published, no book can be fully up to date. A few hours spent in the library searching the journals is frequently a means of saving many hours in the laboratory rediscovering something already known and reported.

A definite and systematic plan for covering the literature on the analytical chemistry of a particular substance is given in the text by Soule.² Much excellent advice on the subject of the analytical literature will be found in this place, as well as an extensive bibliography of analytical books, compilations, and journals, together with comments on their general utility.

OUTLINE OF LABORATORY WORK

The laboratory work presented in this text has been chosen to illustrate a variety of methods with respect to the chemistry and the general procedure involved. A number of the determinations are those commonly made in commercial and industrial practice and they are on the whole more difficult than those carried out in the elementary courses. In fact some of the determinations are among the most difficult of all the analyst is called upon to make. The

² Soule, *Library Guide for the Chemist*, The McGraw-Hill Book Company, Inc., New York, 1938, pp. 168-183.

materials analyzed and the order in which the analyses are undertaken are, first, the analysis of iron ore or steel for the minor constituents, next the analysis of an alloy steel for the alloying metals, then the determination of sodium and potassium in an insoluble silicate, and finally the qualitative and quantitative analysis of some unknown substance.

For convenience the material dealing with iron ore and steel has been treated together, this being possible because many of the determinations made are common to both materials and have many similarities in the chemistry and procedure. The determinations made on iron ore or steel are: loss on ignition, total iron, aluminum, titanium, manganese, carbon, silica, phosphorus, and sulfur. Suggestions as to the general consideration of these analyses, the procedures to be followed, and the method of reporting the results are given on pp. 131 and 133.

The alloy steel is analyzed for chromium, vanadium, tungsten, and molybdenum. The material dealing with these metals follows the section devoted to iron ore and plain carbon steel. Nickel, copper, and cobalt, which could also rightfully be termed alloying metals, are dealt with in a later section of the book, but the discussion of the analytical chemistry of these metals includes the methods and procedures for their determination in steel.

The chapter dealing with the determination of sodium and potassium and the decomposition of insoluble silicates for their determination follows that on alloy steel. It is recommended that in the determination of sodium the sample be decomposed by the hydrofluoric acid-sulfuric acid or the hydrofluoric acid-perchloric acid method, and the sodium be determined directly by the triple acetate method; and that for the determination of potassium, the sample be decomposed by the hydrofluoric acid-fluosilicic acid distillation method, and the potassium determined by the perchlorate method.

The final problem is the qualitative and quantitative analysis of some unknown material such as a mineral, alloy, or commercial product. A careful qualitative analysis is made, bearing in mind the data which should be secured concerning the approximate composition. When the constituents are known, the name, nature and uses of the material should be found if possible. After the required information has been obtained, a report is submitted to the instructor, who will indicate any errors. Next a scheme is worked out for the complete quantitative analysis of the substance. The

principles discussed on pp. 39 and 404 should be considered carefully. Knowledge already gained and the information which can be found in the literature should be employed fully, and imagination and ingenuity should be exercised in devising new methods for difficult or new problems. The instructor will give advice when necessary. The proposed scheme of analysis is then submitted in written form to the instructor who will indicate any objections or possible improvements. Until the method of analysis has been approved, the analysis should not be started, otherwise time may be wasted on a method that will not serve the purpose. As the analysis proceeds, it may be found desirable to make further changes in the original plan, and if any improvement is seen, it should at once be discussed with the instructor. At the end, a detailed description of the method actually used is handed in for permanent record, together with any comments or suggestions, and the results of the analysis reported in the proper manner.

THE KEEPING OF RECORDS

As for estimating the accuracy of his work, it can be said that the determinator is usually an optimist in thought and expression, while the analyst is a confirmed pessimist. The determinator reports silica in glass as 71.61, if not 71.611. The analyst, who knows that he is doing nicely to insure results in the first decimal place, reports 71.6 and thus is honest with himself and deceives no one as to his powers.—LUNDELL.

The prime importance of a notebook is to preserve the record. Naturally, then, the principal concern is that the record be legible and intelligible at some later date when the record is cold and all memory of the event has been long lost. Preferably the notebook should be a bound book with fixed pages and of sufficient value that it will not be lightly discarded. The record should be kept in ink as this is most durable. The relevant data should all be entered, including the date, the source, character, and number or other designation of the sample, all weights and readings taken during the analysis, a brief mention of the method of analysis used, any numerical factors introduced, the results with any explanatory comment, and finally the signature of the analyst. The arrangement is entirely an individual matter, but should be intelligible to another without undue effort in the deciphering of shorthand symbols or sloppy penmanship. Among the emphatic *don'ts* of record keeping

is the very pernicious habit of jotting down significant data on loose scraps of paper. Equally bad is a numerical entry without explanation.

The problem of significant figures, methods of computation, the rejection of data, and related topics were discussed in Willard and Furman, 3rd Ed., pp. 63-71. A more extensive treatment of these subjects will be found in other places.⁸ The method of computation employed is a matter of convenience and speed for the individual. The rejection of data should be justified by some definite reason or observed fault in the process leading to the data. Data otherwise apparently satisfactory but in disagreement with other data on the same measurement should be rejected only on a probability basis when it can be shown that the departure from the mean is far greater than the average deviation, and this can not be done with less than four values. The selection of data is a matter of experience, critical evaluation, and honesty. The mathematical rules governing significant figures are more definite, and precision should not be confused with accuracy. But even in this, in chemical work, much is left to personal judgement and to good taste.

THE USE AND CARE OF PLATINUM WARE

Platinum is attacked by many substances, particularly at a high temperature. Free chlorine and bromine attack it easily, boiling, concentrated sulfuric acid slowly, and the following materials attack it so readily that they should never be heated in platinum vessels:

The hydroxides, nitrates, and cyanides of the alkali metals and barium;

All sulfides or mixtures containing sulfur and a carbonate or hydroxide;

Phosphorus, arsenic, and their alloys;

All metals, since they form alloys with platinum, and all compounds easily reducible by the carbon of the filter paper or by the flame gases, such as lead oxide, silver chloride, lead sulfate, or stannic oxide.

Phosphates are without action on platinum unless reduced to phosphides; because this may occur, owing to the action of the car-

⁸ Yoe and Crumpler, *Chemical Computations and Errors*, John Wiley & Sons, Inc., New York, 1940.

bon of the filter paper or to the flame gases, it is safer to ignite all phosphates, including pyrophosphates, in porcelain.

At high temperatures, platinum allows the gases of the flame to diffuse through it quite readily and this may cause the reduction of some substances not otherwise easily reduced. If the crucible is open, diffusion into the air is so rapid that this effect is much less noticeable, but in a covered crucible heated by a gas flame there is a strong reducing atmosphere in the crucible. Ferric oxide heated in this way is partly reduced to the metal; even in the presence of fused sodium carbonate some reduction seems to occur. The iron then alloys with the platinum, and no matter how thoroughly the latter is cleaned, it will tarnish on ignition, due to the formation of a film of ferric oxide. If this is removed and the crucible again heated, the same thing occurs. This contamination is so common that it is difficult to find a crucible entirely free from iron. It is advisable, therefore, to use a porcelain crucible for the ignition of iron compounds, or if platinum is used, to be sure that the crucible is placed in a slanting position with free access to air. Another illustration of this permeability of platinum is the reduction of sodium sulfate. This salt may be fused in an open crucible without change, but in a covered crucible it is partly reduced to sodium sulfide, as shown by treating it with dilute acid.

A platinum crucible should never be heated so that the inner cone of the flame touches it. This causes the formation of a carbide of platinum and makes the crucible very brittle. Whenever possible, the Meker burner should be used, since there is then no inner cone and the flame is uniform.

When the surface of platinum becomes gray or crystalline, it should be polished with sea sand or powdered pumice. If sand does not readily remove all stains, fusion with potassium or sodium bisulfate or sometimes borax, boiling with hydrochloric acid or with nitric acid (but never with a mixture of the two) will usually be effective. If this is not satisfactory, heating with a mixture of equal parts of concentrated hydrofluoric acid and hydrochloric acid or fusion with potassium acid fluoride will sometimes assist. Iron stains are readily removed by heating the covered crucible with a gram of ammonium chloride at the full heat of a burner.

Crucibles must always be kept polished, and must not be bent or injured in any way. If they become deformed, they should be reshaped on a form of the same style. Never try to rub out a dent

with a glass rod, or by any similar process, since it will only make matters worse. Take it to the instructor.

New platinum crucibles are often covered with a film of iron, which should be removed by boiling in hydrochloric acid for an hour or two before the crucible is heated. Otherwise the iron alloys with the platinum and can not afterwards be completely removed.

THE USE OF PERCHLORIC ACID

The very properties of perchloric acid which make it so extremely useful in the analytical laboratory are those which make its improper use hazardous. Hot, concentrated perchloric acid is a powerful oxidizing agent and a powerful dehydrating agent; cold and dilute, it has neither oxidizing nor dehydrating properties and has only the characteristics of a strong acid.⁴ When hot and concentrated, it is also a powerful solvent for such materials as stainless steel and ferro-alloys. This solvent power is often enhanced by mixing it with phosphoric acid or sulfuric acid.

It follows then, that perchloric acid is dangerous only when hot and concentrated and in the presence of some easily oxidizable material such as organic matter. Perchloric acid can be used to destroy organic matter, but nitric acid must always be added first while the perchloric acid is still dilute. Notable exceptions to this rule are coal and coke; here a contact catalyst such as chromic acid is used to speed the oxidation. The nitric acid oxidizes the easily oxidizable material which would act violently with concentrated perchloric acid, and the remaining more difficultly oxidizable material is then finally destroyed by the concentrated perchloric acid. Such procedures are widely used in the analysis of rubber, leather, coal, and similar materials for their inorganic constituents. A progression of colors, in the oxidation of organic material, changing from a light yellow, to a straw, to light brown, to dark brown, generally precedes a perchlorate explosion. If such a color change

⁴ A thorough discussion of the preparation, properties, and uses of perchloric acid will be found in the following booklets by G. Frederick Smith, published by The G. Frederick Smith Chemical Company of Columbus, Ohio: *Perchloric Acid*, 4th Ed., 1940; *Mixed Perchloric, Sulfuric and Phosphoric Acids and Their Applications in Analysis*, 1935; *Dehydration Studies Using Anhydrous Magnesium Perchlorate*, 1934; *Further Applications in the Use of Perchloric Acid in Analysis*, 1942.

is observed, dilute the solution immediately or leave the vicinity hurriedly.

Concentrated perchloric acid is marketed as 60 or 72 per cent acid and is a perfectly stable chemical which can be kept for any length of time. Anhydrous perchloric acid or acid of greater concentration than 85 per cent explodes ultimately on standing and should never be made in appreciable quantities or stored for any period of time. A monohydrate of perchloric acid, corresponding to 84.79 per cent perchloric acid, is perfectly stable and, having the properties of a salt, is thought to be oxonium perchlorate, OH_3ClO_4 . Commercial concentrated perchloric acid, on boiling at normal pressure, concentrates to a constant boiling mixture of 72.4 per cent perchloric acid and 27.6 per cent water, boiling at 203° . Boiling perchloric acid solutions of this concentration or lower concentrations is a perfectly safe operation.

Care should be exercised in places where quantities of perchloric acid are being boiled that the perchloric acid vapors are not allowed to accumulate as condensate, particularly on wood or dusty hoods or flues. Such hoods are best made of tile or transite and should be flushed out occasionally.

The filtration of a solution containing dilute perchloric acid on filter paper is perfectly permissible, but washing should be exceptionally thorough to remove all perchloric acid if the filter is to be ignited. Otherwise a violent deflagration or even an explosion may occur during the drying. An additional final washing with dilute ammonia, if permissible, eliminates this tendency.

Certain salts of perchloric acid, principally those of magnesium and barium, are excellent drying agents, the former rivalling phosphorus pentoxide in effectiveness. These are very stable compounds and highly satisfactory for practically all drying problems. They should not be used in the presence of a strong acid and organic matter, such as cotton, rubber stoppers, or organic liquids. Several serious explosions have resulted from drying with magnesium perchlorate organic liquids which had previously been in contact with sulfuric acid and had been poorly washed.

The perchlorates of all of the heavy metals are soluble in water, and surprisingly, some metal perchlorates are soluble in organic solvents. Advantage of this is taken in the separation of sodium and potassium. Solutions of perchlorates in organic solvents in the presence of acids are dangerous, however, and should never be heated or

trituated. Ethyl perchlorate and other perchlorate esters are violent explosives. An alcoholic solution of perchloric acid should never be heated unless considerable water is present and on no account should be evaporated.

When properly used, perchloric acid and its salts are without hazard, and hundreds of applications of them are being so continuously developed as to make perchloric acid almost as indispensable as nitric, sulfuric, and hydrochloric acids. In many cases perchloric acid has effected great savings in time and expense; it has simplified and improved the accuracy of many analytical procedures; and in many cases its application can be made to accomplish things which can be done by no other method. However, before using perchloric acid or its salts in a new application, consider the facts of the foregoing discussion.

CHAPTER II

THE GENERAL OPERATIONS OF QUANTITATIVE ANALYSIS

FACTORS WHICH AFFECT THE SPEED AND ACCURACY OF ANALYTICAL METHODS

The policy of the older analysts, of whom Fresenius was the most illustrious example, was to make as many analyses as possible on the same sample. This procedure not only involves a considerable expenditure of time but also a loss of accuracy, since an error in one separation affects the others. The trend of modern analytical chemistry is toward methods which are not only accurate but more rapid as well, and which, therefore, avoid long preliminary separations and make possible the direct determination of the substance sought.

In selecting an analytical method or in devising a new one, several things must be considered in evaluating its accuracy and general suitability.

1. The number of operations should be as few and as brief as possible, thus decreasing the chances of error and loss, and increasing the accuracy and rapidity. This may be accomplished in several ways.

a. Volumetric methods which do not require preliminary separations of substances may be substituted for gravimetric methods which do. For example, the determination of manganese in the presence of iron, aluminum, zinc, and other metals, is best made volumetrically, no separation then being required.

b. The substance desired may be precipitated first, especially if it is one of the smaller constituents. If the reverse process is adopted, it means that smaller samples must be used, and the accuracy is often decreased for other reasons. For example, in the presence of much iron, nickel may be precipitated by dimethylglyoxime, and aluminum by phenylhydrazine without first removing the iron.

c. Separate samples may be used for each determination when possible. This usually involves the condition given under *b*. The greatest chance for improvement in analytical separations lies in finding reagents which will precipitate one or perhaps several metals without precipitating any of the others. The precipitation of nickel by dimethylglyoxime and of phosphoric acid by molybdate are examples of this. Organic compounds offer a promising field for investigation along this line, and the specificity of reagents can be frequently greatly improved by tying up interfering materials in stable complex ions.

2. The process should be free from inherent errors.

a. In gravimetric work, especially, the reaction should be one in which occlusion, mixed-crystal formation, and adsorption are inappreciable, or if this is impossible, conditions should be so chosen that these errors are at a minimum. It should be remembered that the greater the concentration of the impurity in the solution, the greater will be the amount carried down by the precipitate. Dilute solutions are therefore used, and the precipitate may be dissolved and reprecipitated when possible. Adsorption is a surface action and is especially noticeable with amorphous precipitates such as hydrous ferric oxide and silicic acid. No chemical compound is formed. Therefore, not only does the concentration of other salts in solution determine the amount adsorbed, but the amount of the precipitate formed influences the result in the same way. This error often can never be entirely eliminated, owing to the nature of certain precipitates. Thus, iron can not be completely separated from manganese, zinc, cobalt, or nickel with ammonia. If, however, the precipitate of hydrous ferric oxide is very small, the amount of the metals adsorbed will be small, and often may be disregarded.

Mixed-crystal formation is a different phenomenon and occurs largely with highly crystalline precipitates. It involves the formation of definite complex salts or molecular compounds. It is well illustrated by the errors in the precipitation of barium sulfate in the presence of salts of sodium, potassium, ammonium, calcium, and ferric iron, some of the barium being replaced by one of the other metals, forming small amounts of a sort of double salt such as $\text{BaSO}_4 \cdot \text{Fe}_2(\text{SO}_4)_3$, and thus causing low results in the determination of sulfur. Reprecipitation can not be used in this specific case although it is usually applicable. In occlusion some of the mother

liquor is included within the crystal. This occurs with potassium perchlorate.

b. The precipitate should not be appreciably soluble, and the wash solution should be chosen with care. The factors which affect the solubility of precipitates, such as the common ion effect, the diverse ion effect, the effect of a large excess of the precipitating agent, the formation of complex ions, the acidity of the solution, the temperature, the nature of the solvent, and time were discussed thoroughly in Willard and Furman, 3rd Ed., pp. 288-304, and will not be elaborated here.

c. A precipitate of high molecular weight, such as the ammonium molybdiphosphate precipitate used for the separation of phosphorus, is always desirable, since this gives a small conversion factor. Unfortunately, there is seldom much choice in the matter.

d. In volumetric work the process should be preferably not an empirical one but should be accurately expressed by an equation. Although many empirical methods are in use, for lack of better methods, they usually require experience and careful adjustment of conditions to make them successful. The titration of zinc by ferrocyanide is quite empirical and not entirely satisfactory, but is commonly used.

e. The end-point of any titration should be distinct and not much experience should be required to determine it accurately. The end-point should occur exactly at the equivalence point, and the correction for the excess reagent necessary to change the indicator should be negligible or easily determinable.

f. In volumetric work, also, the equivalent weight of the substance being determined should be low, if there is any choice in the matter.

3. The method should be one adapted to the amount of substance present. Certain methods are especially suitable for the determination of small amounts, but are unsuitable for large amounts of substances where the reaction often becomes irregular. Colorimetric methods are especially desirable for very low percentages of materials. Certain volumetric methods in which the equivalent weight of the substance determined is exceptionally low are applicable to the determination of small amounts. This is also true of gravimetric methods in which the compound weighed has a very low content of the substance being determined. For example, only a small amount of manganese can be oxidized to permanganate by

persulfate; and only a small amount can be titrated by the direct fluoride method, since the color of the complex manganic fluoride soon becomes so dark as to obscure the end-point. The precipitation of phosphate by molybdate is unsuitable for the determination of large amounts of phosphorus because of the variable composition of the precipitate and also because of its great bulk, but the method is suitable for small amounts of phosphorus since the precipitate contains only 1.64 per cent of phosphorus.

4. Accuracy may also be increased by using larger samples provided this does not increase the difficulties of manipulation. A practical limit is soon reached, however. In general, large samples should be used for the determination of substances present in small amounts, and small samples for the determination of the major constituents. Thus, large samples are used for the determination of aluminum, phosphorus, and sulfur in iron ore, but small ones for the determination of iron itself. It may be assumed that most methods have a certain absolute accuracy. Suppose that in a certain case the maximum error is 1 mg. If a 1 g. sample is taken, this means 0.10 per cent, and if the total amount of the material being determined is only 0.50 per cent of the sample, this is a relative error of 20 per cent. If the weight of the sample is increased to 5 g., the relative error is only 4 per cent of the material being determined.

5. Accuracy may sometimes be increased by determining a substance by difference. This is often a desirable method when the separation and determination of some constituent of the mixture is difficult or inaccurate. The method is subject to this restriction: if a mixture of two substances A and B is weighed, then A may be accurately determined by subtracting the amount of B when the accuracy with which B may be determined is equal to or, preferably, greater than that in the case of $A + B$. In such a case there is no loss of accuracy in the determination of A . If B represents several substances which are to be separately determined and their sum subtracted, then the accuracy of each determination must be greater than that of $A + B$, if there is to be no decrease in accuracy of A . This greater accuracy may be attained (a) by using a larger sample for B or (b) by using a method which is itself capable of greater accuracy if the size of the sample is the same. For example, if the per cent of pure metal in a commercial sample is required, as for instance, iron, it is more accurate to determine the per cent of each

of the impurities, carbon, sulfur, phosphorus, manganese, and silicon, and to obtain the iron by difference, than to determine it directly, for although the accuracy of a direct determination is about 0.10 to 0.20 per cent, that of the smaller constituents is not far from 0.02 per cent. If in an analysis, iron and aluminum are weighed together as oxides, and the per cent of the iron is low while aluminum is present in larger amount, and if by using a separate large sample it is possible to determine the iron more accurately than the combined oxides, then the aluminum can properly be obtained by difference. If, however, conditions were reversed, aluminum could not be accurately determined in this way, since a large sample could not be used, and the principal error would be that involved in the determination of iron.

6. Finally, accuracy may frequently be increased by running a blank determination in which the entire process is carried through under the same conditions under which the determination is made but without the sample. The result of the blank is then subtracted from that of the determination. Such a blank determination will eliminate the errors caused by the introduction of materials by the attack of glassware, or as an impurity in the reagents, or by contact of solutions with the atmosphere. The attack of glassware by acid solutions other than those of hydrofluoric acid is generally negligible. Attack by alkaline solutions may be appreciable, particularly if the solutions are hot or left for any length of time; indeed such attack may be so serious that the blank may not counteract the effect since there is no assurance that the extent of the attack will be the same.

In recent years chemists have become prone to accept chemicals as labelled by the manufacturers without checking them as to identity or purity. Although in some measure justified, this habit should be decried, at least among analytical chemists. Since this tendency can probably not be halted, the practice of running a blank determination will at least aid in indicating major sources of impurity and of cancelling the effects of small impurities.

In running a blank determination, it should be stressed that the blank be kept parallel to the determination throughout the entire analysis. The same amounts of reagents should be added, the same mechanical operations applied, and the periods of boiling and standing made identical. In general it is better to have a small blank than none at all. In the case of gravimetric methods, the effect of

the solubility of the precipitate may be eliminated by having a small blank, but this is not true if there is no blank. A large blank is undesirable in that it indicates a gross impurity in the reagents or a serious miscarriage of the method, neither of which is likely to be uniform to both the determination and the blank. In many determinations it is not necessary to run a blank, in others it is imperative. Thus, the determination of sulfate by precipitation as barium sulfate can usually be made without running a blank, but the determination of the alkali metals, especially in a silicate where the operations are quite involved, would mean little without one.

THE PROBLEMS OF SAMPLING

Since it is usually impossible and even undesirable to analyze the entire mass of a material the analysis of which is desired, the first task in an analysis is that of obtaining a portion of the material which will suitably represent the whole. The operations of securing this *gross* sample, of reducing it to a size suitable for transportation to the laboratory, the further subdivision in the laboratory to a convenient size for analysis, and the storage of the material before analysis, present more difficulties than might be suspected to exist from a superficial examination of the matter. Moreover, the sampling phase of analytical work is exceptionally important, as the old axiom that a chain is no stronger than its weakest link applies without reservation to the series of operations involved in making an analysis. And as a matter of fact, the sampling process is frequently less accurate than the analytical methods subsequently applied. It is evidently a waste of time, chemicals and effort to determine a constituent with a much greater accuracy than that of the sampling process. Obviously then, time and thought should be expended on the sampling operation, and when the problem at hand is not worth such an effort, neither is the analysis warranted.

It may often be the case that it is impossible or extremely inconvenient to obtain a second sample, as for example in sampling a shipment of ore, which is most advantageously done at the time of loading or unloading, or the sampling of an ore bed at some distant or inaccessible point. The sampling, therefore, should be done correctly the first time.

Since the sample is taken to represent a much larger mass, and from it the percentage of some constituent is to be determined and

this value assumed to be correct for the entire mass, the primary requirement of a sample is that it should be a representative portion of the whole. Its composition should agree with the average composition of the material being sampled, at least within the accuracy wanted for the determination of the constituent desired.

No perfectly general treatment of the theory of sampling appears to be possible. The problems vary widely with the nature and the quantity of the material being sampled, and they often finally resolve into a matter of critical judgment by the sampler or, in the case of widely used or valuable materials, into rigid adherence to empirically established procedures. The methods of sampling commercially important materials are generally very well prescribed by various societies interested in the particular materials involved: water and sewage by the American Public Health Association, metallurgical products, petroleum, and materials of construction by the American Society for Testing Materials, road building materials by the American Association of State Highway Officials, and so on. These procedures are the result of extensive experience and exhaustive tests, and are generally so definite as to leave little to the individual judgment. Where sampling technic is not established by some such organization, a search of the literature will generally disclose an investigation of the particular problem. The indices of *Chemical Abstracts* furnish an enormous bibliography on sampling. Lacking a known method, the analyst can do pretty well by keeping in mind the general principles and the chief sources of trouble as discussed subsequently.

The sampling of solids is complicated by the inhomogeneity of the material, the variation in composition from piece to piece within the body of the material or within a single piece, and by differences in specific gravity between the particles composing the mass. A mixture of potassium sulfate and sodium chloride, thoroughly ground in a ball mill and fine enough to pass a 150-mesh screen, such as is given to elementary students for the determination of sulfate, may be sampled by simply dipping into the container with a spatula. On the other hand, with a shipment of coal consisting of large discrete particles of coal and perhaps of slate and also having fine material running higher in ash, the mere random collection of a few pounds of coal certainly will not yield a sample which will be representative of the whole.

Fine particles may differ considerably in composition from the coarse particles derived by crushing the same material. For example, the ash of coal runs considerably higher in the fine material than in the coarse. Parr¹ has shown that during the process of grinding a coal and sifting through a series of sieves, the ash concentrates in the fines. In one experiment, for example, he found that the portion retained on the 20-mesh screen contained 14.11 per cent ash, on the 60-mesh screen 15.55 per cent ash, while the material which passed through the 60-mesh screen contained 23.89 per cent ash. It is therefore extremely important that the same proportion of fine and coarse material find its way into the sample as occurs in the bulk of the material. The fine material will accumulate in one place in the mass, at the bottom of a carload or directly beneath the chute in a pile. Obviously, a sample taken from the top of the car or from the outside of a pile will not be a true sample.

The greater the particle size and the greater the divergence of the composition of the individual particles from the average, the greater must be the size of the gross sample taken. Brunton,² who did the first important work on the theoretical aspects of the sampling of solids, developed a mathematical formula relating the size of the gross sample with the particle size, the deviation in composition of the particles, the specific gravities of the constituent particles, and other factors. Although the formula was developed for application to gold ores and is not immediately applicable to other materials since it was developed in assay ton units, the general observations which were made are extremely pertinent and the entire paper is recommended to the earnest student of the subject. Another very extensive theoretical treatment of the sampling of solids is given by Baule and Benedetti-Pichler;³ they relate the various factors such as particle size, density, variation in composition, and size of gross sample in a single, rather involved mathematical formula.

Coal is a particularly difficult material to sample, and before the standard method of the Bureau of Mines and the American Society for Testing Materials was adopted, variations in the amount of ash as high as 30 per cent were obtained on the same coal by different

¹ Parr, *Fuel, Gas, Water and Lubricants*, 4th Ed., The McGraw-Hill Book Company, Inc., New York, 1932, p. 199.

² Brunton, *Trans. Amer. Inst. Mining Engrs.*, **25**, 826 (1896).

³ Baule and Benedetti-Pichler, *Z. anal. Chem.*, **74**, 442 (1928).

chemists. Bailey⁴ analyzed the methods of sampling coal in great detail. He found the ratio of the particle size to weight of the sample, the so-called size-weight ratio, at the time of taking the sample and during the subsequent reduction, to be the important factor. The size-weight ratio required to give a certain degree of accuracy to the sampling was found to be conditioned, however, by the amount of ash due to slate; by considering both the size-weight ratio and the slate present it was possible to establish certain limits as to the size of the gross sample which must be taken and the maximum particle size which may be present during the reduction process. Such limits have since been adopted; thus, the gross sample must be at least 1000 pounds if the pieces are greater than 1 in., and must be subdivided to $\frac{3}{4}$ in. before reduction to 500 pounds, to $\frac{1}{2}$ in. before reduction to 250 pounds, and so on, down to the 15 pound sample which is sent to the laboratory. The method of actually carrying out the reduction of the gross sample is shown in Fig. 1 which is taken from the standard method of sampling coal of the American Society for Testing Materials.⁵ Obviously it is of little value to analyze coal unless the sampling is well done and sufficient coal is involved to warrant the time and effort of sampling.

Solid materials, such as metals, are sampled by sawing, milling, or drilling. This operation should be carried out dry whenever possible, that is, without lubrication, but where the latter is necessary the sample must be carefully washed with benzene and ether to remove oil and grease. Surface chips alone will not be representative of the entire mass of a metallic material because of segregation of the various constituents present, but their fair proportion should be included in the sample. Segregation of certain constituents as a molten mass cools is due to differences in the melting points of the constituents, the growth of crystals of pure metal or compounds, or to the immiscibility of the molten metals, and causes appreciable variations in the composition of the material at different positions in the resulting ingot. This is particularly true of low-melting, non-ferrous alloys but is shown to a very marked extent in cast iron and steel also. Segregation studies made at the Bureau of

⁴ Bailey, *J. Ind. Eng. Chem.*, **1**, 161 (1909). For an extensive bibliography on the sampling of coal, see *Bureau of Mines Technical Paper*, 493 (1931).

⁵ American Society for Testing Materials, 1939, *Book of A.S.T.M. Standards*, Philadelphia, 1939, Part III, p. 12.

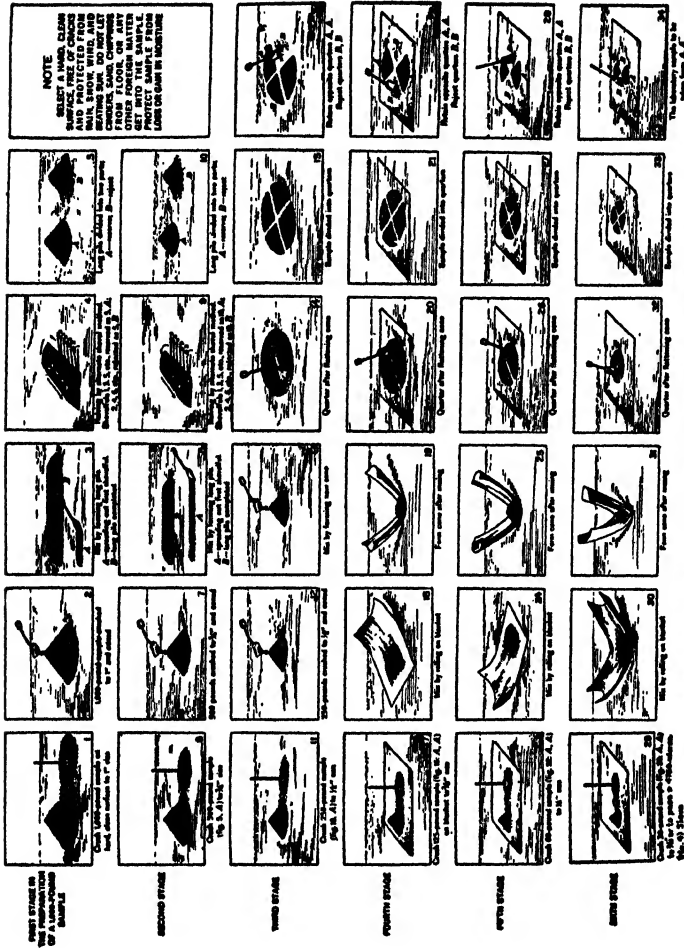

Fig. 1. Sampling Coal. (Courtesy American Society for Testing Materials)

Standards⁶ on a steel ingot 20 in. in diameter and 70 in. long showed a variation in carbon content from 0.58 per cent at the bottom to 0.68 at the top, and at the top going from the outside to the center of 0.65 to 0.68. Variation of composition with particle size was also found, particularly with cast iron where the separation of isolated graphite particles occurs, which introduces a variation in composition with particle size. Care should, therefore, be taken that the correct proportion of coarse and fine material finds its way into the final sample for analysis, and that the sample be secured at various positions and depths over the material.

Large bodies of materials are best sampled when moved. Grab samples taken at random from a stationary mass are not very reliable. Samples taken at the intersections of a net spread over a carload aid in getting a more representative sample, but it is difficult by such a scheme to get a fair sample if a great divergence in particle size has created a vertical grading of coarse and fine material. During the loading or unloading process, however, it is possible to sample the mass at intervals and secure a more representative portion. This operation may be done by hand, the workman, for example, throwing every twentieth shovelful into a sample pile; such fractional shoveling schemes, however, tend to be erratic. A variety of mechanical devices have been constructed to make the sampling process automatic; a divided chute or riffle, or a series of riffles with intervening crushing, sends a definite portion of the material into a sample pile, or oscillating buckets cut through the stream of material falling from a chute thus taking a sample from the whole stream at definite intervals. Apparatus for operations of this type is quite highly developed, and, although independent of any personal factor, is expensive; the sampling of ore material, however, is often so important that during the shipment from seller to buyer the material is frequently sent to a separate company for sampling and crushing.

Liquids of one phase only are more likely to be homogeneous particularly after the agitation received in shipment or transfer from one container to another. Large volumes of liquid are best sampled at various places, however, to aid in eliminating any inhomogeneity, and this may be done by a *thief* sampler, which is a vessel or a device holding a number of bottles which can be unstop-

⁶ Lundell and Hoffman, *Outlines of Methods of Chemical Analysis*, John Wiley & Sons, Inc., New York, 1938, p. 22.

pered at various places through the liquid, see Figs. 2 and 3. A *pipe* sample obtained by carefully lowering into the liquid an empty pipe which can be closed in some manner when it reaches the bottom has the merit of securing the correct proportion of two immiscible liquids present. Liquids flowing in pipes are best sampled immediately following a pump, where the liquids will be better mixed and immiscible liquids have not yet had time to separate.



FIG. 2. Thief Sampler. (Courtesy Fisher Scientific Co.)



FIG. 3. Thief Sampler. (Courtesy Fisher Scientific Co.)

Samples of gases are collected in bottles, conveniently provided with stopcocks and either evacuated or filled with water, or a syringe bulb attachment may be used to displace the air in the bottle by the sample. The sampling of flowing gases, as, for example, flue gas in a chimney where a temperature variation exists from the outside to the center, must be made by a device which will give the correct proportion of the gases in each annular increment; such sampling tubes have been devised. The problems of sampling gases are dealt with in detail in the texts devoted to the subject of gas analysis.

The sample brought to the laboratory must usually be reduced further in size before analysis. In this sampling of the sample, the same problems are present as in taking the gross sample. In addition there arise others due to changes in the composition of the

sample. The moisture content may change; this is particularly serious with coal and a moisture determination is usually made on the entire laboratory sample as received and before any reduction in particle size is made; this *air-dried* material is then subdivided and analyzed, and the analyses calculated back to the *as received* basis. Hygroscopic materials in general will have to be handled in a similar fashion, receiving suitable protection until weighed. Finely divided material, otherwise non-hygroscopic, picks up moisture from contact with air, and such finely ground samples must be stored in air-tight containers or in desiccators. Other chemical changes may go on during the grinding process, chemically combined water may be given off or taken up, carbon dioxide may be absorbed, contact with the oxygen of the atmosphere may cause oxidation of sulfides, and so on.

On storage the material may undergo further changes, ferrous compounds may be oxidized, alkalis may acquire carbon dioxide from the atmosphere, and other similar changes may occur. The sample may even react with the container, as a fluoride or strongly basic material with glass or the tin lining of a metal container.

For his own protection the chemist should supervise the sampling process or at least note the size and condition of the sample when received and report the same with the results of the analysis. This will relieve him of much controversy.

THE PREPARATION AND WEIGHING OF SAMPLES

The sample received at the laboratory will probably have to be further reduced in size. The common laboratory apparatus for mechanically crushing solid materials are the jaw crusher, the disc pulverizer, and the ball mill. Large pieces are first crushed in the *jaw crusher*, see Fig. 4, which consists of two steel plates, one stationary, and another which moves toward the first at the top, being actuated by an eccentric which rotates with a heavy flywheel. The material drops out at the bottom through an adjustable space between the jaws. The jaw crusher reduces the particles to about pea size.

The material may be still further reduced in size by passage through a disc pulverizer which will give a size suitable for further grinding in a ball mill. The *disc pulverizer*, see Fig. 5, consists of

24 OPERATIONS OF QUANTITATIVE ANALYSIS

two vertical, circular, cast iron plates, one of which rotates. The rotating plate is convex and the stationary plate concave. The plates are separated by a space which decreases from the top to the

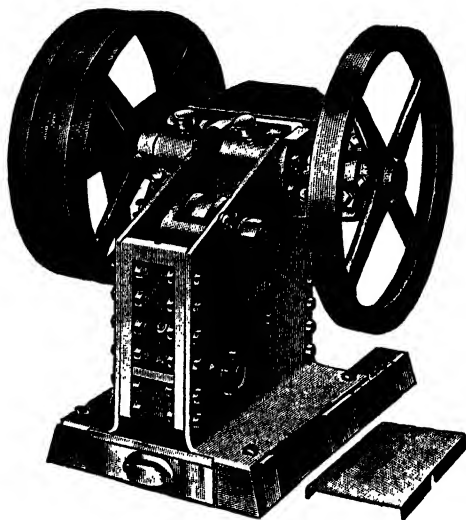

FIG. 4. Jaw Crusher. (Courtesy Fisher Scientific Co.)

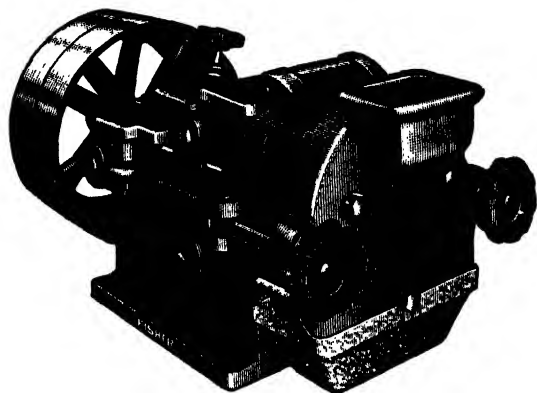

FIG. 5. Disc Pulverizer. (Courtesy Fisher Scientific Co.)

bottom owing to the shape of the stationary plate. The material is fed in at the top, is crushed between the plates, and drops out the narrow opening at the bottom. Very hard materials take up some iron on passing through the disc pulverizer.

The *ball mill*, see Fig. 6, is simply a porcelain crock which is filled about one third with material and one third with flint pebbles or porcelain balls; the crock is then rotated mechanically, the continuous striking of the pebbles and material reducing the particles to any degree of fineness desired. The ball mill introduces no iron

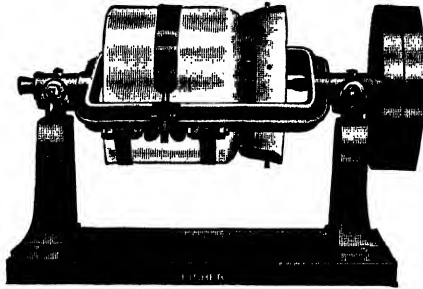

FIG. 6. Ball Mill. (Courtesy Fisher Scientific Co.)

into the sample and very little silica, and mixes the material thoroughly.

Small samples are best ground in a mortar of agate or mullite, see Fig. 7, and this method is used when an extremely fine powder

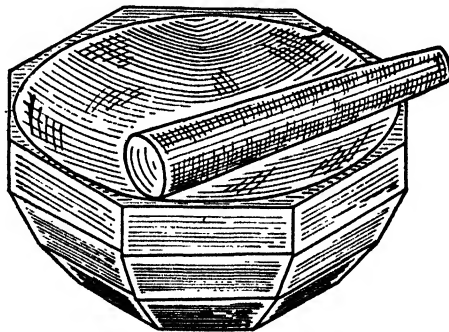

FIG. 7. Agate Mortar.

is required. Mechanically operated agate mortars are on the market which reduce the labor of grinding.

Exceptionally hard materials are crushed in a specially constructed steel mortar, known as a *diamond mortar*, see Fig. 8. The pestle of this mortar operates through a closely fitting steel collar,

and is struck sharply with a hammer. The pestle should be rotated between blows.

While very refractory samples may have to be ground to 200-mesh to be subject to decomposition by fusion or by acids, in general, material passing 100-mesh will be finely enough divided. Usually only a small portion of the sample is tested for fineness, it being assumed that if a small portion of the sample passes completely through the screen that the entire mass will do so. Because of

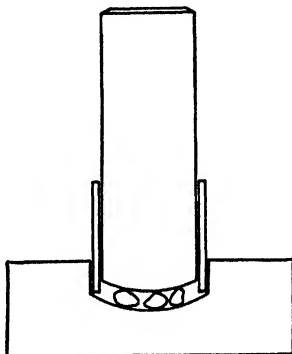

FIG. 8. Diamond Mortar.

the variation of composition with particle size it is usually undesirable to sift the entire sample because the composition of the sample may be altered if not all of the material passes through the sieve. Sieves are made most commonly of wire cloth and are available in sets in a variety of mesh per linear inch.¹ Care should be exercised in the use of screens to prevent their damage. The screens should be tapped or shaken lightly so that all of the material comes in contact with the screen. Material should not be forced through the screen by scraping or pressing, and the screen should be cleaned by light brushing to free particles which may be caught in the meshes. Sieves should be cleaned immediately after use to avoid corrosion. For great amounts of screening, such as in the mechanical analysis

¹ For the specification and calibration of standard sieves see American Society for Testing Materials, 1939, *Book of A.S.T.M. Standards*, Philadelphia, 1939, Part III, p. 534. The usual mesh sizes are 3½, 4, 5, 6, 7, 8, 10, 12, 14, 16, 18, 20, 25, 35, 40, 45, 50, 60, 70, 80, 100, 120, 140, 170, 200, 230, 270, 325, and 400.

for particle size, mechanical devices are available which rotate and tap a set of sieves and save a great deal of labor.

For dividing the material after reducing the particle size, the cone and quartering process illustrated in Fig. 1, p. 20, may be used. The operation should be carried out on an oilcloth or rubber sheet, and it should be noted that it is the opposite quarters which are combined and taken or discarded. The reduction in the amount of material may also be made with a riffle, a laboratory model of

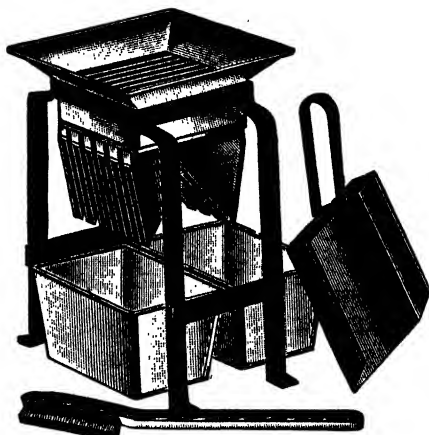

FIG. 9. Riffle. (Courtesy Fisher Scientific Co.)

which is shown in Fig. 9. The riffle consists of an even number of narrow, sloping chutes of equal width, alternate chutes discharging in opposite directions. A so-called split shovel is available for the same purpose.

Finely divided materials absorb moisture when exposed to air; they must therefore be dried before being subjected to analysis. This is best done by placing the material in an unstoppered weighing bottle covered with a cap of filter paper and placing in a covered beaker in the drying oven at 100-110° for at least two hours. When removed from the oven the bottle should be stoppered and kept in a desiccator.

Since fine powders absorb moisture when exposed to air, samples should be weighed out by difference, directly from the weighing bottle into the beaker. The weighing bottle must not be opened too frequently or the sample will absorb moisture and must be dried

again. With constituents present to the extent of only a few per cent, this is not of so much importance, but in the case of substances present in large amount, as iron in iron ore, careful drying and weighing are essential.

Metallic drillings and turnings need not be dried and are weighed out on an open watch glass or piece of celluloid and brushed into the beaker.

The accuracy with which a sample must be weighed will depend on the percentage present of the constituent being determined. If this is one of the major constituents and accurate results are desired, the weighing must be accurately carried out. On the other hand, for a constituent of low percentage, the sample need not be weighed out so carefully. Thus in the determination of carbon present to 1 per cent in steel, if an accuracy of 0.01 per cent is desired, this may be secured, as far as weighing the sample is concerned, by weighing to one part in a hundred or to 10 mg. on a 1 g. sample; obviously then, the extra time which is required to weigh a sample to 0.1 mg. should be saved.

The various topics connected with the process of weighing, with making precise weighings to eliminate the difference in lengths of the balance arms, the correction to weight in vacuum, and the calibration of weights are treated in Willard and Furman, 3rd Ed., pp. 35-60. The correction to weight in vacuum need be applied in the usual type of analytical work only when the accuracy exceeds 5-10 parts in 10,000; and even then it is simpler to use the so-called *rational atomic weights* which are based on apparent or air weight, rather than the regular international atomic weights which are based on weight in vacuum.²

METHODS OF DISSOLVING THE SAMPLE

Preliminary Considerations. Many pure chemicals may be dissolved directly in water, but relatively few natural materials or metallurgical products are water soluble, generally requiring treatment with acids or mixtures of acids, or even a fusion with some

² A thorough discussion of this problem is given in Kolthoff and Sandell, *Textbook of Quantitative Inorganic Analysis*, The Macmillan Company, New York, 1936, pp. 205-209. The rational atomic weights mentioned were calculated for the use of brass weights; the table might not be entirely suitable with the stainless steel weights now being marketed.

basic or acidic flux. The procedure adopted for the solution of a material will depend on the speed and convenience of the reagent employed, the desirability of avoiding the introduction of substances which interfere with the subsequent determinations or are tedious to remove, and due consideration of the possible loss during the solution process of constituents to be determined. In general, where an appreciable amount of a material is soluble in acids, it is best to dissolve this portion in acids, and to fuse the remainder, which will then require less of the flux and introduce less material into the solution.

In effecting the solution of substances and during an analysis, continual care must be exercised that some constituent to be determined later is not lost by volatilization. Volatile weak acids are lost on dissolving materials in stronger acids, and where these weak acids are to be determined, a closed apparatus must be used, as in the analysis of a carbonate or sulfide, where the carbon dioxide or hydrogen sulfide evolved may be collected and determined. Volatile acids, such as boric acid, hydrofluoric acid, and the other halide acids, and nitric acid may be lost during the evaporation of aqueous solutions, and phosphoric acid may be lost when a sulfuric acid solution is heated to a high temperature.

Phosphorus may be lost as phosphine when a phosphide or metallic material containing phosphorus is dissolved in a non-oxidizing acid; and although silicon is not lost during the solution of iron or steel in hydrochloric or sulfuric acids, a very definite loss may occur by volatilization as silicon hydride when aluminum and its alloys are dissolved in non-oxidizing acids.

Germanium tetrachloride, mercuric chloride, antimony trichloride, arsenic trichloride, and stannic chloride are volatilized from hot hydrochloric acid solutions; and from hot sulfuric acid or nitric acid solutions osmium, ruthenium, and rhenium may be lost by volatilization as the oxides.

A very careful study¹ of the losses of the various metals from solutions containing various mixtures of sulfuric acid, perchloric acid, or phosphoric acid and hydrochloric acid or hydrobromic acid has indicated that small amounts of certain metals, normally considered not to form volatile compounds, may be lost by volatilization; for example, bismuth, manganese, molybdenum, tellurium, and thallium.

¹ Hoffman and Lundell, *J. Research Nat. Bur. Standards*, **22**, 465 (1939).

Relatively few things are lost by volatilization from alkaline fusions; mercury may be reduced to the metal and lost, arsenic may be lost if organic matter is present, and of course any gases associated with the material are expelled. From acid fusions such as a pyrosulfate fusion, fluoride may be lost, carrying away with it some silica or boron, and in general those constituents will be volatilized that are volatilized from hot, sulfuric acid solutions.

Solvents for Metals. The electromotive series furnishes a guide to the solution of metals in non-oxidizing acids such as hydrochloric acid, dilute sulfuric acid, or dilute perchloric acid, since this process is simply a displacement of hydrogen by the metal. Thus all the metals above hydrogen in the series displace hydrogen, and thus dissolve in non-oxidizing acids with the evolution of hydrogen. Some exceptions to this may be found. The action of hydrochloric acid on lead, cobalt, nickel, cadmium, and of nitric acid on chromium is slow, and lead is insoluble in sulfuric acid owing to the formation of a surface film of lead sulfate.

	E_0
Li	-3.02 volts
K	-2.92
Ba	-2.90
Sr	-2.89
Ca	-2.87
Na	-2.71
Mg	-2.34
Al	-1.67
Mn	-1.05
Zn	-0.76
Cr	-0.71
Fe	-0.44
Cd	-0.40
Co	-0.28
Ni	-0.25
Sn	-0.14
Pb	-0.13
H	0.00
Sb	+0.15
As	+0.24
Bi	+0.32
Cu	+0.34
Ag	+0.80
Hg	+0.80
Pt	+1.2
Au	+1.42

Oxidizing acids must be used to dissolve the metals below hydrogen. The commonest of the oxidizing acids are nitric acid, hot concentrated sulfuric acid, hot concentrated perchloric acid, or some mixture which yields free chlorine or bromine, such as nitric acid and hydrochloric acid, nitric acid and a chlorate, hydrochloric acid and a chlorate, hydrochloric acid and bromine. The last two combinations avoid the introduction of nitrate, the absence of which is sometimes desirable, its removal by evaporation being very time consuming.

Nitric acid will dissolve all the metals except aluminum and chromium, which become passive on treatment with nitric acid except when present in alloys. Tin, antimony, and tungsten form insoluble acids. In general, nitric acid will oxidize the metal to its higher valence state, at least in part.

Boiling, concentrated sulfuric acid will attack all of the common metals including mercury, bismuth, arsenic, antimony, and tin, which, being below hydrogen in the electromotive series, are not attacked by dilute sulfuric acid.

Hot, concentrated perchloric acid is a powerful oxidizing agent and readily attacks all the common metals.

A summary of the most suitable solvents for the common metals follows:

Alkali, Alkaline Earth Metals and Magnesium. Dissolved by water or dilute acid.

Copper. Readily dissolved by nitric acid; not attacked by hydrochloric acid or sulfuric acid.

Silver. Nitric acid is the best solvent; not attacked by hydrochloric acid or sulfuric acid.

Gold. Dissolved by nitric acid plus hydrochloric acid or an equivalent mixture.

Zinc. Dissolved by nitric acid, hydrochloric acid, or sulfuric acid. Readily dissolved by sodium hydroxide.

Cadmium. Readily dissolved by nitric acid, slowly by hydrochloric acid or sulfuric acid.

Mercury. Nitric acid is the best solvent; hydrochloric acid and cold sulfuric acid have no action on it; hot, concentrated sulfuric acid readily converts it to mercuric sulfate.

Aluminum. Readily dissolved in hydrochloric acid; very slowly attacked by dilute sulfuric acid or nitric acid or by concentrated nitric acid, except in alloys. Easily dissolved by sodium hydroxide.

Tin. Dissolved by hydrochloric acid, hot, concentrated sulfuric acid, hydrochloric acid plus nitric acid, and converted readily to insoluble meta-stannic acid by nitric acid.

Lead. Nitric acid is the best solvent; hydrochloric acid or sulfuric acid act only very slowly even when hot and concentrated.

Arsenic. Readily dissolved by nitric acid and by nitric acid plus hydrochloric acid. Not attacked by hydrochloric acid or dilute sulfuric acid. Hot, concentrated sulfuric acid is a good solvent.

Antimony. Converted to insoluble, hydrated oxide by nitric acid. Dissolved by nitric acid plus tartaric acid, by hydrochloric acid plus nitric acid or by hot, concentrated sulfuric acid.

Bismuth. Nitric acid or nitric acid plus hydrochloric acid are the best solvents; hot, concentrated sulfuric acid is a good solvent, but hydrochloric acid or dilute sulfuric acid is without action.

Chromium. Readily dissolved by dilute sulfuric acid or hydrochloric acid but only slowly by nitric acid. Hydrochloric acid or perchloric acid is the best solvent for chromium alloys.

Molybdenum. Not attacked by hydrochloric acid or sulfuric acid. Converted to soluble molybdic acid by nitric acid.

Tungsten. Not attacked by hydrochloric acid or sulfuric acid. Converted to insoluble tungstic acid by nitric acid. Dissolved by a mixture of phosphoric acid and perchloric acid or nitric acid probably giving tungstiphosphoric acid.

Iron. Readily dissolved by nitric acid, hydrochloric acid, or sulfuric acid.

Cobalt. Dissolved by nitric acid, hydrochloric acid, or sulfuric acid.

Nickel. Dissolved by nitric acid, hydrochloric acid, or sulfuric acid.

Platinum. Dissolved by nitric acid plus hydrochloric acid or an equivalent mixture.

Solvents for Oxides. Hydrochloric acid is the best solvent for most oxides, nitric acid or nitric acid plus hydrochloric acid being practically without action. In the case of silver and lead oxides, nitric acid is, of course, better because of the insolubility of the chlorides.

Strongly ignited oxides and some oxide minerals require a fusion for their decomposition. Fusion with potassium pyrosulfate, $K_2S_2O_7$, is very effective. Fusion with sodium carbonate or sodium peroxide will dissolve many oxides or render them soluble in hydrochloric acid.

Higher oxides, for example, lead dioxide, PbO_2 , dissolve in hydrochloric acid by virtue of the mild reducing properties of that acid, chlorine being liberated. The addition of a reducing agent, such as oxalic acid or ferrous sulfate, assists the solution of such oxides in sulfuric acid.

Some very refractory oxides may be readily converted into chlorides by heating in a current of sulfur chloride, carbon tetrachloride,² phosgene, or chloroform. Sulfur chloride, S_2Cl_2 , seems to be especially powerful and acts upon all oxides except silica and boric oxide, B_2O_3 , at varying temperatures, a bright red heat being required in some cases.³

Decomposition of Silicates. Silicates containing a relatively high percentage of alkali or alkaline earth metals, the so-called basic silicates, may sometimes be dissolved by treatment with mineral acids other than hydrofluoric acid, forming hydrated silica

² Jannasch and Harwood, *J. prakt. Chem.*, [2], **80**, 127, 134 (1909).

³ Hall, *J. Amer. Chem. Soc.*, **26**, 1244 (1904); Hicks, *ibid.*, **33**, 1492 (1911); Lukens, *ibid.*, **35**, 1464 (1913).

and the salts of the metals. Those silicates not dissolved by acids must be supplied with a basic material, generally sodium carbonate, and fused. This process renders them soluble in acids. As much of the silicate as possible is dissolved in acid and the remainder filtered off and subjected to the fusion process; this decreases the amount of flux necessary for the fusion and thus the amount of foreign material introduced into the solution. Fusions with sodium carbonate are carried out in platinum, but those with alkali hydroxide or peroxide in nickel; the former avoids the introduction of any metal other than sodium. Silver and gold are very resistant to fusions with alkali and crucibles and dishes of these metals are frequently used for fusions with sodium hydroxide. Gold is particularly resistant to alkalies. Contact with air having been maintained during a sodium carbonate fusion, the elements will generally be found in their highest valence states; manganese is oxidized, at least in part, to green manganate, and chromium is oxidized to chromate.

When a determination of silica is not desired, hydrofluoric acid may be used to decompose the silicate. The hydrofluoric acid is eliminated by evaporation with sulfuric acid leaving a residue of metal sulfates. The last traces of fluorides are eliminated with difficulty and the evaporation to sulfuric acid fumes had best be repeated. Spattering is likely to occur. Platinum ware must be used in these operations, of course.

The J. Lawrence Smith method of decomposing silicates (see p. 266) is used only for the determination of the alkali metals and never for any others.

The particular problems of decomposing silicates when a determination of silica is to be made are discussed more extensively on p. 181.

Decomposition of Sulfides. Sulfides are best dissolved in nitric acid or in nitric acid and hydrochloric acid. Occasionally hydrochloric acid alone may be used. When sulfur is being determined, an oxidizing solution must be used which will convert the sulfur to sulfate. Because certain metals interfere in the subsequent precipitation of barium sulfate, fusion with sodium peroxide or the evolution method is more commonly used for the determination of sulfur. This subject is discussed in Willard and Furman, 3rd Ed., p. 363. Neither the fusion method nor the evolution method when preceded by ignition with iron powder is suitable for the determination of the metals, because of the other metals introduced.

Decomposition of Phosphates. Most phosphates are dissolved by mineral acids or various mixtures of mineral acids. Thus, phosphate rock, $\text{Ca}_5\text{F}(\text{PO}_4)_3$, can be dissolved in a mixture of hydrochloric acid and nitric acid or in hydrochloric acid, nitric acid, and perchloric acid. In the case of those phosphates which are not soluble even in fairly concentrated acids, such as the phosphates of zirconium, hafnium, and thorium, repeated fusions with sodium carbonate with intervening extraction of sodium phosphate are necessary. The final residue of oxides is then dissolved in acids.

Phosphoric acid solutions should not be heated with sulfuric acid at high temperatures or subjected to prolonged pyrosulfate fusions, for phosphoric acid may be lost by volatilization.

Decomposition of Carbonates. All carbonates are attacked by dilute acids, at least by hot acids, but only in exceptional instances where the carbonate is of high purity as in the case of Iceland spar or calcite will solution be complete. The common carbonates normally contain silicate impurities varying in amounts up to the point where the material could be classed as a silicate. Generally, since a basic oxide is produced on heating a carbonate, a direct, preliminary ignition will render the small amount of silicate present soluble in acid, but in the case of highly siliceous materials, such as a calcareous shale, calcareous sandstone, or argillaceous limestone, the addition of sodium carbonate before the ignition is necessary.

Decomposition of Sulfates. The insoluble sulfates can be decomposed by fusion with sodium carbonate. The melt is leached with water and the sulfate separated as soluble sodium sulfate from the insoluble metal carbonate. Depending on the amount of sulfate, it is generally necessary to repeat the fusion one or more times. Ignition of barium sulfate at 1000° in a stream of hydrogen bearing hydrogen chloride completely decomposes the sulfate giving hydrogen sulfide and barium chloride.⁴

Decomposition of Ferro Alloys. A number of the elements which enter into steel making are marketed as alloys with iron, such as ferrosilicon, ferromanganese, ferrovanadium, and so on. Most of these alloys can be dissolved in various mixtures of mineral acids, but ferrochromium and ferrotungsten require treatment with nitric acid plus hydrofluoric acid or a sodium peroxide fusion. A mixture

⁴ Johnson, *Chemical Analysis of Special Steels*, 4th Ed., John Wiley & Sons, Inc., New York, 1930, p. 122.

of phosphoric acid, sulfuric acid, and perchloric acid has been found to be particularly effective in attacking the latter alloys, and is now the most rapid method of effecting their solution.

Decomposition of Chromite and Other Very Refractory Minerals. The mineral chromite can be decomposed by a peroxide fusion; it can also be decomposed by a mixture of hot, concentrated phosphoric acid, sulfuric acid, and perchloric acid,⁵ but the material must first be ground to 300-mesh. The mineral cassiterite, SnO_2 , is also difficult to get into solution; fusion with sodium peroxide or with a mixture of sodium and potassium carbonates followed by hydrochloric acid will usually effect the decomposition, although ignition in hydrogen followed by solution in hydrochloric acid may be better in that it avoids the introduction of other metals.

CONCENTRATION METHODS FOR THE SEPARATION OF VERY SMALL AMOUNTS OF ONE SUBSTANCE FROM VERY LARGE AMOUNTS OF ANOTHER

In determining the minor constituents of a substance, that is, those constituents present to only a few hundredths of one per cent, such as the impurities of so-called "chemically pure" substances, the usual analytical methods fail because they are not adapted to the extreme ratios in the amounts of the materials involved. In order to reduce the absolute error of such a determination to a small relative error, it is necessary to use very large samples, even as much as 10-100 g., to obtain a sufficient quantity of the minor constituents to handle properly. The use of such large samples renders it necessary first to apply a *concentration method* to separate the minor constituent from all or most of the major constituent. Following the application of the concentration method, the usual analytical methods may be applied. Many of the methods which may be classed as concentration methods are essentially the same as the common analytical methods used for effecting separations, and many of the concentration methods discussed in this section are treated in greater detail in the later sections devoted specifically to these separations.

Many physico-chemical methods, notably the spectrographic, interferometric, nephelometric, and polarographic methods are ideally adapted to the determination of small amounts of materials,

⁵Smith and Getz, *Ind. Eng. Chem., Anal. Ed.*, **9**, 518 (1937).

but a discussion of such methods lies beyond the province of this book. In certain cases concentration methods are not required if a delicate colorimetric, catalytic, or other suitable chemical method is available for determining the small constituents.

The chief concentration methods fall into the following general types.

Direct Precipitation of the Desired Minor Constituent. It is sometimes possible to precipitate the desired minor constituents immediately, usually precipitating at the same time a small amount of the main constituent. Thus, the separation of a small amount of magnesium from a large amount of calcium salts can be accomplished by precipitating the magnesium as magnesium hydroxide by the addition of calcium hydroxide or sodium hydroxide. A small amount of potassium in the presence of a large amount of sodium salts is most expediently precipitated as potassium sodium cobaltinitrite, $K_2NaCo(NO_2)_6$. Occasionally it is possible to carry out a second precipitation and to free the minor constituent from all of the major constituent. Hydrous aluminum oxide when first precipitated by phenylhydrazine invariably carries down some iron if the precipitation was made in the presence of much iron; a reprecipitation eliminates the remaining iron.

Fractional Precipitation of the Desired Minor Constituent. This method is similar to the preceding method except that in this method the major constituent would also be completely precipitated if sufficient reagent were added. For example, a little ammonium sulfide added to an ammoniacal solution of a zinc salt containing a trace of lead, copper, or cadmium will precipitate all of the latter sulfides together with a little zinc sulfide. This separation is based on the fact that solubility of the minor constituents is less than that of the major constituent, but if the acidity were low and sufficient hydrogen sulfide were introduced, obviously the zinc would also be completely precipitated. The fractional precipitation of iodide in the presence of chloride is similarly possible, and the determination of the end-point in the Mohr method for the volumetric determination of chloride using the chromate indicator is based on a similar phenomenon. It is a good general principle that fractional precipitations may be made more complete if only the ion that precipitates the minor component is present. Sometimes this is accomplished by converting all of the material into a hydrated oxide and then dissolving in the proper acid.

Extraction with an Immiscible Solvent. Extraction of the major or minor constituents of a material by shaking the aqueous solution of the material with an immiscible solvent may sometimes be used to effect the separation of large amounts of material from small amounts. The ether extraction of iron, discussed more extensively on p. 51, is a classic example of such a separation. It is used principally in the analysis of iron ore and steel for the determination of aluminum, chromium, nickel, manganese, and other metals present in only small amounts, the major part of the iron simply being extracted and discarded. It is not often that an effort is made to extract the major constituent completely.

Metallic ions may sometimes be treated with an organic compound and converted to a complex compound which is soluble in an immiscible organic solvent. An extremely useful example of this is the extraction of various heavy metals as their dithizonates with carbon tetrachloride or chloroform, a topic discussed extensively on p. 87. Small amounts of nickel may be extracted from slightly ammoniacal solutions as its inner complex compound with dimethylglyoxime by chloroform and thus separated from large amounts of aluminum and other metals.

Sometimes a dry residue obtained by evaporation is extracted with an organic solvent. For example, from magnesium sulfate containing traces of calcium sulfate the magnesium sulfate is dissolved by a mixture of methyl alcohol and ether, leaving the calcium sulfate contaminated with a little magnesium sulfate.

Distillation or Sublimation. The subject of separation by distillation is treated extensively on p. 49. There are a few applications of distillation or sublimation which might be classed as concentration methods. By distillation of the trichloride from a hydrochloric acid solution, even traces of arsenic may be separated from large amounts of foreign metals, and this may be truly termed a concentration method.

Aluminum chloride may be sublimed at a temperature of 250-300° and thus separated from the chlorides of magnesium, copper, manganese, and sodium. Tungsten containing thorium dioxide may be volatilized as tungsten oxydichloride in a stream of air saturated with hydrogen chloride, leaving behind thorium dioxide.

Crystallization or Deposition of the Major Constituent. It is frequently possible to remove the major constituent immediately by depositing it in a dense compact form which will not carry with

it any of the minor constituent. If this process is one of crystallization, it is essential that the major and minor constituents be not isomorphous in the form in which the major constituent is deposited. Thus, tin may be crystallized from a strong hydrochloric acid solution as ammonium chlorostannate, $(\text{NH}_4)_2\text{SnCl}_6$, leaving lead chloride, antimony chloride, other salts, and some stannic chloride in solution. Again, from a dilute hydrochloric acid solution, lead may be removed as lead chloride leaving in solution stannic chloride, antimony trichloride, and cupric chloride together with some lead chloride. A continuous device taking advantage of the temperature coefficient of solubility of lead chloride has been described for carrying this out more effectively.¹

The deposition of the major constituent may also be accomplished electrolytically. The most common uses of electrodeposition as a concentration method are the procedures employing the mercury cathode, which are discussed more extensively in a separate section, p. 58. The mercury cathode is used extensively for the removal of major amounts of iron from small amounts of aluminum, magnesium, titanium, and the metals above manganese in the electromotive series. It is also widely used in the analysis of brass and bearing metals for the removal of the major amounts of copper, lead, and similar heavy metals for the determination of aluminum and beryllium.

Precipitation with a Gathering Agent. It is obviously impossible to collect on a filter a very small amount of a precipitate, of the order of micrograms, distributed through a considerable volume of an otherwise clear liquid. In such cases it is frequently possible to carry down the precipitate mechanically by a relatively large amount of another precipitate, which when practicable is generated simultaneously with the small precipitate. The secondary precipitate is designated as a *gathering agent*. The gathering agent must be sufficiently insoluble so that only a small amount of a possibly foreign material need be introduced. It must be amorphous and flocculent rather than granular or crystalline. It must, of course, also be readily filtered and subsequently dissolved without undue difficulty.

Very small amounts of iron may be collected by such a process using hydrous manganese dioxide as the gathering agent² for hy-

¹ Clarke, Wooten and Struthers, *Ind. Eng. Chem., Anal. Ed.*, **9**, 349 (1937)

² Stokes and Cain, *J. Amer. Chem. Soc.*, **29**, 425 (1907).

drous ferric oxide. Probably the most convenient way of carrying this out is by the addition of a small amount of permanganate to the alkaline solution, followed by a reducing agent such as a formate, sulfur dioxide, or alcohol. The flocculent precipitate of hydrous manganese dioxide carries with it all of the hydrous ferric oxide; it may be filtered without trouble, subsequently dissolved, and the iron determined colorimetrically. Cadmium sulfide may be used in a similar manner as a gathering agent for ferrous sulfide,² this being preferable in the presence of tartrate or other materials which might prevent the precipitation of hydrous ferric oxide, or where it might be desirable to separate the iron from aluminum or chromium. Copper when present to only a few micrograms may be collected by the addition of about five milligrams of lead and precipitation of the two metals as sulfides.³ The isolation of small amounts of lead in urine can be conveniently accomplished by coprecipitation with calcium phosphate and in this manner the very small quantity of lead in a large volume quickly concentrated in a form in which it can be subsequently readily determined with dithizone.⁴ Traces of both iron and indium may be separated from gallium by the use of hydrous manganese dioxide.⁵ Traces of lead and arsenic may be separated by the use of hydrous ferric oxide as the gathering agent.

A very ingenious application of this principle is the recovery of traces of gold and silver from solutions by the precipitation of metallic mercury.⁶ A solution of a mercury salt is added to the solution and the mercury reduced by treatment with metallic magnesium; gold and silver and other heavy metals amalgamate and settle out with the mercury which is then separated and distilled away leaving the noble metals.

METHODS OF EFFECTING SEPARATIONS

Preliminary Considerations. After the decomposition and solution of the sample and the application of a suitable concentration method if necessary, there follows the problem of separating the constituent to be determined from the other substances present.

² Greenleaf, *J. Assoc. Official Agr. Chem.*, **24**, 340 (1941).

³ Fairhall and Keenan, *J. Amer. Chem. Soc.*, **63**, 3076 (1941).

⁵ Willard and Fogg, *J. Amer. Chem. Soc.*, **59**, 40 (1937).

⁶ Caldwell, *J. Chem. Education*, **15**, 507 (1938).

The form in which the constituent is separated may be the same as that in which it is finally determined; more often, however, preliminary separations must precede the actual determination, and the form in which the constituent is separated is unsuited for its determination.

Natural minerals are rarely pure, and the very chemical characteristics which cause similar elements to associate in nature are those which complicate the analyst's problem of separating them. Man-made materials are more frequently pure, but just as frequently then, the major interest centers about the impurities. Even many man-made materials can be complex chemically, for example, an alloy steel containing a half dozen alloying metals, in addition to the elements which are invariably present, such as carbon, sulfur, manganese, phosphorus, silicon, and perhaps aluminum, titanium, and copper.

The process of separating one material from another is often subject to peculiar disturbances, and the analyst must be continually on the alert to detect interferences by unusual elements or changes in behavior of otherwise familiar substances under new conditions. A substance may behave one way when alone but in a very different manner in the presence of another material. A certain separation of one material from another, and again of the first material from a third, may succeed admirably, but when all three are present at once, the separation of the first may fail completely. Thus, nickel may be separated from iron and also from cobalt by precipitation from an ammoniacal tartrate solution with dimethylglyoxime; if, however, the cobalt and the iron are present at the same time, a slimy, brown precipitate containing iron, cobalt, and dimethylglyoxime contaminates the beautiful, scarlet precipitate of nickel dimethylglyoxime.

The presence in the solution of a substance, which itself does not form a precipitate with a reagent, may sometimes prevent the precipitation of another material until sufficient reagent has been added to combine with all of the non-precipitating substance. In this manner cobalt delays the precipitation of nickel by dimethylglyoxime; again, when precipitating calcium as the oxalate in the presence of magnesium, sufficient oxalate must be added to combine with both the calcium and the magnesium.

The more specific a method, the more satisfactory it is for the purpose of effecting separations. Many methods are quite satisfac-

tory in this regard, while others can only be classed as group methods. The use of organic compounds as specific and selective precipitating agents, and the use of so-called *masking reagents*, which in effect remove metals from solution by the formation of very stable complex ions, offer promising fields for improvements in the selectivity of methods of separation.

The various general methods of accomplishing the separation of the chemical elements for analysis will be discussed separately in the following sections. Separations by precipitation are taken up in the order in which they are usually applied in a complete analysis, that is, the acid insoluble group first, the insoluble chloride group second, the hydrogen sulfide group third, and so on. There are many exceptions to this order since many specific reagents and methods are now known, and since in a given material, members of each group may not be present. Separation by volatilization, extraction, electrodeposition, and other methods will then be considered. Necessarily, the discussions of these various methods of separation will be general, and reference to the section dealing with the elements individually should be made for more detailed information on particular applications.

THE ACID INSOLUBLE GROUP. DEHYDRATION

Silicic acid and tungstic acid are precipitated from their solution in alkaline media upon acidification. Both are hydrated, and precipitation is complete only when each is thoroughly dehydrated by evaporation with hydrochloric acid followed by baking. Silica may also be dehydrated by evaporation with sulfuric acid or with perchloric acid. Both silica and tungstic acid carry down considerable amounts of other metals present and must be subjected to purification processes. Details of the methods of dehydration and purification will be found in the sections devoted to their respective determinations, of silica on p. 180, and of tungsten on p. 216.

In the usual course of analysis, these oxides appear immediately following the decomposition and solution of the sample. They will be accompanied by any insoluble salts of the acids originally present or added during the process of fusing, dissolving, or dehydrating the sample, and the composition of the material must be borne in mind in selecting the acids for these purposes.

Tin and antimony appear at this point as hydrated oxides if nitric acid or perchloric acid is used. The precipitation of antimony is incomplete unless a large excess of tin is present. These precipitates also carry down other materials and must be purified.

The earth acids, columbium and tantalum, are also precipitated in this group, as insoluble acids, on acidification.

THE INSOLUBLE CHLORIDE GROUP

The chlorides of silver and univalent mercury are insoluble in dilute hydrochloric acid solutions; those of lead and univalent thallium are sparingly soluble. These chlorides will accompany the insoluble oxides in the preceding group if hydrochloric acid was used in the dehydration. Mercury and thallium can be oxidized to their higher valence states and interference with the separation of silver thus avoided; the separation of lead and silver is made by taking advantage of the solubility of lead chloride in hot water, or of the solubility of silver salts in ammonia, see p. 286.

THE HYDROGEN SULFIDE GROUP

A great many metals are precipitated by hydrogen sulfide. The acidity of the solution from which the precipitation is made is an important factor in the precipitation and a proper control of the acidity makes possible certain separations.

The theoretical aspects of the precipitation of sulfides have received considerable attention from various authors.¹ Calculations based on the ionic equilibrium constants of hydrogen sulfide and on the solubility product constants of the various metal sulfides have not been particularly successful in predicting solubilities and the effectiveness of separations at different acidities with hydrogen sulfide, and in general, it is more satisfactory to rely on experimental data as regards the separation of metals by precipitation of sulfides.

In order of the increasing solubility of their sulfides in hydrochloric acid, the metals precipitated from acid solution by hydrogen

¹ Some discussion of the precipitation of sulfides will be found in Willard and Furman, 3rd Ed., p. 379; an extensive treatment of the problem is given in McAlpine and Soule, *Qualitative Chemical Analysis*, D. Van Nostrand Company, Inc., New York, 1933, p. 100; and in Middleton and Willard, *Semimicro Qualitative Analysis*, Prentice-Hall, Inc., New York, 1939, p. 107.

sulfide are: arsenic, molybdenum, silver, copper, antimony, bismuth, mercury, gold, platinum, tin, cadmium, and lead. These metals are termed the *acid hydrogen sulfide group*. A few separations within the group by control of the acidity of the solution are possible. For example, antimony can be separated in this way from lead and tin. Precipitation of the group as a whole is frequently used to remove these metals from others.

Aluminum, chromium, titanium, magnesium, and the alkaline earths either do not form sulfides, or if they do, the sulfides are soluble. Aluminum, chromium, and titanium are precipitated as hydroxides by alkaline sulfides unless citrate or tartrate is present.

Zinc, cobalt, and nickel are borderline cases; by a close control of the *pH* of the solution they may be precipitated as sulfides and thus separated from certain other metals. Zinc is precipitated from a solution having a *pH* of about 2; several buffer combinations may be used to obtain this *pH*. Zinc may be thus separated from manganese, nickel, iron, aluminum, and chromium, but not from cobalt. Cobalt and nickel may be precipitated from a solution buffered with acetate, and in this manner separated from iron, aluminum, chromium, manganese, but not from zinc; vanadium and uranium are partially precipitated under such conditions.

The sulfides of manganese, iron, indium, thallium, gallium, and a great many other metals are precipitated from neutral or alkaline solution. The addition of tartrate to the alkaline solution will prevent the precipitation of many of these metals. Precipitation from alkaline solution is used to separate copper, lead, bismuth, mercury, and cadmium from arsenic, antimony, and tin, which form soluble thio salts and are not precipitated; this separation is troublesome, however.

Of particular importance among the sulfide separations is that of cadmium from zinc, which is made in a solution 3-4 *N* in sulfuric acid.

Tin is not precipitated as the sulfide from a solution containing fluoride or oxalate with which quadrivalent tin forms stable complex ions. A number of useful separations of tin are based on these facts.

In general, metals can not be weighed satisfactorily as sulfides. When precipitated from acid solutions, the sulfides usually carry considerable free sulfur, and during an ignition, oxidation to the oxide or to the sulfate occurs. Antimony sulfide is sometimes dried

at 280-300° in an atmosphere of carbon dioxide and weighed as antimonous sulfide. It is more common, however, to ignite a sulfide to the oxide for weighing, as is commonly done with zinc, germanium, and tin, or to convert to the sulfate as is done with cadmium, lead, and cobalt. It is also possible to precipitate the sulfide from an alkaline solution from which sulfur will not precipitate; this is frequently done with mercury, which is precipitated from an alkaline solution containing tartrate as mercuric sulfide, which is then dried at 110° and weighed directly. Two methods of eliminating the effects of free sulfur in the determination of mercury by precipitation of mercuric sulfide from an acid solution have been devised. In one of these methods² the precipitate is washed with carbon disulfide which dissolves out the sulfur. In the second method³ hydriodic acid is utilized, which dissolves the mercuric sulfide but not the free sulfur; the weight of mercuric sulfide is then found by difference. These methods might find application with other sulfide precipitates.

THE AMMONIA PRECIPITATE. THE SEPARATION OF WEAK BASES AND BASIC SALTS FROM STRONGER BASES

The weaker a metal as a base, the more acid the solution in which the hydroxide of the metal is precipitated. This subject was made the object of a series of studies by Britton¹ whose results are given in Table I.

If there is a sufficient difference between the values of pH at which two metal hydroxides are precipitated, the metals may often be separated by maintaining the pH of the solution at such a value that the weaker one only will be precipitated. It should be noted that the precipitate is often a basic salt instead of a hydroxide, but this makes no difference provided it is sufficiently insoluble. The regulation of pH for this purpose may be accomplished in various ways.

A buffer solution may be used to regulate the hydrolysis. The buffers usually used are weak acids and one of their salts, and heat-

² Tabern and Shelberg, *Ind. Eng. Chem., Anal. Ed.*, **4**, 401 (1932).

³ Caley and Burford, *Ind. Eng. Chem., Anal. Ed.*, **8**, 43 (1936).

¹ This work was published in the *Journal of the Chemical Society* between 1925 and 1936. A summary of the work will be found in Britton, *Hydrogen Ions*, D. Van Nostrand Company, Inc., New York, 2nd Ed., 1934, pp. 295 ff.

ing is usually required to effect the hydrolysis, which is often a relatively slow process. In this manner, ferric iron is precipitated as a basic acetate from a solution buffered with acetic acid and sodium acetate, which give a pH of about 5.

TABLE I. VALUES OF pH AT WHICH VARIOUS HYDROXIDES ^a PRECIPITATE

Magnesium.....	10.5	Cupric.....	5.4
Silver ^b	9	Chromic.....	5.3
Manganous.....	8.5	Zinc.....	5.2
Mercuric ^c	7.4	Uranic.....	4.2
Various rare earths..	6.8-8.4	Aluminum.....	4.1
Cobalt.....	6.8	Thorium.....	3.5
Cadmium.....	6.7	Stannous ^d	3
Nickel.....	6.7	Ferric ^e	2-3
Lead.....	6.0	Zirconium.....	2.8
Beryllium.....	5.7	Titanium.....	2
Ferrous.....	5.5		

^a In many cases the precipitates are actually basic salts, e.g., $3\text{Cd}(\text{OH})_2 \cdot \text{CdSO}_4 \cdot x\text{H}_2\text{O}$.

^b There appears to be some question about the value for silver; the work reported in paper IV of the series by Britton indicates that precipitation begins at a pH of 5.7 [*J. Chem. Soc.*, **127**, 2151 (1925)].

^c The value for mercuric hydroxide varies considerably, depending on the anion present; this is probably due to the variable extent of ionization of various mercuric salts in solution (*J. Chem. Soc.*, **1932**, 2550).

^d In the case of the stannous ion, a light, colloidal precipitate forms at a pH of about 2, but a precipitate really begins to form at a pH of 3.

^e With ferric iron a color change and the formation of a colloidal suspension precede the formation of a precipitate, paper IV, *loc. cit.*; see also Lamb and Jacques, *J. Amer. Chem. Soc.*, **60**, 967, 1215 (1938).

The precipitation may also be carried out by the addition of a weak base, strong enough to precipitate one metal but not another. Phenylhydrazine is a weaker base than ammonia, and will precipitate aluminum, but not the more basic bivalent metals such as ferrous iron, zinc, nickel, and magnesium. Ammonia will precipitate ferric iron and aluminum but not magnesium; ferrous iron, nickel, zinc, and the other metals which precipitate as hydroxides in the same pH range, may be partially precipitated. Sodium hydroxide will precipitate magnesium but not barium or calcium unless an excess is added.

The pH of a solution may also be regulated by the use of some internal reactions which bring the solution to a definite pH. Vari-

ous types of such reactions are known. Sodium thiosulfate added to an acid solution undergoes decomposition according to

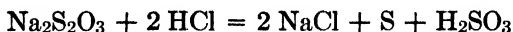

If the solution is boiled, the sulfurous acid is driven off as sulfur dioxide, resulting, if excess sodium thiosulfate is present, in a very slightly acid solution, but one in which a number of metals such as titanium and thorium are completely precipitated. Various combinations of halide and halate acids react to give free halogens, which, if boiled off, leave solutions having definite acidities.² Thus a mixture of hydrobromic acid and bromic acid gives a final acidity of 0.002 *N*; a mixture of hydriodic acid and chloric acid gives an acidity of 0.107 *N*; and hydrochloric acid and bromic acid a solution of 0.048 *N*.

Titanium is completely precipitated from a solution having an acid concentration of 0.05 *N*; hence, if excess of potassium bromate is added to the hydrochloric acid solution, titanium hydroxide is precipitated by boiling until the reaction is complete. Bismuth oxychloride may be precipitated in the same way. Similarly urea, which in a hot solution hydrolyzes to form carbon dioxide and ammonia, is a most convenient reagent for the precipitation of hydroxides and basic salts.³

In addition to the *pH* of the solution, an extremely important factor in the separation of hydroxides and basic salts is the homogeneity of the solution with respect to *pH*. Complete homogeneity can be maintained only when the increase in *pH* comes from a reaction within the solution itself and not by the addition of a reagent. This is best accomplished by the third method of controlling *pH*. For example, if urea is added, no reaction occurs until the solution is heated; then ammonia is uniformly produced throughout the solution and the *pH* rises gradually but never becomes too high in any portion. If a buffer is added and the necessary hydrolysis is produced by heating the solution, a similar result is obtained but less efficiently.

A third important factor is the presence of a suitable anion during the precipitation. The character of the precipitate varies greatly with the anion present when the precipitation is carried out.

² Moser and Iranyi, *Monatsh.*, **43**, 673 (1922).

³ Willard and Tang, *Ind. Eng. Chem., Anal. Ed.*, **9**, 357 (1937); *J. Amer. Chem. Soc.*, **59**, 1190 (1937); Willard and Fogg, *ibid.*, **59**, 2422 (1937).

This is vividly illustrated by Fig. 10, which shows the effect of several anions on the character of the precipitate formed on the hydrolysis of aluminum salts. This is effective, however, only when the pH is slowly and uniformly increased by the third method. Under these conditions, a solution containing the sulfate ion always yields a dense precipitate. In certain cases, other ions are effective; thus, succinate forms a dense precipitate with aluminum. The

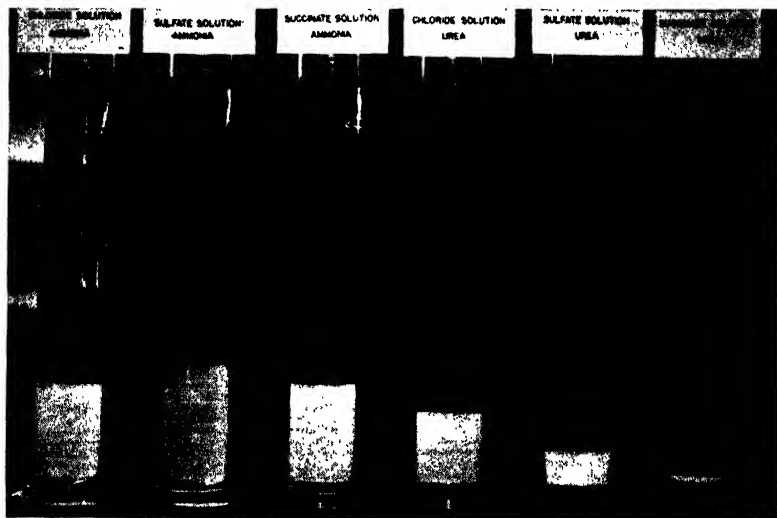

FIG. 10. The Effect of the Method of Precipitation and of the Anion Present on the Character of the Aluminum Precipitate Obtained on Hydrolysis.

error due to adsorption is thus greatly decreased. For example, the precipitation of aluminum as basic succinate by urea results in more complete separations from other metals than can be obtained by any other method involving the precipitation of a basic salt.⁸

By precipitation with ammonia, aluminum, titanium, chromium, and iron may be separated from magnesium and the alkaline earth metals, but not from zinc, manganese, cobalt, or nickel, unless the amount of precipitate is so small that the error may be disregarded. Separation from the latter elements may be made by precipitation as a basic acetate (unsatisfactory for aluminum), benzoate, succinate, or sulfate. Ferrous iron belongs with the bivalent metals with respect to its strength as a base, and this fact is used in connection with the phenylhydrazine precipitation used to separate aluminum

from iron. The very weak base titanium may be separated from iron and aluminum by proper control of the acidity, as is done in the sulfur dioxide method, p. 156.

If phosphates are present, they are precipitated quantitatively unless their amount is more than equivalent to the weak bases precipitating, in which case phosphates of stronger bases may precipitate.

Gallium, indium, beryllium, zirconium, uranium, scandium, yttrium, and the rare earths are also weak bases and appear with the hydroxides just discussed.

PRECIPITATION WITH SODIUM HYDROXIDE. FUSIONS WITH SODIUM CARBONATE AND SODIUM PEROXIDE

Advantage may often be taken of the property of certain amphoteric elements of forming salts soluble in alkaline solution to separate them from other elements. In general, it is best to carry out the separation by the addition of the solution containing the metals to the alkali rather than the reverse, in which case all of the metals are first precipitated and the amphoteric metal redissolved, but only rather incompletely. In this manner aluminum, beryllium, zinc, gallium, tin, lead, arsenic, antimony, vanadium, chromium, molybdenum, tungsten, phosphorus, and sulfur may be separated from iron, titanium, zirconium, thorium, indium, scandium, yttrium, and the rare earths, and other metals which remain behind as oxides or carbonates. These separations are applied particularly to the metals of the ammonia group. Chromium is precipitated if in the trivalent state, but it may be oxidized by air or a peroxide to the soluble chromate form. The separation of silica can not be made complete, and aluminum may be precipitated if certain metals, notably nickel and magnesium, are present. Tartaric acid, glycerol, and other polyhydroxy organic compounds prevent the precipitation of iron, but hydrofluoric acid does not have this effect. Phosphates of the alkaline earths may be precipitated if much phosphate is present.

Hot, strongly alkaline solutions attack glassware rapidly, and the operations must be carried out in platinum if the contamination interferes. The separations with sodium hydroxide in this manner may often be incomplete and require repetition. The precipitates

are never determined directly but are dissolved and converted to other forms for weighing.

A sodium carbonate fusion accomplishes about the same results as precipitation with sodium hydroxide. Contact with air is sufficient to oxidize small amounts of chromium to chromate; manganese may be oxidized to green sodium manganate, Na_2MnO_4 , but this is easily reduced to manganese dioxide. Sodium carbonate fusion is particularly useful in the decomposition of silicates insoluble in acids, and is very useful in the analysis of the ammonia precipitate. A silicate fused with sodium carbonate should never be dissolved in water, always in dilute acid, and the silica separated as usual.

Fusion with sodium peroxide is an exceptionally powerful method of attack. Silicates, chromite and very refractory substances are decomposed by such treatment, and the elements present are oxidized to their highest valence states. Fusion with peroxide is also used in the decomposition of sulfide ores for the determination of sulfur (see Willard and Furman, 3rd Ed., p. 363). The fusion is made in an iron, nickel, or silver crucible, which is less attacked than platinum. Organic compounds are decomposed for the determination of their sulfur content by peroxide fusion, but as this is somewhat violent, the fusion is carried out in a steel bomb.

DISTILLATION

Separations may be often accomplished by a distillation of the constituent being determined. The process is sometimes surprisingly simple and usually gives a very complete separation. Occasionally the technic is used to remove a material whose presence interferes with another determination. This subject of separation by volatilization has already been discussed (Willard and Furman, 3rd Ed., p. 384) and some distillation separations are very familiar.

The Kjeldahl method for the determination of nitrogen by the distillation of ammonia from a solution containing fixed alkali is well known. The determination of carbon dioxide in a carbonate and sulfur in a sulfide by evolution as carbon dioxide or hydrogen sulfide respectively are very commonly made and are good examples of this type of separation.

Moisture and combined water are commonly determined by heating the material under examination. In some cases, such as

the determination of moisture in coal, the amount of water is determined by the loss in weight of the sample. In others, for example, the determination of the combined water in silicate rock by the Penfield method, the water is condensed as liquid water and weighed. More commonly, the water is collected on a drying agent in a suitable tube and weighed. In some materials, such as grain and petroleum products, the water is separated by distillation with an immiscible liquid such as chloroform, benzene, or toluene; the apparatus is provided with a calibrated receiver so that the volume of water which condenses and separates from the immiscible liquid may be found.

Fluoride may be separated from a great variety of other materials by distillation as hydrofluosilicic acid, H_2SiF_6 ; this is the only satisfactory method for separating fluoride from the substances which interfere with its determination, and it is widely used.

Mercury may be volatilized as the metal by ignition of its compounds or ores with reducing agents. This procedure is sometimes used to determine the mercury by collecting it on gold foil, but is more often used simply to eliminate the mercury, particularly where it has been used as a collecting agent, as in the determination of gold.

Boric acid may be separated from most other substances by distillation as methyl borate by heating with methyl alcohol and sulfuric acid or phosphoric acid.

Arsenic is distilled as arsenic trichloride, AsCl_3 , from a concentrated hydrochloric acid solution containing a reducing agent. This is a very convenient method of separating arsenic from copper, antimony, tin, and other metals. Antimony and tin may also be volatilized completely by distillation, but higher temperatures are required. A convenient form of apparatus for this distillation is shown on p. 342. Mercuric halides are appreciably volatile and may partially accompany arsenic, antimony, and tin.

Osmium is distilled as the tetroxide, OsO_4 , from a dilute nitric acid solution and thus separated from the other platinum metals. Ruthenium is distilled as the tetroxide, RuO_4 , from a sulfuric acid solution containing bromate.

Chromium forms a volatile compound, chromyl chloride, CrO_2Cl_2 , which may be used to separate chromium from iron and the other constituents of steel. This is used principally to remove chromium to render the determination of vanadium easier, but the

chromyl chloride may also be collected and the chromium determined.

The volatilization of various elements from solutions containing sulfuric acid, perchloric acid, or phosphoric acid during the gradual addition of hydrochloric acid or hydrobromic acid has been studied¹ and the conditions for distillation of certain elements established.

EXTRACTION METHODS. THE ETHER EXTRACTION OF IRON

The theoretical aspects of the separation of dissolved materials from aqueous solutions by extraction with an immiscible solvent is treated in Willard and Furman, 3rd Ed., p. 382. It should be noted particularly that concentrations rather than amounts are involved in extraction work, and that the concentration in the aqueous phase appears in the denominator of the expression defining the *distribution coefficient*. Thus the greater the numerical value of the distribution coefficient the more effective the separation, and the more concentrated the aqueous solution being extracted the more efficient the separation.¹

The ether extraction of chlorides from a hydrochloric acid solution is of especial importance. The method is applied only to the trivalent chlorides of iron, gold, gallium, and thallium, and to hexavalent molybdenum, although stannic, stannous, antimonious, and arsenious chlorides are also quite soluble. Other metals, such as lead, cadmium, vanadium, and the metals of the third, fourth, and fifth groups of qualitative analysis remain in the aqueous solution. The table given in Willard and Furman, 3rd Ed., p. 383, shows the per cent of the chlorides of various metals extracted by ether from a solution 6 *N* in hydrochloric acid.²

The extraction of ferric chloride by ether may be very efficient, the distribution coefficient being as high as 140 under favorable conditions.³ The concentration of the hydrochloric acid is very important, the optimum concentration being about 6 *N*. The per-

¹ Hoffman and Lundell, *J. Research Nat. Bur. Standards*, **22**, 465 (1939).

² For a more extensive theoretical treatment of extraction and experimental verification of the derived formula, see Griffin, *Ind. Eng. Chem., Anal. Ed.*, **6**, 40 (1934), and Griffin and Saaf, *ibid.*, **8**, 358 (1936).

³ Swift, *J. Amer. Chem. Soc.*, **46**, 2375 (1924); Hillebrand and Lundell, *Applied Inorganic Analysis*, John Wiley & Sons, Inc., New York, 1929, p. 107.

³ Dodson, Forney and Swift, *J. Amer. Chem. Soc.*, **58**, 2573 (1936).

centage of iron extracted falls off at higher and lower acid concentrations, as shown in Table II.

TABLE II. THE DISTRIBUTION OF FERRIC IRON BETWEEN ETHYL ETHER AND AQUEOUS HYDROCHLORIC ACID SOLUTIONS³

Initial HCl Concn., Moles per Liter	Volume after Shaking, ml.		Iron Found, mg.		Iron Extracted, Per Cent	Distribution Ratio $\frac{(\text{Fe}_{\text{ether}})}{(\text{Fe}_{\text{water}})}$
	Ether Layer	Water Layer	Ether Layer	Water Layer		
0.0	23.3	26.5	trace	250	0.0	0.0
2.0	23.2	26.7	2.4	248	0.96	0.011
3.0	22.9	26.8	44.5	205	17.8	0.25
4.0	22.7	26.7	204	46.4	81.5	5.18
5.25	21.2	28.0	246	4.4	98.2	74
6.2	19.6	29.4	247	2.6	99.0	143
7.0	17.3	31.7	244	5.5	97.8	81
7.1	17.1	31.8	244	5.9	97.6	72
8.0	11.8	36.6	218	32.4	87.0	20.9
8.6 ^a	8.0	40.4	169	80.6	67.7	10.6
9.3 ^a	5.3	43.2	35.0	215	14.0	1.33

^a Separate ether phase metastable.

Since ether also dissolves considerable hydrochloric acid, it is best to saturate the ether with hydrochloric acid prior to use. Free chlorine, oxides of nitrogen, and other materials which attack ether must be absent. The iron must be in the trivalent state since ferrous chloride is not extracted by ether. Ether photochemically reduces iron, and if it is desired to remove all of the iron from solution by repeated extraction or by a continuous mechanical extraction, the process should be carried out in the dark.⁴ The ether must be free from alcohol and peroxides, which promote the reduction of ferric chloride. The presence of sodium chloride or of potassium chloride should be avoided, since they are insoluble in strong hydrochloric acid solutions saturated with ether. The solution is usually extracted with ether twice, and the combined ether extracts shaken with hydrochloric acid previously saturated with ether to recover

⁴ Ashley and Murray, *Ind. Eng. Chem., Anal. Ed.*, **10**, 367 (1938).

any chlorides that might be entrapped in the ether. The solutions must be kept cool to prevent the very dangerous and obnoxious fumes of ether saturated with hydrochloric acid from escaping from the separatory funnel. The solutions should be cooled under running tap water, or better with ice, especially during the summer months.

The ether extraction method is used for removing the greater part of the iron from large samples of steel or iron ore, thus making possible the accurate determination of the elements present in small amounts, such as copper, aluminum, chromium, titanium, vanadium, manganese, nickel, cobalt, calcium, magnesium, and sulfur. It is used only where iron is the principal constituent. If a large excess of iron is present, all of the molybdenum goes into the ether layer.⁵ A considerable portion of any phosphate present is extracted with the iron; the amount depends on the amount of iron and on the amount of phosphate present, and is less if the combined ether extracts are washed with hydrochloric acid.⁶ As much as 35 per cent of the phosphorus present may be extracted, and this should be considered in the determination of aluminum and titanium if the oxides of these metals are weighed and corrected for the phosphorus pentoxide which accompanies them in the ammonia precipitate. Copper is partially extracted by ether, and in the determination of copper in high copper steel an appreciable amount of copper may be lost.⁷ The ether separation may very conveniently precede the basic acetate separation, thus avoiding the handling of large precipitates.

The low boiling point of common or diethyl ether and its inflammability make its use in extractions hazardous and inconvenient. *iso*-Propyl ether and dichloroethyl ether have higher boiling points (69° and 178°, respectively) and have been shown to have the same properties as diethyl ether with respect to their capacity to dissolve metal chlorides.^{8,9} Both of the ethers are available at about the same price as that of diethyl ether. The extraction of ferric chloride is complete with either ether over a wider range of hydrochloric acid concentration than is permissible with ethyl ether, 6-8 *N* being satisfactory. The mutual solubility of hydrochloric acid and *iso*-

⁵ Blair, *J. Amer. Chem. Soc.*, **30**, 1229 (1908).

⁶ Wysor, *J. Ind. Eng. Chem.*, **2**, 45 (1910).

⁷ Private communication from Mr. Arba Thomas, American Rolling Mill Co., Middletown, Ohio.

⁸ Axelrod and Swift, *J. Amer. Chem. Soc.*, **62**, 33 (1940).

propyl or dichloroethyl ether is very small in contrast to diethyl ether, so that it is not necessary to saturate the ether or acid prior to the extraction. *iso*-Propyl alcohol and di-*iso*-propyl peroxide do not reduce ferric iron and so may be present in the *iso*-propyl ether used for extraction. No copper is extracted by *iso*-propyl ether.^{3,4} Dichloroethyl ether is more dense than water, affording the advantage that repeated extractions may be carried out without transfer from one separatory funnel. Evidence adduced by Swift and his coworkers indicates that the iron is present in the ether solution as HFeCl_4 , probably associated with water and ether.^{3,8}

The extraction may be made in a common separatory funnel or in more elaborate and convenient designs of such funnels, such as that of Rothe⁹ or of Hillebrand and Lundell¹⁰ shown in Figs. 11 and 12. When it is desired to remove all traces of iron, it is more convenient to use a continuous extraction apparatus,^{4,11} such as the one shown in Fig. 13. Considerably less ether is required for the extraction, and if carried out in the dark, iron may be removed completely in the course of eight or more hours. The continuous apparatus shown will not work with dichloroethyl ether, which is more dense than water.

Procedure for the Removal of Iron by Ether Extraction Preliminary to Other Determinations on Iron Ore, Iron, or Steel. Dissolve 5-10 g. of the iron ore, iron, or steel in hydrochloric acid, and dehydrate and filter off the insoluble material as described under the determination of silica, p. 180. Treat the insoluble matter with hydrofluoric acid and sulfuric acid, and evaporate to dryness without igniting. Dissolve in hydrochloric acid, filter off any insoluble matter and add the filtrate to the main solution, reserving the residue. Add several ml. of nitric acid to the solution to oxidize any ferrous iron. Evaporate the solution until the liquid is syrupy and has a volume of about 10 ml. The residue filtered off as directed above will be very small; it is free from iron, and therefore is not included in the ether separation. Fuse it with a little sodium carbonate or potassium pyrosulfate, dissolve in hydrochloric acid, and later add it to the solution from which the iron has been extracted.

⁹ Rothe, *Stahl u. Eisen*, **12**, 1052 (1892).

¹⁰ Hillebrand and Lundell, *loc. cit.*; see also Lundell, Hoffman and Bright, *Chemical Analysis of Iron and Steel*, John Wiley & Sons, Inc., New York, 1931, p. 44.

¹¹ McNaught, *Analyst*, **62**, 467 (1937).

To the syrupy ferric chloride add a few ml. of hydrochloric acid of sp. gr. 1.13, prepared by diluting 2 volumes of hydrochloric acid of sp. gr. 1.19 with 1 volume of water. With a little more of this acid, wash the solution carefully into a 150 or 200 ml. separatory funnel, the stop-cock and stopper of which have previously been

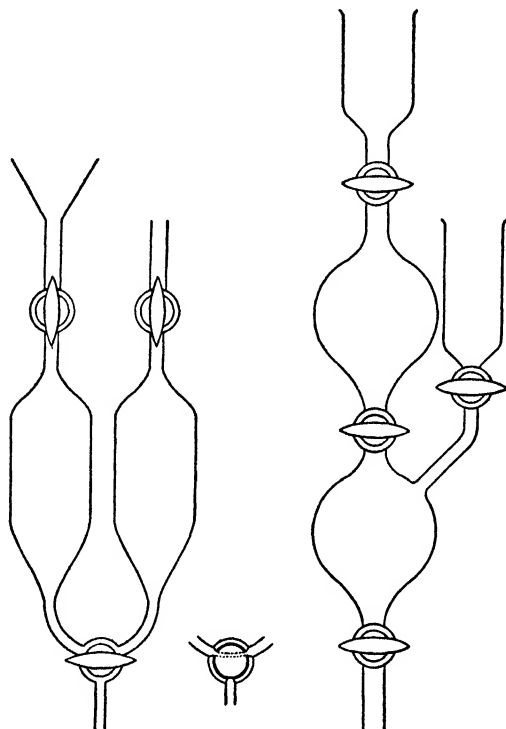

FIGS. 11, 12. Ether Extraction Funnels.

tested and found tight. The tube below the stop-cock should be short and fairly large, not over 4 cm. long. Use as little acid as possible, so that the total volume of solution is not over 40 ml.

Cool the funnel and its contents and cautiously add 50 ml. of ether previously saturated with hydrochloric acid, mixing the two layers slowly and cooling at the same time, since much heat is generated and this causes reduction of some iron to the ferrous form. Finally shake vigorously for 4-5 minutes holding the funnel under the tap to keep it cool. Relieve any excess pressure and set aside

until the two layers have completely separated, which may require half an hour. Most of the iron is now contained in the green ether layer, while the other metals remain in the aqueous solution. Draw

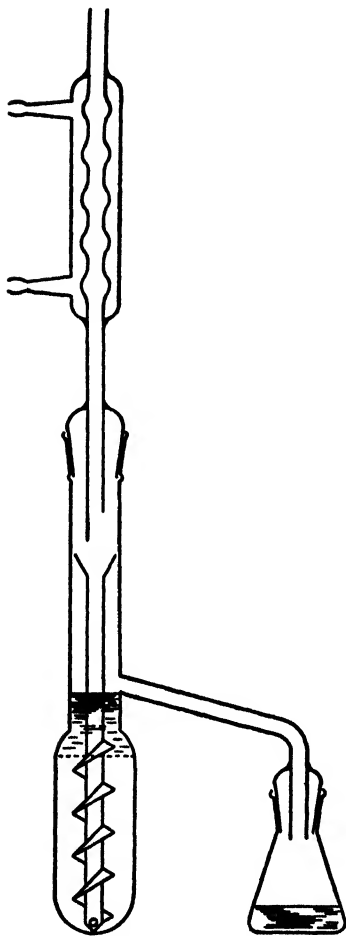

FIG. 13. Continuous Extractor.

off the lower aqueous layer into a 250 ml. beaker, taking care to empty the tube below the stop-cock. Add 8-10 ml. of hydrochloric acid of sp. gr. 1.13, saturated with ether, to the ether layer remaining in the funnel, shake and draw off as before to remove the chlorides adhering to the ether; do this once more, taking care to rinse off each time the stopper and the tube below the stop-cock. The hydrochloric acid solution should contain less than 5 per cent of the iron originally present and about 70 per cent of the phosphorus; if it is desired to remove still more of the iron, the hydrochloric acid solution after having been drawn off may be again extracted with fresh ether, the ether extracts being washed as described.

Unite the acid solutions and add to them the solution of the insoluble residue mentioned above. Heat the solution to drive off any residual ether. Add a little nitric acid or chlorate to oxidize the iron reduced by the ether, evaporate to dryness, take up with a little hydrochloric acid, dilute to 30-40 ml., filter off any silica and wash it with dilute hydrochloric acid (1:100). This residue may be titanium dioxide instead of silica and should be tested with hydrofluoric acid and sulfuric acid. The solution is now ready for whatever separation is desired.

ELECTRODEPOSITION

Constant Current and Controlled Cathode Potential Methods.

An extended treatment of the theoretical aspects of the subject of electrodeposition will be found in Willard and Furman, 3rd Ed., Chapter XIX, p. 411. Particular attention should be paid to the matters of overvoltage and complex ion formation. The determinations most commonly made by electrodeposition are of copper, deposited as the metal at the cathode, and of lead, deposited as the dioxide, PbO_2 , at the anode. The electrodeposition of copper is commonly made under constant current conditions, that is, without any attempt to control the cathode potential; the electrolyte usually used is a solution containing about 3 per cent of sulfuric acid plus nitric acid and a quantity of ammonium nitrate (see Willard and Furman, 3rd Ed., p. 443). In this manner copper may be separated from zinc, aluminum, and the alkali and alkaline earth metals, but not from silver, mercury, tin, and the metals below tin in the electromotive series. By controlling the cathode potential, it is possible to deposit copper in the presence of tin, and by the addition of an anodic depolarizer, such as hydroxylamine or hydrazine, to carry out the deposition from a chloride solution.

Controlled cathode electrodeposition procedures have not been very popular, largely because of the involved apparatus required and the close attention which they demand. Recent simplifications in the apparatus,¹ and the development of an apparatus for full automatic control² should increase the use of the method.

Quite a number of separations of metals from one another may be accomplished by controlled cathode electrodeposition. Copper, antimony, and bismuth, individually, or as a group if present together, may be separated from tin, lead, and cadmium;^{3,4,5,6} tin may be separated from cadmium;³ tin, or tin plus lead if present, from nickel and zinc;^{5,6} copper from quinquevalent antimony;⁶ nickel from zinc;⁷ bismuth from copper.^{3,8} The cathode potentials

¹ Lindsey and Sand, *Analyst*, **59**, 328 (1934).

² Caldwell, Parker, and Diehl, unpublished work.

³ Schoch and Brown, *J. Amer. Chem. Soc.*, **38**, 1660 (1916)

⁴ Engelenburg, *Z. anal. Chem.*, **62**, 257 (1923).

⁵ Lindsey and Sand, *Analyst*, **59**, 335 (1934).

⁶ Torrance, *Analyst*, **62**, 719 (1937).

⁷ Torrance, *Analyst*, **63**, 488 (1938).

⁸ Kny-Jones, *Analyst*, **66**, 101 (1941).

at which these various separations may be accomplished and the electrolytes recommended may be found in the original papers or, in many cases, in the section of this text dealing with the determination of various elements. In general, such separations are very good and quite rapid. It is even possible to run a complete brass analysis, with the exception of the iron and aluminum present, by electrodeposition.⁶

The electrodeposition of nickel using constant current is of value largely as a method of getting the metal into a satisfactory form for weighing rather than for accomplishing its separation from other metals. Ammoniacal sulfate solutions are usually used. Cobalt accompanies nickel when a solution containing the two metals is electrolyzed. When cobalt is deposited from a solution containing no nickel or only a small amount, sodium sulfite must be added to the ammoniacal solution.

Zinc may be deposited electrolytically from ammoniacal chloride or sulfate solutions^{6,7} or from a strong sodium hydroxide solution,⁹ but the results are frequently disappointing. Small amounts of nitrate interfere.

Silver may be deposited satisfactorily from a cyanide solution and thus separated from copper. This is a striking example of the use of complex ion formation to alter the molecular species present in a solution to accomplish separations.

Of the various metals which are deposited on the anode as higher oxides, lead alone is deposited completely and in a form satisfactory for weighing, although even with it an empirical factor is used. While the solution in which this deposition is made usually contains 15 per cent nitric acid, it is possible to cut this acidity down to the point where copper and lead may be determined simultaneously. From a solution containing hydrofluoric acid and nitric acid, lead may be deposited as the dioxide and separated from tin; a certain minimum amount of lead must be present, however, to initiate the deposition.⁴

The Mercury Cathode. Electrolysis using a mercury cathode is a convenient way of removing many metals from solution, although not well adapted to the determination of any of the metals removed, owing to the difficulty of drying and weighing the mercury. The high overvoltage of hydrogen on mercury makes possible the

⁹ Nickolls and Gaskin, *Analyst*, **59**, 391 (1934).

deposition from a fairly acid solution of metals such as iron, nickel, chromium, and zinc, which could not otherwise be completely deposited from such solutions. If a metal alloys with mercury to form an amalgam, the electrode potential of the alloy is more posi-

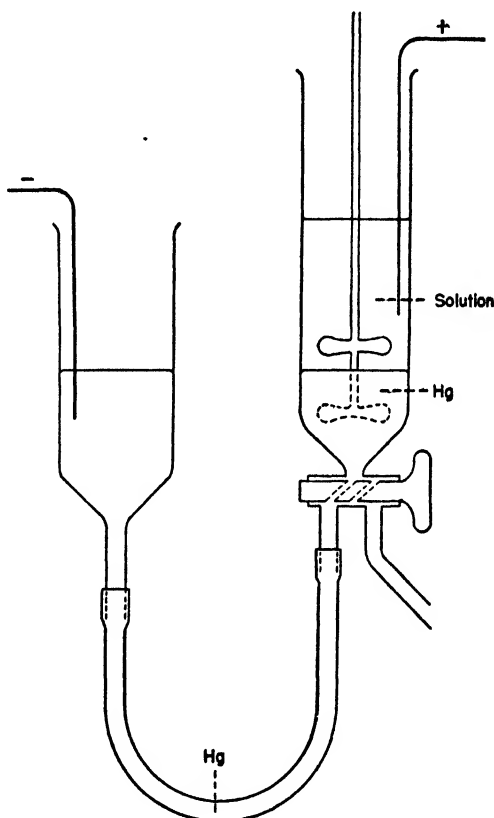

FIG. 14. Apparatus for Electrodeposition with Mercury Cathode.

tive; the metal is also protected to a considerable extent from the solvent action of the acid.

A very convenient form of apparatus¹⁰ for the electrolysis is shown in Fig. 14. A platinum wire, usually a spiral, is used as

¹⁰ Melavan, *Ind. Eng. Chem., Anal. Ed.*, **2**, 180 (1930). For a somewhat better but more complicated form of the apparatus, see Evans, *Analyst*, **60**, 389 (1935).

anode, and contact to the mercury is made by a copper wire. A sulfuric acid solution, about 0.1 *N* in concentration, is generally used as electrolyte. The solution is best stirred mechanically with a stirring rod which agitates both the solution and the mercury. When the deposition is complete, the leveling bulb is lowered until the mercury level just reaches the bore of the stop-cock. The latter is then turned through 180° and the contents of the electrolyzing vessel rinsed into a beaker for further treatment.

When contamination of the mercury by deposited metals reaches about 1 per cent, further deposition is retarded. There is also a possibility that metals may be redissolved. When the mercury becomes too badly contaminated, the mercury may be cleaned by repeated agitation with 10 per cent nitric acid.¹¹

In general, all the metals below zinc in the electromotive series are deposited on the mercury cathode. Manganese is only partially removed, although by adding phosphoric acid to the solution before the electrolysis, the amount of residual manganese may be reduced to a negligible amount.¹² Aluminum is not deposited at all. The method is used mostly for the removal of the metals below zinc in the electromotive series leaving in solution metals that can not be deposited, such as aluminum, beryllium, magnesium, the alkaline earths, vanadium, titanium, zirconium, the rare earths, and phosphorus. It is commonly applied to the determination of aluminum and titanium in ferrous materials.

Internal Electrolysis. The term *internal electrolysis* was applied by Sand¹³ to those electrodeposition processes in which an attackable anode is used, and a direct, external wire connection between the cathode and anode made, so that the electrolysis proceeds spontaneously without the application of an external voltage. This is really a species of controlled cathode potential electrodeposition, for if the metal chosen for the anode is the same as the metal in solution from which the separation of another metal is desired, then automatically the cathode potential is decreased as the electrolysis proceeds and the concentration of the metal deposited at the cathode decreases. The method is particularly well adapted to the determination of small quantities of one metal in the presence of large

¹¹ Scherrer and Mogerman, *J. Research Nat. Bur. Standards*, **21**, 105 (1938).

¹² Clopin, *Z. anal. Chem.*, **107**, 104 (1936).

¹³ Sand, *Analyst*, **55**, 309 (1930).

amounts of another, for example, the determination of bismuth and copper in lead bullion.

Although the method has been known for a long time it has only been recently that applications of it have been made in technical

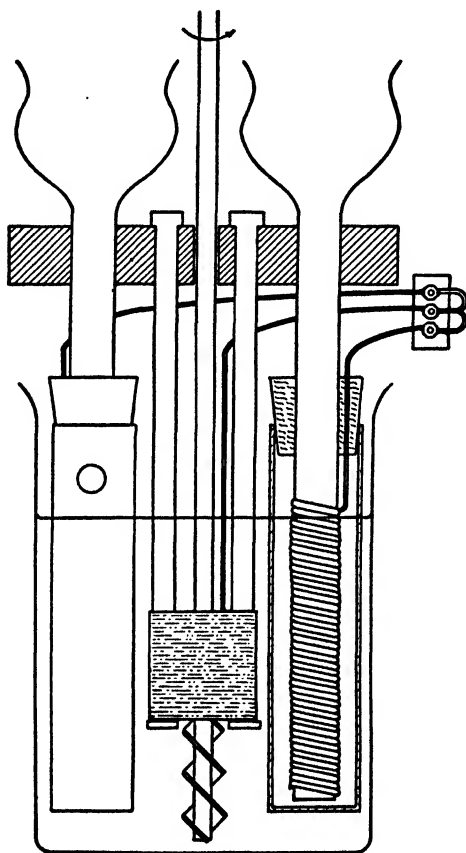

Fig. 15. Apparatus for Electrodeposition by Internal Electrolysis.

analysis. In the apparatus of Sand,¹³ the solutions surrounding the anode and cathode are separated by a parchment membrane; in the apparatus of Clarke, Wooten, and Luke,¹⁴ shown in Fig. 15, they are separated by an alundum shell, which, when new, must be treated with acids to make it more porous. Two anodes are gen-

¹⁴ Clarke, Wooten, and Luke, *Ind. Eng. Chem., Anal. Ed.*, **8**, 411 (1936).

erally used to speed the deposition. The solutions are stirred mechanically, and means are also provided for flushing the anolyte into the catholyte in order to return any metals which may have diffused into the anolyte during the early part of the electrolysis. The electrodes are connected together by wire.

Obviously, the metal being deposited must be lower in the electromotive series than the metal from which it is being separated, copper and bismuth, in the example cited, being lower than lead. The solution surrounding the anode must have a high electrical conductivity, and this may be secured by a high concentration of electrolyte, usually of acids or ammonium salts. The anolyte must also, however, contain a higher concentration of the ions of the anode metal than does the catholyte, otherwise the anode metal might be deposited at the cathode due to the concentration cell effect. Chloride solutions may be used without the addition of an anodic depolarizer, as the anode reaction is the dissolution of the metal of the anode.

One of the most useful applications of the method is the separation of copper and bismuth from lead.^{15,16} A lead anode surrounded by a solution containing 3 per cent nitric acid and 5 per cent lead nitrate is used. The copper and bismuth are plated together on a platinum cathode from a dilute nitric acid solution and at a temperature of 65-90°. The sample is best dissolved in a mixture of nitric acid and tartaric acid. Arsenic and antimony do not interfere if oxidized to their higher valence states by treatment with permanganate. Lead-tin alloys may also be handled in the same way, but it is better to dissolve the sample in a mixture of nitric acid and hydrofluoric acid in this case. The copper plus bismuth plate may be weighed, and one or both metals subsequently determined by the usual methods.

The internal electrolysis method has also been applied to the separation of lead from antimony,¹⁷ in which case a zinc anode immersed in a 10 per cent potassium cyanide solution is used. The separation of copper and cadmium from zinc has been similarly accomplished,¹⁸ and of cadmium and nickel from zinc.^{19,16} Mercury

¹⁵ Collin, *Analyst*, **55**, 312, 680 (1930).

¹⁶ Clarke and Wooten, *Trans. Electrochem. Soc.*, **76**, 63 (1939).

¹⁷ Collin and Sand, *Analyst*, **56**, 90 (1931).

¹⁸ Collin, *Analyst*, **55**, 495 (1930).

¹⁹ Fife, *Analyst*, **61**, 681 (1936).

may be separated from the metals in brass using a copper anode;²⁰ copper may be separated from large amounts of iron using an iron anode and hydrazine to keep the iron reduced to the ferrous state;²¹ copper may be separated from cadmium using a cadmium anode;²² and silver separated from lead, copper, bismuth, and other metals present in sulfide ores, using a copper anode.²³

Efforts have been made to eliminate the porous membrane separating the catholyte from the anolyte.²⁴ Besides being simpler and more convenient to assemble, electrolysis without the membrane permits the separation of metals closer together in the electromotive series, since the internal resistance of the cell is lower. A great disadvantage with this simplified technic, however, is the possibility of depositing the metal on the anode by local cell action on the surface; this can only be circumvented by carefully maintaining the concentration of the metal under a certain limit below which it is not deposited on the anode, and by choosing a metal for the anode which does not give too great a potential difference. A few separations have been made without the membrane: cadmium from zinc,²⁴ copper and bismuth from lead,²⁵ and copper, nickel, and cobalt from iron.²⁶

CHEMICAL REDUCTION TO METAL

By the application of reducing agents of different strengths, certain elements may be differentially reduced to the metallic state and thus separated from other elements. The metals which are more or less easily reduced are those at the bottom of the electromotive series: gold, silver, selenium, tellurium, platinum, palladium, mercury, copper, antimony, and bismuth.

Hydrazine reduces all of the metals mentioned but antimony and bismuth. Hypophosphorous acid will reduce these metals also. Hydroquinone is a very weak reducing agent, precipitating gold from acid solution and separating it quantitatively from all of the other metals mentioned; silver must be removed prior to the precipitation of the gold.

²⁰ Fife, *Analyst*, **63**, 650 (1938).

²¹ Fife and Torrance, *Analyst*, **62**, 29 (1937).

²² Fife, *Analyst*, **65**, 562 (1940).

²³ Fife, *Analyst*, **62**, 723 (1937).

²⁴ Lurie and Troitzkaja, *Z. anal. Chem.*, **107**, 34 (1936).

²⁵ Lurie and Ginsburg, *Ind. Eng. Chem., Anal. Ed.*, **9**, 424 (1937).

²⁶ Lurie and Ginsburg, *Ind. Eng. Chem., Anal. Ed.*, **10**, 201 (1938).

Metallic reducing agents are used principally for the removal of interfering metals from solution although they may be quite selective in action. Thus, iron precipitates antimony but not tin from a mixture of their salts, and advantage is taken of this to separate antimony from tin. Similarly, aluminum is used to displace copper from solution.

THE USE OF ORGANIC PRECIPITANTS

THEORETICAL CONSIDERATIONS

Among the vast number of organic compounds are some which have the property of yielding an insoluble precipitate with a particular metal ion or with a selected group of metal ions. The most spectacular of these reagents is dimethylglyoxime, which yields the characteristic, red, insoluble nickel compound familiar to all who have studied qualitative analysis. Dimethylglyoxime is an almost ideal reagent for analytical purposes, and a study of the structure and behavior of this compound yields principles which may serve as guides to the discovery and investigation of similar reagents. The general field of organic reagents has been the subject of numerous investigations in recent years as attested by the growing body of literature.¹

¹Among the texts dealing exclusively with the application of organic compounds to qualitative and quantitative analysis should be mentioned the following:

Feigl, *Qualitative Analyse mit Hilfe von Tüpfelreaktionen*, 3rd Ed., Akademische Verlagsgesellschaft, Leipzig, 1938; English translation of practical part: J. Matthews, *Spot Tests*, Nordemann Publishing Company, Inc., New York, 1937; English translation of theoretical part: Oesper, *Specific and Special Reactions*, Elsevier Publishing Company, Inc., New York, 1940.

International Committee on New Analytical Reagents, *Table of Reagents for Inorganic Analysis*, Akademische Verlagsgesellschaft, Leipzig, 1938.

Prodinger, *Organische Fällungsmittel in der quantitativen Analyse*, Die Chemische Analyse, Vol. 37, Ferdinand Enke, Stuttgart, 1937; English translation: Holmes, *Organic Reagents Used in Inorganic Analysis*, Elsevier Publishing Company, Inc., New York, 1940.

The Staff of Hopkin & Williams, *Organic Reagents for Metals*, 3rd Ed., Hopkin & Williams, London, 1938.

Mellan, *Organic Reagents in Inorganic Analysis*, The Blakiston Company, Philadelphia, 1941.

Yoe and Sarver, *Organic Analytical Reagents*, John Wiley & Sons, Inc., New York, 1941.

A few review papers dealing with the application of organic reagents have

Differentiation is made between *specific* reagents, which react with one or perhaps two metals, and *selective* reagents, which react with a number of metals. Few specific reagents are known; but the number of selective reagents is fairly large. By careful regulation of such conditions as the acidity, the concentration range, and the temperature, and by the use of so-called masking reagents, the action of selective reagents may be considerably narrowed and made practically specific. Dimethylglyoxime precipitates nickel only from ammoniacal or very weakly acid solutions, but it precipitates palladium from dilute mineral acid solutions. Thus, although dimethylglyoxime is in a sense only a selective reagent, by the proper control of the acidity of the solution, it is possible to determine two metals successively with but the one reagent. This is perhaps even more striking than if the reagent had been truly specific for only one metal.

The requirements that an organic precipitating agent should meet are much the same as those which any gravimetric precipitation process should fulfill. The reagent should be specific or at least selective in its action. The precipitate formed should be extremely insoluble. The precipitate should be of definite composition and stable on drying and inert toward atmospheric moisture. The precipitate should have a high molecular weight with concomitant low content of metal. The precipitate should be highly colored so as to be the more sensitive as a qualitative test. The method should offer the possibility of being used alternatively as a volumetric method. The reagent should be soluble in water.

No known organic reagent fulfills all of these requirements. Dimethylglyoxime is satisfactory on the first five points but not on the last two. Dimethylglyoxime is insoluble in water; a solution of the compound in alcohol is used as reagent, and its addition to aqueous solutions in more than a slight excess causes precipitation of the reagent itself. This is a source of error in the determination of nickel by dimethylglyoxime.

The insoluble compounds of metals with organic compounds fall into two classes, the normal salts and the inner complex compounds. The former are derived from those organic compounds which are been published, notably that of Feigl, *Ind. Eng. Chem., Anal. Ed.*, **3**, 401 (1936). Reports of recent work by Yoe and coworkers will be found in symposia held by the Virginia Academy of Science during the years 1940 and 1942; see the *Virginia J. Sci.*, **1**, 121-167 (1940); **3**, 1-33 (1942).

purely acidic in character, that is, have no functional groups other than those which furnish replaceable hydrogen atoms. Some fifteen groups are capable of functioning as acids when present in organic molecules. Many of these classes of organic compounds have not been investigated for their use as analytical reagents, others are known to be useless, but some are valuable as precipitating reagents. The simple mono-, and dicarboxylic acids, formic, acetic, oxalic, malonic, and so on, have no selectivity, yielding insoluble compounds with practically all heavy metals from neutral or basic solutions; variation in the acidity of the solutions will occasionally make possible certain separations, as, for example, the separation of thorium from a fairly acid solution as the oxalate. The sulfonic acids are strong acids forming insoluble metallic salts, but again without selectivity. The arsonic acids

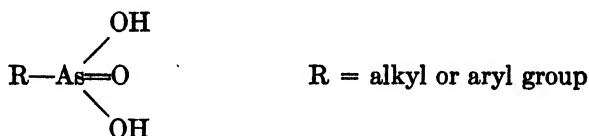

are dibasic acids and exhibit a selective affinity for the metals of the fourth group of the periodic system. Several interesting separations can be effected with such compounds, and these will be considered in detail in a later section of the text. The titanium and zirconium derivatives of the simple arsonic acids are white; by the introduction of a chromophore group into the molecule, the sensitivity of the reagent as a qualitative test may be greatly increased. Feigl and his students prepared *p*-dimethylaminobenzeneazophenyl-arsonic acid ²

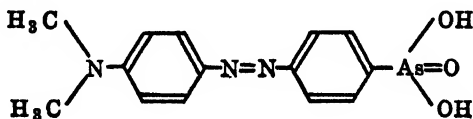

which is purple in color and they found the sensitivity of the derivative as a qualitative test very greatly enhanced over that of the original reagent.

² Feigl, Krumholz and Rajmann, *Mikrochemie*, **9**, 395 (1931); see also the increase in sensitivity of the rhodanine test for silver on the introduction of color, Feigl, *Z. anal. Chem.*, **74**, 380 (1928).

Rhodizonic acid and the analogous, more readily prepared, tetra-hydroxyquinone (T.H.Q.)

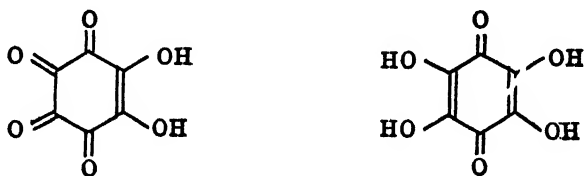

yield colored, insoluble barium salts. So far, these reagents have found use only as indicators in the volumetric determination of sulfate.

The *inner complex* compounds are non-ionic, metallic derivatives of those organic compounds which contain two functional groups so arranged that the metal may become implicated in a ring structure with the organic molecule. The functional groups which react with the metal must be so placed that the union with the metal forms a five- or a six-membered ring, and one of the groups must be acidic and the other coordinating in nature.³ These compounds are non-

³ The concept of secondary or coordinating valence was introduced by Werner to account for the existence of the numerous metal-ammonia compounds. Secondary valences are indicated by dotted lines, and the ammonia molecules or other groups attached non-ionically to the metal atom, in the so-called *coordination sphere*, are enclosed in brackets, thus tetramminocupric chloride is represented

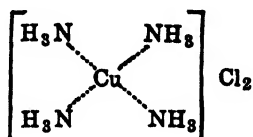

The ammonia molecules in the coordination sphere may be replaced by acid radicals, a corresponding decrease then occurring in the charge on the coordination ion. This successive replacement results in a series of salts of changing ionic character, for example, with bivalent platinum:

[Pt(NH ₃) ₄]Cl ₂	Tetramminoplatinous chloride
[Pt(NH ₃) ₃ Cl]Cl	Chlorotriamminoplatinous chloride
[Pt(NH ₃) ₂ Cl ₂] ⁰	Dichlorodiamminoplatinum
[Pt(NH ₃)Cl ₃]K	Potassium trichloroamminoplatinite
[PtCl ₄]K ₂	Potassium tetrachloroplatinite

all of which are known. Organic amines or any other compound having groups possessing residual valence forces may replace the ammonia and any anion the chloride. When two functional groups occur in the same mole-

polar in character, behaving essentially like organic compounds. They are insoluble in water but soluble in organic solvents. Their colors are striking and widely different from the colors of the normal salts of the metals. They are usually crystalline, of definite composition, and highly stable. They have just the properties required for the purposes of analytical chemistry, and the reagents which form inner complex compounds are, indeed, the most useful type of organic reagent.

The common functional groups which occur in organic compounds reacting with metals are

Acid Groups		Coordinating Groups	
$\begin{array}{c} \text{O} \\ \parallel \\ \text{—C} \\ \diagdown \\ \text{OH} \end{array}$	carboxyl	—NH_2	amino
—OH	enolic hydroxyl	$\begin{array}{c} \diagup \\ \text{N} \\ \diagdown \end{array}$	cyclic amino
=NOH	oxime	=O	carbonyl
$\text{—SO}_3\text{H}$	sulfonic	=NOH	oxime
—SH	mercapto		

The nickel and palladium derivatives of dimethylglyoxime are typical inner complex compounds, having the structure

cule, if they are properly located, both may be attached to the metal, forming a *chelate ring* of five or six members. Three kinds of ring compounds are evidently possible, those derived from organic molecules having two coordinating groups, those from molecules having one coordinating and one acidic group, and those from molecules having two acidic groups:

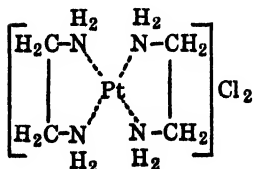

Diethylenediamino-platinous chloride

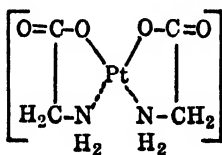

Diglycine platinum

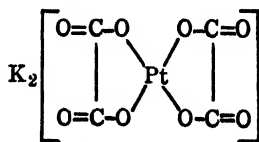

Potassium dioxalato-platinite

Although these compounds are of no interest to the analytical chemist they serve to illustrate the various types of chelate ring compounds. These compounds are members of the first, third, and fifth groups of the above series. The glycine compound is a non-electrolyte; a solution of the compound does not conduct the electric current and reactions for platinum ions fail. This is a typical *inner complex compound*.

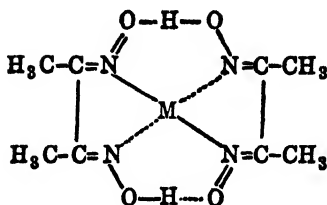

One of the oxime groups of the dimethylglyoxime molecule first undergoes a tautomeric change into the nitrone form:

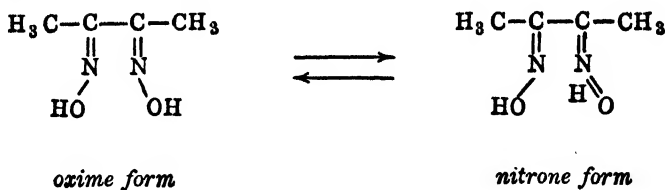

The metal atom becomes attached to the nitrogen of the nitrone group by the replacement of the hydrogen atom. The metal then coordinates to the other oxime group forming a chelate ring structure. The metal atom is part of two such rings. Chemical and other evidence indicates that the hydrogen atoms are shared equally between neighboring oxygen atoms (hydrogen bonding) forming a further ring structure. These compounds are extremely insoluble in water but soluble in chloroform and other organic solvents. They may be sublimed without decomposition.

If the characteristic *ortho*-dioxime structure is preserved, the specificity for nickel is maintained. Among the other dioximes which have been studied are α -furildioxime and *cyclo*-hexanedione-dioxime

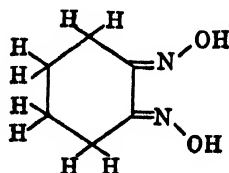
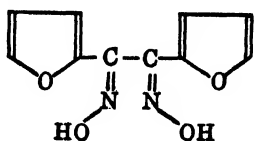

which yield insoluble nickel derivatives and are water soluble, but which have not come into common use as yet.

The organic compound, 8-hydroxyquinoline, also forms typical inner complex compounds with a number of metals

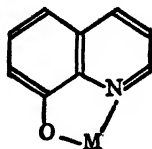

and is finding increasing use as an analytical tool. Other inner complex compounds used in analysis are the cobalt derivative of α -nitroso- β -naphthol (Fig. 16, I), the metallic derivatives of phenylnitrosohydroxylamine, *cupferron* (Fig. 16, II), and the copper derivative of salicylaldoxime (Fig. 16, III). The metallic derivatives of quinaldinic acid (Fig. 16, IV) and of thioglycollic acid- β -aminonaphthalide (Fig. 16, V), which have been used for the determination of various metals, are also inner complex compounds.

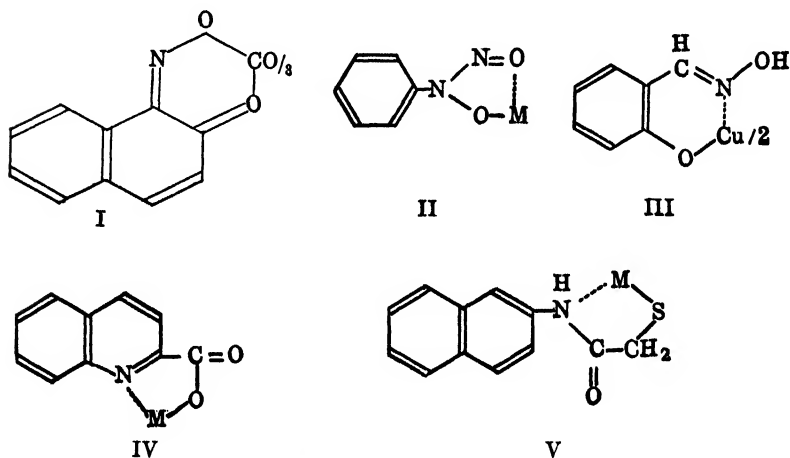

M represents an equivalent of metal

Fig. 16.

In general the inner complex compounds are formed only in weakly acid, neutral, or ammoniacal solutions, and the control of pH during their precipitation is necessary, especially where a separation of chemically similar metals is desired. Of the organic compounds which might possibly yield inner complex compounds of importance to analytical chemistry, only a small part have received study.⁴

⁴For a detailed survey of the field of the chelate ring compounds, see Diehl, *Chem. Revs.*, **21**, 39 (1937).

A few organic bases have found application in analytical chemistry. Benzidine forms a fairly insoluble sulfate and tungstate and has been used for separating these radicals from others. The nitrate ion and a number of other anions are precipitated by a complex heterocyclic nitrogen base known as *nitron*. Triphenyltin chloride, $(C_6H_5)_3SnCl$, has been recommended for the gravimetric determination of fluoride. The alkaloid cinchonine yields an insoluble tungstate and is used to precipitate the last traces of tungsten following its precipitation as the oxide.

DIMETHYLGLYOXIME

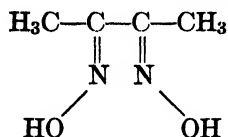

$C_4H_8O_2N_2$
Mol. Wt. 116.12

Dimethylglyoxime is probably the most widely used of the organic precipitating agents. In addition to its use in the determination of nickel gravimetrically, it has a number of other uses, in the colorimetric determination of nickel and in the determination of palladium, iron, copper, cobalt, and bismuth.⁵ Dimethylglyoxime behaves toward the metals as a monobasic acid, a hydrogen of one of the oxime groups being replaced by a metal atom. The metal then coordinates to the nitrogen atom of the second oxime group forming a ring structure. Two such rings surround the metal atom in the cases of the nickel and palladium compounds.

The precipitation of nickel by dimethylglyoxime as the red, insoluble, inner complex compound, $Ni(C_4H_7O_2N_2)_2$, may be made from faintly acid, neutral, or slightly ammoniacal solutions. The precipitate can be dried at 115° and weighed. The method separates nickel from cobalt, manganese, zinc, the alkaline earths, magnesium, and from iron, aluminum, and chromium if sufficient tartrate is present to prevent the precipitation of their hydroxides by ammonia. Although dimethylglyoxime gives a satisfactory separation of nickel from cobalt and from iron when present singly, a brown, amorphous compound containing iron, cobalt, and dimethyl-

⁵ An extensive treatment of the uses of dimethylglyoxime and the dioximes in general will be found in the monograph by Diehl, *The Applications of the Dioximes to Analytical Chemistry*, The G. Frederick Smith Chemical Co., Columbus, 1940.

glyoxime is formed, when iron and cobalt are present together. Ways of circumventing this difficulty as well as a discussion of a number of minor but essential details connected with the determination of nickel by dimethylglyoxime are described in the section devoted to the analytical chemistry of nickel, p. 383.

Palladium is precipitated from dilute mineral acid solution by dimethylglyoxime as a yellow compound, $\text{Pd}(\text{C}_4\text{H}_7\text{O}_2\text{N}_2)_2$, which can be dried and weighed. The composition and structure of the precipitate are strictly analogous to the nickel compound. Since dimethylglyoxime precipitates nickel only from a weakly acid or ammoniacal solution, but precipitates palladium from a dilute mineral acid solution, it is almost a specific reagent for palladium. Gold is reduced to the metal by the reagent, and platinum is partially precipitated, either as the metal or as a greenish complex compound, on boiling the solution. The presence of nitrates in the solution prevents the complete precipitation of palladium.

Small amounts of nickel may escape precipitation by dimethylglyoxime, probably owing to the formation of a quadrivalent nickel compound of dimethylglyoxime. This quadrivalent nickel compound is orange in color and furnishes a sensitive colorimetric method for nickel. Like most inner complex compounds, nickel dimethylglyoxime is soluble in organic solvents. This has been used for the isolation of the small amounts of nickel present in silicate rock. The nickel dimethylglyoxime is extracted from the aqueous, ammoniacal solution by shaking with chloroform, from which it is then recovered by treatment with a dilute hydrochloric acid solution and determined colorimetrically.

Ferrous iron yields a pink, soluble compound with dimethylglyoxime which has sometimes been mistaken for the nickel precipitate. A cupric salt, dimethylglyoxime, and an oxidizing agent give an intense reddish violet color resembling that of permanganate; this is a very suitable colorimetric method for copper. Bismuth, as nitrate or chloride, when treated with dimethylglyoxime and the hot solution made strongly alkaline with ammonia, produces an intense yellow, voluminous precipitate; this is a quite sensitive test for bismuth; sulfate and tartrate interfere.

Two or three methods for the volumetric determination of dimethylglyoxime, and thus indirectly for nickel and palladium, are known, but they have not found much use.

The rather low solubility of dimethylglyoxime in water, 0.40 g. per liter, makes necessary the use of a solution of the reagent in alcohol or acetone. Care must be exercised that only slight excess of the reagent be added; otherwise the reagent itself may be precipitated and contaminate the nickel or palladium precipitate.

CUPFERRON

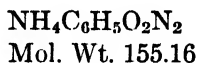
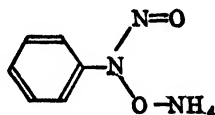

Cupferron, the ammonium salt of phenylnitrosohydroxylamine, yields insoluble compounds with a number of metals.^{6,7} The reagent is much more specific in its action in strongly acid than in weakly acid solutions. From a solution containing 5 to 10 per cent by volume of sulfuric or hydrochloric acid, cupferron precipitates ferric iron, titanium, zirconium, vanadium and tin, separating these elements from aluminum, chromium, manganese, nickel, cobalt, zinc, magnesium, the alkalis and alkaline earths, and from small amounts of phosphorus. A great many other metals are precipitated from weakly acid solution: copper, mercury, bismuth, molybdenum, tungsten, and others. In addition, a number of less common elements are precipitated such as gallium, columbium, and tantalum. The presence of tartrate has no effect on the precipitation of metals by cupferron.

Precipitation with cupferron is widely used to remove metals which would interfere in the determination of other metals. Thus the determination of aluminum is rendered easier by a preliminary separation of ferric iron with cupferron.

Ferrous iron is not precipitated by cupferron from a strongly acid solution, and this furnishes a convenient method of isolating

⁶ Cupferron was introduced as an analytical reagent by Oskar Baudisch in 1909 (*Ber.*, **42**, 3568 (1909); *Chem. Ztg.*, **33**, 1298 (1909)). The name *cupferron* is derived from the fact that the reagent precipitates both iron and copper, but it should not be inferred that the reagent precipitates only these metals.

⁷ A complete treatment of the preparation and storage of the reagent, the solubilities of cupferron metal compounds, the analytical applications of the reagent, and a comprehensive bibliography may be found in the monograph by Smith, *Cupferron and Neo-Cupferron*, The G. Frederick Smith Chemical Company, Columbus, 1938.

small amounts of titanium from large amounts of iron, as in the determination of titanium in steel. Zirconium accompanies titanium in these operations.

Vanadium present in the vanadate state of oxidation is precipitated by cupferron from a strongly acid solution, and in this manner may be separated from hexavalent uranium. The uranium may be subsequently reduced to the quadrivalent state, precipitated by cupferron, and ignited to the oxide, U_3O_8 , for weighing. The precipitation of vanadium with cupferron may also be used to separate it from tungsten, phosphate, and arsenate.

The reagent is usually used as a 6 per cent aqueous solution, which should be made up fresh, since the aqueous solution is not stable for periods longer than a month. Precipitation is always made in the cold as cupferron is decomposed on heating. Sufficient reagent is added to form completely the curdy precipitate of the metallic derivative of cupferron and to give a precipitate of white needles of free phenylnitrosohydroxylamine. The precipitate should be filtered soon after its formation since excess cupferron is not very stable in acid solution. Sulfuric acid or hydrochloric acid solutions may be used for the precipitation, but not nitric acid solutions, as oxidizing agents destroy the reagent. The addition of macerated filter paper aids in the filtration and ignition. The precipitates can not be weighed after drying but must be ignited to the oxide for weighing. The ignition should be done cautiously with a gradual increase in temperature to avoid mechanical loss by the gaseous compounds which are copiously evolved.

Neo-cupferron, the ammonium salt of naphthylnitrosohydroxylamine, $C_{10}H_7N(NO)ONH_4$, forms less soluble and more bulky precipitates and makes possible the direct separation of iron and copper from mineral waters.

8-HYDROXYQUINOLINE (OXINE)

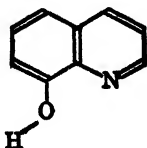

C_9H_7ON
Mol. Wt. 145.15

A variety of metals may be precipitated and determined by precipitation with 8-hydroxyquinoline, and this reagent is now quite

widely used.^{8,9} 8-Hydroxyquinoline is thus a selective rather than a specific agent. The acidity of the solution has a great influence on the precipitation of metals by 8-hydroxyquinoline, however, and by proper control of pH , and by the use of complex-forming agents, the specificity may be greatly increased so that a number of important separations may be made by means of the reagent.

The conditions under which various metals are precipitated by 8-hydroxyquinoline are summarized in Table III. A few metals may be precipitated from fairly concentrated acetic acid solutions; but many more are precipitated only from solutions well buffered with acetate. Some precipitations are made from ammoniacal solutions and others from sodium hydroxide solutions containing tartrate. In a number of cases precipitation is complete only over a limited pH range, and the solubility on either side increases the possibilities of effecting separations.

Titanium, aluminum, ferric iron, and a number of bivalent metals such as copper, zinc, cadmium, cobalt, and nickel are precipitated from solutions buffered with acetate, while beryllium, magnesium, lead, the alkali and alkaline earth metals are not precipitated. The separation of aluminum from beryllium and from phosphate in this manner furnishes about the only completely acceptable method of making these separations. The separation of ferric iron from aluminum, and of the bivalent metals from one another by careful control of pH is possible in many cases, but in others is restricted by coprecipitation.

A few precise studies of the effect of pH on the precipitation of metals by 8-hydroxyquinoline have been made;^{10,11,12} the permissible pH ranges for the precipitation of various metals is given in

⁸ The extensive literature dealing with the uses of 8-hydroxyquinoline has been summarized in the monograph by Berg, *Das O-Oxychinolin*, Die Chemische Analyse, Vol. 34, Ferdinand Enke, Stuttgart, 2nd Ed., 1938; see also *Organic Reagents for Metals*, Hopkin and Williams, London, 3rd Ed., 1938, p. 65.

⁹ The common name *Oxin* or *Oxine*, from which is derived *oxinate* referring to the metallic derivatives of the reagent, is found in the German literature.

¹⁰ Fleck and Ward, *Analyst*, **58**, 388 (1933).

¹¹ Fleck, *Analyst*, **62**, 378 (1937).

¹² Goto, *J. Chem. Soc. Japan*, **54**, 725 (1933), **56**, 314 (1935); *C.A.*, **27**, 5674 (1933), **29**, 3936 (1935).

TABLE III. THE PRECIPITATION OF METALS BY 8-HYDROXYQUINOLINE
(HOx = 8-Hydroxyquinoline)

Metal	Permissible pH for Complete Precipitation	Conditions for Precipitation	Composition after Drying; Recommended Method for Determination
In	2.5-3.0	Acetic acid soln.; not pptd. from alkaline soln.	InO ₂ at 110°.
Fe ⁺⁺⁺	2.8-11.2	Acetic acid soln.; not from alkaline-tartrate soln.	FeO ₃ at 120°.
MoO ₄ ⁻⁻	3.6-7.3	Acetic acid soln.	MoO ₂ Ox ₂ at 130-140°; vol. method impossible due to insol. of empd. in acids.
Al	4.2-9.8	Acetate buffered, ammoniacal, or ammoniacal-tartrate soln.	AlOx ₃ at 130°.
Co	4.4-14.5	Acetate buffered soln.	Pptd. as CoOx ₂ ·2 H ₂ O but variable composition on drying. Vol. method recommended or ignition to Co ₃ O ₄ .
Ni	4.3-14.5	Acetate buffered soln.	Like cobalt; best determined volumetrically or ignited to the oxide.
Zn	6.0-13.4	Acetate buffered, ammoniacal, or alkaline-tartrate soln.	ZnOx ₂ at 130-140°.
Th	4.4-8.8	Acetate buffered soln.	ThOx ₄ at 150-160°.
Ti	4.8-8.6	Acetate buffered or ammoniacal-tartrate soln.; not from alkaline-tartrate soln.	TiOx ₂ at 110°.

TABLE III. THE PRECIPITATION OF METALS BY 8-HYDROXYQUINOLINE—*Cont.*
(HOX = 8-Hydroxyquinoline)

Metal	Permissible pH for Complete Precipitation	Conditions for Precipitation	Composition after Drying; Recommended Method for Determination
Zr		Acetate buffered soln.; chloride and sulfate must not be present.	ZrOx ₄ at 130°.
Bi	4.8-10.5	Acetate buffered, or ammoniacal-tartrate soln.; not from alkaline-tartrate soln.	BiOx ₃ at 130-140°.
WO ₄ ⁻⁻	5.0-5.6	Acetate buffered soln.	WO ₂ Ox ₂ at 120°; vol. method impossible due to insol. of compd. in acids.
Cu	5.4-14.5	Acetate buffered, ammoniacal-, or alkaline-tartrate soln.	CuOx ₂ at 105-110°; bromate vol. method inapplicable.
Cd	5.6-14.5	Acetate buffered, ammoniacal or alkaline soln.	CdOx ₂ at 130°.
UO ₂ ⁺⁺	5.7-9.8	Acetate buffered soln.	UO ₂ Ox ₂ at 200°.
Mn	5.9-10.0	Acetate buffered soln.	Difficult to dry to constant weight; best ignited to Mn ₃ O ₄ .
Ga	7.0-8.0	Strictly neutral soln.; tartrate may be present.	GaOx ₃ at 110°.
Pb	8.5-9.5	Weakly alkaline soln.	PbOx ₂ at 105°.
Mg	9.5-12.6	Ammoniacal, alkaline, or alkaline-tartrate soln. Large amounts of ammonium salts have no effect.	MgOx ₂ ·2 H ₂ O at 105-110°. MgOx ₂ at 130-140°.

Table III, and a few are shown graphically in Fig. 17. In simple cases, the desired pH for these precipitations may be obtained by the addition of specified amounts of acetic acid and sodium hydroxide,¹¹ but in practice, the actual measurement of pH using the glass electrode or other system is necessary.

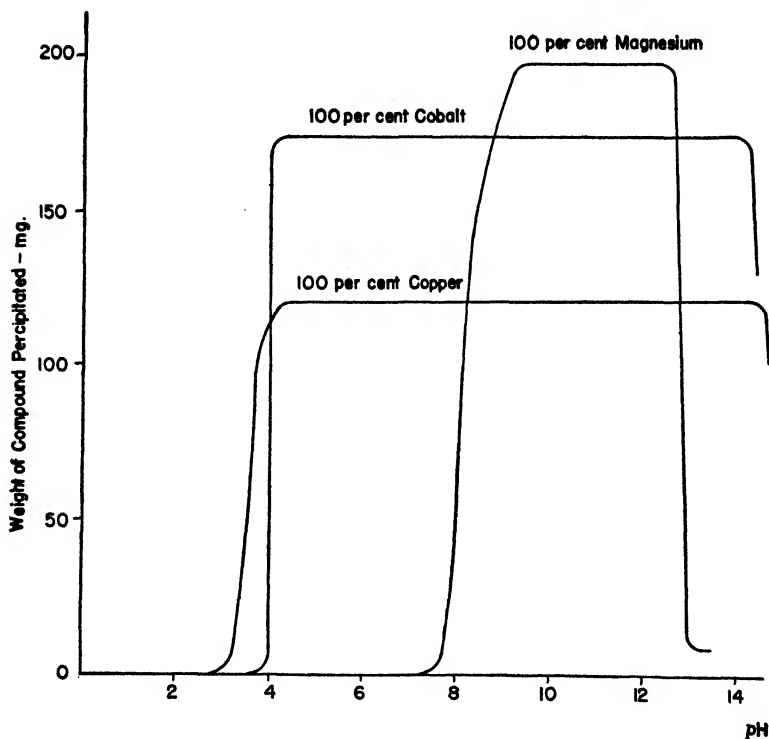

FIG. 17. Permissible pH Range for the Precipitation of Copper, Cobalt, and Magnesium with 8-Hydroxyquinoline. Data of Fleck and Ward.¹⁰

The values of pH at which metals may be precipitated when present in solution alone is not an entirely reliable guide to the pH at which one may be separated from another.¹³ Thus, although magnesium when present alone begins to precipitate when the pH exceeds 7.5, when zinc is precipitated in the presence of magnesium, a partial precipitation of magnesium begins at a pH of 5.5, two pH units below the point of normal precipitation; for the successful

¹³ Moyer and Remington, *Ind. Eng. Chem., Anal. Ed.*, **10**, 212 (1938).

separation of zinc from magnesium then, the *pH* must be held between 4.6 and 5.5.

Aluminum, lead, quadrivalent tin, quinquivalent arsenic, quinquivalent antimony, bismuth, trivalent chromium, and trivalent iron are not precipitated by 8-hydroxyquinoline from an alkaline solution containing tartrate. On the other hand, copper, magnesium, zinc, cadmium, and a number of other metals are precipitated and may thus be separated from the metals just mentioned.

The separation of magnesium is of particular interest in that it makes possible the separation of magnesium from the alkali metals without the addition of phosphate. The presence of large amounts of ammonium salts does not disturb the precipitation of magnesium; it does, however, prevent the precipitation of the alkaline earths, and it is possible in this manner to separate magnesium from large amounts of calcium, strontium, and barium.¹⁴

8-Hydroxyquinoline is a yellow, crystalline material, melting at 74-76°. It is almost insoluble in water. A 3 per cent solution of 8-hydroxyquinoline in methyl or ethyl alcohol or in acetone is used as reagent; it is best if freshly prepared, although stable for 10 days if protected from light. An acetic acid solution of the reagent may also be used; this is prepared by dissolving 3 g. of the solid in the minimum amount of glacial acetic acid, diluting to 100 ml. with water, adding ammonia dropwise until a turbidity begins to form, and then clarifying the solution by the addition of dilute acetic acid. Such a solution is stable for a much longer period.

A sufficient excess of the reagent colors the solution yellow if acidic and orange-yellow if alkaline. Precipitation must generally be made from a hot solution in order to obtain a crystalline precipitate. The precipitates are easily filtered, and any of the usual filtering media may be used. The appearance of a turbidity in the filtrate is usually due to excess reagent crystallizing out and should disappear on warming.

Some of the metal derivatives of 8-hydroxyquinoline may be weighed as such after drying at a suitable temperature. Drying at 105-110° frequently leaves water of crystallization, but obtaining constant weight may be tiresome, especially with large amounts of precipitate; sometimes, too, the compounds are appreciably decomposed at this temperature.

¹⁴ Berg, *loc. cit.*, p. 34; *Z. anal. Chem.*, **71**, 23 (1927).

Ignition to the oxide frequently yields a more suitable form for weighing but caution must be exercised to prevent loss since many of the metallic derivatives are volatilized on heating. In such cases the material is covered with a layer of oxalic acid and the heating carried out gradually.

The determination may also be concluded volumetrically by a reaction based on the bromination of 8-hydroxyquinoline to 5,7-dibrom-8-hydroxyquinoline. The precipitate is dissolved in hydrochloric acid, and an excess of a standard bromate-bromide mixture added. A few drops of indigo-carmin or methyl red are added to indicate when this excess has been added, the color changing first to a blue, then to a red, and when an excess has been added, to a yellow. Potassium iodide is then added and the iodine liberated titrated with standard thiosulfate. After the addition of the iodide a chocolate colored precipitate generally forms, an iodine addition product, which dissolves during the titration with thiosulfate, yielding a clear yellow solution or one which contains a little yellow silky turbidity, so that the end-point with starch may be found in the usual manner. Occasionally, the dark colored material may not dissolve readily and may cause a return of the starch-iodine color, introducing an uncertainty into the end-point; this may be avoided by keeping the solution well diluted and avoiding a large excess of bromate. It has also been found that the addition of carbon disulfide before the addition of the potassium iodide obviates this trouble.¹⁵ The reactions for the determination of aluminum in this manner are:

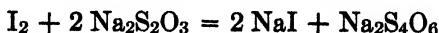
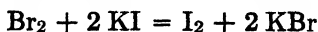
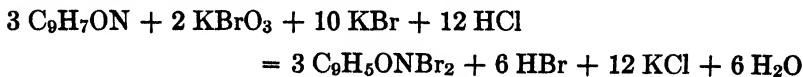
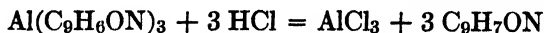
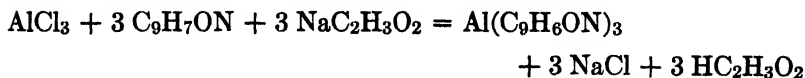

¹⁵ Fleck, Greenane and Ward, *Analyst*, **59**, 325 (1934). For a more recent study of this titration see Smith, *Analyst*, **64**, 577 (1939).

It will be observed that four bromine atoms enter into reaction with each molecule of 8-hydroxyquinoline, and that the equivalent weight of aluminum in this reaction is therefore one twelfth the atomic weight, which is very low and very favorable.

The determination is sometimes made by adding a definite amount of 8-hydroxyquinoline, filtering off the precipitate, and titrating the excess 8-hydroxyquinoline in the filtrate. The reagent is volatilized from hot solutions so that the method is only applicable where a crystalline, easily filtered precipitate can be made in the cold, as with iron and magnesium.

An excess of the reagent may be removed from solution in order to facilitate further determinations on the filtrate following a separation by 8-hydroxyquinoline by extracting the alkaline solution with ether, or by evaporating the ammoniacal solution with occasional addition of dilute ammonia solution, the 8-hydroxyquinoline being quite completely removed by volatilization.

α -NITROSO- β -NAPHTHOL

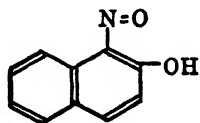

$C_{10}H_7O_2N$
Mol. Wt. 173.16

This reagent precipitates quantitatively cobalt, copper, iron, and palladium from slightly acid solutions. It precipitates partially any tin, silver, chromium, uranium, and bismuth present. It does not, however, precipitate mercury, lead, cadmium, arsenic, antimony, aluminum, beryllium, manganese, zinc, nickel, calcium, magnesium, or the alkali metals.¹⁶

The chief use of α -nitroso- β -naphthol is in the separation of cobalt from large amounts of nickel after any iron present has been removed. The precipitation is made from a dilute hydrochloric acid solution and as the precipitate is extremely bulky, the amount of cobalt is best limited to about 0.1 g. The red precipitate is a cobaltic compound containing reduction products of the reagent, and being of indefinite composition can not be weighed as such. The organic material is burned away carefully and the cobalt weighed

¹⁶ A bibliography on the uses of α -nitroso- β -naphthol may be found in *Organic Reagents for Metals*, Hopkin and Williams, 3rd Ed., p. 88, London, 1938.

as the oxide, Co_3O_4 , or as the metal. It has been stated that a precipitate of theoretical composition can be obtained if the cobalt is first oxidized to the trivalent state;¹⁷ the rate at which the cobaltic hydroxide redissolves, following the alkaline oxidation of the cobalt, is so slow as to make the method impracticable, however.

α -Nitroso- β -naphthol is a brown powder melting at 109° . It is insoluble in water, but soluble in alcohol, benzene, and acetic acid. A solution of 10 g. of the compound in 500 ml. of 50 per cent acetic acid is usually used as reagent, but it has also been recommended that the reagent be freshly prepared for each use by dissolving 1 g. in 15 ml. of glacial acetic acid.¹⁸

α -BENZOINOXIME (CUPRON)

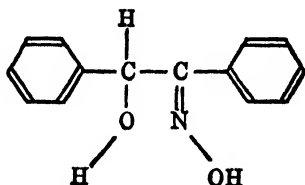

$\text{C}_{14}\text{H}_{13}\text{O}_2\text{N}$
Mol. Wt. 227.25

α -Benzoinoxime is specific for copper in ammoniacal solutions containing tartrate, yielding a green, slightly soluble copper compound, $\text{CuC}_{14}\text{H}_{11}\text{O}_2\text{N}$. Copper may be separated in this manner from cobalt, nickel, cadmium, zinc, aluminum, lead, and small amounts of iron. The precipitate is dried at 110° to constant weight for weighing.

From mineral acid solutions, α -benzoinoxime precipitates hexavalent molybdenum as a grayish white material, probably $\text{Mo}(\text{C}_{14}\text{H}_{11}\text{O}_2\text{N})_3$. Tungstate, chromate, vanadate, columbium, tantalum, and palladium are partially precipitated. The molybdenum compound must be ignited to the oxide for weighing. The method has been applied successfully to the determination of molybdenum in steel.¹⁹

α -Benzoinoxime is a white, crystalline powder, melting at 152° ; it is sparingly soluble in water, but fairly soluble in alcohol. A 2 per cent solution of the compound in alcohol is used as reagent.

¹⁷ Mayr and Feigl, *Z. anal. Chem.*, **90**, 15 (1932).

¹⁸ Hoffman, *Bur. Standards J. Research*, **7**, 885 (1931), **8**, 659 (1932).

¹⁹ Knowles, *Bur. Standards J. Research*, **9**, 1 (1932).

SALICYLALDOXIME

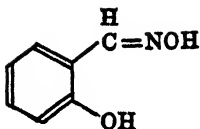

With various bivalent metals salicylaldehyde yields insoluble compounds corresponding to the formulas $\text{M}(\text{C}_7\text{H}_6\text{O}_2\text{N})_2$ or $\text{MC}_7\text{H}_5\text{O}_2\text{N}$. Salicylaldehyde was originally proposed by Ephriam for the determination of copper²⁰ and has subsequently been applied to the determination of nickel,²¹ zinc,^{22,23} lead,^{24,25} bismuth,²³ and palladium.²⁶ As with similar reagents, the pH of the solution is highly important, particularly if a separation of one bivalent metal from another is desired. The precipitation of copper is complete at a pH of 2.6. Nickel begins to precipitate at a pH of 3.3, and thus the pH must be adjusted to the range 2.6 to 3.3 if a separation of copper from nickel is desired.²⁷ Ferric iron is carried down with copper salicylaldehyde and interferes seriously, particularly if the precipitation is made from an acetic acid solution.^{20,27} Cadmium, zinc, silver, arsenic, and mercury do not interfere in the separation of copper. The determination of nickel with salicylaldehyde is also very satisfactory.²¹ The copper and nickel compounds are dried at 110° and weighed as anhydrous compounds having the composition $\text{M}(\text{C}_7\text{H}_6\text{O}_2\text{N})_2$ and containing 18.94 per cent copper and 17.74 per cent nickel respectively.

Zinc is quantitatively precipitated by salicylaldehyde at a pH between 7 and 8; the material first precipitated corresponds to the formula $\text{Zn}(\text{C}_7\text{H}_6\text{O}_2\text{N})_2$ but on digestion at 90° for 10 minutes is converted to $\text{ZnC}_7\text{H}_5\text{O}_2\text{N}$. The latter compound may be dried at 110° and weighed directly, the theoretical factor for zinc, 0.3261, being applicable.^{22,23}

²⁰ Ephriam, *Ber.*, **63**, 1928 (1930), **64**, 1215 (1931).

²¹ Riley, *J. Chem. Soc.*, **1933**, 895.

²² Pearson, *Z. anal. Chem.*, **112**, 179 (1938).

²³ Flagg and Furman, *Ind. Eng. Chem., Anal. Ed.*, **12**, 663 (1940).

²⁴ Ishibashi and Kishi, *Bull. Chem. Soc. Japan*, **10**, 362 (1935).

²⁵ Ligett and Biefeld, *Ind. Eng. Chem., Anal. Ed.*, **13**, 813 (1941).

²⁶ Holzer, *Z. anal. Chem.*, **95**, 392 (1933).

²⁷ Biefeld and Howe, *Ind. Eng. Chem., Anal. Ed.*, **11**, 251 (1939).

Bismuth may be precipitated quantitatively by salicylaldoxime in solutions of *pH* 7.2 to 9.4 or higher; ²⁸ silver and zinc are not precipitated with bismuth at *pH* values above 9. The bismuth compound must be ignited to bismuth sesquioxide, Bi₂O₃, for weighing.

Although lead begins to precipitate with salicylaldoxime at a *pH* of 4.8, it is only at a *pH* above 8.9 that it has a sufficiently definite composition for weighing; the compound is then PbC₇H₅O₂N containing 60.53 per cent lead. Lead may be separated from silver, cadmium, and zinc in strongly ammoniacal solutions in this manner.^{25, 28}

Salicylaldoxime is a white, crystalline powder, melting at 57°. The reagent solution is prepared by dissolving 1 g. of the material in 5 ml. of alcohol and diluting to 100 ml. with water.

THE ARSONIC ACIDS

PHENYLARSONIC ACID

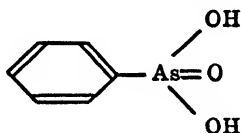

C₆H₅AsO₃H₂
Mol. Wt. 202.03

p-HYDROXYPHENYLARSONIC ACID

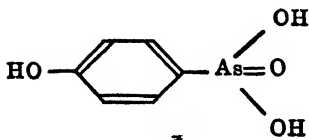

C₆H₅OAsO₃H₂
Mol. Wt. 218.03

n-PROPYLARSONIC ACID

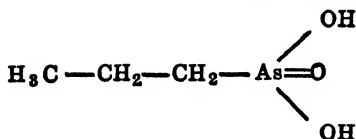

C₃H₇AsO₃H₂
Mol. Wt. 168.02

p-n-BUTYLPHENYLARSONIC ACID

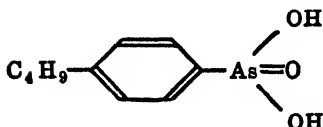

C₁₀H₁₃AsO₃H₂
Mol. Wt. 258.13

²⁸ Biefeld and Ligett, *Ind. Eng. Chem., Anal. Ed.*, **14**, 359 (1942).

A number of alkyl and aryl arsonic acids have been studied as analytical reagents by Chandlee and his coworkers. The arsonic acids are specific for the quadrivalent metals of Period Group IV.

Phenylarsonic acid was originally employed as a reagent for thorium.²⁹ It also precipitates tin from fairly concentrated acid solutions and separates it from all of the common elements excepting titanium and zirconium.³⁰

p-Hydroxyphenylarsonic acid³¹ yields precipitates with titanium and with zirconium from acid solutions and affords very excellent methods of separating these elements from iron and all of the common elements except tin and quadrivalent cerium. Hydrogen peroxide prevents the precipitation of titanium but does not affect the precipitation of zirconium so that a separation of the two elements may be accomplished with the reagent.

n-Propylarsonic acid³² precipitates zirconium but not titanium even in the absence of hydrogen peroxide. None of the common alloying elements with the exception of tin interfere so that the method may be applied to the determination of zirconium in steel. Tin carried down by the precipitate may be later volatilized as stannic iodide.

p-n-Butylphenylarsonic acid³³ precipitates ferric iron quantitatively from mineral acid solutions and separates it from all of the common elements but the quadrivalent elements, titanium, zirconium, tin, thorium, and cerium.

Phenylarsonic acid, *p*-hydroxyphenylarsonic acid and *n*-propylarsonic acid are available on the market. All of the precipitates of the metals with arsonic acids must be ignited to the oxide for weighing. This ignition should not be carried out in a platinum crucible and the ignition must be made at as high temperatures as permissible to eliminate all of the arsenic.

TETRAPHENYLARSONIUM CHLORIDE

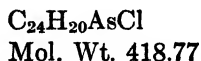
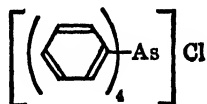

²⁹ Rice, Fogg and James, *J. Amer. Chem. Soc.*, **48**, 895 (1926).

³⁰ Knapper, Craig and Chandlee, *J. Amer. Chem. Soc.*, **55**, 3945 (1933).

³¹ Simpson and Chandlee, *Ind. Eng. Chem., Anal. Ed.*, **10**, 642 (1938).

³² Arnold and Chandlee, *J. Amer. Chem. Soc.*, **57**, 8, 591 (1935); Geist and Chandlee, *Ind. Eng. Chem., Anal. Ed.*, **9**, 169 (1937).

³³ Craig and Chandlee, *J. Amer. Chem. Soc.*, **56**, 1278 (1934).

Tetraphenylarsonium chloride is a strong electrolyte which precipitates quantitatively the perchlorate, permanganate, perrhenate, and periodate ions. A number of anions, such as iodide, thiocyanate, and molybdate, also form insoluble compounds. The reagent also forms insoluble double chlorides with bivalent mercury, cadmium, zinc, and quadrivalent tin, and is useful in the determination of these metals. The determination may also be made volumetrically.⁸⁴

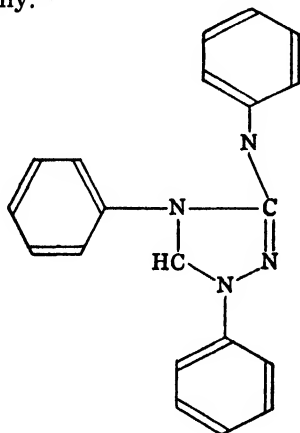

NITRON

$C_{20}H_{16}N_4$
Mol. Wt. 312.36

The organic base 1,4-diphenyl-3,5-phenylimino-4,5-dihydro-1,2,4-triazole, which is given the common name *nitron*, yields a fairly insoluble nitrate, $C_{20}H_{16}N_4 \cdot HNO_3$, containing 16.52 per cent NO_3 . Perchlorate and perrhenate also form insoluble salts and can be determined in a similar manner. Several anions, chlorite, bromide, iodide, thiocyanate, nitrite, chromate, ferrocyanide, and ferricyanide, interfere by forming more or less insoluble compounds with the reagent.

The organic base is a yellow crystalline material melting at 189° . A 10 per cent solution of the base in five per cent acetic acid is used as reagent. The precipitation of nitrate is made from a very weakly acid solution containing not more than 0.1 g. of nitric acid in a volume of 80-100 ml. The solution is best cooled in ice before filtration, and the precipitate is dried at 110° and weighed directly.⁸⁵

⁸⁴ Willard and G. M. Smith, *Ind. Eng. Chem., Anal. Ed.*, **11**, 186, 269, 305 (1939).

⁸⁵ For detailed information see Cope and Barab, *J. Amer. Chem. Soc.*, **39**, 504 (1917); Heck, Hunt and Mellon, *Analyst*, **59**, 18 (1934); Prodinge,

DIPHENYLTHIOCARBAZONE (DITHIZONE)

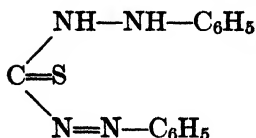

$\text{C}_{13}\text{H}_{12}\text{N}_4\text{S}$
Mol. Wt. 256.32

Dithizone is a black crystalline material which yields characteristic colors with a number of the heavy metals. Not strictly a precipitating agent, dithizone owes its usefulness to the fact that the compounds it forms with the heavy metals are soluble in organic solvents and may thus be extracted and isolated. Since its introduction by Hellmut Fischer in 1926 dithizone has been subjected to very extensive study particularly as applied to the determination of lead.⁸⁶

The reagent is insoluble in water but soluble in carbon tetrachloride and chloroform forming a green solution. A solution of 0.1-0.03 g. of dithizone in a liter of chloroform is usually employed as reagent. It is soluble in ammonia and extracted from organic solvents by basic aqueous solutions. It is oxidized by mild oxidizing agents to a yellow material which is soluble in chloroform but not in water or alkaline, aqueous media and does not react with the metals. This inactive material may be reduced back to dithizone by hydroxylamine or a sulfite. A chloroform solution of dithizone is fairly stable in the dark at room temperature but it has been recommended that the solution be overlaid by a weak solution of sulfur dioxide.

Dithizone is not specific in its action and separations are achieved by extraction of the metal dithizonates with organic solvents only by closely observing the condition of acidity and by varying the extracting liquid and the complex-forming agents present in the aqueous phase. The range of *pH* over which the various metals are extracted quantitatively varies greatly; for example, lead is extracted over the range of 9 to 11, mercury at any *pH* greater than 2, and so on; sufficient data of this sort are not yet available *Organic Reagents Used in Quantitative Inorganic Analysis*, Elsevier Publishing Company, New York, 1940, p. 48.

⁸⁶ For more extensive reviews of the applications and possibilities of this reagent, see Fischer, *Angew. Chem.*, **46**, 442 (1933); **47**, 685 (1934); **50**, 919 (1937), and Wichmann, *Ind. Eng. Chem., Anal. Ed.*, **11**, 66 (1939); references to the determination of specific metals may be found in the latter part of this book under the individual metals, e.g., lead, thallium, mercury.

and the conditions for carrying out the separations have been established empirically in most cases.¹

The dependence of the distribution of the metal dithizonates between the aqueous phase and the immiscible solvent on the acidity of the aqueous phase makes it possible to return the metal to an aqueous phase for its final determination. Thus lead is extracted as the dithizonate with chloroform, the chloroform solution then treated with a 1 per cent nitric acid solution, the lead passing into the acid layer, and the lead finally determined by a suitable method. This process of stripping the metal from the immiscible solvent is very useful. The metal dithizonates also vary in their stability toward alkalis.

Citrate and tartrate are added to prevent the precipitation of hydroxides or phosphates with metal dithizonates in alkaline solution; they do not hinder the extraction. Other complex forming materials do prevent the extraction. The cyanide complexes of most of the metals are stronger than the dithizone complexes; the exceptions are lead, bismuth, stannous tin, and thallium. Therefore the last three metals are extracted together with lead from a cyanide solution. Thiosulfate and iodide act as masking agents in a similar manner in acid solutions, and other such agents used in conjunction with variation in pH make possible quite a variety of separations.

Following the isolation of a heavy metal by extraction of the dithizonate with chloroform or carbon tetrachloride, the metal may be returned to an aqueous solution for determination by one of the methods characteristic of the particular metal.

The determination may also be concluded by a colorimetric measurement of the chloroform or carbon tetrachloride solution of the metal dithizonate. Dithizone itself imparts a green color to the solution and either the excess reagent must be removed or provision made for its compensation. In the so-called *one-color* methods the excess reagent is removed by extraction with dilute ammonia; care must be exercised that the metal dithizonate is not simultaneously decomposed. In the *mixed-color* methods, the excess is not removed but allowed to partition between the aqueous and solvent phases and to modify the color of the extracted metal dithizonate according to the relative amounts of the metal and reagent. Thus in the case of lead, a series of colors from green to red with intermediate blues and purples may be obtained. The shades of these solutions are

matched with standards rather than the intensities as in the usual colorimetric work.

The two-color process can be more accurately carried out with a photo-electric colorimeter in conjunction with suitable filters which permit measurement of the transmittancy at two wave lengths, at the wave lengths corresponding to the adsorption maxima of the metal dithizonate and dithizone. It is necessary to combine the readings mathematically to obtain the results.³⁷ The spectrophotometer, now becoming available as a comparatively inexpensive analytical instrument, will probably greatly improve this process by yielding a method by which the colorimetric measurements can be made over a much narrower band of wave lengths than is possible with filter instruments.

Although a large portion of the work with dithizone has been devoted to lead, the methods for copper, zinc, mercury, silver, cadmium, and thallium have been worked out in fair detail. The interferences by such metals as tin, bismuth, cobalt, nickel, iron, and the platinum metals have been fairly well established. In general dithizone is applicable over the range of 0.1-200 micrograms of metal.

It is absolutely essential, when working with very small amounts of materials, such as separated and determined by dithizone, that the dishwashing be thorough. Only pyrex, vycor, or quartz-ware should be used, and as adsorption and de-adsorption are considerable, it is best that the vessels be finally rinsed with 10 per cent nitric acid and then several times with redistilled water. Solutions in which traces of the heavy metals are to be determined should never be filtered, precipitates should not be allowed to form in them, and the number of times the solution is transferred should be held at a minimum. The usual precautions, such as never laying down a stopper or stirring rod, keeping the hands clean, checking the purity of all reagents, etc., should be more rigidly followed. Zinc is generally the most abundant of interfering elements in trace analysis.

METHODS OF CONCLUDING THE DETERMINATION

Preliminary Note. In a strict sense this section of the discussion of the various general operations of quantitative analysis should

³⁷ Kozelka and Kluchesky, *Ind. Eng. Chem., Anal. Ed.*, **13**, 484 (1941).

contain detailed descriptions of the various ways of concluding the determination of the elements following their separation by one or more of the methods outlined in the preceding section. However, the subjects of gravimetric and volumetric analysis have been well described in the elementary book both from the theoretical and the manipulative viewpoints. Thus, Chapter XV of Willard and Furman, 3rd Ed., pp. 288-314, covers the various factors which are involved in a gravimetric analysis: the conditions which determine solubility, the phenomena of adsorption and co-precipitation, the choice of wash liquids, and the precautions to be observed during drying and ignition. The early chapters of the beginning book treat in detail the three types of volumetric reactions, acid-base, oxidation-reduction, and precipitation.

Thus, the following section of this text does little more than supplement the material to be found in the elementary book, and it is, therefore, rather miscellaneous in character. The topics of gravimetric and volumetric analyses have not been covered exhaustively, but the combined material of the two books supplies sufficient information to provide the working analyst with all of the knowledge he requires. For more complete treatment of gravimetric and volumetric analysis, various specialized treatises are available: see the bibliography in Willard and Furman, 3rd. Ed., pp. 480-492.

The subject of colorimetric analysis is discussed only superficially in the beginning book and is therefore given a more extended treatment in this volume. A short section is also devoted to catalytic methods which can be used for the quantitative determination of certain of the heavy metals.

ABSORBENTS FOR WATER AND CARBON DIOXIDE

For the removal of a constituent from a gaseous mixture, liquids are in general poorer absorbents than solids. They are particularly inefficient when the rate of gas flow is great, although devices which break up the gas stream into fine bubbles materially improve the absorption. Thus, in the determination of carbon and hydrogen by the absorption of carbon dioxide and water from the combustion products of an organic compound, liquid absorbents are satisfactory since the combustion is invariably carried out slowly. On the other hand, liquid absorbents are not sufficiently rapid for use in the determination of carbon in steel where the combustion must neces-

sarily be carried out very rapidly with gas flows of at least 200 ml. per minute.

Solids used as absorbents, however, must be porous. Stick potassium hydroxide is not very satisfactory because it rapidly becomes covered with a protective surface coating, and for the same reason phosphorus pentoxide will take up only a small part of the water it would theoretically be expected to absorb; on the other hand, anhydrous magnesium perchlorate, which is highly porous and does not develop a surface coating, will absorb up to 60 per cent of its weight of water with its efficiency unimpaired.

As the amount of absorbent used must be fairly large and since the apparatus containing it is bulky, precautions must be observed in determining its weight. Surface moisture, electrification, and changes in atmospheric pressure are the greatest sources of trouble. The amount of water adsorbed on the relatively large surface of an absorption vessel will vary with the humidity, which may change appreciably between the two weighings. This difficulty is very simply eliminated by the use of a counterpoise of the same material and size. The counterpoise is treated in exactly the same manner as the absorption vessel, and in all careful work absorption vessels are weighed in this manner. Conveniently, the counterpoise is also filled with the absorbent and the two tubes are used alternately or the second employed when the first has been exhausted. Electrification invariably accompanies wiping and may lead to errors as high as 10-20 mg. Such charges are sometimes troublesome to remove, particularly on dry days. Conveying away the charge by a grounded wire is not always successful with a glass vessel since the glass is not a conductor and since the charge is not uniformly distributed. The presence in the balance case of a small amount of radioactive material is frequently helpful.

A variety of absorption bulbs are available for holding liquid and solid reagents; a few of the commonly used vessels for solids are shown in Fig. 18.

Absorbents for Carbon Dioxide. All of the absorbents for carbon dioxide take advantage of the acidic character of the gas and are themselves therefore alkalis. Being alkaline, the reagents are not specific for carbon dioxide but also absorb other acidic gases such as hydrogen sulfide and sulfur dioxide.

Of the liquid absorbents, a strong *potassium hydroxide solution* is the most commonly used. Sodium hydroxide solutions are seldom used since sodium carbonate is insoluble in strong sodium hydroxide and the precipitate which quickly forms tends to plug up the small openings in the apparatus necessary for the production of fine bubbles. On the other hand, potassium carbonate is soluble in concentrated potassium hydroxide solution. The potassium hydroxide solution must be followed by a drying agent which is weighed along

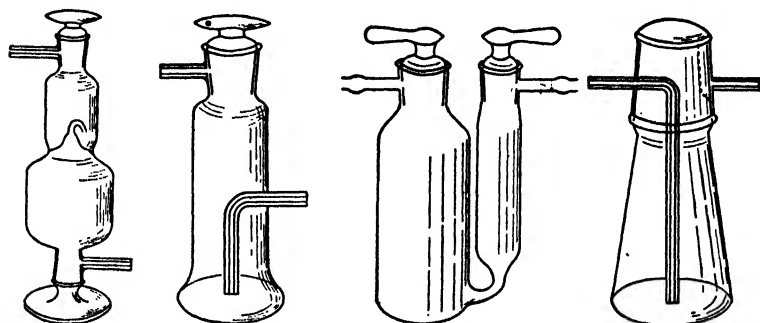

(a) Fleming Bulb (b) Miller Bulb (c) Wesson Bulb (d) Turner Bulb

FIG. 18. Absorption Bulbs.

with the caustic solution to prevent the loss of water from the absorption tube.

Barium hydroxide solutions are occasionally used, the determination being carried out either by titrating the excess barium hydroxide (it is not necessary to filter off the barium carbonate) or by filtering off, drying, igniting, and weighing the barium carbonate precipitated.

Two common, solid absorbents for carbon dioxide are available. *Soda-lime*, which is prepared by evaporating a solution of sodium and calcium hydroxides, is cheap and efficient. A much better absorbent is *Ascarite*, a composition of sodium hydroxide and asbestos. Ascarite acts as its own indicator, turning from gray to white as it is used up. An absorption tube should never be used after half of the ascarite has changed color. As soda-lime and ascarite are only fair drying agents, they are always followed by a drying agent

which insures the retention of the water produced by the absorption of the carbon dioxide.

Absorbents for Water. The major part of the water in an air stream being used to sweep out a solution, as for example in the evolution method for carbon dioxide (see p. 317), can be effectively removed by a water-cooled reflux condenser. The same principle using liquid air as the cooling medium is the most efficient desiccating agent known. The common solid drying agents, however, are more readily available and convenient to handle, although for extremely precise work the uncertainty of the density of the product of absorption makes the vacuum correction doubtful so that the condensing trap method must be used.¹

One precaution which should always be observed in all systems used for the determination of water is that the gas used to sweep out the apparatus must be dried with the same desiccant which is used for absorbing the water.

The efficiency of various drying agents has received considerable study and because the values found in the literature vary, the results of two summaries are given in Table IV; those in the column on the right are probably more consistent among themselves since they were carried out by one worker at one time using the same method, although the figures do not represent equilibrium conditions.

Phosphorus pentoxide is, of course, the classical drying agent and undoubtedly the best of the chemical reagents for water.² It is sticky and hard to handle, however, and suffers the great disadvantage of becoming rapidly glazed with a coating of metaphosphoric acid, HPO_3 , so that only a fraction of the material is ever used.

Barium oxide has also been found³ to be a very active drying agent, forming the hydroxide, from which it cannot be recovered, however. It is cheap and especially useful in drying ammonia gas. Its dehydrating activity is maintained at temperatures up to 1000° . Barium oxide swells considerably on absorbing water and tends to clog drying towers.

¹ Baxter and Hale, *J. Amer. Chem. Soc.*, **58**, 510 (1936).

² Morley, *J. Amer. Chem. Soc.*, **26**, 1171 (1904).

³ Booth and McIntyre, *Ind. Eng. Chem., Anal. Ed.*, **2**, 12 (1930).

TABLE IV. THE EFFICIENCY OF DRYING AGENTS

Drying Agent	Mg. of Residual Water per Liter of Air	
	International Critical Tables ^a	Bower ^b
A trap at -194°	1.6×10^{-28}	
P ₂ O ₅	less than 0.00002	adopted as reference
BaO	less than 0.0001	0.00065
Mg(ClO ₄) ₂	less than 0.0005	0.002
KOH (fused)	0.002	
KOH (sticks)		0.014
Al ₂ O ₃	0.003	0.005
H ₂ SO ₄	0.003	
CaO	0.20	
CaO (freshly ignited)		0.003
CaSO ₄	0.004	0.005
MgO	0.008	
Silica gel		0.030
NaOH	0.16	
NaOH (sticks)		0.80
CaBr ₂	0.20	
CaCl ₂ (gran.)	0.14-0.25	
(fused)	0.36	
(gran., CaCl ₂ ·H ₂ O)		1.5
("anhy.," CaCl ₂ · $\frac{1}{4}$ H ₂ O)		0.36
H ₂ SO ₄ (95 per cent)	0.3	
Ba(ClO ₄) ₂		0.82
ZnCl ₂ (sticks)	0.80	0.98
CuSO ₄	1.40	2.8

^a Vol. III, p. 385.^b *Bur. Standards J. Research*, 12, 241 (1934).

Magnesium perchlorate, known commercially as *Dehydrite*, is as good as phosphorus pentoxide, is porous and easy to handle, and in addition will absorb up to 60 per cent of its weight of water without reduction in efficiency.⁴ It is prepared by dehydration in a high vacuum at temperatures up to 250°. For large-scale drying the material can be recovered and regenerated to advantage.⁵

⁴ Willard and Smith, *J. Amer. Chem. Soc.*, 44, 2255 (1922).⁵ Smith, *Dehydration Studies Using Anhydrous Magnesium Perchlorate*, G. Frederick Smith Chemical Co., Columbus, 1934.

Dehydrite absorbs ammonia gas quantitatively, taking up as much as 50 per cent of its own weight.

A porous *calcium sulfate* is marketed as *Drierite*. It apparently is a very active drying agent.⁶

Aluminum oxide for drying purposes is prepared by careful ignition of the hydroxide to temperatures around 500°. A commercial product is obtainable under the name *Hydralo*. It will absorb up to 15-20 per cent of its weight of water. It may be reactivated in 6-8 hours in an oven at 175° and the reactivation may be repeated indefinitely.⁷

Sulfuric acid (100 per cent) is a very efficient dehydrating agent but suffers the disadvantage of being a corrosive liquid and therefore inconvenient to handle. The use of sulfuric acid in desiccators should be discouraged as numerous experiments have shown that vessels kept over sulfuric acid become coated with a layer of sulfuric acid and examples where such contamination might be serious are readily called to mind.

Calcium chloride is a very cheap and fairly efficient drying agent. Frequently, however, it contains calcium oxide, and must be given a preliminary treatment if it is to be used for drying gases bearing carbon dioxide.

THE STANDARDIZATION OF POTASSIUM PERMANGANATE SOLUTIONS

For the preparation and storage of permanganate solutions, see Willard and Furman, 3rd Ed., p. 222. As primary standard reducing agents for the standardization of potassium permanganate, three materials may be used: electrolytic iron, sodium oxalate, or arsenious oxide. Electrolytic iron is apparently not on the market, but a high grade of iron wire suitable for standardization purposes can be obtained.¹ Weighed samples of the pure iron are dissolved in sulfuric acid, and the determination carried out just as in the determination of iron in iron ore.

Sodium oxalate is most widely used for standardizing permanganate solutions at the present time. A satisfactory grade of sodium oxalate is obtainable on the market, but a certified material

⁶ Hammond and Withrow, *Ind. Eng. Chem.*, **25**, 653, 1112 (1933).

⁷ Barnitt, Derr and Scripture, *Ind. Eng. Chem., Anal. Ed.*, **2**, 355 (1930).

¹ Mallinckrodt Chemical Works.

can be obtained from the Bureau of Standards, *Sodium Oxalate, No. 40c*, purity 99.95 per cent. The oxalate is titrated in a dilute sulfuric acid solution, the major part of the titration being carried out at 27° and the remainder at 60°.²

Arsenious oxide is readily available in highly pure form, and a certified grade can be obtained from the Bureau of Standards, *Arsenious Oxide, No. 83*, purity 99.98 per cent. A catalyst is required for the reaction of arsenite with permanganate; potassium iodate or iodide are satisfactory catalysts.³ The end-point can be determined either potentiometrically or visually.

Procedure Using Sodium Oxalate. Dry the sodium oxalate at 105-110° for 2 hours. Weigh an approximately 0.3 g. sample into a 600 ml. beaker. Add 250 ml. of dilute sulfuric acid (5 : 95) and adjust the temperature to $27 \pm 3^\circ$. Stir until the oxalate has dissolved. Add 39-40 ml. of the approximately 0.1 *N* potassium permanganate solution at the rate of 25-35 ml. per minute while stirring slowly. Let stand until the pink color disappears; this should require about 45 seconds. Heat to 55-60° and complete the titration by adding permanganate until a faint pink color persists for 30 seconds. Add the last 0.5 ml. slowly, allowing time for each drop to decolorize before making a further addition. A sample of 0.3 g. of sodium oxalate requires 44.73 ml. of 0.1 *N* potassium permanganate. If the permanganate was so strong that the end-point was overstepped in the first part of the titration, discard the sample and begin again, adding a few ml. less. In exact work, a correction amounting to 0.03-0.05 ml. should be subtracted to compensate for the excess permanganate required to color the solution.

Procedure Using Arsenious Oxide. Dry the arsenious oxide in the oven for 2 hours at 105-110°. Weigh a sample of approximately 0.25 g. into a 400 ml. beaker. Add 10 ml. of a cool, 20 per cent solution of sodium hydroxide free from oxidizing or reducing substances. Let stand for 8-10 minutes, stirring occasionally. When the solution is complete, add 100 ml. of water, 10 ml. of concentrated hydrochloric acid, and 1 drop of 0.0025 *M* potassium iodate or iodide. Titrate with the permanganate solution until a faint pink color persists for 30 seconds. Add the last ml. dropwise allowing time for each drop to decolorize before making a further addition. The

² Fowler and Bright, *J. Research Nat. Bur. Standards*, **15**, 493 (1935).

³ Lang, *Z. anorg. allgem. Chem.*, **152**, 197 (1926); Bright, *Ind. Eng. Chem., Anal. Ed.*, **9**, 577 (1937).

small correction due to the excess permanganate required to color the solution can be determined by running a blank on the same amount of water, reagents and catalyst. It should amount to less than 0.03 ml.

THE SILVER REDUCTOR

Among the noteworthy results of the studies of the last decade of the reducing action of metals and amalgams is the silver reductor,¹ which affords a rapid and convenient method of effecting certain reductions prior to titration and which is rapidly becoming a very useful analytical tool. The silver reductor has a relatively low oxidation potential, the value for the silver-silver chloride electrode in 1 *M* hydrochloric acid being 0.2245 volts. The silver reductor therefore is not able to effect many of the reductions which occur in the Jones reductor using amalgamated zinc. A summary of the reductions effected by the silver and amalgamated zinc reductors is given in Table V.

TABLE V. THE ACTION OF THE SILVER AND AMALGAMATED ZINC REDUCTORS

Silver Reductor Hydrochloric Acid Solution	Amalgamated Zinc (Jones) Reductor Sulfuric Acid Solution
$\text{Fe}^{+3} = \text{Fe}^{+2}$	$\text{Fe}^{+3} = \text{Fe}^{+2}$
$\text{Ti}^{+4} = \text{not reduced}$	$\text{Ti}^{+4} = \text{Ti}^{+3}$
$\text{Cr}^{+3} = \text{not reduced}$	$\text{Cr}^{+3} = \text{Cr}^{+2}$
$\text{Mo}^{+6} = \text{Mo}^{+5} (2 M \text{ HCl})$	$\text{Mo}^{+6} = \text{Mo}^{+3}$
$\text{V}^{+5} = \text{V}^{+4}$	$\text{V}^{+5} = \text{V}^{+2}$
$\text{UO}_2^{+2} = \text{U}^{+4}$	$\text{UO}_2^{+2} = \text{U}^{+4}$
$\text{Cu}^{+2} = \text{Cu}^{+} (2 M \text{ HCl})$	$\text{Cu}^{+2} = \text{Cu}^0$

The silver reductor is preferably used with hydrochloric acid solutions, the only contamination introduced into the solution being the very small amount of silver chloride necessary to saturate the solution. A vertical tube similar to that used in the Jones reductor is used for the silver reductor except that it is not always necessary to use suction. The silver used is easily prepared by reducing silver

¹ Walden, Hammett and Edmonds, *J. Amer. Chem. Soc.*, **56**, 350 (1934).

nitrate with metallic copper, and although the metal is very finely divided when prepared in this way, solutions pass through it readily. When hydrochloric acid solutions of reducible substances are passed through the silver reductor, the silver of the surface is converted to silver chloride which may later be reduced by filling the reductor with dilute sulfuric acid and placing a piece of zinc in contact with the silver. Very little silver is lost when working with hydrochloric acid solutions, and since less than 30 g. of silver is required for the original charge, the reductor is inexpensive.

The silver reductor may be used to advantage in the determination of iron in iron ore since hydrochloric acid solutions may be used and since titanium is not reduced. The reduction of hexavalent molybdenum to the quinquevalent state is quantitative in 2 *M* hydrochloric acid solution at a temperature of 60-80°, and the molybdenum may then be titrated with ceric sulfate using the *o*-phenanthroline ferrous complex as indicator.² Uranium is reduced to the quadrivalent state on passage through the silver reductor if the solution is about 4 *M* in hydrochloric acid and the solution is at a temperature of 60-90°; the uranium may then be reoxidized by ceric sulfate in the presence of phosphoric acid.³ In view of the variety of the valences of molybdenum and uranium and the usual difficulty of obtaining quantitative reduction to one of the intermediate valence states, the action of the silver reductor is quite unique. Equally unique is its use in the determination of copper, which it reduces to the univalent state in 2 *M* hydrochloric acid solution. The reduced copper is collected under ferric alum and the ferrous iron titrated with ceric sulfate.³

Preparation and Use of the Silver Reductor. Dissolve 29 g. of silver nitrate in 400 ml. of water and add a few drops of nitric acid. Suspend a sheet of electrolytic copper about 10 cm. square in the boiling solution and stir the mixture mechanically. Allow the reaction to proceed until a test shows the absence of silver ions in the solution. Wash the silver by decantation with dilute sulfuric acid until most of the copper has been removed. Place the silver in a regular Jones reductor column and wash with dilute sulfuric acid until a test shows the absence of copper in the wash liquid.

Although the silver is in a finely divided state, solutions flow readily through the reductor but suction is sometimes required.

² Birnbaum and Walden, *J. Amer. Chem. Soc.*, **60**, 64 (1938).

³ Birnbaum and Edmonds, *Ind. Eng. Chem., Anal. Ed.*, **12**, 155 (1940).

Care should be exercised during the use of the reductor not to allow the liquid in the column to drain below the top of the silver, as the presence of air sometimes forms pockets which interfere with the proper flow of liquid.

The dark silver chloride coating which covers the silver of the upper part of the reductor when hydrochloric acid solutions are used moves farther down the column on use, and when it extends over three-quarters of the length of the column, the reductor must be regenerated. This may be accomplished by the following method. Fill the column with dilute sulfuric acid (about 0.1 *M*) and insert a zinc rod into the reductor so that it touches the silver. The reduction proceeds rapidly, and after washing, the column is again ready for use.

When properly prepared, no correction due to the reductor is required in any of the determinations.

THE LEAD REDUCTOR

The use of metallic lead as a reductor has found certain applications, notably in the reduction of iron in hydrochloric acid solutions (p. 139). It is most conveniently used in the form of granulated ("test lead") lead in the usual Jones reductor type of column. The reduction may also be carried out with lead wire or strips dipped into the solution, the coil simply being removed with washing when the reduction is complete. Very curiously, when the iron is above a certain concentration, it is not reduced and the lead becomes coated with a black covering; on dilution the black coating disappears and the reduction proceeds. Lead chloride may separate from the solution on cooling after the reduction but does no harm. Fortunately lead dissolves slowly in hydrochloric acid solutions and is free from iron rendering the determination of a blank unnecessary.

THE POTENTIOMETRIC DETERMINATION OF THE END-POINT

Although requiring somewhat expensive apparatus, the potentiometric method of determining the end-point of a titration has certain advantages over the visual indicator method in that it may often be used when no suitable indicator is available or when the solution being titrated is so deeply colored as to obscure the visual

end-point. The theoretical aspects of this method of detecting the end-point have already been discussed, Willard and Furman, 3rd Ed., pp. 204-218,¹ and the following material is devoted primarily to the more practical aspects of the subject. If the potential of an electrode and a solution is to be used for following changes of concentration of some material in the solution, it is of course necessary that the electrode respond to changes in the composition of the solution; and since it is only possible to measure the potential difference between two electrodes in contact with the solution, the potential of the second electrode and the solution must be constant and independent of the composition of the solution. The former electrode is known as the *indicator electrode*, the latter as the *reference electrode*. Various types of indicator and reference electrodes are commonly used depending on the type of volumetric reaction and the composition of the solution being studied.

Indicator Electrodes. The hydrogen electrode is the most fundamental electrode in that it has been arbitrarily adopted as the zero of the electromotive system. From a practical standpoint it has a number of disadvantages and is not widely used in practice either for the determination of hydrogen ion concentration or for the determination of the end-point in neutralization reactions. It is easily poisoned, it cannot be used in the presence of oxidizing substances, the hydrogen gas bubbling through the solution frequently sweeps out volatile gases and alters the system, and the apparatus is inconvenient to use.

The quinhydrone electrode is much simpler to use in that it consists simply of a platinum wire dipping into the solution to which a little quinhydrone has been added. The quinhydrone electrode responds to change in the hydrogen ion concentration. Quinhydrone consists of an equimolecular mixture of hydroquinone and quinone; the oxidation of hydroquinone to quinone or the reduction of the latter to hydroquinone involves the hydrogen ion concentration of the solution:

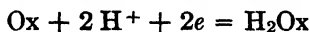

(in which Ox represents quinone and H₂Ox hydroquinone) and

$$E = E_0 + \frac{0.059}{2} \log \frac{[\text{Ox}][\text{H}^+]^2}{[\text{H}_2\text{Ox}]}$$

$$E_0 = 0.6992 \quad (25^\circ)$$

¹ For a more extensive treatment of the theory, see Kolthoff and Furman, *Potentiometric Titrations*, John Wiley & Son, Inc., New York, 1931.

Since the concentrations of quinone and hydroquinone are equal because of the unique composition of quinhydrone, $[Ox] = [H_2Ox]$, and

$$E = 0.6992 + 0.0591 \log [H^+] \quad (25^\circ)$$

Thus quinhydrone becomes an indicator electrode. Oxidizing and reducing substances obviously cannot be present in the solution as they would alter the quinhydrone. Quinhydrone is also decomposed by alkalis and the quinhydrone electrode cannot be used at pH values above 8. The quinhydrone electrode is more convenient to use than the hydrogen electrode and can be used both for acid-base titrations and for the determination of pH .

The antimony electrode consists merely of a rod of metallic antimony that is dipped into the solution. The solubility of the antimony oxide which coats the metallic antimony is very small even in fairly strongly acid solutions, and since the hydrogen ion is involved in the equilibrium between the antimony oxide and the antimony ions in solution, the potential of the antimony electrode depends on the hydrogen ion concentration of the solution. The potential of the antimony electrode varies with the individual piece of antimony and its mechanical and chemical treatment, but this is immaterial as far as its use in titrations is concerned. In strongly oxidizing solutions it will show slow changes in potential. The glass electrode is very widely used for pH measurements and can also be used for titrations.²

The indicator electrode for oxidation-reduction reactions is always a bright platinum wire. The platinum wire is best cleaned with cleaning solution and is used without drying.

An indicator electrode in precipitation reactions may be a silver wire or metallic mercury if these ions are involved in the reaction. It may be a platinum wire if the reaction may be treated as an oxidation-reduction system, as, for example, the titration of lead with chromate.

Reference Electrodes. The hydrogen electrode is of course the fundamental reference electrode, but either as a reference electrode or an indicator electrode is inconvenient to use and subject to certain restrictions so that it is very little used. The most popular reference electrode is the calomel half-cell shown in Fig. 19. The calomel half-cell is connected to the solution by a bridge of potas-

² Dole, *The Glass Electrode*, John Wiley & Sons, Inc., New York, 1941.

sium chloride solution. To prevent the contamination of the solution surrounding the calomel this bridge is flushed out from time to

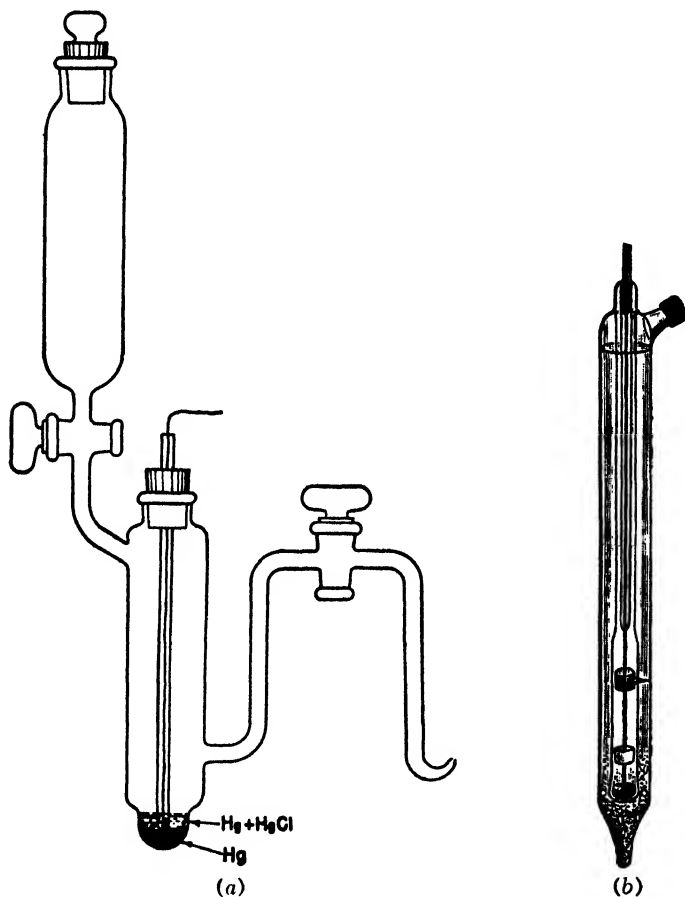

FIG. 19. Calomel Half-cells. (a) Conventional Type. (b) Modern Commercial Type. (Leeds & Northrup Company.) Electrical contact made through minute hole in glass.

time with fresh potassium chloride solution. The potassium chloride solution is usually a 0.1 *N*, 1.0 *N*, or a saturated solution and is saturated with calomel. The potential of this electrode as referred to the hydrogen electrode varies with the concentration of

the potassium chloride solution. The values of various reference electrodes are given in Table VI.

The silver-silver chloride reference electrode is as convenient to use as the calomel electrode and is easily made. It consists of a silver wire coated with a very thin layer of silver chloride (applied electrolytically by making the silver wire the anode in a dilute hydrochloric acid solution) dipping in a potassium chloride solution which acts as a salt bridge.

TABLE VI. THE VALUES OF VARIOUS REFERENCE ELECTRODES AT 25°

Concentration of Potassium Chloride	Calomel	Silver Chloride
0.1 <i>N</i>	0.3334 volt	0.2880 volt
1.0 <i>N</i>	0.2805	0.2355
saturated	0.2458	0.2000

For use in solutions in which the presence of the chloride ion is undesirable, the mercurous sulfate electrode may be used. It is constructed in a manner similar to the calomel electrode but utilizes a sulfuric acid solution rather than a potassium chloride solution as the bridge to make the contact with the solution.

The exact potential of the reference electrodes mentioned above is known (Table VI) and this knowledge is necessary for *pH* measurements. It is not absolutely necessary that the exact voltage of the reference electrode be known when it is only necessary to locate an end-point. In this case simpler reference electrodes may be adopted. One example consists of a platinum wire fused into the tip of the buret, the tip of which dips under the solution^a as shown in Fig. 20. The platinum wire is immersed at all times in a solution of constant composition, and therefore has a constant potential. Sometimes the platinum wire is placed in a glass tube closed at the bottom by a porous porcelain plate to prevent diffusion or in a capillary tube, open at the bottom.

Bimetallic Electrodes. Some metals are very inert toward solutions containing oxidizing and reducing agents and can function as

^a Willard and Boldyreff, *J. Amer. Chem. Soc.*, **51**, 471 (1929).

reference electrodes. Tungsten is such a metal, its potential toward a solution showing relatively little change during an oxidation-reduction reaction. Use is made of this phenomenon in conjunction with a platinum indicator electrode. The platinum-tungsten combination is spoken of as a *bimetallic electrode system*. In actual practice the potential of the tungsten electrode does change with the oxidation-reduction state of the system, but much less than that

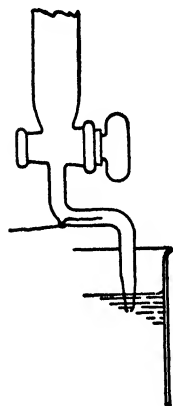

FIG. 20. Reference Electrode for Potentiometric Titrations.³

of the platinum electrode. This leads to a somewhat different titration curve than is normally obtained. Another such bimetallic electrode system uses a platinum-rhodium alloy as the inert electrode. It is characteristic of this electrode that it gives relatively little warning of the approach of the end-point and at the end-point gives a relatively large change in potential. Many other bimetallic systems have been studied but the tungsten-platinum combination is the best. The tungsten electrode is cleaned prior to use by polishing with sand paper or by dipping momentarily in fused sodium nitrite.

Two electrodes of platinum can also be used as a bimetallic electrode system if a small current is passed through the system to polarize the electrodes and thus cause them to function differently toward the solution.

The Apparatus Required for Potentiometric Titrations. In order that the potential of the reference electrode be constant during a titration, it is essential that the current drawn from the cell be kept at a very low value. It is necessary therefore that the measurement of the voltage be made without drawing current from the cell. The usual method of doing this is by means of the potentiometer, a diagram of which is shown in Fig. 21. *AD* is a slide wire, *R* is a variable resistance, *B* a battery, generally two dry cells in a series, *SC* is a standard cell, the voltage of which is known, *G* is a galvanometer, and *K* a tapping key. The potential drop from *A* to *C* opposes the potential being measured so that potential from *A* to *C* is equal to the potential of the cell when no current passes through the galvanometer on closing the key. It is generally most

³ Willard and Boldyreff, *J. Amer. Chem. Soc.*, **51**, 471 (1929).

convenient to calibrate the slide wire so that it reads directly in volts. This is conveniently done by placing the standard cell in place of the cell being measured, setting AC at the potential of the standard cell and adjusting the resistance R until the galvanometer shows no deflection on closing the key.

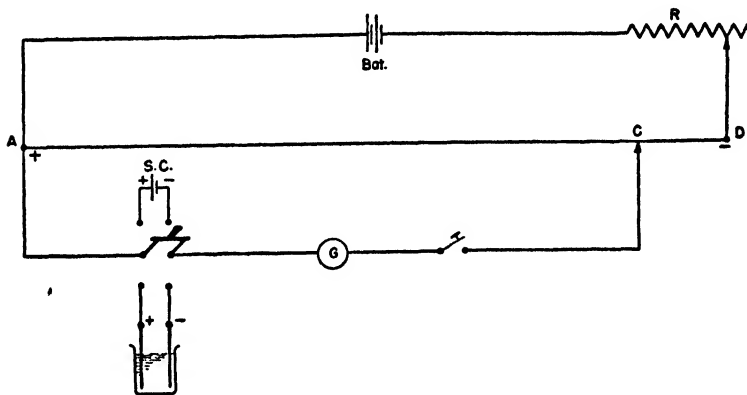

FIG. 21. Potentiometer.

A very suitable potentiometer for titration work is the *Student Potentiometer*, of the Leeds & Northrup Company, shown in Fig. 22. The wiring diagram and method of operation of this instrument are given in Fig. 23.

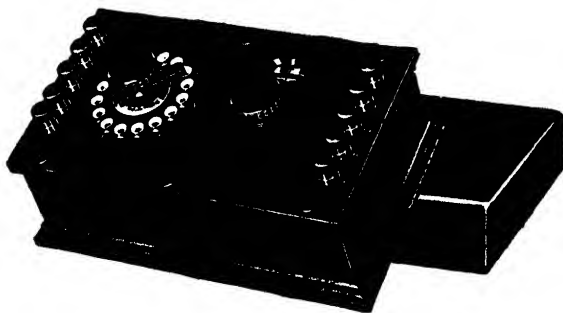

FIG. 22. Student Potentiometer. (Courtesy Leeds & Northrup Co.)

In recent years the measurement of potential has been simplified by the introduction of vacuum tube voltmeters. These instruments draw so little current from the cell that they may be connected directly, and they read the voltage directly without the necessity

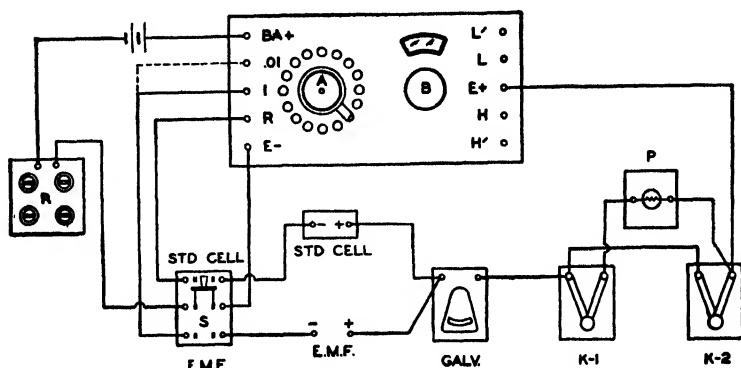

FIG. 23. Wiring Diagram of Student Potentiometer. (Courtesy of Leeds & Northrup Co.)

Operation of Student Potentiometer. Making Connections. Connect exactly as shown above when using 1.6 volt range. When using 16 millivolt range, the lead shown connected to the post marked 1 should be transferred to 0.01. Give strict attention to the polarity markings. Be sure to include 10,000 ohm protecting resistance P. *Checking Against Standard Cell.* First, adjust the working current through the potentiometer. To do this throw switch S to the "Std. Cell" position, and set the dial and slide wire, A and B, to the voltage of the standard cell. The 4-dial rheostat should then be set to give approximately 0.01 ampere through potentiometer, remembering that the voltage of two dry cells in series is approximately 3 volts and that the internal resistance of the potentiometer is approximately 160 ohms. This means that there should be approximately 140 ohms in the 4-dial resistance box. Tap key K-1, note the galvanometer deflection and adjust the rheostat until it is very small, or zero; then tap key K-2 and make final adjustment of the rheostat until galvanometer shows no deflection. The potentiometer is then ready for making measurements. *Measuring e.m.f.* Place switch S in position E.M.F., tap key K-1 and note the galvanometer deflection. Reduce or make it zero by adjusting dial switch A and slide wire B. Tap key K-2 and adjust slide wire B until the galvanometer shows no deflection. The sum of the readings of dial switch and slide wire give directly the voltage being measured on the 1.6 volt range. On the 16 millivolt range, the value is read from the dial switch and slide wire, and multiplied by 0.01.

Suppose the dial switch set at 1.1 and the slide wire at 0.0261; the potentiometer reading would be the sum, 1.1261 volts on the 1.6 volt range and 0.011261 volt on the 16 millivolt range.

To make sure that the current through the potentiometer has not changed, return the switch S to "Std. Cell," set the dial switch and slide wire to the voltage of the standard cell and close key K-2. If there is no deflection, the current has not changed; if there is a small deflection, the rheostat must be readjusted to reduce the deflection to zero.

of tapping a key. Many models do not read directly in volts as does the potentiometer, but they serve admirably to record changes in potential. Some may be calibrated to read directly in volts.*

During a potentiometric titration the solutions should be well stirred; this can best be done mechanically. In running a titration,

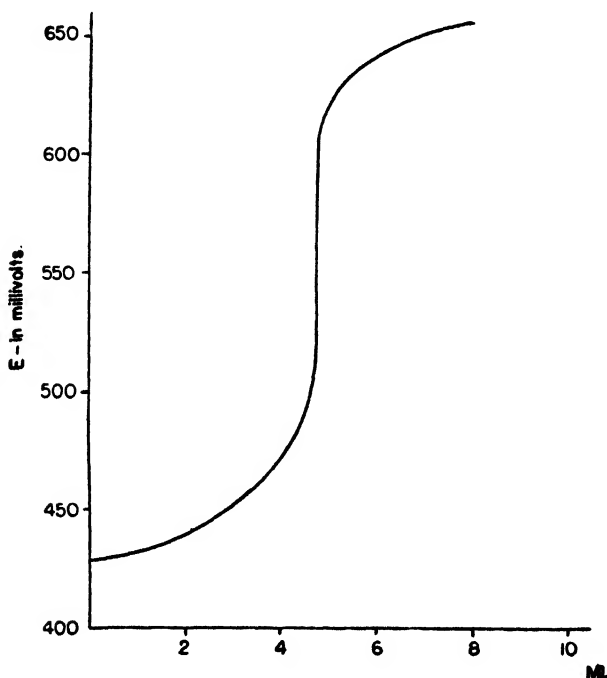

FIG. 24. Titration Curve.

the standard solution is usually added in large increments at first and then dropwise as the end-point is approached. The potential is measured after each addition until a large sudden change occurs, marking the end-point. Obviously such a titration is less convenient and longer than one in which a visual indicator is used.

The data obtained during a titration are usually plotted using the potential as ordinate and the volume of the titrating solution as abscissa. The general shape of the titration curve obtained is the

* For an introduction to this field see Furman, *Ind. Eng. Chem., Anal. Ed.*, **14**, 370 (1942) and the advertising in recent numbers of the journals devoted to analytical chemistry.

108 OPERATIONS OF QUANTITATIVE ANALYSIS

same for neutralization, oxidation-reduction, and precipitation titrations, Fig. 24 (see also Willard and Furman, 3rd Ed., pp. 118, 124, 166, 211). The end-point occurs at the steepest part of the curve, where the rate of change is greatest. In some cases the curve

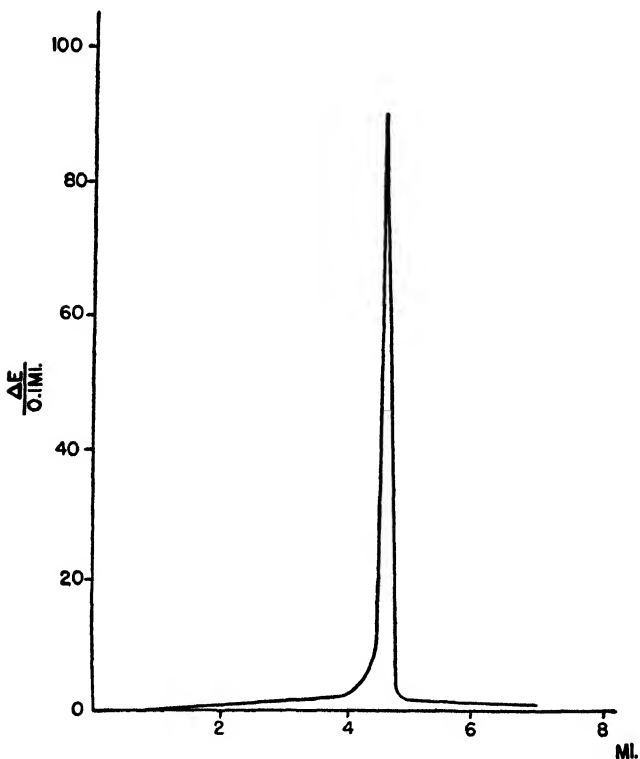

FIG. 25. Differential Plot of Data of a Potentiometric Titration.

is practically vertical, one drop of solution causing a change of 100 to 200 millivolts in the potential of the cell. In other cases the slope is more gradual and sometimes the end-point is not very readily located. An alternative method of determining the end-point from the data is to plot the change in potential per volume against the volume. This gives a differential type of curve, Fig. 25, in which the end-point is indicated by a peak. It is not usually necessary to plot the curve because the data from which the curve is plotted

are sufficient to locate the point of maximum rate of change. The following typical data will indicate this.

Total Added ml.	<i>E</i> mv.	$\frac{\Delta E}{0.1 \text{ ml.}}$
0	430	
1.0	435	0.5
2.0	445	1.0
3.0	458	1.3
4.0	473	1.5
4.5	485	2.4
4.6	500	15
4.7	590	90
4.9	620	15
6.0	640	1.8
7.0	650	1.0
8.0	655	0.5

The maximum change per 0.1 ml. of titrating solution occurred after the addition of 4.7 ml. of solution and this is therefore the end-point of the titration. This is also readily seen from the figures in column 2.

It is usually not necessary to take frequent readings until the vicinity of the end-point has been reached.

Application of Potentiometric Titrations. As has already been mentioned the potentiometric determination of the end-point may be applied to all three types of volumetric reactions. It has been applied most extensively to oxidation-reduction types of reactions since suitable oxidation-reduction indicators have not been available until recent years. Generally, for the titration of acids and bases there are available suitable indicators and the only cases to which the potentiometric method is applied are those where the solution is colored. The potentiometric method is, however, applicable to all neutralization reactions which can normally be carried out with visual indicators. The potentiometric method yields a satisfactory end-point in titrations with strong oxidizing and reducing agents, such as ceric sulfate, potassium permanganate, potassium bichromate, ferrous sulfate, titanous sulfate, and chromous sulfate. It is successful in most iodometric titrations and other titrations with mild oxidizing agents. Fewer applications of

the potentiometric method are known among precipitation and complex ion formation reactions principally because of the difficulty of finding suitable indicator electrodes.⁵

COLORIMETRY

The measurement or matching of color may frequently furnish a convenient method for the quantitative determination of materials which are themselves colored or can be made to yield colored compounds. Such methods are usually rapid and, over the range to which they are applicable, are as accurate as other methods which might be applied. In general, colorimetric methods can be applied only to constituents present in quantities of less than one or two per cent. Larger amounts of materials can be diluted and an aliquot part taken, but it must be remembered that any error in the colorimetric measurement is then multiplied by the dilution factor. The ranges of concentration over which colorimetric methods are usually adaptable to quantitative work fall between 0.5 and 10 mg. per liter, although some methods are not as sensitive as this and others are sensitive even to such low concentrations as 0.01 mg. per liter, that is, a dilution of one part in a hundred million. The number of known colorimetric methods is enormous, and methods are available for the determination of a great variety of inorganic and organic materials.¹

Two general laws govern the behavior of light on transmission through a colored solution. These laws relate the intensity of light to the thickness of the solution and to the concentration of the colored material in the solution through which the light passes. These laws are best expressed mathematically and are derived by solving the differential equations which describe the change in intensity of the light on passage through the solution.

The first of these laws, discovered by Bouguer in 1739 and again by Lambert in 1760, states that at any point within the solution the rate of decrease of the intensity of monochromatic light with

⁵ An extensive bibliography of the applications of the potentiometric method to various types of volumetric reactions is given by Furman, *Ind. Eng. Chem., Anal. Ed.*, **2**, 213 (1930); *ibid.*, **14**, 367 (1942).

¹ For descriptions of these numerous methods consult the treatises on colorimetry: Snell and Snell, *Colorimetric Methods of Analysis*, D. Van Nostrand Company, Inc., Vols. I and II, New York, 1936; Yoe, *Colorimetry*, John Wiley & Sons, Inc., New York, 1928.

the thickness of the transparent medium through which it is passing is proportional to the intensity of the light at that point. Thus for light passing through the cell

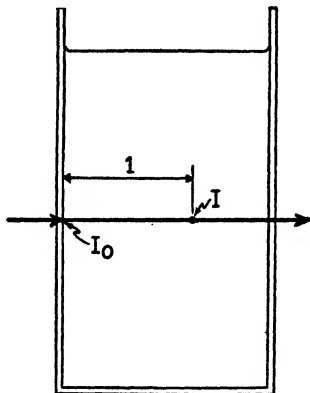

at a point a distance l in the cell

$$-\frac{dI}{dl} = K_1 I$$

Where I is the intensity and l the distance from the side of the cell at which the light is incident. This equation may be solved by separating the variables and integrating

$$\frac{dI}{I} = -K_1 dl$$

$$\log I = -K_1 l + C$$

If I_0 represents the intensity of the light at incidence, that is, when $l = 0$

$$\log I_0 = C$$

and

$$\log I = -K_1 L + \log I_0$$

or

$$(1) \quad \frac{I}{I_0} = e^{-K_1 l}$$

The fraction $\frac{I}{I_0}$ is called the *transmission factor*, or the *transmittancy*, and is that portion of the light which has passed through the solution to the point l .

The second of these laws is that of Beer, who in 1852 stated that the rate of decrease of the intensity of monochromatic light with the

concentration of a colored material in the solution through which it is passing is proportional to the intensity of the light. Thus

$$-\frac{dI}{dc} = K_2 I$$

where c is the concentration of the colored material. This equation may be solved like the one above

$$\frac{dI}{I} = -K_2 c$$

$$\log I = -K_2 c + C$$

and again at the limits, when $c = 0$, $I = I_0$ so that

$$\log I_0 = C$$

and

$$\log \frac{I}{I_0} = -K_2 c$$

or expressed exponentially

$$(2) \quad \frac{I}{I_0} = e^{-K_2 c}$$

When applied simultaneously, these laws take the form of the Bouguer-Beer equation:²

² The combination of these two independent variables is made in the following manner. Since in the development of each equation the other variable factor was held constant

$$(1) \quad \frac{I}{I_0} = e^{-K_1 l} \quad c \text{ being constant}$$

$$(2) \quad \frac{I}{I_0} = e^{-K_2 c} \quad l \text{ being constant}$$

K_1 is a function of c , and K_2 a function of l , that is,

$$K_1 = f_1(c) \quad \text{and} \quad K_2 = f_2(l)$$

Substituting these into equations (1) and (2)

$$(4) \quad \frac{I}{I_0} = e^{-f_1(c)l}$$

$$(5) \quad \frac{I}{I_0} = e^{-f_2(l)c}$$

Since the factors are applied simultaneously, at any point

$$\frac{I}{I_0} = e^{-f_1(c)l} = e^{-f_2(l)c}$$

and

$$f_1(c)l = f_2(l)c$$

which on separating the variables gives

$$(3) \quad \frac{I}{I_0} = e^{-\epsilon cl}$$

in which I and I_0 are the intensities of the transmitted and incident light respectively, c is the concentration in moles per liter, l is the thickness of the solution, and ϵ is the molecular extinction coefficient. There are no exceptions to the Bouguer (Lambert's) Law, but many substances do not obey Beer's Law.

The general methods of using color for the purposes of quantitative analysis fall into three types, the synthesis of a color from the three primary colors to match the color under examination, the measurement of the actual intensity of light transmitted through a solution, and the matching of the intensity of light transmitted with that of a standard solution.³

Instruments based on the synthesis of a color by mixing various intensities of the three primary spectrally pure colors have been designed and are available on the market.⁴ They are, however, quite complicated and are little used by chemists. The Lovibond tintometer falls in this class of instruments, although working on a subtractive rather than an additive basis. In it the primary colors are obtained in different intensities by the use of glass filters of different optical densities. The three sets of filters, one for each of the colors, red, yellow, and blue, are furnished separately or in some instruments are arranged in slides or around the periphery of rotating discs, one series behind the other, so that the light passes through all three colors. By changing the position of the slide or

$$\frac{f_1(c)}{c} = \frac{f_2(l)}{l}$$

Since the only condition under which functions of independent variables are equal is that they equal a constant,

$$\frac{K_1}{c} = \frac{K_2}{l} = K$$

Substituting this into equations (4) or (5) yields

$$(6) \quad \frac{I}{I_0} = e^{-Klc}$$

This K becomes the ϵ , the molecular extinction coefficient, of equation (3) on converting the logarithms to the base ten. This method of combining functions of independent variables was devised by A. T. Lonseth.

³ This classification is essentially that of Mellon, *Ind. Eng. Chem., Anal. Ed.*, **11**, 80 (1939), who designates the instruments used in these three types of colorimetric work as stimulimeters, absorptometers, and color comparators, respectively.

⁴ For example, the Donaldson colorimeter; see Mellon, *loc. cit.*

the disc, any combination of filters, one of each color, may be superimposed and practically any color so produced. The color is then designated in terms of the numbers of the particular filters used. The Lovibond tintometer has been used to specify the colors of pigments, dyes, and other colored materials, and has been employed in a number of colorimetric analyses.⁵

A variety of instruments which make an actual measurement of the intensity of the transmitted light are now in use, such as visual and photoelectric photometers and spectrophotometers. The photometers are generally used with white light, usually from an incandescent bulb, and, except when modified by the introduction of filters, they measure the transmission over all the wave lengths to which the eye or photocell responds. The spectrophotometer, on the other hand, is provided with a monochromator, a device which makes it possible to use only a narrow band of the spectrum, and yields transmittancy data at any desired wave length; the actual measurement of the intensity is generally made photoelectrically. These instruments generally read directly in the per cent of light transmitted by the solution. Photometers can be made more selective in their action by the use of filters which screen out part of the spectrum. Because of their great utility and increasing importance, they will be considered later under the section dealing with filter photometers.

The third general method of making colorimetric measurements is by comparing the color being measured with that of a standard similarly prepared. In a sense the photometers also do this, since for a given color a calibration curve correlating the intensity of the transmitted light with the concentration of the colored material must be obtained. In the comparator methods, however, the standard solution must be actually at hand when the measurement is made. When two solutions of the same colored constituent have the same transmittancy, application of the Bouguer-Beer equation gives

$$\frac{I}{I_0} = e^{-c_1 l_1} = e^{-c_2 l_2}$$

and

$$(7) \quad c_1 l_1 = c_2 l_2$$

⁵ See for example, Bagshawe, *J. Soc. Chem. Ind.*, **57**, 260 (1938).

It will be seen from this expression that two ways of actually making the comparison are available. In one, the depth of the two liquids is made the same, and the concentration of the colored material in the unknown is then the same as that in the standard which it matches; this is the *standard series*, or *Nessler tube* method of comparison. In the other, a single standard may be used and the depths of the solutions varied to produce a match; this is the basis of operation of the Duboseq and similar colorimeters, and is known as the *variable depth* or *balancing method*. A more detailed discussion of the various instruments will be given in a later section.

The Conditions for Making Colorimetric Comparisons. In the standard series method, since the concentration of the colored material in the standard and unknown are identical, it is apparent that Beer's Law need not hold. On the other hand, with the variable depth instruments conformity to Beer's Law is necessary, and the more widely different the depths of the solutions, the more essential this conformity becomes. Unfortunately, the majority of colorimetric methods do not conform to Beer's Law. As the photometers, visual and photoelectric, require a preliminary calibration curve, departure from Beer's Law is permissible so long as the conditions which influence the color are maintained the same in unknown and standard.

In general, those materials obey Beer's Law which do not undergo a change in their molecular or ionic state with change in the environment. The character of the permanganate ion is not affected by dilution, change in acidity, or the presence of foreign salts, and conforms strictly to Beer's Law. The bichromate ion does not conform to Beer's Law, owing probably to the fact that it may be converted in solution to the normal chromate, and that this equilibrium depends on the concentration of the material and the acidity. Materials which undergo changes in the extent of ionization or association do not conform to Beer's Law.

Conformity with Beer's Law is not difficult to check. It can be done with the Duboseq instrument by comparing standard solutions of different concentrations. With instruments which give directly the per cent of light transmitted, the photometers or spectrophotometers, the law may be tested by securing the transmittancy at various concentrations, and making a plot of the logarithm of the transmittancy against concentration, which will yield a straight line

if Beer's Law is obeyed, the same thickness of cell being used throughout the experiment.

The shade and intensity of a colored material often vary with the anion present, thus the intensity of the yellow color of pertitanic acid is deeper in hydrochloric acid than in sulfuric acid solutions, and the yellow color of ferric iron in ferric chloride is greatly weakened in sulfuric acid solution and completely bleached in a solution containing phosphate. Sometimes advantage is taken of this behavior to remove one color when another color is to be measured.

Obviously then, the unknown and standard should be alike as far as possible; they should contain approximately the same amounts of the same acid, or in critical cases should be of exactly the same pH; the same foreign electrolytes should be present in each, and in about the same amounts; and, of course, the temperatures of unknown and standard should be identical. Finally, if the color develops slowly or fades on standing, the unknown and standard should be carried through the reaction simultaneously.

Permanent color standards of other similarly colored materials are often made in those cases where the color is not stable indefinitely or when a suitable primary standard material is not available. For example, in the *o*-tolidine method for residual chlorine, permanent standards are prepared by mixing definite amounts of potassium bichromate and copper sulfate solutions of certain strengths.⁶

The Use and Selection of Filters. As mentioned before, colorimeters and photometers are generally used with white light and give an over-all or integrated value for the transmission at all wave lengths to which the eye or the photocell is responsive. The spectrophotometer yields transmission data at any desired wave length. The plot of transmittancy against wave length gives a curve which specifies the color of the solution and depends also on the concentration of the colored material. Typical curves for materials of different colors are given in Fig. 26.

The variation in transmittancy with concentration of the colored material is greatest in the region of minimum transmittance. Thus, it will be seen from Fig. 27, which gives the transmittancy curves

⁶ American Public Health Association, *Standard Methods of Water Analysis*, New York, 1936, p. 20; Dragt and Mellon, *Ind. Eng. Chem., Anal. Ed.*, **10**, 256 (1938).

for different amounts of iron as ferrous *o*-phenanthroline sulfate,⁷ that the greatest change in transmittancy occurs at 508 m μ .

This behavior, which is general, indicates that the greatest sensitivity for a given process will be obtained at that wave length at

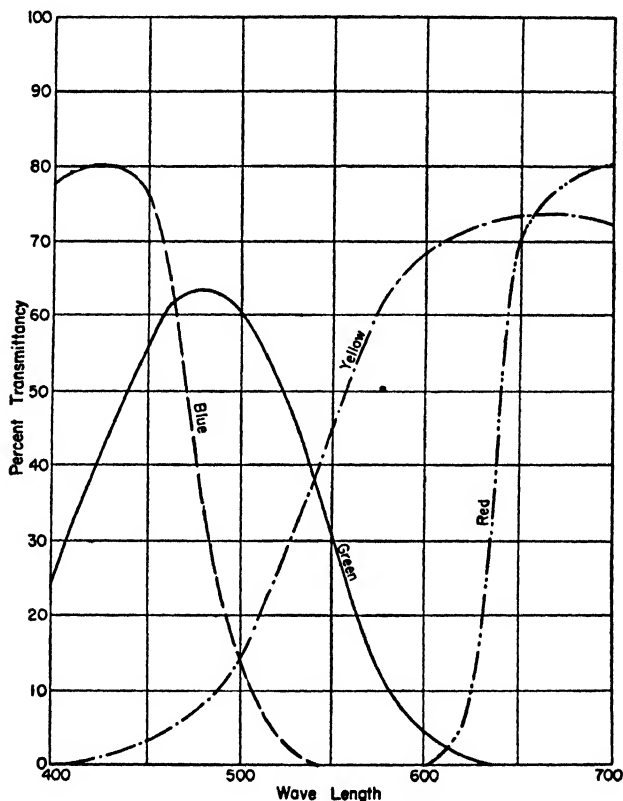

Fig. 26. Spectral Distribution Curves for Materials of Various Colors.

which there exists a transmittancy minimum. If a spectrophotometer is being used for the measurement, this wave length would be used.

A somewhat similar effect can be achieved with the photometers by the use of colored filters which transmit only a portion of the spectrum. These filters transmit a relatively broad band, but their introduction greatly improves the sensitivity of the methods. A

⁷ Fortune and Mellon, *Ind. Eng. Chem., Anal. Ed.*, **10**, 60 (1938).

variety of filters is available so that it is possible with one or more to isolate portions of the spectrum at fairly regular intervals over the visible region. The cut-off of the filters is not as sharp as

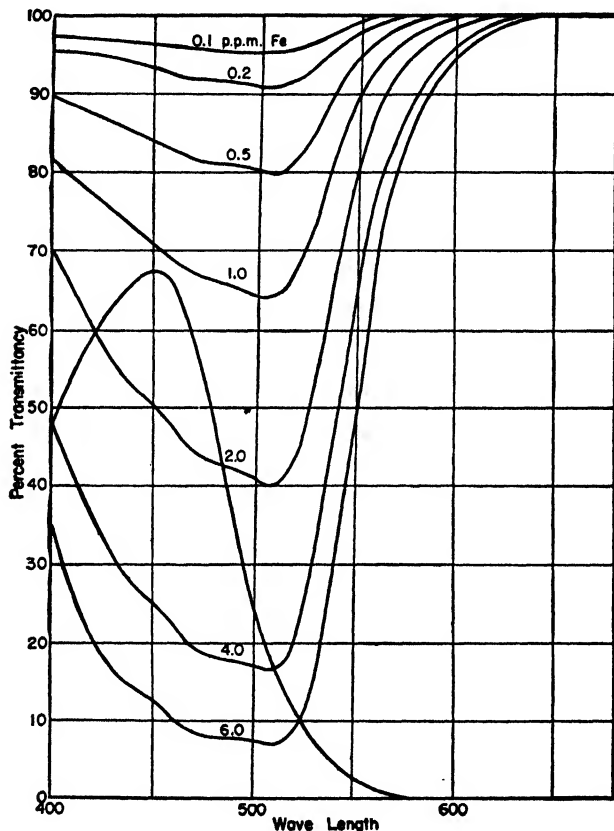

FIG. 27. The Spectral Distribution of *o*-Phenanthroline Ferrous Sulfate. Data of Fortune and Mellon.⁷

might be supposed from the literature describing the filters, in which the logarithm of the transmittancy often is plotted rather than the per cent transmittancy. Combinations of filters with overlapping transmittancy regions may be used to narrow the band, but the decrease in the amount of light transmitted may be serious. Some commercial photometers are provided with a series of filters, generally six or more. A variety of filters is available at low

prices⁸ from which suitable filters can be selected for almost all colorimetric processes. The filter should be chosen so that the band transmitted covers the minimum in the transmission curve of the colored material studied. This choice is best made from the spectral transmission curve obtained by a spectrophotometer. Thus, for the determination of iron as ferrous *o*-phenanthroline sulfate, the Corning filter No. 503, *Dark Theater Blue*, the transmittancy curve given as the dotted line in Fig. 26, is well adapted, since the trans-

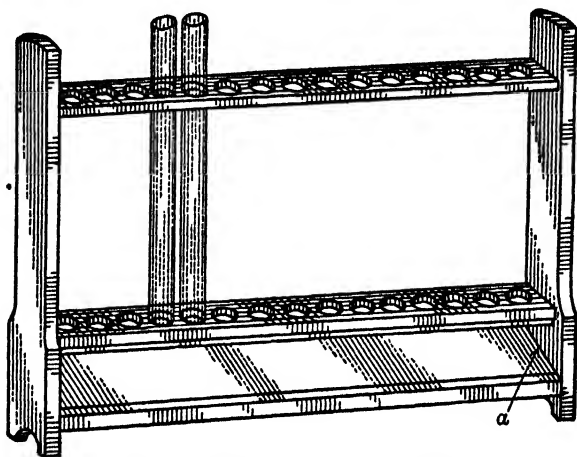

FIG. 28. Nessler Tubes and Rack.

mission band of the filter corresponds to the minimum in the transmission band of the iron compound.

The Standard Series or Nessler Tube Method. The constant depth of solution used in the standard series type of colorimetric measurement is most conveniently obtained by the use of a flat bottomed tube bearing a mark indicating a certain volume and depth, generally 100 ml. and 30 cm. Such tubes are referred to as *Nessler tubes*. They should preferably be of clear white glass and have perfectly flat bottoms. The comparison is made in a *Nessler rack*, Fig. 28, in which the solutions are viewed vertically, a uniform light being reflected from an opalescent white screen up through the bottoms of the tubes. In a series of these tubes, then, the concentration of the material is varied over a suitable range, and the unknown is placed successively between pairs of tubes until the depth

⁸ Corning Glass Works, Corning, N. Y.

of color falls between two of the standards or matches one. The concentrations of the colored material in the tubes which match are then equal.

In general, the standard series method is better than the variable depth method for faint colors, especially yellows, as the depth of solution used is much greater. It is also the more convenient method for routine work when a series of stable, permanent standards can be prepared.

When it is possible to add a standard solution of the material being determined directly to the reagents which develop the color and prepare the standard color rapidly in this manner, it is convenient to add the standard solution from a buret until the color of the standard matches that of the unknown. A minor variation in the depth may usually be disregarded. This process is frequently referred to as a colorimetric titration.

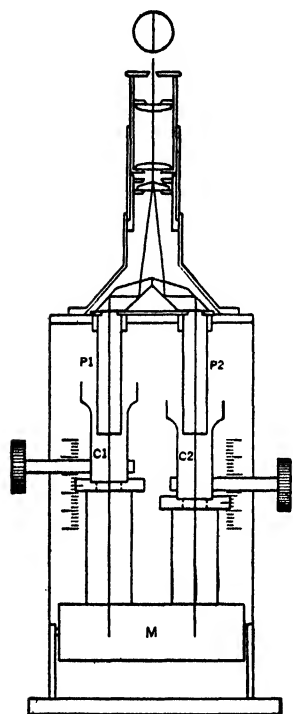

FIG. 29. Duboscq Colorimeter.

The Duboscq Colorimeter. Of the number of instruments⁹ which operate on the variable depth, or balancing principle, the Duboscq colorimeter is the most common, see Fig. 29. The instrument may be arranged for use with either artificial light or daylight. The bottoms of the cups are of clear glass and the walls of clear or black glass.

The plungers, about which the cups can be raised or lowered, have clear glass bottoms and black walls. The scales carried on the tube holders read directly the depth of the solution between the bottom of the cup and the bottom of the plunger. Below the cups is an adjustable mirror or a milk white plate, which reflects the light up through the cups. By means of an arrangement of mirrors and lenses the rays passing through both cups are brought together in a circular field split by a thin line,

⁹ For a description of other instruments which work on the same principle, see Snell, *loc. cit.*, Vol. I, p. 38.

each half representing one of the tubes. Equality is obtained by moving the cups up and down, varying the depths of the liquids until the field appears uniform.

Operation and Precautions. Rinse the cups and plunger with the solution under examination before making a comparison. Do not fill the cups above the shoulder, and exercise care that the outside and bottom of the cups are clean and dry (Kleenex or other paper tissue is excellent for this purpose), and that they are seated properly in the cup holders. Before making a comparison, fill both cups with water, adjust the cups so that the plungers are below the surface of the water and the scales have about the same reading, and adjust the mirror and light source to give a uniform field of maximum brightness. This is of great importance, for if perfect equality in the halves of the field is not obtained all readings will be in error. If daylight is used, the instrument should be placed preferably in front of a north window and not in direct sunlight.

In making a measurement it is well to adopt one side, say the left, for the standard solution and to place the standard always on the same side. As it is desirable to have as long a column of liquid as possible for comparison in order to increase the accuracy, one plunger is set at 50, or at just as great a depth as possible, and balance produced by moving the other until equality is produced in the two halves of the field. The plungers should always remain below the surface of the liquid. The readings are repeated four or five times and the average taken. Since the eye soon becomes fatigued and unable to detect small differences, it is advisable after making the adjustment to close the eyes a minute or to look at something else and then see if the adjustment still appears satisfactory. It is a good plan to approach the equality both from above and below.

The colors must be of the same shade for comparison. If one is orange and the other lemon yellow, they can never be matched with any degree of accuracy. If one solution is clear and the other faintly turbid, accurate comparison is impossible. If the unknown and standard do not give approximately similar readings, make up a new standard. They should not be farther apart than a 50 : 30 ratio, and if Beer's Law does not hold they should be very close to a 50 : 50 ratio.

Calculation of the Results. From equation (7)

$$c_1 l_1 = c_2 l_2$$

it is evident that concentration and depth are inversely proportional, and that the smaller reading on the colorimeter indicates the more concentrated solution. If the unknown and standard were diluted to different volumes, a calculation must be made to reduce them to the same volume. The data are then properly substituted into the formula and the amount of material in the unknown calculated.

Example. An unknown weight of titanium was converted to yellow pertitanic acid and diluted to 100 ml. Three ml. of a standard solution of titanium chloride, known to contain 1 mg. of titanium oxide per ml. was measured out, converted to pertitanic acid and diluted; it was necessary to dilute this solution to 250 ml., however, to get an approximate match with the unknown. On comparison the reading on the standard was 50.0 mm., on the unknown, 60.0 mm. Letting subscript 1 refer to the standard and 2 to the unknown

$$c_1 l_1 = c_2 l_2$$

$$c_1 = 3 \times \frac{1.0}{250}$$

and

$$3 \times \frac{1.0}{250} \times 50.0 = c_2 \times 60.0$$

and therefore

$$c_2 = 1.0 \text{ mg. of titanium oxide}$$

Filter Photometers (Photoelectric Colorimeters). Photometers are instruments for measuring the intensity of light. The instruments include both visual and photoelectric types and most desirably are constructed to read directly the per cent of light transmitted. They are usually used with white light, but are provided with color filters so that isolated portions of the spectrum may be used for the measurements and the sensitivity of the methods thus improved. It is, of course, necessary to run calibration curves on the materials being analyzed and this should be done under conditions closely approximating those which prevail when the unknown is run.

In the visual photometers the light is usually broken into two beams, one of which traverses the colored solution, and another, acting as a reference beam, which passes through a similar cell containing the solvent alone. The beams are united by a system of prisms and lenses into a single field which may be examined by the eye. The halves of the field are brought to a match by decreasing the intensity of the light in the reference beam. In the Pulfrich photometer this is done by means of a variable diaphragm which is calibrated to read directly the per cent of light transmitted. In

the Leifophotometer this is accomplished by a combination of a fixed and rotating Nicol prism, again calibrated to read the per cent transmission.

A number of photoelectric photometers have appeared on the market.¹⁰ The instruments are designed with either one or two cells, and utilize either the photovoltaic type of cell or the photo-emissive type.¹¹ In the two-celled instruments the light beam is



FIG. 30. Two-celled Photoelectric Colorimeter.

divided, one beam passing through the colored solution and the other passing through a similar cell containing only solvent. Although somewhat less convenient to use than the one-celled instrument, the two-celled instrument can be readily designed electrically to counteract variations in the intensity of the light source and in the amplifying system, if one is incorporated in the design, due to fluctuations in the line voltage. Two-celled instruments, then, can be completely line operated, thus eliminating the necessity of frequently charging or replacing batteries. One-celled instruments

¹⁰ See the advertising in recent issues of the chemical journals, particularly those devoted to analytical chemistry.

¹¹ A detailed discussion of the characteristics of photocells and of the electrical design of photoelectric colorimeters will be found in the paper of Müller, *Ind. Eng. Chem., Anal. Ed.*, **11**, 1 (1939).

must be battery operated to eliminate completely the effects of line voltage fluctuation. Deterioration of the photocells on aging has relatively little effect on the calibration curve of a two-celled instrument, as a pair of cells, matched with respect to their spectral response, will deteriorate at about the same rate; on the other hand, this requires a very frequent recalibration in the case of one-celled instruments.

Colorimeters using photovoltaic, or barrier layer, cells require

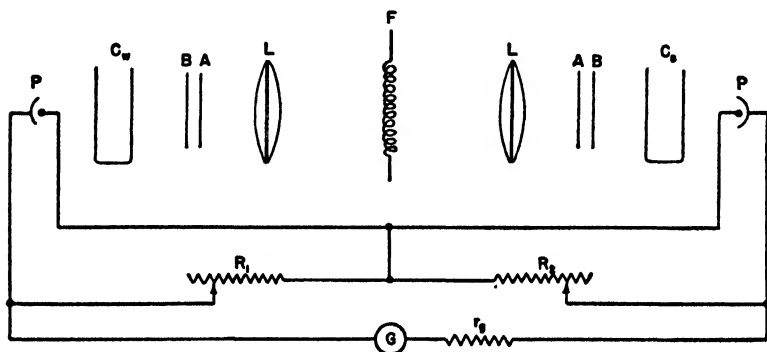

FIG. 31. Diagram of Two-celled Photoelectric Colorimeter. F, filament; L, lens; A, Aklo infra-red filter; B, filter; C_s, cell containing solution measured; C_w, cell containing water; P, barrier layer photocell; R₁, calibrated slide wire resistance; R₂, variable resistance for initial zero adjustment; G, galvanometer; r_g, galvanometer resistance.

no external voltage or amplification since they supply a sufficient voltage to affect meters directly; they do require, however, a fairly sensitive galvanometer. The photovoltaic cell is also much slower in its response to changes in intensity; this, however, is not serious enough to be a great disadvantage except where very rapid work is desired. Photoemissive cells have an instantaneous response, but require the application of an external voltage and an amplifying system.

Directions for operation are furnished with the commercial instruments and invariably these can be readily followed. Usually a zero or 100 per cent adjustment must be made with the solvent only in the cell or cells before making a measurement on a colored solution. In any case, the precautions mentioned in the preceding section dealing with the conditions which affect colorimetric processes

must be fully considered just as when using the Duboscq or other colorimeter.

The photoelectric photometer shown in Fig. 30 is a two-celled instrument constructed at Iowa State College. It uses spectrally matched photovoltaic cells and the electric circuit shown in Fig. 31 automatically compensates for fluctuations in the intensity of the light source. The light source is a 110-volt, 100-watt Mazda bulb with straight helical filament. The bulb may be cooled by a stream of compressed air, although this is not absolutely necessary. The Aklo filters are introduced to remove from the incident light the infra-red radiation to which the photoelectric cells respond slowly. Holders are provided for glass filters and spaces are left large enough to accommodate cells up to 5 cm., although customarily used with 1 cm. cells. The galvanometer used is the Leeds and Northrup lamp and scale type, sensitivity 0.02 microamp. per mm. Resistance R_2 is an initial adjustment to make the scale read 100 when solvent alone is placed in both cells. The slide wire R_1 reads directly the per cent transmittancy.

Spectrophotometers. Spectrophotometers vary greatly in complexity of construction, ease of operation, precision, and cost. High precision instruments have been constructed which work on a 5 Å band and have been used to solve certain difficult problems such as the determination of chlorophyll and carotene; the cost of such equipment is very great. Most analytical research problems dealing with colorimetric methods can be made on somewhat less complicated instruments, which, however, if made automatically recording, are still very expensive. The last few years have seen the development of comparatively inexpensive spectrophotometers¹² which work on about a 10-30 $m\mu$ band and are excellent for a great many colorimetric problems. Using these instruments, one colored substance may be determined in the presence of another which would prevent a visual comparison but which transmits in the spectral region where the material being determined absorbs. In being able to select a given spectral band far more accurately than the filter photometers, the spectrophotometer has a great advantage. Spectrophotometers are adapted to other uses such as the specification of color, reflectance measurements, and the broad study of the

¹² The Coleman "Double Monochromator Spectrophotometer"; the Coleman "Universal Spectrophotometer"; the Central Scientific Company "Spectrophotometer"; and the Beckman "Quartz Spectrophotometer."

various factors which affect colorimetric methods. Spectrophotometers are playing an increasing role in the analytical laboratory.¹⁸

CATALYTIC METHODS FOR THE DETERMINATION OF SMALL AMOUNTS OF MATERIALS¹

If a reaction is catalyzed by a substance, the rate of that reaction will increase as the concentration of catalyst increases, at least within certain limits. If the reaction rates of standards containing known concentrations of the catalyst are compared with that of the unknown prepared in the same way, the concentration of catalyst in the unknown can be readily determined by noting which of the standards has the same reaction rate. Since the rate may be influenced by other substances present in the solution it is obvious that the solutions must contain the same concentration of such substances and must differ only in the concentration of catalyst.

In order to compare the rates of reaction some visual change must occur in the solution such as the appearance or disappearance of a color or a turbidity. For example, bismuth catalyzes the following reaction:

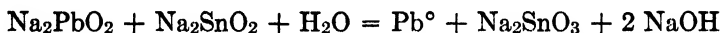

The lead forms a black turbidity. A series of tubes is prepared, each containing sodium plumbite in the same concentration but varying amounts of bismuth, such as 0.001 mg., 0.002 mg., etc., including the unknown. To each of these tubes is added the same amount of sodium stannite solution at the same time. The time of appearance of the blackening in the unknown should coincide with that of one of the standards. The two solutions then contain the same concentration of bismuth, or, if the volumes are the same, the same weights of bismuth.

The catalytic method is extremely sensitive, permitting in some cases the determination of amounts less than 0.0001 mg. It is use-

¹⁸ For reviews of the apparatus and applications of the spectrophotometer, see the papers of Mellon, especially "The Role of Spectrophotometry in Colorimetry," *Ind. Eng. Chem., Anal. Ed.*, **9**, 51 (1937); and "Spectrophotometry in Analytical Chemical Research," *Proc. Seventh Spectroscopy Conference*, 1939, p. 101.

¹ For a more detailed treatment of this subject, see Feigl, *Specific and Special Reactions*, Elsevier Publishing Company, Inc., New York, 1940, pp. 65-80.

ful as a qualitative test in cases in which quantitative comparisons are not applicable. It is also quite specific.

Examples of catalytic methods are:

Copper catalyzes the reduction of ferric to ferrous iron by thio-sulfate.

Mercury catalyzes the reduction of arsenious acid to arsenic by stannous chloride in strong hydrochloric acid solution.

Silver catalyzes the reduction of permanganate or of ceric sulfate by hydrochloric acid. It also catalyzes the oxidation of a man-ganous salt to permanganate by persulfate.

Osmium catalyzes a number of oxidation-reduction reactions. A convenient one is the oxidation of iodide to iodine by chlorate in acid solution.

Palladium catalyzes the reduction of molybdic acid to molybde-num blue (quinivalent molybdenum) by carbon monoxide.

THE METHODS OF REPORTING ANALYTICAL RESULTS

The form in which the results of analyses are given varies with the type of material analyzed. The constituents of metallic ma-terials, in which the elements are usually present in their reduced or elemental state, are generally reported as the per cent of the ele-ment; for example, in a steel, silicon, phosphorus, tungsten and sul-fur are reported as the per cent of each in its elemental form. In the case of most minerals and rocks in which the elements are asso-ciated with oxygen, that is, present as oxides, salts, or derivatives of oxygen acids, it is customary to report results as the per cent of the oxides. This method has the merit that the sum of all of the oxides, metallic and non-metallic, should total 100 per cent. Ac-tually however the summation will almost never be 100 per cent because of the errors which are unavoidable in all analytical proc-esses. This method of reporting results avoids any statement as to the compounds present in the material analyzed, information which generally cannot be learned from chemical analysis but only from a petrographic examination. The small amount of water of constitu-tion present in minerals and rocks, either as water of crystallization or as the water in acid salts, is reported separately. The method is inapplicable to such substances as sulfides and halides where no oxygen is present. In the latter cases the constituents are reported as the per cent of the element.

A convenient and readily interpretable graphical method has been adopted by the United States Geological Survey for reporting the results of water analyses.¹ The milliequivalents per liter of the basic and acidic constituents present in the water are plotted in adjoining columns as shown in Fig. 32. The relative amounts of the various ions present and the discrepancy in the acid-base balance can be seen at a glance. It is often desirable to adjust the results

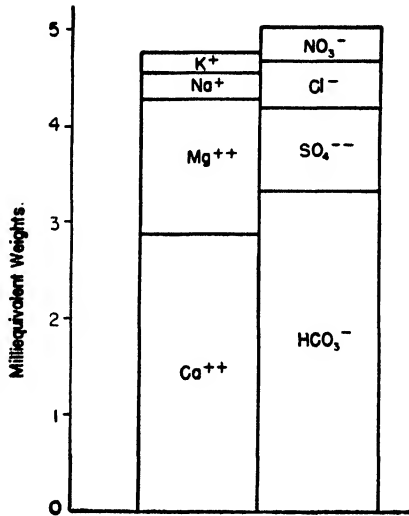

FIG. 32. Graphical Method of Reporting the Results of Water Analysis.

so that no discrepancy appears in the acid-base balance; one way in which this is frequently done is to divide the discrepancy in two and to add and subtract this value from the respective columns, distributing the correction among the various ions in proportion to the amount of each present.

The results of analyses for very small amounts of materials are frequently reported in parts per million (p.p.m.). One p.p.m. is equal to 1 milligram in a 1000 g. sample, or, if as in water analysis the density of the sample may be taken as one, 1 milligram per liter.

Occasionally the results of analyses are reported as some other material than that actually determined. The total acid concentration in salts and neutral organic compounds such as hydrocarbons, oils, and esters, as determined by titration with alkali, is usually

¹ Collins, U. S. Geological Survey, *Water Supply Paper 596-H*, p. 256.

reported as acetic acid. The amount of heavy metals in acids and organic materials is determined by evaporation and weighing as the oxide or sulfate and calculated to an equivalent amount of iron or lead for reporting. It is common practice in water works laboratories to report all of the results of water analyses as an equivalent amount of calcium carbonate. This is applied even to the anions, and although it is odd to express the amount of sulfate or hydrogen ion as calcium carbonate, it is actually a great convenience in plant operation. The molecular weight of calcium carbonate is just 100 and one milliequivalent weight of any substance is equivalent to 50 p.p.m. of calcium carbonate. It would be just as convenient to deal with milliequivalent weights, but custom and the fortuitous value of a molecular weight dictate that the results be expressed as calcium carbonate. Other such systems may be cited; usually they are based on some reasonable foundation and need not give the uninitiated more than momentary puzzlement.

CHAPTER III

THE ANALYSIS OF IRON ORE, IRON, AND STEEL

Iron ores are of three kinds according to whether the principal constituent is hematite, Fe_2O_3 , magnetite, Fe_3O_4 , or siderite, FeCO_3 . There is also a variety of hematite containing varying amounts of hydrated water, known as limonite. The ore is always more or less contaminated with other minerals, so that the number of elements present in small amounts is usually large. The most common foreign elements are manganese, aluminum, titanium, silicon, calcium, magnesium, phosphorus, sulfur, carbon dioxide, potassium, sodium, and water of hydration, the elements being combined with oxygen. The carbon dioxide is usually combined only with calcium and magnesium unless the ore is of the ferrous carbonate type. Sometimes there are present small amounts of chromium, copper, lead, barium, vanadium, and arsenic. Sulfur may be present partly as sulfide (pyrites) but it is usually in the form of sulfate.

During the process of making iron and steel many of the common impurities of the iron ore are eliminated and the chemical state of those remaining is changed from combination with oxygen to the elemental state or to carbides or phosphides. Carbon is introduced. The common minor constituents in cast iron and plain carbon steel are carbon, silicon, sulfur, manganese, and phosphorus.

The methods for the determination of the impurities or minor constituents, sulfur, manganese, phosphorus, and silicon, can with suitable modifications be applied to both iron ore and iron and steel. The modifications necessary arise from the fact these minor constituents are present in the metallic products in the elemental state or possibly as carbides while in ores they are present as oxides or carbonates. It is essential then that in dissolving iron and steel an oxidizing acid be used to insure that no constituent be lost by volatilization, for example, sulfur as hydrogen sulfide, or phosphorus as phosphine. The analytical chemistry of each of these minor constituents will be taken up in turn and methods given for their determination in both types of materials.

An iron ore is always dissolved in hydrochloric acid since it is practically unattacked by sulfuric acid or nitric acid, and only slowly by hydrochloric acid plus nitric acid. Syrupy phosphoric acid dissolves an iron ore readily at a high temperature, but such a solution has little value for analytical purposes except for the colorimetric determination of manganese. Fused potassium or sodium bisulfate attacks iron ore readily. Ferric oxide remains unchanged chemically by fusion with an alkali but the silica present is attacked and rendered soluble in acids. It is essential that the ore be very finely ground, otherwise it is attacked very slowly by hydrochloric acid; it should be ground to pass a 100-mesh sieve.

The methods given in this chapter for the determination of the various minor constituents are applicable to the ore or to iron or steel without first removing the iron. This is of course desirable in the interests of accuracy and of economy of time. Occasionally the prior removal of iron may be necessary or desirable; in such a case the ether extraction of iron (p. 51) or the mercury cathode (p. 58) is used. The presence of alloying elements in steel frequently causes serious interferences; the necessary modifications in procedure will be mentioned or can be found in the extensive treatises covering the subject.

A great body of literature has grown up on the analysis of ferrous materials and a familiarity with the important works in the field is essential when approaching more complicated problems. A bibliography on the analysis of ferrous materials will be found in Willard and Furman, 3rd Ed., p. 489.

Suggestions Regarding the Analysis of Iron Ore, Iron, and Steel. The following methods are recommended to the student for the determination of the elements in iron ore, iron, and steel:

<i>Element</i>	<i>Cast Iron</i>
<i>Determined</i>	<i>or</i>
<i>Iron Ore</i>	<i>Plain Carbon Steel</i>
Iron	Permanganate, bichromate, or ceric sulfate method
Aluminum	Phenylhydrazine method, correcting for $TiO_2 + P_2O_5$ in precipitate
Titanium	Colorimetric determination in $Al_2O_3 + TiO_2 + P_2O_5$ precipitate
Manganese	Periodate colorimetric method
	Periodate colorimetric method

132 THE ANALYSIS OF IRON ORE, IRON, AND STEEL

<i>Element Determined</i>	<i>Iron Ore</i>	<i>Cast Iron or Plain Carbon Steel</i>
Silicon	Hydrochloric acid dehydration, hydrofluoric acid-sulfuric acid correction of impure silica	Sulfuric acid or perchloric acid dehydration, hydrofluoric acid-sulfuric acid correction of impure silica
Sulfur	Sodium carbonate fusion and precipitation as barium sulfate	Evolution of hydrogen sulfide and iodometric titration
✓ Phosphorus	Ammonium molybdiphosphate-gravimetric method	Ammonium molybdiphosphate-alkalimetric method
Carbon		Combustion and absorption of carbon dioxide on ascarite

In many cases several different methods are available but those recommended were selected because they have given the best results in the hands of beginners. Many methods widely used in industrial laboratories, especially volumetric methods, require considerable practice before accurate results can be obtained and the student who has only two or three determinations to make had better avoid such methods unless he has plenty of time at his disposal. A method which is very rapid for routine work may be anything but rapid when carried out for the first time.

The ore should first be dried in the electric oven at 105-110° for 2 or 3 hours or as much longer as desired, and then kept in a weighing bottle in a desiccator. The samples should always be weighed by difference directly from this bottle. Particular care should be used in weighing out samples for the determination of iron, since it is the principal constituent of the ore, but samples for the minor constituents need be weighed only to the nearest milligram.

Steel samples are generally in the form of drillings or turnings which need not be dried but which should be stored in an air tight container. The samples may be weighed by difference from a weighing bottle or weighed directly on an open balance pan.

The size of the sample of ore or steel taken will vary from 1-5 g. depending on the amount present of the constituent to be determined. A small sample is used for iron. This is in accord with the principles discussed on p. 11. Separate samples are used for each determination on steel. In the case of iron ore, the first operation is usually the removal of silica and its determination can

obviously be made to advantage on the sample used for another determination. Aluminum and titanium, together with all of the phosphorus in the ore, are precipitated together, the titanium in the precipitate is then determined colorimetrically and the aluminum determined by correcting the precipitate for the titanium and phosphorus present.

The permissible variation between the results of duplicate analyses and the form in which the results are reported is given in the following table.

TABLE VII. PERMISSIBLE VARIATION BETWEEN DUPLICATE RESULTS AND THE FORM IN WHICH RESULTS ARE REPORTED

Element	Iron Ore		Cast Iron or Steel	
	Reported as	Permissible Variation, Per cent	Reported as	Permissible Variation, Per cent
Loss on ignition.....	Loss	0.2		
Iron.....	Fe	0.2		
Manganese.....	Mn		Mn	
Up to 0.5 per cent....		0.02		0.02
Titanium.....	TiO ₂			
Up to 0.3 per cent....		0.02		
Aluminum.....	Al ₂ O ₃			
Up to 1 per cent....		0.05		
1 to 1.5 per cent....		0.1-0.2		
Phosphorus.....	P, and also P ₂ O ₅		P	
Up to 0.03 per cent..		0.002		0.002
0.03-0.1 per cent....		0.004		0.004
0.1-0.2 per cent....		0.006		0.006
1-2 per cent.....		0.02		
Sulfur.....	S		S	
Up to 0.4 per cent....		0.02		0.005
Silicon.....	SiO ₂		Si	
Up to 1 per cent....		0.02		0.02
Above 1 per cent....		0.1		0.1
Carbon.....			C	
Up to 1 per cent....				0.02
Above 1 per cent....				0.05

All data must be kept in a bound note book. See p. 5.

THE DETERMINATION OF LOSS ON IGNITION OF IRON ORE

This determination of the loss on ignition is a measure of the carbon dioxide, water, and organic matter present in the iron ore. The temperature at which the ignition is made must be high enough to decompose carbonates, about 800°, and an oxidizing atmosphere must be maintained during the heating. The best method is to heat the ore to constant weight in a muffle or electric crucible furnace, since a gas flame readily causes reduction. With magnetite ores a gain in weight occurs owing to oxidation and the loss on ignition has no significance; in this case the determination could only be carried out in an inert atmosphere such as nitrogen, and then only provided no organic matter was present.

Procedure. Weigh into a porcelain crucible about 1 g. of the ore and ignite 1 hour in an electric muffle at 800° or at the full heat of a Meker burner. If a burner is used, keep the crucible in a slanting position to give free access of air and thus avoid any possible reduction by the gases of the flame; this is very important. Cool and weigh. Repeat until the weight is constant within 1 mg. Do not leave crucibles in a muffle over night and do not heat above 900°. If the ore is a magnetite, do not attempt to carry out the determination.

This determination is not very accurate and is of less importance than the others.

THE DETERMINATION OF IRON

In addition to the commercially important ores of iron discussed on p. 130, a variety of other minerals contain iron as a principal component, and iron occurs in small amounts in practically all igneous and sedimentary rock. Because of its widespread distribution and because of its great utility, iron must frequently be determined in a variety of natural and manufactured products, often in only small amounts.

GRAVIMETRIC DETERMINATION

The precipitation of iron as the hydrous oxide was studied in the elementary work, Willard and Furman, 3rd Ed., pp. 345-354. It should be noted that this determination is subject to a number of errors and interferences; of these, the fact that any phosphate pres-

ent will be precipitated as ferric phosphate must be kept well in mind. The precipitation of ferric hydrous oxide is not a separation of iron from the bivalent metals, nickel, cobalt, zinc, and copper. While it is true that the hydroxides of the latter metals are soluble in excess ammonia, some hydroxide becomes surrounded by ferric hydrous oxide and is not leached away in the excess ammonia; even three reprecipitations will not effect this separation if the amount of iron is large. The basic benzoate or acetate separation may be used to accomplish this separation (see p. 47), and the cyanide-ammonia separation of Jones¹ also gives a clean separation. In the latter method cyanide is added to the neutral or barely acid solution. The cyanide ties up the bivalent metals in complex ions in which form they are not precipitated as the hydroxides by ammonia; the ferric hydrous oxide is then precipitated by ammonia and filtered off.

Ferric iron is also precipitated from dilute mineral acid solution by cupferron, the ammonium salt of nitrosophenylhydroxylamine, which separates iron from cobalt, nickel, zinc, chromium, aluminum, and manganese. Cupferron also precipitates a number of other metals including copper, titanium, and zirconium (see p. 73). The precipitate is ignited to the oxide for weighing.

The electrodeposition of iron can be carried out quantitatively from a solution containing phosphate and ammonium carbonate.² The method is accurate and reasonably fast and can be applied in the presence of small amounts of manganese; nickel, cobalt, and tungsten must be absent.

VOLUMETRIC DETERMINATION

The principles and reactions involved in the volumetric determination of iron have been adequately treated in the elementary book and will not be repeated here. The student should review the material covered in Willard and Furman, 3rd Ed., pp. 224-231, the permanganate method; pp. 243-250, the bichromate method; and pp. 252-259, the ceric sulfate method.

For the determination of iron in hydrochloric acid solutions the use of potassium permanganate after the addition of *preventive solution* (a solution of phosphoric acid and manganous sulfate) has been largely displaced by the better methods using potassium bi-

¹ Jones, *Analyst*, **54**, 582 (1929).

² Armistead, *Ind. Eng. Chem., Anal. Ed.*, **14**, 207 (1942).

chromate or ceric sulfate. Stannous chloride is commonly used to reduce the iron in these procedures, mercuric chloride being subsequently added to remove the excess of stannous chloride. The iron in a hydrochloric acid solution may also be reduced by metallic silver or metallic lead, procedures which are so rapid and convenient that they will be described in detail; see section dealing with the silver reductor, p. 97, and the section dealing with the lead reductor, p. 99. Neither stannous chloride nor metallic silver reduces titanium so that this element does not interfere in the determination of iron in this manner. This is also true of the older methods of reducing iron by sulfur dioxide or hydrogen sulfide, where the excess of reducing agent is simply boiled off, best in a stream of carbon dioxide. Reduction with sulfur dioxide or hydrogen sulfide is most applicable only to the reduction of small amounts of iron but is useful under certain conditions.

In the determination of iron in sulfuric acid solutions the reducing agents usually employed are metallic aluminum, metallic zinc, and metallic cadmium. Stannous chloride cannot be used in sulfuric acid solution in which it is not a strong enough reducing agent to reduce iron. Any titanium present is reduced by aluminum, zinc, or cadmium and subsequently titrated by the permanganate so that titanium interferes in the determination of iron using these agents. Zinc as a reductant is usually used in the Jones reductor (see Willard and Furman, 3rd Ed., p. 230), but is also conveniently used in the form of wire spirals³ which can be inserted directly into the solution and can be later withdrawn and rinsed. If ordinary aluminum wire is used a correction for the iron in the aluminum dissolved during the reduction must be made.

Nitric acid cannot be present in the determination of iron because of its reduction to nitrous acid or hydroxylamine which react with the oxidizing agents.

Ferrous iron must be titrated cold as the oxidation to ferric iron by air proceeds more rapidly in the hot solution.

In the permanganate method using sulfuric acid, after the solution has been evaporated to sulfuric acid fumes to remove the hydrochloric acid, insoluble calcium sulfate may remain if the ore is high in calcium. This does no harm but may be mistaken for insoluble ferric sulfate. The presence of calcium sulfate may be

³ Smith and Rich, *J. Chem. Education*, 7, 2948 (1930).

avoided by preliminary precipitation with ammonia. The precipitate, after filtration and brief washing, is dissolved in boiling, dilute sulfuric acid containing a little hydrochloric acid if necessary. This procedure removes most of the calcium. When a hydrochloric acid solution is titrated, of course no such trouble is encountered.

Titanium hydride, a black powder soluble in 8 *N* sulfuric acid yielding hydrogen and titanous sulfate, has been proposed⁴ as a reducing agent for ferric sulfate. The excess of titanous sulfate is removed by a preliminary titration with the standard oxidizing agent using indigo sulfonate as indicator and the ferrous sulfate is then titrated in the normal manner.

Procedure for Total Iron in Ore by Permanganate Titration in Sulfuric Acid Solution. Since iron is the principal constituent, especial care should be taken in this analysis since any error means a great variation in results. Weigh into a 150 ml. beaker a sample of 0.4-0.5 g., depending upon the amount of iron present. Add 10 ml. of water and 20 ml. of concentrated hydrochloric acid. Cover and keep the material just below the boiling point until dissolved. Filter off the insoluble matter, wash with dilute hydrochloric acid (1 : 99) and then with water. Burn off the filter paper in a platinum crucible. To the residue in the crucible add a drop of water, about 1 ml. of hydrofluoric acid, and 2-3 drops of sulfuric acid; evaporate to dense fumes of the latter but do not ignite as the residue would otherwise become insoluble. After cooling, treat the residue with a little hydrochloric acid, which should dissolve nearly all of it, and add this solution to the main solution of the ore. It is not necessary to dehydrate the silica in the main solution.

Add 3 ml. of sulfuric acid, place glass hooks on the edge of the beaker, and evaporate till all the hydrochloric acid is removed, using a suitable electric hot plate or steam bath. It is desirable that the sulfuric acid should not fume strongly, for the lower the temperature to which the mass is heated, the more readily will the ferric sulfate dissolve. If no pungent odor of hydrochloric acid is noticeable when the solution is warm, its removal is complete. Very little sulfuric acid should be evaporated, and the residue should be moist with the acid. To the cold sulfuric acid solution add 6-8 ml. of water and, after heating a few minutes, add a little more water and continue heating. When 20-30 ml. have been added the ferric sulfate should

⁴ Alter and Crouthamel, unpublished work.

all go into solution; it must be kept hot until it does, adding water to replace that lost by evaporation. If the evaporation with sulfuric acid has been carried too far, this may take an hour or two, and in extreme cases the ferric sulfate may seem to be insoluble. Disregard a flocculent precipitate of silica.

The solution of ferric sulfate may be reduced by cadmium, aluminum, or amalgamated zinc wire or by passing it through a Jones Reductor. The wire spiral method is somewhat more convenient in that it requires no special apparatus. Transfer the solution, not over 100 ml. in volume, to a 250 ml. conical flask and insert a spiral containing about 1 meter of pure aluminum, cadmium, or amalgamated zinc wire,⁸ having a diameter of 2.5-3 mm. If smaller spirals are used, two or three may be required. Bend the wire into a hook at one end so that the spirals may be easily lifted out of the flask. Cover the flask with an inverted crucible cover and boil the solution gently. Continue the application of heat for 10-15 minutes after the solution has become colorless; do not let it evaporate to any extent. Cool the flask and the solution quickly under the tap, remove and rinse off the cover; then lift out the spiral with a glass rod provided with a hook on one end, rinsing it carefully with cold water during its removal. Titrate the solution at once with 0.1 N potassium permanganate (standardized as described on p. 95) to the first change in color, a faint brownish or yellowish pink, which persists for 15-20 seconds. The pink color is modified by the yellow color of ferric sulfate which is, however, much less pronounced in a cold than in a hot solution. The end-point is very sharp against a white background in good light. Do not overstep the end-point; if this happens, the analysis must be rejected. From the result obtained with the first sample, the volumes of permanganate required for the others may be estimated approximately and the end-points approached more rapidly.

It is best to standardize the oxidizing solution within two or three days of the time it is to be used. Before use, the spiral should be cleaned by brushing and rinsed thoroughly. If the amount of iron in the aluminum wire used is appreciable, the aluminum spiral must be dried and weighed within 0.02 g. before and after use and a correction made on each sample for the iron introduced into the solution. The amount of iron in the aluminum wire may be found by a blank determination run in a similar manner.

Procedure for Total Iron in Ore in Hydrochloric Acid Solution Using the Silver Reductor. For the preparation and use of the silver reductor see p. 97.

Dissolve the ore and decompose the silica as described in the first paragraph of the procedure for iron given on p. 137. Adjust the volume of the hydrochloric acid solution so obtained to 50-100 ml. Pass the solution through the silver reductor at the rate of about 30 ml. per minute, catching the solution in a 600 ml. beaker. Wash the silver with five or six portions of dilute hydrochloric acid (1 : 10) of about 25 ml. each, allowing the solution each time to fall to a level about 5 mm. above the top of the column of silver before shutting off the stopcock and adding a new portion. Rinse down the sides of the bulb occasionally. Titrate the cool solution immediately, using either ceric sulfate or potassium bichromate.

If ceric sulfate is to be used add 10-15 ml. more of concentrated hydrochloric acid. Add 2-3 drops of 0.025 *M* *o*-phenanthroline ferrous sulfate, and titrate from a red to a yellow or greenish-yellow color. Determine the indicator blank by taking an equal volume of water, adding 15 ml. of hydrochloric acid and the same amount of indicator and titrating to the same color change. The preparation and standardization of ceric sulfate solutions are described in Willard and Furman, 3rd Ed., pp. 254 and 255.

If potassium bichromate is to be used for the titration, add 5 ml. of 85 per cent phosphoric acid and 0.3 ml. of 0.01 *M* sodium diphenylaminesulfonate, and titrate to the point where a distinctly visible purple appears over the green color of the trivalent chromium. Apply a correction for the indicator by subtracting 0.05 ml. from the volume of 0.1 *N* bichromate used. The potassium bichromate solution may be made up by weight or standardized against pure iron.

After a titration the solution may be passed again through the reductor and again titrated. Some of the indicator may be adsorbed on the silver chloride and can only be removed by washing with dilute hydrochloric acid.

Procedure for Total Iron in Ore in Hydrochloric Acid Solution Using the Lead Reductor. For the preparation and use of the lead reductor see p. 99.

Dissolve the ore and decompose the silica as described in the first paragraph of the procedure for iron given on p. 137. Adjust the volume of the solution to at least 50 ml. The color of the solu-

tion should be light yellow; add more water if the solution is orange in color.

Pour the solution through the lead reductor at a rate of 50-75 ml. per minute. Wash the column with three or four portions of 25 ml. of water containing 5-10 ml. of hydrochloric acid per liter. Some lead chloride may precipitate from the reduced solution; it does not affect the accuracy in any way. Titrate the solution immediately, using either ceric sulfate or potassium bichromate.

If ceric sulfate is used, add 2-3 drops of 0.025 *M* *o*-phenanthroline ferrous sulfate, and titrate with 0.1 *N* ceric sulfate until the light red color disappears. Determine the indicator blank by taking an equal volume of water, adding 15 ml. of hydrochloric acid and the same amount of indicator and titrating to the same color change. The preparation and standardization of ceric sulfate solutions are described in Willard and Furman, 3rd Ed., pp. 254 and 255.

If potassium bichromate is to be used, add 5 ml. of 85 per cent phosphoric acid and 0.3 ml. of 0.01 *M* sodium diphenylaminesulfonate, and titrate to the point where a distinctly visible purple appears over the green color of the trivalent chromium. Apply a correction for the indicator by subtracting 0.05 ml. from the volume of 0.1 *N* bichromate used. The potassium bichromate solution may be made up by weight or standardized against pure iron.

After use rinse the lead reductor with 200 ml. of boiling, dilute hydrochloric acid (1 : 99). Never allow the liquid level to fall below the surface of the lead. Should this happen, fill the reductor with water and apply suction at the top.

COLORIMETRIC DETERMINATION

A large number of methods are available for the colorimetric determination of iron. Of these, the official thiocyanate method is not entirely satisfactory because of the rapid fading of the color, the uncertainty of the *pH* factor, and other reasons.⁶ Several studies of the reaction of *o*-phenanthroline with ferrous iron, particularly the exhaustive study by Mellon,⁷ have shown that the red color of the

⁶ For recent studies of the thiocyanate method, see Winsor, *Ind. Eng. Chem., Anal. Ed.*, **9**, 453 (1937); Roberts, Beardsley and Taylor, *ibid.*, **12**, 365 (1940); Peters, MacMasters and French, *ibid.*, **11**, 502 (1939); Woods and Mellon, *ibid.*, **13**, 551 (1941); Peters and French, *ibid.*, **13**, 604 (1941).

⁷ Fortune and Mellon, *Ind. Eng. Chem., Anal. Ed.*, **10**, 60 (1938); Saywell and Cunningham, *ibid.*, **9**, 67 (1937); Hummel and Willard, *ibid.*, **10**, 13 (1938); Mehlig and Hulett, *ibid.*, **14**, 869 (1942).

o-phenanthroline-ferrous complex ion formed is an excellent method for iron over the range of 0.1-6.0 p.p.m. Very few ions interfere with the formation of the color. The color is stable indefinitely. The *pH* of the solution has no effect on the intensity of the color over the range of 2.0-9.0. Either hydroxylamine or hydroquinone is satisfactory for the reduction of ferric iron prior to the addition of *o*-phenanthroline. The color reaction conforms to Beer's Law.

Thorough spectrophotometric studies of a few other color reactions of iron have been made: of the green color with 7-iodo-*o*-hydroxyquinoline-5-sulfonic acid (ferron),⁸ of the pink color with mercaptoacetic acid (thioglycollic acid),⁹ of the red color with salicylal-doxime,¹⁰ and of the orange-red color with kojic acid.¹¹

THE DETERMINATION OF FERROUS IRON

Many ores and minerals such as magnetite and siderite contain both ferrous and ferric iron. To determine only the former, the mineral is dissolved in hydrofluoric and sulfuric acids in a platinum vessel in the absence of air, usually in an atmosphere of carbon dioxide. The hydrofluoric acid must be removed, otherwise the permanganate is not reduced to a manganous salt. Since evaporation is not feasible, boric acid is added which forms harmless fluoboric acid.¹² The total iron being known, the ferric iron is found by difference.

A pyrex flask may be used in place of the expensive platinum vessel mentioned above. The action of hydrofluoric acid on pyrex glassware is surprisingly slow and if the sample be finely powdered the solution process takes place quite rapidly. Some reducing impurities, principally arsenic, are derived from the glassware dissolved, and if permanganate is used to titrate the iron a correction should be applied.¹³ This correction is negligible if ceric sulfate, which does not react with arsenite in the absence of a suitable catalyst, is used instead of permanganate.¹⁴ The use of glassware in

⁸ Yoe, *J. Amer. Chem. Soc.*, **54**, 4139 (1932); Clark and Sieling, *Ind. Eng. Chem., Anal. Ed.*, **8**, 256 (1936); Swank and Mellon, *ibid.*, **9**, 406 (1937).

⁹ Lyons, *J. Amer. Chem. Soc.*, **49**, 1916 (1927); Swank and Mellon, *Ind. Eng. Chem., Anal. Ed.*, **10**, 7 (1938).

¹⁰ Howe and Mellon, *Ind. Eng. Chem., Anal. Ed.*, **12**, 448 (1940).

¹¹ Moss and Mellon, *Ind. Eng. Chem., Anal. Ed.*, **13**, 612 (1941).

¹² Barnebey, *J. Amer. Chem. Soc.*, **37**, 1481, 1829 (1915).

¹³ Soule, *J. Amer. Chem. Soc.*, **50**, 1691 (1928).

¹⁴ Soule, *J. Amer. Chem. Soc.*, **51**, 2117 (1929).

142 THE ANALYSIS OF IRON ORE, IRON, AND STEEL

this determination is advantageous in that it becomes possible to tell when the solution of the sample has been completed and in that the titration may be carried out directly without transfer to another vessel.

THE DETERMINATION OF ALUMINUM

As the third most abundant element of the earth, aluminum is found as a principal component in a great number of minerals including those constituting clays and rocks, and as a minor constituent or impurity in many others. The principal ore of aluminum is bauxite, $\text{Al}_2\text{O}_3 \cdot 2\text{H}_2\text{O}$, although cryolite, Na_3AlF_6 , and emery, Al_2O_3 , are also important. Because of its widespread distribution, aluminum finds its way inevitably into manufactured products, and its determination in iron ore and steel is of some significance. Aluminum bronzes contain up to 10 per cent of aluminum and the newer magnet alloys contain amounts of aluminum from 10-15 per cent. The analysis of metallic aluminum is more often concerned with the impurities present than with the total aluminum.¹

Although readily dissolved by hydrochloric acid, metallic aluminum dissolves very slowly in dilute sulfuric or nitric acid or in concentrated nitric acid; it dissolves rapidly in sodium hydroxide. The hydrated oxide minerals, bauxite and diaspore, are soluble in acids and, of course, also in alkaline fusions, that is, with sodium carbonate, sodium peroxide, or sodium hydroxide. The anhydrous oxides, emery and alundum, are very refractory, and fusion with borax is the most satisfactory method of attacking them. The silicate minerals generally require an alkaline fusion for their decomposition.

SEPARATION AND GRAVIMETRIC DETERMINATION

Aluminum is customarily determined gravimetrically. It is precipitated either as the hydrous oxide at a $p\text{H}$ of 6.5-7.5, its isoelectric point, or as the phosphate, AlPO_4 . The hydroxide is ignited to the oxide for weighing; the phosphate remains on ignition and is weighed as such.

The general problem of separating the weak bases, such as aluminum and ferric iron, from the more basic bivalent metals, such as

¹ Churchill and Bridges, *Chemical Analysis of Aluminum*, 2nd Ed., Aluminum Company of America, New Kensington, Penna., 1941.

copper and nickel, was discussed in the section dealing with the ammonia precipitate, p. 44.

As with ferric iron the separation of aluminum from the bivalent metals, manganese, cobalt, zinc, nickel, cadmium, and copper, cannot be made by precipitation with ammonia. The basic acetate method is not entirely satisfactory as it frequently does not remove all of the aluminum. Aluminum can be accurately separated from these metals, however, by precipitation as the dense basic succinate by boiling the solution containing succinic acid and urea.² Hydrolysis of the urea forms ammonia which gradually and homogeneously raised the pH to 4.2-4.6. Owing to the dense nature of the precipitate, it is easily filtered and washed and shows much less adsorption of other salts than does the precipitate obtained by precipitation with ammonia. The basic sulfate precipitated in this way is also dense, but the pH must be raised to 6.5-7.5 and separations in certain cases are less satisfactory.

Ferric iron, titanium, and a number of rarer metals such as zirconium and thorium are precipitated by the same reactions. A separation of aluminum from iron is possible, therefore, only by keeping the iron reduced to the ferrous form by means of thiosulfate, hydrosulfite, or sulfite, according to the method used. Two methods, the phenylhydrazine and the phosphate, are available for the direct separation of small amounts of aluminum from large amounts of iron and the small amounts of other metals present in iron ore. They are used only for this purpose, and are not suitable where the filtrate is to be used for the determination of other metals. Metals precipitated by hydrogen sulfide in hydrochloric acid solution must be absent. The principles of these methods, which comply with the general principles given on p. 44, will be discussed separately and in detail.

Aluminum may also be separated from the other weak bases, ferric iron, titanium, and zirconium, by repeated fusion of the oxides with an alkali such as sodium carbonate, sodium tetraborate, sodium peroxide, or sodium hydroxide. The same separation may be made in solution by adding an excess of sodium hydroxide, but this method is of little value, owing to the difficulty of obtaining pure sodium hydroxide, and because of the action of strong alkali on glass and porcelain vessels. Aluminum and titanium may be sepa-

² Willard and Tang, *Ind. Eng. Chem., Anal. Ed.*, **9**, 357 (1937).

rated from iron by depositing the iron electrolytically from an oxalate solution or from a sulfate solution using a mercury cathode (see p. 58).

The organic reagent 8-hydroxyquinoline precipitates aluminum from ammoniacal or weakly acid solutions and is a convenient reagent for separating aluminum from phosphate, beryllium, vanadium, arsenic, molybdenum, uranium, fluorine, boron, columbium, and tantalum. The separation from the first two elements is of particular interest.³ It is recommended that the determination be made by decomposing the precipitate with nitric acid and sulfuric acid, by precipitating the hydrous oxide, and by finally igniting to the oxide rather than by direct weighing of the 8-hydroxyquinoline precipitate or by the volumetric method (discussed in the section on organic reagents, p. 74).

Phosphate Method. The phosphates of ferric iron, aluminum, titanium, and some of the rarer metals such as zirconium, thorium, and cerium, are almost insoluble in acetic acid, and are completely insoluble if the acid is dilute and an acetate is added to give a pH of 5.0-5.4. They may be thus separated from ferrous iron, calcium, magnesium, nickel, and very small amounts of manganese. Zinc, cobalt, and manganese form double ammonium phosphates, which are not sufficiently soluble to make possible a separation unless they are present in very small amounts. Chromium is largely but not completely precipitated. In a slightly acid solution the ferric iron is reduced by the addition of thiosulfate:



Ammonium phosphate, ammonium acetate, and acetic acid are also added. Since ferrous phosphate is soluble under these conditions, only aluminum phosphate and titanium phosphate are precipitated.

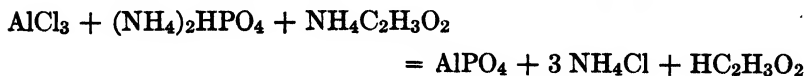

In the presence of acid the excess of thiosulfate breaks up thus:

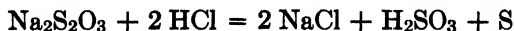

The sulfurous acid is volatilized as water and sulfur dioxide on long boiling, and this aids the acetate buffer in further decreasing the

³ Lundell and Knowles, *Bur. Standards J. Research*, **3**, 91 (1929); Bright and Fowler, *ibid.*, **10**, 327 (1933); Knowles, *J. Research Nat. Bur. Standards*, **15**, 87 (1935).

acidity of the solution. The thiosulfate thus serves a double purpose. The precipitate contains considerable sulfur, which is helpful in coagulating the precipitate since it is a colloid of opposite charge. On ignition, the sulfur burns off leaving the phosphates. If much iron is present, the first precipitate is not free of it, and the precipitate must be dissolved and reprecipitated as before. Metals of the first and second groups of the qualitative analysis scheme interfere since they form insoluble sulfides or phosphates and must therefore be absent. The filtrate is of no value for other determinations because of the large amount of phosphate and other salts present. The composition of titanium phosphate varies somewhat, so that if large amounts are present the method is much less accurate. This method is used only for the determination of small amounts of aluminum in iron, steel, or iron ore.

Procedure for Aluminum in Iron Ore by the Phosphate Method.

Dissolve a 1-5 g. sample of the ore in hydrochloric acid and filter off the insoluble residue. Evaporate the solution to dryness and bake to dehydrate the silica. Take up the residue with dilute hydrochloric acid and filter off the insoluble material. Combine the two filters in a platinum crucible, burn away the filter paper, and ignite the residue. Treat the residue with hydrofluoric acid and sulfuric acid and evaporate to dryness, to volatilize the silica. Fuse this residue with a little sodium carbonate or potassium pyrosulfate, dissolve the melt in dilute hydrochloric acid, and add to the main solution.

To the cool solution, diluted to 400 ml. in an 800 ml. beaker, add a solution of 3 g. of diammonium hydrogen phosphate, neutralize most of the free acid with ammonia, and finally add dilute ammonia drop by drop with constant stirring until a faint precipitate just persists. Add 1-1.5 ml. of concentrated hydrochloric acid and stir until clear. If much titanium is present, a faint turbidity may persist indefinitely and may be disregarded.

Add to the solution 15 g. of sodium thiosulfate dissolved in water, heat to boiling, add 8 ml. of glacial (anhydrous) acetic acid (or 26 ml. of 5 *N* acid) and 5 g. of ammonium acetate, cover, and boil vigorously for 30 minutes. Filter off the precipitate as rapidly as possible and wash two or three times with hot water. The filtrate may become opalescent due to free sulfur but this may be disregarded. Puncture the filter and wash the precipitate through into the original beaker with boiling, dilute hydrochloric acid (1 : 2).

Wash the filter with hot, dilute hydrochloric acid (1 : 50). Boil the precipitate for a few minutes to dissolve out all the phosphates, filter off the sulfur, and wash with hot, dilute hydrochloric acid, and then with water. Combine the two filter papers obtained in this manner and ignite in a porcelain crucible. If any residue is left in the crucible, fuse with a little pyrosulfate, dissolve the melt in water, and add to the main solution.

Dilute the solution to 300 ml. and precipitate again in the same way, this time using only 10 g. of thiosulfate and 3 g. of ammonium acetate, the other quantities remaining the same. Wash the precipitate two or three times with hot water and then with a hot, 5 per cent ammonium nitrate solution. Ignite in a porcelain crucible at a low temperature until the carbon is burned off, then at the full heat of a Meker burner for 1 hour, and weigh as aluminum phosphate plus titanium phosphate. The residue should be white, but may be colored due to the presence of iron; this is not, however, a sensitive indication of the presence of iron since ferric phosphate is also white. If the presence of iron is suspected, fuse with a little potassium pyrosulfate and dissolve in dilute hydrochloric acid (1 : 1). Iron will color the solution yellow. Reprecipitate the aluminum and titanium as before.

Aluminum phosphate contains 41.78 per cent aluminum oxide, Al_2O_3 , and titanium phosphate contains 45.77 per cent titanium dioxide, TiO_2 , so that if the amount of titanium is very small, no appreciable error will be introduced if the factor for aluminum phosphate is used in calculating the sum of the oxides, $\text{Al}_2\text{O}_3 + \text{TiO}_2$. The per cent of aluminum oxide can be calculated only after the titanium dioxide has been determined.

Phenylhydrazine Method. The very weak bases such as aluminum, ferric iron, chromium, titanium, zirconium, and thorium are completely precipitated by the weak base ammonium hydroxide. Moderately weak bases, such as ferrous iron, manganese, zinc, cobalt, nickel, and magnesium, are only partially precipitated, and are not at all precipitated if sufficient ammonium salts are present to repress the ionization of the ammonia. Such a separation is rarely quantitative, however. The strong bases, calcium, barium, and strontium, are not precipitated under any conditions. A much better separation of the two groups mentioned above can be effected by using a base weaker than ammonia such as phenylhydrazine, $\text{C}_6\text{H}_5 \cdot \text{NH} \cdot \text{NH}_2$. Such bases will precipitate the very weak bases

completely, but will not precipitate the moderately weak ones at all. If it is desired to separate aluminum, titanium, chromium, etc., from iron, the latter must be kept in the ferrous form, and for this purpose sodium hydrosulfite, $\text{Na}_2\text{S}_2\text{O}_4$, or ammonium bisulfite, is the reducing agent commonly employed. Reduction by the former is instantaneous, even in cold solution; with the latter it is slow in a strongly acid solution, but if the solution is nearly neutral and hot, the reduction is rapid. Phenylhydrazine, the base usually chosen, is itself a reducing agent, and for this reason is preferred to other very weak bases. After the reduction of the ferric iron

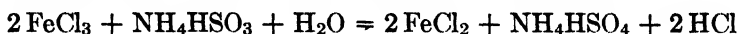

(the equation for reaction with hydrosulfite is not well established) the solution is neutralized, then is made very slightly acid, and a small excess of phenylhydrazine is added. It is necessary to add a solution of the base in alcohol as phenylhydrazine is not very soluble in cold water. Upon boiling, the hydrous oxides precipitate and carry with them any phosphate present, usually as aluminum phosphate.

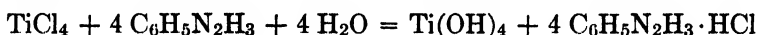
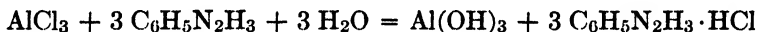

Since the precipitate contains all the phosphorus present in the ore unless, as rarely occurs, there is more than enough to unite with all the aluminum and titanium, it may therefore be used for the determination of phosphorus as described later. The precipitate is not entirely free of iron unless the amount of the latter was small, and must therefore be dissolved and reprecipitated. It is ignited and weighed as aluminum oxide plus titanium dioxide plus phosphorus pentoxide. Metals of the first and second groups of qualitative analysis must not be present since most of them are precipitated as phosphates under these conditions. Cobalt, nickel, and zinc form sparingly soluble double salts with phenylhydrazine, and the solution must be sufficiently dilute to prevent their precipitation, but even so the separation is unsatisfactory.

If excess of phenylhydrazine is added to a slightly acid solution, the resulting solution will be alkaline to methyl orange and practically neutral to methyl red. If, however, much acid is present, a highly ionized salt of phenylhydrazine is formed in sufficient concentration to repress greatly the dissociation of this very weak base;

the solution remains acid and the precipitation of aluminum is incomplete. The same result is produced if too large amounts of aluminum are precipitated. This method, therefore, is not suitable for large amounts of aluminum.

The phenylhydrazine method is used to determine aluminum, titanium, chromium, etc., in the presence of iron and manganese. The filtrate cannot readily be used for anything else because of the difficulty of destroying the organic matter. When it is desired to determine the other metals, a different method is used.

Procedure for Aluminum in Iron Ore by the Phenylhydrazine Method. Dissolve a sample of the ore weighing 1-5 g. in hydrochloric acid and filter off the insoluble residue. Evaporate the filtrate to dryness and bake to dehydrate the silica. Take up the residue with dilute hydrochloric acid and filter off the insoluble material. Combine the two filters in a platinum crucible, burn away the filter paper, and ignite the residue. Treat the residue with hydrofluoric acid and sulfuric acid and evaporate to dryness to volatilize the silica. Fuse this residue with a little sodium carbonate or potassium pyrosulfate, dissolve the melt in dilute hydrochloric acid, and add to the main solution.

Neutralize most of the free acid with filtered ammonia, leaving the solution fairly acid. Add to the warm solution solid sodium hydrosulfite, $\text{Na}_2\text{S}_2\text{O}_4$, by tapping it slowly off the end of a spatula, while stirring the solution constantly. The yellow color of the solution will gradually disappear as the ferric iron is reduced, the color finally changing to colorless or light green. Hydrosulfite is unstable in solution and must therefore be used dry. It reduces ferric salts almost instantly, even in a cold solution. The reduction is slower in a strongly acid solution than in one which is slightly acid. The solution will always smell of sulfur dioxide. If an excess of hydrosulfite is added, an opalescence of free sulfur forms. Although a slight excess does no harm otherwise, the sulfur renders the use of an indicator more difficult.

Add to the reduced solution sufficient bromphenol blue to give a yellow color; then add dilute, filtered ammonia (1 : 10) with constant stirring until the indicator just turns a greenish blue. If a pure color is obtained, some ferrous hydroxide may be precipitated. Because ferrous iron is rapidly oxidized by the air at this pH, a drop or two of hydrochloric acid should be added immediately. The solution may not be entirely clear at this point because any

titanium present will be precipitated, but no greenish ferrous hydroxide should be present.

Dilute the solution to 300 ml., heat to boiling, and add with constant stirring 2 ml. (never more than 3 ml.) of phenylhydrazine diluted with 10 ml. of denatured alcohol and 5 ml. of water. The addition of a little filter paper pulp will aid filtration. Boil for 5 minutes and keep the solution hot for at least 30 minutes more or until the slight, flocculent precipitate of the hydrous oxides of aluminum and titanium settles. Keep the solution hot and filter within two hours. Wash several times with hot water to remove most of the iron. Since a second precipitation is necessary, the precipitate at this point need not be thoroughly washed.

It is best to carry out the precipitation, filtration, and washing directed in the paragraph above during one laboratory period. The operations of filtration and washing should in any case be uninterrupted, and the work should be arranged accordingly, remembering that the precipitate filters and washes rather slowly. If the precipitate is allowed to stand overnight before filtration, there is formed a brown scum of oxidation products of phenylhydrazine. If too much phenylhydrazine is added, or if the solution is too concentrated or too cool, or if a very large excess of hydrosulfite or sulfite is added, a dense, somewhat crystalline precipitate may form, easily distinguished from the flocculent precipitate of the hydroxide. It is a phenylhydrazine compound and usually carries considerable iron. Since the amount of aluminum is low, only a light flocculent precipitate will ordinarily be obtained. Even when the procedure is properly carried out, however, the precipitate obtained is rarely white, a considerable amount of the brown oxidation products being present. Unless the amount of iron originally present was small, the precipitate will always carry some iron which is best removed by a second precipitation.

As soon as the first precipitate has been washed, dissolve it by pouring around the edge of the filter boiling, dilute hydrochloric acid (about 1 : 2), running the liquid through the filter a second time if necessary. Excessive amounts of acid should be avoided. Wash the filter thoroughly with hot, dilute hydrochloric acid (1 : 100), then with water. Since the filter paper will still contain some aluminum, burn the filter in a platinum crucible and fuse the residue with a little potassium pyrosulfate or sodium carbonate. Dissolve the melt in hydrochloric acid and add to the main solution.

The filter paper must never be discarded even if clean, as the brown organic matter which results from the oxidation of phenylhydrazine by air carries some iron, aluminum, or titanium which cannot be completely dissolved in the hydrochloric acid.

Neutralize most of the acid by the addition of filtered ammonia, add sodium hydrosulfite as before, and neutralize the solution, using bromphenol blue indicator. Add filter paper pulp, again precipitate the aluminum with phenylhydrazine, and again digest the precipitate as described before. Filter the precipitate hot and wash uninterruptedly at least 10 times with a hot, 1 per cent solution of ammonium chloride or ammonium nitrate. Ignite the precipitate to constant weight in a platinum crucible at the full heat of the Meker burner. Ignite the precipitate at least 1 hour before the first weighing. The precipitate consists of the combined oxides of aluminum, titanium, and phosphorus, $\text{Al}_2\text{O}_3 + \text{TiO}_2 + \text{P}_2\text{O}_5$. Large precipitates are quite hygroscopic. This property is lost only at 1100-1200°, at which temperature the oxide is gradually converted into the corundum variety. The precipitate should be white or slightly gray. Some ores contain a little chromium, which will give a gray or greenish tinge to the precipitate, but the precipitate should not be brownish from the presence of iron. Before ignition, the precipitate is usually brown due to the presence of oxidation products of the reagent; all of this organic material burns away during the ignition.

If the ether separation of iron (p. 51) was used to remove the major part of the iron, only one precipitation of the aluminum is required; but it must be remembered that only about 70 per cent of the total phosphorus pentoxide will then be present.

After the determination is finished, fuse the precipitate with 2-3 g. of potassium pyrosulfate or sodium carbonate, preferably the former. Dissolve the melt in hydrochloric acid or sulfuric acid which should yield a colorless solution. Determine the titanium colorimetrically. The phosphorus is usually determined on a separate sample. The per cent of aluminum oxide is determined by subtracting the per cents of titanium dioxide and of phosphorus pentoxide from the per cent of the combined oxides. If titanium is not required, this precipitate may be used for the determination of phosphorus.

Sodium Carbonate Fusion Method. This method is suitable only for small precipitates but is often very convenient. If a pre-

cipitate containing the oxides and phosphates of iron, aluminum, chromium, and titanium is fused with sodium carbonate, sodium borate, or sodium peroxide, and dissolved in water, the solution contains all the phosphorus as sodium phosphate, the aluminum as sodium aluminate, NaAlO_2 , and if an oxidizing agent such as sodium peroxide, sodium nitrate, or even air was present during the fusion, the chromium as sodium chromate:

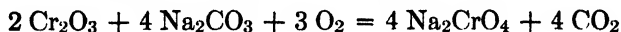
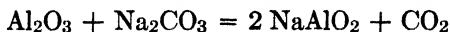

The precipitate consists of ferric and titanium oxides with a little sodium titanate which quickly hydrolyzes to the oxide. In the presence of a reducing agent such as carbon, all the chromium remains in the precipitate as chromic oxide. From the alkaline solution the aluminum is precipitated as aluminum hydrous oxide (which contains borate if borax was used) together with aluminum phosphate by reducing the concentration of hydroxyl ion. This is usually done by boiling with excess of ammonium nitrate, ammonia, and carbon dioxide being volatilized and the alkalinity of the solution thus being reduced:

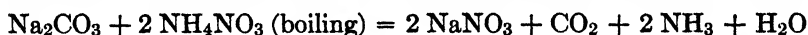
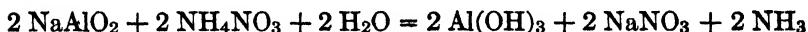

Sodium chromate is unchanged. This is better than acidifying and then adding ammonium hydroxide. Other methods of precipitating the aluminum hydrous oxide involve the neutralization of the alkali by the addition of bromine⁴ or carbon dioxide.⁵ The ferric and titanium oxides can be dissolved in hydrochloric acid and determined by suitable methods.

This method is usually applied to the precipitate produced by ammonia. If manganese is present it forms green manganate, which is reduced to manganese dioxide by a drop of alcohol.

The precipitate of aluminum hydrous oxide obtained in this way is apt to be contaminated with silica, owing to the action of the alkali on the glass or porcelain vessels. Obviously the oxides before fusion must be free of silica. The precipitate of titanium hydrous

⁴ Jakob, *Z. anal. Chem.*, **52**, 651 (1913).

⁵ Allen and Gottschalk, *Amer. Chem. J.*, **24**, 292 (1900).

oxide may show a tendency to run through the filter, which may be prevented by the addition of a little sodium carbonate.

This fusion method is of no value with a substance like iron ore, but is so useful in many other cases that the details will be given.

Procedure for the Determination of Aluminum in R_2O_3 by the Sodium Carbonate Fusion Method. Fuse the precipitate of oxides at least 1 hour in a platinum crucible with 2-5 g. of sodium carbonate, using at least 20 times as much sodium carbonate by weight and never less than 1 g. If a small amount of chromium is present, access to air is sufficient to effect its oxidation; but if the amount of chromium is large, sodium nitrate should be added to the carbonate before fusion. Dissolve the fused mass in hot water preferably in a platinum, silica, or porcelain dish, adding a drop of alcohol if a green color shows the presence of manganate. Filter off the residue and wash with water. It may contain ferric oxide, titanium oxide, and manganese dioxide, and may conveniently be used for the determination of iron or titanium (iron volumetrically, reducing with silver, hydrogen sulfide or sulfur dioxide). If the amount of precipitate is large, the remaining precipitate must be fused a second and sometimes even a third time, the filtrates being united. Any silica present must be removed before fusion by evaporation with hydrofluoric acid and sulfuric acid.

The filtrate contains sodium aluminate, usually some sodium phosphate, and if chromium was present, sodium chromate. Dilute to 300 ml., heat to boiling, and add a solution of ammonium nitrate a little at a time, boiling off the ammonia each time, until finally the addition of more ammonium salt produces no more ammonia and the solution has only a faint odor of it. About 3 g. of the nitrate will be required for every g. of carbonate. When precipitated in this way, the aluminum hydrous oxide is denser and more easily filtered than if the ammonium salt is added all at once. Wash the precipitate with hot, 1 per cent ammonium nitrate solution, ignite for an hour in a platinum crucible at the full heat of the Meker burner and weigh as aluminum oxide plus phosphorus pentoxide. The precipitate is rather hygroscopic. If small, it may be freed from silica by cautiously evaporating with a few drops of hydrofluoric acid and sulfuric acid and again igniting.

If the amount of phosphorus pentoxide is not known, and the aluminum cannot therefore be determined by difference, the alumi-

num may be determined as the phosphate exactly as described under the phosphate method, or by the following method. Add 1 g. of ammonium phosphate to the aluminate solution, dilute to 300 ml., then slightly acidify with hydrochloric acid using methyl orange. Add filter paper pulp, then 7 g. of ammonium acetate, and boil the solution for 5 minutes. Wash the precipitate with a hot, 5 per cent ammonium nitrate solution, ignite in a porcelain crucible, and weigh as aluminum phosphate. This precipitate filters somewhat less readily than that obtained by the other method.

VOLUMETRIC DETERMINATION

No entirely satisfactory method for the volumetric determination of aluminum is known. An indirect method based on the determination of the 8-hydroxyquinoline in the aluminum 8-hydroxyquinoline precipitate is available (see p. 80). An interesting, older method based on the titration of the two hydrogen ions liberated in the reaction of aluminum with alkali citrate has been subjected to a recent study⁶ and found lacking in a number of respects. Still another method is based on the titration of the base liberated when fluoride is added to a solution of aluminum containing tartrate. The solution is first neutralized to a pH of 7 using a pH meter and treated with potassium fluoride. The solution is titrated back to the pH of 7 with standard acid. Iron, cobalt, and nickel do not interfere, and the method is sufficiently accurate for the industrial analysis of magnet alloys.⁷

COLORIMETRIC DETERMINATION

Small amounts of aluminum may be determined colorimetrically as the soluble red lake formed with the organic reagent ammonium aurintricarboxylate, known as *aluminon*. Since it was originally proposed by Hammett and Sottery,⁸ this method has received considerable study, and the interferences, of which there are a great number, and the effect of pH, which is very important, are now well known. The method is excellent for the determination of aluminum in non-ferrous alloys after the removal of other metals by electrol-

⁶ Titus and Cannon, *Ind. Eng. Chem., Anal. Ed.*, **11**, 137 (1939).

⁷ Private communication from M. L. Windle; see also Malaprade, *Cong. chim. ind.*, **18**, 115 (1938).

⁸ Hammett and Sottery, *J. Amer. Chem. Soc.*, **47**, 142 (1925).

ysis with a mercury cathode. A complete bibliography of the earlier work will be found in the paper by Scherrer and Mogerman.⁹

THE DETERMINATION OF TITANIUM

Titanium ranks ninth in abundance among the elements of the earth's solid crust and is one of the most widely distributed of the elements. It is present to some extent in all rocks and oxide ores and is the principal constituent of a number of minerals. Titanium is generally combined with oxygen, and its minerals are quite refractory. From ores, titanium finds its way into cast iron and occasionally into steel. Titanium oxide is used extensively as a pigment.

DETECTION AND IDENTIFICATION

That the earth's ninth most abundant element should be absent from the curricula and texts of qualitative analysis is a curious fact. As late as 1900, however, professional analysts made no attempt to differentiate alumina and titania but reported the total as alumina.

The common valences of titanium are three and four, the trivalent compounds having a blue or purple color and being powerful reducing agents, while the quadrivalent compounds are colorless and stable. Quadrivalent titanium is scarcely amphoteric and sodium titanate is of indefinite composition and readily hydrolyzes to hydrous titanium oxide. Because titanium compounds hydrolyze readily, their solutions must be kept rather strongly acid, and care must be taken to avoid loss of titanium during the analytical operations preceding its determination. The hydrous oxide is completely precipitated at a *pH* of 2. Quadrivalent titanium reacts with hydrogen peroxide to form pertitanic acid, yellow in color, a very sensitive test for titanium; the color is bleached by phosphates and particularly by fluorides, which form complex ions with titanium.

In the common scheme of qualitative analysis titanium will appear in the ammonia precipitate, along with iron, aluminum, and chromium, if sufficient acid has been present during the previous operations to prevent hydrolysis. In the absence of chromium and phosphate, the peroxide test can be applied, otherwise the ammonia precipitate is fused with sodium carbonate to which has been added

⁹ Scherrer and Mogerman, *J. Research Nat. Bur. Standards*, **21**, 105 (1938); Scherrer and Smith, *ibid.*, **21**, 113 (1938).

a small amount of sodium nitrate, the melt leached with water, the residue dissolved in sulfuric acid, and the peroxide test applied.

Ignited titanium oxide, as well as the natural oxide minerals, rutile and brookite, are refractory and require an alkaline fusion for their decomposition. The mineral illmenite, FeTiO_3 , is also very refractory.

SEPARATION AND GRAVIMETRIC DETERMINATION

Titanium is precipitated by hydrolysis as the phosphate (of uncertain composition) or hydrous oxide, or as the salt of phenyl-nitrosohydroxylamine or of *p*-hydroxyphenylarsonic acid. The last three precipitates are ignited to the oxide for weighing. The alkali fusion method, mentioned in connection with the determination of aluminum, is a very convenient method of separating titanium from aluminum or phosphorus but must, of course, be followed by one of the precipitation methods just mentioned. Each of these methods accomplishes certain separations and is applicable to situations where the others may not be suitable.

The methods of precipitating hydrous titanium oxide are similar to those for precipitating aluminum. Since titanium is a much weaker base than aluminum, its salts are much more readily hydrolyzed and it is precipitated at a *pH* of 2 as compared with 5.5 for aluminum. Therefore, although all methods for precipitating aluminum also precipitate titanium, it is possible to increase the concentration of acid so that all the titanium but very little aluminum or iron is precipitated. A solution which is distinctly acid to methyl orange does not precipitate hydrous aluminum oxide on boiling, but hydrous titanium oxide being a much weaker base may be precipitated quantitatively by boiling a solution of the chloride or sulfate even more acid than this:

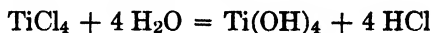

Under such conditions the precipitate is slimy and clogs the filter, but if less hydrochloric acid is present, it is much more readily filtered. If the acid present is mainly sulfurous acid, which is boiled off during the precipitation, thus increasing the *pH* slowly and uniformly, the precipitate filters readily and the iron is kept reduced. Working details for this method will be given.

Precipitation of titanium as the phosphate is complete from a solution containing acetate and acetic acid, but considerable alumi-

num is also precipitated; this is a separation from ferrous iron, the iron being best reduced with either thiosulfate or bisulfite.

From acid solutions, titanium is precipitated quantitatively by cupferron, the ammonium salt of phenylnitrosohydroxylamine. This separates titanium from aluminum, chromium, and ferrous iron, but not from ferric iron. This is a convenient method for separating titanium preliminary to the colorimetric determination of titanium in chromium and nickel steels.¹

The organic reagent, *p*-hydroxyphenylarsonic acid, separates titanium quantitatively from dilute mineral acid solutions containing iron and most of the common elements. The only interfering metals are zirconium, ceric cerium, and tin. The precipitate is ignited to the oxide for weighing.²

Procedure for the Separation and Gravimetric Determination of Titanium by the Sulfur Dioxide Method. In the following method only traces of iron and aluminum are precipitated with the titanium even when considerable amounts of these metals are present. Only chloride solutions may be used. The object of the sulfur dioxide is twofold, first, to reduce the iron, and second, to give a pure and easily filtered precipitate of hydrous titanium oxide, by slowly increasing the *pH* homogeneously by the removal of sulfur dioxide by boiling. The precipitate is dense and easily filtered since it was precipitated in the presence of sulfite. This method is adapted to the determination of moderate amounts of titanium in the presence of any amount of iron and aluminum, but is not satisfactory for very small amounts. The colorimetric method, preceded by a suitable separation from iron, is best for small amounts of titanium.

To the hot, acid solution containing the iron and aluminum add a little potassium iodide, and then ammonium bisulfite drop by drop until all the iron is reduced, as shown by the disappearance of the brown color of iodine. Hydrosulfite may also be used for this purpose as in the phenylhydrazine method for aluminum. Under these conditions, the reduction in strongly acid solution is very rapid.

Cool the solution, dilute to about 300 ml., add sufficient bromphenol blue to give a yellow color, and then add ammonia drop by

¹ Cunningham, *Ind. Eng. Chem., Anal. Ed.*, **5**, 305 (1933); see also the section dealing with cupferron, p. 73.

² Simpson and Chandlee, *Ind. Eng. Chem., Anal. Ed.*, **10**, 642 (1938); see also p. 84.

drop with constant stirring until the color just changes to blue. This gives a nearly neutral solution as a starting point for adjusting the acidity. Add immediately 5-6 drops of concentrated hydrochloric acid, which will adjust the pH of the solution to approximately 2, but will not dissolve the hydrous titanium oxide. Dilute the cold solution to about 400 ml. and saturate it with sulfur dioxide. This will give a fairly strongly acid solution of yellowish color, and most of the precipitate will gradually dissolve, though this may take an hour or more if it is large. It is not necessary to wait for the solution to become clear, and the solution will usually be saturated after bubbling the gas through it at a moderate rate for 20-30 minutes. With small amounts of titanium, only 2-3 drops excess of hydrochloric acid should be added and the solution diluted to 200-250 ml.; it need not be so thoroughly saturated with sulfur dioxide, but the precipitate should then be completely dissolved. Boil the solution until the odor of sulfur dioxide in the escaping steam becomes rather faint but does not disappear entirely; this requires 5-10 minutes. The yellow color becomes fainter as the sulfur dioxide escapes and hydrous titanium oxide is precipitated by hydrolysis as the pH returns to its original value of about 2.

Filter off the precipitate and wash with a hot solution containing about 2 drops of hydrochloric acid and a drop of concentrated ammonium bisulfite per 100 ml. The precipitate is very dense and granular and filters rapidly. Ignite to constant weight in a platinum crucible at the highest attainable temperature of the blast lamp or in a muffle and weigh as titanium dioxide. If the residue is not white, moisten with a little nitric acid and a drop or two of sulfuric acid to oxidize lower oxides, and ignite again. It can rarely be obtained pure white. If much iron and aluminum were originally present, the precipitate may contain traces of these metals, but often it is entirely free of them, depending on the care used in the separation. To remove the iron and aluminum the precipitate may be fused with potassium pyrosulfate or sodium carbonate, dissolved in hydrochloric acid and reprecipitated as before.

Following the separation of titanium, the filtrate, combined with the filtrate obtained from the reprecipitation if made, may be used for the determination of iron and aluminum. It usually contains from 0.1-0.3 mg. of titanium dioxide which escaped precipitation. If phosphorus was originally present, the titanium precipitate contains all or most of it.

VOLUMETRIC DETERMINATION

Titanium is reduced by zinc or aluminum in acid solution to the amethyst colored, trivalent salt, $TiCl_3$ or $Ti_2(SO_4)_3$:

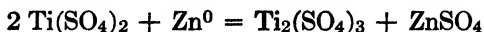

This is a strong reducing agent and may be titrated by various oxidizing agents, for example, with standard ferric chloride:



Potassium thiocyanate is used as indicator, the end-point being the appearance of the red ferric thiocyanate complex. Methylene blue may also be used as a standard solution, being reduced to the colorless leuco-base:³



The trivalent titanium may also be titrated with permanganate, in which case iron interferes:

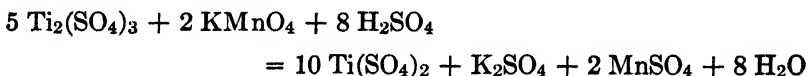

All titrations must be conducted in an atmosphere of carbon dioxide, and when methylene blue is used as the standard oxidizing agent the solution should be hot. Although iron is reduced it does not interfere when a ferric solution or a methylene blue solution is used as the standard oxidizing agent.

COLORIMETRIC DETERMINATION

The addition of hydrogen peroxide to an acid solution containing titanium gives an intense yellow or orange color, due to the formation of pertitanic acid, the formula of which is not entirely certain, but which may be considered as being derived from the anhydride, TiO_3 , just as sulfuric acid is derived from SO_3 . It may be written $TiO_3 \cdot H_2O$, or H_2TiO_4 . This furnishes an extremely delicate test both for titanium and for hydrogen peroxide; it is capable of detecting one part of titanium in one million parts of water. Amounts of titanium up to about 10 mg. per 100 ml. can be determined accurately colorimetrically by this reaction, but beyond this amount the color is too deep for accurate comparison. Obviously, no colored salts such as those of iron and chromium may be present,

³ Neuman and Murphy, *Z. angew. Chem.*, **26**, 613 (1913).

and likewise all metals that give a color with hydrogen peroxide, such as molybdenum and vanadium must be absent. The color of pertitanic acid is completely bleached by even small amounts of fluoride, owing to the formation of the fluotitanate ion, TiF_6^{--} and fluoride must therefore be absent. The color is also greatly weakened by phosphoric acid and slightly weakened by alkali sulfates, also owing to formation of complex ions. It is slightly deeper in hydrochloric acid than in sulfuric acid solution. The standard must be prepared in exactly the same way and contain the same amount of sulfuric acid, sodium sulfate, and phosphate, so as to compensate for this effect. Hydrochloric acid solutions should not be compared with sulfuric acid solutions. It is advisable to use only the latter, since a trace of iron does not give an appreciable color as it does in hydrochloric acid solution. The solution must contain at least 5 per cent of sulfuric acid.

Primary Standards for Titanium. For the preparation of standard titanium solutions several materials may be used. Very pure titanium dioxide can be prepared from distilled titanium tetrachloride,⁴ but such material does not appear to be available on the market. Available commercially are potassium fluotitanate, $\text{K}_2\text{TiF}_6 \cdot \text{H}_2\text{O}$, and potassium titanyl oxalate, $\text{K}_2\text{TiO}(\text{C}_2\text{O}_4)_2 \cdot 2\text{H}_2\text{O}$, which are suitable for the preparation of standard solutions. The proper amount of the salt is evaporated with sulfuric acid and heated so that sulfur trioxide fumes are evolved copiously. In the case of the fluotitanate this treatment should be done in a platinum dish, and it should be made certain that all fluoride has been eliminated since it has a bleaching effect on the color of pertitanic acid. The solutions should be standardized gravimetrically, although the oxalate has been recommended as a primary standard.⁵

Procedure for the Colorimetric Determination of Titanium in Iron Ore. Fuse the precipitate containing aluminum and titanium obtained by the phosphate or phenylhydrazine method (pp. 144 and 148) with 3-4 g. of potassium pyrosulfate, $\text{K}_2\text{S}_2\text{O}_7$. This is prepared by heating the bisulfate, KHSO_4 , or persulfate, $\text{K}_2\text{S}_2\text{O}_8$, below a red heat until sulfur trioxide begins to be evolved and the mass ceases to froth. The melt is then poured into a cold platinum or porcelain crucible from which it is easily removed:

⁴ Plechner and Jarmus, *Ind. Eng. Chem., Anal. Ed.*, **6**, 447 (1934).

⁵ Thornton and Roseman, *Amer. J. Sci.*, [5], **20**, 14 (1930).

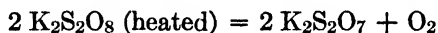
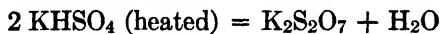

When the pyrosulfate is heated to a bright red heat, it loses sulfur trioxide and is converted into the normal sulfate, which is of no value in the fusion process:



The fusion may be carried out either in a porcelain or a platinum crucible, preferably the former, since a pyrosulfate fusion does not attack porcelain but does noticeably attack platinum. Heat very carefully at a low red heat, keeping the crucible covered until all lumps have disappeared and the liquid appears uniform. This usually requires 15-30 minutes. Too rapid heating causes frothing. If the salt solidifies, raise the temperature. If it becomes solid at a bright red heat all sulfur trioxide has been expelled, and if the fusion is not finished, add a few drops of sulfuric acid to the cool sulfate and again heat cautiously. When all of the oxide has dissolved in the melt, cool, and add 5 ml. of concentrated sulfuric acid, and heat until the mass is liquid. When cool, it will remain liquid. Dissolve in 20-25 ml. of cold water, heating if necessary until the solution is clear. If any undecomposed oxide remains, fuse it again. The solution must be colorless. Dilute to about 75 ml.

Instead of fusing with pyrosulfate, a sodium carbonate fusion may be used, but only in a platinum crucible. Dissolve the melt in 10 ml. of concentrated sulfuric acid diluted to about 25 ml. and evaporate until the solution is clear. Finally dilute to about 75 ml. If the solution is not colorless, it may be due to the presence of iron or platinum. The latter may be removed by precipitation with hydrogen sulfide.

To the cool, colorless solution add 5 ml. of 3 per cent hydrogen peroxide. If only a light yellow color appears, dilute to 100 ml. in a volumetric flask. If it is dark yellow or orange, add to the solution 8 ml. of concentrated sulfuric acid previously diluted with a little water, and dilute to 250 ml. The solution is now ready to be compared with the standard. The color will often fade out after a day or two due to decomposition of the peroxide and can be restored by adding more of it.

Prepare a standard solution of titanium sulfate in 5 per cent sulfuric acid for use in preparing the comparison standard. As has

been stated, the unknown and the standard must contain the same concentration of all substances which in any way influence the intensity of the color, such as sulfuric acid, sodium sulfate, and phosphoric acid, or which add any color themselves, such as iron or platinum. Unless the concentration of phosphorus in the unknown is more than 40 mg. per 100 ml., no phosphate need be added to the standard. The following table shows the effect of phosphoric acid on the solution containing 5 mg. of titanium dioxide per 100 ml.:

mg. P in 100 ml.	TiO ₂ calc. from reading
0	5.00 mg.
25	5.00
50	4.95
80	4.75
115	4.55
160	4.35

A precipitate of aluminum phosphate weighing 0.12 g. diluted to 100 ml., or 0.30 g. diluted to 250 ml., would be about the limit given above. The phenylhydrazine precipitate contains only the phosphorus present in the ore, and this is almost never equal to 30 mg. In case the phosphate precipitate is large enough to require addition of phosphate to the standard, the latter is conveniently added in the form of diammonium hydrogen phosphate, $(\text{NH}_4)_2\text{HPO}_4$, which contains 27 per cent phosphorus. An amount of diammonium hydrogen phosphate equal to 1.08 times the weight of the precipitate is required if the solutions are diluted to the same volume. If the unknown is diluted to 100 ml. and the standard to 250 ml., 2.5 times as much phosphate must obviously be added. Since phosphate removes the yellow color due to ferric iron, it may be used for this purpose when titanium is to be determined in the presence of small amounts of iron, if the same concentration is present in the standard; however, the phosphate must be used sparingly, or the titanium color will be too weak.

Dilute 5 ml. of sulfuric acid to about 75 ml. in a 100 ml. flask, cool, add 1.5 g. of sodium sulfate, and, if needed, the proper amount of phosphate. Add 3 ml. of hydrogen peroxide. From a buret run in standard titanium solution, mixing thoroughly until the intensity of color appears to be about the same as that of the unknown, note the volume added, and dilute to 100 ml. The solutions are now ready to be compared in the colorimeter. The same standard is

162 THE ANALYSIS OF IRON ORE, IRON, AND STEEL

used for both samples. If the sample was diluted to 250 ml. it is advisable to prepare a standard of the same volume; in this case use 13 ml. of concentrated sulfuric acid, 4 g. of sodium sulfate, and 5 ml. of hydrogen peroxide. For the use of the colorimeter, see p. 120. If the color is very faint, it is better to use Nessler tubes for the comparison.

In some ores, traces of vanadium are present which give a reddish tinge to the solution. This is most easily compensated for by adding to the standard a red dye such as methyl orange until the colors have about the same shade.

THE DETERMINATION OF MANGANESE

Manganese is found in limestone, sandstone, and in many rocks and minerals, particularly those containing large amounts of iron. Pyrolusite, MnO_2 , is the chief source of manganese, although rhodochrosite, $MnCO_3$, is also important.

Since manganese is almost invariably associated with iron, both in ores and metallic products, the methods for its volumetric and colorimetric determination are so devised as to avoid the rather troublesome separation of these metals which is necessary when gravimetric methods are used. A large number of methods are available for the determination of manganese, some suitable only for very small amounts, others only for large amounts. In iron ore, in most rocks, and in iron and steel, manganese is present in small amounts. The most accurate method for very small amounts is the colorimetric method. In the form of permanganate, relatively little manganese gives an intense color, and preliminary separations of manganese are not usually necessary, as comparatively few things interfere.

SEPARATION AND GRAVIMETRIC DETERMINATION

In the case of manganese the forms in which the metal may be separated are quite distinct from the form in which it is weighed, as the methods of separation do not leave the manganese in a form suitable for weighing. Three methods are in general use for the separation of manganese from other metals.

The separation of manganese from iron and aluminum is best made by precipitating the iron and aluminum as the basic acetates or benzoates, although the basic acetate separation of aluminum is

not very satisfactory. The precipitate of basic acetates is rather bulky, and therefore the method is not suitable for large samples as are required for the determination of very small amounts of manganese. In such a case, the manganese must first be separated from most of the iron and aluminum by another method and then separated by the basic acetate or benzoate method from the small amount of iron which accompanies it. In the filtrate, the manganese may be precipitated as the double ammonium phosphate if no other metals are present and if the amount of sodium or ammonium salts is not large, otherwise it is best to precipitate it first as manganese dioxide by bromine and ammonia, and then convert it into the double ammonium phosphate.

The separation of manganese from calcium and magnesium may be accomplished by precipitating the manganese as the hydrated dioxide. Manganese is only partially precipitated by ammonia, but if an oxidizing agent such as bromine, hydrogen peroxide, or ammonium persulfate is present, it is completely precipitated as dark brown, hydrated manganese dioxide. Bromine is generally used as the oxidizing agent because it can be obtained in purer form than hydrogen peroxide and because the addition of ammonium persulfate is likely to precipitate calcium, if present, as insoluble calcium sulfate. It is usually necessary to repeat the treatment with bromine and ammonia to remove all traces of manganese. The bromine in excess of that needed to oxidize the manganese oxidizes part of the ammonia to nitrogen:

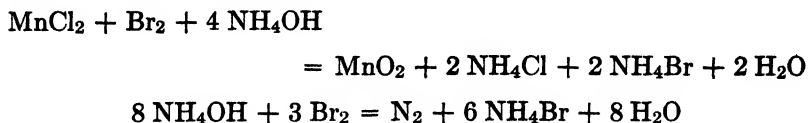

A large concentration of ammonium salts renders the precipitation more difficult. A reprecipitation is necessary if the amount of calcium and magnesium is large. Complete precipitation is more readily obtained with persulfate.

The precipitate of hydrated manganese dioxide may be converted into manganous manganic oxide, Mn_3O_4 , or manganous sulfate for weighing, but since the dioxide is liable to be contaminated with silica or alkali salts, this is not particularly accurate. It is best to convert the dioxide to manganese ammonium phosphate for

weighing; the precipitate may be dissolved in hydrochloric acid containing a bit of bisulfite to hasten the process by reduction:

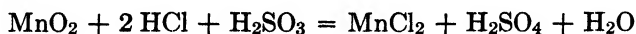

after which it is precipitated as the double ammonium phosphate.

Manganese may be precipitated as the dioxide from a nitric acid solution by boiling with a bromate or chlorate. This separates manganese from metals of the ammonia, ammonium sulfide, and ammonium carbonate groups. This method is commonly known as the *Ford Method*. Sodium chlorate is usually used as the oxidizing agent, and the nitric acid must be concentrated. Chloric acid decomposes on heating to form perchloric acid, HClO_4 , chlorine, and oxygen:

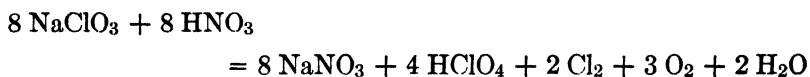

and is consequently a powerful oxidizing agent:

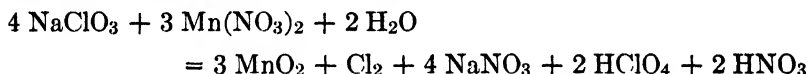

This equation, however, does not represent the exact proportion of the reacting substances; probably less perchloric acid is formed and some oxides of chlorine are produced. The precipitate of manganese dioxide is free of other metals except a little iron which must be separated by the basic acetate or benzoate method. This process has the advantage of separating the manganese without the removal of other metals, thus allowing the use of large samples if necessary. Absence of chloride is essential, and sulfate interferes if much is present. This is also the basis of a volumetric method, in which case the iron in the precipitate need not be removed.

When this method is applied to iron and steel, a nitric acid solution is obtained directly; if silica separates, a few drops of hydrofluoric acid are added. With ores, the chloride solution must be converted into nitrate or perchlorate.

Manganese is weighed as manganous pyrophosphate, $\text{Mn}_2\text{P}_2\text{O}_7$, manganous sulfate, MnSO_4 , or manganous manganic oxide, Mn_3O_4 , the first being the most satisfactory. The oxide Mn_3O_4 is obtained by igniting manganese dioxide or any other oxide of manganese in air at the full heat of the Meker burner, but it often varies slightly in composition and therefore is not recommended where very accu-

rate results are required. Manganese may be weighed very accurately as the sulfate, but the method is not suitable for ordinary work, since the sulfate must be heated to constant weight in a muffle at 450-500° to drive off excess sulfuric acid.¹ A burner cannot be used since careful regulation of the temperature is necessary. The sulfate is usually obtained by evaporating the oxide with sulfuric acid, and therefore the oxide must be free from all other metals.

Precipitation as manganous ammonium phosphate, $MnNH_4PO_4$, is an excellent method and is similar to the procedure used in determining magnesium, with the difference that while the latter is precipitated at once in the cold as the double phosphate, manganese first forms flocculent manganous phosphate, $Mn_3(PO_4)_2$, which changes more or less rapidly to crystalline manganous ammonium phosphate. To accelerate this change the solution is kept hot, and a certain concentration of ammonium salts should be present. Working directions for this determination are given on p. 166.

Procedure for the Separation of Manganese by the Nitric Acid-Chlorate Method. The precipitation of manganese as the dioxide by the nitric acid-chlorate method requires a solution free from hydrochloric acid. Such a solution may be obtained by the following procedure as applied to iron ore. Dissolve 1-5 g. of the ore in hydrochloric acid, evaporate to dryness, take up with hydrochloric acid, filter off the insoluble matter, and treat it with hydrofluoric acid and sulfuric acid, to remove silica. Evaporate off the sulfuric acid but do not ignite the residue. Dissolve the residue in hydrochloric acid and add to the main solution. Evaporate until syrupy, add 50 ml. of nitric acid, and evaporate rapidly to 10-15 ml. to remove all hydrochloric acid, as in the determination of phosphorus, bottom paragraph, p. 200. Care must be taken that basic ferric nitrate does not separate.

To the solution, in a 400 ml. beaker, add 100 ml. of concentrated nitric acid, heat just to boiling, and add dry sodium chlorate a little at a time, waiting until the effervescence ceases before adding the next portion. By the time 2-3 g. have been added, manganese dioxide will have separated as a fine, brownish black precipitate. Add 1 g. more of sodium chlorate and boil gently for 10 minutes. Add 25 ml. of concentrated nitric acid, then 1-2 g. more of sodium chlorate and boil 10 minutes longer or until the yellowish fumes from

¹ Blum, *J. Amer. Chem. Soc.*, **34**, 1379 (1912).

the decomposition of the chlorate are no longer evolved. The solution tends to bump rather badly at times, and a sufficiently large beaker should be used. Cool the solution by placing the beaker in cold water, filter through a Gooch crucible, using an asbestos mat. Wash the beaker and precipitate three or four times with colorless, dilute nitric acid. The nitric acid used above must be free from nitrous fumes which reduce manganese dioxide:



This is particularly important during the washing of the precipitate. If present, the colored nitrous oxides may be removed by blowing air through the acid. Finally wash with cold water. It is advisable to boil the filtrate with more sodium chlorate to make certain that the manganese is all precipitated.

Transfer the precipitate and asbestos to the beaker in which the precipitation was made, add to it 4-5 ml. of hydrochloric acid, 20-30 ml. of water, and a few drops of ammonium bisulfite. The dioxide should dissolve quickly. Filter off the asbestos and wash with hot water. Boil off the sulfur dioxide, add bromine water until the solution is colored by it, and then boil off the excess. The solution now contains manganous chloride and a little ferric chloride. Remove the latter by a double basic acetate or benzoate precipitation using a small quantity of acetate or benzoate. Finally precipitate the manganese as the double phosphate as described below.

Procedure for the Determination of Manganese as the Pyrophosphate. To the manganous solution from which all other metals except the alkalies are absent, and which has a volume of 150 ml., add 2 g. of ammonium phosphate, and dissolve any precipitate which forms by the addition of hydrochloric acid. Heat the solution to boiling and add ammonia drop by drop until a flocculent precipitate begins to form. Continue the heating with constant stirring until the precipitate becomes crystalline and silky; then add another drop of ammonia. Continue in this manner until further additions cause no appreciable change, and the solution is slightly alkaline. If the ammonia is added all at once, the heating must be continued much longer in order to convert the precipitate into the crystalline double phosphate which is absolutely necessary for accurate results. Let stand for 2 hours and cool to room temperature. Filter on a Gooch crucible or paper, and wash with cold water. Ignite the precipitate at a bright red heat, using the full heat of a

Meker burner or better an electric muffle. Weigh as manganous pyrophosphate, $\text{Mn}_2\text{P}_2\text{O}_7$, containing 38.708 per cent of manganese or 49.982 per cent of manganous oxide.

The equations for the reactions in this determination are the same as in the determination for magnesium. Manganous ammonium phosphate is practically insoluble in water, but appreciably soluble in solutions containing ammonium salts, whereas the magnesium precipitate is so soluble in water as to require the use of ammonia in the wash solution.

VOLUMETRIC DETERMINATION

The volumetric methods for the determination of manganese may be divided into three classes: 1) those in which the manganese is oxidized to permanganate and then titrated with a standard reducing agent, 2) those in which the manganese is oxidized to manganese dioxide or a manganic fluoride complex, which is then determined with a standard reducing agent, and 3) those in which the manganese is titrated directly to manganese dioxide or manganic fluoride. All of the methods are applicable to the determination of manganese in the presence of iron and thus to iron, steel, and manganese ores as well as to iron ore. The methods are applicable only to certain amounts of manganese, and this factor must be considered in choosing a method for a particular problem.

When it is desired to standardize the solutions against a known amount of manganese in the same manner that the determination is made, manganous oxalate, $\text{MnC}_2\text{O}_4 \cdot 2\text{H}_2\text{O}$, may be used as a primary standard.²

METHODS INVOLVING OXIDATION TO PERMANGANATE

Only relatively small amounts of manganese can be oxidized to permanganate quantitatively. The oxidizing agents available for oxidizing manganese to permanganate are sodium bismuthate, potassium periodate, and ammonium persulfate. Sodium bismuthate, a compound of uncertain composition generally considered to be NaBiO_3 (about 80 per cent) plus BiO_2 , is an extremely powerful oxidizing agent, and the only one which is effective in a cold solution. Permanganate decomposes in a boiling solution, and for this reason bismuthate will oxidize a greater concentration of manganese

² Coltman, *Ind. Eng. Chem.*, **16**, 606 (1924).

168 THE ANALYSIS OF IRON ORE, IRON, AND STEEL

than any other oxidizing agent. Sodium bismuthate is insoluble and the excess of the reagent can be readily removed by filtering. Potassium periodate is also a powerful oxidizing agent; the excess can be removed by precipitation as mercuric periodate. Persulfate will oxidize manganese to permanganate only when a small amount of silver ion is present as catalyst. Persulfate can be destroyed by boiling, but boiling also decomposes permanganate. By using sodium arsenite as the standard reducing agent, however, the permanganate can be titrated in the presence of the excess persulfate. Because of the reaction

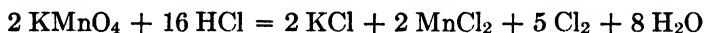

it is essential that in acid solutions chlorides be absent in working with permanganate. Nitric, sulfuric or perchloric acid solutions are satisfactory. In the determination of manganese in steel a preliminary oxidation is usually necessary to destroy carbon before making the final oxidation.

The Bismuthate Method.³ The manganous salt in a chloride free solution is oxidized by sodium bismuthate

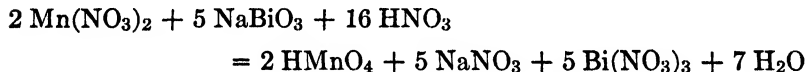

the excess of which is filtered off, and the permanganate formed is reduced by standard ferrous sulfate, the excess of which is back titrated with standard permanganate. The concentration of nitric acid at the time of the oxidation should be between 11 and 22 per cent, and if the temperature is below 25°, the oxidation is complete in one minute of shaking.

Solutions of permanganate of concentrations greater than 0.100 g. of manganese per 100 ml. decompose spontaneously even during the short time required for the filtration. The optimum concentration is about 0.05 g. per 100 ml. of solution, and as much as 0.5 g. of manganese may be oxidized in 1000 ml. of solution if the concentration of the acid is maintained. This is unwieldy, however, and seldom more than 0.1 g. of manganese is determined. Approximately 2.6 g. of sodium bismuthate should be used for 0.1 g. of manganese. The oxidation may be carried out in a sulfuric acid solution if 5-10 ml. of sulfuric acid are present. In the sulfuric acid

³ Blum, *J. Amer. Chem. Soc.*, **34**, 1379 (1912); Cunningham and Coltman, *Ind. Eng. Chem.*, **16**, 58 (1924); Park, *ibid.*, **18**, 597 (1926).

solution the temperature of oxidation may go as high as 50°, but the amount of manganese can not exceed 0.02 g. per 100 ml.

Bismuthate in the cold oxidizes part of any chromium present to chromic acid and any vanadium present completely to vanadic acid. Both of these are reduced by ferrous sulfate and therefore interfere in the determination of manganese. The permanganate may, however, be reduced with standard arsenite which reduces the permanganate before reacting with chromic or vanadic acids. See the persulfate method immediately following for a more detailed discussion of this titration. Mercurous nitrate is a better reducing agent for this purpose, but the end-point must be found potentiometrically.⁴ Also, the chromium may be removed prior to the determination by precipitation with zinc oxide.⁵

The Persulfate-Arsenite Method.⁶ Manganous salts can be oxidized to permanganate by persulfate in the presence of silver nitrate:

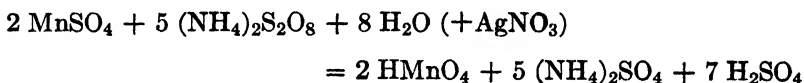

No suitable way is known of removing the excess persulfate; boiling will destroy it but decomposes some permanganate at the same time. Arsenite reacts rapidly with permanganate in the cold, while it does not react with persulfate at all. The silver catalyst should be precipitated out by the addition of a little chloride to prevent the reduced manganese from being reoxidized. The difficulty here is that arsenite does not reduce the permanganate to bivalent manganese but leaves some manganese in the form of a manganic compound⁷ in which the manganese has a valence between three and four and which has a pronounced brown color that obscures the end-point and limits the amount of manganese which can be titrated to about 15 mg.:

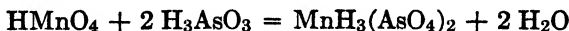

(assuming trivalent manganese). The addition of nitrite to the standard arsenite solution causes the reduction to go all the way to

⁴ Lundell, Hoffman and Bright, *Chemical Analysis of Iron and Steel*, John Wiley & Sons, Inc., New York, 1931, p. 191.

⁵ Silverman, *Ind. Eng. Chem., Anal. Ed.*, **8**, 383 (1936).

⁶ Bright and Larrabee, *Bur. Standards J. Research*, **3**, 573 (1929).

⁷ Ibbotson, *Chem. News*, **117**, 157 (1918).

the bivalent stage,⁸ but allows no greater amount of manganese to be determined. A number of other catalyts such as osmium tetroxide, OsO_4 , and iodine in various forms, have been proposed to accelerate the permanganate-arsenite reaction,⁹ but they are not applicable in the presence of persulfate.

To obtain complete oxidation of manganese without the formation of some manganese dioxide, it is necessary to have present at least 40 mg. of silver, 2.5 g. of ammonium persulfate, and 4 ml. of phosphoric acid. The concentrations of the nitric acid and sulfuric acid can be varied somewhat, but the standardization of the permanganate should be made in solutions having the same acid concentrations. Best results are obtained if the persulfate is added to the cool solution and the solution rapidly brought to the boiling point and boiled for about a half minute. Just enough chloride should be added to give a slight excess over that needed to precipitate the silver. The arsenite solution is best standardized against 0.05 *N* potassium permanganate, which has been standardized against sodium oxalate, using the same procedure as employed in the determination. It is best to add an amount of manganese free iron equal to that present in the determination.

Procedure for Manganese in Iron and Steel by the Persulfate-Arsenite Method. Prepare a 0.025 *N* solution of sodium arsenite by dissolving a weighed sample of approximately 1.23 g. of pure, dried arsenious oxide in a solution of 10 g. of sodium hydroxide in 30 ml. of water. The oxide dissolves readily on warming. Dilute to approximately 500 ml. and neutralize by the addition of 21 ml. of concentrated hydrochloric acid. Then add 10 g. of sodium bicarbonate, and dilute to exactly 1 liter.

Weigh 1.0 g. of the iron or steel into a 500 ml. conical flask and add 15 ml. of water, 3 ml. of sulfuric acid, 4 ml. of 85 per cent phosphoric acid, and 8 ml. of nitric acid. Heat until the sample has dissolved completely and boil to expel oxides of nitrogen. In the case of cast iron it may be necessary to filter off graphite at this point. Add 100 ml. of water, 5 ml. of 0.1 *M* silver nitrate solution, and 2.5 g. of ammonium persulfate dissolved in water. Heat to boiling and boil briskly for one half minute. Cool quickly to 25° or lower and add 75 ml. of cold water and 5 ml. of 0.2 *M* sodium

⁸ Sandell, Kolthoff and Lingane, *Ind. Eng. Chem., Anal. Ed.*, **7**, 256 (1935).

⁹ Park, *Ind. Eng. Chem., Anal. Ed.*, **7**, 427 (1935).

chloride. Titrate with standard arsenite to a clear yellow end-point which does not change upon the addition of more arsenite.

A preliminary oxidation should not be necessary if the above directions are followed. The presence of amounts of chromium up to 15 mg. causes no interference, but above that the yellow color of the chromate masks the permanganate color.

The Periodate Method. As mentioned before, potassium periodate is a powerful oxidizing agent and readily oxidizes manganous salts to permanganate:

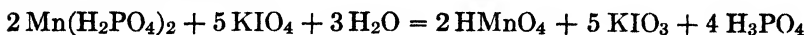

The acidity may vary over a considerable range. In the case of large amounts of manganese, the presence of phosphoric acid is desirable in preventing the formation of manganese dioxide. The excess of periodate is removed by precipitation as mercuric periodate:

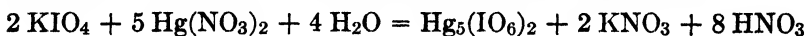

The iodate is also precipitated at the same time. The precipitate is filtered off on an asbestos mat on a Büchner funnel or on a fritted glass filter, allowing the filtrate to run directly into standard ferrous sulfate, the excess of which is back titrated with potassium permanganate.

This method¹⁰ may be applied to the determination of manganese in iron and steel containing up to 0.1 per cent chromium, in oxide ores dissolved in phosphoric acid, in bronze, and in tungsten or ferrotungsten.¹¹

Procedure for Manganese in Steel or Iron Containing Not Over 0.1 Per Cent of Chromium by the Periodate Method. Dissolve 1 g. of the sample in a mixture of 15 ml. of water and 15 ml. of 85 per cent phosphoric acid. Oxidize the ferrous iron and carbonaceous matter by adding carefully to the hot solution 1-2 ml. of concentrated nitric acid. Boil to remove nitrous fumes. Dilute to 100 ml., add 0.3 g. of sodium or potassium periodate, boil gently 15 minutes to oxidize the manganese, dilute to 150 ml., and cool to room temperature. Precipitate the periodate by adding slowly, with constant stirring, 2-3 g. of mercuric nitrate dissolved in a little water. Filter immediately through a fairly large asbestos filter into an excess of standard ferrous sulfate containing 10 ml. of 50 per cent sulfuric

¹⁰ Willard and Thompson, *Ind. Eng. Chem., Anal. Ed.*, **3**, 399 (1931).

¹¹ Smith, McHard and Olson, *Ind. Eng. Chem., Anal. Ed.*, **8**, 350 (1936).

acid to prevent precipitation of mercuric phosphate. Wash with cold water four or five times and back titrate the combined filtrate and washings with standard permanganate. Not more than three minutes should be required for the filtration and washing.

METHODS INVOLVING THE TITRATION OF MANGANESE DIOXIDE

The Ford-Williams Method. In this method, the manganese is precipitated as manganese dioxide by chlorate in hot, concentrated nitric acid solution as described on p. 165. After filtering and washing, the asbestos filtering mat and the manganese dioxide precipitate are washed into the original beaker, and an excess of standard ferrous sulfate added with constant stirring until the manganese dioxide is completely dissolved, taking care to break up the asbestos thoroughly. The excess ferrous sulfate is then titrated with standard permanganate. Since the precipitate is not exactly manganese dioxide, MnO_2 , but contains very slightly less oxygen, the ferrous sulfate should be standardized against an ore or a steel or a solution of known manganese content in the same way as the determination is carried out. Oxalate may be used in place of ferrous sulfate as the standard reducing agent:

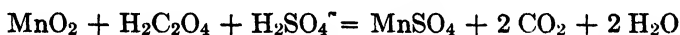

If the normality of the permanganate obtained against sodium oxalate is used, the results will be slightly low; it is best to standardize the permanganate by analyzing a steel of known manganese content the same way.

The precipitate of manganese dioxide obtained by means of ammonia and bromine is of such variable composition that it cannot be titrated. Persulfate without silver oxidizes manganous salts to manganese dioxide, but some permanganate is formed, necessitating the use of an empirical factor depending on the amount of iron present. The use of bromate in sulfuric acid solution has also been recommended, but again an empirical factor must be used.

METHODS INVOLVING THE TITRATION OF MANGANIC FLUORIDE

The Indirect Fluoride Method.¹² Although chromic acid is too weak an oxidizing agent to oxidize a manganous salt in acid solution, it will do so when a suitable reducing agent is added, one which will not reduce the manganic salt formed. Arsenious acid is best

¹² Lange and Kurtz, *Z. anorg. allgem. Chem.*, **181**, 111 (1929).

for this purpose. This oxidation of manganese by the simultaneous reduction of another portion of the oxidizing agent is called an induced reaction. It can, in this case, be explained by assuming the transitory formation of quinquevalent chromium, which has a higher oxidation potential than the hexavalent and is, therefore, capable of oxidizing the manganous salt to the trivalent state. Since an excess of arsenite is added, only trivalent chromium remains. Simple manganic salts are unstable and it is therefore necessary to form the complex manganic fluoride ion, MnF_5^{--} :

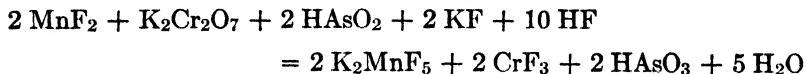

This is then titrated with standard ferrous sulfate using diphenylamine as an oxidation-reduction indicator:

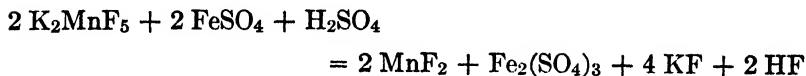

This method is not as good for very small amounts of manganese as one in which the latter is oxidized to permanganate, because the equivalent of manganese in the latter process is only one-fifth as great. The method is particularly advantageous for materials containing considerable chromium. Moderate amounts of chloride, cobalt, and nickel do not interfere, but aluminum and calcium cause low results, probably due to the precipitation of insoluble fluoride complexes containing manganese. Vanadium is also titrated and thus interferes, and ammonium salts prevent complete oxidation of the manganese.

Procedure for Manganese by the Indirect Fluoride Method. Prepare a solution containing 15 g. of potassium bichromate per liter. Prepare a solution containing 15 g. of arsenious oxide and 10 g. of sodium carbonate per liter. Prepare a solution of 1 g. of diphenylamine in 100 ml. of concentrated phosphoric acid. Prepare a 0.025 *N* solution of ferrous sulfate.

To 1 g. of the ore (or more if the manganese content is low) in a 150 ml. beaker, add 15 ml. (or more with larger samples) of concentrated phosphoric acid and a few drops of concentrated sulfuric acid. Do not add any water. Stir until all the ore is free from the bottom of the beaker and is thoroughly mixed with the acid. Cover and heat gently, taking care that the solution does not froth over,

and stirring so that the ore does not cake on the bottom of the beaker. By the time fumes of sulfuric acid have appeared, the ore should have dissolved to form a purplish or brownish solution. If it has not dissolved, keep the mass hot a little longer, stirring frequently; but do not allow the mixture to get any hotter or the beaker will be attacked. Cool the mixture, and then add gradually 25 ml. of water. Stir constantly until everything has dissolved except perhaps some gelatinous silica. No dark particles of undecomposed ore should remain. Transfer to a 250 ml. beaker and dilute to 200 ml.

Cool the solution, and add 10 ml. of hydrofluoric acid, or a little more if a very large amount of silica is present. Add at least 1 ml. of the potassium bichromate solution for every 5 mg. of manganese present plus 5 ml. more, but never less than a total of 10 ml. Now oxidize the manganese by the addition of a measured amount of the arsenite solution, adding 5 ml. more than the total volume of bichromate added. Since the two solutions are approximately equivalent in concentration, there will now be an excess of arsenite and all of the chromium will have been reduced. The solution now contains ferric, manganic, and chromic salts, and arsenite and arsenate. Add immediately 2 drops of the 1 per cent solution of diphenylamine. Allow the solution to stand 2 minutes, because the reduction of the bichromate is a little slow. Too long standing will result in some reduction of the manganic complex. Titrate the manganic salt with 0.025 *N* ferrous sulfate until the blue color of the oxidized indicator changes to green indicating complete reduction to a manganous salt. Since the final change is slow, at least 5 seconds should be allowed between drops at the end. After the titration has been completed, rinse out the beaker immediately as the solution contains hydrofluoric acid which will etch the beaker.

This same method may be applied to the determination of manganese in steel except that the steel is dissolved in dilute phosphoric acid (1 : 4) and the ferrous phosphate first oxidized by the careful addition of 15 ml. of dilute nitric acid (1 : 3) followed by a period of boiling. The equivalent weight of manganese in this reaction is the atomic weight.

METHODS INVOLVING THE DIRECT OXIDATION OF MANGANOUS SALTS
BY PERMANGANATE

The Direct Fluoride Method.¹³ Manganous sulfate or nitrate, free of chloride and ferrous salts or other reducing agents, is oxidized by standard permanganate in the presence of fluoride and hydrofluoric acid, to a brownish manganic fluoride complex, K_2MnF_6 , the permanganate added being reduced to the same form:

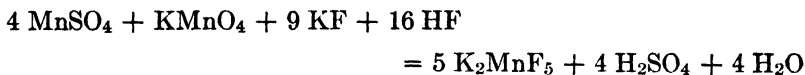

The iron present forms a colorless, complex ion, so that the pink color of the excess permanganate at the end-point is easily seen if the amount of manganese being titrated is small. If more than 40 mg. of manganese is present, the brown color of the manganic salt formed makes the end-point indistinct. This method is therefore suitable only for small amounts.

It is evident that the equivalent weight of manganese in this reaction is the atomic weight, but that of the permanganate is $\frac{KMnO_4}{4}$. Therefore, if it was standardized against oxalate, it will have a different normality in this reaction. This method is not much used.

The Volhard Method. When permanganate is added to a hot, neutral solution of a manganous salt, the latter is oxidized to manganese dioxide, and the permanganate is reduced to the same form. Since acid is formed in the reaction, zinc oxide is added in order to keep the solution neutral:

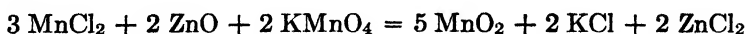

The zinc oxide precipitates all the iron as hydrous ferric oxide, which may be filtered off or not, the manganese remaining in solution. In order that the end-point may be readily seen, the very dilute solution must be boiled and allowed to settle a little after each addition of permanganate. Either a chloride, sulfate, or nitrate solution may be used, but the amount of permanganate used will vary in each case. Different amounts are required according to whether the precipitate of hydrous ferric oxide is present or not during the titration. In fact so many factors have an influence

¹³ Metzger and Marrs, *J. Ind. Eng. Chem.*, **3**, 333 (1911); **5**, 125 (1913).

that the method is quite empirical, and the permanganate must be standardized against a similar ore or steel of known manganese content. Many modifications of the method have been made in the attempt to make the results agree exactly with those calculated from the equation.¹⁴ Ferrous iron, carbon, and other reducing substances must be absent. Chromium interferes unless the zinc oxide precipitate is filtered off. Nickel interferes, and cobalt does also to some extent. Small amounts of the other elements present in ores and steel have little influence. The method is adapted to the determination of moderate or large amounts of manganese, not less than 6 mg.

Procedure for Manganese in Ore by the Volhard Method. Dissolve the ore in hydrochloric acid and add a little potassium chlorate or nitric acid to oxidize any ferrous iron. If a steel, dissolve in nitric acid, evaporate, bake, and take up with hydrochloric acid. Evaporate the solution until all free chlorine is removed (very important) and dilute to about 150-200 ml. One of two methods may now be adopted, titration in the presence of, or in the absence of, the hydrous ferric oxide precipitate. In the first method, add a slight excess of zinc oxide emulsion, dilute the solution to 250-400 ml., heat to boiling and add standard permanganate until the supernatant liquid shows a faint pink after boiling and settling. Because of the large amount of precipitate present, the end-point is rather troublesome. In the second method the hydrous ferric oxide and zinc oxide precipitate is removed. It is not customary in most cases to actually filter off and wash the entire precipitate. Dilute the solution to 150 ml. and pour into a 250 ml. or 500 ml. volumetric flask, add excess of zinc oxide, dilute to the mark, shake and mix thoroughly, and allow to settle. Decant off the supernatant liquid and take an aliquot part for analysis or else filter through a dry filter and take an aliquot part. Dilute to 300 ml., heat to boiling, and titrate as before. In order to facilitate the coagulation of the manganese dioxide, enough zinc oxide may be added to produce a faint turbidity. Sometimes an excess of permanganate is added and the excess back titrated with arsenite.

COLORIMETRIC DETERMINATION

The purple color of permanganic acid, HMnO_4 , is ideally adapted to the colorimetric determination of small amounts of

¹⁴ For an exhaustive investigation of this method, see *Stahl u. Eisen*, **33**, 633 (1913).

manganese. The best reagent for oxidizing the manganese to the permanganate state is periodic acid, HIO_4 , or one of its salts.¹⁵ The periodate is reduced to iodate:

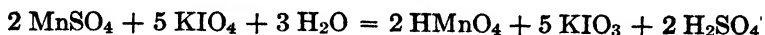

This method possesses several merits: the concentration of acid has little influence and may be varied within very wide limits; the boiling may be prolonged beyond the time necessary to oxidize the manganese without detriment; the permanganate solution will keep for months unchanged if an excess of periodate is present.

Potassium persulfate with silver nitrate as a catalyst has also been used to oxidize the manganese to permanganate, but has several disadvantages. It is erratic in its action, sometimes failing to give complete oxidation without any apparent reason. The solution of permanganic acid formed is rather unstable, and the color often fades in a short time. In the presence of titanium, the persulfate oxidation is of no value at all.

The colorimetric method may be applied to the determination of manganese in iron and steel by dissolving the sample in nitric acid or a mixture of nitric acid and sulfuric acid, oxidizing the carbon with a little persulfate, redissolving any precipitated manganese dioxide, and then oxidizing the manganese by the above method. The determination may be made in the presence of small amounts of metals such as chromium, vanadium, nickel, and others which color the solution, by adding the same amounts of the metals to the standard.

Ferric salts give a yellow color to the solution and this must be compensated by adding the same amount to the standard, or, more conveniently, removed by the addition of phosphoric acid, which forms a colorless complex ion with ferric iron. Fluoride also forms a colorless complex ion with iron. If the amount of iron is large, all the yellow color cannot be removed. The warmer the solution, the deeper the color, hence only cold solutions should be compared.

If the concentration of manganese is greater than 30 mg. per liter, the color is too dark for accurate comparison.

The periodate method is applicable to the determination of manganese in the presence of a variety of inorganic materials.^{16,17}

¹⁵ Willard and Greathouse, *J. Amer. Chem. Soc.*, **39**, 2366 (1917).

¹⁶ Clark, *Ind. Eng. Chem., Anal. Ed.*, **5**, 241 (1933).

¹⁷ Richards, *Analyst*, **55**, 554 (1930).

Procedure for the Colorimetric Determination of Manganese in Iron Ore. Hydrochloric Acid as Solvent. Dissolve in hydrochloric acid a sample of ore of such size that it contains no more than 5-6 mg. of manganese. Filter off any insoluble material, treat it with hydrofluoric acid and sulfuric acid, and evaporate to sulfuric acid fumes but not to complete dryness. Dissolve the residue in hydrochloric acid and return the solution to the main solution. If the insoluble matter is very small, it may be discarded. It usually carries only traces of manganese; but, unless the character of the ore is known, it is best to decompose moderate or large amounts as indicated. Add 10 ml. of sulfuric acid and 20 ml. of nitric acid and continue the evaporation until all chloride is removed. The nitric acid assists in the removal of hydrochloric acid, but the main purpose is to oxidize any ferrous salt that might be present and which might reduce the periodic acid to free iodine and thus color the solution. The evaporation should be conducted with the precautions described under the determination of iron, p. 137. Nitric acid may be present in any amount. No dehydration is necessary since the presence of silica in solution can do no harm. Add 50 ml. or more of water and heat until the ferric sulfate has dissolved. Any flocculent silica should be filtered out. Add 5-10 ml. of syrupy phosphoric acid (10 ml. for 1.5-2.0 g. samples), dilute to 150 ml., and mix thoroughly. If not hot, such a solution should be colorless or very faintly pink. To the solution add about 0.3 g. of potassium or sodium periodate, KIO_4 or $NaIO_4$, and heat the solution just to boiling for 5-10 minutes. The action in the cold is hardly perceptible. If no color appears after 5 minutes, add a little more periodate. The amount of periodate specified is sufficient if no hydrochloric acid or ferrous salt is present. If an odor of chlorine appears, it will be necessary to add enough periodate to oxidize all hydrochloric acid,



before permanganate can be formed. If the brown color of free iodine appears, the sample must be discarded, but this can never happen if directions are carefully followed.

To a third beaker of the same size add about the same volume of water, 10 ml. of sulfuric acid, and 5 ml. of phosphoric acid. Add a little periodate and then standard permanganate until the intensity of the color is about the same as in the samples. Heat to

boiling for a minute or two. Cool all the solutions. If the samples did not contain more than 0.4 g. of iron, the color of the latter will not be noticeable; even 0.7 g. of iron will not interfere if the permanganate color is fairly deep. If only a light pink color is obtained or if a large sample was taken, the yellow color due to ferric iron will make the solution redder than the standard, which has the pure purple red color of permanganate. To compensate for this, add to the standard the same amount of iron in the form of ferric nitrate, free from manganese; this will give it the same reddish tinge. Now dilute the solutions, which must be perfectly clear, to 250 ml. and compare in the colorimeter, see p. 120. If the color is very deep, it may be better to dilute to 500 ml. If it is very faint, Nessler tubes may be better than the colorimeter. In calculating the results, calculate first the amount of manganese in the standard; then calculate the amount of manganese in the sample from the ratio of the heights of the columns in the colorimeter, see p. 121.

▼ **Procedure for the Colorimetric Determination of Manganese in Iron Ore. Phosphoric Acid as Solvent.** To 1 g. of the ore in a 150 ml. beaker, add 15 ml., or more with larger samples, of syrupy phosphoric acid and a few drops of concentrated sulfuric acid. Stir until all the ore is free from the bottom of the beaker. Do not add any water. Cover and heat until fumes of sulfuric acid are given off, taking care that the mass does not froth over, and stir so that it does not cake on the bottom. By this time the ore should have dissolved to form a purplish or brownish solution. If not dissolved, keep the solution hot for a few minutes longer, stirring occasionally but not allowing the mixture to get any hotter, or the beaker will be attacked. A low temperature hot plate is satisfactory only at the beginning; a low flame under a wire gauze is needed to dissolve all of the ore. While still hot, add 5 ml. of concentrated sulfuric acid and stir thoroughly. When cool, add gradually about 25 ml. of water, 2-3 ml. of nitric acid, and heat until everything is dissolved except gelatinous silica. There should be no dark particles of undecomposed ore remaining. If the temperature was allowed to rise too high and the beaker was attacked, discard the sample and start another. Transfer to a 250 ml. beaker, add 0.3 g. of potassium periodate, and heat to boiling for 5-10 minutes to oxidize the manganese to permanganate. Prepare a standard as directed in the preceding procedure and compare the solutions in a colorimeter. Report the results as the per cent of manganese.

If silica separates, it cannot be filtered off. After diluting up to the mark in the flask, allow the solution to stand until the silica settles out and the upper part of the solution is clear. Pipet off sufficient clear liquid to fill the colorimeter cup. If the color is faint and Nessler tubes are used, the solution may be centrifuged, but filtration is too slow.

Procedure for the Colorimetric Determination of Manganese in Steel. Dissolve 0.5-1.0 g. of steel in 70 ml. of dilute nitric acid (1 : 3) and boil for 1 minute. Remove from the heat and add 0.5-1.0 g. of ammonium persulfate. Boil for 10-15 minutes to oxidize carbon compounds and destroy the persulfate. If a permanganate color or dark precipitate of manganese dioxide develops, add a few crystals of sodium sulfite, which reduce the manganese dioxide, to clear the solution. Boil for a few minutes to remove sulfur dioxide and oxides of nitrogen. Add 40 ml. of water, 10 ml. of syrupy phosphoric acid, and 0.5 g. of potassium periodate, and boil for a few minutes. Cool and dilute to 250 ml. in a volumetric flask. To a similar flask add 200 ml. of water, 0.1 g. of periodate, 10 ml. of syrupy phosphoric acid, and then a measured volume of standard permanganate until the color is approximately the same as that of the sample. Dilute to exactly 250 ml. and compare the two solutions in a colorimeter, see p. 120. The concentrations in the two cells are inversely proportional to the depths of the solutions when their colors have been matched. Report the results as the per cent of manganese. The standard will be more stable if it is boiled for a minute or two and then cooled before being transferred to the volumetric flask.

THE DETERMINATION OF SILICA AND SILICON

In ores, rocks, and minerals, silicon is present in the form of metallic silicates or free silica (quartz). The amount of these in a high grade ore will be relatively small but in a rock or silicate mineral, of course, the amount will be very high. In iron and steel, silicon is present as metallic silicides with perhaps some present in slag inclusions as free silica or silicate and it is found in amounts up to 2 per cent in steel and 3 per cent in cast iron. Silicon is usually introduced into the steel as refined silicon or as ferrosilicon during its manufacture, the silicon acting as a deoxidizer. It is sometimes added intentionally in order to increase the electrical re-

sistance of the steel or its resistance to acid corrosion. Silicon up to a few per cent is being introduced into copper alloys to increase their corrosion resistance, and a steel containing 15 per cent of silicon has a remarkable resistance towards strong acids.

SEPARATION AND GRAVIMETRIC DETERMINATION

The Solution of Samples for the Determination of Silica. In the case of ores and minerals low in silicon the sample is first treated with acids, and the material insoluble in acids is then filtered off and rendered soluble by fusion with sodium carbonate. The sodium carbonate melt is then subsequently dissolved in hydrochloric acid and added to the main solution, which can then be dehydrated.

For the determination of silicon in iron or steel, the sample can be dissolved directly in a non-oxidizing acid, careful studies having indicated that no loss of the silicon occurs through volatilization of the hydride during the process. The solution is then ready for dehydration, any carbon present being oxidized during the evaporation.

Silicates are classed as *soluble* or *insoluble* depending on their solubility in mineral acids. This solubility is related to the ratio of basic constituents to silica in the material; the *basic* silicates, in which the ratio is high, tend to be soluble in acids in contrast to the insoluble *acidic* silicates, in which the ratio is low. If hydrochloric acid will dissolve an appreciable amount of the sample, this treatment is first applied and the residue is fused with sodium carbonate; less sodium carbonate is thus used and the subsequent operations are rendered easier and more accurate. If not much of the substance is soluble in hydrochloric acid, it is fused directly with sodium carbonate. The carbonate fusion is always dissolved in dilute hydrochloric acid and not in water as in the latter case the glass would be attacked, introducing silica. Since sodium chloride is insoluble in concentrated hydrochloric acid, dilute acid should be used. Neither nitric acid nor sulfuric acid can be used in place of hydrochloric acid, the former owing to its inability to dissolve the basic salts formed during the dehydration and the latter for reasons mentioned below. Perchloric acid can be used. The hydrofluoric acid-sulfuric acid treatment, used for the purification of silica, cannot be applied directly to the insoluble residue for the amount of remaining oxides would be very large and the results for silica therefore low, because of the incomplete decomposition of the metal sulfates remaining.

The determination of silicon in non-ferrous materials is subject to certain difficulties; for example, in aluminum alloys appreciable amounts of silicon can be lost as the volatile hydride when the sample is dissolved in non-oxidizing acids.¹

Dehydration. The dehydration of soluble silicic acid to insoluble silica,

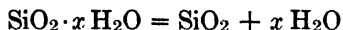

may be accomplished by evaporation with either hydrochloric acid, sulfuric acid, or perchloric acid. Since iron ores are dissolved in hydrochloric acid, the dehydration is usually made by evaporation to dryness with hydrochloric acid and baking at 110-120°. Hot, concentrated sulfuric acid and also perchloric acid are very effective dehydrating agents and are commonly used in steel analysis. The steel is dissolved directly in sulfuric acid in the former method, but in the latter method the sample is generally dissolved in nitric acid to conserve the more expensive perchloric acid and to eliminate any easily oxidizable compounds which might later react violently with the hot, concentrated perchloric acid.

The dry mass of basic chlorides and oxides obtained in the hydrochloric acid dehydration is soluble in hydrochloric acid, and generally its solution presents no problem. In the sulfuric acid dehydration, evaporation is carried to fumes of sulfur trioxide but no longer. If the fuming is unduly prolonged, anhydrous sulfates are often produced, particularly those of iron, aluminum, chromium, and nickel, which dissolve with great difficulty. The best technic at this stage is to take up the warm mass with warm water. If allowed to cool, the mass will cake, cracking the beaker or casserole either immediately or when water is added to dissolve the salts. The perchloric acid method does not have this disadvantage, all metal perchlorates being readily soluble. Another consequence of the solubility of the metal perchlorates is that the silica obtained is considerably purer. In the perchloric acid method gentle boiling is continued for 15 minutes after perchloric acid fumes have appeared.

The silica must be filtered off just as soon as all of the salts have dissolved, as silica redissolves appreciably if left in contact with water or acids for any length of time. A second dehydration must be made if the amount of silica obtained in the first is more than

¹ Churchill, Bridges and Lee, *Ind. Eng. Chem., Anal. Ed.*, **9**, 201, 534 (1937); Callendar, *ibid.*, **9**, 533 (1937).

5-10 mg. For large amounts of silica a third dehydration is necessary, although in the analysis of silicates the last bit of silica is usually brought down with the precipitate of hydrous aluminum and ferric oxides from which it is subsequently recovered. Repeated dehydration without intervening filtration accomplishes nothing. When the amount of silicon in steel exceeds 0.5 per cent, a second dehydration is necessary.²

The silica must be washed with dilute hydrochloric acid to prevent hydrolysis of ferric chloride and consequent precipitation of ferric hydroxide in the filter paper. The precipitate should finally be washed with water a few times to remove the hydrochloric acid which otherwise causes the filter paper to burn away very slowly. Particular care should be exercised in the perchloric acid method to wash all of the perchloric acid out of the filter paper before drying the precipitate, otherwise a sudden deflagration may occur.

In burning off the filter paper in the silica determination, great care must be exercised to avoid mechanical loss of the precipitate, which is very light and fluffy. Direct heating of moist silica and paper to a red heat must also be avoided as black silicon carbide is formed under such conditions.³

Silica obtained by dehydration is always impure, containing some aluminum, titanium, and iron, and occasionally calcium, barium, and sodium sulfates if they are present in sufficient amount. The amount of pure silica is determined by treatment with hydrofluoric acid and sulfuric acid followed by ignition of the residue of impurities to oxides:

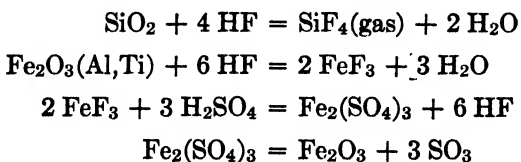

The loss in weight then gives the amount of pure silica. It is necessary to make sure that the impurities are left as oxides and not as fluorides or sulfates, which weigh more and lead to low results for silica. A residue of sulfates may be left if the amount of impurity is large, the conversion of large amounts of sulfates to oxides being very difficult.

² Fowler, *Ind. Eng. Chem., Anal. Ed.*, **4**, 382 (1932).

³ Krieger and Lukens, *Ind. Eng. Chem., Anal. Ed.*, **8**, 118 (1936).

Any silica which escapes dehydration is subsequently carried down with the ammonia precipitate, from which it is customarily recovered by fusion with potassium pyrosulfate and further dehydration. Recently it has shown ⁴ that the ignited R_2O_3 precipitate may be treated directly with hydrofluoric acid and sulfuric acid as in the purification procedure. The residue must be ignited to 1050-1100° to insure complete decomposition of the sulfates. It is possible even to carry out the determinations of both silica and R_2O_3 simultaneously in this manner with a fair degree of accuracy.⁴

Interfering Substances. The principal impurities which accompany silica, as mentioned above, are iron, aluminum, and titanium. Occasionally alkali or alkaline earth metals may also be present, the sulfates of which are not decomposed on ignition during the purification process. The resultant error can be avoided by treating with a little sulfuric acid before the first ignition; the precipitate weighed then is silica plus sulfates, and after volatilization, the impurities are in the same form.⁵ If much calcium sulfate or even a little barium sulfate is present in the mineral, some of it will separate with the silica, and this latter method of determining the amount of silica volatilized must be used. The sulfuric acid dehydration of silica in minerals is usually avoided for this reason. It is possible that some sulfates are partially decomposed in this process. Studies have been made to replace the sulfuric acid in the purification process; perchloric acid is unsatisfactory for the purpose, but oxalic acid or a mixture of oxalic acid and succinic acid is apparently suitable.⁶

When phosphate or tungstic oxide are present as impurities, which may be the case in the determination of silicon in certain steels or minerals, the ignition after treatment with hydrofluoric acid and sulfuric acid should not be as vigorous as that preceding the treatment, as phosphorus pentoxide is slowly volatilized at temperatures above 550° and tungstic oxide above 750°.

Procedure for Silica in Iron Ore. Weigh 1-2 g. of the ore into a 150-250 ml. beaker or casserole, add about 30 ml. of concentrated hydrochloric acid and 10 ml. of water, cover and keep just below the boiling point until residue is rather flocculent and no fine, dark, heavy powder remains. The color of the residue, which may be very dark, is no guide to the completeness of solution, but silica is

⁴ Dawson and Andes, *Ind. Eng. Chem., Anal. Ed.*, **12**, 138 (1940).

⁵ Kuzirian, *Amer. J. Sci.*, [**4**], **37**, 61 (1914).

⁶ Billheimer, Faust and Swift, *Ind. Eng. Chem., Anal. Ed.*, **12**, 409 (1940).

readily distinguished from the fine, dense particles of ore which collect in the center of the beaker when swirled. The rapidity with which the ore dissolves depends to a remarkable degree upon the temperature of the acid and also upon the kind of ore and its fineness. It may require from half an hour to several hours for completion, and with very large samples, still longer. If necessary, add more acid to replace that lost by evaporation. If the ore is difficult to dissolve, decant the clear solution and treat the residue with fresh acid. When dissolved, dilute the solution a little, filter through a small filter, wash thoroughly with hot, dilute hydrochloric acid (1 : 100), then with water.

Place the damp filter in a platinum crucible, dry at about 150°, burn off the carbon, note the approximate weight of the precipitate, and add 6-7 times its weight of sodium carbonate. Cover and fuse till the molten mass is quiet and has ceased to evolve bubbles of carbon dioxide; this usually requires 10-30 minutes. If the amount of silica is very small, up to 10-12 mg., and nearly white, the fusion with sodium carbonate may be omitted as explained above. Add a little water to the crucible, keep warm till the cake loosens, and pour it into a beaker, adding immediately an excess of hydrochloric acid, and adding hydrochloric acid to the crucible to dissolve what remains. If preferred, the entire crucible may be placed in dilute hydrochloric acid (1 : 2) and heated till the melt has dissolved sufficiently to make it possible to remove the crucible and rub off the adhering silica. A clear solution will seldom be obtained as some silicic acid separates immediately. It is most convenient to add this solution to the solution of the ore, but it may be treated separately. Place hooks on the edge of the beaker, evaporate to dryness, and dehydrate at about 110-125° for 2 hours or longer; a suitable electric hot plate will give the proper temperature. To the dry residue add 10-12 ml. of concentrated hydrochloric acid, heat gently, and after a few minutes when the basic salts have been acted on, add an equal volume of water. When the ferric salt has dissolved, add 20-30 ml. of water (if much sodium chloride is present, more water may be necessary to dissolve it), filter through a filter moistened with dilute hydrochloric acid, wash with dilute hydrochloric acid, and finally with water. Unless the amount of silica is only 5-10 mg., evaporate the filtrate and washings for a second recovery, dehydrate, and treat as before. If the sodium carbonate fusion was not added to the main solution of the ore, one dehydration of the

latter is sufficient. Ignite the two filters in a platinum crucible, finally at the full heat of the Meker burner for 30 minutes, cool, and weigh as impure silica.

Moisten the precipitate with 1-2 drops of water, add 2 drops of sulfuric acid (no more) and 1-5 ml. of hydrofluoric acid depending on the amount of silica, evaporate carefully until all sulfuric acid is removed, then ignite at a bright red heat for 2-3 minutes, and weigh. The loss in weight represents the pure silica volatilized. Be sure that the hydrofluoric acid does not come in contact with glass or porcelain, and that such material is not used to cover the crucible. A piece of cardboard held in a clamp about 6-8 inches above the crucible is a convenient way of protecting the contents from dust. The crucible must be heated evenly to avoid spattering; the contents must not boil. Set it inside another crucible or else on a piece of asbestos or in an evaporator to distribute the heat. If any hydrofluoric acid is spilled upon the skin, wash it off at once with dilute ammonia.

The difference between pure and impure silica should be only a few tenths of 1 per cent and less if the amount of silica is small. If a larger residue of impurities is obtained, it indicates careless work somewhere or the presence of insoluble sulfates, and the determination will probably be incorrect. Report the percentages of pure and impure silica.

Fuse the residue, which contains some aluminum, titanium, and perhaps iron, with 0.5-1.0 g. of sodium carbonate or potassium pyrosulfate, dissolve the melt in hydrochloric acid, and add this to the main solution of the ore. If it is not entirely soluble in hydrochloric acid, the residue should again be fused with sodium carbonate, or if this is not effective, with potassium pyrosulfate. This solution may now be used for the determination of one of the smaller constituents, such as aluminum or manganese.

It should be noted that the fusion with sodium carbonate is not required if silica is simply to be removed but not determined. In this case the insoluble matter is treated with hydrofluoric acid and sulfuric acid as above described, and the residue fused and added to the main solution.

Procedure for Silicon in Iron and Steel. Sulfuric Acid Method. Weigh 3 g. of sample for steels containing more than 0.5 per cent silicon or 5 g. of sample for steels containing less than 0.5 per cent silicon into a porcelain casserole. Add 100 ml. of dilute sulfuric

acid (1 : 3) and warm gently. When the vigorous reaction is over, evaporate carefully to fumes of sulfur trioxide. Heat for 2-3 minutes after the appearance of heavy, white fumes but no longer. Cool to 50-70°, and add all at once 100 ml. of warm water (temperature about 50°). Stir the solution until all the salts have dissolved, heating gently if necessary. Filter immediately and make sure that all silica is transferred to the filter by scrubbing thoroughly with a rubber tipped stirring rod. Wash well with hot, dilute hydrochloric acid (1 : 20) and finally with hot water. All iron must be washed out of the filter paper or injury may result to the platinum crucible. If the amount of silicon is greater than 0.4 per cent, a second dehydration is necessary. Transfer the combined filters to a platinum crucible. Dry, char at a low temperature, burn off the paper, and ignite at the full heat of a Meker burner for 15 minutes. Cool and weigh. Add a drop or two of water, a few drops of sulfuric acid, and about 3 ml. of hydrofluoric acid. Evaporate carefully, preferably using a larger crucible as an air bath, until the sulfuric acid has all been expelled. Ignite for 10 minutes, cool, and weigh. The loss in weight represents silica. Report the results as per cent of silicon. Silica contains 46.720 per cent of silicon.

Procedure for Silicon in Iron and Steel. Perchloric Acid Method. Dissolve the sample, 3 g. for steels containing more than 0.5 per cent silicon or 5 g. for steels containing less than 0.5 per cent silicon, in 60 ml. of dilute nitric acid (1 : 1). When solution is complete, add 40-60 ml. of perchloric acid (60-70 per cent), depending on the weight of sample taken. Evaporate to fumes of perchloric acid, cover the dish, and continue heating at such a rate that the solution boils gently and the perchloric acid condenses on the sides of the vessel for 15 minutes. Cool somewhat, and add 125 ml. of hot water. Stir until all the salts have dissolved, heating a little if necessary. Filter immediately, scrubbing thoroughly with a rubber tipped stirring rod. Wash well with dilute hydrochloric acid (1 : 20) and finally with hot water. This washing must be done thoroughly, at least 15 times. A second dehydration should be made if the amount of silicon exceeds 0.5 per cent. No more perchloric acid need be added for this dehydration; proceed just as with the first dehydration. Transfer the combined filters to a platinum crucible. Dry, char the paper at a low temperature, burn off the carbon, and ignite at the full heat of a Meker burner for 15 minutes.

188 THE ANALYSIS OF IRON ORE, IRON, AND STEEL

Cool and weigh. Add a drop or two of water, a few drops of sulfuric acid, and about 3 ml. of hydrofluoric acid. Evaporate carefully, using an air bath, until all the sulfuric acid has been expelled. Ignite for 10 minutes, cool, and weigh. The loss in weight represents silica. Report the results as per cent of silicon. Silica contains 46.720 per cent of silicon.

COLORIMETRIC DETERMINATION

Small amounts of silica may be determined colorimetrically by the yellow silicomolybdate produced by the action of ammonium molybdate on dissolved silica. Recent work on this method has established the proper conditions of pH and concentration of reagents and has shown the interferences by foreign substances.^{7,8}

THE DETERMINATION OF SULFUR

The determination of sulfur in the form of sulfate by precipitation as barium sulfate, a procedure peculiarly subject to errors, has been thoroughly discussed in the elementary book, Willard and Furman, 3rd Ed., pp. 323-327. The decomposition and analysis of sulfide ores were also extensively treated there, pp. 363-370. Both of these subjects should be reviewed before proceeding. The volumetric determination of sulfur in the form of sulfate and related topics are discussed on p. 361 of this volume. The material which follows immediately deals only with the determination of sulfur in iron ore, iron, and steel, although the general principles may be applicable in other situations.

THE DETERMINATION OF SULFUR IN IRON ORE

In iron ore, the sulfur is present as sulfate, with only a trace of sulfide, and the amount is very small. For these reasons large samples are used, and no provision is made for any considerable oxidation, so that the methods given here would be entirely useless with an ore containing much sulfide. The determination is, of course, made as barium sulfate. Since the amount of barium sulfate precipitated is very small, the amount of iron carried down is small and the iron need not necessarily be reduced to the ferrous state as

⁷ Knudson, Juday and Meloche, *Ind. Eng. Chem., Anal. Ed.*, **12**, 270 (1940).

⁸ Thayer, *Ind. Eng. Chem., Anal. Ed.*, **2**, 276 (1930); King vs. Thayer, *ibid.*, **3**, 117 (1931).

in the gravimetric determination of sulfur in iron and steel described later although such a reduction is advantageous.

In the *Fusion Method*, the sulfur is converted into a soluble alkali sulfate by fusing the ore with a mixture of sodium carbonate and potassium carbonate, which melts at a lower temperature than either one alone. Sodium peroxide is also sometimes added to sodium carbonate to lower the melting point. The melt is extracted with water, and the residue filtered off; the filtrate then contains the sulfate together with silicate, aluminate, and phosphate. After oxidizing any traces of sulfide with a few drops of a potassium permanganate solution and acidifying the solution with hydrochloric acid, the sulfate is precipitated as barium sulfate. The silicic acid may precipitate or it may remain in the solution depending upon the amount present; to be on the safe side it is, therefore, best to remove most of it before precipitating the barium sulfate.

In the *Wet Method*, the ore is dissolved in hydrochloric acid with a little nitric acid to oxidize traces of sulfide. A double evaporation with hydrochloric acid must be made to eliminate all nitric acid, and the solution must be filtered to remove insoluble matter. Excessive amounts of hydrochloric acid are then eliminated by careful evaporation and the solution finally diluted and the sulfate precipitated as barium sulfate either with or without previous reduction of the ferric chloride. The precipitation is made in the cold since less basic ferric salts are formed by hydrolysis and the amount of iron included in the precipitate is much less in the cold. Although it is evident that most of the errors of this method tend toward low results, the method is nevertheless accurate.

Procedure for Sulfur in Iron Ore by the Fusion Method. Mix 3-5 g. of the ore intimately with 15 g. of a mixture of equal parts of sodium carbonate and potassium carbonate and fuse for 30 minutes in a covered platinum or nickel crucible (preferably the latter) set into a hole in a 6-inch square of sheet asbestos in order to deflect the flame gases away from the top of the crucible. The carbonates must melt, although the mass will not be very fluid. Extract the melt with hot water, and if the solution is colorless, add permanganate until the solution has a pink or green tinge. Reduce the excess permanganate with a drop of alcohol or formaldehyde. Wash the residue thoroughly, neutralize the colorless filtrate with hydrochloric acid, using methyl orange indicator, and add 5-6 drops excess. Filter the solution if it is not clear. If the ore contains only

190 THE ANALYSIS OF IRON ORE, IRON, AND STEEL

1-3 per cent of silica, the latter need not be removed and the solution is ready for precipitation. If the ore contains more than a small amount of silica, the solution, after the addition of several ml. of hydrochloric acid, should be evaporated to dryness, taken up with water containing 6-8 drops of hydrochloric acid, and filtered to remove insoluble matter, before carrying out the precipitation.

To the boiling solution, having a volume of about 300 ml., add 10 ml. of 0.5 *N* barium chloride. Allow the solution to stand 24 hours, and then filter off the barium sulfate and ignite and weigh as usual. The precipitate contains 13.735 per cent sulfur or 34.299 per cent sulfur trioxide. A partial fusion of the precipitate on ignition indicates contamination with sodium salts.

Since the reagents contain some sulfate and more is likely to be taken up from the gas during the heating, it is necessary to run a blank, fusing the same quantity of carbonate in exactly the same way, but without adding the ore. The barium sulfate thus found is subtracted from the amount obtained in the analysis. About 1 mg. of barium sulfate remains in the solution under the conditions under which this precipitation was made, but this correction is included in the blank determination. The sulfur in the blank may be equal to or greater than that in the ore, so the importance of this correction is readily evident.

Procedure for Sulfur in Iron Ore by the Wet Method. Weigh a 5 g. sample of the ore into a 600 ml. beaker and treat with 50-100 ml. of a mixture of 1 part of nitric acid and 9 parts of hydrochloric acid. Heat the mass gently until the soluble portion of the sample has dissolved. Begin blank determinations using the same amounts of reagents but adding 0.2-0.3 g. of sodium carbonate in place of the sample; the sodium carbonate prevents the loss of sulfur by volatilization of sulfuric acid by forming sodium sulfate, which is not volatile. Evaporate the solution to dryness. Heat the residue with 20-40 ml. of hydrochloric acid and after the salts have passed into solution, dilute with water, and filter. Discard the residue if it is small in amount. If the insoluble residue is suspected to contain sulfur compounds insoluble in strong acid, fuse the residue as directed in the *Fusion Method*. Dissolve the melt in hydrochloric acid, evaporate to dehydrate silica, take up with hydrochloric acid, filter, and add the filtrate to the main solution.

Evaporate the main solution to dryness to remove the nitric acid present, take up with 20-40 ml. of hydrochloric acid, and again

evaporate, stopping at the first appearance of solid ferric chloride. These evaporations are best conducted over a hole in a piece of asbestos in order to prevent the formation of a crust of salts on the sides of the beaker. Dissolve the ferric chloride by the addition of 2-3 drops of hydrochloric acid. Continue the determination by either method *A* or *B*.

A. Precipitation in the Presence of Ferric Iron. Dilute to a volume of 75 ml. by the addition of cold water. Filter the solution if it is not clear, washing the filter alternately with the least possible amount of cold, dilute, hydrochloric acid (1 : 99) and water until the yellow color of ferric chloride disappears. Finally wash with water. The appearance of a considerable, brownish precipitate of a basic salt of iron indicates that not enough free acid was present. Add enough hydrochloric acid to dissolve it and evaporate again. Dilute the cold solutions containing the sample to 200 ml., and dilute the solutions containing the blank determinations to 100 ml. Add 15 ml. of 0.5 *N* barium chloride, and allow the cold solution to stand 24 hours with occasional stirring.

Decant the clear, supernatant liquid through a filter to which a little paper pulp has been added. Set this first filtrate aside and place a clean beaker under the funnel. Transfer the precipitate to the filter, and if it runs through, pour the solution through again, repeating until the filtrate runs clear. Wash the barium sulfate alternately with cold water and cold, dilute hydrochloric acid (1 : 99) until the stain on the filter paper due to the iron disappears. Finally wash with cold water. Ignite and weigh. Set the filtrate aside for 24 hours to make sure that no further precipitation occurs. Subtract the weight of barium sulfate obtained in the blank from that obtained in the sample before calculating the per cent of sulfur.

B. Precipitation with Prior Reduction of Ferric Iron. Dilute the solution to a volume of 100 ml. and add 5 g. of granulated zinc. Warm gently until the iron is reduced to the ferrous state. Before the evolution of hydrogen has stopped completely, filter and wash with dilute hydrochloric acid (1 : 99). Dilute the solution containing the sample to a volume of 200 ml., and dilute the solution containing the blank determination to a volume of about 100 ml. Heat the solution to 80-90° and add 15 ml. of 0.05 *N* barium chloride. Add filter paper pulp and allow the mixture to stand for 24 hours with occasional stirring.

Decant the clear, supernatant liquid through a filter. Set this first filtrate aside and place a clean beaker under the funnel. Transfer the precipitate to the filter and if it runs through, pour the solution through again, repeating until the filtrate runs clear. Wash the barium sulfate with cold, dilute hydrochloric acid (1 : 99) and then with cold water until free from chlorides. Ignite and weigh. Set the filtrate aside for 24 hours to make sure that no further precipitation occurs. Subtract the weight of barium sulfate obtained in the blank from that obtained in the sample before calculating the per cent of sulfur.

THE DETERMINATION OF SULFUR IN IRON AND STEEL

For the most part, sulfur is present as sulfide in steel where the amount of sulfur present is usually less than 0.1 per cent. In cast iron, the amount of sulfur may run as high as 0.3-0.4 per cent and may also be present partially in the form of compounds which do not yield hydrogen sulfide on treatment with hydrochloric acid or sulfuric acid.

The sulfur in a steel may be determined directly gravimetrically by conversion to barium sulfate or by a hydrogen sulfide evolution method followed by either a gravimetric or volumetric determination. The direct gravimetric method is most accurate but the most time consuming. The volumetric method is subject to errors but is rapid and widely used in routine work.

In the gravimetric method, all of the sulfur must be converted to sulfate, and therefore the steel is dissolved in a strongly oxidizing solution such as nitric acid or nitric acid plus hydrochloric acid. As nitrate and ferric ions seriously interfere in the precipitation of barium sulfate, both of these must be removed prior to precipitation. The nitrate is easily removed by several evaporations with hydrochloric acid. The effect of iron is most expediently eliminated by reducing the iron to the ferrous state in which it is not carried down by barium sulfate. The reduction is usually brought about by the addition of metallic zinc, the excess of which is filtered off along with any silica present. The residue is washed with dilute hydrochloric acid and finally with water, and the sulfate in the filtrate precipitated by the addition of barium chloride:

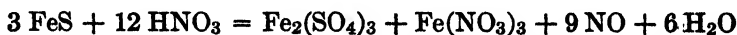

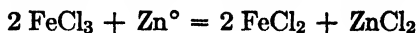

In accurate work the barium sulfate in the filtrate must be recovered.

In the evolution method, some uncertainty always exists as to the complete evolution of all of the sulfur as hydrogen sulfide on treating the sample with hydrochloric acid. In the case of cast iron a preliminary annealing aids materially in converting sulfur into a form which will yield hydrogen sulfide. This is done by wrapping the sample in filter paper and heating it to 750° in a crucible. The sample is then allowed to cool slowly and paper and sample are transferred together to the evolution flask.

The absorbent used for the hydrogen sulfide depends on the method by which the sulfur is to be determined subsequently. In the gravimetric procedure a solution containing ammonia and hydrogen peroxide is used, which oxidizes the sulfide to sulfate. This solution is acidified afterwards, and the sulfate precipitated as barium sulfate. Practically any amount of sulfur may be handled in this manner.

The volumetric method, however, is definitely limited to small amounts of sulfur. The absorbent used in this case is an ammoniacal solution either of zinc or cadmium from which hydrogen sulfide precipitates the sulfides:

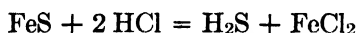

After the evolution is complete, the cold solution is acidified with hydrochloric acid and the liberated hydrogen sulfide titrated with iodine:

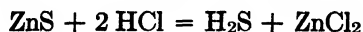

The titration must be made immediately after acidifying and before any hydrogen sulfide can escape, and for this reason the method is limited to small amounts of sulfur. The use of a standard solution of potassium iodate plus potassium iodide in place of the iodine solution has been recommended. Such a mixture undergoes no reaction in a neutral solution and is stable indefinitely, but when added to acid, immediately liberates iodine according to the equation:

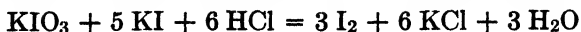

or when such a solution is added to an acid solution containing sulfide:

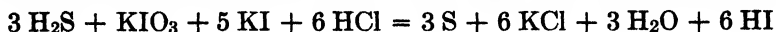

The end-point is marked by the appearance of the blue starch iodine complex just as in ordinary iodometric titrations. The iodate-iodide solution is best standardized against a steel of known sulfur content or sodium thiosulfate, which in turn is standardized against potassium iodate or against potassium permanganate which has been standardized against sodium oxalate.

Ammoniacal zinc is somewhat preferred as absorbent for hydrogen sulfide as cadmium sulfate is more expensive than zinc sulfate; also cadmium sulfide is less soluble in acids than zinc sulfide and appears to be affected by light.

The evolution method when applied to alloy steels frequently yields unsatisfactory results. Several methods have been devised for determining sulfur to circumvent the evolution method and to avoid the tedious gravimetric procedure. Combustion in oxygen, similar to that in the carbon determination, and absorption in sodium or hydrogen peroxide of the sulfur dioxide and trioxide produced and subsequent volumetric determination of the sulfuric acid or gravimetric determination as barium sulfate have been proposed and subjected to considerable study.¹ Ignition in a stream of hydrogen and absorption of the hydrogen sulfide evolved has also been used.²

Procedure for Sulfur in Iron or Steel by the Evolution Method.

Solutions required: (1) Ammoniacal zinc sulfate. Dissolve 200 g. of zinc sulfate in 1000 ml. of water and add 100 ml. of ammonium hydroxide. Let stand 24 hours and filter. (2) Potassium iodate-potassium iodide. Dissolve 1.12 g. of potassium iodate and 12 g. of potassium iodide in 1000 ml. of water.

Special apparatus: See Fig. 33. Fit a 500 ml. Florence flask with a two hole rubber stopper bearing a thistle tube extending close to the bottom of the flask and a trap which is connected to a delivery tube which dips into a 400 ml. beaker.

Procedure: Wrap a 5 g. sample of the steel in two 11 cm. filter papers and place in a porcelain crucible with cover. Heat in an

¹ Kar, *Ind. Eng. Chem., Anal. Ed.*, **7**, 244 (1935); Hale and Muehlberg, *ibid.*, **8**, 317 (1936).

² Clarke, Wooten and Pottenger, *Ind. Eng. Chem., Anal. Ed.*, **7**, 242 (1935).

electric muffle at 750° for a half hour and allow to cool slowly. Transfer charred paper and sample to the evolution flask. Place 10 ml. of the ammoniacal zinc sulfate solution and 200 ml. of water in the receiving beaker, assemble the apparatus, and treat the sam-

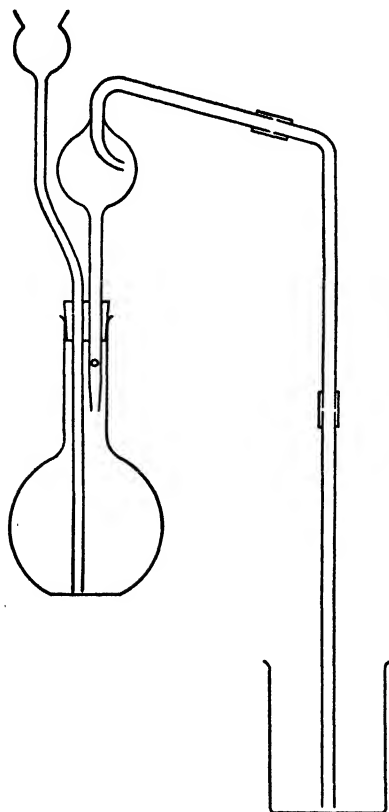

FIG. 33. Apparatus for the Determination of Sulfur in Steel by the Evolution Method.

ple with 100 ml. of dilute hydrochloric acid (1 : 1); heat the solution almost to boiling. Avoid distilling hydrochloric acid over with the hydrogen sulfide. When the sample is completely dissolved, boil the solution for 1 minute to drive over any remaining hydrogen sulfide, and disconnect the trap, leaving the delivery tube in the receiver as a stirring rod. Cool the receiving solution, add 40 ml. of dilute hydrochloric acid (1 : 1), add 3 ml. of starch solution, and

titrate immediately with the standard iodate-iodide mixture. A pink color develops during the titration, but continue the titration to the formation of a permanent blue color. Report the per cent of sulfur; the equivalent weight is one half the atomic weight of sulfur.

THE DETERMINATION OF PHOSPHORUS

The widespread distribution of phosphorus, its prime importance in the economy of the plants and the animals, and its numerous commercial uses make its determination one of the most frequently encountered by the analyst. The principal ore of phosphorus is apatite, or phosphate rock, $\text{Ca}_5\text{F}(\text{PO}_4)_3$; many other phosphate minerals are known, particularly where the phosphorus is associated with the rare earths and related metals.

SEPARATION AS AMMONIUM MOLYBDIPHOSPHATE

In rocks, minerals, and ores, phosphorus is invariably present as phosphate; in iron and steel, however, it is present principally as phosphide. As the analytical chemistry of phosphorus is based on reactions of phosphoric acid, no special problems are involved in dissolving the former materials; but with the latter, precautions must be taken to insure that all the phosphorus is oxidized to the quinquivalent state. Metallic materials must be dissolved in an oxidizing acid, generally nitric acid, which prevents any loss of phosphorus as gaseous phosphine, PH_3 , and then subjected to strong oxidizing action to complete the oxidation to ortho-phosphoric acid. Permanganate is generally used for this purpose, the excess being partly reduced to manganese dioxide, which is dissolved by the action of a sulfite or ferrous sulfate.

Phosphorus is generally separated from iron and other metals as ammonium molybdiphosphate,¹ $(\text{NH}_4)_3[\text{P}(\text{Mo}_3\text{O}_{10})_4]$; several methods are available for the determination of the phosphorus in

¹ X-Ray crystallographic studies of the compound indicate that the ions present are the ammonium ions and a large ion in which the phosphorus atom is surrounded tetrahedrally by four Mo_3O_{10} groups; Pauling, *J. Amer. Chem. Soc.*, **51**, 2868 (1929); Keggin, *Proc. Roy. Soc. (London)*, **A**, **144**, 75 (1934); Signer and Gross, *Helv. Chim. Acta.*, **17**, 1076 (1934). The correct name and formula for the compound are therefore *ammonium molybdiphosphate* and $(\text{NH}_4)_3[\text{P}(\text{Mo}_3\text{O}_{10})_4]$ rather than the older and more common forms *ammonium phosphomolybdate* and $(\text{NH}_4)_3\text{PO}_4 \cdot 12 \text{MoO}_3$.

the ammonium molybdiphosphate precipitate, including both gravimetric and volumetric methods.

Conditions for the Precipitation of the Yellow Precipitate.

The precipitate of ammonium molybdiphosphate, frequently referred to as the *yellow precipitate*, is obtained pure only when formed under very exact conditions; so that in all the methods in which the determination of phosphorus is based on the yellow precipitate having the theoretical composition, the precipitation must be carried out with rigorous adherence to the prescribed conditions. The potassium salt of molybdiphosphoric acid, like the ammonium salt, is also fairly insoluble and consequently potassium must not be present. The yellow precipitate contains water of crystallization when first precipitated, and there is some evidence that it also carries a molecule of nitric acid of crystallization.

The factors which must be considered in precipitating phosphorus as ammonium molybdiphosphate are:

1. All phosphorus must be present as ortho-phosphoric acid, H_3PO_4 .
2. A certain excess of free nitric acid must be present; perchloric acid may be present if nitric acid is also present.
3. A large excess of ammonium nitrate must be present.
4. Too much free acid must be avoided, or precipitation will be incomplete. A sufficient excess of molybdic acid solution prevents this solvent action of the free acid owing to the common ion effect, and ammonium nitrate serves a similar purpose.
5. The precipitation should be made from a hot solution, at 65° , but should not be allowed to stand at this temperature more than 15 minutes. In the cold, precipitation is slow, and the precipitate is difficult to filter; if too hot, or kept at 65° too long, it is contaminated with molybdic oxide, MoO_3 .
6. Molybdic oxide may separate with the precipitate as a white or yellowish-white crystalline deposit, which cannot be washed out. Sometimes it is easily mistaken for the yellow precipitate. Its separation must always be guarded against when the yellow precipitate is to be weighed or titrated. It forms when the solution contains too much molybdic acid solution, too much ammonium nitrate, is too concentrated or too dilute, too strongly acid or too nearly neutral. Too high a temperature precipitates it and long standing favors its separation.

7. The precipitate may be contaminated by ferric molybdate if digested too long or at too high a temperature. If the solution contains much iron and not sufficient acid, basic salts are liable to accompany the precipitate, making it reddish in color, especially if the solution is hot.

It is evident that a proper balance between the various reagents is necessary to secure good results. If pure, the precipitate is completely and easily soluble in ammonia; any iron present separates at the same time as ferric phosphate.

The best results are obtained when the precipitation is made from a nitric acid solution or from a perchloric acid solution containing ammonium nitrate. In the cases of ores and alloy steels which require hydrochloric acid for solution, an evaporation with nitric acid or perchloric acid is necessary to remove the hydrochloric acid. With nitric acid this is troublesome, as there is a tendency for basic salts to separate toward the end of the evaporation. This inconvenience can be avoided by substituting perchloric acid for nitric acid, and in the case of stainless steels a considerable saving of time can be effected by dissolving the metal directly in perchloric acid. Hot, fairly concentrated, at least 60 per cent, perchloric acid must be used as otherwise there occurs a loss of phosphorus.² No error is introduced into the determination of phosphorus by the presence of perchloric acid; nitric acid must be added, however, before making the precipitation as erratic results are obtained if the precipitation is made from a solution containing perchloric acid alone.

Silica in solution does not interfere with complete precipitation, but it comes down with the precipitate to a small extent. Titanium greatly delays the precipitation because it forms a complex with phosphate. Ores containing much titanium require special treatment. When arsenic is present in the solution, some of it will precipitate, the amount increasing with the temperature. Only very small amounts come down at temperatures below 25°. When vanadium and tungsten are present, special methods are necessary.

Procedures for the Separation of Phosphorus as the Yellow Precipitate. *Preparation of Molybdic Acid Solution.* To 100 g. of pure molybdic anhydride, MoO_3 , or 117 g. of 85% Molybdic Acid (the word *acid* is used when *anhydride* is meant), add 300 ml. of

²Susano and Barnett, *Ind. Eng. Chem., Anal. Ed.*, **8**, 183 (1936).

water and 120 ml. of concentrated ammonia. Shake the mixture occasionally until the molybdic acid has dissolved, warming gently if necessary. The solution must smell distinctly of ammonia; if it does not, add more. Dilute to about 800 ml. Mix 500 ml. of concentrated nitric acid with enough water to make about 1200 ml. Cool both solutions and mix by pouring the molybdate solution into the dilute nitric acid slowly and with constant stirring. The volume should now be about 2000 ml. Add 3-4 drops of a 10 per cent solution of sodium phosphate, shake thoroughly, and allow to settle. The clear solution should be siphoned or filtered off. The phosphate is added to cause precipitation of enough molybdiphosphate to carry down any finely divided molybdic oxide, which would otherwise settle very slowly. In case the solution becomes turbid, it may be necessary from time to time to add a drop of phosphate solution and allow the precipitate to settle.

Solution and Preliminary Treatment for Phosphorus in the Aluminum Oxide Residue. As was stated under the determination of aluminum, the precipitate of hydrous aluminum oxide obtained by the phenylhydrazine method contains all the phosphorus in the ore except in rare cases in which insufficient aluminum to combine with the phosphorus is present. This precipitate, therefore, affords a satisfactory starting point for the determination of phosphorus, since all the iron, which complicates the usual method, has been removed. Fuse the precipitate with 2-3 g. of sodium carbonate, dissolve in water, filter off any titanium oxide present, acidify the filtrate with nitric acid using methyl orange as indicator, add a 3 ml. excess of nitric acid, and then add 25 ml. of a 50 per cent solution of ammonium nitrate. Dilute the solution to about 75 ml. and heat to 80°. Add 50 ml. of molybdic acid solution as described below under Precipitation of Ammonium Molybdiphosphate.¹

Solution and Preliminary Treatment for Phosphorus in Iron Ore. The method described below is applicable to all ores unless they contain a very large amount of titanium. In some ores free from titanium, the insoluble residue may be free from phosphate; in others, the phosphate in the residue may be rendered soluble by ignition, which is followed by extraction with hydrochloric acid. Unless the character of the ore is known, it is safer to proceed as directed, assuming that the residue carries some phosphorus.

If the ore is high in titanium (none of the samples issued requires this treatment), fuse the sample directly with 8-10 times its

200 THE ANALYSIS OF IRON ORE, IRON, AND STEEL

weight of sodium carbonate, dissolve in water, filter, fuse the residue again if necessary, acidify the filtrates with hydrochloric acid, and evaporate to dryness to remove silica. In order to separate the phosphorus from the sodium salts, add a little ferric chloride free from phosphorus, precipitate with ammonia, and dissolve in nitric acid.

When the amount of titanium is low, the following procedure is employed. Use a sample of 1-5 g. of the ore, depending on the amount of phosphorus, or if the latter is unknown, use about 2 g. Dissolve the sample in hydrochloric acid, evaporate to dryness, dehydrate by baking at about 130°, take up with 20-30 ml. of hydrochloric acid, dilute, filter into a 250 ml. beaker, and after burning off the carbon, treat the residue with hydrofluoric acid and sulfuric acid to remove silica. Fuse the residue with 1-2 g. of sodium carbonate, dissolve in water, and filter. This removes any titanium in the residue, the presence of this element being very undesirable. Acidify the filtrate with nitric acid, and add this to the other solution, which in the meantime is being evaporated. Two methods are available for removing chloride.

A. Perchloric Acid Method. Add 10 ml. of 70 per cent perchloric acid. Evaporate to white fumes to remove chloride (the boiling point of perchloric acid is 203°), dilute with 50 ml. of water, and add 10 g. of ammonium nitrate or 20 ml. of a 50 per cent solution of ammonium nitrate. A precipitate of ammonium perchlorate may form but this will be washed out later. If the perchloric acid solution should evaporate to dryness, add 4 ml. more of the acid, heat, add a little water and heat again until everything is dissolved, then dilute to 50-60 ml., and add ammonium nitrate as directed above. If the solution is not clear, it must be filtered, receiving the filtrate in a 250 ml. beaker. If a brown, basic salt was formed which does not dissolve, the evaporation was carried too far; add hydrochloric acid which will dissolve the material and repeat the evaporation with perchloric acid more carefully. The amount of perchloric acid added is just the amount of acid needed. Carry out the precipitation as described below under Precipitation of Ammonium Molybdiphosphate.

B. Nitric Acid Method. Evaporate the hydrochloric acid solution until ferric chloride just begins to separate. Then add 30 ml. of nitric acid and evaporate rapidly to about 15 ml., taking care that an insoluble basic nitrate is not formed by excessive heating

towards the end of the process. This operation requires careful attention and especially toward the end should be watched constantly to prevent spattering. It is important that the sides of the beaker should not be heated, otherwise a basic nitrate forms which cannot be dissolved. The beaker should be placed on a piece of asbestos having a hole somewhat smaller than the bottom of the beaker. It is best evaporated on a gauze over a flame (in the hood) or on a very hot steam or electric hot plate, the beaker being covered with a watch glass supported by glass hooks. Cool it as soon as signs of spattering occur or a film of ferric nitrate starts to form on the surface of the solution. This should not be allowed to occur, but if it does, add 3-4 ml. of nitric acid to redissolve it. Add 25 ml. of water and warm until everything has dissolved, then add 15 ml. of a 50 per cent solution of ammonium nitrate. If at this point the solution is not clear, it must be filtered, receiving the filtrate in a 250 ml. beaker or conical flask and keeping the volume down to 50-60 ml. Add ammonia until a permanent precipitate just forms (the solution will be very dark in color), then add nitric acid till it just dissolves and 3 ml. more. This is a very important part of the process. The precipitate will redissolve rather slowly and requires constant stirring, especially if it is in compact curds. When ready for precipitation, the solution should have a brown or amber color, depending on the size of the sample, but should be without any red tint. A light amber color indicates a greater concentration of nitric acid than a darker brown. Too much acid prevents complete precipitation; too little allows the precipitate to become contaminated by basic iron salts. The volume should be about 75-80 ml.; it must not exceed 100 ml. Carry out the precipitation as described below under Precipitation of Ammonium Molybdiphosphate.

Solution and Preliminary Treatment for Phosphorus in Steel.

Weigh 2-3 g. of the iron or steel into a 400 ml. conical flask and treat the sample with 40 ml. of concentrated nitric acid diluted to 100 ml. When the solution of the steel is complete (except possibly for some black graphite), heat to a gentle boil and add dropwise a 2 per cent solution of potassium permanganate until a permanent precipitate forms. Add small portions of sodium sulfite to the boiling solution to dissolve the precipitated manganese dioxide. Boil for a few minutes to expel oxides of nitrogen. Add 15 ml. of a 50 per cent solution of ammonium nitrate, cool the solution, and add concentrated ammonia until a permanent precipitate just forms

(the solution will be very dark in color); then add nitric acid until the precipitate just dissolves and 3 ml. more. This is a very important part of the process. The precipitate will redissolve rather slowly and requires constant stirring, especially if it is in compact curds. When ready for precipitation the solution should have a brown or amber color, depending on the size of the sample, but should be without any red tint. A light amber color indicates a greater concentration of nitric acid than a darker brown. Too much acid prevents complete precipitation; too little allows the precipitate to become contaminated by basic iron salts. The volume should be about 100 ml. Carry out the precipitation as described below under Precipitation of Ammonium Molybdiphosphate.

Precipitation of Ammonium Molybdiphosphate. Heat the solution obtained by one of the procedures above, containing nitric acid or perchloric acid and containing 5-15 per cent of ammonium nitrate, to 80°. Add with constant stirring 50 ml. of clear, fresh molybdic acid solution, and continue stirring for several minutes. If the solution is in a flask, it may be closed with a clean rubber stopper and shaken for a few minutes. The solution should not be heated again. Set the solution aside until the precipitate has settled completely. This should not require more than half an hour. Longer standing will do no harm if the solution is at room temperature. If it is heated above 80° or allowed to stand in a warm place for several hours, white molybdic oxide is likely to precipitate. If no precipitate forms, the solution is too acid, or not enough ammonium nitrate is present, or the molybdate solution is not fresh and has lost part of its molybdic acid. Add 5-10 g. of ammonium nitrate and let stand a little longer. At 65°, the separation of molybdic oxide may begin in 20 minutes; at 50°, not within 2 hours. If no precipitate appears, a new sample should be started. Sometimes the acidity may be reduced by the cautious addition of a little ammonia.

If the determination is to be completed by the direct gravimetric procedure, filter the yellow precipitate on a Gooch crucible and wash with cold, dilute nitric acid (1 : 50) until the precipitate is free from salts of iron and molybdenum; this will require 10-12 washings. Avoid excessive amounts of wash solution. Complete the determination as described below, p. 205.

If the determination is to be completed by the alkalimetric method, filter the precipitate using a fine paper and wash the pre-

cipitate thoroughly first with cold, dilute nitric acid and then with a solution of potassium nitrate as described below under Alkali-metric Method, p. 205.

On the other hand, if the final determination is to be made by the oxidation-reduction method, filter off the precipitate using a fine paper but wash with an acid ammonium sulfate solution made by mixing 10 ml. of concentrated ammonia with 500 ml. of water and adding 15 ml. of concentrated sulfuric acid. Conclude the determination as described below under Oxidation-Reduction Method, p. 206.

GRAVIMETRIC DETERMINATION

The determination of phosphorus by precipitation as magnesium ammonium phosphate followed by ignition to the pyrophosphate was discussed in Willard and Furman, 3rd Ed., pp. 334-338. This is the only satisfactory method for large amounts of phosphorus. The yellow precipitate seldom approaches the theoretical composition when used to separate large amounts of phosphorus and must be dissolved in ammonia and precipitated by the addition of magnesia mixture. This procedure is of no value for small amounts of phosphorus, however. A reprecipitation of the magnesium ammonium phosphate is generally necessary to free the precipitate from molybdenum.

Two gravimetric methods are known for the direct determination of phosphorus in the yellow precipitate. Both are based on the assumption that the ammonium molybdiphosphate has the theoretical composition and are therefore good only for small amounts of phosphorus.

When first precipitated, the yellow precipitate is generally supposed to contain water and nitric acid of crystallization. This water and nitric acid are driven off by drying at 110° , and the precipitate then has the composition $(\text{NH}_4)_3[\text{P}(\text{Mo}_3\text{O}_{10})_4]$, theoretically containing 1.65 per cent phosphorus. Actually the precipitate contains 1.63-1.64 per cent phosphorus, depending on the method of precipitation followed. The empirical factor 1.64 is used when the procedure given here is followed. This procedure is acceptable for amounts of phosphorus up to 10 mg. The precipitate is hygroscopic and must be weighed rapidly.

When the yellow precipitate is heated at $400\text{-}450^{\circ}$ for 30 minutes, ammonia is eliminated and the residue consists of the oxides

204 THE ANALYSIS OF IRON ORE, IRON, AND STEEL

of phosphorus and molybdenum, $P_2O_5 \cdot 24 MoO_3$. In this method, ammonium nitrate may partly replace the nitric acid in the water used to wash the yellow precipitate, thus decreasing the solubility loss.

For only a few determinations of phosphorus, one of the gravimetric methods is probably most expedient. For routine work, a volumetric method is usually adopted.

Procedures for the Gravimetric Determination of Phosphorus in the Yellow Precipitate. By Conversion to Magnesium Pyrophosphate for Weighing. Prepare magnesia mixture as follows. Dissolve 50 g. of magnesium chloride, $MgCl_2 \cdot 6 H_2O$, and 100 g. of ammonium chloride in 500 ml. of water. Make the solution slightly ammoniacal, allow to stand overnight, and then filter. Acidify with hydrochloric acid and add 5 ml. excess of concentrated hydrochloric acid. Dilute the solution to 1 liter.

Dissolve the yellow precipitate in 20-30 ml. of warm, dilute ammonia (1 : 4), wash the filter 3-4 times with water, then with dilute hydrochloric acid to dissolve any ferric phosphate, using small amounts of wash solution each time to keep the volume considerably below 100 ml. If the solution is turbid, because of iron, add hydrochloric acid until acid (the yellow precipitate usually separates), then about 0.2 g. of citric acid, then ammonia until the liquid is alkaline and clear. The citric acid keeps the iron in solution. Add a few drops of magnesia mixture, then dilute hydrochloric acid (1 : 10) drop by drop until the precipitate just dissolves. Add drop by drop 10-15 ml. of magnesia mixture which will cause the precipitate to form again; then add enough ammonia to make the solution smell strongly of it. After standing a few hours, filter the precipitate using paper. Wash with cold, dilute ammonia (1 : 20). Dissolve the precipitate in 50 ml. of warm, dilute hydrochloric acid (1 : 9) and wash the paper thoroughly with hot, dilute hydrochloric acid. Dilute the solution to about 125 ml., add 10-15 ml. of magnesia mixture. If a precipitate forms, add dilute hydrochloric acid (1 : 10) until the precipitate just dissolves. Add drop by drop enough ammonia to make the solution smell strongly of it. After standing a few hours, filter the precipitate, preferably on a Gooch crucible, wash with cold, dilute ammonia (1 : 20), and ignite to magnesium pyrophosphate, $Mg_2P_2O_7$, containing 27.835 per cent of phosphorus or 63.774 per cent of phosphorus pentoxide.

☐ **By Direct Weighing of the Yellow Precipitate.** Dry the precipitate at 120-130° to constant weight. This should require from 1-2 hours. The residue contains 1.64 per cent of phosphorus or 3.753 per cent of phosphorus pentoxide. It is hygroscopic and must be weighed quickly. It often has a greenish color, due to a slight reduction, which does not appreciably affect the weight.

VOLUMETRIC DETERMINATION

Both of the following volumetric methods also assume that the yellow precipitate has the theoretical composition. Of the two methods, the alkalimetric method is more commonly used.

Alkalimetric Method. Alkalies decompose the yellow precipitate giving phosphate and molybdate. The molybdic oxide can be titrated like any moderately weak acid. In practice the precipitate is dissolved in an excess of standard sodium hydroxide, and the excess back titrated with standard nitric acid using phenolphthalein as indicator. The ammonia present somewhat obscures the end-point, especially if the amount is fairly large. The equivalent weight of phosphorus in this determination is P/23 since the phosphate is present as a tri-basic salt at the beginning of the reaction but at the end-point is present as a dibasic salt:

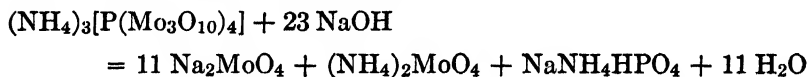

One of the critical points in this method lies in washing the precipitate completely free of acid. This is difficult, probably because the nitric acid of crystallization is washed out only very slowly.

Procedure for Phosphorus in the Yellow Precipitate by the Alkalimetric Method. Filter the yellow precipitate on a fine paper and wash the precipitate thoroughly with dilute nitric acid (1 : 50) and then thoroughly with a 1 per cent potassium nitrate solution. Wash until a 10 ml. portion of the filtrate will not decolorize 1 drop of 0.1 *N* sodium hydroxide to which a drop of phenolphthalein has been added. Transfer the paper and precipitate to the original flask and add 25 ml. of water and a measured excess of 2-3 ml. of standard 0.1 *N* sodium hydroxide. Shake and stir until the precipitate has dissolved. Dilute to 150 ml., add 3 drops of phenolphthalein, and back titrate with the standard nitric acid. The end-point is somewhat obscure, especially with large precipitates, but the low

206 THE ANALYSIS OF IRON ORE, IRON, AND STEEL

equivalent weight compensates for this. The milliequivalent weight of phosphorus in this determination is 0.001348.

Oxidation-Reduction Method. In this method the precipitate is dissolved in ammonium hydroxide and acidified with strong sulfuric acid. The reduction is generally carried out in a Jones Reductor containing metallic zinc which has been amalgamated with mercury to render it more reactive. The molybdenum is reduced from the sexavalent to the trivalent condition:

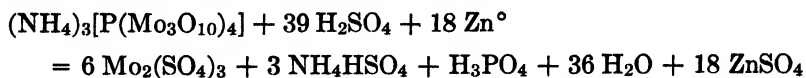

As trivalent molybdenum is oxidized with great rapidity by air, the best procedure is to run the reduction products directly into a solution of ferric iron. The ferric iron and trivalent molybdenum react to give an equivalent mixture of ferrous iron and quinquivalent molybdenum which is then titrated with potassium permanganate with less danger of atmospheric oxidation. The over-all reaction for the oxidation is then:

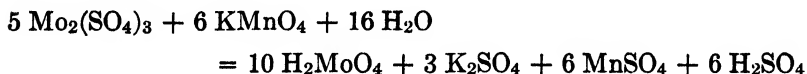

The equivalent of phosphorus in this determination is P/36. This is obviously a method for molybdenum and only indirectly a method for phosphorus.

Procedure for Phosphorus in the Yellow Precipitate by the Oxidation-Reduction Method. When well washed with acid ammonium sulfate solution, dissolve the yellow precipitate by pouring small portions of dilute ammonia (1 : 3) onto the filter, catching the filtrate in the beaker in which the precipitation was originally made. Add 50 ml. of dilute sulfuric acid (1 : 1). Prepare a solution of ferric sulfate by dissolving 20 g. of ferric ammonium sulfate in a mixture of 200 ml. of water, 5 ml. of concentrated sulfuric acid, and 10 ml. of phosphoric acid. Prepare the Jones Reductor, containing granulated zinc amalgamated with mercury, by flushing and rinsing it carefully, then by placing in the receiving flask 50 ml. of the ferric sulfate solution. Have the bottom of the reductor dipping below the surface of the ferric sulfate solution. Pour the sulfuric acid solution into the reductor taking about 2 minutes. Flush out the reductor with 4 portions of 30 ml. of water, being careful not to

allow any air to be drawn into the flask. Titrate to a faint pink color which persists for 30 seconds with approximately 0.05 *N* potassium permanganate standardized as described on p. 95. The milliequivalent weight of phosphorus in this determination is 0.0008605.

COLORIMETRIC DETERMINATION

Under suitable conditions molybdates react with phosphates, arsenates, silicates, and certain other salts or acids to form heteropoly compounds, such as ammonium molybdiphosphate, $(\text{NH}_4)_3\text{[P}(\text{Mo}_3\text{O}_{10})_4]$, or molybdisilicic acid, $\text{H}_4\text{[Si}(\text{Mo}_3\text{O}_{10})_4]$. These complexes, after controlled reduction to give molybdenum blue, serve for the colorimetric determination of various reducing agents or of elements which function as the central atom in the complex anion, such as phosphorus, arsenic, or silicon. The procedure must be carefully controlled, as the excess molybdate reagent itself may be reduced to molybdenum blue. A complete spectrophotometric study of this method³ has shown that several variable factors must be closely controlled. These include the ratio of molybdate to acid, the acidity, the amount of molybdate, the time required to develop the color, the temperature at which the color develops, and the presence of certain diverse ions in the solution. The color was found to conform to Beer's Law over the range 0.2-10 p.p.m. Of the various reducing agents which were studied, stannous chloride and hydrazine appeared to be the most satisfactory. The method has also been applied to the determination of phosphorus in steel,⁴ and has been found to yield results accurate to 0.003 per cent on steels containing amounts of phosphorus up to 0.1 per cent.

The yellow color of the complex phosphovanadomolybdic acid has also been used for the determination of phosphorus,⁵ particularly in iron ore. The color of the iron present is minimized by conversion to ferric perchlorate which is practically colorless. The measurement of the intensity of the yellow color of the complex acid over the barely visible color of the ferric perchlorate is made at a wave length of 450 $\text{m}\mu$ using a spectrophotometer. If the amount of iron in the sample is less than 50 per cent, slightly low results for phosphorus will be obtained; the correction to be applied

³ Woods and Mellon, *Ind. Eng. Chem., Anal. Ed.*, **13**, 760 (1941); see also Stoloff, *ibid.*, **14**, 636 (1942).

⁴ Hague and Bright, *J. Research Nat. Bur. Standards*, **26**, 405 (1941).

⁵ Willard and Center, *Ind. Eng. Chem., Anal. Ed.*, **13**, 81 (1941).

for this effect is a function of the iron content and has been determined.⁶ The colorimetric measurements on the sample and the standards used in making a calibration curve should be made at the same temperature; 27.0° has been suggested.⁶ The method may be applied to the determination of phosphorus in steel.⁷ It appears best to obtain a calibration curve by analyzing iron ores or steels of known phosphorus contents. The method has also been applied to the determination of phosphorus in biological materials.⁸

Procedure for the Colorimetric Determination of Phosphorus in Iron Ore. Prepare an ammonium vanadate solution by dissolving 2.350 g. of ammonium metavanadate and 20 ml. of dilute nitric acid (1 : 1) in 500 ml. of hot water and dilute to 1 liter. Prepare an ammonium molybdate solution by dissolving 50 g. of molybdic acid and 40 ml. of concentrated ammonia in 200 ml. of water; filter the solution, boil the filtrate 20 minutes, and dilute to 500 ml.

Weigh a 1.0 g. sample of iron ore into a 150 ml. beaker, add 10 ml. of concentrated hydrochloric acid, cover the beaker, and heat on a hot plate until the ore has dissolved, adding more hydrochloric acid if necessary. When the ore has dissolved, add 0.5 ml. of concentrated nitric acid, evaporate the solution to dryness, and bake gently to dehydrate the silica present. Add 15 ml. of 70 per cent perchloric acid. Boil the mixture on the hot plate until the dark ferric solution has changed to a light straw color; this usually takes 3-6 minutes depending on the temperature of the hot plate. At this point the mass should be fuming strongly. Cool the solution slightly and add, from a pipet, 10 ml. of the ammonium vanadate solution. Boil for about 30 seconds to remove any chlorine present, remove the beaker from the hot plate and place it in a pan of cold water until cooled sufficiently so that it may be held in the hand. Wash off the cover glass and the sides of the beaker with a little water and filter the solution into a 100 ml. volumetric flask. Scrub the beaker and wash the contents onto the filter paper. Wash the filter paper thoroughly with distilled water. The insoluble residue on the paper may be used for a silica determination.

Fill the volumetric flask to the mark with water. Stopper and mix by repeatedly inverting the flask. Measure out 50.0 ml. to use

⁶ Center and Willard, *Ind. Eng. Chem., Anal. Ed.*, **14**, 287 (1942).

⁷ Private communication from H. F. Beeghly, Jones and Laughlin Steel Corporation, Pittsburgh, Penna.

⁸ Koenig and Johnson, *Ind. Eng. Chem., Anal. Ed.*, **14**, 155 (1942).

for a manganese determination if required. If a determination of manganese is not required, the 50 ml. aliquot may be used for phosphorus.

To the remaining 50 ml. in the flask add 7.5 ml. of ammonium molybdate solution. Invert and shake the flask to mix the reagents and dissolve the precipitate that first forms. Place the sample in a water bath maintained at 27°. When the sample has come to the temperature of the bath measure the transmittance at 450 $m\mu$ in a spectrophotometer.

Prepare a calibration curve by running a series of iron ores of known and varying phosphorus content and plotting the per cent transmission against per cent phosphorus on semilogarithmic paper, using distilled water as a blank, or use the curves in the paper by Center and Willard.⁶ If a series of ores is not available, known amounts of phosphorus as potassium dihydrogen phosphate may be added to one ore.

THE DETERMINATION OF CARBON IN STEEL

(The more general analytical chemistry of carbon is treated on p. 316.)

Carbon occurs in steel combined in the form of carbides and free in the form of graphite. The total carbon content of steel will range up to 2 per cent. While methods are available for determining combined carbon directly, based for the most part on the color of the products produced on dissolving the steel in nitric acid, they are not much used. Combined carbon is usually obtained by difference from the determinations of total carbon by combustion and of graphitic carbon by combustion following its separation by its insolubility in nitric acid. A knowledge of the total amount of carbon is frequently all that is desired and its determination is by far the most important.

COMBUSTION METHOD

The combustion method for total carbon is based on the conversion of the carbon to carbon dioxide when the steel is burned in oxygen and the subsequent absorption of the carbon dioxide in an alkali where it is determined gravimetrically or volumetrically, see Fig. 34. The combustion is usually carried out in a tube of sillimanite, quartz, vitrified clay, or porcelain. The sample is

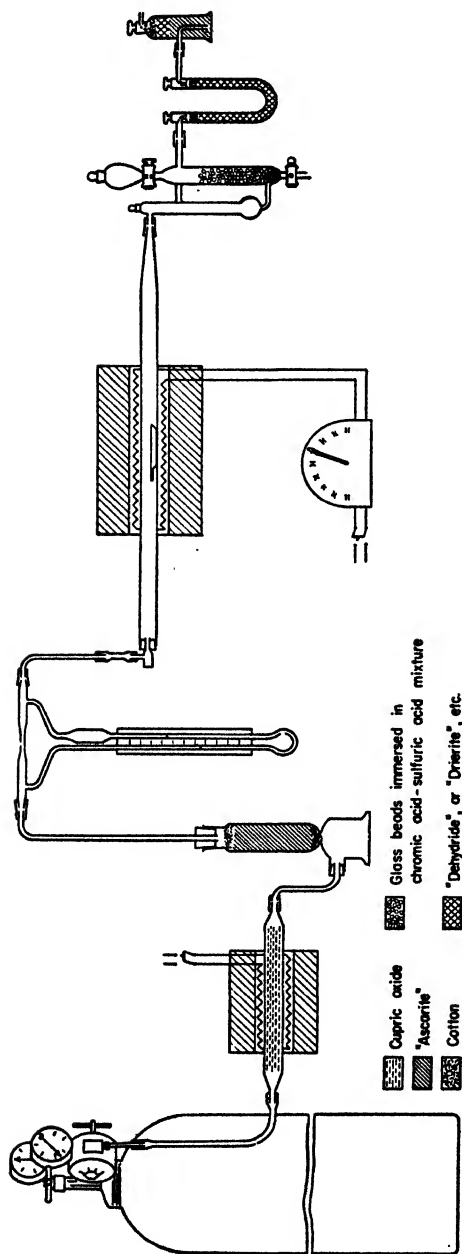
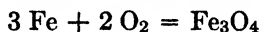

FIG. 34. Apparatus for the Determination of Carbon in Steel.

placed in a boat of nickel, alundum, or platinum protected by a layer of alundum or chromite. The sample is also covered with a thin layer of alundum or chromite to protect the tube from spattering. The temperature of the combustion furnace is maintained at about 1000°, electrical heating always being used. This temperature is required merely to start the combustion, which proceeds spontaneously at a temperature of about 2500° due to the reaction:



Magnetic iron oxide, Fe_3O_4 , rather than ferric oxide, is formed during the reaction as it is the stable oxide at the high temperature of the reaction. This very rapid burning requires a great deal of oxygen in a short time, and in order to prevent the gas from being sucked back from the absorption train, the oxygen stream must be greatly increased during the time of actual burning. Normally a flow of about 200 ml. per minute is maintained, and this is about doubled during the burning. The steel must burn and fuse completely, and in the case of alloy steels and materials which burn slowly, carbon-free iron or iron of known carbon content, is added to increase the temperature. Metallic tin, which forms no carbides and is more easily obtained pure than iron, is even better; lead oxides, which usually contain lead carbonate and are very hard on the tube, are very poor for the purpose. There are now available on the market furnaces which furnish temperatures as high as 1200° and make the use of such accelerators unnecessary in all but exceptional cases.

The sulfur in steel burns to sulfur dioxide and sulfur trioxide during the combustion and these gases must be removed prior to the absorption of the carbon dioxide. This is accomplished by passing the gas through a tower containing a solution of potassium bichromate in fairly concentrated sulfuric acid, which oxidizes and retains any sulfur dioxide and absorbs sulfur trioxide, or less satisfactorily through a tower containing granulated zinc. The absorption of sulfur trioxide is largely a mechanical process and is accomplished more by baffling and condensing action than by straight absorption; the absorption tower is generally filled with beads and arranged to break up thoroughly the gas stream. Platinized asbestos is sometimes placed at the end of the combustion tube to oxidize sulfur dioxide to sulfur trioxide. For steels low in sulfur, ironized asbestos placed in the end of the combustion tube

may be used to remove the oxides of sulfur, the dehydrating agent and the carbon dioxide absorption tube following immediately. The sulfur must be eliminated occasionally from the ironized asbestos by drawing the end of the tube into the hot furnace while passing oxygen through the tube. For steels high in sulfur, ironized asbestos alone cannot be relied upon but must be used in conjunction with the sulfuric acid-chromic acid mixture. The latter is satisfactory in itself anyway. If used with high sulfur steels, ironized asbestos must be treated frequently to remove the sulfur or the results will become erratic.

In the gravimetric determination, the carbon dioxide is absorbed in soda-lime or, better, on ascarite (see *Absorbents for Water and Carbon Dioxide*, p. 90). The gas must be dried before passing into the absorption vessel. Dehydrite is always used for this purpose. The oxygen used for the combustion should first pass through a pre-heater containing hot cupric oxide to oxidize any carbonaceous gases in the oxygen to carbon dioxide, and then pass through ascarite to remove any carbon dioxide unless this precaution is known to be unnecessary.

In the volumetric determination, the carbon dioxide is absorbed in an excess of standard barium hydroxide which is back titrated with a standard acid after the absorption. The extreme insolubility of barium carbonate makes it unnecessary to filter before back titrating. Phenolphthalein is used as indicator.

A gas volumetric method has also been proposed¹ in which approximately a liter of the gas from the combustion is collected in a bulb, its volume measured, the carbon dioxide absorbed by passage through a potassium hydroxide solution, and the decrease in volume measured.

Uncombined carbon is insoluble in dilute nitric acid (1 : 1) and can be filtered off and weighed, or better burned to carbon dioxide as the direct weighing method is subject to numerous difficulties. A narrow, tall-form, alundum or quartz filtering crucible which fits directly into the ordinary combustion tube is available for this purpose.

Procedure for Carbon in Iron or Steel. Allow about one and a half hours for heating the furnace and preheater to the correct temperatures; make certain that the ascarite in the purification

¹ Apparatus designed and marketed by the H. L. Dietert Company of Detroit, Mich.

train is fresh (grey in color), that the scrubbing tower contains fresh sulfuric acid-chromic acid mixture (85 ml. sulfuric acid, 15 ml. of water, and 2 g. of potassium bichromate), and if the gravimetric method is to be used, that the flow meter is properly adjusted and that the tower preceding the absorption tube is filled with fresh dehydrite (this tower is left empty in the volumetric method). Ignite the boat to remove carbonaceous matter by placing it in the hot combustion tube for 5 minutes in a stream of oxygen. Insert and withdraw the boat by means of a hooked wire rod. When withdrawing the hot boat, pull it out quickly onto a piece of asbestos board. Do not let the hot boat stop on the cooler portion of the tube or it will crack it. Do not lay the hooked rod where it will pick up dust or dirt.

Weigh out to the nearest milligram a sample of about 1 g. of steel. Transfer the sample to an alundum boat lined with alundum powder, spreading the sample out in a furrow in the alundum but keeping the particles in intimate contact. Cover the sample with a thin layer of alundum.

Gravimetric Determination. Fill two absorption bulbs (see p. 92 for types available) about two-thirds full with ascarite and in the upper third place dehydrite and a plug of cotton as shown in the diagram. Recharge the tube when half of the ascarite has changed from grey to white due to the absorption of carbon dioxide. Before making the initial weighing, displace the air in the bulbs by oxygen by connecting them to the apparatus for several minutes. Allow the bulbs to stand in the balance case at least 10 minutes before making a weighing. Use one bulb as counterpoise during the weighing to eliminate any effects due to surface moisture. The counterpoise is in effect part of the weights and care must be taken that nothing happens to it. While the absorption bulb stands, place a rubber tube closed by a glass plug over the open inlet tubes if the bulb is not provided with stopcocks; remove the rubber tubing for weighing. To make sure that everything is working properly, connect the absorption tube to the apparatus and pass oxygen through at the rate of 200 ml. per minute for 10 minutes. Cool and weigh. The gain in weight should be less than 0.0003 g.

When sample and absorption bulb are weighed and everything is ready, connect the absorption bulb to the drying tower. Insert the boat bearing the sample into the hottest part of the tube, close the tube, and adjust the flow of oxygen to 200 ml. per minute. When

the sample begins to burn after a minute or two, increase the rate of flow to about 400 ml. per minute and continue this flow during the time the combustion is taking place, taking care to have the stream of oxygen rapid enough to prevent back suction. After 3-4 minutes, slow the gas stream down to 200 ml. per minute and sweep the tube out for 10-15 minutes. Finally, turn off the oxygen, disconnect the absorption bulb, place the rubber cap over the inlet tube, and place the bulb in the balance room for 10 minutes, and weigh. A hard fused mass of magnetite should remain on the boat if combustion was complete. Report the results as per cent of carbon.

Volumetric Determination. Rinse the ten-bulb tube with boiled, distilled water. Place 50.0 ml. of standard barium hydroxide solution (approximately 20 g. barium hydroxide, $\text{Ba}(\text{OH})_2 \cdot 8 \text{H}_2\text{O}$ per liter) in the ten-bulb tube and attach the bulb of the tube to the sulfuric acid-chromic acid tower. Insert the alundum boat with sample into the hottest part of the combustion tube and immediately attach the connection from the oxygen purification train, and adjust the flow of oxygen to about one bubble per second. The sample will begin to burn within 1-2 minutes, and the oxygen stream may have to be increased during the burning in order to prevent sucking back. After the sample has burned, sweep out the tube for 10-15 minutes. Disconnect the ten-bulb tube and quickly transfer the solution and precipitate to a 500 ml. conical flask washing the tube with boiled, distilled water. Immediately add a few drops of phenolphthalein and back titrate the cold solution with standard hydrochloric acid. Carry out rapidly the operations where barium hydroxide is exposed to prevent the absorption of carbon dioxide from the air.

Standardize the barium hydroxide by titrating a sample with the standard acid. Calculate the per cent of carbon; the milliequivalent weight of carbon is 0.0060 in this determination.

CHAPTER IV

THE ANALYSIS OF ALLOY STEELS

One of the significant results of the rapid development of chemistry during the last quarter century is the change it has produced in the science and practice of metallurgy. As the less common elements were made commercially available they were investigated as possible alloying constituents of iron and steel and of base metal alloys, and the beneficial results which these extensive studies have yielded have made possible the development of our highly mechanized civilization.

As the rarer elements have become more familiar, an increasing burden has been placed on the analyst to detect and determine these elements in varied combinations with certainty and accuracy and with ever increasing speed. That the analytical chemist has responded is amply proved by the increasing volume of literature of analytical chemistry. Reliable and rapid methods are still lacking for many of these elements, however, and the speed and accuracy with which some elements may be determined are in great contrast to the inconvenience and difficulty of determining others.

The elements most commonly encountered in ferrous materials and which, in addition to the common impurities always present, must frequently be determined, are tungsten, molybdenum, chromium, vanadium, nickel, and copper. Of secondary, but increasing importance, are boron, tantalum, arsenic, antimony, tin, magnesium, aluminum, titanium, cobalt, zinc, zirconium, and columbium. While many of these metals are added intentionally, their presence is frequently due to the indiscriminate use of scrap; this is particularly true of arsenic, antimony, and tin.

Since many of these elements are not commonly treated in elementary chemistry courses at the present time, a short discussion of the general chemistry and qualitative analysis of some of these metals is included in this text.

THE DETERMINATION OF TUNGSTEN

Tungsten occurs naturally as the tungstates of various metals. Wolframite is a tungstate of magnesium and iron; scheelite, of calcium; stolzite, of lead; and hübnerite, of manganese. Tungsten is marketed as ferrotungsten, an alloy usually containing about eighty per cent tungsten, and as metallic tungsten, usually in the form of wire. Tungsten is found in alloy steels in amounts frequently as high as 20 per cent, and is generally accompanied by chromium and vanadium, and sometimes by molybdenum. Tungsten carbide, bonded by metallic cobalt, is used as a cutting tool.

GENERAL CHEMISTRY

Valences, Oxides, and Characteristic Reactions. Tungsten belongs to the same group of the periodic system as sulfur, chromium, and molybdenum and like the other members of the group, is principally an acid-forming element. It has a variety of valences, the lower, less stable states of three and four being basic in nature, the quinquivalent state existing as the hybrid oxygen-containing ion, while the hexavalent state is exclusively acidic in character. The principal oxide is tungstic oxide, WO_3 , light yellow in color. Lower oxides are also known, of which the pentoxide, W_2O_5 , tungsten blue, is important as a qualitative test. Tungstic oxide, WO_3 , is the anhydride of tungstic acid, H_2WO_4 , and is precipitated when a solution of a soluble tungstate is acidified. Tungsten is commonly separated from the other elements in this form. It resembles silica in this respect, and indeed, is rightly classed as a member of the acid insoluble or zero group of the qualitative analysis scheme (see p. 41). It is slightly soluble in water, especially when first precipitated, probably owing to the ease with which a portion of it becomes colloidal. Like silica it is rendered less soluble by dehydration, and like silica it carries down other constituents. Metatungstic acid, $\text{H}_2\text{W}_4\text{O}_{13}$, is readily soluble in water.

Tungstic acid forms soluble complex ions with citric acid, tartaric acid, hydrofluoric acid, and phosphoric acid, and if these acids are present, tungstic acid is not precipitated on acidifying a solution of tungstate. With phosphoric acid, tungstic acid forms tungstiphosphoric acid, $\text{H}_3[\text{P}(\text{W}_3\text{O}_{10})_4]$, analogous to the corresponding molybdenum compound, and like it, forms insoluble

potassium and ammonium salts. The complex formed with hydrofluoric acid has been shown to be $H_2WO_2F_4$.

Most tungstates, with the exception of the alkali metal tungstates, are insoluble, and tungstic acid may be quantitatively precipitated by a variety of reagents. The most important of these reagents are univalent mercury, benzidine, and various alkaloids, especially cinchonine and quinine. The precipitates obtained with univalent mercury and benzidine are partly soluble in acids, but cinchonine and quinine tungstates are insoluble even in fairly concentrated hydrochloric acid. They thus afford an excellent method of removing from solution the small amount of tungstic acid which nearly always remains when the precipitate is filtered off, thus avoiding the necessity of a dehydration.

Any tungsten compound when fused with sodium carbonate forms soluble sodium tungstate. Metallic tungsten is insoluble in non-oxidizing acids such as hydrochloric acid or sulfuric acid, and a black powder of metallic tungsten is deposited when an alloy containing tungsten is dissolved in one of these acids. An oxidizing acid such as nitric acid converts the metal to insoluble tungstic acid. When a fusion is necessary to decompose a tungsten alloy, sodium peroxide is added to the sodium carbonate. An alkaline fusion serves to separate tungsten from a number of metals, but this is used mostly for correcting a tungstic oxide precipitate for impurities.

Stannous chloride, hypophosphorous acid, hydrosulfite, and other mild reducing agents reduce sexavalent tungsten to the quinquevalent state; stronger reducing agents such as zinc and aluminum reduce the tungsten to variable degrees, valences of 2, 3, 4, and 5 having been reported.

Detection and Identification. The most delicate and characteristic test for tungsten is the reduction to the dark blue pentoxide, W_2O_5 , by stannous chloride in hydrochloric acid solution, by mercurous nitrate plus potassium iodide (oxidized to K_2HgI_4), or by other reducing agents. When metallic reducing agents are used, aluminum or zinc, the reduction may go still further, giving a brown color. In case a soluble complex salt is present, a blue solution is obtained instead of a precipitate. A convenient field test for tungsten is to place the powdered ore on a piece of aluminum, to add a drop or two of hydrochloric acid, and to rub gently, observing the color changes.

The formation of a flocculent, white or yellow precipitate of tungstic acid upon the addition of acid to a tungstate also serves as a test for tungsten, but it is not very characteristic nor especially delicate.

SEPARATION AND GRAVIMETRIC DETERMINATION

Tungsten is usually separated as tungstic acid and ignited to tungstic oxide, WO_3 , for weighing. Tungstic acid is slightly soluble in water when first precipitated, and usually a dehydration with hydrochloric acid is necessary before filtering, and even a second dehydration may be necessary. Dehydration may be avoided, however, by precipitating the residual tungsten in the filtrate with cinchonine hydrochloride, cinchonine tungstate being insoluble in cold, dilute hydrochloric acid and readily decomposed on ignition, giving tungstic oxide. The ignition of tungstic acid to the oxide for weighing

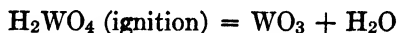

must not be carried out above a moderate heat or unduly prolonged as tungstic oxide is volatile above 750° and a considerable loss in weight may easily result.

Tungsten ores may require an alkaline fusion for their decomposition, such treatment yielding sodium tungstate, Na_2WO_4 . If a fusion is necessary to decompose a tungsten alloy, sodium peroxide is added to the sodium carbonate. The metal is not soluble in non-oxidizing acids, and impure tungsten deposits as a black powder on dissolving a steel in hydrochloric acid. Nitric acid or other oxidizing agents convert the metal rapidly into yellow tungstic acid:

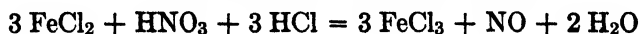
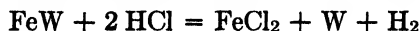

If steel is dissolved directly in nitric acid or nitric acid plus hydrochloric acid, tungstic acid separates directly, but the two step method outlined above gives a purer precipitate since the iron is practically all in solution before the tungsten is oxidized. The precipitate is filtered off and washed with dilute acid. Any traces of tungsten in the filtrate may then be precipitated by cinchonine unless it is desired to use the solution for some other determination, in which case it is evaporated and dehydrated to recover the tung-

sten. Tungstic acid is not completely precipitated from sulfuric or perchloric acid solutions.¹ The tungsten in a sulfate solution may be recovered by precipitation with a reagent consisting of tannin and cinchonine.

The precipitate so obtained is always impure, containing silica, ferric oxide, and sometimes titanium, chromium, aluminum, and molybdenum as oxides. The silica may be removed by evaporation with hydrofluoric acid and sulfuric acid which is done before weighing if a silicon determination is not desired. A sodium carbonate fusion will convert the tungsten to soluble sodium tungstate, and chromium and molybdenum, if present, to sodium chromate and sodium molybdate, while the iron present will remain as insoluble ferric oxide which can be filtered off, ignited, and weighed. The chromium and molybdenum can be determined colorimetrically.

The presence of phosphate has been shown to lead to low results in the determination of tungsten in sodium tungstate solutions by the acid digestion method and to high results when cinchonine is used.² The extent of the effect on the determination of tungsten in steel has not been studied.

Determinations of tungsten have been recommended in which tungstic acid is precipitated as mercurous tungstate, Hg_2WO_4 , by the addition of mercurous nitrate to a neutral solution, and as benzidine tungstate; both forms are ignited to tungstic oxide for weighing. Chromium, molybdenum, and vanadium interfere with the first method, however, and ferric iron interferes with the latter.

Procedure for Tungsten in Steel. Place in a small beaker or casserole 1 g. or more of the sample, add 10 ml. of water and 30 ml. of concentrated hydrochloric acid, and heat just below boiling until the evolution of hydrogen ceases. This will require from 15 minutes to 1 hour. Tungsten separates as a black powder, containing a large amount of carbides, especially of chromium and vanadium. Add nitric acid cautiously to the hot solution, a few drops at a time; the oxidation of the ferrous salt is violent. When the action is over, add 5-10 ml. more nitric acid and boil down to a volume of 5-10 ml., but do not evaporate to dryness. The precipitate should be yellow with no trace of dark, metallic tungsten. If it is not yellow, add more hydrochloric acid and a little nitric acid, and continue the

¹ Lambie, *Analyst*, **64**, 481 (1939).

² Simpson, Schumb and Sieminski, *Ind. Eng. Chem., Anal. Ed.*, **10**, 243 (1938).

boiling. Add 50 ml. of water, heat for a few minutes, and filter off the tungstic acid. Wash it with hot, dilute hydrochloric acid (1 : 20) 8-10 times until all ferric chloride is removed and then several times with a 1 per cent ammonium nitrate solution to remove the acid. The precipitate very easily becomes colloidal and runs through the filter; it must, therefore, never be washed with pure water. If a little of it does run through, however, it will be recovered later.

This precipitate may contain all the tungsten, but frequently a little remains in the filtrate as colloidal tungstic acid. In a sulfuric or perchloric acid solution, especially when considerable ferric or alkali salt is present, a very appreciable amount usually remains in solution and cannot be recovered by the usual methods. It is important, therefore, to use only hydrochloric acid and nitric acid solutions. Evaporate to dryness, take up with a little concentrated hydrochloric acid, and when the salts have dissolved, dilute, filter, and wash as before. Add to the main precipitate and burn off the carbon in a platinum crucible at a low red heat. The tungstic oxide will contain all of the silica present in the sample and a little ferric oxide; it will sometimes contain chromic oxide and will always contain vanadium pentoxide if vanadium is present in the sample. If any tungstic acid adheres to the beaker it may be removed by wiping with a piece of filter paper moistened with concentrated ammonia, this paper being ignited with the main precipitate. Or, a drop of ammonia may be added, the precipitate loosened by rubbing with a rubber tipped rod and washed into the filtrate for the second recovery.

Instead of evaporating to dryness, the tungstic acid may be recovered by adding 5 ml. of 10 per cent cinchonine hydrochloride. The precipitate, which will be very small in any case, is filtered, washed with water containing a little cinchonine solution, then with 1 per cent ammonium nitrate solution and added to the main precipitate. The ignited precipitates in this case will not contain all the silica.

If a silica determination is not desired, the precipitate need not be weighed. Add 1 ml. of hydrofluoric acid, 1 drop of sulfuric acid, and evaporate very carefully to dryness. It is best to put the crucible on a low temperature hot plate or inside another, so that the acid never boils, otherwise spattering will occur. Then raise the temperature until no more sulfuric acid fumes appear. This heat-

ing must be done carefully to avoid spattering. Heat to a moderate red heat for not more than 5 minutes. Weigh as the combined oxides, $\text{WO}_3 + \text{Fe}_2\text{O}_3 + \text{Cr}_2\text{O}_3$. Fuse with 1-2 g. of sodium carbonate in an open crucible for 5 minutes with free access to air to oxidize any chromium to sodium chromate. Dissolve the melt in water, filter through a small filter, using a little paper pulp if necessary, wash thoroughly 10-15 times, ignite in the same crucible and weigh. This is done because the crucible usually contains a stain of oxides that cannot be removed except by hydrochloric acid. This gives the weight of crucible plus ferric oxide and the weight of tungstic oxide plus chromic oxide is found by difference. If the sodium carbonate filtrate is colorless, no chromium is present. If it is slightly yellow, estimate the chromic oxide by adding to the same volume of sodium carbonate solution in a similar beaker, sufficient standard potassium bichromate to match the colors when placed on white paper. The potassium bichromate may conveniently contain 0.1935 g. of potassium bichromate per liter, corresponding to 0.10 mg. of chromic oxide per ml. Subtract from the weight of tungstic oxide plus chromic oxide the weight of chromic oxide thus found, to obtain the weight of pure tungstic oxide, WO_3 . From this the per cent of tungsten may be calculated, the conversion factor being 0.7930.

Tungstic oxide is volatile above 750° , and if ignited at the full heat of a Meker burner, the loss may be considerable. At a moderate red heat there is no danger of loss if heating is not unduly long.

The tungstic oxide precipitate will contain a little vanadium pentoxide, V_2O_5 , if vanadium is present; this is generally disregarded but may be determined colorimetrically as the yellow vanadophosphotungstate.⁸

If the steel contains molybdenum, the tungstic oxide will be contaminated with it and the amount should be determined, and subtracted from the amount of tungstic oxide. After the impure tungstic oxide has been fused with sodium carbonate, the iron oxide filtered off and the chromium determined colorimetrically on the filtrate, add 5 g. of tartaric acid to the solution and then add sulfuric acid until the solution is slightly acid. Heat to boiling and pass a rapid stream of hydrogen sulfide through the solution for several minutes. Filter off the molybdenum sulfide, wash with 2 per cent

⁸ Willard and Young, *Ind. Eng. Chem.*, **20**, 769 (1928); Wright and Mellon, *Ind. Eng. Chem., Anal. Ed.*, **9**, 251 (1937).

sulfuric acid saturated with hydrogen sulfide, and once or twice with a 1 per cent solution of ammonium nitrate. Ignite the precipitate at a temperature of 500-550° to molybdenum oxide. Subtract the molybdenum oxide so obtained from the weight of the tungstic oxide found above.

If the amount of the molybdenum is very small, it may be determined colorimetrically by the thiocyanate method, p. 228.

VOLUMETRIC DETERMINATION

Since tungstic oxide is an acid anhydride, it may be determined volumetrically by dissolving in excess of standard sodium hydroxide, and titrating the excess with standard acid, using phenolphthalein as indicator.

Because of the variability in the extent of reduction of tungsten compounds, no suitable oxidation-reduction reactions are available for the volumetric determination of tungsten.⁴

THE DETERMINATION OF MOLYBDENUM

Practically all molybdenum at the present time is derived from the sulfide ore, molybdenite, MoS_2 , produced almost entirely in a few western states of the United States. Molybdenum also occurs naturally as the trioxide, a mineral known as molybdenum ochre, and as various molybdates, principally of lead. The mineral wulfenite, PbMoO_4 , is of secondary importance as an ore. Molybdenum is marketed as ferromolybdenum, containing 60-70 per cent molybdenum, and as calcium molybdate. Although a few other uses are known, the principal use of molybdenum is in alloy steels. It is occasionally added alone to steel but is more frequently accompanied by other alloying constituents, mainly by nickel, chromium, vanadium, and silicon.

GENERAL CHEMISTRY

Valences, Oxides, and Characteristic Reactions. Like chromium and tungsten with which it is associated in periodic group VI, molybdenum exhibits a variety of valences, the valence states of 3, 4, 5, and 6 being known. Like tungsten, molybdenum is most stable and most commonly found in the valence of 6, in the form of molyb-

⁴ Holt, *Ind. Eng. Chem., Anal. Ed.*, **6**, 476 (1934).

dic acid, H_2MoO_4 . Molybdic acid is a stronger acid than tungstic acid, and is far more soluble; on acidifying a solution of a soluble molybdate, molybdic acid does not precipitate immediately although it may settle out on standing for a long period. Molybdic acid is more or less completely precipitated by the reagents which precipitate tungstic acid, for example, cinchonine, benzidine, and mercurous salts. The heavy metal molybdates are generally insoluble.

The reduction of molybdates proceeds variably to lower valence states, accompanied by a progressive color change from colorless to blue, to green, and to brown. Metallic molybdenum and molybdenum in the lower valence states may be oxidized to the valence of 6 by boiling with nitric acid.

Detection and Identification. Molybdenum, like tungsten, is left as an insoluble black powder on dissolving a steel in hydrochloric acid or sulfuric acid. Oxidizing agents such as nitric acid, hydrogen peroxide, or ammonium persulfate, convert it to soluble molybdic acid. The decomposition of molybdenum ores may require a fusion with sodium carbonate or with a mixture of sodium carbonate and sodium peroxide; sodium molybdate, Na_2MoO_4 , is formed.

Molybdenum is precipitated as the sulfide, MoS_3 , from a dilute sulfuric acid solution by hydrogen sulfide; molybdenum thus falls into the acid hydrogen sulfide group of qualitative analysis. The sulfide is soluble in ammonium polysulfide forming dark brown ammonium thiomolybdate, $(NH_4)_2MoS_4$, from which molybdic sulfide is reprecipitated on acidifying. The sulfide is dissolved by nitric acid. It is precipitated from solutions containing oxalic acid or tartaric acid; this distinguishes it from tungsten.

Ammonium phosphate added to a molybdate in nitric acid solutions gives a yellow precipitate of ammonium molybdodiphosphate; this is very useful as a confirmatory test.

The colors formed during the reduction of molybdic acid are quite characteristic. Particularly valuable is the red, complex thiocyanate, $H_2MoO_2(CNS)_3$, formed on the addition of potassium thiocyanate and stannous chloride; this complex thiocyanate is extracted with ether and, because iron is reduced by stannous chloride to the ferrous ion which is not extracted by ether, it is a useful and very sensitive test for molybdenum. Other reducing agents may be used, but if the reduction is carried too far, the color disappears.

SEPARATION AND GRAVIMETRIC DETERMINATION

Molybdenum is commonly weighed as molybdic oxide, MoO_3 , usually obtained by ignition of molybdic sulfide at 500-550°. The oxide is much more volatile than tungstic oxide and appreciable amounts of molybdenum can be lost if the temperature of the ignition exceeds 550°.

Molybdenum is best separated from iron by precipitation as the sulfide from a hot solution slightly acid with sulfuric acid; hydrochloric acid solutions are not satisfactory. Some molybdenum is always reduced and escapes precipitation, so that a second or even a third treatment with hydrogen sulfide after intervening filtration and reoxidation with persulfate is necessary to insure complete precipitation.¹ When tungsten is present, tartaric acid is added, which keeps the tungsten from precipitating. The sulfide precipitation is, of course, not a separation from copper, and the oxide obtained on igniting the sulfide generally contains some copper and iron. This impurity is determined by dissolving the oxide in sodium hydroxide, the insoluble ferric and cupric oxides being then recovered, ignited, and weighed.

The molybdenum may be precipitated as lead molybdate from a slightly acid solution and weighed as such after ignition. Sulfate, chromate, and tungstate must be absent.

Molybdenum is also separated by the organic reagent α -benzoin-oxime,² the precipitate being ignited to molybdic oxide for weighing. The precipitate is corrected for iron and silica impurities by solution in ammonia. Tungsten, if present, is removed first as tungstic acid and treated as described in the next paragraph to recover the molybdenum contained in it. Any tungsten present is also precipitated by the reagent.

When tungsten is separated as the oxide in the presence of molybdenum, it carries with it a small amount of molybdenum; this may be recovered by dissolving the impure tungstic oxide in sodium hydroxide, adding tartaric acid and sulfuric acid, and precipitating the molybdenum as the sulfide. This molybdenum can also be determined colorimetrically.

¹ Yagoda and Fales, *J. Amer. Chem. Soc.*, **58**, 1494 (1936), state that the precipitation of molybdenum is complete in one treatment with hydrogen sulfide if made in a weakly acid solution at 0°.

² Knowles, *Bur. Standards J. Research*, **9**, 1 (1932); Yagoda and Fales, *J. Amer. Chem. Soc.*, **60**, 640 (1938).

Molybdenum cannot be determined as ammonium molybdiphosphate because excess of molybdic acid must be present to give a precipitate of the correct composition.

Procedure for Molybdenum in a Steel Not Containing Tungsten.

Weigh 2 g. of the steel into a 600 ml. beaker and treat with 150 ml. of dilute sulfuric acid (1 : 6). Warm, and when the action is over, add 2 g. of ammonium persulfate and boil for 10 minutes. This oxidizes the molybdenum to molybdic acid and the ferrous iron to ferric. Cool the solution and add ammonia until the solution is nearly neutral. Add 5 g. of tartaric acid (not really necessary in most cases), heat to boiling, and pass a rapid stream of hydrogen sulfide through the solution for 10 minutes. Digest on a hot plate for 1 hour and filter. Wash with dilute sulfuric acid (1 : 50) saturated with hydrogen sulfide, and once or twice with a 1 per cent solution of ammonium nitrate.

To effect the recovery of the molybdenum which escaped precipitation, boil the filtrate to expel hydrogen sulfide and evaporate to reduce the volume to at least 450 ml. Add 1 g. of ammonium persulfate and boil to reoxidize any molybdenum not previously precipitated, reoxidizing also part of the iron. Pass hydrogen sulfide into the boiling solution. Digest 1 hour, filter, and combine the precipitate with the first precipitate. A second reoxidation and reprecipitation may be necessary; the precipitate of sulfur obtained on passing in hydrogen sulfide will be white when no molybdenum is present.

Burn off the filter paper in a muffle at 500-550° using a thermocouple to be sure that the temperature does not exceed 550°. Weigh the residue as impure molybdic oxide. Add dilute hydrochloric acid (1 : 1) to the crucible and heat gently. Transfer the solution to a small beaker and rinse the crucible with a solution of sodium hydroxide. Add a slight excess of sodium hydroxide to the solution and boil for 1 minute. Dissolve the precipitate in dilute hydrochloric acid (1 : 1) and precipitate with sodium hydroxide as before. Filter, wash well with water, ignite the oxides, consisting usually of iron and copper, in the original crucible and weigh. The difference in the two weights represents molybdic oxide. The oxide contains 66.66 per cent molybdenum.

Procedure for Molybdenum in a Steel Containing Tungsten.

Procedure A. Tungsten Also to Be Determined. Follow the directions given for the determination of tungsten in steel, p. 219,

combining the filtrates obtained from the two precipitations of tungstic oxide made, and reserving this solution for treatment as described in the next paragraph since it contains the major portion of the molybdenum. Following the colorimetric determination of chromium impurity in the tungstic oxide, the solution must be treated to determine the molybdenum carried down by the tungstic oxide. This may be done colorimetrically by the thiocyanate method, or the molybdenum may be precipitated as the sulfide. Directions for the recovery of molybdenum as the sulfide are given in the last paragraph of the procedure for tungsten.

To the combined filtrates from the tungstic oxide precipitates add 15 ml. of sulfuric acid and evaporate to fumes of sulfuric acid. Cool and dissolve the residue in 75 ml. of water. Add 5 g. of tartaric acid and then add ammonia until the solution is nearly neutral. Heat to boiling and pass a rapid stream of hydrogen sulfide through the solution for 10 minutes. Digest on a hot plate for 1 hour and filter. Wash with 2 per cent sulfuric acid saturated with hydrogen sulfide, and once or twice with a 1 per cent solution of ammonium nitrate. Some molybdenum escapes during this treatment with hydrogen sulfide and must be recovered by reoxidation and further treatment with hydrogen sulfide; follow the directions given in paragraphs 2 and 3 of the procedure for molybdenum in steel not containing tungsten, p. 225, to effect the recovery of this molybdenum and to complete the determination. Add to the molybdenum found in this manner the amount of molybdenum found from the tungstic oxide precipitate as discussed in the preceding paragraph.

Procedure B. Tungsten Not to Be Determined. Follow the directions given in the first paragraph of the procedure for the determination of tungsten in steel, p. 219. The dehydration step or the treatment with cinchonine may be omitted, and the tungstic oxide obtained need not be ignited. After washing the tungstic oxide precipitate with the 1 per cent ammonium nitrate solution, treat the filtrate as directed in the next paragraph and the tungstic oxide precipitate as follows. Dissolve the tungstic oxide precipitate on the filter paper in a hot, 5 per cent solution of sodium hydroxide, and then wash with a little hot, dilute, sulfuric acid (1 : 50). Add 5 g. of tartaric acid, and then add dilute sulfuric acid until the solution is slightly acid. Heat to boiling and pass a rapid stream of hydrogen sulfide through the solution for several minutes. Filter off the molybdic sulfide, wash with 2 per cent sulfuric acid satu-

rated with hydrogen sulfide and once or twice with a 1 per cent solution of ammonium nitrate. Combine this precipitate of the molybdic sulfide with the molybdic sulfide obtained from the main solution as described in the next paragraph.

To this main solution (filtrate from the tungstic oxide) add 15 ml. of sulfuric acid and evaporate to fumes of sulfuric acid. Cool and dissolve the residue in 75 ml. of water. Add 5 g. of tartaric acid and then add ammonia until the solution is nearly neutral. Heat to boiling and pass a rapid stream of hydrogen sulfide through the solution for 10 minutes. Digest on a hot plate for 1 hour and filter. Wash with 2 per cent sulfuric acid saturated with hydrogen sulfide and once or twice with a 1 per cent ammonium nitrate solution. Some molybdenum is reduced during this treatment and must be recovered from the filtrate by reoxidation and further treatment with hydrogen sulfide; follow the procedure described in paragraph 2 of the procedure for molybdenum in the steel not containing tungsten to effect this recovery. Combine this precipitate of molybdic sulfide with the precipitate obtained in the preceding paragraph and complete the procedure as described in the last paragraph of the procedure for molybdenum in steel containing no tungsten.

VOLUMETRIC DETERMINATION

Volumetrically, molybdenum may be determined by the following reactions when iron and other interfering metals are not present:

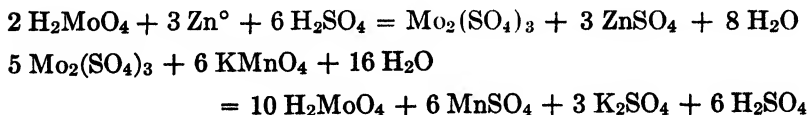

The reduction is carried out in the usual Jones reductor using amalgamated zinc; it is best to collect the reduced molybdenum in a solution of ferric sulfate as trivalent molybdenum is extremely sensitive to oxidation by air. The ferrous iron and molybdenum are then titrated with permanganate which, in effect, is titration of molybdenum from the valence of 3 to 6. Molybdenum may be reduced to the valence of 5 by metallic mercury and silver using a hydrochloric acid solution; the oxidation must then be made with ceric sulfate.³ Molybdenum may also be determined, but less ac-

³ Furman and Murray, *J. Amer. Chem. Soc.*, **58**, 1689 (1936).

curately, by titration with lead acetate in the presence of sodium acetate, forming lead molybdate, PbMoO_4 , using tannin as external indicator.

COLORIMETRIC DETERMINATION

Molybdenum is determined colorimetrically by adding to a solution of molybdic acid a thiocyanate and stannous chloride; the complex thiocyanate, $\text{H}_2\text{MoO}_2(\text{CNS})_3$, produced is extracted with ether and compared with a standard similarly prepared. This is a convenient way of determining the molybdenum in tungstic oxide, tartaric acid being added to keep the tungsten from precipitating.⁴ The molybdenum in plain carbon or alloy steels may be determined in this manner if the amount of molybdenum does not exceed 1 per cent.⁵ A careful study of the variables involved in this method has led to a few changes in the procedure and it is recommended that cyclohexanol or a higher ether be used instead of ethyl ether.⁶

THE DETERMINATION OF CHROMIUM

Practically all chromium is derived from the deposits of the mineral chromite, FeCr_2O_4 , of Turkey, Rhodesia, and New Caledonia. Chromium is marketed as ferrochromium containing 60-70 per cent chromium. Although most chromium finds its way into metallic products, large quantities are also used in the manufacture of refractories and in various chemical operations such as electroplating, dyeing, tanning, and the manufacture of pigments. The general chemistry of chromium is taught in elementary courses and will not be discussed here.

THE DECOMPOSITION OF CHROMITE AND OTHER CHROMIUM COMPOUNDS AND ALLOYS

The mineral chromite is exceptionally refractory and is not decomposed by the usual treatment with acids. Fusion with sodium peroxide effects the decomposition of the mineral and at the same time oxidizes the chromium to chromic acid. The excess of peroxide

⁴ King, *Ind. Eng. Chem.*, **15**, 350 (1923).

⁵ Maag and McCollan, *Ind. Eng. Chem.*, **17**, 524 (1925); Cunningham and Hamner, *Ind. Eng. Chem., Anal. Ed.*, **3**, 106 (1931); James, *ibid.*, **4**, 89 (1932).

⁶ Hurd and Reynolds, *Ind. Eng. Chem., Anal. Ed.*, **6**, 477 (1934); Hurd and Allen, *ibid.*, **7**, 396 (1935).

may be destroyed by boiling. Chromite may also be decomposed by boiling the very finely powdered ore for several hours with 70 per cent perchloric acid.¹ It has been recommended also that a mixture of phosphoric acid, sulfuric acid, and perchloric acid be used as the solvent.²

Alloy steels can generally be completely dissolved by treatment with sulfuric acid and an oxidizing agent such as nitric acid or persulfate. Carbides present in steels containing chromium are frequently difficult to decompose and may require a considerable period of heating. They may be dissolved much more rapidly in perchloric acid. Fusion with sodium peroxide is of no value in steel analysis because of the large amount of iron present and because the steel is not completely attacked.

SEPARATION AND GRAVIMETRIC DETERMINATION

Chromium is almost never determined gravimetrically because volumetric methods for its determination are more accurate and more easily carried out. Chromium may, however, be precipitated by ammonia if care is exercised to avoid an excess. Chromates must first be reduced to the chromic state by alcohol, sulfur dioxide, hydroxylamine, or other convenient reducing agent. The hydroxide is ignited to the oxide, Cr_2O_3 , for weighing; it has been stated that chromic oxide ignited in air always contains too much oxygen, and ignition in an atmosphere of hydrogen has been recommended.³ Chromates may be precipitated as barium chromate or lead chromate, which remain unchanged on ignition and may be weighed as such.

VOLUMETRIC DETERMINATION

Chromium is practically always determined volumetrically by oxidizing it to chromic acid and titrating the latter with a standard reducing agent. Various oxidizing agents are available for oxidizing the chromium; these will be discussed in detail in the later section devoted to the determination of chromium in steel. If iron is present with the chromium, ferrous sulfate is the standard reducing agent generally used.

In the absence of iron, chromic acid may be reduced by an excess of potassium iodide and the liberated iodine titrated with thiosul-

¹ Willard and Gibson, *Ind. Eng. Chem., Anal. Ed.*, **3**, 88 (1931).

² Smith and Getz, *Ind. Eng. Chem., Anal. Ed.*, **9**, 378, 518 (1937).

³ Rothaug, *Z. anorg. Chem.*, **84**, 165 (1913).

fate. This is possible even in the presence of moderate amounts of iron if sufficient phosphoric acid is present and not too large an excess of iodide added.⁴ The ferric iron forms a complex ion with the phosphate which prevents its reduction by iodide.

Chromic acid may also be reduced by adding an excess of arsenite and titrating the excess with a standard bromate solution⁵ or with permanganate.⁶ It can also be titrated directly with arsenite in the presence of manganese or ferric iron as catalyst,⁷ but the conditions are too critical for practical use.

COLORIMETRIC DETERMINATION

The color of chromate in an alkaline solution is sufficiently intense that it may be used for the colorimetric determination of small amounts of chromium. A more successful method, however, is based upon the red color produced by the action of chromates on diphenylcarbazide,⁸ $C_6H_5 \cdot NH \cdot NH \cdot CO \cdot NH \cdot NH \cdot C_6H_5$.

THE DETERMINATION OF CHROMIUM IN STEEL

Principle. The oxidation-reduction methods in use at the present time for the determination of chromium in steel are of two classes. The first class embraces the various indirect methods in which the sum of the chromium and vanadium present is determined. The chromium and vanadium in solution are oxidized to chromic acid and vanadic acid, and after the removal of the excess oxidizing agent, the two acids are then titrated with standard ferrous sulfate. Knowing the vanadium content as a result of a separate determination, the chromium may then be obtained by difference. This is not a serious disadvantage because the amount of vanadium is usually much smaller than the amount of chromium and can be very accurately determined, and because the equivalent weight of chromium is only one-third that of vanadium.

In the second class of methods for the determination of chromium, the chromium is determined directly. Again the chromium

⁴ Barnebey, *J. Amer. Chem. Soc.*, **39**, 604 (1917).

⁵ Spitalsky, *Z. anorg. Chem.*, **69**, 179 (1911).

⁶ Kolthoff and Sandell, *Ind. Eng. Chem., Anal. Ed.*, **2**, 140 (1930).

⁷ Zintl and Zaimis, *Z. angew. Chem.*, **40**, 1286 (1927); Lang and Zwerina, *Z. Elektrochem.*, **34**, 364 (1928).

⁸ Rothaug, *Z. anorg. Chem.*, **84**, 184 (1913); Stover, *J. Amer. Chem. Soc.*, **50**, 2363 (1928).

and vanadium are oxidized to chromic acid and vanadic acid, but following the removal of the excess oxidizing agent, the procedure is different. An excess of standard ferrous sulfate is added which quantitatively reduces the chromic acid and the vanadic acid. The excess of ferrous sulfate and the vanadyl sulfate are then titrated with standard permanganate. The difference between the volume of standard ferrous sulfate added and the volume of it equal to the permanganate used gives at once the volume of ferrous sulfate used to reduce the chromic acid. The difficulty with this method lies in the indistinctness of the end-point. Using a blank correction for the dilution and the color effects at the end-point, the method is rapid and accurate in the hands of an experienced operator.

Of the various methods which may be used to effect the oxidation of the chromium and vanadium to chromic acid and vanadic acid, oxidation with ammonium persulfate in a dilute sulfuric acid solution containing silver as a catalyst, is the most accurate and the least troublesome.⁹ The other methods of carrying out the oxidation, that is by permanganate¹⁰ and by perchloric acid,¹¹ are subject to certain difficulties.

⁹ Kelley and Conant, *J. Ind. Eng. Chem.*, **8**, 719 (1916); Lundell, Hoffman and Bright, *Ind. Eng. Chem.*, **15**, 1064 (1923); Willard and Young, *ibid.*, **20**, 769 (1928); *idem.*, *Ind. Eng. Chem., Anal. Ed.*, **5**, 158 (1933).

¹⁰ The oxidation of the chromium and vanadium may be effected by the addition of a strong permanganate solution to the boiling sulfuric acid solution. Manganese dioxide is formed which must be filtered off (Lundell, Hoffman and Bright, *Chemical Analysis of Iron and Steel*, John Wiley & Son, Inc., New York, 1931, p. 298). If phosphoric acid is present at the time the permanganate is added, and if only a moderate excess of permanganate is used, and if the period of boiling is short, the oxidation may be made with the formation of only a small amount of manganese dioxide (Willard and Young, *Ind. Eng. Chem., Anal. Ed.*, **5**, 158 (1933)). The addition of phosphoric acid is not permissible when tungsten and vanadium are both present.

¹¹ Hot, concentrated perchloric acid is a very effective solvent for chrome-vanadium steel, and converts the chromium and vanadium directly to chromic acid and vanadic acid (Willard and Gibson, *Ind. Eng. Chem., Anal. Ed.*, **3**, 88 (1931); Willard and Young, *ibid.*, **6**, 48 (1934)). To remove the excess of oxidizing agent it is only necessary to cool the solution, dilute, and boil off the chlorine which is formed during the oxidation. The method generally leads to slightly low results for chromium. This is thought to be due to the formation of hydrogen peroxide which causes the reduction of some chromic acid when the solution is diluted. It has been found that satisfactory results may be obtained if the oxidizing agent is a mixture of sulfuric acid and perchloric acid and if the hot mixture is cooled rapidly before dilution (Smith and Smith, *J. Soc. Chem. Ind.*, **54**, 185T (1935)).

Chromium and vanadium are completely oxidized by ammonium persulfate only when a small amount of a silver salt is present as a catalyst. The reactions involved in the oxidation of the chromium and vanadium are:

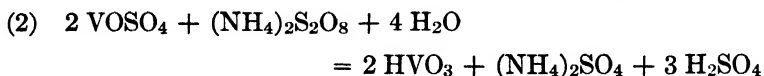
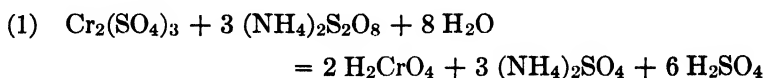

Some of the manganese always present in steel is oxidized to permanganic acid and manganese dioxide or both. The dioxide is not formed in the presence of phosphoric acid. After boiling to destroy the excess of persulfate the permanganic acid must also be destroyed. This may be done by a treatment with either sodium azide or dilute hydrochloric acid. The sodium azide on addition to the hot, acid solution reacts with permanganate with the liberation of nitrogen:

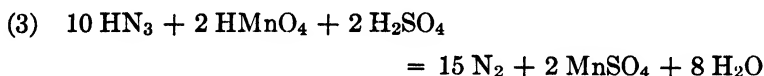

Hydrazoic acid is very volatile and a few minutes' boiling serves to remove the excess of it. Hydrochloric acid may also be used to reduce the permanganate, the reaction being:

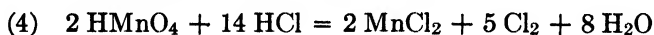

The chlorine liberated is removed by boiling. The silver chloride precipitated acts as a catalyst in this reduction. It has no effect on the determination and may be left in the solution.

The vanadic acid and chromic acid are then titrated with standard ferrous sulfate:

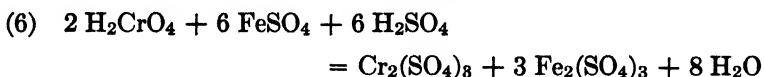
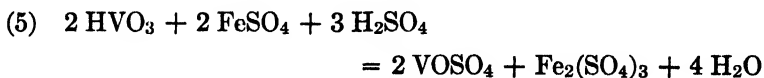

The end-point may be determined with an oxidation-reduction indicator such as diphenylamine or diphenylaminesulfonic acid, or potentiometrically.

Dissolving the Sample; Modifications Necessary when Tungsten Is Present. The reactions involved in dissolving a chrome-vanadium steel and in oxidizing the ferrous salt and carbonaceous matter are described in connection with the determination of vanadium, p. 243. The solution obtained as described is also suitable for the determination of chromium.

In the case of steels containing tungsten the procedure must, of course, be modified. The tungsten may be removed as tungstic oxide after the steel has been dissolved in hydrochloric acid and the black residue of metallic tungsten converted to tungstic acid by oxidation with nitric acid. The tungstic acid removed in this manner, however, sometimes carries with it a small amount of chromium which must be determined, generally colorimetrically, and added to the amount of chromium determined in the filtrate. The filtrate must also be treated with sulfuric acid and evaporated to fumes of sulfur trioxide to remove all hydrochloric acid which would otherwise interfere in the subsequent quantitative oxidation of chromium. Such a procedure is undesirably long, and therefore is not recommended.

A much better method is to hold the tungsten in solution as a complex fluoride while the determination of chromium plus vanadium is carried out. The steel is dissolved directly in sulfuric acid and the metallic tungsten taken into solution by the addition of hydrofluoric acid and nitric acid forming a clear green solution in which the tungsten is present as fluotungstic acid, $H_2WO_2F_4$. To this solution the persulfate method may be applied and either the sodium azide or hydrochloric acid method used to reduce the permanganic acid formed during the oxidation process. The chromic acid and vanadic acid are then titrated with standard ferrous sulfate with diphenylaminesulfonic acid as indicator. The student should select this method for the determination of chromium when tungsten and vanadium are also present.

Another possibility, but only in the absence of vanadium, is to dissolve the steel in a mixture of dilute sulfuric acid and phosphoric acid, which, on treatment with nitric acid, converts the metallic tungsten to soluble tungstiphosphoric acid. The determination of chromium may then be carried out on this solution. If vanadium is present, however, it enters the complex acid and is only partially reduced by the standard ferrous sulfate.

The presence of molybdenum does not interfere with the determination of chromium by the method discussed above. The procedure in the case of a chrome-vanadium-molybdenum steel is, therefore, the same as for a chrome-vanadium steel.

Procedure for Chromium Plus Vanadium in Chrome-Vanadium Steel by the Persulfate Method; Tungsten Absent. Prepare and standardize a solution of 0.05 *N* ferrous sulfate, using the procedure given under the determination of vanadium, p. 247, but using twice the amount of ferrous sulfate directed and in the standardization twice the amount of bichromate specified.

From an estimate of the chromium content of the steel, choose a suitable size for the sample as follows: less than 2.5 per cent chromium, 2 g.; 2.5-5 per cent chromium, 1 g.; 5-10 per cent chromium, 0.5 g.; above 10 per cent chromium, 0.25 g. Weigh the sample into a 600 ml. beaker, add 15 ml. of water, 15 ml. of dilute phosphoric acid (1 : 1), and add from a buret a measured volume of concentrated sulfuric acid using 1.5 ml. of acid for each g. of steel and an excess of 3 ml. Heat the mixture gently and after the steel has been decomposed, boil until a considerable quantity of salts separates out, which will assist in decomposing carbides. Dilute with 20 ml. of water and heat until the salts have dissolved. Add concentrated nitric acid, drop by drop, to the hot liquid until the violent oxidation of ferrous sulfate is over; a volume of 2-3 ml. is sufficient. Avoid any appreciable excess.

Boil the solution to destroy oxides of nitrogen, dilute to 300 ml., add a few very small pieces of broken porcelain to prevent bumping later, heat to boiling, and add 10 ml. of a silver nitrate solution containing 2.5 g. of silver nitrate per liter. Add cautiously to the boiling solution, first a crystal, then 1.5 g. of ammonium persulfate and boil gently. If no permanganate tinge appears in the solution within a few minutes, add more ammonium persulfate. In no case will more than 2-2.5 g. be required if samples of the weights suggested above are used. Boil the solution for 10 minutes to decompose the excess persulfate, and use either of the following procedures, *A* or *B*, to reduce the permanganate formed; procedure *A* is recommended.

A. Add 0.1 *M* sodium azide, drop by drop, from a pipet to the boiling hot solution until all permanganate has been reduced, limiting the excess of azide added to 2-3 drops. Carry the reaction out in a hood. Boil for 2 minutes to remove the hydrazoic acid. A reddish color which may develop in the solution during the boiling

period may be disregarded. Too great an excess of azide will cause low results.

B. Add 5 ml. of dilute hydrochloric acid (1 : 3) to the hot solution and boil vigorously for 10 minutes to reduce the permanganate and to remove all chlorine.

Cool the solution thus obtained, either from method *A* or *B*, and add 15 g. of crystallized sodium acetate, $\text{NaC}_2\text{H}_3\text{O}_2 \cdot 3 \text{H}_2\text{O}$. This should be the correct amount of acetate to react with the 3 ml. excess of concentrated sulfuric acid used in dissolving the steel and with the slight amount of nitric acid present since 1 ml. of concentrated sulfuric acid is equivalent to 4.8 g. of sodium acetate. If too much acetate is added so that a permanent precipitate of ferric phosphate forms, dilute sulfuric acid, added drop by drop, will cause the solution to clear. In this buffered solution the color change of the indicator from purple to a clear green at the end-point is much sharper than in a solution of high hydrogen ion concentration. As soon as the acetate has dissolved, add 0.5 ml. of 0.1 per cent, oxidized diphenylamine prepared as described on p. 246, and titrate the chromic acid and vanadic acid with 0.05 *N* ferrous sulfate. There is no indicator correction.

The end-point may be determined potentiometrically. To the solution obtained from method *A* or *B* add 25 ml. of dilute sulfuric acid (1 : 1). Cool to room temperature or below and titrate with 0.05 *N* ferrous sulfate using a platinum-calomel or platinum-tungsten electrode system.

Since the sum of chromium and vanadium is commonly determined with a stronger standard reducing solution than is used for the determination of vanadium, it is rather troublesome to calculate the volume of standard solution used for the latter and to reduce it to the same size of sample. This may be avoided thus: calculate chromium plus vanadium as if it were all chromium using the milliequivalent weight of chromium, 0.01734:

$$\frac{(\text{ml. FeSO}_4)(N_{\text{FeSO}_4})(0.01734)100}{\text{wt. sample}} = \text{per cent (Cr + V as Cr)}$$

Suppose this gives 2.55 per cent. Multiply the per cent of vanadium found as the result of a separate determination by the ratio of the equivalent weights of chromium and vanadium, 17.34/50.95, or 0.3403 (log is 1.53191) to convert the vanadium into an equivalent amount of chromium. Suppose the per cent of vanadium is 0.56.

$$0.56 \times 0.3407 = 0.191 \text{ per cent of chromium equivalent} \\ \text{to the vanadium}$$

This is then subtracted from the per cent of chromium plus vanadium calculated as chromium to give the per cent of chromium:

$$2.55 - 0.19 = 2.36 \text{ per cent chromium}$$

Procedure for Chromium Plus Vanadium in Chrome-Vanadium-Tungsten Steel by the Fluoride-Persulfate Method. Prepare and standardize a solution of 0.05 *N* ferrous sulfate, using the procedure given under the determination of vanadium, p. 247, but using twice the amount of ferrous sulfate directed and in the standardization twice the amount of bichromate specified and oxidized diphenylaminesulfonic acid as indicator rather than diphenylamine.

From an estimate of the chromium content of the steel choose a suitable size for the sample as follows: less than 2.5 per cent chromium, 2 g.; 2.5-5 per cent chromium, 1 g.; 5-10 per cent chromium, 0.5 g.; above 10 per cent chromium, 0.25 g. Add 25 ml. of water and 5 ml. of sulfuric acid. Warm gently until the steel is completely decomposed and the tungsten separates out as heavy, black powder on the bottom of the beaker. Swirl the solution while tilting the beaker to loosen as much tungsten as possible from the glass. This should not be allowed to stand more than an hour or two before proceeding with the oxidation of the tungsten, otherwise some of the latter may stick firmly to the beaker.

Dilute the solution with water to a total volume of 50-75 ml. Heat to boiling, add 10 ml. of 48 per cent hydrofluoric acid, and immediately add carefully to the boiling liquid 5 ml. of concentrated nitric acid. The boiling liquid must be swirled continuously until the black tungsten powder has dissolved to leave a clear, green solution. Stirring with a rod is not sufficient. If, in spite of these precautions, a very slight turbidity persists, it may dissolve later, but this will not be true if there is a distinct precipitate. Dilute to 100 ml., add a small crystal of ammonium persulfate followed by 1 g. more in small portions. Adding the small crystal first prevents the solution from foaming over. Boil for 5 minutes. If yellow tungstic acid appears, the sample must be discarded. On standing, the glass is badly attacked, the solution is contaminated, and the results are unsatisfactory.

Dilute the solution to approximately 300 ml., add a few very small pieces of broken porcelain to prevent bumping later, heat to

60° or higher, add 10 ml. of a silver nitrate solution containing 2.5 g. of silver nitrate per liter. Add 1.5 g. of ammonium persulfate and boil vigorously for a few minutes. If no permanganate color appears in the solution, add more ammonium persulfate. In no case will more than 2-2.5 g. be required if samples of the weights suggested above are used. Boil the solution for 10 minutes to decompose the excess persulfate, and use either of the following procedures, *A* or *B*, to reduce the permanganate formed; procedure *A* is recommended.

A. Add 0.1 *M* sodium azide, drop by drop, from a pipet to the boiling hot solution until all permanganate has been reduced, limiting the excess of azide used to 2-3 drops. Carry the reaction out in a hood. Boil for 2 minutes to remove the hydrazoic acid. A reddish color which may develop in the solution during the boiling period may be disregarded. Too great an excess of azide will cause low results.

B. Add 5 ml. of dilute hydrochloric acid (1 : 3) to the hot solution and boil vigorously for 10 minutes to reduce the permanganate and remove all chlorine.

Cool the solution obtained to room temperature after applying either method *A* or *B*. Add 3 ml. of hydrofluoric acid and 0.3 ml. of diphenylaminesulfonic acid indicator, oxidized as described on p. 246. Titrate at once with 0.05 *N* ferrous sulfate. Immediately after the addition of the indicator the solution is a yellowish brown in color. As the ferrous sulfate is added, this yellow color gradually disappears, being replaced first by a purplish red and then by a clear purple. The color change at the end-point from purple to green is very sharp. An indicator blank of -0.30 ml. of 0.05 *N* ferrous sulfate should be applied to the volume of ferrous sulfate used in the titration. If no purple color is obtained, it may be due to incomplete removal of hydrazoic acid or to insufficient indicator. Try doubling the amount of the latter.

The end-point may be determined potentiometrically. To the solution obtained from method *A* or *B* add 25 ml. of dilute sulfuric acid (1 : 1). Cool the solution to room temperature or below and titrate with standard ferrous sulfate using a platinum-calomel or platinum-tungsten electrode system.

Calculate the results as described in the last paragraph of the procedure given above for chromium in the absence of tungsten.

THE DETERMINATION OF VANADIUM

Vanadium is surprisingly well distributed, being a minor constituent of many rock-forming minerals and finding its way into organic life, particularly in connection with the oxygen-carrying mechanism of various animals. Although formerly the exclusive source of vanadium, the Peruvian deposits of patronite, a vanadium sulfide mineral, are gradually approaching depletion, and increasing amounts of vanadium are being obtained from blast furnace slag, from phosphate rock, from the caustic liquors employed in the refining of bauxite, from concentrates in other mining operations, and from the soot collected from the smokestacks of oil-burning ships and industrial plants. Vanadium is marketed as ferrovanadium, containing 30-40 per cent of vanadium, and as such is used in the manufacture of alloy steel. The vanadium content of alloy steels seldom exceeds 4 per cent and is generally less than 1 per cent. A few minor uses of vanadium are known, principally as catalysts in chemical operations.

GENERAL CHEMISTRY

Valences, Oxides, and Characteristic Reactions. Vanadium is a member of group V of the periodic system, and like the other elements of the group, nitrogen, phosphorus, and arsenic, it is primarily an acid-forming element, although in its lower valences it has pronounced basic properties. Its principal oxide is the brown pentoxide, V_2O_5 , which is the anhydride of vanadic acid, HVO_3 . The free acid tends to form the oxide; it is fairly insoluble in water, although sufficient of it dissolves to give its solution a yellow color. Like phosphoric acid, it exists in several forms, salts of which are well known: metavanadate, $NaVO_3$; orthovanadate, Na_3VO_4 ; and pyrovanadate, $Na_4V_2O_7$. Most of the vanadates are insoluble, and the mercurous, lead, barium, and ammonium salts are of some analytical importance. Vanadates form fairly stable complexes with a mixture of phosphoric acid and either tungstic acid or molybdic acid.

Vanadic acid is readily reduced to vanadyl ion, VO^{++} , in which the vanadium has a valence of 4, by mild reducing agents such as sulfur dioxide, hydrogen sulfide, oxalic acid, hydrobromic acid, and ferrous sulfate. Vanadyl salts are sky-blue in color, like cupric

salts. Strong reducing agents reduce vanadium to the trivalent state, V^{+++} , which is green, or to the bivalent state, V^{++} , which is violet. The latter form is obtained quantitatively by passing a sulfuric acid solution containing vanadium through a zinc reductor.

Detection and Identification. Ammonium sulfide added to a vanadate forms a permanganate colored thiovanadate, $(NH_4)_3VS_4$, corresponding to similar compounds of arsenic and antimony. When this solution is acidified, vanadium sulfide, V_2S_5 , is partially precipitated.

The most important qualitative test for vanadium is the formation of brownish red pervanadic acid, $HVO_2(O_2)$ or HVO_4 , when hydrogen peroxide is added to an acid solution of a vanadate.¹ This is a delicate test and the color is not affected by the presence of phosphate or fluoride. Vanadium may be thus distinguished from titanium. It serves also as the basis of a colorimetric determination of vanadium, in which phosphoric acid or fluoride is used to remove the yellow color of ferric iron. Pervanadic acid is not soluble in ether, a distinction from perchromic acid and ferric thiocyanate. If titanium is also present, the yellow color of pertitanic acid may be removed by the addition of fluoride. By the gradual addition of ferrous sulfate, pervanadic acid is reduced before pertitanic acid.

The purple color of thiovanadate is a fairly good test. The blue color of vanadyl salts is only a moderately sensitive test. To detect a very small amount of vanadium, it may be concentrated by coprecipitation with ammonium molybdiphosphate.²

SEPARATION AND GRAVIMETRIC DETERMINATION

Vanadium is rarely determined gravimetrically. It may be precipitated from a strongly acid solution of either a vanadyl salt or vanadic acid by cupferron or from a neutral solution of a vanadate as mercurous vanadate. The precipitates are ignited to vanadic oxide for weighing.

VOLUMETRIC DETERMINATION

Three oxidation-reduction reactions may be used for the volumetric determination of vanadium.

¹ Meyer and Pawletta, *Z. anal. Chem.*, **69**, 17 (1926), claim that in sulfuric acid solution the colored compound is $V(O_2)_2(SO_4)_3$.

² Cain and Hostetter, *J. Ind. Eng. Chem.*, **4**, 250 (1912).

In the first method the vanadic acid is reduced to a vanadyl salt by a mild reducing agent such as sulfur dioxide or ferrous sulfate, and the vanadyl salt then titrated with permanganate. The equations for the reactions involved are:

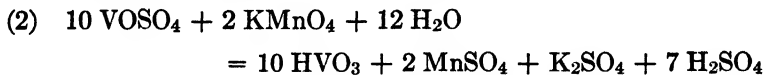

The excess of the reducing agent must, of course, be removed prior to the titration with permanganate; the excess of sulfur dioxide is removed by boiling, and the excess of ferrous sulfate is destroyed by the addition of ammonium persulfate to the cold solution. The oxidation of the vanadyl ion by the permanganate is slow in a cold solution, and the titration is preferably made in a hot solution if persulfate is absent. This method may be used in the presence of iron if ferrous sulfate is used as the reducing agent but not if sulfur dioxide is used, since the iron would not be reduced by ferrous sulfate but is reduced by sulfur dioxide.

In the second method the vanadium is oxidized to vanadic acid, if it is not already in that form, and titrated with ferrous sulfate, using an oxidation-reduction indicator:

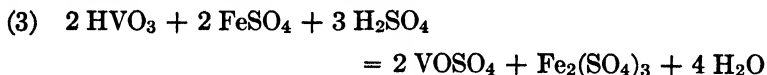

This method is especially valuable in steel analysis and will be discussed in detail in the later section devoted to the determination of vanadium in steel.

In the third method the vanadium is reduced to the bivalent state by passage through a zinc reductor and is then titrated with permanganate. Bivalent vanadium is a very powerful reducing agent and is very sensitive to oxidation by air. To avoid the necessity of carrying out the titration in an atmosphere of carbon dioxide, the reduced vanadium solution is best run directly into a solution of ferric sulfate which oxidizes the bivalent vanadium to vanadyl sulfate with the formation of an equivalent amount of ferrous sulfate, both of which are stable in air for a short time. The vanadyl sulfate and ferrous sulfate are then titrated with permanganate, the overall effect being the titration of the vanadium from a valence of two to five. The equations for the reactions involved are:

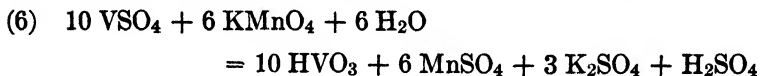
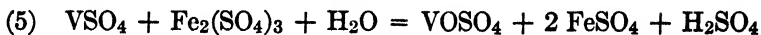
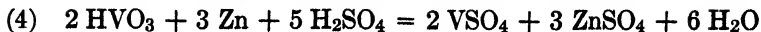

This method cannot be used in the presence of iron or chromium.

Since chromium is practically always present with vanadium in alloy steels, the methods for the determination of vanadium in steel are devised either to eliminate the interference due to chromium or to determine both elements simultaneously. The determination of vanadium in steel is treated more extensively in a later section.

COLORIMETRIC DETERMINATION

The usual method for the colorimetric determination of vanadium is based upon the color of pervanadic acid, the chemistry of which has already been discussed. Tungstic acid, which produces a yellow color with hydrogen peroxide, interferes with the determination; however, if oxalic acid is added to the solution, the interference is eliminated, probably because of the formation of a complex acid.³ Even when oxalic acid is present, a large amount of molybdenum will produce a yellow color and interfere with the determination of vanadium. The variable factors and substances which interfere with this method of determining vanadium have been carefully investigated.⁴

Another convenient colorimetric method for the determination of vanadium is based upon the yellow color developed when a solution containing phosphate, tungstate, and vanadate is acidified, the color being due to a complex heteropoly acid of unknown composition. This method is particularly useful for determining the vanadium present as impurity in the tungstic oxide precipitate obtained in the determination of tungsten in steel containing vanadium.⁵

THE DETERMINATION OF VANADIUM IN ALLOY STEEL

Principle. The most rapid and satisfactory methods for vanadium in steel are those which involve no separation of the vanadium from chromium or from iron but depend upon preliminary differen-

³ Lukas and Jilek, *Z. anal. Chem.*, **76**, 348 (1929).

⁴ Wright and Mellon, *Ind. Eng. Chem., Anal. Ed.*, **9**, 375 (1937).

⁵ Willard and Young, *Ind. Eng. Chem.*, **20**, 768 (1928); Wright and Mellon, *Ind. Eng. Chem., Anal. Ed.*, **9**, 251 (1937).

tial oxidation. Vanadic acid is a weaker oxidizing agent than chromic acid, the E_0 value for the vanadic acid-vanadyl system being 1.000 and that of the chromic acid-chromic system being 1.36. Consequently, vanadyl salts are more readily oxidized than chromic salts. It is possible, therefore, to oxidize vanadyl salts without oxidizing chromic salts, but it is not practical to reduce chromic acid without reducing vanadic acid.

Of the three methods discussed in the section devoted to the volumetric determination of vanadium, methods 1 and 2 are applicable in the presence of iron, and therefore may be adapted to the determination of vanadium in steel. Since chromium is usually present in steels containing vanadium, the methods must be such that chromium does not interfere. It is possible by using a suitable oxidizing agent to oxidize vanadium to vanadic acid without at the same time oxidizing chromium to chromic acid. After the excess of the oxidizing agent has been removed, the vanadic acid may then be titrated with standard ferrous sulfate. There is a variety of methods for effecting this oxidation, the best of which utilizes cold, dilute potassium permanganate.⁶ A detailed discussion and the laboratory procedure for this method are given below.

The other general method of determining vanadium in steel involves the reduction of the vanadium to vanadyl sulfate and the chromium to chromic sulfate.⁷ The vanadyl sulfate is then titrated with standard permanganate, the chromic sulfate not being oxidized under the conditions chosen. The preliminary reduction is accomplished by the addition of ferrous sulfate, the excess of which is removed by the addition of ammonium persulfate to the cold solution. The vanadium and the chromium are not oxidized by the excess of persulfate since no silver catalyst is present, and the excess of persulfate may be left in the solution during the subsequent titration of the vanadyl sulfate with the standard permanganate. The difficulty in this titration lies in determining the end-point, which is obscure because of the deep color of the green, trivalent chromium.

⁶ Among the other methods, which are now largely of historical interest, using this principle of oxidizing the vanadium without oxidizing the chromium are the following: the bromate method of Willard and Young, *Ind. Eng. Chem.*, **20**, 764 (1928); the nitric acid method of Kelley, Wiley, Bohn and Wright, *J. Ind. Eng. Chem.*, **11**, 632 (1919), **13**, 939 (1921).

⁷ Hamner, *Met. Chem. Eng.*, **17**, 206 (1917).

If the steel contains tungsten, the latter may be removed in the form of insoluble tungstic acid, H_2WO_4 ; and the vanadium determined in the filtrate by a suitable method. The precipitated tungstic acid, however, carries with it some vanadium which must be separately determined. This may be conveniently done by a colorimetric method.⁸ A far more convenient and rapid procedure in the presence of tungsten depends upon keeping the tungsten in solution as a complex fluoride, $\text{H}_2\text{WO}_2\text{F}_4$, in which form it does not interfere in the permanganate method for vanadium. The reactions and the manipulations involved are given in detail below.

Dissolving the Sample; Modifications Necessary when Tungsten Is Present. The most effective way to dissolve the alloy steel is to treat it with dilute sulfuric acid and an oxidizing agent, such as nitric acid. The nitric acid serves to oxidize the carbonaceous matter. The reactions involved for a typical chrome-vanadium-steel are:

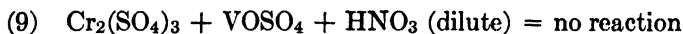
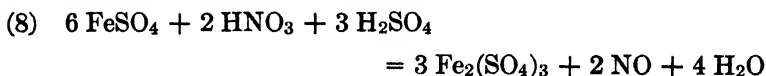
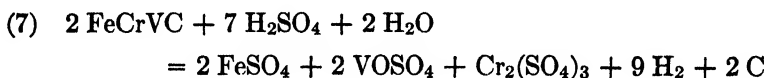

A little of the vanadium and the chromium may be oxidized to vanadic acid and chromic acid during this treatment, and after the steel has been completely dissolved the first step must necessarily be the reduction of these acids with ferrous sulfate. The determination may then be carried out in this solution.

When tungsten is present, a black powder of metallic tungsten separates when the steel is decomposed with sulfuric acid:

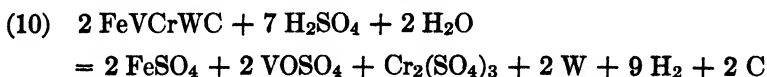

If sulfuric acid is used to decompose such a steel, and then, to the solution containing the tungsten as a black powder, hydrofluoric acid is added, followed by nitric acid, the ferrous iron is oxidized to ferric, and the tungsten is converted to a complex fluoride:

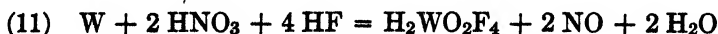

⁸ Willard and Young, *Ind. Eng. Chem.*, **20**, 764 (1928).

Experiments have shown that not quite all of the tungsten appears to be in the hexavalent form after this treatment so that a little persulfate (in the absence of Ag^+) is used to oxidize the remainder of it. If this is not done, low results for vanadium are invariably obtained. The excess persulfate is removed by boiling and a little ferrous sulfate is finally added to reduce any traces of persulfate which might remain. The determination of vanadium may then be carried out in this solution, the tungsten causing no interference. The only modification which must be made is in the choice of indicator, a matter which is discussed in the next section. This method for vanadium in steel containing tungsten is accurate and more rapid than any other method now in use.

Phosphoric acid, which may be used to keep tungsten in solution when only chromium is present, cannot be used in the presence of vanadium because the complex vanadophosphotungstate only partially reacts with reducing agents.

Preliminary Oxidation and Reduction. The solution obtained on dissolving the steel as discussed in the preceding section, containing sulfuric acid, ferric sulfate, vanadyl sulfate, chromic sulfate, and ferrous sulfate, and if tungsten is present, tungsten as a complex fluoride and hydrofluoric acid, is next treated in the cold with dilute permanganate which oxidizes the ferrous iron to ferric, and oxidizes the vanadyl sulfate to vanadic acid:

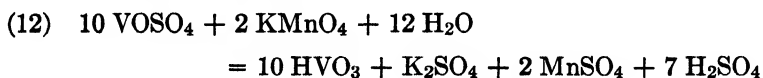

If the oxidation is carried out at room temperature, only the vanadyl sulfate is oxidized. The slight excess of permanganate necessary to insure the complete oxidation of the vanadyl sulfate is then destroyed by one of the following methods.

In the first method sodium nitrite is added to the solution. Nitrous acid is formed and is oxidized to nitric acid by the permanganate:

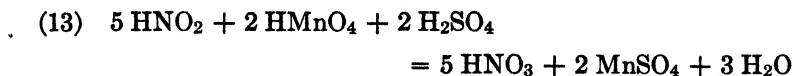

The excess of nitrous acid is then destroyed by the addition of a small amount of urea to the solution, the excess of which does no harm:



Nitrous acid is also readily destroyed by the addition of sulfamic acid, NH_2HSO_3 .

A second method of destroying the excess of permanganate depends upon the addition of an excess of sodium azide, NaN_3 , to the solution, which is then boiled for a few minutes. The reaction of hydrazoic acid, HN_3 , formed from the sodium azide and sulfuric acid, and permanganic acid is slow at room temperature but rapid in a hot solution. The reaction is:

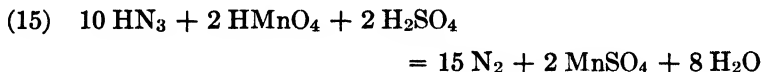

The solution is boiled for a few minutes to remove all hydrazoic acid, which is very volatile; if left in solution, it later prevents the color development of the indicator. Obviously, neither the hydrazoic acid nor the nitrous acid affects vanadic acid.

The Determination of the End-Point. After the removal of the permanganate by either of the above methods, the vanadic acid may then be titrated with standard ferrous sulfate.

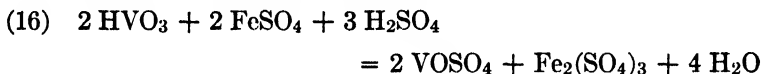

The end-point may be determined with an oxidation-reduction indicator such as diphenylamine or diphenylaminesulfonic acid or potentiometrically.

In the potentiometric method of determining the end-point, it is important to cool the solution at least to 5° , and to add a considerable amount of sulfuric acid; no satisfactory change at the end-point will be obtained if the solution is at room temperature. A bright platinum wire is used as the indicator electrode and a calomel or silver chloride electrode is used as the reference electrode. A bimetallic electrode system, such as platinum and tungsten, may also be used.

A very small amount of tungsten in solution prevents any color development with diphenylamine so that this indicator is useless for the titration when tungsten is present. On the other hand, diphenylaminesulfonic acid may be used in the presence of tungsten.⁹ A

⁹ Sarver and Kolthoff, *J. Amer. Chem. Soc.*, **53**, 2902 (1931); Willard and Young, *Ind. Eng. Chem., Anal. Ed.*, **4**, 187 (1932), **5**, 154 (1933).

small correction is necessary to compensate for the amount of ferrous sulfate required to effect the change in the color of the indicator. A table listing the corrections is given below in the section devoted to the procedure for the determination of vanadium in chrom-vanadium-tungsten steel. The corrections may be eliminated entirely if the indicator, diphenylamine, has been previously oxidized to an intermediate green form. Directions for preparing the oxidized indicator, both of diphenylamine and diphenylamine-sulfonic acid, are given. The reactions involved in the oxidation of these indicators are explained in Willard and Furman, 3rd Ed., p. 199.

Preparation of Diphenylamine and Oxidized Diphenylamine Indicator. Dissolve 0.1 g. of diphenylamine in 10 ml. of concentrated sulfuric acid and dilute the solution with 90 ml. of glacial acetic acid. When used, the correct volume of this solution should be measured out by means of a small graduated pipet and should be oxidized by the following procedure. Place the volume of the 0.1 per cent diphenylamine solution specified for a given determination in a 30 or 50 ml. beaker, add 5-6 drops of approximately 0.025 *N* ferrous sulfate, 5 ml. of dilute phosphoric acid (1 : 1), and 2-3 drops of 0.1 *N* potassium bichromate. Then add from a buret approximately 0.02 *N* ferrous sulfate until the purple color of the solution just turns to a bluish-green. As this purple begins to fade, add the ferrous sulfate in parts of a drop in order that no excess of ferrous sulfate will be left in the solution of the oxidized indicator. Add this solution of the oxidized indicator to the solution to be titrated. The preparation of this oxidized indicator should not be carried out until immediately before the titration is to be performed because it is not very stable.

Preparation of Diphenylaminesulfonic Acid and Oxidized Diphenylaminesulfonic Acid Indicator. Mix 0.32 g. of barium diphenylaminesulfonate with 100 ml. of water and add 3 ml. of concentrated sulfuric acid. Heat the solution to boiling and digest for 10 minutes. Allow the barium sulfate to settle and decant the supernatant liquid, passing it through a filter if necessary. About 0.3 ml. of this solution, 0.01 *M* in strength, is required for each determination. An indicator correction must be applied if the standard solutions with which the indicator is used are rather dilute as in the following determination of vanadium.

Place the volume of 0.01 *M* diphenylaminesulfonic acid solution specified for a given titration in a 30 or 50 ml. beaker, add 5 ml. of water, 5-6 drops of approximately 0.02 *N* ferrous sulfate, 3-4 drops of concentrated sulfuric acid, and 3-4 drops of 0.1 *N* potassium bichromate. Add from a buret approximately 0.02 *N* ferrous sulfate until the purple color of the solution just turns to a bluish-green. The purple color will appear when the first few drops of ferrous sulfate are added. As the purple color begins to disappear, add the ferrous sulfate in parts of a drop in order to have no excess of ferrous sulfate present in the oxidized indicator solution. Add this bluish-green solution to the solution to be titrated.

A stock solution of this oxidized indicator, which will keep for several weeks, may be prepared.¹⁰

Procedure for Vanadium in Chrome-Vanadium Steel; Tungsten Absent. Prepare and standardize a 0.025 *N* solution of ferrous sulfate as follows. Dissolve 10 g. of ferrous ammonium sulfate, $\text{Fe}(\text{NH}_4)_2(\text{SO}_4)_2 \cdot 6 \text{H}_2\text{O}$, or 7 g. of ferrous sulfate, $\text{FeSO}_4 \cdot 7 \text{H}_2\text{O}$, in water containing 10 ml. of concentrated sulfuric acid and dilute the solution to 1 liter. Standardize this solution on the same day that it is to be used. For the standardization, weigh out a sample of 0.04-0.06 g. of pure potassium bichromate into a 400 ml. beaker and dissolve in a little water; or measure out that volume of standard potassium bichromate solution which will require 35-50 ml. of 0.025 *N* ferrous sulfate for titration. Add 5 ml. of dilute sulfuric acid (1 : 1), 5 ml. of dilute phosphoric acid (1 : 1), and dilute to 200 ml. Add 0.3 ml. of 0.01 *M* oxidized diphenylamine prepared as described above, and titrate with the ferrous sulfate solution. No indicator correction is required if the oxidized indicator is used.

If the amount of vanadium in the steel is less than 0.3 per cent, use a sample of 4-5 g.; if it is larger than this, use a proportionately smaller sample. Place the sample in a 600 ml. beaker, add 30-40 ml. of water, and run in from a buret a measured volume of concentrated sulfuric acid, allowing 1.5 ml. for each g. of steel and an excess of 3 ml. After the steel has been completely decomposed, boil until a considerable quantity of salts separates out, in order to assist in decomposing carbides. Dilute with 30-40 ml. of water and heat until the salts have dissolved. To the boiling solution add concentrated nitric acid, drop by drop, until the violent oxidation of

¹⁰ Willard and Young, *Ind. Eng. Chem., Anal. Ed.*, **5**, 155 (1933).

ferrous sulfate is complete. A volume of 3-3.5 ml. of acid is sufficient; avoid any appreciable excess. Boil the solution for 2-3 minutes to expel oxides of nitrogen, cool to room temperature, add 25 ml. of dilute phosphoric acid (1 : 1), and dilute to 300 ml. Add 5 ml. of approximately 0.1 *N* ferrous sulfate; this is important if long boiling with nitric acid was necessary in decomposing the carbides. Add approximately 0.1 *N* potassium permanganate from a buret until an excess is present. Then add 3-4 drops more and let the solution stand for 2 minutes to be sure that the color persists and all of the vanadium is oxidized. Either of the following procedures, *A* or *B*, may be used to destroy the excess permanganate.

A. Add 0.05 *M* sodium nitrite slowly from a buret until the solution becomes green and then add an excess of 5 ml. Add 2 g. of urea and stir the solution thoroughly. Allow it to stand for 5 minutes.

B. Add 5 ml. of 0.1 *M* sodium azide and boil vigorously for 5 minutes to remove all hydrazoic acid. Carry this boiling out in a hood as hydrazoic acid is somewhat poisonous. Add a few very small pieces of broken porcelain to the solution to prevent bumping. Cool the solution to room temperature.

To the solution thus obtained, either from method *A* or *B*, add 15 g. of crystallized sodium acetate, $\text{NaC}_2\text{H}_3\text{O}_2 \cdot 3 \text{H}_2\text{O}$. This should be the correct amount of acetate to react with the 3 ml. excess of concentrated sulfuric acid used in dissolving the steel and with the slight amount of nitric acid present, since 1 ml. of concentrated sulfuric acid is equivalent to 4.8 g. of sodium acetate. If too much acetate is added so that a permanent precipitate of ferric phosphate forms, dilute sulfuric acid, added drop by drop, will cause the solution to clear. The solution should be green in color and not brown, and sufficiently acid to keep ferric phosphate from precipitating. In this buffered solution the color change of the indicator from purple to a clear green at the end-point is much sharper than in a solution of high acidity. As soon as the acetate has dissolved, add 0.5 ml. of 0.1 per cent oxidized diphenylamine, and titrate the vanadic acid with 0.025 *N* ferrous sulfate. The method of preparing the oxidized indicator and the standard ferrous sulfate is given above.

If the end-point is to be determined potentiometrically, cool the solution obtained after removing the excess of potassium permanganate, by either method *A* or *B*, to below 5°. When this temperature has been reached, add 25 ml. of dilute sulfuric acid (1 : 1),

which has also been cooled to 5°. Titrate the vanadic acid with 0.025 *N* ferrous sulfate using a platinum-calomel, platinum-silver chloride, or a platinum-tungsten electrode system.

Procedure for Vanadium in Chrome-Vanadium-Tungsten Steel.

Prepare and standardize a 0.025 *N* solution of ferrous sulfate as follows. Dissolve 10 g. of ferrous ammonium sulfate, $\text{Fe}(\text{NH}_4)_2(\text{SO}_4)_2 \cdot 6 \text{H}_2\text{O}$, or 7 g. of ferrous sulfate, $\text{FeSO}_4 \cdot 7 \text{H}_2\text{O}$, in water containing 10 ml. of concentrated sulfuric acid and dilute the solution to 1 liter. Standardize this solution on the same day that it is to be used. For the standardization, weigh out a sample of 0.04-0.06 g. of pure potassium bichromate into a 400 ml. beaker and dissolve in a little water; or measure out the volume of standard potassium bichromate solution which will require 35-50 ml. of 0.025 *N* ferrous sulfate solution for titration. Add 5 ml. of dilute sulfuric acid (1 : 1), 5 ml. of dilute phosphoric acid (1 : 1), and dilute to 200 ml. Add 0.3 ml. of 0.01 *M* oxidized diphenylaminesulfonic acid prepared as described on p. 246, and titrate with the ferrous sulfate solution. No indicator correction need be applied.

Place not over 1 g. of the steel in a 400 or 600 ml. beaker, add 25-30 ml. of water and 5 ml. of concentrated sulfuric acid. Warm gently until the steel is completely decomposed and the tungsten separates out as a heavy, black powder on the bottom of the beaker. Swirl the solution while tilting the beaker to loosen as much tungsten as possible from the glass. This should not be allowed to stand more than an hour or two before proceeding with the oxidation of the tungsten, otherwise some of the latter may stick firmly to the beaker.

Dilute the solution with water to a total volume of 50-75 ml. Heat to boiling, add 10 ml. of 48 per cent hydrofluoric acid, and immediately add carefully to the boiling liquid 5 ml. of concentrated nitric acid. The boiling liquid must be swirled continuously until the black tungsten powder has dissolved to leave a clear, green solution. Stirring with a rod is not sufficient. If, in spite of these precautions, a very slight turbidity persists, it may dissolve later, but this will not be true if there is a distinct precipitate. Dilute to 100 ml., add a small crystal of ammonium persulfate followed by 1 g. more in small portions. Adding the small crystal first prevents the solution from foaming over. Boil for 5 minutes. If yellow tungstic acid appears, the sample must be discarded. On standing, the glass is badly attacked, the solution is contaminated, and the

results are unsatisfactory. Add 5 ml. of approximately 0.1 *N* ferrous sulfate to the hot solution, dilute to 200-225 ml., cool to room temperature, and add 0.1 *N* potassium permanganate from a buret until an excess is present. Add 3-4 drops more and let the solution stand for 2 minutes to be sure that the color persists and all of the vanadium is oxidized. Either of the following procedures, *A* or *B*, may be used to destroy the excess of permanganate; procedure *A* is preferred.

A. Add 0.05 *M* sodium nitrite slowly from a buret until the solution becomes green and then add an excess of 5 ml. Add 2 g. of urea and stir the solution thoroughly. Allow it to stand for 5 minutes.

B. Add 5 ml. of 0.1 *M* sodium azide and boil vigorously for 5 minutes to remove all hydrazoic acid. Carry this boiling out in a hood as hydrazoic acid is somewhat poisonous. Add a few very small pieces of broken porcelain to the solution to prevent bumping. Cool the solution to room temperature.

To the solution thus obtained, either from method *A* or *B*, add 3 ml. of hydrofluoric acid and 0.3 ml. of 0.01 *M* diphenylaminesulfonic acid which has been previously oxidized by the procedure given above, to the solution. Titrate the vanadic acid at once with 0.025 *N* ferrous sulfate. The color change of the indicator at the end-point is from purple to green. If no purple color is obtained at first, double the quantity of indicator. The correction to be applied for the indicator is determined from the following table and should be subtracted from or added to the volume of ferrous sulfate used in the titration.

Per Cent Vanadium in Steel	Indicator Corrections in ml. of 0.025 <i>N</i> FeSO ₄
0 to 0.85	-0.10
0.85 to 1.2	+0.05
1.2 to 4.0	+0.10

If the end-point is to be determined potentiometrically, cool the solution obtained after removing the excess of potassium permanganate, by either method *A* or *B*, to below 5°. When this temperature has been reached, add 25 ml. of dilute sulfuric acid (1 : 1), which has also been cooled to 5°. Titrate the vanadic acid with 0.025 *N* ferrous sulfate using a platinum-calomel, a platinum-silver chloride, or a platinum-tungsten electrode system.

THE SIMULTANEOUS DETERMINATION OF
CHROMIUM AND VANADIUM IN CHROME-VANADIUM STEEL

A rapid method for the simultaneous determination of chromium and vanadium in steel was devised by Willard and Young.¹¹ The method takes advantage of the effect of the hydrogen ion concentration on the vanadic acid-vanadyl system and utilizes the high potential oxidation-reduction indicator ferrous *o*-phenanthroline sulfate. The chromium and vanadium are first oxidized to chromic acid and vanadic acid as described under the determination of chromium in steel, p. 231. After removal of the excess oxidizing agent, an excess standard ferrous sulfate is added, and, with the solution cold and strongly acid, the excess ferrous sulfate is titrated with potassium permanganate using ferrous *o*-phenanthroline sulfate as indicator. The reaction between permanganate and vanadyl ions in this cold solution of high acidity is sufficiently slow so that an excellent end-point is obtained. If the hydrogen ion concentration of the solution is then reduced by the addition of sodium acetate and the temperature raised somewhat, the vanadyl ion may be titrated with permanganate because the indicator has such a high potential that it is not affected by vanadic acid. This then gives a rapid indicator method of determining both chromium and vanadium in a single sample. It cannot be applied to the fluoride solution of a tungsten steel.

The reason for the repressing influence of the hydrogen ion on the vanadyl permanganate reaction is evident from the equation



while the potential of the ferric-ferrous system



is not appreciably influenced by the hydrogen ion concentration of the solution.

For working details the original paper should be consulted.

¹¹ Willard and Young, *Ind. Eng. Chem., Anal. Ed.*, **6**, 48 (1934).

CHAPTER V

THE DETERMINATION OF ALKALI METALS

The alkali metals consist of the elements lithium, sodium, potassium, rubidium, cesium, and presumably the missing element 87, all of which occur in the first periodic group. Sodium and potassium are the sixth and seventh most abundant elements of the earth and are widely distributed in both the lithosphere and hydrosphere. The preponderance of sodium existing in the seas and salt beds is offset by the larger amount of potassium in the alkali-bearing silicate rocks. The alkali metals are constituents of rock in general, for example, in the feldspars, which vary in composition from albite, $\text{NaAlSi}_3\text{O}_8$, to orthoclase, KAlSi_3O_8 , and in leucite, $\text{KAl}(\text{SiO}_3)_2$, and other feldspathoid rocks. Lithium is much less abundant but is assuming some commercial importance.

The determination of the various alkali metals is among the more difficult of the problems of chemical analysis. Because none of the salts of the alkali metals can be classed as insoluble, the analyst must resort to the use of non-aqueous solvents or exaggerate the common technics for decreasing solubility in water, and he must adhere rigidly to precisely controlled conditions to secure even acceptable results.

From the standpoint of their analytical chemistry, the alkali metals fall into two classes, lithium and sodium into one, and potassium, rubidium, and cesium, into the other. The ammonium ion behaves like a member of the second group, but since its removal is readily accomplished by simple ignition, and because other methods are available for its determination, its presence need not be considered as a complicating factor. Although the separation of members of one group from those of the other is possible, separations within the groups are very difficult and at present practicable only between lithium and sodium.

When merely a determination of the total alkali metals present is desired, or when only one is known to be present as in the analysis of a pure salt or of an organic compound, the mixture is simply

evaporated with sulfuric acid, after the removal of all metals other than the alkalis, and weighed as sulfates. The sulfates must be ignited to a temperature of about 900° to insure the removal of the excess of sulfur trioxide:



When a differentiation between the two groups of alkali metals is desired then one of two methods can be employed. The total alkalis can be weighed together as chlorides and then the potassium, rubidium, and cesium separated from the sodium and lithium by either the chloroplatinate or the perchlorate method, the residual potassium, rubidium, and cesium salts being then weighed and the sodium plus lithium found by difference. Or, the sodium may be separated and determined directly as the triple salt, sodium magnesium uranyl acetate or sodium zinc uranyl acetate, and the potassium determined directly as the chloroplatinate or perchlorate. The first of these methods, weighing the combined chlorides and subsequently using chloroplatinic acid for the separation, is the older. The separation and determination of potassium using the perchloric acid method is more convenient and accurate, however, and is now more widely used. The triple salt procedure for sodium is a more recent development, but has now received considerable study and is known to be accurate and reliable.

When drying the chlorides of the alkali metals preliminary to weighing, care should be taken not to maintain them at their melting points more than momentarily or some will be lost by volatilization. On the other hand, an appreciable amount of water is occluded by the chlorides on crystallization, particularly from a hydrochloric acid solution, and the amount of water remaining even after drying at 550° is not negligible.¹

Potassium is also separated as potassium sodium cobaltinitrite, $\text{K}_2\text{NaCo}(\text{NO}_2)_6$, but the method is applicable only to the determination of small amounts of potassium and its separation from large amounts of sodium. Potassium forms an insoluble periodate, which furnishes another method for the determination of potassium.

Each of the methods mentioned above will be discussed in some detail and the methods of decomposing silicate materials for the

¹ Smith, Stubblefield and Middleton, *Ind. Eng. Chem., Anal. Ed.*, **6**, 314 (1934).

determination of the alkali metals will be discussed in the last third of the chapter.

THE DETERMINATION OF POTASSIUM

THE PERCHLORATE METHOD

The perchlorates of the alkali metals potassium, rubidium, and cesium, are insoluble in various alcohols and in ethyl acetate; the perchlorates of thallium and ammonium are sparingly soluble in these solvents, but the perchlorates of all other metals are soluble. The solubilities of a few metal perchlorates are given in Table VIII. These facts furnish a convenient method for the separation and determination of potassium, and when properly carried out the perchlorate method is the most accurate method for potassium. Most of the directions given in the literature are not entirely correct, and the accurate results often obtained are due to a compensation of errors.

In order to determine the best solvent for the separation of sodium and potassium, the solubilities of potassium and sodium perchlorates have been determined in various organic liquids. The results of several studies² are shown in Tables VIII and IX.

TABLE VIII. THE SOLUBILITY OF ALKALI AND ALKALINE EARTH PERCHLORATES IN WATER AND OTHER SOLVENTS²
Grams per 100 ml. of solution at 25°

	Water	Methyl Alcohol	Ethyl Alcohol	n-Butyl Alcohol	Ethyl Acetate	Acetone	Ethyl Ether
LiClO ₄ (anhy.)	47.42	89.44	79.41	49.25	63.40	76.38	64.47
NaClO ₄	113.88	35.833	11.134	1.495	8.425	36.596	insol.
KClO ₄	2.0394	9.0830	0.0094	0.0036	0.0013	0.1179	insol.
RbClO ₄	1.328	0.0472	0.0071	0.0016	0.0014	0.0745	insol.
CsClO ₄	1.961	0.0734	0.0086	0.0048	insol.	0.1178	insol.
NH ₄ ClO ₄	21.91	5.268	1.488	0.0137	0.0286	1.768	insol.
Mg(ClO ₄) ₂	73.453	37.749	18.398	44.638	54.173	32.410	0.2059
Ca(ClO ₄) ₂	112.34	113.68	89.551	68.419	57.377	43.812	0.1846
Sr(ClO ₄) ₂	157.51	113.95	100.01	71.205	76.67	89.92	insol.
Ba(ClO ₄) ₂	128.99	119.85	78.543	41.716	80.812	81.054	insol.

² Willard and Smith, *J. Amer. Chem. Soc.*, **44**, 2819 (1922); **45**, 286 (1923); Smith, *ibid.*, **47**, 762 (1925).

TABLE IX. THE SOLUBILITIES OF SODIUM AND POTASSIUM PERCHLORATES
IN VARIOUS ORGANIC SOLVENTS
Grams per 100 ml. of solution at 25°

	NaClO ₄	KClO ₄	NaClO ₄ /KClO ₄
Ethyl alcohol, 100 per cent.	11.1	0.0094	1180
“ “ 98.8 per cent.		0.019	
“ “ 93.5 per cent.		0.051	
Normal butyl alcohol.	1.5	0.0036	415
Ethyl acetate.	8.4	0.0013	6480
Ethyl acetate, 80 per cent, + normal butyl alcohol, 20 per cent.	13.2 ^a	0.0025 ^a	5280

^a Grams per 100 g. of solution.

The last two solvents are obviously the best, the solubility of potassium perchlorate being least and that of sodium perchlorate greatest. Anhydrous ethyl acetate is readily available and is perhaps somewhat more convenient than the mixed solvent in spite of the somewhat higher solubility of the sodium salt in the latter. The fallacy of using ethyl alcohol containing some water is readily apparent, although the above solubilities can be decreased to 3 mg., 10 mg., and 18 mg. respectively by adding 0.2 per cent of perchloric acid.

The solution containing the potassium is evaporated to dryness with excess of perchloric acid to expel all acids of lower boiling point, such as hydrochloric acid, nitric acid, hydrofluoric acid, or acetic acid, and to form perchlorates of the metals present. It is necessary that salts of strong, non-volatile acids, insoluble in the organic solvent, such as sodium sulfate, be absent. The boiling point of sulfuric acid is over 300°, that of perchloric acid about 200°; boiling with perchloric acid does not, therefore, expel the sulfuric acid. Since sulfuric acid is a strong acid, little sulfuric acid is formed on treating sodium or potassium sulfate with perchloric acid, even though perchloric acid is also a strong acid. Sulfates must therefore be absent. Salts of weak acids may be present provided the free acids are soluble in the organic solvent, since in this case, sodium perchlorate and the free acid will be formed. Thus, since phosphoric acid is a considerably weaker acid than perchloric

acid, and since it is soluble in the organic solvents, the determination may be carried out in the presence of phosphate even though phosphoric acid is volatile only at a bright red heat. Arsenic and boric acids, being weak acids, behave like phosphoric acid. Sulfate may be removed by precipitation as barium sulfate, but there is a tendency for some potassium and sodium to be carried down. If all hydrochloric acid or nitric acid is not expelled, some sodium chloride or nitrate precipitates when ethyl acetate is added. Often a second evaporation is necessary to expel completely other acids.

Due to a peculiar characteristic of its crystal structure, potassium perchlorate occludes mother liquor and therefore contains water and some perchloric acid, sodium perchlorate, and any other metal perchlorates present.³ This would lead to high results, of course, and is remedied by dissolving in water the residue of potassium perchlorate from the extraction with the organic solvent, and again evaporating to dryness. It is not necessary to add more acid, so that only water is occluded during the second crystallization. This occluded water can be removed only by heating to 300-350°, a temperature sufficiently high for the pressure of the water vapor to burst the crystal. Drying at 100-105° does not accomplish this, and if correct results are obtained the positive error must have been compensated by a solubility loss. This is the reason that correct results are often obtained when ethyl alcohol is used as the solvent.

The filtrate containing the sodium perchlorate in solution in the organic liquid may be used for the determination of sodium or lithium, but the sodium is best determined on a separate sample as the triple acetate without removal of potassium.

Procedure for the Determination of Potassium by the Perchlorate Method. To the solution of the weighed combined chlorides, or, if the potassium and sodium are determined on separate samples, to the filtrate resulting from the J. Lawrence Smith method of decomposing a silicate, from which the calcium need not have been removed, add 7-8 ml. of c.p. 70 per cent perchloric acid, and evaporate in a 250 ml. beaker to dense fumes of perchloric acid.

If the sample was decomposed by hydrofluoric acid and perchloric acid followed by distillation of hydrofluosilicic acid (p. 274), it will be necessary to dehydrate any silica which may be present by boiling the hot, concentrated perchloric acid solution for a few

³ Smith and Ross, *J. Amer. Chem. Soc.*, **47**, 744, 1020 (1925).

minutes. Sufficient perchloric acid may already be present in solution; if necessary, however, add 2 ml. more so that the mixture may be boiled without spattering.

Continue the evaporation at a somewhat higher temperature and gradually expel the excess of perchloric acid. Evaporate until the residue is just moist but do not evaporate to dryness; otherwise insoluble basic salts of aluminum will be formed. A little silica may separate with the potassium perchlorate. Cool the residue by immersing the beaker in cold water. Add 20-30 ml. of anhydrous ethyl acetate⁴ (prepared by distilling "purified" ethyl acetate from phosphorus pentoxide), and stir until the soluble salts (sodium, calcium, and aluminum perchlorates) have dissolved and the potassium perchlorate remains. Cool in cold water and filter through a small, dry, fine filter paper, transferring most of the precipitate with ethyl acetate from a wash bottle. Wash three or four times with 2 ml. portions of ethyl acetate and discard the filtrate. Dissolve the potassium perchlorate remaining in the beaker with hot water, pour it through the filter, collecting the filtrate in a 150 ml. beaker. Wash with hot water until all the potassium perchlorate has dissolved and then at least ten times more, using small portions. Any silica will remain on the filter. Add half a drop of perchloric acid to the filtrate, and evaporate gently to dryness. Cool and add 15 ml. of anhydrous ethyl acetate; warm slightly, and stir to extract the small amount of soluble perchlorates remaining. Cool and transfer to a weighed filtering crucible, wash with five or six portions of ethyl acetate of about 1 ml. each. Pyrex sintered glass crucibles of medium porosity are very satisfactory. Dry the beaker and scrape loose any adhering salt crystals with a bright metal spatula and brush into the crucible. Dry in an oven at 110° for 20-30 minutes and then heat the covered crucible to 310° for 20 minutes using a muffle or oven. Cool and weigh. Reheat at 310°, cool, and weigh to insure constant weight. The crystals usually burst during the heating and leave a fine powder. Subtract the weight of the potassium perchlorate in the blanks, usually 1 mg. or less in the case of the hydrofluoric acid decomposition method, and 5-7 mg. in the case of the J. Lawrence Smith decomposition. The factor for converting potassium perchlorate to potassium oxide, K_2O , is 0.3399.

⁴ A satisfactory grade of anhydrous ethyl acetate can be obtained on the market.

THE CHLOROPLATINATE METHOD

The chloroplatinate separation of potassium utilizes the solubility of sodium chloroplatinate, Na_2PtCl_6 , and chloroplatinic acid, H_2PtCl_6 , in 80 per cent ethyl alcohol. The solubility of potassium chloroplatinate, K_2PtCl_6 , in 80 per cent ethyl alcohol is about 8.5 mg. per 100 ml.; the free acid, sodium, and lithium salts are fairly soluble, although if a stronger alcohol is used, these also become insoluble. The ammonium salt is about 60 per cent as soluble as the potassium salt. The chloride solution containing the alkali metals is evaporated with a slight excess of chloroplatinic acid to transform the chlorides into chloroplatinates and to expel hydrochloric acid. The chloroplatinates are then extracted with 80 per cent ethyl alcohol and the potassium salt dried at 130° and weighed. An empirical factor is used in calculating the results since the salt does not have exactly the theoretical composition, this defect being variously ascribed to the retention of water, the reduction of platinum to the bivalent state, or to the replacement of chlorine by hydroxyl or nitroso groups.

The use of lithium chloroplatinate, Li_2PtCl_6 , instead of chloroplatinic acid as the precipitating agent has been found to yield a potassium salt of the theoretical composition.⁵ It has also been recommended that the chlorides be converted to perchlorates before the addition of chloroplatinic acid or lithium chloroplatinate as an economy measure, sodium perchlorate being soluble in 80 per cent ethyl alcohol and only sufficient precipitating agent to combine with the potassium then being necessary.⁶

A modification of the chloroplatinate method by Hicks⁷ involves the reduction of the platinum in the potassium chloroplatinate precipitate to metal by metallic magnesium and the weighing of the metallic platinum. The separation of potassium chloroplatinate may then be made in the presence of sulfates, phosphates, borates, silicates, barium, strontium, calcium, magnesium, iron, aluminum, and any other metals which form chloroplatinates which are either dissolved or decomposed by 80 per cent alcohol. The residue then consists of potassium chloroplatinate mixed with other salts which do not contain platinum, so that the platinum obtained on solution

⁵ Smith and Shead, *J. Amer. Chem. Soc.*, **53**, 947 (1931).

⁶ Smith and Shead, *J. Amer. Chem. Soc.*, **54**, 1722 (1932).

⁷ Hicks, *J. Ind. Eng. Chem.*, **5**, 650 (1913).

and reduction is equivalent to the potassium present. Ammonium salts must be absent.

The platinum used in the determination of potassium may be recovered without great trouble from the residues and filtrates and converted to chloroplatinic acid for further use. This greatly decreases the expense inherent in the chloroplatinic acid method.⁸

Procedure for the Determination of Potassium by the Original Chloroplatinate Method. Dissolve in 10 ml. of water the chlorides of potassium and sodium remaining after removal of ammonium salts by ignition, and add a slight excess of a solution of chloroplatinic acid containing 10 per cent of platinum; the amount required can be calculated by assuming that only sodium chloride is present. Evaporate on the steam bath until the solution is syrupy and solidifies on cooling, but do not evaporate to dryness as this will dehydrate the sodium salt and make its solution in alcohol more difficult. Cool, add 20-25 ml. of 80 per cent (by volume) ethyl alcohol, and stir until everything except the yellow potassium chloroplatinate has dissolved. The alcohol must be colored by the excess of reagent. Wash with 80 per cent alcohol three or four times by decantation, transfer to a filtering crucible, wash until the alcohol runs through colorless, dry at 135° for an hour, repeating until constant weight is obtained, and weigh as potassium chloroplatinate. The empirical factor for converting potassium chloroplatinate to potassium oxide is 0.19375; to potassium, 0.1608. If it is desired to determine sodium or lithium in the filtrate, the platinum must be removed by reducing it to the metal by formaldehyde or hydrazine in slightly ammoniacal solution, or by evaporating to dryness with a globule of mercury.

Procedure for the Determination of Potassium by the Modified Chloroplatinate Method. Dissolve in 10 ml. of water the chlorides of potassium and sodium remaining after removal of ammonium salts by ignition, evaporate the slightly acid solution to a syrup with chloroplatinic acid slightly in excess of that required for complete precipitation of the potassium, and treat with 80 per cent alcohol as above. Thoroughly crush and grind the residue with a flattened glass rod and allow it to stand with the alcohol for half an hour. The solution must be colored yellow from excess of plati-

⁸ For a method of recovering the platinum from such residues, see Hillebrand and Lundell, *Applied Inorganic Analysis*, John Wiley & Sons, Inc., New York, 1929, p. 39.

num. Filter, wash three or four times by decantation, rubbing the precipitate each time, transfer it to the filter, and wash with the alcohol until it runs through colorless. Dissolve it on the filter in hot water, wash, and to the filtrate add 1 ml. of hydrochloric acid and about 0.5 g. of magnesium ribbon, previously washed with water, for every 0.2 g. of potassium present. Press the ribbon into the form of a ball and hold it at the bottom by means of a glass rod. When the action has ceased, add 1-2 ml. of hydrochloric acid and allow the platinum to settle. To be sure of complete precipitation, add more magnesium; the solution will darken if reduction was incomplete. Add hydrochloric acid and boil to dissolve any basic salts; filter, wash with hot water, ignite, and weigh. One gram of platinum corresponds to 0.4825 g. of potassium oxide, 0.40051 g. of potassium, and 0.7638 g. of potassium chloride.

THE COBALTINITRITE METHOD

Potassium may be precipitated as potassium sodium cobaltinitrite, $K_2NaCo(NO_2)_6 \cdot H_2O$, which is weighed or titrated by adding excess of potassium permanganate, in the presence of alkali, and, after acidifying, titrating the excess with standard oxalate. The nitrite is oxidized to nitrate and the trivalent cobalt reduced to the bivalent state:

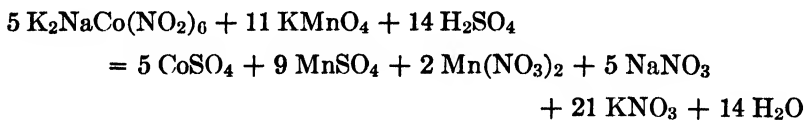

The literature of this method is voluminous, most of it being in the biological journals. Precipitation has customarily been made from acetic acid solution with a reagent prepared by dissolving cobalt nitrate and sodium nitrite in dilute acetic acid, and the precipitate has been of such variable character that the method has been regarded as highly empirical. Recent work,⁹ however, indicates that if the precipitation is made from a nitric acid solution by the addition of a solution of pure trisodium cobaltinitrite, the precipitate has the theoretical composition, $K_2NaCo(NO_2)_6 \cdot H_2O$, for amounts of potassium up to 10 mg., and the reaction with permanganate is

⁹ Wilcox, *Ind. Eng. Chem., Anal. Ed.*, **9**, 136 (1937); see also Robinson and Hauschildt, *ibid.*, **12**, 676 (1940).

stoichiometric. Ceric sulfate may be used in place of permanganate with advantage.¹⁰

The method is particularly useful for the preliminary concentration of potassium and its separation from large amounts of sodium. The precipitate may be converted into potassium perchlorate for weighing.¹¹

THE PERIODATE METHOD

Potassium can be quantitatively precipitated as the periodate, KIO_4 . The method is quite new¹² but possesses a number of advantages, the potassium content of the precipitate being very low and the oxidizing properties of the periodate ion making possible a convenient volumetric method for concluding the determination. The precipitation is carried out by adding periodic acid to a solution of small volume and subsequently completing the precipitation by addition of a much larger volume of a mixture of equal parts of aldehyde-free ethyl alcohol and anhydrous ethyl acetate. The solution must be maintained at 0° and stirred for 30 minutes.

The precipitate of potassium periodate may be weighed or it may be dissolved in a boric acid-borax buffer, potassium iodide added, and the free iodine titrated with arsenite. In this reaction the periodate is reduced to iodate.

Potassium may be separated in this manner from calcium, magnesium, zinc, aluminum, sodium, lithium, nickel, and cobalt, but not from manganese, iron, chromium, rubidium, cesium, or ammonium. It is possible to separate as little as 0.4 mg. of potassium from seventy times as much sodium. If both calcium and sulfate are present the results are too low, probably because of the formation of a double potassium calcium sulfate. Small amounts of sulfuric, phosphoric, nitric, and boric acids may be present, but with large amounts the precipitate becomes gelatinous and difficult to filter. In the presence of sulfate the gravimetric determination is impossible, but the volumetric method gives satisfactory results. Chloride must be absent.

Free periodic acid is available at the present time and this method may find considerable use.

¹⁰ Brown, Robinson and Browning, *Ind. Eng. Chem., Anal. Ed.*, **10**, 652 (1938); Kaye, *ibid.*, **12**, 310 (1940).

¹¹ Bennett, *Analyst*, **41**, 165 (1916); Miller and Traves, *J. Chem. Soc.*, **1936**, 1392.

¹² Willard and Boyle, *Ind. Eng. Chem., Anal. Ed.*, **13**, 137 (1941).

THE DETERMINATION OF SODIUM

THE MAGNESIUM URANYL ACETATE METHOD

The direct determination of sodium was formerly rather troublesome, but the introduction in 1928 of the *triple acetate method* has made it rapid and exact. Sodium, various bivalent elements, and hexavalent uranium (the uranyl ion, UO_2^{++}), form slightly soluble acetates corresponding to the formula

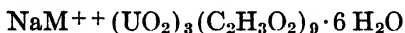

Of the various bivalent metals, magnesium, zinc, nickel, cobalt, copper, and manganese, which form triple salts of this type, only the zinc and magnesium salts have been investigated for their use in the determination of sodium. The triple acetate method proposed by Barber and Kolthoff¹³ utilized the zinc salt, which although only a little more soluble than the magnesium salt, does not appear to give quite as good results as the latter. The best work on the use of the magnesium salt is that of Caley.¹⁴ Although the triple acetate salts are appreciably soluble in water, their solubility is enormously decreased by an excess of their three common ions, the bivalent metal, the uranyl, and the acetate ions, so that they precipitate sodium quantitatively. Because of the high molecular weight of the precipitates, the methods are very accurate for sodium. They are particularly well adapted to the determination of small amounts of sodium but are not suitable for large amounts.

The solubility of sodium magnesium uranyl acetate is 3.28 g. per 100 ml. of water, and 0.025 g. per 100 ml. of 100 per cent alcohol. Its solubility is greatly decreased by a large excess of its ions, however, so that even in aqueous solution it can be used for quantitative work. The salts tend to form supersaturated solutions and the solution must be stirred vigorously for an hour to secure complete precipitation, which otherwise is very slow. Vigorous mechanical stirring is best. The precipitation must be carried out at a temperature not exceeding 20°, and since the temperature coefficient of

¹³ Barber and Kolthoff, *J. Amer. Chem. Soc.*, **50**, 1625 (1928); **51**, 3233 (1929).

¹⁴ Caley and Foulk, *J. Amer. Chem. Soc.*, **51**, 1664 (1929); Caley, *ibid.*, **52**, 1349 (1930); Caley and Sickman, *ibid.*, **52**, 4247 (1930); Caley, *ibid.*, **54**, 432 (1932).

solubility is large, the temperature must be controlled within 1°. The reagent is a solution of uranyl acetate, magnesium acetate, and acetic acid, and like the alcohol wash solution, is previously saturated with sodium magnesium uranyl acetate; the temperature of these solutions must also be within 1° of the precipitation temperature when filtered from the salt prior to the determination and when used. The volume of the reagent which must be added depends both on the amount of sodium present and on the volume of the solution. The precipitate is dried at 100-110° and weighed as the hydrated salt, $\text{NaMg}(\text{UO}_2)_3(\text{C}_2\text{H}_3\text{O}_2)_9 \cdot 6.5 \text{H}_2\text{O}$.

The determination may be carried out in a sulfate, nitrate, chloride, or perchlorate solution. Amounts of potassium up to ten times the amount of sodium do not interfere; the high results due to amounts in excess of this may be somewhat reduced by increasing the volume of the solution. Magnesium, ammonium, calcium, barium, strontium, ferric, aluminum, chromic, rubidium, cesium, and many other metal ions¹⁵ may be present in amounts up to 200 mg. when 100 ml. of reagent is used, and more may be present if larger volumes are employed. Lithium is partially precipitated if more than 1 or 2 mg. are present. Substances which precipitate constituents of the reagent, such as phosphate, arsenate, and ferrocyanide, must be absent. Phosphate is most conveniently removed prior to the precipitation by digestion with zinc carbonate.¹⁶

For small amounts of sodium, the determination may be concluded centrifugally¹⁷ or colorimetrically.¹⁸

Procedure for the Determination of Sodium by the Magnesium Uranyl Acetate Method. Preparation of reagent: In 800 ml. of water dissolve 45 g. of uranyl acetate, $\text{UO}_2(\text{C}_2\text{H}_3\text{O}_2)_2 \cdot 2 \text{H}_2\text{O}$, 300 g. of magnesium acetate, $\text{Mg}(\text{C}_2\text{H}_3\text{O}_2)_2 \cdot 4 \text{H}_2\text{O}$, and 60 ml. of glacial acetic acid, heating to dissolve the salts. Cool, dilute to 1000 ml. and place in a vessel containing water at 20° for at least 2 hours, stirring or shaking frequently. Filter through a dry filter into a dry bottle or flask.

If the sodium in an insoluble silicate is to be determined, the silicate must be decomposed by one of the two methods discussed

¹⁵ Elliott, *Ind. Eng. Chem., Anal. Ed.*, **12**, 416 (1940).

¹⁶ Overman and Garrett, *Ind. Eng. Chem., Anal. Ed.*, **9**, 72 (1937).

¹⁷ Caley, Brown and Price, *Ind. Eng. Chem., Anal. Ed.*, **6**, 202 (1934).

¹⁸ Darnell and Walker, *Ind. Eng. Chem., Anal. Ed.*, **12**, 242 (1940).

on the following pages, the J. Lawrence Smith method or the Berzelius method using hydrofluoric acid and sulfuric acid or perchloric acid. The sample should not be too large; usually the amount of sodium should not exceed 25 mg., otherwise too much reagent may be required later.

Nearly neutralize the solution containing the sodium with ammonia or hydrochloric acid until just acid to methyl orange. Evaporate to 5-7 ml. in a 400 ml. beaker, or if previously evaporated to a smaller volume, dilute to this volume. It is best not to let the solution go to dryness. If the solution is not clear, filter it through a small filter, wash the precipitate, and evaporate the filtrate again to the proper volume. The solution at this point must be only slightly acid; it cannot be neutralized after the reagent is added. Add 100 ml. of reagent if not over 13 mg. of sodium oxide is present. If more sodium than this amount is present add 10 ml. more of the reagent for each 1.3 mg. of sodium oxide in excess of the first 13 mg. For example, 26 mg. of sodium oxide would require about 200 ml. of reagent.

Stir the solution vigorously, 500-1000 r.p.m., by a motor driven stirrer for 45-60 minutes while the beaker or flask is partly immersed in water held at 20° within 1°, by the addition of cold water or chipped ice from time to time. Filter through a Gooch crucible (porous porcelain filtering crucibles seem to clog readily with the precipitate), keeping the temperature of the solution at 20°. Wash once or twice with the reagent at 20°, then with a wash solution consisting of a mixture of 35 ml. glacial acetic acid, 405 ml. of anhydrous ethyl acetate, and 460 ml. of ethyl alcohol. When considerable sulfate is present, it is especially important to wash the precipitate first with the reagent once or twice before using alcohol to prevent precipitation of sulfates. The alcohol washings will cause precipitation of the sodium salt in the filtrate, but disregard this. Dry the precipitate 30-45 minutes at 100-110°; do not keep the precipitate at this temperature more than 1 hour. Decomposition occurs at temperatures above 120°, acetic acid being lost and the precipitate darkening to an orange tint. The factor for converting sodium magnesium uranyl acetate, $\text{NaMg}(\text{UO}_2)_3(\text{C}_2\text{H}_3\text{O}_2)_9 \cdot 6.5 \text{H}_2\text{O}$, into sodium oxide is 0.0206, and into sodium 0.01528. A blank determination should always be run on the reagents, following each step from the beginning just as in the analysis.

THE DETERMINATION OF LITHIUM

THE SEPARATION OF LITHIUM FROM SODIUM

Lithium remains with sodium in all the methods for separating potassium from the latter. Lithium and sodium are so much alike in their reactions that only one method has been found for separating them. This depends on the solubility of lithium chloride in certain organic solvents: 2-ethylhexanol,¹⁹ acetone,²⁰ and ether-alcohol mixtures. Of these, 2-ethylhexanol is undoubtedly the best.

The lithium chloride obtained from any of these solvents is converted to lithium sulfate for weighing. Like sodium, lithium also forms triple acetates but the conditions for the precipitation of lithium in this manner are critical.²¹

Lithium can be quantitatively precipitated, in the presence of alkali metals only, as a periodate containing somewhat less lithium than corresponds to the formula Li_5IO_6 by the addition of a strongly alkaline potassium periodate solution. The precipitate cannot be weighed but must be dissolved in sulfuric acid and the determination concluded iodometrically.²²

THE SEPARATION OF POTASSIUM, RUBIDIUM, AND CESIUM

While satisfactory methods for separating these elements on a larger scale by repeated fractional crystallization of certain salts are known, the quantitative separation for analysis is still a largely unsolved problem.²³ Recently methods have been devised for separating these alkalies in the amounts ordinarily found in rock analysis which, although somewhat empirical, appear to give fairly satisfactory results.²⁴

¹⁹ Caley and Axilrod, *Ind. Eng. Chem., Anal. Ed.*, **14**, 242 (1942).

²⁰ Brown and Reedy, *Ind. Eng. Chem., Anal. Ed.*, **2**, 304 (1930).

²¹ Miller and Traves, *J. Chem. Soc.*, **1936**, 1395; Caley and Baker, *Ind. Eng. Chem., Anal. Ed.*, **11**, 604 (1939).

²² Rogers and Caley, *Ind. Eng. Chem., Anal. Ed.*, **15**, 209 (1943).

²³ A review of the literature on this subject may be found in the paper of O'Leary and Papish, *Ind. Eng. Chem., Anal. Ed.*, **6**, 107 (1934).

²⁴ Wells and Stevens, *Ind. Eng. Chem., Anal. Ed.*, **6**, 439 (1934); Hillyer, *ibid.*, **9**, 236 (1937).

THE DECOMPOSITION OF INSOLUBLE SILICATES FOR THE DETERMINATION OF THE ALKALI METALS

In most cases all of the alkali metals can be extracted from a substance by treatment with water or acid. Insoluble silicates, however, require special treatment. Obviously, they cannot be fused with sodium carbonate or potassium carbonate; some other base must be used, calcium oxide being the one usually chosen. Silicates may also be decomposed for the determination of the alkali metals present by treatment with hydrofluoric acid, a procedure first proposed by Berzelius,²⁵ but the method has certain disadvantages which have only recently been overcome. The calcium oxide fusion, first put in practicable form by the American analyst, J. Lawrence Smith,²⁶ has been the most widely used method during the last sixty years. The J. Lawrence Smith method is the only satisfactory method of obtaining a solution from which the combined chlorides of sodium and potassium may be obtained for weighing; however, the method is lengthy and involves tedious extractions and evaporations. For the direct, separate determination of sodium and potassium, decomposition with hydrofluoric acid followed by a suitable method of removing the excess hydrofluoric acid is more rapid and equally satisfactory. It is strongly recommended that the direct method involving hydrofluoric acid be used. Detailed discussions of both the J. Lawrence Smith method and of the hydrofluoric acid method are given in the following sections.

²⁵ Berzelius, *Pogg. Ann.*, [2], 1, 169 (1824).

²⁶ Smith investigated a number of fluxes to assist the calcium oxide fusion and finally settled on the mixture of calcium carbonate and ammonium chloride. He devised the tall form crucible used in the determination, investigated the removal of ammonium salts, and worked out the method essentially as it is used today. During the interim of Smith's earlier and later papers, the Bunsen burner was introduced, and Smith's relief at relinquishing his charcoal furnace, together with his comments, and the methods by which he himself had to prepare such common chemicals as calcium carbonate and ammonium chloride in sufficiently pure state, are interesting sidelights on the chemistry of the time of this pioneer American analyst. J. Lawrence Smith, *Chemical Gazette*, 11, 252 (1853); *J. prakt. Chem.*, [1], 59, 159 (1853); [1], 60, 244 (1853); *Amer. J. Sci.*, [2], 15, 234 (1853); [2], 16, 53 (1853); [3], 1, 269 (1871); *Ann. Chem. Pharm.*, 159, 82 (1871); *Chem. News*, 23, 223, 234 (1871).

THE J. LAWRENCE SMITH METHOD

In the J. Lawrence Smith method of decomposing silicates, the silicate is heated with a mixture of ammonium chloride and calcium carbonate. Calcium chloride and calcium oxide are formed on heating:

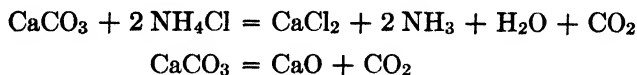

The chloride is added to give a little fluidity to the mass so that partial fusion will occur and the action be more thorough. Chlorides of the alkali metals are formed during the ignition which are easily and completely extracted with water.

Calcium chloride and calcium oxide cannot be used directly for they are hygroscopic and cannot be readily mixed intimately with the silicate as they form a sticky mass on short exposure. It is necessary, therefore, to use the mixture of calcium carbonate and ammonium chloride, which is not at all hygroscopic, can be mixed thoroughly with the silicate, and which forms the necessary compounds on ignition. Best results are obtained when the calcium carbonate and ammonium chloride are ground together in a ball mill, after which they react more readily in the fusion and give better results. Otherwise much of the ammonium chloride may be volatilized unchanged.

The fineness to which the sample is ground is very important; difficultly decomposed silicates may not be completely decomposed even when ground to pass 150 mesh, but will be decomposed entirely on one treatment if the sample is ground to 200 mesh.²⁷ Care must be taken during the ignition of the silicate to keep the cover of the crucible cool to avoid volatilization of alkali chlorides. A special tall form crucible is used for the fusion, see Fig. 35.

After the ignition the mass is extracted with water; an acid is never used, for this would spoil the process entirely. The insoluble residue contains all the silica, iron, aluminum, magnesium, and other metals as calcium silicate or aluminate, or as metal oxides. The solution contains only the alkali metal chlorides, calcium chloride, calcium hydroxide, and a very little calcium aluminate, $\text{Ca}(\text{AlO}_2)_2$. One of the main advantages of the Smith method is the fact that by

²⁷ Lamar, Hazel and O'Leary, *Ind. Eng. Chem., Anal. Ed.*, **7**, 429 (1935).

simply extracting with water, all the metals present in the silicate remain in the insoluble residue except the alkali metals, calcium, and traces of aluminum. If it is desired to weigh the combined chlorides of potassium and sodium, the calcium is precipitated as calcium carbonate by ammonium carbonate from very dilute solution, the last traces being removed by ammonium oxalate, and ammonium

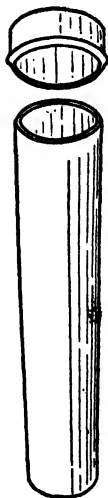

FIG. 35. Crucible for J. Lawrence Smith Fusion.

salts removed by gentle ignition. The ammonium salts may also be removed by evaporation with nitric acid and hydrochloric acid, which oxidize the ammonium ion to nitrous oxide, leaving a residue containing largely nitrates. Occasionally a persistent carbonaceous residue forms, undoubtedly from the oxalate, which causes some trouble, so that the ignition procedure is recommended. The oxalate precipitation to remove the last traces of calcium is necessary only when the combined alkali chlorides are to be weighed, and may be dispensed with if potassium alone is being determined on the sample.

Since the reagents contain traces of alkali metals and since a certain amount is taken up from the glass and porcelain vessels used, it is necessary to run blanks for both potassium and sodium on the same amount of the calcium carbonate-ammonium chloride mixture, and in exactly the same way as in the analysis. This blank is as important as the analysis itself.

The J. Lawrence Smith method is applied only to silicates, and the sample thus treated cannot be used for the determination of any metals except the alkalis. For the determination of silica, aluminum, calcium, iron, and other metals, separate samples are fused with sodium carbonate and analyzed in the usual way. Potassium cannot be determined on a sample fused with sodium carbonate, since the separation from large amounts of other metals is unsatisfactory. For the same reason it is often desirable to remove most of the calcium in the J. Lawrence Smith method, even though sodium is not to be determined.

The presence of sulfate in the silicate makes necessary special treatment to remove the sulfate following the J. Lawrence Smith fusion. Replacement of the ammonium chloride in the fusion mix-

ture by barium chloride is said to circumvent this trouble,²⁸ and in addition eliminate the very slow preliminary heating necessary to expel the ammonia.

Procedure for the Decomposition of Insoluble Silicates by the J. Lawrence Smith Method. Transfer to a clean, dry, glass mortar about 10 cm. in diameter, a 1 g. sample of the finely powdered silicate and mix it with 10 times its weight of a specially prepared mixture of calcium carbonate and ammonium chloride. This mixture is prepared by grinding for about an hour in a ball mill 8 parts of special, alkali-free calcium carbonate with 1.5 parts of ammonium chloride. Mix the silicate well with the fusion mixture but do not grind too hard. Brush it carefully into the special, tall form nickel crucible (Fig. 35) made purposely for this fusion.²⁹ Take care that none is lost. Add a few tenths of a gram of fusion mixture to the mortar so that it will sweep up all particles of silicate remaining, and transfer to the crucible. Start blank determinations at the same time and carry them through all of the operations simultaneously with the samples.

Tap the crucible gently to settle the powder, place it in a hole in a piece of transite or heavy asbestos sheet, so that 2 or 3 cm. project above, put on the cover, and heat with a very small flame. The preliminary heating must be very gradual; otherwise ammonium chloride is driven off before it reacts with the calcium carbonate. If fumes of ammonium chloride appear, the heat should be reduced at once. Some loss of ammonium chloride is inevitable. The heat may be gradually increased as the evolution of ammonia ceases, until after 30-50 minutes the bottom of the crucible is just red. Apply the full heat of a Meker or Fisher burner for 50-60 minutes. Place the crucible inside a clay chimney with slots to allow the escape of the flame gases and adjust the burner so as to be just below the bottom of the chimney or flame collar. If the latter is not used the bottom of the crucible should be within at least 1 cm. of the top of the burner. That portion containing the mixture must be bright red, while that part above the asbestos must not be at all red; otherwise some of the alkali chlorides will be lost. Do not remove the cover while the crucible is hot. An ordinary type of nickel or

²⁸ Stevenis, *Ind. Eng. Chem., Anal. Ed.*, **12**, 413 (1940).

²⁹ These crucibles may be obtained from Eberbach and Sons Co., Ann Arbor, Mich.

platinum crucible or even an iron crucible may be used if the cover is cooled by placing on it another crucible in which is kept some water, adding more as it evaporates. This is, however, much less convenient than the tall form type of crucible, and it is more difficult to heat it properly. To be certain of complete decomposition with all types of silicates, a temperature of 1000° is necessary, and it is difficult and often impossible to attain this unless a flame collar is used.

When cool, the mass will be found to have sintered together into a cake and to have shrunk considerably. It should not fuse; if it does, the proportion of calcium carbonate should be increased. Rinse off the cover into the crucible with a little warm water, and add enough water to cover the cake. Allow the mixture to stand until the mass falls apart; the calcium oxide slakes, forming calcium hydroxide. Add more water, warming and stirring; no lumps should be seen or felt. This may take only a few minutes or it may require an hour or two. If convenient, it may be allowed to stand overnight in a warm place. Heating will promote the disintegration. If the cake does not disintegrate, and the lumps cannot be broken up by a flattened glass rod, start a new sample, using a somewhat larger proportion of the calcium carbonate and ammonium chloride, or a higher temperature, or both.

The next operation of filtering and washing is a rather long one, and should not be started unless about two hours are available in which to complete it, for it cannot be interrupted. Wash the contents of the crucible into a casserole with hot water, heat to boiling, let settle, and decant the clear liquid through a filter. The precipitate settles quite rapidly. After washing in this way seven or eight times by decantation, transfer the residue to one or two filters and wash ten or twelve times with hot water. Then test the washings with nitric acid and silver nitrate; only a very faint opalescence should appear. It is impossible to wash out every trace of chloride. If necessary, wash a few more times, and always allow all the water to drain through before adding the next portion. Collect the filtrate and washings, which will amount to 800-900 ml., in a large casserole.

The precipitate is discarded, but to see if decomposition was complete it may be dissolved in hydrochloric acid. Only a little flocculent silica should separate, but there should be no hard par-

ticles, except perhaps scale from the crucible. The filtrate containing the alkali metals as chlorides, calcium chloride, and calcium hydroxide, will not be perfectly clear, owing to the precipitation of calcium carbonate by absorption of carbon dioxide from the air. About three eighths of the calcium will be found in this solution.

If only potassium is to be determined on the sample, the calcium in solution need not be removed. For the determination of potassium, continue as directed under the perchlorate method, p. 256. For the determination of sodium, continue as directed under the triple acetate method, p. 263. In any case the solution should at once be acidified with perchloric acid in the former case and with hydrochloric acid in the latter.

If it is desired to determine both potassium and sodium on the same sample by weighing the combined chlorides and subsequently determining the potassium and obtaining the sodium by difference, it is necessary to remove all of the calcium from solution. This is accomplished by precipitation as calcium carbonate by the addition of ammonium carbonate, and then precipitation of the last traces as calcium oxalate by ammonium oxalate. The carbonate gives a better separation from the alkali metals than the oxalate and hence is used for removing the major part of the calcium. The ammonium salts are eliminated from the filtrate by evaporation and gentle ignition. The procedure is as follows:

To the hot filtrate and washings from the disintegrated fusion add a solution of about 4 g. of ammonium carbonate, 5-10 ml. of ammonia, and a little water. Heating will not hasten the dissolution of the carbonate, since it decomposes the carbonate. Boil a few minutes and allow to settle. The precipitate is coarse and filters easily. Any aluminum is precipitated as hydroxide. Filter and wash with hot water. Add to the slightly alkaline filtrate 0.2-0.3 g. of ammonium oxalate. Evaporate to 150-200 ml., filter, and wash with cold water. The filtrate now contains potassium chloride, sodium chloride, ammonium chloride, and ammonium oxalate. Add 5 ml. of hydrochloric acid, evaporate, and if necessary, filter into a medium sized platinum dish, previously ignited and weighed, washing thoroughly. Evaporate to dryness, and ignite the residue carefully just below a red heat. If any carbon does not burn off, the residue must be dissolved, the carbon filtered off, and the solution evaporated and ignited.

METHODS EMPLOYING HYDROFLUORIC ACID

Most silicates may be completely decomposed by treatment with dilute hydrofluoric acid and sulfuric acid; occasionally nitric acid or hydrochloric acid is also added. Platinum ware must be used, of course, and the mixture is evaporated to fumes of sulfuric acid to expel the excess hydrofluoric acid. The evaporation must be repeated once or twice to remove all hydrofluoric acid, which is rather tenaciously retained. This gives a solution free from silica in which all the metals are present as sulfates. Such a solution is well suited for the determination of heavy metals and for the determination of sodium by the triple acetate method in which the removal of sulfate and other metals is not necessary. Detailed directions for the decomposition of silicates in this manner are given at the end of this section. The sulfate must be removed first, however, if the solution is to be used for the determination of potassium or for the determination of the combined alkalis by weighing as the combined chlorides.

Sulfate may be removed from the solution by precipitation as barium sulfate. The excess barium and other heavy metals present are then removed by the addition of ammonium carbonate and ammonia. Magnesium is not removed completely by this operation, and it is necessary to destroy the ammonium salts and repeat the carbonate precipitation. All this is very troublesome, and there is a great tendency toward the loss of alkalis by coprecipitation during the process.

Methods of removing the hydrofluoric acid without the introduction of sulfate have been tried. Boiling with concentrated perchloric acid does not expel all fluoride, probably because of the great stability of the fluoaluminate ion, AlF_6^{---} . Precipitation of the fluoride as calcium fluoride by the addition of calcium hydroxide has been suggested,³⁰ but the method is unsatisfactory and cannot be recommended. Some fluoride escapes precipitation, again probably due to the stability of the fluoaluminate ion, and alkali metals are lost by adsorption. In another method, which has recently been shown to be very satisfactory,³¹ the fluoride is volatilized as hydrofluosilicic acid, H_2SiF_6 . This method will be discussed in detail.

³⁰ Koenig, *Ind. Eng. Chem., Anal. Ed.*, **7**, 314 (1935).

³¹ Willard, Liggett and Diehl, *Ind. Eng. Chem., Anal. Ed.*, **14**, 234 (1942).

The conditions for the distillation of hydrofluosilicic acid were originally worked out by Willard and Winter in connection with the determination of fluorine.³² The distillation is carried out by in-

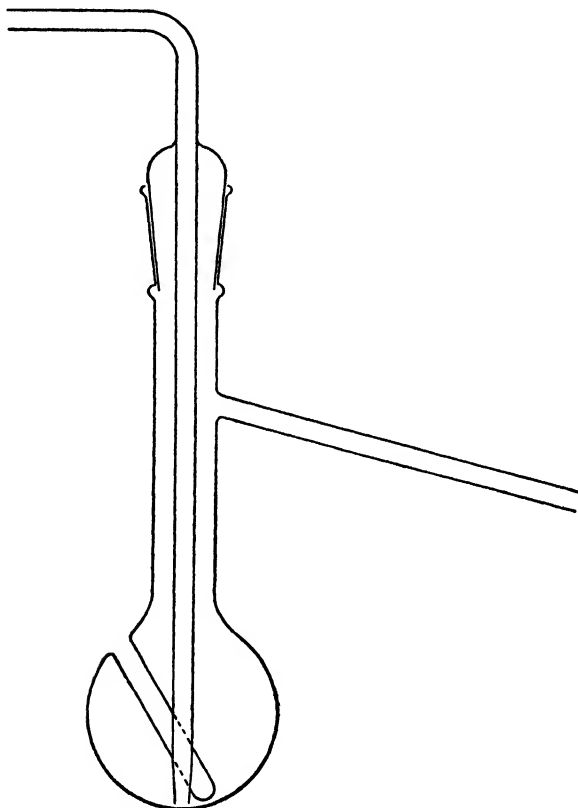

FIG. 36. Distilling Flask for the Removal of Fluorine During the Determination of Potassium.

jecting steam into the solution which is maintained at a temperature of 140-150°.³³ Perchloric acid is added to effect the elevation in

³² Willard and Winter, *Ind. Eng. Chem., Anal. Ed.*, **5**, 7 (1933).

³³ This temperature is somewhat higher than the 135° recommended by Willard and Winter for the separation of fluorine. The removal can be carried out faster at the higher temperature, the small amount of perchloric acid which may be carried over at this temperature being immaterial in this determination.

temperature. This yields directly the perchloric acid solution desired for the determination of potassium, and following the distillation, it is only necessary to dehydrate and remove the small amount of silica introduced during the distillation before determining the potassium. As no ammonium salts are introduced during the analysis, their removal is obviated. The pyrex distilling flask shown in Fig. 36 is convenient for carrying out the distillation, but equally satisfactory results can be obtained with a common distilling flask

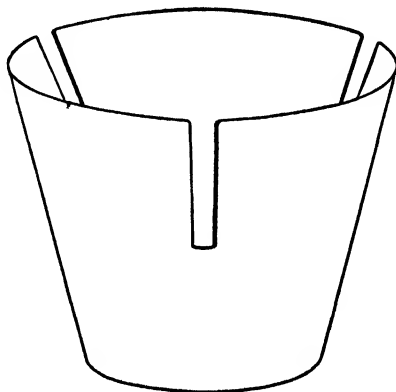

FIG. 37. Hillebrand Evaporator.

provided with a two-hole rubber stopper for the thermometer and steam inlet tube. Since the apparatus used in the determination is platinum and pyrex throughout, and the time required for the determination is not great, the blank for potassium is very small and consistent, averaging about 0.0005 g. of potassium perchlorate. The method tends to give slightly higher results than the J. Lawrence Smith method. The method cannot be used for the determination of sodium because the glassware is somewhat attacked.

Procedure for the Determination of Potassium by Hydrofluoric Acid Decomposition Followed by Distillation of Hydrofluosilicic Acid. Weigh 1-2 g. of the sample, depending on the potassium content, into a 20 ml. platinum crucible, moisten with water, and add 10 ml. of hydrofluoric acid and 3 ml. of perchloric acid. Stir well with a platinum wire, or the rubber end of a policeman, taking care not to let the acid touch the glass; rinse and remove the stirring rod, place in a Hillebrand evaporator (Fig. 37) in a 'good hood and

allow to evaporate almost to dryness. Moisten with water, add 2-5 ml. more of hydrofluoric acid, depending on the size of the sample taken, and 3 ml. of perchloric acid; stir well and again evaporate almost to dryness. Transfer the salts to a 125 ml. pyrex distilling flask, using a long stem funnel and as little water as possible. Make sure that all insoluble material is transferred to the flask. Blanks should be started with the samples and carried through the entire procedure.

Fit the distilling flask with a two-holed rubber stopper carrying a thermometer, the black paint on the lower part of which has been removed by acetone, and a glass inlet tube slightly constricted at the bottom for introducing steam. Add a few pieces of broken quartz or pyrex to the flask and connect the flask to a steam generator and to a water-cooled condenser. Four of these may be set up and run simultaneously by one person. The all-glass distilling apparatus previously described is more convenient, and eliminates the possibility of danger of the hot perchloric acid coming into contact with the rubber stopper. No trouble has ever been experienced from the latter, however, since the acid is not in the concentrated form. Care should, nevertheless, be taken that the perchloric acid is never allowed to concentrate, for it might spatter on the rubber stopper and perhaps attack it violently.

With the steam generator disconnected, concentrate the liquid in the flask to a volume of about 12 ml. by boiling gently; draw a slow current of air through the inlet tube to facilitate the evaporation and to prevent bumping. Cool somewhat, add 8 ml. of 70 per cent perchloric acid, heat to 140-150° and pass steam through the mixture at a moderate rate until 300-500 ml. of distillate has been collected. The larger volume is necessary only in case a large sample is employed. Shake the flask occasionally to wash down material spattered on the walls.

Transfer the contents of the flask to a 250 ml. beaker and wash out well with hot water, leaving behind the pieces of glass or quartz. Evaporate on a hot plate to strong fumes of perchloric acid, adding an additional 2 ml. of perchloric acid or enough so that the mixture may be boiled without spattering. Continue the evaporation at a somewhat higher temperature to dehydrate completely the silica and to expel the excess of perchloric acid. Evaporate until the residue is just moist but do not evaporate to dryness; otherwise insoluble basic salts of aluminum will be formed. Continue the determina-

tion as directed under the perchlorate method for potassium, p. 256, beginning with paragraphs two and three of the procedure.

Procedure for the Decomposition of Silicates by Hydrofluoric Acid and Sulfuric Acid. This method is seldom used for the decomposition of silicates prior to the determination of potassium because of the necessity of removing the sulfate and because of the danger of spattering. It is, however, a short and convenient method for decomposing the silicate for the determination of sodium by the triple acetate method, where the presence of sulfate does no harm, and where a small sample is used so that there is less danger of spattering.

Place in a platinum crucible a dried sample of 0.25 g. If organic matter is present, a brief ignition will remove it. Moisten with water, add 5-6 drops of sulfuric acid, 2 ml. of hydrochloric acid, and about 5 ml. of hydrofluoric acid. A paraffined, calibrated test tube makes a suitable graduate. Place the uncovered platinum crucible in a Hillebrand evaporator (Fig. 37) and gently heat it. There will be a considerable evolution of silicon tetrafluoride. When there is no further apparent reaction, heat the evaporator as much as possible without causing the solution to boil, looking at the crucible occasionally to be sure of this.

The initial rate of evaporation may be fairly rapid but after half an hour or when the volume is about 0.5 ml. the rate should be reduced. Take extreme care to avoid spattering, as the last traces of moisture are expelled. Then evaporate off all excess of sulfuric acid, using the full heat of the Meker or Fisher burner under the evaporator at the end of the operation, but do not heat the crucible directly.

Place the crucible in 50 ml. of hot, distilled water in a 150 ml. beaker, rinse and rub out the contents, and remove the crucible. Boil the solution 10 minutes. It will not be clear and must be filtered from the basic aluminum salts. Collect the filtrate directly in a 250 ml. beaker, which is the proper size for the triple acetate precipitation.

Precipitate the sodium as directed under the triple acetate method, p. 263, but do not neutralize the solution, because the excess of sulfuric acid has been driven off and what little remains will do no harm. In fact, if a flocculent precipitate of hydrous aluminum oxide forms while the solution is evaporating, it may be necessary to dissolve it with a trace of sulfuric acid. If any additional pre-

precipitate is formed and filtered off, low results will sometimes be obtained. If calcium sulfate precipitates when the volume is reduced to 5-7 ml., disregard it. It may dissolve in the larger volume when the reagent is added, but since it may not, the weight of the triple acetate may be obtained by difference by washing it through the filtering crucible with hot water, drying, and weighing the crucible again.

Procedure for the Determination of Sodium in Silicates by Decomposition with Hydrofluoric Acid and Perchloric Acid. If the silicate contains much calcium, the use of sulfuric acid causes the separation of so much calcium sulfate that the preceding process is not satisfactory. The substitution of perchloric acid avoids this trouble. It has already been stated that all fluoride cannot be removed in this way, but although the presence of a small amount of it interferes with the determination of potassium it does not prevent the precipitation of sodium as the triple acetate.

Place in a platinum crucible a dried sample of 0.25 g. Add 10 ml. of hydrofluoric acid from a bakelite graduate or a test tube or graduate coated with paraffin and 3 ml. of 70 per cent perchloric acid. Stir well with a platinum wire or the rubber end of a policeman, taking care not to let the acid touch the glass, rinse and remove the stirring rod, place in a Hillebrand evaporator (Fig. 37) in a hood, and evaporate almost to dryness. Moisten with water, add 3 ml. of perchloric acid, stir well, and evaporate almost to dryness. The residue should be slightly moist with the acid. A third evaporation with 3 ml. more is desirable in most cases. Dissolve the residue in a little water, wash it into a 250 ml. beaker, evaporate to 5-7 ml. taking particular care not to allow the solution to go to dryness, and, paying no attention to any slight insoluble material, precipitate the sodium with the uranyl magnesium acetate reagent as directed on p. 263. When the precipitate has been weighed, dissolve it out of the crucible by pouring hot water through it and weigh again, thus correcting for any insoluble material. A blank should be run in the same way.

CHAPTER VI

THE DETERMINATION OF THE ELEMENTS

The following section of the text contains discussions of each of the elements frequently or occasionally encountered by the practicing analyst. The section is arranged according to the periodic table, the members of each group having been placed together and preceded by a short summary of the outstanding characteristics of the group as a whole with particular reference to those properties of importance to the analytical chemistry of the members. This is not the order in which the elements are removed from a solution during the course of the analysis of a complex mixture for that order approximates the order in which the elements are removed in the scheme of qualitative analysis commonly employed. There is nothing fundamental about the order of removal, however, and so many exceptions to it are now being made because of the discovery of new specific reagents or to investigations of the conditions under which old methods can be made more specific in action, that little is gained by arranging the treatment of the individual metals according to such a system. The periodic arrangement, on the other hand, has the merit of grouping together those elements which have the maximum number of similarities in their occurrences, properties, and reactions. This is of great assistance in assimilating the enormous mass of chemical facts, of assisting the memory to retain them by the process of association, and of enabling the mind to reason from one situation to another by analogy.

At the beginning of the treatment of each element is given a short survey of the natural occurrences and the uses of the element. Analytical chemistry is the handmaiden of many other branches of science and necessarily the analyst will find useful the knowledge of a variety of related fields, mineralogy, geological chemistry, metallurgy, agricultural chemistry, and many others. A knowledge of the elements likely to be present in a given material is frequently a

means of saving time and avoiding grievous mistakes. Where not commonly studied in the beginning courses in chemistry, the general reactions and qualitative analysis of the metals have been included.

Under the quantitative analysis of the various elements, the methods of separating the element from other elements are given first and then the gravimetric, volumetric, and colorimetric methods for their determination. A sharp differentiation should be made between the forms into which an element is converted to separate it from other metals and the forms in which it is weighed. The two may be the same, but usually they are different. In some cases, as, for example, magnesium, the element cannot be separated directly in any way, and all other metals, excepting the alkali metals, must be removed first.

The Bohr form of the periodic table is reproduced in the back cover of the book. This form of the periodic table, although showing the superficial resemblance of copper, silver and gold to the alkali metals with respect to their common valence, and of manganese and rhenium to the halogens, has the merit of emphasizing the positions of copper, silver and gold, and of manganese and rhenium as transition elements, that is, in the proximity of the members of group VIII. This holds also for the members of groups II and VI, although the differences between the subgroups are less pronounced. The differences between the subgroups of groups III and V, although still very definite, are less evident and the differences disappear almost completely in group IV.

The members of the second and third periods, that is, the periods beginning with lithium and sodium, in general differ from the remaining members in the same group and this is emphasized by the Bohr arrangement. Thus, lithium and sodium differ from potassium, rubidium, and cesium; beryllium and magnesium differ from the alkaline earths, and so on.

With the exception of a few of the rare earths, all of the elements which form colored ions are found in the center of the fourth, fifth and sixth periods, the so-called transition elements; this is of importance in the colorimetric determination of these elements.

The relations between atomic structure, electron configuration and the periodic table will be found extensively treated in such books as Sidgwick's *Electronic Theory of Valency*, Oxford University Press, 1929.

PERIODIC GROUP I

This group comprises the alkali metals, lithium, sodium, potassium, rubidium, and cesium and the currency metals, copper, silver, and gold. There is little similarity between these subgroups other than that their members both exhibit the valence of 1. The early members of the group, lithium and sodium, are distinctly alkali metals.

The alkali metals are divided into two groups, lithium and sodium in one, and potassium, rubidium, and cesium in the other. This was discussed in connection with the determination of alkali metals, p. 252, and the important characteristics of the group with respect to the analytical chemistry of these elements will be found there.

The currency metals, copper, silver, and gold, occur in the native state and the stability of these metals is responsible for their use in coinage and for the designation given the group. The currency metals all exhibit a valence of 1, but this is the common valence state only in the case of silver. Stable univalent compounds of copper and gold are known only as insoluble normal salts or soluble complex compounds, their soluble normal salts rapidly decomposing according to the reactions



The common valence state of copper is 2 and that of gold 3. A number of stable bivalent silver compounds have been prepared but the higher valence state of silver is important in analytical chemistry only because of its catalytic action in oxidations with persulfate.

The solubilities of the salts of the univalent metals are very similar, for example, the insolubility of the halides and thiocyanates. The ions of the currency elements form a number of very stable complex ions: with ammonia, $\text{Cu}(\text{NH}_3)_4^{++}$, $\text{Ag}(\text{NH}_3)_2^+$; with cyanide, $\text{Ag}(\text{CN})_2^-$, $\text{Cu}(\text{CN})_3^{--}$, $\text{Au}(\text{CN})_4^-$, $\text{Au}(\text{CN})_2^-$; and with excess of halide, CuCl_4^{--} , CuBr_4^{--} (in part), AgCl_2^- , AgBr_2^- (in part), and AuCl_4^- . The currency metals are all weak bases, aurous hydroxide, AuOH , being the weakest.

The mercurous ion, Hg_2^{++} , is similar to the corresponding ions of this group in many respects.

THE DETERMINATION OF THE ALKALI METALS

The determination of the alkali metals is discussed on p. 252.

THE DETERMINATION OF THE CURRENCY METALS

THE DETERMINATION OF COPPER

Copper occurs naturally as native copper, as the oxide mineral cuprite, Cu_2O , as basic carbonates, malachite and azurite, and as a number of sulfide minerals, chalcocite, chalcopyrite, tetrahedrite, and bornite. The widespread use of copper in electrical equipment, numerous non-ferrous alloys, and coinage metal make its determination quite a common one. Copper is added to steel to increase its resistance to corrosion. Generally the copper in steel will not exceed 1 per cent, but in cast iron may run as high as 5 per cent.

SEPARATION AND GRAVIMETRIC DETERMINATION

The electrolytic deposition of copper was discussed in Willard and Furman, 3rd Ed., pp. 443-446, and the factors influencing the character of the deposit, the composition of the electrolyte, and the manipulative technic were treated extensively there. Electrodeposition yields a deposit of metallic copper which is eminently suited for weighing, and indeed electrodeposition is the best method for the gravimetric determination of copper. The electrodeposition method, however, is not a separation of copper from silver, arsenic, antimony, bismuth, tin, selenium, and tellurium, and chloride solutions can be used only when a suitable anodic depolarizer is present in the solution.¹ Copper and silver can be separated electrolytically by deposition of the latter from a suitable complex ion, see p. 286. Copper may also be separated from antimony and arsenic by electrodeposition; an ammoniacal solution containing fluoride is used, and the antimony and arsenic are first oxidized to the quinquivalent condition by means of persulfate.² The separation of copper from large amounts of iron may be accomplished by electrodeposi-

¹For a discussion of the electrodeposition of copper using controlled cathode potential see Engelenberg, *Z. anal. Chem.*, **62**, 257 (1923); Schoch and Brown, *J. Amer. Chem. Soc.*, **38**, 1660 (1916); *Trans. Amer. Electrochem. Soc.*, **22**, 265 (1912); this method permits the separation of copper from tin in a chloride solution, hydroxylamine being used as the anodic depolarizer.

²Furman, *Ind. Eng. Chem., Anal. Ed.*, **3**, 217 (1931).

tion of the copper from a solution containing phosphate or fluoride; the latter materials tie up the iron in stable complex ions in which form they do not adversely affect the copper deposit. This is particularly useful for the determination of copper in steel.⁸

One of the most useful separations of copper is the precipitation as cuprous thiocyanate:

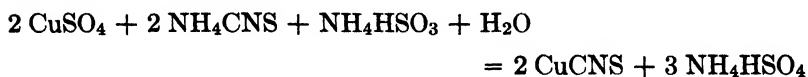

The conditions for this separation and the errors and interferences involved are given in Willard and Furman, 3rd Ed., pp. 446-449. Silver, mercury, selenium, tellurium, and the precious metals interfere. The thiocyanate can be dried at 105° and weighed as such, but it is better ignited to the oxide for weighing or determined by one of the volumetric methods mentioned later.

Copper may be precipitated as cupric sulfide by hydrogen sulfide from solutions containing hydrochloric acid as concentrated as 4 *N*; it may also be precipitated as cuprous sulfide by boiling a dilute sulfuric acid solution containing thiosulfate, the latter procedure giving a sharper separation from other metals. These methods serve to separate copper from all the metals except those of the acid hydrogen sulfide group. The precipitate from either method may be ignited at a faint red heat in a current of hydrogen or carbon dioxide and weighed as cuprous sulfide, although it is much better to conclude the determination by depositing the copper electrolytically. If reduction to metal occurs during the ignition, as it often does, a little sulfur is added and the ignition repeated. Small amounts of copper sulfide may be ignited to cupric oxide for weighing.

Molybdenum if present accompanies copper when the latter is precipitated as the sulfide. Two methods are available for separating these two elements from each other after ignition of the sulfides and solution of the oxide residuc. Treatment with sodium hydroxide in slight excess will precipitate the copper but leave the molybdenum in solution as sodium molybdate. A large excess of sodium hydroxide must be avoided or the precipitation of copper will be incomplete.

The second method utilizes the precipitation of copper with α -benzoinoxime from a solution containing excess ammonia. Mo-

⁸ Frediani and Hale, *Ind. Eng. Chem., Anal. Ed.*, **12**, 736 (1940); see also Silverman, Goodman and Walter, *ibid.*, **14**, 236 (1942).

lybdenum is quantitatively precipitated in acid solution by α -benzoinoxime but not at all precipitated in ammoniacal solution.⁴ The copper benzoinoxime may be ignited to the oxide for weighing, or the organic material destroyed by nitric acid plus perchloric acid and the copper determined electrolytically.⁵ Volumetric methods based on the determination of the hydroxylamine derived from the precipitate have also been devised.⁶ In ammoniacal solution containing tartrate, copper is quantitatively separated from cobalt, nickel, lead, iron, and aluminum. The separation is not satisfactory from large amounts of iron.

By precipitation from an acetic acid solution with a large excess of cupferron, copper may be separated from cadmium, zinc, antimony, and arsenic.⁷

VOLUMETRIC DETERMINATION

The volumetric methods most used for the determination of copper are the iodide, thiocyanate, and cyanide methods.

The iodide method is based upon the reactions:

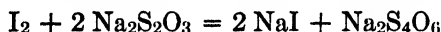

The determination is usually carried out in an acetic acid solution although dilute mineral acids are satisfactory.⁸ Iron, arsenic, and antimony, which are commonly associated with copper in its ores, when in their higher valence states also liberate iodine from an iodide. Iron may be converted into the ferric fluoride complex, FeF_6^{--} , in which the concentration of ferric ion is so low that it has no oxidizing action on an iodide. Arsenic and antimonie compounds do not oxidize iodide in a solution having $p\text{H}$ of 3.5 or more, whereas the reduction of copper is complete even in a solution having a $p\text{H}$ of 5.5. An extensive study of these relations was made by Park,⁹ who recommended the use of a phthalate buffer to obtain the

⁴ Kar, *Ind. Eng. Chem., Anal. Ed.*, **7**, 193 (1935).

⁵ Silverman, *Ind. Eng. Chem., Anal. Ed.*, **12**, 343 (1940).

⁶ Mironoff, *Bull. Soc. Chim. Belg.*, **45**, 1 (1936); Furman and Flagg, *Ind. Eng. Chem., Anal. Ed.*, **12**, 738 (1940).

⁷ Hanus and Soukup, *Z. anorg. Chem.*, **68**, 52 (1910); Tscherviakov and Ostramow, *Ann. Chim. anal.*, [3], **18**, 201 (1936).

⁸ Whitehead and Miller, *Ind. Eng. Chem., Anal. Ed.*, **5**, 15 (1933).

⁹ Park, *Ind. Eng. Chem., Anal. Ed.*, **3**, 77 (1931).

proper pH value. Hydrofluoric acid and bifluoride, however, also act as a buffer, giving the solution the pH desired so that the addition of phthalate is unnecessary.¹⁰ The addition of potassium thiocyanate near the end-point of the titration prevents the adsorption of iodine by the precipitate and makes the end-point much sharper.¹¹ Not more than 0.3 g. of iron may be present which excludes this method for the determination of copper in ore or steel. The amount of antimony present should not exceed 20 mg., nor the amounts of aluminum or calcium 0.3 g., as otherwise insoluble fluorides are formed which carry down some copper.¹²

As mentioned previously, the precipitate of cuprous thiocyanate may be determined volumetrically. Either permanganate or iodate¹³ may be used as the standard oxidizing agent, but with the former an empirical factor is used:

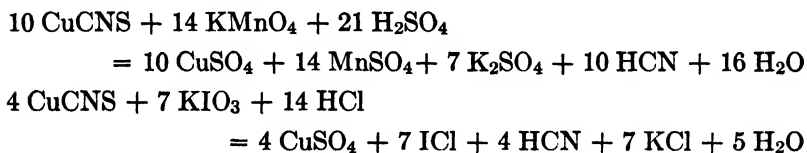

Excess iodate is always added and a back titration with thiosulfate made:



or the equivalent:

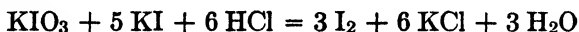

and finally:

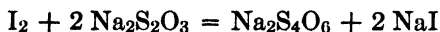

The equivalent weight of copper in these reactions is one-seventh of the atomic weight of copper. The determination may also be made by titrating the excess thiocyanate with iodate¹⁴ or with silver nitrate.¹⁵

¹⁰ Crowell, Hillis, Rittenberg and Evenson, *Ind. Eng. Chem., Anal. Ed.*, **8**, 9 (1936); Crowell, Silver and Spiher, *ibid.*, **10**, 80 (1938).

¹¹ Foote and Vance, *J. Amer. Chem. Soc.*, **57**, 845 (1935); *Ind. Eng. Chem., Anal. Ed.*, **8**, 119 (1936); *ibid.*, **9**, 205 (1937); Foote, *J. Amer. Chem. Soc.*, **60**, 1349 (1938).

¹² Crowell and Spiher, *Ind. Eng. Chem., Anal. Ed.*, **12**, 147 (1940).

¹³ Chemists of the United States Steel Corporation, *Sampling and Analysis of Carbon and Alloy Steels*, Reinhold Publishing Corp., New York, 1938, p. 120.

¹⁴ Hope and Ross, *Ind. Eng. Chem., Anal. Ed.*, **6**, 316 (1934).

¹⁵ Edgar, *J. Amer. Chem. Soc.*, **33**, 884 (1916).

The cyanide method for the volumetric determination of copper depends upon the formation of a complex cyanide of univalent copper when potassium cyanide is added to the blue, ammoniacal solution:

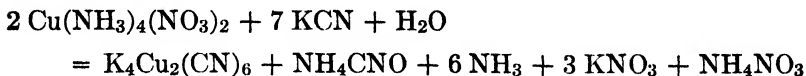

The end-point is the disappearance of the blue, copper ammonia color. In this reaction, one molecule of the cyanide acts as a reducing agent and is oxidized to a cyanate, one molecule of cyanide reducing two atoms of copper. The method is highly empirical.

COLORIMETRIC DETERMINATION

A great number of colorimetric methods for the determination of copper may be found in the literature. Of these methods, a few have been studied adequately, and the precise conditions and interfering substances are now well known.

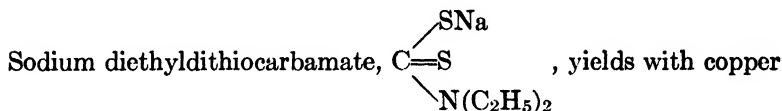

in acid, ammoniacal, or neutral solution, a golden brown color which is satisfactory for amounts of copper up to 0.1 mg. Silver, lead, mercury, cadmium, antimony, tin, aluminum, and zinc give white turbidities, and bismuth, iron, manganese, nickel, and cobalt give colored compounds with the reagent. An excellent summary of the rather extensive investigations which have been made of this method may be found in *Organic Reagents for Metals*.¹⁶

Rubeanic acid (dithiooxamide), $[\text{C}(=\text{S})\text{NH}_2]_2$, yields an olive green color with copper, supplying a very sensitive and reliable method for the colorimetric determination of copper.¹⁷ The determination is best carried out at a pH of about 4 with a little gum arabic present to stabilize the system. Small amounts of iron do not interfere if citric acid is present. Manganese and zinc do not interfere but cobalt and nickel give colors with the reagent.

¹⁶ Hopkin and Williams, 3rd Ed., London, 1938, p. 120.

¹⁷ Unpublished work by H. H. Willard. For the applications of rubeanic acid to qualitative analysis, see Feigl-Matthews, *Spot Tests*, Nordemann Publishing Company, Inc., New York, 1937, p. 46.

THE DETERMINATION OF SILVER

Silver occurs naturally as the metal, frequently associated with native gold and copper; it also occurs as the sulfide, arsenide, telluride, and chloride. Commercially it may be encountered in coinage, jewelry, photographic materials, electrical equipment, certain pharmaceutical products, and alloys.

SEPARATION AND GRAVIMETRIC DETERMINATION

By precipitation as the chloride from dilute nitric acid solution, silver may be separated quantitatively from all metals but bismuth, large amounts of lead, and the univalent ions of mercury, copper, and thallium. The interference of the latter three elements is easily eliminated by preliminary oxidation of the metals to their higher valence states. Reprecipitation will eliminate any lead or bismuth accompanying silver chloride. A much better separation of silver from lead may be made by precipitating the lead as phosphate from an ammoniacal solution containing tartrate.¹⁸

The solubility of silver chloride, the effect of light upon it, and the technic of handling silver chloride precipitates are described in Willard and Furman, 3rd Ed., pp. 317-321. The more refined technic used in atomic weight work is discussed in this book, p. 409.

The dehydration of silica in the presence of silver should be made with nitric acid plus sulfuric acid or with perchloric acid; if the hydrochloric acid dehydration were used, silver chloride would accompany the silica and probably be reduced on ignition with the filter paper and the silver would then alloy with the platinum of the crucible. When a precipitate of silver chloride and silica is obtained, as in the analysis of a material for gold and silver, it may be filtered on paper and a separation effected by decomposing the silver chloride with a mixture of sulfuric acid and fuming nitric acid.¹⁹

When deposited electrolytically from an acid solution, silver tends to form large, dendritic, loosely adherent crystal growths unsuitable for quantitative work, and a separation from copper is practically impossible in such a solution. Deposited from an alkali cyanide or an ammoniacal solution, it forms a smooth, satisfactory,

¹⁸ Vortmann and Hect, *Z. anal. Chem.*, **67**, 276 (1925).

¹⁹ Seath and Beamish, *Ind. Eng. Chem., Anal. Ed.*, **9**, 373 (1937).

white plate. A sharp separation of silver from copper may be obtained using an ammoniacal solution and this appears to be of value in the rapid analysis of silver-copper solders.²⁰

VOLUMETRIC DETERMINATION

Silver is usually titrated with a standard thiocyanate solution in the presence of a ferric salt as indicator, the excess thiocyanate giving the brownish red color of the soluble ferric thiocyanate ion, Willard and Furman, 3rd Ed., p. 185. It may also be titrated with standard potassium iodide solution using gum arabic or soluble starch to prevent the silver iodide from coagulating and adsorbing silver or iodide ions. A palladous salt added to the solution yields dark brown palladous iodide,²¹ PdI_2 , with the first excess of iodide and marks the end-point. The end-point may also be found by the addition of starch and an oxidizing agent such as nitrite²² or ceric ammonium sulfate; ²³ free iodine is liberated at the end-point, producing a blue color with the starch. Both of these end-points are sharper than that of the thiocyanate method.

COLORIMETRIC DETERMINATION

Silver may be determined colorimetrically by *p*-dimethylamino-benzalrhodanine with which it gives a red, soluble salt. This is an extremely sensitive qualitative test and may be used to determine silver in the concentration range of 0.06-9 mg. per liter.²⁴ Univalent copper and mercury interfere.²⁵

THE DETERMINATION OF GOLD

In nature gold is found in the native state usually associated with copper, silver, and the platinum metals. It also occurs as the telluride, AuTe_2 . The principal uses of gold are in coinage, jewelry, and dental alloys.

²⁰ Miller, *Ind. Eng. Chem., Anal. Ed.*, **8**, 431 (1936).

²¹ Schneider, *J. Amer. Chem. Soc.*, **40**, 583 (1918).

²² McLean and Van Slyke, *J. Amer. Chem. Soc.*, **37**, 1128 (1915); McCracken and Walsh, *ibid.*, **39**, 2501 (1917).

²³ Bloom and McNabb, *Ind. Eng. Chem., Anal. Ed.*, **8**, 167 (1936).

²⁴ Feigl, *Z. anal. Chem.*, **74**, 380 (1928); Schoonover, *J. Research Nat. Bur. Standards*, **15**, 377 (1935).

²⁵ Kolthoff, *J. Amer. Chem. Soc.*, **52**, 2222 (1930).

GENERAL CHEMISTRY

Two series of gold salts are known, in which gold assumes the valences of 1 and 3. Aurous salts decompose rapidly into metallic gold and auric salts, unless tied up in complex ions. Oxygen acid salts of gold in either valence state are practically unknown.

Metallic gold dissolves in cyanide solutions in the presence of air giving the ion $\text{Au}(\text{CN})_2^-$ and a complex ion of trivalent gold, $\text{Au}(\text{CN})_4^-$, is also known. Both chlorides are soluble in excess hydrochloric acid forming chloraurous acid, HAuCl_2 , and chlorauric acid, HAuCl_4 .

All gold salts are easily reduced to metallic gold, a variety of inorganic and organic reducing agents being capable of effecting the reduction.

Detection and Identification. Gold is usually detected in ores by physical examination or by fire assay. In the wet method of analysis, the gold is dissolved in aqua regia and, after separation of silica and insoluble chlorides, is precipitated as the metal by the action of reducing agents. Depending on the conditions, colloidal gold in a variety of colors is formed on reduction, the classical case being the *Purple of Cassius* resulting when stannous chloride is used as the reducing agent. If not removed at this point in the analysis, gold is precipitated with the acid hydrogen sulfide metals, is dissolved in ammonium polysulfide, reprecipitated with arsenic pentasulfide by hydrochloric acid, and finally separated from the latter by nitric acid.

SEPARATION AND GRAVIMETRIC DETERMINATION

Gold is always separated and determined in its ores in the dry way by fire assay. The wet methods for gold have recently attracted more attention, particularly in connection with those problems where the gold is accompanied by the platinum metals. In the wet methods the gold is separated by reduction to metal. Ferrous sulfate, sulfur dioxide, and oxalic acid have been used for this purpose; ferrous sulfate complicates the analysis by the introduction of iron, sulfur dioxide precipitates in part any platinum or palladium present, and oxalic acid is slow in action and yields a fine precipitate which makes filtering difficult and uncertain. Hydroquinone is probably the best reducing agent for this purpose; it yields a precipitate which is easily handled, and gives a sharp separation of gold from the platinum metals and from copper, nickel, and zinc.

Moreover, palladium can be determined directly in the filtrate by dimethylglyoxime, and platinum subsequently by reduction with sodium formate.²⁶

The separation of gold from tellurium is occasionally necessary because of the occurrence of gold as the telluride. Nitrous acid or ferrous sulfate may be used,²⁷ but the conditions must be closely controlled. The hydroquinone reduction is less subject to limitations and gives a sharp separation of gold from tellurium and selenium.²⁸

The gold in a cyanide solution is precipitated by direct treatment with sulfuric acid and heating; the addition of a little silver has a pronounced effect on coagulating the colloidal gold.²⁹

A method for the recovery of minute amounts of gold by collection on a precipitate of mercury and mercurous chloride formed by treating the solution with mercuric chloride, metallic magnesium, and hydrochloric acid has been described.³⁰ They conclude the determination by assay methods. Silver is recovered also by this method. The same technic can be applied to cyanide leach solutions by first converting the cyanide to ferrocyanide by the addition of ferrous sulfate.³¹

Gold is always weighed as the metal. No special precautions are necessary in its ignition other than that it must not be done in platinum.

VOLUMETRIC DETERMINATION

Gold may be determined volumetrically by titrating with a standard reducing agent, the gold being reduced from the trivalent state to the metal. Various metals interfere depending on the reducing agent used. This subject has received some study recently.³² The determination may also be made by an indirect iodometric method.³³

²⁶ Beamish, Russell and Seath, *Ind. Eng. Chem., Anal. Ed.*, **9**, 174 (1937).

²⁷ Lehner, Smith and Knowles, *Ind. Eng. Chem., Anal. Ed.*, **6**, 43 (1934).

²⁸ Seath and Beamish, *Ind. Eng. Chem., Anal. Ed.*, **9**, 373 (1937).

²⁹ Kushner, *Ind. Eng. Chem., Anal. Ed.*, **10**, 641 (1938).

³⁰ Caldwell and McLeod, *Ind. Eng. Chem., Anal. Ed.*, **9**, 530 (1937).

³¹ Caldwell and Smith, *Ind. Eng. Chem., Anal. Ed.*, **10**, 318 (1938).

³² Zintl, *Z. Electrochem.*, **36**, 551 (1930); Müller and Bennewitz, *Z. anorg. allgem. Chem.*, **179**, 113 (1929); Müller and Tänzler, *Z. anal. Chem.*, **89**, 339 (1932).

³³ Herschlag, *Ind. Eng. Chem., Anal. Ed.*, **13**, 561 (1941).

COLORIMETRIC DETERMINATION

The usual colorimetric methods for gold involve reduction to colloidal metallic gold with one of a number of reducing agents and comparison with standards similarly prepared. A mixture of potassium mercuric iodide, K_2HgI_4 , and potassium iodide is an excellent reducing agent for the purpose.³⁴ The conditions for carrying out the reduction with stannous chloride have also been well worked out.³⁵

PERIODIC GROUP II

The members of this group are beryllium and magnesium, the alkaline earths, calcium, strontium, barium, radium, and the members of the B subgroup, zinc, cadmium, and mercury. From the viewpoint of atomic structure beryllium and magnesium should be classed with the A subgroup, that is, with the alkaline earths which they resemble strongly. The alkaline earths, however, form a distinct subgroup; they are very similar in properties and reactions, and are separated from each other only with some difficulty. They may be separated from beryllium and magnesium with much less trouble. The metals of the subgroup, zinc, mercury, and cadmium, resemble the neighboring transition metals, although their ions are colorless. Their salts are much less highly ionized than those of the alkali or alkaline earth metals, and they have a great tendency to form complex ions with the halogens.

The metals of group II are all bivalent with the exception of mercury which also exhibits a stable valence of 1. The mercurous ion has the curious aggregation Hg_2^{++} , and resembles the univalent ions of the subgroup of periodic group I, copper, silver, and gold. There is some evidence for a valence of 1 among the other elements; univalent cadmium compounds are known and magnesium monoiodide, MgI , plays a role in organic reduction reactions.

The gradation in properties among the alkaline earths is particularly striking. The solubilities of the sulfates decrease while those of the oxalates increase with rising atomic weight; thus, radium forms the least soluble sulfate and calcium the most soluble sulfate, but calcium the least soluble oxalate and radium the most soluble. The order of the solubilities of the chromates and car-

³⁴ Nider, *Kolloid Z.*, **44**, 139 (1938).

³⁵ Fink and Putnam, *Ind. Eng. Chem., Anal. Ed.*, **14**, 468 (1942).

bonates follows that of the sulfates except that strontium carbonate is less soluble than barium carbonate. Radium hydroxide is the most soluble of the hydroxides. In general, the solubilities of the halides of the alkaline earths increase with increasing weight of the halogens and decrease with increasing weight of the metal.

The alkaline earth group as a whole is separated from magnesium and the alkali metals by ammonium carbonate in the presence of ammonium salts. Separation within the group is more difficult, particularly in the case of calcium and strontium. Radium is separated from barium by fractional crystallization of the halides or chromates.

The alkaline earths are all strong bases. Beryllium, magnesium, and the members of the B subgroup are weak bases. The members of the B subgroup form insoluble sulfides in contrast to the other elements whose sulfides are soluble or unstable in water.

Beryllium and zinc are amphoteric although beryllates are not very stable. The metals of the B subgroup form complex halides increasing in stability with atomic weight, the HgI_4^{--} ion being the most stable. Beryllium, magnesium, zinc, and cadmium form double ammonium phosphates which are important in analysis.

THE DETERMINATION OF BERYLLIUM

Beryllium occurs naturally in certain complex silicates and aluminates, the most important mineral being beryl, $3\text{BeO}\cdot\text{Al}_2\text{O}_3\cdot 6\text{SiO}_2$. The metal is finding rapidly increasing use in copper alloys, amounts of beryllium up to about 3 per cent having a highly beneficial effect on the mechanical properties of the alloy.

GENERAL CHEMISTRY

Beryllium is always bivalent but unlike magnesium and the alkaline earths is amphoteric, its hydroxide dissolving in excess alkali forming the beryllate ion, HBeO_2^- . Solutions of beryllates are completely hydrolyzed on boiling, forming beryllium hydroxide, $\text{Be}(\text{OH})_2$.

Beryllium hydroxide is precipitated by ammonia and in analytical procedures beryllium thus accompanies aluminum, from which it can be separated by methods given in the next section.

Beryllium forms lakes with various organic dyestuffs such as aluminon, curcumin, and quinalizarin, which can be used for de-

tecting beryllium; aluminum interferes with the aluminon and curcumin tests but not with the quinalizarin test. The yellow-green fluorescence which morin gives with beryllium appears to be a quite specific and a very sensitive test for beryllium.¹

SEPARATION AND GRAVIMETRIC DETERMINATION

The principal separation of beryllium is from aluminum and iron. This is best accomplished by precipitating the aluminum and iron with 8-hydroxyquinoline from an acetic acid solution containing ammonium acetate. The beryllium in the filtrate is then precipitated with ammonia. It is not necessary to destroy the excess 8-hydroxyquinoline before making the precipitation with ammonia.²

The separation of beryllium from aluminum can also be made less sharply and conveniently by several other methods. The precipitation of beryllium hydroxide on boiling a diluted solution of an alkali beryllate separates beryllium from aluminum and those metals forming stable alkali metal salts; this method yields good results if the beryllium is in excess of the aluminum.³

In a hot, fairly concentrated bicarbonate solution beryllium forms a soluble double carbonate while iron and aluminum are precipitated as hydroxides.⁴

Beryllium is precipitated as the hydroxide by ammonia, washed with dilute ammonium nitrate solution, and ignited to the oxide, BeO, for weighing.

Beryllium may be precipitated as the double ammonium phosphate, BeNH_4PO_4 , and ignited to the pyrophosphate, $\text{Be}_2\text{P}_2\text{O}_7$, for weighing, but the precipitate contains a slight excess of phosphorus pentoxide necessitating the use of an empirical conversion factor.⁵

¹ Sandell, *Ind. Eng. Chem., Anal. Ed.*, **12**, 762 (1940); see also White and Lowe, *ibid.*, **13**, 809 (1941).

² Kolthoff and Sandell, *J. Amer. Chem. Soc.*, **50**, 1900 (1928); Lundell and Knowles, *Bur. Standards J. Research*, **3**, 91 (1929); Niessner, *Z. anal. Chem.*, **76**, 135 (1929); Knowles, *J. Research Nat. Bur. Standards*, **15**, 87 (1935).

³ Dewar and Gardiner, *Analyst*, **61**, 536 (1936).

⁴ See also Churchill, Bridges and Lee, *Ind. Eng. Chem., Anal. Ed.*, **2**, 405 (1930); Hills, *ibid.*, **4**, 31 (1932).

⁵ Ruff and Stephen, *Z. anorg. allgem. Chem.*, **185**, 217 (1929).

VOLUMETRIC AND COLORIMETRIC DETERMINATION

A volumetric method has been proposed for beryllium based on the acid required to dissolve its hydroxide.⁶ The beryllium must obviously be first separated from other elements.

A colorimetric titration of beryllium in alkaline solution with an alkaline solution of quinalizarine, 1,2,5,8-tetrahydroxyanthraquinone, has been described. The method appears to be satisfactory in the presence of large amounts of aluminum.⁷

THE DETERMINATION OF MAGNESIUM

Magnesium constitutes about two per cent of the lithosphere and occurs naturally as a variety of derivatives of oxygen acids, the principal minerals being magnesite, $MgCO_3$; dolomite, $CaMg(CO_3)_2$; epsomite, $MgSO_4 \cdot 7H_2O$; spinel, $Mg(AlO_2)_2$; talc, $H_2Mg_3(SiO_3)_4$; and a number of other silicates of which magnesium is a major constituent. Magnesium alloys, particularly those with aluminum, are finding extensive applications in the light alloy field; magnesium salts and compounds are widely used for a variety of industrial purposes.

SEPARATION AND GRAVIMETRIC DETERMINATION

Magnesium ammonium phosphate, $MgNH_4PO_4$, is ignited to the pyrophosphate, $Mg_2P_2O_7$, for weighing. As all metals but the alkalis and ammonium form phosphates insoluble in neutral and usually in ammoniacal solutions, all of the metals must be separated before magnesium can be determined. The determination of magnesium as the phosphate is subject to a number of errors; these have been thoroughly discussed in Willard and Furman, 3rd Ed., pp. 328-334; see also Hoffman and Lundell.⁸

The precipitation of magnesium ammonium phosphate may be made in the presence of small amounts of iron and aluminum if tartaric acid or citric acid is added to keep these metals in solution. This is important in speeding up the determination of magnesium in aluminum alloys following the solution of the sample in sodium hydroxide which leaves a residue of metallic magnesium containing a small amount of iron and aluminum; the residue can then be dis-

⁶ Evans, *Analyst*, **60**, 291 (1935).

⁷ Fischer, *Z. anal. Chem.*, **73**, 54 (1928).

⁸ Hoffman and Lundell, *Bur. Standards J. Research*, **5**, 279 (1930).

solved in acid and the magnesium determined without preliminary separation of the hydroxides.⁹ Again, this is of importance in the analysis of phosphate rock following removal of the calcium from the sample by precipitation as calcium sulfate by alcohol. The small amounts of iron and aluminum present are not precipitated by the alcohol and since they may be present when the magnesium is precipitated, the extra operation of their removal is avoided.¹⁰

Magnesium is precipitated from an ammoniacal solution by 8-hydroxyquinoline and may be determined volumetrically by titration of the 8-hydroxyquinoline in the precipitate with a bromate-bromide mixture. This method is not a separation from any metals except the alkalis but is somewhat faster than the routine gravimetric phosphate method. The determination can be speeded up even more by precipitating the magnesium in the solution immediately after precipitating calcium oxalate. The precipitates are filtered off together, dissolved in hydrochloric acid and the 8-hydroxyquinoline titrated. The calcium oxalate does not interfere and the results are sufficiently accurate for routine analysis of Portland cement.¹¹

VOLUMETRIC AND COLORIMETRIC DETERMINATION

Magnesium 8-hydroxyquinoline may be dissolved in hydrochloric acid, treated with an excess of a standard bromate-bromide mixture, potassium iodide added, and the liberated iodine titrated with thiosulfate. The equivalent weight is Mg/8. See the section devoted to 8-hydroxyquinoline and its volumetric determination, pp. 74 and 80. It is possible also to dissolve the precipitate of magnesium 8-hydroxyquinoline and titrate with ammonium hexanitratocerate;¹² some 59.7 equivalents of oxidizing agent are used per magnesium and the results appear quite satisfactory.

The colorimetric methods for the determination of magnesium are in general not very satisfactory although several have been proposed, for example, using titan yellow.¹³

⁹ Singer, *Ind. Eng. Chem., Anal. Ed.*, **2**, 288 (1930).

¹⁰ Hoffman, *Bur. Standards J. Research*, **9**, 487 (1932).

¹¹ Redmond and Bright, *Bur. Standards J. Research*, **6**, 113 (1931); Redmond, *ibid.*, **10**, 823 (1933).

¹² Nielsen, *Ind. Eng. Chem., Anal. Ed.*, **11**, 649 (1939).

¹³ Gillam, *Ind. Eng. Chem., Anal. Ed.*, **13**, 499 (1941); Ludwig and Johnson, *ibid.*, **14**, 895 (1942).

THE DETERMINATION OF CALCIUM

Calcium is the fifth most abundant element of the earth and occurs generally in combination with oxygen acids. Calcium carbonate occurs as limestone, marble, calcite, and a variety of other forms; calcium sulfate occurs as gypsum, $\text{CaSO}_4 \cdot 2\text{H}_2\text{O}$, calcium fluoride as fluorspar, CaF_2 , calcium phosphate as phosphate rock, $\text{Ca}_5\text{F}(\text{PO}_4)_3$; all of these minerals are important industrially. Calcium plays an essential role in animal and vegetable life and enters into a variety of commercial materials. The determination of calcium is thus a matter of great importance.

A convenient test¹⁴ for calcium in the presence of strontium and barium is based on the precipitation of calcium hydroxide in boiling water at which temperature calcium hydroxide is least soluble but at which the other hydroxides are most soluble. Alkali free from carbonate is produced in the solution by the action of potassium iodide on mercuric oxide:

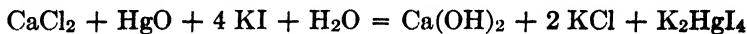

A large excess of potassium iodide should be used.

SEPARATION AND GRAVIMETRIC DETERMINATION

Calcium can be separated as the oxalate from magnesium and the alkali metals, see Willard and Furman, 3rd Ed., pp. 339-344. When a reprecipitation of the calcium oxalate is made the method gives satisfactory results if the ratio of magnesium to calcium is not too great. The method is not well adapted, however, to the separation of small amounts of calcium in the presence of large amounts of magnesium.

A successful method of attacking the latter problem is the precipitation of calcium sulfate from a 90 per cent methyl alcohol solution. Amounts of calcium up to 0.1 g. can be separated quantitatively from 0.1 g. of magnesium and smaller amounts of calcium can be separated from still larger amounts of magnesium. Small amounts of iron and aluminum do not interfere but large amounts of ammonium and potassium salts must be avoided because of the insolubility of their sulfates in the methanol solution.¹⁵

¹⁴ Caley, *Ind. Eng. Chem., Anal. Ed.*, **6**, 445 (1934).

¹⁵ Caley and Elving, *Ind. Eng. Chem., Anal. Ed.*, **10**, 264 (1938).

The separation of large amounts of calcium from small amounts of magnesium, such as in the analysis of phosphate rock, can be made by precipitating calcium sulfate with ethyl alcohol.¹⁶

The separation of calcium from barium is made by a double precipitation of the latter as barium chromate from a solution containing ammonium acetate; the calcium in the filtrate is then separated as the oxalate and reprecipitated.

Calcium also may be separated from magnesium by precipitating the calcium as the molybdate from slightly acid or slightly alkaline solutions. The excess molybdate does not interfere with the subsequent precipitation of magnesium as the double ammonium phosphate. Single precipitations apparently yield entirely satisfactory results for both calcium and magnesium thus avoiding the reprecipitations necessary when calcium is separated as the oxalate.¹⁷

Large amounts of lead can be separated from the small amounts of calcium in cable alloys by separating the lead as sulfate.¹⁸

Calcium oxalate is ignited to the oxide or, better, to the carbonate for weighing; see Willard and Furman, 3rd Ed., p. 339.

Calcium sulfate and calcium molybdate are ignited to the anhydrous salts for weighing.

VOLUMETRIC DETERMINATION

Calcium may be determined by dissolving the calcium oxalate precipitate in dilute sulfuric acid and titrating the liberated oxalic acid with permanganate. The calcium oxalate is best filtered on an asbestos mat in a Gooch crucible rather than on paper for the permanganate reacts with filter paper.¹⁹

It is necessary to standardize the permanganate solution against a pure calcium compound, conveniently calcium carbonate, carrying out the standardization under the same conditions as in the determination; the use of the normality obtained by standardizing the permanganate against sodium oxalate gives results as much as two per cent low for calcium.²⁰

¹⁶ Hoffman, *Bur. Standards J. Research*, **9**, 487 (1932); Harvey, *Analyst*, **61**, 817 (1936).

¹⁷ Wiley, *Ind. Eng. Chem., Anal. Ed.*, **3**, 127 (1931).

¹⁸ Shaw, Wittemore and Westby, *Ind. Eng. Chem., Anal. Ed.*, **2**, 401 (1930); Clarke and Wooten, *ibid.*, **5**, 313 (1933).

¹⁹ Curtis and Finkelstein, *Ind. Eng. Chem., Anal. Ed.*, **5**, 318 (1933).

²⁰ Private communication from M. G. Mellon; see also Haslam, *Analyst*, **60**, 668 (1935).

No suitable method for the colorimetric determination of calcium is known.

THE DETERMINATION OF STRONTIUM

The principal minerals of strontium are strontianite, SrCO_3 , and celestite, SrSO_4 .

SEPARATION AND GRAVIMETRIC DETERMINATION

The precipitation of strontium as the sulfate or oxalate is quantitative only from solutions containing alcohol to decrease the solubility, 50 per cent alcohol in the case of the sulfate and 80 per cent in the case of the oxalate being necessary. Calcium and barium interfere in these separations.

Barium can be separated from strontium by double precipitation of the chromate from an acetate solution. The strontium in the filtrate is precipitated as the carbonate by ammonia and ammonium carbonate, then redissolved in hydrochloric acid and precipitated as the sulfate, from 50 per cent alcohol.

The separation of calcium and strontium is very difficult. One method is based on the fact that calcium nitrate is soluble in certain organic solvents whereas strontium nitrate is not; amyl alcohol, anhydrous acetone,²¹ butyl cellosolve,²² and a mixture of absolute ethyl alcohol and ether have been proposed as the solvent.

Probably the best separation of strontium from calcium, however, is the precipitation of strontium nitrate from an 80 per cent nitric acid solution, which separates it from calcium and all other metals except barium and lead. The precipitation is carried out by the slow addition of 100 per cent nitric acid to the water solution until the nitric acid concentration is 80 per cent. A reprecipitation is necessary when large amounts of calcium are present.²³

Strontium is best weighed as strontium sulfate, SrSO_4 . The oxalate, however, is usually ignited to the oxide for weighing. The nitrate is dried at 130-140° for two hours and weighed as such.

²¹ Shreve, Watkins and Browning, *Ind. Eng. Chem., Anal. Ed.*, **11**, 215 (1939).

²² Barber, *Ind. Eng. Chem., Anal. Ed.*, **13**, 572 (1941).

²³ Willard and Goodspeed, *Ind. Eng. Chem., Anal. Ed.*, **8**, 414 (1936).

THE DETERMINATION OF BARIUM

Like strontium, the principal minerals of barium are the carbonate, witherite, and the sulfate, barite.

SEPARATION AND GRAVIMETRIC DETERMINATION

Barium is precipitated as the sulfate when the interfering metals, lead, strontium, and calcium, are absent. When precipitated as the sulfate, the precipitate is ignited directly for weighing, care being taken to avoid reduction by filter paper or flame gases during the ignition. Lead sulfate present in the barium sulfate precipitate may be removed by solution in ammonium acetate solution; see lead, p. 333.

The most satisfactory method of separating barium from calcium and strontium is a double precipitation of barium chromate from a slightly acid solution containing ammonium acetate. The barium chromate is finally ignited at a low red heat and weighed as such. Small amounts of barium chromate may be dissolved in hydrochloric acid and the determination concluded colorimetrically.²⁴

Barium may be titrated with sulfate, the end-point being determined with rhodizonic acid or tetrahydroxyquinone which form red, insoluble barium salts. Barium sulfate is less soluble than barium rhodizonate and the disappearance of the red color of the latter marks the end-point. The method is subject to a number of factors which are discussed in connection with the volumetric determination of sulfate, p. 362.

The analysis of barium sulfate presents some problems. It can be converted to barium carbonate by fusion with sodium carbonate and extracting the sodium sulfate produced with water. A second fusion is necessary for highly precise work. The same conversion can be made in aqueous solution by boiling with fifteen times the theoretical amount of sodium carbonate; the conversion is about 99.5 per cent complete and accurate enough for certain commercial analyses, such as the determination of sulfur in rubber in which it may be present as barium sulfate.²⁵

²⁴ Frediani and Babler, *Ind. Eng. Chem., Anal. Ed.*, **11**, 487 (1939).

²⁵ Wolessensky, *Ind. Eng. Chem., Anal. Ed.*, **1**, 29 (1929).

THE DETERMINATION OF ZINC

The commercial sources of zinc are almost entirely sulfide ores, sphalerite, ZnS , being the principal mineral. Other minerals of lesser importance are: zincite, ZnO ; smithsonite, ZnCO_3 ; franklinite, $\text{Fe,Mn,Zn(FeO}_2)_2$; hemimorphite, $\text{H}_2\text{Zn}_2\text{SiO}_5$; and willemite, Zn_2SiO_4 . Zinc is used in many alloys, in galvanizing iron, in desilvering lead, in recovering gold, and in the compounding of pigments. Its determination, therefore, is a matter of common concern.

SEPARATION AND GRAVIMETRIC DETERMINATION

The precipitation of zinc as the double ammonium phosphate is satisfactory only in the absence of all metals except the alkalis. A small amount of nickel may be present, however, and if tartrate is present, copper does not interfere. The details of this precipitation are given in Willard and Furman, 3rd Ed., pp. 451-456.

Zinc may be precipitated as the sulfide from a solution in which the $p\text{H}$ is maintained between 2 and 3. Zinc sulfide is not precipitated completely from more acid solutions and is gelatinous and difficult to filter when precipitated from less acid solutions. The proper hydrogen ion concentration can be obtained by a formate-formic acid buffer,²⁶ a sulfate-sulfuric acid buffer,²⁷ a chloracetate-chloroacetic acid buffer,²⁸ or a citrate-citric acid buffer.²⁹ This serves to separate zinc from iron, aluminum, chromium, nickel, and manganese, but not from cobalt. The amount of these metals carried down by the zinc sulfide can be reduced to a negligible amount by the addition of gelatin or agar-agar which causes the zinc sulfide to flocculate rapidly and filter more easily.³⁰ If the precipitation of zinc sulfide is made in the presence of small amounts of certain aldehydes, particularly acrolein, the amount of cobalt carried down is reduced to such an extent that one precipitation gives a satisfactory separation. The separation of small amounts of zinc from large amounts of nickel, as for example, in the determination of

²⁶ Fales and Ware, *J. Amer. Chem. Soc.*, **41**, 487 (1919).

²⁷ Jeffreys and Swift, *ibid.*, **54**, 3219 (1932).

²⁸ Mayr, *Z. anal. Chem.*, **96**, 273 (1934).

²⁹ Hills, *Ind. Eng. Chem., Anal. Ed.*, **5**, 201 (1933); Coleman and Smith, *ibid.*, **13**, 377 (1941).

³⁰ Caldwell and Moyer, *J. Amer. Chem. Soc.*, **57**, 2372, 2375 (1935).

zinc impurities in metallic nickel, cannot be made by the usual sulfide precipitation. Evans³¹ found that the precipitation could be made from a cyanide solution slightly acid with acetic acid and a clean separation from nickel obtained.

Zinc may be precipitated as zinc mercuric thiocyanate $\text{ZnHg}(\text{CNS})_4$, but a recent study of this method indicates that it is not entirely satisfactory.³² The method has been used for estimating the amount of zinc in cadmium by matching the color and abundance of the precipitate with standards.³³

Zinc may be deposited electrolytically, but the conditions for quantitative deposition are critical and the results are usually disappointing. Various types of electrolytes have been suggested, for example, a strong sodium hydroxide solution from which all traces of nitrates must be absent,³⁴ and another having a definite concentration of citric acid and a pH between 4 and 5.³⁵ Many metals interfere.

The determination of very small amounts of zinc has received considerable study. Methods have been devised for the determination of zinc in iron and steel³⁶ involving the prior separation of the interfering elements, for the determination of zinc in soil³⁷ based on the measurement of a turbidity of zinc sulfide, and for the determination of zinc in plant materials and foodstuffs based on a polarographic method³⁸ and on an extraction of zinc dithizonate with immiscible solvents.³⁹ A survey of the literature on this subject will be found in these and other papers.⁴⁰

Zinc ammonium phosphate yields the pyrophosphate, $\text{Zn}_2\text{P}_2\text{O}_7$, on ignition and zinc is best weighed in this form. The sulfide on

³¹ Evans, *Analyst*, **60**, 464 (1935).

³² Vosburg, Cooper, Clayton and Pfann, *Ind. Eng. Chem., Anal. Ed.*, **10**, 393 (1938).

³³ Isbell, *Ind. Eng. Chem., Anal. Ed.*, **4**, 284 (1932); see also *C.A.*, **30**, 7488 (1936).

³⁴ Nickolls and Gaskin, *Analyst*, **59**, 391 (1934).

³⁵ Winchester and Yntema, *Ind. Eng. Chem., Anal. Ed.*, **9**, 254 (1937).

³⁶ Bright, *Bur. Standards J. Research*, **12**, 383 (1934).

³⁷ Boggs and Alben, *Ind. Eng. Chem., Anal. Ed.*, **8**, 97 (1936).

³⁸ Reed and Cummings, *Ind. Eng. Chem., Anal. Ed.*, **12**, 489 (1940).

³⁹ Allport and Moon, *Analyst*, **64**, 395 (1939); Sylvester and Hughes, *Analyst*, **61**, 735 (1936); Cowling and Miller, *Ind. Eng. Chem., Anal. Ed.*, **13**, 145 (1941).

⁴⁰ Pope, *Analyst*, **58**, 30 (1933).

first ignition is converted largely to the sulfate; on ignition at 1000° the sulfate gives the oxide ZnO, a satisfactory form for weighing. Zinc sulfate is also a suitable form for weighing, but the precipitate should be treated once or twice with a little sulfuric acid, the excess sulfuric acid evaporated away gently, and the final ignition made at 400°.

Procedure for the Precipitation of Zinc as Sulfide. Adjust the volume of the zinc solution, which must not contain chlorides or metals of the hydrogen sulfide group, to 200 ml. and add 6-8 g. of ammonium sulfate. Neutralize the solution with ammonia using methyl orange as indicator and then make it just acid by adding dilute sulfuric acid. Pass a rapid stream of hydrogen sulfide through the solution at room temperature for 30 minutes. Add 5-10 ml. of a 0.02 per cent solution of gelatin (ash less than 0.1 per cent) to the solution, stirring rapidly. Allow the precipitate to settle. The precipitate should flocculate immediately. After 15 minutes, filter, washing the precipitate by decantation with water. Transfer the precipitate to a porcelain crucible and dry and burn off the paper at as low a temperature as possible. Finally ignite at 950-1000° and weigh as zinc oxide.

This procedure will separate zinc from nickel, manganese, chromium, aluminum, and iron, but if the latter is present it is best reduced before the treatment with hydrogen sulfide. Sulfur dioxide is bubbled through the solution and the sulfur dioxide removed by a stream of carbon dioxide. This reduction is necessary since the acidity of the solution allows the formation of a small amount of hydrous ferric oxide before the reduction of iron by hydrogen sulfide is complete. In the presence of iron, the zinc sulfide precipitate is washed with water containing hydrogen sulfide.

Cobalt is seriously coprecipitated with zinc sulfide by the above procedure. A satisfactory separation can be made, however, if a small amount of acrolein, 0.20 ml., is present and the precipitation made in the cold as above.

VOLUMETRIC DETERMINATION

The common volumetric determination of zinc is the titration with potassium ferrocyanide:

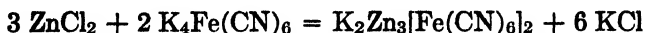

The end-point is determined using uranyl acetate as external indi-

cator, reddish-brown uranyl ferrocyanide, $(\text{UO}_2)_2\text{Fe}(\text{CN})_6$, forming with an excess of ferrocyanide, or diphenylbenzidine may be used as internal indicator, changing from blue to yellowish green on reduction with excess ferrocyanide.⁴¹ The method is empirical, depending on such factors as the temperature, the hydrochloric acid concentration, the amount of ammonium chloride present, the volume of the solution, and the rate of titration. The ferrocyanide solution should, therefore, be standardized against pure zinc in exactly the manner in which the determination is made. The end-point of this titration may also be determined potentiometrically.⁴²

Another very satisfactory method for the volumetric determination of zinc is the iodometric method of Lang^{42a} which takes advantage of the fact that the reaction

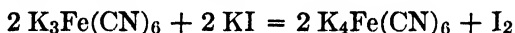

does not proceed to the right in a neutral solution but does so in the presence of zinc owing to the removal of the ferrocyanide by the formation of insoluble potassium zinc ferrocyanide, $\text{K}_2\text{Zn}_3[\text{Fe}(\text{CN})_6]_2$. It is recommended that the titration be carried out by the successive addition of small amounts of a ferricyanide solution followed in each case by the titration of the liberated iodine with thiosulfate. After all of the zinc has been precipitated the solution retains a faint yellow color after the thiosulfate titration of the liberated iodine owing to the presence of the excess ferricyanide. The empirical equivalent weight 99.07 must be used in calculating the results rather than the theoretical value of 98.07 (three halves the atomic weight of zinc); this is probably due to the precipitation of a portion of the zinc as the normal ferrocyanide. Chloride interferes by converting the zinc to a complex ion from which the zinc is not precipitated. Even large amounts of iron do not interfere if fluoride is added, and the titration may be carried out in the presence of copper, cobalt, and nickel if suitable modifications are made. Magnesium, calcium, and aluminum do not interfere. Manganese in more than small amounts interferes.

Another volumetric method which has been proposed utilizes the precipitate of zinc mercuric thiocyanate, which is dissolved in a

⁴¹ For an extensive study of other indicators suitable for this titration, see Tyler, *Ind. Eng. Chem., Anal. Ed.*, **14**, 114 (1942).

⁴² Sturges, *Ind. Eng. Chem., Anal. Ed.*, **11**, 267 (1939).

^{42a} Lang, *Z. anal. Chem.*, **79**, 161 (1930); **93**, 21 (1933).

potassium iodide solution. The mercury is converted to the complex ion HgI_4^{--} , and the excess iodide is then titrated with a standard mercuric nitrate solution. The method is quite empirical but gives acceptable results on fairly large amounts of zinc.⁴³

THE DETERMINATION OF CADMIUM

Cadmium is found in almost all zinc minerals, the ratio of cadmium to zinc being 1 to 300 or 400. The mineral greenockite, CdS , is rather uncommon. The principal uses of cadmium are in electroplating and in pigments.

SEPARATION AND GRAVIMETRIC DETERMINATION

Cadmium may be precipitated as the double ammonium phosphate, but this serves to separate cadmium only from the alkali metals and ammonia.

The most important separation of cadmium is its precipitation as the sulfide. Cadmium may be completely precipitated in the cold by hydrogen sulfide, from a solution containing enough sulfuric acid to make the solution 6 *N*. The acidity need not be so high in separating cadmium from zinc, 3-4 *N* being sufficient.⁴⁴ A second precipitation is usually necessary, particularly if the amount of zinc is large. The separation is very poor in chloride solutions owing to the adsorption of cadmium chloride by the cadmium sulfide.⁴⁵

The electrolytic determination of cadmium is very satisfactory. The electrolyte used is an alkaline solution containing just enough potassium cyanide to keep the cadmium in solution.

A convenient and rapid determination of small amounts of cadmium in zinc can be made by the so-called internal electrolysis method, p. 60, in which the cadmium is plated on a platinum cathode connected by a wire outside of the solution to a zinc anode immersed in a zinc sulfate solution separated from the main solution by a permeable membrane. The zinc simply displaces the cadmium from solution.⁴⁶

The complex iodide ion of cadmium, CdI_4^{--} , yields insoluble

⁴³ Titus and Olsen, *Ind. Eng. Chem., Anal. Ed.*, **12**, 133 (1940).

⁴⁴ Zöllner, *Z. anal. Chem.*, **114**, 8 (1938).

⁴⁵ Weiser and Durham, *J. Phys. Chem.*, **32**, 1061 (1928).

⁴⁶ Sand, *Analyst*, **55**, 309 (1930); Collin, *Analyst*, **55**, 495 (1930); Fife, *Analyst*, **65**, 562 (1940).

salts with a number of organic bases, a reaction which differentiates cadmium from zinc. Brucine⁴⁷ and 8-naphthoquinoline⁴⁸ give precipitates which are insoluble enough to be used quantitatively. Amounts of cadmium up to about 50 mg. may be handled. The determination is usually concluded by determining the iodide in the precipitate by one of the customary volumetric methods.

Cadmium is weighed as the pyrophosphate, $Cd_2P_2O_7$, the sulfate, $CdSO_4$, or as the metal following electrolytic deposition.

The precipitation of cadmium ammonium phosphate is made from neutral solution, just as with zinc, but the precipitation is best made in the cold and the solution allowed to stand until the flocculent phosphate has been converted to the crystalline double phosphate.

Cadmium sulfide is converted to cadmium sulfate for weighing by ignition at low temperature. It is finally treated with a little sulfuric acid and ignited at 400-500° and weighed.

VOLUMETRIC AND COLORIMETRIC DETERMINATION

There is no satisfactory, direct volumetric method for cadmium. Indirectly, cadmium may be determined by precipitating the sulfide, dissolving the sulfide in hydrochloric acid, and titrating the sulfide with iodine.

Small amounts of cadmium on treatment with hydrogen sulfide yield a yellow coloration which is much more intense under ultra-violet light and can be used for the colorimetric determination of amounts of cadmium up to 1 mg.⁴⁹

Dithizone, diphenylthiocarbazon, has been found useful in the colorimetric determination of cadmium,⁵⁰ as well as a great many other metals, see p. 87.

THE DETERMINATION OF MERCURY

Mercury occurs naturally as the sulfide mineral cinnabar, HgS . It finds extensive use in fulminate detonators, pharmaceuticals, and scientific apparatus.

⁴⁷ Thompson, *Ind. Eng. Chem., Anal. Ed.*, **13**, 164 (1941).

⁴⁸ Berg and Wurm, *Ber.*, **60**, 1664 (1927); Pass and Ward, *Analyst*, **58**, 667 (1933).

⁴⁹ Fairhall and Prodan, *J. Amer. Chem. Soc.*, **53**, 1321 (1931).

⁵⁰ Sandell, *Ind. Eng. Chem., Anal. Ed.*, **11**, 364 (1939).

SEPARATION AND GRAVIMETRIC DETERMINATION

Mercuric chloride is appreciably volatilized when its solutions are boiled, and care must be exercised to prevent the loss of mercury in this manner during analysis. The presence of sodium or potassium chloride decreases the volatility somewhat.

Mercurous salts may be precipitated as mercurous chloride, Hg_2Cl_2 ; mercuric salts may be precipitated the same way by the addition of a reducing agent, such as phosphorous acid or hypophosphorous acid, H_3PO_2 , together with hydrogen peroxide to prevent reduction to metallic mercury. It is not advisable to weigh mercurous chloride since it is perceptibly volatile at 100° and cannot be properly dried.

Precipitation as mercuric sulfide from acid solution separates mercury from all metals except those of the acid hydrogen sulfide group. The precipitate always contains sulfur and cannot therefore be weighed directly. In order to be free from sulfur, the sulfide must be precipitated in alkaline solution; this requires, of course, a preliminary separation of the mercury from other metals. If the separation was made as the sulfide, the sulfide is then dissolved in nitric acid and hydrochloric acid, ammonium thiocyanate or tartaric acid is added to prevent the precipitation of mercury, and then an excess of ammonia is added. Into the clear, hot solution hydrogen sulfide is passed for a few minutes; sulfur is soluble in ammonium sulfide and does not precipitate. The precipitate is filtered off on a Gooch crucible, dried at $110\text{-}120^\circ$ (never above 150°) and weighed as mercuric sulfide, HgS .

Several attempts have been made to circumvent the reprecipitation of mercuric sulfide. In one procedure the sulfur is dissolved out of the precipitate by washing with carbon bisulfide.⁵¹ Another method involves weighing the precipitate, dissolving out the mercuric sulfide with cold, concentrated hydriodic acid and weighing the sulfur residue.⁵²

The precipitation of mercuric sulfide from an alkaline solution serves to separate mercury from arsenic and antimony but not from tin unless the process is suitably modified.⁵³

⁵¹ Tabern and Shelberg, *Ind. Eng. Chem., Anal. Ed.*, **4**, 401 (1932).

⁵² Caley and Burford, *Ind. Eng. Chem., Anal. Ed.*, **8**, 43 (1936).

⁵³ Hiltner and Gittel, *Z. anal. Chem.*, **101**, 28 (1935).

Mercury may also be separated as the metal, which serves to isolate mercury from all the common metals except silver. The reduction can be made by the addition of a hydrazine or a hydroxylamine salt to an ammoniacal solution to which enough tartrate has been added to keep all the mercury salts in solution. The reduction may also be carried out in a fairly strong hydrochloric acid solution with stannous chloride.⁵⁴ A technic for drying and weighing the mercury as the metal was devised by Willard and Boldyreff⁵⁴ who use a porous porcelain or fritted glass filtering crucible, wash with acetone, and dry in a stream of air; a small constant loss of mercury occurs in this procedure. By coagulating the mercury into a single drop this loss can be avoided.⁵⁵

It is also possible to separate mercury from copper, iron, bismuth, quinquivalent arsenic, and doubtless many other metals by distilling mercuric chloride from a hot sulfuric acid solution in a stream of hydrogen chloride;⁵⁶ the method has not been extensively used but has possibilities.

Mercury may be quantitatively precipitated as mercuric *para*-periodate, $\text{Hg}_5(\text{IO}_6)_2$, from a solution 0.15 *N* in nitric acid or 0.1 *N* in sulfuric acid. It may be dried at 100° and weighed in this form or determined volumetrically. Halides interfere. Moderate amounts of aluminum, cadmium, zinc, copper, nickel, calcium, and magnesium do not interfere.⁵⁷

Mercury has also been separated as bipyridinomercuric bichromate $[\text{Hg}(\text{C}_5\text{H}_5\text{N})_2]\text{Cr}_2\text{O}_7$,⁵⁸ and as dipropylenediaminocupric tetraiodomercuroate $[\text{Cu}(\text{C}_3\text{H}_6(\text{NH}_2)_2)_2]\text{HgI}_4$ containing 21.81 per cent mercury.⁵⁹ So many metals are also precipitated that these methods are of little value as separation methods; these compounds are advantageous forms in which to weigh mercury because of their low mercury content.

All compounds of mercury are volatile on ignition and the metal may thus be completely removed from its ores. This is often used

⁵⁴ Willard and Boldyreff, *J. Amer. Chem. Soc.*, **52**, 569 (1930).

⁵⁵ Rauscher, *Ind. Eng. Chem., Anal. Ed.*, **10**, 331 (1938).

⁵⁶ Newcomb, Rajagopalnaidu and Varadachar, *Analyst*, **60**, 732 (1935).

⁵⁷ Willard and Thompson, *Ind. Eng. Chem., Anal. Ed.*, **3**, 398 (1931).

⁵⁸ Spacu and Dick, *Z. anal. Chem.*, **76**, 273 (1929); Furman and State, *Ind. Eng. Chem., Anal. Ed.*, **8**, 467 (1936).

⁵⁹ Spacu and Spacu, *Z. anal. Chem.*, **89**, 187 (1932); Sandin and Margolis, *Ind. Eng. Chem., Anal. Ed.*, **7**, 293 (1935).

in assaying cinnabar, the metal being collected on gold foil and weighed⁶⁰ or dissolved and titrated.⁶¹

VOLUMETRIC AND COLORIMETRIC DETERMINATION

Mercury is commonly determined volumetrically by titration with potassium thiocyanate. Slightly dissociated mercuric thiocyanate is formed which is, however, not precipitated as in the case of silver:

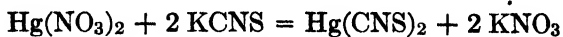

A ferric salt is used as indicator. Chloride, bromide, iodide, and cyanide must be absent because they, too, form slightly dissociated mercuric salts.⁶²

A great number of volumetric methods for mercury which have been proposed are based on its reduction to metallic mercury with standard reducing agents or on the solution of the precipitated mercury in a standard oxidizing agent.⁶³ Probably the best of these methods is the recent modification of the old Rupp iodometric method;⁶⁴ the mercury is first precipitated by reduction of an alkaline solution of its double iodide by the addition of hydrazine sulfate:

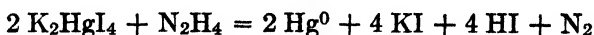

In order to make the filtration of this precipitate easier, magnesium carbonate is then precipitated in the solution by the addition of magnesium sulfate and sodium bicarbonate. The combined precipitate is then treated with sulfuric acid and an excess of standard bromate-bromide solution (in effect a standard bromine solution), causing the mercury to dissolve:



The excess of the standard bromine is determined by the addition of potassium iodide and subsequent titration of the liberated iodine with thiosulfate.

⁶⁰ Cumming and MacLeod, *J. Chem. Soc.*, **103**, 513 (1913); Fahey, *Ind. Eng. Chem., Anal. Ed.*, **9**, 477 (1937).

⁶¹ Bouton and Duschak, *U. S. Bur. Mines, Tech. Paper*, 227.

⁶² Rupp, *Chem. Ztg.*, **32**, 1077 (1908).

⁶³ For a review of these methods see Dunncliff and Suri, *Analyst*, **54**, 405 (1929).

⁶⁴ Sloviter, McNabb and Wagner, *Ind. Eng. Chem., Anal. Ed.*, **13**, 890 (1941); Rupp, *Ber.*, **39**, 3702 (1906).

As mentioned previously, mercuric periodate may also be measured volumetrically; the precipitate is dissolved in an excess of potassium iodide acidified with hydrochloric acid:



and the liberated iodine titrated with thiosulfate.⁶⁷

Small amounts of mercury can be determined colorimetrically with diphenylcarbazone with which it produces a violet or blue color. This reaction is extremely sensitive for mercury and has been used not only for the detection and determination of mercury but also for determining the end-point in titrations using mercuric nitrate as a standard solution.⁶⁵ Unfortunately, the reagent is not highly specific for mercury since other metals give similar colors with the reagent; the halides also decrease the sensitivity.

A careful spectrophotometric study has been made of the reaction of mercury and di- β -naphthylthiocarbazon, a reagent similar in nature and action to dithizone.⁶⁶

The decomposition of organic mercury compounds for the determination of the mercury content may be accomplished in several ways; heating with fuming sulfuric acid with dropwise addition of 30 per cent hydrogen peroxide is particularly effective.⁶³ The use of metallic sodium and the organic solvent ethanolamine has also been suggested; ^{67, 67} this yields metallic mercury directly which is filtered off and suitably determined.

The determination of small amounts of mercury, particularly in biological materials, has received considerable study.⁶⁸

PERIODIC GROUP III

The elements of this group are boron, aluminum, scandium, yttrium, the rare earths and actinium, and the B subgroup elements gallium, indium, and thallium.

⁶⁵ See Hopkin and Williams, *Organic Reagent for Metals*, 3rd Ed., Hopkin and Williams, London, 1938, pp. 53-56, for a review and bibliography of this reagent.

⁶⁶ Hubbard, *Ind. Eng. Chem., Anal. Ed.*, **12**, 768 (1940).

⁶⁷ Shukis and Tallman, *Ind. Eng. Chem., Anal. Ed.*, **12**, 123 (1940).

⁶⁸ Pope, *Analyst*, **58**, 280 (1933) (bibliography); Ballard and Thornton, *Ind. Eng. Chem., Anal. Ed.*, **13**, 893 (1941); Jacobs, *The Analytical Chemistry of Industrial Poisons, Hazards and Solvents*, Interscience Publishers, Inc., New York, 1941, pp. 183-193.

Boron is distinctly an acid-forming element; aluminum and gallium are amphoteric but the oxide of the latter is only weakly acidic. Scandium, yttrium, and the rare earths are weak bases.

All of the elements of this group exhibit the valence of 3, and in addition gallium has a valence of 2, indium of 1 and 2, thallium of 1, cerium of 4, and one or two of the rare earths the valence of 2.

With the exception of boron all of the elements are precipitated by ammonia and therefore appear in the ammonia group along with aluminum, iron, beryllium, and chromium.

Aluminum, indium, gallium, and thallium form alums.

THE DETERMINATION OF BORON

Boron occurs naturally as boric acid, H_3BO_3 , and as various borates of which colemanite, $Ca_2B_6O_{11} \cdot 5 H_2O$, is the most important; boric acid occurs in a few silicate minerals.

SEPARATION AND DETERMINATION

The loss of boron as the trifluoride or the introduction of boron into the solution by the attack of borosilicate glassware (pyrex) by alkalis should be guarded against during the quantitative analysis of boron.¹

Boric acid may be separated from most other substances by distillation as methyl borate from a solution containing methyl alcohol and either sulfuric acid, phosphoric acid, or calcium chloride. The methyl ester is hydrolyzed by sodium hydroxide and titrated as described later. Recent studies on the determination of boron in soil, plant materials and in steel utilize the separation by distillation.²

More direct methods for the determination of boron in boron minerals are available.³

Boric acid is too weak an acid to be titrated; however, it forms a much stronger monobasic acid with certain organic compounds containing hydroxy groups, such as glycerol or mannitol. The boric

¹ Boron free glassware suitable for use in analytical work involving boron can be obtained from the Corning Glass Works, Corning, New York.

² Wilcox, *Ind. Eng. Chem., Anal. Ed.*, **2**, 358 (1930); Scott and Webb, *ibid.*, **4**, 180 (1932); Hague and Bright, *J. Research Nat. Bur. Standards*, **21**, 125 (1938).

³ Scott and Colleagues, *Ind. Eng. Chem., Anal. Ed.*, **4**, 306 (1932); and Glaze and Finn, *J. Research Nat. Bur. Standards*, **16**, 421 (1936).

acid is first liberated by the addition of acid until the solution is neutral to methyl red; considerable mannitol or glycerol, preferably the former, is then added, forming the complex acid, and the latter is titrated using phenolphthalein as indicator. Weak acids and bases must be absent. The reaction of boric acid with polyhydroxy compounds involves the formation of ring structures about the boron atom.⁴ The titration may also be carried out potentiometrically.⁵ By making certain modifications, the boric acid in water can be determined directly.⁶

The red color which boric acid gives with turmeric may be used for the colorimetric determination of boron.^{6a}

THE DETERMINATION OF ALUMINUM

The analytical chemistry of aluminum is discussed on p. 142.

THE DETERMINATION OF SCANDIUM, YTTRIUM, AND THE RARE EARTHS

Although scandium, yttrium, and the rare earths form only a very small fraction of the lithosphere, they are very widely distributed and are commonly found in small deposits or intimately mixed with other minerals. Over 150 minerals containing rare earths are known, mostly silicates but also phosphates, columbates, tantalates, carbonates, zirconates, and many others.

SEPARATION AND GRAVIMETRIC DETERMINATION

Scandium, yttrium, and the rare earths are quantitatively precipitated by ammonia, and a double precipitation serves to separate them from the alkaline earths, magnesium and almost completely from the bivalent elements such as manganese and nickel. Aluminum, zirconium, titanium, thorium, and iron are also precipitated.

The fluorides of the rare earths are insoluble in hydrofluoric acid solutions and this can be used to separate them from columbium, tantalum, titanium, zirconium, iron, beryllium, and aluminum whose fluorides are soluble. Following the extraction, the hydrofluoric

⁴ Diehl, *Chem. Revs.*, **21**, 53 (1937).

⁵ Wilcox, *Ind. Eng. Chem., Anal. Ed.*, **4**, 38 (1932).

⁶ Foote, *Ind. Eng. Chem., Anal. Ed.*, **4**, 39 (1932).

^{6a} Naftel, *Ind. Eng. Chem., Anal. Ed.*, **11**, 407 (1939).

acid is eliminated by converting the earths to sulfates by evaporation with sulfuric acid. The sulfates are dissolved in cold water and the rare earths precipitated as oxalates by oxalic acid. The oxalates are ignited to the oxides for weighing. Scandium and thorium accompany the rare earths through these reactions.

Beyond simply isolating the rare earths in this manner, there is little the analyst can do. Except for europium, which can be reduced to the bivalent state and fairly readily isolated, the separation of the individual rare earths is an extremely laborious task involving repeated fractional crystallization of various salts. Fairly satisfactory methods are available for separating scandium and thorium from the rare earths and from each other, and cerium can be separated from the other rare earths by oxidation to the quadrivalent state.⁷

THE DETERMINATION OF GALLIUM

No minerals of gallium are known, but the element is quite widely distributed in small amounts in many rocks and minerals, being particularly associated with iron, aluminum, and zinc.

GENERAL CHEMISTRY

Gallium is precipitated as the hydroxide by ammonia in the presence of ammonium salts, and thus appears in the ammonia group along with beryllium, aluminum, chromium, iron, titanium, zirconium, indium, thallium, uranium, vanadium, and the rare earths. Precipitation by sodium hydroxide will separate all but beryllium, aluminum, chromium, and vanadium. Chromium and vanadium may be readily oxidized to their highest valence states and others precipitated by ammonia. Finally the gallium may be detected by precipitation as the ferrocyanide from a dilute hydrochloric acid solution.

A more direct separation can be made by extracting gallium chloride with ether; if iron is first reduced to the bivalent state it is not extracted.

Minute amounts of gallium are readily detected spectrographically.

⁷ For an extensive treatment of the analytical chemistry of the rare earths, see Hillebrand and Lundell, *Applied Inorganic Analysis*, John Wiley & Sons, Inc., New York, 1929, pp. 430-441.

SEPARATION AND GRAVIMETRIC DETERMINATION

Extraction of gallium from a hydrochloric acid solution with ether may be used to separate gallium from all but ferric iron.⁸

The precipitation of gallium ferrocyanide can be used for isolating gallium from many metals; zinc, indium, and zirconium also give precipitates. The ferrocyanide must then be decomposed and the iron separated by precipitation with sodium hydroxide.

The separation of gallium from aluminum can be made expediently by precipitating the former with cupferron. A method for determining the other metals precipitated by cupferron, titanium, zirconium, and vanadium, has been devised.⁸

Traces of gallium may be isolated by extracting the 8-hydroxyquinoline compound precipitated at a pH of 2.6-3 with chloroform.⁹

Precipitation of gallium as the basic sulfate by the slow neutralization of the solution by the decomposition of urea on boiling affords a separation of gallium from zinc, manganese, and calcium.¹⁰

Gallium is precipitated as the hydroxide by ammonia, avoiding excess, and ignited to the oxide Ga_2O_3 for weighing.

A method of separating gallium from interfering metals and of determining it colorimetrically has been described by Willard and Fogg.¹¹

THE DETERMINATION OF INDIUM

No minerals of indium are known but the element is found in small amounts in most zinc ores and is also occasionally found associated with tin, lead, manganese, and iron. The metal is recovered commercially from flue dusts of zinc smelters and finds use in precious metal and dental alloys and in bearing surfaces.

GENERAL CHEMISTRY

Like gallium, indium is precipitated by ammonia. The hydroxide, however, is not soluble in sodium hydroxide. Yellow indium sulfide, In_2S_3 , is precipitated from dilute acetic acid solution by hydrogen sulfide; a white sulfide is precipitated by ammonium sulfide. The use of these and other reactions for qualitative purposes

⁸ Scherrer, *J. Research Nat. Bur. Standards*, **15**, 585 (1935).

⁹ Sandell, *Ind. Eng. Chem., Anal. Ed.*, **13**, 844 (1941).

¹⁰ Willard and Fogg, *J. Amer. Chem. Soc.*, **59**, 1197, 2422 (1937).

¹¹ Willard and Fogg, *J. Amer. Chem. Soc.*, **59**, 40 (1937).

is the same as in the quantitative analysis discussed in the next section.

Indium chloride imparts a bright blue color to the gas flame, but minute amounts are better detected spectrographically using the spark spectrum.

SEPARATION AND DETERMINATION

Like zinc, indium is not precipitated by hydrogen sulfide from a mineral acid solution but is carried down by certain members of the hydrogen sulfide group when they are precipitated. The precipitation of indium by hydrogen sulfide from dilute acetic acid solutions serves to separate it from iron. Precipitation by ammonium sulfide from solutions containing tartrate or fluoride separates it from zirconium, titanium, and aluminum. The sulfide is dissolved in hydrochloric acid and finally precipitated as the hydroxide.¹²

A double precipitation of indium with ammonia is generally used for separating indium from zinc and other bivalent metals, but the process is probably no better than the corresponding separation of iron or aluminum from these metals.

When precipitated as the hydroxide, indium is ignited at a temperature below 800° to the oxide, In_2O_3 , for weighing. Chloride solutions should be avoided as indium chloride is volatile.

Indium may be separated from the amphoteric elements of the ammonia group by precipitation with potassium hydroxide; the solution must be boiled and care exercised to insure complete precipitation of the indium.

Like zinc, indium may be titrated with ferrocyanide using diphenylbenzidine as internal indicator.¹³

THE DETERMINATION OF THALLIUM

A few rare minerals of thallium are known and the element is also found in minute amounts in pyrites and zinc sulfides and also associated with the alkali metals, tellurium, and other elements. It is obtained from the flue dusts of sulfuric acid works which burn pyrites, and because of its highly poisonous properties is used as a rodenticide.

¹² Lawrence and Westbrook, *Ind. Eng. Chem.*, **30**, 611 (1938).

¹³ Hope, Ross and Skelly, *Ind. Eng. Chem., Anal. Ed.*, **8**, 51 (1936).

GENERAL CHEMISTRY

The thallose ion resembles lead in forming a chloride, $TlCl$, which is insoluble in cold but soluble in hot water, and in not forming complexes with ammonia. It also resembles potassium in that thallose hydroxide, $TlOH$, is a strong base whose chloroplatinate, perchlorate, and cobaltinitrite are sparingly soluble.

In the common scheme of qualitative analysis thallose chloride will accompany lead chloride, from which it can be separated by treatment with sulfuric acid. Thallose iodide is insoluble and serves as a good confirmatory test for thallium. Thallose chromate, Tl_2CrO_4 , is also insoluble, and the thallose chloroplatinate and thallose cobaltinitrite can be used for confirmatory tests. Hydrogen sulfide does not precipitate thallium from mineral acid solutions, but the metal is carried down by other metals precipitated by hydrogen sulfide. Trivalent thallium is precipitated as the hydroxide, $Tl(OH)_3$, by ammonia and thus accompanies iron and aluminum.

Thallose salts are oxidized more or less to thallic by most strong oxidizing agents and thallic salts are reduced by sulfur dioxide, hydrogen sulfide, hydroxylamine, and other reducing agents. Thallium salts color the gas flame a characteristic green. Minute amounts of thallium are best detected spectrographically. A summary of the reactions of thallium salts with many reagents will be found in the paper by Munch and Ward.¹⁴

SEPARATION AND DETERMINATION

Thallium is coprecipitated with members of the acid hydrogen sulfide group and the separation of these elements from thallium by precipitation of the sulfides is unsatisfactory. Precipitation as thallose iodide may be used to separate thallium from aluminum, zinc, iron, and most of the bivalent metals excepting lead and mercury. Thallic chloride may be extracted from a hydrochloric acid solution by means of ether.¹⁵

After isolation thallium may be oxidized to the trivalent state by bromine, precipitated by ammonia, and ignited to the oxide, Tl_2O_3 , for weighing.¹⁶

¹⁴ Munch and Ward, *J. Amer. Pharm. Assoc.*, **24**, 351 (1935).

¹⁵ Shaw, *Ind. Eng. Chem., Anal. Ed.*, **5**, 93 (1933).

¹⁶ Browning, *Ind. Eng. Chem., Anal. Ed.*, **4**, 417 (1932).

Precipitation and weighing as thallos chromate, Tl_2CrO_4 , is also satisfactory, and in conjunction with sulfosalicylic acid may be used to separate thallium from many of the common elements.¹⁷

Thallos salts in the presence of chloride are oxidized to thallic by titration with ceric sulfate, potassium permanganate, bromate, or iodate. Hydrochloric acid solutions are used, the complex chloride, $HTlCl_4$, being formed.¹⁸ When bromate is used, methyl orange serves as indicator:

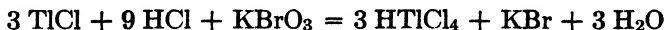

Thallium in the trivalent state may be determined iodometrically



the liberated iodine being titrated with sodium thiosulfate or sodium arsenite either in the usual way or potentiometrically.¹⁹

Because of the extreme toxicity of thallium salts, the detection and measurement of traces of thallium are of considerable importance. The conditions for the separation of small amounts of thallium from other metals by dithizone have been investigated²⁰ and methods have been devised for the determination of small amounts of thallium: by the color of iodine liberated by thallic salts,¹⁵ and by thioglycollic acid- β -aminonaphthalide which is quite specific for thallium.²¹

PERIODIC GROUP IV

The elements of this group are carbon, silicon, titanium, zirconium, hafnium, thorium, germanium, tin, and lead. Quadrivalent cerium may be properly considered a member of this group, falling between hafnium and thorium. The differences between the subgroups of periodic group IV are very much less pronounced than between the subgroups of previous periodic groups. Carbon, silicon, titanium, zirconium, hafnium, and thorium are exclusively quadrivalent with the exception of titanium which also has a valence of

¹⁷ Moser and Brukl, *Monatsh.*, **47**, 709 (1927).

¹⁸ Zintl and Rienacker, *Z. anorg. allgem. Chem.*, **153**, 276 (1926); Willard and Young, *J. Amer. Chem. Soc.*, **52**, 36 (1930); Swift and Garner, *ibid.*, **58**, 113 (1936); Beale, Hutchison and Chandler, *Ind. Eng. Chem., Anal. Ed.*, **13**, 240 (1941).

¹⁹ Hollens and Spencer, *Analyst*, **60**, 672 (1935).

²⁰ Haddock, *Analyst*, **60**, 394 (1935).

²¹ Berg and Fahrenkamp, *Z. anal. Chem.*, **109**, 305 (1937).

3; the remaining elements are bivalent as well as quadrivalent. Bivalent germanium is very unstable, stannous salts are strong reducing agents, and lead salts are normally bivalent. The elements become more basic with increasing atomic weight but even the most basic is only a weak base.

Carbon and silicon are acidic in nature. The remaining elements are primarily basic in nature but the members of both subgroups have many similarities to silicon. Germanium, tin, and lead are amphoteric, titanium forms insoluble or unstable titanates but the remaining elements, zirconium, hafnium, cerium, and thorium are not acidic. Zirconium is present in solution as the zirconyl ion, ZrO^{++} , and titanium probably exists largely as the titanyl ion, TiO^{++} .

Like silicon, all of the members of the group form complex fluorides, MF_6^{--} , with the exception of thorium and cerium which form insoluble fluorides. All of the tetrachlorides, except that of thorium, are volatile liquids.

Germanium, tin, and lead form sulfides which are insoluble in acids but the sulfides of the main group elements are not stable. Like the elements of group III, none of the elements of group IV form complexes with ammonia. The phosphates of zirconium, hafnium, and quadrivalent cerium are the most insoluble known.

THE DETERMINATION OF CARBON

Carbon occurs naturally in the free state in the crystalline forms of graphite and diamond and in the amorphous form of coal. Carbon dioxide is present in the atmosphere and numerous carbonates occur naturally, constituting great rock masses. Complex compounds of carbon are found in large amounts in the form of natural gas, petroleum, bituminous material, and peat. Although it constitutes only 0.08 per cent of the material of the earth it is very widely distributed and is, of course, absolutely essential to all life and gives rise to the vast structure of organic chemistry.

The ultimate quantitative analysis of carbon is based on oxidation of the carbon to carbon dioxide and absorption of the latter by an alkali. This is generally done by a combustion procedure. In gas analysis the combustion is carried out very rapidly by passage of the carbon containing gas over hot cupric oxide or mixed with oxygen and ignited by passage over a red hot wire. The com-

bustion is carried out extremely rapidly in the determination of carbon in steel (see p. 209). The combustion of organic compounds is generally carried out very slowly in an atmosphere of oxygen. Wet oxidation methods have also been used. In the case of a carbonate, the carbon is already in its highest state of oxidation, and no preliminary oxidation is necessary.

The methods of absorbing carbon dioxide are discussed on p. 90.

THE DETERMINATION OF CARBON DIOXIDE IN CARBONATE ROCKS

A large portion of the lithosphere consists of carbonate rock, the carbonates of calcium and magnesium, such as limestone, dolomite, and magnesite being most abundant; carbonates of a great many other metals, principally of the bivalent metals, are also known. Carbonates are all decomposed by acids with the liberation of carbon dioxide; the latter may be absorbed and determined by one of the methods mentioned on p. 212. The gravimetric determination using ascarite is the method generally used for absorbing and determining carbon dioxide. The vessel containing the absorbent, which is weighed before and after the absorption, should contain a drying agent to prevent the escape of water formed during the absorption of the carbon dioxide.

The analysis of a carbonate rock is occasionally complicated by the presence of a sulfide which liberates hydrogen sulfide during the treatment with acids. The gas stream containing the carbon dioxide and hydrogen sulfide may be bubbled through a solution of silver sulfate to remove the sulfide; a much better method, however, is to prevent the liberation of the hydrogen sulfide in the first place by adding an oxidizing agent such as bichromate to the acid used to decompose the sample.

Apparatus and Procedure for the Determination of Carbon Dioxide in a Carbonate Rock. An apparatus for the determination of carbon dioxide in a carbonate is described in Willard and Furman, 3rd Ed., pp. 402-406. A more compact form of apparatus is described here, Fig. 38. It consists of a 300 ml. flask connected by a rubber stopper to a reflux condenser which carries a dropping funnel having a long narrow stem which passes through the condenser into the flask; the funnel has a two-way stopcock as shown, the tail of which is connected to a drying tube charged with ascarite. At the top of the condenser is a side tube connected to a large

U-tube filled with a drying agent, usually with dehydrite. This is in turn connected to the large side of a Wesson absorption bulb.

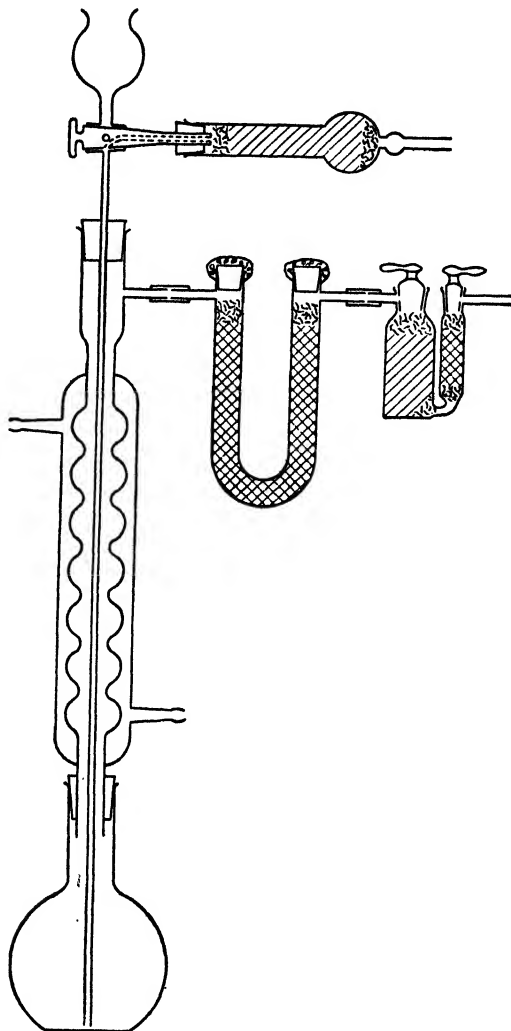

FIG. 38. Apparatus for the Determination of Carbon Dioxide in a Carbonate.

The large side of the Wesson bulb is charged with ascarite, the small side with the same drying agent used in the U-tube. Suction is applied to the exit end of the absorption bulb, a trap containing sul-

furic acid sometimes being included for convenience in judging the rate of flow of air.

The apparatus should be made gas tight throughout. A good grade of handmade rubber tubing should be used for connecting the U-tube, absorption vessel, and condenser, and glass to glass contacts should be made. The absorbents are retained by loose plugs of cotton which also act as dust filters. The corks closing the U-tube should be pushed in far enough to eliminate any dead air space in the tube and then sealed smoothly with sealing wax. The ground glass stoppers of the Wesson bulb should be dry when the tube is filled and then lubricated lightly with stopcock grease, taking care to avoid an excess which might be later wiped off and cause a change in the weight of the tube.

In weighing the absorption vessel the precautions mentioned on p. 91 should be observed. A counterpoise must be used. Since considerable heat is generated during the absorption process the vessels should be allowed to stand in the balance case long enough for complete temperature equalization and the stopcocks should be opened momentarily before weighing to obtain atmospheric pressure inside. Care should be exercised to avoid electrification effects during weighing. To avoid contamination with moisture from the hands, the absorption vessels should be handled as little as possible. The counterpoise may be exchanged with the absorption vessel used in the determination when the activity of the latter has been exhausted. When connecting or disconnecting the Wesson bulb always hold the tube by the side on which the pressure is being exerted as the glass connection at the bottom of the vessel is quite fragile.

When using the apparatus for the first time, a known pure substance, such as calcium carbonate, should be analyzed in order to indicate whether or not the apparatus is working properly and to familiarize the operator with the manipulation. A little experience is generally required to obtain accurate results.

Weigh into the flask a sample of such weight that it will evolve 0.3-0.5 g. of carbon dioxide; this will usually mean a sample of from 1-10 g. If too small a sample is used, the errors of weighing may seriously affect the results. Add 5-10 ml. of water, two or three small pieces of porous plate, and assemble the apparatus, connecting the suction directly to the drying tube, that is, omitting the

ascarite absorption vessel. Draw a slow stream of air through the apparatus for 15-20 minutes to sweep out the apparatus with carbon dioxide free air, adjusting the rate of flow to 3-4 bubbles per second by means of a screw clamp on the suction line. Properly connect the weighed absorption vessel to the U-tube, adjust the air flow again, place 60 ml. of dilute hydrochloric acid (1 : 2) in the dropping funnel and carefully draw the acid into the flask in portions by turning the stopcock. After the acid has been added, adjust the air flow to 2-3 bubbles per second. With cold water flowing through the condenser, boil the solution in the flask gently for 8-10 minutes, then sweep out the apparatus for 15-20 minutes with a somewhat faster stream of air. Finally disconnect the absorption tube and weigh. The gain in weight is carbon dioxide. Results on known pure material should check the theoretical within 0.15 per cent.

THE DETERMINATION OF SILICON

The analytical chemistry of silicon is treated on p. 180.

THE DETERMINATION OF TITANIUM

The analytical chemistry of titanium is discussed on p. 154.

THE DETERMINATION OF ZIRCONIUM (AND HAFNIUM)

Zirconium occurs as the minerals zircon, $ZrSiO_4$, and baddeleyite, ZrO_2 . The element is widely distributed in rocks but seldom exceeds a few tenths of 1 per cent in amount. Zirconium is finding increasing use in refractories and metallurgical products. Hafnium is present in all zirconium minerals, sometimes to the extent of 1 per cent.

GENERAL CHEMISTRY

Zirconium is uniformly quadrivalent. In solution it is present principally as the zirconyl ion, ZrO^{++} . Like titanium salts, zirconium salts hydrolyze very readily and the element is not amphoteric. Zirconium is not precipitated by hydrogen sulfide in acid solutions but is precipitated by ammonia as zirconium hydroxide, $Zr(OH)_4$, from a cold solution, and zirconyl hydroxide, $ZrO(OH)_2$, from a hot solution. Zirconium thus appears in the ammonia group and its qualitative differentiation from the other members of the

group follows the quantitative separations given in the next section. A number of confirmatory tests are available for zirconium.¹ Hafnium accompanies zirconium in all reactions.

SEPARATION AND GRAVIMETRIC DETERMINATION

The oxalate of zirconium is soluble in hydrochloric acid and this serves to differentiate it from the rare earths, thorium, and cerium. Zirconyl hydrogen phosphate, $ZrOHPO_4$, is insoluble in 10 per cent sulfuric acid and affords a separation from all metals but quadrivalent cerium; titanium, if present, is first converted to pertitanic acid by treatment with hydrogen peroxide and is then not precipitated. The composition of the phosphate is too variable to permit ignition and weighing, except for very small amounts, when the ignited precipitate may be considered to be the pyrophosphate, ZrP_2O_7 .² The phosphate precipitate must therefore be fused with sodium carbonate, extracted with water, the zirconium oxide dissolved in hydrochloric acid and reprecipitated with ammonia. The hydroxide is then ignited to the oxide, ZrO_2 , for weighing.

Zirconium may be precipitated from hydrochloric acid solutions by selenious acid and thus separated from all metal but ceric cerium, titanium, and thorium. The presence of hydrogen peroxide eliminates the interference of cerium by reducing it to the trivalent state and of titanium by forming pertitanic acid which is not precipitated. The basic selenite first precipitated is readily soluble in acids and thus permits reprecipitation. The selenite method has been applied to zirconium ores³ and steel⁴ although a combination of the selenite and phosphate methods appears to be better in the case of tungsten steels.⁵

The precipitate of zirconium with selenious acid slowly changes to crystalline zirconium selenite, $Zr(SeO_3)_2$. This precipitate is ignited to the oxide for weighing.

¹ See McAlpine and Soule, *Qualitative Chemical Analysis*, D. Van Nostrand Company, Inc., New York, 1933, p. 397.

² Cunningham and Price, *Ind. Eng. Chem., Anal. Ed.*, **3**, 105 (1931); **5**, 334 (1933).

³ Smith and James, *J. Amer. Chem. Soc.*, **42**, 1764 (1920); Simpson and Schumb, *ibid.*, **53**, 921 (1931).

⁴ Simpson and Schumb, *Ind. Eng. Chem., Anal. Ed.*, **5**, 40 (1933).

⁵ Simpson and Schumb, *Ind. Eng. Chem., Anal. Ed.*, **5**, 211 (1933); **7**, 36 (1935).

Thorium and zirconium are best separated by precipitating the former as the oxalate from dilute acid solution.⁶

Like titanium, zirconium is precipitated by cupferron, which serves to separate it from aluminum and a number of bivalent metals.⁷ The cupferron precipitate is ignited to the oxide for weighing.

The organic reagent *n*-propylarsonic acid has been found highly advantageous for the separation of zirconium from large amounts of iron, as in the analysis of steel. Titanium, aluminum, chromium, cobalt, nickel, copper, uranium, vanadium, thorium, and molybdenum do not interfere. Tin is precipitated but is removed by volatilization with ammonium iodide. A second precipitation is necessary to remove adsorbed iron and the precipitate is ignited to the oxide for weighing.⁸ *p*-Dimethylaminobenzeneazophenylarsonic acid has been recommended for the colorimetric determination of zirconium, particularly in steel.⁹

Zirconium may also be separated as the arsenate $Zr_3(AsO_4)_4$.¹⁰

THE DETERMINATION OF CERIUM

The reactions and properties of quadrivalent cerium relate cerium to the elements of periodic group IV; trivalent cerium exhibits the properties of the rare earths with which it is associated in nature. Cerous oxalate, $Ce_2(C_2O_4)_3$, is insoluble in hydrochloric acid, a reaction characteristic of the rare earths. Like thorium phosphate, ceric phosphate, $Ce(HPO_4)_2$, is insoluble in strong acids. Ceric hydroxide, $Ce(OH)_4$, is an extremely weak base and ceric salts are easily hydrolyzed. Ceric salts are powerful oxidizing agents and are widely used in chemical analysis.

Cerium may be separated from titanium and zirconium by precipitation as cerous oxalate; it is accompanied in this precipitation by the rare earths and thorium. Cerium may be separated from the latter elements by precipitation as ceric hydroxide from neutral solutions containing an oxidizing agent such as potassium perman-

⁶ Simpson and Schumb, *J. Amer. Chem. Soc.*, **53**, 921 (1931); *Ind. Eng. Chem., Anal. Ed.*, **7**, 36 (1935).

⁷ Lundell and Knowles, *J. Ind. Eng. Chem.*, **12**, 562 (1920); *J. Amer. Chem. Soc.*, **42**, 1439 (1920).

⁸ Geist and Chandlee, *Ind. Eng. Chem., Anal. Ed.*, **9**, 169 (1937).

⁹ Hayes and Jones, *Ind. Eng. Chem., Anal. Ed.*, **13**, 603 (1941).

¹⁰ Schumb and Nolan, *Ind. Eng. Chem., Anal. Ed.*, **9**, 371 (1937).

ganate, chlorine, potassium bromate, or potassium persulfate. The precipitate of ceric hydroxide is ignited to the oxide, CeO_2 , for weighing.

Volumetrically cerium may be determined by oxidation to the quadrivalent state in a sulfate solution by persulfate plus silver¹¹ or by sodium bismuthate;¹² the excess of persulfate is destroyed by boiling, or the excess of sodium bismuthate filtered off. The ceric sulfate is then titrated with ferrous sulfate using *o*-phenanthroline ferrous sulfate as indicator.

The intense yellow to orange color of ceric sulfate may be used for the colorimetric determination of cerium.

THE DETERMINATION OF THORIUM

Thorite, a silicate mineral, and thorianite, ThO_2 , are the common minerals of thorium although most thorium is derived from monazite sand which usually contains up to 10 per cent of thorium phosphate. Thorium is used principally in gas mantles.

Like zirconium, thorium is uniformly quadrivalent and is not amphoteric. Thorium is not precipitated from acid solution by hydrogen sulfide but is completely precipitated by ammonia together with aluminum, iron, zirconium, and other metals. The separations of thorium from these metals for identification purposes are made by the reactions used for quantitative work.

SEPARATION AND DETERMINATION

Thorium oxalate, $\text{Th}(\text{C}_2\text{O}_4)_2$, is less soluble in hydrochloric acid than any other oxalate, and this serves to separate it from titanium, zirconium, and the common metals not in the hydrogen sulfide group. Thorium iodate, $\text{Th}(\text{IO}_3)_4$, is completely precipitated from nitric acid solution, a separation from trivalent cerium, the rare earths, and phosphate, but not from titanium and zirconium. Thorium hydroxide, $\text{Th}(\text{OH})_4$, is a very weak base and is precipitated by boiling an acid solution containing a thiosulfate; this is a separation from the rare earths and cerous cerium but is not especially sharp. Thorium pyrophosphate, ThP_2O_7 , is precipitated in hydrochloric acid or sulfuric acid solutions by sodium pyrophosphate, $\text{Na}_4\text{P}_2\text{O}_7$, which separates thorium from titanium, cerous cerium,

¹¹ Willard and Young, *J. Amer. Chem. Soc.*, **50**, 1379 (1928).

¹² Metzger, *J. Amer. Chem. Soc.*, **31**, 523 (1909).

the rare earths, and the common metals, but not from quadrivalent cerium or zirconium.

When alone thorium may be precipitated with ammonia and ignited to the oxide for weighing. Thorium oxalate is ignited directly to the oxide but the phosphate must be fused with sodium carbonate, extracted with water, the thorium dioxide dissolved in hydrochloric acid, precipitated with ammonia, and ignited to the oxide.

THE DETERMINATION OF GERMANIUM

A few rare minerals of germanium are known; the element is, however, commonly present in small amounts in many sulfide ores, particularly those of zinc and lead.

Germanium exhibits the valences of 2 and 4, the latter being the more stable. Both forms are amphoteric, quadrivalent germanium giving the ion GeO_3^{--} . Germanium tetrachloride is volatile and germanium may be lost during hydrochloric acid evaporations. Hydrogen sulfide precipitates brown germanous sulfide, GeS , and white germanic sulfide, GeS_2 . The sulfides are insoluble in hydrochloric acid but soluble in alkaline sulfide and polysulfide, and germanium thus accompanies arsenic, antimony, and tin in the common scheme of qualitative analysis.

SEPARATION AND DETERMINATION

Germanium tetrachloride may be distilled from a hydrochloric acid solution, and if an atmosphere of chlorine is maintained, arsenic and practically all other elements are left behind.¹³

Precipitation as germanic sulfide is best made from a solution 6 *N* in sulfuric acid. The sulfide is oxidized to the oxide for weighing; this oxidation has been usually made with nitric acid but a more recent method recommends hydrolysis of the germanic sulfide by boiling water.¹⁴ The germanium dioxide, GeO_2 , is finally ignited at 900° and weighed.

Several other methods of precipitating germanium have been devised.¹⁵ Small amounts of germanium can be detected and determined by a modified Marsh test.¹⁶

¹³ Dennis and Johnson, *J. Amer. Chem. Soc.*, **45**, 1380 (1923); see also, Scherrer, *J. Research Nat. Bur. Standards*, **16**, 253 (1936).

¹⁴ Müller and Eisner, *Ind. Eng. Chem., Anal. Ed.*, **4**, 134 (1932).

¹⁵ Davies and Morgan, *Analyst*, **63**, 388 (1938).

¹⁶ Aitkenhead and Middleton, *Ind. Eng. Chem., Anal. Ed.*, **10**, 633 (1938).

THE DETERMINATION OF TIN

The most important mineral of tin is cassiterite, SnO_2 . The principal uses of tin are in the manufacture of tin plate and alloys such as bronze, solder, and other white metal alloys.

SOLVENTS FOR TIN AND TIN COMPOUNDS

Concentrated hydrochloric acid acts slowly on compact metallic tin; contact with platinum hastens the action. Stannous chloride is formed. Hydrochloric acid containing bromine or nitric acid acts more readily, yielding stannic chloride. Hot, concentrated sulfuric acid acts rapidly forming stannic sulfate. A mixture of nitric acid and oxalic acid or tartaric acid dissolves tin fairly rapidly yielding a clear solution. Stannous chloride is not volatile, but stannic chloride is and tin may be lost if a stannic chloride solution is evaporated with an excess of hydrochloric acid.

Tin ores are difficult to dissolve. Cassiterite, SnO_2 , is not attacked at all by acids. It may be decomposed by reduction in hydrogen to metallic tin which may then be dissolved in hydrochloric acid; it is usually necessary to repeat the reduction on the residue until no more tin is extracted. Fusion with potassium acid fluoride followed by evaporation with sulfuric acid will also decompose tin ores. Fusion with sodium hydroxide or sodium peroxide and solution in hydrochloric acid is very convenient if the contaminations introduced by the attack on the crucible are permissible. It is often convenient to reduce in hydrogen, dissolve in hydrochloric acid, and then fuse the residue with sodium carbonate and borax or with sodium peroxide.

SEPARATION AND GRAVIMETRIC DETERMINATION

Digestion with nitric acid converts tin to insoluble stannic acid, H_2SnO_3 . The characteristics and sources of error in this precipitation were discussed in Willard and Furman, 3rd Ed., pp. 434-437. If the metal is dissolved in sulfuric acid and the solution diluted and boiled, stannic acid will separate; the addition of ammonium sulfate or nitrate gives a better precipitate. Chloride solutions may also be used, the precipitation being made by neutralizing with ammonia, acidifying slightly with nitric acid, adding a large amount of ammonium nitrate, and boiling. Antimony if present will accompany the stannic acid precipitate but all of the antimony will not be precipi-

tated unless the ratio of tin to antimony is greater than 3 to 2. Part or all of any arsenic and phosphorus, depending upon the relative amounts, will be carried down with the stannic acid.¹⁷ The precipitate carries with it some lead, iron, copper, and other metals present and the stannic oxide formed on ignition must be corrected for these impurities. Two methods are available.¹⁸

Tin may be deposited electrolytically from a solution containing ammonium oxalate slightly acidic with oxalic acid. From time to time it is necessary to replace the oxalic acid destroyed by electrolysis, otherwise stannic acid will precipitate as the solution becomes alkaline. This method gives excellent results, but is rather slow since a low current is advisable and the last traces of tin are not readily deposited. The presence of chloride is not detrimental since a reducing agent is present. Tin may also be deposited from a chloride solution containing a hydroxylamine salt as anodic depolarizer (p. 57).

Arsenic, antimony, and tin may be separated from each other by distillation. Arsenic is first distilled as the trichloride at 110-111°; antimony is then distilled as the chloride at 155-165°, phosphoric acid being added to prevent the tin from distilling. On the addition of a mixture of hydrobromic acid and hydrochloric acid, the tin is then distilled at a temperature of 140-150°. It is collected in water and then determined gravimetrically or volumetrically. An all-glass distillation apparatus should preferably be used¹⁹ (see Fig. 39, p. 342).

Tin may be precipitated as the sulfide from an acid solution containing about 4.5 per cent (1.25 *N*) of hydrochloric acid. This is a troublesome procedure and does not separate tin from arsenic, antimony, and most of the other metals of the hydrogen sulfide group. It is, however, very useful for separating tin from iron, chromium, vanadium, and tungsten in the analysis of iron and steel, provided these metals are all in solution and all carbides have been decomposed.²⁰

¹⁷ Gates and Silverman, *Ind. Eng. Chem., Anal. Ed.*, **11**, 370 (1939); for a procedure to correct the stannic oxide precipitate for the phosphorus and arsenic present, see Dunbar-Poole, *Analyst*, **64**, 870 (1939).

¹⁸ Craig, *J. Ind. Eng. Chem.*, **11**, 750 (1919); Caley and Burford, *Ind. Eng. Chem., Anal. Ed.*, **8**, 114 (1936); see Willard and Furman, 3rd Ed., p. 435.

¹⁹ Hartmann, *Z. anal. Chem.*, **58**, 148 (1919); Scherrer, *J. Research Nat. Bur. Standards*, **18**, 253 (1936); **21**, 95 (1938).

²⁰ Scherrer, *Bur. Standards J. Research*, **8**, 309 (1932).

The precipitation of tin as sulfide is made from an acid solution containing 4.5 per cent hydrochloric acid or 1.25 *N* (10 ml. of concentrated hydrochloric acid per 100 ml.). The sulfide precipitate is best washed with dilute ammonium acetate or nitrate solution and ignited carefully in an open crucible to stannic oxide. The precipitate should be ignited at a low heat until the sulfide is oxidized to oxide to prevent volatilization of stannic sulfide, then finally ignited at a bright red heat. At first the precipitate usually decrepitates, and the crucible should be covered to prevent loss until this ceases. The residue should be moistened with nitric acid and ignited to oxidize the tin that has been reduced to metal by the carbon of the filter. The precipitate holds some sulfuric acid very tenaciously, and to remove this a piece of ammonium carbonate the size of a pea is added, the crucible covered, heated carefully, and finally ignited, open, at a bright red heat, this treatment being repeated until constant weight is obtained. The precipitate of stannic sulfide is sometimes difficult to filter; to obviate this, filter paper pulp may be added. It has been suggested that mercuric chloride be added to the tin solution, the mixed precipitate of mercuric sulfide and stannic sulfide being easier to filter and the mercuric sulfide being volatilized on ignition. Stannous sulfide filters very easily, and it is desirable to have at least a part of the tin in the stannous form; but since this sulfide is more readily soluble in hydrochloric acid than the other, the concentration of hydrochloric acid should not be greater than 1.0 *N*.

Stannic salts form complex ions with hydrofluoric acid and with oxalic acid which are not decomposed by hydrogen sulfide; this affords a separation of tin from trivalent arsenic, antimony, and other metals of the hydrogen sulfide group which are precipitated.

Arsenic, antimony, and tin are not precipitated from alkaline solution by sulfides and this serves to separate them from the copper group of sulfide metals. This method gives a good separation but is troublesome. See note on the analysis of base metal alloys, p. 354.

Precipitation with ammonia may be used to separate tin from copper, molybdenum, nickel, and cobalt preliminary to the volumetric determination of tin.²⁰

Procedure for the Separation of Tin by Distillation. After removal of arsenic and antimony by distillation of their trichlorides (pp. 341 and 348), proceed as follows for the separation of tin.

Place a mixture of seven parts by volume of concentrated hydrochloric acid and two parts of hydrobromic acid (sp. gr. 1.40) in the dropping funnel. Continue the distillation at 140°, adding the acid at a rate of 30-40 drops per minute. Distill over 150-200 ml. of mixed acid or more if the amount of tin is very large.

Determine the tin volumetrically by reduction with lead and titration with iodine as described on p. 329.

VOLUMETRIC DETERMINATION

Iodometric Method. Volumetrically tin is determined by titrating stannous chloride with iodine in an atmosphere of carbon dioxide:



There are various methods of reducing the tin to the bivalent state prior to the titration. Metallic nickel, lead, iron, antimony, or a mixture of iron and antimony may be used:

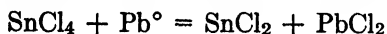
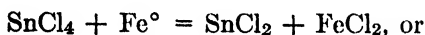

Nickel in concentrated hydrochloric acid does not precipitate antimony; a mixture of iron and antimony is more rapid than either alone but the black precipitate of antimony interferes subsequently with the end-point. Iron alone will reduce antimony to the metal if it is present with the tin and freshly precipitated antimony interferes with the subsequent titration by reducing the tin as it is oxidized.²¹ If zinc or aluminum is used, the tin is reduced to the metal and must be redissolved in excess of hydrochloric acid. Lead is the most convenient reducing agent because it need not be removed if the solution is cooled to 0-3° before beginning the titration.

The iodine solution should be standardized against pure tin. Ceric sulfate may be used as the standard oxidizing agent and the normality obtained against oxalate may then be used;²² iron interferes.

Arsenic and antimony do not interfere in this titration if iodine is used because of the high acidity of the solution. In the presence of lead sulfate the results for tin are very slightly low.²³ Not more

²¹ Hourigan, *Analyst*, **61**, 328 (1936).

²² Bassett and Stumpf, *Ind. Eng. Chem., Anal. Ed.*, **6**, 477 (1934).

²³ Scherrer, *J. Research Nat. Bur. Standards*, **21**, 103 (1938).

than 0.05 g. of copper may be present. When the amount of copper exceeds this, it is best to separate the tin as stannic acid, dissolve the latter together with the filter in hot, concentrated sulfuric acid plus potassium bisulfate, and to treat the solution as above.

Nitric acid must not be present in the solution during the volumetric determination of tin. The stannous chloride must not be allowed to come in contact with air during the titration since it is quickly oxidized. Low results have often been reported for tin as determined by the iodometric method; recent work has shown that this error is due to the presence of oxygen dissolved in the standard iodine solution; ²⁴ this effect is not always eliminated by standardization against pure tin and varies with the diverse ions present in the tin solution. A technic for obtaining and using an air-free iodine solution has been devised.²⁴

Procedure for the Volumetric Determination of Tin by the Iodometric Method. Transfer the tin solution to a 500 ml. conical flask and adjust the acidity of the solution to about 25 per cent by volume of hydrochloric acid or hydrochloric acid plus hydrobromic acid if the tin has been separated by distillation. Place a three-hole rubber stopper in the flask, carrying an inlet tube for bubbling carbon dioxide through the solution, an air condenser (about 30 cm. of 10 mm. glass tubing) having a Bunsen valve at the top, and an opening for the buret tip, this opening being plugged with a piece of glass rod during the first part of the procedure. It is more convenient to use a three-neck round bottom flask with a mechanical stirrer passing through the center neck. Add 10 g. of granulated lead, pass a slow stream of carbon dioxide through the solution, and boil gently until all of the stannic salts have been reduced, generally about 30 minutes. Cool the solution to 0-3° and then, with a slightly faster stream of carbon dioxide flowing, add 5 ml. of freshly prepared starch solution. Insert the tip of the buret and titrate with standard iodine or iodate-iodide solution until the first permanent blue color appears. For low percentages of tin use 0.01 *N* solutions, for higher (greater than 0.1 per cent) use 0.1 *N* solutions. Standardize the solutions against a sample of pure tin in the same manner.

Sulfide-Iodometric Method. Another method for the volumetric determination of tin is based on the conversion of stannic tin to potassium oxalatostannate, $K_6Sn_2(C_2O_4)_7$, by the addition of potas-

²⁴ Okell and Lumsden, *Analyst*, **60**, 803 (1935).

sium oxalate.²⁵ This is then converted to dipotassium dioxalatothiometastannate, $K_2SnS(C_2O_4)_2$, by the addition of potassium sulfide or hydrogen sulfide to give a final pH of approximately 3.3. The excess of hydrogen sulfide is then removed by a current of carbon dioxide and the sulfide in the compound titrated with iodine. The equations for these reactions are:

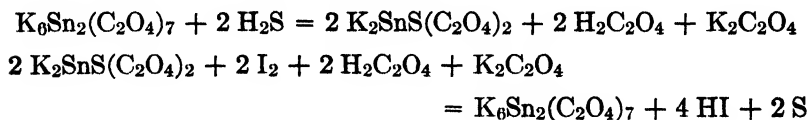

An inert atmosphere is not required during the titration except to remove the excess of hydrogen sulfide. The method is satisfactory in the presence of many other metals but in the presence of considerable amounts of foreign metals the tin is best first separated as metastannic acid.

Procedure for the Determination of Tin by the Sulfide-Iodometric Method. For the analysis of samples containing large amounts of lead or copper a preliminary separation of the tin as metastannic acid is necessary. In the case of a high tin bearing metal containing small quantities of antimony and copper, the antimony and copper may be removed as sulfides prior to carrying out the titration.

If the tin is to be separated first, dissolve 1 g. of the sample in 5 ml. of concentrated nitric acid. After the reaction has ceased, add 30 ml. of water and some filter paper pulp and allow the mixture to digest for 30 minutes. Filter the mixture hot using a fine filter and wash several times with hot water. Transfer the filter paper and contents back to the original beaker. Add 2 ml. of concentrated sulfuric acid and 10 ml. of concentrated nitric acid and heat to destroy the filter paper. Add more nitric acid if necessary and then evaporate to sulfuric acid fumes. Add 0.5 g. of hydroxylamine sulfate or hydrazine sulfate to the concentrated sulfuric acid solution, and heat strongly until all of the reducing agent is decomposed; this point can be recognized as that when all evolution of gas has ceased. This reduces any antimony present to the trivalent state and prevents the precipitation of antimonious sulfide later. If the amount of antimony is large add 5 g. of potassium chloride to the

²⁵ Wheeler, *Analyst*, **63**, 883 (1938); Willard and Toribara, *Ind. Eng. Chem., Anal. Ed.*, **14**, 716 (1942); *J. Amer. Chem. Soc.*, **64**, 1759, 1762 (1942).

concentrated sulfuric acid solution; this will aid in keeping the antimony in solution. Cool the solution and add 2-3 g. of solid potassium oxalate to the concentrated acid solution. Wash the sides of the beaker and the cover glass with about 20 ml. of wash liquid made by dissolving 5 g. of oxalic acid in 1 liter of water and adding potassium oxalate to a pH of 3. At this point and during the subsequent addition of potassium oxalate all of the solid will not dissolve because considerable potassium bioxalate is formed. Add thymol blue indicator and continue to add solid potassium oxalate until a pH of 2.5 is obtained as evidenced by the disappearance of all of the red tint of the indicator. Heat the solution, about 60 ml. in volume, to 60° and, with mechanical stirring, add dropwise 3.5 ml. of potassium sulfide solution prepared by saturating with hydrogen sulfide gas a solution of 20 g. of potassium hydroxide in 100 ml. of water. Cover the beaker with a split watch glass since considerable gas is evolved. Hold the temperature at 60° for 5 minutes to insure decomposition of the excess potassium sulfide and to insure complete reaction with the tin. Add a few drops more of the potassium sulfide solution, continue heating for 1 minute, and cool the solution to room temperature under a stream of cold water. Neither the temperature nor the time of heating is critical and temperatures between 55 and 80° for periods of from 3 to 10 minutes are satisfactory. Continue the determination as described in the second paragraph below.

If the amounts of antimony and copper are small and these elements are to be removed as the sulfides, dissolve a sample of about 0.15 g. in a mixture of 2 ml. of 18 N sulfuric acid and 1 ml. of concentrated nitric acid. Cool and add 2-3 g. of solid potassium oxalate to the concentrated acid solution. Wash down with about 20 ml. of wash liquid made by dissolving 5 g. of oxalic acid in 1 liter of water and adding potassium oxalate to a pH of 3. At this point and during the subsequent addition of potassium oxalate, all the solid will not dissolve because much potassium bioxalate is formed. Continue to add solid potassium oxalate until a pH of 2.5 is attained as shown by the disappearance of the red color of a few drops of thymol blue added to the solution. Heat the solution, about 60 ml. in volume, to 60° with mechanical stirring and add dropwise 3.5 ml. of a potassium sulfide solution prepared by saturating with hydrogen sulfide gas a solution of 20 g. of potassium hydroxide in 100 ml. of

water. Cover the beaker with a split watch glass since considerable gas is evolved. Filter off the precipitate of the sulfides of antimony and copper using a small funnel fitted with a Witte plate on which is placed a filter paper covered with asbestos. Wash out the beaker with about 50 ml. of hot wash solution prepared by dissolving 5 g. of oxalic acid in 1 liter of water and adding potassium oxalate to a pH of 3. With constant stirring, heat the solution to 60°, add 0.5 ml. of potassium sulfide solution, and heat for a few minutes. Cool the solution to room temperature. At this point the volume should be sufficiently great (about 120 ml.) to prevent the precipitation of any solid material which would occlude some of the sulfur compound.

Continue the stirring and pass carbon dioxide through the solution until the escaping gas gives no test for hydrogen sulfide with lead acetate paper. Carbon dioxide taken from a cylinder will cause the deposition of solid material by evaporation in the inlet tube and may clog it; this difficulty may be eliminated by bubbling the carbon dioxide through water before passing it into the solution.

Titrate the solution with a standard iodine solution, going slightly past the end-point. Add starch solution and back titrate with standard thiosulfate.

Hydrogen sulfide gas may be used in place of potassium sulfide, but the time required for the reaction will be greater and more potassium oxalate will be needed.

Standardize the iodine solution against pure metallic tin or against arsenic trioxide.

COLORIMETRIC DETERMINATION

The determination of small amounts of tin is of some importance, particularly in connection with the contamination of foodstuffs from contact with tin cans. A recent bibliography of these methods indicates a variety of approaches to this problem.²⁶ The most convenient colorimetric method for tin is that employing the red coloration stannic salts yield with 1-methyl-3,4-dimercaptobenzene, a reagent known as *dithiol*.²⁷

²⁶ Pope, *Analyst*, **58**, 398 (1933).

²⁷ Clark, *Analyst*, **61**, 242 (1936); **62**, 661 (1937); Stone, *Ind. Eng. Chem., Anal. Ed.*, **13**, 791 (1941); De Giacomi, *Analyst*, **65**, 216 (1941).

THE DETERMINATION OF LEAD

In nature lead is found as the sulfide, galena, PbS , as the sulfate, anglesite, $PbSO_4$, as the carbonate, cerussite, $PbCO_3$, and in a variety of other forms of minor importance. Practically all lead is derived from sulfide deposits. The multitude of uses of lead, in storage batteries, cable covers, pipe, shot, solder, type metal, numerous alloys, and pigments make its determination a frequent one. The toxic nature of lead makes its identification and determination in small amounts of great importance.

SEPARATION AND GRAVIMETRIC DETERMINATION

Lead may be separated as the sulfate from all metals except the alkaline earths, calcium, strontium, barium, and radium. Complete precipitation of lead as the sulfate occurs only when all other acids have been expelled by evaporation to fumes of sulfuric acid. Since lead sulfate is appreciably soluble,²⁸ dilute sulfuric acid must be used for transferring and washing the precipitate. When tin, antimony, or bismuth are present, the solution must contain at least 15 per cent of sulfuric acid to prevent the precipitation of basic salts of these metals and the wash solution must be of the same concentration until these metals are removed, and even then the lead sulfate is always contaminated. Lead sulfate may be freed from these metals by dissolving it in ammonium acetate and filtering off the stannic hydroxide and impurities, after which the clear solution may be evaporated with sulfuric acid and the lead sulfate recovered. This also removes barium sulfate and other insoluble substances, but a part of any calcium sulfate present accompanies the lead sulfate.²⁹ Lead may also be precipitated by the addition of sulfuric acid to a solution containing hydrofluoric acid and thus separated from tin, arsenic, and antimony.³⁰

Lead sulfate is easily reduced by carbon from filter paper so that lead sulfate should always be filtered on a Gooch or other type of filtering crucible. The final ignition of lead sulfate should be made with all reducing gases carefully excluded and at a barely visible red heat,³¹ for above 700° sulfur trioxide is given off and

²⁸ Craig and Vinal, *J. Research Nat. Bur. Standards*, **22**, 55 (1939).

²⁹ Scott and Alldredge, *Ind. Eng. Chem., Anal. Ed.*, **3**, 32 (1931).

³⁰ Scherrer, *J. Research Nat. Bur. Standards*, **21**, 95 (1938).

³¹ Nichols and White, *Ind. Eng. Chem., Anal. Ed.*, **13**, 251 (1941).

a basic sulfate remains. See Willard and Furman, 3rd Ed., pp. 437-440.

Precipitation as the molybdate serves to separate lead from zinc, nickel, cobalt, and manganese; copper and cadmium are coprecipitated.³²

Lead molybdate is soluble in hydrochloric acid or nitric acid but less soluble in perchloric acid of the same concentration and it is insoluble in dilute acetic acid. If precipitated by the addition of ammonium molybdate to a nearly neutral solution, or one free from other salts, it is colloidal and difficult to filter. The precipitate is much more satisfactory if precipitated slowly from a hot solution containing a little free hydrochloric acid or nitric acid (8 drops per 100 ml.) in which the precipitate is somewhat soluble, the last traces being thrown down by the addition of sufficient ammonium acetate to combine with the free acid.³³ The precipitate usually contains a slight excess of molybdic oxide which may be removed by a reprecipitation. Lead molybdate is ignited at a low red heat and weighed as such. No reduction occurs during the ignition if reasonable care is taken.

Precipitation of lead as the chromate from a dilute nitric acid solution is reported to give an excellent separation of lead from copper, silver, nickel, manganese, zinc, cadmium, aluminum, ferric iron, and even the alkaline earths.³⁴ The precipitation can advantageously be made from a dilute perchloric acid solution,³⁵ or from an acetic acid-ammonium acetate solution.³⁶ The precipitate is ignited at a low red heat and weighed as lead chromate.

Lead may be separated from the metals of the iron, zinc, and calcium groups of the qualitative analysis scheme by precipitation as the sulfide, PbS, from a solution 0.5 *N* in hydrochloric acid, the sulfide being converted to the sulfate or molybdate for weighing.

Lead can also be separated from nickel, copper, zinc, cadmium, aluminum, calcium, and manganese by precipitating it as triplumbous paraperiodate, $Pb_3H_4(IO_6)_2$, from 0.025 *N* nitric acid solution

³² Pass and Ward, *Analyst*, **58**, 667 (1933).

³³ Weiser, *J. Phys. Chem.*, **20**, 660 (1916).

³⁴ Karaoglanov and Michov, *Z. anal. Chem.*, **103**, 113 (1935).

³⁵ Willard and Kassner, *J. Amer. Chem. Soc.*, **52**, 2391, 2402 (1930); Brown, Moss and Williams, *Ind. Eng. Chem., Anal. Ed.*, **3**, 134 (1931).

³⁶ Guzelj, *Z. anal. Chem.*, **104**, 107 (1936).

by the addition of sodium periodate, NaIO_4 . The precipitate can be weighed or determined volumetrically.³⁷

The electrodeposition of lead on the anode as the dioxide, PbO_2 , from a solution containing 15 ml. of concentrated nitric acid per 100 ml. serves to separate lead from all the common metals but silver, bismuth, and manganese, which form peroxides at the anode, and chromium, antimony, arsenic, tin, phosphate, and chloride which either contaminate the deposit or hinder precipitation. A study of the factors affecting the electrodeposition has been made³⁸ and the mechanism of the electrodeposition of lead dioxide discussed.³⁹ The lead dioxide obtained by electrodeposition at the anode usually contains a slight excess of oxygen or some water so that the empirical factor 0.8640 instead of the theoretical 0.8662 is used in converting the lead dioxide to lead. Consult Willard and Furman, 3rd Ed., pp. 440-442, for details regarding the procedure.

A precipitate of calcium phosphate plus calcium carbonate was found to be a suitable gathering agent for collecting a small amount of lead present in an ammoniacal solution containing a large amount of copper. The lead can be readily recovered as the sulfide.⁴⁰

VOLUMETRIC DETERMINATION

The common volumetric methods for lead involve its precipitation as chromate or molybdate. The chromate method is more reliable but both of these methods are more or less empirical and the solutions must be standardized under exactly the same conditions. The lead is first separated as sulfate, which is dissolved in ammonium acetate acidified with acetic acid. In the chromate method an excess of potassium bichromate is added, the precipitate of lead chromate filtered off and dissolved in dilute hydrochloric acid (the presence of considerable sodium chloride facilitates this), potassium iodide added, and the liberated iodine titrated with thiosulfate. Or, an excess of standard bichromate is added, the lead chromate filtered off and the excess titrated.

The precipitation may be made from a perchloric acid solution

³⁷ Willard and Thompson, *J. Amer. Chem. Soc.*, **56**, 1828 (1934); *Ind. Eng. Chem., Anal. Ed.*, **6**, 425 (1934).

³⁸ Schrenk and Delano, *Ind. Eng. Chem., Anal. Ed.*, **3**, 27 (1931).

³⁹ Nichols, *Ind. Eng. Chem., Anal. Ed.*, **3**, 385 (1931).

⁴⁰ Park and Lewis, *Ind. Eng. Chem., Anal. Ed.*, **7**, 182 (1935).

in which lead chromate is less soluble than in nitric or hydrochloric acid solutions.³⁵

In the molybdate method the acetate solution is titrated with ammonium molybdate, precipitating lead molybdate.

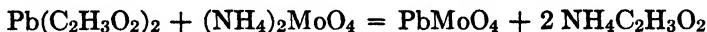

A solution of tannic acid or pyrogallol in chloroform used as external indicator gives a yellow or brown color with an excess of molybdate.

The periodate of lead may be dissolved in concentrated hydrochloric acid containing an excess of standard arsenite

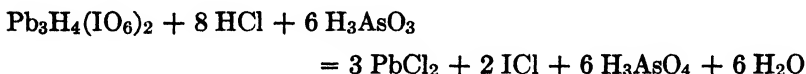

the excess of which is titrated with standard iodate, using chloroform as indicator.³⁷

COLORIMETRIC DETERMINATION

The importance of the determination of small amounts of lead has stimulated a large number of investigations of the colorimetric methods for determining lead. Several surveys of the various methods have been made.⁴¹ Of the various methods, the dithizone method has perhaps received the most attention.

The dithizone method is based on the change in the green color of a solution of diphenylthiocarbazone in chloroform when shaken with a neutral or ammoniacal solution containing lead. It has been applied to the determination of lead in a variety of biological and agricultural materials and the conditions and interfering elements have been well established;⁴² the extraction of lead dithizonate is best made from a solution having a *pH* of 8-9 and containing citrate and cyanide. The addition of a reducing agent such as hydroxylamine or sulfite aids in avoiding the formation of oxidation products of dithizone and in decreasing the interference by iron and tin.

Small amounts of lead may also be conveniently isolated by electrodeposition as metallic lead^{43,44} and they may also be determined

⁴¹ Cholak, Hubbard, McNary and Story, *Ind. Eng. Chem., Anal. Ed.*, **9**, 488 (1937).

⁴² Bambach, *Ind. Eng. Chem., Anal. Ed.*, **11**, 400 (1939); Kozelka and Kluchesky, *ibid.*, **13**, 492 (1941); Biefeld and Patrick, *ibid.*, **14**, 275 (1942).

⁴³ Bambach and Cholak, *Ind. Eng. Chem., Anal. Ed.*, **13**, 504 (1941).

⁴⁴ Cholak and Bambach, *Ind. Eng. Chem., Anal. Ed.*, **13**, 583 (1941).

polarographically.⁴⁴ Studies comparing the various methods for determining small amounts of lead have been published.^{42, 45}

PERIODIC GROUP V

The members of this group are nitrogen, phosphorus, arsenic, antimony, and bismuth and the elements of the B subgroup vanadium, columbium, tantalum, and protoactinium.

The members of the A subgroup are primarily acid-forming elements. Their acidities decrease with increasing atomic weight; antimony is only very weakly acidic and bismuth is chiefly a basic or metallic element. Elements of this group have valences of 3 and 5, although phosphorus and nitrogen, particularly the latter, have other valences of importance. Vanadium displays the valences of 2, 3, 4, and 5, being basic in the lower valences but acidic in the highest. Columbium and tantalum, together spoken of as the *earth acids*, are quinquevalent in most reactions; columbium also has a fairly stable valence of 3. Both columbium and tantalum are exclusively acidic in nature.

THE DETERMINATION OF NITROGEN

In addition to its occurrence in the free state in the atmosphere, nitrogen is found in arid regions in great amounts as inorganic nitrates, principally as sodium nitrate. Nitrogen plays an important role in the chemistry of the organic compounds and is essential to all plant and animal life. The determination of nitrogen in its various forms is thus a matter of great importance.

The complexity of the chemistry of nitrogen multiplies the problems of the analyst. The methods of detecting and identifying inorganic nitrogen, such as ammonia, nitrite, and nitrate, are commonly known. The identification of organic nitrogen compounds, however, constitutes an important phase of organic chemistry and is an enormous subject in itself. A simple test for the presence of nitrogen in organic materials involves fusion of the material with metallic sodium, which reduces the nitrogen to cyanide; the cyanide is then converted to ferrocyanide by treatment with ferrous sulfate

⁴⁴ Hubbard, *Ind. Eng. Chem., Anal. Ed.*, **9**, 493 (1937); Morton, *Analyst*, **61**, 465 (1936).

and the ferrocyanide, precipitated as *Prussian Blue* by the addition of a ferric salt.

SEPARATION AND DETERMINATION

Nitrogen as ammonia is determined by distilling off the base liberated by treatment with a fixed alkali. The ammonia is collected in an excess of standard acid which is back titrated with a standard base, using methyl red as indicator. Organic materials having the nitrogen in its lowest valence state (amino nitrogen) may be decomposed by the *Kjeldahl Method*, in which the material is digested with concentrated sulfuric acid and a catalyst which converts the nitrogen to ammonium sulfate, which is then determined as just described; higher valence forms of nitrogen must be given a preliminary reduction. The Kjeldahl method is discussed in detail in Willard and Furman, 3rd Ed., pp. 157-160.

Nitrogen of all forms in organic materials may be determined by the Dumas method in which the material is oxidized by copper oxide in an atmosphere of carbon dioxide and the volume of the free nitrogen liberated measured after collection over potassium hydroxide. This method is discussed in detail in texts dealing with the ultimate analysis of organic compounds.

The determination of nitrite nitrogen may be made volumetrically by titration with permanganate in neutral solution. For the determination of small amounts of nitrite, such as might be present in a water, sensitive colorimetric methods are available based on the diazonium reaction of nitrous acid and an organic amine. The intermediate diazonium salt, usually of sulfanilic acid, is coupled with an organic amine, usually α -naphthylamine, yielding an intensely red solution which may be compared with standards.¹

For the determination of nitrate nitrogen, several methods are available. Nitric acid yields a fairly insoluble salt with nitron, a complex heterocyclic nitrogen base, diphenylendoanilohydrotriazole, $C_{20}H_{16}N_4$ (see p. 86). Precipitation is made from a solution containing about 1 per cent acetic acid. Perchlorate, iodide, thiocyanate, chromate, nitrite, and bromide also yield more or less soluble precipitates with the reagent.

Nitrate may be determined volumetrically by reduction with ferrous sulfate to nitric oxide in strong hydrochloric acid solution

¹ American Public Health Association, *Standard Methods for the Examination of Water and Sewage*, 8th Ed., New York, 1936, p. 46.

with molybdate as catalyst, and the excess of the ferrous salt back titrated with bichromate.²

Nitrate may also be reduced to ammonia which may be distilled from a fixed alkali and determined as mentioned above. The reduction is usually made in an alkaline solution with *Devarda's Alloy*, an alloy containing 50 per cent copper, 45 per cent aluminum, and 5 per cent zinc.

A number of colorimetric methods are available for the determination of small amounts of nitrate. The phenoldisulfonic acid method, the one most commonly used, is based on the nitration of phenoldisulfonic acid by the nitric acid liberated in the presence of concentrated sulfuric acid; the nitrated acid gives a bright yellow soluble compound on dilution and treatment with an excess of potassium hydroxide.³

Several gas analysis methods are available for the determination of nitrogen in various forms; these methods are rapid, accurate, and convenient, though requiring some special apparatus.⁴

THE DETERMINATION OF PHOSPHORUS

Phosphorus compounds are usually identified and determined as phosphoric acid. The methods of separating and determining phosphoric acid are discussed on p. 196 and of decomposing phosphate minerals on p. 34.

THE DETERMINATION OF ARSENIC

The common minerals containing arsenic are arsenopyrite, FeSAs, realgar, As₂S₂, and orpiment, As₂S₃. Practically all the arsenic of commerce, however, is derived as a by-product of copper smelters using sulfide ores. Arsenic is used chiefly as an insecticide in the form of arsenic trioxide and as the arsenates of copper and lead.

² Kolthoff, Sandell and Moskovitz, *J. Amer. Chem. Soc.*, **55**, 1454 (1933).

³ American Public Health Association, *Standard Methods for the Examination of Water and Sewage*, 8th Ed., New York, 1936, p. 48.

⁴ See the section devoted to nitrometer methods in Dennis and Nichols, *Gas Analysis*, The Macmillan Company, New York, 1929, pp. 422-436; also the Van Slyke amino nitrogen apparatus in Morrow, *Biochemical Laboratory Methods*, John Wiley & Sons, Inc., New York, 1935, p. 124.

SEPARATION AND GRAVIMETRIC DETERMINATION

Arsenic is almost always separated from other metals by the distillation of the volatile trichloride, AsCl_3 , in the presence of concentrated hydrochloric acid and some reducing agent, such as cuprous chloride or hydrazine.⁵ The presence of bromide greatly facilitates the reduction of arsenic acid. The hydrazine reduction method is the best one because the residue may be used for the determination of other metals, the excess of reagent being easily destroyed; it will therefore be described in detail. The reactions are

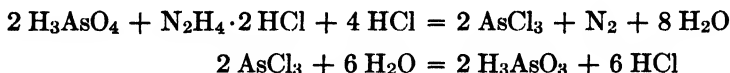

Arsenic trichloride does not exist in aqueous solution. The arsenious acid is conveniently titrated with bromate. The distillation method serves to separate arsenic from all other metals except germanium. Antimony and tin may also be distilled, but antimony requires a higher temperature than arsenic, so that a separation is possible, and tin does not distill at all if phosphate is present. Following the successive distillation of arsenic and antimony, tin may be distilled by the addition of hydrobromic acid. It is recommended that an all glass apparatus be used in these distillations as rubber stoppers or tubing absorb the volatile chlorides in varying amounts and release it from time to time.⁶

Trivalent arsenic may be completely volatilized by evaporation with hydrofluoric acid and sulfuric acid, while quinivalent arsenic is not affected.⁷

Small amounts of arsenic may be accurately determined by reduction to metal by stannous chloride or hypophosphorous acid, H_3PO_2 , in concentrated hydrochloric acid solution. The arsenic may then be dissolved in an excess of a standard iodine solution or dissolved in hot, concentrated sulfuric acid, reduced with a sulfite, and titrated with bromate. The method is applicable to tin, bearing metals, and lead.⁸

Arsenic cannot be determined electrolytically, since a portion of the arsenic is reduced to arsine, AsH_3 , which escapes as a gas.

⁵ Jannasch and Seidel, *Ber.*, **43**, 1218 (1910).

⁶ Scherrer, *J. Research Nat. Bur. Standards*, **16**, 253 (1936).

⁷ Allen and Zies, *J. Amer. Ceram. Soc.*, **1**, 739 (1918).

⁸ Andrews and Farr, *Z. anorg. Chem.*, **62**, 123 (1909); Brandt, *Chem. Ztg.*, **37**, 1445 (1913); Anderson, *Ind. Eng. Chem., Anal. Ed.*, **9**, 569 (1937).

Arsenic may be separated from most metals except tin by precipitation as sulfide in concentrated hydrochloric acid solution, but the precipitate is rarely pure. This is valuable mainly as a concentration method for small amounts.

Arsenic may be weighed as magnesium pyroarsenate, $Mg_2As_2O_7$; the gravimetric method is rarely used, however. The arsenic is oxidized to arsenic acid, usually by nitric acid or by hydrogen peroxide in an ammoniacal solution. Magnesium chloride, ammonium chloride, and then an excess of ammonia are added, and after standing 12 hours, the precipitate of magnesium ammonium arsenate, $MgNH_4AsO_4$, is filtered off on a Gooch crucible, washed with as little dilute ammonia (1 : 7) as possible, and ignited to the pyroarsenate in an electric muffle or in a current of air or oxygen to avoid reduction by flame gases. Magnesium ammonium arsenate is appreciably soluble in dilute ammonia, about 1 mg. of arsenic per 100 ml.; alcohol may be added to reduce the solubility.

Very small amounts of arsenic are determined by special methods, many descriptions of which will be found in the literature.⁹

Procedure for the Separation of Arsenic by Distillation of the Trichloride. *The Distillation Apparatus.* A suitable distillation apparatus for this purpose is the all glass modification of Scherrer; see Fig. 39. The 50 ml. dropping funnel *A* is used to introduce the sample and the acids added during the course of the distillation. The long stem of the dropping funnel is necessary to overcome the pressure of the carbon dioxide introduced through the side arm of *B*. The somewhat constricted stem of the funnel remains filled with acid so that the rate of addition of acid may be judged by the number of drops falling into *B*. The distilling flask *C* has a capacity of 200-300 ml., carries a thermometer well, and is connected to the condenser by a ground glass joint at *D*, rubber bands being used to hold the parts together. The ground glass joint *D* is lubricated by the viscous liquid obtained by exposing phosphorus pentoxide to air for some time or more rapidly by grinding together phosphorus pentoxide and a little phosphoric acid. The end of the condenser dips into a beaker containing 50-100 ml. of water which collects the chlorides which distill over. To facilitate emptying the flask with quantitative recovery of the contents, a short glass tube having a right angle bend is connected at *D* in place of the condenser; the

⁹ How, *Ind. Eng. Chem., Anal. Ed.*, **10**, 226 (1938).

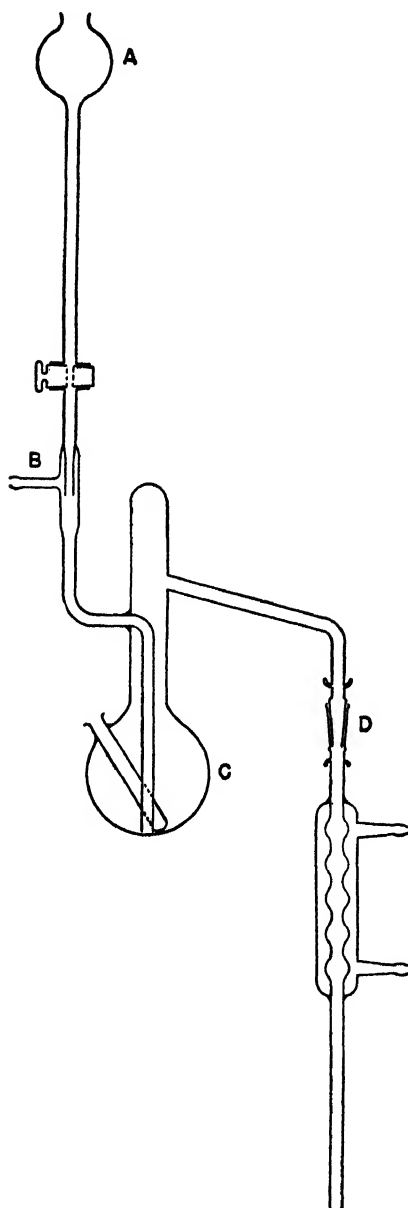

FIG. 39. Apparatus for the Distillation of Arsenic, Antimony, and Tin.

flask is then emptied through the side arm and wash solution introduced through the dropping funnel.

The arsenic solution may contain sulfuric acid or phosphoric acid but any nitric acid must be first removed by evaporation to gentle dryness. If the solution was previously diluted, evaporate until not more than 20-25 ml. of water are present (in addition to the sulfuric acid present), and transfer to the distilling flask, washing in the solution with a total of 100 ml. of concentrated hydrochloric acid. Dissolve 3 g. of hydrazine sulfate or chloride in 10 ml. of water and add it to the flask. Place 50 ml. of water in a 400 ml. beaker and place so the end of the condenser dips below the level of the water. Bring the solution to a gentle boil and pass carbon dioxide through the apparatus at the rate of three or four bubbles per second. Distill until the temperature of the distillation is 111-112°. Small amounts of arsenic will have been quantitatively distilled at this stage; for larger amounts of arsenic, add 25 ml. of water and 25 ml. of concentrated hydrochloric acid and continue the distillation until the temperature rises just above 112°. If antimony is to be determined, exchange receivers and continue as described under the distillation of antimony.

Titrate the arsenic trichloride in the receiver with bromate as described on p. 344.

VOLUMETRIC DETERMINATION

Volumetrically arsenic is usually determined by the titration of arsenious acid with various standard oxidizing agents. The titration with iodine must be made in strictly neutral solution containing a boric acid-borate buffer or an excess of bicarbonate, see Willard and Furman, 3rd Ed., pp. 276-281. Titration with potassium bromate in strong hydrochloric acid solution is an excellent method, since the concentration of hydrochloric acid may vary considerably provided it is not below 10 per cent of the total volume, and since hydrochloric acid solutions are always obtained when arsenic is separated by distillation. The reaction is:



The indicator used is methyl orange, the slightest excess of bromate oxidizing the dye to a colorless compound; the color cannot be made to reappear. Various other irreversible indicators have been sug-

gested.¹⁰ Directions for the bromate titration are given below. Arsenious acid may be titrated with permanganate but the reaction is slow unless a catalyst is used; see the standardization of permanganate against arsenic trioxide, p. 95.

Arsenic may also be determined when present in the quinquevalent form by adding potassium iodide and sufficient hydrochloric acid to give a concentration not less than 4.5 *N* at the end of the titration and titrating the liberated iodine with thiosulfate. The solution must stand in an atmosphere free from oxygen for five minutes before titration.¹¹ Potassium iodide may be used as the standard solution if the end-point is determined electrometrically.¹²

Still another oxidation-reduction method for arsenic is based on the reduction of the arsenic to the metal by hypophosphorous acid and the oxidation of the arsenic to the quinquevalent state by standard ceric sulfate the excess of which is back titrated; this method is well adapted to the determination of small amounts of arsenic.¹³

Arsenic acid may be determined by the Volhard method in which silver arsenate is precipitated from a neutral solution, the precipitate filtered off and dissolved in nitric acid, and the silver then titrated with thiocyanate.¹⁴

Procedure for the Volumetric Determination of Arsenic Using Bromate. Dissolve the arsenious oxide in sodium hydroxide, acidify with hydrochloric acid, add 20-25 ml. excess of concentrated hydrochloric acid, and dilute to a volume of 100-150 ml. If the arsenic has been separated by distillation as the trichloride, it is all in the trivalent form and there is probably enough free hydrochloric acid present from the distillation, depending on the volume of water placed in the receiver and the amount of distillate; add enough more acid to make the solution at least 10 per cent by volume of hydrochloric acid.

Heat the solution to 80° but do not boil as arsenic trichloride may be volatilized. Add sufficient methyl orange to give the solution a good pink color and titrate with standard bromate until the

¹⁰ Smith and May, *Ind. Eng. Chem., Anal. Ed.*, **13**, 460 (1941).

¹¹ Kolthoff, *C.A.*, **14**, 34 (1920).

¹² Robinson and Winter, *J. Ind. Eng. Chem.*, **12**, 775 (1920).

¹³ Kolthoff and Amdur, *Ind. Eng. Chem., Anal. Ed.*, **12**, 177 (1940).

¹⁴ Low, Weinig and Schoder, *Technical Methods of Ore Analysis*, John Wiley & Sons, Inc., New York, 1939, p. 53; Waddell, *J. Ind. Eng. Chem.*, **11**, 939 (1919).

color just disappears. Add the bromate slowly toward the end, since it sometimes requires several seconds to complete the reaction and the end-point is easily overstepped; this is especially true if the solution is not hot enough or if too little hydrochloric acid is present. The color of the indicator becomes fainter toward the end; sometimes it is necessary to add a little more. It is better to add the indicator after most of the bromate has been run in. Run a blank using the same amounts of hydrochloric acid and methyl orange; the blank is usually very small.

The standard solution of potassium bromate may be made up by weight, if pure, but it is best to standardize it against pure arsenic trioxide.

COLORIMETRIC DETERMINATION

Arsenic may be determined colorimetrically by the blue color formed when a solution containing an arsenate and a molybdate is treated with a reducing agent such as hydrazine; this method has been applied to a variety of materials after separation of the arsenic in various ways.¹⁵

Very small amounts of arsenic may be isolated by evolution in the form of arsine and determined colorimetrically by the Gutzeit method. The modified Gutzeit method^{15a} commonly used depends upon the evolution of arsine by the action of hydrogen on arsenic compounds under the catalytic action of zinc, the reaction taking place either in alkaline or acid solutions. The evolved arsine reacts with mercuric chloride, forming a colored compound. From the length and intensity of the color stain the amount of arsenic is estimated by comparison with standard stains similarly prepared. The color reaction is carried out on strips of paper sensitized by mercuric chloride or bromide. An accuracy of ± 0.002 mg. to ± 0.004 mg. can be obtained by this method.^{15a}

THE DETERMINATION OF ANTIMONY

The principal ore of antimony is stibnite, Sb_2S_3 . Antimony is used chiefly in bearing alloys and type metal and in lead to give

¹⁵ Rodden, *J. Research Nat. Bur. Standards*, **24**, 7 (1940); Zinzadze, *Ind. Eng. Chem., Anal. Ed.*, **7**, 230 (1935); Sandell, *ibid.*, **14**, 82 (1942); Hubbard, *ibid.*, **13**, 915 (1941).

^{15a} Furman, *Scott's Standard Methods of Chemical Analysis*, 5th Ed., D. Van Nostrand Co., Inc., New York, 1939, p. 101.

it hardness for use as cable covering and storage battery plates. Antimony is used in the manufacture of certain pharmaceuticals and of enamel on kitchen ware.

SOLVENTS FOR METALLIC ANTIMONY

The best solvents for metallic antimony and its alloys are (1) boiling, concentrated sulfuric acid, which gives a solution containing only trivalent antimony if the boiling is stopped as soon as all the metal is dissolved; (2) nitric acid containing tartaric acid; (3) concentrated hydrochloric acid containing bromine, nitric acid, or potassium chlorate. The two latter methods usually give a mixture of the two forms of antimony. In hot hydrochloric acid solution, antimony is readily reduced to the trivalent form by sulfur dioxide, the excess being expelled by boiling, a current of air or carbon dioxide aiding the removal, and by stannous chloride, the excess being removed by mercuric chloride as in the iron titration. Metallic antimony is practically insoluble in hydrochloric acid and absolutely so if hydriodic acid or a similar reducing agent is present.¹⁶

Antimonous chloride may be lost by volatilization when its solution is evaporated nearly to dryness, although it is not nearly as volatile as arsenious chloride; no loss of antimonous chloride need be feared below 120° if a moderate amount of hydrochloric acid is present; potassium chloride also decreases the volatility somewhat. Antimonic solutions are only slightly volatile. Antimony is not lost from a sulfate solution.

SEPARATION AND GRAVIMETRIC DETERMINATION

Antimony cannot be completely separated by nitric acid as is the case with tin, since the antimonic acid formed is slightly soluble; but if one and a half times its weight of tin is present the antimony and tin are separated quantitatively together. The precipitate is never pure and the purification is troublesome (see tin, p. 325, and Willard and Furman, 3rd Ed., p. 434). On ignition, antimonic acid yields the tetroxide, Sb_2O_4 , which is an accurate method for weighing antimony if the ignition is made at 820-850°. Above this temperature oxygen is lost and below it the precipitate contains an excess of oxygen. Antimony sulfide may be converted to the oxide for weighing, but the operation is troublesome.

¹⁶ Andrews, *J. Amer. Chem. Soc.*, **17**, 869 (1895).

Precipitation of antimony as the sulfide, Sb_2S_3 , from a fairly concentrated hydrochloric acid solution separates antimony from all metals except copper, silver, mercury, bismuth, and arsenic. Tin does not interfere if the solution contains 15 per cent of hydrochloric acid (4.45 *N*).¹⁷ The precipitation of antimony sulfide is usually made in a hydrochloric acid solution, and if the acid concentration is high, the precipitate is purer and more crystalline; ordinarily it is orange, but in strongly acid solutions it finally turns into the black modification. Antimony may be very accurately weighed as antimonous sulfide.

If the precipitate is heated to 280-300° in an atmosphere of carbon dioxide free from oxygen, to expel most of the chlorine carried down and the excess of sulfur which is always present in sulfides precipitated from acid solution, it still contains a small amount of chlorine, which, however, does not apparently detract from the accuracy of the method.

A better separation of antimony from tin is obtained by precipitating the antimonous sulfide from a solution containing hydrofluoric¹⁸ acid or oxalic acid,¹⁹ from which tin is not precipitated but antimony and most other hydrogen sulfide group metals are completely precipitated.

The sulfides of arsenic, antimony, and tin are soluble in colorless sodium or potassium sulfide, while lead, copper and other sulfides are insoluble. This affords an accurate method of separating these groups of metals but one which is very troublesome. The solution is first made alkaline in the presence of tartrate and sodium sulfide added. The precipitated sulfides, after washing with dilute sodium sulfide, usually contain some antimony or tin and must be dissolved and reprecipitated. The accumulation of sulfide increases the difficulty of the subsequent separation of antimony and tin. The insoluble sulfides of lead, copper, and other metals may be dissolved and separated by suitable methods. The sulfides of antimony and tin may be precipitated together with excess of sulfur by acidifying with sulfuric acid; they may be filtered off, dissolved

¹⁷ Vortmann and Metzl, *Z. anal. Chem.*, **44**, 525 (1905); Panajotow, *Ber.*, **42**, 1296 (1909).

¹⁸ McCay, *J. Amer. Chem. Soc.*, **32**, 1241 (1910); Furman, *ibid.*, **40**, 895 (1918).

¹⁹ Henz, *Z. anorg. Chem.*, **37**, 56 (1903); Thompson, *J. Soc. Chem. Ind.*, **15**, 179 (1896).

in either hydrochloric acid or concentrated sulfuric acid, the sulfur filtered off, and the tin and antimony separated by a suitable method.

Antimony is precipitated as the metal by metallic iron and thus separated from tin, cadmium, and all metals except those which are very easily reduced. The precipitation is best made from a chloride solution containing at least 3 per cent of free hydrochloric acid. This method is accurate as well as rapid. Copper and bismuth are also precipitated; lead is only partially precipitated or not at all; arsenic is partially precipitated; cadmium and the metals of the other groups are not precipitated.

Antimony is also reduced to the metallic state by sodium hydro-sulfite, $\text{Na}_2\text{S}_2\text{O}_4$, in alkaline solution. As might be expected, silver, mercury, bismuth, selenium, lead, and copper are also precipitated but the precipitation of arsenic is incomplete, and cadmium is partially precipitated as sulfide. Nitric acid and other anionic oxidizing agents do not interfere since the reaction is carried out in alkaline solution. In the presence of cyanide, copper is not precipitated while antimony is completely deposited and this is the most important use of this method.²⁰

Distillation of antimonous chloride²¹ at 160° separates antimony from all metals except mercury, any arsenic and germanium having been distilled off at a lower temperature. In the presence of tin, phosphoric acid is added which prevents the tin from distilling. After the antimonous chloride has distilled off, the tin may be distilled at 140° by adding a mixture of hydrochloric acid and hydrobromic acid. Any lead and copper remain in the residue.

The electrodeposition of antimony always leads to high results owing to the presence of some oxygen compounds in the metal. The usual electrolyte is a solution of sodium thioantimonite with excess sodium sulfide. In order to prevent the formation of polysulfide, potassium cyanide is added, which combines with the excess of sulfur to form thiocyanate. A sulfuric acid solution may also be used, but the metal is not very adherent and traces of it are not deposited.

Procedure for the Separation of Antimony by Distillation of Antimonous Chloride. Arsenic having been removed by distillation

²⁰ Evans, *Analyst*, **54**, 395 (1929).

²¹ Plato, *Z. anorg. Chem.*, **68**, 26 (1910); Hartmann, *Z. anal. Chem.*, **58**, 148 (1919); Strecker and Riedemann, *Ber.*, **52**, 1935 (1919); Scherrer, *J. Research Nat. Bur. Standards*, **16**, 253 (1936); **21**, 95 (1938).

(p. 341), antimony may next be separated by distillation. If tin is present, add 7 ml. of syrupy phosphoric acid to the distilling flask, increase the heat gradually until the temperature reaches 155°. If tin is absent, sulfuric acid may be substituted for phosphoric acid. Add concentrated hydrochloric acid at the rate of 30-40 drops per minute, maintaining the temperature between 155° and 165°. Distill over about 75 ml. if the amount of antimony is relatively low, but 150-200 ml. in the case of larger amounts. Exchange receivers and proceed as described under the distillation of tin.

Neutralize the distillate with ammonia and add 5 ml. of hydrochloric acid per 100 ml. of solution. Pass hydrogen sulfide through the solution for 15 minutes. Allow to stand 30 minutes, filter and wash with dilute sulfuric acid (1 : 50) saturated with hydrogen sulfide. Transfer the sulfide and filter paper to a Kjeldahl flask, add 20 ml. of sulfuric acid, allow to stand several minutes stirring the mixture up occasionally. Add 25 ml. of nitric acid, and heat to destroy the filter paper. Evaporate to sulfuric acid fumes to expel the nitric acid, add about 0.2 g. of sulfur and boil gently for 10 minutes to reduce the antimony. Cool, add 25 ml. of water and 10 ml. of hydrochloric acid. Filter through a loose-textured filter paper and wash with dilute hydrochloric acid (1 : 3). A total of 25 ml. of concentrated hydrochloric acid in all should be present. Dilute to 300 ml., boil 5 minutes, cool to 5-10° and titrate with 0.1 *N* potassium permanganate to the appearance of a pink color which should persist for 30 seconds. See volumetric determination of antimony, p. 350.

Procedure for the Separation of Tin and Antimony by Precipitation of Antimony Sulfide in the Presence of Hydrofluoric Acid. To the cold, sulfuric acid solution, from which any lead sulfate has been filtered off, add 5 ml. of hydrofluoric acid and pass in hydrogen sulfide for 1 hour. Filter off the antimony and other sulfides for determination by suitable methods. Add an excess of boric acid, H_3BO_3 , to the filtrate and precipitate the tin as stannic sulfide and ignite to the oxide for weighing. The method is accurate but requires the use of wax-coated glass, bakelite, or platinum vessels.

Procedure for the Separation of Tin and Antimony by Precipitating Antimony Sulfide in the Presence of Oxalic Acid. Dissolve the sulfides in the least possible amount of potassium sulfide and to the solution of potassium thio-salts, containing not over 0.3 g. of the mixed metals, add 6 g. of potassium hydroxide, 3 g. of tartaric acid,

and then 30 per cent hydrogen peroxide until the solution is decolorized. The sulfide is oxidized to sulfate. After boiling a few minutes, cool somewhat and add a hot solution of 15 g. of oxalic acid. The total volume of the solution should be 80-100 ml. Heat the solution to boiling and pass in a rapid current of hydrogen sulfide. For 5-10 minutes only a white turbidity appears, then the solution becomes orange and the antimonous sulfide precipitates. Counting from this time, after 15 minutes, add enough water to bring the volume to 250 ml. After 15 minutes more, reduce the flame and after 10 minutes more stop the hydrogen sulfide and filter the solution through a Gooch crucible. Decant twice with hot, dilute oxalic acid (1 : 99) and twice with very dilute acetic acid, both saturated with hydrogen sulfide. Wash the precipitate with the latter, dry and heat in carbon dioxide to 280-300° for half an hour and weigh as antimonous sulfide, Sb_2S_3 . The precipitate may also be dissolved in hydrochloric acid and the antimony determined volumetrically, see below.

The tin in the filtrate may be precipitated as stannic sulfide. Make the solution alkaline with ammonia, then acid with acetic acid, and pass in hydrogen sulfide. It may also be precipitated by zinc and determined volumetrically.

This separation of tin and antimony is a very accurate one. Other metals will be precipitated with the antimony unless the potassium sulfide separation was used previously. Lead and zinc precipitate as oxalates. The method is applicable either to the sulfides of tin and antimony, as directed above, or to the chloride or sulfate solution, the latter being first neutralized with ammonia, after which the oxalic acid is added.

VOLUMETRIC DETERMINATION

Antimony, like arsenic, is usually determined volumetrically and the methods are very similar. Solutions of antimonous chloride may be titrated in strongly acid solutions with bromate, permanganate, or with iodate, and in neutral solutions, containing tartrate to prevent the precipitation of antimonous hydroxide, with iodine. Antimonic chloride may be treated with hydrochloric acid and an iodide, and the liberated iodine titrated with thiosulfate. The bromate and permanganate methods are the most commonly used, but a comparison of the bromate, permanganate, and iodine procedures

has shown that there is little choice between the three as far as accuracy or convenience is concerned.²²

Antimony is generally reduced to the trivalent state by boiling the strongly acid solution with a sulfite. Arsenic, if present, is also reduced and of course will then interfere in any of the titration procedures; small amounts of arsenic are easily eliminated as the volatile trichloride by a short boiling of the hydrochloric acid solution, and with larger amounts the same procedure may be used if care is exercised not to also distill away antimony as the trichloride. The reduction of antimonous salts may also be made in hydrochloric acid solution by shaking with mercury; mercurous chloride is formed which is filtered off with the excess metallic mercury. Arsenic, tin, cadmium, and bismuth do not interfere, but copper causes some complication.²³

Besides hydrochloric acid plus bromine, which is a good solvent for base metal alloys, hot, concentrated sulfuric acid is also a good solvent; fusion with potassium acid sulfate or with sulfuric acid containing a large portion of alkali sulfate, which is more convenient to carry out, has also been recommended. Hot, concentrated sulfuric acid and the acid sulfate fusions oxidize antimony only to antimonous sulfate, if the action is not continued too long, but oxidize tin completely to stannic sulfate; such a solution need only be diluted with a hydrochloric acid solution and the antimony titrated directly by bromate. Stannic salts are not reduced by sulfur dioxide; therefore tin does not interfere with the volumetric determination of antimony. Sulfur dioxide does reduce iron and copper, however, although the interference of the former may be obviated by the addition of phosphoric acid which forms a complex with ferric iron in which the iron is not reduced by sulfur dioxide.

The bromate titration

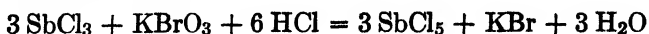

must be carried out in a strong hydrochloric acid solution, at least 20 per cent by volume of concentrated hydrochloric acid, and at a temperature above 60°. Methyl orange is the best indicator, but indigo is used in certain cases where a blue color is more easily distinguished. The dyestuff is bleached by a slight excess of the oxidizing agent. The bromate solution must be standardized against

²² McNabb and Wagner, *Ind. Eng. Chem., Anal. Ed.*, **2**, 251 (1930).

²³ McCay, *Ind. Eng. Chem., Anal. Ed.*, **5**, 1 (1933).

pure antimony.²⁴ The bromate method may be applied to the determination of antimony in solder, tin, and lead.²⁵

Titration with iodate is carried out in a somewhat different way.²⁶

The titration of antimonous salts with permanganate

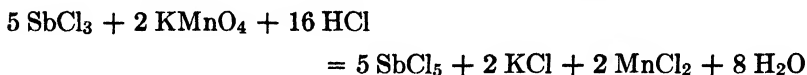

must also be carried out in a strongly acid solution. Several studies have indicated that the best results are obtained in a mixture of hydrochloric acid and sulfuric acid in definite proportions. As the concentration of hydrochloric acid increases the end-point becomes less readily detectable due to the liberation of chlorine, and of course too much permanganate is then used; with the optimum ratio of the two acid concentrations, the end-point persists for at least a minute. In the absence of hydrochloric acid the reduction of permanganate does not proceed quantitatively to bivalent manganese except under very special conditions. The effect of the presence of a precipitate of lead sulfate during the titration is a disputed point.²⁷

Titration with iodine

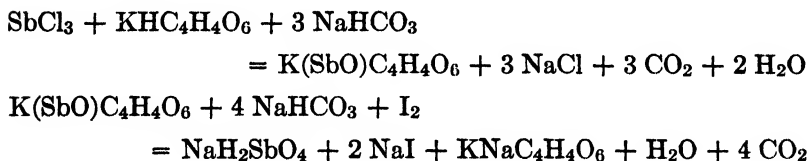

is carried out exactly as with arsenic except that before neutralizing, tartaric acid is added to keep the antimony in solution. The bicarbonate solution must be cool and not too dilute.

In the titration of quinivalent antimony, the antimony is first oxidized to the pentavalent form by alkaline peroxide or by potas-

²⁴ Rowell, *J. Soc. Chem. Ind.*, **25**, 1181 (1906); Wooten and Luke, *Ind. Eng. Chem., Anal. Ed.*, **13**, 771 (1941).

²⁵ Anderson, *Ind. Eng. Chem., Anal. Ed.*, **5**, 52 (1933); **6**, 456 (1934).

²⁶ Andrews, *J. Amer. Chem. Soc.*, **25**, 756 (1903); Lang, *Z. anorg. allgem. Chem.*, **142**, 229, 242 (1925).

²⁷ Knop, *Z. anal. Chem.*, **63**, 81, 96 (1923); Collenberg and Bakke, *ibid.*, **63**, 229 (1923); McNabb and Wagner, *loc. cit.*; Pugh, *J. Chem. Soc.*, **1933**, 1; Barber, *Ind. Eng. Chem., Anal. Ed.*, **6**, 443 (1934); Stanford and Adamson, *Analyst*, **62**, 23 (1937); Robinson, *ibid.*, **62**, 191 (1937).

sium chlorate, the excess of which is destroyed by boiling. Then in a cold solution containing 15 per cent by volume of concentrated hydrochloric acid and in an atmosphere of carbon dioxide, an excess of potassium iodide is added and after a time the liberated iodine titrated with thiosulfate:

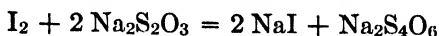

Procedure for the Determination of Antimony by the Bromate Titration. If the antimony was precipitated as sulfide, dissolve the sulfide in hydrochloric acid, boil to expel hydrogen sulfide, filter off any free sulfur, and titrate directly as in the concluding paragraph since all of the antimony will be present in the trivalent condition.

If the hydrochloric acid solution contains some antimonious chloride, reduce the hot solution by the addition of several grams of sodium sulfite and allow to stand for 15-20 minutes; or pass sulfur dioxide through the hot solution for 10 minutes, and boil off the excess sulfur dioxide in a current of carbon dioxide. The reduction is rather slow.

Adjust the acidity to at least 20 per cent by volume of concentrated hydrochloric acid, heat to 70°, add a drop of methyl orange indicator and titrate with bromate to the disappearance of the pink color. Note the precautions given for the bromate titration of arsenic, p. 343. The indicator is prepared by dissolving 0.1 g. of methyl orange powder in 100 ml. of water and filtering.

Proceed for the Volumetric Determination of Antimony by Permanganate Titration. Prepare the solution as described in either of the first two paragraphs under the procedure for the bromate titration, then proceed as follows:

Adjust the acidity of the solution so that it contains one of the following acid concentrations, preferably that having 10 or 20 ml. of sulfuric acid:

In a total volume of 200 ml.

ml. conc. H ₂ SO ₄	0	10	20	30
ml. conc. HCl	30-50	30-35	15-20	10-15

Cool the solution to 5-10° and titrate with 0.1 *N* potassium permanganate to the appearance of a pink color which should persist for 30 seconds. Standardize the permanganate against sodium oxalate or arsenic trioxide as described on p. 95.

Alternatively, the titration may be carried out at 60°, a few drops of methyl orange being added as indicator.

COLORIMETRIC DETERMINATION

Quinquevalent antimony and the organic dyestuff rhodamine B yield a red, water-insoluble compound which is soluble in organic solvents. The excess reagent may be destroyed with bromine and the red antimony-rhodamine B compound dissolved in alcohol and measured colorimetrically. The interferences and conditions have been well worked out.²⁸ The method is quite specific for antimony and useful over the range of 0.1-300 micrograms of antimony.

ANALYSIS OF ALLOYS OF LEAD, ANTIMONY, TIN, AND COPPER

There are in use many alloys containing arsenic, antimony, tin, copper, and lead, such as solder, bearing metal, Babbitt metal, type metal, and others. Their analysis is a matter of considerable importance. The literature on the subject is very extensive, and is scattered throughout various journals and books.²⁹

Arsenic is so readily separated from all other metals by distillation that its determination is quite simple. Other methods are also available for the separation of arsenic; see p. 340.

While it is possible to determine antimony and tin in the presence of each other and in the presence of lead and copper, the determinations are subject to small errors, the results for antimony being somewhat high, those for tin somewhat low,³⁰ so that although the direct methods may be used for rapid, routine control work, more accurate work requires preliminary separations.

In general, lead is separated first as the sulfate, generally after dissolving the sample in hot concentrated sulfuric acid. The solution must contain at least 15 per cent (but not above 20 per cent) sulfuric acid to prevent the hydrolysis of stannic salts. The pre-

²⁸ Fredrick, *Ind. Eng. Chem., Anal. Ed.*, **13**, 922 (1941).

²⁹ For descriptions of the methods in common use see: Wölbinger, *Die Bestimmungsmethoden des Arsens, Antimons, und Zinns*, F. Enke, Stuttgart, 1914; Ibbotson and Aitchison, *The Analysis of Non-Ferrous Alloys*, 2nd Ed., Longmans, Green and Co., New York, 1922; Price and Meade, *The Technical Analysis of Brass and Non-Ferrous Alloys*, J. Wiley & Sons, Inc., New York, 1922; Furman, *Scott's Standard Methods of Chemical Analysis*, 5th Ed., D. Van Nostrand Company, Inc., New York, 1939.

³⁰ Scherrer, *J. Research Nat. Bur. Standards*, **21**, 102 (1938).

precipitate of lead sulfate always carries with it antimony and tin and must be purified by solution in a strong, ammonium acetate solution; the lead is recovered from the ammonium acetate solution by evaporation with sulfuric acid. The precipitate containing the antimony and tin, if very appreciable, will carry some lead which is not extracted by acetate. If the distillation procedure is used to separate the antimony and tin, this lead together with any lead which escaped in the first precipitation in strong sulfuric acid may be recovered in the residue from the distillation.

If the distillation procedure is not used or if the per cent of tin plus antimony is high, a double sodium sulfide separation is advisable although the method is troublesome particularly if the amount of lead and copper is high; the tin and antimony are then separated by the oxalic acid-sulfide procedure, deposition of metallic antimony by iron, or one of the other procedures given under antimony.

Copper may be separated as the thiocyanate immediately after removing the lead, tartaric acid being added to keep antimony and tin in solution; or if the antimony and tin are separated from the solution by distillation, the copper may be determined in the residue.

THE DETERMINATION OF BISMUTH

Bismuth occurs as native bismuth, as bismuthinite, Bi_2S_3 , and as bismite, $\text{Bi}_2\text{O}_3 \cdot \text{H}_2\text{O}$; most bismuth, however, is obtained as a by-product of the electrolytic refining of lead. Bismuth is used in medicine and in low melting alloys and alloys which expand on cooling.

SEPARATION AND GRAVIMETRIC DETERMINATION

Bismuth may be separated from all metals, except silver, arsenic, tin, and antimony by precipitation as bismuthyl chloride, BiOCl . The precipitate may be formed by adding a little hydrochloric acid to a nitrate or perchlorate solution containing just enough acid to keep the solution almost clear, or by pouring a slightly acid, chloride solution into considerable water. If sulfate, phosphate, and arsenate are absent, the precipitate may be dried at 105° and weighed as bismuthyl chloride.

Precipitation of bismuth as the phosphate serves to separate it from silver, copper, cadmium, mercury and the aluminum, zinc, and calcium groups. The precipitation is made from a hot, acid solution

by the addition of phosphoric acid and then of trisodium phosphate until the solution is just acid to rosolic acid indicator. The dense, crystalline precipitate of bismuth phosphate, BiPO_4 , is filtered on a Gooch crucible, washed with water containing 0.5 g. of ammonium nitrate and 2 drops of nitric acid per 100 ml. of water, and then ignited and weighed. This is the best of the methods for bismuth.³¹

In the absence of chloride, bismuth may be precipitated by ammonium carbonate and ignited to the oxide, Bi_2O_3 , for weighing. This separates bismuth from copper and cadmium.

Bismuth may be precipitated as the metal from dilute hydrochloric acid solution by hypophosphorous acid, H_3PO_2 .³² Bismuth may also be deposited electrolytically from sulfuric acid or oxalic acid solutions, but the process must be carried out with cathode potential control.³³

The separation of bismuth from lead is very important. It may be accomplished by precipitation as bismuthyl chloride, BiOCl ; as the basic formate;³⁴ as metallic bismuth by reduction with iron wire;³⁵ or as bismuthyl iodide, BiOI , from a dilute nitric acid solution.³⁶

A survey of the older methods for the determination of bismuth may be found in the book of Moser.³⁷

VOLUMETRIC AND COLORIMETRIC DETERMINATION

The volumetric methods for bismuth are not entirely satisfactory. The most common ones are precipitation as the basic oxalate, followed by solution in acids and titration of the oxalate with permanganate, and precipitation as phosphate by a standard phosphate

³¹ Staehler and Scharfenberg, *Ber.*, **38**, 3862 (1905); Moser, *Z. anal. Chem.*, **45**, 19 (1906); Stähler, *Chem. Ztg.*, **31**, 615 (1907); Schoeller and Waterhouse, *Analyst*, **45**, 435 (1920); Blasdale and Parle, *Ind. Eng. Chem., Anal. Ed.*, **8**, 352 (1936); Schoeller and Lambie, *Analyst*, **62**, 533 (1937).

³² Muthmann and Mawrow, *Z. anorg. Chem.*, **13**, 209 (1897).

³³ Kny-Jones, *Analyst*, **64**, 172, 575 (1939).

³⁴ Little and Cahen, *Analyst*, **35**, 301 (1910); Benkert and Smith, *J. Amer. Chem. Soc.*, **18**, 1055 (1896); Kallmann, *Ind. Eng. Chem., Anal. Ed.*, **13**, 897 (1941).

³⁵ Galletly and Henderson, *Analyst*, **34**, 389 (1909); Schoeller and Waterhouse, *ibid.*, **45**, 435 (1920).

³⁶ Strebinger and Zins, *Z. anal. Chem.*, **72**, 417 (1927); Strebinger and Ortner, *ibid.*, **107**, 14 (1936).

³⁷ Moser, *Die Bestimmungsmethoden des Wismuts*, F. Enke, Stuttgart, 1909.

solution, the excess of which is then titrated with uranyl acetate. Bismuth may also be determined by precipitation as caffeine tetraiodobismuthite and titration of the iodine in the precipitate.³⁸

Very small amounts of bismuth may be determined colorimetrically by conversion into the yellow or orange potassium bismuth iodide, in hydrochloric acid or sulfuric acid solution; a little sulfurous acid or hypophosphorous is added to remove free iodine.³⁹

A soluble yellow orange complex compound,

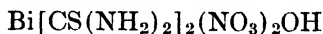

is formed in a nitric acid solution of a bismuth salt on the addition of thiourea and may be used for the colorimetric determination of bismuth; ⁴⁰ dithizone has also been applied to the determination of bismuth.⁴¹

The determination of very small amounts of bismuth, particularly in biological materials, has attracted some attention.⁴²

THE DETERMINATION OF VANADIUM

The analytical chemistry of vanadium was discussed on p. 238.

THE DETERMINATION OF COLUMBIUM AND TANTALUM

Columbium and tantalum, known as the *earth acids*, are usually found together, the important minerals columbite, FeCb_2O_6 , and tantalite, FeTa_2O_6 , being the ends of an isomorphous series containing all proportions of columbium and tantalum. Tantalum metal is finding use in places where extreme hardness or resistance to acids (except hydrofluoric) or alkalis is required.

Columbic and tantallic acids, HCbO_3 and HTaO_3 , are very weak acids and their alkali metal salts hydrolyze very readily precipitating the acids. Fusion of the acids or their oxides, Cb_2O_5 and Ta_2O_5 , with potassium hydroxide or carbonate yields the complex salts, $\text{K}_8\text{Cb}_6\text{O}_{19}$ and $\text{K}_8\text{Ta}_6\text{O}_{19}$, both soluble but easily hydrolyzed; the

³⁸ Beale and Chandlee, *Ind. Eng. Chem., Anal. Ed.*, **14**, 43 (1942).

³⁹ Wiegand, Lann and Kalich, *Ind. Eng. Chem., Anal. Ed.*, **13**, 912 (1941); Sproull and Gettler, *ibid.*, **13**, 463 (1941); Fitter, *Analyst*, **63**, 107 (1938).

⁴⁰ Mahr, *Z. anal. Chem.*, **94**, 161 (1933).

⁴¹ Hubbard, *Ind. Eng. Chem., Anal. Ed.*, **11**, 343 (1939).

⁴² For a bibliography of this work see Pope, *Analyst*, **58**, 607 (1933), and Haddock, *ibid.*, **59**, 163 (1934).

sodium salts are less soluble. The elements are very weak bases so that the hydroxides, or rather, the acids are completely precipitated by hydrolysis of their salts even from strongly acid solutions.

Columbium and tantalum may be separated from most other metals by hydrolysis in strong acid solution, for example, after a bisulfate fusion and solution in hydrochloric acid or in alkaline solution after fusion with hydroxide or carbonate. The elements are weighed as the pentoxides, Cb_2O_5 and Ta_2O_5 . Both of the elements are precipitated by cupferron.

Columbium is distinguished from tantalum by the fact that it may be reduced by zinc in an acid solution to the trivalent state, blue in color, which may be titrated with permanganate. Tantalum is not affected. Both of the elements form complex fluorides, K_2CbOF_5 and K_2TaF_7 , the latter being twelve times more soluble. They are used in preparing pure salts of the elements.

The analytical separation of these elements from titanium and zirconium and especially from each other is a very difficult problem. Schoeller and his students have solved many of the problems in this field in recent years.⁴³ Columbium and tantalum are finding their way into alloy steels and a literature on the subject is beginning.⁴⁴

PERIODIC GROUP VI

The members of the main group of periodic group VI are oxygen, sulfur, selenium, tellurium, and polonium, and the subgroup elements chromium, molybdenum, tungsten, and uranium.

Oxygen, sulfur, selenium, and tellurium all have a valence of -2 . Although oxygen does not exhibit positive valences, sulfur, selenium, and tellurium do; the valences of 4 and 6 are most common, being confined largely to compounds of these elements with oxygen or sulfur. Sulfur is distinctly a non-metal, but selenium and especially tellurium exhibit the characteristics of metals. The few facts known about the radioactive element polonium indicate that

⁴³ A short treatment of the analysis of columbium and tantalum, written by Schoeller, will be found in Furman, *Scott's Standard Methods of Chemical Analysis*, 5th Ed., D. Van Nostrand Company, Inc., New York, 1939, Vol. I, pp. 331-348; for a much larger treatise of the subject see the book by Schoeller: *The Analytical Chemistry of Tantalum and Niobium*, Chapman and Hall, Ltd., London, 1937.

⁴⁴ Silverman, *Ind. Eng. Chem., Anal. Ed.*, **6**, 287 (1934); Cunningham, *ibid.*, **10**, 233 (1938).

it is metallic in nature forming the ion Po^{+++} , an insoluble sulfide, and a dioxide by anodic oxidation.

The elements of the subgroup all have a valence of 6 and in addition a variety of lower valences. They are basic in the lower valence states but acidic in the highest, having many similarities to sulfur. Thus, corresponding to sulfuric acid are chromic acid, H_2CrO_4 , molybdic acid, H_2MoO_4 , and tungstic acid, H_2WO_4 , the strength of the acid decreasing with increasing atomic weight. The lead and barium salts of these acids are insoluble. The corresponding higher oxides melt or sublime at progressively higher temperatures, and this fact is of importance in the ignition of these oxides for weighing, molybdenum trioxide being volatilized about 550° , tungsten trioxide about 700° . Molybdenum and tungsten have a great tendency to form polyacids with silicic, vanadic, and phosphoric acids, the "yellow precipitate" being an ammonium salt of the heteropoly-acid of the latter with molybdic acid. The metals of this group have high melting points and find use in many alloys. Uranium also has a stable valence of 6 in which it exists in combination with two atoms of oxygen and functions as the bivalent uranyl ion, UO_2^{++} .

THE DETERMINATION OF OXYGEN

As the most abundant element on earth, oxygen is very widely distributed as free oxygen, as water, and as the salts and derivatives of oxygen-containing acids.

Free oxygen is detected and determined by the decrease in volume of the gas on absorption of the oxygen in a suitable medium such as alkaline pyrogallol, alkaline hydrosulfite containing anthraquinone- β -sulfonate as catalyst, yellow phosphorus, or chromous chloride. The apparatus, technic, and interfering gases, will be found in books dealing with gas analysis.¹

The absorbents for water were discussed on p. 93.

The determination of oxygen present in chemical combination is a problem which has never been adequately solved. The ter Muelen method for the determination of oxygen in organic compounds has received some recent study. In it the organic material

¹ Dennis and Nichols, *Gas Analysis*, The Macmillan Company, New York, 1929; Lunge-Ambler, *Technical Gas Analysis*, 2nd Ed., D. Van Nostrand Company, Inc., New York, 1934.

is boiled or sublimed into a stream of hydrogen and passed over a catalyst whereby the compound is catalytically hydrogenated, the oxygen going to water, the carbon to methane, and the nitrogen to ammonia. By absorbing the water and ammonia in suitable absorbents both oxygen and nitrogen in the material may be determined.²

The oxygen dissolved in steel is commonly determined by fusing the metal with carbon in a vacuum at 1600°. ^{2a} The oxygen is converted to carbon monoxide which may be determined volumetrically, or after oxidation to carbon dioxide, determined gravimetrically. Nitrogen present is converted to free nitrogen the volume of which is measured; hydrogen present is converted to water which is absorbed and weighed.

THE DETERMINATION OF SULFUR

Sulfur occurs naturally as free sulfur, as the sulfides of many metals, and as sulfate. Because of the great importance of sulfur in its various forms, the determination of sulfur is a very common one.

Several methods are available for the determination of sulfur in a sulfide. The evolution-volumetric method, discussed in connection with the determination of sulfur in steel, p. 193, is rapid and suitable for relatively small amounts of sulfide. If a preliminary heating with iron powder is necessary to render the sulfide soluble in acids, as mentioned in connection with the attack of sulfide ores, p. 33, the results will indicate the total sulfur present. Any sulfate is reduced to sulfide during the ignition with iron unless the amount of sulfate is very large. Reduction is complete, however, if the ignition is made in an atmosphere of hydrogen. The evolution-gravimetric process, in which the hydrogen sulfide evolved is absorbed and oxidized in a solution of ammonia and hydrogen peroxide and the sulfate precipitated as barium sulfate, is adapted to the determination of large amounts of sulfide. This again will give the total sulfur if ignition with iron was employed. Fusion with sodium peroxide or wet decomposition with nitric acid and hydrochloric

² Russell and Fulton, *Ind. Eng. Chem., Anal. Ed.*, **5**, 384 (1933); Russell and Marks, *ibid.*, **6**, 381 (1934); **8**, 453 (1936); Goodloe and Frazier, *ibid.*, **9**, 223 (1938).

^{2a} Vacher and Jordan, *Bur. Standards J. Research*, **7**, 375 (1931).

acid followed by gravimetric determination gives the total sulfur; see p. 188 and Willard and Furman, 3rd Ed., pp. 363-370 for a further treatment.

Sulfite and thiosulfate may be determined volumetrically by titration with iodine or gravimetrically as barium sulfate after oxidation to sulfate.

Sulfate is commonly determined as barium sulfate; particular attention should be paid to the sources of error in this determination, Willard and Furman, 3rd Ed., p. 323. The barium sulfate method is highly accurate in the absence of ions which are carried down by barium sulfate but suffers from the general slowness of gravimetric methods. An enormous amount of work has been done to speed up the determination of sulfate. A comprehensive review of the work up to 1933 will be found in the paper by Schroeder.³

The organic base benzidine forms an insoluble sulfate and considerable study has been devoted to using this as a gravimetric and a volumetric method for sulfate. The solubility of benzidine sulfate is too great for even reasonably accurate work, however.⁴

Small amounts of sulfate, such as might normally be present in a water, can be rapidly and quite accurately determined turbidimetrically; the Parr turbidimeter was designed specifically for this determination; the photoelectric colorimeter has been used to measure the turbidity. The turbidimetric method requires careful calibration and exact duplication of technic with respect to a number of points such as temperature, rate and manner of mixing, time of standing, concentration range, the presence of foreign salts, and so on. The range of sulfate concentration normally covered without resorting to a procedure of taking aliquot samples is from 0.01 to 100 or 150 parts per million.⁵

Of the older volumetric methods for sulfate, the barium chromate method has been most frequently used and has recently received further study. An acid solution of barium chromate is added to the sulfate solution precipitating barium sulfate, the excess barium precipitated as chromate by neutralization with ammonia, and the chromate left in solution determined by titration, usually by treating with an iodide and titrating the liberated iodine with

³ Schroeder, *Ind. Eng. Chem., Anal. Ed.*, **5**, 403 (1933).

⁴ Meldrum and Newlin, *Ind. Eng. Chem., Anal. Ed.*, **1**, 231 (1929).

⁵ Parr and Staley, *Ind. Eng. Chem., Anal. Ed.*, **3**, 66 (1931); Sheen, Kahler and Ross, *ibid.*, **7**, 262 (1935); Treon and Crutchfield, *ibid.*, **14**, 119 (1942).

thiosulfate, although treatment with excess ferrous sulfate and back titration with permanganate is satisfactory. The slight error due to the solubility of barium chromate may be eliminated by a blank determination.⁶

Rhodizonic acid (I) and tetrahydroxyquinone (II)

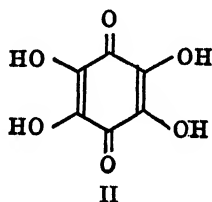
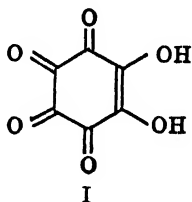

yield red, somewhat insoluble salts with barium and can be used as indicators in the titration of sulfate with barium chloride. An excess of barium chloride is added, then the indicator, and the excess barium is titrated with standard sodium sulfate. The red color of the barium salt disappears at the end-point as all of the barium is converted to the less soluble sulfate. Tetrahydroxyquinone is an intermediate in the synthesis of rhodizonic acid, is much easier to obtain than the latter, and is marketed as "THQ."⁷ Solutions of the indicator are not stable and a dispersion of the tetrahydroxyquinone in sodium chloride or some organic material is used so that a small but definite amount of indicator may be added to the determination. Ethyl or *iso*-propyl alcohol is added to decrease the solubility. If the pH of the solution is adjusted to about 4.0, phosphate up to 60 p.p.m. causes no interference. The method has been adapted to the determination of sulfate in concentrations from 80 p.p.m. up to 3 g. per 100 ml. and the determination of sulfur in a variety of materials following decomposition and conversion to sulfate. It is claimed that much better results are obtained if the tetrahydroxyquinone is used as an external indicator. The literature of this subject is quite extensive.⁸

⁶ Andrews, *Amer. Chem. J.*, **11**, 567 (1889), **32**, 476 (1904); Andrews, *Ind. Eng. Chem., Anal. Ed.*, **3**, 361 (1931); Foster, *ibid.*, **8**, 195 (1936).

⁷ W. H. and L. D. Betz, Philadelphia, Penna.

⁸ Rhodizonic acid method: Strebinger and Zomory, *Z. anal. Chem.*, **79**, 1 (1929); Zomory, *ibid.*, **110**, 278 (1937); Paschke, *Z. Untersuch. Lebensm.*, **62**, 378 (1931); *C.A.*, **26**, 3205 (1932). Tetrahydroxyquinone method: Schroeder, *Ind. Eng. Chem., Anal. Ed.*, **5**, 403 (1933); Ampt, *Australian Chem. Inst., J. and Proc.*, **2**, 10 (1935); *C.A.*, **29**, 2883 (1935); Gibson and Caulfield, *Analyst*, **60**, 522 (1935); Manov and Kirk, *Ind. Eng. Chem., Anal. Ed.*, **9**,

Several more or less successful attempts have been made to adapt an adsorption indicator to the volumetric determination; thus when titrating with a lead chloride solution, eosin has been used⁹ and also erythrosin.¹⁰

THE DETERMINATION OF CHROMIUM, MOLYBDENUM, AND TUNGSTEN

The analytical chemistry of chromium was treated on p. 228, of molybdenum on p. 222, and of tungsten on p. 216.

THE DETERMINATION OF URANIUM

The principal minerals of uranium are uranite or pitchblende, a mixture of oxides of uranium, lead, and rare earths, and carnotite, a vanadate of uranium and potassium, $K_2(UO_2)_2(VO_4)_2 \cdot 8 H_2O$. The chief interest in these minerals is in their radium content and uranium is of secondary importance. Uranium is marketed as uranyl nitrate or acetate, $UO_2(NO_3)_2 \cdot 6 H_2O$ and $UO_2(C_2H_3O_2)_2 \cdot 2 H_2O$, and as ferro-uranium. It is occasionally added to alloy steels and finds uses in glass making and in ceramics.

GENERAL CHEMISTRY

Uranium has valences of 2, 3, 4, 5, and 6, but only the valences of 4 and 6 are of importance. Uranium oxide, U_3O_8 , is the stable oxide at red heat in contact with air; heated in hydrogen it forms the dioxide UO_2 . The trioxide, UO_3 , is also known, and like tungstic and molybdic oxides, is amphoteric but is only very weakly acidic, forming salts of the biurate type, such as $Na_2U_2O_7$. The uranyl ion, UO_2^{++} , is distinctly basic and its salts, which are yellow in color and fluoresce green, are not appreciably hydrolyzed. In the quadrivalent state, uranium is exclusively basic, uranous salts, for

198 (1937); Sheen and Kahler, *ibid.*, **8**, 127 (1936), **10**, 206 (1938); Sheen, Kahler and Cline, *ibid.*, **9**, 69 (1937); Kahler, *ibid.*, **12**, 266 (1940); Tomkins, *ibid.*, **14**, 141 (1942); Mutschin and Pollak, *Z. anal. Chem.*, **107**, 18 (1936), **108**, 8, 309 (1937), **110**, 278 (1937). THQ as external indicator: Kochor, *Ind. Eng. Chem., Anal. Ed.*, **9**, 331 (1937); Peabody and Fisher, *ibid.*, **10**, 651 (1938).

⁹ Ricci, *Ind. Eng. Chem., Anal. Ed.*, **8**, 130 (1936).

¹⁰ Burg, *Ind. Eng. Chem., Anal. Ed.*, **11**, 28 (1939).

example the sulfate, $U(SO_4)_2$, being green in color and having strong reducing properties.

Neither the uranous nor the uranyl ion is precipitated by hydrogen sulfide from an acid solution. Sodium or ammonium hydroxide precipitates uranous hydroxide, $U(OH)_4$, and sodium or ammonium biuranate, $Na_2U_2O_7$ and $(NH_4)_2U_2O_7$, insoluble in excess of the reagent. Ammonium sulfide precipitates uranyl sulfide, UO_2S , from alkaline solution. Both the alkali biuranates and uranyl sulfide are soluble in ammonium or sodium carbonate forming a very stable, double carbonate, $(NH_4)_4UO_2(CO_3)_3$, which distinguishes uranium from iron, aluminum, zinc, manganese, and other metals of these groups.¹¹

SEPARATION AND DETERMINATION

The formation of the soluble double carbonate affords a separation of uranium from iron and aluminum.

The uranous ion is precipitated by cupferron but the uranyl ion is not. Thus, if all of the uranium is in the hexavalent state, iron, vanadium, titanium, and zirconium can be separated by precipitation with cupferron, then the uranium reduced to the quadrivalent state and precipitated with cupferron which separates it from aluminum, chromium, manganese, zinc, phosphate, and so on.

The separation of uranium from vanadium, which is usually associated with it, is important. As just mentioned this can be done with cupferron. The vanadium may also be precipitated from a dilute acetic acid solution as lead vanadate. This requires an extra separation then to remove the lead. In another method the dry nitrates are extracted with a mixture of glacial acetic acid and nitric acid; the uranyl nitrate is extracted leaving the vanadium.¹²

When uranium is precipitated as ammonium biuranate, the ammonia used must be free from carbonate or the precipitation will be incomplete. The precipitate is ignited to the green oxide, U_3O_8 , for weighing. Uranium may also be precipitated as uranyl ammonium phosphate, $UO_2NH_4PO_4$, and ignited to the pyrophosphate, $(UO_2)_2P_2O_7$, for weighing.

A better method is the precipitation of uranium as uranyl arsenate followed by ignition to the oxide, U_3O_8 , for weighing. The pre-

¹¹ For confirmatory tests for uranium see McAlpine and Soule, *Qualitative Chemical Analysis*, D. Van Nostrand Company, Inc., New York, 1933, p. 390.

¹² Scott, *J. Ind. Eng. Chem.*, **14**, 531 (1922), *Ind. Eng. Chem., Anal. Ed.*, **4**, 244 (1932).

precipitation is made from a solution buffered with acetate and the precipitate is crystalline and easy to handle.¹³

Uranium is determined volumetrically by reduction by zinc in sulfuric acid solution to the quadrivalent state and titration with permanganate:

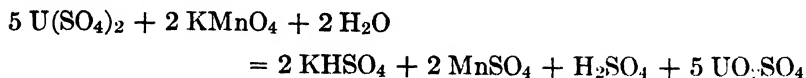

Some trivalent uranium is formed at the same time but is quickly oxidized by bubbling a rapid stream of air through the solution for 5 minutes.

THE DETERMINATION OF SELENIUM AND TELLURIUM

Selenium occurs in small amounts associated with native sulfur and sulfide minerals. Soils derived from shale containing seleniferous pyrites contain selenium which concentrates in vegetation and leads to serious diseases in stock foraging in such regions. Selenium has been intentionally added to stainless steel in recent years to improve the machining qualities. It is also extensively used in the manufacture of red glass. The determination of selenium is thus a matter of increasing importance. The chief source of selenium is the by-product in the electrolytic refining of copper and in the manufacture of sulfuric acid.

Tellurium is found in small amounts as the telluride of heavy metals. It is sometimes added to bearing metals.

GENERAL CHEMISTRY

The principal compounds of selenium and tellurium resemble the corresponding compounds of sulfur, for example, hydrogen selenide and telluride, H_2Se and H_2Te , selenious and tellurous acids, H_2SeO_3 and H_2TeO_3 , and selenic and telluric acids, H_2SeO_4 and H_2TeO_4 . Selenic acid is a strong acid forming an insoluble barium salt, but telluric acid is a very weak acid and sparingly soluble. Both selenium and tellurium are classed with the hydrogen sulfide metals in that they give precipitates with hydrogen sulfide; the precipitates are, however, not sulfides but the free metals mixed with sulfur. The precipitates are soluble in ammonium sulfide. Sulfur dioxide or hydrazine salts reduce the compounds of both elements to the

¹³ Rice, Dissertation, Columbia University, New York, 1928.

metal; selenium, however, is reduced only in a weakly acid chloride solution. Selenium dissolves in potassium cyanide forming potassium selenocyanate, $KCNSe$, but tellurium does not dissolve.

SEPARATION AND DETERMINATION

Selenium may be separated from all elements but arsenic and germanium by distillation from a solution containing bromine and potassium bromide. This is a convenient way to isolate selenium from soil, agricultural materials, or pyrite rock following decomposition and oxidation.¹⁴

Precipitation as the metal is used more commonly, however, particularly in connection with steel analysis. Sulfur dioxide, hydrazine, hydroxylamine, or stannous chloride¹⁵ are the commonly used reducing agents, and by controlling the acidity a separation of selenium and tellurium may be accomplished. The metals are not soluble in non-oxidizing acids and this is sometimes used to separate selenium from the major amount of iron in steel. A small amount of hydrogen selenide escapes when the sample is first treated with acid and must be caught, either on nitric acid on glass wool, or in a solution of potassium iodide, and returned to the main solution.¹⁶

Selenium may also be separated from tellurium by distillation from a sulfuric acid solution in a current of hydrogen chloride at 300°. A convenient separation of selenium from lead and antimony is based on the deposition of copper selenide on metallic copper from a nitric acid solution containing urea.¹⁷

When precipitated as the metal, selenium or tellurium may be determined gravimetrically by drying at 110° and weighing as the metal. An inert atmosphere is desirable during the drying. The effect of any impurities may be eliminated in the case of selenium by ignition, which volatilizes the selenium, after which the residue may be weighed.

Tellurium may also be weighed as the dioxide, TeO_2 .

Volumetrically selenium may be determined by oxidizing seleni-

¹⁴ Robinson, Dudley, Williams and Byers, *Ind. Eng. Chem., Anal. Ed.*, **6**, 274 (1934); Dudley and Byers, *ibid.*, **7**, 3 (1935).

¹⁵ Schoeller, *Analyst*, **64**, 318 (1939).

¹⁶ Marvin and Schumb, *Ind. Eng. Chem., Anal. Ed.*, **8**, 109 (1936); Silverman, *ibid.*, **8**, 132 (1936); Coleman and McCrosky, *ibid.*, **8**, 196 (1936).

¹⁷ Evans, *Analyst*, **64**, 87 (1939).

ous acid to selenic acid with an excess of permanganate and back titrating with ferrous sulfate, or iodometrically by treating selenious acid with an iodide and titrating the liberated iodine: ¹⁶

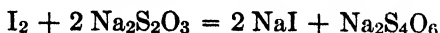
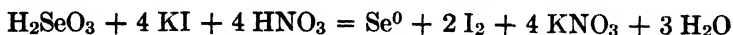

Selenates may be determined by reduction with hydrobromic acid, the liberated bromine being caught in a potassium iodide solution for determination.¹⁸ Another satisfactory volumetric method for selenium is based on the reaction: ¹⁹

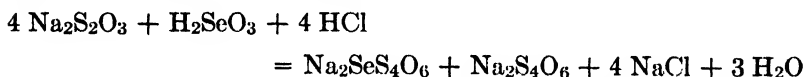

Tellurium may be oxidized by excess bichromate from tellurous to telluric acid and the excess titrated with ferrous sulfate; selenious acid is not oxidized. A second volumetric method for tellurium is based on reduction of the tellurium to the metal by hypophosphorous acid and solution in standard iodine, the excess of which is back titrated.²⁰

Colorimetrically selenium may be determined by the blue color formed with codeine; this method has been applied particularly to the determination of selenium in biological materials.²¹

PERIODIC GROUP VII

Included in the seventh group of the periodic table are the halogens, fluorine, chlorine, bromine, and iodine, and the subgroup elements, rhenium, masurium, and manganese. Some doubt still exists as to the existence of masurium, but rhenium is available commercially and has undergone a spectacular development since its discovery in 1925.

The halogens show a progressive increase in melting and boiling points with increasing atomic weight. The oxidizing power of the

¹⁸ Soth and Ricci, *Ind. Eng. Chem., Anal. Ed.*, **12**, 328 (1940).

¹⁹ Coleman and McCrosky, *Ind. Eng. Chem., Anal. Ed.*, **9**, 431 (1937). For still another volumetric method for selenium see Coleman and McCrosky, *J. Amer. Chem. Soc.*, **59**, 1458 (1937).

²⁰ Evans, *Analyst*, **58**, 452 (1933), **63**, 874 (1938).

²¹ Horn, *Ind. Eng. Chem., Anal. Ed.*, **6**, 34 (1934); Gortner and Lewis, *ibid.*, **11**, 198 (1939).

free elements also changes successively, fluorine being the most powerful. The affinity for hydrogen falls off rapidly with increasing atomic weight.

With the exception of fluorine, the halogens, in addition to their common valence of -1 , have positive valences of $1, 3, 5,$ and 7 , although perbromates have never been prepared and little is known about bromites and iodites. The halogens are strongly acidic and have no basic properties. The compounds of the positive valences of the halogens are almost exclusively with oxygen but polyhalides of a number of types are known in which halogens are apparently united with each other, for example, potassium triiodide, KI_3 , iodine trichloride, ICl_3 , iodine pentafluoride, IF_5 , and potassium tetrachloroiodite, $KICl_4$.

Resemblance between the halogens and the members of the subgroup is limited to the compounds in which they have a valence of 7 , such as in the volatile heptoxides, Cl_2O_7 , Mn_2O_7 , Re_2O_7 , and in the peracids, $HClO_4$, $HMnO_4$, $HReO_4$. Rhenium, however, also resembles the halogens in having a valence of -1 . Permanganates and perchlorates are isomorphous and the solubilities of the salts of the four acids perchloric, permanganic, periodic, and perrhenic are very similar. As usual, manganese and rhenium are acidic in their higher valences and basic in the lower. Manganates are isomorphous with the corresponding chromates. Quadrivalent and trivalent manganese are stable only when protected by complex formation, both forms being strongly oxidizing. The behavior of manganic and manganous salts is very similar to that of ferric and ferrous, but manganous salts are more stable than ferrous salts.

THE DETERMINATION OF FLUORINE

Fluorine constitutes about 0.03 per cent of the crust of the earth, occurring largely as fluorite, or fluorspar, CaF_2 , and cryolite, Na_3AlF_6 . The presence of fluoride in water, above a small necessary amount, has a detrimental effect on growing teeth; this and the increasing use of fluorides in certain industrial processes makes its determination of considerable importance. The reactions which serve for its separation and determination, are useful for its identification. Silver fluoride, very curiously, is about as soluble as silver nitrate.

SEPARATION AND GRAVIMETRIC DETERMINATION

The gravimetric and volumetric methods of determining fluorine are subject to a great number of interferences and the preliminary separation of fluorine is very important. Of the methods tried for the separation of fluorine, distillation as hydrofluosilicic acid is by far the most successful. This method, originally proposed by Willard and Winter,¹ has been subjected to a number of further studies and is now almost universally used for the isolation of fluoride. Separation by distillation as silicon tetrafluoride, boron trifluoride, or hydrofluoboric acid is not satisfactory, at least not on all types of materials.

The distillation of fluoride as hydrofluosilicic acid is carried out by adding perchloric acid or sulfuric acid to the fluoride solution and steam distilling, holding the temperature constant at 135° by heating. Several pieces of glass are placed in the distilling flask to minimize the etching of the flask. If small amounts of gelatinous silica or boric acid are present it is necessary to prolong the distillation at 135°. Small amounts of aluminum do not interfere but large quantities do. A large amount of inert silicate will also retain fluorine.² On the other hand, the method is applicable to all types of phosphate rocks and slags containing silicates decomposable by perchloric acid, if the amount of distillate collected is increased.³ When phosphoric acid is added to raise the boiling point of the distillation or in the analysis of fluorine in materials containing phosphates, an appreciable amount of phosphoric acid is carried into the distillate where it interferes with the subsequent volumetric determination of fluorine; a second distillation using perchloric acid is recommended in this case, sulfuric acid being used in the first distillation, particularly if any organic matter be present.⁴ A small blank due to the apparatus should be taken into consideration when working with very small amounts of fluoride.⁵ The effects of varying certain factors in the distillation have been studied.⁶ A device

¹ Willard and Winter, *Ind. Eng. Chem., Anal. Ed.*, **5**, 7 (1933).

² Graham, *J. Assoc. Official Agri. Chem.*, **20**, 392 (1937).

³ Reynolds, *J. Assoc. Official Agri. Chem.*, **17**, 323 (1934).

⁴ Reynolds, *J. Assoc. Official Agri. Chem.*, **18**, 108 (1935); Churchill, Bridges and Rowley, *Ind. Eng. Chem., Anal. Ed.*, **9**, 222 (1937); Reynolds and Hill, *ibid.*, **11**, 21 (1939).

⁵ Dahle, *J. Assoc. Official Agri. Chem.*, **21**, 208 (1938).

⁶ Dahle and Wichmann, *J. Assoc. Official Agri. Chem.*, **19**, 313 (1936), **20**, 297 (1937).

to assist in maintaining the temperature at 135° has been described.⁷

Fluoride may be precipitated as lead chloro-fluoride, $PbClF$, or as calcium fluoride, CaF_2 , which is difficult to filter and wash. Both of these are dried and weighed as such.⁸

VOLUMETRIC DETERMINATION

Fluoride may be titrated with cerous nitrate using methyl orange as indicator. Cerous fluoride is insoluble and at the end-point hydrolysis occurs, liberating nitric acid which affects the indicator. The mechanism of this end-point is actually more complicated than this.⁹

Fluoride or hydrofluosilicate may also be titrated with thorium nitrate.¹ The end-point is determined by a zirconium alizarin lake which is bleached by the fluoride present due to the formation of a complex fluozirconate ion but which reappears when all of the fluoride has been precipitated as insoluble thorium fluoride. For very small amounts of fluoride, so little indicator must be added, since the fluoride reacts with the indicator, that the end-point is difficult to detect. This difficulty may be overcome by using alizarin sulfonate as indicator;¹⁰ at the end-point a pink color of a thorium lake is formed. This titration has now been applied to the determination of fluoride in amounts from 0.001-50 mg. and titration in aqueous solution appears to be better than in the 48 per cent alcohol solution as originally recommended. The acidity of the solution is an important factor in the sharpness of the end-point; it has been recommended that a pH of 3.5 be maintained during the titration when done in 48 per cent alcohol, and between 2.9 and 3.4 when done in water, chloracetic acid-sodium chloracetate being used as the buffer in both cases.¹¹

⁷ Gilkey, Rohs and Hansen, *Ind. Eng. Chem., Anal. Ed.*, **8**, 150 (1936); see also Eberz, Lamb and Lachele, *ibid.*, **10**, 259 (1938).

⁸ For a review of these methods and the gravimetric methods of separating fluoride and silica, see Bright and Larrabee, *Bur. Standards J. Research*, **3**, 573 (1929).

⁹ Batchelder and Meloche, *J. Amer. Chem. Soc.*, **53**, 2135 (1931).

¹⁰ Armstrong, *J. Amer. Chem. Soc.*, **55**, 1741 (1933).

¹¹ Hoskins and Ferris, *Ind. Eng. Chem., Anal. Ed.*, **8**, 6 (1936); Rowley and Churchill, *ibid.*, **9**, 551 (1937); see also Carter, *J. Assoc. Official Agri. Chem.*, **20**, 394 (1937); Dahle, Bonnar and Wichmann, *ibid.*, **21**, 459 (1938); McClure, *Ind. Eng. Chem., Anal. Ed.*, **11**, 171 (1939); McClendon and Foster, *ibid.*, **13**, 280 (1941).

If the precipitation of thorium fluoride is prevented by the addition of a protective colloid, the end-point is often improved because of the tendency of the precipitate to adsorb the dye.

COLORIMETRIC DETERMINATION

Fluoride may be determined by its bleaching effect on the yellow color of pertitanic acid. This method, frequently referred to as the Steiger-Merwin method from the names of the early investigators, has been critically reviewed recently and the interferences and conditions established.¹²

The bleaching effect of fluoride on the lake of zirconium with alizarin has been used for the colorimetric determination of fluoride. The fading is not proportional to the concentration of the fluoride,¹ although the method has been recommended for the determination of fluoride in water.¹³ A similar method is based on the bleaching effect of fluoride on the ferric compound of 7-iodo-8-hydroxyquinoline-5-sulfonic acid (ferron).¹⁴

THE DETERMINATION OF CHLORINE

Chlorine occurs naturally only as chloride, mostly as sodium chloride but also as the chlorides or double chlorides of potassium and magnesium.

Chlorine. Free chlorine is very readily determined iodometrically by absorption in potassium iodide solution and titration of the liberated iodine with thiosulfate; hypochlorite, chlorite, chlorate, bromine, and many other oxidizing agents also liberate iodine, of course. Small quantities of chlorine, such as the residual chlorine in drinking water after chlorination, are determined colorimetrically, generally by the color chlorine gives with *o*-tolidine.¹⁵ All oxidizing agents interfere with this method. Another colorimetric method using *p*-aminodimethylaniline has also been carefully investigated.¹⁶

¹² Dahle and Wichmann, *J. Assoc. Official Agri. Chem.*, **16**, 612 (1933); Dahle, *ibid.*, **20**, 505 (1937).

¹³ Sanchis, *Ind. Eng. Chem., Anal. Ed.*, **6**, 134 (1934); Lamar and Seegmiller, *ibid.*, **13**, 901 (1941).

¹⁴ Fahey, *Ind. Eng. Chem., Anal. Ed.*, **11**, 362 (1939).

¹⁵ See *Standard Methods for the Examination of Water and Sewage*, 8th Ed., American Public Health Association, New York, 1936, pp. 20, 229.

¹⁶ Byers and Mellon, *Ind. Eng. Chem., Anal. Ed.*, **11**, 202 (1939).

Chloride. The methods of determining the chloride ion are well known, precipitation as silver chloride being used both gravimetrically (Willard and Furman, 3rd Ed., p. 317) or volumetrically. The common volumetric methods are the Volhard method using the blood red color of the ferric thiocyanate complex as indicator (*ibid.*, p. 185), the Mohr method using the appearance of red, insoluble, silver chromate as the indicator (*ibid.*, p. 178),¹⁷ and various adsorption indicators (*ibid.*, p. 182). The nephelometric end-point is used in very precise work (*ibid.*, p. 174).

Hypochlorite. Hypochlorite may be determined gravimetrically by reduction to chloride and precipitation as silver chloride, or volumetrically by the titration of the iodine liberated on treatment with an iodide. It may also be determined by a direct potentiometric titration with arsenite.¹⁸ Hypochlorite may be titrated directly with thiosulfate in dilute acetic acid solution, the available chlorine of the hypochlorite oxidizing the thiosulfate to sulfate:

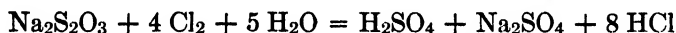

The end-point is determined by starch-potassium iodide paper used as an external indicator.¹⁹

Chlorite. Chlorite is usually determined iodometrically. Sodium chlorite has been recommended as a standard oxidizing agent.²⁰

Chlorate. Chlorate is also determined by reduction with iodide in an acid solution and titration of the iodine liberated. It is reduced by excess of ferrous sulfate and the latter back titrated. It may also be titrated directly with trivalent titanium salts.

Perchlorate. Tetraphenylarsonium chloride precipitates the perchlorate ion and may be used for its gravimetric or volumetric determination. Nitron is a less satisfactory reagent. Perchlorate may be reduced by titanous sulfate, either as a standard solution or simply as a means of forming chloride. The perchlorate ion may also be determined by reduction with starch in concentrated sulfuric acid, followed by the liberation of free chlorine by permanganate, absorption in alkaline arsenite, and precipitation as silver chloride.²¹

¹⁷ For a recent study of the Mohr method, see Berry and Driver, *Analyst*, **64**, 730 (1939).

¹⁸ Ditz and May, *Z. anal. Chem.*, **79**, 371 (1929).

¹⁹ Willson, *Ind. Eng. Chem., Anal. Ed.*, **7**, 44 (1935).

²⁰ Jackson and Parsons, *Ind. Eng. Chem., Anal. Ed.*, **9**, 14 (1937).

²¹ Willard and Thompson, *Ind. Eng. Chem., Anal. Ed.*, **2**, 272 (1930).

Chlorine in Organic Material. The determination of chlorine in organic material has received a great deal of study and a number of satisfactory methods are now available. The older Carius method in which the material was decomposed by nitric acid in the presence of silver nitrate at 320° in a sealed tube is now seldom used.

The Thompson-Oakdale method is rapid and accurate and applicable to practically all types of chlorine compounds.²² In it the organic material is first sulfonated with fuming sulfuric acid to render it non-volatile, then decomposed with sulfuric acid and potassium persulfate, the chlorine liberated by treatment with permanganate is distilled off and collected in alkaline arsenite, and finally precipitated as silver chloride. A special apparatus described is needed for the determination.

Decomposition of the organic material by fusion with sodium peroxide in a Parr bomb followed by the usual chloride determination is also a very satisfactory method.²³

The so-called Stepanow method in which the halogen is split away from the organic molecule by the action of metallic sodium in alcohol is applicable to all types of materials including aromatic compounds. The results are occasionally erratic, however.²⁴

Metallic sodium in liquid ammonia or direct fusion with metallic sodium in a sealed tube have also been used for decomposing the organic material and are apparently rapid and convenient.²⁵

THE DETERMINATION OF BROMINE

Bromine occurs naturally as various soluble bromides generally associated with far larger amounts of sodium or potassium chloride. It is recovered from Michigan salt brines and from sea water.

²² Thompson and Oakdale, *J. Amer. Chem. Soc.*, **52**, 1195 (1930); **55**, 1292 (1933); Willard and Thompson, *ibid.*, **52**, 1893 (1930); Oakdale and Powers, *J. Amer. Pharm. Assoc.*, **20**, 881 (1931).

²³ Lemp and Broderson, *J. Amer. Chem. Soc.*, **39**, 2069 (1917); Brown and Beal, *ibid.*, **45**, 1289 (1923); Beamish, *Ind. Eng. Chem., Anal. Ed.*, **6**, 352 (1934); Elek and Hill, *J. Amer. Chem. Soc.*, **55**, 2550 (1933).

²⁴ Cook and Cook, *Ind. Eng. Chem., Anal. Ed.*, **5**, 186 (1933); Rauscher, *ibid.*, **9**, 296, 503 (1937); Feldman and Powell, *ibid.*, **11**, 89 (1939).

²⁵ Vaughn and Nieuwland, *Ind. Eng. Chem., Anal. Ed.*, **3**, 274 (1931); Elving and Liggett, *ibid.*, **14**, 449 (1942).

Bromine. Free bromine may be reduced to bromide and then determined by one of the methods applicable to bromides, or it may be treated with potassium iodide and the iodine liberated titrated with thiosulfate.

Bromide. The bromide ion may be determined by precipitation as silver bromide either gravimetrically by drying and weighing or volumetrically by the Volhard method by adding excess of silver nitrate and back titrating with thiocyanate, using ferric iron as indicator.

The determination of bromide in the presence of a large amount of chloride is a matter of some difficulty. In a method described by Willard and Meloche²⁶ the bromine and a little chlorine is liberated from a hydrochloric acid solution by permanganate, and the free halogens swept by air into an alkaline absorbent. After reduction with hydrazine they are precipitated by silver nitrate. The weighed halides are then ignited in chlorine and the bromine calculated from the loss in weight. Large quantities of bromine may be handled by this method.

In another method²⁷ the bromine is liberated by treatment with chlorine water, the bromine swept out with air, collected in sulfite which is then oxidized to sulfate by a current of air. The bromine is then titrated potentiometrically with bromate in sulfuric acid solution. Other oxidizing agents may be used to liberate the bromine and the free bromine may be extracted with carbon tetrachloride.²⁸

Still another method, and a very convenient one, is described in which the bromine is not removed by volatilization but oxidized to bromate in the solution by hypochlorite at a pH of 6-6.5. The excess of hypochlorite is removed by sodium formate and the bromate determined iodometrically.²⁹

Bromate. Reduction to bromide and determination of bromide by the usual methods may be used for the determination of bromate. In a fairly strong acid solution bromate is a powerful oxidizing

²⁶ Willard and Meloche, *J. Ind. Eng. Chem.*, **14**, 422 (1922).

²⁷ Newton and Newton, *Ind. Eng. Chem., Anal. Ed.*, **6**, 213 (1934); see also Edwards, Nanji and Parkes, *Analyst*, **61**, 743 (1936).

²⁸ Kapur, Verma and Khosla, *Ind. Eng. Chem., Anal. Ed.*, **14**, 157 (1942).

²⁹ Kolthoff and Yutzy, *Ind. Eng. Chem., Anal. Ed.*, **9**, 75 (1937); Willard and Heyn, *ibid.*, **15**, 321 (1943).

agent and may be determined iodometrically or by the addition of an excess of arsenite and back titration with a standard bromate solution, using methyl orange as indicator (Willard and Furman, 3rd Ed., p. 281).

THE DETERMINATION OF IODINE

Iodine occurs naturally as iodide in sea water and salt beds, as iodate and periodate in Chile salt-peter, and in the ashes of sea plants.

Iodine. Free iodine is titrated in acid solutions with thiosulfate, this titration being the final step in the iodometric determination of numerous oxidizing agents. Iodine and bromine in the presence of each other may be determined by taking advantage of the fact that bromine oxidizes formic acid but iodine does not; thus iodine may be titrated with thiosulfate in one sample and in another the total iodine plus bromine determined by treating with potassium iodide and titrating with thiosulfate.³⁰

Iodide. Iodide may be precipitated and weighed as silver iodide, but as the precipitate has a tendency to adsorb silver nitrate and other salts it is advisable to precipitate from a very dilute solution with dilute silver nitrate. Volumetrically, iodide may be determined by the Volhard method adding excess silver nitrate and back titrating with thiocyanate. Iodides may also be determined by potentiometric titration with ceric sulfate in sulfuric acid solution, forming iodine.³¹ A number of methods of determining this end-point visually have been proposed; in one method³² the iodine liberated is removed by combination with acetone and the end-point determined using *o*-phenanthroline ferrous sulfate as indicator. By adjusting the volume and acidity of the solution it is possible to determine iodine by this method in the presence of bromides up to a ratio of bromide to iodide of 5 to 1. Iodides may also be determined in the presence of bromides by liberating iodine with bromine, reducing the excess bromine with formic acid, and titrating with thiosulfate.³⁰ Another method is based on the oxidation of the iodide to iodate by sodium chlorite; the pH must be controlled and

³⁰ Spitzer, *Ind. Eng. Chem., Anal. Ed.*, **8**, 465 (1936).

³¹ Willard and Young, *J. Amer. Chem. Soc.*, **50**, 1368 (1928).

³² Lewis, *Ind. Eng. Chem., Anal. Ed.*, **8**, 199 (1936).

the end-point is determined visually by the disappearance of a starch iodine color.⁸³

Iodate and Periodate. Very small amounts of periodate in the presence of a large amount of iodate may be detected by removing most of the iodate with barium nitrate and then precipitating the periodate with bismuth nitrate. Very small amounts of iodate may be detected in the presence of a great excess of periodate by first removing the periodate as insoluble potassium periodate, KIO_4 , and then precipitating the iodate with silver nitrate.⁸⁴ Iodide and iodate are oxidized to periodate by ozone in alkaline solution and the periodate determined volumetrically.⁸⁵

Periodate may be determined in the presence of iodate by reduction to iodate upon addition of excess iodide in a neutral, buffered solution, and the iodine liberated titrated with arsenite.⁸⁶

THE DETERMINATION OF MANGANESE

The analytical chemistry of manganese was discussed on p. 162.

THE DETERMINATION OF RHENIUM

The element rhenium was discovered in 1925 by Noddack and Tacke in tantalite, wolframite, columbite, and a number of other ores. Commercially it is obtained from molybdenite and is marketed as potassium perrhenate, $KReO_4$. Manganese minerals contain no significant amount of rhenium.

GENERAL CHEMISTRY

Several oxides of rhenium are known. The heptoxide, Re_2O_7 , formed on heating the metal in contact with air and oxygen above 150° , is the anhydride of perrhenic acid, $HReO_4$, which it readily forms by solution in water. A red trioxide, ReO_3 , a black dioxide, ReO_2 , and the lower oxides, $ReO \cdot H_2O$ and $Re_2O \cdot H_2O$, are also known. The higher valences of rhenium are acid forming, the valence of 7 being the most important. The valences of 6, 4, 1, and -1 have been definitely established for rhenium. In the valence of

⁸³ Yntema and Fleming, *Ind. Eng. Chem., Anal. Ed.*, **11**, 375 (1939).

⁸⁴ Willard and Thompson, *J. Amer. Chem. Soc.*, **56**, 1827 (1934).

⁸⁵ Willard and Merritt, *Ind. Eng. Chem., Anal. Ed.*, **14**, 489 (1942).

⁸⁶ Müller and Friedberger, *Ber.*, **35**, 2652 (1902).

4, rhenium is known principally as the chloro compounds ReCl_4 and K_2ReCl_6 . Perrhenic acid is a strong acid, capable of dissolving ferric hydroxide or metallic zinc and iron; it forms sparingly soluble salts with potassium, thallium, silver, and a number of organic bases such as tetraphenylarsonium, nitron, and strychnine. Perrhenates are mild oxidizing agents.

The qualitative analysis of rhenium has been carefully investigated by Hurd.³⁷ In the usual scheme of qualitative analysis rhenium is precipitated along with arsenic sulfide from a strong acid solution. The sulfide does not dissolve in yellow ammonium sulfide and so may be confirmed in the residue by solution in potassium hydroxide and hydrogen peroxide and examination under the microscope for the characteristic, rhombic bipyramids of potassium perrhenate. If large amounts of molybdenum are present, small amounts of rhenium will be lost during the yellow ammonium sulfide extraction, and in this case the rhenium is best separated from the bulk of the molybdenum by distillation. Any rhenium which escapes precipitation in the acid hydrogen sulfide group will not be precipitated in the next groups and will appear with the alkali metals. This may happen if the rhenium has not all been oxidized to the valence of 7. Quadrivalent rhenium, however, will not be precipitated as the hydrated dioxide, ReO_2 , by ammonia but will oxidize during the washing and will escape notice in the subsequent separation of iron, chromium, and aluminum. For the behavior of rhenium in the Noyes and Bray scheme of qualitative analysis, the spectroscopic detection of rhenium and other confirmatory tests, see the paper of Hurd (*loc. cit.*).

SEPARATION AND DETERMINATION

On a large scale rhenium and molybdenum are separated by precipitating the latter as the yellow precipitate. For analytical purposes several methods are available. The molybdenum may be precipitated with 8-hydroxyquinoline.³⁸ This is satisfactory for moderate amounts of each element but with larger amounts of molybdenum the adsorption on the very bulky precipitate of the molybdenum-8-hydroxyquinoline compound becomes serious. A second method may then be used in which the rhenium is separated

³⁷ Hurd, *Ind. Eng. Chem., Anal. Ed.*, **8**, 11 (1936).

³⁸ Geilmann and Weibke, *Z. anorg. allgem. Chem.*, **199**, 347 (1931).

by distillation from sulfuric acid. In the original method of Geilmann and Weibke³⁹ the rhenium was carried over in a stream of moist hydrogen chloride. Carbon dioxide and steam have been recommended.⁴⁰

Rhenium may also be separated by precipitation as the sulfide, Re_2S_7 , from a fairly strong acid solution.

The perrhenate ion is precipitated by nitron and after drying at 110° is weighed as nitron perrhenate.⁴¹ The oxidation to perrhenate must, of course, not be done by nitric acid in this case; hydrogen peroxide does very well. The best method is that of Willard and Smith,⁴² in which the perrhenate is precipitated as tetraphenylarsonium perrhenate from an acid solution and weighed as such after drying at 110° .

Volumetric methods for the determination of rhenium in its various oxides were devised by Geilmann and Hurd.⁴³

Perrhenate when treated with hydrochloric acid, stannous chloride, and potassium thiocyanate, yields an intensely colored, soluble compound, said to be $\text{ReO}(\text{CNS})_4$. This reaction is suitable for the colorimetric determination of very small amounts of rhenium.⁴⁴

PERIODIC GROUP VIII

The eighth group of the periodic table is comprised of the three triads:

iron	cobalt	nickel
ruthenium	rhodium	palladium
osmium	iridium	platinum

The elements in both the horizontal and vertical groups have many properties in common.

Some interesting transitions occur in the first long period on passing from chromium and manganese through iron, cobalt, and

³⁹ Geilmann and Weibke, *Z. anorg. allgem. Chem.*, **199**, 120 (1931); see also, Kronmann, *Z. anal. Chem.*, **90**, 31 (1932).

⁴⁰ Hurd and Hiskey, *Ind. Eng. Chem., Anal. Ed.*, **10**, 623 (1938).

⁴¹ Geilmann and Voigt, *Z. anorg. allgem. Chem.*, **193**, 311 (1930); Geilmann and Weibke, *ibid.*, **195**, 289 (1931).

⁴² Willard and Smith, *Ind. Eng. Chem., Anal. Ed.*, **11**, 186, 269, 305 (1939).

⁴³ Geilmann and Hurd, *Z. anorg. allgem. Chem.*, **210**, 351 (1933).

⁴⁴ Geilmann, Wrigge and Weibke, *Z. anorg. allgem. Chem.*, **208**, 217 (1932); Hurd and Babler, *Ind. Eng. Chem., Anal. Ed.*, **8**, 112 (1936).

nickel to copper and zinc. Although manganese is somewhat exceptional, the stability of the bivalent state increases while that of the trivalent state decreases; the ferric ion is a good oxidizing agent, cobalt a powerful one, but a trivalent nickel ion is unknown.

The second and third triads occupy similar transition positions in the second and third long periods. All six of these elements, however, are very much alike and are usually designated as the *platinum metals*.

As the atomic weight increases, in all three of the vertical groups, the stability of the higher valence forms increases and that of the lower valence forms decreases, and as usual the higher valence states are primarily acidic. All of the members of the eighth group have a great tendency to form complex or *coordination compounds*. This tendency becomes stronger as the atomic weight increases. In some respects this complicates the analytical chemistry of these elements; for example platinum salts on contact with ammonia and a number of other reagents form very stable, soluble compounds which do not give the ordinary reactions of the metal but give curious reactions of their own. Frequently, on the other hand, differences between the complex compounds of the elements are much greater than differences between the normal salts and can be utilized for the separation of the elements.

In alkaline solution in contact with strong oxidizing agents, iron forms the ferrate and perferrate ions, in which it has the valences of 4 and 6. In this respect iron is similar to ruthenium and osmium, and all three in the hexavalent state have similarities with chromium, molybdenum, and tungsten. Ruthenium and osmium form volatile tetroxides, which iron does not. Osmium forms an octafluoride, OsF_8 .

Cobalt, rhodium, and iridium form an enormous number of coordination compounds, mostly of the trivalent state of the elements. The higher valences of these elements are respectively 3, 4, and 6, the valence of 2 being doubtful with the two heavier elements. The valence of 5 is unknown in group VIII.

Palladium is almost always bivalent although quadrivalent compounds are known. Platinum is stable in the valences of both 2 and 4 but more so in the latter. Nickel, palladium, and platinum have the very remarkable property of absorbing hydrogen. These elements also show many similarities to the neighboring elements copper, silver, and gold.

IRON

The analytical chemistry of iron was discussed on p. 134.

COBALT

The principal ores of cobalt are cobaltite, CoAsS , and smaltite, CoAs_2 , which occur associated with nickel, iron, and copper sulfides, the principal deposits being those of the Belgian Congo and Ontario. Cobalt is used in various alloy steels, in ceramics and glass, and in drying oils.

SEPARATION AND GRAVIMETRIC DETERMINATION

Cobalt and nickel may be precipitated as the sulfides from an acetic acid solution containing ammonium acetate, and thus separated from manganese, magnesium, and the alkali and alkaline earth metals, but not from zinc. The separation from manganese is said to be much sharper if the precipitation is made from a solution containing pyridine and pyridine hydrochloride.¹

Cobalt is precipitated quantitatively by α -nitroso- β -naphthol from neutral or slightly acid solution. Copper, palladium, and iron are also precipitated quantitatively and tin, silver, chromium, uranium, and bismuth are partially precipitated; mercury, lead, arsenic, antimony, cadmium, beryllium, aluminum, manganese, nickel, and the alkaline earth and alkali metals are not precipitated although it is best to make a double precipitation when nickel is present in large amount. Following the removal of the major portion of the iron by ether extraction and the removal of the remainder by cupferron, the cobalt in steel may be separated to advantage with α -nitroso- β -naphthol.² If the α -nitroso- β -naphthol reagent is dissolved in syrupy phosphoric acid and the precipitation of cobalt made in a dilute nitric acid solution, ferric iron is not precipitated.³ The cobalt compound precipitated is a derivative of trivalent cobalt, oxidation having occurred at the expense of the reagent and the precipitate containing as a consequence considerable amounts of insoluble reduction products. For this reason the precipitate

¹ Ostroumov, *Ind. Eng. Chem., Anal. Ed.*, **10**, 693 (1938); Ostroumov and Maslenikova, *ibid.*, **10**, 695 (1938).

² Hoffman, *Bur. Standards J. Research*, **8**, 659 (1932); *ibid.*, **7**, 883 (1931).

³ Evans, *Analyst*, **62**, 371 (1937).

cannot be weighed but must be converted to the oxide or metal for weighing. It has been claimed that the precipitate obtained by a preliminary oxidation of the cobalt by hydrogen peroxide in alkaline solution, followed by solution in acetic acid and precipitation, gives a compound of definite composition; the method is not satisfactory, however.

Cobalt is quantitatively precipitated from an ammoniacal solution containing citrate by phenylthiohydantoic acid, $C_6H_5 \cdot NH \cdot CS \cdot NH \cdot CH_2 \cdot COOH$, and separated from all of the common metals except antimony and copper which are also precipitated quantitatively. Nickel and iron are carried down slightly so the method cannot then be used for a gravimetric determination of cobalt, but is, however, suitable as preliminary separation to a volumetric determination. The precipitate is best converted to the sulfate for weighing by heating with sulfuric acid and hydrogen peroxide.⁴

Cobalt may be determined electrolytically but a preliminary separation of cobalt is necessary and the method is not a separation from copper or nickel. The results are usually a little high. The electrolyte commonly used is an ammoniacal solution containing ammonium sulfate; ammonium sulfite or hydrazine sulfate is often added to hinder the oxidation of cobalt to cobaltic hydroxide at the anode, such a tendency being much greater with cobalt than with nickel. Varying amounts of sulfur are deposited with the metal when sulfite is added and must be corrected for in accurate work. The addition of gelatin to the electrolyte is beneficial and the amount of sulfite required varies with the amount of cobalt.⁵

If cobalt and nickel are deposited together electrolytically, the metals may be dissolved, the nickel determined by dimethylglyoxime, and the cobalt obtained by difference.

Cobalt is most accurately weighed as cobalt sulfate, obtained by evaporating the oxide or sulfide with sulfuric acid and igniting at 550° . When the sulfide or oxide is ignited in air to $700-900^\circ$, the residue approximates cobaltous-cobaltic oxide, Co_3O_4 , in composition, but this is only a fairly accurate form in which to weigh cobalt. Reduction to the metal by ignition in hydrogen is an excellent method for the determination of cobalt. Cobalt may also be weighed as the pyrophosphate, $Co_2P_2O_7$, after precipitation as the

⁴ Willard and Hall, *J. Amer. Chem. Soc.*, **44**, 2219 (1922); Hopkin and Williams, *Organic Reagents for Metals*, 3rd Ed., London, 1938, p. 93.

⁵ Brophy, *Ind. Eng. Chem., Anal. Ed.*, **3**, 363 (1931).

double ammonium phosphate but the method is not accurate. Cobalt ammonium phosphate is not precipitated in the presence of citrate; manganese ammonium phosphate is precipitated, however, and may thus be separated from cobalt.⁶

VOLUMETRIC DETERMINATION

Of the numerous methods which have been proposed for the volumetric determination of cobalt, the majority are based on the formation of cobaltic hydroxide, $\text{Co}(\text{OH})_3$, and the subsequent titration of trivalent cobalt with a reducing agent. Hydrogen peroxide in alkaline solution is most commonly used as the oxidizing agent although sodium perborate in alkaline solution may also be used, the excess oxidizing agent in both cases being removed by boiling. The subsequent determination is complicated by the great instability of the cobaltic ion in acid solution, and by the slowness with which the cobaltic hydroxide dissolves in reducing agents. A number of variations of this procedure have been tried. Low results are obtained if the precipitate is dissolved in strongly acid ferrous sulfate; stannous chloride and titanous chloride may be used if air is rigidly excluded; the addition of potassium iodide and solution in sulfuric acid followed by back titration of the iodine liberated is satisfactory although very slow;⁷ an excess of standard ferrous sulfate may be added to the alkaline solution, in an inert atmosphere, the precipitate then dissolved by the addition of sulfuric acid, and the excess ferrous sulfate back titrated with standard bichromate.⁸ None of these methods yields consistently accurate results. The conversion of the cobalt to cobalticyanide is the basis of an exceptionally interesting method for cobalt;⁹ the results are not very satisfactory, however.

The only good volumetric method for cobalt is the titration to the trivalent state in an ammoniacal citrate solution with ferricyanide. The end-point must be determined potentiometrically and is somewhat sharper if an excess of ferricyanide is added and a back titration made with a standard cobalt sulfate solution. Iron, chromium, nickel, and vanadium do not interfere; manganese

⁶ Fairchild, *Ind. Eng. Chem., Anal. Ed.*, **11**, 326 (1939).

⁷ Willard and Hall, *J. Amer. Chem. Soc.*, **44**, 2237 (1922).

⁸ Sarver, *Ind. Eng. Chem., Anal. Ed.*, **5**, 275 (1933).

⁹ Evans, *Analyst*, **62**, 363 (1937); Agnew, *ibid.*, **65**, 643 (1940).

is oxidized quantitatively to the trivalent state, however, so that the titration yields the sum of the cobalt and manganese.¹⁰

COLORIMETRIC DETERMINATION

The lack of small amounts of cobalt in the diet is the cause of certain types of sickness in animals, and for this reason considerable attention has been devoted to the determination of traces of cobalt.¹¹ The most popular colorimetric method utilizes the brownish-yellow color of cobalt with nitroso-R-salt.¹²

DETERMINATION OF NICKEL

Nickel is derived chiefly from complex sulfide ores of northern Ontario. Most nickel finds its way into metallurgical products, electroplate, coinage metal, armament and stainless steel, german silver, invar, nichrome, permalloy, monel, and many other alloys. Because of the variety and importance of these materials, the determination of nickel is a common one and the methods employed must be adapted to the separation and determination of amounts of nickel varying from traces to the major constituent.

SEPARATION AND GRAVIMETRIC DETERMINATION

The separation of nickel from other elements is most conveniently accomplished with dimethylglyoxime.¹³ The scarlet precipitate of nickel dimethylglyoxime is formed in ammoniacal, neutral, or acetate-buffered solution. It is soluble in mineral acids, cyanide solutions, and organic solvents such as alcohol, carbon tetrachloride, and ether. Iron, aluminum, and chromium are normally precipitated under the conditions under which nickel dimethylglyoxime may be precipitated; the addition of tartrate prevents the precipitation of these metals but does not interfere with the precipitation of nickel dimethylglyoxime. Small amounts of manganese such as

¹⁰ Dickens and Maasen, *Arch. Eisenhüttenw.*, **9**, 487 (1935); Tomiček and Freiburger, *J. Amer. Chem. Soc.*, **57**, 801 (1935).

¹¹ For bibliographies of this work see Pope, *Analyst*, **58**, 341 (1933); Daw, *ibid.*, **65**, 513 (1940).

¹² Stare and Elvehjem, *J. Biol. Chem.*, **99**, 473 (1932); McNaught, *Analyst*, **64**, 23 (1939).

¹³ For an extensive treatment of this subject see Diehl, *The Application of the Dioximes to Analytical Chemistry*, The G. Frederick Smith Chemical Company, Columbus, 1940, p. 23.

are present in a normal iron or steel cause no trouble in the separation of nickel dimethylglyoxime from an ammoniacal tartrate solution; but when larger amounts are present the precipitation must be made from an acetate solution. The separation of nickel from copper is best made by first reducing the copper to the univalent state by a sulfite and the precipitation then made by the addition of tartrate, dimethylglyoxime, and acetate. The separation of nickel from cobalt can be very conveniently made with dimethylglyoxime. An orange-brown, soluble cobalt compound containing dimethylglyoxime is formed and it is necessary to add sufficient dimethylglyoxime to combine with all of the cobalt to insure complete precipitation of the nickel. When iron and cobalt are both present in addition to the nickel there is produced, even in the presence of tartaric acid, a voluminous, amorphous, red-brown precipitate which is a compound of iron, cobalt, and dimethylglyoxime and which is very slimy in character and cannot be removed by washing. This material is not formed by ferrous iron so that interference from this source may be avoided by reducing the iron with sulfur dioxide prior to the precipitation of the nickel.

Because of the bulkiness of the nickel dimethylglyoxime precipitate, it is desirable to work with amounts of nickel not exceeding 30 mg. Care should be exercised during the precipitation that not more than a 5 per cent excess of the alcohol solution of dimethylglyoxime be added, otherwise contamination will result because of the insolubility of dimethylglyoxime in water. It is best to cool the solution before filtering off the nickel dimethylglyoxime. The precipitate of nickel dimethylglyoxime is best dried at 110-120° and weighed as such. It may also be ignited carefully in one or two wet, filter paper wrappings to prevent loss by sublimation, ignited at about 800°, and the nickel weighed as nickel oxide, NiO.

Nickel may be deposited electrolytically from an ammoniacal solution containing ammonium sulfate. This is a convenient method for large amounts of nickel but it is not a separation from copper, cobalt, or large amounts of manganese.

An excellent separation of nickel and cobalt from manganese can be made by passing hydrogen sulfide into a solution containing pyridine hydrochloride and free pyridine. The precipitate of sulfide obtained under these conditions is crystalline and carries with it little absorbed material.¹⁴

¹⁴ Ostroumov, *Ind. Eng. Chem., Anal. Ed.*, **10**, 693 (1938); Ostroumov and Maslenikova, *ibid.*, **10**, 695 (1938).

Procedure for the Determination of Nickel in Iron and Steel.

The size of sample taken should be such that not more than 30 mg. of nickel will be present because of the great bulk of the precipitate; thus for a steel containing

up to 1 per cent nickel,	use a 3 g. sample
1 to 3 " " " "	a 1 g. "
3 to 6 " " " "	a 0.5 g. "
above 6 " " " "	a 0.25 g. "

Weigh the sample into a 400 ml. beaker and treat with 30 ml. of hydrochloric acid and heat to dissolve the steel. Add 10 ml. of nitric acid to decompose any carbides remaining and oxidize the ferrous salts; boil for 15 minutes and dilute to 200 ml. Add 40 ml. of a 20 per cent solution of citric or tartaric acid, neutralize with ammonia, and add 1 ml. of ammonia in excess. Filter off any silica or insoluble matter present and wash with hot water containing a little ammonia. Make slightly acid with acetic acid, heat to 60°, and add 20 ml. of a 1 per cent solution of dimethylglyoxime in alcohol. Add ammonia until slightly alkaline and digest for 30 minutes at 60°. Allow the solution to stand at least 1 hour and to cool to room temperature during this time. Filter on a Gooch or fritted glass crucible, keeping the crucible filled with liquid. Wash with cold water, dry at 110-120°, and weigh as nickel dimethylglyoxime which contains 20.32 per cent nickel.

VOLUMETRIC DETERMINATION

The cyanide method for the volumetric determination of nickel is based upon the reaction:



The end-point is determined by the addition of a small amount of silver iodide, the opalescence of which disappears at the end-point, since silver iodide is insoluble in ammonia but soluble in an excess of cyanide:

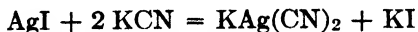

Usually a measured amount of standard silver nitrate is added and the amount of cyanide necessary to react with it subtracted from the total used in the reaction. Iron does not interfere and is kept in solution by the addition of citric acid. Copper and cobalt interfere by reacting with the cyanide. The method may conveniently be used for determining nickel after precipitation with dimethylgly-

oxime and subsequent solution of the precipitate in nitric and hydrochloric acids.

COLORIMETRIC DETERMINATION

In the presence of an oxidizing agent and dimethylglyoxime, nickel forms a quadrivalent, orange, soluble compound which furnishes a sensitive and very satisfactory colorimetric method for the determination of nickel. This method has been applied to the determination of very small amounts of nickel in steel and in silicate rock.^{15, 16} Potassium dithiooxalate, $K_2C_2O_2S_2$, gives a deep magenta color with nickel salts and the reaction conforms to Beer's Law over a range suitable for colorimetric work. Many other ions, particularly iron and cobalt, interfere.¹⁷ The isolation of very small amounts of nickel may be accomplished by a chloroform extraction of the solution after the addition of dimethylglyoxime and neutralization; the nickel passes into the chloroform as nickel dimethylglyoxime and can be later returned to an aqueous solution for determination by shaking the chloroform extract with dilute hydrochloric acid. The literature on the determination of small amounts of nickel is voluminous.¹⁸

THE PLATINUM METALS RUTHENIUM, OSMIUM, RHODIUM, IRIIDIUM, PALLADIUM, AND PLATINUM

Platinum occurs as the native metal alloyed with varying amounts of the other metals of the group and with gold, iron, and copper. The deposits are widespread, the principal producing regions being in Colombia, the Ural Mountains, Ontario, and Transvaal. Platinum is used extensively in jewelry, dental alloys, and laboratory apparatus, and as a catalyst. A small amount of iridium or rhodium is usually added to increase its hardness.

¹⁵ Jones, *Analyst*, **54**, 582 (1929); Murray and Ashley, *Ind. Eng. Chem., Anal. Ed.*, **10**, 1 (1938); see Diehl, *loc. cit.*, p. 35.

¹⁶ Sandell and Perlich, *Ind. Eng. Chem., Anal. Ed.*, **11**, 309 (1939).

¹⁷ Yoe and Wirsing, *J. Amer. Chem. Soc.*, **54**, 1866 (1932).

¹⁸ For bibliographies of the methods for the determination of small amounts of nickel see Pope, *Analyst*, **58**, 340 (1933); Daw, *ibid.*, **65**, 603 (1940).

GENERAL CHEMISTRY

The platinum metals are attacked only by strong oxidizing agents. Aqua regia, however, is practically without action on rhodium, ruthenium, iridium, and osmium although platinum alloys containing these metals will dissolve completely. An alkaline oxidizing fusion is necessary for the solution of these elements or their alloys with each other.

The valences of platinum are 2 and 4. Normal salts with oxygen acids are not stable and the halogen salts pass readily to complex compounds of the types K_2PtCl_4 and K_2PtCl_6 . Both platinous and platinic compounds are precipitated by hydrogen sulfide. The black sulfides, PtS and PtS_2 , are both soluble in alkali sulfides. Platinum has a great tendency to form soluble, stable ammonia complexes. Platinum compounds are easily reduced to the metal, formic acid being the reducing agent generally used.

The principal valence of palladium is 2, although quadrivalent compounds are also known. Like platinum, palladium forms a sulfide insoluble in acids but soluble in alkali sulfides. Dimethylglyoxime yields a yellow, insoluble palladium compound from acid solution, and α -nitroso- β -naphthol gives a brownish red precipitate.

Ruthenium and osmium have a variety of valences, the higher states being the more important. Their tetroxides are volatile and serve for the separation of the elements from the other members of the group. Both rhodium and iridium have valences of 3 and 4 and the latter also of 6. Like the other platinum metals, they form sulfides insoluble in acids. For confirmatory tests for these elements, see McAlpine and Soule.¹⁹

As already pointed out, gold may easily be separated from the platinum metals by reduction with hydroquinone. Several methods may be employed for the separation of the platinum metals from other common metals. Precipitation as the sulfides from acid solutions will separate the metals from all but the members of the hydrogen sulfide groups. Precipitation as the hydrated oxides or as ammonium salts of chloro complexes will accomplish certain other separations but are not entirely satisfactory. For the separation of the platinum metals from other members of the hydrogen sulfide group, specific methods for each particular metal must be used, that

¹⁹ McAlpine and Soule, *Qualitative Chemical Analysis*, D. Van Nostrand Company, Inc., New York, 1933, p. 282.

is, copper removed as the thiocyanate, lead as the sulfate, tin and bismuth as oxy-salts, and so on.

The outstanding work on the separation of the platinum metals from each other and their determination is that of Gilchrist and Wichers.²⁰ Osmium is first removed by distillation as osmium tetroxide from a nitric acid solution; it is collected in hydrochloric acid containing sulfur dioxide, precipitated as the hydrated dioxide, and ignited in hydrogen to the metal for weighing. Ruthenium is then removed by distillation from a dilute sulfuric acid solution containing bromate; it also is collected in hydrochloric acid containing sulfur dioxide, precipitated as the hydrated oxide, $\text{Ru}_2\text{O}_3 \cdot x\text{H}_2\text{O}$, ignited in hydrogen, and weighed as the metal. Palladium, rhodium, and iridium are next precipitated as the hydrated dioxides from a neutral solution containing bromate and thus separated from platinum. The platinum in the filtrate is precipitated as the sulfide, ignited, and weighed as the metal. The oxides of palladium, rhodium, and iridium are dissolved in hydrochloric acid and palladium precipitated by dimethylglyoxime; it may be weighed as such or ignited in hydrogen, cooled in carbon dioxide, and weighed as the metal. Rhodium is next removed by reduction to the metal by titanous chloride; it is redissolved in sulfuric acid, precipitated as the sulfide, ignited in air and then in hydrogen, and weighed as metallic rhodium. The titanium is removed from the filtrate by precipitation with cupferron. The iridium is then precipitated as the hydrated dioxide, and finally ignited in hydrogen and weighed as the metal.

²⁰ Gilchrist and Wichers, *J. Amer. Chem. Soc.*, **57**, 2565 (1935).

SUMMARY OF THE PRINCIPAL METHODS FOR THE SEPARATION AND GRAVIMETRIC
DETERMINATION OF THE ELEMENTS

Element	Separated as	Elements from Which the Separation is Particularly Noteworthy	Principal Interfering Elements	Best Form for Weighing Following the Separation
Li	Extraction of LiCl by octyl alcohol	Na		Li ₂ SO ₄
Na	Na ₂ Mg(UO ₂) ₃ (C ₂ H ₃ O ₂) ₉ ·6.5 H ₂ O	K, NH ₄ ⁺ , Ca, Mg, Ba, Fe ⁺⁺⁺ , Al, Cr ⁺⁺⁺	Li, PO ₄ ⁻⁻⁻	Na ₂ Mg(UO ₂) ₃ (C ₂ H ₃ O ₂) ₉ ·6.5 H ₂ O
K	Extraction of soluble perchlorates by ethyl acetate leaving KClO ₄ Extraction of soluble chloroplati- nates by 80 per cent alcohol leaving K ₂ PtCl ₆	Na, Li, Ca, Al Na, Li	NH ₄ ⁺ , TI ⁺ , SO ₄ ⁻⁻⁻ NH ₄ ⁺ , most heavy metals, SO ₄ ⁻⁻⁻	KClO ₄ K ₂ PtCl ₆
Cu	Cu ⁰ by electrodeposition CuCNS	Pb, Cd, Zn Most metals	Sn, Sb, As, Ag, Bi, Hg Hg ⁺ , Ag, Se, Te, Pt	Cu ⁰ CuO, CuCNS
Ag	AgCl	Most metals	Hg ₂ ⁺⁺ , Cu ₂ ⁺⁺ , TI ⁺	AgCl
Au	Au ⁰ by reduction with hydroqui- none	Pt metals, Cu, Ni, Zn		Au ⁰

SUMMARY OF THE PRINCIPAL METHODS FOR THE SEPARATION AND GRAVIMETRIC DETERMINATION OF THE ELEMENTS—Continued

Element	Separated as	Elements from Which the Separation is Particularly Noteworthy	Principal Interfering Elements	Best Form for Weighing Following the Separation
Be	Be(OH) ₂ Fe and Al precipitated by 8-hydroxyquinoline or bicarbonate	Mg, Ca, Sr, Ba, Na, K	Fe, Al, Ti, Cr ⁺⁺⁺	BeO
Mg	MgNH ₄ PO ₄	Na, K, NH ₄ ⁺	All other metals	Mg ₂ P ₂ O ₇
Ca	CaC ₂ O ₄ CaSO ₄ from 90 per cent methyl alcohol	Mg, Na, K, NH ₄ ⁺ Mg	All other metals Most other metals	CaCO ₃ , CaO CaSO ₄
Sr	SrSO ₄ Sr(NO ₃) ₂ from 80 per cent nitric acid	Na, K, NH ₄ ⁺ , Al Ca, Mg, and most other metals	Ca, Ba, Pb Pb, Ba	SrSO ₄ Sr(NO ₃) ₂
Ba	BaSO ₄ BaCrO ₄	Most metals Ca, Sr	Ca, Sr, Pb	BaSO ₄ BaCrO ₄
Zn	ZnS ZnNH ₄ PO ₄	Ni, Mn, Fe, Al, Cr, Ti, Ca, Sr, Mg, Na, Co (acrolein present) Na, K, NH ₄ ⁺ , Ni	Acid hydrogen sulfide group, Co All other metals	ZnO Zn ₂ P ₂ O ₇

Cd	CdS Cd(NH ₄) ₂ PO ₄	Zn, Fe, Al, Co, Ni, Mn, Ca, Sr, Ba, Na, K Na, K, NH ₄ ⁺	Acid hydrogen sulfide group All other metals	CdSO ₄ Cd ₂ P ₂ O ₇
Hg	Hg ⁰ by chemical reduction HgS	Most common metals Fe, Al, Ni, Co, Zn, Mn, Ca	Cu, Ag, Au, Pt Acid hydrogen sulfide group	Hg ⁰ HgS
B	Distillation of methyl borate	Practically all inorganic materials		None
Al	Al(OH) ₃ by phenylhydrazine AlPO ₄	Fe ⁺⁺ , Mn, Ca Fe ⁺⁺ , Mn, Ca	Fe ⁺⁺⁺ , Ti, Zr, Th, Zn, Co, Ni, acid hydro- gen sulfide group Fe ⁺⁺⁺ , Ti, Zr, Th, Zn, Co, Ni, acid hydro- gen sulfide group SiO ₂	Al ₂ O ₃ AlPO ₄
Sc, Y, Rare Earths	NaAlO ₂ Al 8-hydroxyquinoline R ₂ (C ₂ O ₄) ₃	Fe ⁺⁺⁺ , Ti, Zr, PO ₄ ⁻⁻⁻ Be, As, Mo, U, B, Cb, Ta, PO ₄ ⁻⁻⁻ , F ⁻ , VO ₃ ⁻	Fe ⁺⁺⁺	Al(C ₉ H ₆ ON) ₃
Ga	Extraction of GaCl ₃ by ether	Cb, Ta, Ti, Zr, Fe, Be, Al Most metals	Th Fe ⁺⁺⁺ , Th ⁺⁺⁺ , Au ⁺⁺⁺	R ₂ O ₃ Ga ₂ O ₃

SUMMARY OF THE PRINCIPAL METHODS FOR THE SEPARATION AND GRAVIMETRIC
DETERMINATION OF THE ELEMENTS—Continued

Element	Separated as	Elements from Which the Separation is Particularly Noteworthy	Principal Interfering Elements	Best Form for Weighing Following the Separation
In	In ₂ S ₃ In(OH) ₃		Acid hydrogen sulfide group Fe ⁺⁺⁺ , Al, Ti	In ₂ O ₃
Tl	Extraction of TlCl ₃ by ether TlI Tl(OH) ₃	Most metals Al, Zn, Fe	Fe ⁺⁺⁺ , Ga, Au ⁺⁺⁺ Ag, Hg, Pb Ammonia group	Tl ₂ O ₃
C	Combustion to or evolution of carbon dioxide		Acidic gases	Na ₂ CO ₃
Si	SiO ₂		H ₂ SnO ₃ , WO ₃ , TiO ₂	SiO ₂
Ti	Precipitation of Ti(OH) ₄ at a pH of 2 Ti cupferron Ti <i>p</i> -hydroxyphenylarsonate	Al, Fe ⁺⁺⁺ Al, Cr ⁺⁺⁺ , Fe ⁺⁺ Fe, all of the common elements	Zr, Sn, Sb, Bi Fe ⁺⁺⁺ Ce ⁺⁺⁺⁺ , Sn	TiO ₂ TiO ₂ TiO ₂

Zr	ZrOHPO ₄ Zr(SeO ₃) ₂ Zr cupferron Zr n-propylarsenate	All of the common elements and Ti as per-titanic acid All of the common elements and Ti as per-titanic acid Al, bivalent metals Fe, Ti, Al, Cr, Co, Ni, Th	Ce ⁺⁺⁺ , Ti Ce ⁺⁺⁺⁺ , Ti, Th Ti, Fe ⁺⁺⁺ Sn	ZrO ₂ , ZrP ₂ O ₇ ZrO ₂ ZrO ₂ ZrO ₂
Ce	Ce ₂ (C ₂ O ₄) ₃ Ce(OH) ₄ (probably a basic salt)	Ti, Zr Rare Earths, Th	Rare Earths, Th	CeO ₂ CeO ₂
Th	Th(C ₂ O ₄) ₂ Th(IO ₃) ₄ ThP ₂ O ₇	Ti, Zr, Fe, Al Ce ⁺⁺⁺ , Rare Earths, PO ₄ ⁻⁻⁻⁻ Ti, Ce ⁺⁺⁺ , Rare Earths	Rare Earths Ti, Zr Ce ⁺⁺⁺ , Zr	ThO ₂
Ge	Distillation of GeCl ₄ in a stream of Cl ₂ + HCl	As ⁺⁵ , all common metals		GeO ₂
Sn	H ₂ SnO ₃ Distillation of SnCl ₄ SnS ₂ + SnS from acid solution	Fe, Pb, Zn, Zr, all common metals All common elements Fe, Cr, V, W, Co, Ni, Mn	Sb, SiO ₂ , WO ₃ , PO ₄ ⁻⁻⁻⁻ , As Ge, As, Sb As, Sb, Cu, Bi, Pb, Hg	SnO ₂ SnO ₂ SnO ₂

SUMMARY OF THE PRINCIPAL METHODS FOR THE SEPARATION AND GRAVIMETRIC
DETERMINATION OF THE ELEMENTS—Continued

Element	Separated as	Elements from Which the Separation is Particularly Noteworthy	Principal Interfering Elements	Best Form for Weighing Following the Separation
Pb	PbSO ₄ PbO ₂	Most common metals Most common metals	Ca, Sr, Ba Ag, Bi, Mn, As, Sb, Sn, PO ₄ ⁻⁻⁻ , Cl ⁻	PbSO ₄
N	Combustion to N ₂ Distillation of NH ₃ Nitron nitrate	(Dumas combustion) (Kjeldahl distillation) SO ₄ ⁻⁻⁻ , Cl ⁻	ClO ₄ ⁻ , Br ⁻ , I ⁻ , CNS ⁻ , CrO ₄ ⁻⁻⁻ , NO ₂ ⁻	Gas-volumetric Usually volumetrically
P	(NH ₄) ₃ [P(Mo ₃ O ₁₀) ₄] MgNH ₄ PO ₄	Fe, Al, most metals Na, K	As ⁺⁵ All heavy metals	(NH ₄) ₃ [P(Mo ₃ O ₁₀) ₄] Mg ₂ P ₂ O ₇
As	Distillation of AsCl ₃ MgNH ₄ AsO ₄	Sb, Sn, all other metals	Ge PO ₄ ⁻⁻⁻ , all heavy metals	Usually volumetrically Mg ₂ As ₂ O ₇
Sb	Sb ₂ S ₃ (acid solution) Distillation of SbCl ₃	Pb, Sn, Cd Most metals	As As, Ge	Usually volumetrically Usually volumetrically
Bi	BiOCl BiPO ₄	Most metals Ag, Cu, Cd, Hg, Al, Zn	Ag, As, Sn, Sb Ti, Zr, As ⁺⁵ , Sn, Sb	BiOCl BiPO ₄

V	VO^{++} or VO_3^- cupferron	UO_2^{++}	Fe^{+++} , Ti, Zr	V_2O_5
Cb, Ta	$HClO_3$, $HTaO_3$	Most metals	Ti, Sn, Zr, Sb	Cb_2O_6 , Ta_2O_6
O	Evolution of H_2O			H_2O
S	Evolution of H_2S $BaSO_4$		NO_3^- , ClO_3^-	Usually volumetrically, $BaSO_4$ $BaSO_4$
Se	$SeBr_4$ Se^0	Most metals Most metals	As, Ge, Os Au, Pt	Te^0 Se^0
Te	Te^0	Most metals	Se, Au, Pt	Te^0 , TeO_2
Cr	CrO_2Cl_2	Most metals	Os, Ge, Sn, Sb, Ru	Usually volumetrically
Mo	MoS_3 (acid tartrate solution) α -Benzoinoxime molybdate	Fe, W, Zn, Co, Ni, etc. Fe^{+++}	Acid H_2S group W	MoO_3 MoO_3
W	$WO_3 \cdot xH_2O$	Most metals	SiO_2 , Sn	WO_3
U	Forms soluble $(NH_4)_4UO_2(CO_3)_3$ U^{++++} cupferron $(UO_2)_3(AsO_4)_2$	Fe, Al, Zn, Mn Al, Cr, Mn, Zn, PO_4^{---} Al, Mg, Ca, Fe	Fe, Ti, Zr Zr, Pb	U_3O_8 U_3O_8
F	Evolution of H_2SiF_6 PbClF	Most metals		PbClF

SUMMARY OF THE PRINCIPAL METHODS FOR THE SEPARATION AND GRAVIMETRIC DETERMINATIONS OF THE ELEMENTS—Continued

Element	Separated as	Elements from Which the Separation is Particularly Noteworthy	Principal Interfering Elements	Best Form for Weighing Following the Separation
Cl	AgCl	NO_3^-	Br^- , I^- , CN^- , CNS^-	AgCl
Br	AgBr		Cl^- , I^- , CN^- , CNS^-	AgBr
I	AgI		Cl^- , Br^-	
Mn	$\text{MnO}_2(\text{HNO}_3 + \text{NaClO}_3)$ MnS MnNH_4PO_4	Fe, Ni, Zn, Ca Ca, Sr, Mg	All heavy metals	Usually volumetrically, Mn_3O_4 MnSO_4 $\text{Mn}_2\text{P}_2\text{O}_7$
Re	Evolution of Re_2O_7 Tetraphenylarsonium perchlenate	Mo	NO_3^- , I^- , ClO_4^-	Tetraphenylarsonium perchlenate
Fe	$\text{Fe}(\text{OH})_3$ Fe basic acetate or benzoate Fe cupferron	Mn, Zn, Co, Ni, Ca, Ba, Sr, Mg Al, Cr, Mn, Ni, Co, Zn, PO_4^{---}	Al, Cr, Co, Ni, Zn, Cu, PO_4^{---} Ti, Al, Zr, Cr, metals of acid hydrogen sul- fide group Ti, Zr, Sn	Fe_2O_3 Fe_2O_3 Fe_2O_3

Co	CoS Co α -nitroso- β -naphthol Co phenylthidhydantoin	Mn, Mg, Ca Ni, Hg, Pb, As, Sb, Cd, Be, Al, Mn, Mg, Ba, Sr, Ca Most metals, small amounts of Ni and Fe carried down	Zn Fe, Cu Sb, Cu	CoSO ₄ , Co ₃ O ₄ CoSO ₄ , Co ₃ O ₄ CoSO ₄ , Co ₃ O ₄
Ni	Ni dimethylglyoxime	Fe, Co, all metals	Fe ⁺⁺⁺ and Co together	Ni dimethylglyoxime
Ru	Distillation of RuO ₄ Ru ₂ O ₃ · xH ₂ O	Most metals	Os	Ru ⁰
Os	Distillation of OsO ₄ OsO ₂ · xH ₂ O	All metals	Ru	Os ⁰
Rh	Rh ⁰			Rh ⁰
Ir	IrO ₂ · xH ₂ O			Ir ⁰
Pd	Pd dimethylglyoxime	Most metals, Ni	Au, Pt	Pd dimethylglyoxime
Pt	(NH ₄) ₂ PtCl ₆ PtS ₂	Most metals		Pt ⁰ Pt ⁰

SUMMARY OF THE PRINCIPAL METHODS FOR THE VOLUMETRIC
DETERMINATIONS OF THE ELEMENTS

- Cu** (1) $2 \text{CuSO}_4 + 4 \text{KI} = \text{Cu}_2\text{I}_2 + \text{I}_2 + 2 \text{K}_2\text{SO}_4$
 $2 \text{I} + 2 \text{Na}_2\text{S}_2\text{O}_3 = 2 \text{NaI} + \text{Na}_2\text{S}_4\text{O}_6$
 (2) $4 \text{CuCNS} + 7 \text{KIO}_3 + 14 \text{HCl} = 4 \text{CuSO}_4 + 7 \text{ICl} + 4 \text{HCN} + 7 \text{KCl} + 5 \text{H}_2\text{O}$
- Ag** (1) $\text{AgNO}_3 + \text{KCNS} = \text{AgCNS} + \text{KNO}_3$
 (2) $\text{AgNO}_3 + \text{KI} = \text{AgI} + \text{KNO}_3$
 $2 \text{Ce}(\text{SO}_4)_2 + 2 \text{KI} + \text{starch} = \text{Ce}_2(\text{SO}_4)_3 + \text{K}_2\text{SO}_4 + \text{I}_2 \text{ starch}$
- Be** No satisfactory method.
- Mg** (1) $\text{Mg}(\text{C}_9\text{H}_6\text{ON})_2 + 2 \text{HCl} = \text{MgCl}_2 + 2 \text{C}_9\text{H}_7\text{ON}$ (8-hydroxyquinoline)
 $2 \text{C}_9\text{H}_7\text{ON} + 8 \text{Br} = 2 \text{C}_9\text{H}_5\text{ONBr}_2 + 4 \text{HBr}$
- Ca** (1) $5 \text{CaC}_2\text{O}_4 + 2 \text{KMnO}_4 + 8 \text{H}_2\text{SO}_4 = 5 \text{CaSO}_4 + 10 \text{CO}_2 + \text{K}_2\text{SO}_4 + 2 \text{MnSO}_4 + 8 \text{H}_2\text{O}$
- Sr** (1) $5 \text{SrC}_2\text{O}_4 + 2 \text{KMnO}_4 + 8 \text{H}_2\text{SO}_4 = 5 \text{SrSO}_4 + 10 \text{CO}_2 + \text{K}_2\text{SO}_4 + 2 \text{MnSO}_4 + 8 \text{H}_2\text{O}$
- Ba** (1) $2 \text{BaCrO}_4 + 6 \text{KI} + 16 \text{HCl} = 2 \text{BaCl}_2 + 3 \text{I}_2 + 6 \text{KCl} + 2 \text{CrCl}_3 + 8 \text{H}_2\text{O}$
 $\text{I}_2 + 2 \text{Na}_2\text{S}_2\text{O}_3 = 2 \text{NaI} + \text{Na}_2\text{S}_4\text{O}_6$
 (2) $\text{BaCl}_2 + \text{Na}_2\text{SO}_4 = \text{BaSO}_4 + \text{Na}_2\text{SO}_4$
 $\text{Ba}(\text{THQ}) + \text{Na}_2\text{SO}_4 = \text{BaSC}_4 + \text{Na}_2(\text{THQ})$
- Zn** (1) $3 \text{ZnCl}_2 + 2 \text{K}_4\text{Fe}(\text{CN})_6 = \text{K}_2\text{Zn}_3[\text{Fe}(\text{CN})_6]_2 + 6 \text{KCl}$
 (2) $3 \text{ZnSO}_4 + 2 \text{K}_3\text{Fe}(\text{CN})_6 + 2 \text{KI} = \text{K}_2\text{Zn}_3[\text{Fe}(\text{CN})_6]_2 + \text{I}_2 + 3 \text{K}_2\text{SO}_4$
 $\text{I}_2 + \text{Na}_2\text{S}_2\text{O}_3 = 2 \text{NaI} + \text{Na}_2\text{S}_4\text{O}_6$

- Cd** No satisfactory method.
- Hg** (1) $\text{Hg}(\text{NO}_3)_2 + 2 \text{KCNS} = \text{Hg}(\text{CNS})_2 + 2 \text{KNO}_3$
 (2) $2 \text{K}_2\text{HgI}_4 + \text{N}_2\text{H}_4 = 2 \text{Hg}^0 + 4 \text{KI} + 4 \text{HI} + \text{N}_2$
 $3 \text{Hg}^0 + \text{KBrO}_3 + 5 \text{KBr} + 3 \text{H}_2\text{SO}_4 = 3 \text{HgBr}_2 + 3 \text{K}_2\text{SO}_4 + 3 \text{H}_2\text{O}$
 (3) $5 \text{Hg}(\text{NO}_3)_2 + 2 \text{H}_4\text{IO}_6 = \text{H}_6\text{I}(\text{IO}_6)_2 + 10 \text{HNO}_3$
 $\text{Hg}_2(\text{IO}_6)_2 + 34 \text{KI} + 24 \text{HCl} = 5 \text{K}_2\text{HgI}_4 + 8 \text{I}_2 + 24 \text{KCl} + 12 \text{H}_2\text{O}$
 $\text{I}_2 + 2 \text{Na}_2\text{S}_2\text{O}_3 = 2 \text{NaI} + \text{Na}_2\text{S}_4\text{O}_6$
- B** (1) $\text{HBO}_2 \cdot \text{mannitol} + \text{NaOH} = \text{NaBO}_2 \cdot \text{mannitol} + \text{H}_2\text{O}$
- Al** (1) $\text{Al}(\text{C}_9\text{H}_6\text{ON})_3 + 3 \text{HCl} = \text{AlCl}_3 + 3 \text{C}_9\text{H}_7\text{ON}$ (8-hydroxyquinoline)
 $3 \text{C}_9\text{H}_7\text{ON} + 12 \text{Br} = 3 \text{C}_9\text{H}_5\text{ONBr}_2 + 6 \text{HBr}$
- Ga** No satisfactory method.
- Tl** (1) $3 \text{TlCl} + 9 \text{HCl} + \text{KBrO}_3 = 3 \text{HTlCl}_4 + \text{KBr} + 3 \text{H}_2\text{O}$
- Ti** (1) $2 \text{Ti}(\text{SO}_4)_2 + \text{Zn}^0 = \text{Ti}_2(\text{SO}_4)_3 + \text{ZnSO}_4$
 $\text{Ti}_2(\text{SO}_4)_3 + \text{Fe}_2(\text{SO}_4)_3 = 2 \text{Ti}(\text{SO}_4)_2 + 2 \text{FeSO}_4$
- Zr** No satisfactory method.
- Ce** (1) $\text{Ce}_2(\text{SO}_4)_3 + (\text{NH}_4)_2\text{S}_2\text{O}_8 = 2 \text{Ce}(\text{SO}_4)_2 + (\text{NH}_4)_2\text{SO}_4$
 $2 \text{Ce}(\text{SO}_4)_2 + 2 \text{FeSO}_4 = \text{Ce}_2(\text{SO}_4)_3 + \text{Fe}_2(\text{SO}_4)_3$
- Sn** (1) $\text{SnCl}_4 + \text{Pb}^0 = \text{SnCl}_2 + \text{PbCl}_2$
 $\text{SnCl}_2 + \text{I}_2 + 2 \text{HCl} = \text{SnCl}_4 + 2 \text{HI}$
 (2) $\text{K}_6\text{Sn}_3(\text{C}_2\text{O}_4)_7 + 2 \text{H}_2\text{S} = 2 \text{K}_2\text{SnS}(\text{C}_2\text{O}_4)_2 + 2 \text{H}_2\text{C}_2\text{O}_4 + \text{K}_2\text{C}_2\text{O}_4$
 $2 \text{K}_2\text{SnS}(\text{C}_2\text{O}_4)_2 + 2 \text{I}_2 + 2 \text{H}_2\text{C}_2\text{O}_4 + \text{K}_2\text{C}_2\text{O}_4 = \text{K}_6\text{Sn}_3(\text{C}_2\text{O}_4)_7 + 4 \text{HI} + 2 \text{S}$

SUMMARY OF THE PRINCIPAL METHODS FOR THE VOLUMETRIC
DETERMINATIONS OF THE ELEMENTS—Continued

- Pb** (1) $2 \text{PbCrO}_4 + 6 \text{KI} + 16 \text{HCl} = 2 \text{PbCl}_2 + 6 \text{KCl} + 2 \text{CrCl}_3 + 3 \text{I}_2 + 8 \text{H}_2\text{O}$
 $\text{I}_2 + 2 \text{Na}_2\text{S}_2\text{O}_3 = 2 \text{NaI} + \text{Na}_2\text{S}_4\text{O}_6$
 (2) $3 \text{Pb}(\text{NO}_3)_2 + 2 \text{NaIO}_4 + 4 \text{H}_2\text{O} = \text{Pb}_3\text{H}_4(\text{IO}_6)_2 + 2 \text{NaNO}_3 + 4 \text{HNO}_3$
 $\text{Pb}_3\text{H}_4(\text{IO}_6)_2 + 8 \text{HCl} + 6 \text{H}_3\text{AsO}_3 = 3 \text{PbCl}_2 + 2 \text{ICl} + 6 \text{H}_3\text{AsO}_4 + 6 \text{H}_2\text{O}$
 $2 \text{H}_3\text{AsO}_3 + \text{KIO}_3 + 2 \text{HCl} = 2 \text{H}_3\text{AsO}_4 + \text{KCl} + \text{ICl} + \text{H}_2\text{O}$
- N** (1) $\text{NH}_4\text{OH} + \text{HCl} = \text{NH}_4\text{Cl} + \text{H}_2\text{O}$
- P** (1) $(\text{NH}_4)_2\text{P}(\text{Mo}_3\text{O}_{10})_4 + 23 \text{NaOH} = 11 \text{Na}_2\text{MoO}_4 + (\text{NH}_4)_2\text{MoO}_4 + \text{NaNH}_4\text{PO}_4 + 11 \text{H}_2\text{O}$
 (2) $(\text{NH}_4)_2\text{P}(\text{Mo}_3\text{O}_{10})_4 + 39 \text{H}_2\text{SO}_4 + 18 \text{Zn}^0 = 6 \text{Mo}_2(\text{SO}_4)_3 + 3 \text{NH}_4\text{HSO}_4 + \text{H}_3\text{PO}_4 + 36 \text{H}_2\text{O} + 18 \text{ZnSO}_4$
 $5 \text{Mo}_2(\text{SO}_4)_3 + 6 \text{KMnO}_4 + 16 \text{H}_2\text{O} = 10 \text{H}_2\text{MnO}_4 + 3 \text{K}_2\text{SO}_4 + 6 \text{MnSO}_4 + 6 \text{H}_2\text{SO}_4$
- V** (1) $2 \text{HVO}_3 + 2 \text{FeSO}_4 + 3 \text{H}_2\text{SO}_4 = 2 \text{VOSO}_4 + \text{Fe}_2(\text{SO}_4)_3 + 4 \text{H}_2\text{O}$
 (2) $10 \text{VOSO}_4 + 2 \text{KMnO}_4 + 12 \text{H}_2\text{O} = 10 \text{HVO}_3 + 2 \text{MnSO}_4 + \text{K}_2\text{SO}_4 + 7 \text{H}_2\text{SO}_4$
- As** (1) $3 \text{H}_3\text{AsO}_3 + \text{KBrO}_3 (+\text{HCl}) = 3 \text{H}_3\text{AsO}_4 + \text{KBr}$
 (2) $5 \text{H}_3\text{AsO}_3 + 2 \text{KMnO}_4 + 6 \text{HCl} = 5 \text{H}_3\text{AsO}_4 + 2 \text{MnCl}_2 + 2 \text{KCl} + 3 \text{H}_2\text{O}$
 (3) $2 \text{H}_3\text{AsO}_3 + \text{KIO}_3 + 2 \text{HCl} = 2 \text{H}_3\text{AsO}_4 + \text{KCl} + \text{ICl} + \text{H}_2\text{O}$
 (4) $\text{H}_3\text{AsO}_3 + 2 \text{Ce}(\text{SO}_4)_2 + \text{H}_2\text{O} = \text{H}_3\text{AsO}_4 + \text{Ce}_2(\text{SO}_4)_3 + \text{H}_2\text{SO}_4$
 (5) $\text{H}_2\text{AsO}_4 + 2 \text{KI} + 2 \text{HCl} = \text{H}_3\text{AsO}_3 + \text{I}_2 + 2 \text{KCl} + \text{H}_2\text{O}$
 $\text{I}_2 + 2 \text{Na}_2\text{S}_2\text{O}_3 = 2 \text{NaI} + \text{Na}_2\text{S}_4\text{O}_6$
- Sb** (1) $3 \text{SbCl}_3 + \text{KBrO}_3 + 6 \text{HCl} = 3 \text{SbCl}_5 + \text{KBr} + 3 \text{H}_2\text{O}$
 (2) $\text{SbCl}_3 + 2 \text{Ce}(\text{SO}_4)_2 + 2 \text{HCl} = \text{SbCl}_5 + \text{Ce}_2(\text{SO}_4)_3 + \text{H}_2\text{SO}_4$
 (3) $5 \text{SbCl}_3 + 2 \text{KMnO}_4 + 16 \text{HCl} = 5 \text{SbCl}_5 + 2 \text{KCl} + 2 \text{MnCl}_2 + 8 \text{H}_2\text{O}$
 (4) $2 \text{SbCl}_3 + \text{KIO}_3 + 6 \text{HCl} = 2 \text{SbCl}_5 + \text{KCl} + \text{ICl} + 3 \text{H}_2\text{O}$
 (5) $\text{SbCl}_5 + 2 \text{KI} = \text{SbCl}_3 + 2 \text{KCl} + \text{I}_2$
 $\text{I}_2 + 2 \text{Na}_2\text{S}_2\text{O}_3 = 2 \text{NaI} + \text{Na}_2\text{S}_4\text{O}_6$

- Bi** No satisfactory method.
- S** (1) $\text{Na}_2\text{SO}_4 + \text{BaCl}_2 = \text{BaSO}_4 + 2 \text{NaCl}$ (THQ indicator)
 (2) $\text{H}_2\text{S} + \text{I}_2 = \text{S} + 2 \text{HI}$
- Se** (1) $\text{H}_2\text{SeO}_3 + 4 \text{KI} + 4 \text{HCl} = \text{Se}^\circ + 2 \text{I}_2 + 4 \text{KCl} + 3 \text{H}_2\text{O}$
 $\text{I}_2 + 2 \text{Na}_2\text{S}_2\text{O}_3 = \text{Na}_2\text{S}_4\text{O}_6 + 2 \text{NaI}$
 (2) $5 \text{H}_2\text{SeO}_3 + 2 \text{KMnO}_4 + 3 \text{H}_2\text{SO}_4 = 5 \text{H}_2\text{SeO}_4 + \text{K}_2\text{SO}_4 + 2 \text{MnSO}_4 + 3 \text{H}_2\text{O}$
 (3) $\text{H}_2\text{SeO}_3 + 4 \text{Na}_2\text{S}_2\text{O}_3 + 4 \text{HCl} = \text{Na}_2\text{SeS}_4\text{O}_6 + \text{Na}_2\text{S}_4\text{O}_6 + 4 \text{NaCl} + 3 \text{H}_2\text{O}$
- Te** (1) $3 \text{H}_2\text{TeO}_3 + \text{K}_2\text{Cr}_2\text{O}_7 + 8 \text{HCl} = 3 \text{H}_2\text{TeO}_4 + 2 \text{KCl} + 2 \text{CrCl}_3 + 4 \text{H}_2\text{O}$
- Cr** (1) $2 \text{H}_2\text{CrO}_4 + 6 \text{FeSO}_4 + 6 \text{H}_2\text{SO}_4 = \text{Cr}_2(\text{SO}_4)_3 + 3 \text{Fe}_2(\text{SO}_4)_3 + 8 \text{H}_2\text{O}$
- Mo** (1) $2 \text{H}_2\text{MoO}_4 + 3 \text{Zn}^\circ + 6 \text{H}_2\text{SO}_4 = \text{Mo}_2(\text{SO}_4)_3 + 3 \text{ZnSO}_4 + 8 \text{H}_2\text{O}$
 $5 \text{Mo}_2(\text{SO}_4)_3 + 6 \text{KMnO}_4 + 16 \text{H}_2\text{O} = 10 \text{H}_2\text{MoO}_4 + 6 \text{MnSO}_4 + 3 \text{K}_2\text{SO}_4 + 6 \text{H}.$
 (2) $\text{Na}_2\text{MoO}_4 + \text{Pb}(\text{C}_2\text{H}_3\text{O}_2)_2 = \text{PbMoO}_4 + 2 \text{Na}_2\text{C}_2\text{H}_3\text{O}_2$
- W** No satisfactory method.
- U** (1) $\text{UO}_2\text{SO}_4 + \text{Zn}^\circ + 2 \text{H}_2\text{SO}_4 = \text{U}(\text{SO}_4)_2 + \text{ZnSO}_4 + 2 \text{H}_2\text{O}$
 $5 \text{U}(\text{SO}_4)_2 + 2 \text{KMnO}_4 + 2 \text{H}_2\text{O} = 2 \text{KHSO}_4 + 2 \text{MnSO}_4 + \text{H}_2\text{SO}_4 + 5 \text{UO}_2\text{SO}_4$
- F** (1) $4 \text{NaF} + \text{Th}(\text{NO}_3)_4 = \text{ThF}_4 + 4 \text{NaNO}_3$
- Cl** (1) $\text{NaCl} + \text{AgNO}_3 = \text{AgCl} + \text{NaNO}_3$
 $\text{Na}_2\text{CrO}_4 + 2 \text{AgNO}_3 = \text{Ag}_2\text{CrO}_4 + 2 \text{NaNO}_3$
 (2) $\text{NaCl} + \text{AgNO}_3$ (excess) = $\text{AgCl} + \text{NaNO}_3$
 $\text{AgNO}_3 + \text{KCNS} = \text{AgCNS} + \text{KNO}_3$
- Br** (1) $\text{NaBr} + \text{AgNO}_3$ (excess) = $\text{AgBr} + \text{NaNO}_3$
 $\text{AgNO}_3 + \text{KCNS} = \text{AgCNS} + \text{KNO}_3$

**SUMMARY OF THE PRINCIPAL METHODS FOR THE VOLUMETRIC
DETERMINATIONS OF THE ELEMENTS—Continued**

- I**
- (1) $\text{NaI} + \text{AgNO}_3 \text{ (excess)} = \text{AgI} + \text{NaNO}_3$
 $\text{AgNO}_3 + \text{KCNS} = \text{AgCNS} + \text{KNO}_3$
- (2) $\text{I}_2 + 2 \text{Na}_2\text{S}_2\text{O}_3 = 2 \text{NaI} + \text{Na}_2\text{S}_4\text{O}_6$
- Mn**
- (1) $2 \text{Mn}(\text{NO}_3)_2 + 5 \text{NaBiO}_3 + 16 \text{HNO}_3 = 2 \text{HMnO}_4 + 5 \text{NaNO}_3 + 5 \text{Bi}(\text{NO}_3)_3 + 7 \text{H}_2\text{O}$
 $10 \text{FeSO}_4 + 2 \text{KMnO}_4 + 8 \text{H}_2\text{SO}_4 = 5 \text{Fe}_2(\text{SO}_4)_3 + 2 \text{MnSO}_4 + \text{K}_2\text{SO}_4 + 8 \text{H}_2\text{O}$
- (2) $\text{MnO}_2 + 2 \text{FeSO}_4 + 2 \text{H}_2\text{SO}_4 = \text{MnSO}_4 + \text{Fe}_2(\text{SO}_4)_3 + 2 \text{H}_2\text{O}$
- Fe**
- (1) $\text{Fe}_2(\text{SO}_4)_3 + \text{Zn}^0 = 2 \text{FeSO}_4 + \text{ZnSO}_4$
 $10 \text{FeSO}_4 + 2 \text{KMnO}_4 + 8 \text{H}_2\text{SO}_4 = 5 \text{Fe}_2(\text{SO}_4)_3 + 2 \text{MnSO}_4 + \text{K}_2\text{SO}_4 + 8 \text{H}_2\text{O}$
- (2) $2 \text{FeCl}_3 + \text{SnCl}_2 = 2 \text{FeCl}_2 + \text{SnCl}_4$
 $\text{SnCl}_2 + 2 \text{HgCl}_2 = \text{SnCl}_4 + \text{Hg}_2\text{Cl}_2$
- (3) $6 \text{FeCl}_2 + \text{K}_2\text{Cr}_2\text{O}_7 + 14 \text{HCl} = 6 \text{FeCl}_3 + 2 \text{KCl} + 2 \text{CrCl}_3 + 7 \text{H}_2\text{O}$
 $2 \text{FeCl}_3 + \text{Pb}^0 = 2 \text{FeCl}_2 + \text{PbCl}_2$
 $6 \text{FeCl}_2 + \text{K}_2\text{Cr}_2\text{O}_7 + 14 \text{HCl} = 6 \text{FeCl}_3 + 2 \text{KCl} + 2 \text{CrCl}_3 + 7 \text{H}_2\text{O}$
- Co**
- (1) $\text{CoCl}_2 \text{ (ammoniacal solution)} + \text{K}_3\text{Fe}(\text{CN})_6 + \text{NH}_4\text{OH} = \text{CoCl}_2\text{OH} \text{ (ammoniacal solution)} + \text{K}_3\text{NH}_4\text{Fe}(\text{CN})_6$
- Ni**
- (1) $\text{Ni}(\text{NH}_3)_4\text{Cl}_2 + 4 \text{KCN} = \text{K}_2\text{Ni}(\text{CN})_4 + 2 \text{KCl} + 4 \text{NH}_3$
 $\text{AgI} + 2 \text{KCN} = \text{KAg}(\text{CN})_2 + \text{KI}$

PROBLEMS INVOLVING THE SEPARATION AND DETERMINATION OF THE VARIOUS ELEMENTS

From a study of the preceding sections of the text, a knowledge of the following points should have been derived for the common elements and those of the rarer elements which are now finding their way into commercial products:

1. The important separations of the element, that is, those which separate it from the greatest number of elements or from the elements with which it is commonly associated.

2. The forms in which the element is weighed when determined gravimetrically.

3. The equations for the reactions involved in the volumetric determination of the element including the reaction for the end-point if one can be written. At least two volumetric methods should be known if more than one is possible.

Before beginning the quantitative analysis of an unknown material, the substance under examination should be subjected to a thorough qualitative analysis in order that all of the constituents, their state of combination, whether as oxide, carbonate, phosphate or some other form, and approximately their relative amounts, shall be known. This knowledge is absolutely necessary in devising a suitable scheme for analysis, for different methods are often required according to whether an element is present in large or small amount. Care must be taken to detect the elements present in small quantity.

In most minerals, even when fairly pure, will be found variable amounts of silica, iron, aluminum, calcium, magnesium, sulfur, and phosphorus, though the two latter elements especially may not respond to ordinary qualitative tests. If the amount of aluminum is large, an appreciable quantity of titanium is usually present. Alloys are liable to contain impurities, such as silicon, phosphorus, sulfur, and carbon; non-ferrous alloys usually carry a little iron. Even when ordinary qualitative tests have given negative results some of these elements may still be present in amounts sufficient to be determined quantitatively, and may be detected by tests which approximate the quantitative methods.

The methods chosen should be adapted to the amount of the element present and to its state of combination. For example, the method of determining sulfur in a sulfate would fail if applied to a

sulfide; the determination of aluminum in its ore, bauxite, of which it is the main constituent, would be different from that used in iron ore, where it is present in a relatively small amount. Methods chosen should be as simple and as easily carried out as possible, and require the minimum number of operations.

Those volumetric methods which are empirical or have indistinct end-points and require experience to make them yield accurate results should be avoided; however valuable and rapid these may be in routine work, they are not suitable for the beginner who has only a few determinations to make, and does not have time to acquire the necessary familiarity and skill. A longer gravimetric method may often be shorter in the long run.

As many preliminary separations as possible should be avoided; that is, the element to be determined should be separated first, or if this ideal is impracticable it should be approached as nearly as possible. This means the use of separate samples for many of the elements. The size of the sample should be adapted to the amount of the element present and the solution should not be loaded with large amounts of sodium or potassium salts, which cannot be removed if they cause difficulty in subsequent operations.

The following problems are given for the purpose of obtaining practice in applying the knowledge gained from earlier portions of the text to the analysis of more complex materials. When working the following problems bear in mind the principles just discussed and also the factors which influence the accuracy and rapidity of analytical methods (p. 11). Write out a brief outline of the scheme of analysis proposed for the solution of these problems giving enough detail so that the method will be perfectly clear. Number each sample with a Roman numeral, each step with an Arabic numeral. The following examples illustrate cases in which all of the constituents must be determined on one sample and in which each constituent can be determined on a separate sample.

ANALYSIS OF AN ALLOY OF ALUMINUM, ZINC,
MAGNESIUM AND COPPER

I. For aluminum, zinc, magnesium and copper

1. Dissolve in nitric acid and evaporate with sulfuric acid.
2. Deposit copper electrolytically and weigh.
3. Adjust pH to 2-3, add ammonium sulfate and precipitate zinc sulfide by hydrogen sulfide.
4. Ignite zinc sulfide and weigh as zinc oxide.
5. Precipitate aluminum as hydroxide in filtrate by ammonia.
6. Ignite and weigh as aluminum oxide.
7. Precipitate magnesium in the filtrate as the double ammonium phosphate.
8. Ignite and weigh as the pyrophosphate, $Mg_2P_2O_7$.

ANALYSIS OF AN ALLOY OF MANGANESE, NICKEL AND IRON

I. For nickel

1. Dissolve in nitric acid.
2. Add citric acid and an excess of ammonia.
3. Precipitate the nickel with dimethylglyoxime.
4. Filter on a Gooch crucible, dry at 120° and weigh as nickel dimethylglyoxime.

II. For manganese

1. Dissolve in nitric acid.
2. Oxidize manganese to permanganic acid by sodium bismuthate.
3. Filter into excess of standard ferrous sulfate and back titrate with permanganate.

III. For iron

1. Dissolve in sulfuric acid.
2. Reduce iron with metallic aluminum (if dissolved in the absence of air no reduction is necessary).
3. Titrate ferrous sulfate with permanganate.

Determine all of the constituents of the materials, that is, sulfur, carbon dioxide, silica, and phosphorus as well as the metals when these elements are stated to be present. Assume that all metals are present in large amounts unless enclosed in parentheses which indicates that they are present as impurities or as minor constituents.

Alloys:

1. Ti, Al, Fe
2. Al (98 per cent), Mg, Ti
3. Al (95 per cent), Mg, Cr, Mn
4. Mn, Mg, Zn, Fe
5. Fe, Mn, Si (15 per cent) (insoluble in acids)
6. Fe (90 per cent), Mo, Cu (Si, P, C, S, Mn)
7. Fe (80 per cent), Si (15 per cent), Mo, Mn
8. Cu, Mn, Al, Zn
9. Cu (90 per cent), Be (5 per cent), Al, Fe
10. Cu (70 per cent), W (30 per cent), Mo
11. Ag, Mn, Al
12. Au (90 per cent), Cu
13. Mg (90 per cent), Al, Mn (0.5 per cent)
14. Cu, Pb, Zn, P
15. Ag, Cd, Cu
16. Al (99 per cent), Ca, Ba
17. Cu (80 per cent), Al, Zn, Mn, Si
18. Fe, Zr, W
19. Pb (75 per cent), Sb, Sn, Cu
20. Pb, Li, Cd
21. Pb (98.5 per cent), Ca, Na, Li, Al
22. Pb, Sn, Mg, Ca
23. Cu, Si, Sn
24. Sn (80 per cent), Al, Zn, Cd
25. Ag (40 per cent), Sn (40 per cent), Cu, Zn
26. Zn, Al, Sn, Fe
27. Pb (99 per cent), Ca
28. Pb, As (2 per cent)
29. Pb, Sb (2 per cent)
30. Hg, Cd, Sn
31. Cu (90 per cent), Sn, Si (5 per cent)
32. Hg, Cu, Zn, Sn

33. Be, Cd, Pb
34. Cu (90 per cent), As, Sn
35. Cu (99.8 per cent), As
36. Sn (80 per cent), Pb, Sb, Cu
37. Pb (80 per cent), Sb, Cu, Sn
38. Sb, Pb, As
39. Pb, Te (2 per cent)
40. Fe, Cr, Ni, Cb (0.5 per cent)
41. Cd, Pb, Sn, Bi
42. Hg (80 per cent), Bi
43. Fe, Cr, Ni, Se (0.3 per cent)
44. Fe, Cr, V, U
45. Ni, Ba (0.2 per cent)
46. Cu, Cr, Ni
47. Cr, Ni, Mn
48. Fe, Ni, Cr, Mn
49. Cu (80 per cent), Al, Ni, Zn
50. Ni (70 per cent), Cu (25 per cent), Fe
51. Ni (60 per cent), Cr (20 per cent), Cu, Mo, W, Fe, Al, Mn
52. Ni, Cr, Cu, Mo
53. Ni, Mo, Cr, Fe
54. Cr, Ni, Al
55. Zn, Fe, Mn, Ni, Ag
56. Cu (90 per cent), Be (5 per cent), Cr, Co, Ni
57. Fe (60 per cent), Co, Ni
58. Co (50 per cent), Cr (40 per cent), W
59. Al, Ni, Co
60. Co, Cr, W
61. Cr, Al, Co, Mn
62. Cu, Zn, Ag, Au, Pt, In

Ores, Minerals, Commercial Products:

1. $\text{BaSO}_4 + (\text{Al}, \text{Ca}, \text{Fe})$ (Barite)
2. $\text{FeO} \cdot \text{Cr}_2\text{O}_3 + (\text{Mg}, \text{Al})$ (Chromite) Insoluble in acids.
3. $\text{Ca}_5\text{F}(\text{PO}_4)_3 + (\text{Al}, \text{Fe}, \text{Mg})$ (Apatite)
4. Cu As Fe sulfide
5. $\text{Sb}_2\text{S}_3 + (\text{Fe}, \text{Al}, \text{Pb})$ (Stibnite)
6. $\text{ZnSiO}_3 + (\text{Fe}, \text{Ca}, \text{Mn})$ (Calamine) Soluble in acids.
7. $\text{PbCO}_3 + (\text{Zn}, \text{Cu}, \text{Mn}, \text{Fe})$ (Cerrusite)

8. Ni As sulfide + (Co, Fe)
9. Cu arsenite + (Fe)
10. K Na Al silicate + (Fe, Ca, Mg) Insoluble.
11. $\text{Al}_2\text{O}_3 \cdot 2\text{H}_2\text{O}$ + (Ti, Fe, Ca) (Bauxite)
12. SnO_2 + (Ti, Al, Fe) (Cassiterite) Insoluble in acids.
13. SrCO_3 + (Ba, Ca, Mg) (Strontianite)
14. HgS + (Al, Ca, Mg, SiO_2) (Cinnabar)
15. CaWO_4 + (Fe, Mn, Sn) (Scheelite)
16. KCl , NH_4Cl , Na_2SO_4 , MgCl_2
17. ZrSiO_4 + (Al, Ti, Th, Fe, Rare Earths) (Zircon)
18. $\text{Be}_3\text{Al}_2(\text{SiO}_3)_6$ + (Ti, Zr, Fe) (Beryl)
19. Co Ni Cu Fe sulfide + (As)
20. Fe, Mn + (P, C, S, Si) (Ferromanganese)
21. Fe, P + (Mn, S, C, Si) (Ferrophosphorus)
22. Fe, V + (C, Si, P, S, Al) (Ferrovanadium)
23. $\text{K}_2(\text{UO}_2)_2(\text{VO}_4)_2 \cdot 3\text{H}_2\text{O}$ (Carnotite)
24. Al B silicate + (Li, Fe, Na, Mg) (Tourmaline)
25. Mg Ni silicate + (Cu, Cr, Al, Fe, Mn) (Garnierite)
26. Mn Al silicate + (Fe, Ca, Mg) (Spessartite)
27. MnO_2 + (Fe, Ba, Al, Ca, Mg) (Pyrolusite)
28. MgCO_3 + (Ca, Fe, SiO_2) (Magnesite)
29. $\text{Na}_2\text{B}_4\text{O}_7$, Na_2CO_3 , Na_3PO_4
30. LiF , NaF , NaCl , KCl
31. $\text{Zn}(\text{H}_2\text{PO}_4)_2$, $\text{Fe}(\text{H}_2\text{PO}_4)_2$, $\text{Mn}(\text{H}_2\text{PO}_4)_2$

CHAPTER VII

THE DETERMINATION OF ATOMIC WEIGHTS

The highest precision attainable in quantitative technic is applied to the determination of atomic weights by chemical methods. It is appropriate, therefore, that a chapter should be devoted to this subject.

THE HISTORICAL DEVELOPMENT OF ATOMIC WEIGHT DETERMINATIONS

After the laws of constant and multiple proportions had been placed on a firm footing by Dalton in about 1803, the relative masses or combining weights of the elements assumed great significance. Dalton, himself, was not a very good experimentalist and his values of the combining weights of the elements were rather poor. The great Swedish chemist Berzelius, who analyzed some two thousand inorganic materials during the course of his lifetime, composed an atomic weight table of his own from the results of his extensive investigations. His table, which contained over fifty elements, was based on oxygen equal to one hundred, and when calculated to the modern basis of oxygen equal to sixteen, is found to contain values which in a number of striking cases differ from present day values by only a few parts in a thousand. The French chemists de Marignac and Dumas and others made numerous contributions to the determination of atomic weights during the first half of the nineteenth century.

Much of this early work was devoted to testing the Prout hypothesis, formulated in 1815, that all atomic weights are even multiples of the atomic weight of hydrogen. This hypothesis was thoroughly discredited toward the end of the nineteenth century but has been since revived by the discovery of the existence of isotopes. It should be remembered that the early work was complicated by the lack of precise knowledge of the relations between combining and atomic weights, and that when the concepts of valence, combining weight, equivalent weight and atomic weight

were clarified by Cannizzaro in 1858, a great advance was made in chemical thought and the way laid open to a more precise understanding of chemical phenomena.

The great work on the determination of atomic weights during the middle part of the nineteenth century was that of the Belgian chemist, Stas, who devoted practically his whole lifetime to this one subject. Stas expended enormous pains in the purification of materials and took elaborate precautions to make his analyses as correct as possible. His work, however, suffered errors of occlusion and adsorption, errors he could not have suspected at that time, but which were quite serious since he worked with large quantities of materials and at high concentrations. Stas' silver was also impure and his values for the atomic weights of the metals are usually high. Nevertheless, his work represents the best possible work of the period and his labors were a paragon of unremitting zeal and unflagging patience.

The determination of atomic weights was brought to its greatest refinement by T. W. Richards at Harvard University. Richards devised the bottling apparatus in which materials could be appropriately treated and sealed for weighing and he developed the nephelometer by which the end-point in the titration of chloride with silver could be precisely determined. He secured results of extreme accuracy and precision. The work at Harvard was summarized by Richards, shortly before he died in 1929, in the classical paper *Atomic Weights and Isotopes*.¹ G. P. Baxter conducts the present investigations at Harvard. The greatest volume of atomic weight work in recent times has been carried out at Munich by Hönigschmid, who learned the technic under Richards and is still working actively in the field.²

For the determination of atomic weights three methods, widely different in theory and technic are available. The first of these, chemical analysis or synthesis, is convenient, precise, and reliable. The second, the determination of gas density, is limited in applicability and yields accurate results only when deviations from the gas laws are fully considered. The third method, utilizing the mass spectrograph, is based on the deflections of charged particles in electrostatic and electromagnetic fields; it approaches the chemical

¹ Richards, *Chem. Revs.*, **1**, 1 (1924).

² A review of the work by Hönigschmid may be found in *Angew. Chem.*, **53**, 177 (1940).

method in accuracy and in some cases exceeds it. Using any of the methods, the final goal is always to obtain the highest possible accuracy and no limit is ever set on time or expense.

THE CHEMICAL METHODS OF DETERMINING ATOMIC WEIGHTS

An excellent discussion of the technic and reactions involved in the determination of atomic weights is contained in the paper by T. W. Richards, *Methods Used in Precise Chemical Investigation*,³ from which some of the following material has been taken. The student is advised to examine a typical atomic weight paper, for example, one of those of Richards and his students.⁴

In an investigation of this character, the work is divided into two parts. The first task is the preparation of pure chemicals, and this is usually the longest part of the work. The second is the actual analysis or synthesis.

The Purification of Materials. The usual method of purifying a substance is to effect a change in the state in which it exists. This is usually done by crystallization, distillation, or sublimation. The phases must be completely separated from each other if an effective purification is to be accomplished, and every effort must be made to approach such a complete separation. This part of the purification is a purely mechanical problem. A more insidious source of impurity, however, is the tendency of every phase to dissolve something from any phase with which it may come in contact. This tendency is manifested in solids as the solid solution or isomorphous mixture, in liquids as solubility, in gases as the vapor tension of the impurity. Thus, one rule which must always be borne in mind in any endeavor to purify a solid substance is: *Every substance separating as a new solid phase tends to retain upon itself or within itself some of the other substance of the phase from which it separates.*

This tendency may be very great, as in the case of isomorphous substances, or very small, as in the case of crystals formed by sublimation; but the tendency must never be overlooked as it is never safe to assume without proof to the contrary that a new solid does not contain some of the phase from which it was separated.

The most obvious cause of contamination is the adherence of liquid to the surface of a solid. This is most expeditiously reduced

³ *Publ. Carnegie Inst.*, **125**, 95 (1910).

⁴ Richards and Wells, *J. Amer. Chem. Soc.*, **27**, 459 (1905); Richards and Willard, *ibid.*, **32**, 4 (1910).

by centrifugal drainage,⁵ which is always employed in careful work.

A less obvious cause of contamination is due to the fact that all precipitates or crystals obtained from aqueous solutions contain included water, even the bright crystals of electrolytic silver. Thus, as a rule, every solid which is prepared from a liquid and which is to be weighed accurately should first be fused in a dry atmosphere in order to expel this water. Merely heating, even to 200° or more, is not enough because the traces of included liquid cannot force their way out of the firmly knit structure of the crystal.

Water is also held in chemical fashion, with great tenacity. In fact, the unsuspected presence of water is unquestionably one of the most insidious sources of error in precise chemical work. Water is not easily found by chemical tests, and often produces no change in the appearance of the substance in which it lurks, although its presence may be far more injurious than almost any other impurity. A specific example will illustrate this. In the determination of the atomic weight of nickel, the presence of 0.1 per cent of water in the nickel bromide used will raise the atomic weight by 0.22; the same amount of an impurity of cobalt bromide would cause an error of only 0.0003, a negligible amount.

The elimination of water has been solved at Harvard by the so-called bottling apparatus, which is discussed in the next section.

Besides water, however, the precipitate or crystal is likely to contain traces of all acids, bases, or salts present in the solution from which it was formed. The only method of guarding against this source of error is to conduct the precipitation in solutions which are as dilute as possible. That portion of the impurity held on the surface may usually be removed by thorough washing, but some is generally imprisoned beneath the surface. Those precipitates which have a loose, sponge-like structure, such as silver chloride, may be more successfully washed than the crystalline ones, for the pores of the former are accessible while those of the latter are sealed. Hence, such precipitates are more suitable for precise work than are crystalline precipitates.

Solids formed from other solids show the same tendency to hold the impurities which surround them at the moment of their formation. Thus, cupric oxide made by the ignition of the nitrate always contains nitrogen gas, which is only eliminated at the temperature at which the oxide itself begins to decompose.

⁵ Richards, *J. Amer. Chem. Soc.*, **27**, 104 (1905).

Another source of error is that due to solubility. The following rule must always be borne in mind: *All liquids tend to dissolve something from every other phase, solid, liquid, or gas, with which they come in contact.* Sometimes the solubility is so slight as to be negligible, but more often than is generally supposed its extent is appreciable. If a precipitate is somewhat soluble in water, it will not all be collected upon the filter, and some means must be taken to estimate the amount which remains in solution. This may be done advantageously with the nephelometer which is discussed in detail later.

The materials of the vessels in which the operations are conducted are soluble. The plentiful use of vessels of platinum and of fused quartz further accounts for the increased accuracy of modern work.

The solubility of gases, particularly the gases of the atmosphere, must also be considered. Solids also tend to dissolve gases as well as liquids. Silver fused in the air dissolves oxygen. It must, therefore, be fused in hydrogen or in a vacuum.

Gases escaping from liquids or solids often carry away fine drops or powder. When an evaporation is conducted without the formation of bubbles there is no such loss.

As a test of the efficacy of a purification process, impurities suspected or known to be present are deliberately added to a portion of the material and specific tests for the impurities are applied as the purification proceeds. The spectrograph is particularly useful at this point.

When crystallization is employed as the method of purification, it is desirable to crystallize the material being purified in two different forms, because all impurities may not be eliminated by recrystallization in one form. For example, if potassium antimonyl tartrate is crystallized, any lead present accompanies the crystals; the lead can be eliminated only by recrystallizing the antimony as some other compound.

Electrodeposition is often a suitable method of purification.

Pure silver is prepared by recrystallization of the nitrate from concentrated nitric acid and reduction to metallic silver by ammonium formate (from redistilled formic acid and ammonia), or by slow electrodeposition using as the anode, buttons of silver to be further purified. The volatile impurities are then eliminated by fusion in hydrogen and finally under reduced pressure; the silver is

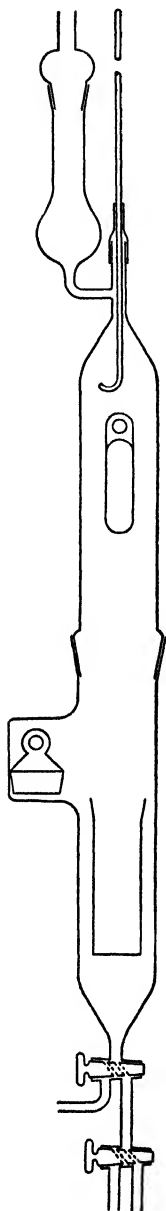

FIG. 40. Richards Bottling Apparatus.

carried on a porcelain boat lined with calcium oxide, which, unlike most substances, does not react with molten silver. The lime adhering to the surface of the silver buttons is etched off with dilute nitric acid and the silver then dried.

The Bottling Apparatus. For the various reasons mentioned above, it is desirable to fuse a material to drive out the last traces of moisture prior to weighing; it is also desirable to carry out the subsequent operations of transferring and weighing without contact with air. To accomplish these manipulations Richards devised the so-called bottling apparatus,⁶ shown in Fig. 40. This apparatus consists of an ignition tube connected by a ground joint with a soft glass tube which has a pocket in one side. A weighing bottle is placed at the end of the latter tube, and its stopper is placed in the pocket. The boat containing the substance to be dried is heated in the hard glass tube in a current of dry hydrogen chloride, if a chloride is to be weighed, or of hydrogen bromide if a bromide, and the temperature gradually raised until the salt fuses. The formation of a basic salt is thus prevented. The hydrogen chloride or hydrogen bromide gas is then displaced by pure, dry nitrogen, in which the salt is allowed to solidify. When it has cooled the nitrogen is replaced by dry air. The boat is then pushed past the stopper into the weighing bottle by means of a long glass rod, while a current of dry air is passing to prevent back diffusion of moisture. The tube is then turned slightly, the stopper rolled out and pushed into place; thus the substance is shut up in the weighing bottle in an entirely dry atmosphere. The weighing bottle may then be removed, placed in a desiccator, and weighed at leisure, with assurance that water has been precluded during the entire

⁶ Richards and Parker, *Z. anorgan. Chem.*, **13**, 86 (1897); Richards and Willard, *J. Amer. Chem. Soc.*, **32**, 4 (1910).

operation. A more recent modification of the apparatus permits the bottle to be sealed in a vacuum.⁷

The Nephelometer. The small amounts of materials remaining in solution can frequently be determined by measuring the turbidity produced by the addition of a further amount of a common ion. The earlier, rough methods of estimating such turbidities were improved by Richards, who devised the so-called nephelometer.⁸

The apparatus consists of two tubes which are observed from above, the light entering at right angles to the axis of the tubes. The precipitate reflects the light and the tubes appear faintly luminous. The depth of liquid observed is varied by moving a plunger in the liquid, or an opaque jacket around the tubes until the precipitates appear the same, in the manner in which colorimeter tubes are matched. In this way, the amount of suspended precipitate or turbidity may be estimated with considerable precision by comparison with a standard, and a trace of dissolved substance may be determined. For example, silver may be precipitated by the addition of chloride and the faint turbidity thus estimated; as little as 0.02 mg. of silver may be determined in this manner.

The General Methods of Synthesis and Analysis. The chemical methods of determining atomic weights may be divided into synthetic or analytic methods depending on the particular reaction or procedure adopted. Since the metal halides can more often be obtained pure than other metal compounds, and since they are usually also stable enough to permit complete drying, the analytical methods most frequently employ the reaction of a metal halide with silver nitrate

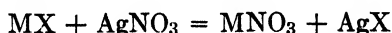

The silver halide, usually either the chloride or bromide, may be filtered off and weighed, or the reaction may be carried out as a titration, the end-point being determined nephelometrically. From the weights of the materials entering into the reaction there is then obtained either the ratio

$$\frac{\text{Wt. MX}}{\text{Wt. AgX}} \quad \text{or} \quad \frac{\text{Wt. MX}}{\text{Wt. Ag}}$$

⁷ Hönigschmid and Sachtleben, *Z. anorg. allgem. Chem.*, **178**, 18 (1929).

⁸ Richards and Wells, *Amer. Chem. J.*, **31**, 235 (1904); Richards, *ibid.*, **35**, 510 (1906).

Two other ratios must also be known

$$\frac{\text{AgX}}{\text{Ag}} \quad \text{and} \quad \frac{\text{Ag}}{\text{O}}$$

Then the atomic weight of M can be calculated

$$\frac{\text{Wt. MX} - \text{Wt. AgX} \left(\frac{\text{X}}{\text{AgX}} \right)}{\text{Wt. AgX}} \times \frac{\text{AgX}}{\text{Ag}} \times \frac{\text{Ag}}{\text{O}} = \frac{\text{M}}{\text{O}}$$

$$\text{At. Wt. M} = \frac{\text{M}}{\text{O}} 16.000$$

or, if the ratio of metal halides to silver was determined,

$$\frac{\text{Wt. MX} - \text{Wt. Ag} \left(\frac{\text{X}}{\text{Ag}} \right)}{\text{Wt. Ag}} \times \frac{\text{Ag}}{\text{O}} = \frac{\text{M}}{\text{O}}$$

and

$$\text{At. Wt. M} = \frac{\text{M}}{\text{O}} 16.000$$

The details of the methods by which these various ratios are determined are discussed later.

Synthetic methods are occasionally employed in determining the atomic weights of the non-metals, a typical reaction being

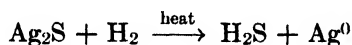

in which the silver sulfide and metallic silver are weighed. This reaction is also applicable to selenium and tellurium. In the synthetic methods the entire process may be carried out in the bottling apparatus. No transfer of material is involved in these methods, which increases their accuracy.

The Determination of the Ratio of Silver to Oxygen. Since the atomic weights of silver and the halogen (usually chlorine or bromine) are involved in the calculations they may be considered to be secondary standards. It is desirable to determine the atomic weight of silver directly against oxygen, the primary standard, as accurately as possible. A number of methods have been used for carrying out this determination. In one,⁹ lithium chloride was converted into lithium perchlorate. The increase in weight represented four atoms of oxygen and made it possible to calculate the ratio $\frac{4 \text{ O}}{\text{LiCl}}$.

⁹ Richards and Willard, *J. Amer. Chem. Soc.*, **32**, 4 (1910).

The ratio $\frac{\text{LiCl}}{\text{Ag}}$ was determined by the method already described and by multiplying these two ratios together, the ratio $\frac{4 \text{ O}}{\text{Ag}}$ was obtained, from which a direct calculation of the atomic weight of silver was possible. In another method¹⁰, barium perchlorate was converted into barium chloride by heating in a stream of hydrochloric acid gas. This barium chloride was then titrated with silver as previously described, and by multiplying together the ratios $\frac{8 \text{ O}}{\text{BaCl}_2}$ and $\frac{\text{BaCl}_2}{2 \text{ Ag}}$ the ratio $\frac{4 \text{ O}}{\text{Ag}}$ was obtained.

In a more recent work¹¹ the thermal decomposition of potassium bromate to yield potassium bromide and oxygen was utilized to determine the atomic weight of silver. The ratio of potassium bromide to silver was then determined and from these data the atomic weight of silver found to be 107.879, agreeing within one part in 100,000 with the present accepted value and thus affording an important check on the barium perchlorate method just mentioned.

Still another method which affords a check on the atomic weight of silver involves the synthesis or decomposition of silver nitrate; the synthesis was carried out by the action of nitric acid on silver¹² and the decomposition by reduction in hydrogen to metallic silver.¹³

The ratio $\frac{\text{Ag}}{\text{NO}_3}$ is obtained in either case and the calculation of the atomic weight of silver involves a knowledge of the atomic weight of nitrogen. The results of these determinations agreed with the present accepted value of 107.880.

The ratio of silver halide to silver has been determined with great accuracy and with no transfer of material.¹⁴ Pure silver was dissolved in nitric acid in a quartz dish and hydrochloric acid gas was allowed to pass over the solution until an excess was present. The nitric acid was evaporated, the silver chloride fused and weighed. The ratio of silver bromide to bromine and of silver to bromine has been determined.¹⁵ From these ratios the atomic

¹⁰ Hönigschmid and Sachtleben, *Z. anorg. allgem. Chem.*, **178**, 1 (1929).

¹¹ McAlpine and Bird, *J. Amer. Chem. Soc.*, **63**, 2964 (1941).

¹² Richards and Forbes, *J. Amer. Chem. Soc.*, **29**, 808 (1907).

¹³ Hönigschmid, Zintl and Thilo, *Z. anorg. allgem. Chem.*, **163**, 65 (1927).

¹⁴ Richards and Wells, *J. Amer. Chem. Soc.*, **27**, 515 (1905).

¹⁵ Hönigschmid and Zintl, *Ann.*, **433**, 201 (1923).

weights of bromine and chlorine can be calculated. Thus the atomic weights of the three secondary standards have been accurately determined.

The Determination of the Ratio of Metal Chloride or Bromide to Silver. From 3-10 g. of the anhydrous halide, bottled as already described and weighed to within 0.01 mg., is dissolved in a liter or more of redistilled water in a 3 liter Erlenmeyer flask. The proper weight of pure silver to react with the halide, calculated as closely as possible, is dissolved in nitric acid in a flask provided with a tower of bulbs to catch the spray. The silver solution, diluted to about 1 liter, is poured slowly with constant agitation into the halide. The glass stopper of the flask is then inserted, and the solution shaken repeatedly at intervals during two or three days. The solution is kept in the dark during this period and sufficient time is allowed so that the impurities in the silver halide may be completely leached out. From the clear supernatant liquid, two samples of equal volume (10-20 ml.) are withdrawn and placed in the nephelometer tubes. To one is added a solution containing about one mg. of silver, and to the other an equivalent amount of halide. If the two opalescences are equal in intensity, equivalence has been attained. If, however, the tube containing the excess of silver shows a stronger opalescence it indicates an excess of halide and vice versa. From the nephelometer readings the amount of a standard solution of silver nitrate or of the halide which must be added to the main solution to reach the end-point is calculated. The necessary addition is made using a rather dilute standard solution and measuring the volume added by a buret. The solution is again shaken at intervals during another day or two and again tested in the nephelometer, until equivalence is attained. A correction is made for the volume of liquid withdrawn. Only one or two trials will usually be necessary to reach the end-point. As mentioned before, the nephelometric method is extremely sensitive.

The weights of silver and halide are corrected to vacuum and the ratio of halide to silver is calculated. The maximum precision attainable in such a method is about 1 part in 100,000.

The Determination of the Ratio of a Metal Halide to Silver Halide. The procedure for preparing the solutions of the metal halide and the silver is essentially that described, except that excess of silver is added and the nitrate may be used instead of the metal. The solution is filtered through a platinum sponge filtering crucible,

washed first with very dilute silver nitrate, and finally with dilute nitric acid. The silver halide in the washings is determined nephelometrically and the flask is rinsed with ammonia, which is acidified and tested for possible halide. The silver halide is dried at 250° , as much as possible is removed to a quartz crucible in which it is fused, and the loss in weight calculated to the whole precipitate. The weight of pure silver halide, corrected to vacuum is now known, including the correction for solubility. From this the ratio of metal halide to silver halide is calculated.

GAS DENSITY METHODS

As a consequence of Avagadro's Law, the weights of equal volumes of two gases under the same conditions of temperature and pressure are in the same ratio as their molecular weights, or considering the number of atoms per molecule, to the sums of the atomic weights of the constituent elements. For elements having suitable gaseous compounds, this furnishes a method for determining their atomic weights.

The method, however, is subject to certain difficulties. Large volumes of gases must be weighed and in containers considerably heavier than the gases themselves, the precise situation where errors of weighing are greatly accentuated. It is also more difficult to insure absolute purity of the gases. Even more serious, however, are the deviations from the gas laws. Gases are only perfect at infinite dilution, but by making a series of measurements at varying conditions and extrapolating to infinite dilution, much of the trouble can be overcome.

In accuracy, the method cannot compare with chemical methods. In the case of the rare gases where the chemical methods are inapplicable, the gas density method is very important.

THE MASS SPECTROGRAPH

The method of positive ray analysis, devised by J. J. Thomson, and improved by Aston, Dempster, and Bainbridge, is a measure of atomic mass rather than of atomic weight. Positively charged gas particles are passed successively through an electric field in which they are deflected according to their charge and velocity and through a magnetic field in which they are deflected according to charge, mass, and velocity. The fields are adjusted so that the velocity factor cancels and the rays are focused on a photographic

plate where particles having the same $\frac{e}{m}$ fall together. The method separates the isotopes of the elements and the atomic weight is obtained by combining the intensities of the spots due to the individual isotopes. For details the student is referred to the book by Aston.¹⁶

For the light elements the method is particularly accurate, and for the heavier elements it approaches in accuracy the chemical methods.

The element, oxygen, is a mixture of three isotopes having the isotopic weights of sixteen, seventeen, and eighteen, and the naturally occurring mixture of these isotopes, taken as equal to sixteen, is the basis of the atomic weight scale. The three isotopes appear as individuals on the photographic plate obtained in the mass spectrograph and since the isotope of sixteen predominates it is taken as reference for the measurement of other elements. There thus arise two atomic weight scales, the chemical scale and the physical scale. The factor for converting values from one scale to another will immediately be seen to depend on a determination of the relative abundance of the three isotopes of oxygen; the factor for converting values on the physical scale to the chemical has the numerical value of 1.000275.

THE CONSTANCY AND IMPORTANCE OF ATOMIC WEIGHTS

On several occasions it has been reported that the atomic weights of certain elements varied with the source from which the element was obtained. Further investigation, however, has always shown that within the limits of experimental error, the atomic weights were actually identical.

Richards carried out an extended investigation into the variations of atomic weight with geographical and geochemical origin, and was unable to find a variation in any case. Thus native copper from Lake Superior, copper obtained from the sulfide ores of Erzebirge, and copper isolated from the blood of the horseshoe crab were all found to be identical in atomic weight. Nickel and iron from meteorites were shown to have the same atomic weights as nickel and iron of terrestrial origin.

The only exceptions to this phenomenon of extraordinary consistency are those elements formed by radioactive disintegration,

¹⁶ Aston, *Mass-Spectra and Isotopes*, Edward Arnold & Co., London, 1933.

such as lead from uranium or thorium, or strontium from rubidium. In such cases a single isotope only is produced; thus, thorium lead has an atomic weight of 208, while uranium lead has an atomic weight of 206, and rubidium strontium has an atomic weight of 87.¹⁷

The knowledge of the atomic weights of the radioactive elements has played an important role in unravelling the complicated relations of the radioactive series. The determination of the age of the various rocks of the earth by the radioactivity methods also rests ultimately on the determination of atomic weights.

The extreme importance of the atomic weight table in ordinary chemical work is so obvious as to require only mention. An accurate knowledge of atomic weights is also necessary in evaluating many natural physical constants, for example, the Faraday, Avogadro's number, and the absolute electrical conductivity of solutions. Considered broadly then, the determination of atomic weights is of the utmost importance in modern physical science. It is a field, however, in which only the most critical and the most patient may labor and one which demands the ultimate in care and refinement. It is a field in which the results must be authoritative.

¹⁷ Strassman and Walling, *Ber.*, **71B**, 1 (1938); see also Hahn, *ibid.*, **71A**, 1 (1938).

AUTHOR INDEX

- Adamson, D. C. M., 352
Agnew, W. J., 382
Aitchison, L., 354
Aitkenhead, W. C., 324
Alben, A. O., 300
Aldredge, S. M., 333
Allen, E. T., 151, 340
Allen, H. O., 228
Allport, N. L., 300
Alter, C. M., 137
Ambler, H. R., 359
Amdur, E., 344
Ampt, G. A., 362
Anderson, C. W., 340, 352
Andes, R. V., 184
Andrews, J. R., 362
Andrews, L. W., 340, 346, 352, 362
Armistead, W. H., Jr., 135
Armstrong, W. D., 370
Arnold, F. W., 85
Ashley, S. E. Q., 52, 386
Aston, F. W., 420
Axelrod, J., 53
Axilrod, H. D., 265

Babler, B. J., 298, 378
Bagshawe, B., 114
Bailey, E. G., 19
Baker, W. O., 265
Bakke, G., 352
Ballard, A. E., 308
Bambach, K., 336
Barab, J., 86
Barber, C. L., 352
Barber, H. H., 262, 297
Barnebey, O. L., 141, 230
Barnett, J. H., Jr., 198
Barnitt, J. B., 95
Bassett, L. G., 328
Batchelder, G., 370

Baudisch, O., 73
Baule, B., 18
Baxter, G. P., 93, 410
Beal, G. D., 373
Beale, R. S., 315, 357
Beamish, F. E., 286, 289, 373
Beardsley, C. L., 140
Beghly, H. F., 208
Benedetti-Pichler, A., 18
Benkert, A. L., 356
Bennett, A. H., 261
Bennewitz, R., 289
Berg, R., 75, 79, 304, 315
Berry, A. J., 372
Berzelius, J. J., 266, 409
Biefeld, L. P., 83, 84, 336
Billheimer, J. S., 184
Bird, E. J., 417
Birnbaum, N., 98
Blair, A. A., 53
Blasdale, W. C., 356
Bloom, A., 287
Blum, W., 165, 168
Boggs, H. M., 300
Bohn, R. T., 242
Boldyreff, A. W., 103, 306
Bonnar, R. V., 370
Booth, H. S., 93
Bouton, C. N., 307
Boyle, A. J., 261
Brandt, L., 340
Bridges, R. W., 142, 182, 292, 369
Bright, H. A., 54, 96, 144, 169, 207,
231, 294, 300, 309, 370
Britton, H. T. S., 44, 45
Broderson, H. J., 373
Brophy, D. H., 381
Brown, C. T., 263
Brown, D. J., 57, 281, 334
Brown, D. S., 261

- Brown, J. B., 373
 Brown, M. H., 265
 Browning, G. M., 261
 Browning, J. C., 297
 Browning, P. E., 314
 Brukl, A., 315
 Brunton, D. W., 18
 Burford, M. G., 44, 305, 326
 Burg, W. V., 363
 Byers, D. H., 371
 Byers, H. G., 366
- Cahen, E., 356
 Cain, J. R., 38, 239
 Caldwell, C. W., 57
 Caldwell, J. R., 299
 Caldwell, W. E., 39, 289
 Caley, E. R., 44, 262, 263, 265, 295, 305, 326
 Callendar, L. H., 182
 Cannon, M. C., 153
 Carter, R. H., 370
 Caulfield, T. H., 362
 Center, E. J., 207, 208
 Chandlee, G. C., 85, 156, 315, 322, 357
 Cholak, J., 336
 Churchill, H. V., 142, 182, 292, 369, 370
 Clark, N. A., 141, 177
 Clark, R. E. D., 332
 Clarke, B. L., 38, 61, 62, 194, 296
 Clayton, W. J., 300
 Cline, D. C., 363
 Clopin, N. J., 60
 Coleman, S. A., 299
 Coleman, W. C., 366, 367
 Collenberg, O., 352
 Collin, E. M., 62, 303
 Collins, W. D., 128
 Coltman, R. W., 167, 168
 Conant, J. B., 231
 Cook, K. H., 373
 Cook, W. A., 373
 Cooper, G., 300
 Cope, W. C., 86
 Cowling, H., 300
 Craig, A., 326
 Craig, D. N., 333
- Craig, K. A., 85
 Crouthamel, C. E., 137
 Crowell, W. R., 284
 Crumpler, T. B., 6
 Crutchfield, W. E., Jr., 361
 Cumming, A., 307
 Cummings, R. W., 300
 Cunningham, B. B., 140
 Cunningham, T. R., 156, 168, 228, 321, 358
 Curtis, R. W., 296
- Dable, D., 369, 370, 371
 Darnell, M. C., Jr., 263
 Davics, G. R., 324
 Daw, E. B., 383, 386
 Dawson, L. R., 184
 De Giacomo, R., 332
 Delano, P. H., 335
 Dennis, L. M., 324, 339, 359
 Derr, R. D., 95
 Dewar, J., 292
 Dick, J., 306
 Dickens, P., 383
 Diehl, H., Preface, 57, 70, 71, 272, 310, 383
 Ditz, H., 372
 Dodson, R. W., 51
 Dole, M., 101
 Dragt, G., 116
 Driver, J. E., 372
 Dudley, H. C., 366
 Dunbar-Poole, A. G., 326
 Dunicliff, H. B., 307
 Durham, E. J., 303
 Duschak, L. M., 307
- Eberz, W. F., 370
 Edgar, G., 284
 Edmonds, S. M., 97, 98
 Edwards, F. W., 374
 Eisner, A., 324
 Elek, A., 373
 Elliott, E. C., 263
 Elvehjem, C. A., 383
 Elving, P. J., 295, 373
 Engelenburg, A. J., 57, 281
 Ephriam, F., 83

- Evans, B. S., 59, 293, 300, 348, 366,
 367, 380, 382
 Evenson, R. F., 284

 Fahey, J. J., 307, 371
 Fahrenkamp, E. S., 315
 Fairchild, J. G., 382
 Fairhall, L. T., 39, 304
 Fales, H. A., 224, 299
 Farr, H. V., 340
 Faust, R. H., 184
 Feigl, F., 64, 65, 66, 82, 126, 285, 287
 Feldman, H. B., 373
 Ferris, C. A., 370
 Fife, J. G., 62, 63, 303
 Fink, C., 290
 Finkelstein, J., 296
 Finn, A. N., 309
 Fischer, H., 87, 293
 Fisher, R. S., 363
 Fitter, H. R., 357
 Flagg, J. F., 83, 283
 Fleck, H. R., 75, 80
 Fleming, T., 376
 Fogg, H. C., 39, 46, 85, 312
 Foote, F. J., 310
 Foote, H. W., 284
 Forbes, G. S., 417
 Forney, G. J., 51
 Fortune, W. B., 117, 140
 Foster, M. D., 362
 Foster, W. C., 370
 Foulk, C. W., 262
 Fowler, R. M., 96, 144, 183
 Frazier, J. C. W., 360
 Frediani, H. A., 282, 298
 Fredrick, W. G., 354
 Freiburger, F., 383
 French, C. L., 140
 Friedberger, O., 376
 Fulton, J. W., 360
 Furman, N. H., 83, 100, 107, 110, 227,
 281, 283, 306, 345, 347, 354, 358

 Galletly, J. C., 356
 Gardiner, P. A., 292
 Garner, C. S., 315
 Garrett, O. F., 263

 Gaskin, J. G. N., 58, 300
 Gates, O., 326
 Geilmann, W., 377, 378
 Geist, H. H., 85, 322
 Gettler, A. O., 357
 Getz, C. A., 35, 229
 Gibson, D. T., 362
 Gibson, R. C., 229, 231
 Gilchrist, R., 388
 Gilkey, W. K., 370
 Gillam, W. S., 294
 Ginsburg, L. B., 63
 Gittel, W., 305
 Glaze, F. W., 309
 Goodloe, P., 360
 Goodman, W., 282
 Goodspeed, E. W., 297
 Gortner, R. A., Jr., 367
 Goto, H., 75
 Gottschalk, V. H., 151
 Graham, J. J. T., 369
 Greathouse, L. H., 177
 Greenane, F. J., 80
 Greenleaf, C. A., 39
 Griffin, C. W., 51
 Gross, H., 196
 Guzelj, L., 334

 Haddock, L. A., 315, 357
 Hague, J. L., 207, 309
 Hahn, O., 421
 Hale, A. H., 93
 Hale, C. H., 282
 Hale, C. H., Jr., 194
 Hale, D., 381, 382
 Hall, R. D., 32
 Hamner, H. L., 228, 242
 Hammett, L. P., 97, 153
 Hammond, W. A., 95
 Hansen, H. V., 370
 Hanus, J., 283
 Hartmann, W., 326, 348
 Harwood, H. F., 32
 Haslam, J., 296
 Harvey, C. O., 296
 Hauschildt, J. D., 260
 Hayes, W. G., 322
 Hazel, W. M., 267

- Heck, J. E., 86
 Hect, O., 286
 Henderson, G. G., 356
 Henz, F., 347
 Herschlog, V. E., 289
 Heyn, A. H. A., 374
 Hicks, W. B., 32, 258
 Hill, D. W., 373
 Hill, W. L., 369
 Hillebrand, W. F., 51, 54, 259, 311
 Hillis, T. H., 284
 Hills, F. G., 292, 299
 Hillyer, J. C., 265
 Hiltner, W., 305
 Hiskey, C. F., 378
 Hoffman, J. I., 21, 29, 51, 54, 82, 169,
 231, 293, 294, 296, 380
 Hollens, W. R. A., 315
 Holmes, S., 64
 Holt, M. L., 222
 Holzer, H., 83
 Hönigschmid, O., 410, 415, 417
 Hope, H. B., 284, 313
 Horn, M. J., 367
 Hoskins, W. M., 370
 Hostetter, J. C., 239
 Hourigan, H. F., 328
 How, A. E., 341
 Howe, D. E., 83, 141
 Hubbard, D. M., 308, 336, 337, 345,
 357
 Hughes, E. B., 300
 Hulett, H. R., 140
 Hummel, F. C., 140
 Hunt, H., 86
 Hurd, L. C., 228, 377, 378
 Hutchison, A. W., 315

 Ibbotson, F., 169, 354
 Iranyi, E., 46
 Isbell, H. G., 300
 Ishibashi, M., 83

 Jaanasch, P., 340
 Jackson, D. T., 372
 Jacobs, M. B., 308
 Jacques, A. G., 45
 Jakob, W., 151
 James, C., 85, 321

 James, L. H., 228
 Jannasch, P., 32
 Jarmus, J. M., 159
 Jeffreys, C. E. P., 299
 Jilek, A., 241
 Johnson, C. M., 34
 Johnson, C. R., 208, 294
 Johnson, E. B., 324
 Jones, B., 135, 386
 Jones, E. W., 322
 Jordon, L., 360
 Juday, C., 188

 Kahler, H. L., 361, 363
 Kalich, F. V., 357
 Kallmann, N. S., 356
 Kapur, P. L., 374
 Kar, H. A., 194, 283
 Karaoglanov, Z., 334
 Kassner, J. L., 334
 Kaye, I. A., 261
 Keenan, R. G., 39
 Keggin, J. F., 196
 Kelley, G. L., 231, 242
 Khosla, B. D., 374
 King, E. J., 188
 King, W. J., 228
 Kirk, P. L., 362
 Kishi, H., 83
 Kluchesky, E. F., 89, 336
 Knapper, J. S., 85
 Knop, J., 352
 Knowles, D. C., Jr., 289
 Knowles, H. B., 82, 144, 224, 292
 Knudson, H. W., 188
 Kny-Jones, F. G., 57, 356
 Kochor, S. J., 363
 Koenig, E. W., 272
 Koenig, R. A., 208
 Kolthoff, I. M., 28, 100, 170, 230, 245,
 262, 287, 292, 339, 344, 374
 Kozelka, F. L., 89, 336
 Krieger, K. A., 183
 Kronmann, E., 378
 Krumholz, P., 66
 Kurtz, F., 172
 Kushner, J. B., 289
 Kuzirian, S. B., 184

- Lachele, C. E., 370
 Lamar, M. O., 267
 Lamar, W. L., 371
 Lamb, A. B., 45
 Lamb, F. C., 370
 Lambie, D. A., 219, 356
 Lang, R., 96, 172, 230, 302, 352
 Lann, G. H., 357
 Larrabee, C. R., 169, 370
 Lawrence, R. E., 313
 Lee, M. F., 182, 292
 Lehner, V., 289
 Lemp, J. F., 373
 Lewis, D., 375
 Lewis, E. J., 335
 Lewis, H. B., 367
 Liggett, W. B., 83, 84, 373
 Liggett, L. M., 272
 Lindsey, A. J., 57
 Lingane, J. J., 170
 Little, H. F. V., 356
 Lonseth, A. T., 113
 Low, A. H., 344
 Lowe, C. S., 292
 Ludwig, E. E., 294
 Lukas, J., 241
 Luke, C. L., 61, 352
 Lukens, H. S., 32, 183
 Lumsden, J., 329
 Lundell, G. E. F., 1, 21, 29, 51, 54, 144,
 169, 231, 259, 292, 293, 311
 Lunge, G., 359
 Lurie, J. J., 63
 Lyons, E., 141

 McAlpine, R. K., 42, 321, 364, 387,
 417
 McCay, L. W., 351
 McClendon, J. F., 370
 McClure, F. J., 370
 McCollan, C. H., 228
 McCracken, R. F., 287
 McCrosky, C. R., 366, 367
 McHard, J. A., 171
 McIntyre, L. H., 93
 McKay, L. W., 347
 McLean, F. C., 287
 MacLeod, J., 307
 McLeod, K. N., 289
 MacMasters, M. M., 140
 McNabb, W. M., 287, 307, 351
 McNary, R. R., 336
 McNaught, K. J., 54, 383
 Maag, O. L., 228
 Maasen, O., 383
 Mahr, C., 357
 Malaprade, L., 153
 Manov, G. G., 362
 Margolis, E. T., 306
 Marks, M. E., 360
 Marrs, L. E., 175
 Marvin, G. G., 366
 Maslenikova, G. S., 380, 384
 Matthews, J., 64, 285
 Mawrow, F., 356
 May, R., 372
 May, R. L., 344
 Mayr, C., 82, 299
 Meade, R. K., 354
 Mehlig, J. P., 140
 Melavan, A. D., 59
 Meldrum, W. B., 361
 Mellan, I., 64
 Mellon, M. G., 86, 113, 116, 117, 126,
 140, 141, 207, 221, 241, 296, 371
 Mcloche, C. C., 374
 Meloche, V. W., 188, 370
 Merritt, L. L., Jr., 376
 Metzger, F. J., 175, 323
 Metzl, A., 347
 Meyer, J., 239
 Michov, M., 334
 Middleton, A. R., 42, 324
 Middleton, E. B., 253
 Miller, C. C., 261, 265
 Miller, E. J., 300
 Miller, H. S., 283
 Miller, W. L., 287
 Mironoff, J., 283
 Mogerman, W. D., 60, 154
 Moon, C. D. B., 300
 Morgan, G., 324
 Morley, E. W., 93
 Morrow, C. A., 339
 Morton, F., 337
 Moser, L., 46, 315, 356

- Moskovitz, B., 339
 Moss, J. A., 334
 Moss, M. L., 141
 Moyer, H. V., 78, 299
 Muehlberg, W. F., 194
 Müller, E., 289, 376
 Müller, J. H., 324
 Müller, R. H., 123
 Munch, J. C., 314
 Murphy, R. K., 158
 Murray, W. M., Jr., 52, 227, 386
 Muthmann, W., 356
 Mutschin, A., 363
- Naftel, J. A., 310
 Nanji, H. R., 374
 Neuman, B., 158
 Newcomb, C., 306
 Newlin, I. G., 361
 Newton, E. R., 374
 Newton, R. F., 374
 Nichols, M. L., 333, 335, 339, 359
 Nickolls, L. C., 58, 300
 Nider, D., 290
 Nielsen, J. P., 294
 Niessner, M., 292
 Nieuwland, J. A., 373
 Nolan, E. J., 322
- Oakdale, U. O., 373
 Oesper, R. E., 64
 Okell, F. L., 329
 O'Leary, W. J., 265, 267
 Olsen, J. S., 303
 Olson, K. L., 171
 Ortner, G., 356
 Ostrovnow, E. A., 283, 380, 384
 Overman, O. R., 263
- Panajotow, G., 347
 Papish, J., 265
 Park, B., 168, 170, 283, 335
 Parker, H. G., 414
 Parker, R., 57
 Parkes, E. B., 374
 Parle, W. C., 356
 Parr, S. W., 18, 361
 Parsons, J. L., 372
- Paschke, B., 362
 Pass, A., 304, 334
 Patrick, L. P., 336
 Pauling, L., 196
 Pawletta, A., 239
 Peabody, W. A., 363
 Pearson, T. G., 83
 Perlich, R. W., 386
 Peters, C. A., 140
 Pfann, H., 300
 Plato, W., 348
 Plechner, W. W., 159
 Pollak, R., 363
 Pope, T. H., 300, 308, 332, 357, 383, 386
 Pottenger, C. H., 194
 Powell, A. L., 373
 Powers, J. L., 373
 Price, H. P., 263
 Price, R. J., 321
 Price, W. B., 354
 Prodan, L., 304
 Prodingler, W., 64, 86
 Pugh, W., 352
 Putnam, G. L., 290
- Rajagopalnaidu, S., 306
 Rajmann, E., 66
 Rauscher, W. H., 306, 373
 Redmond, J. C., 294
 Reed, J. F., 300
 Reedy, J. H., 265
 Remington, W. J., 78
 Reynolds, D. S., 369
 Reynolds, F., 228
 Ricci, J. E., 363, 367
 Rice, A. C., 85, 365
 Rich, J. R., 136
 Richards, M. B., 177
 Richards, T. W., 410, 411, 412, 414, 415, 416, 417
 Riedemann, A., 348
 Rienacker, G., 315
 Riley, H. L., 83
 Rittenberg, S. C., 284
 Roberts, H. L., 140
 Robinson, C. S., 344
 Robinson, R. G., 352

- Robinson, R. J., 260
Robinson, R. R., 261
Robinson, W. O., 366
Rodden, C. J., 345
Rogers, L. B., 265
Rohs, H. L., 370
Roseman, R., 159
Ross, F. M., 361
Ross, J. F., 256
Ross, M., 284, 313
Rothaug, G., 229, 230
Rothe, J. W., 54
Rowell, H. W., 352
Rowley, R. J., 369, 370
Ruff, O., 292
Rupp, E., 307
Russell, J. J., 289
Russell, W. W., 360
- Saaf, M., 51
Sachtleben, R., 415, 417
Sanchis, J. M., 371
Sand, H. J. S., 57, 60, 62, 303
Sandell, E. B., 28, 170, 230, 292, 304,
312, 339, 345, 386
Sandin, R. B., 306
Sarver, L. A., 64, 245, 382
Saywell, L. G., 140
Scharfenberg, W., 356
Scherrer, J. A., 60, 154, 312, 323, 326,
328, 333, 340, 348, 354
Schneider, L., 287
Schoch, E. P., 57, 281
Schoeller, W. R., 356, 358, 366
Schoonover, I. C., 287
Schrenk, W. T., 335
Schroeder, W. C., 361, 362
Schumb, W. C., 219, 321, 322, 366
Scott, W. W., 309, 333, 364
Scripture, E. W. J., 95
Seath, J., 286, 289
Seegmiller, C. G., 371
Seidel, T., 340
Shaw, L. I., 296
Shaw, P. A., 314
Shead, A. C., 258
Sheen, R. T., 361, 363
Shelberg, E. F., 44, 305
Shoder, W. P., 344
Shreve, R. N., 297
Shukis, A., 308
Sickman, D. V., 262
Sidgwick, N. V., 279
Sieling, D. H., 141
Sieminski, M. A., 219
Signer, R., 196
Silver, S., 284
Silverman, L., 169, 282, 283, 326, 358,
366
Simpson, C. T., 85, 156
Simpson, S. G., 219, 321, 322
Singer, S. S., 294
Skelly, J. F., 313
Sloviter, H. A., 307
Smith, E. F., 356
Smith, G. B. L., 289, 299
Smith, G. Frederick, 8, 35, 73, 94, 173,
171, 229, 231, 253, 254, 256, 258, 344
Smith, G. M., 86, 378
Smith, G. P., 231
Smith, G. S., 80
Smith, J. Lawrence, 266
Smith, L. E., 289
Smith, M. M., 321
Smith, W. H., 154
Snell, C. T., 110, 120
Snell, F. D., 110, 120
Soth, G. C., 367
Sottery, C. T., 153
Soukup, A., 283
Soule, B. A., 3, 42, 141, 321, 364, 387
Spacu, G., 306
Spacu, P., 306
Spencer, J. F., 315
Spiher, A. T., 284
Spitalsky, E., 230
Spitzer, L., 375
Sproull, R. C., 357
Staehler, A., 356
Staley, W. D., 361
Stanford, K., 352
Stare, F. J., 383
Stas, J. S., 409
State, H. M., 306
Stephen, E., 292
Stevens, R. E., 265, 269

- Stokes, H. N., 38
 Stoloff, L. S., 207
 Stone, I., 332
 Story, R. V., 336
 Stover, N. M., 230
 Strassman, F., 421
 Strebinger, R., 356, 362
 Strecker, W., 348
 Struthers, J. D., 38
 Stubblefield, F. M., 253
 Stumpf, L. F., 328
 Sturges, D. G., 302
 Swank, H. W., 141
 Swift, E. H., 51, 53, 184, 299, 315
 Suri, H. D., 307
 Susano, C. D., 198
 Sylvester, N. D., 300
- Tabern, D. L., 44, 305
 Tallman, R. C., 308
 Tang, N. K., 46, 143
 Tänzler, K. H., 289
 Taylor, L. V., 140
 Thayer, L. A., 188
 Thilo, P., 417
 Thomas, A., 53
 Thompson, C. W., 347
 Thompson, J. J., 171, 306, 335, 372, 373, 376
 Thompson, T. L., 304
 Thornton, C. D., 308
 Thornton, W. M., Jr., 159
 Titus, A. C., 153, 303
 Tomicek, O., 383
 Tomkins, S. S., 363
 Toribara, T. Y., 330
 Torrance, S., 57, 63
 Traves, F., 261, 265
 Treon, J. F., 361
 Troitzkaja, M. I., 63
 Tscherviakov, N. J., 283
 Tyler, W. P., 302
- Vacher, H. C., 360
 Vance, J. E., 284
 Van Slyke, D. D., 287
 Varadachar, K. S., 306
 Vaughn, L. H., 373
- Verma, M. R., 374
 Vinal, G. W., 333
 Voigt, A., 378
 Vortmann, G., 286, 347
 Vosburg, W. C., 300
- Waddell, J., 344
 Wagner, E. C., 307, 351
 Walden, G. H., Jr., 97, 98
 Walker, B. S., 263
 Walling, E., 421
 Walsh, M. D., 287
 Walter, D., 282
 Ward, A. M., 75, 80, 304, 334
 Ward, J. C., 314
 Ware, G. M., 299
 Waterhouse, E. F., 356
 Watkins, C. H., 297
 Webb, S. K., 309
 Weibke, F., 377, 378
 Weinig, A. S., 344
 Weiser, H. B., 303, 334
 Wells, R. C., 265, 411, 415, 417
 Westbrook, L. R., 313
 Westby, T. H., 296
 Wheeler, W. C. G., 330
 White, B. E., 333
 White, C. E., 292
 Whitehead, T. H., 283
 Wichers, E., 388
 Wichmann, H. J., 87, 369, 370, 371
 Wiegand, C. J. W., 357
 Wilcox, I. V., 260, 309, 310
 Wiley, J. A., 242
 Wiley, R. C., 296
 Willard, J., 42
 Willard, H. H., Preface, 39, 46, 86, 94, 103, 140, 143, 171, 177, 207, 208, 221, 229, 231, 241, 242, 243, 245, 247, 251, 254, 261, 272, 273, 285, 297, 306, 312, 315, 323, 330, 334, 335, 369, 372, 373, 374, 375, 376, 378, 381, 382, 411, 414, 416
 Williams, J. B., 334
 Williams, K. T., 366
 Willson, V. A., 372
 Wilson, B. M., 45
 Winchester, R., 300

- Windle, M. L., 153
Winsor, H. W., 140
Winter, O. B., 273, 344, 369
Wirsing, F. H., 386
Withrow, J. R., 95
Wittemore, C. F., 296
Wölbing, H., 354
Wolesensky, E., 298
Woods, J. T., 140, 207
Wooten, L. A., 38, 61, 62, 194, 296, 352
Wrigge, F. W., 378
Wright, E. R., 221, 241
Wright, W. C., 242
Wurm, O., 304
Wysor, R. J., 53
Yntema, L. F., 300, 376
Yogoda, H., 224
Yoe, J. H., 6, 64, 65, 110, 141, 386
Young, P., 221, 231, 241, 242, 243, 245,
247, 251, 315, 323, 375
Yutzy, H., 374
Zaimis, P., 230
Zics, E. G., 340
Zins, W., 356
Zintl, E., 230, 289, 315, 417
Zinzadze, C., 345
Zöllner, C., 303
Zomory, L., 362
Zwerina, J., 230

SUBJECT INDEX

- Absorbents**, for carbon dioxide, 90
 hydrogen sulfide, 193
 sulfur dioxide, 211
 water, 91, 93
- Absorption, of gases, 90
- Absorption bulbs, types, 92
 use of, 91
 weighing of, 91
- Accelerators used in combustion of steel, 211
- Accuracy, factors influencing, 11
 to which certain elements are determined, 133
- Acetate, basic, method, 47
 application to aluminum, 143, 162
 iron, 135, 162
- Acid, benzoic, precipitation of basic salts with, 47
 bromic, determination of, 347
 use with hydrobromic acid to regulate pH , 46
 with hydrochloric acid, 46
 chloroacetic, buffer in determination of zinc, 299
 chloric, determination of, 372
 use with hydriodic acid to regulate pH , 46
 chloroplatinic, determination of potassium, 258
 citric, buffer, 299
 masking agent, 88
 formic, buffer in zinc determination, 299
 hydrazoic, removal of permanganate by, 232
 hydriodic, extraction of mercuric sulfide with, 44, 305
 use with chloric acid to regulate pH , 46
- Acid, hydrobromic, determination of, 374
 volatilization of elements from solutions of, 51, 326
 use with bromic acid to regulate pH , 46
 hydrochloric, volatilization of elements from solutions of, 51, 326, 340, 348
 use with bromic acid to regulate pH , 46
 hydrofluosilicic, distillation of, apparatus for, 273
 for determination of fluorine, 50, 369
 for removal of fluorine, 272
 hydrofluoric, behavior with arsenic, 340
 tin, 43, 347, 349
 tungsten, 233, 243
 decomposition of silicates with, 33, 272
 determination of,
 colorimetric, 371
 gravimetric, 369
 volumetric, 370
 determination of rare earths with, 310
 effect on precipitation of stannic sulfide, 43, 347, 349
 tungsten, 243
 removal of, 33, 272
 separation by distillation, 369
 use in volumetric determination of copper, 283
 volatilization of silica with, 183
 hypophosphorous, reduction of various elements to metal with, 63

- Acid, hypophosphorous, arsenic, 340,
344
bismuth, 356
iodic, determination of thorium
with, 323
molybdic, preparation of reagent,
198
nitrous, removal of, 244
determination of, 338
removal of excess permanganate
with, 244
oxalic, determination of rare earths
with, 311
prevention of the precipitation of
stannic sulfide, 43, 347, 349
perchloric, care of, 8
dangers attending, 8
dehydrating properties, 8
dehydration of silica with, 182
determination of, 372
determination of chromium with,
231
potassium with, 254
oxidizing properties of, 8
removal of fluorine with, 272, 277
uses of, 8
volatilization of elements from so-
lutions of, 51
periodic, determination of, 376
determination of lead with, 334
manganese, 167, 171, 177
mercury, 306, 308
potassium, 261
removal of excess, 171
pertitanic, determination of titan-
ium with, 158
fluorine, 371
interference in test for vanadium,
239
phosphoric, heteropoly acid with
vanadium and tungsten, 207,
233, 244
interference in determination of
tin, 326
solvent for iron ore, 179
chromite, 35
volatilization of elements from so-
lutions of, 51
- Acid, selenious, determination of zir-
conium with, 321
succinic, use in determination of
aluminum, 143
sulfamic, removal of nitrous acid
with, 245
sulfuric, absorbent for water, 94, 95
volatilization of elements from
solutions of, 51
tartaric, complex with tungsten, 216,
224
effect on precipitation of hydrox-
ides, 48, 88
Acid-base balance, 128
Acid insoluble group, members and
general properties, 41
Acids, general use as solvent, 30
as solvents for carbonates, 34
ferro alloys, 34
metals, 30
oxides, 32
phosphates, 34
sulfides, 33
Acrolein, 299
Adsorption indicators, for sulfate de-
termination, 363
Agate mortar, 25
Aldehydes, removal of hydrogen sul-
fide with, 299
Alizarin, 370
Alizarin sulfonic acid, 370
Alkali metals, general considerations
in the determination of, 252
J. Lawrence Smith method for, 266,
267
Alkaline earths, general properties of,
290
Alloy, non-ferrous, analysis of, 354
steel, analysis of, 215
chromium, 228
molybdenum, 222
nickel, 385
tungsten, 216
vanadium, 238
Alpha-benzoinoxime, general uses of,
82
separation of copper, 282
of molybdenum, 224

- Alpha-benzoinoxime, volumetric determination of, 282
- Alpha-furildioxime, 69
- Alpha-naphthylamine, 338
- Alpha-nitroso-beta-naphthol, determination of cobalt with, 380
palladium, 387
properties and general uses of, 81
structure of compounds of, 70
- Aluminon, detection of beryllium with, 291
aluminum, 153
- Aluminum, colorimetric determination, 153
determination of, 142
in iron ore, 142, 145, 148
gravimetric determination as basic acetate, 143
basic succinate, 143
basic sulfate, 143
8-hydroxyquinoline, 75, 76, 144
oxide, 142
phenylhydrazine, 146
phosphate, 142, 144
precipitation as hydrous oxide, 47, 142, 151
pH for, 45
removal by sublimation of chloride, 37
separation by sodium carbonate fusion, 150
from heavy metals by mercury cathode, 60
by 8-hydroxyquinoline, 76, 144
by sodium hydroxide, 48
from various metals, 142
solvents for metal, 31
for minerals of, 142
volumetric determination, 153
- Aluminum oxide, as absorbent for water, 94, 95
- Alundum, decomposition for analysis, 142
- p*-Aminodimethylaniline, 371
- β -Aminonaphthalide, determination of thallium with, 315
structure of metal derivatives, 70
- Ammonia, determination of, 338
precipitation of hydrous oxides with, 45
- Ammonia group, members of, 74
methods of precipitating, 44
presence of phosphate, 48
- Ammonium acetate, extraction of lead sulfate with, 333
- Ammonium molybdate reagent, preparation of, 198
- Ammonium molybdiphosphate, conditions for precipitation, 197
determination of phosphorus as, gravimetrically, 203
volumetrically, 205, 206
structure of, 196
test for molybdenum, 223, 225
- Ammonium phosphomolybdate.
See Ammonium molybdiphosphate
- Ammonium salts, removal of, 252
- Amphoterism, separations based upon, 48
- Analysis, of alloy steels, 215
catalytic methods for small amounts, 126
colorimetric, 110
complex mixtures, 39, 404
electrodeposition, 57
factors affecting accuracy, 11
factors affecting speed, 11
general operations, 11
iron, 130
iron ore, 130
non-ferrous alloys, 354
plain carbon steel, 130
silicates for the alkalis, 266
various elements, 278
- Anion effect on precipitation of weak bases, 47
- Annealing, necessity for release of sulfur, 193
- Antimony, colorimetric determination, 354
determination, 345
in non-ferrous alloys, 354
electrodeposition of, 348
loss by volatilization of trichloride, 29, 346

- Antimony, precipitation as antimonious acid, 42, 325, 346
 as sulfide, 43, 347
 separation by controlled cathode, potential electrodeposition, 57
 distillation of antimonious chloride, 50, 348
 reduction to metal, 63, 348
 thioantimonate, 347
 from tin by distillation, 348
 as sulfide, 347
 as sulfide from fluoride solution, 43, 347, 349
 solvents for metal, 31, 346
 volumetric determination, 350
- Antimony electrode, 101
- Apatite,
 solution for analysis, 34
- Apparatus, for absorption of gases, 91
 bottling materials for weighing, 414
 colorimeters, Duboseq, 120
 Nessler, 119
 photoelectric, 123
 distillation of arsenic, antimony, and tin, 342
 hydrofluosilicic acid, 273
 combustion for carbon in steel, 210
 crushing material, 23
 electrodeposition,
 internal electrolysis, 61
 mercury cathode, 59
 evaporation, 274
 evolution of hydrogen sulfide, 195
 carbon dioxide, 318
 extraction with ether,
 continuous, 54, 56
 Hillebrand-Lundell, 54, 55
 Rothe, 54, 55
 fusions, J. Lawrence Smith, 268
 measuring voltage, 104
 platinum, care of, 6
 potentiometric titrations, 104
 reducing size of sample, 23
 sampling coal, 20
 liquids, 21
- Arsenic, colorimetric determination, 345
 determination, 339
 gravimetric determination as magnesium pyroarsenate, 341
 loss by volatilization of trichloride, 29
 during alkaline fusion, 30
 precipitation as sulfide, 43, 341
 separation by distillation of trichloride, 50, 340, 341
 reduction to metal, 340
 as thioarsenate, 43, 347
 solvents for metal, 31
 volumetric determination, 343
- Arsenious oxide, primary standard, 96
- Arsenic acids, general uses of, 66, 84
- Ascarite, 92
- Ash, variation of content in coal, 18
- Atomic weight, constancy of, 420
 determination of, 409
 chemical methods, 411
 gas density methods, 419
 historical development, 409
 mass spectrograph method, 420
 importance of, 420
 rational, 28
 table, Inside front cover
- Aurintricarboxylic acid, detection of beryllium with, 291
 aluminum, 153
- Ball mill, 25
- Barium, determination of, 298
- Barium hydroxide, absorbent for carbon dioxide, 92
- Barium oxide, absorbent for water, 93, 94
- Barium perchlorate, absorbent for water, 9
- Barium sulfate, analysis of, 298
- Basic salts, precipitation of, 47
- Basic acetate method, 47
 application to aluminum, 143
 iron, 135, 162
- Basic benzoate method, 47
 application to iron, 135

- Basic succinate method, 47
 application to aluminum, 143
- Basic sulfate, of aluminum, 143
- Bauxite, solution of for analysis, 142
- Beer's Law, definition and derivation of, 111
 testing conformity to, 115
- Benzidine, precipitation of sulfate with, 71, 361
 reaction with molybdenum, 223
- Benzoates, basic, 47, 135
- α*-Benzoinoxime, general uses of, 82
 separation of copper, 282
 molybdenum, 224
 volumetric determination of, 283
- Beryllium, colorimetric determination, 293
 determination of, 291
 general chemistry, 291
 gravimetric determination, as oxide, 292
 pyrophosphate, 292
 precipitation on hydrolysis, 48
 pH for, 45
 separation, 292
 from aluminum and iron, 292
 volumetric determination, 293
- Beta-aminonaphthalide, determination of thallium with, 315
 structure of metal derivatives, 70
- Bimetallic electrode systems, 103
- Bismuth, colorimetric determination, 356
 determination of, 355
 catalytic method, 126
 gravimetric as oxychloride, 355
 phosphate, 355
 precipitation with 8-hydroxyquinoline, 77
 salicylaldehyde, 83
 sulfide, 43
 reaction with dimethylglyoxime, 72
 separation of, by controlled cathode potential electrodeposition, 57, 356
 internal electrolysis, 61
 reduction to metal, 63, 356
 solvents for metal, 31
- Bismuthate method for manganese, 167, 168
- Boric acid, separation by distillation as methyl borate, 50
- Boron, determination of, 309
- Bottling apparatus, 414
- Bouguer's Law, derivation of, 110
- Brass, analysis by electrodeposition, 58
- Bromic acid, determination of, 374
 use with hydrobromic acid to regulate pH, 46
 with hydrochloric acid to regulate pH, 46
- Bromide, determination of, 374
- Bromine, determination of, 374
- Brucine, determination of cadmium with, 304
- Buffer, use of in hydrolysis, 44
- p-n*-Butylphenylarsonic acid, uses of, 84
- Cadmium**, colorimetric determination, 304
 concentration of by precipitation as sulfide, 36
 determination of, 303
 gravimetric determination, as pyrophosphate, 304
 electrolytically, 57, 62, 303
 sulfate, 304
 iodide complex, 303
 precipitation by hydrolysis, 45
 with 8-hydroxyquinoline, 77
 sulfide, 43, 303
 separation, by internal electrolysis, 62, 303
 from zinc, 303
 solvents for metal, 31
- Cadmium salts, absorbents for hydrogen sulfide, 194
- Cadmium sulfide, as a gathering agent, 39
- Caffeine, determination of bismuth with, 357
- Calcium, determination of, 295
- Calcium bromide, absorbent for water, 94

- Calcium carbonate, use in J. Lawrence Smith fusion, 267
- Calcium chloride, absorbent for water, 94, 95
- Calcium oxide, absorbent for water, 94
- Calcium phosphate, as a gathering agent, 39
- Calcium sulfate, absorbent for water, 95
- Calomel electrode, 102
- Carbides in steel, decomposition of, 229
- Carbon, determination of, 316
in carbonate rocks, 317
steel, 209
variation of content in steel ingot, 21
- Carbon dioxide, absorbents for, 90
absorption of by ascarite, 213, 317
barium hydroxide, 214
determination of in carbonate rock, 317
- Carbon tetrachloride, use in decomposition of oxides, 32
- Carbonates, decomposition of, 34
determination of carbon dioxide in, 317
- Carius method, 373
- Cassiterite, decomposition of, 35, 325
- Catalytic methods for determining traces, 126
- Cerium, determination of, 322
- Cesium, separation from potassium, 265
- Chelate ring compounds, 67, 68
- Chloroacetic acid, buffer in determination of zinc, 299
- Chloric acid, determination of, 372
use with hydriodic acid to regulate pH, 46
- Chloride, determination of, 372
- Chlorine, determination of, 371
in organic materials, 373
- Chlorite, determination of, 372
- Chloroform, use in the decomposition of oxides, 32
- Chloroform, extraction of nickel dimethylglyoxime with, 37
metal dithizonates, 37, 38
- Chloroplatinate method for potassium, 258
- Chromium, behavior in alkaline fusions, 48
in Jones reductor, 97
silver reductor, 97
- Chromium, colorimetric determination, 230
determination of, 228
in steel, dissolving sample, 233
interference of vanadium, 230
principle, 230
procedure, tungsten absent, 234
tungsten present, 236
simultaneous with vanadium, 251
gravimetric determination, 229
interference in determination of vanadium, 241
oxidation to chromate, 231
precipitation as hydrous oxide, 45
removal of by mercury cathode, 59
separation by volatilization of chromyl chloride, 50
solvents for metal, 31
volumetric determination, titration with ferrous sulfate, 229, 230
interference of manganese, 232
interference of molybdenum, 234
interference of tungsten, 233
interference of vanadium, 230
preliminary oxidation, 231
iodometrically, 229
- Chromite, decomposition of, 35, 228
- Chromyl chloride, volatilization of, 50
- Cinchonine, determination of tungsten with, 71, 217
reaction with molybdenum, 223
- Citric acid, buffer, 299
masking agent, 88
- Cobalt, colorimetric determination, 383
gravimetric determination, 381

- Cobalt, precipitation by hydrolysis,
 pH for, 45
 as sulfide, 43
 reaction with dimethylglyoxime, 384
 separation with 8-hydroxyquinoline,
 76, 78
 α -nitroso- β -naphthol, 141, 732
 phenylthiohydantoic acid, 381
 sulfide, 43, 380
 solvents for metal, 32
 volumetric determination, 382
- Cobaltinitrite method for potassium,
 260
- Codeine, determination of selenium
 with, 367
- Color, introduction into organic re-
 agents, 66
 spectral distribution corresponding
 to, 117
- Color measurement, Duboscq color-
 imeter, 120
 calculations, 121
 instruments for, 113, 114
 Leifophotometer, 123
 Lovibond tintometer, 113
 Nessler method, 119
 photoelectric colorimeter, 114, 122
 photometer, 114, 122
 Pulfrich photometer, 122
 spectrophotometer, 114, 125
- Color standards, permanent, 116
- Colorimetric methods, conditions for,
 115
 range, 110
 See also individual metals
- Colorimetry, general discussion, 110
 instruments, 119, 120, 122, 124
 laws governing, 110
 principles relative to chemical
 aspects, 115
- Columbium, as a member of the acid
 insoluble group, 42
 determination, 357
 general chemistry, 357
- Combustion of steel for carbon de-
 termination, 209
- Composition, variation with particle
 size and location, 18, 21
- Concentration methods for isolating
 traces, 35
 collection on a gathering agent, 38
 crystallization of the major consti-
 tuent, 38
 distillation, 37
 dithizone, 87
 extraction, 37
 precipitating the minor constituent,
 36
- Cone and quartering process, 20, 27
- Coordination theory, application to
 organic reagents, 67
- Copper, colorimetric determination,
 285
 concentration by precipitation as
 sulfide, 36, 39
 constancy of atomic weight, 420
 determination, 281
 in non-ferrous alloys, 354
 gravimetric determination, electro-
 deposition, 57, 61, 63, 281
 by controlled cathode potential,
 57, 281
 from fluoride solution, 281
 by internal electrolysis, 61, 62
 as oxide, 282
 separation from antimony, 281, 347,
 354
 molybdenum, 224, 282
 tin, 281, 327, 355
 separation with α -benzoinoxime, 82,
 282
 controlled cathode potential elec-
 trodeposition, 57
 cupferron, 283
 hydrolysis, pH for, 45
 8-hydroxyquinoline, 77, 78
 internal electrolysis, 61, 62
 neo-cupferron, 74
 reduction to metal, 63
 salicylaldoxime, 83
 sulfide, 43, 282
 thiocyanate, 282
 solvents for metal, 31
 volumetric determination, cyanide
 method, 285
 iodometric method, 283

- Copper, volumetric determination, thiocyanate method, 282
- Copper sulfate, absorbent for water, 94
- Counterpoise, use of, 91
- Crucible, for J. Lawrence Smith fusions, 268
- Crushing, methods of, 23
- Cupferron, general properties and uses of, 73
separation of columbium with, 73
copper, 283
gallium, 312
iron, 135, 364
tantalum, 73
tin, 73
titanium, 156
uranium, 364
vanadium, 239, 364
zirconium, 321, 364
structure of compounds of, 70
- Cupron, general uses of, 82
separation of copper, 282
molybdenum, 224
volumetric determination of, 282
- Curcumin, 291
- Cyanide method for volumetric determination of cobalt, 382
copper, 285
nickel, 385
- Cyanide, use as masking agent, 88, 135
- Cyclo-hexanedionedi oxime, 69
- Cyclo-hexanol, extraction of molybdenum thiocyanate, 228
- Decomposition of materials for analysis,**
general considerations, 28
loss during by volatilization, 29
methods of, for alloy steel, 233, 243
carbonate, 34
ferro alloys, 34
iron ore, 131
metals, 30
oxides, 32
phosphates, 34
refractory minerals, 35
silicates, 32, 266
- Decomposition of materials for analysis, methods of, sulfates, 34
sulfides, 33
- Dehydration, of acid insoluble group, 41
silica, 182
tungsten, 218
- Dehydration, with hydrochloric acid, 182
perchloric acid, 8, 182
sulfuric acid, 182
- Dehydrite, characteristics and uses, 9, 94
- Desiccants, list of, 94
- Devarda's Alloy, 339
- Diamond mortar, 26
- Dichloro-diethyl ether, 53
- Diethylthiocarbamate, 285
- p*-Dimethylaminobenzalrhodaninc, 287
- p*-Dimethylaminobenzeneazophenylarsonic acid, 66
determination of zirconium with, 322
- Dimethylglyoxime, general properties, of, 64, 71
determination of nickel with, colorimetrically, 386
gravimetrically, 71, 383
in traces, 37
determination of palladium, 72, 387, 388
extraction of nickel compound with chloroform, 72
reaction with bismuth, 72
cobalt, 71
copper, 72
gold, 72
iron, 72
iron and cobalt together, 72
nickel, 64, 71
quadivalent, 72, 386
palladium, 72, 387
platinum, 72
solubility of, 73
structure of compounds of, 69
volumetric determination of, 72
- Di- β -naphthylthiocarbazone, 308

- Dioximes, organic uses as precipitates, 69
- Diphenylamine, oxidation-reduction indicator, oxidized form, 246
- Diphenylaminesulfonic acid, oxidation-reduction indicator, 246
 corrections for, 140, 250
 oxidized form, 246
- Diphenylbenzidine, in ferrocyanide titration of indium, 313
 zinc, 302
- Diphenylcarbazide, 230
- Diphenylcarbazone, 308
- Diphenylendoanilohydrotriazole, determination of nitrate, 338
 perchlorate, 372
 rhenium, 378
 general properties and uses, 71, 86
- Diphenylthiocarbazonc, determination of cadmium, 88, 304
 lead, 88, 336
 mercury, 88, 308
 thallium, 88, 315
 properties and general uses of, 87
- Disc pulverizer, 23
- Distillation, apparatus for, 273, 342
 as a concentration method, 37
 as a method of effecting separations, 49
- Distillation, of antimony, 50, 348
 arsenic, 50, 340
 boron, 50, 309
 chromium, 50
 fluorine, 50, 272, 369
 germanium, 324
 hydrofluosilicic acid, 50, 272, 369
 mercury, 50, 306
 osmium, 50, 388
 rhenium, 378
 ruthenium, 50, 388
 selenium, 366
 water, 49
- Distribution coefficient, 51
- Dithiol, 332
- Dithiooxalic acid, 386
- Dithizone, determination of cadmium with, 88, 304
 lead, 88, 336
- Dithizone, mercury, 88, 308
 thallium, 88, 315
 properties and general uses of, 87
- Dividing sample, 20, 23
- Drierite, 95
- Drying agents, list of, 94
- Duboseq colorimeter, 120
- Dumas method for nitrogen, 338
- Earth acids, 357**
- Electrodes, bimetallic, 103
 indicator, 100
 reference, 101
- Electrodeposition, constant current methods, 57
 controlled cathode methods, 57
 from chloride solution, 57
 internal electrolysis, 60
 apparatus for, 61
 mercury cathode, 58
- Electrodeposition, of bismuth, 57, 61, 356
 cadmium, 57, 62, 303
 chromium, 59
 cobalt, 58, 381
 copper, 57, 61, 63, 281
 iron, 59, 135
 lead, 58, 62
 as dioxide, 58, 335
 from fluoride solution, 58
 internal electrolysis, 62
 manganese, 60
 mercury, 62
 nickel, 57, 58, 62, 384
 silver, 58, 63
 tin, 57, 326
 zinc, 58, 60
- Electromotive series, 30
- Elements, atomic weight table, Inside front cover
 forms for separation and weighing, 390
 periodic table of, Inside back cover
- Emery, decomposition for analysis, 142

- End-point, potentiometric determination of, 99
- Eosin, as adsorption indicator, 363
- Equations for the principal volumetric methods for the elements, 398
- Erythrosin, as adsorption indicator, 363
- Ether extraction, of ferric chloride, 51
gallium chloride, 51
gold chloride, 51
molybdenum thiocyanate, 228
thallium chloride, 51
- Ethyl acetate, extraction of solid sodium perchlorate, 254
solubility of alkali and alkaline earth perchlorates in, 254
- Ethylhexanol, extraction of lithium chloride, 265
- Evolution method, for carbon dioxide in carbonates, 317
sulfur in steel, 193
- Extinction coefficient, 113
- Extraction, apparatus for, 54, 55, 56
as a concentration method, 37
as a method of effecting separations, 51
- Extraction, with carbon tetrachloride, of metal dithizonates, 37, 87
chloroform, of nickel dimethylglyoxime, 37
cyclohexanol, of molybdenum thiocyanate, 228
dichloroethyl ether, of ferric chloride, 53
ether, of ferric chloride, 51
gallium chloride, 51, 312
gold chloride, 51
molybdenum thiocyanate, 228
thallium chloride, 51
ethyl acetate, of solid sodium perchlorate, 254
ethyl alcohol, of chloroplatinic acid, 258
solid sodium chloroplatinate, 258
ethylhexanol, of solid lithium chloride, 265
- Extraction, *iso*-propyl ether, of ferric chloride, 53
- Ferro alloys, solution of for analysis, 34
- Ferron, determination of fluorine with, 371
iron, 140
- Ferrous iron, determination of, 141
- Ferrous *o*-phenanthroline sulfate, as indicator in the determination of iron, 139, 140
chromium and vanadium, 251
spectral distribution of, 118
- Ferrous sulfate solution, preparation and standardization, 247
- Filters in colorimetry, use and selection of, 116
- Fleming absorption bulb, 92
- Fluorine, colorimetric determination, 371
gravimetric determination, 370
separation by distillation, of hydrofluosilicic acid, 272, 369
apparatus for, 273
volumetric determination, 370
- Ford method for manganese, 164, 165
- Ford-Williams method for manganese, 172
- Formic acid, buffer in determination of zinc, 299
- α -Furildioxime, 69
- Fusion with iron powder, 33
potassium pyrosulfate, 32, 159
sodium carbonate, behavior of elements during, 49
decomposition of oxides, 32
phosphates, 34
silicates, 32, 181
sulfates, 34
effecting separations by, 49
sodium peroxide, behavior of elements during, 49
decomposition of ferro alloys, 34
organic material, 49
refractory minerals, 35, 228
sulfides, 33
effecting separations by, 49

- Gallium**, determination of, 312
- Gas density methods for atomic weight determination, 419
- Gathering agents, 38
- General characteristics of the periodic groups of the elements, 279
- Periodic Group I, 280
 - Periodic Group II, 290
 - Periodic Group III, 308
 - Periodic Group IV, 315
 - Periodic Group V, 337
 - Periodic Group VI, 358
 - Periodic Group VII, 367
 - Periodic Group VIII, 378
- Germanium, determination, 324
- loss by volatilization, 29, 324
- Glass electrode, 101
- Glassware, boron free, 309
- Glycerol, prevention of the precipitation of hydroxides, 48
- use in determination of boron, 310
- Gold, colorimetric determination, 290
- concentration method for, 39, 289
 - detection and identification, 288
 - general chemistry, 287
 - gravimetric determination, 288
 - separation by extraction with ether, 51
 - reduction to metal, 63, 288, 387
 - sulfide, 43, 288
 - solvents for metal, 31
 - volumetric determination, 289
- Grab sample, definition of, 21
- Graphical method of reporting results, 128
- Gravimetric methods for the determination of the elements, summary of, 389
- Grinding of samples, 23
- Gutzzeit method for arsenic, 345
- Halogens**, determination of,
- bromine, 373
 - chlorine, 371
 - fluorine, 368
 - iodine, 375
 - general properties of, 367
- Hexanedionedioxime, 69
- Hillebrand evaporator, 274
- Hillebrand-Lundell ether extraction funnel, 54, 55
- Homogeneity of solution during hydrolysis, 46
- Hydrazine, reduction of certain elements to metal with, 63
- mercury, 306
 - selenium, 366
- Hydrazoic acid, removal of permanganate with, 232
- Hydriodic acid, extraction of mercuric sulfide with, 44, 305
- use with chloric acid to regulate pH, 46
- Hydrobromic acid, determination of, 374
- use with bromic acid to regulate pH, 46
 - volatilization of elements from solutions of, 51, 326
- Hydrochloric acid, use with bromic acid to regulate pH, 46
- volatilization of elements from solutions of, 51, 326, 340, 348
- Hydrofluoric acid, behavior with arsenic, 340
- behavior with manganese, 172, 175
 - tin, 43, 347, 349
 - tungsten, 233, 243
 - decomposition of silicates with, 33, 272
 - determination of,
 - colorimetric, 371
 - gravimetric, 369
 - volumetric, 370
 - determination of rare earths with, 310
 - effect on precipitation of stannic sulfide, 43, 347, 349
 - tungsten, 243
 - removal of, 33, 272
 - separation by distillation, 369
 - use in volumetric determination of copper, 283
 - volatilization of silica with, 183

- Hydrofluosilicic acid, distillation of, apparatus for, 273
for determination of fluorine, 50, 369
for removal of fluorine, 272
- Hydrogen electrode, 100
- Hydrogen, ignition in, of barium sulfate, 34
cassiterite, 35
- Hydrogen sulfide, evolution of, 193
precipitation with, 42
removal by aldehydes, 299
retention of in carbon dioxide determination, 317
volumetric determination of, 193
- Hydrogen sulfide group, precipitation of members, 42
separation of members with alkaline sulfide, 347
- Hydrolysis, of aluminum, 47, 142, 143
chromium, 47, 229
columbium, 357
iron, 47, 135
manganese, 163
tantalum, 357
titanium, 47, 155
- Hydrolysis, separation of metals by, 44
influence of anion, 46
methods of effecting, 44
pH required, 44
separations possible, 47
- Hydroquinone, determination of gold with, 288
reduction of iron with, 141
separations with by reduction to metal, 63
- Hydrous oxides, precipitation of, aluminum, 47, 142
chromium, 47, 229
columbium, 357
factors affecting, 44
iron, 47, 134
manganese, 163
tantalum, 357
titanium, 47, 155
- p*-Hydroxyphenylarsonic acid, determination of titanium with, 156
general properties and uses, 84
- 8-Hydroxyquinoline, conditions for precipitating various metals, 75, 76
determination of aluminum with, 144
gallium, 312
magnesium, 77, 79, 294
molybdenum, 377
general properties and uses of, 74
important separations by, 75
methods of concluding determination following precipitation with,
gravimetric, 79
volumetric, 80
structure of compounds of, 69
- Hypochlorite, determination of, 372
- Hypophosphorous acid, reduction of various elements to metal with, 63
arsenic, 340, 344
bismuth, 356
- Independent** variables, combination of, 112
- Indicators, diphenylamine, 246
oxidized form, 246
diphenylaminesulfonic acid, 246
corrections for, 140, 250
oxidized form, 246
diphenylbenzidine,
ferrocyanide titration of indium, 313
zinc, 302
ferrous *o*-phenanthroline sulfate,
determination of iron, 139, 140
chromium and vanadium, 251
- Indicator electrodes, 100
- Indium, determination of, 313
general chemistry, 312
precipitation as sulfide, 43, 312, 313
- Inner complex compounds, 76
characteristics of, 68
definition of, 67
structures of, 70

- Insoluble chloride group, 42
 Internal electrolysis, apparatus for, 61
 theory and application, 60
 Iodate, determination of, 376
 Iodic acid, determination of thorium
 with, 323
 Iodide, determination of, 375
 Iodine, determination of, 375
 7-Iodo-8-hydroxyquinoline-5-sulfonic
 acid, determination of fluorine
 with, 371
 iron, 141
 Iridium, determination of, 386
 Iron, colorimetric determination, 140
 o-phenanthroline method, 117, 140
 thiocyanate method, 140
 concentration of small amounts, 38
 constancy of atomic weight, 420
 determination of ferrous iron, 141
 total iron in ore, 134
 gravimetric determination as oxide,
 134
 by electrodeposition, 59, 135
 precipitation as sulfide, 43
 primary standards for, 95
 reaction with dimethylglyoxime, 72,
 383
 in lead reductor, 99, 139
 silver reductor, 97, 139
 removal by ether extraction, 51
 by mercury cathode, 59
 separation as basic acetate, 135, 162
 p-*n*-butylphenylarsonic acid, 85
 cupferron, 73, 135, 364
 electrodeposition, 59, 135
 extraction with ether, 51
 dichlorethyl ether, 53
 iso-propyl ether, 53
 hydrous oxide, 46, 134
 pH for, 45
 separations effected, 135
 8-hydroxyquinoline, 76
 neo-cupferron, 74
 solvents for metal, 32
 volumetric determination, 135
 in sulfuric acid solution, 137
 in hydrochloric acid solution,
- Iron, volumetric determination, in hy-
 drochloric acid solution, silver
 reductor, 139
 lead reductor, 139
 Iron Ore, determinations made on,
 131
 aluminum, 142
 iron, ferrous, 141
 total, 134
 loss on ignition, 134
 manganese, 162
 phosphorus, 196
 silica, 180, 184
 sulfur, 188
 titanium, 154, 159
 impurities in, 130
 suggestions regarding analysis of, 131
 types of, 130
 Iron powder, fusion with, 33
Iso-propyl ether, use in extraction of
 iron, 53
- Jaw crusher, 23
 J. Lawrence Smith method, 266, 267
 Jones reductor, 97, 138
- Kjeldahl** method for nitrogen, 338
- Lambert's Law**, definition and deriva-
 tion of, 110
- Laws, Beer's, 111
 Lambert's, 110
- Lead, colorimetric determination, 336
 concentration of, by precipitation
 as sulfide, 36
 precipitation with calcium phos-
 phate, 39, 335
 determination of, 333
 in non-ferrous alloys, 354
 gravimetric determination as chro-
 mate, 334
 electrodeposition, as dioxide, 58,
 335
 from fluoride solution, 58
 by internal electrolysis, 62
 molybdate, 334
 periodate, 334
 sulfate, 333

- Lead, removal of, by crystallization
 of lead chloride, 38
 mercury cathode, 58
 separation with dithizone, 88, 336
 extraction of sulfate with ammonium acetate, 333
 internal electrolysis, 62
 8-hydroxyquinoline, 77
 periodate, 334
 salicylaldehyde, 83
 sulfide, 43, 334
 solvents for metal, 31
 volumetric determination, 335
- Lead chloride, crystallization of for removal of lead, 38
- Lead chlorofluoride, determination of fluoride as, 370
- Lead dioxide, electrodeposition of, 57, 335
 from fluoride solution, 58
 solvents for, 32
- Lead reductor, 99
- Light, absorption laws, 110
 measurement of intensity, 113, 122, 125
- Liquids, sampling of, 21
- Lithium, determination of, 265
 separation from sodium, 265
- Loss on ignition, of iron ore, 134
- Lovibond tintometer, 113
- Magnesium**, colorimetric determination, 294
 determination with 8-hydroxyquinoline, 75, 78, 294
 as pyrophosphate, 293
 pH for precipitation of hydroxide, 45
 separation from calcium, 295
 volumetric determination with 8-hydroxyquinoline, 294
- Magnesium oxide, absorbent for water, 94
- Magnesium perchlorate, absorbent for water, 9, 94
- Manganese, colorimetric determination, 176
 oxidizing agents available, 177
- Manganese, periodate method,
 procedure for iron ore, 178, 179
 procedure for steel, 180
 determination, general considerations, 162
 in iron ore, 176, 178, 179
 in steel, 167, 170, 180
 gravimetric determination as oxide, 163
 pyrophosphate, 163, 166
 sulfate, 164
 precipitation as hydrated dioxide
 with ammonia and oxidizing agent, 163
 with nitric acid and chlorate, 164, 165
 hydrolysis, pH for, 45
 8-hydroxyquinoline, 77
 sulfide, 43
 primary standard for, 167
 removal of by mercury cathode, 60
 separation from various elements, 162
 volumetric determination by titration of manganese dioxide, 172
 Ford-Williams method, 172
 titration of manganic fluoride, indirect fluoride method, 172
 titration of manganous salts with permanganate, direct fluoride method, 175
 Volhard method, 175
 titration of permanganate, 167
 bismuthate method, 168
 oxidizing agents for, 167
 periodate method, 171
 persulfate-arsenite method, 169
- Manganese dioxide as a gathering agent, 38
- Manganous oxalate, 167
- Mannitol, use in determination of boron, 310
- Materials, sampling of, 16
 solvents for, 28
- Mercaptoacetic acid, determination of iron with, 141

- Mercurous sulfate electrode, 103
Mercury, colorimetric determination, 308
determination, 304
in organic compounds, 308
gathering agent for gold, 39
gravimetric determination, 305
loss by volatilization of chloride, 29, 305
separation, as basic salt, 45
distillation of metal, 50, 306
chloride, 50, 306
internal electrolysis, 62
mercurous chloride, 305
reduction to metal, 63, 306
sulfide, 43, 44, 305
solvents for metal, 31
volumetric determination, 307
Mercury cathode, apparatus for, 59
general uses of, 58
use in the determination of aluminum, 153
Metals, sampling of, 19
solvents for, 30
Methyl borate, distillation of, 309
1-Methyl-3, 4-dimercaptobenzene, 332
Methylene blue, 158
Miller absorption bulb, 92
Molecular extinction coefficient, definition of, 113
Molybdenum, colorimetric determination, 228
detection and identification, 223
determination of, 222
in steel, tungsten absent, 225
tungsten present, 225, 226
extraction of thiocyanate with ether, 223, 228
general chemistry, 222
gravimetric determination, as molybdate, 224, 225
oxide, 224
interference in determination of chromium, 234
reaction in silver reductor, 97
separation with α -benzoinoxime, 82, 224
8-hydroxyquinoline, 76
Molybdenum, separation from copper, 282
sulfide, 43, 223, 224
solvents for metal, 31
valences, 222
volumetric determination, 227
Molybdic acid reagent, preparation of, 198
Molybdenum blue, determination of phosphorus, 207
Morin, 291
Mortar, agate, 41
diamond, 26
mullite, 25
8-Naphthoquinoline, 304
 α -Naphthylamine, 338
Naphthylnitrosohydroxylamine, 74
Neo-cupferron, 74
Nephelometer, use in determinations of atomic weight, 415
Nessler method of color comparison, 119
Nessler tubes, 119
Nickel, colorimetric determination, 386
concentration of traces, 37, 386
constancy of atomic weight, 420
determination, 383
in steel, 385
gravimetric determination with dimethylglyoxime, 64, 71, 383
electrodeposition, 58, 384
separation by electrodeposition, 58, 384
controlled cathode potential method, 58
internal electrolysis, 63
mercury cathode, 58
8-hydroxyquinoline, 76
salicylaldoxime, 83
sulfide, 43, 384
solvents for metal, 32
volumetric determination, 385
Nickel dimethylglyoxime, conditions for precipitation of, 71, 383
extraction with chloroform, 37

- Nickel dimethylglyoxime, separations effected by precipitation of, 71, 333
 structure of, 68, 69
- Niobium.
See Columbium
- Nitrate, determination of, 338
- Nitrite, determination of, 338
 removal of excess, 244
 use to remove excess permanganate, 244
- Nitrogen, determination of in various forms, 337
- Nitron, determination of nitrate with, 339
 perchlorate, 372
 rhenium, 378
 general properties and uses, 71, 86
- α -Nitroso- β -naphthol, determination of cobalt with, 380
 palladium, 387
 general properties and uses of, 70, 81
 structure of compounds of, 70
- Nitrosophenylhydroxylamine, general properties and uses of, 73
 separation of columbium with, 73
 copper, 283
 iron, 135, 364
 gallium, 312
 tantalum, 73
 tin, 73
 titanium, 156
 uranium, 364
 vanadium, 239, 364
 zirconium, 322, 364
 structure of compounds of, 70
- Nitroso-R-salt, 383
- Non-ferrous alloys, analysis of, 354
- Organic material, destruction of by fuming sulfuric acid and hydrogen peroxide, 308**
 nitric acid, 373
 perchloric (and nitric) acid, 8
 sodium metal, 308, 373
 sodium peroxide, 373
- Organic precipitants, arsonic acids as, 66**
- Organic precipitants, bases as, 71**
 coordination theory applied to, 67
 dibasic acids as, 66
 functional groups in, 68
 inner complex compounds, 67
 introduction of color into, 66
 literature of, 64
 requirements of, 65
 ring formation of, 67, 68
 selective reagents, definition of, 65
 specific reagents, definition of, 65
 theoretical considerations, 64
- Organic reagents, alizarin, 370**
 alizarinsulfonic acid, 370
 aluminon, 153, 291
p-aminodimethylaniline, 371
 β -aminonaphthalide, 70, 315
 aurintricarboxylic acid, 153, 291
 benzidine, 71, 223, 361
 α -benzoinoxime,
 general properties and uses, 82
 determination of copper, 282
 molybdenum, 224
- brucine, 304
- p*-*n*-butylphenylarsonic acid, 84
- caffeine, 357
- cinchonine, 71, 217, 228
- codeine, 367
- cupferron,
 general properties and uses, 70, 73
 separation of copper, 283
 iron, 135, 364
 gallium, 312
 titanium, 156
 uranium, 364
 vanadium, 239, 364
 zirconium, 322, 364
- cupron.
See α -benzoinoxime
- curcumin, 291
- diethyldithiocarbamate, 285
- p*-dimethylaminobenzalrhodanine, 287
- p*-dimethylaminobenzeneazophenylarsonic acid, 66, 322
- dimethylglyoxime,
 general properties and uses, 64, 68, 71

- Organic reagents, dimethylglyoxime,
determination of nickel, 37, 383,
386
palladium, 387, 388
di- β -naphthylthiocarbazono, 308
diphenylcarbazide, 230
diphenylcarbazone, 308
diphenylendoanilohydrotriazole.
See nitron
diphenylthiocarbazono.
See dithizone
dithiol, 332
dithiooxalic acid, 386
dithizone,
determination of lead, 88, 336
mercury, 88, 308
thallium, 88, 315
general properties and uses, 87
 α -furdioxime, 69
cyclo-hexanedionedioxime, 69
p-hydroxyphenylarsonic acid, 84,
156
8-hydroxyquinoline,
determination of aluminum with,
144
gallium, 312
magnesium, 77, 79, 294
molybdenum, 377
general properties and uses, 69,
74
7-iodo-8-hydroxyquinoline-5-sulfonic
acid, 141, 371
mercaptoacetic acid, 141
1-methyl-3,4-dimercaptobenzene,
332
morin, 292
8-naphthoquinoline, 304
 α -naphthylamine, 338
naphthylnitrosohydroxylamine, 74
neo-cupferron, 74
nitron,
determination of nitrate with,
339
perchlorate, 372
rhenium, 378
general properties and uses, 71, 86
- Organic reagents, α -nitroso- β -naph-
thol, determination of cobalt
with, 380
palladium, 387
general properties and uses, 70,
81
nitrosophenylhydroxylamine.
See cupferron
nitroso-R-salt, 383
oxine.
See 8-hydroxyquinoline
o-phenanthroline, 118, 140
phenoldisulfonic acid, 339
phenylarsonic acid, 84
phenylnitrosohydroxylamine.
See cupferron
phenylthiohydantoic acid, 381
n-propylarsonic acid, 84, 322
quinaldinic acid, 70
quinalizarin, 291, 293
rhodamine B, 354
rhodizonic acid, 67, 298, 362
rubeanic acid, 285
salicylaldoxime, 70, 83
tetrahydroxyquinone, 67, 298, 362
tetraphenylarsonium chloride, 86,
372, 378
thiourea, 357
T.H.Q.
See tetrahydroxyquinone
titan yellow, 294
o-tolidine, 116, 371
triphenyltin chloride, 71
turmeric, 310
Ortho-phenanthroline, 118, 140
Ortho-tolidine, 116, 371
Osmium, determination, 386
separation by volatilization, 50,
388
Osmium tetroxide, catalyst for per-
manganate-arsenite reaction,
170
Oxalic acid, determination of rare
earths with, 310
prevention of precipitation of stan-
nic sulfide, 43, 347, 349
Oxides, solvents for, 32

- Oxine.
See 8-Hydroxyquinoline
- Oxygen, determination, 359
 in organic compounds, 359
- Palladium**, determination of, 386
 gravimetric determination with dimethylglyoxime, 72, 387, 388
 separation by reduction to metal, 63
 8-hydroxyquinoline, 83
 α -nitroso- β -naphthol, 81, 387
- Para-aminodimethylaniline, 371
- Para-dimethylaminobenzeneazophenylarsonic acid, 66
 determination of zirconium with, 322
- Para-dimethylaminobenzalrhodanine, 287
- Para-normal-butylphenylarsonic acid, 84
- Parr turbidimeter, 361
- Penfield method, 50
- Perchloric acid, care of, 8
 dangers attending, 8
 dehydrating properties, 8
 dehydration of silica with, 182
 determination of, 372
 determination of chromium with, 231
 potassium, 254
 oxidizing properties of, 8
 removal of fluoride with, 272, 277
 uses of, 8
 volatilization of elements from solutions of, 51
- Periodic acid, determination of, 376
 determination of lead with, 334
 manganese, 167, 171, 177
 mercury, 306
 potassium, 261
 removal of excess, 171
- Periodic groups, general properties of, 279
 Group I, 280
 Group II, 290
 Group III, 308
 Group IV, 315
 Group V, 337
- Periodic groups, Group VI, 358
 Group VII, 367
 Group VIII, 378
- Periodic Table, Inside back cover
- Permanganate, removal of, 232, 234, 244
- Persulfate-arsenite method for manganese, 169
- Pertitanic acid, determination of titanium as, 158
 fluorine, 371
 interference in test for vanadium, 239
- Pervanadic acid, 241
- p*H, methods of adjusting, 44
- o*-phenanthroline, 118, 140
- o*-phenanthroline ferrous sulfate, as indicator in the determination of iron, 139, 140
 chromium and vanadium, 251
 spectral distribution curve of, 118
- Phenoldisulfonic acid, 339
- Phenylarsonic acid, 84
- Phenylhydrazine, precipitation of weak bases with, 45
 aluminum, 146
- Phenylnitrosohydroxylamine, general properties and uses of, 73
 separation of columbium with, 73
 copper, 283
 iron, 135, 364
 gallium, 312
 tantalum, 73
 tin, 73
 titanium, 156
 uranium, 364
 vanadium, 239, 364
 zirconium, 322, 364
 structure of compounds of, 70
- Phenylthiohydantoic acid, 381
- Phosgene, use in decomposition of oxide, 32
- Phosphate, determination of.
See Phosphorus
 heteropoly acid with vanadium and tungsten, 207, 233, 241, 244
- Phosphate, interference in determination of tin, 326

- Phosphate, precipitation on hydrolysis of alumium, 48, 144
iron, 135
titanium, 155
- Phosphate rock, solution of for analysis, 34
- Phosphates, decomposition of insoluble, 34
- Phosphorus, colorimetric determination as molybdenum blue, 207
as phosphovanadomolybdic acid, 207
determination of, 196
in iron ore, 199, 208
 R_2O_5 , 199
steel, 201, 207
gravimetric determination, as ammonium molybdiphosphate, 203
magnesium pyrophosphate, 203
loss by volatilization as phosphine, 29, 196
separation, as ammonium molybdiphosphate, 196
conditions for precipitation, 197
volumetric determination, alkalimetric method, 205
oxidation-reduction method, 206
- Phosphorus pentoxide, absorbent for water, 94
- Phosphovanadomolybdic acid, determination of phosphorus as, 207
vanadium, 241
- Photoelectric cells, types and use in colorimetry, 123
- Photoelectric colorimeter, 122
- Photometer, 114, 122
- Platinum, determination of, 386
general chemistry, 387
precipitation as metal, 63
sulfide, 43, 388
solvents for metal, 32
- Platinum metals, general chemistry of, 386
- Platinum ware, use and care of, 6
- Potassium, determination of, 254
gravimetric determination, chloroplatinate method, 258
modified, 259
- Potassium, gravimetric determination of, cobaltinitrite method, 260
decomposition of silicates for, 266
general considerations, 252
ignition of chloride, 253
sulfate, 253
perchlorate method, 254
periodate method, 261
separation from rubidium and cesium, 265
sodium, 253, 263
- Potassium fluotitanate, 159
- Potassium hydroxide, absorbent for carbon dioxide, 91
for water, 94
- Potassium perchlorate, solubility of, 254
- Potassium permanganate, standardization of solutions of, 95
- Potassium pyrosulfate, fusion with, 32, 34, 159
- Potassium titanyl oxalate, 159
- Potential measurement, potentiometric, 104
vacuum tube voltmeter, 105
- Potentiometer, diagram of, 106
"student" type, 105
- Potentiometric titration, applications of, 109
apparatus for, 104
electrodes for,
indicator, 100
reference, 101
bimetallic, 103
principles of, 99
- Primary standards, for iron, 95
manganese, 167
oxidation-reduction, 95
titanium, 159
- Problems in the analysis of ores and alloys, 405
- n*-Propylarsonic acid, general properties and uses, 84
determination of zirconium with, 322
- iso*-Propyl ether, 53

- Purification of materials for atomic weight determinations, 411
- Purple of Cassius, 288
- Quinaldine** acid, 70
- Quinalizarin, 291, 293
- Quinhydrone electrode, 100
- R₂O₃**, determination of aluminum in, 152
 phosphorus, 199
 silica, 184
 titanium, 159
- Rare earths, determination of, 310
 precipitation, as fluoride, 310
 hydrrous oxides, 45
 oxalates, 311
- Records, keeping of, 5
- Reduction of metal, separations by, 63
- Reduction of sample size, 20, 23
- Reducers, lead, 99
 use in determination of iron, 139
 silver, 97
 use in determination of iron, 139
 zinc, 97, 138
- Reference electrodes, 101
- Reporting of results, 127
- Results, agreement of, 133
 reporting of, 127
- Rhodamine B, 354
- Rhenium, detection and identification, 377
 determination, 376
 general chemistry, 376
- Rhodium, determination of, 386
- Rhodizonic acid, determination of
 barium, 298
 sulfate, 362
 general uses of, 66
- Rifle, 21, 27
- Rothe ether extraction funnel, 54, 55
- Rubeanic acid, 285
- Rubidium, separation from potassium, 265
- Ruthenium, determination of, 386
 separation by volatilization, 50, 388
- Salicylaldoxime**, general properties and uses, 83
 structure of metallic derivatives, 70
- Sample, crushing of, 23
 fineness of, 26
 grab, 21
 gross, 16
 methods of dissolving, 28
 preparation for weighing, 27
 reduction in size, 20, 23
 storage of, 23
 weighing of, 28
- Sampling, apparatus for,
 crushing machinery, 24
 rifle, 21, 27
 sampling net, 21
 sieves, 26
 thief sampler, 22
 changes during, 22
 moisture content during, 23
 objectives and principles, 16
 segregation affecting, 19
 size-weight ratio, 19
 storage after, 23, 27
 variation in composition affecting, 18
- Sampling, of gases, 22
 liquids, 21
 solids, 17
 coal, 17, 19
 metals, 19
- Scandium, determination of, 310
- Segregation, errors caused by, 19
- Selective reagent, definition of, 65
- Selenious acid, determination of zirconium with, 321
- Selenium, determination of, 365
- Separations, general principles, 39
 methods of effecting.
 See Table of Contents
 summary of principal methods for each element, 390
- Sieves, 26
- Silica, colorimetric determination, 188
 determination of, 180
 in iron ore, 180, 184
 silicates, 181
 steel, 180, 186

- Silica, member of the acid insoluble group, 41
volatilization with hydrofluoric acid, 183
- Silica gel, absorbent for water, 94
- Silicates, decomposition of, 32, 181
for determination of alkalis, 266
types of, 181
- Silicon, determination in steel, 180, 186
sulfuric acid method, 186
perchloric acid method, 187
loss by volatilization during solution of sample, 181
See silica for further details
- Silicon carbide, formation during ignition of silica, 183
- Silver, importance and determination of atomic weight of, 415, 416
colorimetric determination, 287
gravimetric determination, 42, 286
member of the insoluble chloride group, 42
separation as chloride, 286
 electrodeposition, 58, 286
 internal electrolysis, 63
 reduction to metal, 63
 sulfide, 43
separation from silica, 286
solvents for metal, 31
volumetric determination, 287
- Silver-oxygen ratio, 416
- Silver reductor, 97
- Silver-silver chloride electrode, 103
- Size-weight ratio, 19
- Small amounts, concentration methods for, 35
- Smith, J. Lawrence, method for alkalis, 266, 267
- Soda-lime, absorbent for carbon dioxide, 92
- Sodium, determination of, 262
decomposition of silicates for, 266
general considerations, 252
ignition of chloride, 253
 sulfate, 253
triple acetate method for, 262
separation from lithium, 265
potassium, 253
- Sodium azide, removal of permanganate with, 245
- Sodium bismuthate, oxidation of manganese with, 167
- Sodium carbonate, fusions with, behavior of elements during, 49
decomposition of oxides, 32
 phosphates, 34
 silicates, 32, 33, 181
 sulfates, 34
effecting separations by, 49
- Sodium hydroxide, absorbent for water, 94
separations by precipitation with, 48
- Sodium metal, decomposing organic material with, 373
- Sodium oxalate, as primary standard, 95
- Sodium peroxide, fusion with, behavior of elements during, 49
decomposition of ferro alloys, 34
 organic material, 49
 refractory minerals, 35, 228
 sulfides, 33
effecting separations by, 49
- Sodium thiosulfate, decomposition of to regulate pH, 46
- Solvents for alloy steel, 233, 243
 carbonates, 34
 ferro alloys, 34
 iron ore, 130, 131
 metals, 30
 oxides, 32
 phosphates, 34
 refractory minerals, 35
 silicates, 32, 181, 266
 sulfates, 34
 sulfides, 33
- Specific reagents, definition of, 65
- Spectrophotometer, 114
types and uses, 125
- Standardization of potassium permanganate, 95
- Steel, analysis of,
 alloy, 215
 chromium, 228
 molybdenum, 222

- Steel, alloy,
 nickel, 385
 tungsten, 216
 vanadium, 238
 plain carbon, 130
 carbon, 209
 manganese, 162
 phosphorus, 196
 silicon, 180
 sulfur, 188
- Steiger-Merwin method, 371
- Stepanow method for halogen in organic material, 373
- Strontium, determination of, 297
- Student potentiometer, 105
- Sublimation, separations effected by, 37
- Succinic acid, use in determination of aluminum, 143
- Sulfamic acid, removal of nitrous acid with, 245
- Sulfate, gravimetric determination, 188, 361
 turbidimetric determination, 361
 volumetric determination, 361
- Sulfates, insoluble, decomposition of, 34
- Sulfide-iodometric method for tin, 329
- Sulfides, decomposition of for analysis, 33, 188, 189, 360
 determination of sulfur in, 360
- Sulfides, precipitation of, from acid solutions, 42
 alkaline solutions, 42, 347
 ignition of, 43
 separations effected by, 42
 sulfur contamination of, 44
- Sulfite, determination of, 361
- Sulfosalicylic acid, 315
- Sulfur, determination of, 188, 360
 in iron ore,
 fusion method, 189
 wet method, 189, 190
 in steel,
 combustion methods, 194
 gravimetric method, 192
- Sulfur, in steel,
 evolution-volumetric method, 193, 194
See hydrogen sulfide, sulfate, sulfite, thiosulfate
- Sulfur chloride, use in decomposition of oxides, 32
- Sulfur dioxide, reducing action, 136
 removal of from gas stream, 211
- Sulfuric acid, absorbent for water, 94, 95
 volatilization of elements from solutions of, 51
- Summary of gravimetric methods for various elements, 389
 volumetric methods for various elements, 398
- Tantalum**, determination of, 357
 general chemistry, 357
 member of acid insoluble group, 42
- Tartaric acid, complex with tungsten, 216, 224
 effect on precipitation of hydroxides, 48, 88
- Tellurium, general chemistry, 365
 gravimetric determination, 366
 separation by reduction to metal, 63, 366
 volumetric determination, 367
- ter Muelen method for oxygen in organic material, 359
- Tetrahydroxyquinone, determination of barium, 298
 sulfate, 362
 general uses, 67
- Tetraphenylarsonium chloride, determination of perchlorate, 372
 rhenium, 378
 general uses, 85
- Thallium, determination of, 313
 general chemistry, 314
 extraction with ether, 51, 314
 member of the insoluble chloride group, 42
- Thief sampler, 22
- Thioglycollic acid, 141

- Thiosulfate, determination of, 361
determination of selenium with, 367
precipitation of aluminum phosphate with, 144
- Thiourea, 357
- Thompson-Oakdale method for halogens in organic material, 373
- T.H.Q., determination of barium, 298
sulfate, 362
general uses, 67
- Thorium, determination, 323
general chemistry, 323
separation with 8-hydroxyquinoline, 76
phenylarsonic acid, 85
- Tin, colorimetric determination, 332
concentration of traces, 38
decomposition of tin minerals, 35, 325
determination of, 325
in non-ferrous alloys, 354
gravimetric determination, by electrodeposition, 57, 326
oxide, 325
loss by volatilization, 29
member of acid insoluble group, 42
separation by distillation, 50, 326, 327, 348
electrodeposition with controlled cathode potential, 57, 326
metastannic acid, 42, 45, 325
phenylarsonic acid, 85
sulfide, from alkaline solution, 43, 327, 347
hydrochloric acid solution, 43, 326
hydrofluoric acid solution, 43, 327, 347, 349
oxalic acid solution, 43, 327, 347, 349
solvents for metal, 31, 325
various tin compounds, 325
volumetric determination, 323
- Tintometer, 113
- Titan yellow, 294
- Titanium, colorimetric determination, 158
detection and identification, 154
- Titanium, determination of, 154
in iron ore, 159
gravimetric determination as oxide, 155
primary standards for, 159
reaction in silver and zinc reducers, 97
separation with cupferron, 73, 156
p-hydroxyphenylarsonic acid, 84, 156
8-hydroxyquinoline, 76
hydrous oxide, 46
pH for, 45
sulfur dioxide method, 155, 156
phosphate, 155
volumetric determination, 158
- Titanous sulfate, reduction of perchlorate with, 372
- Titration curve, normal, 107
differential, 108
- o*-Tolidine, 116, 371
- Traces, concentration methods for, 35
dithizone, 89
- Transmission factor, definition of, 111
- Transmittancy, of light, 111, 113
- Triphenyltin chloride, 71
- Triple acetate method for lithium, 265
sodium, 262
- Tungsten, detection of, 217
determination of, 216
in steel, 219
general chemistry, 216
gravimetric determination as oxide, 218
methods of keeping in solution, 233, 243
precipitation as cinchonine tungstate, 218
mercurous tungstate, 219
tungstic acid, 41, 218
reaction with citric acid, 216
hydrofluoric acid, 233
phosphoric acid, 216, 219, 233
tartaric acid, 216
removal by volatilization of oxychloride, 37
solvents for metal, 32, 218
- Tungsten electrode, 104

- Turbidimeter, 361
 Turmeric, 310
 Turner absorption bulb, 92
- Urea**, precipitation of aluminum, 143
 weak bases, 46
 removal of nitrous acid, 244
- Uranium**, gravimetric determination
 as oxide, 364
 general chemistry, 363
 reaction in silver and zinc reductors,
 97
 separation as arsenate, 364
 cupferron, 73, 364
 double carbonate, 364
 hydrous oxide, 45, 364
 8-hydroxyquinoline, 77
 volumetric determination, 365
- Uranyl acetate**, determination of
 sodium with, 262
- Vanadium**, colorimetric determination,
 241
 detection, 239
 determination of, 238
 in steel, principle, 241
 procedure, tungsten absent, 247
 tungsten present, 249
 simultaneous with chromium,
 251
 general chemistry, 238
 reaction with cupferron, 73, 74, 239,
 364
 hydrogen peroxide, 239
 hydrogen sulfide, 239
 reducing agents for, 238
 silver reductor, 97
 separation from uranium, 364
 sources of, 238
 valences, 238
 volumetric determination, titration
 of bivalent vanadium with per-
 manganate, 240
 titration of vanadic acid, determina-
 tion of end-point, 245
 interference of chromium, 241
 interference of tungsten, 243
- Vanadium**, titration of vanadic acid,
 preliminary oxidation with
 bromate, 242
 permanganate, 242, 244
 principle, 240, 242
 procedure, tungsten absent, 247
 tungsten present, 249
 titration of vanadyl sulfate,
 with permanganate, 240, 242
 interference of chromium, 241
- Volatilization**, as a concentration
 method, 37
 as a method of effecting separations,
 49
 loss by during solution process, 29
- Volatilization**, of aluminum, 37
 antimony, 29, 50, 346, 348
 arsenic, 29, 50, 340
 boron, 50, 309
 chromium, 50
 fluorine, 30, 50, 272, 369
 germanium, 324
 hydrofluosilicic acid, 50, 272, 369
 mercury, 50, 306
 osmium, 50, 388
 ruthenium, 50, 388
 selenium, 366
 silica, 183
 tungsten, 37
 water, 49
- Volhard method** for manganese, 175
- Voltage**, measurement of, 104
- Volumetric methods**, summary of,
 398
- Water**, absorbents for, 90, 93
 contamination of material by, 412
 extent of removal from gases by
 various agents, 94
 separation by volatilization, 49
- Water analysis**, reporting results of,
 128
- Weak bases**, separation from stronger
 bases, 44
- Weighing**, of absorption bulbs, 91
 samples, 28

- Weighing**, correction to weight in vacuum, 28
- Wesson** absorption bulb, 92
- Willard and Winter** method for fluorine, 369
- Yellow** precipitate, conditions for precipitation, 197
crystal structure of, 196
determination of phosphorus as, gravimetrically, 203
volumetrically, 205, 206
test for molybdenum, 223, 225
- Yttrium**, determination of, 310
- Zinc**, gravimetric determination as pyrophosphate, 299, 300
electrodeposition of, 58
precipitation as sulfide, 43, 299
removal of by mercury cathode, 59
- Zinc**, separation with 8-hydroxyquinoline, 76
salicylaldehyde, 83
solvent for metal, 31
volumetric determination, 301
- Zinc chloride**, absorbent for water, 94
- Zirconium**, gravimetric determination as oxide, 321
general chemistry, 320
separation with cupferron, 73, 322, 364
basic selenite, 321
hydrous oxide, 48
*p*H for, 45
8-hydroxyquinoline, 77
p-hydroxyphenylarsonic acid, 85
phosphate, 321
n-propylarsonic acid, 85, 322
- Zirconium alizarin lake**, determination of fluorine with, 370, 371

Acc. No

ISSUE LABEL

Not later than the latest date stamped below.

--	--	--

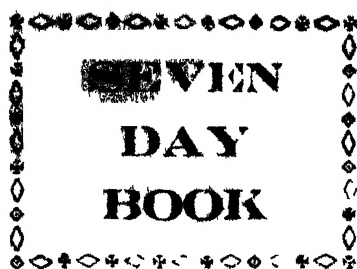

VIN
DAY
BOOK