

Birla Central Library

PILANI (Jaipur State)

Engg. College Branch

Class No :- 626.8

Book No :- E801 I V.2

Accession No :- 31528

Acc. No

ISSUE LABEL

Not later than the latest date stamped below.

~~10/27/4~~

**IRRIGATION PRACTICE AND
ENGINEERING**

**VOLUME II
CONVEYANCE OF WATER**

*This book is produced in full compliance
with the government's regulations for con-
serving paper and other essential materials.*

Books by
B. A. ETCHEVERRY
and
S. T. HARDING

IRRIGATION PRACTICE AND ENGINEERING

THREE VOLUMES

VOL. I—USE OF IRRIGATION WATER AND IRRIGATION PRACTICE. *Second Edition.*
256 pages, 6 × 9, over 100 illustrations
By *B. A. Etcheverry and S. T. Harding*

VOL. II—CONVEYANCE OF WATER. *First Edition.* 364 pages, 6 × 9, over 100 illustrations
By *B. A. Etcheverry*

VOL. III—IRRIGATION STRUCTURES. *First Edition.* 438 pages, 6 × 9, over 200 illustrations
By *B. A. Etcheverry*

LAND DRAINAGE AND FLOOD PROTECTION
327 pages, 6 × 9, over 100 illustrations
By *B. A. Etcheverry*

OPERATION AND MAINTENANCE OF IRRIGATION SYSTEMS
271 pages, 6 × 9, 25 illustrations
By *S. T. Harding*

IRRIGATION PRACTICE
AND
ENGINEERING

VOLUME II
CONVEYANCE OF WATER

GENERAL CONSIDERATIONS AND FEATURES
PERTAINING TO IRRIGATION SYSTEMS;
CONVEYANCE OF WATER IN CANALS,
TUNNELS, FLUMES AND PIPES.

B. A. ETCHEVERRY
HEAD OF THE DEPARTMENT OF IRRIGATION
UNIVERSITY OF CALIFORNIA

FIRST EDITION
TWELFTH IMPRESSION

McGRAW-HILL BOOK COMPANY, INC.
NEW YORK AND LONDON
1915

COPYRIGHT, 1915, BY THE
MCGRAW-HILL BOOK COMPANY, INC.

PRINTED IN THE UNITED STATES OF AMERICA

THE MAPLE PRESS COMPANY, YORK, PA.

PREFACE

Volumes II and III are essentially devoted to a presentation of the fundamental principles and problems of irrigation engineering. While the author has endeavored to meet specially the needs of teachers and students in technical schools, considerable descriptive information and cost data have been added for the purpose of making these volumes more valuable to the engineers engaged in the construction and operation of irrigation systems. For use as text-books in class-room work, some of the descriptive material and detailed information may be considered only briefly and more emphasis laid on the fundamental principles and on the problems of economic construction.

The preparation of these two volumes results in part from the development of a course in Irrigation engineering presented at the University of California. It is based on an acquaintance with a large number of irrigation systems, located in most of the States of the western part of the United States and in western Canada, obtained through many opportunities for examination of these projects and through connection with a number of them. The writer has not confined himself to his own experience and observations, but has discussed the principles of irrigation engineering presented in this work with a number of successful engineers, who have had much experience in the construction and operation of irrigation systems. He has also availed himself not only of contemporary literature pertaining to American Irrigation engineering, but has consulted a large collection of foreign publications, mostly from India, Egypt, Spain and France. While there is still considerable difference of opinion among engineers regarding some of the principles of design of irrigation works, it is believed that the opinions and principles presented are in accordance with correct theory and good practice as demonstrated by careful observation.

This treatise on irrigation engineering, as presented in Volumes II and III, is largely confined to canals and other works which pertain to the usual types of irrigation systems. No attempt has been made to discuss the subject of dams used for the de-

velopment of storage, and of high masonry dams used for the diversion of water. Excellent books on dams made it unnecessary and undesirable to include a brief presentation of this subject. On the other hand, much space has been devoted to a rather complete consideration of low dams used for diversion weirs.

The division of this work in two volumes has been made primarily to avoid an excessively bulky book in one volume. The division has had to be made more or less arbitrarily. Volume II, on The Conveyance of Water, begins with three chapters which pertain to irrigation engineering as a whole, and Volume III, on Irrigation Structures and Distribution Systems, contains chapters which are closely related to the conveyance of water. These two volumes are not entirely separate from Vol. I on Irrigation Practice, which has been presented as an introductory volume, and to which reference is made in Volumes II and III.

The author wishes to acknowledge his indebtedness to those who have aided him in the collection of the large amount of data and information used in the preparation of this work and to the large number of publications from which much valuable information has been obtained. Special acknowledgment is made to the engineers and managers of irrigation projects, who have so willingly made it possible for the writer to examine these projects under the most favorable conditions, and who have kindly furnished a large number of drawings and photographs, of which many have been selected for the illustrations of this work. The acquaintance with these engineers and managers has been a source of much satisfaction and encouragement, and the relations and interchange of opinions with them have resulted in a large measure in whatever may be the merits of this work. To the United States Reclamation Service thanks are especially given.

The tabulated references presented at the end of each chapter will serve in many cases as specific acknowledgment for the use of published articles.

The author will appreciate any suggestions for betterments and will be greatly obliged to any reader who will inform him of any errors which may have been overlooked.

B. A. ETCHEVERRY.

BERKELEY, CALIFORNIA,
August, 1915.

VOL. II

CONTENTS

	PAGE
PREFACE	v
LIST OF PLATES	xiii

CONVEYANCE OF WATER—DESIGN OF CANALS, FLUMES, PIPES, ETC.

CHAPTER I

GENERAL FEATURES AND PRELIMINARY INVESTIGATIONS TO DETERMINE THE GENERAL FEASIBILITY OF AN IRRIGATION PROJECT	1
<p>General features of an irrigation system—Elements and parts of a gravity irrigation project—Character of irrigation systems—Preliminary investigations to determine feasibility of project—The land and crops—Water supply—General physical features and character of the irrigation system—Cost of the system—Miscellaneous considerations—References for Chapter I.</p>	

CHAPTER II

PROCEDURE IN THE PLANNING AND LOCATION OF AN IRRIGATION SYSTEM	22
<p>Preliminary investigations to determine feasibility of system—Alignment and location of diversion line and headworks—Reconnaissance survey and trial line surveys—Preliminary survey—Paper location and field location survey—Location of distribution system—Topographic survey—Miscellaneous considerations—Curvature—Profile of canal lines and grade lines—Cost of surveys—Right-of-way for canals—References for Chapter II.</p>	

CHAPTER III

HYDRAULIC FORMULAS SPECIALLY APPLICABLE TO COMPUTATIONS OF IRRIGATION CANALS AND STRUCTURES	45
<p>Flow of water in canals and open conduits—Principles and formulas for steady uniform flow—Values of the coefficient of roughness “n” for canals in earth and in rock—Values of the coefficient of roughness “n” for concrete-lined canals and concrete flumes—Values of the coefficient of roughness “n” for retaining wall canal cross sections in rock—Values of coefficient of roughness “n” for wooden flumes—Values of coefficient of roughness “n” for semicircular</p>	

sheet steel flumes—Values of coefficient of roughness “n” for pipes—Values of “n” for concrete pipes—Values of “n” for riveted steel and cast-iron pipes—Effect of curvature on the coefficient of roughness “n”—Accuracy of results obtained by Chezy-Kutter’s formula—Diagram for solution of Chezy-Kutter’s formula—Desirable maximum and minimum velocities in canals—Velocities required to prevent the growth of aquatic plants and moss.	
FORMULAS FOR THE FLOW OF WATER IN PIPES	62
Losses of head in pipes—The most common problems of hydraulic pipe-line computations.	
FLOW OF WATER THROUGH LARGE ORIFICES, TUBES AND GATES	69
Standard orifices—Standard short tubes and short pipes—Rectangular gate openings, free discharge, contracted flow—Gate openings with submerged discharge, suppressed side and bottom contraction—Large gate openings with submerged discharge, suppressed bottom and side contractions—Large tubes, submerged discharge, with and without contraction—References for Chapter III.	

CHAPTER IV

SILT PROBLEMS IN THE DESIGN OF IRRIGATION SYSTEMS	79
Fertility of silt—Amount of silt in irrigation waters; methods of determination and variations due to condition of silt—Silt contents of river waters used for irrigation—Distribution of silt at different depths in a stream—Coarse sediment transported or rolled along the bottom of canals and rivers—Silt carried by irrigation waters in India—Theory regarding silt-carrying capacity of a channel—Prevention of silt deposits in canals—References for Chapter IV.	

CHAPTER V

CONVEYANCE LOSSES IN CANALS	96
Nature of conveyance losses—Factors influencing seepage losses in canals—Extent of conveyance losses in canals—Extent of conveyance losses for entire system—Extent of conveyance loss measured in cubic feet per square foot of wetted surface, in 24 hours—Rates of conveyance loss for the design of canals—Extent of conveyance losses expressed in per cent. of flow per mile—Extent of evaporation loss in the conveyance of water in canals—References for Chapter V.	

CHAPTER VI

THE DESIGN OF CANAL CROSS SECTIONS	112
General considerations—Proportion of bed width to depth—Canal cross section having most advantageous hydraulic elements	

—Canal cross section for minimum seepage loss—Safety against breaks—Location of canal and purpose for which it is used—Form of construction, lined or not lined—Unit cost of excavation and methods of excavation—Limitations in the selection of the form of cross section because of grade and velocity and of the necessity for the prevention of silt deposits—Empirical rules for proportion of bed width to depth—Selection of side slopes for the water cross section and for the outside of the banks—Berms and spoil banks—Selection of height of top of bank above full water supply or free-board—Top width of the crown of the bank.

SELECTION OF DEPTH OF CUT AND SPECIAL CASES OF EARTH-WORK COMPUTATION	127
Canals in level ground—Economic depth of cut in level ground for a balanced cut-and-fill cross section—Canals in side hills—Field method of balancing cut-and-fill for a one-bank canal section in side hill.	
TRANSITION FOR CHANGE OF CANAL CROSS SECTION	134
References for Chapter VI.	

CHAPTER VII

CANAL LININGS AND THE PREVENTION OF SEEPAGE LOSSES	139
Types of canal linings—Efficiency of different types of canal linings—Comparative cost of linings—Strength and durability; resistance to high velocities, to the growth of weeds and burrowing animals—Concrete linings—Form of cross section and thickness of lining—Minimum thickness—Thickness when sloping side walls resist earth pressure—Contraction and expansion; construction joints and expansion joints—Methods of construction of concrete linings—Construction of concrete linings by means of forms—Construction of concrete linings without forms—Drainage and effect of frost—Examples and cost of concrete linings—Economy of concrete linings—Special forms of concrete linings—Partial linings; outer slope lining for canals on side hills—Semicircular concrete lining; Umatilla project, Oregon—Reinforced concrete linings—Yakima Valley canal, Washington—Cheliff canal, Algeria—Tieton canal, Washington—References for Chapter VII.	

CHAPTER VIII

TUNNELS, CONCRETE RETAINING WALL CANAL SECTIONS, BENCH FLUMES	173
Size and form of tunnel—Tunnels on Tieton canal, Yakima project, Washington—Tunnels on Truckee Carson project, Nevada—Tunnel on Belle Fourche project, South Dakota—Tunnel on Huntley project, Montana—Concrete retaining walls for canal sections and bench flumes—Wooden bench flumes—Reinforced	

concrete bench flumes—Reinforced concrete bench flume of Kamloops Fruitlands Irrigation Co., British Columbia—Reinforced concrete flume for the Yakima Valley Canal Co. in Washington—Flume of Naches Power Co., Washington—Flume of Big Fork plant, Montana; Northern Idaho and Montana Power Co.—References for Chapter VII.

CHAPTER IX

FLUMES 198

Rectangular wooden flumes—Flume lining—Framework of flume box—Substructures—Design and economic proportioning of wooden flumes on trestle—Cost of wooden flumes—Life of wooden flumes—Semicircular wooden stave flumes—Steel flumes—Types of—Expansion and contraction of steel flumes—Substructure for steel flumes—Cost of steel flumes—Durability and economy of steel flumes—Reinforced concrete flumes—Reinforced concrete elevated flumes of Kamloops Fruitlands Irrigation and Power Co., British Columbia—Reinforced concrete flume of Yakima Valley Canal Co., Washington—Reinforced concrete flume of Naches Power Co., Washington—Reinforced concrete elevated flumes on canal of Hamiz, Algeria—Faleva flume on canal of Aragon and Catalogne, Spain—Reinforced concrete flume on interstate canal, North Platte project, Nebraska, Wyoming—Inlet and outlet to flumes—References for Chapter IX.

CHAPTER X

PIPES AND INVERTED SIPHONS 239

Uses of pipes in irrigation—Kinds of pipes used.

WROUGHT-IRON AND STEEL PIPES 240

Design of steel pipes—Stresses and thickness of pipe—Expansion and contraction and temperature stresses—Types of longitudinal and circumferential joints—Design of riveted joints—Examples of steel-pipe installations—Ingot iron pipes—Covering steel pipes—Expansion joints in steel pipes—Supports for steel pipe lines built above ground—Anchorage for steel pipe lines—Examples of anchorages—Design of air vents for steel pipes—Air valves—Corrosion and durability of steel pipes—Coating of steel pipes—Cost of small size steel pipes.

WOODEN PIPES 274

General description—Use and adaptability—Staves—Curvature and bends—End butt joints of staves—Bands and shoes—Design of staves and bands—Principles of design—Size of bands—Spacing of the bands—Durability of wood pipe—Average useful life—Covered pipes vs. exposed pipes—Painting or coating of staves and bands—Construction of continuous wood stave pipe lines—Connec-

tions and fixtures—Supports for wood stave pipe lines built above ground—Overhead stream crossing vs. undercrossing—Anchors for wood stave pipes—Cost of wood stave pipes—Specifications for continuous wood stave pipe.

CEMENT MORTAR AND PLAIN CONCRETE PIPES 301

General use of pipe—Description of pipe and properties—Method of manufacturing and laying hand-tamped cement pipes—Cost of making pipe—Other methods of making cement pipes—Machine-tamped pipe—Wet process pipe.

REINFORCED CONCRETE PIPES 310

General description and use—Reinforcement—Concrete—Reinforced concrete pipes cast in sections—Method of casting pipe lengths used on Umatilla project, Oregon—Method of casting small diameter pipe on Tieton project, Washington—Method of making wire-wound concrete pipe, used on the Roswell project, Idaho—Methods of joining pipe sections—Expansion and contraction in concrete pipe lines built of separately moulded sections—Method of construction to decrease contraction—Theoretical consideration of contraction movement—Contraction joints—Water-tightness, durability, and examples of use of reinforced concrete cast pipe—Tests of water-tightness of reinforced concrete pipe on the Umatilla project, Oregon—M-line siphon, Umatilla project, Oregon—Pressure pipe for the aqueduct of Acheres, Paris, France—Distributary pipes for the agricultural park of Acheres, Paris, France—Venice pressure pipe, Italy—Bone pressure pipe, Algeria—Cost of making and laying reinforced concrete pipe cast in sections—Reinforced concrete pipe and conduits built in place—Belle Fourch project siphons—Clay Creek siphon, American Beet Sugar Co., Colorado—Reinforced concrete siphons on irrigation system of Aragon and Catalogne, Spain—Piers and supports for reinforced concrete continuous pipe.

ECONOMIC PIPE-LINE LOCATION AND DESIGN 338

SPECIAL CONSIDERATION OF INVERTED SIPHONS AND AUXILIARY WORKS 340

General description and design—Siphon inlet structure—Sand box and wasteway—Siphon outlet structure—Pipe line—Examples of inlet and outlet structures—Inlet and outlet structures of Wolf Creek lateral siphon, American Beet Sugar Co., Colorado—Inlet to 48-inch concrete pipe chute on Boise project, Idaho—Inlet to Anderson siphon of Belle Fourche project, South Dakota—Inlet structure of a 4-foot wood stave siphon, Kamloops Fruitlands Irrigation and Power Co., British Columbia—Blow-offs and mud valves—Air valves and air stands—Anchorages and expansion joints—References for Chapter X.

INDEX 355

LIST OF PLATES

	FACING PAGE
PLATE I	2
Fig. A.—Diversion dam and headworks for Modesto and Turlock Irrigation Systems, Calif.	
Fig. B.—Storage and diversion dam and inlet to diversion tunnel. Twin Falls, Salmon River Project, Idaho.	
Fig. C.—Low diversion weir and headworks for main feed canal. Umatilla Project, Ore.	
Fig. D.—Diversion weir and headworks of Sunnyside Project on Yakima River, Wash.	
PLATE II	2
Fig. A.—Retaining wall canal section with wasteway, near headworks. Twin Falls, North Side Irrig. Co., Idaho.	
Fig. B.—Steel flume leading to tunnel entrance. Grand Valley Irrigation District, Rifle, Colo.	
Fig. C.—Tunnel outlet. Twin Falls, Salmon River Irrigation Project, Idaho.	
Fig. D.—48-inch continuous wood stave pipe, Walla Walla, Wash.	
PLATE III	4
Fig. A.—Newly constructed lateral. Twin Falls, Salmon River Irrigation Project, Idaho.	
Fig. B.—Concrete-lined canal near Riverside, Calif.	
Fig. C.—Concrete-lined canal on steep sidehill. South Kelowna Irrigation System, B. C.	
Fig. D.—Reinforced concrete distribution pipe line. Tieton Project, Wash.	
PLATE IV	4
Fig. A.—Reinforced concrete drop. Truckee Carson Project, Nev.	
Fig. B.—Check gate structure. Canadian Pacific Railway Irrigation System, Alberta, Can.	
Fig. C.—Excavation of main drain. Modesto Irrigation District, Calif.	
Fig. D.—Construction of tile drain for reclamation of alkali water-logged land, Utah.	
PLATE V	26
Fig. A.—Concrete-lined diversion canal on steep rocky hillside. South Kelowna System, B. C.	
Fig. B.—Diversion canal on steep sidehill. Belgo-Canadian Fruitlands System, B. C.	
PLATE VI	118
Fig. A.—Diversion canal in deep rock cut. Truckee Carson Project, Nev.	
Fig. B.—Main lateral, recently completed.	

Fig. C.—Warped wing transition, at connection of reinforced concrete flume with concrete-lined canal. Naches Power Canal, Wash.	
Fig. D.—Outlet transition at connection of semicircular concrete-lined canal with earth canal. Umatilla Project, Ore.	
PLATE VII	140
Fig. A.—Concrete-lined canal of Kelowna Irrigation Co., Kelowna, B. C.	
Fig. B.—Concrete-lined canal of Kamloops Fruitlands Irrigation & Power Co., Kamloops, B. C.	
Fig. C.—Concrete-lined canal. Ridenbaugh Canal, Idaho.	
Fig. D.—Curves on Ridenbaugh Canal, Idaho.	
PLATE VIII	156
Fig. A.—Forms in place, to shape canal for concrete lining. Kamloops Fruitlands Irrigation & Power Co., B. C.	
Fig. B.—Finished earth canal, ready for concrete lining. Kamloops Fruitlands Irrigation & Power Co., B. C.	
Fig. C.—Concrete form in place. Kamloops Fruitlands Irrigation & Power Co., B. C.	
Fig. D.—Completed concrete-lined canal. Kamloops Fruitlands Irrigation & Power Co., B. C.	
PLATE IX	160
Fig. A.—Building forms for concrete lining. Truckee Carson Project, Nev.	
Fig. B.—Partly completed concrete-lined canal. Truckee Carson Project, Nev.	
Fig. C.—Preparation of earth canal for concrete lining. Ridenbaugh Canal, Idaho.	
Fig. D.—Placing concrete lining. Ridenbaugh Canal, Idaho.	
PLATE X	160
Fig. A.—Placing concrete lining. Naches Power Canal, Wash.	
Fig. B.—Completed concrete lining. Naches Power Canal, Wash.	
Fig. C.—Completed lining before filling contraction joints. Naches Power Canal, Wash.	
Fig. D.—Concrete-lined canal. Yolo Water and Power Co., Irrigation System, Calif.	
PLATE XI	168
Fig. A.—Sloping retaining wall concrete lining. Turlock Irrigation System, Calif.	
Fig. B.—Constructing semicircular concrete lining. Umatilla Project, Ore.	
Fig. C.—Tieton diversion canal, formed with reinforced concrete shapes. Tieton Project, Wash.	
Fig. D.—Reinforced concrete shapes at manufacturing yard. Tieton Project, Wash.	
PLATE XII	170
Fig. A.—Interior view of reinforced concrete shapes in place, before filling joints. Tieton Project, Wash.	

- Fig. B.—Adjusting metal moulds. Tieton Project, Wash.
 Fig. C.—Hauling shapes on tramway. Tieton Project, Wash.
 Fig. D.—Setting shapes in place. Tieton Project, Wash.
- PLATE XIII 174
- Fig. A.—Entrance portal of diversion tunnel of Twin Falls, Salmon River Project, Idaho. (See also Plate I, Fig. B.)
 Fig. B.—Interior of Strawberry Valley Tunnel, in timbered section; steel ribs in place for supporting concrete forms; tramway and trolley; ventilation pipe. Strawberry Valley Project, Utah.
 Fig. C.—Outlet portal, Strawberry Tunnel. Strawberry Valley Project, Utah.
 Fig. D.—Inlet portal to tunnel on Truckee Carson Project, Nev.
- PLATE XIV 180
- Fig. A.—Hauling by cableway reinforced concrete cast circular shapes for tunnel lining. Tieton Project, Wash.
 Fig. B.—Tunnel outlet and transition to connect with semicircular concrete-lined canal. Tieton Project, Wash.
 Fig. C.—Concrete retaining wall canal section in process of construction. Turlock System, Calif.
 Fig. D.—Concrete retaining wall canal section. Turlock System, Calif.
- PLATE XV 192
- Fig. A.—Forms in place for construction of reinforced concrete bench flume. Kamloops Fruitlands Irrigation & Power Co., B. C.
 Fig. B.—Completed reinforced concrete bench flume. Kamloops Fruitlands Irrigation & Power Co., B. C.
 Fig. C.—Reinforced concrete bench flume. Yakima Valley Canal Co., Wash.
 Fig. D.—Forms and reinforcement for reinforced concrete flume of Yakima Valley Canal Co., Wash.
- PLATE XVI 198
- Fig. A.—Small wooden flume on rocky bluff. Penticton System, B. C.
 Fig. B.—Large wooden flume on trestle. Turlock System, Calif.
 Fig. C.—Hess steel flume—7 feet diameter. Mountain Home Coöperative Irrigation Co., Idaho.
 Fig. D.—Lennon steel flume—9 feet diameter. Trinchera Irrigation District, Blanca, Colo.
- PLATE XVII 216
- Fig. A.—Hess steel flume, 15 feet 6 inches diameter, on steel trestle. Twin Falls, North Side Irrigation Project, Idaho.
 Fig. B.—Hess steel flume, 10 feet 10 inches diameter. Belle Fourche Project, S. D.
 Fig. C.—Lennon steel flume, 6 feet 4 inches diameter, on 3 to 120-foot span steel bridge across Laptata River at Farmington, N. Mex., for Farmer's Mutual Ditch Co.
 Fig. D.—Lennon steel flume, 9 feet diameter on 110-foot span steel

bridge over Las Animas River, Cedar Hill, N. Mex., for Aztec Irrigation Co.

PLATE XVIII 226

Fig. A.—Reinforced concrete flume. Naches Power Canal, Wash.

Fig. B.—Reinforced concrete flume. Naches Power Canal, Wash.

Fig. C.—Reinforced concrete flume. Naches Power Co., Wash.

Fig. D.—Reinforced concrete flume. Faleva Flume, Spain.

PLATE XIX 228

Fig. A.—Reinforced concrete flume at Spring Canyon Draw. Interstate Canal, North Platte Project, Wyo., Neb.

Fig. B.—Reinforced concrete flume at Spring Canyon Draw. Interstate canal, North Platte Project, Wyo., Neb.

PLATE XX 230

Fig. A.—Warped wing inlet. Twin Falls, Salmon River Land & Water Co., Idaho.

Fig. B.—Sheet metal inlet for Hess steel flume.

Fig. C.—Outlet to steel flume. Snake River Irrigation Co., Mountain Home, Idaho.

Fig. D.—Inlet to wooden flume. Orchard Mesa Power Canal, Palisade, Colo.

PLATE XXI 240

Fig. A.—Steel pipe. Kelowna Irrigation Co., B. C.

Fig. B.—36-inch wooden stave continuous pipe.

Fig. C.—66-inch continuous fir stave siphon for Wyoming Land & Irrigation Co. (Pacific Tank & Pipe Co.)

Fig. D.—72-inch continuous fir stave pipe, 120-foot head, for King's Hill Irrigation & Power Co., Boise, Idaho. (Pacific Tank & Pipe Co.)

PLATE XXII 246

Fig. A.—Details of lock-bar steel pipe.

Fig. B.—Types of joints for steel pipes. (American Spiral Pipe Works.)

PLATE XXIII 274

Fig. A.—36-inch continuous wooden stave pipe. Eastern Washington (Washington Pipe & Foundry Co.)

Fig. B.—24-inch machine banded wooden stave pipe. Eastern Washington (Washington Pipe & Foundry Co.)

Fig. C.—Types of joints for wire wound machine banded wood stave pipes.

Fig. D.—Three types of shoes for wooden stave pipe. Marion Malleable Iron Works, Marion, Ind.

PLATE XXIV 290

Fig. A.—48-inch wooden stave pipe along steep bluff. Walla Walla, Wash. (Pacific Tank & Pipe Co.)

Fig. B.—48-inch wooden stave pipe (same as Fig. A) showing difficult construction of a curve on a steep bluff.

Fig. C.—Constructing a 45½-inch continuous wood stave pipe Whittier, Cal. (Pacific Tank & Pipe Co.)

- Fig. D.—Construction of wooden stave pipe on cradles.
- PLATE XXV 292
- Fig. A.—48-inch continuous fir stave pipe, 180-foot head, Southern Alaska. (Pacific Tank & Pipe Co.)
- Fig. B.—Anchor well used at angles on 60-inch pipe line of Denver Union Water Co., Colo. (Eng. Rec., Jan. 18, 1913.)
- Fig. C.—48-inch X 30-inch steel connection with wood stave pipe. Dayton, Wash. (Pacific Tank & Pipe Co.)
- Fig. D.—Anchor on 42-inch pipe line. Tacoma, Wash. (Washington Pipe & Foundry Co.)
- PLATE XXVI 294
- Fig. A.—24-inch machine banded wooden stave pipe on trestle. Southern Oregon. (Washington Pipe & Foundry Co.)
- Fig. B.—60-inch continuous wooden stave pipe on bridge over Bear River, Oneida Irrigation District, Idaho. 300-foot head, $\frac{3}{4}$ -inch bands, $\frac{5}{8}$ -inch center to center. (Pacific Tank & Pipe Co.)
- Fig. C.—Pipe yard. Kamloops Fruitlands Irrigation & Power Co., B. C.
- Fig. D.—Moulds for making hand-tamped cement pipe showing inside core in place.
- PLATE XXVII 304
- Fig. A.—Tamping mixture in moulds to make cement pipe.
- Fig. B.—Moulds for casting 47-in. reinforced concrete pipe. Umatilla Project, Ore.
- Fig. C.—Reel for making wire spiral reinforcement. Umatilla Project, Ore.
- Fig. D.—Moulds for casting 30-inch reinforced concrete pipe. Umatilla Project, Ore.
- PLATE XXVIII 314
- Fig. A.—Placing mixture in moulds, for 30-inch reinforced concrete pipe. Umatilla Project, Ore.
- Fig. B.—Moulds for making small size reinforced concrete pipe. Tieton Project, Wash.
- Fig. C.—Placing reinforcement cage, surrounded with tarred paper cylinder, in moulds. Tieton Project, Wash.
- Fig. D.—Laying and joining reinforced concrete pipe. Tieton Project, Wash.
- PLATE XXIX 318
- Fig. A.—Laying and joining 30-inch reinforced concrete pipe. Umatilla Project, Ore.
- Fig. B.—Cast collars on 30-inch reinforced concrete pipe. Umatilla Project, Ore.
- Fig. C.—Reinforced concrete pipe and lock joints made by Reinforced Concrete Pipe Co. of Los Angeles, Calif.
- Fig. D.—Method of making lock joint. Reinforced Concrete Pipe Co., Los Angeles, Calif.

	FACING PAGE
PLATE XXX	332
Fig. A.—Clay Creek Siphon during construction. American Sugar Beet Co., Colo.	
Fig. B.—Clay Creek Siphon, completed.	
Fig. C.—Sosa Siphon, nearly completed. Spain.	
Fig. D.—Cradles of lean concrete to support reinforced concrete pipes of Sosa Siphon. Spain.	
PLATE XXXI	334
Fig. A.—Placing steel tubes surrounded with outside reinforcement, in cradles. Sosa Siphon, Spain.	
Fig. B.—Steel tubes in position on Sosa River Bridge. Spain.	
Fig. C.—Construction of concrete shell around steel tubes on bridge. Sosa Siphon, Spain.	
Fig. D.—Steel reinforcement in place for Albelda Siphon, Spain.	

CONVEYANCE OF WATER—DESIGN OF CANALS, FLUMES, PIPES, ETC.

CHAPTER I

GENERAL FEATURES AND PRELIMINARY INVESTIGATIONS TO DETERMINE THE GENERAL FEASIBILITY OF AN IRRIGATION PROJECT

GENERAL FEATURES OF AN IRRIGATION SYSTEM

Irrigation systems may be classified as gravity systems and pumping systems. A gravity system derives its water supply by direct diversion from a stream and conveys the water in a system of canals or channels down to the land to be irrigated. A pumping system obtains its supply by pumping from a stream or other surface body of water or from underground sources and ranges from the small individual system to one supplying several thousand acres. Small individual plants are used extensively for the development of ground water supply by wells, especially in California, Arizona, and New Mexico. Large pumping projects have during the past 10 years been constructed in California, Washington, Idaho and Utah, which elevate the water from streams, in some cases from lower canals, to the upper point of large bodies of irrigable land, from which it is conveyed in a distribution system. Where the total lift is relatively high the area is divided into zones of economic lifts, by canals located on flat grades along the upper boundary of each zone of land. The pumping installation may consist of a large central station, with an independent pump unit for each canal, or may consist of a series of separate pump stations, one for each lift, with which water is pumped in stages from one canal to the next higher canal. The distribution system for these classes of pumping systems will be similar to that of a gravity system with the additional requirement that it must be designed to give minimum total cost of operation and maintenance for the entire system, including the distribution system and pump installations. This will involve the determination of the most economic number

of lifts and of the economic grades for the main canals commanding the different zones of land. The economic grades will usually be comparatively flat and the canal can often be economically lined with concrete to prevent seepage losses. The design of pumping plants is not included in the scope of this book.

The great majority of irrigation systems are gravity systems. The stream diversion usually requires that the stream flow be checked and the water level raised to force the desired flow through the headgates into the head of a canal (Plate I). This is obtained in most cases by the construction of an overflow dam, called diversion weir, across the stream. In a few cases where the natural stream flow is supplemented by storage, it has been feasible to make the diversion at the site of the storage dam (Plate I, Fig. B).

The grade of the diversion canal must be less than that of the stream to divert the canal line away from the river and to obtain the necessary gain in difference of elevation between the canal bed and stream bed to reach the higher point of the land to be irrigated. This portion of the canal is called the diversion line.

The character of construction and cost of the diversion line is determined by the topography. If the diversion site is high up on the river, where its channel is through rough hilly country or in deep canyons, the construction will be correspondingly difficult and expensive. Hillsides which are too steep for open canal excavation will require fluming supported on benches cut in the hillsides or a concrete rectangular section made with a retaining wall on the downhill side (Plate II, Fig. A.) Depressions must be crossed with flumes or siphons (Plate II, Figs. B and D). Ridges may have to be tunnelled through (Plate II, Fig. C). These difficulties of construction may make the cost of a long diversion line a considerable part of the total cost of the project.

When the diversion weir can be constructed lower down on the stream, where it emerges into the valley, the diversion line is shorter and difficult construction is largely eliminated, thus materially reducing the cost.

From the highest point of the irrigable area the main canal is continued on a prominent ridge or along the higher boundary of the land to be irrigated. The main laterals head at this main canal and run along commanding situations, usually down the ridges formed by the irregularities of the topography, to supply the distributaries which deliver the water to each farm unit.



A.—Diversion dam and headworks for Modesto and Turlock Irrigation Systems, Calif. Diversion dam is about 130 feet high.

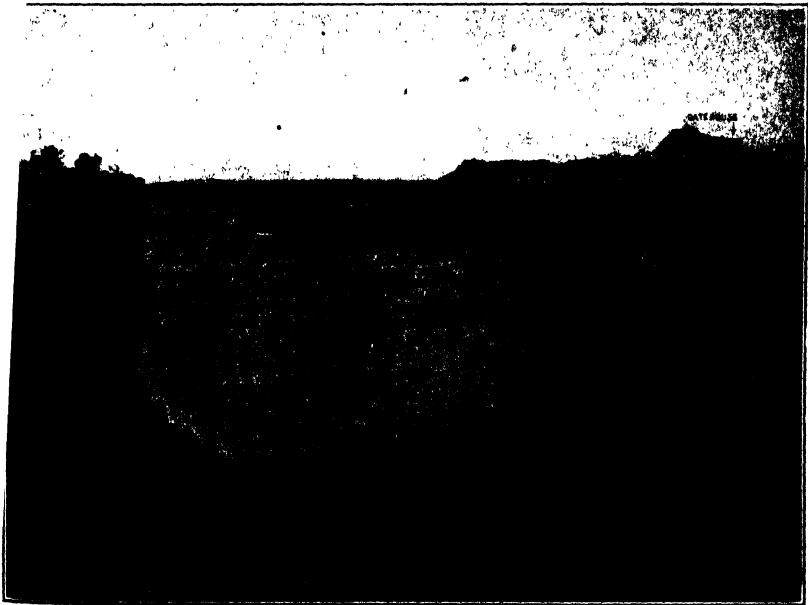

Fig. B.—Storage and diversion dam and inlet to diversion tunnel. Twin Falls, Salmon River Project, Idaho. Dam is about 220 feet high, 560 feet length on top.

(Facing page 2)

PLATE I

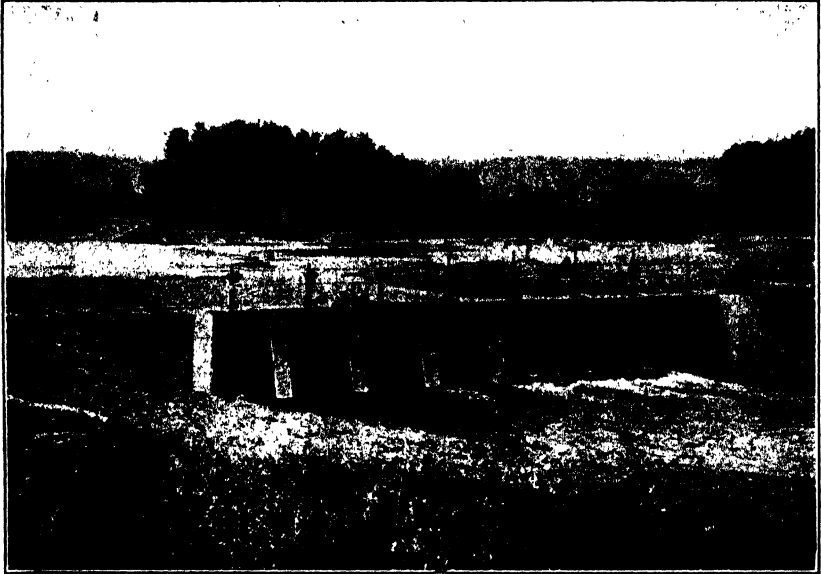

FIG. C.—Low diversion weir and headworks for main feed canal, Umatilla Project, Ore.



FIG. D.—Diversion weir and headworks of Sunnyside Project on Yakima River, Wash.



FIG. A.—Retaining wall canal section with wasteway near headworks. Twin Falls, North Side Irrig. Co., Idaho.

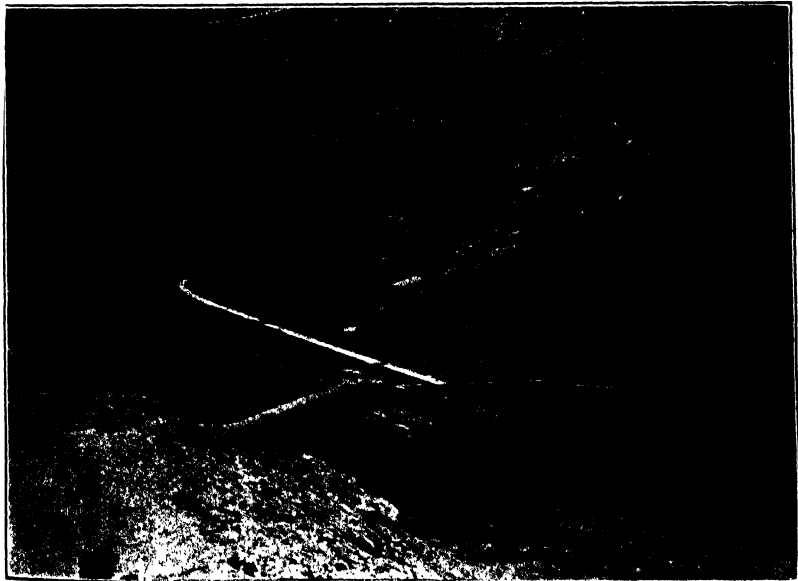

FIG. B.—Steel flume leading to tunnel entrance. Grand Valley Irrigation District, Rifle, Colo.

(Following plate I)

PLATE II



FIG. C.—Tunnel outlet. Twin Falls, Salmon River Irrigation Project, Idaho.



FIG. D.—48-inch continuous wood stave pipe, Walla Walla, Wash.

The system has main arteries and branches similar to a stream and its tributaries, but differs in that the canals and ditches of an irrigation system must be located along the ridges and higher land and maintained in that position against the natural tendency of the water to find its way to the lowest positions or natural water courses.

Drainage channels are generally required to receive all waste or surplus water from the main canals and laterals and to collect and remove the surface and underground drainage water produced by seepage and deep percolation losses. This is necessary in most cases to prevent the damage to considerable land by water-logging and by the accumulation of alkali on the surface. These drains may be either well-defined natural channels, or water courses, or series of depressions, or artificial channels excavated to supplement or improve natural drainage.

ELEMENTS AND PARTS OF A GRAVITY IRRIGATION PROJECT

It is thus seen that the elements of an irrigation project may be classified into six main groups, with their corresponding parts as follows:

1. The land and the crops.
2. The source of water supply and in some cases the storage works or other works for its development.
3. The diversion works including:
 - (a) The diversion weir with scouring sluices, fish ladder, logway.
 - (b) Canal headgates or regulator to control the flow diverted into the head of the diversion canal.
4. The diversion canal, including the following structures and forms of construction.
 - (a) Spillways, wasteways or escapes to dispose of excess flow in the canal and to protect the canal.
 - (b) Sandgates or sluices to prevent the accumulation of or to remove sand or silt in the canal.
 - (c) Tunnels, retaining wall canal sections, bench flumes for the conveyance of water in difficult country.
 - (d) Elevated flumes, inverted siphons, for the crossings of wide depressions or natural drainage channels.
 - (e) Culverts, overchutes, level inlet crossings, etc., for the crossing of water courses.
 - (f) Falls, rapids, or chutes to regulate canal grades and velocities.
 - (g) Highway and railroad crossings such as bridges and culverts.
5. The distribution system consisting of:
 - (a) Main canals, laterals and distributaries

- (b) Checkgates across the canals, laterals, and distributaries, located at certain points of division or delivery where it is necessary to raise and control the water level, to force the required flow through the gate structures at the heads of the laterals and distributaries and at points of delivery.
 - (c) Headgates at the heads of laterals and distributaries, and delivery boxes.
 - (d) Structures enumerated above, as used on the diversion canal; of these flumes, culverts, falls, rapids, chutes and especially highway crossings are most numerous.
 - (e) Measuring boxes or devices at points of delivery to water users or farm units.
6. The drainage system consisting of:
- (a) Natural drainage channels and water courses.
 - (b) Artificial drains.

CHARACTER OF IRRIGATION SYSTEMS

The character of irrigation systems varies considerably with the topography along the diversion line, the configuration of the irrigable land, the available water supply and its value.

Where the irrigable area is a large body of land, in a broad flat valley, the water supply ample, the diversion canal short and along regular side hills or foothills, then the system will consist of earth canals with comparatively few unusual structures. These will consist largely of checkgates, lateral headgates, delivery gates, and of bridges and culverts at roadway crossings.

Where the irrigable area is rolling and a long diversion canal along rough rocky side hills is necessary, the difficulties encountered along the diversion canal may require the extensive use of practically all of the structures enumerated above and a more complicated system of distribution will usually be necessary.

Where water is valuable and in some cases where the irrigable area is steep or rolling, concrete-lined canals and pipe distribution systems have been used to advantage. Systems of this type are usually small and comparatively few; until recently they were located almost exclusively in Southern California serving high-priced citrus lands, but during the past 10 years a number of systems have been constructed in Oregon, Washington, Colorado, Idaho and British Columbia.

The cost of construction will correspondingly vary greatly. Where the diversion line is short, the irrigable area large, with regular and smooth slopes, and sufficient grade to give suitable velocities in the canals, the cost of construction of a complete system, with distributaries delivering water to each farm unit,



FIG. A.—Newly constructed lateral. Twin Falls, Salmon River Irrigation Project, Idaho.

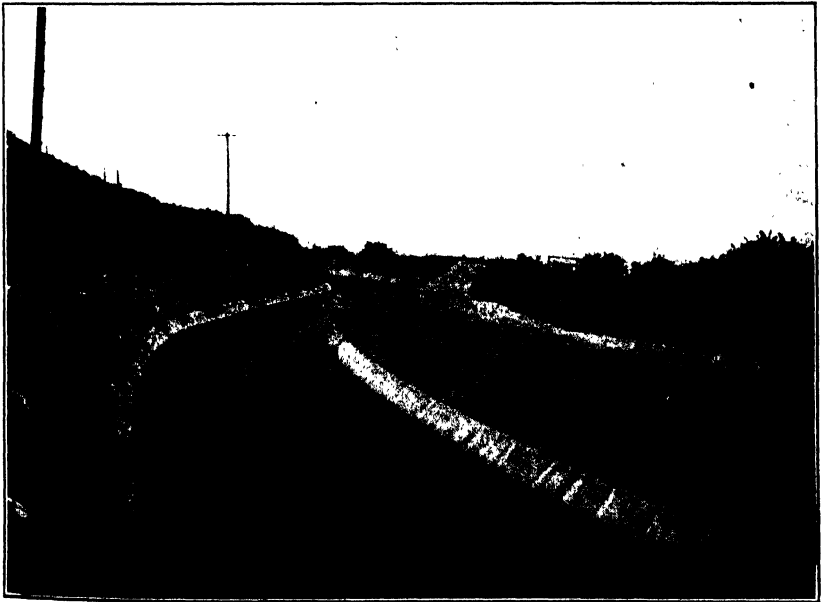

FIG. B.—Concrete-lined canal near Riverside, Calif.

(Facing page 4)

PLATE III



FIG. D.—Reinforced concrete distribution pipe line. Tieton Project, Wash.

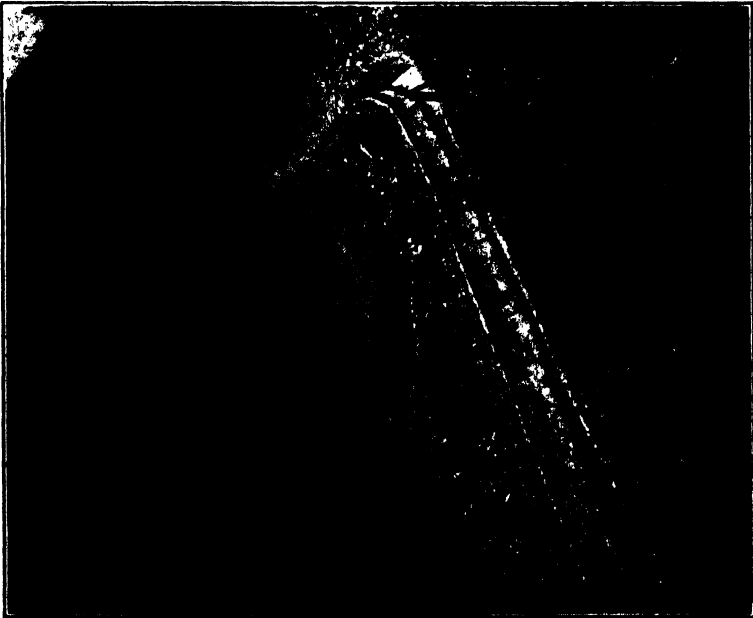

FIG. C.—Concrete-lined canal on steep sidehill. South Kelowna Irrigation System, B. C.

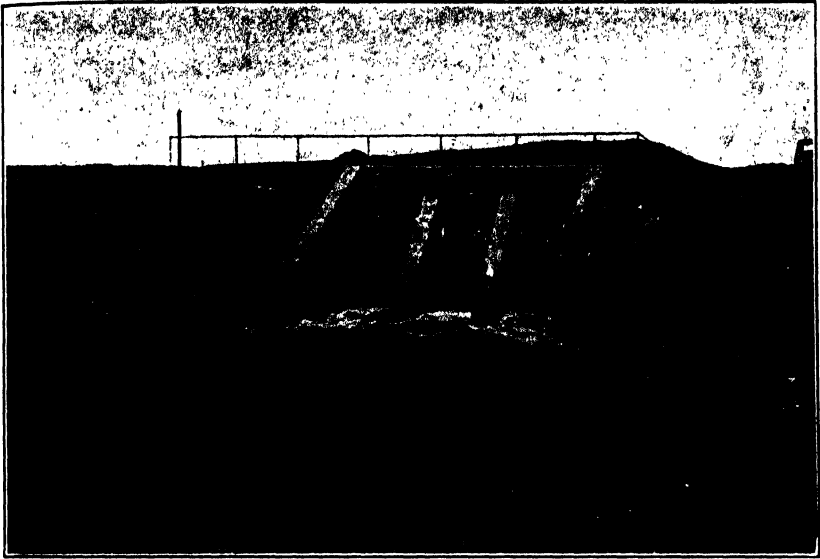

FIG. A.—Reinforced concrete drop. Truckee Carson Project, Nev.

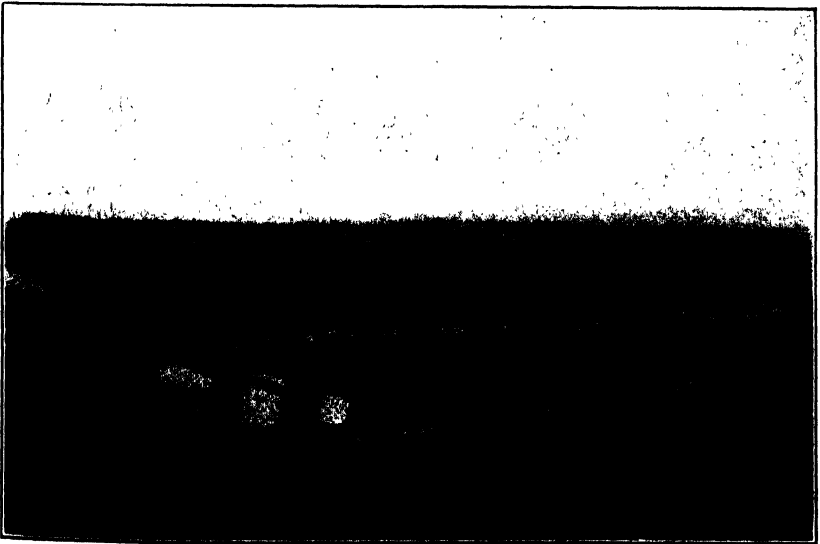

FIG. B.—Check gate structure. Canadian Pacific Railway Irrigation System, Alberta, Can.

(Following plate III)

PLATE IV

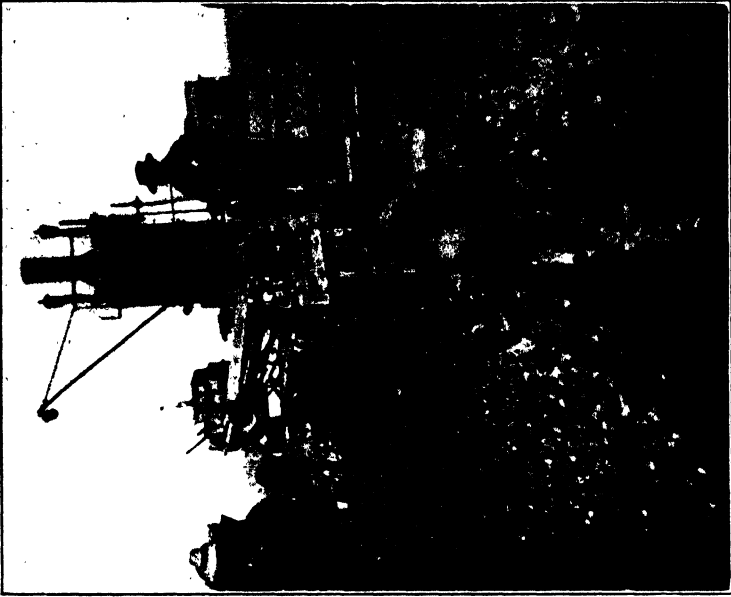

FIG. D.—Construction of tile drains for reclamation of alkali waterlogged land, Utah.

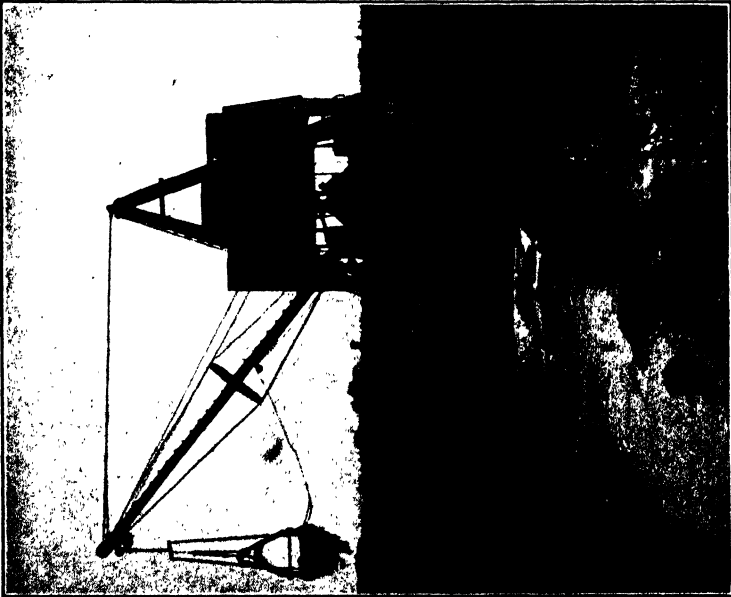

FIG. C.—Excavation of main drain. Modesto Irrigation District, Calif.

will range between \$15 to \$25 per acre. Where the irrigable area is more or less rolling but with well-defined continuous ridges, and the diversion line fairly long (not over 10 to 15 miles) with no great construction difficulties, the cost will range from \$25 to \$40 per acre. Where the diversion line is long and along rough rocky hillsides with expensive diversion works, and the area to be irrigated is rolling with no regular slopes, requiring considerable fluming or pipe distribution lines, the cost of construction will usually range between \$40 to \$60, and in exceptional cases may be as high as \$80 to \$100. The lower price in each case is for favorable conditions and less permanent construction and where no storage must be developed. The costs given include all construction overhead charges, but not the development expenses or interest charges on the capital invested.

PRELIMINARY INVESTIGATIONS TO DETERMINE FEASIBILITY OF PROJECT

Before undertaking an irrigation project, the promoters must know its general feasibility, as determined by preliminary investigations. The cost of these investigations must usually be kept down to a minimum which often precludes the making of a detailed examination and surveys. The engineer can in some cases obtain the necessary information by consulting the reports, bulletins and maps of the different bureaus of the U. S. Department of Agriculture, the Water Supply papers of the U. S. Geological Survey, and other information compiled by the State Agriculture Colleges and private parties.

A general field examination is usually warranted and in some cases the importance of the project and lack of available information may justify extensive hydrographic and topographic surveys. Usually the investigations will include a study of the land, the crops, the ownership of the land and method of development, the water supply, the general physical features and the character of the irrigation system, the cost of the system per acre, and miscellaneous considerations of smaller importance. These factors are related and must therefore be considered together.

THE LAND AND CROPS

The determination of the extent of the area to be irrigated includes an estimate of the land area to be covered by the system

and of the proportion of the land to be actually irrigated to the total area under the system. The maximum irrigable area to be included is limited by the available water supply, and may be further decreased to meet the desired magnitude of the project. The engineer will in many cases be assisted by the topographic maps of the U. S. Geological Survey, or by state, county and private maps.

The configuration of the irrigable land will affect not only the cost of construction of the distribution system but that of the preparation of the land for irrigation. Rough land with steep slopes increases the cost and may limit the method of irrigation to be used. A flat slope may require small velocities in the canals, with correspondingly large cross sections; it also makes it difficult to install measuring devices and to deliver water to the farms at sufficient elevation. The best land is that which is smooth, comparatively free from irregularities or depressions, and with a fairly good slope. A general slope of 10 to 25 feet per mile will permit the use of all methods of irrigation.

The character of the soil and subsoil includes a study of the chemical composition and physical texture. The soil must contain the necessary chemical plant food elements and humus formed from decayed organic matter. As a rule if the soil is deep, the available plant food is present in sufficient quantity with the exception of humus, which is often lacking; this can be corrected by growing suitable crops. The soil and subsoil should be free from an excess of alkali salts. The practice of irrigation will usually aggravate the alkali conditions, especially at the depressions and low-lying lands. This results from the accumulation of alkali salts, leached out, from higher surrounding lands, by the seepage water from canals and by the excess water applied on these high lands.

As regards the texture, the best soil is one which is deep, retentive of moisture and underlaid with an open subsoil. The presence of an impervious stratum or hardpan closer than 3 to 4 feet to the surface is usually detrimental, at least for deep-rooted crops. A shallow soil underlaid with open gravel may be lacking in plant food, will require frequent irrigations, and is favorable to a large loss of water by deep percolation. The behavior of the soil when irrigated is important. A clay soil or tight textured soil will absorb water slowly, is more difficult to irrigate and cultivate and is liable to bake after each irriga-

tion. As a rule a sandy loam irrigates well and is easy to cultivate.

The character of the soil and subsoil may be indicated by the native vegetation. Sagebrush, cactus, and buffalo grass usually indicate a soil easily cultivated, well drained, deep, free from alkali, fertile in chemical plant food but sometimes deficient in humus. Greasewood, salt grass and other alkali weeds indicate that alkali salts may be present in excessive quantities. A soil survey is usually desirable. A great part of the arid lands in the United States has been examined by the Bureau of Soils of the U. S. Department of Agriculture, and the results presented in reports and survey maps obtainable from this bureau. The chemical composition is determined from the analysis of samples, taken at various points in the typical soils, by means of soil augers. These samples are usually taken to represent the average upper 4 feet of the soil. The important elements of plant food are potash, phosphoric acid, nitrogen, lime and humus. The physical texture of the soil and subsoil is best determined by borings taken to a depth of 10 feet.

The drainage of the lands is very important, but the experience on many projects indicates that it is practically impossible to predict the adequacy of the natural drainage. For instance, the soil of the bottom lands may be quite porous, underlaid with gravel with the water-table far below the surface; but with the extension of irrigation drainage conditions often become very inadequate. The soil of the higher lands is usually porous, absorbs water readily with a loss by deep percolation, which cannot be entirely avoided. This loss combined with the seepage loss from canals causes a rise of the water-table, and unless natural drainage conditions are unusually favorable, gradual waterlogging and accumulation of alkali frequently occur on considerable areas of land. While the higher lands are usually free from injury, there are many instances where layers of hardpan interfere with the downward percolation of water and cause the water-table to rise too near the surface. There are few irrigation systems where natural drainage must not be supplemented by artificial drainage and the construction of an irrigation system may ultimately require a complete drainage system.

The character of the crops depends on the soil, elevation and all climatic conditions. Valuable information can usually be obtained from observations of crops grown in surrounding

regions under similar conditions. The conditions favorable for large alfalfa crops are a long growing season. For fruit growing the season must be sufficiently long to mature the fruits and there must be no great or sudden fluctuations between high and low temperatures in the winter and spring. At very high elevations the growing season may be too short. Early severe frosts in the fall and sudden increases in temperature in the spring, followed by severe late spring frost, is often detrimental to fruit growing.

The demand for crops may be local, but for an extensive area there must usually be a general demand. The possibilities for development of various industries, such as creameries, sugar factories, mills, fruit packing houses and canneries must be investigated. Alfalfa comprises the largest acreage on most projects. On account of the quick yields obtained with alfalfa, it is the main crop, especially during the period of early development. But unless the farm stock and especially dairy stock in the district is sufficient to use all the alfalfa raised, overproduction with no market is very liable to occur.

The cost of producing crops comprises:

1. Interest chargeable to the cost of the land, including the cost of the farm distribution system, preparation of the land, all improvements and development expenses.
2. Yearly cost of irrigation water delivered to the farm.
3. Seeds and labor cost of applying water, of cultivation, planting, harvesting, etc.
4. Depreciation of improvements and equipment.
5. Taxes and insurance.

The cost of marketing crops will depend on the distance from markets, on the means of communication, either by railroads or navigation, and on the character of product to be marketed. For instance, alfalfa is generally used for dairy purposes and for feeding live stock in general; sugar beets are used in the manufacture of sugar, etc.

The value of the crops will determine largely the feasibility of the project. The cost of the project, although prohibitive for cereals and alfalfa, may be considered feasible for orchards or high-priced products.

The ownership of the land and method of development will largely determine the success of the project. The land may be government public lands, or private lands belonging either to the

builders of the project or to private owners. Projects built by private companies to serve public lands, not under their control, have almost invariably resulted disastrously to at least the original financiers. The land has been largely taken up by speculators who held their claims, without using the water or purchasing a water right, waiting until they could dispose of their holdings to a real settler at a high profit, thus deriving all the benefits of the system. This results in slow development, the company receiving little revenue, while the interest on the capital invested and the depreciation of the system means ruin to the investors in the project. More favorable results, but still not financially successful to the company in most cases, have been obtained where the projects serving public lands have been constructed under the settlement restrictions and provisions of the Carey Act, by which companies enter into a contract with the state for the construction and settlement of the project. The construction of projects by private companies to serve land owned by private individuals has not resulted more favorably, and cannot hope to be successful unless the project is undertaken where the climatic conditions make the growing of crops without irrigation impossible, and only if the property owners will agree by contracts to purchase a water right or interest in the company with a minimum annual payment sufficient to cover the cost of operation and maintenance.

The construction of projects by irrigation districts or associations of property owners, by which the cost of construction, operation and maintenance of the system is met by assessments, has been more successful when the conditions are favorable and with proper state supervision and legal restrictions, included in irrigation district laws of some states, which insure the stability of the project and security of the bonds.

The most favorable condition for the construction of an irrigation system by a private company is ownership by the company of the irrigable land under the project, for the profits come from the increased value of the land and not from the annual sale of water.

The method of colonization or settlement and the financial policy during the period of development is of greatest importance. Except in very few cases, irrigation projects in general have resulted disastrously to the original investors or bond holders of the company. To the community as a whole and to the settlers the

construction of most sound irrigation systems has resulted in general good and prosperity. The failures to the financiers of systems, properly constructed with a good water supply and favorable agricultural conditions, have been caused mainly by the long period of development, due to slow settlement. The resulting great development expense is usually larger than has been estimated or provided for in the financial policy. The long period of development even under favorable conditions is illustrated by some of the most successful projects. Only in unusual cases and for comparatively small projects under 50,000 acres will the irrigable land be fully settled and developed in the 10 years following the completion of the system or the time when the water is first turned in the system. Probably the most successful large project in the United States is the Twin Falls South Side Irrigation project, built in Idaho under the provisions of the Carey Act by the Twin Falls Land & Water Co. Construction was started in 1903 and in the spring of 1905 water was turned in the completed part of the system, the system being finally completed in 1907. In 1913 the acreage settled upon, fully planted, was 150,000 acres out of a total of 215,000 acres included in the project. This rapid development must be considered exceptional. The experience on similar Carey Act projects and other projects has been far less satisfactory. The development of the Modesto and Turlock irrigation districts in California represents what may be expected under favorable conditions. These districts, which have a joint source of supply, were organized in 1887, but on account of complications and litigations water was first run for irrigation in 1901 for the Turlock district and in 1903 for the Modesto district. Since then the area irrigated has increased every year. On the Turlock district the area irrigated in 1914 was 94,000 acres out of 175,500 acres included in the district. On the Modesto district the area irrigated in 1912 was about 40,000 acres out of 81,000 acres in the district. These districts included comparatively large holdings on which cereals were grown by dry farming, the average annual rainfall being 12 inches; these conditions and the comparative lack of advertising and efforts to subdivide and colonize have no doubt been unfavorable to rapid development; on the other hand, the land was already privately owned and therefore partly settled and the assessments for annual operation and maintenance are made on the land not irrigated as well as on the

irrigated land; these conditions have been favorable to rapid development.

The long period of development has had to be recognized in the adjudication and creation of water rights by appropriation. Mr. S. C. Weil, in his treatise on "Water Rights in the Western States," says: "But in most states actual use had been added as itself an element in the creation of the right, as well as the bona fide intention; that is, the intention must be actually consummated by use within a reasonable time before an appropriation has any existence as such." In all states due diligence is required in the prosecution of the work. In Idaho, North Dakota, Oklahoma, South Dakota, and Wyoming the work must be completed within 5 years, but a shorter time may be fixed by the State Engineer. In Utah the time allowed by law to apply the water to a beneficial use was limited to a period not exceeding 4 years from the time of completion of the system, but by amendments in 1909 and 1911 the State Engineer has the power to extend the time for completion of construction and proof of beneficial use to not exceed 14 years from the date of approval; except that additional extensions of time may be allowed for delays in construction caused by the operation of law beyond the power of the applicant. These amendments extending the period of development have in a measure been the result of the experience obtained on irrigation projects constructed and developed by the state.

WATER SUPPLY

A study of rainfall data, the extent of precipitation, its monthly distribution, and its relation to the needs of crops is important. This information is usually obtained from the Weather Bureau of the U. S. Department of Agriculture. A large mean annual rainfall is no indication that irrigation is not necessary or desirable. The value of irrigation in regions where the annual rainfall is large is well demonstrated by the extension of irrigation in the Rogue River Valley and the Willamette Valley of western Oregon and in parts of the Sacramento Valley where a few years ago it was thought that irrigation was not desirable. In the Willamette Valley the mean annual rainfall is about 44 inches, but the rainfall during the spring months of April, May and June is about 7.05 inches and during the summer months of July, August and September only 2.81 inches. Experiments

made in the Willamette Valley by the U. S. Department of Agriculture show that in general the intelligent application of water to crops such as potatoes, clover, alfalfa, corn, beans, onions, etc., will easily increase yields from 75 to 150 per cent. In the Rogue River Valley the total annual rainfall is about 26.57 inches, the rainfall during the spring months is 4.22 inches and during the summer months, 1.45 inches. In this valley the orchards that are producing the heaviest and yielding the largest profits are irrigated.

A careful study of the stream flow is most important. The best information is obtained from gaugings extending over a number of years, especially those including periods of drought. On a large part of the streams in the arid states this work has been done by the U. S. Geological Survey and the information may be obtained in the Water Supply Papers. In some states, the State Engineer has done considerable work on stream gaugings, the results of which are given in his annual reports. These are the two main sources of information. At times it is possible to obtain information from private sources. If no information is obtainable it is best to establish at once a gauging station and make observations and measurements for as long a period as possible. These records, even though they may be obtained only for one season, may be of considerable value if used carefully with rainfall data extending over a number of years. Stream flow data from similar adjacent watersheds is often available, in which case fairly reliable estimates may be obtained by comparison of areas and character of watersheds and their average precipitation. These comparisons are especially valuable when stream flow data for the water supply considered extend over a very brief period, when those of adjacent streams extend for a considerable period.

Where the water supply is largely obtained by storage development, it is desirable to have the same stream flow data as suggested above; but where the time available or any other cause does not permit the gauging of stream for any considerable period, a rough estimate of the total mean annual stream flow available for storage may be obtained by considering the area and character of the watershed, the precipitation and the rate of run-off. A study of the watershed as affecting run-off will include:

1. Area of watershed.
2. Character of surface—rough or smooth, steep or level.

3. Bare or wooded.

4. Elevation of watershed. An increase in elevation increases the precipitation and will retain the snow or ice later in the year, helping to maintain the summer flow.

5. Character of soil and subsoil with its geological formation.

6. Climatic conditions; temperature, wind, etc.

7. Probable changes in character of supply due to settlement and use of water in upper valleys.

A study of the precipitation will include:

1. Distribution of precipitation.

2. Character and extent of precipitation—whether in the form of rain or snow and whether sudden storms or gradual falls.

The U. S. Weather Bureau is the main source of information concerning precipitation. With the precipitation and the area of the watershed, the run-off is estimated by assuming a coefficient of run-off. This estimate is necessarily rough, but one may obtain a fairly close approximation by determining the coefficient of run-off from stream gaugings which it has been possible to obtain for a limited period, or from stream gaugings of similar adjacent watersheds. This method of estimating is more feasible for determinations of the mean annual stream flow than it is for determinations of the seasonal or monthly variations.

No irrigation project should be undertaken without reliable stream flow data.

The relation between supply and demand is different for an irrigation system than for a domestic water-supply system or for a hydroelectric project. Especially for a domestic water-supply system the supply available during the most severe periods of drought must always be sufficient to serve the full demand. With an irrigation system it would be an unwise policy in the development of the natural resources to limit the area to be served from a stream to that for which an ample supply is available during all years of deficient flow. To obtain full development, the area included in a project should be that for which there is an ample supply during normal years and not less than half of this supply during periods of dry years.

The quality of the water must be determined whenever there is indication that it may contain detrimental salts or excessive quantities of silt. A chemical analysis of the water, during the low water period when the water contains the highest percentage of salts, is especially desirable.

The volumes appropriated and used, and earlier water rights limit the available water supply and must be determined. This will include a study of the volumes of water recorded, appropriated and used; the volumes recorded or filed, but not used; and the riparian rights in those states which recognize them. In those states where modern water codes are operative and where riparian rights are not recognized, the methods of obtaining and defining rights are provided for; and accurate information can frequently be obtained from the State Engineer. In the states which have no modern codes and where riparian rights are recognized, it is difficult and often impossible to learn with any degree of certainty the extent of prior rights. An inspection of recorded rights is of little value, for without a field examination the value of the records cannot be determined. A field survey of volumes actually used and of probable future extensions is necessary. Not only the extent of the uses must be known, but also the character of the uses. There are: (1) uses which may not diminish the volume, such as power and some forms of mining; (2) the uses which diminish the volume, such as domestic and stock use and irrigation of areas having prior rights or riparian rights; (3) uses which increase the flow, such as return waters from areas irrigated above or water stored for power purposes; (4) uses which affect the quality of water, such as some forms of manufacturing and mining.

The location of proposed diversion with reference to other uses must be considered. This includes (1) the possibility of interfering with riparian or prior rights below, or the interference by increased use by riparian rights above; (2) the necessary regulation in case of stored water and the exchange of stored water where water is stored below point of diversion. The seasons of the diversions, whether continuous or intermittent, must also be considered.

The volumes unappropriated of available stream flow are obtained from the stream flow data and the rights of prior appropriators and riparian owners. A study of the relation of this flow to the water supply needed for the system is the next consideration.

The water supply required for the system involves the determination of the amount needed and the season of need. When the demand is greater than the available supply during part of

the irrigation season, but is less at other times, the deficiency may be supplied in three ways:

1. By storage in artificial reservoirs, which will require: (a) the examination and survey of reservoir sites; (b) a study of dam sites and foundations; (c) a study of the type of dam adapted to the foundation and materials available for its construction; (d) the effect of silt carried by the water; (e) feasibility of construction, etc.

2. By encouraging the growth of crops which will create a demand for irrigation water at the time when the supply is most plentiful.

3. By storing water in the soil by winter irrigation or by heavy irrigations applied during period of maximum flow. This requires a soil which will retain the moisture and have it available for the crops during the growing season. Orchards and deep-rooted crops are best adapted to this practice. This same process may be applied to the replenishing of underground waters where pumping is extensive, by spreading the flood waters over the porous fan-shaped deposits formed where the stream emerges from the hills into the valleys. In southern California this is done by means of flood ditches placed on a flat grade across the longitudinal slope of the valley.

The water supply needed must be obtained from a study of the crops to be grown and the duty of water. The net seasonal duty must be based on a study of the water requirements for maximum economical crop production. The gross duty is determined from estimates of the net duty and of the conveyance losses in the system. Information from projects in the same general region, with similar crops and water-supply condition, is the most valuable data. Chapters III and IV of Volume I present the results, obtained by investigations, experiments and measurements, on the quantity of irrigation water and the time of application to give the most economic use of water in the production of crops. Chapter V of Volume I presents the duty of water obtained on a large number of projects selected to represent typical irrigated districts.

The capacity of the different parts of the system must not be based entirely on the estimates of the monthly seasonal duties, but especially on the short periods of peak load or maximum use, as explained in the chapter on distribution systems in Volume III.

The water supply from underground sources is generally of considerable importance for domestic supply and may in some cases be desirable to supplement the surface water supply for irrigation. The forms of occurrence of ground water are usually: (1) in the surface zone above the first impervious stratum; (2) between two impervious strata, in which case it is often under pressure and in some cases artesian; (3) below the bed of streams or natural water courses, as an underflow, which may be partly the result of return waters from irrigation. The means of development are: (1) wells, either deep or shallow, with pumping plants; (2) artesian wells; (3) underground collecting galleries or submerged dams to divert the underflow. Wells with pumping plants are most commonly used; underground galleries and submerged dams seldom result in a developed flow sufficient to make the investment profitable. Existing wells are the best indicators of ground-water conditions. Explorations by borings may be desirable on large projects. Where underground water is not available for domestic purposes, it is usually necessary to use ditch water, which requires continuous flow or storage in tanks during the period that the ditches are empty.

GENERAL PHYSICAL FEATURES AND CHARACTER OF THE IRRIGATION SYSTEM

A general investigation of the controlling physical features of the project and of special conditions which will determine the character and cost of the system is necessary to make rough preliminary estimates of cost. These will include especially: (1) a study of the feasibility of storage, when storage is necessary; (2) an examination of the approximate location and character of the diversion works and diversion lines; (3) the approximate location of the main canal and laterals of the distribution system; (4) the area of rights-of-way, which may be an important item of cost; (5) the types of structures (concrete or wood), the classes of canal excavation, the possible need of concrete lining or other special construction, and the physical difficulties. The cost of storage, diversion weir, headworks and diversion canal will often be a large part of the total cost and should be estimated separately.

Cost of the System.—The cost of the system cannot be closely estimated without the final plans and designs of structures and canals, which must be preceded by extensive surveys.

However, for purposes of determining the general feasibility, a rough approximate estimate can be made, by one whose experience has brought him in contact with a number of projects, after a general examination of the controlling features as outlined above. Where a reasonably accurate preliminary estimate is required, preliminary trial survey lines or a hasty reconnaissance survey may be desirable. The necessity for this will be greater when no general topographic survey maps are obtainable and when the project presents unusual features or difficulties. To estimate the cost of the distribution system, it will be desirable to know the approximate location, length and size of the main canal, laterals and distributaries. A fair preliminary estimate of the total cost of the structures may be obtained by assuming a percentage ratio between the cost of the earthwork in canal construction and the cost of structures. This ratio will depend on the type of structures and on the general character of the system. A consideration of the cost of construction of ten projects and the valuation of two projects shows the following ratios:

For a distribution system in which the structures are largely built of concrete, the cost of all structures is 80 to 100 per cent. of the cost of excavation. For a distribution system in which the structures are nearly all built of wood, the cost of all structures is 40 to 60 per cent. of the cost of excavation. These figures may be applied for complete distribution systems with no unusual expensive construction on the main canal and with laterals and distributaries, largely excavated in balanced cut and fill.

Estimates of costs are frequently too low. The actual field cost of construction is only one item. The cost of right-of-way, where the land must be purchased, or the value of the land reserved, may represent a considerable investment. Other items for which due allowance is not always made are:

1. Field engineering and supervision—about 5 per cent. of construction cost, which should be included as part of the construction.

2. Equipment depreciation, waste of material, and lost time—about 4 per cent., which should be included as part of the construction cost.

3. Contingencies, omissions, risk and unusual disasters—about 10 to 20 per cent.

4. Preliminary surveys, designs, estimates and general engineering—about 6 to 8 per cent. of construction cost.

5. The expense of organization and promotion with the reimbursement of original promoters—about 10 per cent. of construction cost.

6. General administrative expense during construction—about 3 to 5 per cent. of construction cost.

7. Legal expenses, taxes, insurance, injuries and damages—about 5 per cent. of construction cost.

8. Discounting of bonds—about 10 to 15 per cent. of face value of bonds.

9. Interest charges on bonds during the construction period (2 to 5 years), equivalent to about 15 per cent. of the total face value of bonds sold for an average period of $2\frac{1}{2}$ years.

10. Development expenses or investment necessary to bring the constructed system through the period of development and settlement up to the time when fair revenues on the total investment can be obtained. The development expenses chargeable to the cost of the system are equal to the difference between the actual income obtained from the sale of water, and the expenditures for operation, maintenance, depreciation of the system plus the interest on outstanding bonds and other capital investment. Under favorable conditions the period of development may be taken at about 12 years. During this time the income will depend on the method of development. When the irrigation system is constructed by a company, not owning or controlling the irrigable land under the system but which proposes to retain ownership of the system, the desired income required to meet the cost of operation, maintenance, depreciation and pay interest on bonds and capital invested, must be obtained from annual water payments. If the company proposes to sell its system to the water users, it will usually require from each property owner an initial payment or series of payments, proportionate to the acreage, for shares or an interest in the system. The money thus received is used for the retirement of bonds and for the profits on the investment, and should result in a lower rate of the additional annual water payment for operation and maintenance than when the company proposes to retain the system.

The results of experience indicate that during the period of development the total income from annual water charge will

probably not more than equal the cost of operation, maintenance and depreciation, with no surplus for interest on the outstanding bonds or capital invested. Assuming that the deficiency is equivalent to the interest on about two-thirds of the total issue of the bonds sold, for the entire period of development, taken as 12 years from the time water is first turned into the system, the development cost under favorable condition will probably be not less than about 50 per cent. of the total bond issue.

A consideration of all the above items of cost, with the exception of items (1) and (2) which are usually included in the estimates of construction cost, shows that under favorable conditions the actual total cost of the system when completed will be from 90 to 110 per cent. greater than the construction cost; and the ultimate cost or investment when fully developed will be fully three times the construction cost.

When the company owning the system is also a land-selling company, the sale price of the land must include the total cost of the system, the purchase price of the land, the interest on the capital invested in the land business, the commission for the sale of the lands or the expenses of settlement and colonization, and the expected profit, which should be commensurate with the risk involved. The land must usually be sold by a distribution of the payments over a period of several years, and a large part if not all of the first payments is absorbed by the sales commissions, which may amount from 10 to as much as 25 per cent. or even more of the sale price of the land, when subdivided and disposed of in small tracts.

Miscellaneous Considerations.—These will include rural advantages such as the existence or establishment of hotels, stores, churches, schools, etc.; the distance to railroads, the construction of roads; the available fuel, such as wood, oil, coal, natural gas and electric power, especially important for heating, pumping and factories. The feasibility of developing by hydro-electric power in connection with the irrigation system may be an important consideration.

REFERENCES FOR CHAPTER I

SPECIAL REFERENCES ON IRRIGATION INSTITUTIONS AND WATER RIGHTS:
MEAD, ELWOOD.—Irrigation Institutions—1903—Macmillan Co., New York.

- CHANDLER, A. E.—Elements of Western Water Law—1913—Technical Publishing Co., San Francisco, Cal.
- WEIL, S. C.—Water Rights in the Western States, 3 volumes—1911—Bancroft Whitney Co., San Francisco, Cal.
- KINNEY C. S.—Treatise on Irrigation and Water Rights, 4 volumes—1912—Bender-Moss Co., San Francisco, Cal.
- MILLS, J. W.—Mill's Irrigation Manual—1907—Mills Publishing Co., Denver, Colo.
- SPECIAL REFERENCES ON IRRIGATION DEVELOPMENT AND FINANCING:**
- LAGERQUIST, W. E.—The Security of Irrigation Bonds—p. 563 Engineering News—May 11, 1911.
- MURPHY, D. W.—Operation and Maintenance of Irrigation Projects—p. 170 Engineering Record—Vol. 64.
- NEWELL, F. H.—Increased Cost of Construction—p. 119 Engineering and Contracting—Aug. 10, 1910.
- NEWELL, F. H.—Irrigation Developments in the United States—Part I: p. 711 Engineering Record—Dec. 16, 1911; Part II: p. 745 Engineering Record—Dec. 23, 1911.
- WEBSTER, N. E.—Irrigation Finance—p. 225 Proceeding 19th National Irrigation Congress—1911; *also* p. 765 Engineering Record—Dec. 30, 1911; p. 70 Engineering News—Jan. 11, 1912.
- A Discussion of Methods of Financing Irrigation Development—p. 188 Engineering and Contracting—Feb. 14, 1912.
- The Irrigation Situation—p. 222 Engineering Record—Feb. 24, 1912.
- What is the Matter with Irrigation?—Engineering News—June 12, 1913.
- HANNA, F. W.—Carey Act Projects—Senate Document No. 1097, 62d Congress, 3d Session Government Printing Office, Washington, D. C.—1913.
- BERRY, THOMAS.—The Private Irrigation Project as an Investment—Engineering News—Oct. 30, 1913.
- HENNY, D. C.—Federal vs. Private Irrigation—Engineering News—Jan. 15, 1914.
- GEIJSBERG, J. B.—Bondholder's Reorganization Plans for an Irrigation District—Journal of Accountancy—July, 1914.
- ROSS, D. W.—Failure of Irrigation and Land Settlement Policies of the Western States—Address Delivered Before the 21st Meeting of the International Irrigation Congress at Calgary, Alberta, Canada—Oct. 5, 1914.
- NEWELL, F. H.—The Human Side of Irrigation—p. 236 Engineering Record—August 29, 1914.
- Irrigation in America and Victoria—p. 220 Engineering Record—Aug. 22, 1914.
- SPECIAL REFERENCES ON DRAINAGE OF IRRIGATED LANDS:**
- McCULLOUGH, ERNEST—Drainage of Irrigated Lands—p. 158 Engineering News—Aug. 20, 1903.
- HART, R. A.—Evil Effect of Alkali Salts on Crops—p. 12 Nat. Land and Irrig. Journal—Nov., 1911.
- HART, R. A.—How Drainage Reclaims Alkali Lands—p. 10 Nat. Land and Irrig. Journal—Feb., 1912.

- FOGG, P. M.—Drainage of Irrigated Lands on the Minidoka Project, Idaho—*Journal Idaho Soc. Civ. Eng.*—June, 1912.
- HART, R. A.—Construction Difficulties in the Drainage of Irrigated Lands—p. 23 *Nat. Land and Irrig. Journal*—Aug., 1912.
- CRONHOLM, F. N.—Drainage System for the North Side Minidoka Irrigation Project—*Engineering Record*—April 15, 1914.
- MURPHY, D. W.—Drainage of Shoshone Irrigation Project—p. 635 *Engineering Record*—June 6, 1914.

ALSO FOLLOWING REPORTS AND BULLETINS:

- Water Supply Papers of the U. S. Geological Survey—U. S. Dept. of Interior, Washington, D. C.
- Bulletins and Circulars of Irrigation Investigations of the U. S. Dept. of Agriculture, Washington, D. C.
- Bulletins and Circulars of Drainage Investigations of the U. S. Dept. of Agriculture, Washington, D. C.
- Bulletins and Circulars of Bureau of Plant Industry of the U. S. Dept. of Agriculture, Washington, D. C.
- Bulletins and Circulars of the Bureau of Soils of the U. S. Dept. of Agriculture, Washington, D. C.
- Bulletins and Circulars of Agricultural Experiment Stations of Arizona, California, Colorado, Idaho, Montana, Nebraska, Nevada, New Mexico, North and South Dakota, Oregon, Texas, Utah, Washington, Wyoming.
- State Engineers' Reports of the same states as above, excepting Arizona and Washington, which have no State Engineer.
- Reclamation Record published by U. S. Reclamation Service, Washington, D. C.

CHAPTER II

PROCEDURE IN THE PLANNING AND LOCATION OF AN IRRIGATION SYSTEM

I. PRELIMINARY INVESTIGATIONS TO DETERMINE FEASIBILITY OF SYSTEM

The character of these investigations has been described in the preceding pages. They consist of a study of the land, the crops, the ownership of the land and method of development, the water supply, the general physical features and the character of the irrigation system, the cost of the system per acre and miscellaneous considerations. In most cases the investigations will require a field hydrographic survey, a reconnaissance survey and often trial line or preliminary surveys. The investigations must be as thorough as the importance of the project will justify, but as the feasibility of the project is not at first known, the expenses must be kept down to a minimum.

II. ALIGNMENT AND LOCATION OF DIVERSION LINE AND HEADWORKS (FIG. 1)

This will include the following surveys: (1) Reconnaissance survey and trial line surveys. (2) Preliminary survey. (3) Location survey. The survey methods are in general similar to those used in railroad work. It is not the purpose to give all the details pertaining to survey work, which would be beyond the scope of this book, but to emphasize special procedures and details peculiar to irrigation work. For additional details and special diagrams to facilitate canal location, the references given at the end of the chapter should be consulted.

1. Reconnaissance Survey and Trial Line Surveys.—The purpose of these surveys is to determine the possible position of the headworks and the probable position of one or more diversion lines and their relation to the irrigable area. Where topographic maps are available, such as those of the U. S. Geological Survey, the reconnaissance survey may not be necessary to determine the general feasibility, but in most cases the scale and contour

intervals of the map will only permit rough general location and perhaps indicate two or more possible diversion lines. This will usually have to be supplemented by a reconnaissance survey followed by trial line surveys along each possible diversion line. The final selection of the best diversion line may require more complete surveys of the nature of preliminary surveys.

The reconnaissance survey will consist of a rapid survey of the various possible lines, in which are taken elevations, distances and bearings, with notes regarding controlling features. To determine the general feasibility of long diversion lines in rough country, the elevations may be obtained with aneroid barometers and a hand level, the distances measured by pacing and the bearings with a compass. In place of this survey or following it, a rapid trial line survey is generally desirable to determine more closely the feasibility of one or more lines.

A reconnaissance trial line survey is made with the level and usually begins at the lower end of the diversion line, which is fixed by the highest point of boundary of the irrigable area. From this point the line is run on an approximate grade, along the side hill, toward the point of diversion along the river up to a point suitable for the diversion works. The point of diversion is selected from a careful consideration of the favorable conditions presented in a following chapter in Vol. III, and may be at an elevation giving considerable excess grade or difference in elevation. The excess grade may have to be taken up by the use of falls, chutes or concrete-lined sections, or may be used advantageously in better adjusting the final located line to the topography by avoiding some difficult and expensive construction. From the selected point of diversion, a trial line survey can then be run on a grade contour along each of the favorable possible lines. Where the feasibility of the project is practically determined from the above reconnaissance survey and the prospects are favorable to the project being carried out, a more careful trial line survey accompanied by a rapid transit or plane table stadia survey along each of the favorable lines is usually made. In many cases, however, there will be natural features or topographic conditions, such as steep rocky side hills, bluffs or ridges to be pierced by tunnels, favorable benches, difficult stream crossings, indicating the best line or limiting the selection to perhaps not more than two feasible lines.

The trial line and the transit or stadia survey, although not made

CONVEYANCE OF WATER

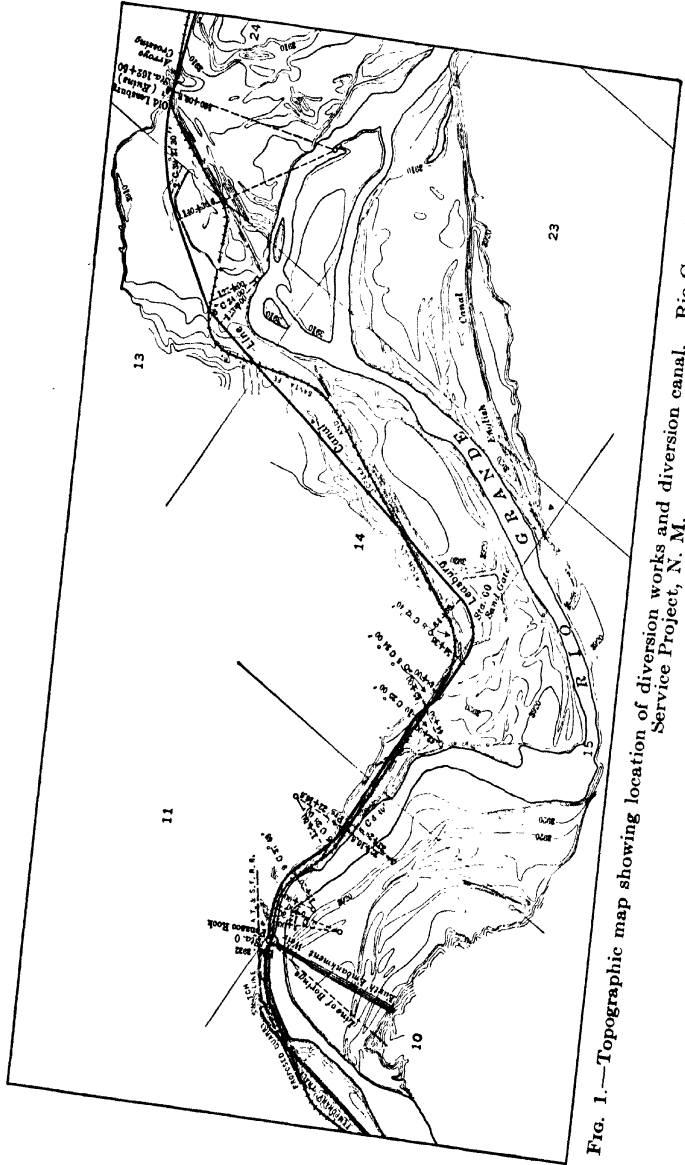

Fig. 1.—Topographic map showing location of diversion works and diversion canal. Rio Grande, U. S. Recl. Service Project, N. M.

as complete as for the preliminary surveys, described below, should be made accurate in order that they may be of value for the work to follow. The trial line survey is made by locating hubs on a grade contour at distances apart not exceeding about 600 feet. Bench-marks, for future reference in the preliminary surveys, should be established at controlling points near the location of important structures and special construction, at intervals not farther apart than about half a mile. The trial line survey is followed by a transit or a plane-table party. A stadia traverse is run over the hubs set by the level party, and a few stadia shots taken at controlling points on each side of the line for a width which will include all possible positions of the canal. With a transit party it is desirable to have a field draughtsman to sketch the topography. The survey is essentially an incomplete preliminary survey, for which additional details are given below.

In addition to the survey notes, the field-book should contain general information on the character of the material to be excavated, the slope of the hillsides, the obstructions, and all special features having an important effect on the cost of construction.

2. Preliminary Survey.—The purpose of the preliminary survey is to locate, or to obtain the necessary topography to locate on the ground, the most favorable diversion line. This may be done by different methods, depending on the character of the topography: (1) by a series of tangents with topography taken for a strip of land on each side of a grade contour line, followed by a paper location; (2) by a series of shorter tangents and curves fitted to the ground, without the paper location. The second method permits a closer and more economical adjustment of the canal line to the topography and is usually considered preferable when the possible position of the canal line is fixed within a narrow strip of land, such as is the case when the canal line is preceded by the trial line surveys indicated above. In heavily timbered country this method cannot very well be used. The first method is best when the general location of the canal line is not closely fixed by trial line surveys, and at such points where a selection between different types of construction is possible and must be made on economic comparisons, such as when the choice is between a canal running around a ridge and a deep cut or a tunnel through the ridge, or between a canal running around a depression and a canal in heavy fill or an

inverted siphon or flume. The second method, combined with the use of the first method at such places where the location requires economic comparisons, will usually be preferable.

The first method of preliminary survey requires a level party and either a transit party or a plane-table party. The level party runs ahead of the transit or plane-table party, on a contour grade, setting stakes spaced not farther apart than 400 to 600 feet with additional stakes at prominent breaks in the alignment and at controlling points, from which topography is to be taken with the transit or plane-table. When the topography presents conditions which make it desirable to consider alternative locations or designs, the level party must run lines along each possible location in order that the topographic survey may be extended to cover the entire range of locations. The importance of the selection of control points makes it desirable for the chief of the party or locating engineer to become head rodman. The stakes are set on the center line of the canal, allowing for the grade and the depth of center cut.

The distances necessary to obtain the canal grades are obtained sufficiently close by pacing. The depths of center cuts are usually obtained from diagrams or tables prepared for this purpose and which are kept by the rodman, who should carry the grade elevations on profile paper. The center cuts for the required range of side-hill slopes and for the desired canal cross section are computed either on the basis that the amount of cut will equal the fill, which usually brings part of the water cross sectional area in fill, or on the basis that the water area will be entirely in cut. The latter basis is safer, especially on steep side hills, but will usually, especially with large canals, give an excess of excavated material for the banks. To obtain the center cut from the tables or diagram, the side-hill slope is obtained by taking rod readings to points 50 to 100 feet on each side of the canal or by using a clinometer carried by the rodman.

Where the water cross sectional area is to be kept all in cut, instead of using the computed center cut, the center line may be staked out without tables as follows: Locate the stakes at the point where the ground surface and the water surface on the downhill side intersect, the elevation of these points being at a height above the bottom of canal equal to the depth of water in the canal; from each of these points measure horizontally a distance equal to half the width of the canal at the water surface,



Fig. B.—Diversion canal on steep sidehill. Belgo-Canadian Fruitlands Systems, B. C.



Fig. A.—Concrete-lined diversion canal on steep rocky hillside. South Kelowna System, B. C.

driving the center line stake on the other end of this measured distance (Fig. 2). Where the center cut must be such that the cut will balance the fill, the pivotal point method, used on reclamation projects in Montana and described in Chapter V, can often be used to advantage.

The level party on its first survey must establish a system of well distributed permanent bench-marks, especially near structure locations and wherever they will be most desirable for the work to follow, such as running final profiles, cross sectioning, staking out of structures, and construction. The spacing between bench-marks should not exceed $\frac{1}{2}$ mile and preferably $\frac{1}{4}$ mile.

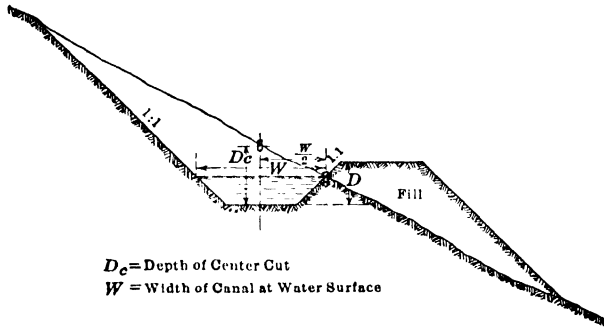

FIG. 2.—Location of Side-hill Canal with water cross section all in cut.

The transit party or plane-table party follows the level party, runs chained traverses between the stakes set by the level party, and takes the stadia side shots for the topography of a strip of land of sufficient extent to include the final located line. When the stations are on a contour grade line, started from the head of the diversion line and run on the minimum grade of the canal so as to keep it at its highest position, leaving all excess or surplus grade for the adjustment of the canal line to the topography by paper location, then the strip of land on which topography must be taken will lie largely or entirely below the contour grade line. When a transit is used, the topography may be taken either by transit and stadia or by accompanying topographers, using a hand level or clinometer. A field draughtsman usually plots the results and sketches all topographical features which will affect the canal location, including drainage channels, rock outcroppings, railroad crossings, etc. In open country the plane-table may be used for running the traverses and

taking topography; or it may be used for taking topography only, in conjunction with the transit, by transferring the traverse notes, taken with the transit, to plane-table sheets. The use of the plane-table is preferred by many; the advantage claimed is that it facilitates and permits the sketching in of all necessary topographic features, thus giving maps more nearly representing the actual topography, from which more accurate paper location may be made.

The level party must not work too far ahead of the transit party, in order that the grade elevation used by the level party may be corrected for any error which may have accumulated by the grade allowance being made on paced distances. A correction every 1 or 2 miles will usually be sufficient for this method of preliminary survey.

The maps and profiles are the basis for the paper location. The scale and completeness of the maps depend on the configuration of the country and the desired accuracy of the paper location. To obtain accurate paper location, which will require few or no changes in the field, or to study problems of economic location by comparison of different types or form of construction, a large scale must be used. Where a considerable portion of the line is along rough broken country, with side-hill slopes of 25 per cent. or more, a scale of 40 feet to the inch will be found desirable. Where the topography is more regular, a scale of 100 feet to the inch may be used. Where the country is regular and the general side-hill slope under about 25 per cent., a scale of 200 feet to the inch may be used. For purposes of general paper location, such as when considering the feasibility of different routes, a scale of 1 inch to 1,000 or 2,000 feet will be desirable. Maps for this purpose may be drawn from the small scale maps by reduction with a pantograph.

The second method of preliminary survey combines the preliminary survey and field location survey. It is best adapted for the conditions stated above, and has been used on a number of projects of the U. S. Reclamation Service and also by L. E. Bishop, an irrigation engineer of Colorado, who has presented various features of it and several diagrams in a paper on the "Economic Canal Location in Uniform Countries" in the *Trans. Am. Soc. Civil Eng.* of December, 1911. In this method the work of the level party is the same as in the first method described above, except that the grade contour stakes are located at

every station (measured by pacing) and at every controlling point. The importance of this work requires that the rodman be a man experienced in canal location. The transit party carries tables of tangent offsets, external secants, semi-tangent lengths, etc., and diagrams of equivalent lengths, of different forms of construction and of types of conduit, including canals in cuts of different depths, canals in fills of different heights, bench flumes, elevated flumes, tunnels, concrete-lined canals, inverted siphons, etc. The transit party runs tangents which fit approximately the stakes or flags set by the level party, straightening out the irregularities by moving in general as many stakes above the new line as below it, so as to keep the proper balance between the cut and fill, preferably within the limit of free haul and not exceeding the limit of economical haul. The limit of free haul, specified on a number of projects of the U. S. Reclamation Service, is 200 feet. For longer hauls the contractor is allowed for each additional 100 feet a bid price or a stated price, which in many cases is 2 cents per cubic yard. At this price, with earth excavation at 20 cents a cubic yard, the limit of economical haul would be 1200 feet. The limit of economical haul will determine the extent to which the canal line may be shortened and straightened by using deeper cuts or shallower cuts, or by making the canal all in fill. Where sections of canal, approximately on a grade contour, can be eliminated by a tunnel, flume, siphon, or other type of construction, the selection must be based not only on a basis of equivalent first cost, but also on safety and ultimate cost.

The general procedure for the transit party in ordinary location consists in running the tangents, setting stakes at every station, 50 feet apart, until the head chainman comes to the P. I. of a curve. The importance of proper selection will usually make it desirable for the chief of party to select the position of the tangents and points of P. I. The transit man sets up at the P. I., and from the central angle and lay of the ground selects the degree of the curve; the semi-tangents are then measured off to establish the P. C. and P. T., and the curve may be run by tangent offsets. When the P. I. cannot be used for a transit setup, another method must be used for running the curves. In the location of the Tieton main canal in Washington, along steep rocky irregular hillsides, one method used for curves of 100 feet radius or less consisted in the rear and head chainmen

describing the curve, with a radius and from a center of curvature, both selected by trial to fit the tangents and the topography. The transit party will establish the usual ties with section lines and property lines. The chief of party will select the most economical and best location for structures, make notes regarding the types of structures and determine by high-water marks the maximum flood-flow or flood-water area to be provided for at crossings with natural water courses.

Special topography, by the first method of preliminary survey, outlined above, will be taken at the location of important structures and along sections of the line which require study to determine the most economic location or type of construction.

The final profile of the stakes set by the transit party is taken by the same level party which preceded the transit party, or by a second level party, if the transit work can be kept up close to the level party ahead. In taking the final profile, the elevation of the bottom of all depressions and of the top of ridges must be obtained and the side-hill slope at right angles to the canal line recorded in the notes. The profile and alignment notes are turned over to the field draftsman, who does the plotting, prepares right-of-way maps and works up the estimates of excavation and overhaul to serve as a basis to let the contracts until the line is cross sectioned.

The character and qualities of the material affecting the cost of excavation and its suitability for the conveyance of water, such as porosity and hardness, must be determined by test pits or borings. A testing party may be necessary, and in the case of tunnel construction may involve considerable expense.

3. Paper Location and Field Location Survey (Fig. 3).—On most projects it will often be found desirable to use both methods of preliminary survey, each method being used along those sections of the canal lines where the conditions are favorable to its use. The second method combines with it the field location, eliminating the paper location. The topography taken by the first method and plotted on the map, with the profile of the preliminary line, give the basis for paper location. On the map trial lines, made up of curves and tangents, are adjusted to the topography, so as to obtain either a proper balance between cut and fill within the limit of free haul or economical haul, or, when desired, a canal section with water cross sectional area all in cut. Profiles of the trial lines are made up for the consideration of

haul and for the estimate of earthwork. The final trial line is the one which will give the most economic location. Ties between the final trial line and the preliminary line are measured and computed to serve as checks in the field location.

The field location consists in staking out the selected trial line of the paper location. The transit party checks his line with the

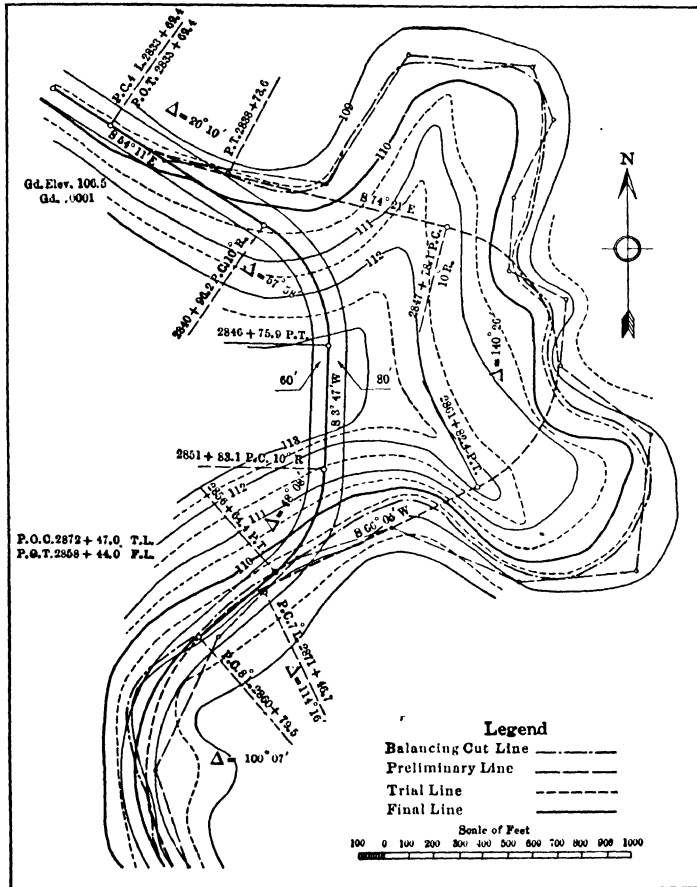

FIG. 3.—Details of paper location.

ties at the intersections with the preliminary survey line. The level party follows the transit party, taking the elevations at each station. From these a profile is made, on which the sub-grade of the canal is placed to give the depth of cuts or fills at

each station. These are indicated on the center line stakes and the line is then ready for cross sectioning.

III. LOCATION OF DISTRIBUTION SYSTEM

The location of the distribution system, except where adequate topographic maps are available, is preceded by a rapid survey to determine the general feasibility of the distribution system. This will consist of a trial line survey of the upper boundary of the irrigable area to be included in the project, which will usually be the approximate position of the main canal, and of trial lines on the ridges which the main laterals will probably occupy. To plan the system it is best to have a complete topographic contour survey of the entire irrigable area. In addition to its value for this purpose, accurate topographic maps may be of greater importance and value in the assistance which they will give to the settlers in establishing satisfactory distribution systems on the farm units. The details of the design and location of a distribution system are discussed in another chapter in Vol. III. The following paragraphs present some of the general features pertaining to the usual survey methods.

Topographic Survey.—The topographical survey is usually based on one or a combination of the three following systems: (1) a triangulation system; (2) the U. S. land survey system; (3) a system of main traverses or control lines located along the upper boundary of the irrigable area, on the main ridges and drainage lines, connected by cross lines. The purpose of each system is to give a skeleton of control lines for the topographic survey. The first two systems are those most commonly used; the third system is seldom used, except perhaps for secondary control in connection with the other two systems.

A triangulation system of primary control may be an independent system or may be, as on the re-survey of about 42,000 acres of the Truckee-Carson project in Nevada, tied to the triangulation system of the U. S. Coast and Geodetic Survey. In either case the triangulation system consists of a base line, very accurately measured, extending preferably in the center of the tract, and of triangulation stations located as much as possible at prominent points and well distributed in the area to be surveyed, in such numbers that at least three and preferably four stations will be located on each plane-table sheet. On the Truckee-Car-

son survey the base line extended between two knolls, about 7,215 feet apart, and was tied to the Geodetic stations; the triangulation system was developed so as to place the stations near the four corners of each sheet. The plotting was done on a scale of 400 feet to the inch, so that each sheet took in an area of 2 miles long east and west, by $1\frac{1}{2}$ miles wide north and south. The maximum allowable error in closure in any triangle was 5 minutes. The triangulation points were marked by signal rods, 16 to 20 feet high. Each rod was guyed by three wires to sacks filled with sand, and supported a cubical shaped frame covered with white cloth, just below the top, to which a flag was fastened (Fig. 4).

The U. S. land survey system of primary control consists of the township and section lines. This will usually require the reestablishment of lost corners and in some cases a more or less complete re-survey of section lines. When the survey is for the purpose of extending the distribution system of an existing system, the absence of adequate topographic maps may require a complete topographic survey of the entire irrigable area. In the portion which is already irrigated and well settled, the corners may be practically all lost, but the section lines are indicated by established fences and road lines. For such conditions on a project in California a topographic survey for 70,000 acres was based on primary control lines accurately run around the most central township and extended to the outer edge of the area. Lines following or parallel to fence lines and roadways were run to divide the area into approximate sections, and these were tied to the township control lines. A similar system described by L. E. Bishop of Colorado was used by him for a 56,000 acre survey. On the survey of about 90,000 acres in the Sunnyside Unit of the Yakima project in Washington, all government land subdivision survey corners were re-established. This is practically necessary where the company building the system will also subdivide the land to put it on the market.

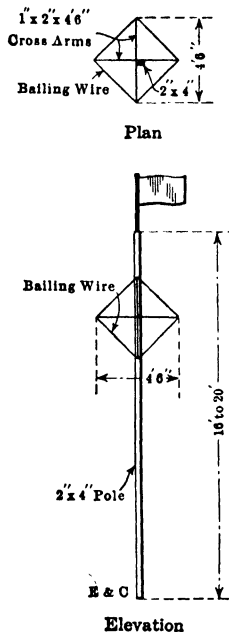

FIG. 4.—Signal for plain table work. Truckee-Carson Topographic Survey.

The selection between the triangulation system and the U. S. land survey system of primary control is dependent on a number of factors. The U. S. land survey system is best adapted to flat uniform slopes, especially if the work must be done during the hot summer, when the heat waves would make it difficult to use triangulation stations. The triangulation system is best adapted to rolling country where prominent controlling stations are well distributed in the area.

The primary control system includes topography levels or bench-marks for vertical or elevation controls. In some cases U. S. Geological Survey bench-marks will be found in the irrigable area; these must be supplemented to obtain a number of bench-marks well distributed. On the Truckee-Carson re-survey, topography levels were taken along the boundaries of each plane-table sheet and bench-marks established at every quarter mile. On the Sunnyside survey they were established on the section lines at every section corner, $\frac{1}{4}$ -section corner and $\frac{1}{16}$ -section corner.

The topographic survey is developed from the primary control system by secondary control lines or traverses. The distance may be chained or measured by stadia, and the secondary elevations carried by the transit or plane-table alidade. The traverses may be: (1) irregular traverses between controlling points; (2) lines run along the ridges and natural drainage lines; (3) long straight lines run across ridges and depressions with spur lines along the ridges; (4) rectangular traverses parallel to the section lines. The first two methods are better adapted for plane-table than for transit work. The second method was used to some extent on the Sunnyside re-survey run with transit, but it was found that the third method with long straight lines simplified the office work and facilitated the closure of traverses. The fourth method with transit was used by L. E. Bishop, who combined it to some extent with the survey of the primary control by the procedure indicated in the accompanying diagram (Fig. 5). The sections were worked up into tiers by rectangular zigzag traverses run by transit and tape; the lines used as section lines did not coincide exactly with the section lines, but were tied to all government section corners. The rectangular zigzag traverses extend along and on one side of each north and south assumed section line, and make the perpendicular distance between transit lines about $\frac{1}{3}$ of a mile. The distance between transit points was

kept below 1,800 feet, giving a maximum distance from transit point to any point in the section of not over 1,200 feet. The level party and transit party worked fairly close together. At times the transit party would be a mile ahead, which gave time for taking extra readings on rough topography. The level party took topography levels and also chained the distance between the transit points, set by the chief of the party. The transitman with four stadia rodmen took the topography readings. Two rodmen worked on each side of the zigzag course, each rodman taking a strip 450 feet wide parallel to the control lines. This method of control and taking topography is best adapted to the conditions existing in this case. The land was in a broad flat valley. For 30 per cent. of the sections the average difference in elevation in one section was about 70 feet and for the other 70 per cent. about 40 feet per section. The country was open with practically no timber.

The topography side shots are usually taken from stations on stadia traverses. The elevations for the traverse stations are carried by stadia from the bench-marks previously established by the level party. Transit or plane-table stations must

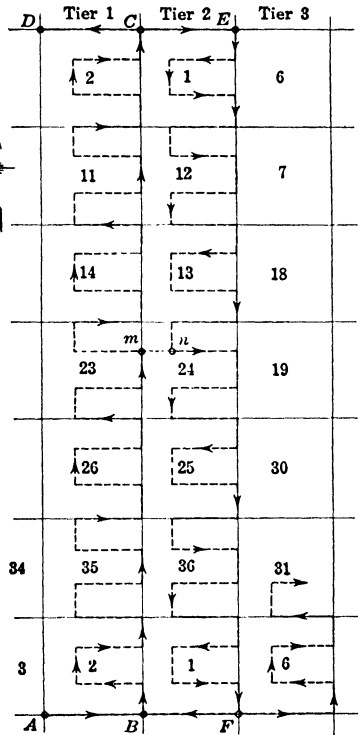

FIG. 5.—Method of traversing sections.

be located at points selected to best command the area within the desired range of the instrument. The maximum length of stadia shots for topography of 1-foot contours should not exceed 1,000 to 1,200 feet. The topography is usually taken by having each rodman cover a strip of land from 300 to 500 feet wide, readings being taken at controlling points, such as summits, depressions, along ridges, change of slope, etc., and at points required to

locate irrigation canals, natural water courses, swamps, alkali lands, fences, buildings, roadways, etc.

The plane-table has the following advantages over the transit; it largely eliminates computations, with fewer chances for errors, permits frequent checks in the field, makes it possible to sketch the topography directly on the sheets, and requires no note-taking in a field-book. The topography is more liable to be correct and the total cost will be materially less than that of transit topography with the larger amount of computations and mapping, made in the office. Under equal conditions transit work will cost about 5 cents per acre more than plane-table work. On the other hand, the plane-table cannot be used conveniently in timbered or heavy brush country and requires fair weather.

The scale and contour interval to be used on the topographic map are dependent on the character of the topography and number of shots per acre. Scales of 1 inch to 200 feet and 1 inch to 400 feet and contour intervals of 1 foot and 2 feet are commonly used. A scale of 200 feet to the inch is desirable for 1-foot contour intervals for average slopes of 50 to 75 feet per mile, or for 2-foot contour interval for average slopes of 75 or more feet per mile. A scale of 400 feet to the inch is desirable for 1-foot contour interval for slopes under 50 feet per mile and for 2-foot contour interval for slopes less than 75 to 100 feet per mile. One-foot contour interval is desirable for irregular topography, or for flat valley land with knolls and depressions. Two-foot contour interval is sufficient for land with smooth regular slopes, or with well-defined continuous ridges and depressions. Contour intervals greater than 2 feet are of very little value in the location of the distribution system and of less or no value in obtaining the information desired by the water users for laying out of farm distribution systems and the preparation of land for irrigation. In many cases 5-foot contour surveys have proven worthless and necessitated re-surveys to obtain 1-foot or 2-foot contours.

The contour interval must be consistent with the accuracy and the completeness of the survey. For 1-foot contour interval about 4 times as many shots or readings will be required on the same land as for a 2-foot contour interval. On the Sunnyside survey the land varied from moderately smooth to rough; the map scale was 200 feet to the inch and the contour interval was 1 foot, with about 5 shots to the acre. On the project described by L. E. Bishop, for presumably smoother land, the scale was

200 feet to the inch, and the contour interval was 2 feet with only 0.7 shot per acre. On the Truckee-Carson survey for comparatively rough land with flat slope, the scale was 400 feet to the inch and the contour interval 2 feet with about 2 shots per acre. On the survey of the South San Joaquin irrigation district in California, where the land is comparatively smooth valley land, the topography was taken by transit, with about 2.1 shots per acre. The irrigable area under the Yolo Water and Power Company's system in California, which is smooth valley land, was taken by plane-table, with about 1 shot per acre.

The scales and contour intervals recommended above are for the detail topographic maps. For the purpose of general location, or for the study of several possible plans with variations in the positions of main canals and laterals, it is difficult to make the paper location by the use of large scale topographic sheets joined together. It will usually be desirable to reduce the topographic maps by the use of a pantograph, to maps on a scale of 1,000, 2,000 or 2,500 feet to the inch. On these reduced scales it will usually be necessary to use a larger contour interval, which may be every 5-foot contour, when reduced from a 1-foot contour map, or every 10-foot contour when reduced from a 2-foot contour map.

The accuracy of the survey must be consistent with the required accuracy of the maps and paper location. For a primary control system, when the distances are measured by tape, the error of closure in latitude and departure should not exceed 1 foot in 5,000 feet, and in azimuth not more than 1 minute per mile with a maximum of 5 minutes in closure. A rule which is sometimes recommended for running section lines and subdivision lines is that the maximum allowable error in feet be equal to $1.2\sqrt{D}$ where D is the length of the traverse in miles.

For secondary traverses measured by tape the error of closure in latitude and departure should not exceed 1 foot in 2,000 feet, although 1 foot in 1,000 may be allowed for short traverses.

For stadia traverses a maximum error of closure of 1 foot in 1,000 feet will usually be consistent with the required accuracy.

For vertical control, the maximum error of closure in feet, usually allowed for a circuit of levels between bench-marks is equal to $0.03\sqrt{D}$ or $0.05\sqrt{D}$ where D is equal to the distance around the circuit in miles.

Paper and Field Location.—The topographic maps are the basis for the paper location of the distribution system. For a

general study, maps on a scale of 1 inch to 1,000, 2,000 or 2,500 feet, reproduced from the larger maps, or where available, U. S. Geological Survey maps on a scale of 2 inches to the mile with 5-foot contour intervals are generally used; the final paper location being made with the use of the larger maps.

On these maps should be plotted section lines, property or subdivision lines, bench-marks with their elevations, buildings, roadways, etc. Drainage channels or depressions, natural water courses, ridges, and tops of knolls which cannot be reached from the irrigation system should be well indicated.

The main canal is usually located along the higher boundary of the land to be irrigated. The main laterals and sublaterals are located along the main ridges and secondary ridges, disregarding property lines, and are extended to discharge into drainage or waste channels. Distributaries are located, preferably along property lines and placed at an elevation to deliver the water to the high point of irrigable land in each farm unit. Where a farm unit is cut into two parts by a deep water course, a distributary may be constructed on each side of the water course to deliver to the two parts. The final paper location is made on the large-scale maps. The length of the courses, the angles of deflections, the ties to property and section lines, the canals' rights-of-way are shown on the map.

The paper location is transferred to the field by a transit party. The center line of each canal is started from its upper end and stakes are set at every 100 feet. A level party follows the transit party to obtain the elevations for profiles. In some cases the same level party may run scout levels in advance of the transit party to obtain foresights for the transit. The field location of 87 miles of canal on the distribution system of the Sacramento Valley Irrigation Company in California was done at an average rate by transit and level parties of 3.4 miles per day, and cost \$5.00 per mile for the transit work and \$3.30 per mile for the level work.

IV. MISCELLANEOUS CONSIDERATIONS

Curvature.—Excessive curvature may be obtained when a canal line on a side hill is fitted too close to the irregularities of the ground, or at sharp turns in laterals and especially in distributaries located to conform with property lines. The most

serious effect of sharp curves in earth canals is the erosion on the outside or concave side of the curve and the deposit or fill on the inside. This may result in the formation of deep pools on one side and grass grown shores on the other side, which will require bank protection and removal of deposits. Another effect of minor importance in earth canals but more serious in concrete lined canals or in canals excavated in materials which permit the use of high velocities is the increase in loss in head or decrease in carrying capacity, produced by the deflected currents and turbulent flow resulting from the curves. Some of the added benefits obtained by eliminating sharp curves are the decrease in the length of line and the increase in grade; these will partly offset the added cost of eliminating sharp curves.

A number of empirical rules have been suggested for the maximum curvature to be used on irrigation canals, most of them having no logical basis. H. M. Wilson has recommended that for large canals with moderate velocity the minimum radius be not less than 3 to 5 times the bed width. S. Fortier has recommended a minimum radius of 100 feet. F. H. Newell and D. W. Murphy have recommended a minimum radius of $2\frac{1}{2}$ times the bed width. L. E. Bishop is more specific, recommending the following: For canals of less than 400 second feet capacity a minimum radius of 10 times the bottom width, and for canals of 900 to 1,500 second feet a minimum radius of 12 times the bottom width.

On the Bow Valley Irrigation system of the Canadian Pacific Railway, in Alberta, Canada, the largest project in North America, extending over a gross area of three million acres, the minimum radius allowed on the laterals was between 15 and 30 times the depth of water, which ranged from $4\frac{1}{2}$ to 8 feet, and on the distributaries 6 to 8 times the depth of water, but not less than 10 feet, was used. The canals were designed for velocities of about $2\frac{1}{2}$ feet per second and not exceeding 3 feet per second. This rule is based on a more logical assumption than the others, which is that erosion, assuming the velocity constant, is dependent not on the width of the canal but on depth of water in the canal.

On the distribution system it will frequently be possible to make a change in the direction of a canal, by a sharp turn at the foot of a drop or checkgate. This is desirable because it will not add much if any to the cost of the structure, and it

eliminates the cost of protection and maintenance which might be required if a separate curve was introduced.

Profile of Canal Lines and Grade Lines.—The profile of a canal is obtained from the plot on profile paper of the elevations taken by the level party of stations and other controlling points.

Preliminary profiles are required to accompany the preliminary surveys of the diversion line for the adjustment of the line to the topography, in the manner previously indicated, and for the establishment of grades and the depth of cut or position of bed of the main canal laterals and distributaries, with respect to the ground surface, in order to maintain the water level in the different parts of the distribution system to the height desired to make deliveries to the high points of the farm units.

The final profile will show the natural ground surface, the subgrade or bed of canal line, the full supply water-grade line, the top of the bank-grade line, alignment notes, and structure locations.

The profile is plotted on regular profile paper, of which the smallest vertical space is usually taken equal to 0.2 feet and the smallest horizontal space equal to 100 feet. The final profile of the final location gives the depth of cut or fill at each station, used on the construction survey. The preliminary profile differs from the final profile in that it is less complete.

The use of a profile for the location of the diversion canal and for a canal along a side hill is largely to obtain an economic canal location. A diversion canal or a canal on a side hill must usually be located to be at least in balanced cut and fill section, or preferably with its water cross section all in cut, with few or no parts of it in fill. Laterals and distributaries are usually placed to obtain a proper balance between cut and fill within the economic haul. In flat country it may be desirable to raise the water level in the distributaries by using an excess of fill obtained by borrowing from the high land on both sides. The profile of a lateral or distributary will usually show sections of canal all in cut, others in fills, others partly in cut and fill.

When the location of the canal line is fixed by the topography, such as by a ridge or a boundary line, as is often the case with laterals and distributaries, then the determination of the correct grade and the proper adjustment of the subgrade line requires a careful study of the profile. If the slope of the country is exactly uniform and equal to the desired canal grade, then

the subgrade line is parallel to the surface slope and at a depth below it equal to the required depth of cut, which will often be the cut for a balanced cut and fill section. With the usual inequalities in the surface slope, the following cases often arise: (1) the grade of the canal is parallel to the average surface slope; (2) the grade of the canal is less than the average surface slope, which necessitates the use of drops or chutes. For the first case the procedure is as follows: (a) Draw the surface grade line, which, within the limits of economical haul, will coincide as much as possible with the average ground surface. (b) Determine the suitable cross section for the above grade and the desired cut. (c) Draw the subgrade line parallel to the average surface grade line at a distance below it equal to the depth of cut. (d) Draw the high-water grade line and top of bank grade line. For the second case the procedure is: (a) Determine suitable cross section and grade for a velocity not excessive; (b) Fix the minimum depth of cut, and with the average surface grade line find the most economic height of drop, as discussed in Vol. III. (c) With the height of drop and minimum depth of cut locate the subgrade line on the profile.

The procedure in the first case will have to be altered when it is necessary to maintain the water level as high as possible to reach high points of deliveries, in which case the elevations of these points must be plotted on the profile, and either the water grade line must be made to join these points, which may require a canal section all in fill, or checkgates provided at these points to raise the normal water level, which will require the building up of the banks to the required height above the back water level. The factors controlling the desirable water level in the distributaries are considered in detail in the chapter on distribution systems in Vol. III.

Cost of Surveys.—*The cost of reconnaissance, preliminary and location surveys* necessarily varies within wide limits, depending largely on the topography and the methods used. The average cost of 100 miles of rapid trial line or fly level lines in gently sloping country, run to determine the feasibility of diversion for a project in Montana, is reported by C. E. Cleghorn at \$10 per mile. This was followed by the survey, with level, of a falling contour grade line, tied in by transit and stadia, followed by plane-table topography on a scale of 1 inch to 200 feet. The level and transit work cost \$31.97 per mile and the plane-table

topography \$20.87 per mile. More accurate plane-table topography at special points, on a scale of 100 feet to 1 inch, cost \$76.92 per sheet. L. E. Bishop states that the field location of canals in open country by the method which combines the preliminary survey with the field location costs from \$45 to \$65 per mile. The high cost in difficult location is illustrated by the cost of canal location on the Grand Valley project in Colorado. The Canyon line, 6.25 miles in length, includes 3 tunnels and a flume on nearly vertical hillside and involved a careful selection from several possible routes. The total cost of location including complete plans, estimate and report, was \$4,645 or \$749 a mile. Another line on this project for a canal of 750 second feet capacity, 25.20 miles long, in broken, open country cost \$171.55 per mile.

The cost of the topographic survey and maps required for the planning of the distribution system consists of the horizontal and vertical control system, the field topography and the map. The cost per acre will vary within wide limits, which may, however, be narrowed down by qualifying the character of the topography by the number of shots taken per acre and by the method of taking the topography. With these qualifications the cost per acre on ten projects falls within the following limits:

For 1 shot per acre and plane-table for taking topography	\$.10-.15 per acre.
For 2 shots per acre and plane-table for taking topography	.15-.20 per acre.
For 1 shot per acre and transit for taking topography	.15-.20 per acre.
For 2 shots per acre and transit for taking topography	.20-.25 per acre.

These costs include all field work, mapping, and from 8 to 10 per cent. overhead. The number of shots taken by one party per day will depend largely on the organization of the party; in the projects referred to, it averages for all working days about 150 to 200 shots per rodman. Two or three rodmen are generally employed per party.

Right-of-way for Canals.—Right-of-way must be acquired for all parts of the system and may form an important part of the cost of the system, depending on the ownership of the land. Right-of-way on public lands is granted by the Government in accordance with the regulations of the General Land Office, which specify the form of surveys and the information to be shown on the maps accompanying the application. Right-of-way on lands belonging to the builders of the system is reserved

and the title of ownership held by the company. Right-of-way on lands held in private ownership must be acquired either by purchase of an easement for the use of the right-of-way or by purchase of the land.

The high cost of right-of-way may make it necessary to make the width of right-of-way as small possible; on the other hand, access to the different parts of the system is important for operation and maintenance. The minimum width of right-of-way must usually be from outer toe to outer toe of the canal banks. This may be sufficient for the distributaries; but for main canals and laterals it is desirable and practically necessary to provide a roadway. For a canal or lateral in balanced cut and fill, the volume of excavated material is usually not enough to give a top width of bank, sufficient for roadway, in which case the width of right-of-way must be wide enough to include at least a 10-foot roadway adjacent to the outer toe of one bank; and it may be desirable to provide a similar roadway along the outer toe of the other bank. For a canal largely in fill an additional width may have to be reserved for borrow material. For a canal in deep cut giving sufficient excavated material to form a top width of bank of at least 8 feet (sufficient for a roadway), the width of right-of-way is from outer toe to outer toe of banks. A canal in rolling country is liable to have considerable variation in cut, with a corresponding variation in the width between outer toes, in which case it will be desirable to avoid a variable width of right-of-way by using a larger average width.

REFERENCES FOR CHAPTER II

- Rapid Topographical Surveys with Aneroid Barometer—p. 349 Engineering Record—April 13, 1901.
- ERNEST McCULLOUGH—Methods of Running Transit and Stadia Surveys—p. 296 Engineering News—April 10, 1902.
- Plane-table and Transit Methods in Irrigation Canal Surveys—p. 353 Engineering News—May 1, 1902.
- Establishing Irrigation Canal Tangents so Cut and Fill Will Balance—p. 149 Engineering News—Aug. 10, 1905.
- Establishing Irrigation Canal Tangents so Cut and Fill Will Balance—p. 311 Engineering News—Sept. 21, 1905.
- PAUL McGEEHAN—A Diagram to Aid the Location of Small Irrigation Canals—p. 119 Engineering News—Feb. 1, 1906.
- The Reconnaissance of Irrigation Systems with Some Cost Data on the Crow Project. Montana—p. 120 Engineering and Contracting—Aug. 19, 1908.

- Cost of Irrigation Reconnaissance Survey—p. 204 Engineering Record—Aug. 22, 1908.
- Cost of Topographical Survey, San Antonio, Texas—p. 327 Engineering and Contracting—Nov. 11, 1908.
- Methods and Cost of Making Triangulation and Plane-table Surveys, Grand Valley Irrigation Project—p. 427 Engineering and Contracting—May 26, 1909 and Reclamation Record—May, 1909.
- BARTLETT, A. B.—Field Work in Locating Irrigation Ditch and Canal Lines—p. 611 Engineering News—May 26, 1910.
- Methods of Making Topographical Surveys and Their Costs—p. 186 Engineering News—Aug. 10, 1911.
- BISHOP, L. E.—Economic Canal Location in Uniform Countries—p. 179 Trans. Am. Soc. C. E.—Dec., 1911.
- Topographical Surveys on the Canadian Pacific Railway Irrigation Project—p. 41 Engineering Record—Jan. 13, 1912.
- Topographical Surveys for a Large Irrigation Project in Southern Alberta—p. 788 Engineering News—April 25, 1912.
- Methods and Cost of Making Subdivision on Topographical Survey for Sunnyside Unit—p. 669 Engineering and Contracting—June 12, 1912.
- McNOWN, W. C.—A Convenient and Economical Method of Subdividing Tracts of Irrigated Lands—p. 450 Engineering News—Sept. 5, 1912.
- GALE, L. E.—Methods and Cost of Making a Topographic Resurvey on the Truckee Carson Project, Nevada—p. 254 Engineering and Contracting—Feb. 25, 1914.
- BISHOP, L. E.—Speed on Topographic Surveys—p. 319 Engineering Record—Sept. 19, 1914.
- HICKOCK, C. E.—A Study of Economic Conduit Location—p. 778 Trans. Am. Soc. C. E.—Dec., 1914.

CHAPTER III

HYDRAULIC FORMULAS SPECIALLY APPLICABLE TO COMPUTATIONS OF IRRIGATION CANALS AND STRUCTURES

The scope of this chapter includes a presentation of principles of hydraulics and formulas which are specially adapted to the computations involved in the design of irrigation canals and structures. It is not intended as a substitute for a text-book on hydraulics; it being presumed that no one shall attempt to design an irrigation system without a fundamental knowledge of hydraulics.

A careful search has been made of all available information and data specially applicable to the conditions of flow existing on irrigation systems. The results of a large number of hydraulic experiments and measurements made in recent years on several irrigation systems have been studied in connection with older accepted hydraulic data, and have enabled the presentation in this chapter of considerable new data, which it is believed will permit greater accuracy in the application of standard hydraulic formulas to the special conditions of flow existing on irrigation systems. The following subjects of hydraulics have been considered:

1. The flow of water in canals or open conduits.
2. The flow of water in pipe lines and culverts.
3. The flow of water through large orifices and gates.
4. The flow of water through large tubes

The principles of flow and formulas pertaining more especially to certain types of structures have been included in the principles of design of such structures, presented in Volume III. In all cases it is presumed that reference will be made to standard text-books on hydraulics for more complete tables and diagrams used in hydraulic computations.

FLOW OF WATER IN CANALS AND OPEN CONDUITS

Principles and Formulas for Steady Uniform Flow.—Steady uniform flow is obtained when the following conditions exist:

Constant cross section, uniform roughness, and constant slope; these imply a constant velocity with the water surface grade parallel to the grade of the bed of the canal. In practice, especially in earth canals, there is more or less variation, so that this condition of flow is only approached; but all hydraulic computations assume uniform steady flow, except in such special cases where the conditions are clearly those of accelerated or variable flow.

The principles of steady, uniform flow in canals are:

First.—In any canal where there is uniform flow the two factors involved are the frictional resistance and the accelerating force; these two must be equal or acceleration would occur.

Second.—The frictional resistance is proportional to the square of the velocity, the area of canal in contact with water, its roughness and the density of the liquid. The general formula of flow is obtained as follows (Fig. 6):

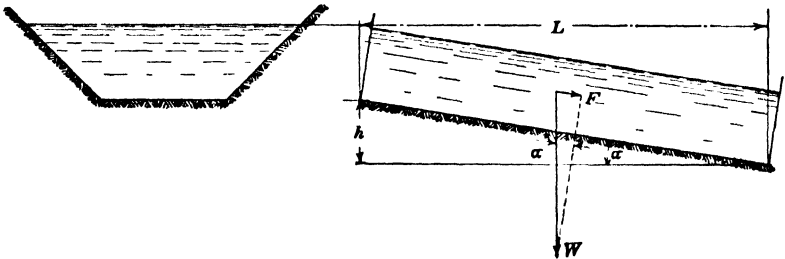

FIG. 6.

Let F = accelerating force parallel to the canal grade.

F_f = friction-resisting force.

S = area of surface in contact with water for a length L .

V = velocity of flow in feet per second.

A = area of cross section in square feet.

L = length of canal considered in feet.

p = wetted perimeter in feet.

r = hydraulic radius = $\frac{A}{p}$, in feet.

h = fall in length L , in feet.

s = grade of canal = $\frac{h}{L}$.

d = density of liquid.

W = weight of water in length L in pounds.

C & C_1 = constants.

Then:

$$\frac{F}{W} = \frac{h}{L}$$

or

$$F = \frac{Wh}{L}$$

and:

$$F_f = C_1 S d V^2$$

but

$$S = pL;$$

therefore

$$F_f = C_1 p L d V^2$$

but

$$F = F_f \text{ therefore } \frac{Wh}{L} = C_1 p L d V^2$$

from which:

$$V^2 = \frac{Wh}{C_1 p L^2 d} \text{ but } W = ALd$$

therefore:

$$V^2 = \frac{ALdh}{C_1 p L^2 d} = \frac{1}{C_1} \frac{h}{L} \frac{A}{p} = \frac{1}{C_1} sr$$

or,

$$V = \sqrt{\frac{1}{C_1}} \sqrt{rs} = C \sqrt{rs} \text{ (Chezy's Formula.)}$$

The coefficient C in Chezy's formula is dependent on the form of cross section, on the roughness of the channel surface, and very slightly on the grade. Several formulas have been derived to express C ; those most commonly used are Kutter's formula and to a smaller extent Bazin's formula. Kutter's formula is that exclusively used in the United States and in India; it has the following form:

$$C = \frac{1.811}{n} + 41.65 + \frac{0.00281}{s} \\ 1 + \frac{n}{\sqrt{r}} \left(41.65 + \frac{0.00281}{s} \right)$$

Although apparently complicated, extensive tables and numerous diagrams have been prepared which make the use of the formula very simple. "n" is the coefficient of roughness. The accuracy of the results depends on the selection of the value of "n." The following values are determined from the experiments of Ganguillet and Kutter, from more recent experiments

by Fortier, by various members of the U. S. Reclamation Service, and from a large number of miscellaneous experiments. For some of the special forms of conduit the value of " n " is followed by a statement of the number of measurements and range of values obtained.

Values of the Coefficient of Roughness " n " for Canals in Earth and in Rock.—1. $n = 0.015$.—For canals in indurated clay, soft shale, brule clay, in excellent condition, constructed with well-graded smooth surfaces, or worn smooth by the water, uniform cross section, regular alignment, free from sand, gravel, pebbles and vegetation.

2. $n = 0.016$.—For canals, coated with a heavy layer of silt or sediment, in excellent condition, uniform cross section, regular alignment, free from sand, gravel, pebbles and vegetation. This may be obtained with silt-carrying waters, or where the canal is in fine sedimentary silt soil.

3. $n = 0.0175$.—For canals well coated with sediment or in stiff tenacious clay soils; in volcanic ash soils; in hardpan in good condition, constructed with well-graded surfaces or worn slick and smooth by the water; uniform cross section, regular alignment, free from gravel, pebbles, cobbles or vegetation.

4. $n = 0.0200$.—For canals in clay loam; in worn smooth adobe; in firm sandy loam soils; in well-graded cemented gravel; in compact small gravel; in good average condition, uniform cross section, regular alignment, free from large gravel, with little loose gravel, pebbles or sand, and practically free from weeds and moss.

5. $n = 0.0225$.—(a) For canals in sandy and clay loam soils, in average condition, small variations in cross section, fairly regular alignment, small amount of gravel, or a few small cobbles, few aquatic plants, thin growth of grass along edges and a little moss.

(b) For canals in volcanic ash soils; or lined with sediment or silt; in fair condition with vegetation along the banks, near water edges only, and a little moss.

(c) For canals newly cleaned, plowed and harrowed.

6. $n = 0.025$.—(a) For canals in mixed compact gravelly soil or gravel, ranging up to about 3 inches in diameter; in loose sandy soils, forming sand dunes or ripples on the bottom, in average fair condition; wavy banks with vegetation in the shallow water near the edges.

(b) For canals in sandy loam, and in clay loam a little below average fair condition, with overhanging sodded banks, roots or weeds along the edges trailing in the water.

(c) For loose slate or shale rock, with projections of 3 to 6 inches.

7. $n = 0.0275$.—(a) For canals in loose, large size gravel up to 6 inches in diameter; in disintegrated rock or rough hardpan, with small scattered fragments.

(b) For canals in earth below average fair condition; variations in cross section, with eroded indentations on the sides, and either with scattered rocks or a few cobbles or loose gravel on the bottoms, or with considerable weeds or vegetation on the sloping banks.

8. $n = 0.030$.—(a) For canals in rough gullied hardpan with eroded irregular cross section, blast holes. For canals in seamy granite, or broken slate with projections of 3 to 12 inches.

(b) For canals in earth in poor condition, irregular cross section, with few aquatic plants and moss on the bed and overhanging trailing weeds, or vegetation on the sides.

9. $n = 0.035$.—For canals in large size loose gravel and cobbles, or in earth in poor condition, badly eroded irregular cross section, indented with cattle tracks, partly filled with vegetation on the sides and moss.

10. $n = 0.040$.—(a) For canals with rough scoured beds, with cross section about half filled with aquatic plants.

(b) For canals with uneven surfaces of loose large size cobbles.

(c) For canals with grass and brush slopes.

11. $n = 0.050$.—For canals with bottoms entirely covered with dead moss, or entirely grass lined, with scattered aquatic plants on the bottoms and long moss trailing on the bottoms and sides.

12. $n = 0.075$.—For canals in very poor condition; thick vegetation on the banks trailing in the water, and dense growth of aquatic plants on the bottoms.

13. $n = 0.100$.—For canals with channels completely filled with cat tails, scattered willows, and trailing moss, with considerable dead water.

Canals in earth should not be allowed to reach a condition where n is greater than 0.0275; if kept in good average condition, n will usually range from 0.020 to 0.025. For purposes of computation, when the desired velocity approaches the erosive velocity, it is preferable to use a value of n slightly too small,

rather than too large, because if the selected value of n is larger than that which is actually obtained, then the actual velocity will be greater than the desired velocity, the increase being very nearly proportional to the decrease in the value of n ; for instance, if the selected value of n is 0.025 and the grade is determined for a corresponding desired velocity of 2.00 feet per second, then if the actual value of n is 0.020, the velocity will be about 2.50 feet per second.

The value of n must be selected for the material and the factors affecting the roughness; the indiscriminate use of a single value for all canals, such as $n = 0.025$, has resulted in serious erosion on some canals or sections of canals with a deposit of eroded material in other sections. The practice has been toward the use of too large values for n . The large value which is ultimately obtained is frequently the result of the erosion produced by the use of such large values. That this has been recognized in India is indicated by the following statement by R. B. Buckley: "Formerly the value of $n = 0.025$ was usually adopted in India; now $n = 0.0225$ is often taken on small channels and $n = 0.020$ on large canals."

On the other hand, where the climatic conditions and other factors are favorable to the growth of vegetation in the canals, and where there is no danger of erosion, it may be desirable to use a value of n of .025 or even .0275 to be able to carry a full flow during the period of maximum demand where the growth of vegetation is greatest.

Values of the Coefficient of Roughness "n" for Concrete-lined Canals and Concrete Flumes.—1. $n = 0.012$.—(a) For concrete-lined canals having smooth hard mortar finish, similar to sidewalk surface, uniform cross section built to templet, joints smooth and flush with surface, long tangents, no curves for velocities exceeding about 4 feet per second and flat tapered curves for velocities under 4 feet.

(b) For concrete flumes or concrete-lined canals built with wet concrete mixture, poured between and carefully spaded against new planed matched lumber, painted smooth with cement grout or plastered smooth with trowelled cement mortar, and for same alignment conditions as above.

2. $n = 0.0125$.—(a) For flumes or concrete lining built of separate sections or slabs moulded or cast in steel forms and joined in place.

(b) For concrete-lined canals, built without forms, but screed with rich grout to true surfaces; smooth joints even with surfaces, and for alignment conditions as in (1).

3. $n = 0.013$.—For concrete-lined canals or flumes, built with forms and partly trowelled or floated with cement mortar and for alignment conditions as in (1).

4. $n = 0.014$.—For concrete-lined canals placed without forms, screed to true surfaces and floated to give a fairly smooth sand finish, for alignment conditions slightly inferior to those in (1).

5. $n = 0.015$.—For concrete-lined canals built with forms of planed lumber, partly roughened in construction, not plastered or grouted, for alignment conditions slightly inferior to those in (4) with a few sharp curves up to about 100 feet radius and 7 feet velocity. For linings as in (1), (2) and (3), with bottom partly covered with sand or gravel.

6. $n = 0.016$.—For concrete-lined canals built with forms of rough lumber, no other finish, and for other conditions as in (5).

7. $n = 0.017$.—For concrete-lined canals built without forms, rough construction, with wavy surfaces or shaped fairly smooth by tamping with the backs of shovels.

8. $n = 0.018$.—For concrete-lined canals as in (7) with considerable sand or gravel on the bottom, or as in (5) and (6) with slime or moss deposit.

Values of the Coefficient of Roughness "n" for Retaining Wall Canal Cross Sections in Rock.—This type of conduit is used on steep side-hill work, and forms a bench flume consisting of the natural excavated rock surface for the uphill side; a concrete retaining wall on the downhill side, with the floor in between, either left as excavated or lined with concrete.

1. $n = 0.020$.—For retaining wall cross section, with smooth concrete wall, floor lined with concrete, and clean; uphill rock side without sharp projecting points; no sharp curves.

2. $n = .025$.—For retaining wall cross section, with smooth concrete wall, floor covered with sand or gravel, or left as excavated, without projections; uphill rock side with a few projecting points, such as obtained with careful excavation in hard rock.

Values of Coefficient of Roughness "n" for Wooden Flumes.—

1. $n = 0.0115$.—For wooden flumes of surfaced lumber, when new and in excellent condition, boards all longitudinal, either smooth battens or smooth joints with no projecting calking, straight

alignment, no curves, no angles, no silt or deposit (average of 8 flumes ranging from 0.0112 to 0.0129).

2. $n = 0.0125$.—For wooden flumes of surfaced lumber, when new and in excellent condition, same as above, except slightly inferior or with flat curves or change in alignment by small angles, or straight with smooth coat of tar; no silt or deposit (average of 6 flumes, ranging from 0.01186 to 0.0127).

3. $n = 0.0130$.—For wooden flumes of surfaced lumber in average good condition, or of rough lumber worn smooth by sediment and fine sand in water; straight in alignment, no silt or deposit (average of 7 flumes, ranging from 0.0118 to 0.0149).

4. $n = 0.0150$.—For wooden flumes of surfaced lumber in poor condition, over 10 years old, or with numerous changes in alignment made by sharp angles with short tangents (200 feet or less), or with old transverse flooring (average of 7 flumes, ranging from 0.0142 to 0.0155).

5. $n = 0.0160$.—For wooden flumes of rough lumber when new and not worn smooth or with many short tangents (average of 7 flumes, ranging from 0.0149 to 0.0167).

6. $n = 0.0180$.—For wooden flumes in poor condition, rough asphalted, or projecting calking, or thickly slimed (average of 4 flumes, ranging from 0.0163 to 0.0196).

7. $n = 0.020$.—For wooden flumes with floor nearly covered with sediment, sand, gravel, or scattered rocks, or with considerable slimy moss (average of 3 flumes, ranging from 0.0191 to 0.0217).

In all of the above flumes in which a deposit of sand, gravel, cobbles or rock was obtained, the velocity was less than 3 feet per second.

Values of Coefficient of Roughness "n" for Semicircular Sheet Steel Flumes.—1. $n = 0.0115$.—For steel flumes, with countersunk joints flush with smooth interior surface; no silt or sediment. (The average of 8 measurements on different flumes, ranging from 0.010 to 0.0126, average 0.01116, velocities ranging from 1.66 to 6.00 feet per second.)

2. $n = 0.013$.—For steel flumes, with projecting bands or ribs at each joint; no silt or sediment; for velocities under 2 feet per second (average of 4 measurements).

3. $n = 0.016$.—For steel flumes, with projecting bands or ribs at each joint; no silt or sediment; for velocities from 2 feet to 3.50 feet per second (average of 4 measurements).

4. $n = 0.018$.—For steel flumes, with projecting bands or ribs at each joint; no silt or sediment; for velocities from 4 feet to 6 feet per second (average of 5 measurements).

5. $n = 0.022$.—For steel flumes made of corrugated sheets (velocity 1.91, three measurements).

Values of Coefficient of Roughness “n” for Pipes.—Kutter’s formula was originally intended for open channels and not for pipes. It is, however, often used for pipes, and the accuracy of the results will be satisfactory if its use is based on values of n obtained for nearly identical conditions of smoothness, velocity and diameter. The value of n is not constant, but in general has been found to increase with an increase in the diameter and to decrease with an increase in velocity. The values of n given below for wooden stave pipes are the approximate interpolated averages of the numerous measurements reported by E. A. Moritz, several by Messrs. Marx, Wing and Hoskins, and a few by others. Those for concrete pipes are those reported from measurements made on the Umatilla project, Oregon, and on the Tieton project, Washington. Those for cast iron and steel pipes are those commonly given in text-books.

VALUES OF “n” FOR WOODEN STAVE PIPES

Velocity	Diameter in inches								
	6 in.	8 in.	14 in.	18 in.	22 in. ¹	44 in.	54 in.	55½ in.	72 in.
1	.0104	.0109	.0111	.0109	.01070140
2	.0101	.0103	.0109	.0105	.01200130	.0111	.0134
3	.0100	.0100	.0106	.0103	.0126	.0135	.0125	.0108	.0132
400980131	.0122	.0108	.0130
50129	.0120

Mr. A. Swickard, after a consideration of all available data, recommends the following formula:

$$n = \frac{D}{30,000} + 0.0105$$

where D represents the inside diameter of the pipe in inches.

Values of “n” for Concrete Pipes.—1. $n = 0.0112$.—For 46-inch reinforced concrete pipe, made of a wet mixture poured in metal

¹ Pipe line has one sharp vertical curve. The 44 inch and 54 inch were reported as badly distorted.

moulds, built in sections 8 feet long and joined in the trench (average of 4 measurements with velocities between 3.98 and 4.21 feet per second).

2. $n = 0.0109$.—For 30-inch reinforced concrete pipe made of a wet mixture poured in metal moulds, built in sections 4 feet long, and joined in the trench (average of 4 measurements with velocities between 2.78 and 3.61).

3. $n = 0.0135$.—For 8-inch to 16-inch plain concrete pipe made of a comparatively dry mixture, tamped in metal moulds, in sections 2 feet long, and joined in the trench (average of 7 measurements).

Values of "n" for Riveted Steel and Cast-iron Pipes.—Riveted steel pipes are used only to a comparatively small extent in irrigation work, and cast-iron pipes are practically never used, except for short culverts or similar purposes. The carrying capacity of both is much affected by tuberculation and incrustations, liable to occur with age. A comparison of measurements shows that for a riveted steel pipe, smooth on the interior, the value of n is about 20 to 25 per cent. greater than the corresponding value for wooden pipe, and that for a smooth cast-iron pipe the value of n is approximately the same as the corresponding value for wooden pipes. The allowance required to provide for the decrease in carrying capacity in steel and cast-iron pipes, due to tuberculations and incrustations, is referred to later in this chapter. No decrease in capacity has been observed in wooden pipes.

Effect of Curvature on the Coefficient of Roughness "n".—The effect of curvature on the coefficient of roughness is of minor importance for low velocities, such as 2 to 3 feet per second, which are seldom exceeded in average earth canals; but for velocities exceeding these values, such as those which may be used in flumes and concrete-lined canals, the effect of curvature is of greater importance and should be considered in selecting the value of n . No definite relation has been derived between velocity, radius of curvature and the value of n . The effect of curvature is well illustrated by gaugings on different sections of a semicircular concrete-lined canal on the Umatilla project, Oregon. The diameter of the semicircular cross section is 9.8 feet, and the velocity was about 7 feet; the values of n were: $n = 0.0132$ on a tangent, $n = 0.0149$ on a 100-foot radius curve, and $n = 0.0189$ for two 50-foot radius reverse curves. The flow

in the curved sections was irregular with the water surface broken by waves and deflected currents.

Accuracy of Results Obtained by Chezy-Kutter's Formula.—The formula shows that the velocity depends on the coefficient of roughness, the hydraulic radius and the grade. A variation in the value of the grade affects the value of C , as obtained by Kutter's formula, only to a very small extent; the velocity, therefore, varies almost exactly with the square root of the grade. A variation in the value of n produces a very nearly equal proportionate inverse variation in the velocity. Therefore, the accuracy of the results will be dependent on the correctness of the value of n . For instance, if the grade is computed to give a desired velocity of 2.0 feet per second by using a value of $n = 0.025$, and the coefficient of roughness as actually obtained is 0.020, the corresponding velocity will be very nearly 2.5 feet per second. The design of canals or conduits must be based on a value of n selected to fit as nearly as possible the conditions which it is expected the canal will have not only when first constructed but in which it will be maintained. An accuracy in the selection of n closer than about 5 or even 10 per cent. cannot be reasonably expected; this will produce about the same degree of accuracy in the corresponding velocity. Consequently it is not necessary or desirable to carry the computations of canal sections to a degree of refinement which is not consistent with the degree of accuracy obtainable.

Diagram for Solution of Chezy-Kutter's Formula.—Several diagrams have been prepared to simplify the solution of problems by Chezy-Kutter's formula. Of these the diagram prepared by L. I. Hewes and J. W. Roe (Fig. 7) has the advantage of simplicity and will give a degree of accuracy consistent with the results obtained in practice.

DESIRABLE MAXIMUM AND MINIMUM VELOCITIES IN CANALS

The velocity of water in canals must not exceed a certain value, or *maximum velocity*, beyond which it would erode the bottom and sides of the canal, place the canal deeper in cut, lower the water surface to such an extent as to make it difficult to divert water from the canal and endanger the foundation of bridges and other structures by undermining. On the other hand it is desirable that the velocity be not smaller than a certain *minimum velocity* required to prevent the excessive growth of aquatic

plants and also the deposition of silt in the canals. The maximum velocity depends on the erosive power of water and is that required to overcome the adhesion between particles and to move or lift the separated particles. It must be distinguished from the velocity required to transport the loosened particles or particles held in suspension by the water. The resistance to erosion depends largely on the texture of the material and on the size of the particles. The greater the amount of clay in a soil, the greater will be its resistance to erosion, but clay particles when loosened and disseminated in the water can be moved along with a small transporting velocity. In such a case the difference between erosive velocity and transporting velocity will be large while in sandy or gravelly soil with little or no clay the erosive velocity will approach the transporting velocity. The erosive power of water varies with the square of the velocity. Values frequently given as safe maximum velocities are taken from various interpretations and quotations of values originally obtained from Du Buat's experiments (published in 1786), to which have been added in some cases a few additional values of erosive velocities reported by other early writers on hydraulics.

Du Buat's values represent transportation velocities of loose material and material already in motion and not erosive velocities, and these are therefore given further as transportation velocities. *Safe maximum values of mean velocities* are tabulated below. These are obtained from a careful compilation of data presented by various authors of irrigation works, especially: Irrigation Canals and Other Irrigation Works, by P. J. Flynn; Irrigation Works of India, by R. B. Buckley; Roorkee Treatise on Civil Engineering Irrigation Work in India, by J. C. Clibborn; and of miscellaneous observations on a large number of irrigation canals. They are values of mean velocity which practice has shown to be maximum values for safety against erosion, or values obtained on canals, in which velocities which originally were excessive have been reduced to a safe value by the flattening of the grade resulting from erosion. Mean velocities are given, as these are generally used in computations. Bottom velocity is approximately 75 per cent. of the mean velocity.

The values given for concrete are safe for water carrying small amounts of fine sand; where the water carries coarse sand the velocity should probably not exceed 10 or 12 feet per second, while for clear water there is practically no definite limit for

DIAGRAM FOR THE COMPLETE SOLUTION OF KUTTER'S FORMULA

$$V = \left[\frac{41.08 + \frac{1.481}{n} + \frac{0.000148}{S^{0.0475}}}{1 + \left(41.08 + \frac{1.481}{n} + \frac{0.000148}{S^{0.0475}} \right) \sqrt{R}} \right] \sqrt{RS}$$

DESIGNED BY
W. H. ROO,
YALE UNIVERSITY
SHEFFIELD ROBERTS SCHOOL
NEW HAVEN, CT.

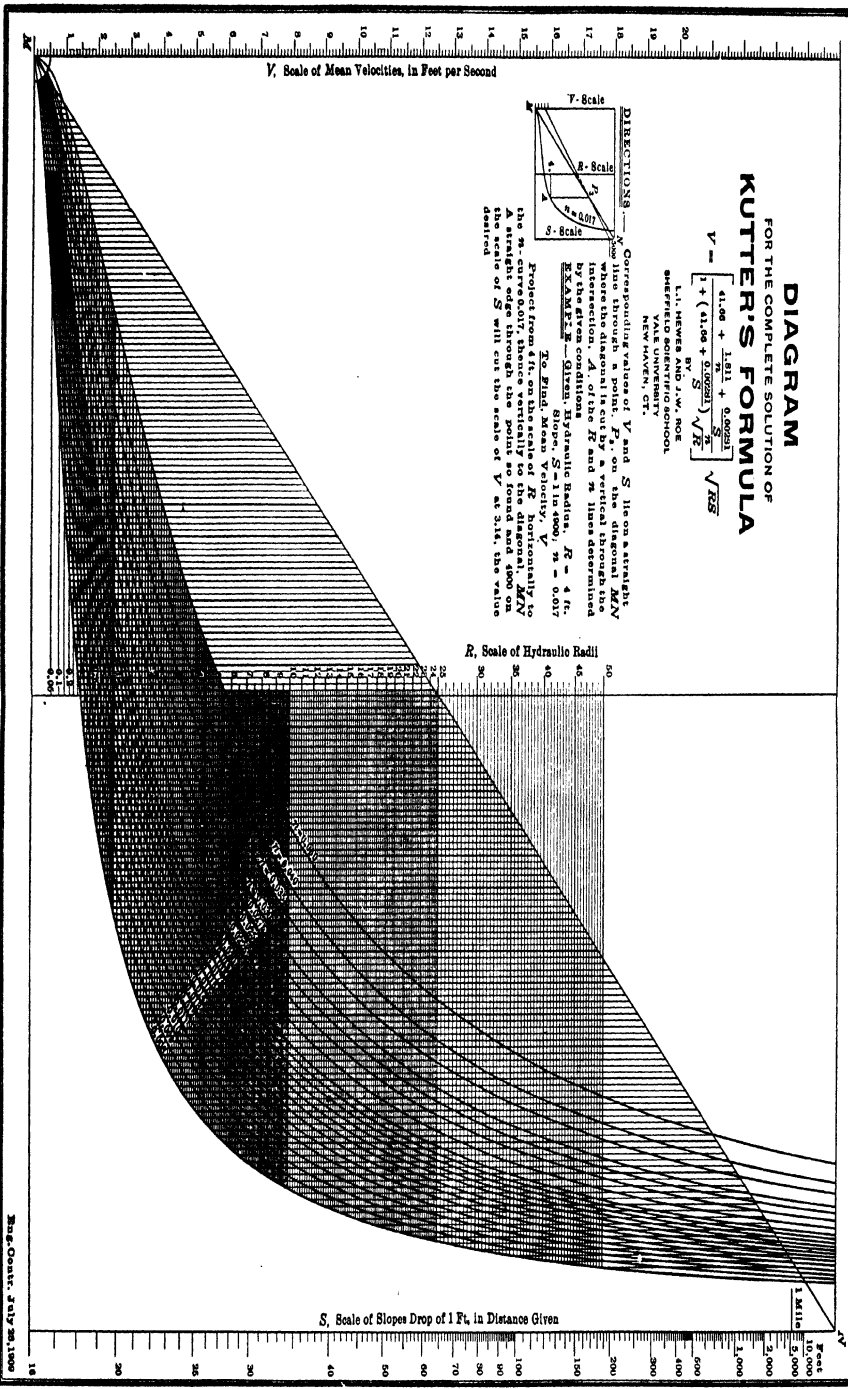
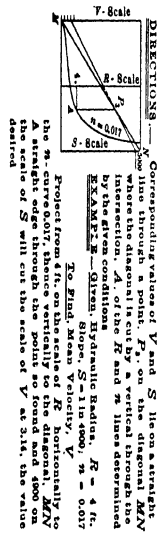

Fig. 7.—Diagram for solution of Chezy-Kutter's formula by Hewes and Roo.

MAXIMUM MEAN VELOCITIES SAFE AGAINST EROSION

Material	Mean velocity in feet per second
Very light pure sand of quicksand character.....	0.75- 1.00
Very light loose sand.....	1.00- 1.50
Coarse sand or light sandy soil.....	1.50- 2.00
Average sandy soil.....	2.00- 2.50
Sandy loam.....	2.50- 2.75
Average loam, alluvial soil, volcanic ash soil.....	2.75- 3.00
Firm loam, clay loam.....	3.00- 3.75
Stiff clay soil, ordinary gravel soil.....	4.00- 5.00
Coarse gravel, cobbles, shingles.....	5.00- 6.00
Conglomerates, cemented gravel, soft slate, tough hardpan, soft sedimentary rock.....	6.00- 8.00
Hard rock.....	10.00-15.00
Concrete.....	15.00-20.00

the maximum velocity. A. P. Davis, Chief Engineer of the U. S. Reclamation Service, in a paper on Safe Velocities of Water on Concrete (Engineering News, Jan. 4, 1912) gives the following illustrations of high velocities safely resisted by concrete: First, a velocity of 40 feet per second and more in a spillway chute of the Strawberry Valley project, Utah. Second, a velocity in excess of 20 feet per second in the South Canal of the Uncompagheree Valley project, Colorado. Third, velocities estimated at 75 to 90 feet per second, for a period of 6 months in a culvert tunnel through the Pathfinder reservoir.

The resistance of a concrete surface against erosion or wear is greater when the surface is smooth and comparatively rich in cement, such as when the cement is drawn to the surface by trowelling, or when the surface is painted with a rich cement grout or plastered with cement mortar.

The *minimum mean velocity* required to prevent deposits is dependent on the transporting power of water. A law of transporting capacity is that the diameter of bodies which can be moved varies as the square of the velocity, or that the weight varies as the sixth power of the velocity. This law applies, however, only to particles of the same shape and is only approximately correct. While of theoretical interest, it is of little practical value. The transporting velocities usually given are those originally obtained by Du Buat:

TRANSPORTING VELOCITIES IN FEET PER SECOND, BY DU BUAT'S EXPERIMENTS

Material	Bottom velocities at which		
	Transportation begins	Material is kept in motion	Silting begins
Dark clay fit for pottery (specific gravity 2.64)...	0.35	0.27
Coarse yellow sand (specific gravity 3.36).....	1.07	0.71	0.62
Small gravel size of anise seed (specific gravity 2.55)	0.53	0.35	0.27
Gravel size of pea (specific gravity 2.55).....	0.71	0.62	0.53
Gravel size of large bean (specific gravity 2.55)...	1.56	1.07	0.71
Round pebbles 1 inch or more (specific gravity 2.61)	3.20	2.14	1.56
Angular flint, egg size (specific gravity 2.25).....	4.00	3.20	2.14

These results were obtained by experiment in small rectangular and trapezoidal wooden troughs.

Transporting velocities obtained on the Loire River in France are as follows:

Bottom velocities in ft. per. sec.

Gravel 0.04 inch diameter.....	1.64
Gravel 0.16 inch diameter.....	3.28
Gravel 0.39 inch diameter.....	4.92
Gravel 0.67 inch diameter.....	6.56

The general process of transportation is a very complicated phenomenon, for which definite rules have not as yet been determined. The general term, silt or sediment, usually includes not only the finer silt or sediment but sand, gravel or other material carried by the water. The process then involves two methods of transportation: The greater part of the finer material is carried in suspension in the water and the coarser material is moved or transported along the bottom as bed silt or bed load. Extensive investigations have been made to study the phenomena of transportation. Those recently made by G. K. Gilbert of the U. S. Geological Survey are especially applicable to the transportation of bed load. Those of Deacon and Lechalas are concerned with the general process of transportation. Those of R. G. Kennedy are largely based on experiments of the transportation of silt in suspension.

The transportation of bed load is of greater importance in its application to the design of scouring sluices and sand boxes.

As it is not usually feasible or desirable to so design the canals that the coarser material be carried through the system and deposited on the irrigated lands, the main object should be to keep the coarser sediment out of the system or to remove it from the canals as soon as possible.

The transportation in suspension of the finer silt by selection of velocities, which will carry the silt through the canal system and deliver it on the irrigated lands, is desirable for all silts having fertilizing value.

G. K. Gilbert found that the transportation of bed load is a combination of the separate movement of the particles and of a collective movement, which he summarizes as follows: "Some particles of the bed load slide, many roll; the multitude make short skips or leaps, the process being called saltation. Saltation grades into suspension. When particles of many sizes are moved together, the larger ones are rolled. When the conditions are such that the bed load is small, the bed is moulded into hills, called dunes, which travel downstream. Their mode of advance is like that of Eolian dunes, the current eroding their upstream faces and depositing the eroded material on the downstream faces. With any progressive change of conditions tending to increase the load, the dunes eventually disappear and the debris surface becomes smooth. The smooth phase is in turn succeeded by a second rhythmic phase, in which a system of hills travel upstream. These are called antidunes, and their movement is accomplished by erosion on the downstream face and deposition on the upstream face." Mr. P. M. Parker in his book on "The Control of Water" reviews the experiments made by Deacon and Lechalas, and from their results and his own observations obtains the following rules, in which v is the mean velocity in feet per second and d the depth of water in feet:

1. For fine silt, with mean diameter of about 0.01 inch:
Heavily silted water gives no deposit if v exceeds $1.05\sqrt{d}$.
2. For coarse sand, say with a mean diameter of about 0.04 inch:
Heavily charged water gives no deposit if v exceeds $2.2d^{0.33}$.
3. For coarse gravel, say pea size:
Heavily charged water gives no deposit if v exceeds $2.5d^{0.25}$.
4. Boulders are moved along if v exceeds $5d^{0.25}$.

It is added that these results are only approximate, and except for the first two cases, rest on very slender experimental evidence. The last rule would seem to give a velocity too small

to move anything larger than coarse gravel or small cobbles about egg size.

The transportation of any material coarser than silt or fine sand is of comparatively little importance on a properly designed irrigation system. The headworks of the system can usually be designed and operated to take in the canal nothing coarser than the material carried in suspension by the river water; or sand sluices and sand traps are placed along the canal line, usually toward the upper end of the diversion canal, to dispose of the coarser material. With these provisions, unless excessive velocities causing erosion are used on sections of canals, comparatively little coarse material will have to be transported.

The finer material or silt must usually be kept in suspension and delivered on the irrigated land. The importance of silt transportation, for systems diverting water heavily loaded with silt, has led to extensive investigations on systems in Egypt and India, resulting in a number of remedies or solutions. Sir William Wilcocks states that any appreciable deposit is prevented by a mean velocity of 2.30 to 3.30 feet per second. The extensive investigations of R. G. Kennedy show that the required mean velocity is dependent on the depth of water, and should not be less than that obtained by the formula:

$$v = cd^{0.64}$$

where v = velocity in feet per second, d = depth of water in feet, c = a coefficient varying with the character of silt between about 0.82 to 1.07. This formula has been well tested in practice and is extensively used in India.

Except for systems diverting river waters heavily loaded with silt, such as those from the lower Colorado River in Arizona and California, the Salt and Gila Rivers in Arizona and from other rivers mainly in Arizona, New Mexico and Texas, the majority of systems in the United States divert water comparatively free from silt, in which cases silt troubles are usually the result of local erosion on certain sections of the canals where the velocity is excessive, with a deposit at other sections of the canals where the velocity is too small. The result of experience in the United States indicates that a velocity of 2 to 3 feet will prevent objectionable deposits of silt.

A more complete study of silt problems in the design of irrigation systems is presented in a following chapter.

**VELOCITIES REQUIRED TO PREVENT THE GROWTH OF
AQUATIC PLANTS AND MOSS**

The velocity required to prevent the growth of weeds and aquatic plants and the occurrence of moss is dependent on the character of vegetation and on the extent to which the conditions favorable to their growth are obtained. On canals such as smaller distributaries and farm ditches operated intermittently, in which the water is turned in only for a short time, not more than a few days at a time, the period of submergence may not be long enough to drown out or kill the ordinary weeds and grasses, and these will grow rapidly, especially during the period that water is out of the ditch. On the other hand these conditions will prevent the growth of real aquatic plants, but will not free the water from the moss carried down from the main canals and laterals.

The growth of aquatic plants and moss is usually most troublesome where the following favorable conditions are obtained: (1) Clear, warm, shallow water. (2) Small velocity. Algæ and moss do not begin to develop to any extent unless the temperature of the water is 65 to 70 degrees. Turbid waters or deep waters interfere with the action of sunlight and are unfavorable to plant growth.

In small canals under 2 feet in depth and with a mean velocity of flow less than 1.5 and in some cases 2 feet per second, the entire cross section, if not properly cleaned out at intervals, may become entirely filled with aquatic plants and moss, so as to have its carrying capacity reduced to $\frac{1}{4}$ or less of its capacity when clean.

In large, deep canals the growth of aquatic plants is largely confined to the sides of the canal in the shallow water along the edges. Additional obstruction to the flow is frequently produced by the weeds, grass or alfalfa growing along the water edges, drooping and trailing in the water.

The growth of aquatic plants and the formation of moss are directly affected by the velocity of flow. The growth of grass and weeds on the beds and sides of small ditches carrying water intermittently for short periods may be indirectly affected by the use of a velocity sufficiently high to carry the seeds of plants through the ditches to the fields. On the distributaries of a new canal system in the Sacramento Valley, California, it was found that a velocity of 1.8 feet per second or greater prevented weed growth

in the water, and that below this velocity it was necessary to clean out the waterway before each irrigation.

S. Fortier concludes from a large number of observations on canal systems, mostly in Utah, that a mean velocity not less than $2\frac{1}{2}$ feet per second and preferably $2\frac{3}{4}$ feet per second is desirable to prevent aquatic plants, moss and silt deposits. P. J. Flynn states that in Spain velocities of 2 to $2\frac{1}{4}$ feet per second are considered necessary. The results of a large number of measurements of the velocity of flow in canals distributed in most of the states of the arid region, available to the writer, show many instances of growth of aquatic plants or moss for velocities lower than 1.5 feet per second, several for velocities of 1.5 to 2.0 feet per second, a few for velocities slightly greater than 2 feet per second and practically none for velocities greater than 2.5 feet per second.

FORMULAS FOR THE FLOW OF WATER IN PIPES

The formulas most generally used are:

1. Chezy's formula:

$$V = C\sqrt{RS}$$

where C = a coefficient increasing in general with the diameter and the velocity, and varying with the roughness.

It may be obtained approximately by Kutter's formula.

R = mean hydraulic radius in feet.

S = slope in decimals of a foot per foot.

2. Weisbach's formula:

$$h_f = f \frac{LV^2}{D2g}$$

where:

h_f = head lost in friction in the length L in feet.

f = coefficient of friction.

L = length of pipe line in feet.

V = mean velocity in feet per second.

D = diameter of pipe in feet.

g = acceleration due to gravity, usually taken as 32.16.

Weisbach's formula is essentially another form of Chezy's formula.

3. Exponential formulas of the general form:

$$V = C_e R^n S^m$$

where

C_e = a coefficient varying with the roughness but not with the velocity or diameter of the pipe.

Values of C for Chezy's formula and of f for Weisbach's formula are given in the standard text-books on Hydraulics for different kinds of pipes or degree of roughness, for different velocities and diameters. The values of C and f given by Hamilton Smith for cast-iron pipes are considered most reliable. The following values are taken from more complete tables:

APPROXIMATE VALUES OF f AND C TAKEN FROM H. SMITH, JR., TABLE SUITABLE FOR NEW SMOOTH PIPES

Diameter, inches	Mean velocity in feet per second							
	1		3		5		10	
	C	f	C	f	C	f	C	f
12	96	0.0279	109	0.0217	114	0.0198	121	0.0176
18	103	0.0243	116	0.0191	121	0.0176	129	0.0155
24	109	0.0217	121	0.0176	127	0.0160	135	0.0141
30	113	0.0210	125	0.0165	131	0.0150	139	0.0133
36	117	0.0188	128	0.0157	134	0.0143	143	0.0126
48	123	0.0170	134	0.0143	140	0.0131	150	0.0114
60	128	0.0157	139	0.0133	145	0.0122
72	132	0.0148	142	0.0128	148	0.0117
84	135	0.0141	145	0.0122	151	0.0113

For equal diameter and grade the velocity or discharge of a wooden stave pipe is about 3 per cent. greater than that of a smooth new cast-iron pipe, and of a new riveted steel pipe, asphalt coated, is about 20 per cent. smaller than that of a smooth new cast-iron pipe. The above values of C and f can therefore be applied to wooden stave and steel pipes as follow:

For wooden stave pipe use $1.03C$ and $0.94f$.

For new smooth riveted steel pipe use $0.80C$ and $1.44f$.

Allowance for the decrease in carrying capacity of cast-iron and riveted steel pipe, produced by tuberculation or incrustation, must be made, as indicated further.

Exponential formulas which give results very nearly equal to those obtained by the use of Hamilton Smith's coefficient for cast-iron pipe in Chezy's or Weisbach's formulas are:

Lampé's formula for smooth cast-iron pipes:

$$V = 77.68D^{0.694}S^{0.555}$$

Flamant's formula for smooth new cast-iron pipe:

$$V = 86.38D^{5/7}S^{4/7}$$

A recent set of exponential formulas has been developed by E. A. Moritz, which are essentially Lampé's formula with different values of the coefficient for the different kinds of pipe. These are as follows:

1. Moritz formula for wooden stave pipe:

$$V = 1.72 D^{0.7}H^{0.555} \text{ and } Q = 1.35D^{2.7}H^{0.555}$$

2. Moritz formula for smooth or new cast-iron pipe, and for smooth concrete pipe made of a wet mixture, cast in sections in metal moulds:

$$V = 1.67D^{0.7}H^{0.555} \qquad Q = 1.31D^{2.7}H^{0.555}$$

3a. Moritz formula for a new riveted steel pipe, and for concrete pipe made of a dry mixture, hand tamped in metal moulds:

$$V = 1.50D^{0.7}H^{0.555} \qquad Q = 1.18D^{2.7}H^{0.555}$$

The writer believes that the best available information on new riveted steel pipe shows that the coefficient (1.50) is too large, and that for steel pipes the formulas should be written (3b) $V = 1.34D^{0.7}H^{0.555}$ and $Q = 1.05D^{2.7}H^{0.555}$.

In these formulas H is the friction loss in feet per 1,000 feet. Formula (1) is based on a large number of measurements on wood stave pipe and promises to become a standard formula. By substituting for H its value in terms of S , formula (2) may be written $V = 77D^{0.7}S^{0.555}$, in which form it is practically the same as Lampé's formula. The application of formulas (2) and (3a) to concrete pipe is based on the limited number of experiments previously referred to in the discussion of "n" for pipes.

Because of the limitations of the accuracy of the formulas and to allow for possible decrease in capacity due either to deposits (specially with low velocities carrying silted water) or to vegetable growth, it is often desirable to design for carrying capacities 10 to 15 per cent. greater than the actual required discharge.

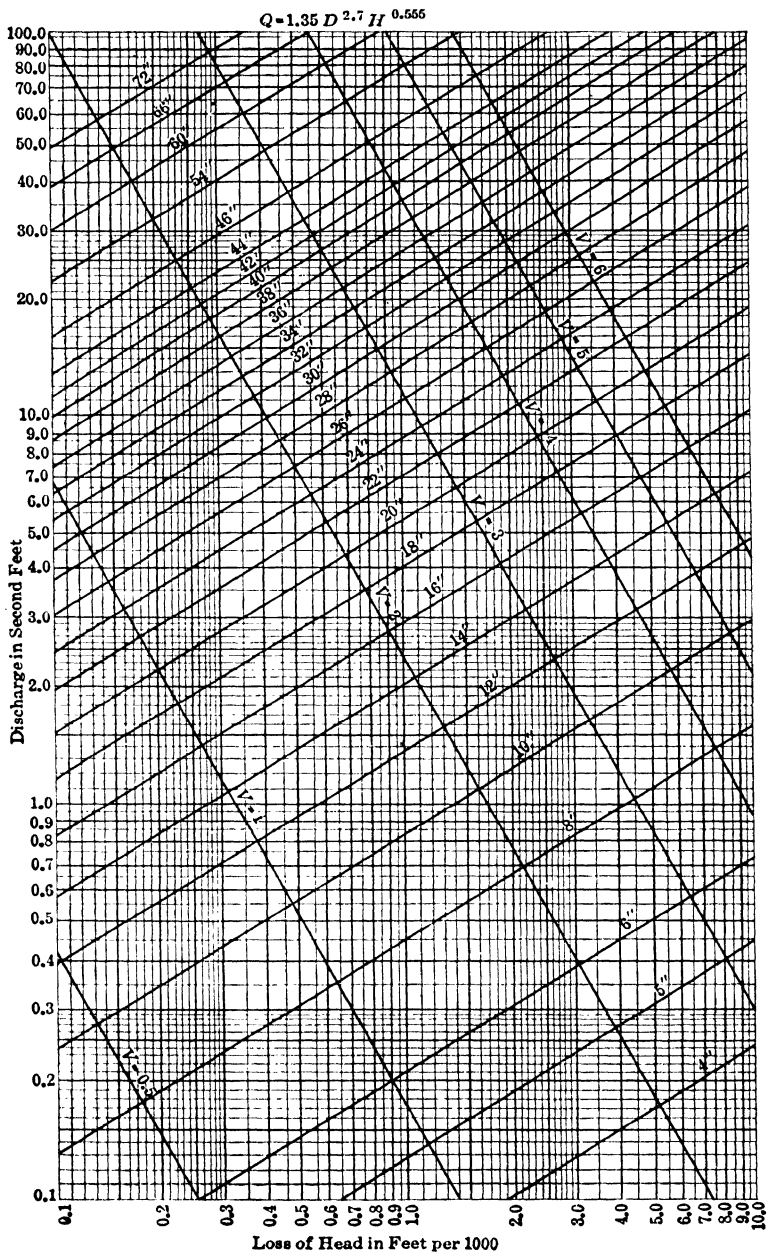

FIG. 8.—Diagram for the flow of water in wood-stave pipes, by E. A. Moritz.

NOTE.—From later and more extensive experimental data, Moritz concludes that his formula for wood stave pipe should be written:

$$V = 1.60 D^{0.7} H^{0.565} \text{ and } Q = 1.25 D^{2.7} H^{0.565}$$

This formula gives carrying capacities 7.6 per cent. smaller.

RELATIVE VELOCITY AND CAPACITY OF DIFFERENT PIPES

Kind of pipe	Corresponding formula	Based on cast iron	Based on wood stave pipe
Wood stave.	(1) $V = 1.72D^{0.7}H^{0.555}$	1.03	1.00
Cast iron, new & smooth	(2) $V = 1.67D^{0.7}H^{0.555}$	1.00	0.975
Concrete pipe, smooth made of wet mixture.	(2) $V = 1.67D^{0.7}H^{0.555}$	1.00	0.975
Concrete pipe, hand tamped.	(3 _a) $V = 1.50D^{0.7}H^{0.555}$	0.90	0.875
Riveted steel pipe, new & smooth.	(3 _b) $V = 1.34D^{0.7}H^{0.555}$	0.80	0.78

In the design of steel and cast-iron pipes it is usually desirable to allow for the decrease in carrying capacity resulting from tuberculation or incrustation. In Williams and Hazen's hydraulic tables it is assumed that the friction head increases 3 per cent. per year, and that the diameter decreases 0.01 inch per year. E. B. Weston suggests an increase in friction head of about 16 per cent. each 5 years over what it is at the beginning, but no allowance is made for a decrease in size of the pipe. Special cases of tuberculation are reported in the discussion of steel pipes in a following chapter.

Losses of Head in Pipes.—The above pipe formulas and Chezy-Kutter's formula give the friction head or the head required to overcome frictional resistance for conditions of uniform steady flow. This, however, is only part of the head required to produce the flow through a conduit, such as an inverted siphon, commonly used in irrigation work. The total head or difference in elevation between the inlet and outlet water surfaces must include: the friction loss in the conduit, other losses of head due to change in velocity or direction of flow, and the resultant net velocity head required to produce the velocity of flow. The conditions of flow for a case which involves all losses of head is illustrated by the accompanying sketch of an inverted siphon (Fig. 9). The total head consists of: (a) the friction head for each length of pipe; (b) a loss of head due to contraction at *B*; (c) a loss due to enlargement at *D*; (d) a loss of head due to the sharp bend at *C*; (e) an entrance loss at *A*; (f) an exit loss at *E*; and (g) the net velocity head. The velocity heads required to produce the increase in velocities at *A* and *B* are

$\frac{V_1^2 - V_0^2}{2g}$ and $\frac{V_2^2 - V_1^2}{2g}$, respectively; the velocity heads recovered at *D* and *E* are $\frac{V_2^2 - V_3^2}{2g}$ and $\frac{V_3^2 - V_4^2}{2g}$, respectively, and the net velocity head required to produce the flow will be $\frac{V_4^2 - V_0^2}{2g}$.

The losses of head are usually classified as follows:

1. The friction head or loss obtained by Weisbach's, Chezy-Kutter's, or other pipe formula of flow, expressed as follows:

$$h_f = f \frac{L}{D} \frac{V^2}{2g} \text{ or } h_f = \frac{V^2}{C^2 R} L$$

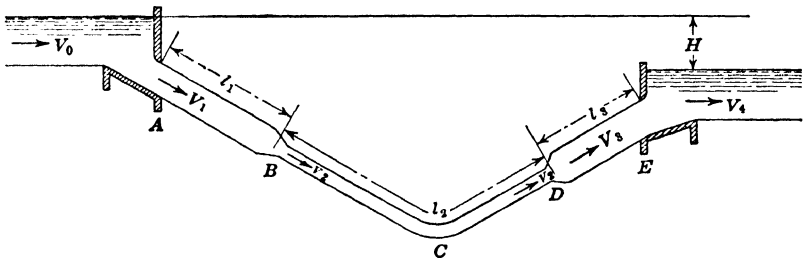

FIG. 9.

2. The loss of head by eddies at inlet of pipe, expressed as follows:

$$h_i = C_i \frac{V^2}{2g}$$

in which $C_i = 0.50$ for end of pipe set flush in a flat surface, with square corners = 0.04 to 0.15 for tapering, conical or bell-shaped entrance.

3. The loss of head by eddies at outlet of pipe, expressed as follows:

$$h_o = C_o \frac{V^2}{2g}$$

In practice it is generally assumed that when the outlet discharges into a comparatively large body of water the outlet velocity is entirely lost, in which case C_o is equal to 1.00.

When the outlet discharges into a canal or conduit, which is not much greater than the cross-sectional area of the pipe, the loss of head may be obtained on the same basis as for an enlargement.

4. The loss of head due to enlargement, expressed by:

$$h_e = C_e \frac{V^2}{2g}$$

in which V is the smaller velocity and

C_e for an abrupt enlargement with square corners = $\left(\frac{A_2}{A_1} - 1\right)^2$
 A_2 and A_1 are the cross sections of the smaller and larger pipes

C_e for a gradual tapering enlargement = $\left(\frac{A_2}{A_1} - 1\right)^2 \sin \theta$

θ is the central angle formed by the taper.

5. The loss of head due to contraction, expressed by:

$$h_c = C_c \frac{V^2}{2g}$$

in which V is the larger velocity.

For sudden contraction, the following values are given dependent on the ratio of the smaller to the larger area:

$\frac{A_2}{A_1}$	0.1	0.2	0.3	0.4	0.5	0.6	0.7	0.8	0.9	1.0
C_c	0.47	0.43	0.39	0.34	0.30	0.26	0.21	0.16	0.08	—

6. Loss of head due to bends, expressed by:

$$h_b = C_b \frac{V^2}{2g}$$

The value of the factor C_b has been shown by experiments to depend not only on the radius of curvature but also on the length of curve or angle of curvature. The results of experiments are complex and are mostly for small size pipes. The following values should be safe:

Ratio of $\frac{\text{radius of curvature}}{\text{diameter of pipe}}$	2	5	10
C_b	0.25	0.15	0.10

The Most Common Problems of Hydraulic Pipe-line Computations.—The most common problems of hydraulic pipe-line computations occurring in irrigation work are for inverted siphons and culverts. The inverted siphon usually consists of a pipe line of constant cross section and uniform smoothness, throughout its entire length, with inlet and outlet structures to make the connections with the open canal. For such cases there is no loss of head due to enlargements or contractions and

usually no loss due to bends. The equation for the total difference in elevation between the water surface at the inlet and outlet will then be:

$$H = \frac{V_4^2 - V_0^2}{2g} + C_i \frac{V^2}{2g} + C_o \frac{V^2}{2g} + h_f$$

Where H = total head

V_0 = velocity in channel upstream from the entrance or approach velocity.

V_4 = velocity in channel downstream from the outlet or exit velocity.

V = velocity in pipe line.

C_i and C_o = factors to determine entrance and outlet loss of head.

h_f = frictional loss in pipe line.

Generally V_4 and V_0 are comparatively small and about equal, and it is commonly assumed that the entire velocity head at the outlet is lost. The equation can then be written:

$$H = \frac{V^2}{2g} (1 + C_i) + h_f$$

If

$C_i = 0.50$, then:

$$H = 1.5 \frac{V^2}{2g} + h_f = (1.5 + f \frac{L}{D}) \frac{V^2}{2g}$$

or

$$H = 1.5 \frac{V^2}{2g} + \frac{V^2}{C^2 R} L$$

These simplified equations will give larger values of H than should be obtained with a properly rounded tapered entrance, and with well-proportioned inlet and outlet structures.

FLOW OF WATER THROUGH LARGE ORIFICES, TUBES AND GATES

The flow of water through gates for the conditions existing in irrigation structures is very different from that through standard orifices. The fundamental laws of flow are the same, but the coefficients entering in the formulas will vary considerably. The conditions existing for a gate in irrigation structures may in some cases approach those obtained in a large orifice with complete contraction on all four sides, but in most cases the contrac-

tion on the bottom and the two sides will be either partly or entirely suppressed and the orificè or gate opening will be subject to large variations in size and in velocity of approach. The greater part of hydraulic experiments have been made on small size orifices, while the gate openings generally used in irrigation work are comparatively large. In the following paragraphs are presented the fundamental formulas for orifices and a number of coefficients obtained from the rather limited number of reliable experiments on large orifices, tubes and gates. These coefficients must be used with caution, for they are only applicable where similar conditions exist. They will serve as a basis for the computations involved in the design of structures, but will not usually be adapted for the accurate measurement of water. The discussion of measuring devices is presented in the last chapter of Vol. III.

Standard Orifices.—The approximate general formula commonly used for flow through orifices in thin plates, or in thicker plates in which the edges are sharp, with complete contraction on all sides is:

$$1. Q = CA\sqrt{2gH}$$

where

C = coefficient of discharge.

A = area of opening in square feet.

H = head on the center of the opening in feet, for condition of free discharge.

= difference in upstream and downstream water levels for condition of submerged discharge.

This formula is only approximately correct. To allow for velocity of approach, the formula is written:

$$2. Q = CA\sqrt{2g\left(H + \frac{v^2}{2g}\right)} \text{ where } v = \text{velocity of approach.}$$

When, in the case of free discharge, the opening is large as compared with the head, the following formula for a rectangular opening is more correct:

$$3. Q = C\sqrt{2g}\left[\left(H_b + \frac{v^2}{2g}\right)^{3/2} - \left(H_t + \frac{v^2}{2g}\right)^{3/2}\right] l \times \frac{2}{3}$$

where

H_b = head on bottom edge of opening in feet

and

H_t = head on top edge of opening in feet.

The results obtained with formulas (1) or (2) differ by only about 1 per cent. from those obtained with formula (3), when the head on the center of the opening is equal to the height of the opening. In practice formulas (1) and (2) are generally used. The more usual conditions of flow through a gate in an irrigation structure is that of submerged discharge.

The values for the coefficient of discharge range in general from about 0.59 to 0.65 and have been largely obtained for circular orifices less than 1 foot in diameter, or square orifices smaller than 1 foot by 1 foot. The following values represent the average for the larger orifices:

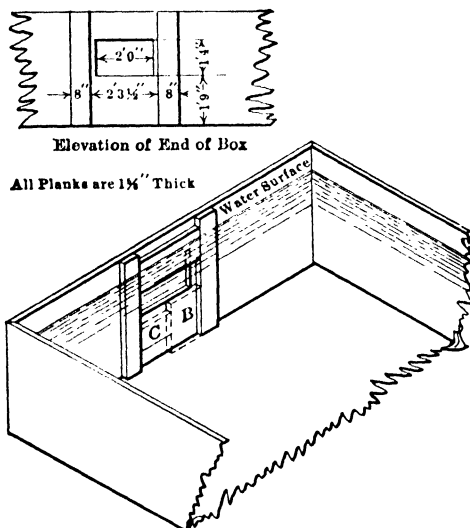

FIG. 10.—Isometric sketch of box. Forms of free discharge gate opening, to accompany results given by Unwin.

$C = 0.58 - 0.61$ for circular or square orifices.

$C = 0.61 - 0.63$ for rectangular orifices, where the width is equal to from 2 to 6 times the height.

Submergence decreases the above values from 0.5 to 1 per cent.

Standard Short Tubes and Short Pipes.—A standard short tube is formed of a cylindrical tube with the entrance end set flush with the face of a flat wall, forming square corners, and a length of $2\frac{1}{2}$ to 3 times the diameter. The formula for flow is the same as for an orifice, with $C = 0.82$.

For short pipes the following values are given by Merriman, Unwin, and Bellasis:

Length of pipe in diameters..	2	3	5	10	25	50	75	100
Coefficient.....	0.82	0.82	0.79	0.77	0.71	0.64	0.59	0.55

Rectangular Gate Openings, Free Discharge, Contracted Flow (Fig. 10).—The following values of the coefficient of discharge, taken from a large number of measurements, show the effect of the variation in the height of opening. The conditions of the orifice are shown in the accompanying sketch. Types *B* and *C* differ from type *A* in the addition of sill boards indicated in part by dotted lines. The boards are not thick and the conditions approach those of complete contraction and discharge through a thin plate. The measurements are given in full in the book on "The Control of Water," by P. M. Parker, in which they are apparently reproduced from tables presented by Unwin.

COEFFICIENTS OF DISCHARGE FOR GATE OPENING 2 FEET WIDE

Head measured from upper edge of gate in feet	Type <i>A</i> Height of gate opening in feet				Types <i>B</i> or <i>C</i> Height of gate opening in feet			
	1 31	0 66	0 16	0 10	1 31	0 66	0 16	0 10
0.328	0.598	0.634	0.691	0.710	0.646	0.666	0.665	0.695
0.656 to 1.968	0.614	0.640	0.683	0.693	0.656	0.676	0.691	0.708
3.28 to 9.84	0.600	0.636	0.672	0.675	0.621	0.673	0.692	0.699

Gate Openings with Submerged Discharge, Suppressed Side and Bottom Contraction.—Experiments, consisting of 45 measurements of discharge on 10 lateral concrete headgates of irrigation systems in Punjab, India, reported by J. Benton, Executive Engineer, give results which will be found applicable to the gate openings of many irrigation structures. The general position and proportions of the type of structure are shown in the accompanying sketch (Fig. 11); the gate fits in grooves made in the side walls, and when closed the lower edge of the gate rests on the concrete floor of the structure. The measurements of the upstream and downstream water levels were made in two stilling wells placed respectively at considerable distance from the inlet and outlet of the headgate structure; the difference between water levels was taken for the effective head, no correction being made for the velocity of approach, which, for the measurements taken

as indicated, must have been small. The gates included widths of 10 feet, 8 feet, 6 feet and 4 feet; the height of openings ranged from 0.20 feet to 3.20 feet, and the effective head from 0.072 feet to 4.85 feet. The formula derived from a careful analysis of all the results is

$$Q = C A \sqrt{2gH}$$

where A = the area of the gate opening H = the effective head

and $C = 0.720 + 0.0074w$, in which w = width of gate opening.

This formula was found to be not applicable when the effective head was less than 0.25 feet, unless the velocity of approach is negligible.

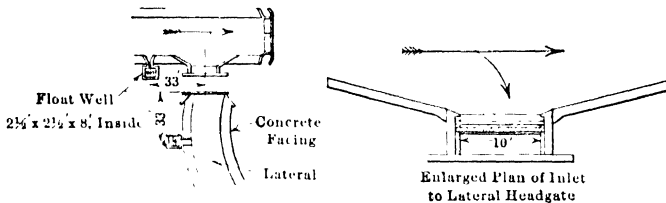

FIG. 11.—Type of lateral headgate on Punjab System, India, used in determination of coefficient of discharge.

The following values of C were found to satisfy the results for heads less than 0.25 feet and gates 10 feet wide:

Head in feet.....	0.24	0.21	0.18	0.15	0.12	0.09	0.06	0.03
Value of C for 10-foot gate	0.800	0.815	0.830	0.845	0.860	0.875	0.890	0.905

Large Gate Openings with Submerged Discharge, Suppressed Bottom and Side Contractions.—The following values are given by W. G. Bligh, for large gate openings, in which apparently the gate is placed in a channel formed by two side walls and a floor which suppress contraction on the sides and bottom and therefore produce a considerable velocity of approach.

$C = 0.90$ for narrow bridge openings, as canal heads and undersluices of small span, say 4 feet by 6 feet, with side walls.

$C = 0.94$ for large sluice openings with side walls, as wide undersluice openings of modern type (in India), 15 to 20 feet span.

$C = 0.96$ for wide openings, such as undersluices or escape heads of exceptional size; also wide bridge openings.

Large Tubes, 4 Feet Square, Submerged Discharge, with and without Contraction.—The following table of coefficients of dis-

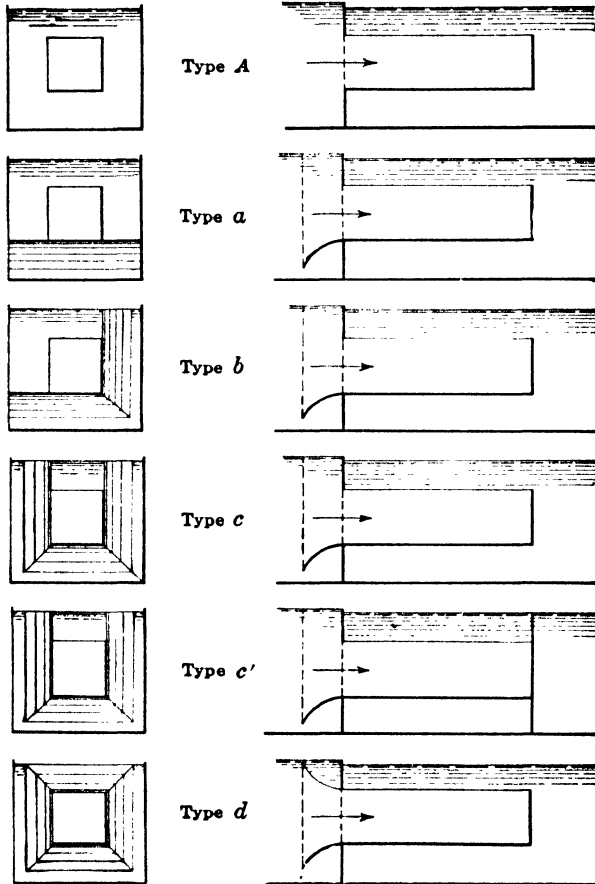

FIG. 12.—Forms of entrance of submerged tubes, 4 feet square, used in experiments made at University of Wisconsin.

charge gives the results of laboratory experiments made at the University of Wisconsin by C. B. Stewart, on large tubes 4 feet square, submerged and for the conditions of entrance shown in the accompanying diagram (Fig. 12). The results are not directly applicable to any one type of irrigation structure, but

will be useful in selecting suitable coefficients where the conditions approach those indicated by the table and diagram.

The velocity of approach was neglected in this set of measurements, but a parallel set of measurements in which the velocity approach was considered show that in these experiments it was small. The values of the coefficient are about 1 per cent. larger than those obtained by considering the velocity of approach.

REFERENCES FOR CHAPTER III

GENERAL WORKS ON HYDRAULICS:

- FLYNN, P. J.—Irrigation Canals and Other Irrigation Works—George Spaulding & Co., San Francisco, Cal.—1892.
- GANGUILLET AND KUTTER—Flow of Water in Rivers and Other Channels—Wiley & Sons, New York—1901.
- WILLIAMS, G. S. AND HAZEN, A.—Hydraulic Tables—Wiley & Sons, New York—1905.
- BOVEY, H. T.—Hydraulics—Wiley & Sons, New York—1906.
- LEA, F. C.—Hydraulics—Longmans Green & Co., New York—1907.
- UNWIN, W. C.—A Treatise on Hydraulics—Adams & Charles Black, London—1907.
- MOLITOR, D. A.—Hydraulics of River Weirs and Sluices—Wiley & Sons, New York—1908.
- GIBSON, A. H.—Hydraulics and its Applications—D. Van Nostrand Co., New York—1908.
- BELLASIS, E. S.—Hydraulics with Tables—Livingtons, London—1911.
- HUGHES & SAFFORD—Hydraulics—The Macmillan Co., New York—1911.
- HOYT & GROVER—River Discharge—Wiley & Sons, New York—1912.
- PARKER, P. M.—The Control of Water—D. Van Nostrand Co., New York—1913.
- BUCKLEY, R. B.—Irrigation Pocket Book—Spon & Chamberlain, New York—1913.
- MERRIMAN, M.—Treatise on Hydraulics—Wiley & Sons, New York—1904.

SPECIAL REFERENCES ON FLOW IN OPEN CHANNELS AND CONDUITS:

- FORTIER, S.—Conveyance of Water in Irrigation Canals, Flumes and Pipes—Water Supply Paper No. 43, U. S. Geological Survey, Washington, D. C.—1901.
- BABB, C. C.—An Experiment to Determine "N" in Kutter's Formula—p. 123 Engineering News—Feb. 1, 1906.
- LIPPINCOTT, J. B.—Observations to Determine the Value of "C" and "N" as Used in Kutter's Formula—p. 612 Engineering News—June 6, 1907.
- MERRILL, A. P.—Flow of Water in Open Conduits—p. 708 Engineering Record—Dec. 28, 1907.
- PRINCE, G. T.—A Logarithmic Diagram for the Flow of Water in Open Channels—p. 141 Engineering News—Feb. 6, 1908.

- Flow of Water in Steep Curved Flumes (Kern River Power Plant)—p. 705 Engineering News—Dec. 24, 1908.
- A Diagram for Bazin's Formula for Flow in Open Channels—p. 419 Engineering News—April 15, 1909.
- HEWES, L. I., AND ROE, J. W.—A Graphic Solution of Kutter's Formula—p. 77 Engineering and Contracting—July 28, 1909.
- DABNEY, A. L.—Economic Sections for Canals—p. 140 Engineering Record—Aug. 7, 1909.
- A Method for Determining the Most Economical Sections for Canals—p. 233 Engineering and Contracting—Sept. 15, 1909.
- HOPSON, E. G.—Gaugings in the Concrete Conduit of the Umatilla Project, Oregon—Engineering Record—Oct. 21, 1911.
- JOHNSTON, C. T.—A Formula and Diagram for Determining the Velocity of Flow in Ditches and Canals—p. 542 Engineering Record—Nov. 4, 1911.
- Diagram for Designing Trapezoidal Channels and Ditches—p. 647 Engineering and Contracting—June 5, 1912.
- KENNISSON, K. R.—A New Kutter Formula Diagram—p. 1191 Engineering News—June 20, 1912.
- SCHODER, E. W.—Kutter and Bazin Formulas, Notes on the Coefficient of Roughness—p. 351 Engineering News—Aug. 22, 1912.
- CUSHMAN, J. A.—Coefficient of Flow in Wachussett Aqueduct—p. 416 Engineering News—Aug. 29, 1912.
- HATCH, E. H.—Hydroelectric Power Plant in Chile—p. 357 Engineering Record—Sept. 28, 1912.
- Experimental Values of Kutter's Coefficient "N" for Open Channels—p. 141 Reclamation Record, U. S. Reclamation Service—July, 1913.
- FORTIER, S.—Concrete Lining as Applied to Irrigation Canals—Bull. 126 U. S. Dept. of Agriculture, Washington, D. C.—1914.
- SPECIAL REFERENCES ON VELOCITIES OF FLOW IN CHANNELS:**
- BURR, W. A.—Resistance of Soils to Erosion by Water—p. 124 Engineering News—Feb. 8, 1894.
- Scouring Velocities—p. 300 Engineering and Contracting—May 13, 1908.
- Safe Velocities of Water on Concrete—p. 20 Engineering News—Jan. 4, 1912.
- GILBERT, G. K.—The Transportation of Débris by Running Water—Professional Paper 86, U. S. Geological Survey—1914.
- GILBERT, G. K.—The Transportation of Débris by Running Water—p. 563 Engineering News—Sept. 10, 1914.
- SPECIAL REFERENCES ON FLOW IN PIPES:**
- MARX, WING, & HOSKINS.—Experiments on the Flow of Water in the 6-foot Steel and Wood Pipe Line of the Pioneer Electric Power Co. at Ogden, Utah—p. 471 Trans. Am. Soc. Civ. Eng., Vol. XL—1898.
- MARX, WING, & HOSKINS.—Experiments on the Flow of Water in the 6-foot Steel and Wood Pipe Line of the Pioneer Electric Power Co. at Ogden, Utah—p. 34 Trans. Am. Soc. Civ. Eng., Vol. XLIV—1900.
- GREGORY, J. H.—Diagram Giving Discharge of Pipes by Kutter's Formula—p. 415 Engineering Record—Nov. 3, 1900.
- NOBLE, T. A.—The Flow of Water in Wood Pipes—p. 112 Trans. Am. Soc. Civ. Eng., Vol. XLIX—1902.

- Diagram Giving Discharge of Pipes by Kutter's Formula—p. 349 Engineering Record—Sept. 17, 1904.
- The Discharge of a 12-foot Wood Stave Pipe—p. 244 Engineering Record—Feb. 26, 1910.
- Diagram for Velocities in Short Pipe—p. 600 Engineering Record—May 27, 1911.
- MORITZ, E. A.—Experiments on the Flow of Water in Wood Stave Pipes—p. 411 Trans. Am. Soc. Civ. Eng., Vol. LXXIV—1911.
- NEWELL, H. D.—Studies of Coefficient of Friction in Reinforced Concrete Pipe, Umatilla Project, Oregon—p. 904 Engineering News—May 1, 1913.
- SPECIAL REFERENCES ON FLOW IN LARGE ORIFICES, GATES AND TUBES:**
- Experiments on Gauging the Supply Entering Rajbahas by Means of the Headgates—Punjab Irrigation Branch Papers No. 8, Madras, India—1897.
- IRELAND, W. P.—Discharging Capacity of Culverts—p. 420 Engineering Record—April 2, 1904.
- Experiments with Submerged Tubes 4 feet Square—p. 352 Engineering Record—Sept. 28, 1907.
- STEWART, C. B.—The Flow of Water through Submerged Tubes, Results of Experiments at the University of Wisconsin—p. 35 Engineering News—Jan. 9, 1908.
- STEWART, C. B.—Investigation of Flow through Large Submerged Orifices and Tubes—Bull. 216 University of Wisconsin, Madison, Wisconsin—April, 1908.
- The Flow of Water through Submerged Screens and Baffles—p. 762 Engineering Record—Dec. 31, 1910.

CHAPTER IV

SILT PROBLEMS IN THE DESIGN OF IRRIGATION SYSTEMS

The occurrence of large amounts of silt in the water used for irrigation involves difficult problems. On irrigation canals it is necessary to minimize the excessive deposit of silt. In storage reservoirs the accumulation of silt continually decreases the storage capacity and in some cases limits the value of a storage reservoir to a comparatively short period. In an irrigation system it is usually desirable to permit the deposition of a small amount of silt in the canals because of its beneficial effect in decreasing seepage losses but where the amount of silt is considerable the excessive deposition of silt must be prevented, for the deposit must be removed at considerable expense and may have to be piled up on both banks of the canal where it may be a serious detriment. To prevent the excessive deposit of silt, the following methods are those commonly used:

First.—Design the diversion works on the stream and canal headgates so as to decrease the amount of silt carried by the water diverted in the canal.

Second.—Provide sand boxes or sand traps on the canal by means of which some of the silt and sand will be deposited or stopped and removed from the canal.

Third.—Design the canal sections, select and adjust the velocities, so that the silt will be carried through the canals and deposited on the land, where it will be beneficial if it has fertilizing value. The third method is usually the most efficient and is frequently used, supplemented in the case of excessive amounts of silt or in the case of coarse silt or sand by the use of the other two methods.

The amount of suspended matter carried by many streams used for irrigation in the United States is so small that it requires no consideration in the design of an irrigation system, but on some streams such as many in the southwest the silt problems are important; such streams are: the Colorado River, in its lower part in California and Arizona; the Gila River and to a smaller extent the Salt River, both tributaries to the Colorado

River in Arizona; the Rio Grande in New Mexico and Texas; the Pecos River in New Mexico; the Brazos River in Texas, and the Wichita in Texas.

The solution of silt problems must be based on a consideration of the extent and character of silt, on the distribution of silt in the water and on the silt transporting power of water.

Fertility of Silt.—The fertilizing value of silt is shown by the following analysis of silt carried by different rivers:

Professor Goss found that the silt content of the Rio Grande River from June, 1893 to June, 1894 averaged 0.831 per cent. by weight, which is equivalent to 22,606 pounds of silt per acre-foot of water and containing 31.4 pounds of phosphoric acid, 325.5 pounds of potash, and 24.4 pounds of nitrogen.

Professor R. H. Forbes found the following results: The silt in 1 acre-foot of water taken out by canals from Salt River from August 1, 1899 to August 4, 1900 contained an average of 10.5 pounds of phosphoric acid, 26.5 pounds of potash and 9 pounds of nitrogen; this is in addition to the soluble salts in the water. The silt in 1 acre-foot of Colorado River water from Jan. 10, 1900 to Jan. 24, 1901 contained from a minimum of 2.26 pounds to a maximum of 43.56 pounds of phosphoric acid, from a minimum of 16.34 pounds to a maximum of 444.60 pounds of potash, and from a minimum of 1.03 pounds to a maximum of 69.7 pounds of nitrogen. The maximum content was generally obtained during the period of maximum flow. The value of this silt is indicated from the following requirements to produce 1 ton of alfalfa as given by Prof. Goss: 42 pounds of nitrogen, 16.7 pounds of phosphoric acid, 33 pounds of potash.

Amount of Silt in Irrigation Waters; Methods of Determination and Variations Due to Condition of Silt.—The amount of silt in proportion to the water by which it is carried is expressed in two ways: *First*, as a per cent. by weight; *second*, as a per cent. by volume. The first form of expression is preferable because it is more accurate. The weight of silt is obtained by evaporating a certain volume of water and drying the sediment by artificial heat, at a temperature of 110° Centigrade maintained for an hour. The second form of expression is not accurate, because of the varying degree of compression of the silt under different conditions. The per cent. by volume is usually obtained by measurements of the volume of silt settling at the bottom of a vessel containing a given volume of water. The method used

by the Irrigation Investigations of the U. S. Department of Agriculture consisted in filling a glass tube with a given volume of the silty water and measuring the volume of silt in the bottom of the tube at the end of a week of settlement. The length of the period of settlement and the depth of silt deposited will affect the degree of compression and therefore the weight per cubic foot of silt. The per cent. by volume obtained by this method gives the per cent. of wet silt saturated with water, a cubic foot of which will contain only a fraction of a solid cubic foot of dry silt.

The specific gravity of silt, from the Colorado, Gila and Salt Rivers, was found by R. H. Forbes to average 2.643; this value gives for the weight of a cubic foot of silt, compacted to the condition of solid rock, 165 pounds. But as ordinary fine silt soil will contain about 50 per cent. voids, the weight of a cubic foot of compacted drained silt will be about 85 pounds. When wet, the silt occupies a larger volume and a cubic foot of silt mud, such as deposited in canals and reservoirs has been found to contain only about 50 pounds of dried silt and when saturated with water, such as obtained by the method of determination of the U. S. Department of Agriculture, a cubic foot of saturated silt contains from about 20 pounds to 30 pounds of dried silt, depending on the period of settlement.

The relation between the per cent. by volume of saturated silt and the per cent. by weight of dry silt is shown by the measurements of Prof. Nagle in Texas and R. H. Forbes in Arizona. Prof. Nagle obtained the following average results from several samples taken on the Rio Grande and Brazos Rivers in 1900, 1901, 1902 and on the Wichita River in 1900 and 1901.

COMPARISONS OF SILT DETERMINATION BY VOLUME OF SATURATED SILT AND BY WEIGHT OF DRY SILT

Stream and locality	Wet silt by volume end of 1 week	Dry silt by weight	Ratio
	per cent	per cent	
Rio Grande at El Paso, Texas.....	10.808	2.976	3.632
Brazos River at Jones Bridge, Texas...	1.935	0.6481	2.986
Wichita River at Wichita Falls, Texas.	1.555	0.704	2.210

R. H. Forbes made investigations on the silt carried by the Gila River in Arizona. The measurements were made by

the method used by Prof. Nagle and for different periods of settlement; the results are the average of samples taken at five different dates in August and September, 1900. The per cent. by weight of dry silt averaged 5.89; the average values for the ratio between the per cent. by volume of wet silt to per cent. by weight for periods of settlement of 1 day, 7 days, 1 month, and 1 year were 3.88, 2.83, 2.49, and 2.06, respectively.

J. B. Lippincott in his report on Storage of Water on Gila River, Arizona, quotes from a report of A. P. Davis, both using a ratio of 5. The values obtained by Mr. Forbes are based on more extended observations. Measurements made on the Brazos River silt showed that by increasing the period of settlement to 5 months the volume of silt was 15 per cent. smaller than for a period of 1 week. Similar measurements on the Rio Grande silt showed a reduction of 23.5 per cent. in 132 days. Prof. Nagle has taken a general 25 per cent. reduction for a period of settlement in water for 1 year and obtains the following reduced ratios: for the Rio Grande 2.72, for the Brazos 2.24, and for the Wichita 1.66; these values give for the corresponding weights of dried silt in 1 cubic foot of wet silt 21.50, 26.1, and 35.4 pounds respectively, averaging 27.4 pounds. Silt measurements made by R. H. Forbes for the Gila River, Salt River and Colorado River, all in Arizona, give the following ratio of the volumes of saturated mud, obtained for periods of settlement of 10 to 30 days, to the volume of solid sediment compacted to a stone condition: 6.7, 6.2, and 6.2, respectively, averaging 6.37. This value gives an average weight of dried silt in 1 cubic foot of saturated silt or mud of 26 pounds.

Under natural condition of silt deposits in rivers and canals a more dense deposit of silt is obtained. A 3-inch cube of silt mud taken from the bed of the Rio Grande when dried and weighed showed that a cubic foot of moist silt contained 53 pounds of dry silt. The corresponding ratio of the per cent. by volume of moist silt to the per cent. by weight of dry silt is 1.18. Silt measurements made on the Sirhind Canal, India, show that a cubic foot of moist silt, as deposited in the fields by the water, contained about 50 pounds of dry silt and the weight of a cubic foot of dried silt averaged about 88 pounds. Silt measurements made on the silt contained in the water of Guadalquivir, at Cordova, Spain, in 1906, show that 1 cubic foot of moist silt contains about 50 pounds of dry silt.

The experiments and measurements mentioned above indicate the following average results:

First.—One cubic foot of saturated silt, as obtained by experiment, by placing a given volume of silty water in a tube and measuring the depth of silt at the bottom of the tube which has settled after a period of 1 year, will contain about 30 pounds of dry silt. The per cent. by volume of saturated silt is equal to the per cent. by weight multiplied by 2.10.

Second.—One cubic foot of moist silt, as deposited under natural conditions, in a river or canal, or on a field, will contain about 50 pounds of dry silt. For this condition the per cent. by volume of moist silt is equal to the per cent. by weight multiplied by 1.20.

Third.—One cubic foot of dried silt will weigh about 90 pounds.

Silt Contents of River Waters Used for Irrigation.—The silt content of rivers is very variable, being in general greatest during flood flows and smallest during low water flow. A study of silt problems on the Kaw River by Herman Stabler, show that such a general relation between amount of silt and discharge exist, but that numerical results obtained from this relation will be in error by several hundred per cent. in many cases. The variation in silt content is much greater than that of the discharge. The maximum content of silt in any flood occurs considerably in advance of the maximum discharge, and the per cent. of silt carried in suspension for a given stage is generally greater on a rising than a falling stage.

The amount of silt carried in suspension by some of the streams in the southwest of the United States, which are known to carry a large percentage of silt, is shown by the following examples.

In Texas, the Brazos River at Jones Bridge, the Rio Grande River at El Paso, the Wichita River at Wichita Falls, have been the subject of extensive silt investigations carried on by Prof. Nagle for the U. S. Department of Agriculture during the years 1899, 1900, 1901, and 1902. Some of the summarized results are given in the following table.

The measurements on the Rio Grande were made between February 14, 1901 to May 9, 1901 and between April 26, 1902 to June 3, 1902; the average value is the average of the measurements taken and does not give the average silt-carrying capacity for the entire period.

SILT-CARRYING CAPACITY OF RIVERS IN TEXAS

Stream	Per cent. of wet silt by volume after 1 week of settling		Per cent. of dried silt by weight, average
	Maximum	Average	
Rio Grande River at El Paso.....	33.75	6.997	1.92
Brazos River at Jones Bridge.....	8.018	1.246	0.42
Wichita River at Wichita Falls.....	6.84	1.382	0.60

The measurements on the Brazos River were made from August 1, 1899 to December 31, 1902, and those on the Wichita River from February 10 to December 31, 1900 and from June 1 to December 31, 1901. The average silt content given for these two streams is the ratio of the total silt carried to the total stream flow for the entire period.

The U. S. Reclamation Service has made computations of the silt-carrying capacity of the Rio Grande River at two localities, near Engle, New Mexico, and at El Paso, Texas, in connection with proposed reservoirs. The estimates are based on measurements of silt extending over a period of 7½ years from 1897 to 1904. The silt content, expressed in volume of moist silt, averaged 1.80 per cent. near Engle, New Mexico, and 1.43 per cent. at El Paso, Texas. The corresponding per cent. by weight of dry silt are 1.53 and 1.21, respectively. The result of the studies of the U. S. Reclamation Service show an accumulation of silt at the proposed reservoir near Engle, New Mexico, of 14,578 acre-feet per year, and at the proposed reservoir at El Paso of 7,107 acre-feet per year. With storage capacities of 2,000,000 acre-feet at Engle, and 542,000 acre-feet at El Paso, the time to fill each reservoir with silt, assuming that none is sluiced out, would be 137 and 76 years, respectively.

The variation in silt content is shown by the following table which gives the average per cent. of silt of each month for the Brazos River in 1902, which, according to Prof. Nagle, represents conditions prevailing on most of the streams in Texas, for the Rio Grande as obtained from the values compiled by the Reclamation Service for a 7½-year period from 1897 to 1904, and for the Colorado River as obtained by daily measurements made by the U. S. Geological Survey from January 1, 1905 to December 30, 1905, during a year of unusually high flood flow.

Month	Monthly Silt-carrying capacity of			
	Brazos River, Texas		Rio Grande River near El Paso, Texas	Colorado River
	Per cent. of wet silt by volume	Per cent. of dry silt by weight	Per cent. of dry silt by weight	Per cent. of dry silt by weight
Jan.....	0	0	1.17	0.357
Feb.....	0	0	1.15	1.37
March.....	0.798	0.267	1.17	2.42
April.....	1.494	0.502	1.37	1.90
May.....	2.078	0.698	1.18	1.36
June.....	1.848	0.621	0.81	0.347
July.....	1.508	0.506	1.50	0.337
Aug.....	0.790	0.265	2.10	0.405
Sept.....	0.541	0.181	2.83	0.515
Oct.....	1.075	0.361	1.32	0.89
Nov.....	1.082	0.364	0.56	0.87
Dec.....	0.484	0.162	0.72	0.98

In the following table are assembled the maximum and average silt content obtained on various rivers of the arid region:

SILT CONTENT OF MISCELLANEOUS RIVERS OF THE ARID REGION

Stream and locality	Period of measurement	Per cent. of silt dry weight		Authority
		Maximum	Average for entire period	
Gila River at the Buttes, Ariz.....	July 29-Dec. 31, 1895 and Jan. 1-July 31, 1899.	2.00	U. S. Geol. Survey.
Gila River near Florence, Ariz.....	Nov. 28, 1899-Aug. 14, 1899	9.41	R. H. Forbes.
Colorado River.....	Jan. 1, 1905-Dec. 30, 1905	3.08	1.15	U. S. Geol. Survey.
Colorado River.....	Jan. 10, 1900-Jan. 24, 1901	2.07	0.30	R. H. Forbes.
Hondo River near Roswell, N. Mex.....	Mar. 26, 1905-Aug. 4, 1905	2.22	0.97	U. S. Geol. Survey.
Rio Grande near El Paso, Texas.....	Jan. 8, 1905-Apr. 30, 1907	8.39	0.81	U. S. Geol. Survey.
Rio Grande at San Manuel, N. Mex.....	May 28, 1905-Apr. 30, 1907	10.20	0.605	U. S. Geol. Survey.
Salt River—Canals in Salt River Valley.....	Aug. 1, 1899-Aug. 4, 1900	0.95	0.21	R. H. Forbes.
Pecos River at Carlsbad, N. Mex.....	May 22, 1905-Apr. 30, 1907	0.148	0.052	U. S. Geol. Survey.
Kern River at Bakersfield, Cal.....	Jan. 1, 1906-Dec. 12, 1906	0.1836	0.0163	U. S. Geol. Survey.
Boise River near Boise, Idaho.....	May 26, 1905-Apr. 30, 1907	0.30	0.010	U. S. Geol. Survey.
Tuolumne River at La Grange, Cal.....	Jan. 1, 1906-Dec. 31, 1906	0.02	0.0068	U. S. Geol. Survey.

The results obtained by the U. S. Geological Survey are based on daily measurements. Those obtained by R. H. Forbes are based on measurements taken at different intervals. The rivers in New Mexico, Arizona and Texas are the most important streams of high silt-carrying capacity. The Boise River in Idaho, Tuolumne River and Kern River in California represent the more usual condition of streams used for irrigation in the arid region of the United States.

Distribution of Silt at Different Depths in a Stream.—It is generally believed that the larger part of the silt carried in suspension by the water is found toward the bottom of the channel. Although there is some coarser material, not carried in suspension but rolled or pushed along the bottom, the amount of silt carried in suspension is distributed throughout the body of water. While the distribution is probably not uniform, the quantity carried near the surface is not very much less and in some cases may be greater than that found toward the bottom of the channel. This is partly indicated by the following results obtained on the Brazos River, Wichita River and Rio Grande River in Texas by Prof. Nagle and on the Pecos River by Prof. Goss.

DISTRIBUTION OF SILT AT DIFFERENT DEPTHS IN A STREAM

Sample taken	Silt measured in per cent. of		
	Wet silt by volume		Dry silt by weight
	Brazos River, Texas. Mean of 27 sets	Wichita River, Texas. Mean of 8 sets	Pecos River, Mean of 6 sets
From top.....	1.1281	3.42	0.1486
From $\frac{1}{2}$ depth.....	1.1554	3.37	0.1557
From $\frac{2}{3}$ depth.....	1.1931	3.37	0.1508
From bottom.....	1.1644	3.34	0.1559
	1.1603	3.375	0.1528
	Brazos River.	Wichita River.	Rio Grande River.
	Mean of 12 sets.	Mean of 6 sets.	Mean of 6 sets.
From top.....	1.3412	1.845	6.911
From mid-depth.....	1.3323	1.777	6.528
From bottom.....	1.3092	2.047	6.516
	1.3276	1.890	6.652

Coarse Sediment Transported or Rolled Along the Bottom of Canals and Rivers.—Very little information on the extent of coarse sediment moved along the bottom is obtainable. It

depends on the velocity of water, the degree of erosion, and the character of material the river or canal passes through. Mr. A. P. Davis observed that on the San Carlos River, Costa Rica, the amount of sediment thus transported during June, July, and August was 5.2, 1.7 and 7.1 per cent., respectively, of the total sediment carried by the river.

Silt Carried by Irrigation Waters in India.—The most valuable investigations on silt problems have been made in India. The application of the theories resulting from these investigations to similar problems in other countries can best be considered after a knowledge of the extent of silt carried by irrigation waters in India. This information is largely contained in the papers of the Punjab irrigation branch and in a book entitled "Facts, Figures, and Formulas for Irrigation Engineers," compiled by R. B. Buckley.

SILT CONTENT OF SOME IRRIGATION WATERS IN INDIA

	Period	Average per cent. of silt	
		Damp silt by volume	By dry weight
Water from Sutlej River entering Sirhind Canal.....	June to Sept. 20, 1895	0.165	0.132
Water from Sutlej River entering Sirhind Canal.....	June to Sept. 20, 1896.	0.234	0.187
Water from Sutlej River entering Sirhind Canal.....	June to Sept. 20, 1897.	0.546	0.436
Water from Sone River entering Sone Canal.....	June, 1898	0.1875	0.15
Water from Sone River entering Sone Canal.....	July, 1898	0.325	0.26
Water from Sone River entering Sone Canal.....	Aug., 1898	0.275	0.22
Water from Sone River entering Sone Canal.....	Sept., 1898	0.062	0.05
Water from Bengal rivers near surface.....	Mean for whole year of 234 experiments.....	0.076	0.06
Water from Indus.....	Flood season.	0.53	0.425
Water from Nile.....	Flood season.	0.19	0.15
Water from Ganges near head of Ganges Canal.....	Maximum	1.00	0.80
Water from Ganges near head of Ganges Canal.....	Four samples in Aug. and Sept.	0.16	0.13

The extent of silt carried by some irrigation waters in India is summarized in the preceding table.

The distribution of the silt in the water or relative percentages of silt at different depths is shown by the following typical silt determinations on the Sutlej River and at two points on the Sirhind Main Canal, supplied from the Sutlej River; one point is at the head of the canal and the other 15 miles below. These measurements are selected from a large number and represent the silt content and distribution during periods of high silt content.

PERCENTAGE OF SILT AT DIFFERENT DEPTHS OF WATER IN SUTLEJ RIVER

Date	Gauge height in feet	Velocity in feet per second	Per cent. of silt by weight at depths in feet of									
			0	1.5	3 0	4 5	6 0	7.5	9.0	10.5	12.0	
July 7, 1894	12 00	7.70	1.44	1.47	1.50	1.50	1.54	1.57	1.68	2.94	
June 13, 1895	11.00	6.33	1.68	2.00	2.08	2.20	2.35	2.48	
Aug. 13, 1895	13.60	9.62	1.21	1.26	1.27	1.28	1.30	1.32	1.37	1.39	1.40	

IN SIRHIND MAIN CANAL

	Gauge height in feet	Velocity in feet per second	Depths of						
			0	1	2	3	4	5	6
At intake June 18, 1894.....	9.80	1.12	1.28	1.30	1.36	1.44	1.53	1.68
15 miles below intake, June 18, 1894.....	7.54	3.53	1.13	1.34	1.37	1.47	1.54	1.60

These measurements as well as the large number from which these were selected show that toward the bottom the silt content is from about 1.5 to 2 times that of the surface water. About the same ratio, for silt content of the bottom and surface water, is indicated by the results given by R. B. Buckley for the Sone River and Bhagiratti River in Bengal.

Theory Regarding Silt-carrying Capacity of a Channel.—The extensive experience obtained on irrigation systems of India, where water of high silt-carrying capacity are commonly used, should be of considerable value in the consideration of theories and problems concerned with silt.

Mr. R. G. Kennedy, Executive Engineer of the Irrigation

Branch of the Public Works Department, Punjab, India, made interesting silt studies on the Bari Doab Canal System, selected because the canals had reached permanent condition, and at the points of measurement the silt-transporting power in each was just sufficient to carry all the sediment brought down. The observations were made on 90 miles of canal, including the main canal of 1,700 cubic feet per second capacity, and distributaries of 30 to 250 cubic feet per second capacity. The form of cross section permanently assumed by the canals was nearly rectangular, the sides being vertical and formed of fine sediment, and the bed horizontal and of coarser sand. As a result of his observations he concludes that the silt-carrying capacity of a channel varies with some function of the mean velocity and inversely with some function of the depth. This conclusion is in accord with the results obtained by T. Login, from several years of observations on the Ganges Canal and other channels. The explanation is that in any channel there are eddies and circulating cross currents which maintain the sediment or silt in suspension. The force of these cross currents is proportional to some power of the velocity (probably to the square of the velocity) and would have a proportionately greater effect for a small depth of water than for a larger depth, so that if two channels have the same velocity but different depths of water, the one with the shallow depth would be able to hold a larger percentage of silt than the other. As a result of all measurements he found that for every depth of water there is a velocity which will just prevent silting; this is called the critical velocity, and the relation between this velocity and the depth is expressed by the following empirical equation

$$V_0 = Cd^m$$

where

V_0 = critical velocity

and

d = depth of water in canal.

The equation for the fine sand silt of the Punjab on which the observations were made assumes the following form:

$$V_0 = 0.84 d^{0.64}$$

The following special values are also given:

$$\begin{aligned} C &= 0.82 \text{ for light sandy silt} \\ &= 0.90 \text{ for coarser light sandy silt} \\ &= 0.99 \text{ for sandy loam} \\ &= 1.07 \text{ for coarse silt.} \end{aligned}$$

According to R. B. Buckley, the critical velocity for the canals of Sind, taking water from the Indus, may be taken as $\frac{3}{4}$ of that applicable to canals in the Punjab; and in Egypt, the silt being finer than that of the Indus, the critical velocity may be as low as $\frac{2}{3}$ of that used in the Punjab. The corresponding values for C are 0.63 for the canals of Sind and 0.56 for those of Egypt.

The critical velocity is the minimum velocity necessary to keep the silt in suspension, and for every depth of water there is a corresponding value for the critical velocity. Mr. Kennedy states that for a system of canals designed and constructed so as to obtain the critical velocity in each canal the percentage of silt carried in suspension will be the same throughout all parts of the canal system and the total amount of silt carried is equal to the discharge of the canal multiplied by that percentage. If a velocity smaller than the critical velocity be obtained, a smaller percentage of silt is carried and there is a deposit. To obtain the effect of a change of velocity on the amount of silt transported, Mr. Kennedy has deduced an equation based on the following principles and assumptions:

First.—The amount of silt held in suspension is proportional to the upward force of the cross currents acting on the base (b) of the canal. The force of the cross currents varies with the square of the velocity, so that the amount of silt held in suspension may be represented by the equation $C_1 b V^2$ where C_1 is a constant.

Second.—The silt held in suspension moves with a velocity V , so that the amount of silt transported is equal to $C_1 b V^3$.

Third.—A small quantity of coarser silt simply rolls along the bottom with a velocity V , and the amount thus carried is equal to $C_2 b V$, where C_2 is a constant.

Fourth.—If the amount of coarser silt rolled along the bottom be included with the silt held in suspension the total amount of silt transported is given by the equation $K b V^n$, where K is a constant and n is somewhat less than 3, or about $\frac{5}{2}$ as shown by the following numerical deductions:

Let V_0 = critical velocity. D = discharge corresponding to velocity V_0 . p = per cent. of silt carried. b = bottom width of canal. d = depth of canal.

Then: pD = amount of silt carried with velocity V_0 .

KbV_0^n = amount of silt carried with velocity V_0 .

bd = area of cross section, assuming vertical sides.

$KbV_0^n = pD = pbdV_0$, from which $V_0 = \left(\frac{p}{K}d\right)^{\frac{1}{n-1}}$; but $V_0 = Cd^m$ and for Punjab silt $= 0.84d^{0.84}$ therefore $\frac{1}{n-1} = m$ or $n = 2.56$ for Punjab silt and the total amount of silt transported is equal to $KbV_0^{2.56}$ or $KbV_0^{5/2}$ (approximately).

From this deduction the amount of silt transported may be taken as proportional to $V^{5/2}$. The percentage of silt held in suspension for any velocity V can then be obtained from the above relations as follows:

Let p = per cent. of silt transported for critical velocity V_0 .
 x = per cent. of silt transported for velocity V , then $p : x :: V_0^{5/2} : V^{5/2}$ or $x = p \left(\frac{V}{V_0}\right)^{5/2}$.

If V is greater than V_0 and greater than the bed channel can resist, there will be scouring. If V is less than V_0 there will be a deposit of silt and the per cent. of silt deposited is

$$p - x = p \left[1 - \left(\frac{V}{V_0}\right)^{5/2} \right]$$

Kennedy silt theory, which is based on extensive observations and measurements, deserves careful consideration and should carry considerable weight. Mr. T. Higham, Chief Engineer, Irrigation Works, Punjab, states that the formulas require further verification, and that the formula for critical velocity does not appear to allow for the effect of the side slopes in producing the cross currents or eddies. Mr. Kennedy does not consider this effect because he assumes that the sides of the canals on which his observations were taken, being nearly vertical, the cross currents formed by them must be of a smaller extent and produce a horizontal force with little or no upward force.

Prevention of Silt Deposits in Canals.—The proper design and operation of headworks, at the point of diversion on the river, may lessen the amount of coarse silt entering the main canal; but the finer silt carried in suspension in the water, more or less uniformly distributed throughout the body of water cannot be lessened to a considerable extent before entering the canals. To prevent silt deposits in the canals it is necessary and usually desirable to carry the silt through into the smaller distributaries and on the fields where it may be of fertilizing value. According to Kennedy's theory, the desired result is obtained by designing the canal cross sections, so as to have their mean velocities not

less than the critical velocity V_0 ; it may be higher if the bed of the channel will stand a higher velocity without erosion. The equation for the critical velocity has the following general form $V_0 = Cd^m$ and for the canals in Punjab, where the experiments were made, has the special form $V_0 = 0.84d^{0.64}$. Special values of C for different types of silt have been previously given.

The equation for the Punjab Canal gives the following values for the critical velocity.

CRITICAL VELOCITIES FOR THE PREVENTION OF SILT DEPOSITS IN CANALS
(FOR CANALS IN PUNJAB BY R. G. KENNEDY)

Depth of water in feet.....	1.0	2.0	3.0	4.0	5.0	6.0	7.0	8.0	9.0	10.0
Critical velocity..	0.84	1.30	1.70	2.04	2.35	2.64	2.92	3.18	3.43	3.67

In the design of canal cross sections the carrying capacity and grade are usually known and the side slopes of the canal are selected. This is not sufficient to determine the dimensions of the cross section, for it leaves a range within which the proportion of bed width to depth may be varied and the corresponding velocity obtained; but if the problem is further limited by the requirement of providing a critical velocity there is only one proportion of bed width to depth which will give a critical velocity corresponding to the depth. This is well illustrated by the results plotted on the accompanying diagram, for a typical example (Fig. 13). The carrying capacity of the canal is 200 cubic feet per second, the side slopes 1 to 1 and the coefficient of roughness $n = 0.0225$. The curve drawn as a full line represents the curve of critical velocities obtained by the equation $V_0 = 0.84d^{0.64}$. The two dotted curves give the velocities corresponding to different depths of water (or different proportions of bed width to depth). One curve is for a grade of 1 foot in 5,000, and the other for a grade of 1 foot in 2,000. The detailed results are given in the following table.

The tabulated results show that if several canal cross sections are considered for a given grade and discharge, the maximum velocity is obtained with the section having maximum hydraulic radius but this requires an unusually deep section which is seldom used in practice. For canal sections of smaller depth a smaller velocity is obtained and a larger cross section is necessary, but the smaller depth of water requires a corresponding smaller critical velocity to prevent silt deposit. Because of the above

EXAMPLE SHOWING THE EFFECT OF DIFFERENT RATIOS OF BED WIDTH TO DEPTH ON AVERAGE VELOCITY AND CRITICAL VELOCITY

Carrying capacity 200 second-feet—side slopes 1 to 1- $n = 0.225$

Grade	Depth feet	Bed width feet	Area sq. ft.	Hydraulic radius	Velocity ft. per sec.	Critical velocity corresponding to depth ft. per sec.
1 in 2,000.....	3	22.0	75.0	2.460	2.66	1.70
1 in 2,000.....	4	13.12	68.5	2.803	2.92	2.04
1 in 2,000.....	5	8.2	66.0	2.954	3.04	2.35
1 in 2,000.....	6	4.9	65.5	2.995	3.05	2.64
1 in 2,000.....	7	2.45	66.0	2.967	3.04	2.92
1 in 5,000.....	3	35.0	113.5	2.610	1.76	1.70
1 in 5,000.....	4	21.0	100.0	3.095	2.00	2.04
1 in 5,000.....	5	14.5	97.5	3.405	2.06	2.35
1 in 5,000.....	6	9.43	92.6	3.503	2.16	2.64
1 in 5,000.....	7	6.11	91.8	3.543	2.18	2.92

relations, when the available grade is flat, the velocity obtained for the deep section may be less than the critical velocity for that depth, but with a smaller depth the velocity obtained although less may be sufficient to prevent silting. This is well shown by the curves for the above example. The curve for the canal on a flat grade of 1 in 5,000 shows that the critical velocity is obtained with a depth of 3.8 feet of water; for a smaller depth the corresponding velocity is greater than the required corresponding critical velocity for that depth; while for a greater depth the corresponding velocity is smaller

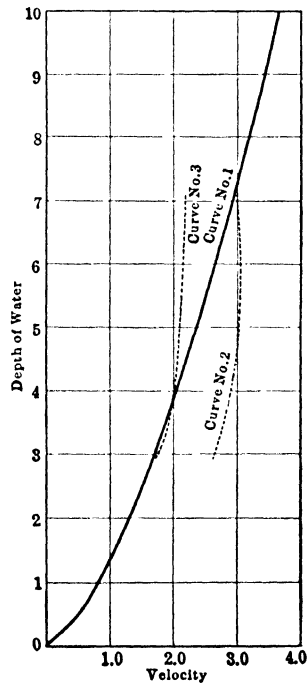

FIG. 13.

Curve No. 1.—Critical velocity curve to prevent silting.

Curves No. 2 and 3.—Examples to illustrate the effect of form of cross section and corresponding velocity on critical velocity. For both curves, $Q = 200$; $n = 0.225$; side slopes 1 to 1.

For Curve No. 2, $s = 0.0005$; for Curve No. 3, $s = 0.0002$.

than the required critical velocity and silt deposit would occur. The curve for the steeper grade shows that the velocities obtained for all depths are greater than the required corresponding critical velocities; there would be no silt deposit for any of the forms of cross sections and the selection of the proportion of depth to bed width would depend on a number of theoretical and practical considerations discussed in Chapter VI. Another common occurrence in the design of canal cross section is where the discharge is known, but the grade may be selected within a certain range. With these requirements the problem is indeterminate; it may be satisfied by any proportion of bed width to depth, with a critical velocity corresponding to the depth selected. To make the problem definite it is necessary to select the most desirable proportion of bed width to depth and this will determine the critical velocity and the grade. To illustrate, the following example is taken: The carrying capacity of a canal is 100 cubic feet per second, the side slopes 1 to 1, and the coefficient of roughness $n = 0.225$. The dimensions for different forms of cross section required to give the critical velocity in each case are tabulated below:

Ratio of bed width to depth	Area of cross section in square feet	Bed width in feet	Depth of water in feet	Velocity = critical velocity	Grade
0.828	43.27	4.02	4.865	2.31	1 in 2,400
2.0	48.78	8.06	4.03	2.05	1 in 3,500
4.0	55.175	13.29	3.322	1.82	1 in 4,200

The deepest section is that having best hydraulic elements, but it requires a steeper grade than the shallower sections to obtain a velocity equal to the critical velocity. The above results indicate that for a special grade above a certain minimum there is a corresponding form of cross section which will give a velocity equal to the critical velocity, and *vice versa*.

The case may arise when there is not sufficient slope to obtain the critical velocity necessary to prevent silting, the curves of velocities for different ratios of bed width to depth would then lay altogether on the left-hand side of the critical velocity curve. It is, however, possible to obtain a form of cross section which will give the least amount of silt for the given grade; this is obtained when the expression for the extent of silt deposit $p - x =$

$p \left[1 - \left(\frac{V}{\bar{V}_0} \right)^{3/2} \right]$ is a minimum. By substituting in the equation the following values: $V_0 = Cd^m$ and $V = \frac{Q}{d(b + nd)}$ where $n:1 =$ side slope and $Q =$ discharge, then

$$p - x = p \left[1 - \left(\frac{Q}{Cbd^{m+1} + Cnd^{m+2}} \right)^{3/2} \right]$$

which is a minimum when $bd^{m+1} + nd^{m+2}$ is a minimum. Using the value of m obtained for the Punjab canals, the minimum amount of silt is deposited when $bd^{1.64} + nd^{2.64}$ is a minimum and for vertical side slopes such as obtained on silted canals in the Punjab when $bd^{1.64}$ is a minimum.

REFERENCES FOR CHAPTER IV

- GOSS, ARTHUR—Principles of Water Analysis as Applied to New Mexico Waters—1900, Bulletin 34, New Mexico Agricultural Experiment Station, New Mexico.
- FORBES, R. H.—The River-irrigating Waters of Arizona—1902—Bull. 44, University of Arizona Agricultural Experiment Station, Tucson, Ariz.
- NAGLE, J. C.—Progress Report on Silt Measurements—1900 1901, 1902—Bulls. 104, 119, 133, Office of Experiment Stations, U. S. Dept. of Agriculture.
- LIPPINCOTT, J. B.—Storage of Water on Gila River, Arizona—1900—Water Supply Paper No. 33, U. S. Geological Survey.
- DAVIS A. P.—Water Storage on Salt River Arizona—1903—Water Supply Paper No. 73, U. S. Geological Survey.
- STABLER, HERMAN—The Silt Problem, Kaw River, by Herman Stabler—p. 643 Engineering News—June 2, 1910.
- REED, W. M.—Operations in New Mexico—1903-04—Third Annual Report of the Reclamation Service.
- STABLER, HERMAN—Some Stream Waters of the Western United States—1911—Water Supply Paper 274, U. S. Geological Survey.
- VAN WINKLE, WALTON—The Quality of the Surface Waters of California, 1910—Water Supply Paper 237, U. S. Geological Survey.
- KENNEDY, R. G.—HIGHAM T.—Prevention of Silting in Irrigation Canals—1896—Punjab Irrigation Branch Paper No. 7.
- JEFFERY, T. J. P.—KENNEDY, R. G.—Report on the Deposit and Scour of Silt in the Main Line, Sirhind Canal, and on the Silt Experiments—1893 to 1898, Punjab Irrigation Branch Paper No. 9.
- KENNEDY, R. G.—The Prevention of Silting in Irrigation Canals—p. 281 Proc. Inst. of Civ. Eng., Part 1—1894-95.
- BUCKLEY, R. B.—Facts, Figures and Formulas for Irrigation Engineers—1908—Spon and Chamberlain, 123 Liberty Street, New York.
- BUCKLEY, R. B.—The Design of Channels for Irrigation or Drainage—1911—Spon and Chamberlain, 123 Liberty Street, New York.
- FOLLETT, W. W.—Silt in the Rio Grande—Engineering News—Jan. 1, 1914.

CHAPTER V

CONVEYANCE LOSSES IN CANALS

Irrigation water is usually conveyed in canals of earth. The exceptions are on some projects where water is so valuable that it is found economical to carry the water in channels lined with concrete or with some more or less impervious material to reduce the conveyance losses; or on projects, usually small, where the value of water and the topographical conditions favor the use of cement or wood pipes or flumes. However, on many projects there are sections of canals where lining with some material is necessary to either prevent excessive losses or to overcome construction difficulties.

The losses of water in earth canals are often very large and with a system of newly excavated canals they may be so great as to make it difficult to deliver water. The extent of the losses must be carefully considered, in order to make allowances in the planning of an irrigation system.

Nature of Conveyance Losses.—The conveyance losses are due to seepage from the sides and bed of the canal and to evaporation from the water surface. The seepage losses can be divided into the losses due to absorption and those due to percolation. These two factors of losses are intimately related and are dependent on so many factors that they cannot be stated separately and each expressed numerically.

By absorption loss is meant the loss due to the action of capillarity; and by percolation, the loss due to the action of gravity. If in a canal capillarity alone were acting, then the loss of water through the soil would follow the laws of capillarity: the water would pass from the wet surface to the dry soil surrounding it, moving in all directions, upward and horizontally as well as downward and would stop when it had reached the maximum limit of capillarity, which will vary with the texture of the soil. The upper part of this area of capillary water surrounding the canal may extend up to the surface where some of the water will be lost by evaporation. This will be obtained to a

greater extent with canals built in fill or with embankments. This action, as well as evaporation caused by the air motion in the pores of the soil, will produce a continuous rate of absorption, which, however, cannot be of great magnitude. The result is, however, modified by the action of percolation. The water lost by percolation travels downward, because of the force of gravity, to the subsoil beyond the above limit of capillary action. This water is disseminated laterally by capillarity and the wetted area increased. That water lost by percolation, which is not held as capillary water, will, if sufficient, reach the water-table and pass as an underflow to a drainage channel. The path of this underflow will be deflected by hardpan or impervious layers of soil and the velocity of the underflow will depend largely on the distance the water has to travel and the grade in the direction of the underflow. The absorption loss is greatest when a dry canal is first filled, after which it is probably very small; but the percolation loss is continuous and will usually be of much more importance than the absorption loss.

Factors Influencing Seepage Losses in Canals.—The factors which have a marked influence on seepage losses are:

First.—The texture of the soil and subsoil and extent of absorbing medium.

Second.—The position of the water-table and drainage conditions of the soil and subsoil.

Third.—The temperature of the water.

Fourth.—The age of the canal and amount of silt carried by the water.

Fifth.—The depth of water in the canal and the distance the seepage water must travel to reach an outlet or the slope of the ground-water flow.

Sixth.—The velocity of water in the canal.

The absorption loss is greatest in soils of fine texture, which have a large capacity for capillary water, but the seepage loss is more dependent on the percolation loss and is therefore greatest for coarse textured soils, which drain readily.

Mr. J. S. Beresford concludes from his studies on this subject in the Northwest Provinces, India, that the seepage loss is greater when a canal is in cut than when in embankment. This is no doubt only true where all other conditions are the same, including the distance to the water-table, and can be explained from the fact that the absorbing medium on the two sides of the canal built in

fill is confined to the two embankments, while in a canal built in cut the absorbing medium is not limited.

A coarse subsoil not saturated with ground water will produce a large rate of seepage. A rise in the water-table usually decreases the seepage loss, and the extent of the loss will depend on the rate at which the ground water finds its way to a drainage channel. The water-table may rise above the canal bed and produce a gain instead of a loss. A canal located along a side hill, or on a ridge, or along the upper boundary of an irrigated area, with no irrigated lands or wet lands above, will be subject to a loss; while a canal located on lower land will frequently receive drainage water or waste water from a higher canal or from irrigated lands above, which may more than offset the seepage losses and show a considerable gain. For this reason and also to save in cost of construction, natural depressions or coulies have been used on a number of irrigation projects, in the place of artificial canals, to convey irrigation water. This practice, however, has been limited to natural depressions of moderate depth, with a comparatively regular cross section and where the bed was naturally formed of gravel, cobbles or rocks which would not be eroded by the high velocity frequently obtained. To form an efficient channel and confine the water, these depressions often require some straightening and improvement of the cross section.

The temperature of the water and soil have some effect on the rate of seepage loss. An increase in temperature decreases the viscosity of water, which will increase the rate of percolation. This is indicated by Hazen's formula for flow of ground water; according to this formula the velocity of flow is proportional to the temperature Fahrenheit plus 10° so that an increase in temperature from 50° Fahrenheit to 70° Fahrenheit would increase the velocity of ground water and therefore the seepage loss 33 per cent. Mr. R. G. Kennedy states that in Punjab, India, the rate of seepage for the 6 warm months from April to September is $15\frac{1}{2}$ inches depth of water per day, or 50 per cent. greater than for the 6 cool months from October to March, when it is about $10\frac{1}{2}$ inches in depth; and for the 3 dry hot summer months $16\frac{1}{2}$ inches or more than double that of the 3 cold spring months ($7\frac{1}{2}$ inches). The decrease in seepage loss produced by a decrease in temperature makes a deep canal pref-

erable to a shallow canal, because in a deep canal the temperature of the water will remain lower than in a shallow canal.

A canal will usually become more impervious with age, the result being dependent on the amount of silt carried by the water. The silt is deposited on the surface and drawn by the seepage water in the pores of the soil, forming a less pervious channel.

The effect of the depth of water in the canal has been probably much overestimated. It is sometimes assumed that the seepage loss varies directly with the depth or the square root of the depth of water. There is very little data to show that any such direct relation exists. The loss must depend not only on the depth of water, but also on the depth of soil through which the seepage water percolates, the direction of flow of the ground water and the slope in that direction. The variations in the texture of the soil and in soil stratum add further complications. Where the seepage water travels through a large depth of soil, the depth of water in the canal can have very little influence on the loss; but where the water percolates only a short distance into some underlying coarse stratum which drains very freely, the loss will depend largely on the depth of water.

Mr. Weymouth, Supervising Engineer, U. S. Reclamation Service, states that experiments made by the Service in Idaho show that within a small range, such as the depth of water in canals, the depth makes very little difference on the loss.

Experiments made by A. E. Wright, for the U. S. Department of Agriculture, at Irrigon, Oregon, in 1906, by measuring the rate of loss from circular pits, with depths of water ranging from 1 to 2 feet, show that the loss per square foot of wetted area remains very nearly constant, regardless of the depth. These results, however, are obtained for shallow depths within a small range. The effect of depth on seepage loss, where the seepage water percolates only through a small depth of soil, is indicated by results of experiments made by the Irrigation Investigations of the U. S. Department of Agriculture. Tanks were filled with 3 feet depth of ordinary clay loam soil, held by a mesh screen at the bottom; a constant depth of water was maintained on the surface of the soil and the seepage water was caught and measured. The following results were obtained:

RATE OF PERCOLATION THROUGH A SOIL DEPTH OF 3 FEET

Depth of water in inches	Depth of water lost per 24 hours, in inches	Ratio of loss to square root of depth
36	11.75	1.96
30	10.58	1.94
24	9.07	1.85
18	8.10	1.91
12	7.00	2.02
6	6.21	2.53

Excepting the values obtained for the smaller depth of 6 inches, the last column seems to indicate that for these special conditions the seepage loss might be proportional to the square root of the depth.

Mr. T. Ingham, Chief Engineer of Irrigation Works of Punjab, India (1896), gives as the most approved formula for loss by seepage in Punjab canals

$$P = C \sqrt{d} \frac{WL}{1,000,000}$$

where P = loss by seepage in cubic feet per second for a length of canal L .

C = a constant usually taken at 3.5.

d = depth of water in canal in feet.

W = width of water surface in canal in feet.

L = length of canal section considered in feet.

This formula and the results obtained from the tank experiments given above, within a limited extent, indicate that the seepage loss is proportional to the square root of the depth. But the many factors involved preclude the use of any such simple relation for general application.

The velocity of the water in the canal has several effects on the seepage loss. A high velocity may produce erosion of the canal and remove the finer material, so as to leave the bed and bottom of the canal porous, which will have a tendency to increase the seepage loss. While not favorable to the deposition of silt carried in suspension by the water, a high velocity does not prevent entirely the drawing into the pores of the soil by the seepage water of the finer particles of silt and sediment. Due to these actions there will probably be an increase in seepage loss, but another effect which may overbalance the result is

the effect of an increase in velocity acting against the percolation of water in the soil. For the same reason that the discharge, through an orifice or entering a channel, is less when the water is moving at right angles to the direction of entrance than when it is still, a theoretical consideration would lead one to expect that an increase in velocity of water at right angles to the percolation flow will act against and decrease the percolation loss. That this result is obtained in practice seems to be partly demonstrated by a few experiments and measurements. Experiments made by the U. S. Department of Agriculture in running water in short sections of canals, formed by supporting earth on screens, show that the seepage loss is greater with still water than with water in motion. A very small velocity does not seem to make a great difference, but a moderate bottom velocity, probably of 1.5 feet per second for shallow canals and greater for deep canals, has a marked influence. A velocity higher than this will no doubt further decrease the seepage, but the difference will not be so marked as the difference between no velocity or still water and a velocity of 1.5 feet per second (greater for deep canals).

The following measurements, made in 1909 by P. Bailey on a section 22 miles in length of the main canal of the Modesto irrigation district and on a section 18 miles in length of the main canal of the Turlock irrigation district, indicate the combined effect of increased depth of water in the canal and of the corresponding increase in velocity.

EFFECT OF DISCHARGE, DEPTH OF WATER AND VELOCITY OF FLOW ON SEEPAGE

Modesto main canal; 22 miles in length

Discharge in cubic feet per second	Depth of water in feet	Average velocity in feet per second	Total seepage loss, cubic feet per second	Remarks
44	0.62	1.00	15.9	Smallest discharge used.
77	0.90	1.25	9.0	Discharge corresponding to minimum loss.
522	3.29	2.7	35.0	Largest discharge used.

Turlock main canal; 18 miles in length

70	0.6	1.2	29.2	Smallest discharge used.
400	3.0	2.8	15.0	Discharge corresponding to minimum loss.
865	6.0	3.5	30.5	Largest discharge used.

The increase in depth of water and the corresponding increase in wetted area have a tendency to increase the total seepage loss, but a study of the results obtained on these two canals shows that the seepage loss does not increase uniformly with the increase in depth of water. In both cases the increase in velocity produces a decrease in the seepage loss, sufficient to overbalance the increase in seepage, due to a moderate increase in depth of water. The minimum seepage loss was not obtained with the smallest depth of water. On the Turlock canal the minimum seepage loss was obtained with a depth of water of 3 feet and was equal to about $\frac{1}{2}$ the loss obtained with the smaller depth of 0.6 feet. The decrease in seepage loss produced by the increase in velocity was sufficient on the Turlock canal to balance the increase in seepage loss produced by the increase in depth of water from a minimum of 0.6 feet to a maximum of 6 feet.

The above consideration of the effect of velocity on seepage loss shows that, within a certain range of velocities not exceeding the velocity beyond which erosion will take place, a high velocity will produce a smaller seepage loss. From this it is safe to conclude that of two canal sections having the same dimensions but placed on different grades, the one having the steeper grade and therefore the greater velocity will not only have a greater carrying capacity but a smaller total seepage loss.

The effect of vegetation in a canal on seepage loss is closely related to the effect of velocity. Vegetation decreases the velocity, especially next to the bottom and sides of the canal, and as a result there is an increase in the seepage loss. Some interesting investigations on this subject were carried on in 1908 by P. Bailey on two canals of the San Joaquin and Kings River Canal and Irrigation Co. near Los Banos, California. On this project the necessity of enlarging the carrying capacity of the system led to the construction of a new canal parallel to the old main canal for a distance of 27 miles, with only a 20-foot bank in between. The two canals are about of the same width, but the old main is about a foot deeper than the new parallel canal; the water surfaces in both canals were at about the same elevation. A stretch 5.44 miles long was selected where there was an abundant growth of weeds in the parallel canal and almost none in the main. The weeds had been growing in the

parallel canal for about 10 years; once or twice each season a chain was run over the canal, which removed trailing weeds, but had little effect on the grasses and tules. At the time of the measurements the weeds extended above the water on both sides of the canal so as to cover over 30 per cent. of the water surface. The old main canal was cleaned and the weed growth removed by excavators the previous season. The results obtained are tabulated below:

SEEPAGE LOSSES FROM CLEAN AND WEEDY CANALS, 5.44 MILES IN LENGTH,
NEAR LOS BANOS, CALIFORNIA

Canal	Flow in cubic feet per second	Total conveyance loss	Evaporation loss	Seepage loss	Seepage loss in per cent. of flow per mile	Condition of canal
Original Main	234.79	4.94	0.64	4.30	0.34	Clean
Parallel	199.57	6.50	0.51	5.99	0.55	Weedy

The results show that the presence of vegetation in the canal increased the seepage loss 60 per cent. over what it would have probably been when free from vegetation. However, the results should not be given much weight, as they are almost beyond the accuracy of such measurements.

Extent of Conveyance Losses in Canals.—The conveyance losses are due to seepage and evaporation, and in some cases the regulation loss at wasteways is also included, but this is not customary and will not be considered here. The evaporation loss is generally very small as compared to the conveyance loss; it will seldom be as much as 10 per cent. of the conveyance loss and will generally be not over 5 per cent. For this reason the term *seepage loss* is frequently used in the same sense as conveyance loss without making any deduction for the evaporation loss. The extent of the conveyance losses is expressed in three ways:

First.—As a per cent. of the entire flow carried by the canal system.

Second.—As the depth of loss in 24 hours over the wetted surface of the canal or in cubic feet per square foot of wetted surface in 24 hours.

Third.—As a per cent. per mile of the water carried by the canal.

The first form of expression is a statement of the efficiency of a system and shows the relation between the gross duty and net duty. It is the most satisfactory form of expression when studying an entire system or when making estimates of the necessary water supply for a new system.

The second form of expression is best suited to make comparisons of losses in different parts of a canal system or in obtaining an adequate comprehension of the extent of losses. The rate of loss is dependent on many factors, the effect of which it is impossible to express numerically. The most important factors are probably the texture of the soil and subsoil and the position of the water-table; these two factors are usually the only ones considered in expressing the rate of loss.

The third form of expression, while very commonly used, is not satisfactory, for it does not take into consideration the extent of the wetted surface.

Extent of Conveyance Losses for Entire System.—The results presented on pages 82 and 84 of Vol. I, which give the relation between Gross Duty, Net Duty, Conveyance Loss and Regulation Waste, show that on irrigation systems consisting, as most canal systems do, of canals in earth not lined, the total conveyance loss ranges from 13 per cent. to 55 per cent. For a new canal system the loss is usually from 40 to 55 per cent. while for an old system, where the canals have been used for several years, so as to become well settled and made partly water-tight by the natural deposition of silt from irrigation water, or by improving the worst places, the total seepage loss is from 20 to 30 per cent. Similar values are obtained for some of the canal systems in India. According to Mr. J. H. Ivens, the losses on an entire canal system in the United Provinces of India are in general as follows: 15 per cent. loss on main canal, 7 per cent. on laterals, and 22 per cent. on smaller distributaries giving a total loss of 44 per cent. Mr. K. G. Kennedy obtained the following values for the Bari Doab Canal in Punjab, India: 20 per cent. on main canal, 6 per cent. on laterals, 21 per cent. on smaller distributaries, giving a total of 47 per cent. .

Extent of Conveyance Loss Measured in Cubic Feet Per Square Foot of Wetted Surface, in 24 Hours.—A large number of measurements on this basis have been made on irrigation

canals distributed throughout Idaho, by Don H. Bark of the U. S. Department of Agriculture, on the Sunnyside canal system by J. C. Stevens, then of U. S. Geological Survey, and on the Boise Project, Idaho, by the Reclamation Service.

The results of Don H. Bark are based on measurements on 58 canals and range from a maximum loss of 6.338 feet in a rock cut to a gain of 1.647 feet for a canal where there was porous irrigated land above. Mr. Bark deduces the following average values:

CONVEYANCE LOSS IN CUBIC FEET PER SQUARE FOOT OF WETTED AREAS, FOR SOUTHERN IDAHO SOILS, BY DON H. BARK

Character of soil	Loss in cubic feet per square foot
Rather impervious clay soils or retentive lava ash soils	0.5
Medium soils	1.0
Somewhat pervious soils	1.5-2.0
Gravel soils	2.5-5.0

The results of J. C. Stevens show losses ranging from 1.15 cubic feet per square foot for a loam and volcanic ash soil to 2.04 for a more porous sandy soil. The measurements on the Boise project show losses ranging from 0.168 for a canal with a mud and hardpan bottom to 3.12 for a canal in cemented gravel and sand. Mr. F. W. Hanna, after a consideration of the measurements on the Sunnyside system, those on the Boise project and some miscellaneous measurements compiled by Saville in his report on Gatum Dam in the Annual Report of the Isthmian Canal Commission for 1908, suggests that a loss of 0.5, 1 and 1.5 cubic feet per square foot of wetted area per day might be assumed for losses in canals not affected by the rise of ground water, respectively, for rather impervious, mediumly impervious and rather pervious soils. These values agree well with those given by Mr. Bark.

From a careful study of the measurements above referred to, of special measurements compiled by L. G. Carpenter of Colorado, of average results on eight different irrigation projects of the U. S. Reclamation Service given by E. A. Moritz (page 402

Engineering News, August 28, 1913), and of other values obtained from a number of sources, the writer believes that the following values will represent average results, the larger values in each case being for a comparatively new canal, less than 5 years old.

CONVEYANCE LOSS IN CUBIC FEET PER SQUARE FOOT OF WETTED PERIMETER FOR CANALS NOT AFFECTED BY THE RISE OF GROUND WATER

Character of material	Cubic feet per square foot in 24 hours
Impervious clay loam	0.25-0.35
Medium clay loam underlaid with hardpan at depth of not over 2 to 3 feet below bed.	0.35-0.50
Ordinary clay loam, silt soil, or lava ash loam	0.50-0.75
Gravelly clay loam or sandy clay loam, cemented gravel, sand and clay	0.75-1.00
Sandy loam	1.00-1.50
Loose sandy soils	1.50-1.75
Gravelly sandy soils	2.00-2.50
Porous gravelly soils	2.50-3.00
Very gravelly soils	3.00-6.00

Rates of Conveyance Loss for the Design of Canals.—The above rates of conveyance loss represent average loss per square foot of wetted perimeter. The intensity of loss is, however, maximum at the bottom and decreases uniformly on the sides, being zero at the water surface. If the intensity of loss is assumed to vary with the square root of the depth as indicated by the results previously given, then the total seepage loss from the two side slopes is equal to $\frac{4}{3}$ the length of one side slope, multiplied by the maximum intensity on the bottom. For ordinary proportions of bed width to depth, the error resulting by applying the average loss per square foot to the entire wetted perimeter to obtain the total seepage loss will be small compared to the accuracy with which the loss can be estimated for different materials.

The values given above can, therefore, be applied to any cross section and the loss expressed in cubic feet per second per mile in the following manner.

For the general case:

Let A = area of cross-section in square feet.

b = bottom width in feet.

d = depth in feet.

r_{bd} = ratio of bed width to depth.

i = average intensity of seepage in cubic feet per square foot.

$n_1 : 1$ = side slope of n_1 feet horizontal in 1 vertical.

Q = carrying capacity in cubic feet per second.

V = velocity of flow in feet per second.

S = total seepage loss in cubic feet per second per mile.

Then:

$$S = \frac{(r_{bd} \times d + \frac{1}{3} \sqrt{n_1^2 + 1} d) i \times 5280}{86,400}$$

Substitute for d its value in terms of A , r_{bd} and n_1 and for A its value in terms of Q and V and obtain:

$$S = 0.061 \left[r_{bd} \sqrt{V(r_{bd} + n_1) \frac{Q}{V(r_{bd} + n_1)}} + \frac{1}{3} \sqrt{n_1^2 + 1} \sqrt{V \frac{Q}{V(r_{bd} + n_1)}} \right] i$$

In the above equation a considerable variation in r_{bd} produces only a small change in the value of S . Assuming a proportion of bed width to depth of 4 and a side slope of $1\frac{1}{2}$ to 1, which are commonly used for canals of a distribution system, the equation

reduces to $S = 0.17i \sqrt{\frac{Q}{V}}$ cubic feet per second per mile. For

proportions of bed width to depth similar simplified equations may be obtained.

In a similar manner F. W. Hanna has obtained the results tabulated below for the following conditions, which he recommends for average lateral construction:

First.—The form of the cross section is based on the following relation of bottom width of canal (b) to depth (d); $b = 1.5 d^2 + 1.5$, but not less than 3 feet.

Second.—Side slopes 2 to 1.

Third.—Mean velocity is equal to 2 feet per second.

The values given are worked out for a seepage rate of 1.00 cubic foot per square foot of wetted area in 24 hours. For smaller or larger seepage rates the corresponding values can be obtained by multiplying the values given by the ratio of the seepage rate to one.

SEEPAGE LOSSES FOR LATERALS BASED ON A SEEPAGE RATE OF 1.0 CUBIC FOOT PER SQUARE FOOT OF WETTED AREA IN 24 HOURS

Depth	Dimensions of canal			Capacity	Seepage losses	
	Bottom width	Area	Wetted perimeter		Second feet per mile	Per cent. loss per mile
0.5	3	2	5.24	4	0.31	8.0
1.0	3	5	7.48	10	0.45	4.6
1.5	5	12	11.72	24	0.70	3.0
2.0	8	24	16.96	48	1.02	2.0
2.5	11	40	22.20	80	1.33	1.6
3.0	15	63	28.44	126	1.71	1.4

From the above computations Mr. Hanna has prepared the following table of general values for designing irrigation laterals:

SEEPAGE VALUES FOR DESIGNING IRRIGATION LATERALS FOR MEAN VELOCITY OF 2 FEET PER SECOND, BY F. W. HANNA

Capacity of canal, cubic feet per second	Loss in per cent. of flow per mile		
	For rather impervious soil, rate of seepage, 6 inches in 24 hours	Mediumly pervious soil, rate of seepage, 12 inches in 24 hours	Rather pervious soil, rate of seepage, 18 inches per day
10 or less	4.0	8.0	12.0
11-25	2.5	4.5	7.0
26-50	1.5	3.0	4.5
51-75	1.0	2.0	3.0
76-100	0.75	1.5	2.5

The formula for seepage loss used in Punjab, India, gives the loss in cubic feet per second and is based on the assumption that the seepage loss is proportional to the square root of the depth of water. It can be applied to soils of various textures by using different values for the coefficient C in the formula $P = C\sqrt{d}$
 $\frac{WL}{1,000,000}$. The value of C generally used in Punjab is 3.5. To obtain the value of the coefficient for different textures of soil, it is necessary to know for what soil the average value 3.5 is obtained. Measurements on older canals in Punjab give an average loss of 8 cubic feet per second for each million square feet of wetted area; this is a general value used in Punjab and is equivalent to a loss of 0.7 cubic feet of water per square foot

of wetted area, or a depth of loss of 8.4 inches. A comparison of this value with the values given above for different textures of soil will give the ratio by which the Punjab coefficient can be multiplied to make it applicable to the special soil texture.

Extent of Conveyance Losses Expressed in Per Cent. of Flow Per Mile.—Because of the many factors which affect the rate of seepage loss and because of the very varying conditions, the rate of seepage will vary over a very wide range, from extremes of 100 per cent. loss to no loss or even a gain in some cases. The extensive measurements of the Irrigation Investigations of the U. S. Department of Agriculture are of interest in showing what these losses commonly are. Series of measurements on 67 ditches in the western states show an average loss per mile of ditch of 5.77 per cent. of the entire flow; the measurements range from a maximum loss of 64 per cent. per mile to a slight gain. Expressed in per cent. of the flow per mile, large canals in general lose less in proportion than small ones. The measurements give the following average values:

AVERAGE CONVEYANCE LOSSES FROM CANALS FROM U. S. DEPARTMENT OF AGRICULTURE MEASUREMENTS

Capacity of canal, cubic feet per second	Number of canals measured	Loss per mile, per cent.
Over 100	13	0.95
50 to 100	15	2.58
25 to 50	15	4.21
Less than 25	24	11.28

W. L. Strange gives the following values in "The Design and Construction of Small Irrigation Canals," Pretoria Government Press, 1905.

CONVEYANCE LOSSES IN CANALS, BY W. L. STRANGE

Capacity of canal, cubic feet per second	Loss per mile in per cent. of flow
Over 100	0.25
50 to 100	0.50
25 to 50	1.00
10 to 25	2.00
Less than 10	4.00

The values obtained by computations based on different rates of seepage for different classes of material show that the values given by W. L. Strange correspond more nearly with those obtained for rather impervious soil, while those given by the measurements of the U. S. Department of Agriculture are not very different from those obtained for a rather pervious soil.

Extent of Evaporation Loss in the Conveyance of Water in Canals.—Contrary to the common belief, the losses of evaporation from flowing water in a canal are insignificant, when compared with those of seepage. It has been shown that the combined losses of seepage and evaporation will usually range from about 3 inches in depth in 24 hours for a very impervious clay loam to a maximum of about 72 inches in 24 hours for a very gravelly soil, averaging usually from about 12 inches for a medium clay loam to 18 inches for a sandy soil. As compared to these figures, the evaporation from the water surface will generally average for the irrigation season about $\frac{1}{4}$ inch per day or from 50 to 75 times less than the seepage loss, and will seldom be as much as $\frac{1}{10}$ of the seepage loss.

Seepage and evaporation measurements made at Twin Falls, Idaho, by Elias Nelson (Bulletin 58, University of Idaho) show that the evaporation ranged from less than 1 per cent. to not more than 2 per cent. of the total conveyance loss in the canals.

Evaporation measurements made in tanks placed in the main canal of the San Joaquin and Kings River Canal Co., California, gave an average loss per day during the two hottest months, July and August, 1908, of 0.37 and 0.36 inches, respectively. The total seepage loss for the 165 miles of canal was estimated, from a number of measurements, to be about 28 per cent. and the evaporation loss 0.9 per cent. or about 30 times smaller.

Measurements reported by Don H. Bark for three localities in Idaho show the average weekly evaporation loss during the irrigation season to be less than 1.50 inches, or about $\frac{1}{5}$ of an inch per day.

In India on the Bari Doab Canal, the mean of several observations taken during the hot weather gives a depth of evaporation 0.18 inch, while the minimum seepage loss was 1.92 inches in depth, and the average seepage loss, as obtained by 63 measurements on small channels was 9.8 inches. The evaporation

loss was 9.4 per cent. of the minimum seepage loss and about 2 per cent. of the average seepage loss.

The above results show that the evaporation loss of water from canals is generally so small compared to the seepage loss that it is negligible.

REFERENCES FOR CHAPTER V.

- BERESFORD, J. S., KENNEDY, R. G., AND HIGHAM, T.—Remodelling of Distributaries on Old Canals—Punjab Irrigation Branch Papers No. 10—1905.
- CARPENTER, L. C.—Losses from Canals from Filtration or Seepage—1898—Bull. No. 48, State Agricultural College, Fort Collins, Colo.
- FORTIER, S.—The Quantity of Water Used in Irrigation and the Seepage Loss from Canals—1900—Montana College of Agriculture—Bozeman, Mont.
- WRIGHT, A. E.—Experiments with Ditch Linings for the Prevention of Seepage—1907—Thesis, College of Civ. Eng., Univ. of Cal., Berkeley, Cal.
- BAILEY, PAUL—Evaporation and Seepage Losses in Irrigation Canals—1910—Thesis, College of Civ. Eng., Univ. of Cal., Berkeley, Cal.
- BARK, DON H.—Losses and Waste of Water, 9th Biennial Report of the State Engineer of Idaho—1911-12—Boise, Idaho.
- MORITZ, E. A.—Seepage Losses from Earth Canals—p. 402 Engineering News—Aug. 28, 1913.
- MORITZ, E. A., AND ELDER, H. W.—Enlargement and Improvement of the Main Canal Sunnyside Unit—Yakima Project, Washington—Engineering and Contracting—Sept. 11, 1912.
- TEELE, R. P.—Review of Ten Years of Irrigation Investigations—Reprint from Annual Report of Office of Experiment Stations for 1908—U. S. Dept. of Agriculture, Washington, D. C.
- HANNA, F. W.—Water Losses in Irrigation Canals and Methods of Prevention—Engineering and Contracting—June 21, 1911.
- Results of Seepage Measurements on the Irrigation Canals of the Twin Falls Tract, Idaho—Engineering and Contracting—Oct. 9 1912.
- FORTIER, S.—Concrete Lining as Applied to Irrigation Canals—Bull. 126, U. S. Dept. of Agriculture, Washington, D. C.—1914.

CHAPTER VI

THE DESIGN OF CANAL CROSS SECTIONS

GENERAL CONSIDERATIONS

The required carrying capacity of a canal is determined by the area to be served and the duty during the period of maximum use. Where the grade is fixed by the topographic conditions, a variation in the form of the cross section will give different values for the hydraulic radius, with a corresponding range in velocities from which either the best velocity or best form of cross section may be selected; this may, however, be limited by the requirements of design for minimum silt prevention.

Where the grade is not fixed, such as where the available grade is excessive, requiring the use of falls to correct the excess grade, or where the canal location may be varied to obtain different grades, then by selecting both the velocity and form of cross section the corresponding required grade is determined, and where silt problems are to be considered the form of cross section may be selected and a certain minimum grade is then necessary to prevent silt deposit.

Where the form of the cross section is not limited by the necessity of silt prevention, the form of section best adapted to meet certain requirements, discussed further, may be used.

The design of canal cross section involves:

I. Determination of proportion of bed width to depth or the selection of a fixed depth and the determination of the corresponding bottom width required to give a desired fixed velocity.

II. Selection of side slopes for the water cross section and for the outside of the bank.

III. The consideration of berms and spoil banks.

IV. Selection of height of top of bank above full water supply level or freeboard.

V. Selection of top width of the crown of the bank.

1. PROPORTION OF BED WIDTH TO DEPTH

The selection of the proportion of bed width to depth may be limited on canals carrying silt by the requirements for the pre-

vention of silt deposit; this is considered in Chapter IV. The other practical and theoretical conditions which must be considered are:

A. Form of canal cross section having most advantageous hydraulic elements.

B. Form of canal cross section for minimum seepage loss.

C. The safety against breaks.

D. The location of the canal and the purpose for which it is used.

E. The form of construction: lined or not lined.

F. The unit cost of excavation and methods of excavation.

G. The limitations in the selection of the form of cross section because of grade and velocity and of the necessity for the prevention of silt deposits.

A. Canal Cross Section Having most Advantageous Hydraulic Elements.—The velocity of water in a canal is proportional to the square root of the hydraulic radius. When the cross-sectional area, grade and side slopes are fixed, the form of cross section which will give the greatest hydraulic radius or least wetted perimeter will have the greatest velocity and the greatest discharge.

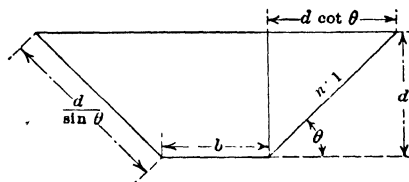

FIG. 14.

To obtain the relation between depth and bottom width for this maximum carrying capacity, an equation for the wetted perimeter will be deduced in terms of one variable (the ratio of bed width to depth) and solved for the minimum value of the perimeter.

It will be worked out: *First*, for a general case applicable to any value of the side slope; *second*, for the value of the side slope which will give the best one of the advantageous sections.

First.—General case applicable to any value of side slope (Fig. 14):

Let A = area of water cross section.

θ = side-slope angle made with horizontal.

$n:1$ = side slope of n feet horizontally to 1 foot vertically.

p = wetted perimeter.

r = hydraulic radius = $\frac{A}{p}$.

d = depth of water.

b = bottom of width of canal.

r_{bd} = ratio of bottom width to depth.

Then $p = b + 2 \frac{d}{\sin \theta}$

But $b = r_{bd}d$ and $A = (dr_{bd} + d \cot \theta)d$ or $d = \sqrt{\frac{A}{r_{bd} + \cot \theta}}$

Substitute in equation for p the values of b and d in terms of A , r_{bd} and θ .

Then $p = \left(r_{bd} + \frac{2}{\sin \theta} \right) \sqrt{\frac{A}{r_{bd} + \cot \theta}}$

To obtain the minimum value of p , take the first derivative of p in terms of r_{bd}

which gives $r_{bd} = 2 \left(\frac{1 - \cos \theta}{\sin \theta} \right) = \frac{b}{d} = 2 \tan \frac{\theta}{2}$

$d = \sqrt{2 \frac{A \sin \theta}{1 - \cos \theta}}$

$b = 2d \tan \frac{\theta}{2}$

$r = \frac{d}{2}$

The following graphical method may be used to find the proportions of the cross section having most advantageous hydraulic elements.

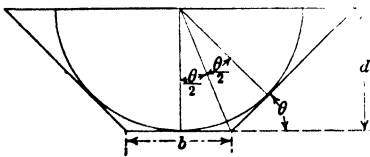

FIG. 15.

Describe a semi-circle with the center of the curve in the water surface, draw the sides on the desired slope and tangent to the semi-circle, and draw the bottom tangent to the lower point of the circle (Fig. 15).

The section thus obtained gives the same value for the ratio $r_{bd} = \frac{b}{d} = 2 \tan \frac{\theta}{2}$.

Second.—Special value of side slope which gives best advantageous section hydraulically: The problem is to find which value of θ will give the least wetted perimeter or greatest hydraulic radius for a section having the proportion of bed width to depth necessary to give it the best hydraulic elements

$r = \frac{d}{2} = \frac{1}{2} \sqrt{\frac{A \sin \theta}{2 - \cos \theta}}$

To obtain maximum value of r , take the derivative of r in terms of θ and place it equal to zero, it reduces to $2 \cos \theta - 1 = 0$, from which $\cos \theta = \frac{1}{2}$ or $\theta = 60^\circ$.

The dimensions of cross sections proportioned to give best hydraulic elements are given in the accompanying table, for various side slopes, in terms of the desired cross-sectional area. In all cases the hydraulic radius is equal to $\frac{1}{2}$ of the depth.

DIMENSIONS OF CANAL SECTIONS HAVING MOST ADVANTAGEOUS HYDRAULIC ELEMENTS IN TERMS OF WATER CROSS SECTIONAL AREA (A)

Side slope	Angle of slope with horizontal	Depth	Bottom width	Width at water surface	Wetted perimeter	Material and form of construction for which adapted
Vertical 1 to 2	90° 00	0.707 \sqrt{A}	1.414 \sqrt{A}	1.414 \sqrt{A}	2.828 \sqrt{A}	Flumes, channel in rock.
	63° 26	0.759 \sqrt{A}	0.938 \sqrt{A}	1.697 \sqrt{A}	2.645 \sqrt{A}	Channel in rock—concrete-lined canal.
1 to 1½	60° 15	0.760 \sqrt{A}	0.882 \sqrt{A}	1.750 \sqrt{A}	2.633 \sqrt{A}	Channel in rock—concrete-lined canal.
1 to 1	45° 00	0.740 \sqrt{A}	0.613 \sqrt{A}	2.093 \sqrt{A}	2.705 \sqrt{A}	Channel in firm clay soil.
1¼ to 1	38° 40	0.716 \sqrt{A}	0.503 \sqrt{A}	2.293 \sqrt{A}	2.795 \sqrt{A}	Channel in firm clay soil.
1½ to 1	33° 41	0.689 \sqrt{A}	0.418 \sqrt{A}	2.485 \sqrt{A}	2.904 \sqrt{A}	Channel in sandy loam.
2 : 1	26° 34	0.636 \sqrt{A}	0.300 \sqrt{A}	2.844 \sqrt{A}	3.144 \sqrt{A}	Channel in loose soil.
Semicircular	0.798 \sqrt{A}	1.596 \sqrt{A}	2.507 \sqrt{A}	Flumes—concrete-lined channel.

B. Canal Cross Section for Minimum Seepage Loss.—The seepage loss varies mainly with the texture of the soil and sub-soil and the depth to the water-table. It is proportional to the wetted perimeter and is affected by the depth. That there is probably no simple relation between the seepage loss and the depth has been shown in the discussion on seepage losses. If the assumption, indicated in the above discussion, that the intensity of seepage loss varies with the square root of the depth be made, then the intensity of seepage loss at any point may be expressed by $C\sqrt{d_1}$

where C = a constant depending on texture of soil, depth to water-table, etc.

d_1 = depth of water at any point.

d = full water depths of canal.

The intensity of seepage at different points of a canal section is represented by the diagram (Fig. 16), the average intensity for the sides is $\frac{2}{3}$ of the intensity on the base and the total seepage

for a given canal cross section may be deduced as follows, using the same notation as above and

S = seepage loss per unit of length

$$S = C\sqrt{d} \left(b + \frac{4}{3} \frac{d}{\sin \theta} \right)$$

Substitute for d and b their values in terms of A, r_{bd} and θ

$$\text{then } S = C \left(\frac{A}{r_{bd} + \cot \theta} \right)^{3/4} \left(r_{bd} + \frac{4}{3 \sin \theta} \right)$$

To obtain minimum value of S , take the first derivative in terms of r_{bd} and place it equal to zero, which gives $r_{bd} = 4 \left(\frac{1 - \cos \theta}{\sin \theta} \right) =$

$$4 \tan \frac{\theta}{2}$$

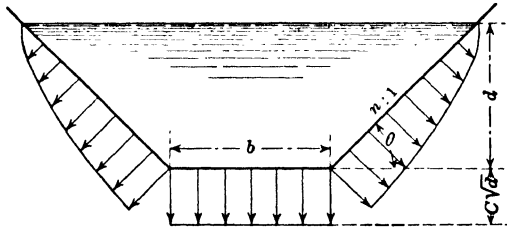

FIG. 16.

$$d = \sqrt{\frac{A \sin \theta}{4 - 3 \cos \theta}}$$

$$b = 4d \tan \frac{\theta}{2}$$

The value of the ratio bottom width to depth, r_{bd} , for minimum seepage loss, is twice the value required for maximum hydraulic radius or maximum velocity.

C. The Safety against Breaks.—The safety against breaks is dependent on the depth of water in the canal and especially on that part of the depth which is in fill. In a deep canal the pressure of the water on the banks is greater and will produce a higher velocity through holes or breaks started by burrowing animals.

D. Location of Canal and Purpose for Which it is Used.—A canal may be intended for either a diversion canal, a main lateral, a small lateral or a farm distributary. A diversion canal is

frequently constructed on a side hill where a deep narrow section (Plate VI, Fig. A) has the advantage that it requires less volume of excavation than a broad shallow section with the same water cross section; the difference in volume depending on the degree of the slope of the side hill. The deep cross section has the additional advantage that as it approaches the form of cross section which gives the maximum hydraulic radius, it will have a velocity greater than the shallow section for the same grade, and therefore a greater carrying capacity or else the same velocity may be used for both sections, with a flatter grade for the deeper one. The deeper cross section has the disadvantage, due to the greater depth, of decrease in safety against breaks and of increase in unit cost of excavation, which will partly offset the decreased volume of excavation.

A lateral or distributary is usually constructed on comparatively level ground and for main laterals at least the cross section is placed in the ground to a depth which will give an amount of excavation equal to the amount of fill necessary to make the banks (Plate VI, Fig. B). It is important that the water level in the canal be maintained above the surface of the land in order to carry as large a volume of water as feasible above the land which it commands and facilitate its diversion on this land. To meet this requirement, smaller laterals and distributaries are sometimes constructed with a greater volume of fill than excavation, which requires borrowing of earth. For a balanced cut-and-fill cross section in level ground, a shallow cross section will carry a larger volume of water above the ground surface than a deeper cross section.

The above relations are shown by the following examples:

1. Side-hill canal—water cross section all in cut:

- Let A = area of water cross section.
 A_1 = area of earth excavation above water level.
 $A + A_1$ = total area of excavation.
 $n : 1$ = side slopes of water cross section.
 $n_1 : 1$ = slope of side hill.
 r_{bd} = ratio of bed width to depth.

The equation for A_1 reduces to $A_1 = \frac{A}{2} \frac{(2n + r_{bd})^2}{(n + r_{bd})(n_1 - n)}$

and the total area of excavation is:

$$A + A_1 = A + \frac{A}{2} \left[\frac{(2n + r_{bd})^2}{(n + r_{bd})(n_1 - n)} \right]$$

The effect of different proportions of bed width to depth, of different side slopes for the water cross section and of different inclinations or slopes of side hill is shown by the following tabulated examples:

AREA OF EXCAVATION, IN TERMS OF WATER CROSS-SECTIONAL AREA (*A*),
FOR CANALS OF DIFFERENT PROPORTIONS OF BED WIDTH TO DEPTH,
WITH DIFFERENT SIDE SLOPES AND ON DIFFERENT DEGREES OF
SIDE-HILL SLOPE, WITH WATER CROSS SECTION ALL IN CUT

Form of cross-section,	Slope of side hill 2 : 1 and canal slopes of			Slope of side hill 3 : 1 and canal slopes of			
	½ : 1	1 : 1	1½ : 1	½ : 1	1 : 1	1½ : 1	2 : 1
Best hydraulic elements.....	1.96 <i>A</i>	3.19 <i>A</i>	7.17 <i>A</i>	1.58 <i>A</i>	2.09 <i>A</i>	3.06 <i>A</i>	5.04 <i>A</i>
Minimum seepage.....	2.35 <i>A</i>	3.52 <i>A</i>	7.54 <i>A</i>	1.81 <i>A</i>	2.26 <i>A</i>	3.18 <i>A</i>	5.15 <i>A</i>
Bottom width depth = 2.....	2.20 <i>A</i>	3.67 <i>A</i>	8.16 <i>A</i>	1.72 <i>A</i>	2.34 <i>A</i>	3.38 <i>A</i>	5.50 <i>A</i>
Bottom width depth = 3.....	2.52 <i>A</i>	4.13 <i>A</i>	9.00 <i>A</i>	1.92 <i>A</i>	2.56 <i>A</i>	3.66 <i>A</i>	5.90 <i>A</i>
Bottom width depth = 4.....	2.86 <i>A</i>	4.60 <i>A</i>	9.93 <i>A</i>	2.12 <i>A</i>	2.80 <i>A</i>	3.97 <i>A</i>	6.34 <i>A</i>

Form of cross-section,	Slope of side hill 4 : 1 and canal slopes of				Slope of side hill 5 : 1 and canal slopes of			
	½ : 1	1 : 1	1½ : 1	2 : 1	½ : 1	1 : 1	1½ : 1	2 : 1
Best hydraulic elements.....	1.41 <i>A</i>	1.73 <i>A</i>	2.24 <i>A</i>	3.03 <i>A</i>	1.32 <i>A</i>	1.54 <i>A</i>	1.88 <i>A</i>	2.35 <i>A</i>
Minimum seepage.....	1.58 <i>A</i>	1.84 <i>A</i>	2.31 <i>A</i>	3.07 <i>A</i>	1.45 <i>A</i>	1.63 <i>A</i>	1.91 <i>A</i>	2.38 <i>A</i>
Bottom width depth = 2.....	1.53 <i>A</i>	1.89 <i>A</i>	2.43 <i>A</i>	3.25 <i>A</i>	1.40 <i>A</i>	1.66 <i>A</i>	2.02 <i>A</i>	2.50 <i>A</i>
Bottom width depth = 3.....	1.65 <i>A</i>	2.04 <i>A</i>	2.60 <i>A</i>	3.45 <i>A</i>	1.51 <i>A</i>	1.76 <i>A</i>	2.14 <i>A</i>	2.63 <i>A</i>
Bottom width depth = 4.....	1.75 <i>A</i>	2.20 <i>A</i>	2.78 <i>A</i>	3.67 <i>A</i>	1.62 <i>A</i>	1.90 <i>A</i>	2.27 <i>A</i>	2.78 <i>A</i>

These results show the advantages of deep sections over shallow sections in decreasing the amount of excavation, especially on steep side hills.

2. Canals in level country, with balanced cut and fill.

The effect of different proportions of bed width to depth is well illustrated by the numerical examples, worked out for the following two typical limiting conditions: *First*, for a given grade which is the same for all canal sections; *second*, for a given velocity which is the same for all canal sections. For all sections the carrying capacity is 300 cubic feet per second, the side slope 1 to 1 the coefficient of roughness 0.025, the width of the top of

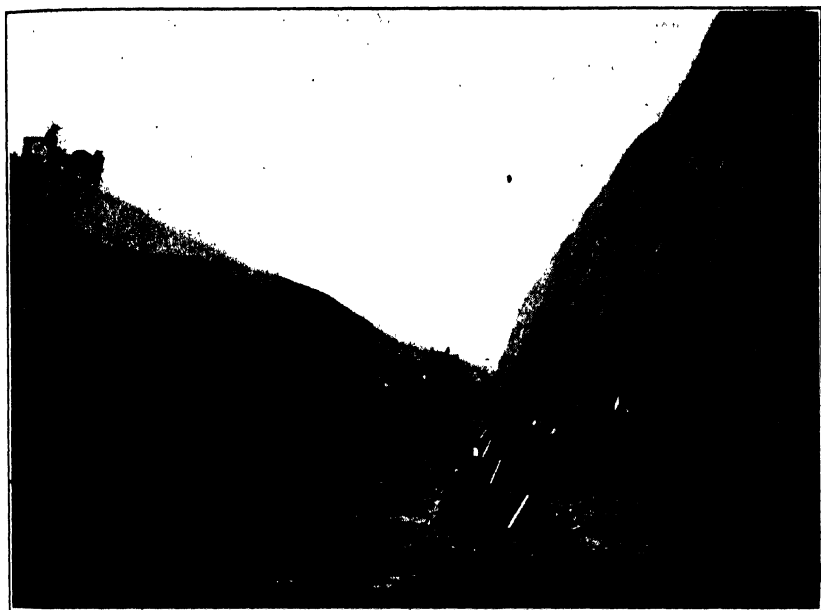

FIG. A.—Diversion canal in deep rock cut. Truckee Carson Project, Nev.

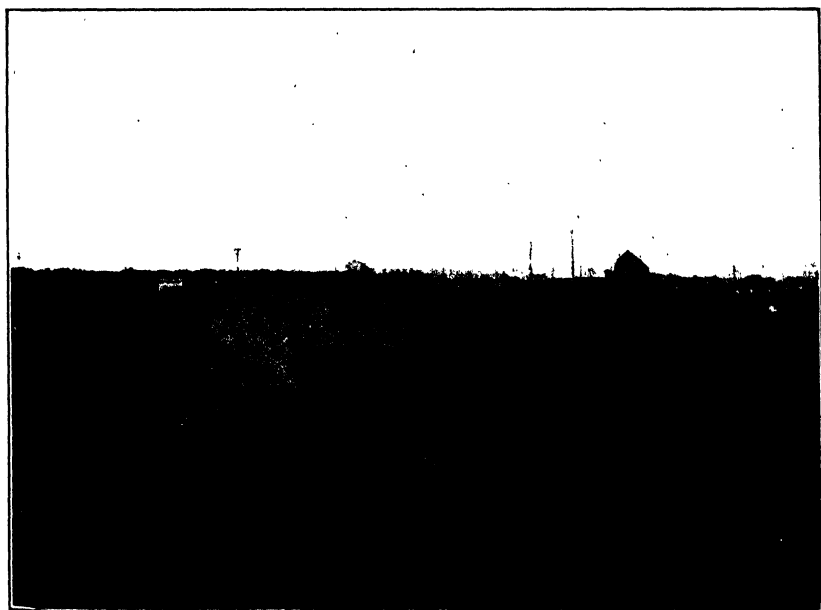

FIG. B.—Main lateral, recently completed.

(Facing page 118)

PLATE VI



FIG. C.—Warped wings transition at connection of reinforced concrete flume with concrete-lined canal. Naches Power Canal, Wash.

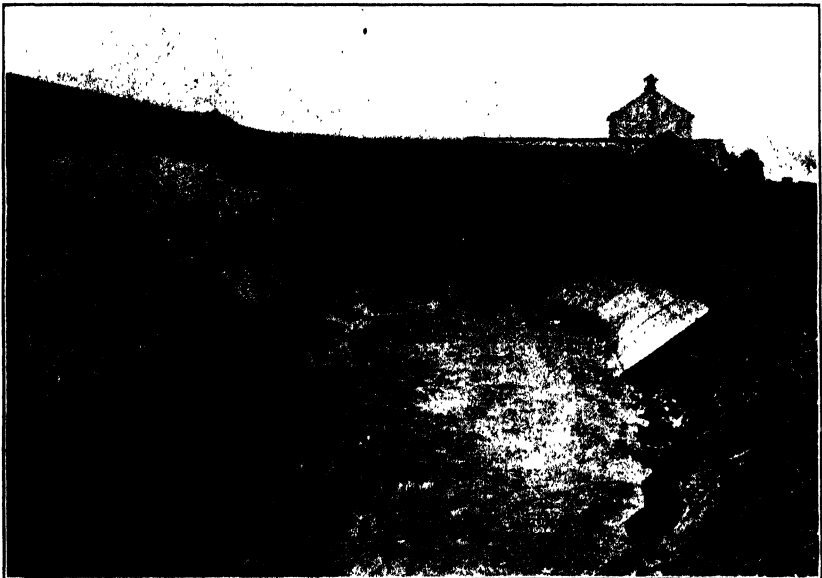

FIG. D.—Outlet transition at connection of semicircular concrete-lined canal with earth canal. Umatilla Project, Ore.

the bank 10 feet, and the height from the full supply water level to the top of the bank 2 feet. The depth of cut is computed to give an amount of excavation equal to the fill plus 10 per cent. of fill for shrinkage. The first canal section is proportioned to give the best hydraulic elements, the second canal section gives minimum seepage loss, the other sections are shallower.

EFFECTS OF FORM OF CROSS SECTION FOR A FIXED GRADE OF 5 FEET IN 10,000 FOR ALL SECTIONS

Element of canal section	First canal section	Second canal section	Third canal section	Fourth canal section	Fifth canal section
Ratio of bed width to depth.....	0 8284	1. 657	3 0	6. 0	10. 0
Bed width in feet.....	5. 988	9. 985	14. 950	23. 442	32. 320
Depth in feet.....	7. 228	6. 026	4. 985	3. 907	3. 232
Wetted perimeter in feet.....	26 468	27. 026	29. 050	34. 500	41. 465
Area of water section in square feet.....	95. 54	96 47	99. 350	106. 750	115. 000
Average velocity in feet per second.....	3. 14	3. 110	3. 020	2. 910	2. 610
Depth of cut in feet.....	6. 414	5. 215	4. 164	3. 050	2. 350
Height of fill in feet.....	2. 814	2. 810	2. 821	2. 857	2. 882
Volume of excavation in cubic feet per lineal foot.....	79 5	79 300	79. 600	80. 800	81. 500
Height of water level above ground surface	0. 814	0. 810	0 821	0. 857	0. 882
Volume of water level above ground surface based on average velocity.....	50. 000	53. 000	60. 000	73. 000	88 000
Relative seepage loss.....	52. 6 C	52. 5 C	54. 5 C	60. 8 C	68. 1 C

EFFECTS OF FORM OF CROSS SECTION FOR A FIXED VELOCITY OF 3 FEET PER SECOND FOR ALL SECTIONS

Elements of canal section	First canal section	Second canal section	Third canal section	Fourth canal section	Fifth canal section
Ratio of bed width to depth.....	0. 8284	1. 657	3. 000	6. 000	10. 000
Bed width in feet.....	6. 127	10. 165	15. 000	22. 675	30. 150
Depth in feet.....	7. 397	6. 135	5. 000	3. 779	3. 015
Wetted perimeter in feet.....	27. 050	27. 530	29. 140	33. 360	38. 680
Area of water section in square feet.....	100. 000	100. 000	100. 000	100. 000	100. 000
Average velocity in feet per second.....	3. 000	3. 000	3. 000	3. 000	3. 000
Depth of cut in feet.....	6. 500	5. 260	4. 170	3. 020	2. 320
Height of fill in feet.....	2. 900	2. 870	2. 830	2. 750	2. 690
Volume of excavation in cubic feet per lineal foot.....	82. 080	81. 140	79. 940	77. 600	75. 340
Height of water level above ground surface	0. 900	0. 870	0. 830	0. 750	0. 690
Volume of water above ground surface based on average velocity.....	53. 770	56. 580	60. 180	67. 200	73. 980
Grade in feet per 10,000.....	4. 440	4. 511	4. 910	5. 920	7. 320
Relative seepage loss.....	54. 7 C	54. 0 C	54. 7 C	58. 0 C	62. 5 C

The tabulated results for these and other examples worked out by the author indicate the following deduction:

For canal sections in level country having same carrying capacity, same side slopes, same fixed grade but varying proportions of bed width to depth:

(a) The area of water cross section is least, for the deepest section, which has the proportion of bed width to depth required for best hydraulic element; consequently this form of section for a canal with the water section all in cut would give the least amount of excavation, but the greater depth of excavation would increase the unit cost of excavation when the earth is excavated either by hand or with teams.

(b) The volume of excavation for a balanced cut and fill cross section in level country seems to be nearly the same for all forms of sections. The smaller unit cost of excavation for the shallow canals would make the shallowest section the least expensive.

(c) The height of the water level above the ground surface is practically the same for all three sections, but this height gives a greater volume of water above the ground surface for the wider sections. An equal fluctuation in the volume of water carried would produce a smaller change in the water level of the shallower sections. These advantages are of special value for laterals of the distribution system; for it facilitates the diversion of the water to the land and the regulation of the flow.

(d) A decrease in the proportion of bed width to depth made in the form of the canal cross section giving minimum seepage loss, gives a relatively smaller increase in seepage loss than that produced by an equal increase in the proportion.

For canal sections having same carrying capacity, same side slopes, and varying grades to produce an equal velocity for all forms of cross sections, deductions of the same character may be made. The sections have then equal water areas. The amount of excavation for a balanced cut-and-fill section decreases with the shallower sections, and while the height of water level above the ground surface is less for the shallower sections the volume of water carried above the ground surface remains greater for the shallow sections.

The disadvantages of a deep section are greater unit cost of excavation, greater volume of excavation for an equal velocity, smaller volume of water carried above the ground surface, difficulty in maintaining side slopes in a deep canal, which may require flatter side slopes, decrease safety and greater damage in case of a break. The disadvantages of a shallow section are greater seep-

age loss, more favorable conditions for plant growth, greater width of right of way, greater wetted perimeter, which is a disadvantage especially for concrete-lined canals, and higher grade required to produce the same velocity.

From the above studies it may be concluded that in general a moderately shallow section, for instance in the above cases one whose bed width is equal to about 3 times the depth, is best adapted. Where it is necessary to maintain a large volume of water above the original ground surface, a larger proportion of bed width to depth may be advisable. Where the canal is in rock or for a concrete-lined canal section, and especially for a diversion canal from which there is little or no necessity to divert the water on the land, it usually will be advantageous to use the section approaching that having best hydraulic elements.

E. The Form of Construction, Lined or not Lined.—The section giving least wetted perimeter will require less area of lining, but it is usually more difficult to place the lining on the sides than on the bottom; this is especially true of concrete linings, and for this reason a moderately shallow section which will give a slightly greater wetted perimeter may not give a greater cost of lining.

F. The Unit Cost of Excavation and Methods of Excavation.—When a canal is excavated with teams and scraper, a shallow broad canal will decrease the unit cost of excavation, because the conditions permit the working of a number of teams without interference and the earth is carried out of the canal on low runways with less work than in a deep canal.

When machinery is used for excavation the depth of canal will have little or no effect on the cost of excavation, depending on the type of machinery.

G. The Limitations in the Selection of the Form of Cross Section because of Grade and Velocity and of the Necessity for the Prevention of Silt Deposits.—When the canal is located on a line where the grade is too large, the selection of a deep cross section will give an excessive velocity; it may then be necessary to overcome this excess in grade by the insertion of falls; but the use of a shallow cross section will reduce the velocity and may either eliminate the necessity for falls or reduce the excess grade so that fewer falls are necessary.

When the grade is small it may be desirable to use a section approaching that having greatest hydraulic radius to obtain a sufficiently large velocity.

Where the occurrence of silt in the water must be considered, Kennedy's silt theory explained in Chapter IV shows that a shallow canal will generally be more favorable to the prevention of silt deposit, and for every depth of water there is a minimum velocity required to prevent silt deposits.

Empirical Rules for Proportion of Bed Width to Depth.—The above study of the factors influencing the design of the form of canal sections shows that in general a moderately deep cross section is desirable. A consideration of the dimensions of canal cross sections used on a number of modern irrigation systems and especially on the systems of the U. S. Reclamation Service show that the full supply depth of water may be expressed by the empirical formula:

$D = \frac{1}{2}\sqrt{A}$, where D = depth of water in feet and A area of water cross section in square feet. The application of this formula to different side slopes gives the results tabulated below, with which are given for comparison the proportions obtained for maximum hydraulic radius and for minimum seepage.

PROPORTION OF BED WIDTH TO DEPTH

For section of	Side slopes of				
	$\frac{1}{2} : 1$	1 : 1	$1\frac{1}{2} : 1$	2 : 1	3 : 1
Maximum hydraulic radius . . .	$b = 1.236d$	$b = 0.8284d$	$b = 0.607d$	$b = 0.472d$	$b = 0.325d$
Minimum seepage	$b = 2.472d$	$b = 1.656d$	$b = 1.214d$	$b = 0.944d$	$b = 0.650d$
Empirical rule $d = \frac{1}{2}\sqrt{A}$. . .	$b = 3\frac{1}{2}d$	$b = 3d$	$b = 2.5d$	$b = 2d$	$b = d$

For special values of A the empirical rule gives the following depths of water in the canal:

FULL SUPPLY DEPTH OF WATER IN CANALS BY EMPIRICAL RULE $d = \frac{1}{2}\sqrt{A}$

Area in square feet	5	10	25	50	75	100	200	400	600
Depth in feet.	1.12	1.53	2.50	3.54	4.33	5.00	7.07	10.00	12.25

These values may be taken as representing average practice in the United States. These values should not be exceeded unless there are special conditions, such as the lining of canals with concrete, the location of a canal on a steep side hill; on the other hand where a canal is used as a distribution lateral, or where the water carries much silt, it may be desirable, especially for large canals, to use smaller depths. Some of the largest depths of

water for diversion and main canals in earth built by the U. S. Reclamation Service are:

Canal	Water area	Depth	Side slopes
Truckee Carson project main canal . .	497.25 to 419.25	13 feet	1:1
Truckee Carson project main canal . .	513.50 to 427.70	13 feet	1½:1
Truckee Carson project main canal . .	455.00	13 feet	2:1
Sun River project main canal	478.50	11 feet	1½:1
Klamath storage unit main canal	555.50	11 feet	1½:1
North Platte storage unit main canal . .	490.00	10 feet	1½:1
Uncompaghre storage unit main canal . .	500.00	10 feet	2:1
Shoshone storage unit Garland canal . .	382.20	9.7 feet	2:1
St. Mary storage unit main canal	368.70	9.5 feet	1½:1

II. SELECTION OF SIDE SLOPES FOR THE WATER CROSS SECTION AND FOR THE OUTSIDE OF THE BANKS

The selection of the side slopes of a canal will depend on the character and texture of the material, the condition it is in, whether well compacted or loose, in cut or in fill and on the method of excavation. The desirable side slope to give to a canal would be the one which it would naturally assume and maintain after the canal has become well seasoned and compacted through the natural process of weathering and of water action. The natural slope which a canal slope will take is difficult to predict. F. H. Newell formerly Director of the U. S. Reclamation Service states that the weathering and erosion have a tendency to flatten the slopes, so that banks constructed with a 1½ to 1 slope after a few years are found to have become 2 to 1 or even flatter. C. E. Grunsky, at one time consulting engineer for the U. S. Reclamation Service, states that side slopes when seasoned are generally as steep as 1 to 1 or even ½ to 1. In India, where the irrigation water carries considerable silt, according to various authorities connected with the irrigation departments of the governments of India (R. G. Kennedy, J. Clibborn, N. F. Mackenzie), the natural side slope of a self-graded channel is ½ to 1 for ordinary soil. This side slope is recommended by them in making the computations, but as the slopes of a newly excavated canal will not stand on as steep a slope as this, the usual slope used in construction is 1 to 1 for ordinary firm soil, and the bed width is decreased accordingly to give the same sectional area.

The slope on which the canal is excavated cannot be steeper than the angle of repose of the material, and this slope will be flatter for a bank in fill than for a canal in cut. The slope of a newly constructed canal may be changed by many weathering actions. The action of the wind on the water surface forms small waves or ripples which acting on the slopes at the water edge, produce undercutting of the bank at the water surface and a little below it, with flattening of that part of the slope near the bottom of the canal. Where the material is well compacted and of such texture that it will stand on a steep slope, this action will result in a steepening of the slope except near the bottom, which will be rounded off. A clay loam or a mixture of gravel or sand and clay will stand on a steeper slope than a very sandy soil. The establishment of a root system by the vegetation on a well-seasoned bank will aid materially in holding the soil on a steep side slope. With a sandy soil, free from vegetation, the side slope will ordinarily be flattened by the action of the water to a slope of 2 to 1 or 3 to 1. The tramping of stock will naturally flatten side slopes and is largely responsible for the flat side slopes obtained on laterals which are not fenced in to keep the stock out.

The side slope may have to be adjusted to the method of excavation. Laterals are often constructed with Fresno scrapers driven across the canal, in which case side slopes not steeper than $1\frac{1}{2}$ to 1 and preferably 2 to 1 are necessary; this method of excavation produces a slightly curved bottom and corners which conform more closely to the section obtained with a sandy soil through the natural process of weathering. Where the earth is excavated by running the scrapers longitudinally with runways up the slopes the value of the side slope has very little effect on the cost of excavation. The side slopes commonly given to irrigation canals are:

For cuts in firm rock.....	$\frac{1}{4}$ to 1
For cuts in fissured rock, more or less disintegrated rock, tough hardpan.....	$\frac{1}{2}$ to 1
For cuts in cemented gravel, stiff clay soils, ordinary hardpan.....	$\frac{3}{4}$ to 1
For cuts in firm, gravelly, clay soil or for side hill cross section in average loam.....	1 to 1
For cuts or fill in average loam or gravelly loam.....	$1\frac{1}{2}$ to 1
For cuts or fill in loose, sandy loam.....	2 to 1
For cuts or fill in very sandy soil.....	3 to 1

On a steep side hill, where the downhill slope is partly or wholly in fill, in ordinary loam, side slopes of 1 to 1 on the uphill side and $1\frac{1}{2}$ to 1 on the downhill side are frequently used.

The outer side slope of a canal bank is usually $1\frac{1}{2}$ to 1, which is a little flatter than the angle of repose of most materials. For loose, sandy soils an outer slope of 2 to 1 is often used, and with a new canal this may be further flattened by the action of the wind.

On steep side hills an outer slope as steep as 1 to 1 may be necessary.

III. BERMS AND SPOIL BANKS

Berms may be used: *First*, when a canal in level ground is partly in fill and partly in cut; in which case the berms are placed usually at the original ground surface and below the water surface; *second*, when a canal is all in deep cut, with the water surface several feet below the ground; the berms are then made above the water surface at a height above it equal to the ordinary free board height; *third*, when a canal is all in cut and berms are made at the ground surface between the edges of the canal and the spoil banks.

The desirability of berms will depend on their position. The use of berms in the first position, stated above, has the advantage that it increases the water area, without increasing the amount of excavation, but the low velocity of the water above the berms due to the shallow depth of water encourages plant growth, and this is further increased when the flow in the canal is decreased or varied so as to keep the berms alternately wet and dry. Another disadvantage is the irregularity due to the variations in the longitudinal profile of the ground; the position of the berms below the water surface is irregular, and the water area is therefore not uniform; this can be remedied and the appearance of the canal improved by keeping the berms at the same elevation above the bed of the canal, but requires extra excavation. Professor Fortier concludes from a study of a large number of canal sections in level ground, well seasoned, that the use of berms in this position will give a canal section which will adjust itself better to the form which it will take when finally seasoned. For these conditions the width of berms is made equal to the depth of water, the side slopes below the berms 1 to 1 and above the berms 2 to 1; when seasoned, the sides will work down to uniform rounded slopes. The majority of engineers do not favor

the use of these berms and most canals are constructed without them.

The use of excavated berms in the second position is especially desirable where the water surface is at considerable depth below the ground; the purposes of the berms are: (1) to receive the material which may wash down or slide down from the part of the bank above it, (2) to lessen the pressure of the earth above the berms on the material below which has a tendency to push this material in the canal, especially when this material is soft and wet, and (3) to facilitate the repairs and patrolling of the canal. In rock excavation there is no real necessity for berms, and they are omitted for economy in excavation. In this position a width of berm equal to the depth of water with a minimum width of 3 feet is considered sufficient, and the berms are placed at a height above the water surface equal to about 1 foot for small canals and 2 feet for large canals.

The use of berms in the third position, is usually desirable when a canal cross section up to the free board is all in cut. For this condition the minimum width of berms is made about equal to the total depth of cut and for appearance it is desirable to make the berms at a uniform height above the water level and to dress the top of the spoil banks to a uniform height by varying the top width.

IV. SELECTION OF HEIGHT OF TOP OF BANK ABOVE FULL WATER SUPPLY OR FREEBOARD

The height of freeboard will depend on the depth of water, the wind action, the liability of drainage water or storm water entering the canal and raising the water level, the liability of excess water due to lack of regulation of flow, whether the canal is in cut or in fill, the position of the canal, whether straight or on a curve. Proper allowance must be made for the settlement of fills. A fill of ordinary earth as usually constructed will settle about 10 per cent. The common practice is to provide a minimum freeboard of 1 foot for small canals and a maximum of 3 feet for large canals. Within these limitations a safe rule is to make the freeboard above the maximum water level equal to one-third of the depth of water. The maximum water level must be carefully studied by considering the rise in water level due to the operation of check gates or to the maximum volume of storm water or excess of water which is liable to enter the canal. For a section of a canal on a curve

it will be desirable to increase the freeboard on the outside of the curve if the velocity is high or when there is a long stretch of canal above this curve exposed to the prevailing wind direction.

V. TOP WIDTH OF THE CROWN OF THE BANK

When the top of the canal bank is to be used for a roadway, this determines its top width; if it is to be used only for ditch tenders' carts, a minimum width of 6 feet is necessary and 8 feet is preferable; for ordinary conveyances a minimum width of 10 feet is desirable and for a roadway which will give room for teams to pass a width of 12 to 14 feet is necessary. It must be remembered that weathering action and the sliding of carts or wagons has a tendency to reduce the width. To construct the bank by moving the earth longitudinally along the line of the canal a width of 6 feet is necessary to prevent the crowding of the teams.

Without these limitations the width generally used ranges from a minimum of about 2 feet for small canals to a maximum of about 10 feet for large canals and may usually be taken as about equal to the depth of water.

SELECTION OF DEPTH OF CUT AND SPECIAL CASES OF EARTH-WORK COMPUTATION

Canals in Level Ground.—The larger part of the canals comprising an irrigation system are in level land or on land having a comparatively flat slope. The canals on side hill or on steep land are generally limited to the diversion or main canals.

The cross section of the canal being determined, the next step is to establish the depth of cut. This may be fixed so that the cross section will be (1) all within the soil or in cut, (2) all above the soil or in fill, (3) partly in cut and partly in fill. The variations in the slope along the canal line will frequently give a profile which will require the three forms of construction; but alternate location of the line may give a certain range of selection which will require a consideration of each form of construction. A canal all in cut is necessary when the canal goes through a ridge or through some high ground and may be desirable where the canal is on a side hill to make it safe. Care must be taken, by sinking trial pits, that a porous stratum be not reached by deep cutting, as this would increase the loss of water and may cause waterlogging

of the land below. A canal all in fill is necessary when the canal line crosses a depression or is along low ground. It has the advantage that the body of water is kept above the general level of the ground surface, which is favorable to the diversion of the water on the land and facilitates the installation of measuring devices. This advantage is only of value for laterals, and it will ordinarily suffice if the water level is kept from 1.5 to 2.0 feet above ground level; there is usually no advantage in more than this. It has the serious disadvantage of being more subject to breaks with the consequent damage which may also involve damage to the crops supplied by this canal because of the stoppage of irrigation water. The banks must be formed from borrow pits, which are always objectionable.

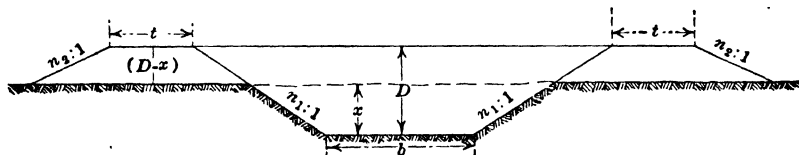

FIG. 17.

A canal partly in cut and partly in fill has several advantages. The water has usually sufficient elevation above the land to give easy diversion into the distributaries or on the land to be irrigated, and it is the most economic canal, for the depth of cut can be selected so that the amount of excavation will be just sufficient to make the banks after making the proper allowance for shrinkage.

Economic Depth of Cut in Level Ground for a Balanced Cut-and-fill Cross Section (Fig. 17).—The economic depth of digging in level ground can be obtained as follows:

- Let d = depth of water in canal.
 D = total depth of canal section = depth of water + freeboard.
 b = bottom width of canal.
 t = width of top of bank.
 $n_1:1$ = side slope of water cross section.
 $n_2:1$ = side slope of outside of bank.
 x = economic cut.

$$\text{Then area of one bank} = \left[\frac{2t + n_2(D-x) + n_1(D-x)}{2} \right] (D-x)$$

$$\frac{1}{2} \text{ area of excavation} = \frac{1}{2}(b + n_1x)x$$

Making an allowance of 10 per cent. for shrinkage cut = 1.1 fill
or

$$\frac{1}{2}(b + n_1x)x = 1.1 \left[\frac{2t + n_2(D - x) + n_1(D - x)}{2} \right] (D - x)$$

which reduces to

$$\begin{aligned} x^2 \left(\frac{n_1}{10} + 1.1n_2 \right) - x[b + 2.2t + 2.2(n_1 + n_2)D] \\ = -2.2tD - 1.1D^2(n_1 + n_2) \end{aligned}$$

Substituting the known numerical values, the equation is readily solved for x .

Canals in Side Hills.—The minimum cost of construction is obtained for a depth of cut which will give sufficient excavation to make the required fill plus the shrinkage. To obtain this balanced cut-and-fill section, a canal on side hills of small inclination, usually less than about 10 or 15 per cent., will be formed by two banks, the one on the uphill side being smaller than on the downhill side, the difference decreasing as the side-hill slope gets smaller. By using a deeper cut the uphill bank may be eliminated, but this produces an excess of excavation. In some cases, such as when crossing a depression or drainage channel, the uphill bank is left out and the water spreads into a basin formed by the downhill embankment and the sides of the depression; this form of construction will decrease the cost and the basin may be desirable to settle the silt, and if of considerable size will help in the regulation of the flow, provided the canal is operated at a time of the year when there is no run-off into this drainage channel which would hinder instead of help the operation of the canal. The formation of large basins increases the evaporation loss and the seepage loss.

On steeper side hills a balanced cut-and-fill section requires only the one bank on the downhill side. This section, while it is the most economical, will in the case of large canals usually bring the water level in the canal above the natural ground surface on the downhill side, which is not desirable because of the danger of breaks, especially when the canal is in unfavorable material and on steep side hills. For small canals the amount of excavation required to make a bank of normal dimensions may be sufficient to form the desired water area all in cut. The extent of the water area all in cut which may be obtained with a balanced cut-and-fill cross section will depend on the form of the canal cross section,

the top width of the bank, the freeboard, the inner and outer side slopes of the cross section and bank, and the slope of the side hill. This is illustrated by the following examples:

EXAMPLES SHOWING WATER AREAS ALL IN CUT WHICH MAY BE OBTAINED WITH BALANCED CUT-AND-FILL CROSS SECTIONS OF DIFFERENT FORMS, FOR THE FOLLOWING CONDITIONS

Shrinkage allowance of 10 per cent. or cut = 1.1 fill; width of top of bank = 6 feet; freeboard = 2 feet.

First.—For inner and outer side slopes of canal and bank of $1\frac{1}{2}$ to 1

Ratio of bed width to water depth	Water areas all in cut for slopes of side hill of			
	2 : 1 = 26 deg. 30 min., square feet	3 : 1 = 18 deg. 30 min., square feet	4 : 1 = 14 deg., square feet	5 : 1 = 11 deg. 20 min., square feet
Section of maximum hydraulic radius				
$b = 0.607d$	25.0	23.5	23.0	22.5
$b = 2d$	21.9	21.4	21.2	21.0
$b = 3d$	19.8	19.8	19.8	19.8
$b = 4d$	18.0	18.3	18.5	18.7

Second.—For inner and outer side slope of canal and bank of 1 to 1

Ratio of bed width to water depth	Water areas all in cut for slopes of side hill of			
	2 : 1 = 26 deg. 30 min., square feet	3 : 1 = 18 deg. 30 min., square feet	4 : 1 = 14 deg., square feet	5 : 1 = 11 deg. 20 min., square feet
Section of maximum hydraulic radius				
$b = 0.828d$	22.8	21.5	20.7	20.1
$b = 2d$	19.8	19.2	19.0	18.6
$b = 3d$	17.6	17.6	17.6	17.6
$b = 4d$	15.8	16.1	16.3	16.3

Third.—For inner canal side slopes of 1 to 1 and for outer bank slope of $1\frac{1}{2}$ to 1

Ratio of bed width to water depth	Water areas all in cut for slopes of side hill of:			
	2 : 1 = 26 deg. 30 min., square feet	3 : 1 = 18 deg. 30 min., square feet	4 : 1 = 14 deg., square feet	5 : 1 = 11 deg. 20 min., square feet
$b = 0.828d$	56.0	34.7	29.8	27.5
$b = 2d$	48.6	31.0	27.2	25.5
$b = 3d$	43.2	28.3	25.2	24.1
$b = 4d$	38.8	25.9	23.4	22.3

The tabulated results show that for a top width of bank and freeboard commonly used in practice a balanced cut-and-fill section gives a water area all in cut only for comparatively small canals. Using steeper side slopes for the cut than for the fill, such as frequently is done in practice, gives larger water areas all in cut; this is illustrated by the third example. The effect of proportion of bed width to depth on the area of the water cross section all in cut is shown by all three examples; the largest water area in cut is obtained with the narrowest, deepest section.

Larger areas of water cross section all in cut for a balanced cut-and-fill section may be obtained by an increase in the top width of the bank or by an increase in the height of freeboard. To illustrate: A change in top width of the bank from 6 to 8 feet increases the water area about 29 per cent. for the deepest section and 34 per cent. for the shallowest section in the first and third example, and about 35 per cent. for the deepest section and 38 per cent. for the shallowest section in the second example. A change in the height of freeboard from 2 feet to $1\frac{1}{2}$ feet which would be usually sufficient for comparatively small canals will decrease the water areas about 25 per cent. (from 22 to 27 per cent.) in all three examples.

These examples show that for larger canals a balanced cut-and-fill section with ordinary dimensions of top width of bank, freeboard and side slopes will not give a cut sufficient to keep all the water area in cut. The added security may well justify the greater cost of a deeper cut and the extra excavated material can be well used to make a stronger bank in fill with a good roadway on top. Where first cost of construction is to be kept down, it is desirable to have a depth of cut which will give at least $\frac{2}{3}$ of the water area in cut.

Field Method of Balancing Cut and Fill for a One-bank Canal Section in Side Hill (Fig. 18).—A very satisfactory method of staking out on the ground a balanced cut-and-fill section, with a minimum amount of computation or office work, has been developed for some of the U. S. Reclamation Service projects in Montana. The method is known as the Pivotal Point Method, and is best adapted to canals with light curves. It is especially worked out for a one-bank side-hill canal and for equal side slopes on the uphill side of the water cross section and on the downhill side slope of the bank. The downhill side slope of the canal need not be the same. The procedure is as follows:

Select the side slopes for the canal, the proportion of bed width to depth, the freeboard, the top width of banks and determine the dimensions of the canal cross section. Then compute the depth of economic cut necessary to make one bank for a level section, with allowance for shrinkage. The slope of the side hill does not enter in these computations. With this depth of economic cut, the field work consists in first locating a grade contour line by driving, at each station, a stake whose elevation is equal to the elevation of the subgrade of the canal plus the economic cut. The center line of the canal will then be uphill from this line of stakes at a uniform horizontal distance, which is independent of the slope of the hill. The center line is staked out by moving the stake at each station uphill the required horizontal distance. This horizontal distance

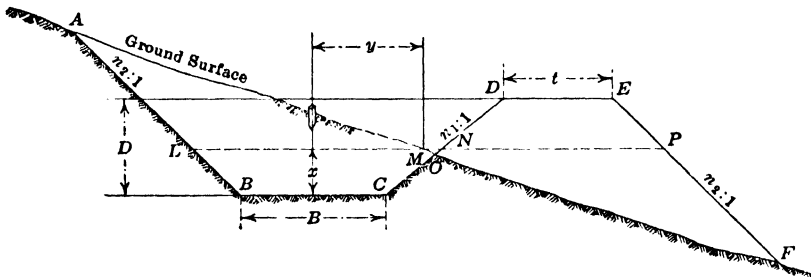

FIG. 18.

will be fixed for any given cross section. The value of this distance and the basis of this method are developed as follows:

Let B = base width of canal section.

t = top width of the bank.

D = total depth of canal section including freeboard.

$n_1:1$ = downhill slope of water cross section.

$n_2:1$ = uphill slope of water cross section and outer slope of bank.

x = depth of cut for a balanced cut-and-fill level section, for one bank only, with allowance for shrinkage.

y = distance from center line of canal to the point on the ground whose elevation is equal to the elevation of the subgrade of the canal plus x .

In the accompanying sketch (Fig. 18) the point M , called the pivot point, shows the position of the grade stake located at a

height above the subgrade equal to the depth of cut x , which is obtained as for a two-bank balanced cut-and-fill cross section in level ground, except that only one bank is used in this case: Trapezoid $LBCN = 1.1$ Fill $NDEP$.

The position of the point M with respect to the center line of the canal is determined from the condition that the triangle in cut $ALM = 1.1$ triangle MPF ; these triangles being similar, their areas will be in proportion to the squares of their corresponding sides. Therefore:

$$\frac{\text{Triangle } ALM}{\text{Triangle } MPF} = \frac{(LM)^2}{(LP - LM)^2} = 1.1$$

or
$$\frac{LM}{LP - LM} = \sqrt{1.1}$$

from which $LP = \frac{LM}{\sqrt{1.1}} + LM = 1.95 LM$ or $LM = 0.514LP$.

The value of LP is known from the following equation: $LP = B + (n_1 + n_2)D + t$.

The distance from the center line to the point M is therefore

$$y = LM - \left(\frac{B}{2} + n_2x\right) = 0.514LP - \frac{B}{2} - n_2x$$

The value of Y is independent of the slope of the side hill and remains the same for a given cross section.

The method is exactly correct when no shrinkage allowance is made and the inaccuracy resulting from a shrinkage allowance is negligible, as is shown from the following relations between the cut-and-fill areas resulting from the requirements stated above:

First.—Cut $LBCOM = 1.1$ fill $NDEP -$ small triangle MNO .

Second.—Cut $ALM = 1.1$ fill $ONPF + 1.1$ small triangle MNO . The sum of these gives:

Total cut $ABCO = 1.1$ total fill $ODEF + \frac{1}{10}$ of small triangle MNO . The inaccuracy is $+\frac{1}{10}$ triangle MNO , which will usually be very small and can be neglected.

When the canal is on a curve, correction should be made. When the curve is concave on the fill side, it reduces the amount of excavation necessary to make the fill and when convex increases it. The amount of correction will increase with steeper slopes and is computed for any size of canal by considering the relative length of the center of gravity of the cut and the center of gravity of the fill.

TRANSITION FOR CHANGE OF CANAL CROSS SECTION

Where there is a change in canal cross section there may be an increase or decrease in velocity which must be adjusted by means of a transition. The problem frequently occurs in the following manner:

First.—Where the canal passes from a soft material where a low velocity must be used to a harder material which allows a higher velocity, and *vice versa* (Plate VI, Fig. C).

Second.—Where the earth canal connects to a concrete-lined canal, flume, tunnel, culvert, etc., the velocity being usually increased at the inlet and decreased at the outlet (Plate VI, Fig. D).

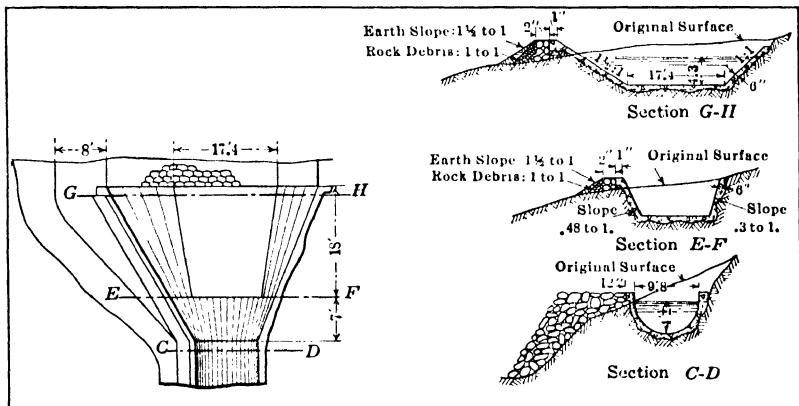

FIG. 19.—Transition from earth to concrete-lined section. Umatilla Project, Ore.

To properly make the connection, a transition is introduced with which the change in cross section is made and in which the difference in water level in both sections is adjusted. The form of the transition will depend on the shape of the cross sections which are to be connected. Where the two cross sections are trapezoidal canals of different side slopes, such as where an earth canal joins with a concrete-lined canal, the side slope of the transition may be either that of the lined canal or that of the earth canal, or intermediate between the two or a warped surface.

Where the trapezoidal canal cross section joins with a rectangular section, as at the inlet and outlet to flumes, or with a semicircular section as at the inlet or outlet of steel flumes, or

with a tunnel or culvert section, the transition may be formed with vertical wings or warped wings placed at an acute angle to the direction of flow.

The difference in elevation between the surfaces of the water level must be adjusted within the transition according to the change in velocity required. The formula which will give the proper relation may be developed as follows:

Let H_1 = total fall in water surface at inlet to produce the required increase in velocity and to overcome the friction and impact in the transition.

H_2 = raise in water surface at outlet corresponding to the decrease in velocity, minus the loss of head due to friction and impact.

h_v = velocity head required to produce the increase in velocity.

h_f = friction head corresponding to friction loss in the transition.

h_i = impact head resulting from eddies in transition.

l = length of transition.

v_1 = velocity at upper end of transition.

v_2 = velocity at lower end of transition.

C_1 = coefficient obtained by Kutter's formula for channel which has velocity v_1 .

C_2 = coefficient obtained by Kutter's formula for channel which has velocity v_2 .

$$h_v = \frac{v_2^2}{2g} - \frac{v_1^2}{2g}$$

The theoretically correct determination of the friction loss could only be obtained for transitions with warped surfaces and would require the application of the principles of integral calculus. This loss is very small and no material error will be introduced by the following approximation:

$$v_m = \frac{v_1 + v_2}{2} = \text{velocity in transition.}$$

$$C_m = \frac{C_1 + C_2}{2} = \text{Kutter's coefficient for the transition.}$$

r_m = hydraulic radius of section at middle of transition.

The friction loss in transition is then obtained from the relation:

$$v_m = C_m \sqrt{r_m \frac{h_f}{l}}$$

$$h_f = \frac{v_m^2 l}{C_m^2 r_m}$$

The loss of head due to impact produced by eddies and irregular currents in the transition may be expressed by the following equations:

$$h_i = c \frac{(v_2^2 - v_1^2)}{2g} \text{ where } c \text{ is a coefficient, which will}$$

depend on the length and form of the transition; it will probably not exceed 0.25 and may be considerably less for a well-designed transition; 0.25 may be taken as a safe value.

The total fall in the water surfaces to be provided at the inlet is then:

$$H_1 = h_v + h_f + h_i = \frac{v_2^2 - v_1^2}{2g} + \frac{v_m^2 l}{C_m^2 r_m} + 0.25 \frac{v_2^2 - v_1^2}{2g}$$

or

$$H_1 = 1.25 \frac{v_2^2 - v_1^2}{2g} + \frac{v_m^2 l}{C_m^2 r_m}$$

The gain in elevation in the water surfaces at the outlet is then:

$$H_2 = h_v - h_f - h_i = \frac{v_2^2 - v_1^2}{2g} - \frac{v_m^2 l}{C_m^2 r_m} - 0.25 \frac{v_2^2 - v_1^2}{2g}$$

or

$$H_2 = 0.75 \frac{v_2^2 - v_1^2}{2g} - \frac{v_m^2 l}{C_m^2 r_m}$$

On the Umatilla project in Oregon gaugings were made at different points on a semicircular concrete-lined conduit and at the inlet transition where it connects with the earth canal (Fig. 19). The concrete-lined conduit is 9 feet 8 inches in diameter with maximum carrying capacity of about 300 second-feet. The earth canal has a bottom width of 17.4 feet, a depth of 7.5 feet, side slopes of 1 to 1 on one side and $1\frac{1}{2}$ to 1 on the other. The transition is formed with warped surfaces 25 feet long. The concrete-lined canal has a total length of 2,085 feet and has a number of sharp curves, including a double reverse curve with 100 feet, and 50 feet radii. When the gaugings were made the volume carried was 205 second-feet and considering the channel as a whole, the mean depth of water was 3.95 feet, the mean area of the water cross section 28.47 square feet, the hydraulic radius

2.11 feet, the velocity 7.20 feet per second and the coefficient of roughness $n = 0.0146$. The earth section had a depth of water of 4.3 feet, and a velocity of 2 feet per second. With this data the computations for the transition are:

$$v_m = \frac{7.20 + 2.0}{2} = 4.6$$

$$C_m = \frac{117 + 77}{2} = 97$$

$$r_m = \frac{2.11 + 3.13}{2} = 2.62$$

$$H_1 = 1.25 \frac{7.20^2 - 2.0^2}{64.4} + \frac{4.6^2 \times 25}{97^2 + 2.62} = 0.93 + 0.0213 = 0.9513$$

feet

The drop in water surfaces actually measured was 0.95 feet or almost exactly the value obtained from the above computations. The loss of head due to friction in the transition itself is very small (0.0213 feet) and is practically negligible in any case. The loss due to impact is considerable, amounting in this case to about $0.25 \frac{v_2^2 - v_1^2}{2g}$ or 0.185 feet. This indicates the necessity of a longer transition section where the loss of head is a detriment.

REFERENCES FOR CHAPTER VI

DESIGN OF CANAL CROSS SECTIONS:

GRUNSKY, C. E.—Depth of Water in Irrigation Canals—p. 285 Engineer. ing News—Sept. 10, 1908.

KENNEDY, R. G.—Instructions for Grading and Designing Irrigation Channels—Paper No. 10, Punjab Irrigation Branch, Punjab Govern- ment, India—1904.

FORTIER, SAMUEL—Conveyance of Water in Irrigation Canals, Flumes and Pipes—Water Supply Paper No. 43, U. S. Geological Survey, Washington, D. C.—1901.

TABOR, E. F.—Economic Location of Irrigation Canals—Operation and Maintenance Conference, Annual Meeting, Helena, Montana, U. S. Reclamation Service, Washington, D. C.—1911.

BISHOP, L. E.—Economic Canal Location in Uniform Countries—Trans. Am. Soc. Civ. Eng., Vol. LXXIV—Dec., 1911.

EARTHWORK COMPUTATIONS FOR IRRIGATION CANALS:

An Excess Curve of Quantities for Trapezoidal Canal Sections—p. 369 Engineering and Contracting—June 17, 1908.

MORITZ, E. A.—Earthwork Diagram for Estimating Quantities in Small

- Irrigation Canals in Level Section—p. 634 *Engineering News*—June 10, 1909.
- Determining End Areas for Preliminary Earthwork Estimates on Irrigation Canals—p. 31 *Engineering Record*—January 7, 1911.
- Tables and Diagrams for Setting Slope Stakes—p. 987 *Engineering News*—May 23, 1912.
- Rules for Estimating the Cost of Excavating Earth with Fresno Scrapers—p. 987 *Engineering News*—May 23, 1912.
- Low Cost of Excavating with Fresno Scrapers—p. 370 *Engineering and Contracting*—Nov. 3, 1909.
- PIERCE, R. C.—The Use of Slope Stake Tables in Irrigation Work—p. 986 *Engineering News*—May 23, 1912.

CANAL TRANSITIONS:

- YOUNG, H. A.—Methods of Tunnel Work and Cost Data on an Irrigation Project—p. 128 *Engineering News*—Feb. 4, 1909.
- BALCOMB, J. B.—The Design of Intakes for Hydro-electric Plants—p. 382 *Engineering News*—April 8, 1909.
- HANNA, F. W.—The Effects of Changes in Canal Cross Sections upon the Rate of Flow—p. 630 *Engineering News*—June 6, 1907.
- HANNA, F. W.—The Effect of Changes in Canal Cross Sections upon the Rate of Flow—p. 545 *Engineering News*—Nov. 21, 1907.
- HOPSON, E. G.—Gaugings in the Concrete Conduit of the Umatilla Project—p. 480 *Engineering Record*—Oct. 21, 1911.

CHAPTER VII

CANAL LININGS AND THE PREVENTION OF SEEPAGE LOSSES

A good canal lining should fulfil the following requirements: It should be practically water-tight to prevent seepage loss and the resulting damages of waterlogging and rise of alkali; its cost should not be excessive; it should prevent the growth of weeds, resist burrowing animals, be strong and durable, preferably not affected by the tramping of cattle, adapted to the construction of a smooth canal of the proper shape to increase its carrying capacity and permit the use of a high velocity. The first requirement, that of prevention of seepage losses, is the most important one and the adoption of canal linings has largely been limited to where the seepage loss was excessive and the value of water high. On systems where water is abundant and the seepage loss not excessive either no canal lining is used or else the lining is limited to a few sections where the loss is known to be very great. On a few systems the high value of water has made it economically feasible to line all the canals with the best type of lining, and in many arid districts the increasing value of water due to the big demand and to its limited supply makes the use of linings on canals one of growing importance.

Types of Canal Linings.—Different materials have been used or experimented with; these include: Cement concrete and cement mortar, masonry of rocks set in cement or lime mortar, clay puddle, road oils, asphalt, wood and sheet steel. A cement concrete lining usually consists of a mixture of cement, sand and gravel or rock, placed on the bottom and sides of the canal, from 2 to 6 inches thick (Plate VII, Fig. A,B,C,D). A cement mortar lining is used for thinner linings from $\frac{1}{4}$ to $1\frac{1}{2}$ or 2 inches, and is made of a mixture of cement and sand or cement and an aggregate of sand and fine gravel. The design of cement mortar and cement concrete linings and the methods of construction are considered in detail in pages to follow.

A masonry lining of cobbles or stones set in lime mortar or cement mortar is 6 to 12 inches thick, depending on the size of

the cobbles. The bottom is made by laying the cobbles in the mortar true to grade, and the sides are built either by fitting and laying the stones with mortar by hand against the trimmed earth slope to the cross section given by a templet, or by the use of forms having the same cross section as the finished ditch; this form is placed on the finished bottom, and the sides are built up by placing and tamping in layers, the cobbles thrown into the mortar, in the space between the earth side slopes and the outside of the walls of the form. This type of lining can only be used economically as compared to concrete lining, where stones or cobbles are abundant and cement high. Lime mortar which was originally used in southern California over 30 years ago, when cement was high, would not now be used. The use of masonry linings is very limited.

A clay puddle lining consists of a layer of clay or clayey material which is spread on the bed and sides of the canal to a thickness of 3 to 6 inches and puddled by the tramping of cattle or sheep or worked in by harrows or by dragging heavy chains over it.

An oil lining is made by sprinkling the oil on the bottom and sides of the canal. The use of oil lining in actual practice is limited to very few ditches and reservoirs, and the results obtained are not sufficient to indicate the best practice. The lining may vary in the quality and quantity of oil, the method of treatment of the canal, and the method of application. A few oil linings for canals and reservoirs in California have been made of asphaltic crude oils, such as are used for the building of oiled roads. These oils vary from the lighter oils (16° to 18° Baumè scale) to the heavier oils (10° to 11° Baumè) containing 90 per cent. or more asphaltum. The heavier oils are better suited, on account of the smaller percentage of volatile constituents. To make them sufficiently fluid they must be heated to a temperature preferably not less than 200° to 250° Fahrenheit, but not higher than 300° Fahrenheit. The quantity applied varies from about 1 to 3 or more gallons per square yard. The sides and bottom of the canal are first cleared of all vegetation, and for flat side slopes and shallow depths, such as on the few canals lined with oil in California, the oil is applied with an ordinary road sprinkler by driving it first along the bottom and then on the bank. On ordinary side slopes it is difficult to apply the oil and obtain

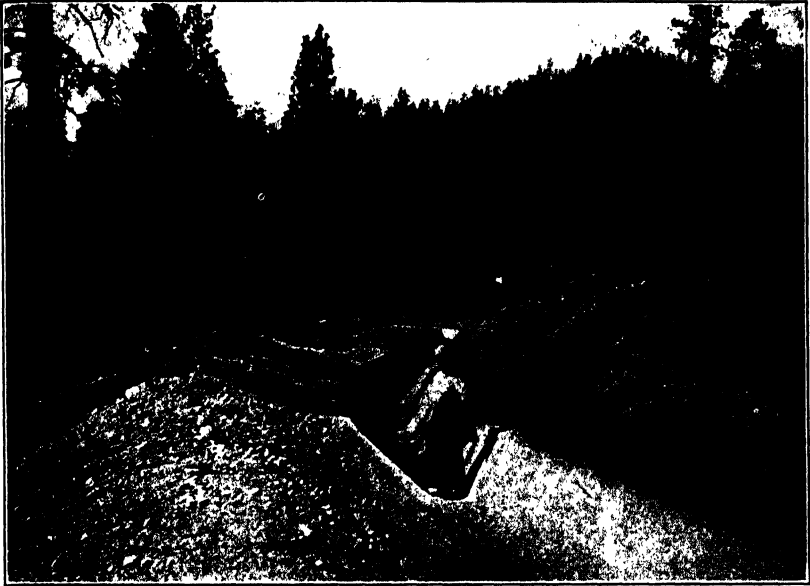

FIG. A.—Concrete-lined canal of Kelowna Irrigation Co., Kelowna, B. C.



FIG. B.—Concrete-lined canal of Kamloops Fruitlands Irrigation & Power Co., Kamloops, B. C.

PLATE VII



FIG. C.—Concrete-lined canal. Ridenbaugh Canal, Idaho.

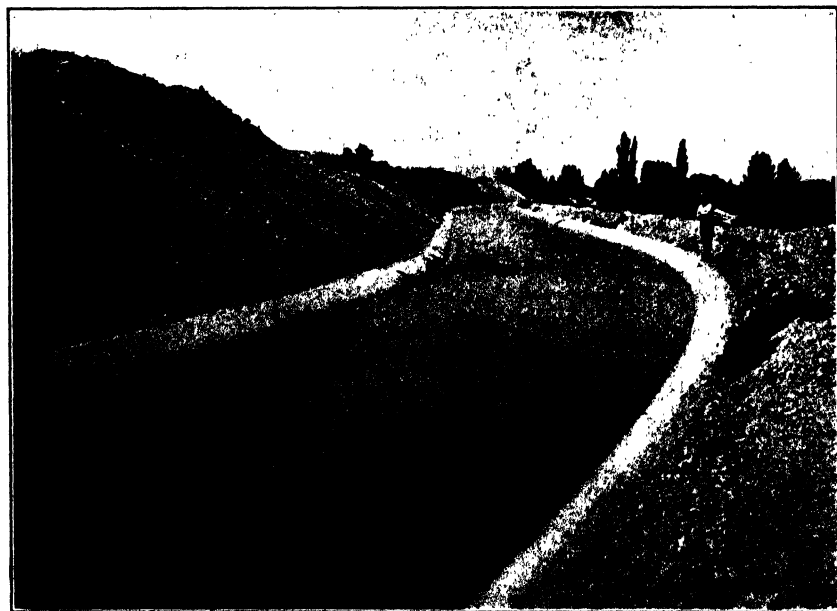

FIG. D.—Curves on Ridenbaugh Canal, Idaho.

sufficient absorption of the oil, without an excess running down the slopes. For the slopes of a reservoir near Los Angeles the oil was applied with sprinkling buckets. It may also be applied by sprinkling under pressure from a spraying jet. Several light applications are necessary to produce the absorption of a sufficient quantity of oil. The oil is usually raked or harrowed in until it is well mixed with the soil, but the depth to which the soil is worked should not be more than 2 or 3 inches, in order to produce a thin layer of soil well saturated with oil and not disseminate the oil through too great a depth of soil. The lining is completed by compacting the oiled surfaces either by tamping or rolling, or by the tramping of cattle or sheep. The use of a road roller is not practicable on the side slopes commonly used for canals but a garden or hand roller may be used to advantage.

Asphalt has been suggested for the lining of canals, but its cost will usually be as great if not greater than that of a concrete lining, and its durability would probably be less, as the continued action of the water on the asphalt would gradually make it more or less spongy and have a disintegrating effect.

Wood linings have been used in very few cases; they are usually built of the same cross section as the canal and consist of the lining boards nailed to sills on the bottom and sides. The high cost and the shorter life will usually make a concrete lining preferable.

Sheet steel linings consisting of curved sheet steels joined together, as for the semicircular sheet steel flumes described further, have been used by placing in the canal the sheets joined together, then backfilling nearly to the top. This form of lining is usually more expensive than a concrete lining. The writer knows of only one case, in the United States, where it has been used; this is in a canal of the Burbank Water Co. in eastern Washington. A section of canal 3,000 feet long, in sandy soil on a side hill, is lined with semicircular steel fluming 6 feet $4\frac{1}{2}$ inches in diameter, made of No. 22 gauge metal. The cost was \$1.62 per lineal foot.

In upper Egypt the Kom-Ombo Irrigation Canal for about 1 mile in length is formed of a semicircular steel flume 19 feet 8 inches in diameter with sides extending vertically 20 inches above the horizontal diameter, placed in soil and carefully back-filled. The flume is formed of $\frac{1}{4}$ steel plates, 15 feet in length,

with 7 plates to form the semi-circumference. The plates are riveted together and to ribs of T-bars 5 inches \times 6 inches \times $\frac{3}{8}$ spaced 30 inches c. to c. The top is braced across by flat bars 3 \times $\frac{3}{8}$ inches placed diagonally and by angles 3 \times 2 $\frac{1}{2}$ \times $\frac{3}{8}$ inches crosswise. Expansion joints were provided every 330 feet by resting the ends of the flume on cross walls of masonry about 13 feet long with an inside cross section equal to that of the flume. The ends of the flume extend for about 3 feet 3 inches on this wall leaving a space between adjacent ends of 6 feet 6 inches. This form of lining was used because the canal had to be carried across shifting, unstable desert sands.

Efficiency of Different Types of Canal Linings.—The efficiency as regards the prevention of seepage has been the subject of investigations in California, by the writer in 1906, continued later by the Irrigation Investigations of the U. S. Department of Agriculture, and of extensive experiments made by the Irrigation Branch of the Punjab Government in India. The investigations in California were carried on at two different localities. A number of parallel short ditch sections (about 50 feet in length), closed at both ends, were excavated in average sandy loam of uniform texture, some were lined with the different types of lining, the remaining ones being left unlined to compare the seepage losses. For the oil linings the oil was applied on the firm excavated surface by means of a sprinkling bucket, the surface was not disturbed and it was not attempted to work the oil in by raking as a more uniform lining could be obtained by using several light applications, allowing each to be absorbed by the soil. The results of the two sets of experiments made in California indicate that the following results can be anticipated: (1) A good oil lining constructed of heavy asphalt road oil, applied at the rate of about 3 gallons per square yard, will stop 50 to 60 per cent. of the seepage. (2) A clay puddle lining from 3 to 4 inches thick is as efficient as a good oil lining. (3) A thin cement mortar lining, about 1 inch thick, made of one part of cement to four of sand, with no waterproofing coating, will prevent 75 per cent. of the seepage. (4) A first class concrete lining, 3 inches thick, made of one part of cement to two of sand and four of gravel, with no cement mortar or other waterproof coating, will stop 95 per cent. of the seepage.

These results were obtained from pits excavated in a sandy

loam, in which the loss of seepage for unlined canals averaged about 9 inches' depth per day. In a more porous soil the seepage loss for unlined canals would be greater; while for a lined canal the loss is more dependent on the porosity of the lining and would not be affected to the same extent by the texture of the soil, therefore, the greater the porosity of the soil, the greater should be the percentage of saving obtained by lining.

The experiments made by the Irrigation Branch of the Punjab Government, India, were begun in 1904 at a selected site. The experimental ditches were excavated in a sandy loam containing some clay. The ditches were short trapezoidal trenches; for each material experimented with there was a set of four parallel trenches, two lined and two unlined; these were necessary in the comparison of the seepage losses and effect of lining, to eliminate errors due to variation in soil texture and position of ditches. Twenty-three kinds of lining were used, giving in all 92 trenches. The linings were made of oil, clay puddle, coal-tar and of grouts of neat cement, lime cement mortar and lime mortar, spread in thin layers on the banks and bed of the canal by sprinkling. These materials were used in different quantities and in different combinations. The oil and coal-tar linings were put on by sprinkling with a large watering can. The oil was a paraffine oil, hard at 50° Fahrenheit and of about the consistency of butter at 84° Fahrenheit, and was heated up to between 120° and 130° Fahrenheit; the coal-tar was a heavy, viscous liquid when cold and was heated nearly to boiling. The slopes, if dry, were gently watered so as to make them as cool as possible and thus cause the oil to congeal as soon as it came into contact with the earth. Immediately after sprinkling the oil, fine sifted damp earth was dusted over the oiled surface to prevent it from running down the slope under the hot sun. When a second or third coat of oil was desirable, each coat was carefully dusted. All linings, sprinkled on the slopes and bed, whether cement lime, oil or coal-tar, were covered with an earth layer 8 inches thick, intended to protect them against the weather, the tramping of cattle and the operation of cleaning. The clay puddle lining was 8 inches thick on the bottom and 6 inches thick on the sides and was well wetted and carefully puddled by hand; the lining was covered with 6 inches of earth on the side and 8 inches on the bottom. The finished trenches above the earth covering were of the same dimensions for all materials.

These experiments, which were started at one site in 1904, were extended to four other sites in the Punjab and continued up to at least June, 1910. The extensive observations indicate that for the linings which seemed to be most practicable the following results may be expected for the saving in conveyance loss as obtained from linings 4 years old, compared with unlined canals: (1) A crude oil lining $\frac{1}{16}$ inch thick, of about $\frac{1}{3}$ gallon per square yard, will prevent 75 per cent. of the loss. (2) A Portland cement grout lining $\frac{1}{16}$ inch thick will prevent 82.5 per cent. of the loss. (3) A clay puddle lining, 6 inches thick will prevent 82.5 per cent. of the loss.

By comparison of the results for 2 consecutive years it was found that the retentiveness of crude oil lining deteriorated at the rate of about 10 per cent. per year, while that of clay and cement improved at the rate of about 10 per cent. and 2 per cent. per year respectively. The determinations made in these experiments give total conveyance loss, no correction being made to eliminate the evaporation loss, which was small compared to the total loss for unlined canals, but comparatively large for lined canals. If the corrections were made to give seepage loss alone, the above percentages representing the saving in seepage loss would be materially increased. The silt carried by the canal water with which these experimental channels were filled was found to reduce the rate of loss for lined and unlined canals about 10 per cent. per year. A comparison of the experiments made in India with those made in California show that the thin cement grout lining was more efficient than the cement mortar lining 1 inch thick used in California; the 6-inch clay puddle lining used in India was more efficient than the $3\frac{1}{2}$ -inch clay puddle used in California, and the oil lining used in India, although made with a much smaller quantity of oil than the oil linings in California, was considerably more efficient. The higher efficiency of the cement grout lining is due to the neat cement being more impervious than the thicker cement mortar lining, but the grout lining is too thin to have any strength and must be protected by an earth covering. The clay puddle lining was thicker in India than in California and was applied with considerable more labor. The greater efficiency for the oil linings in India may be due to two causes: the quality of the oil, and the method by which it was placed; in California the oil was applied on the comparatively dry soil surface, which permitted

the oil to penetrate into the soil and disseminate itself through a thickness of 2 or 3 inches of soil, while the method used in India of applying the oil on a moist surface produces a thin, continuous layer of oil which is more impervious; the covering of earth adds to the efficiency in preventing the oil layer from becoming more fluid by the action of the sun and decreases the evaporation of the more volatile constituents of the oil. The earth covering on the thin linings of cement grout and of oil, while necessary to their protection, has the disadvantage that it does not permit the use of a velocity higher than the earth covering can stand without erosion and permits the growth of vegetation.

Comparative Cost of Linings.—The cost of a clay puddle lining depends largely on the distance that the clay has to be hauled. On the Huntley project, Montana, 7,000 feet of canal in a sandy soil were lined with 4 inches of clay puddle. The material was hauled 1.2 miles, spread by hand, pulverized with a plank drag; then water was allowed to stand in the canal for 24 hours when it was lowered to a depth of about 12 inches and a harrow was dragged through the canal 4 times. A total of 2,247 cubic yards of clay was placed, for 20,220 square yards of canal lining, costing 7.1 cents per square yard or .80 cent per square foot.

On the Yakima Sunnyside project, Washington, a canal section $1\frac{1}{2}$ miles long with a bottom width of 6 feet, depth 3.7 feet, side slopes $1\frac{1}{2}$ to 1, was lined with puddle by dumping good silt soil into the canal, which was partly filled with water, and the material was puddled by men wading with rubber boots, the cost was about 10 cents per square yard or 1.1 cents per square foot.

The cost of an oil lining on 43,700 square yards of the Lemoore Canal, San Joaquin Valley, averaged about 4.5 cents per square yard, or 0.5 cents per square foot. Oil cost about $2\frac{3}{4}$ cents per gallon delivered at the canal, and the rate of application was 1.15 gallons per square yard. The oil was spread by means of a road sprinkler and was harrowed in and rolled. The side slopes were very flat; for steeper side slopes such as generally used on new canals, the application of the oil would be more difficult. An oil lining of 2 to 3 gallons per square yard, carefully applied and compacted, would probably cost from 1.0 to 1.5 cents per square foot.

The cost of concrete lining will depend on the prices of material,

the wages, the character of the work, smoothness of finish, difficulties of construction such as inaccessibility on rough steep side hills, contention with frost, etc. From a careful consideration of the cost of concrete lining built on various irrigation projects in California, Idaho, Washington, Oregon, British Columbia and Utah, the average costs given below are obtained for the following normal prices and conditions:

Concrete mixture: 1 part of cement to 6 parts of natural mixture of sand and gravel as taken from the pit, or 1 part of cement to 3 of sand and 5 of screened gravel or crushed rock, requiring about 1.25 barrels of cement per cubic yard. Cement \$2.50 a barrel, sand and gravel \$1.00 a cubic yard, delivered on the job. Wages \$2.50 for common labor, \$3.00 for skilled labor \$3.50 to \$5.00 for foreman. Surface finished by troweling or by tamping against forms, depending on method of construction, or with a thin coat of cement mortar grout. Canal in accessible location where there are no difficulties in setting up and moving plant equipment.

COST OF CONCRETE LININGS, FOR NORMAL CONDITIONS, EXCLUSIVE OF EARTHWORK AND TRUING CROSS SECTION

Thickness of lining, inches	Cost in cents per square foot							
	Cement	Gravel	Labor		Plant and equipment; supervision; engineering; miscellaneous		Total	
			From	To	From	To	From	To
1	0.95	0.35	0.95	1.30	0.50	0.90	2.75	3.5
1½	1.45	0.50	1.00	1.60	0.55	0.95	3.50	4.50
2	1.95	0.65	1.10	1.95	0.60	1.00	4.25	5.50
2½	2.40	0.80	1.25	2.20	0.65	1.10	5.10	6.50
3	2.90	0.95	1.45	2.45	0.70	1.20	6.00	7.50
4	3.95	1.30	1.60	2.85	0.75	1.50	7.50	9.50

The total cost given above does not include the cost of preparing the earth surfaces for the lining. For a canal newly excavated to its approximate dimensions by scrapers or otherwise, the cost of final grading and trimming to bring the canal cross section to its true shape will be from 1.00 to 1.5 cents per square foot; for an old canal which requires an average depth of trimming and backfilling of 6 to 12 inches to bring it to its true shape, the cost will be from 2 to 3 cents per square foot, and

for a canal which is to be enlarged before lining, the extra excavation will cost 50 to 75 cents per cubic yard.

Strength and Durability—Resistance to High Velocities, to the Growth of Weeds and Burrowing Animals.—A clay puddle lining is not affected by the tramping of stock, it will not deteriorate by the action of water, and will increase in efficiency unless disturbed by the growth of weeds or by the cleaning operations. It will not stop the burrowing animals and will not prevent the growth of weeds, as the velocity of the water must be small, usually less than 2 or 3 feet, to prevent the erosion or washing away of the lining. This will occur unless the clay puddle lining is protected with a layer of gravel or other material not so easily eroded but which in many cases would be too costly.

An oil lining being flexible will not be cracked by the tramping of cattle or by contraction due to lower temperatures. It is not a permanent lining; its efficiency seems to decrease with time, probably because of the effect of the water and the evaporation of the more volatile constituents of the oil. It has sufficient tenacity to resist wave action well and it will probably stand safely velocities of at least 5 feet per second. It will not stop burrowing animals and the experience obtained on the few canals lined with oil in California, where the velocities of flow were low, indicate that while it will largely prevent the growth of vegetation for from two to four seasons, after this time it has little effect. The use of higher velocities, which this lining will stand, will greatly assist in preventing vegetation and should give more favorable results.

Concrete linings will vary in strength and durability, depending on the thickness, quality of material and workmanship, and the climatic and field conditions. Thin linings, not over 1 or $1\frac{1}{2}$ inches thick, used not only in Southern California but on a few canals in Washington and Oregon, where the minimum winter temperatures are as low as 10° to 20° Fahrenheit below zero, have given quite satisfactory results. The durability of such thin linings is well illustrated by the results obtained on the Gage Canal, near Riverside, California. This canal has been lined with a $\frac{3}{4}$ -inch lining of cement mortar for almost its entire length of 20 miles. After running water in the canal for the first 10 years, the last 4 years of which the water was run continuously, giving no opportunity for repairs, the total

cost to repair thoroughly all sections ruptured during these 4 years was less than $\frac{1}{2}$ of 1 per cent. of the original cost. Where the winter temperatures are below freezing and the soil behind the lining not well drained, there is the danger of soil heaving, which would cause concrete linings to crack; but usually a canal which must be lined is located where the water drains too readily from the soil. Where storm water or drainage water is liable to collect behind the lining, it may increase the pressure on the back of the lining sufficiently to push the lining of the side slopes in. This has occurred on side hills where the rapid snow-melting due to a warm wind, or where a cloudburst, has produced a run-off toward the canal too large to be absorbed by the soil and to drain under the canal before reaching it; for these conditions a system of intercepting surface drains will prevent this action to a large extent. A concrete lining will permit the use of high velocities, especially if the water does not carry much sand. It will stop burrowing animals and will prevent the growth of vegetation.

CONCRETE LININGS

The earliest use of concrete linings was in Southern California at about 1880, when the increasing value of water made it necessary to prevent the conveyance losses in earth canals. Since that time practically all canals in that part of California have been lined with concrete and in some cases replaced with concrete pipes. These canals are all comparatively small, carrying usually less than 100 cubic feet per second. Until about 1902 the use of concrete linings for canals was practically limited to that region, but since then concrete-lined canals have been constructed on many of the projects of the United States Reclamation Service and on a number of systems built by other agencies. There are now many miles of concrete-lined canals in California, Colorado, Oregon, Utah, Nevada, New Mexico, Idaho, Washington, and other states and in British Columbia. On some systems only short sections of canals, where seepage losses were excessive, have been lined; on other systems, such as the Umatilla project in Oregon, the Okanogan project in Washington, the Kamloops Fruitland Irrigation Co. in British Columbia, entire canals several miles in length are lined with concrete.

Form of Cross Section and Thickness of Lining.—Unlined canals in earth are usually constructed comparatively broad and shallow, with side slopes varying according to the soil. For a concrete-lined canal it is more economical to use a cross section comparatively narrow and deep with fairly steep side slopes, approaching the section, giving maximum hydraulic radius. This reduces the amount of concrete and the amount of excavation, especially on side hills. The side slopes must not be much steeper than the slope on which the earth will naturally stand, or else the earth exerts a pressure on the sides which must be considered and the side lining designed as a sloping retaining wall. The top of the lining is carried up 6 inches ordinarily and 12 inches for very large canals above the full supply water level. In some cases the top of the lining terminates in a horizontal extension about 6 inches wide and 2 to 4 inches thick to form a coping.

Minimum Thickness.—When the lining is placed on the natural slope of the ground, it resists no earth pressure and it can be made very thin; the minimum thickness will then depend on practical considerations, such as cost, strength and durability. In southern California linings of cement mortar from $\frac{3}{4}$ to 1 inch thick have been used with satisfactory results on many irrigation systems, and there are many canals where the lining is as thin as $\frac{1}{4}$ to $\frac{1}{2}$ inch thick; such thin linings have no considerable strength, but ordinarily in a well-drained soil, thoroughly settled, few cracks occur other than contraction cracks, which will occur also with thicker linings. In some cases there is sufficient space at the contraction joints for the water to work under the lining and if the soil is loose and fine it may wash out a small cavity or creep under the lining and produce settlement and cracking, which is not so liable to occur with thicker linings and in coarse well-drained soil. It can be largely prevented by constructing the lining so as to distribute the contraction at construction joints close together; this divides the lining into panels or narrow strips extending across the canal and the contraction crack at each joint is very small, leaving very little space for the water to work through. In a few instances water-tight expansion or contraction joints of special design have been constructed. The rupture of thin linings can also be produced by gophers working behind the side walls so as to undermine them or by surface run-off or drainage water percolating into the soil back

of the lining and pushing the sloping side walls in. While in some cases the available funds limit the choice to a very thin lining or no lining at all, it is very poor economy to put in a smaller thickness than 1 inch even for the most favorable conditions. For thinner linings the cost of materials (cement and gravel) will be less, but this produces only a comparatively small saving in the total cost, as the labor of preparing the ditch surfaces and the placing and finishing of the lining will be nearly the same. Where the winter temperatures are severe, it is essential that the soil be well drained to prevent the saturation of the soil in the winter, which would cause heaving when the frost entered the ground. A canal which requires lining usually is in soil which is well drained naturally but where this is not the condition, artificial drains must be provided. With perfect drainage there is apparently no reason why a canal lining should be made thicker where there is ground freezing than where there is no frost; nevertheless it is doubtful that a lining thinner than $1\frac{1}{2}$ inches would be satisfactory. On the Umatilla project in eastern Oregon linings $1\frac{1}{2}$ inches thick have given satisfactory results, with minimum temperatures of several degrees below zero Fahrenheit. At Kamloops, British Columbia, concrete linings 3 inches thick have been through several winters, with minimum temperatures of 20° Fahrenheit below zero, and with the ground frozen to a depth of probably at least 2 feet. The minimum thickness which should be used for concrete linings in favorable soil conditions may therefore be taken at 1 inch and preferably $1\frac{1}{2}$ inches where the winter temperatures are not far below freezing, and $1\frac{1}{2}$ to preferably 2 inches for more severe winter temperatures. Where the funds available will not prohibit it, the greater strength, durability and safety of a thickness of 3 inches will well justify the difference between its cost and that of a thickness of 2 inches.

Thickness when Sloping Side Walls Resist Earth Pressure.—The above minimum thicknesses are for linings placed on the floor of the canal and on side slopes sufficiently flat to produce no earth pressure. For a lining on a steeper slope than the natural slope of repose of the earth, the floor lining need not be made thicker, but the side lining must be designed as a sloping retaining wall to resist the earth thrust. The natural slope of repose will vary with the texture of the soil and its condition, whether wet or dry, and are about as follows:

SLOPE OF REPOSE OF MATERIALS

Material	Angle of repose, degrees	Slope
Firm clay soils well drained.....	45	1 to 1
Clay loam or average sandy loam.....	36-33	1½ to 1-1½ to 1
Sandy or gravelly soils.....	33-26	1½ to 1-2 to 1

The thicknesses of lining for different side slopes of lining and slope of repose of earth, are given in the table below. The values are obtained by computations, using Coulomb's formulas:

First.—For earth pressure with no surcharge $P = \frac{1}{2}wh^2 \frac{\sin^2 \frac{1}{2}(\theta - \phi)}{\sin \theta \sin^2 \frac{1}{2}(\theta + \phi)}$.

Second.—For earth pressure with maximum surcharge $P = \frac{1}{2}wh^2 \frac{\sin^2(\theta - \phi)}{\sin^3 \theta}$.

P = earth pressure per lineal foot; w = weight of earth in pounds per cubic foot; h = vertical height of side lining; θ = slope angle made between side wall and the horizontal; ϕ = angle of repose of earth. The overturning moment is assumed to be equal to the earth pressure, P , multiplied by $\frac{h}{3}$; this is the common assumption for no surcharge and introduces an error on the side of safety for maximum surcharge. The overturning moment is balanced by the moment of the weight of the side lining. The

THICKNESS OF CONCRETE LINING AND CORRESPONDING DEPTHS OF CANALS FOR DIFFERENT SLOPES OF LINING AND SLOPES OF REPOSE

Side slope of canal	Slope of repose of earth	Maximum depth of canal in feet					
		For no surcharge and thickness of lining of			For maximum surcharge and thickness of lining of		
		1 inch	2 inches	3 inches	1 inch	2 inches	3 inches
½ to 1	1 to 1	5.3	10.6	16.0	1.6	3.3	5.0
½ to 1	1½ to 1	1.6	3.2	4.8	0.6	1.2	1.8
½ to 1	2 to 1	1.0	2.0	3.0	0.4	0.8	1.2
½ to 1	3 to 1	0.5	1.1	1.6	0.3	0.6	0.9
1 to 1	1½ to 1	15.8	31.6	47.4	4.8	9.7	14.5
1 to 1	2 to 1	3.8	7.7	11.5	1.9	3.8	5.7
1 to 1	3 to 1	1.9	3.8	5.7	0.8	1.7	2.5
1½ to 1	2 to 1	37.0	74.0	111.0	11.3	22.6	34.0
1½ to 1	3 to 1	6.2	12.4	18.6	2.5	5.1	7.6

weight of a cubic foot of earth is taken as 100 pounds and that of concrete as 150 pounds. The results obtained may be considered as useful for practical application only within reasonable limits.

Contraction and Expansion.—Construction Joints and Expansion Joints.—Contraction cracks result from the excessive tensile stress produced in the concrete by the contraction due to lowering in temperature and to the process of hardening. The last cause is the most important, but even a comparatively small decrease in temperature is sufficient to produce a greater tensile stress than the concrete can resist. A decrease of 10° Fahrenheit will produce, in a concrete of 3,000,000 pounds modulus of elasticity, a tensile stress of about 180 pounds per square inch, which is about its ultimate strength when thoroughly hardened. Cracks due to this cause alone would therefore occur unless the concrete lining was built at a temperature very nearly equal to the lowest to which it may be exposed; this is often not practicable, but where it can be done it will decrease the size of the cracks. The contraction due to the process of hardening in air is of considerable magnitude. Experiments have shown that for the first day or two a very slight expansion takes place; this is followed by contraction, the extent of which varies with the amount of cement in the mixture; for instance, a neat cement contracts about 3 times as much as a 1:3 mortar or a 1:2:4 concrete. The extent of contraction for a 1:2:4 concrete is about equal to that produced by a lowering in temperature of about 125° Fahrenheit. Due to the combined action of temperature contraction and shrinkage in hardening, if a concrete lining is constructed at a temperature of 70° Fahrenheit, the total contraction obtained at a minimum temperature of -10° Fahrenheit would be equivalent to that obtained for a decrease of 205° Fahrenheit or about 1.5 inches in 100 feet. This would only be obtained for the severe conditions given above and for a concrete thoroughly dry. On the other hand, the experiments show that when the concrete becomes wet by absorbing moisture, it will expand and the expansion will be about equal to the contraction resulting from the process of hardening in air; on drying again it contracts to its original condition and will be subject to expansion and contraction according to whether it is wet or dry. The concrete lining when the canal carries water will, on becoming wet, be in the expanded condition, but the contraction cracks will open if the temperature of the lining

at the time it carries water is below that at which it was constructed; on the other hand if the temperature of the water or canal lining is above that at the time of construction the cracks will be closed. Observations of concrete linings, concrete flumes, and concrete pipes show this to be true; when these are empty and the concrete dry, the cracks will open, and when water is turned in, the cracks become smaller and the leakage gradually diminishes. When the water is sufficiently warm to raise the concrete to a temperature higher than that at which it was constructed the cracks will be closed.

Due to the above described actions, contraction cracks will occur, but the contraction must overcome the frictional resistance on the plane of contact between the earth's surface and the back of the lining. This frictional resistance will be least when the canal is empty, and when the plane of contact is a smooth surface. It is proportional to the coefficient of friction, multiplied by the sum of the weight of the concrete lining and the normal water pressure on the lining. While it is too small to prevent cracking, it controls the interval or spacing between cracks. This interval will be equal to twice the length of lining that will give a frictional resistance equal to the tensile strength of the cross-sectional area of concrete. Applying this theory to a concrete-lined canal carrying a depth of water of 4 feet, assuming a coefficient of friction of 1, a tensile strength in the concrete of 150 pounds per square inch, the distance between cracks would be 40 feet for a lining 3 inches thick, or 13 feet for a lining 1 inch thick. If the concrete was constructed at a temperature of 80° Fahrenheit and the temperature of the lining when it carries water is 50°, then the contraction cracks would be about $\frac{1}{12}$ inches wide for a distance between cracks of 40 feet. When the lining is dry and in cold weather, the cracks would be much larger, as stated above. Careful observations of concrete lining show that these actions are actually obtained to some extent in practice.

Construction Joints.—Construction joints at regular intervals are desirable to prevent irregular cracks in the lining. The distance between joints must be made no greater than that deduced from the above theoretical considerations, but with intervals too large the width of contraction cracks may be greater than desirable. Where the climatic conditions make it feasible to construct the lining at a temperature lower than

that which it will have when carrying water, the cracks would be closed when in use. For ordinary conditions a small distance between joints is desirable. In practice the lining is constructed in short sections or strips transversal to the length of the canal. The width of these strips usually range from about 4 feet to 16 feet, and widths of 8 to 12 feet for linings 2 to 3 inches thick are most commonly used. These construction joints occur at the edges of these transversal strips or panels and are formed by either preventing the adhesion between adjacent strips or by making the joints sufficiently weak that the lining will open at the joints.

Contraction and Expansion Joints.—The great majority of concrete linings are built without special contraction or expansion joints; and the results obtained as well as the explanation and theories presented above show that for ordinary conditions, there is very little necessity for special forms of joints, designed to prevent entirely the seepage which may occur from ordinary contraction joints placed not farther apart than 8 to 12 feet. Where the contraction joints are farther apart than this and the temperature conditions during construction and when in use conducive to severe contraction, then it may be desirable to provide special types of contraction joints to prevent leakage which might produce a break where the lining is undermined by gophers. Unusual conditions which may justify the added expense of special joints were obtained in short sections of a concrete lined canal in the dry belt of British Columbia. Although the concrete lining was placed on a canal entirely in cut, at a few special points on the canal, a settlement in the floor of several inches occurred after the concrete-lined canal had carried water for considerable time. This settlement occurred where a new canal was excavated in fan-shaped deposits at the mouth of a canyon. It is probable that these deposits were formed of material carried down the canyon during unusual run-off conditions or by cloud bursts and had never received sufficient water to settle them in a permanent condition, and that the small leakage through the joints of the lining was sufficient to gradually wash down the finer particles of surface soil in the coarser sand and gravel below. The settlement may, however, have been due to some other cause or to leakage through the lining itself. Where feasible, it is desirable to thoroughly settle the soil by running water in the canal prior

to lining it; this is especially necessary where the canal is in fill.

On the Naches power canal, near Naches, Washington, of the Pacific Power and Light Co., the contraction joints were formed across the canal every 8 feet. These joints (Fig. 20) were made by separating the adjacent sections of lining by a bevelled piece of timber 2 inches wide at the top, $\frac{1}{2}$ inch wide at the bottom and 4 inches high. The wooden piece was removed and the groove filled, as shown. On the main canal of the Patterson Project and that of the East Contra Costa irrigation project in

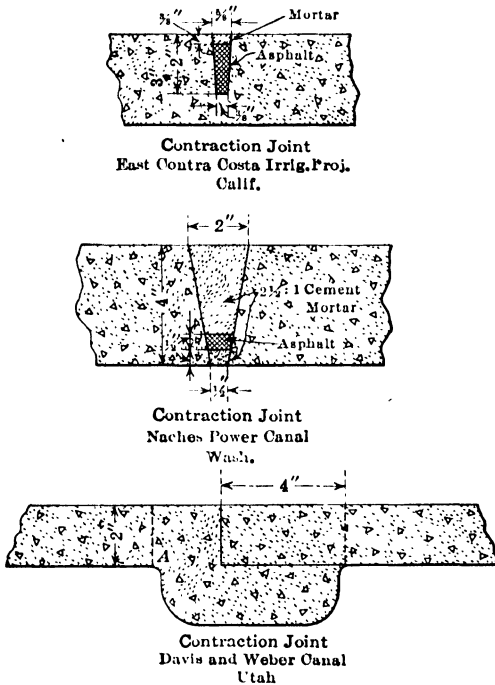

FIG. 20. --Contraction joints for concrete canal linings.

California; contraction joints of the same type were made transversally at intervals of 12 feet and longitudinally at the toe of the side slopes (Fig. 20). On a section of canal of the Davis and Weber Canal Co., in Utah, the contraction joints were formed by building one edge of the lining on top of a projection or offset formed by the extension of the adjacent edge, as shown in the sketch (Fig. 20). The same type was tried for the Kern River

Power Co.'s canal in California, but was abandoned because it was found that the part extending under the lining broke off along the line *A*; which is a line of weakness, since this part is anchored in the earth, so that the contraction in the lining produces tension at *A*. However, on the Davis and Weber Canal satisfactory results were obtained probably because the joints were spaced closer.

Methods of Construction of Concrete Linings.—The details of construction vary with the ideas and judgment of the engineers in charge. There are two general methods. The first method of construction requires forms behind which the concrete for the side slopes is placed. The second method requires no forms, the concrete being spread on the bottom and side slopes much in the same manner as for sidewalk work. The first method is best adapted to linings not less than 2 inches thick and to side slopes steeper than 1 horizontal to 1 vertical, such as can be used to advantage on side-hill canals. With flatter side slopes it is difficult to keep the forms from rising up. Careful trimming of the earth surfaces is required; this is best obtained by excavating the canal sufficiently large to receive a set of forms larger than the concrete forms, by the thickness of the lining and by backfilling against these earth forms, with moist or wet earth. The method is therefore well adapted to a canal roughly excavated. The second method is best adapted to side slopes not steeper than 1 to 1, and preferably $1\frac{1}{4}$ or $1\frac{1}{2}$ to 1, as a comparatively wet concrete mixture has a tendency to slough down on steeper slopes.

Construction of Concrete Linings by Means of Forms (Fig. 21, Pl. VIII).—This method has been used in British Columbia by the Fruitlands Irrigation and Power Co., near Kamloops, by the Kelowna Irrigation Co. and the South Kelowna Irrigation Co., and on a number of canals in southern California. It is well adapted to canals less than 8 or 10 feet wide at the top. The method is as follows:

For a new canal the excavation is made about 6 inches larger on each side than the finished earth section when ready to receive the lining. For an old earth canal all vegetable matter is removed and if necessary more material taken out in the same manner as for a new canal. In each case the bottom is brought carefully to grade. To shape the canal ready for the lining, the means used on the canals of the Fruitlands Irrigation



FIG. A.—Forms in place, to shape canal for concrete lining. Kamloops Fruitlands Irrigation & Power Co., B. C.

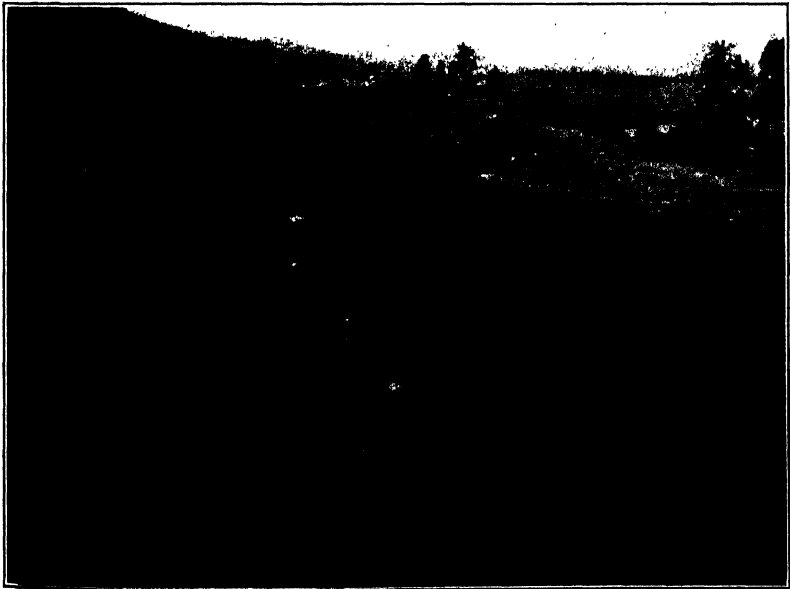

FIG. B.—Finished earth canal, ready for concrete lining. Kamloops Fruitlands Irrigation & Power Co., B. C.

PLATE VIII

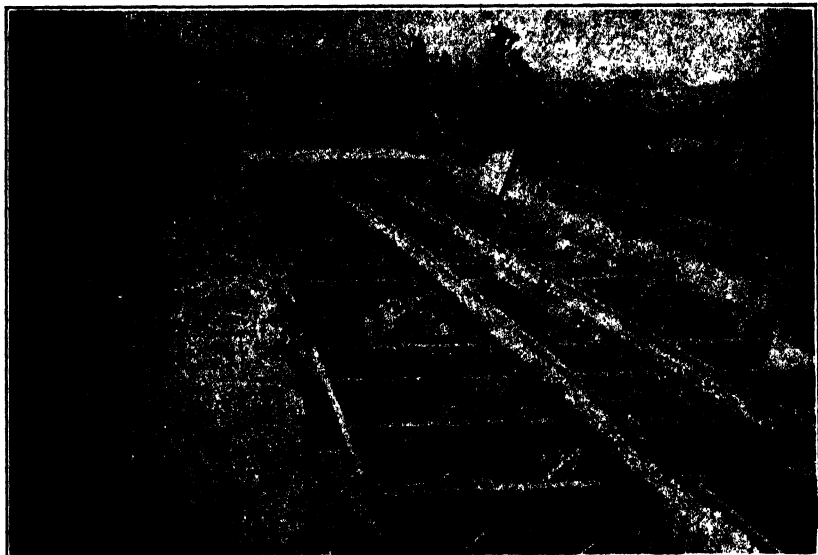

FIG. C.—Concrete form in place. Kamloops Fruitlands Irrigation & Power Co., B. C.



FIG. D.—Completed concrete-lined canal. Kamloops Fruitlands Irrigation & Power Co., B. C.

system near Kamloops, were wooden forms 6 feet long (Fig. 21). The form is a trapezoidal trough with no bottom; the sides are tongue and groove or shiplap boards nailed to frames made of 2 inch \times 4-inch scantlings cross braced for rigidity. These forms are placed in position in the excavated section, then earth is thrown in between the form and the earth bank and well puddled with plenty of water, pumped for this purpose

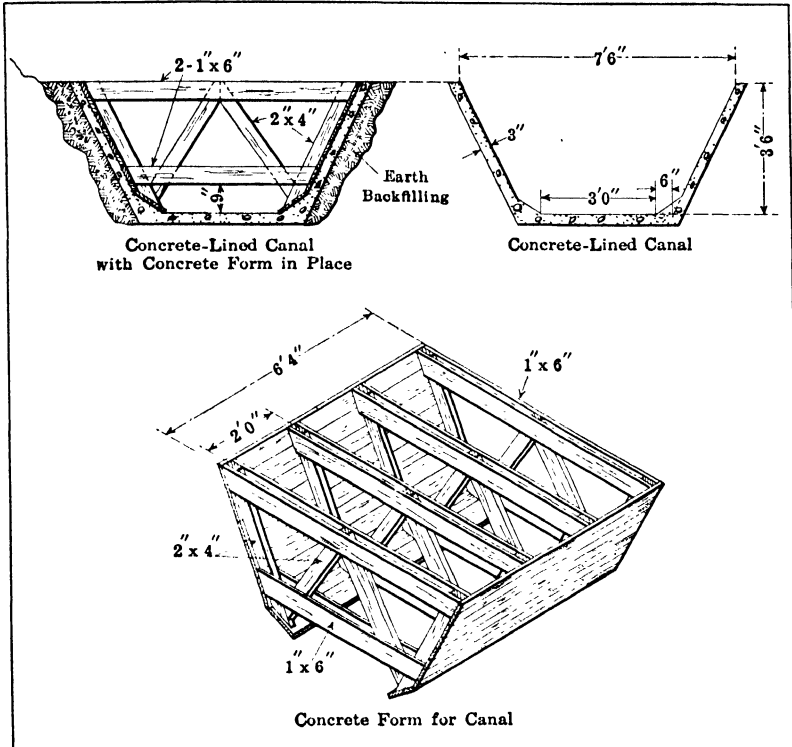

FIG. 21.—Method of concrete lining canals with forms. As used by Fruitlands Irrigation & Power Co., B. C.

This was found much better and more economical in labor than tamping the earth. Even when using a very wet mud the ground drains sufficiently to allow the removal of the forms in less than 12 hours. This leaves a very smooth ditch with moist banks ready to receive the concrete lining.

To place the concrete, forms similar to the earth forms are used. This concrete form is smaller than the earth form by the

thickness of the lining and is built so as to give a greater thickness of concrete at the corners where the floor and sides come together. The concrete work follows shortly after the earth forms are taken off when the banks are still moist. The concrete forms are placed in position in the finished earth ditch, but instead of placing them continuously as the earth forms, only every alternate form is put in place; then the concrete, which is mixed wet, is placed between the form and the earth, and is well stirred or cut with thin bars. To protect the earth slope when pouring the concrete mixture, it is well to cover the earth slope with thin galvanized iron sheets, which are pulled up as the concrete is poured in. The sides and bottom are put in at the same time. This gives a good connection at the corners, which is very desirable. To do this it is necessary to block the forms 3 inches above the ground (the thickness of the lining). To hold the concrete at the ends of the sides and also to hold the form the right distance away from the earth side, 2×3 inch pieces are placed edgewise between the earth slope and the wooden forms. When the sections have hardened, the forms are removed and moved ahead to the adjacent section. In order that the ends of the form will rest on the two adjacent completed sections, the forms should be a little longer than 6 feet (the length of a section), preferably 6 feet 4 inches. After the removal of the forms the concrete must be prevented from drying out quickly and preferably kept moist for several days. This may be done by protecting it with burlap kept wet by sprinkling or by letting water in the completed section as soon as possible after the concrete has hardened but not before as it may leach out the cement. The construction of the lining in alternate sections makes the joints the weakest places in the lining and the contraction cracks will occur at these joints. To separate the sections more distinctly the edges of the sections may be painted with oil or a strip or tarred paper may be placed between the edges; this, however, is not necessary.

The proper handling of the forms, especially on rough side-hill work will materially affect the cost. When the lining is started from the upper end of a canal and the work progresses downstream, probably the most economical manner is to place the forms in position for a length of canal which can be lined in 1 day and begin the concrete work at the downstream end and extend it upstream. The concrete at the downstream end

hardens first and this allows the removal of the downstream forms which are carried downstream in the ditch and placed in position at a distance from their previous position equal to the length of canal lined in one setting of the forms. This procedure allows continuous work and does away with the necessity for carrying the forms out of the ditch along what may be a steep rocky hillside.

The method used by the Kelowna Irrigation Co. differed from the above method in that no separate earth forms were used. The concrete forms were placed in position in the excavated ditch and galvanized iron metal plates were put outside of the concrete form and held away from it by pieces of timber of the thickness of the lining. The earth backfilling was placed against these plates and the concrete was poured in between the plates and the concrete forms. The plates and pieces of timber were pulled out as fast as the concrete was poured in.

Construction of Concrete Linings without Forms.—This method is used for side slopes of 1 to 1 or flatter and is in most cases better adapted to the lining of large irrigation canals than the method of construction with forms. It is the method most extensively used. It consists in shaping and grading the earth canal to the desired cross section and in applying the concrete on the trued surfaces.

Preparation of Earth Canal (Fig. 22, Plate IX, Fig. C, D and Plate X).—A new canal is excavated to its approximate cross section by the ordinary means of excavation. An old canal must be brought to the approximate dimensions by excavation where too small and by backfilling where too large, and may be improved by a change in alignment. In all cases the canal must be thoroughly settled before lining. To prepare the earth surfaces for the lining, grade stakes are set along the bottom on the toe of the side slopes and on the line of the top edge of the slopes. These grade stakes are usually placed 16 to 20 feet apart on tangents and 8 to 10 feet on curves, and set in position by measurements from one line of stakes driven to grade on the center line of the canal or from a line of stakes along the top bank of the canal. The measurements are taken usually by means of frames or templets having the required cross section of the trimmed ditch, and brought level by means of a plumb bob or carpenter's level. For very large canals each line of stake may be set by transit and level. When the grade stakes are set, the surface is carefully graded with pick and shovel and hollow places

well tamped or puddled. Chalk lines stretched between grade stakes, templets or slope levels and straight edges will help to give true surfaces. On the Gage Canal in California the bottom grade stakes were set, by measurements from a line of stakes driven along the top of one of the banks, and 1 foot horizontally from the top edge of the lining; the bottom was brought to grade and to trim the side slopes, iron strips, 1 inch wide and $\frac{1}{4}$ inch thick, were driven edgewise, 3 feet apart, across the sloping sides, with the lower ends placed in line by means of a line stretched between the bottom grade stakes and given the proper slope by a slope level consisting of a wooden rod on which a level bubble is placed on an angle, so that the bubble comes to the

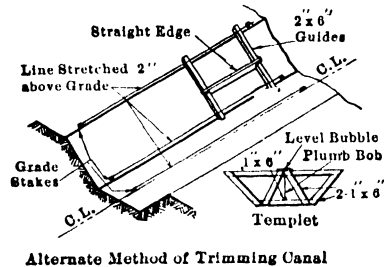
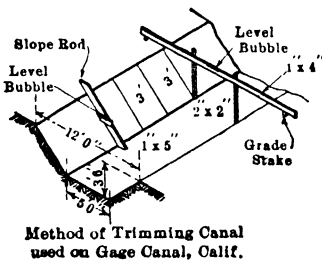

FIG. 22.

center when the bars are on the desired slope. These iron bars are guides for a sharp iron straight edge, with which the irregularities are shaved off. The method used successfully by the Yolo Water and Power Co. in California for larger canals was essentially the same, using guide strips placed up and down the slopes, spaced about 8 feet apart, and a cutting or shaving straight edge.

The placing of the concrete follows the trimming as soon as possible and if the earth's surfaces are dry they should be thoroughly moistened by sprinkling. The concrete lining is built in sections or strips extending across the canal, formed by placing studding or pieces of timber of the desired thickness across the canal. The side slopes are usually built first, in panels to insure distinct construction joints along the edges, and the bottom lining is applied afterward. The concrete mixture is spread between these studdings, raked to about a uniform thickness, tamped and made smooth by means of a straight edge resting on the guide timbers. The surface thus obtained will

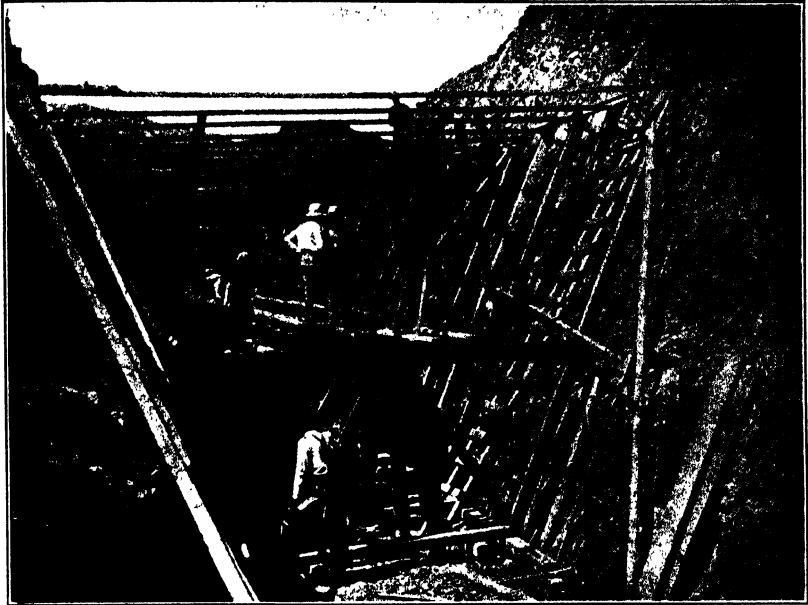

FIG. A.—Building forms for concrete lining. Truckee Carson Project, Nev.

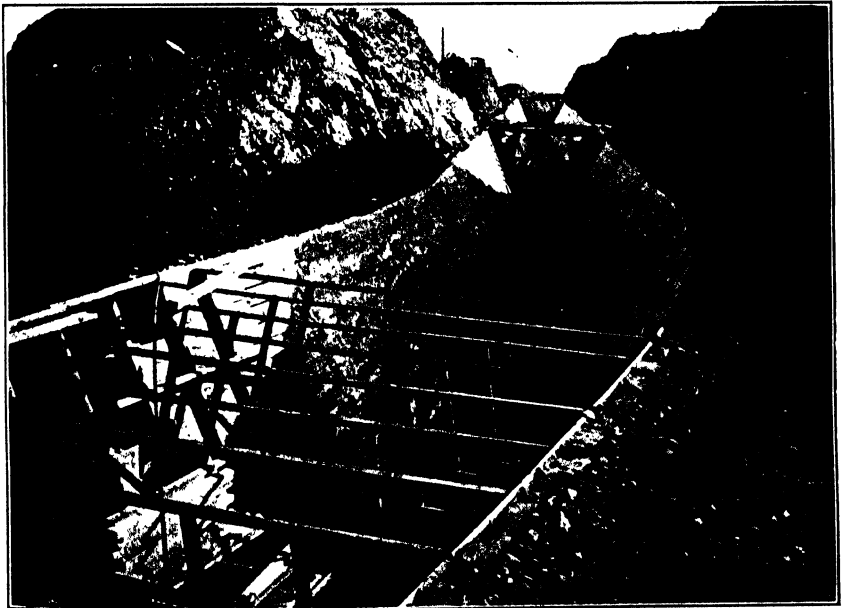

FIG. B.—Partly completed concrete-lined canal. Truckee Carson Project, Nev.

(Facing page 160)

PLATE IX

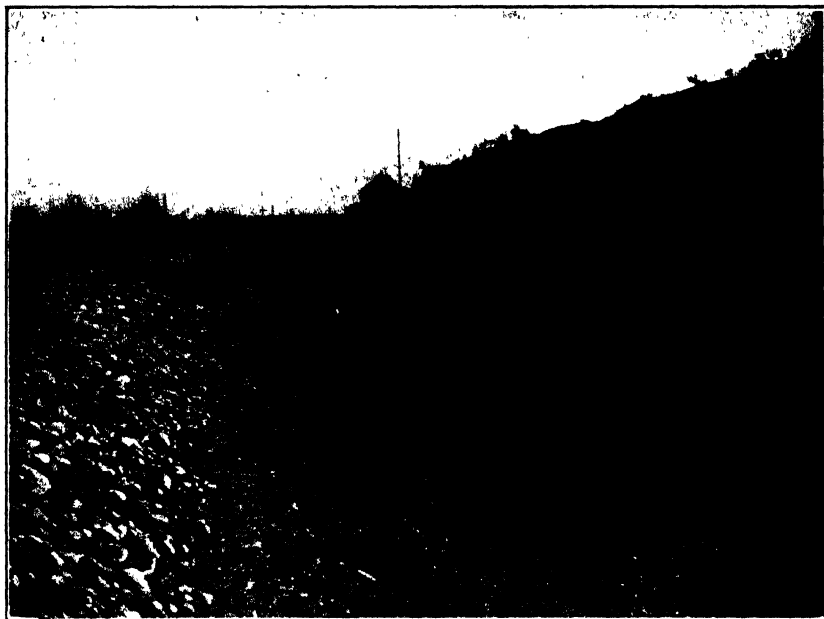

FIG. C.—Preparation of earth canal for concrete lining. Ridenbaugh Canal, Idaho.

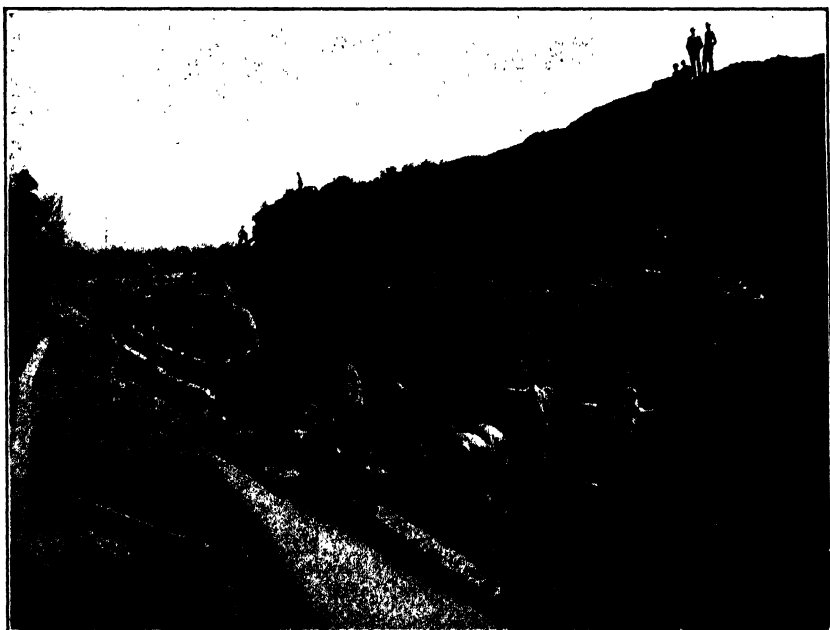

FIG. D.—Placing concrete lining. Ridenbaugh Canal, Idaho.

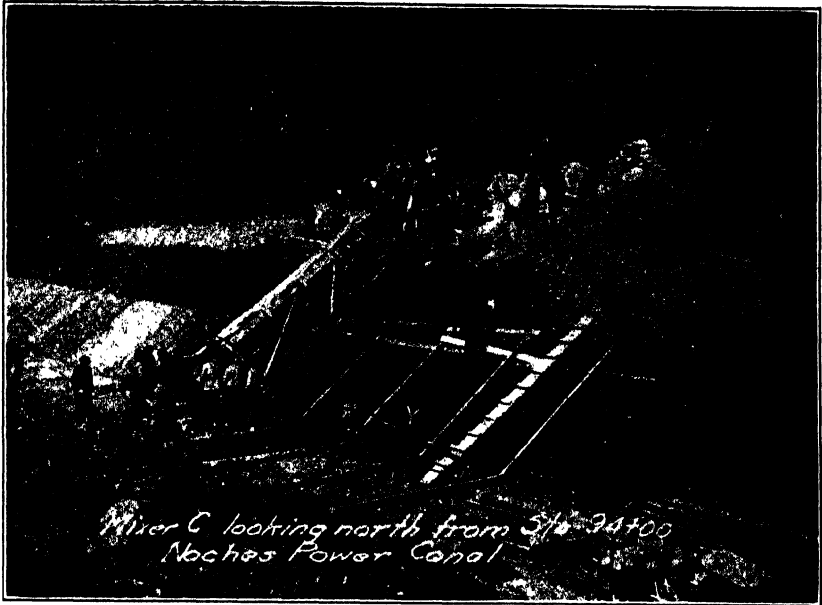

FIG. A.—Placing concrete lining. Naches Power Canal, Wash.



FIG. B.—Completed concrete lining. Naches Power Canal, Wash.

(Following plate IX)

PLATE X

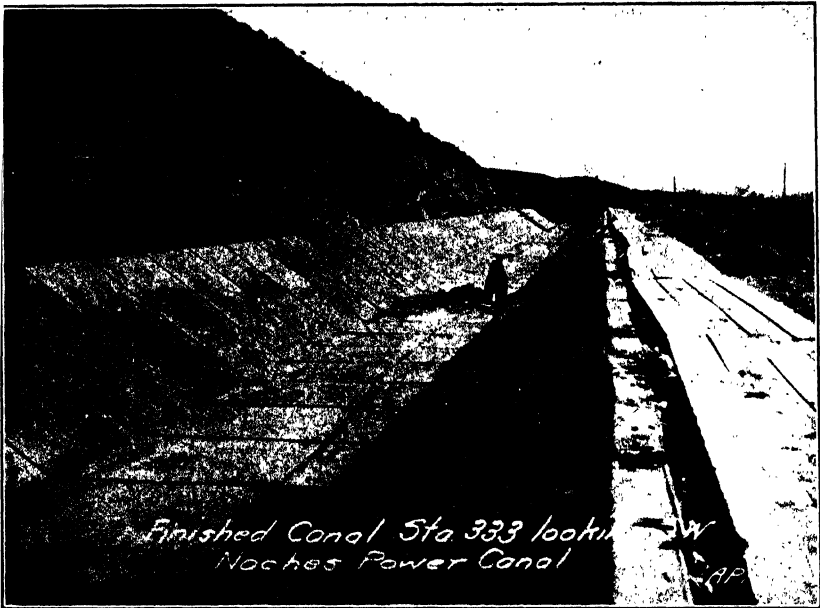

FIG. C.—Completed lining before filling contraction joints. Naches Power Canal, Wash.

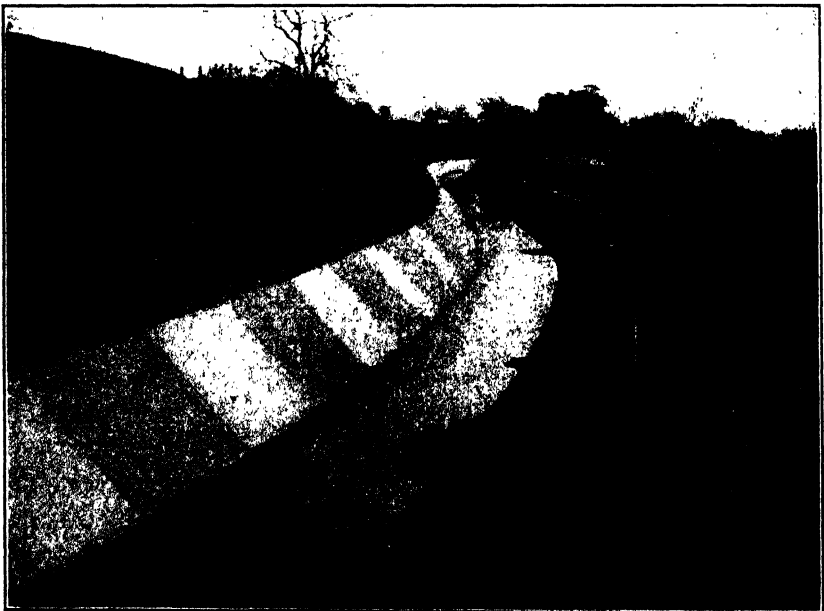

FIG. D.—Concrete-lined canal. Yolo Water and Power Co., Irrigation System, Calif.

be comparatively smooth if the concrete mixture is applied in a fairly wet condition. Otherwise a finish coat is often applied; this consists of a cement mortar paste or grout of 1 part of cement to 2 or $2\frac{1}{2}$ parts of sand, put on the fresh concrete to insure a good bond. It is spread evenly and made smooth with hand trowels or wooden floats. The thickness of the finish coat may be as much as $\frac{1}{2}$ inch, as on the Ridenbaugh Canal in Idaho but is usually applied as a grout only thick enough to give a smooth surface and fill the surface pores. On the main canal of the Boise Irrigation project the lining was divided into rectangles by longitudinal construction joints, halfway down the side slopes and also in the floor and transverse joints across the canal. The longitudinal joints are of questionable value and should preferably be omitted.

Drainage and Effect of Frost.—A canal is usually lined to prevent seepage losses and is therefore naturally well drained, but a canal may be lined for some other reason than excessive seepage loss, or it may be so located that run-off water from higher adjacent land may drain toward it and fill the ground next to the lining with moisture faster than it will drain out. The accumulation of water in the soil surrounding the canal will produce an added pressure on the side walls of the canal and in regions of low winter temperatures will be specially harmful in causing heaving of the soil, which will not be resisted even by thicker linings than those recommended. Where artificial drainage is necessary it is provided by the construction of drains, under the floor of the canal; it will usually consist of a 4 to 6-inch tile placed in a trench 12 inches deep, parallel with and under the uphill edge of the floor, covered preferably with loose rock or gravel and connected to cross drains every 400 or 600 feet, through which the water collected is discharged. The tile may be omitted and the drain trench filled entirely with rock or gravel. Where the canal is located on a side hill and where the surface run-off due to rapid snow melting or heavy rains will not drain into natural drainage channels, but flow toward the canal, it is usually necessary to construct intercepting drain ditches along the side hill, parallel with the canal a short distance above the uphill edge of the canal, to collect the surface run-off water which is either carried over the uphill side lining into the canal or preferably under the canal through a culvert or across the canal in a flume.

Examples and Cost of Concrete Linings.—In the following tables are assembled the dimensions and cost items of typical concrete linings:

DIMENSION OF CONCRETE-LINED CANALS

Canal	Length in feet	Bottom width, feet	Depth, feet	Side slopes	Thick- ness of lining, inches	Distance between construc- tion joints, feet
1. Little Valley Ditch, Hemet, Cal.		2	1 5	1 to 1	½ to 1
2. Gage Canal—Riverside, Cal. ...	100,000	5 to 10	3.5	1 to 1	¾	3
3. M Line, Umatilla project, Ore. ...	12,409	4	4 0	1½ to 1	1½
4. Lateral, Orland project, Cal.		6	3 0	1½ to 1	1½
5. High Line Canal, Orland project, Cal.		14	5 0	1½ to 1	2
6. Moore Canal, Yolo Water & Power Co., Cal.	6,400	11	3½	1½ to 1	2 to 2½	12
7. Main Canal, Burbank Irrig. Co., Wash.	8,250	6	3 0	1½ to 1	2½	5
8. Lateral, Anaheim Union Water Co., Cal.	4,070	1	1½	½ to 1	2	16
9. Main Canal, Anaheim Union Water Co., Cal.	1,000	6	3 0	½ to 1	3 to 3½	16
10. Main Canal, Fruitland Irrig. Co., British Columbia	12,000	4	3½	½ to 1	3	8
11. Main Canal, Kelowna Irrig. Co., British Columbia.	2,400	3	2½	½ to 1	3	8
12. Ridenbaugh Canal, Idaho ...	7,882	10	6½	1½ to 1	4	14
13. Main Canal, Boise project, Idaho.	30,700	40	9 0	1½ to 1	4	16

COST OF CONCRETE-LINED CANALS

The canals of the Anaheim Union Water Co. of the Fruitland Irrigation Co. and the Kelowna Irrigation Co. were lined with forms; the others were lined without forms by spreading the concrete on the prepared earth surfaces. The high cost on the Ridenbaugh Canal was partly due to the large amount of earth-work required to bring the old canal to the proper shape for lining, to the high cost of cement and gravel (cement, \$3.00 a barrel; gravel, \$1.75 a yard), to the great care used in obtaining an unusually fine finish with the application of a top coat ½ inch thick of cement mortar (1 part of cement to 2½ of sand), to the necessity of protecting the concrete from freezing (70 cents a cubic yard), and to the added cost of providing a very unusual form of joints between sections. These joints were made by using ¾ by 12-inch steel pins, coated with asphalt embedded 2 inches deep in the lining, placed 12 inches apart and extending 6

COST OF CONCRETE-LINED CANALS

Locality	Thickness of lining, inches	Concrete mixture	Cost of lining in cents per square foot							Total, cents
			Trueing ditch	Cement	Sand and gravel	Water	Labor	Plant charge and supplies	Super- vision engineering, etc	
Little Valley Ditch, Hemet, Cal.	1½-1	1:5	2.88
Gage Canal, Riverside, Cal.	¾	1:4	3.75-4.00
M Line, Umatilla project, Oregon	1½	1:4	0.57	1.95	0.41	0.79	0.23	0.14	4.09
Lateral, Orland project, Cal.	1½	1:2¹/²:3¹/²	0.42	3.40
High Line Canal, Orland project, Cal.	2	1:2:4¹/²	0.95	6.95
Moore Canal, Yolo Water Co., Cal.	2 to 2½	1:7	1.27	1.75	0.50	1.70	0.27	0.36	5.95
Main Canal, Burbank, Wash.	2½	1:6	1.03	2.14	1.35	0.20	1.18	0.46	0.34	6.70
Lateral, Anaheim Union W. Co., Cal.	2	1:7	1.00	2.44	1.27	0.53	5.24
Main Canal, Anaheim Union W. Co., Cal.	3 to 3½	1:7	2.00	3.62	0.87	1.67	8.16
Main Canal, Fruitland Irr. Co., B. C.	3	1:3:4	1.52	4.23	1.35	2.60	9.70
Main Canal, Kelowna Irr. Co., B. C.	3	1:3:5	2.56	5.75	1.95	6.30	1.93	18.49
Ridenbaugh Canal, Idaho	4	1:2:2:5	6.35	5.50	2.65	6.35	0.63	0.75	22.23
Main Canal, Boise project, Idaho	4	1:3:6	3.00	3.80	1.38	0.27	2.05	1.45	0.35	12.30

inches into the ends of each section. These pins were probably intended to prevent displacement of the strips. The high cost on the canal of the Kelowna Irrigation Co. in British Columbia was due to the canal being located along a rocky side hill not easily accessible, to the added cost of a rock drain under the floor of the canal, and to high prices of cement and labor. Cement was \$3.20 to \$4.10 a barrel, common labor \$2.75, skilled labor \$3.50 to \$5.00. The lining was constructed with forms, the handling of which on steep side hills increased the labor cost considerably. The canal of the Fruitlands Irrigation Co., also in British Columbia, is on a side hill and the lining was constructed with forms without a rock drain but under more favorable conditions than the Kelowna Canal. The cost of cement was \$3.40 a barrel, common labor \$2.50 to \$2.75 a day. The total cost does not include plant charge and supervising. On the other canals listed in the table the cost of cement ranges from \$2.00 to \$2.50 per barrel, delivered on the job, gravel \$0.75 to \$1.50 per cubic yard; the wages of common labor are about \$2.50 to \$2.75 a 10-hour day, except for the Anaheim Canals, which were lined when labor was cheaper (\$1.75 to \$2.00) and for the projects of the Reclamation Service (Umatilla, Orland and Boise projects), where the wages are \$2.50 for an 8-hour day.

Economy of Concrete Linings.—The increasing value of water has caused a growing use of concrete linings; in most cases the water saved and the other advantages gained from a concrete lining well justify the cost, but in a few cases concrete-lined canals have been constructed indiscriminately, where the benefits derived do not justify them. On the other hand, there are many canals where concrete linings would produce benefits far in excess of the cost. The problem resolves itself into a comparison between the cost and the benefits derived. The most important factors to consider are (1) first cost of construction; (2) value of water loss; (3) cost of operation and maintenance; (4) damages due to waterlogging and rise of alkali.

When a new canal is to be constructed, as the extent and value of water loss by seepage can only be estimated, the choice between an unlined canal and a concrete-lined canal will depend largely on the first cost of construction. When the fall available is sufficient, a concrete-lined canal can be given a steeper grade than an unlined canal, which could not resist the resulting high

velocity. The steep grade and the smoother concrete surfaces will give a high velocity with a corresponding smaller cross section; and as steeper side slopes can be used, the volume of excavation will be much smaller than for an unlined canal. This difference will be greatest on side-hill work and will reduce the cost of excavation sufficiently to balance at least part of the cost of lining and in hard material, excavated at a high unit cost, the concrete-lined canal may cost less than an unlined canal. Where there is not sufficient fall available to give the lined canal a steep grade, the comparison will not be as favorable; but even then the cross section of the lined canal will be smaller than that of an unlined canal on the same grade. In comparing the difference in cost, the smaller width of right-of-way and the smaller cost of structures on a concrete-lined canal should be considered. E. G. Hopson states that on the lateral system of the Orland project, in California, which includes 54 miles of ditches, covering 14,000 acres free from topographic irregularities, 28 per cent. of the total cost represents the cost of checks, drops and turnouts, which could be very much decreased if the system was entirely lined with concrete. Other benefits are the decreased cost of maintenance and operation and the greater safety; there are no weeds to contend with, the danger of breaks and resulting damages are largely prevented and consequently the cost of patrolling is nearly eliminated. To these benefits must be added the value of water saved and the prevention of waterlogging of the land below leaky ditches, which, however, cannot be closely estimated before the canal is in operation.

With existing canals the problem may be to prevent the seepage losses or to increase the carrying capacity by either enlarging the canal or by lining it with concrete. The extent of the seepage losses can be obtained by measurements, the damages done to adjacent land below and the cost of maintenance of the canal are fairly well known and will furnish sufficient data to estimate what can reasonably be spent in concrete lining. When the capacity of the canal must be increased, the choice is between making larger unlined canal or to use a lined canal of smaller cross section which will have a higher velocity because of the smoothness of the sides and bed. There are many cases where the value of the water loss alone will justify the improvement of the canals by lining. This is obtained when the value of the water loss will be equal to or larger than the depreciation

and interest on the capital invested. As an illustration, if a canal carrying 50 cubic feet per second throughout the irrigation season of 4 months or 120 days, loses 3 per cent. per mile, which is not excessive, this loss is equal to a continuous flow of 1.5 cubic feet per second or 3 acre-feet per day, which gives a total of 360 acre-feet whose value at \$1.50 an acre-foot is \$540. For this case we would be justified in spending per mile a capital, the interest of which plus depreciation is equal to \$540. If we assume interest and depreciation at 10 per cent., the capital is \$5,400. For an assumed velocity of 4 feet per second and the following dimensions: bottom width 2 feet, side slopes $1\frac{1}{2}$ to 1, depth with 6 inches freeboard 2.75 feet, the perimeter is about 12 feet and the cost of a 2-inch concrete lining would not be ordinarily more than 6 cents a square foot or \$3,800 per mile. The following general formulas give the cost of concrete lining justifiable for different conditions, and the rate of seepage for which linings of different costs can be used economically:

$$C = \frac{SQvd}{26.4ip} \qquad S = \frac{26.4ipc}{Qvd}$$

C = cost of lining per square foot in cents, which will vary with the thickness.

S = rate of loss by seepage in per cent. of flow per mile.

Q = flow in canal in cubic feet per second.

v = value of 1 acre-foot of water, in dollars.

d = number of 24-hour days during which canal is operated.

p = length of perimeter to be lined in feet.

i = rate of interest, repairs, depreciation.

SPECIAL FORMS OF CONCRETE LININGS

Partial Linings—Outer Slope Lining for Canals on Side Hills.—

The lining of a canal usually includes the lining of the floor and of the two side slopes. There are conditions, however, which do not justify or necessitate the lining of the entire canal section. For instance a canal located on side hills may require a downhill bank in fill, and the material available for its construction may be disintegrated rock, broken rock, rocky soil, or other unsuitable material excavated from the side hill which will give a dangerous bank liable to cause much trouble. The floor and uphill slope may be solid rock or firm material, fairly

water-tight, requiring no lining; in which case the concrete lining will be confined to the outside slope and may be either a thin lining or a thicker, sloping, retaining wall, depending on the material and the slope.

On a dangerous section of the New York Canal of the Boise project in Idaho, where the floor and side slope on uphill side required no lining, the outer slope only was lined with concrete 4 inches thick, and the lining was extended below the canal bottom a foot or more to form a cut-off wall. On another section the outer slope and the adjacent outer 12 feet of floor were lined, and a cut-off wall 2 feet deep was formed at the edge of the floor. In these sections the depth of canal up to the top of lining was 11.0 feet and the bottom width 40 feet.

On the main diversion canal of the Turlock Irrigation System in California, the outer slopes of some sections were lined with a sloping retaining wall (Pl. XI, Fig. A). The wall has a slope of 3 feet 6 inches for a depth of canal of 9 feet; it is 8 inches thick at the top and 18 inches thick at the bottom, and extends below the floor into a slate rock about 9 inches. Similar construction has been used on sections of the diversion canal of the Bear River Canal System in Utah.

Semicircular Concrete Lining—Umatilla Project, Oregon.—

On the Umatilla project, Oregon, 2,148 feet of the main canal were lined in August, 1907. The lined section is in rock on a side hill. The cross section is semicircular, 9.8 feet in diameter with the lining extending 1 foot above the horizontal diameter or high water line. The lining is 6 inches thick up to the water line and 12 inches thick above this. The lower part of the lining was constructed by placing templets or semicircular guides in position in the excavated canal and spreading the concrete in each alternate space formed by the templets (Plate XI, Fig. B). The concrete was given the proper shape and made smooth, then the templets were removed and the alternate unlined strips filled in. The upper part of the lining was put in by building forms and placing the concrete behind them in alternate strips to correspond with the lower strips.

The proportion of the concrete was 1 part cement to 3 of sand and 6 of gravel. The cost per cubic yard of concrete in place was \$17. The material was hauled 3,000 feet. Cement cost \$2.17 a barrel and the wages were: laborers \$2.00 to \$2.80, teamsters and teams \$4.00 to \$5.80 and carpenters \$3.00 to

\$3.50 for an 8-hour day. The high cost of concrete is due to the difficulty in placing and using templets and forms which required much labor. The semicircular canal obtained has the advantage over a trapezoidal section of better hydraulic shape and greater strength, but its high cost would generally make a trapezoidal section preferable.

Reinforced Concrete Linings.—Reinforced concrete linings have the advantage over plain concrete linings that they can be designed to prevent cracks due to settlement and have greater strength to resist earth pressures and shocks due to unusual causes. The greater cost due to the addition of the reinforcement and to the difficulty of construction has limited their use to special conditions, such as when a canal is in unstable ground, on steep side-hill, exposed to falling boulders, rock or earth slides, or where there is the possibility of the accumulation of storm water behind the lining.

Yakima Valley Canal, Washington (Fig. 23).—This canal is located on a steep side hill and for several miles is constructed

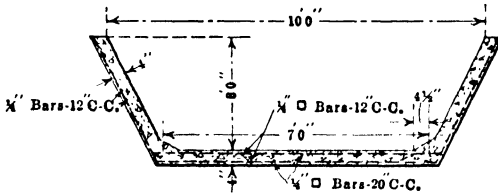

FIG. 23.—Reinforced concrete lining. Yakima Valley Canal, Wash.

as a canal lined with reinforced concrete and partly as a reinforced concrete flume supported on a bench cut in the side hill.

The reinforced concrete-lined canal has a bottom width of 7 feet, a depth varying from 2 feet 8 inches to 3 feet, and side slopes of $\frac{1}{2}$ to 1. The concrete lining is 4 inches thick, reinforced longitudinally and transversely. There are no expansion joints; the longitudinal reinforcement which distributes the temperature stresses and resists longitudinal settlement has an area of steel of about 0.13 per cent. of the concrete area in the side walls and 0.15 per cent. of the concrete area in the floor. The transversal reinforcement in the side walls gives added strength to resist, as cantilever walls fixed to the floor, the full hydrostatic pressure on the back of the lining or extra earth pressure due to heaving or some other cause. The transversal reinforcement in the floor gives added strength to resist upward heaving on the

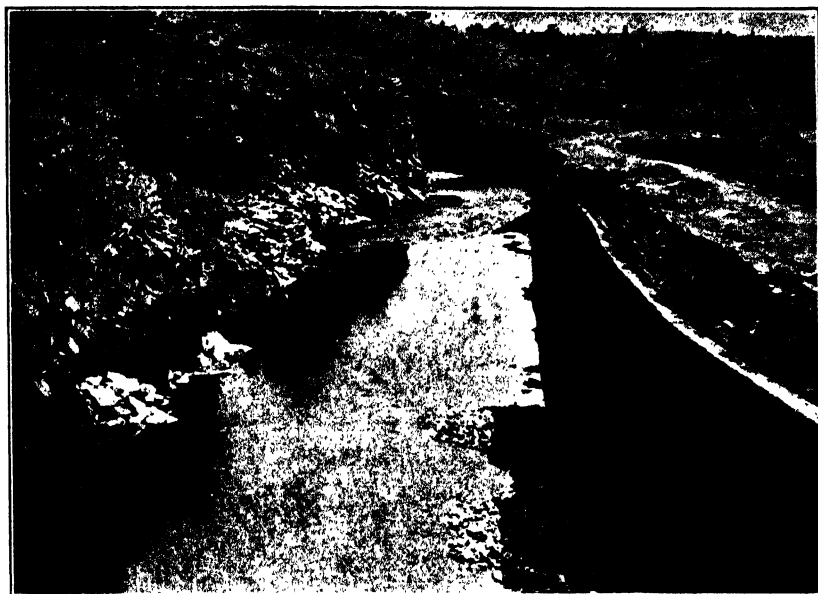

FIG. A.—Sloping retaining wall concrete lining. Turlock Irrigation System, Calif.



FIG. B.—Constructing semicircular concrete lining. Umatilla Project, Ore.

(Facing page 168)

PLATE XI



FIG. C.—Tieton diversion canal, formed with reinforced concrete shapes. Tieton Project, Wash.



FIG. D.—Reinforced concrete shapes at manufacturing yard. Tieton Project, Wash.

under side of the floor and to hold the floor with its weight of water if leakage through the lining or storm water should wash out a cavity under the floor.

Cheliff Canal, Algeria.—This canal is about 1,000 feet in length. The lining is about 2 inches thick, the reinforcement consists of $\frac{1}{4}$ -inch round rods placed longitudinally and transversally about $1\frac{1}{2}$ inches apart, tied together to form a square mesh. The tops of the side walls are connected every 16 feet by cross beams, 10 inches wide and 2 inches thick, reinforced as the rest of the lining. Where the conditions required a section of greater strength, added reinforcement was provided by additional round rods, $\frac{3}{10}$ inch in diameter, in both directions, spaced about 15 inches apart, and by imbedding a bar longitudinally along each of the corners formed by the floor and sides. The concrete was made of 1 part of cement to about 2.3 of sand and was placed with trowels; a finishing coat about $\frac{1}{8}$ inch thick of 1 part of cement to 2 of fine sand was applied. The total cost, including all material and labor was about \$3.50 per lineal foot for the first type and \$4.00 for the second type. The heavy reinforcement, the small thickness of lining and the very rich mixture of the cement mortar would usually be objectionable features in construction and cost.

Tieton Canal, Washington (Pl. XI, Figs. C and D, and Pl. XII Figs. A, B, C and D).—The main canal of the Tieton U. S. Reclamation Service project, for a length of 12 miles, is constructed on a very rough, steep side hill of the Tieton canyon. The side-hill material was mostly volcanic, unstable soils, with slide rock and outcroppings of volcanic rocks. The slope of the side hill averaged a rise of about 6 feet vertically to 10 feet horizontally with occasional vertical bluffs. The unstable character of the soil required a canal lining of considerable strength, which could only be constructed with great difficulty. The steep, rocky hillsides, with the canal line far above the wagon road, constructed by necessity along the bottom of the canyon, led to the adoption of a reinforced concrete lining, built of separate sections of reinforced concrete, which were cast in moulds, at selected camps along the bottom of the cañon, where sand, gravel, cement, and water were available, then conveyed to the canal and joined together. The entire length of the canal was lined; this included about 10 miles of open canal and 8,000 feet of tunnel. Each section or shape used for lining the open

canal was built in the shape of a reinforced concrete shell, 4 inches thick, 2 feet long, curved on an internal diameter of a little over 8 feet, with the top edges extending about 22 inches above the horizontal diameter and stiffened by a 4 by 6-inch reinforced cross bar across the top (Fig. 24). The reinforcement of the shell was designed to resist full hydrostatic pressure from the inside; this was deemed necessary, as the backfilling of the shape could not be depended upon.

The shapes were cast on their side in metal moulds, which consisted of an inside core and an outside jacket, each made of a steel sheet, riveted to angles and stiffened with adjustable braces. The inside form was adjusted each time to a portable templet or setting frame, which insured exact dimensions for each shape

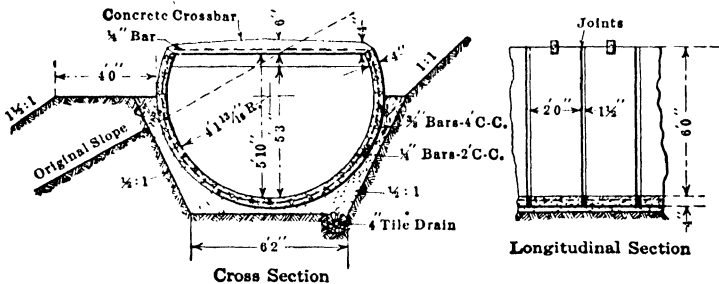

FIG. 24.—Reinforced concrete sectional lining. Tieton Project, Wash.

(Pl. XII, Fig. B). The inside form was then placed on the ground, the outside jacket clamped to it and blocked to give a 4-inch thickness. Before placing the concrete a base was made to form one end of the shape by spreading uniformly on the earth at the bottom of the mould a mixture of sand and plaster of paris. When this base had hardened, the concrete was distributed in the moulds in layers, the steel reinforcement being placed in position for every 4 inches in depth. Before the initial set of the concrete, the upper edge was made smooth and the groove formed with a moulding tool.

The moulds were removed at the end of about 36 hours; the shapes were kept moist for 10 days, and after curing not less than 30 days, were lifted and conveyed to the canal; this required special lifting devices and special cars. The cars were pulled on a track leading to the canal, where they were switched to another track running along the floor of the canal. The shapes were lifted off the cars and placed in position, with

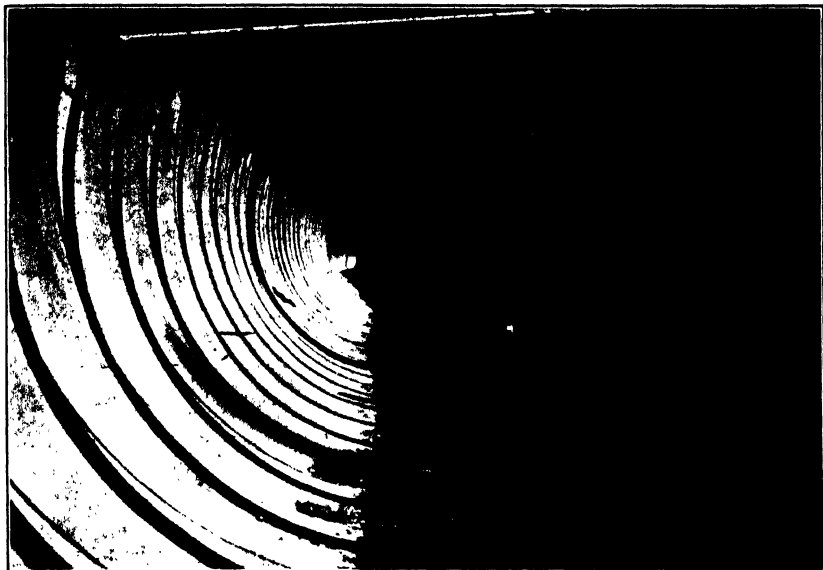

FIG. A.—Interior view of reinforced concrete shapes in place, before filling joints
Tieton Project, Wash.



FIG. B.—Adjusting metal moulds. Tieton Project, Wash.

(Facing page 170)

PLATE XII



Fig. D.—Setting shapes in place. Tieton Project, Wash.



Fig. C.—Hauling shapes on tramway. Tieton Project, Wash.

an open joint $1\frac{1}{2}$ inches wide, filled later with 1 to 5 cement mortar. The concrete was a 1:3:4 mixture, each shape requiring about 35 pounds of steel. The cost of each shape in the yard, including all administration, engineering and plant charges, was about \$8.00 or \$4.00 a lineal foot, equal to about \$17.00 per cubic yard, and the total cost in place in the ditch was \$5.80 per lineal foot or about \$25.00 a cubic yard.

REFERENCES FOR CHAPTER VII

- ETCHEVERRY, B. A.—Lining of Ditches and Reservoirs to Prevent Seepage Losses—June, 1907—Bull. 188, College of Agriculture, Agriculture Experiment Stations, Berkeley, Cal.
- ETCHEVERRY, B. A.—The Economy of the Prevention of Conveyance Losses of Irrigation Water—1911—Report Fourth Annual Convention of the Western Canada Irrigation Association—Government Printing Bureau, Ottawa, Canada.
- ETCHEVERRY, B. A.—Conveyance of Water for the Irrigation Systems of British Columbia—1912—Part of Bull. 44 on Irrigation in British Columbia—Dept. of Agriculture, Victoria, British Columbia.
- TEELE, R. P.—Losses of Irrigation Water and Their Prevention—Reprint from Annual Report of Office of Experiment Stations for the year ending June 30, 1907—U. S. Dept. of Agriculture, Washington, D. C.
- KANTHACK, G. E.—KENNEDY, R. G.—Lining of Water Courses for Prevention of Absorption—1904-1905—Paper No. 11, Punjab Irrigation Branch, Madras, India.
- SCHÖNEMANN, F. W.—BATES, F. T.—LALA BAIJ NATH.—GEE, C. D.—JEFFRIES, E. H.—JEFFRIES, A. E.—Lining of Water Courses to Reduce Absorption Losses—1906-1908—Paper No. 11-B, Punjab Irrigation Branch.
- SCHÖNEMANN, F. W.—Lining of Water Courses to Reduce Absorption Losses—1908-1910—Paper No. 11-C, Punjab Irrigation Branch.
- HOPSON, E. G.—The Economic Aspect of Seepage and other Losses in Irrigation Systems—Proc. Am. Soc. of Civ. Eng.—Oct., 1912, March, 1913, Vol. XXXVIII, No. 8, No. 10; Vol. XXXIX, No. 1, No. 3.
- HOPSON, E. G.—Sectional Concrete Lining of the Tieton Canal—Proc. Am. Soc. Civ. Eng.—Aug., 1910.
- MORITZ, E. A.—Seepage Losses from Earth Canals—Engineering News—Aug. 28, 1913.
- HANNA, F. W.—Water Losses in Irrigation Canals and Methods of Prevention—Engineering and Contracting—June 21, 1911.
- HANNA, F. W.—Concrete Lining of the Main Canal on the Boise Irrigation Project—Engineering Record—Dec. 21, 1912.
- NEWELL, H. D.—Cost of Mortar Linings on Irrigation Canal—Engineering News—Oct. 10, 1912.
- WHITE, A. H.—The Destruction of Mortars and Concrete through Expansion and Contraction—Engineering and Contracting—Aug. 2, 1911; also Engineering Record—July 8, 1911.

- PAGE, L. W.—Abstract of a Paper by Page on Influence of Moisture on the Expansion and Contraction of Concrete—Engineering Record—Oct. 5, 1912.
- PESMAN, O. P.—Seepage from Canals and Prevention—Report of Operation and Maintenance Conference at Helena, Montana—Dec., 1911—p. 114, U. S. Reclamation Service.
- WEYMOUTH.—Report of Operation and Maintenance Conference at Helena, Montana—Dec., 1911—p. 127, U. S. Reclamation Service.
- MORITZ, E. A.—Report of Operation and Maintenance Conference at Helena, Montana—Dec., 1911—p. 126, U. S. Reclamation Service.
- Irrigation by Pumping on the Patterson Ranch—p. 284 Engineering Record—Sept. 10, 1910.
- Construction on the Los Angeles Aqueduct—p. 6 Engineering Record—Jan. 6, 1912.
- Method and Cost of Lining Earthen Channel with Concrete (Los Angeles Aqueduct)—Engineering and Contracting—May 4, 1910.
- Methods and Cost of Constructing Main Canals and Laterals for the Willow River Land and Irrigation Project in Malheur County, Oregon—Engineering and Contracting—Aug. 2, 1911.
- CHANDLER, E. M.—Lining an Irrigation Ditch with Hess Metallic Flume—Engineering News—Sept. 4, 1913.
- An Egyptian Irrigation Canal Steel Lined—Engineering News—April 18, 1907; also The London Engineer—March 8, 1907.
- FORTIER, S.—Concrete Lining as Applied to Irrigation Canals—Bull. 126, U. S. Dept. of Agriculture—1914.

CHAPTER VIII

TUNNELS, CONCRETE RETAINING WALL CANAL SECTIONS, BENCH FLUMES

Tunnels have been built on a number of irrigation systems to overcome difficulties resulting from topographic conditions or to produce more economic canal location. Some of the conditions which make a tunnel desirable or necessary are the following:

First.—The headworks of the systems must be built at a point on the river where the banks extend high above the canal line and so nearly vertical that no form of construction other than a tunnel is desirable or even possible (Plate XIII, Fig. A). Flume construction may be feasible by constructing it to skirt the bank, but it must either be built on a trestle or held to the bluff by inclined braces or tie rods and partly supported on a narrow shelf cut in the rock, or may be entirely hung from supports anchored in the bluff. The flume will be longer than a tunnel, and even if it be cheaper in first cost, is not as durable nor as desirable as a tunnel which is the safest form of construction.

Second.—Where a low diversion weir is used and the river banks are steep and high above the canal bed, such that an open canal or flume would have to be located near the bed of the stream and along its bank; in which position the rise in water level in the river below the weir during flood flows may be sufficient to endanger if not destroy the canal. For these conditions, safety in construction, which is of prime importance, can best be obtained by means of a tunnel.

Third.—The location of the diversion canal, especially when in mountainous regions, will frequently present obstacles such as rocky bluffs, which may be pierced through by a short tunnel, but around which nothing but expensive flume construction is possible; or the canal may come to a long narrow ridge where the choice is between a canal or flume following around the ridge and a tunnel driven through the ridge.

Fourth.—The development of water supply for an irrigation system may require that a stream from one watershed be taken

into another watershed by driving a tunnel through the separating mountains or ridges. Notable examples of this type are the Gunnison tunnel on the Uncompaghre project in Colorado, the

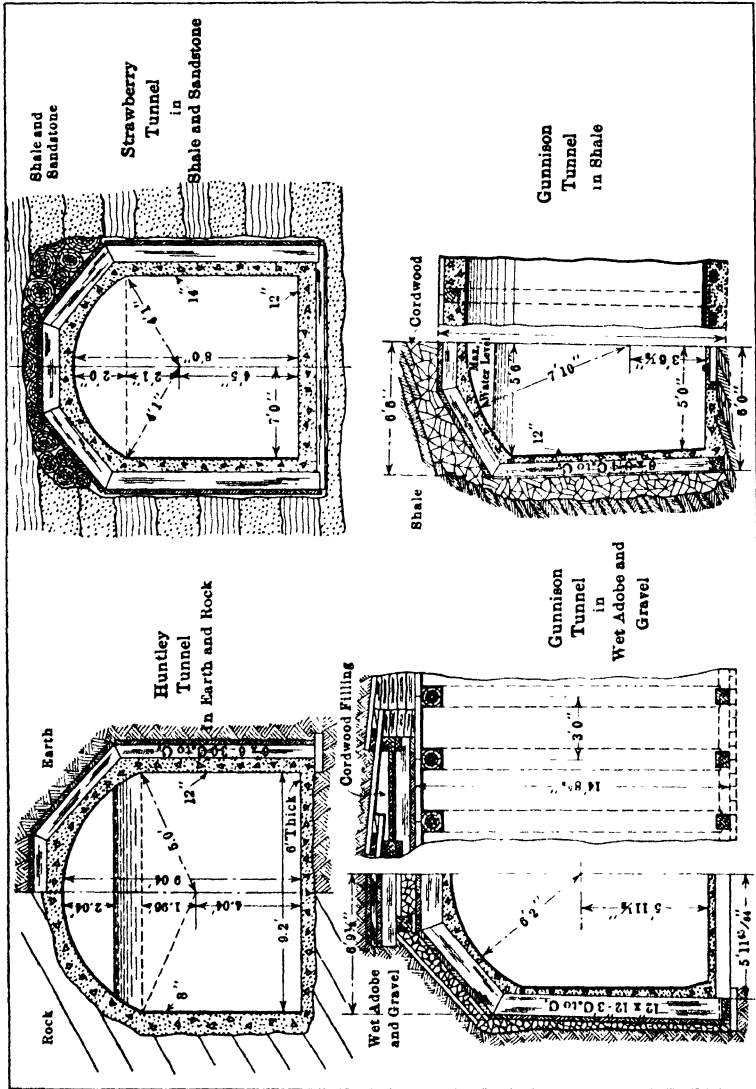

FIG. 25.

Strawberry Valley tunnel of the Strawberry Valley project in Utah, the Laramie Poudre tunnel in Colorado.

The Gunnison tunnel, 30,582 feet in length, was driven



FIG. A.—Entrance portal of diversion tunnel of Twin Falls, Salmon River Project, Idaho. (See also Plate I, Fig. B.)

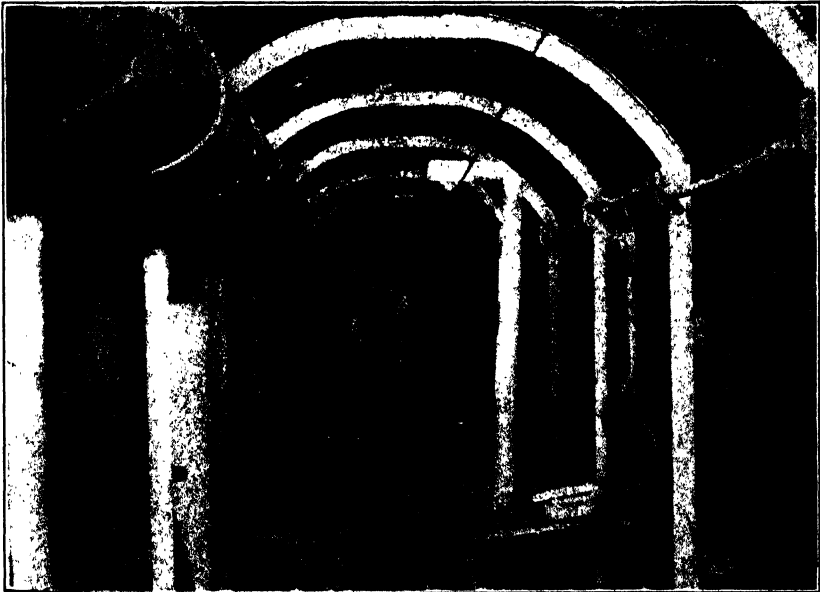

FIG. B.—Interior of Strawberry Valley Tunnel, in timbered section; steel ribs in place for supporting concrete forms; tramway and trolley; ventilation pipe. Strawberry Valley Project, Utah.

PLATE XIII

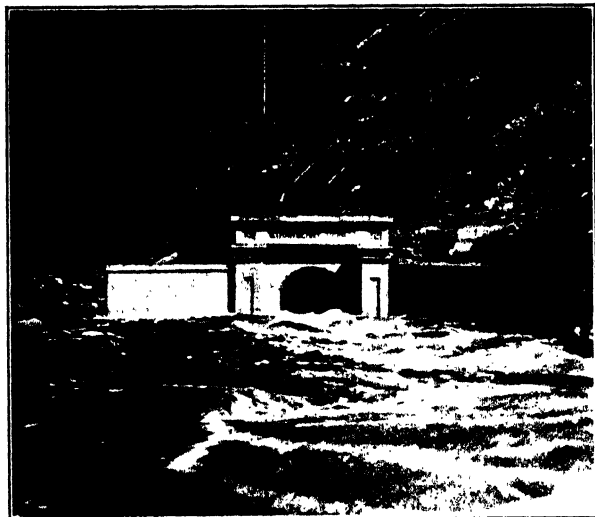

FIG. C.—Outlet portal, Strawberry Tunnel. Strawberry Valley Project, Utah.

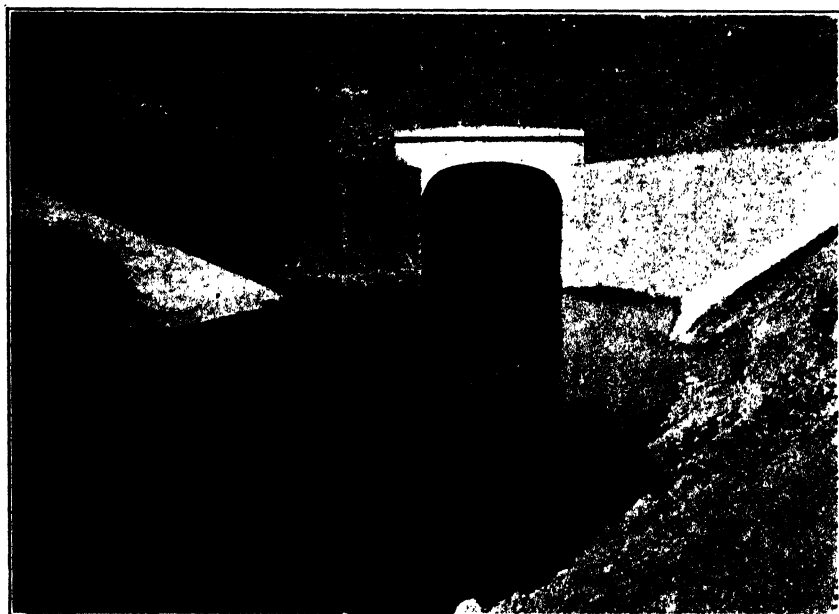

FIG. D.—Inlet portal to tunnel on Truckee Carson Project, Nev.

through a ridge which separates the Gunnison River from the Uncompaghre Valley, to take the entire flow of the river for the irrigation of 147,000 acres in that valley. The tunnel is lined with concrete; the total area of cross section is 122 square feet; it is designed for a full capacity of 1,300 cubic feet per second with a water area of 100 square feet (Fig. 25). The material through which it was driven varied greatly, offering different degrees of difficulties. About 15,000 feet were in metamorphic rock, with occasional seams of water; 10,000 feet in black shale with small pockets of gas; 2,000 feet in water bearing alluvial deposits of clay, gravel and sand; 2,000 feet through a fault zone of badly shattered material in which were encountered coal, marble, hard and soft sandstone, limestone with hot water and high temperatures; 1,200 feet with lower part in shale and upper part in gravel with water along the plane contact in which timbering of the upper part was necessary while the lower part had to be blasted.

The Strawberry Valley tunnel, 19,200 feet in length, is driven through a rim of the Wasatch mountains, to divert water from the Duchesne and Green Rivers into the watershed of the Great Basin. The tunnel passes through hard blue limestone and hard, coarse-grained sandstone with an occasional stratum of soft swelling shale. Considerable timbering was found to be necessary to hold some swelling, shaley ground and to protect workmen and machinery from falling rock caused by the disintegration of the rock when exposed to air (Plate XIII Fig. B.) The timbering was done with 8 by 8-inch sets from 3 to 6 feet on centers. A flow of water of 6 cubic feet per second occurring in the face of the heading stopped the tunnel progress for several days. The tunnel is lined with concrete (Fig. 25). The carrying capacity is computed at 520 cubic feet per second with a velocity of 9.31 feet per second. The slope is 1.6 feet per 1000 feet. The cost of excavation, based on 1 month's work, is tabulated below. This is for the record month of November when 500 lineal feet of tunnel were driven; the average monthly progress for the year of 1910 was 419 feet.

The Laramie Poudre tunnel, 11,306 feet in length, is driven through a ridge to divert the flow of Laramie River and carry it to the Cache La Poudre River for the irrigation of 125,000 acres in the Cache La Poudre Valley, Colorado. The tunnel is in hard gray or red granite, requiring no timbering, except for

COST OF EXCAVATION AND TIMBERING PER LINEAL FOOT FOR NOVEMBER,
1910, STRAWBERRY TUNNEL, UTAH
500 feet of tunnel driven

Labor.....	\$8.530
Tramway, labor and electrician (for haulage)...	1.223
Materials.....	5.168
Machine shop, blacksmithing, corral expense...	1.975
Power (from specially constructed power plant)	3.763
Depreciation.....	1.200
Camp expense.....	0.545
General expense.....	3.292
Engineering.....	0.500
Supervision.....	0.500
Total per lineal foot.....	
	\$26.696

985 feet where it passes through soft seams. This section only was timbered and was to be lined with concrete; the rest remaining unlined. The tunnel cross section is rectangular with the corners rounded. The average dimensions are: height $7\frac{1}{2}$ feet, width $9\frac{1}{2}$ feet, grade 1.7 feet per 100 feet, carrying capacity 800 cubic feet per second.

The total cost of excavation of the tunnel to the contractor averaged \$29.81 per lineal foot. The total overhead charges, including power plant, camp buildings and furnishings, pipes, rails, etc., furnished by the company and which had practically no value after the completion of the tunnel, was \$9.73 per lineal foot. The 985 feet of timbering cost \$2.32 for material and \$4.73 for labor.

These notable tunnels have been constructed in the high mountains accessible only with the greatest difficulty, where a large part of the cost is represented by the construction of roads and the construction of hydroelectric power plants for the generation of the power required to operate the drilling machinery, the blowers for ventilation, the electric lighting system, the electric tramways (as used on the Strawberry project), the shops and all machinery used. This plant charge is proportionately greater for a tunnel like the Laramie Poudre tunnel than for the other two tunnels which are longer and where a good proportion of it may be charged against the cost of the concrete lining. The cost of transportation is also high; for the Laramie Poudre tunnel freighting had to be done for a distance of 65 miles on roads covered with snow and ice, with several pitches steeper than

20 per cent.; it cost \$1.40 per 100 pounds for heavy pieces of machinery and \$1.12½ for lighter material.

The methods of drilling, ventilation, haulage of excavated material, drainage, timbering, etc., cannot be discussed in this book, but considerable valuable detailed information will be obtained from the references given at the end of this chapter.

The discussion and descriptions which follow are concerned more especially with the hydraulic elements of tunnels.

The choice between open canal construction and a tunnel must be based not only on first cost of construction, but also on a careful consideration of operation, maintenance and safety. A canal or flume built on a steep slope is difficult to maintain and is exposed to slide or falling rock from above which are a continuous source of danger; and if a break should occur the damage of a large volume of water turned loose down a steep slope may require a long time to repair, resulting in a loss in crop yield much more serious than the actual cost of repair.

Size and Form of Tunnel.—The minimum dimensions of a tunnel must be large enough to give sufficient room for the working of men and the operation of the necessary machinery, in order that the unit cost of excavation be not excessively high. This will depend somewhat on the length of the tunnel; but usually a minimum height of no less than 6 feet and preferably 7 is desirable. Above this minimum size the area of the tunnel cross section will depend on the volume to be carried and the maximum velocity which may be given to the canal; this will depend on the available grade and the character of the material. Where the tunnel is part of a hydroelectric power canal, the economic size must be obtained by balancing the smaller cost of a smaller tunnel on a steep grade against the value of the loss of power. Where the tunnel is part of an irrigation system, the irrigable area commanded by the system may be decreased by giving the tunnel a steep grade to decrease its size. Where these limitations need not be considered, the maximum velocity will be that which may be given without producing erosion. A tunnel is usually lined with concrete, except when in firm compact solid rock; the safe velocity will therefore be that for rock or for concrete. A maximum velocity of 10 feet per second is considered safe for ordinary irrigation water, and where the water is free from silt or sand much higher velocities can be used. The velocity in the tunnel will usually be higher than in the canal with

which it connects; this will require properly designed transition sections at the inlet and outlet to obtain the necessary change in velocity.

Short tunnels in hard stable rock are sometimes left in the rough condition produced from excavation by blasting, but it is usually desirable to remove the projections and trim the cross section to approximately true dimensions. The form of cross section depends on the material through which it is driven, on whether it is to be lined or timbered, on the effect that different forms will have on the facility with which the material can be excavated and hauled out of the tunnel, and on the hydraulic properties of the different forms. The forms commonly used are the rectangular section with a flat or arched roof, the horse-shoe section with a flat or inverted arched floor and the circular section. The circular section has the best hydraulic properties, but it will usually be found more difficult to construct than either the rectangular or horseshoe shape. The horseshoe shape approaches the good hydraulic properties of the circle better than the rectangular section, but may be more difficult to construct. The rectangular section is more easily excavated and the irregularities left after blasting can be more easily removed and the cross section trimmed; it is best adapted to solid self-supporting stable material, with no tendency to slide laterally or vertically.

In unstable material there may be lateral pressure on the sides and downward pressure on the roof, in which case the sheathing or lining must be designed to resist these pressures; the tunnel will then have an arched roof and either vertical battered or arched sides, depending on the degree of cohesion of the material. In very soft material a floor lining will also be necessary, in which case the best form to resist the pressures is a complete circular section, but a horseshoe section may be preferable because it may be more easily constructed. In addition to the use of lining to resist inward pressures, there are other reasons for lining tunnels which must carry water. Concrete linings are used to prevent seepage losses through porous ground or fissured rock, to protect, from contact with water, material which disintegrates or has a tendency to slide when wet, to permit the use of velocities higher than the natural material will stand, to give a smooth cross section which will require a much smaller water area than a tunnel with a rough channel.

The types of lining may be of three kinds, depending on the material through which the tunnel is driven:

First.—The tunnel may be in hard, stable rock formation, where no timbering is necessary. In which case a lining only thick enough to fill cavities and form smooth surfaces is all that is required and if the roof needs no support the lining may be applied only on the floor and sides to form the water channel.

Second.—The tunnel may be in material which is sufficiently stable to require no timbering during the process of construction or where temporary timbering can be removed at the time the lining is put on.

Third.—The tunnel may be in unstable rock or soil where the roof or roof and sides must be supported by timbering which cannot be removed before the concrete lining is built, in which case the lining is placed against the sheathing and the posts are imbedded in the concrete.

When in solid, stable rock the thickness of the lining required to fill cavities, cover the rock projections and give smooth surfaces will depend on the care used in blasting and the accuracy with which the trimming was done. An average thickness of 4 to 6 inches will usually be sufficient. In unstable material a thickness of lining 8 to 12 inches is generally used, except for very large tunnels when the thickness may be as great as 18 inches.

A special form of concrete lining used on small tunnels in southern California consists of sections of ordinary concrete pipe 2 feet in length, placed on grade, carefully backfilled and joined with cement mortar. This method has been successfully used for tunnels on the Tieton Canal, Yakima project, Washington.

Tunnels on Tieton Canal, Yakima Project, Washington.—On this canal 3 tunnels, totaling 8,000 feet in length, were lined with reinforced concrete circular shapes, 6 feet $1\frac{1}{4}$ inches in internal diameter, 2 feet in length and 4 inches thick; made of 1 part of cement to 10 parts of unmixed aggregate (Fig. 26). The volume of water for which they were designed was 336 cubic feet per second; the grade was 23.9 feet per mile, the corresponding velocity 12.65 feet per second, and the depth of water 5 feet 3 inches.

The general topographic conditions, difficulties and method of construction were similar to those previously stated in the

description of the semicircular canal lining. The tunnels were in lava rock and basaltic formation, most of which was fractured so that the greater part required timbering. The shapes were cast in metal moulds at selected yards at the bottom of the canyon, and were carried by special devices on inclined railways or cableways up to the portals of the tunnel (Plate. XIV, Fig. A); they were delivered in the tunnel on small cars, then set in place by

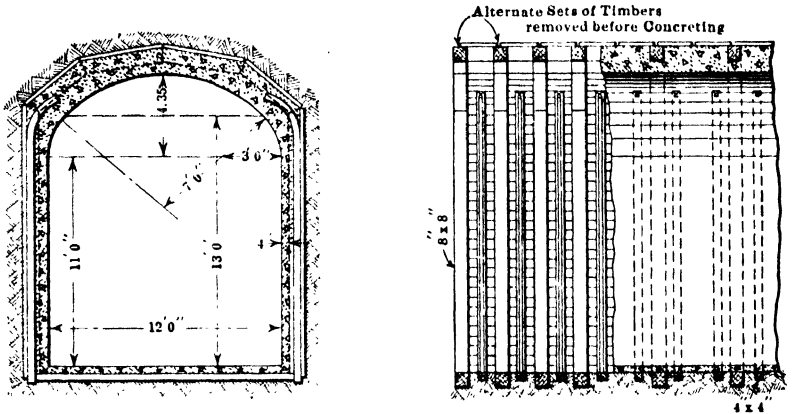

Tunnel Lining with Walls Reinforced with Rails
Truckee Carson Project

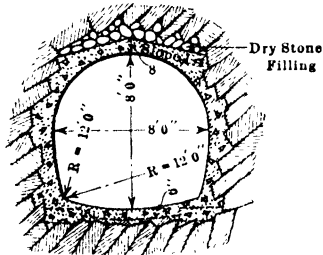

Tunnel in Untimbered Shale
Bellefourche Project

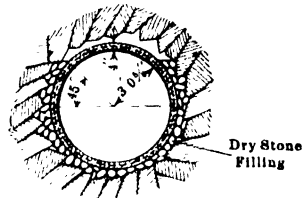

Tunnel in Sound Rock
Tieton Project

FIG. 26. --Tunnel cross sections.

a special supporting centering device which held them in place until the backfilling was rammed into position, after which the joints were made with mortar.

The tunnels were driven by compressed air drills, operated by hydroelectric power. The inside dimensions were about 8 by 8 feet; the average cost of driving of two tunnels 2,900 and 3,000 feet was as follows:



FIG. A.—Hauling by cableway reinforced concrete cast circular shapes for tunnel lining. Tieton Project, Wash.

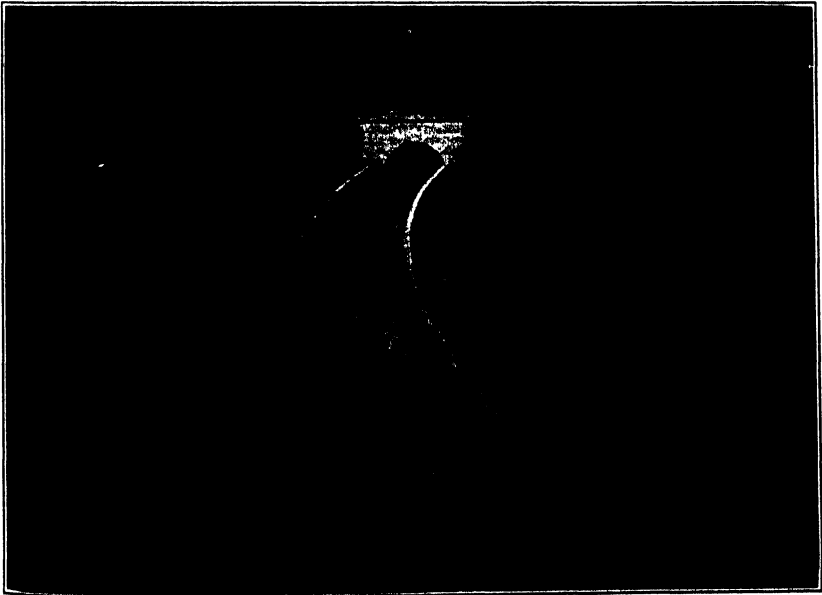

FIG. B.—Tunnel outlet and transition to connect with semicircular concrete-lined canal. Tieton Project, Wash.

PLATE XIV



FIG. C.—Concrete retaining wall canal section in process of construction. Turlock System, Calif.

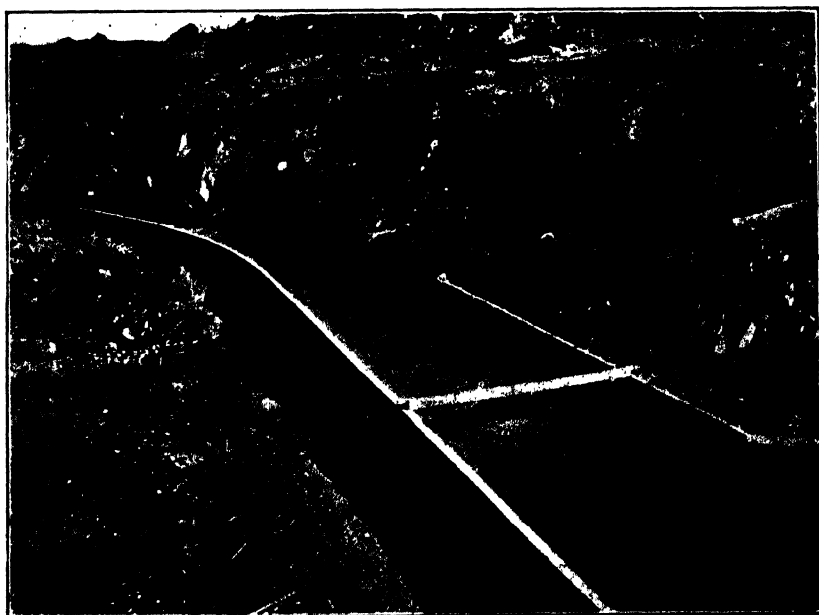

FIG. D.—Concrete retaining wall canal section. Turlock System, Calif.

Labor in tunnel.....	8.00 per lineal foot.
Explosives.....	1.50 per lineal foot.
Supplies.....	0.50 per lineal foot.
Power-plant operation.....	1.10 per lineal foot.
Blacksmith shop.....	0.75 per lineal foot.
Timbering.....	2.50 per lineal foot.
Plant charges.....	5.00 per lineal foot.
<hr/>	
Total.....	\$19.35 per lineal foot.

The above cost includes engineering and administration. Wages were \$2.00 to \$2.50 for common labor, \$3.00 to \$3.75 for tunnel drill men for an 8-hour day. The average cost of lining with the concrete shapes was:

Cost of shapes in the yard.....	\$4.75 per lineal foot.
Transporting, laying and backfilling.....	3.60 per lineal foot.
<hr/>	
Total cost, including plant and operation charges.....	\$8.35 per lineal foot.

The total cost of the completed lined tunnel, including excavation and timbering was \$27.70.

The economy of this method of construction was well indicated by the greater cost of another tunnel, 3,200 feet in length, in hard firm basalt, built by the usual method. No roof was required; the floor and sides only were lined and the lining built in place. The higher cost was due to the greater amount of concrete required to fill the cavities resulting from irregularities in blasting.

Tunnels on Truckee Carson Project, Nevada.—On this project four tunnels with a total length of 2,937.7 feet have been constructed. The capacity of each is 1,200 cubic feet per second with a depth of water of 13 feet and a velocity 8.10 feet per second. The tunnel sections are rectangular with a three-centered arched roof. The vertical sides are 11 to 12 feet high; the floor is flat and 12 feet wide and the rise in the arch varies from 3.35 to 4.35 feet, depending on the form of construction. The depth of water for full capacity is 13 feet (Fig. 26, Plate XIII, Fig. D).

Where timbering was necessary, the timbered sets are built of 8 by 8-inch timber, spaced according to the material from 2 to 6 feet on centers. The concrete lining is 4 inches thick on the bottom, 12 inches thick on the sides between the timbers, 4 inches at the timbers and 16 inches thick at the center of the arch. Tunnel No. 3, 1,515 feet long, excavated through silt and

cemented gravel, has a thicker arch lining than the other three and where the ground was very loose, the side lining was reinforced with railroad rails. The sets of timber were spaced 4 feet apart for most of the tunnel. Tunnel No. 2, 308.7 feet long, was in compact red rock free from seams, requiring no timbering. The tunnel was lined with an average thickness of 8 inches of concrete. The approximate actual cost, excluding extras and contractor's profits, are tabulated below. Cement was furnished by the Reclamation Service and cost about \$2.55 per barrel. The cost of the cement is included on the basis of 1 barrel of cement to 1 cubic yard of concrete.

COST OF TUNNELS ON TRUCKEE CARSON PROJECT

	Tunnel No. 1	Tunnel No. 2	Tunnel No. 3	Tunnel No. 4
Length of tunnel in feet.....	901	308.7	1515	213
Cost of driving and timbering per lineal foot.....	\$25.63	\$16.45	\$23.76	\$26.02
Volume of concrete, cubic yard....	1,567	619	2,879	320
Cost of concrete lining per cubic yard.....	9.72	10.87	9.14	9.47
Cost of concrete lining per lineal foot	16.90	21.80	17.35	14.25
Total cost per lineal foot.....	42.53	38.25	41.11	40.27

Tunnel on Belle Fourche Project, South Dakota.—This tunnel 1,306 feet in length, has a horseshoe cross section with inverted arch floor (Fig. 26). The capacity is 320 cubic feet per second. Where necessary, the tunnel is timbered and above the exterior of the arch roof the space is filled with stone, placed and wedged tightly to carry any exterior pressure uniformly to the arch.

The forms used in the construction of the lining proved to be very satisfactory (Fig. 27). They consist of I-beam supporting frames made in two equal sections, each curved to the form of one side and extending up to the center of the arch, where they are connected together by a wedge-shaped key block. The foot of the I-beams rests on concrete footings built along the outer edges of the floor. To stiffen the frame and hold the I-beam ribs in the correct position, a channel placed horizontally about halfway up above the floor is bolted to the I-beams. These frames, spaced 4 feet apart, support the lagging, built of 1-inch lumber in sectional pieces, 8 feet long in curved widths of 20 to

24 inches. The frames and lagging can be taken apart and moved ahead through the erected forms, thus permitting the

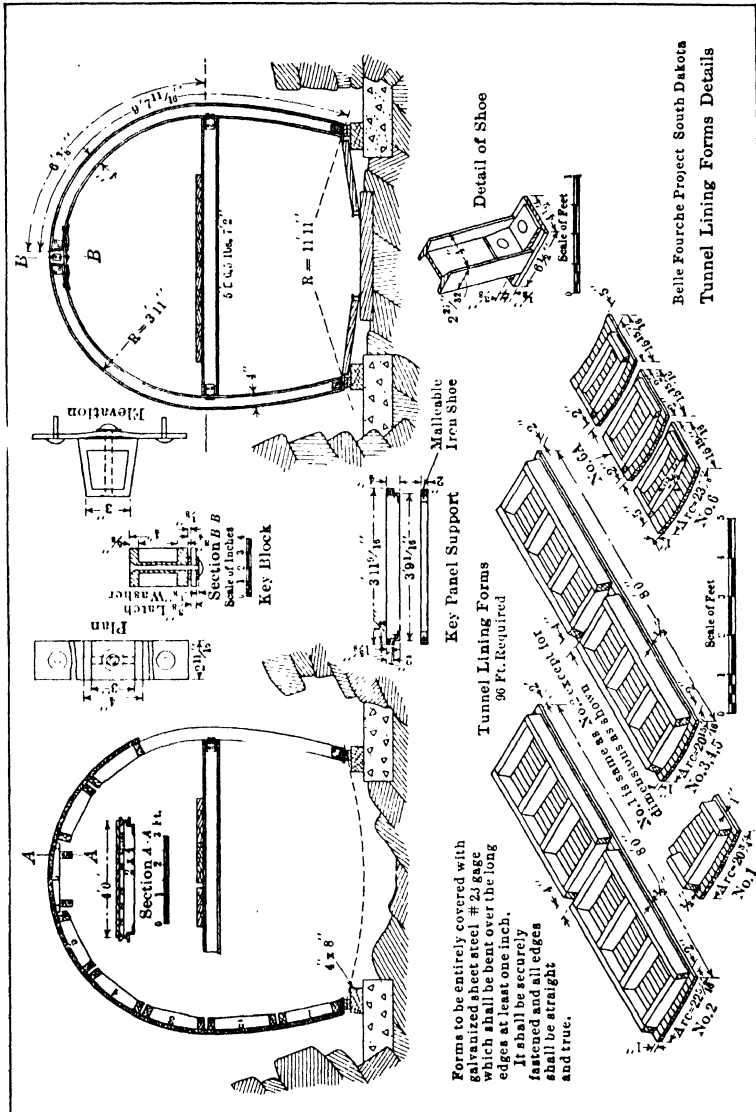

Fig. 27.

continuous placing of concrete. The concrete used was a mixture of $1:2\frac{1}{2}:5$. Bids were submitted, but the work was done by force account for about one-third of the lowest bid.

Had the contract been awarded, payment would have been allowed for 1,712 cubic yards of concrete; but by greater accuracy in excavation the actual amount used was reduced to 1,595 cubic yards. Sand and gravel were obtained at one end of the tunnel from natural beds and the concrete was mixed at this point. The wages were \$2.30 for 8-hour day. The cost data given below do not include charges for surveys and designs. The unit costs are based on 1,712 cubic yards; these would be 8 per cent. larger if based on actual amount of concrete put in.

COST OF CONCRETE LINING, BELLE FOURCHE TUNNEL

Distribution of cost	Total cost	Cost per cubic yard
Preparation expense.....	\$731.30	\$0.43
Plant depreciation.....	725.73	0.42
Superintendence.....	318.00	0.18
Camp maintenance.....	430.03	0.25
Cement.....	4,544.11	2.65
Lumber and steel forms.....	861.08	0.50
Miscellaneous materials.....	45.20	0.03
Fuel.....	105.14	0.06
Lighting.....	81.43	0.05
Miscellaneous supplies.....	230.80	0.14
Hauling cement.....	1,624.25	0.95
Hauling gravel and sand.....	432.32	0.25
Crushing and screening gravel and sand.....	205.17	0.12
Mixing and placing concrete.....	1,565.71	0.92
Hauling forms.....	106.95	0.06
Labor on forms and runways.....	890.61	0.52
Blacksmith.....	137.19	0.08
Finishing.....	373.02	0.22
Miscellaneous labor.....	611.74	0.36
Administration.....	878.25	0.51
Engineering.....	633.07	0.37
	\$15,531.10	\$9.07

Tunnel on Huntley Project, Montana.—The tunnel for which cost data are given below, is one of three built on this project. It is 390 feet in length and is driven through a sandstone of medium hardness which required no timbering. The cross section is rectangular with an arched roof (Fig. 25). The sides and roof are lined with about 8 inches of concrete and the floor with 6 inches. The computed carrying capacity for a

depth of water of 7 feet was 400 cubic feet per second with a velocity 6.23 feet per second. Hand boring machines were used and the amount of excavation was 3.6 cubic yards per lineal foot. Continuous pumping at both headings was necessary during construction, as the tunnel is about 100 feet away from and on grade with the Yellowstone River.

The concrete lining was placed with forms consisting of supporting frames of steel ribs and wooden lagging. The volume of concrete lining averaged 1.13 cubic yards per lineal foot. The concrete mixture was 1:2½:5½ gravel. Cement cost \$1.86 a barrel, exclusive of hauling ¾ mile; sand and gravel were obtained from a pit near the mixer. Wages were: miners \$3.00, common labor \$2.00 to \$2.40, carpenters \$4 to \$5 for 8-hour day. The summarized cost is as follows:

COST OF TUNNEL ON HUNTLEY PROJECT

	Per lineal foot	Unit cost
Cost of excavation:		
Explosives and candles.....	\$1.394	\$0.3870 per cubic yard.
Labor.....	11.075	3.0027 per cubic yard.
Pumping water out.....	1.798	0.4995 per cubic yard.
Superintendence.....	0.791	0.220 per cubic yard.
	<hr/> 15.058	<hr/> 4.1012 per cubic yard.
Cost of trimming:		
Explosives.....	0.3814	1.145 per 100 square feet.
Labor.....	1.9981	6.001 per 100 square feet.
Superintendence.....	0.25	0.754 per 100 square feet.
	<hr/> \$2.629	<hr/> \$7.90 per 100 square feet.
Cost of concrete lining:		
Materials: Cement, sand, gravel, coal, etc.....	4.092	3.635 per cubic yard.
Forms material.....	0.675	0.606 per cubic yard.
Forms labor.....	2.092	1.879 per cubic yard.
Mixing and placing.....	3.005	2.731 per cubic yard.
Superintendence.....	0.474	0.423 per cubic yard.
	<hr/> 10.398	<hr/> 9.274 per cubic yard.

The total completed cost of the tunnel is \$28.085 per lineal foot.

CONCRETE RETAINING WALLS FOR CANAL SECTIONS AND BENCH FLUMES

Concrete retaining walls to form one side or both sides of the canal and bench flumes of wood or reinforced concrete, supported on a bench cut in the side hill or on the natural ground surface are used to advantage for the following special cases of canal construction:

First.—On side-hill location where the slope of the ground is too steep to form the downhill bank of the canal, or where the excavation required for a canal cut in the side hill is so large as to make its cost greater than that of a retaining wall cross section or bench flume construction. These conditions are obtained specially on steep side hills and in rock or material hard to excavate.

Second.—Where the location would require that the canal cross section be formed by embankments all in fill, and the difficulty and cost of obtaining earth for the fill makes it more economical to use a cross section formed by retaining walls or bench flumes.

Third.—Where the material of the side hill is unstable and not suited to the ordinary form of canal.

Concrete Retaining Walls for Canal Sections (Fig. 28).—On the diversion canals of the Modesto and Turlock Irrigation systems in California several thousand feet of concrete walling along steep and rocky side hills have been built to replace the original construction, which consisted in part of canal sections formed by a cut with an earth embankment on the downhill slope, and of wooden bench flumes. The embankments had to be made of material of inferior quality; required careful watching to avoid breaks and were a continuous cause of worry and expense. The flumes decayed rapidly and the cost of maintenance was high. A few typical retaining wall sections are shown in the accompanying sketch. The walls extend below the bed of the canal down to solid foundation, and where seepage is liable to occur and undermine the wall a floor lining is used. On the uphill side where the rock is fissured or where the material will not stand the erosive action of the water a sloping concrete retaining wall is built and where the uphill wall has no backing it is designed as the lower wall to resist water pressure.

Part of the Turlock walling consists of an inclined retaining wall, placed against the made embankment, braced with buttresses 12 inches thick, spaced 10 feet apart and extending down to solid foundation. These buttresses would only be brought into service if the earth backing of the side wall settled; the sloping wall would then be a slab supported on the buttresses and the water pressure would produce a tensile stress in the concrete. This action would not be desirable for there is no reinforcement in the concrete; but settlement of the embankment was not likely to occur, as the material was thoroughly compacted through several years of use before the wall was built.

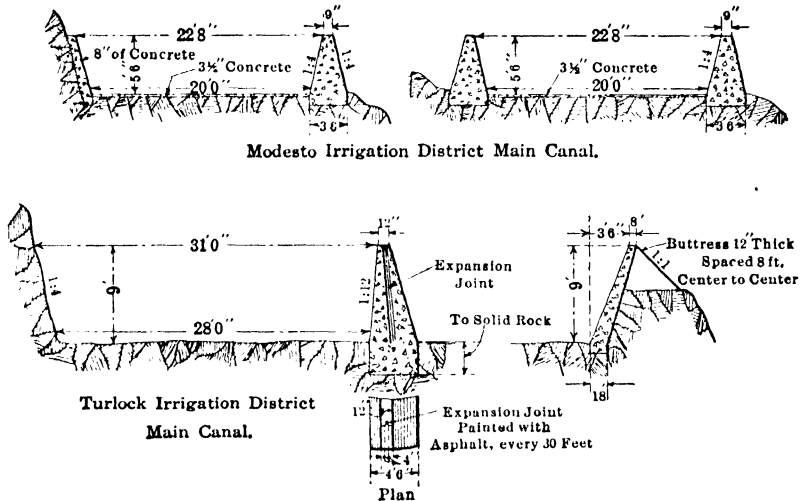

FIG. 28.—Concrete retaining wall, canal sections.

Another section of the Turlock Canal is formed of a regular gravity type retaining wall with expansion joints every 25 feet (Plate XIV, Figs. C and D). These joints were made by placing a temporary dam with a V-shaped tongue between the wooden forms. This dam was removed when the concrete had hardened sufficiently and the surface of the joint was then painted with an asphalt mixture before the next section was started. At the apex of the V an iron rod was placed, which was removed after the adjacent section of wall was built, and the hole formed was filled with hot asphalt.

This same type of construction has been used on the main diversion canal of the Bear River Canal Co. in Utah. There are

several sections on the Del Rio Canal in Texas, where 5,000 feet of canal, 4.5 feet deep, have been formed with a concrete wall 18 inches on the bottom, 9 inches thick on the top, and extending 18 inches into the ground.

A retaining wall of gravity section must be designed to maintain the resultant pressure within the middle third. A vertical face on the water side will require the least material and the base width required for a wall whose base is level with the floor of the canal is obtained by the equation $B = \sqrt{1.25 b^2 + \frac{d^2}{s}} - 0.5b$ where B = base width of wall in feet, b = top width of wall in feet, d = total height of wall in feet, s = specific gravity of masonry. The application of this equation to the wall section of the Turlock Canal and the Del Rio Canal gives base widths much larger than those actually used, showing that these walls must depend for their stability on the anchorage or extension of the wall below the canal floor. A gravity retaining wall of plain concrete requires a larger volume of concrete than a reinforced concrete wall either of the cantilever type or of the buttress type for higher walls. In some cases the material available may justify the gravity type of retaining wall but greater economy will generally be obtained with reinforced concrete construction.

Bench flumes of plain concrete consisting of two side walls and the floor between have been constructed on many canals in California with side walls very much thinner than the gravity section with good results. Concrete head flumes in southern California with side walls 12 inches high and 3 inches thick at the bottom and even 24 high and 4 inches thick at the bottom are quite common, but can resist water pressure only by the tensile strength of the concrete and require that the floor and sides be built monolithically. This form of construction would not be considered good engineering practice, and will save little in cost on the construction of properly designed reinforced concrete flume.

Wooden Bench Flumes.—The wooden bench flume supported on a bench or shelf cut into the side hill is a common type of construction. It consists usually of the rectangular flume box formed of the lining nailed to the floor sills, and side yokes, made rigid with tie beams or side braces and supported on mud sills placed on the ground. Semicircular wooden flumes have been used to a more limited extent. The flume box does not differ

from that used for wooden flumes supported on posts or trestle, and the various forms of supporting the flume box are frequently used at different points along the same flume. The details of design and construction of the flume box is therefore considered further in Chapter IX.

Reinforced Concrete Bench Flumes.—A reinforced concrete bench flume in its simplest form consists of the two side walls and the floor built directly on the ground. The side walls must be designed to resist the water pressure; for this three forms of construction may be used:

First.—The side walls are designed as cantilever walls fixed at the floor, with transverse reinforcement in the walls to take up water pressure and longitudinal reinforcement for temperature stresses, which may be very light when expansion joints are provided.

Second.—The side walls are supported by buttresses or by side posts forming part of the side walls and which must be anchored at the base or connected to the floor and may or may not be connected across the top with a tie beam. The side walls are then designed as slabs whose span is equal to the distance between buttresses and with a varying amount of longitudinal reinforcement to conform with the variation in unit pressure, which is maximum at the bottom. The addition of transverse reinforcement brings into play the cantilever action, for which due allowance could be made by reducing the amount of longitudinal reinforcement.

Third.—The side walls are designed as slabs fixed at the upper end to a reinforced beam and at the base to the floor or by anchorage. The top beam is formed as part of the wall, and is divided into spans either by the cross or tie beams connecting the upper ends of the walls across the flume or by buttresses or side braces. The total water pressure when the flume is full, with no freeboard, will then be transmitted about $\frac{1}{3}$ at the top beam and $\frac{2}{3}$ at the base connection. The reinforcement in the side wall to resist the stresses due to water pressure is placed vertically in the wall, between the top beam and the base connection. For temperature stresses the usual percentage of steel reinforcement is placed.

Reinforced concrete bench flume of the first type are simpler to construct, they are more commonly used, and are more economical for flumes with low side walls. This form of flume

is illustrated by the following: Flume for Kamloops Fruitlands Irrigation Co. in British Columbia; flume on Yakima Valley Canal, Wash. The second type is illustrated by the flume of the Naches Power Co. in Washington, and the third type by the

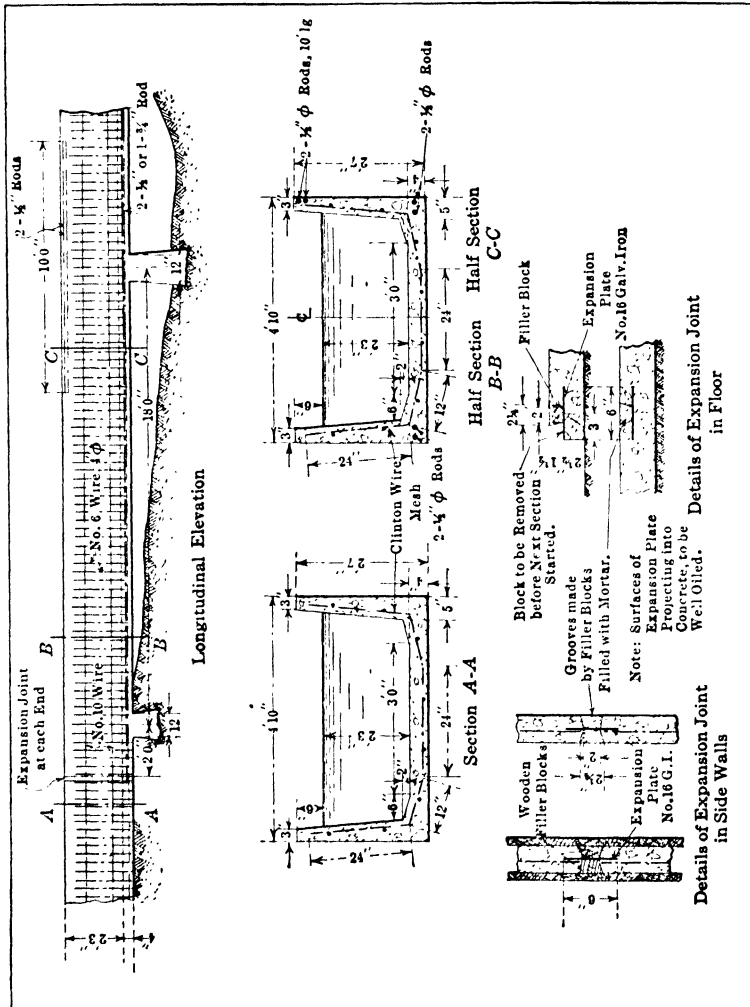

Fig. 29.—Reinforced concrete bench flume. Kamloops Fruitlands Irrigation & Power Co., B. C.

flume on the Big Fork Plant of the Northern Idaho and Montana Power Co.

Reinforced Concrete Bench Flume of Kamloops Fruitlands Irrigation Co., British Columbia (Fig. 29, Plate XV, Figs. A and B).

—This flume was constructed at the foot of a steep rocky hillside

in preference to a concrete lined canal, cut in the side hill. It is about 1,000 feet long, supported all the way on a level bench except at certain points where it is carried over shallow drainage channels by placing additional steel in the side walls to make them act as girders and carry the flume over a span of 16 feet. The side walls are cantilever walls reinforced with Clinton wire mesh of No. 6 wire spaced 4 inches apart for transverse reinforcement and a lighter wire, No. 10, 12 inches apart for longitudinal reinforcement. There is very little need for the temperature reinforcement, as there are expansion joints 16 feet apart; these are formed by placing transversally in the forms a 6-inch strip of galvanized iron, held during construction between tapered wooden filler blocks set in the forms, as shown in the drawing. This permits building the flume continuously. The edges of the plate protruding out of the filler block are well oiled to form a free tongue in the concrete. After the removal of the forms the wooden wedges are taken out, then the concrete edges in the groove thus formed are painted with oil to prevent adhesion, and the two faces of the plate are well cleaned; the plate is punctured with a pick and the grooves on both sides are then filled with a rich mortar. This forms a block of cement mortar with projecting metal tongues on each side, which permit contraction. The joint in the floor is made much in the same manner, except that the filler block is placed under the plate near the outer edge of it and removed before the adjacent floor section is built. The forms consist of an inside trough, well braced, not collapsible, with vertical sheathing, which permits its easy removal, and of the outside forms on each side. The cost of 1,000 feet of flume averaged \$2.17 a foot in place, exclusive of overhead charges. The flume is light in construction and design, but has given perfect satisfaction; the expansion joints were cheap and have proven efficient.

Reinforced Concrete Flume for the Yakima Valley Canal Co. in Washington (Plate XV, Figs. C and D).—This flume about 6 miles in length is located on a steep side hill, in some places very rocky. Several types of cross sections were used to fit the topographic conditions (Fig. 30). Type *A* is used where the side wall on the uphill side is backfilled with earth and is designed to resist the earth pressure; the downhill side wall is designed for water pressure. Type *B* is similar to *A* with the uphill side wall sloping and built against the earth. Type *C* is built

as a covered section; this was necessary where the canal was exposed to slides of earth or rock from above. The roof was covered with earth which would absorb the shock of rolling boulders. The only object of extending the wall reinforcement horizontally through the entire floor was the additional

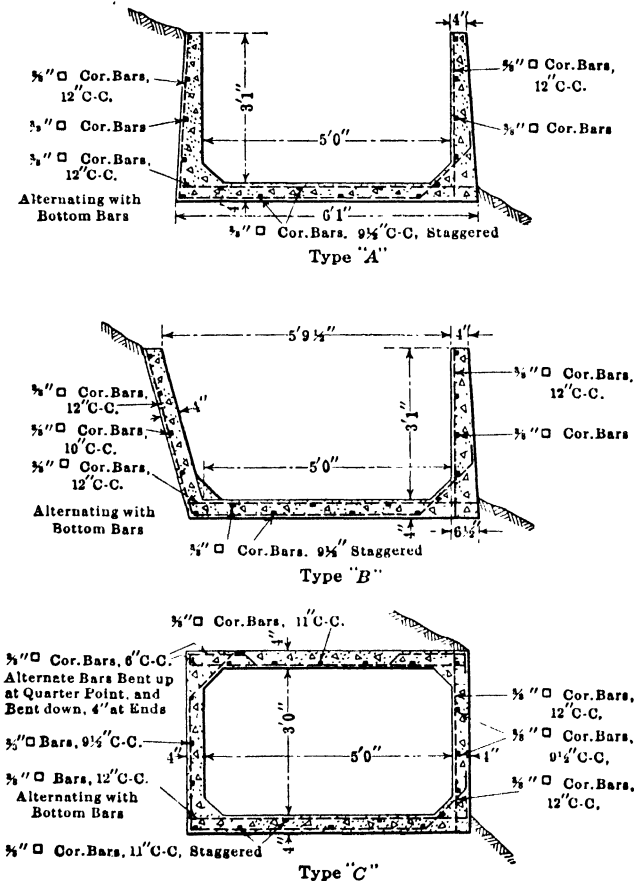

FIG. 30.—Reinforced concrete bench flumes. Yakima Valley Canal Co., Wash.

security against breaks in case the flume would be undermined by cross drainage or would tend to settle unequally, and to resist upward heaving, due to frost. With proper care for surface drainage and a more stable firm material for foundation there would be little danger of this occurrence. The flume was built with continuous longitudinal reinforcement to provide for tem-

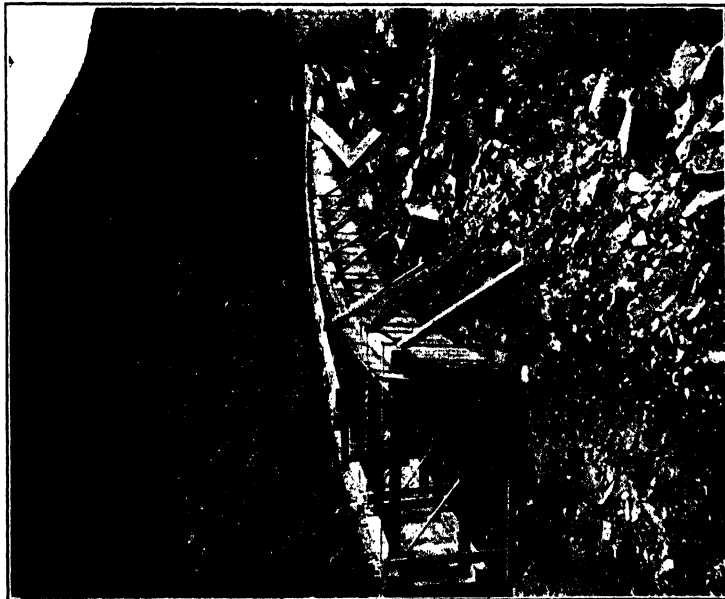

FIG. A.—Forms in place for construction of reinforced concrete bench flume. Kamloops Fruitlands Irrigation & Power Co., B. C.

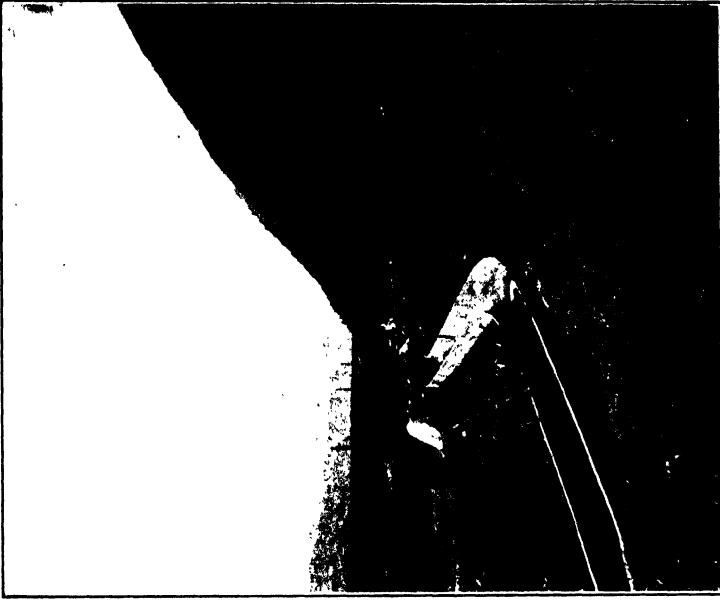

FIG. B.—Completed reinforced concrete bench flume. Kamloops Fruitlands Irrigation & Power Co., B. C.

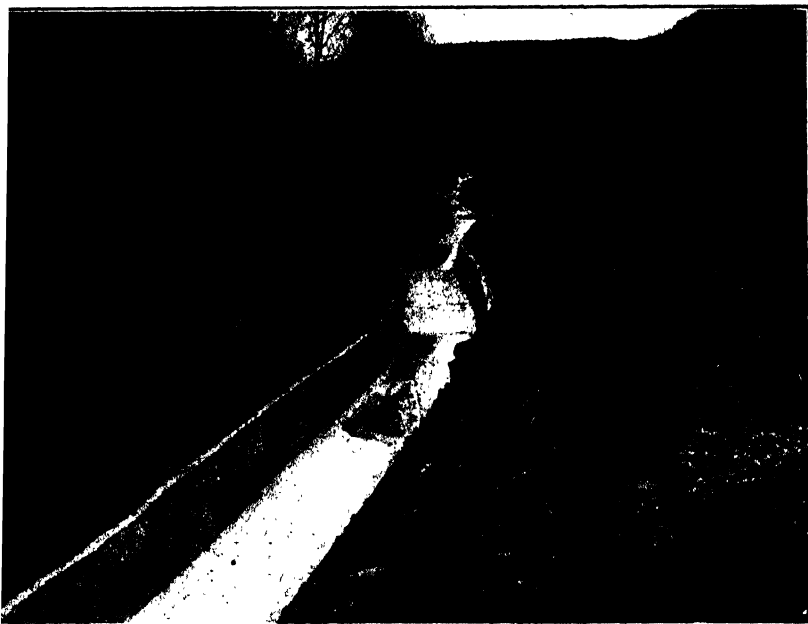

FIG. C.—Reinforced concrete bench flume. Yakima Valley Canal Co., Wash.

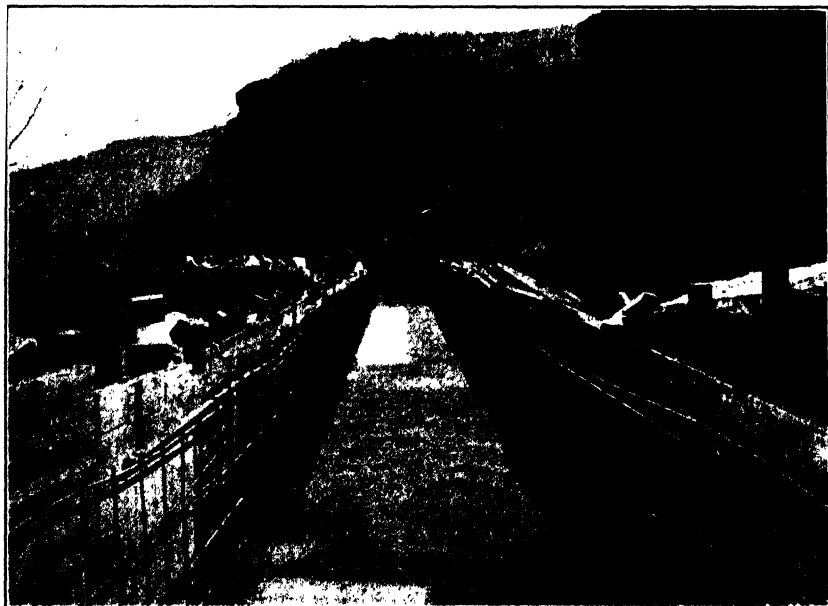

FIG. D.—Forms and reinforcement for reinforced concrete flume of Yakima Valley Canal Co., Wash.

perature stresses and to give added strength. Contraction joints were not considered desirable because of the fear that leakage through them would undermine the flume at those sections where the material was fine ash soil, which would slush down and erode easily. The structure is more heavily reinforced than would ordinarily be considered necessary, but the unstable foundation and the liability of frost heaving on the floor and uphill side wall justified the design. The concrete mixture was 1:2½:4. The work was done in the winter and required frost protection, obtained by the use of coal burning salamander placed 50 feet apart, for a period of 48 hours after the concrete was poured. The cost of this flume was unusually low, as shown by the following cost table for 4,500 feet of flume founded on the excavated bench:

COST OF REINFORCED CONCRETE BENCH FLUME
Yakima Valley Canal Co., Wash.

	Total cost	Cost per foot
1,140 barrels of cement @ \$2.50.....	\$2,850	0.633
1,070 yards sand and gravel @ \$1.50 delivered.	1,605	0.357
Steel.....	918	0.204
Coal.....	109	0.024
Teaming.....	425	0.094
Hardware, tools, etc.....	342	0.076
Form lumber.....	363	0.080
Concrete labor.....	4,304	0.968
Engineering and supervision.....	200	0.044
	\$11,116	\$2.48
Grading, not including original excavation for wooden flume, @ \$1 per foot	1,250	0.278
	\$12,366	\$2.758

The low cost of supervision is due to the superintendent dividing his time between two jobs. The cost of labor was 25 cents and of teaming 50 cents per hour.

Since this flume was constructed in the early part of 1912, it has resisted successfully on two different occasions very severe tests. In each case a land slide of earth and boulders dammed the flume, causing an overflow which resulted in the erosion of the foundation. In the more severe case it left a section of

flume unsupported for a length of 41 feet, with the entire stream of 40 second-feet overflowing for a period of 8 hours before it could be shut off. After removing the material which had dammed the flume, the full 40 second-feet flow was turned in again and continued while three concrete piers were being built to support the suspended section.

Flume of Naches Power Co., Washington (Fig. 31).—The original form of construction was an earth canal, with wooden flumes, located on a side hill of the Naches Canyon; it has now been largely replaced by a concrete-lined canal, with reinforced concrete flumes. Sections of the flume are built on a shelf cut in the side hill, and where depressions are crossed it is elevated on a reinforced concrete trestle. The bench flume is formed of the side walls and floor, supported every 10 feet by a framework consisting of the side posts connected across at the top

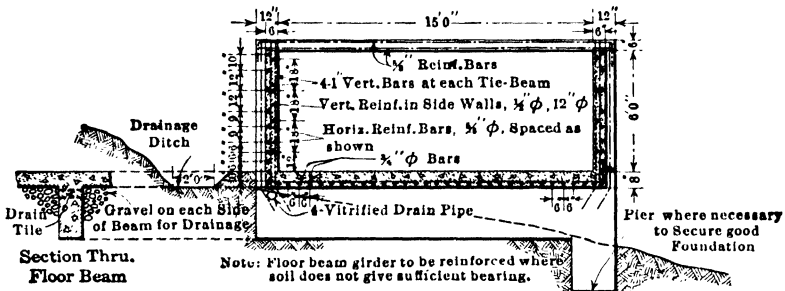

FIG. 31.—Reinforced concrete bench flume. Naches Power Canal, Wash.

by a tie beam and at the bottom to a floor beam or sill (Fig. 31). The side walls are continuous vertical slabs, supported on the side posts, with a span of 10 feet; the longitudinal reinforcement of the side walls consists of $\frac{5}{8}$ -inch bars, spaced from 6 inches apart at the bottom to 12 inches apart at the top to correspond with the difference in intensity of water pressure and of four $\frac{3}{4}$ -inch bars spaced 18 inches apart. The floor slab is reinforced longitudinally to carry the entire weight of the water over a span of 10 feet, from one floor sill to the other; this action would only occur if the material under the floor would be washed out so as to leave the floor unsupported, between floor sills. The transversal reinforcement is provided for temperature stresses. The side posts are built as part of the side walls and are equivalent to beams 12 inches square, reinforced at

the four corners with 1-inch bars; these posts are anchored at the bottom to the floor sill and connected at the top by the tie beams.

Flume of Big Fork Plant, Montana; Northern Idaho and Montana Power Co. (Fig. 32).—This reinforced concrete bench flume, 1,500 feet in length, was constructed to replace an old wooden flume, built on a hillside. It has an inside width of 22 feet, a depth of 10 feet to the top of the walls, and is

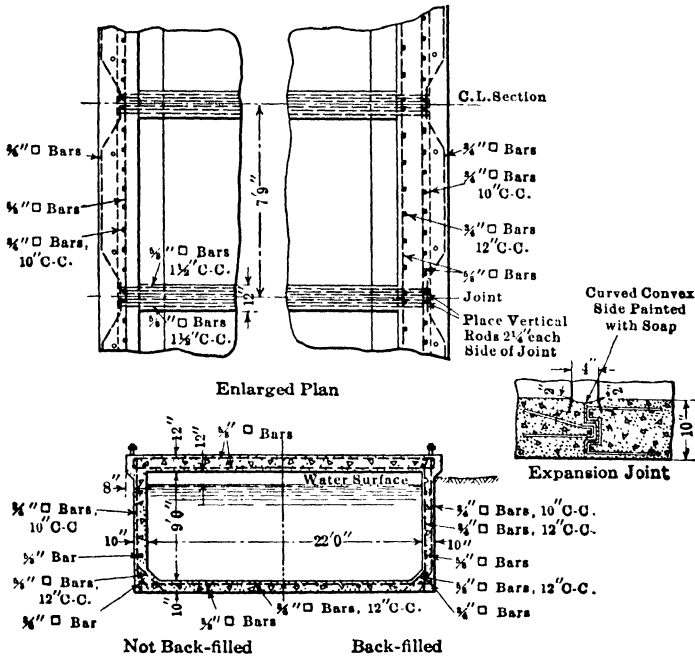

Fig. 32.—Bench flume of Big Fork Power Plant, Mont.

designed for an 8-foot depth of water. The floor is 12 inches thick, the side walls are 10 inches thick, and are designed as slabs supported at their lower end by the floor connection and at their upper end by the horizontal beam or coping, which is divided in lengths of 7 feet 9 inches by the tie beams, extending across the top of the flume.

Specially designed contraction joints were built at every 46.5 feet. These were made by forming a regular tongue and groove joint with the adjacent ends of the concrete wall sections and by placing a special shaped flexible copper plate on the water

side of the joint. This plate of 24-ounce copper was made flexible by being shaped longitudinally into a curved groove, with projecting edges bent back to extend in the concrete. This plate was deemed necessary to prevent water from entering the joint, for it was thought that the expansion of water freezing in the joint would spall off the concrete edges and enlarge the crack. From observations of contraction cracks in concrete linings, walls and flumes, it is not at all apparent that this action will occur so that there is probably no real necessity for the addition of a plate of this type.

REFERENCES FOR CHAPTER VIII

TUNNELS:

- Coy, B. G.—The Laramie Poudre Tunnel with Discussions—p. 724 Trans. Am. Soc. Civ. Eng., Vol. LXXV—Dec., 1912.
- The Strawberry Tunnel of the U. S. Reclamation Service—p. 432 Engineering Record—Apr. 22, 1911.
- Driving the Laramie Poudre Irrigation Tunnel—p. 109 Engineering News—July 28, 1910.
- Driving the Laramie Poudre Irrigation Tunnel—p. 208 Engineering News—Aug. 25, 1910.
- Some Published Costs of Tunnel Work on the Los Angeles Aqueduct—p. 504 Engineering and Contracting—June 1, 1910.
- The Location and Design of Conduits on the Los Angeles Aqueduct—Engineering Record—Dec. 16, 1911.
- Arrangement of Blast Holes in Roosevelt Tunnel—p. 567 Engineering Record—May 1, 1909.
- I. W. McCONNELL.—The Gunnison Tunnel of the Uncompaghre Project—p. 228 Engineering Record—Aug. 28, 1909.
- Methods and Cost of Lining a Section of the Gunnison Tunnel with Concrete—p. 341 Engineering and Contracting—Dec. 18, 1907.
- Cost Data on Concrete Lining in Gunnison Tunnel—p. 692 Engineering Record, May 30, 1908.
- Methods and Cost of Driving and Lining 375 Feet of Small Tunnel for Irrigation Work (Huntley Project)—p. 20 Engineering and Contracting—July 7, 1909.
- Methods and Cost of Driving a Small Rock Tunnel—p. 67 Engineering and Contracting—Sept. 12, 1906.
- HALL, WILLIAM H.—The Santa Ana Canal of the Bear Valley Irrigation Co.—p. 61 Trans. Am. Soc. Civ. Eng., Vol. XXXIII—1895.
- HOPSON, E. G.—The Tieton Canal—p. 158 Trans. Am. Soc. Civ. Eng., Vol. LXXI—1911.

CONCRETE RETAINING WALL CANAL SECTIONS AND BENCH FLUMES:

- BOWIE, A. J.—Irrigation in Southern Texas—1904—Part 6 of Bulletin No. 158, Office of Experiment Station, U. S. Dept. of Agriculture.
- ETCHEVERRY, B. A.—The Design of a Reinforced Concrete Flume in

- British Columbia—*Journal of Electricity, Power and Gas*—Oct. 19, 1912.
- Reconstruction of a Power Canal and Flumes under Service—*Engineering Record*—May 27, 1911.
- LINK, J. WM.—An Effective Type of Expansion for Concrete Flume—*Engineering Record*—March 2, 1912.
- MASSON, R. S.—Hydroelectric Development on the Arizona Power Co.—*Engineering Record*—Aug. 20, 1910.
- STOVALL, S. L.—Concrete Slab Flume Construction—*Western Engineering*—May, 1913, June, 1913.
- Concrete Flumes and Culverts Los Angeles Aqueduct—*Engineering Record*—June 22, 1912.
- Concrete Flumes That Did Not Fail—*Engineering Record*—Nov. 22, 1913.

CHAPTER IX

FLUMES

A flume may be either a bench flume, supported on a shelf or cut in the side hill, or may be an elevated flume for the conveyance of water over a depression or drainage channel (Plate XVI, Fig. B). In steep side-hill work the uphill side of the flume may be supported on a narrow shelf and the downhill side held up by posts or other form of substructure (Plate XVI, Fig. A). Flumes may be classified according to the material used in forming the waterway. The types most commonly used are:

1. Wooden rectangular box flume.
2. Wooden stave semicircular flume.
3. Steel flumes or metal sheet flumes.
4. Reinforced concrete flumes.

The water area to be provided depends on the volume to be carried and the velocity. For a long high flume it is economy, where the available grade will permit it, to make the water area small by using as high a velocity as possible within practical limits; velocities as high as 10 feet are frequently used. To obtain the increase in velocity in passing from the earth canal to the flume section and to decrease the velocity at the outlet, well designed inlet and outlet connections are necessary. With short flumes it will be preferable and usually more economical to make the water area of the flume not much smaller, if any, than the water area of the canal.

Rectangular Wooden Flumes.—The flume consists of the flume box or waterway, formed by the flume lining nailed to the necessary framework, and of the substructure. The form of the waterway which gives the maximum velocity for a given area is that which has a bottom width equal to twice the depth of water. This proportion of bottom width to depth of water is commonly used. There are conditions, however, which may make some other proportion more economical. A comparatively deeper and narrower section will require less excavation for a bench flume, which on steep side hills may decrease the total cost

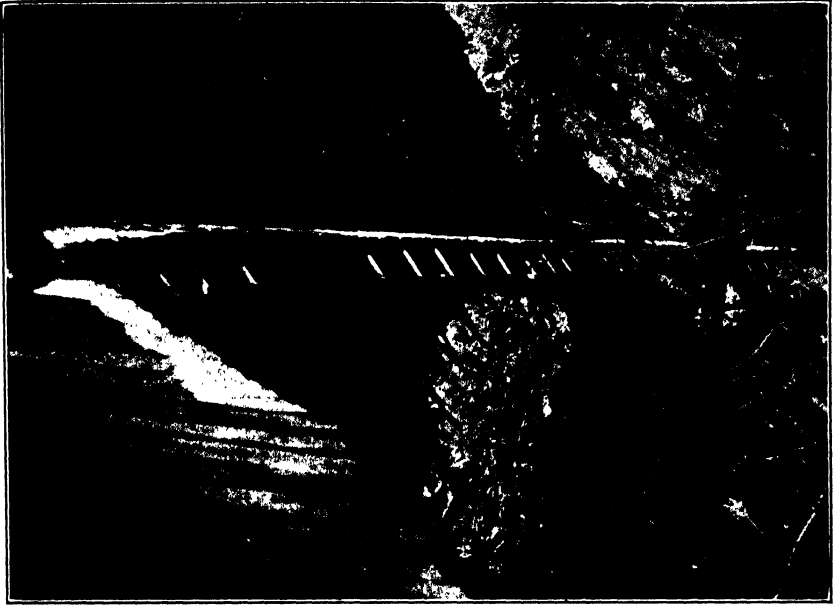

FIG. A.—Small wooden flume on rocky bluff. Penticton System, B. C.



FIG. B.—Large wooden flume on trestle. Turlock System, Calif.

(Facing page 198)



FIG. C.—Hess steel flume—7 feet diameter. Mountain Home Cooperative Irrigation Co., Idaho.

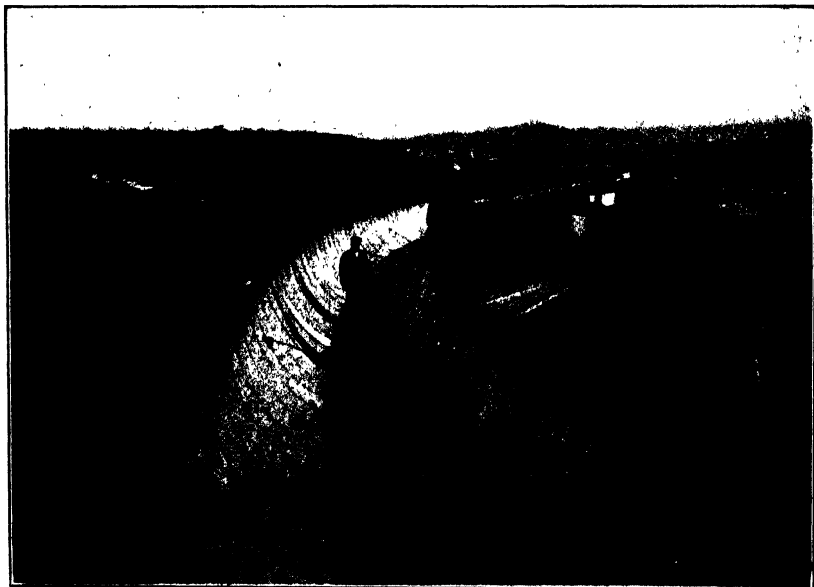

FIG. D.—Lennon steel flume—9 feet diameter. Trinchera Irrigation District, Blanca, Colo.

(Picture taken during erection, before intermediate rods with wooden carriers were placed.)

considerably; it will also decrease the cost of a flume which must be anchored to a vertical cliff. A wider and shallower waterway may be preferable where the flume is short and it is desired to keep the depth of water in the flume about the same as the depth of water in the canal to which it is connected.

The flume lining is extended on the sides above the full water supply a height which depends on the size of the flume. To conform with good practice, the following empirical formula is suggested: Free board in inches = $\frac{\text{depth of water in inches}}{12} + 2$.

Since the tendency on irrigation projects is to crowd more water in the canals than the capacity for which they were designed, it is specially important that this be considered in making estimates of the capacity of the flume. Provisions for increasing the capacity of the flumes is sometimes made by making the framework and length of the side yokes so that the lining can be extended on the sides when necessary (Plate XVI, Fig. B).

Flume Lining.—The flume lining should be made of well-seasoned lumber free from knots. The quality of material, type of joints and workmanship are specially important with an irrigation flume, as it is usually dry for a good part of the year and for that reason more difficult to maintain and less durable than a flume used on a hydroelectric power project. The minimum thickness of lining is usually $1\frac{1}{2}$ inches and preferably 2 inches; smaller thicknesses even for small flumes are liable to warp and crack and are not durable or economical. The thickness also depends on the strength required to resist the water pressure and is designed for the span or distance between side posts. In a large deep flume it is good practice and economical to use a smaller thickness of lining for the upper part of the sides.

The different methods of joining the edges of the boards are shown in the accompanying sketches (Fig. 33).

The butt joint lining is the simplest, but is more liable to leak and requires caulking with oakum. To facilitate caulking and to hold the oakum, the edges of the board should be bevelled on the water side to form a groove when the boards are put together. The efficiency of the joint can be increased by filling the caulked groove with hot asphalt. To asphalt the joints of the side lining, a bevelled edge batten is nailed with its lower edge just below the joint. With green lumber the joints may open $\frac{1}{4}$ inch or more.

The batten joint lining is made by covering the joints with battens $1/2$ to 1 inch thick and 4 to 6 inches wide. Before the battens are placed, the joints may first be caulked with oakum. The battens increase the cost and have a tendency to warp and pull away from the joint. It is the usual practice to place them

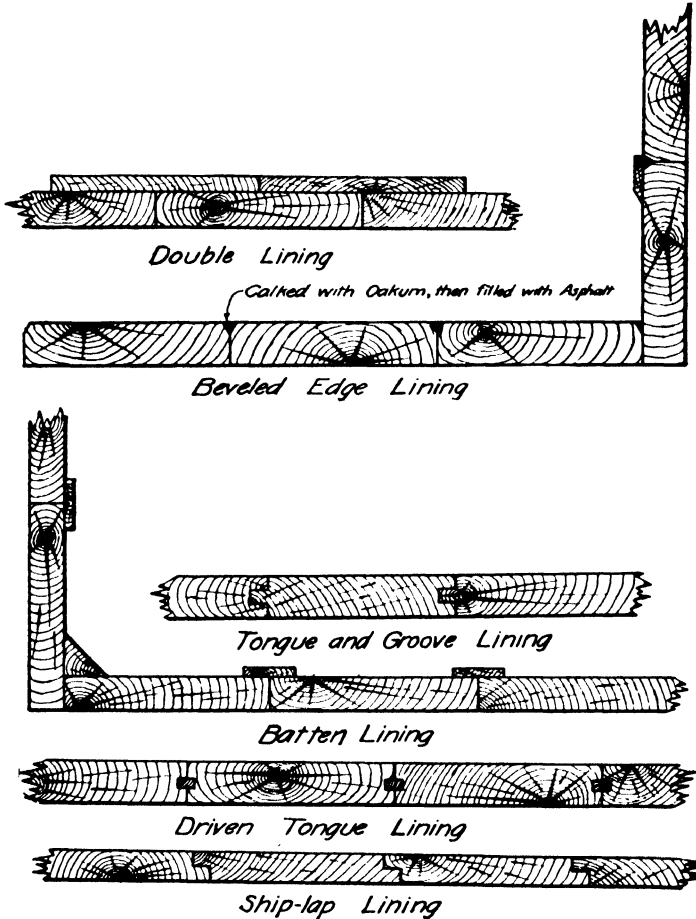

FIG. 33.—Types of lining for wooden flumes.

on the waterside of the lining, but they may be placed on the outside to favor the filling of the joints with sediment and to interfere less with the flow; in this position the floor battens are not exposed to the sun and are therefore less liable to warp.

The double lining is formed by using two layers of board,

either of the same thickness or of different thicknesses. One and two inches are generally used. It is preferable to put the thicker layer on the water side. This lining requires an excessive quantity of lumber and is not satisfactory because the two layers of planks—especially when made of material less than 2 inches thick—are gradually worked apart by the silt and sand lodging between the layers and in some cases by the expansion produced by the freezing of the water in between. Planks not planed to a uniform thickness give imperfect contact between the two layers and favor the above actions.

The regular tongue and groove joint is not satisfactory because of the cost of milling and especially the tendency of the tongue or the sides of the grooves breaking off when the lining warps.

The driven tongue lining is the most satisfactory but requires lumber at least 2 or $2\frac{1}{2}$ inches thick; for 2-inch lumber the grooves may be made $\frac{9}{16}$ inch wide and $\frac{1}{2}$ inch deep, to insert a tongue $\frac{1}{2}$ inch thick and 1 inch deep; for 3-inch lumber the groove may be $\frac{7}{8}$ inch wide and $1\frac{1}{2}$ inches deep, to insert a tongue $\frac{3}{4}$ inch wide and $1\frac{1}{2}$ inches deep. The thickness of the tongue is usually a fraction of an inch less than the width of the groove.

The ship lap joint is well adapted for linings $1\frac{1}{2}$ to $1\frac{3}{4}$ inches thick. It requires from 8 to 10 per cent. more lumber to allow for the lap, but this is less than for a double lining and if shrinkage occurs the open joint can be easily caulked.

Framework of Flume Box.—The framework of the flume box consists of side yokes or posts to which the side lining is nailed; sills or stringers to which the floor lining is nailed; tie beams or braces to hold the side yokes in place; and a foot walk. The makeup of the framework depends on the form of the substructure supporting the flume box, which may be mud-sills, piles, trestles, trusses or arches. There are two standard forms of flume box; in one the floor lining runs longitudinally and in the other transversally. The two types are shown in the accompanying sketches. The first type is illustrated by the Delaney flume (Fig. 34), on the Turlock main canal in California and by the flume of the Kern River Power Co., California (Fig. 35). In this type the floor lining is nailed to the sills. The second type is illustrated by the flume of the South Alberta Land Co., Canada (Fig. 36), and the flume of

North Poudre Canal, Colorado (Fig. 37). In this type the floor is nailed to the stringers. The first type is most commonly used; it has the advantage that the lining is placed in the direction of the flow. The second type requires less material for an elevated flume, because it eliminates the floor sill, but in practice it is found more difficult to repair and to keep water-tight. With this type the side posts are single pieces, usually

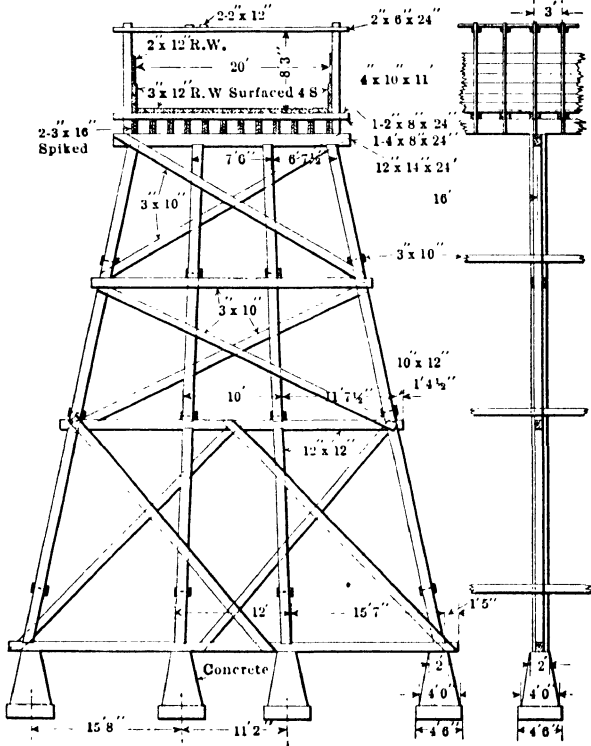

FIG. 34.—Delaney flume. Turlock main canal, Calif.

connected in pairs across the flume at the top by a tie beam and fastened at the bottom to the stringers by means of bolts. The tie beam is sometimes omitted but only for shallow flumes, in which case the posts act as cantilevers fixed at the bottom. The connections with the stringers give to the sides lateral bracing against wind pressure.

For the first type the side posts are made either of one or two pieces; they are connected, in pairs across the flume, at the

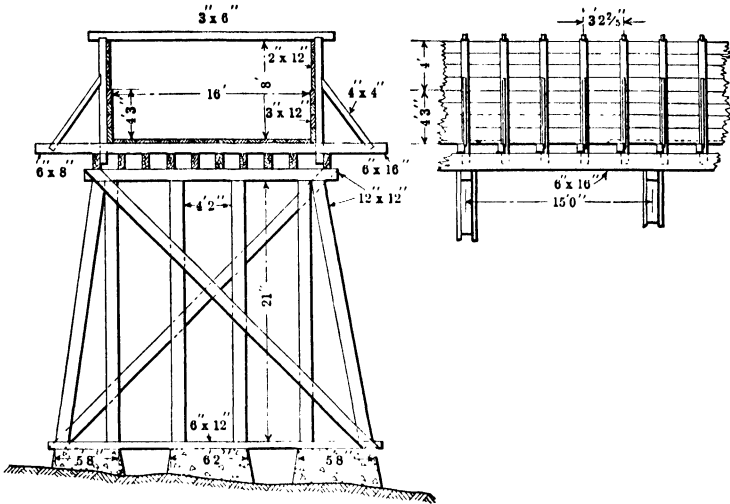

FIG. 35.—Flume of Kern River Power Co., Calif.

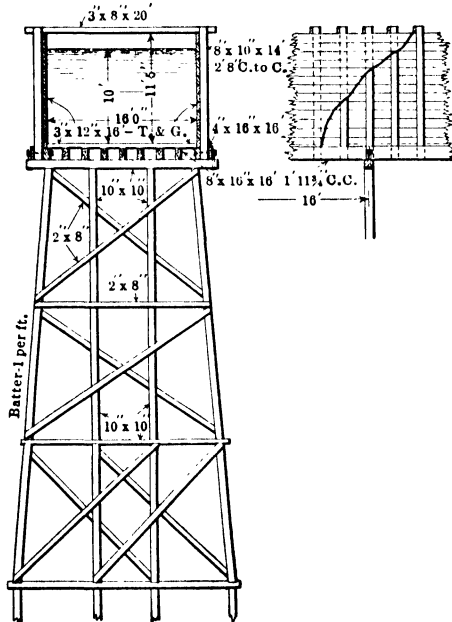

FIG. 36.—Flume of South Alberta Canal Co., Province of Alberta, Can.

top by a tie beam or the tie beam may be omitted and for it an inclined brace substituted on each side, extending from the

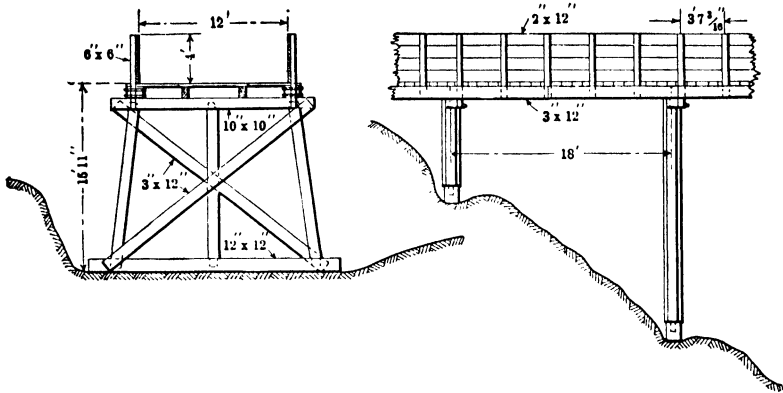

FIG. 37.—Flume on extension of North Poudre Canal, Colo.

floor sill to a point on the side post above the lower third. The use of tie beams is usually more economical for flumes up to 20

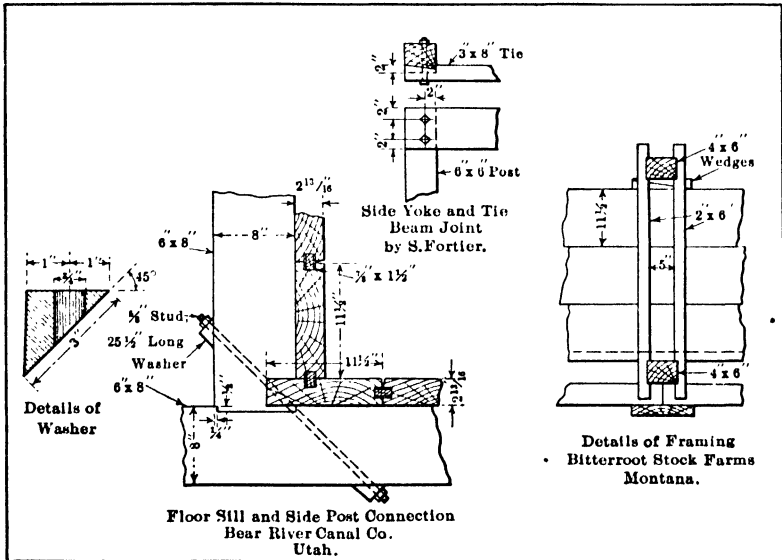

FIG. 38.—Details of framing for wooden flume box.

feet in width and is desirable for the support of the foot walk. The lateral stiffness of a flume of this type can be increased by

placing the outside face of the outside stringers flush with the outside of the lining and extending the side posts so as to bear against the face of the stringer; this form of framing is adapted to side posts made of two pieces, one on each side of the floor sill, or to a floor sill made of two pieces with the side post made of one piece placed in between as shown by the Delaney flume. It is usually desirable to use some cross bracing; this is done by placing inclined braces at every second or fourth side post or only one above each trestle bent. A common form of framework consists of side posts and floor sills of the same thickness, connected together by gaining the side post into the floor sill; one of the best and most rigid types of connection is that used for the flumes of the Bear River Canal Co., Utah (Fig. 38).

The tie beam is made of one or two pieces and to resist the tension due to water pressure on the side walls it can be a piece of very small dimensions or may be a metal tie rod, but the required rigidity and the desirability of a foot walk will usually control its design. The foot walk is usually placed near one side. The connection between tie beam and side post is usually made with bolts; a form recommended by Fortier for a single piece tie beam and post is illustrated in the accompanying sketch.

A form of framing which permits the tightening of the joints in the side lining, used for flumes on the Bitterroot stock farm, Montana (Fig. 38), and adopted in the standard flume design of the Reclamation Service, provides for wooden wedges between the tie beam and the upper edge of the lining (Fig. 39).

Substructures.—The usual forms of substructure are mudsills for bench flumes, posts or columns for low flumes, piles and wooden trestles for elevated flumes. In a few cases steel trestles, wooden or steel trusses and arches have been used.

Mudsills are made of 2 by 12 or 3 by 12-inch planks laid on the ground; redwood is preferable because of its greater durability. With a longitudinal floor lining the floor sills are transversal and the mudsills on which the floor sills rest are placed longitudinally. For small flumes two rows of mudsills are sufficient; for larger flumes and ground which is soft when wet three or more rows are needed. For flumes of the second type the mudsills are placed transversally.

Piles or posts are used when the flume is entirely above ground, but not sufficiently high to require a trestle, or when the flume

is partly supported on a bench (Plate XVI, Fig. A). Posts resting on a mudsill, which can be replaced, or on concrete footings are preferable to piles, because of the early decay of piles at the ground surface. A flume placed on a sharp curve may require anchorage with drift bolts to the side hill. The flume box is carried on stringers which are supported on the caps placed on top of the posts. Except for flumes whose uphill side is partly supported on a bench cut in the hill side, two or more posts are required to each bent. The design is then similar to that of a flume on trestle except that the posts are shorter and no lateral bracing is necessary.

A trestle consists of frames or bents spaced at regular intervals, usually from about 12 to 18 feet, joined at the top by the stringers, on which the flume box is carried. Wooden trestles are of the same type as the ordinary railroad trestle (See Figs. 34-37). A bent may be a one-story bent or may be formed of two or more stories. A one-story bent is made up of two or more posts or columns, connected at the top by the cap and at the bottom by a sill supported on concrete footing or mudsills. The sill is sometimes omitted and the posts then rest directly on concrete footings. Sway bracing and sash bracing give the bent the necessary stiffness. The height from cap to sill is limited by the maximum length of timber, which can be obtained economically; this is usually from 25 to 40 feet. For greater heights of trestle bents, two or more stories are necessary. The outside posts of the bents are given the necessary batter or inclination outward to make the structure stable against wind pressure, and on sharp curves the outward water pressure should also be considered. A batter of 1 in 12 for low flumes to 1 in 6 where exposed to high winds and for high flumes will usually fulfill the requirements. Except in narrow canyons, longitudinal bracing from bent to bent is necessary; this will consist of horizontal bracing running longitudinally to connect the outside posts of each bent, placed usually above the caps between stories, and of some diagonal bracing between alternate bents or where the bents are highest. The bents should be supported on concrete footings, which must extend to firm material or solid rock or must be made sufficiently large to give a bearing pressure not in excess of what the soil will stand when softened by the water leaking from the flume; a pressure of 1 ton per square foot will usually be safe.

To give additional stability the bents are usually anchored to the concrete footings.

The other types of substructures for elevated flumes are not so commonly used. Wooden trusses between trestle bents may be used to increase the span between bents when it is necessary to leave an unobstructed waterway under the flume or to decrease the cost for high trestle by reducing the number of bents in the trestle. Short deep depressions can sometimes be economically crossed by means of a single span wooden or steel truss supported on concrete supports at the two ends. Steel trusses are better adapted to longer spans. Steel trestles are seldom used to support wooden flumes.

Design and Economic Proportioning of Wooden Flumes on Trestle.—Wooden flumes have frequently been constructed, without any other considerations than prevailing practice and practical experience. The structure as a whole may have sufficient strength, but the separate parts are frequently not properly dimensioned, resulting in waste of material. Practical considerations must enter largely in the design, but economic design requires proportioning of the various members, in accordance with the stresses and maximum deflection and the detail study of the framing joints.

The timbers in flume construction are exposed to alternate wet and dry condition, and the water leaking through the flume lining enters the framing joints and produces early decay. This must be considered in selecting comparatively low unit working stresses. Pieces subject to bending are usually designed as simple beams with free ends; their dimensions are determined by the outer fiber stress, longitudinal shear and maximum deflection and the bearing area at points of supports. To obtain equal safety in outer fiber stress and in longitudinal shear in a beam uniformly loaded, the ratio between the depth of the beam, d , to the span l , as obtained from the formulas for bending moment and for longitudinal shear, is equal to the ratio of the unit stress in horizontal shear to the unit stress in outer fiber stress; this ratio is equal to about 10 for the kinds of timber commonly used. For a larger depth longitudinal shear controls the required dimensions of the beam, and for a smaller depth the outer fiber stress controls it. The extent of deflection must also be considered; it varies inversely with the width and with the cube of the depth. The depth of the beam satisfying the de-

flection requirement may be less than, equal to, or greater than that required to produce equal safety in longitudinal unit shear and in outer fiber unit stress. When less, the width to use will be the greater of the two values: one satisfying the formula for strength in outer fiber and the other the formula for maximum deflection; when equal the width is determined by either the formula for strength or for longitudinal shear; when greater the width is determined by the formula for shear as well as by the formula for maximum deflection; this greater depth of beam will for a given cross-sectional area give greater stiffness against deflection and an excessive strength for outer fiber stress. But there are practical considerations which prevent the use of excessively deep beams. For instance: The stiffest rectangular beam which can be cut from a circular log is that whose depth is equal to 1.75 times the width, but the difference in unit cost for beams of different depths must also be considered. These principles will apply specially to the dimensioning of the stringers.

The dimensions of the pieces subject to compression such as the caps, sills and posts of the trestle are usually controlled, not by the stresses in end compression, but by the area required in bearing across the grain. The controlling factors will usually be the required bearing area of the end of the stringers on the caps and of the caps on the posts. The bearing areas for the ends of the stringers can be increased by lapping the ends of the stringers, except those of the two outside stringers, so that they rest on the caps for the entire width of the cap, instead of half its width as obtained when the ends of the stringers butt up against each other. In determining the required bearing areas allowance must be made for the added pressure produced by the wind pressure on the sides of the flume. The diagonal sway bracing in each bent can be extended from the posts to the ends of the cap and sill and through the connections reduce by a small amount the pressures between the posts, the cap and the sill. This will also increase the stability against wind pressure.

The correct framing of the different pieces of the flume and trestle require careful study; shear and compressive stresses in the timber and bending in the fastenings or bolts usually determine the dimensions. Common bolts and drift bolts are preferable to nails, for all important connections. To increase the stability of the flume against wind pressure and reduce the batter of the outer posts, the diagonal sway brace must be ex-

tended to tie the sills and caps to the posts. To make use of the weight of the concrete footings for resisting the overturning moment it is necessary that they be connected to the trestle bent by means of anchor bars or bolts. However, it is safer not to include the weight of the footing in determining the batter of the outside posts required to prevent overturning. For the details of framing, the following works are of special value "Structural Details or Elements of Design in Heavy Framing" by H. S. Jacoby, published by Wiley & Sons, New York, and "Wooden Trestle Bridges," by W. G. Foster, published by Wiley and Sons.

The most economic flume is the one which will give the lowest total cost of flume lining framework and substructure. The cost of framework for the flume box can be decreased by spacing the side posts far apart, but this increases the required thickness and cost of the flume lining. The economic spacing of side posts will depend partly on the minimum thickness of lining. The cost of trestle work and foundation is usually decreased by increasing the span between bents, but this increases the cost of stringers. The economic span is smaller for a low trestle than for a high trestle. For very high trestles it may be more economical to further increase the span between bents, either by bracing the stringers from the bents by knee braces or by carrying the flume on a series of short trusses, but this increases the weight carried to each trestle bent, which make it necessary to use larger caps and larger bearing areas. In determining the most economic design, the principles of design and practical considerations presented above must be considered.

Cost of Wooden Flumes.—The cost of constructing a wooden flume with a low substructure on the Klamath project, Oregon, is tabulated below. This flume is 4,303 feet in length; it has an inside width of 11 feet, and an inside depth of $5\frac{1}{2}$ feet; it is supported on concrete piers with rubble stone foundations. It is built of red fir lumber. The difference between lumber purchased and lumber in place showed a waste of about 1 per cent.

The cost of erection, including labor, hardware and supervision, will generally be proportionately greater for small than for large flumes; it will also depend on the location as affecting the ease of construction and the quantity of fluming to be built. It will usually range from about \$8 to \$15 per M.B.M. The hard-

ware alone will cost from about \$1.50 per M.B.M. for flumes where nails are largely used for framing, to about \$3.00 per M.B.M. for larger flumes carefully framed with bolts.

COST OF KLAMATH PROJECT TIMBER FLUME 4303 FEET LONG, SUPPORTED ON CONCRETE PIERS

	Lumber in place per M.B.M.		Flume per lineal foot
	For frame-work 438,000 feet B.M.	For lining 284,200 feet B.M.	
Superintendence.....	\$0.46	\$1.02	\$0.11
Labor:			
Carpenters' work.....	5.97	4.83	0.93
Distributing timbers.....	0.63	0.63	0.11
Miscellaneous.....	0.21	0.17	0.03
Material:			
Lumber delivered.....	15.64	21.60	3.02
Bolts and washers.....	0.36		0.04
Nails and spikes.....	0.94	0.94	0.16
Engineering and inspection.....	2.91	2.91	0.50
Total for flume proper.....	\$27.12	\$32.10	\$4.90
Piers and foundations.....			1.62
			\$6.52

Life of Wooden Flumes.—Wooden flumes when used for irrigation purposes are usually alternately wet and dry; this favors earlier decay than when a flume is kept full nearly all the time. From practical observations and from data compiled from a number of sources, the durability and cost of repairs of flumes are as follows:

A pine flume has an ultimate life of about 10 to 12 years.

A red fir or redwood flume has an ultimate life of about 13 to 15 years.

The cost of repairs and maintenance will be small during the first half of the life of the flume, when very little repairs are necessary other than recalking. It will increase gradually and during the last 3 or 4 years will be 10 per cent. or more of the first cost. The average annual cost of repairs and maintenance for the entire life of the flume will be about 5 per cent. of the first cost.

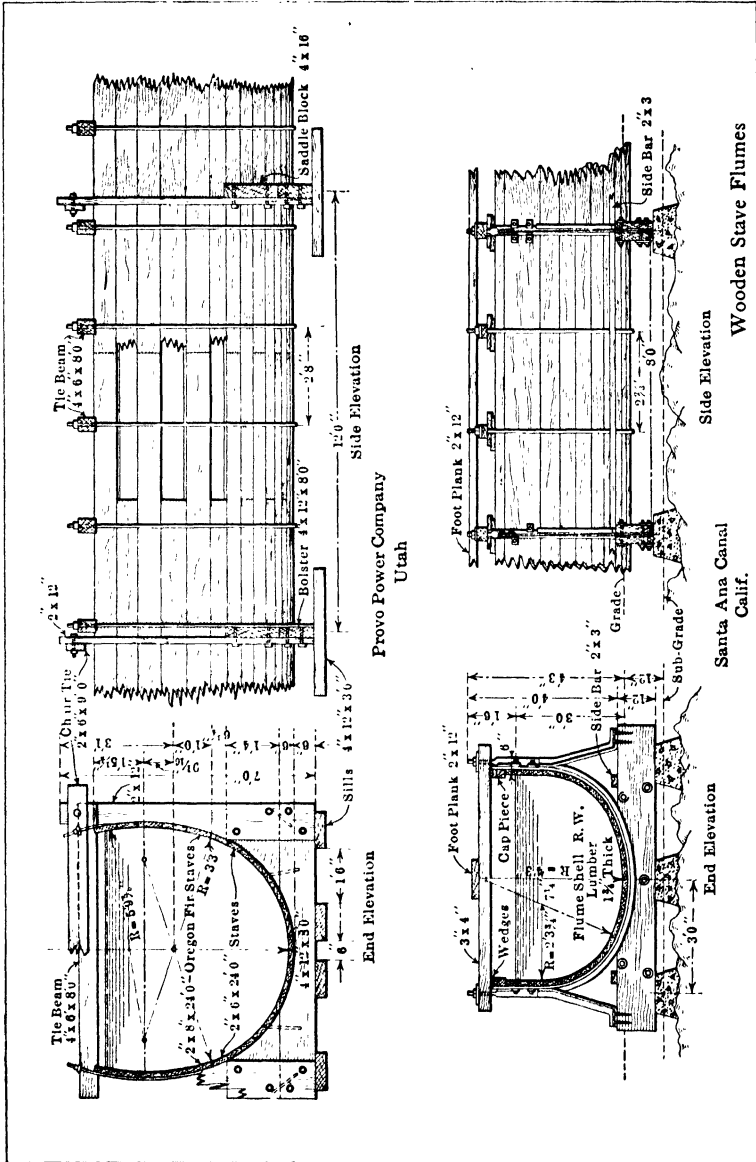

Fig. 40.—Wooden stave flumes.

Semicircular Wooden Stave Flumes (Figs. 40 to 41).—This type of flume in its construction resembles the wooden stave pipe, in that the flume box is made of staves held together and tightened by metal bands. Two types have been used. In one type, illustrated by the flumes on the old Santa Ana Canal in California (Fig. 40), the flume is built in sections 8 feet long with the ends supported on T-irons curved to fit the flume. Between the supports the staves are bound by two $\frac{5}{8}$ -inch round

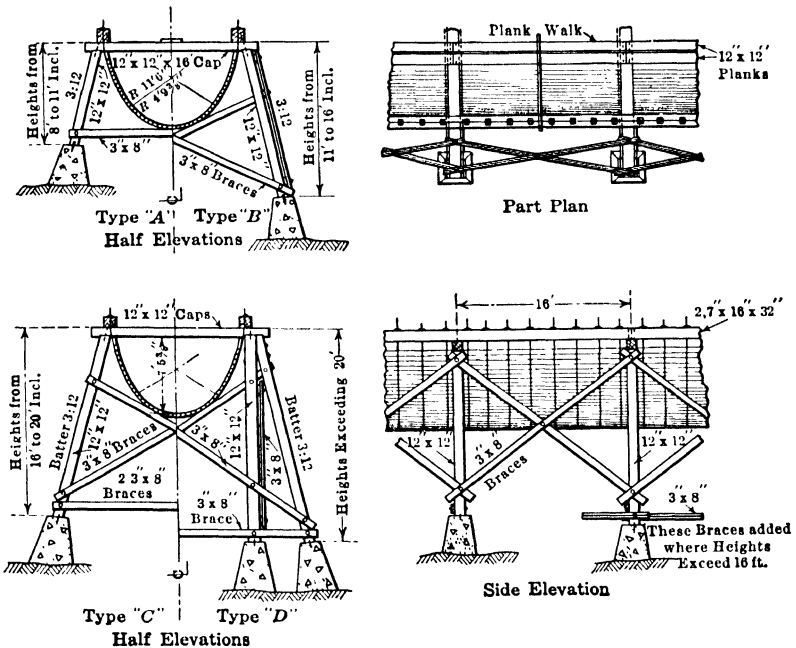

FIG. 41.—Wood stave flume. Puntledge River Power Canal, Vancouver Island, B. C.

steel rods with threaded ends, extending through the tie beams, which rest on the top edges of the flume box. The staves are drawn together at the ends of the sections by means of double wedges driven between the tie beams and the edges of the flume, and in between the supports by cinching the nuts of the two iron bands.

The other type, illustrated by the flume on the canal of the Provo Power Co., in Utah, is made continuous, with the staves placed so as to break joints and with the ends connected by

metallic tongues. Half-inch steel bands pass around the flume box through the tie beams, and the staves are drawn together by screwing up the nuts at the ends of each threaded band. The flume is supported on wooden chairs placed 12 feet apart, which consist of a bolster, two vertical pieces curved by band sawing to fit the exterior of the flume and a cross piece at the top for tie beam. In both forms of construction the weight of the water and flume is carried to the supports by the beam strength of the semicircular stave box and no girders or stringers are used.

In a semicircular wooden flume recently constructed for the Puntledge River power development in British Columbia, the flume is elevated on trestle and the flume box is carried by the steel rods which extend on each side through a stringer, supported on the cap of each trestle bent. The inside of the flume is 12 feet wide at the top and 7 feet deep; the staves are $2\frac{9}{16}$ by $5\frac{7}{16}$ inches thick, made from 3 by 6 lumber; the rods are $\frac{3}{4}$ inch in diameter, spaced 24 inches apart. Each stringer is built of two pieces, 8 by 16 inches, separated by spacers for the insertion of the ends of the supporting rods, which terminate with screw ends and nuts resting on specially designed washers.

The semicircular flume has some advantages over the rectangular flume. It is easily adjusted to curves, requires no nails through the staves, can be tightened to prevent leakage, and will require less lumber than a rectangular flume of the same capacity, especially as it may be constructed without stringers by placing the points of supports sufficiently close to use the resisting strength in bending of the flume box. The greater difficulty of shaping the staves and the introduction of sheet-steel flumes is probably the reason for the very limited use of this type of flume.

STEEL FLUMES

Types of.—The steel or metal flumes are of two types: rectangular and semicircular. The rectangular form is seldom used; the only examples known to the writer are an iron flume on the Bear River Canal in Utah and one on the Henares Canal in Spain. These are illustrated in Wilson's book on Irrigation Engineering and in P. J. Flynn's book on Irrigation Canals and Other Irrigation Works. The waterway or flume box is formed by the two sides and the floor. The sides are designed as plate girders to carry the load to the points of support and

must also be designed to resist the water pressure. To act as plate girders they consist of a web plate strengthened with flange angles and cover plates and web stiffeners. To resist the water pressure the side walls of the Henares flume are designed as cantilever walls without tie pieces across the top, while the side walls of the Bear River Canal flume are tied across the top with angle irons. The floor in both flumes is formed of metal plates reinforced crossways with structural shapes to carry the load to the side girders. The substructure for the Bear River flume consists of masonry piers at the two ends with two intermediate steel bents resting on cylinders filled with concrete with a pile foundation. The Henares flume is 70 feet long, resting at the two ends on masonry piers with a clear span of 62 feet. Conditions favorable to this form of construction are a short deep depression, or the necessity of providing an unobstructed waterway by using comparatively longer spans than obtained with the usual trestle construction, and a location which is sufficiently accessible to the railroad to permit the transportation of the large and heavy steel members. A span of not more than 75 to 100 feet may be taken as the maximum. But with the development of reinforced concrete design and construction even for these favorable conditions a steel flume of the girder type has little if anything to warrant its use. For larger spans a reinforced concrete flume supported on an arch will usually be the best and most economical form of structure.

The semicircular metal flume during the last few years has become a very popular type of flume because of its moderate cost, ease of construction and water-tightness, and in many cases it is replacing wooden flumes. The flume is made of thin metal sheets, curved so as to form short semicircular sections, which are joined together. The edges of the metal sheets are shaped into a bead or groove. The sheets are put together by overlapping the grooved edges of the adjacent sheets, and a water-tight locked joint is formed by special shaped rods or bars placed on the inside and outside of the groove. These steel rods carry the weight of the water and flume to the stringers, which form part of the trestle. The ends of the outside rods are threaded for nuts and either pass through carrier beams supported on the stringers or fit into brackets directly connected to the stringers. By screwing the nuts the outside and inside rods are drawn together and press the edges of the overlapping sheets together.

The earliest patented flume of this type on the market was the Maginnis flume, made by the Maginnis Flume Co. of Kimball, Nebraska. This flume has been used extensively and during the last few years a number of other patented makes have been placed on the market; those which are now most widely used are the Hess flume, made by the Hess Flume Co. of Denver, Colorado; the Lennon flume, made by the Lennon Flume Co. of Colorado Springs, Colorado; the Hydroduct flume, made by the Hinman Hydraulic Manufacturing Co. of Denver, Colorado; and the Standard flume, made by the Standard Corrugated Pipe Co. of San Francisco (Plate XVI, Figs. C and D and Plate XVII, Figs. A and B). The different makes differ in the details of forming the interlocking joints and in the method of connection of the suspending rods to the stringers or carrier beams. The flumes are made in sizes ranging in diameter from about 8 inches to as large as 15 feet 6 inches in diameter for a flume on steel trestle on the main canal of the Twin Falls South Side Irrigation project in Idaho. In determining the proper size of the flume, it is necessary to allow for the necessary freeboard and to select a proper value for the coefficient of roughness, which is affected by the method of making the interlocking joints in the sheets. The locking bars forming the joint of the Maginnis flume consist of a small channel on the inside and a rod on the outside. The inside channel projects above the surface of the metal sheets and produces eddies in the flow which affect the coefficient of roughness. The effect is not constant, but seems to increase with an increase in velocity. This is indicated by a set of several measurements made by the Reclamation Service on a number of different sized Maginnis flumes of the Boise project. The results give values of " n ," ranging from about 0.013 for small depths and low velocities to about 0.019 for greater depths and velocities.

The other makes of flumes have interlocking bars on the inside, which fit into a groove so as to be flush with the inside surface. A single measurement on a Hydroduct flume of the Boise project gave a value of n equal to 0.01173, and single measurements on two Hess flumes gave an average value of n equal to 0.01170 (other values are given in Chapter III).

The metal used in the manufacture of these flumes is either galvanized iron, or iron or steel specially manufactured known as



FIG. A.—Hess steel flume, 15 feet 6 inches diameter, on steel trestle. Twin Falls, North Side Irrigation Project, Idaho.

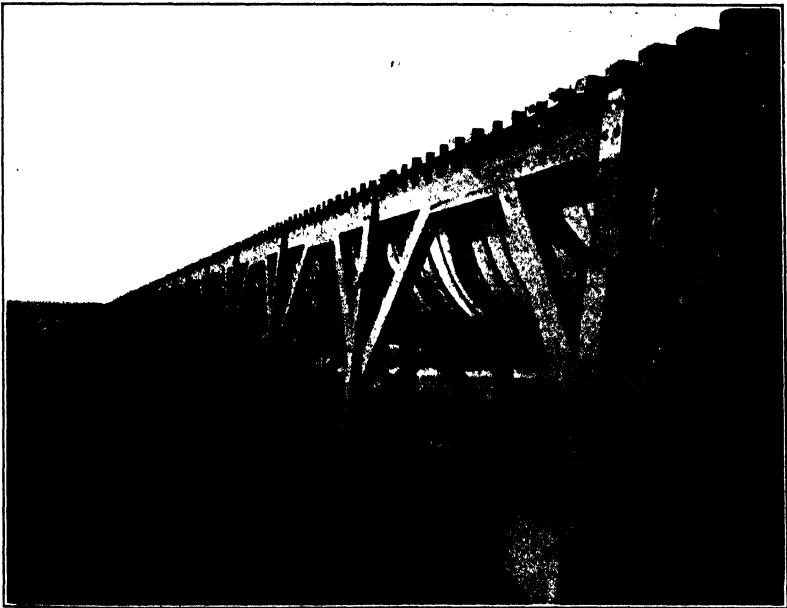

FIG. B.—Hess steel flume, 10 feet 10 inches diameter. Belle Fourche Project, S. D.

(Facing page 216)

PLATE XVII

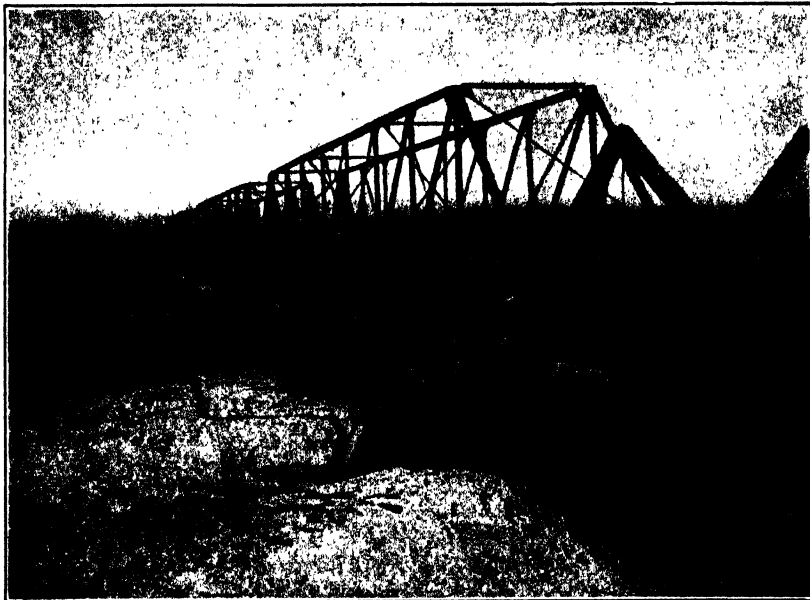

FIG. C.—Lennon steel flume, 6 feet 4 inches diameter, on 3 to 120-foot span steel bridge across Laptata River at Farmington, N. Mex., for Farmer's Mutual Ditch Co.



FIG. D.—Lennon steel flume, 9 feet diameter on 110-foot span steel bridge over Las Animas River, Cedar Hill, N. Mex., for Aztec Irrigation Co.

ingot iron which it is claimed will resist corrosion better than the common iron and steel.

Expansion and Contraction of Steel Flumes.—Most of the manufacturers make specially designed contraction and expansion joints to be inserted in the flume at intervals. However, many flumes are constructed without such special provision for contraction and expansion, and in some cases the locking joints are loosened when not in use in the winter to permit contraction and tightened again before water is turned in the flume. When no expansion joints are provided and the locking joints are not loosened, the locking joints will usually give sufficiently to permit the contraction, but the expansion obtained before the beginning

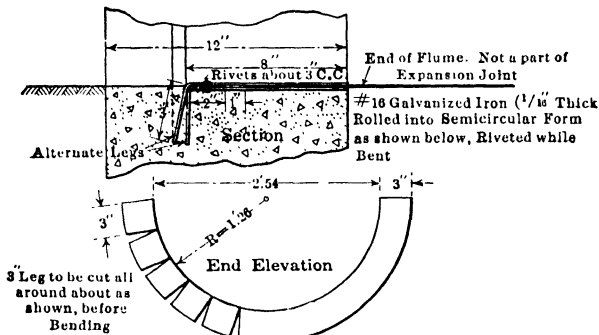

FIG. 42.—Expansion joint for Maginnis steel flume. Boise Payette project, Idaho.

of the irrigation season has in some cases caused the sheets to buckle. In some cases where the flume connects to a concrete-lined canal, the contraction has exerted sufficient force to break the connections at the inlet and outlet with the concrete-lined canal, producing a transverse crack across the canal sufficiently wide to give excessive leakage and endanger the ends.

On the Boise Project of the U. S. Reclamation Service the form of contraction joint used at the flume end consists of a metal tongue extending between a groove formed of double flume sheets (Fig. 42). This form of joint has prevented the buckling of sheets, which occurred when no contraction or expansion joints were provided.

Substructure for Steel Flumes.—The steel flume waterway is generally supported on a wooden trestle (Plate XVI, Figs. C and D, and Plate XVII, Fig. B). Steel trestles have been used for

some large flumes (Plate XVII, Fig. A), and in a few cases steel or wooden bridge trusses have been used at stream crossings (Plate XVII, Figs. C and D). The wooden trestle consists of the trestle bents, spaced usually 16 feet apart, the stringers with or without the carrier beams, depending on the make of the flume, knee bracing extending from the trestle posts to the third point of the stringers on each side, and the longitudinal bracing. When the suspension rods are connected directly to the stringers with-

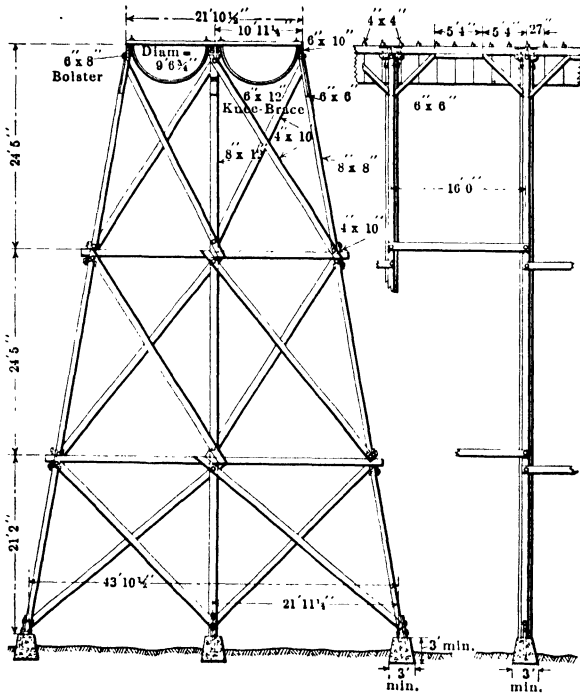

FIG. 43.—Sheet metal twin flume. Medina Irrigation Co., Tex.

out the carrier beams, as is done with one make of flume, the eccentric pull on the stringers tend to cause torsion. To strengthen against this torsion and to give lateral stiffness, in the larger flumes (above 4 feet in diameter) three to four cross beams are used for each span of 16 feet to connect the stringers together. A one-story bent usually consists of two posts, the diagonal sway braces and either a wooden sill support or concrete footings. In addition a horizontal sash brace toward the top of the posts and under the metal flume is often used. While the

metal sheets are approximately semicircular when first erected and empty, when full of water the sheets assume the shape of a catenary; it is therefore important that the top sash brace and the diagonal sway brace be placed sufficiently below the metal sheets to leave enough clearance to permit the sag in the flume when full of water without the sheets bearing on them. The details of construction are illustrated by the flume of the Medina Irrigation Co., Texas (Fig. 43), and by the flume on the Twin Falls Salmon River project in Idaho (Fig. 44).

The Twin Falls Salmon River flume differs from the usual construction in that, in the place of two posts, four posts are

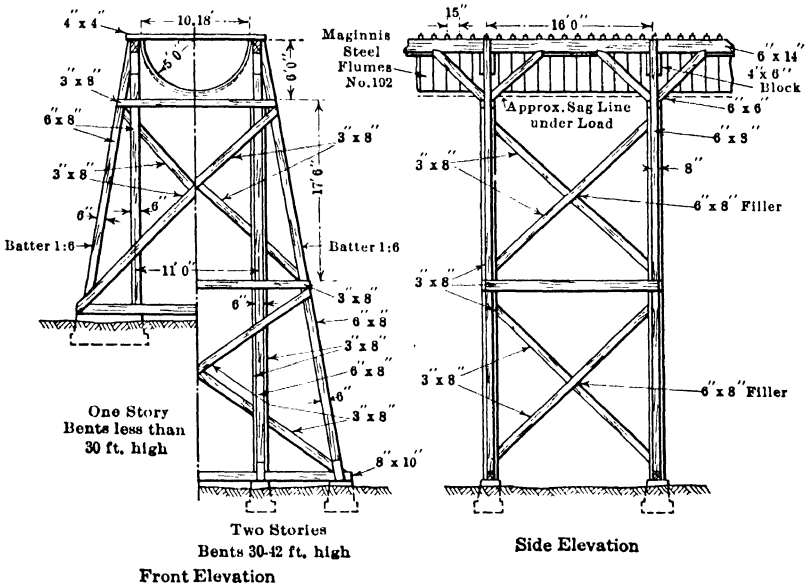

FIG. 44.—Steel flume. Twin Falls, Salmon River Land & Water Co., Idaho.

used in each bent, the posts being arranged in pairs, bolted together at the upper ends where the connection is made with the stringer. The usual construction for this size flume requires two 8 by 8-inch posts, while in this flume four 6 by 8-inch posts were used. This divergence from the usual form of construction would be justifiable where the larger size timber is not available. The sill resting on concrete footings is not necessary and increases the cost.

Cost of Steel Flumes.—The price of the metal part of the flumes (metal sheets, locking bars, etc.) has materially de-

creased during the past year. The prices in 1914 were about the same for the standard makes and were about as indicated by the following table (f. o. b. Denver, Colorado).

PRICE OF GALVANIZED STEEL FLUMES PER LINEAL FOOT FOR DIFFERENT THICKNESSES OF STEEL SHEETS, INCLUDING STEEL SHEETS, LOCKING AND SUSPENSION BARS, ETC.

Price per lineal foot for			Price per lineal foot for			Price per lineal foot for		
Diameter, inches	24 gauge	22 gauge	Diameter, feet and inches	20 gauge	18 gauge	Diameter, feet and inches	16 gauge	14 gauge
8	\$0.14	\$0.16	5 8¾	\$1.70	\$2.10	10 10	\$6.10	\$7.20
10	0.19	0.20	6 4¾	1.90	2.35	11 5¾	6.45	7.35
12	0.20	0.24	7 0	2.10	2.55	12 1	7.40	8.30
15¾	0.30	0.32	7 7¾	2.50	2.95			
20	0.36	0.39	8 4	2.70	3.20			
23	0.40	0.44						
30.5	0.55	0.63						

Diameter, feet and inches	22 gauge	20 gauge	Diameter, feet and inches	18 gauge	16 gauge	Diameter, feet and inches	14 gauge	12 gauge
3 2¾	\$0.76	\$0.87	8 11	\$3.90	\$4.45	12 9	\$9.15	\$11.35
3 10	0.91	1.03	9 6	4.40	5.00	13 5	10.30	12.60
4 5½	1.07	1.22	10 2	4.90	5.55			
5 1	1.22	1.40						

The detailed cost of construction of steel flumes is illustrated by the tabulated cost data on pages 221 and 222.

Durability and Economy of Steel Flumes.—The advantages claimed for steel flumes as compared with wooden flumes are: Ease of erection, water-tightness, lower cost of maintenance and repairs, and greater durability. These advantages have been well demonstrated by the results obtained in practice, with the exception possibly of the durability. The extensive use of steel flumes is of comparatively recent origin, and for that reason the durability can only be predicted. It is probably true that the useful life of a steel flume made of thin metal sheets will be less than is commonly claimed. The most valuable information on this subject is presented by Mr. C. R. Burkey in a paper presented at the Third Annual Report of Operating Engineers, held at Boise, Idaho, in 1914, in which he gives the following summary of a report made by C. C. Fisher of the U. S. Reclamation Service, on the condition of metal flumes on the Boise project

COST OF MAGINNIS FLUMES COMPLETE ON CONCRETE FOOTINGS AND WITH CONCRETE INLET AND OUTLET. LAFAYETTE DRAINAGE PROJECT, U. S. RECLAMATION SERVICE

FLUMES

221

	Maginnis flume, 5 ft. 8 in. diameter, 272 feet long	Maginnis flume, 3 ft. 1 in. diameter, 2,000 feet long
Excavation and backfilling	65 cubic yards 50 per cent. rock and hardpan	279 cubic yards
	\$78.17	\$55.75
Concrete	32 cubic yards	41 cubic yards
Labor.....	\$181.71	\$416.31
Cement delivered.....	113.41	136.19
Reinforcement in place.....	20.80	4.42
Lumber for forms and miscellaneous.....	34.43	49.28
	\$340.35	\$606.20
Flume	265 feet long	2,000 feet long
Labor erecting.....	\$181.54	\$792.51
Steel flume material delivered.....	571.20	\$2,112.66
Lumber delivered.....	112.96	725.66
Nails, bolts and anchor bolts.....	24.41	323.16
Miscellaneous.....	22.69	5.99
	\$912.80	\$3,959.98
Depreciation on equipment	35.00	50.00
Supervision and accounts	94.38	20.72
Engineering	16.34	66.83
	\$145.72	\$137.55
Total Cost	\$1,477.04	\$4,759.48
Cost per Lineal Foot (inlet and outlet, incl.)	5.43	2.38

**COST OF MAGINNIS FLUMES COMPLETE ON CONCRETE FOOTINGS BUILT
BY KELOWNA IRRIGATION CO., BRITISH COLUMBIA**

14 flumes, 5 feet, 1 inch diameter, built over rock slides elevated up to a maximum height of
50 feet above footings, total length 4,128 feet

Item	Cost per lineal foot	Unit cost
Grading.....	\$0.021	
Concrete piers.....	0.314	\$2.03 each
Lumber.....	0.502	\$19.75 per M.
Framing and raising.....	0.452	\$17.75 per M.
Galv. iron nails, bolts, straps, tar, etc.	0.134	
Steel flume.....	1.789	
Hanging steel.....	0.144	
Supervision.....	0.110	
Miscellaneous expense.....	0.067	
Engineering.....	0.150	
	\$3.674	
Labor prices were:		
Common labor.....	\$2.75 per 10-hour day	
Skilled labor.....	\$3.50 to 5.00 per 10-hour day	

in January, 1914. Some fifty or sixty flumes were examined; these included flumes of the following makes: Maginnis, Hess, Hinman and Williams, built in 1909, 1910, 1911 and 1912. The results of the investigations are as follows:

“Of the flumes built in 1909, practically all were more or less corroded.

“Of about thirteen flumes built in 1910, the majority were in good condition, but one was considerably corroded.

“Of about twenty-one flumes built in 1911, two were considerably corroded.

“Of about fourteen flumes built in 1912, two were seriously corroded.

“From a study of Mr. Fisher’s data, there appears to be no decided advantage of one make over another, as regards deterioration. Mr. Fisher stated that the greatest amount of corrosion and rust appeared to be along the joints, on the downstream side, leading him to conclude that this was due to rust washing downstream from the joints, as the bands, etc., forming the joints were not galvanized.”

"Mr. Weymouth stated that he had looked into the matter of protection of metal flumes against rust, and had found that coal-tar and similar products were the best and also the cheapest form of paint for this purpose. Mr. Weymouth had corresponded with engineers on the subject of rust, and had received from Mr. O. H. Ensign, Chief Electrical Engineer of the Reclamation Service, a formula for this use. Mr. Ensign recommended coal-tar and water-gas tar, stating that as the coal-tar is difficult to apply directly, the water-gas tar should be applied first, diluted if necessary with distillates of petroleum, after which the hot liquid coal-tar should be applied. Mr. Ensign advises that the tars must be guaranteed refined, or free from moisture, or they cannot be heated.

"From the above information and the discussion at the conference, it appears to the writer that the bands, channels, etc., forming the joints of a metal flume, should be galvanized, as well as the sheet metal of the flume. And it also seems that it would be a good plan to paint metal flumes after 4 years' use, if they show any signs of deterioration, using the coal-tar products."

As regards the relative cost of wooden and steel flumes, a comparison of a number of designs of elevated flumes of both types, for the same condition, shows that the first cost of a sheet metal circular flume will usually be about 20 to 40 per cent. more than that of a wooden flume. Against this greater first cost should be balanced the water-tightness, and the smaller cost of repairs and maintenance obtained with the steel flume.

REINFORCED CONCRETE FLUMES

The use of reinforced concrete for flume construction has been limited to side-hill bench flumes and to very few elevated flumes. This limited use of reinforced concrete for elevated flumes is due largely to the high cost when compared to wooden or sheet metal flumes and to the difficulty in construction. The false work and forms used in the construction and the inaccessibility of most flume locations bring the cost per cubic yard of concrete in place higher than for any other type of irrigation structure.

The water channel of a reinforced concrete flume is usually rectangular; the only exception known to the writer is a flume built on the irrigation system of the Canadian Pacific, which has a water channel curved approximately to a catenary cross section. The substructure may be either solid piers, columns, a reinforced concrete trestle or arches. The side walls must be designed to resist the inside water pressure and may have to be designed also as girders to carry the weight of the flume box and

water between the points of support; this will depend on the form of substructure. The structural design of the side walls of the flume box to resist the water pressure alone does not differ from that of the bench flume; they may be designed as cantilever walls or as slabs supported by side posts or as slab walls anchored to the bottom and supported at the upper end by a reinforced concrete beam formed as part of the wall in the manner described and illustrated for bench flumes. Where the flume box is supported on piers, column, or trestle, the floor slab is usually suspended to the side walls by transverse reinforcement in the floor slab designed to carry its weight and that of the water, and the flume box is carried between points of supports by designing the side walls as girders. For a wide shallow flume a more economical design may be obtained by carrying the flume box between supports through the action of the floor slab, designed with the main reinforcement placed longitudinally; the side walls are then designed for lateral water pressure only. A third form of design may be obtained by dividing the total weight to be carried between the side walls, designed as girders, and the floor slab, designed for beam action between the points of supports.

Where the flume substructure is one or more arches, the arch may consist of a single curved slab or may be formed of two or more ribs. Three forms of construction are feasible for the support of the flume box. *First*, the flume box may be supported on spandrel columns or transverse piers, extending from the curved slab or rib to the under side of the flume floor, in which case the design of the flume box is the same as stated above. *Second*, the ribs of a two-ribbed arch may be extended to the under side of the floor in the same vertical plane as the side walls, in which case the floor slab is reinforced transversally to carry the weight between the two ribs, and the side walls have no girder action. *Third*, the flume box may be supported on spandrel arches, in which case there is no beam action in the floor and no girder action in the side walls.

The most desirable type of substructure can only be determined after an economical comparison of designs for each case. In general the most favorable conditions for reinforced concrete flumes elevated on arch substructures are a comparatively large flume, a narrow deep canyon which can be crossed with a single arch span, and the necessity of providing an unobstructed large waterway.

Reinforced Concrete Elevated Flumes of Kamloops Fruitlands Irrigation and Power Co., British Columbia (Fig. 29).—Where the bench flume, constructed for this system as previously illustrated and described, crosses shallow natural drainage depressions, the flume is elevated on low concrete piers and carried across the spans by adding to the steel reinforcement used for the side walls of the bench flume, sufficient reinforcement to obtain the required girder action. For a two-span flume, this consisted of longitudinal rods placed at the top of the side wall over the center pier to resist the negative bending moment and at the bottom to resist the positive bending moments. Longitudinal shear in the side walls is resisted by the transverse reinforcement. The floor slab is reinforced for beam slab action between side walls. Temperature reinforcement is not necessary, as provision

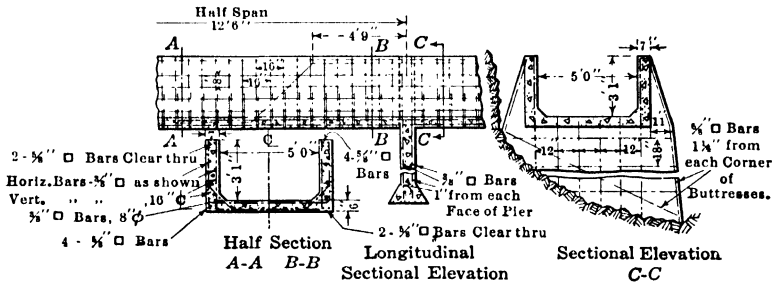

FIG. 45.—Reinforced concrete elevated flume. Yakima Valley Canal, Wash.

for contraction is obtained through the contraction joints at both ends of the flume, spaced 40 feet apart.

Reinforced Concrete Flume of Yakima Valley Canal Co., Washington (Plate XVIII, Fig. C).—This flume was constructed around steep rocky bluffs, to cross drainage depressions, and where the foundation did not permit the bench flume construction previously described. The flume is supported on reinforced concrete piers, 8 inches thick, spaced 25 feet apart and constructed on solid rock (Fig. 45). The side walls are cantilever walls to resist the water pressure and are also designed as girders between the piers. There is no apparent necessity for the transversal reinforcement next to the outside face of the side wall and to the inside face of the floor slab other than the possible requirement of added stiffness because of the large span and also possibly the provision of greater strength against falling rock

or slides; which, however, is not necessary for the downhill side wall. The longitudinal reinforcement in excess of that needed for the girder action provides for temperature stresses.

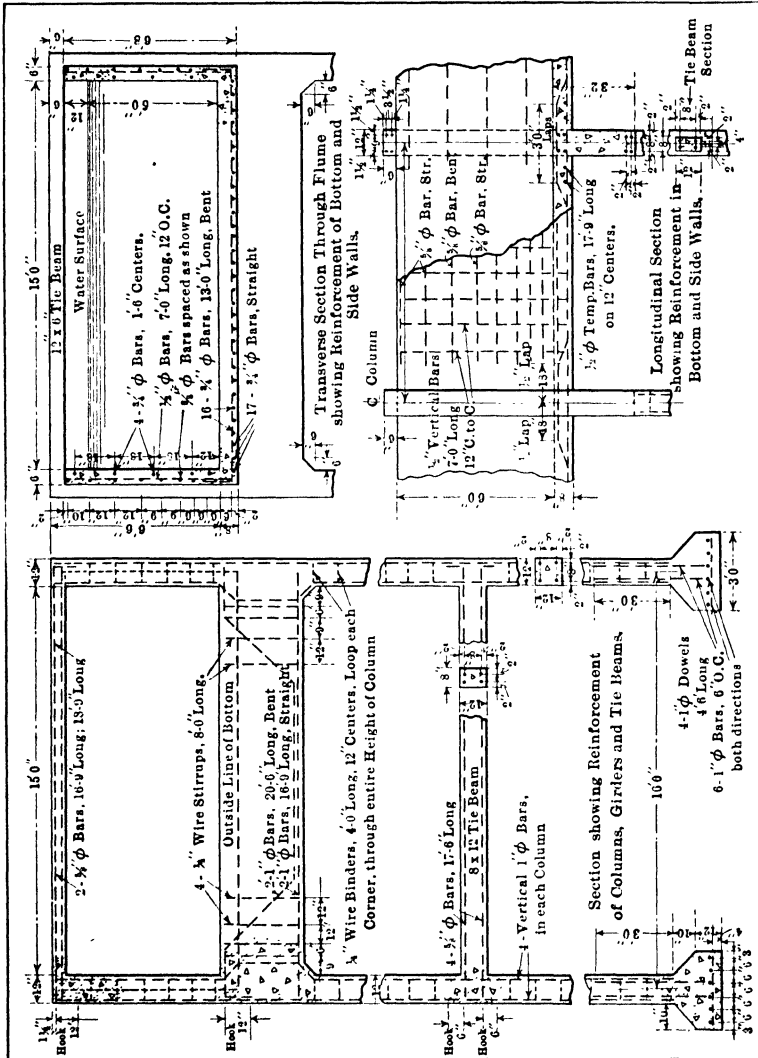

FIG. 46.—Reinforced concrete elevated flume, Naches Power Canal, Wash.

Reinforced Concrete Flume of Naches Power Co., Washington (Plate XVIII, Figs. A and B).—The design of the flume box does not differ from that used for the bench flume previously

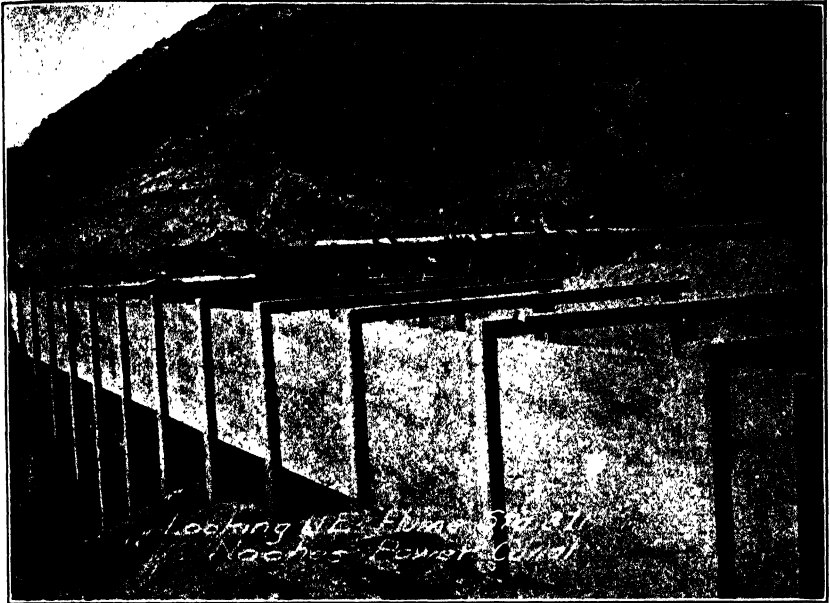

FIG. A.—Reinforced concrete flume. Naches Power Canal, Wash.



FIG. B.—Reinforced concrete flume. Naches Power Canal, Wash.

PLATE XVIII

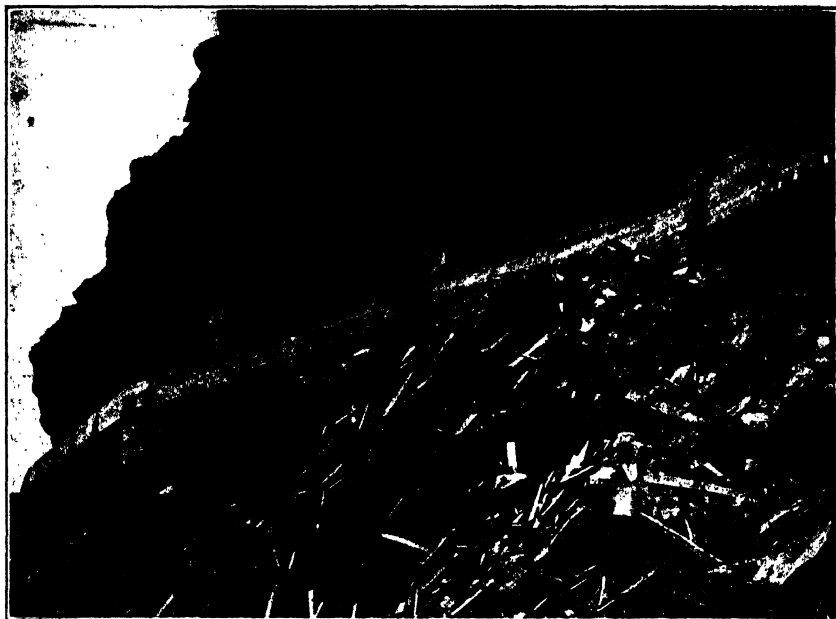

FIG. C.—Reinforced concrete flume. Naches Power Co., Wash.

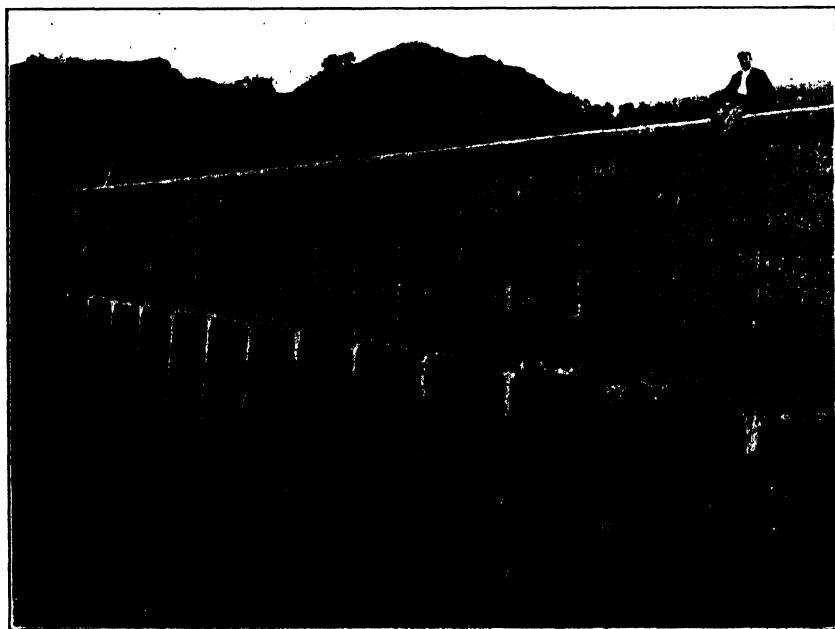

FIG. D.—Reinforced concrete flume. Faleva Flume, Spain.

described. The floor slab is designed to carry the entire weight of the flume box and water to the supporting bents, spaced 10 feet apart; there is no special reinforcement in the side walls to produce the girder action (Fig. 46). Each trestle bent is formed by two columns with spread footings, a cross stringer connecting the tops of the columns, formed as a cross rib on the under side of the floor, and a tie beam, corresponding to a sash brace on a wooden flume trestle, connecting the columns at a point midway between the girder and footing. The upward extensions of the columns form the side posts of the flume box.

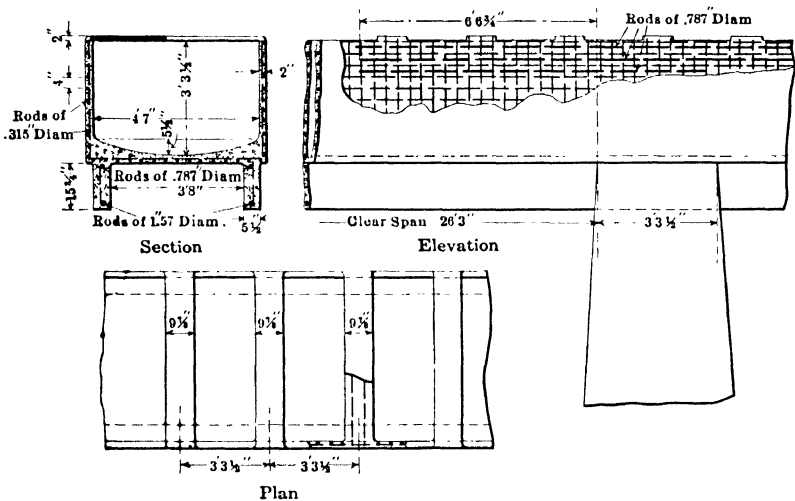

FIG. 47.—Reinforced concrete flume of Hamiz, Algeria.

Reinforced Concrete Elevated Flumes on Canal of Hamiz, Algeria (Fig. 47).—An interesting type of flume has been used on this canal for the conveyance of water over two depressions, one 92.5 feet long and the other 187 feet long. The flume box is formed of the two side walls, the floor slab, concave on the inside, and tie beams across the top to connect the side walls. The flume box is supported on top of two reinforced concrete beams placed directly under the side walls and built monolithically with the flume box. These beams carry the total weight to the points of supports, which consist of concrete piers, 3 feet 3 1/2 inches thick at the top, spaced 29 feet 6 1/2 inches c. to c., giving a clear span of 26 feet 3 inches.

The side walls, which are only 2 inches thick, are formed as

beam slabs divided by the tie beams into spans of 3 feet $3\frac{1}{2}$ inches and to resist the water pressure are reinforced with a mesh of iron rods 0.315 inch in diameter, spaced longitudinally and transversally 4 inches apart. The transverse reinforcement of the side walls is continuous with that in the floor beam. The supporting beams are reinforced at the bottom with a rod 1.57 inches in diameter and at the top with a rod 0.787 inch in diameter. These rods are suspended to the reinforcement of the superstructure by iron wires 0.275 inch in diameter. To resist the negative bending moment produced in the upper part of the side walls, three rods 0.787 inch in diameter are placed, extending on both sides of the pier to the $\frac{1}{4}$ points of the span.

The flume was built of mortar composed of about 1 part of cement to 3.2 parts of sand. When completed, the flume resisted successfully a test of 1,000 pounds load per lineal foot for 24 hours. The total cost was \$4.95 a running foot.

The flume is unusual in design and in the very thin walls. Thicker walls designed as girders to carry the load to the supporting piers, without the addition of the girder beams, would facilitate construction and for ordinary conditions would be more economical. There is no apparent necessity for the very thick supporting piers.

Faleva Flume on Canal of Aragon and Catalogne, Spain (Plate XVIII, Fig. D).—This flume has a carrying capacity of about 775 cubic feet per second and a length of 220 feet. The flume box is formed by the side walls 6 inches thick, 10 feet 4 inches in height, spaced 13 feet $1\frac{1}{2}$ inches apart, framed with reinforced ribs or beams, 6 feet 6 inches c. to c. The flume box is supported on square columns of reinforced concrete, 10 by 10 inches cross section, about 16.5 feet high. The total cost was about \$6,000 or about \$27.25 a lineal foot.

Reinforced Concrete Flume on Interstate Canal, North Platte Project, Nebraska, Wyoming (Plate XIX, Figs. A. and B).—This flume has a total length, from inlet to outlet, of 206 feet 6 inches (Fig. 48). The flume box has an inside width of 34 feet, a total depth of 12 feet 6 inches; the floor forms part of the crown of the main arches and of the spandrel arches, supported on cross walls which rest on the curved slab of three arches. The center arch, which is the main one, has a clear span 53 feet $6\frac{1}{4}$ inches; the arches on each side are equal and have a span of 32 feet $1\frac{1}{4}$ inches.

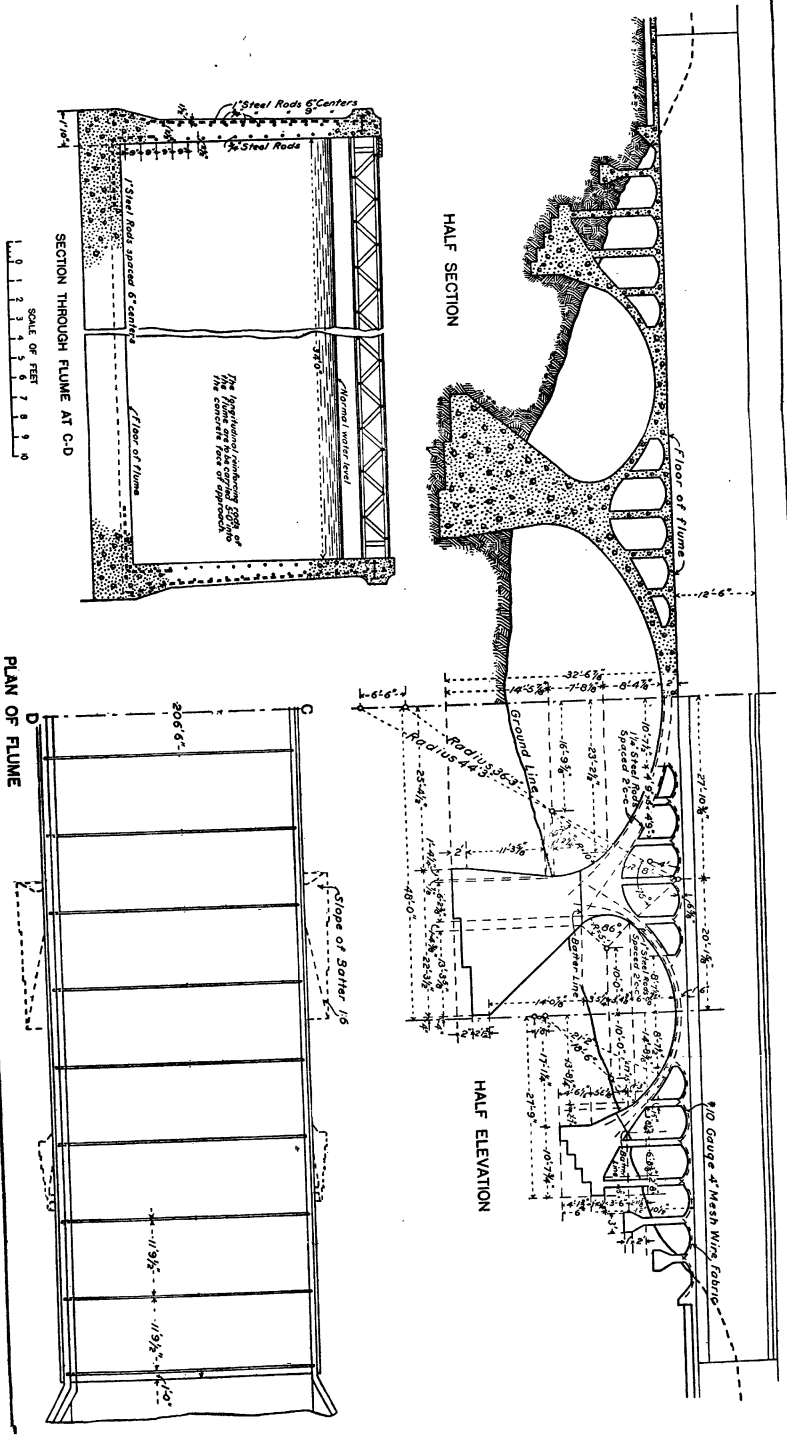

FIG. 48.—Reinforced concrete flume at Spring Canyon Draw, Interstate Canal, North Platte Project, Neb., Wyo.

(Facing page)

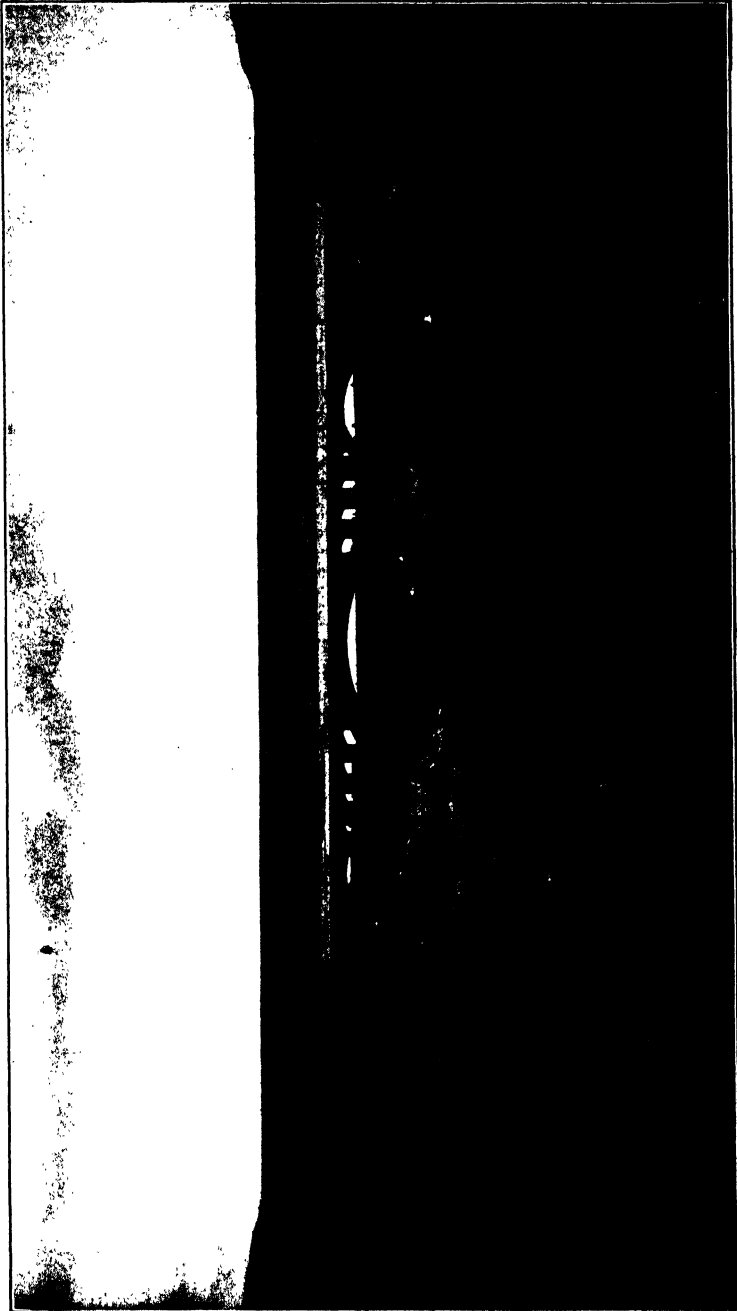

FIG. A.—Reinforced concrete flume at Spring Canyon Draw. Interstate Canal, North Platte Project, Wyo., Neb.



FIG. B.—Reinforced concrete flume at Spring Canyon Draw. Interstate Canal, North Platte Project, Wyo., Neb.

The side walls of the flume box are reinforced transversally to resist the water pressure, through the action of a vertical beam slab, fixed at the floor for the lower point of support and to the reinforced beam formed at the upper part of the side wall for the upper point of support. This upper beam is reinforced with a 10-inch, 25-pound I-beam, and is divided into spans of 11 feet 9½ inches by tie beams in the form of lattice girders, extending across the top of the flume with the ends anchored in the side walls. The longitudinal reinforcement is probably intended for temperature reinforcement and has a cross-sectional area equal to about 0.7 of 1 per cent. of the concrete area. The spandrel

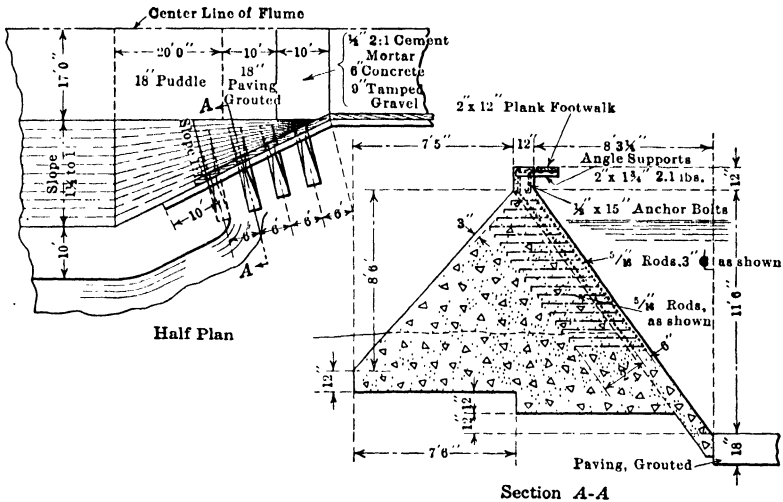

FIG. 49.—Inlet to flume, at Spring Canyon Draw. Interstate Canal, North Platte Project, Wyo., Neb.

arches have a clear span of 4 feet 9 inches, a crown thickness of 65⅞ inches and are reinforced with No. 10 gauge, 4-inch mesh wire, placed near the under face. The main center arch has a crown thickness of 2 feet and is reinforced with 1¼-inch rods, 2 feet apart, placed both near the concave and convex surface of the arched slab. The two side arches have a crown thickness of 18 inches and are reinforced with 1-inch rods, 2 feet apart.

The inlet and outlet are alike (Fig. 49) and are formed by using warped surfaces to connect the canal sides on a 1½ to 1 slope with the vertical side walls. These warped surfaces are 40 feet in length and are made with a section of riprap 18 inches thick,

nearest the canal, to change from a $1\frac{1}{2}$ to 1 slope to a 1 to 1 slope, and of a section of reinforced concrete surface supported on buttresses.

INLET AND OUTLET TO FLUMES

In order to decrease the cross-sectional area of the flume and correspondingly the cost, it is desirable, where the available grade will permit it and where the flume is of considerable length, to use a high velocity of flow in the flume. Usually at the inlet there will be an increase in velocity from a comparatively low velocity in the canal to a higher velocity in the flume, and at the outlet the velocity must be decreased before the water passes into the canal. To produce the increase in velocity at the inlet, the required drop in the water surface must be made and the transition designed accordingly. At the outlet the decrease in velocity can be used to produce a rise in the water surface, but unless it is necessary to retain the available head it is preferable to neglect this gain in head. The principles of transition design have been discussed in Chapter VI.

The object of the inlet and outlet structures is to produce the change in cross section by the proper form of transition and to make a connection of the flume with the canal which will protect the ends of the flume against settlement, erosion, undermining or outflanking. The structure will usually consist of the wings, the floor, cut-off walls on the sides, and a toe wall at the far end of the floor.

To make the transition, the wings may be (1) warped wings, (2) straight wings placed on an acute angle to the axis of flow, (3) straight wings placed at right angles to the axis of flow. Warped wings or warped channels give the best hydraulic design, but the increased cost and difficulty of construction frequently lead to the adoption of straight vertical wings. For a permanent concrete or steel flume when it is essential to retain as much of the available grade as possible and to obtain a comparatively large change in velocity, they give the best form of structure. Warped wings may be made of wooden staves to connect with a wooden stave flume, or of concrete with a floor between to connect with a concrete, steel, or wooden stave flume (Plate XX, Fig. A). Sheet steel warped inlets and outlets have been put on the market by the manufacturers of sheet steel semicircular flumes (Plate XX, Fig. B); they have been used only

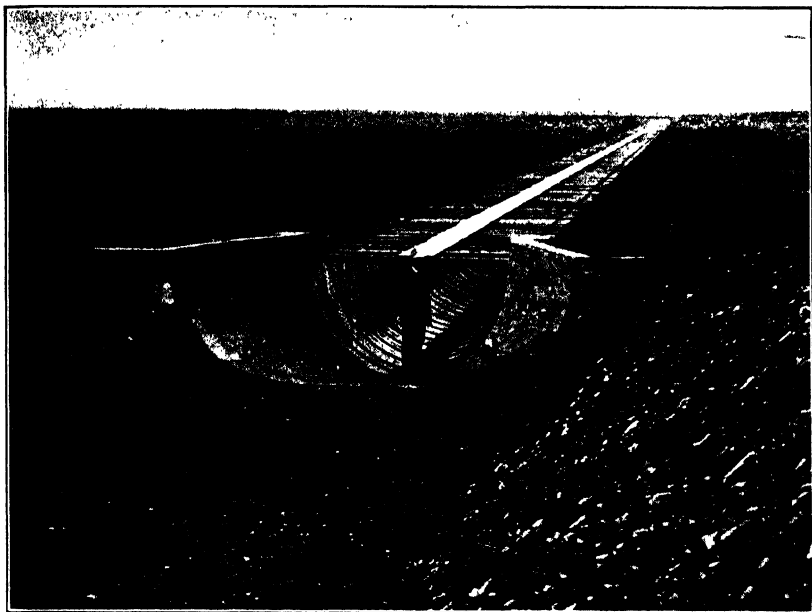

FIG. A.—Warped wing inlet. Twin Falls, Salmon River Land & Water Co., Idaho.

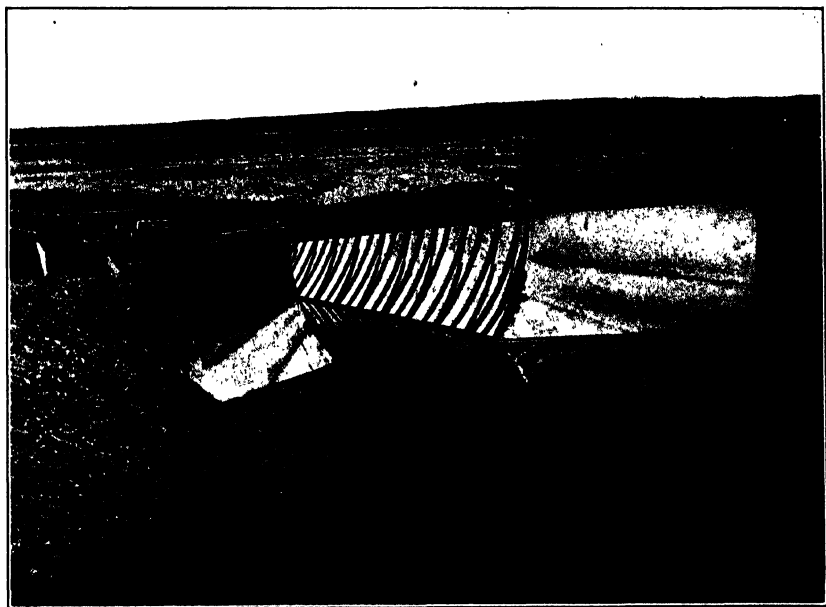

FIG. B.—Sheet metal inlet for Hess steel flume.

(Facing page 230)

PLATE XX

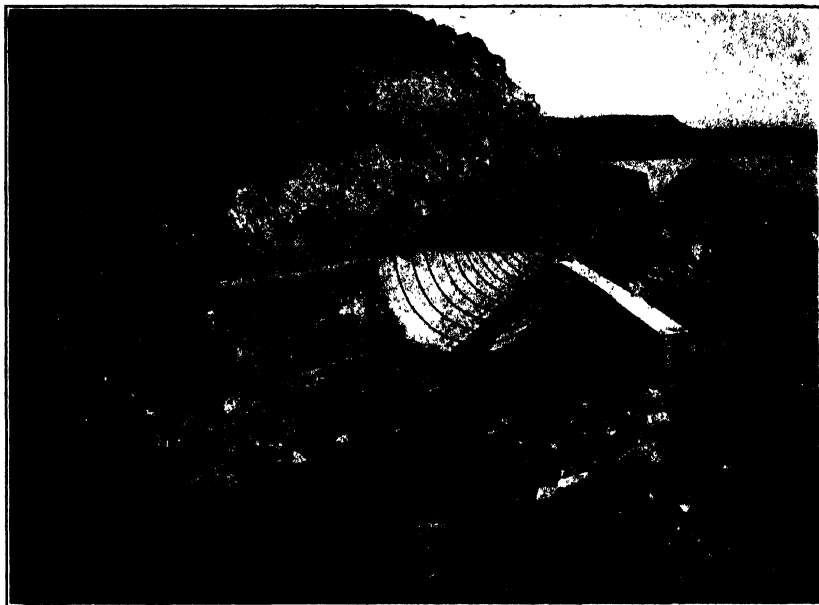

FIG. C.—Outlet to steel flume. Snake River Irrigation Co., Mountain Home, Idaho.

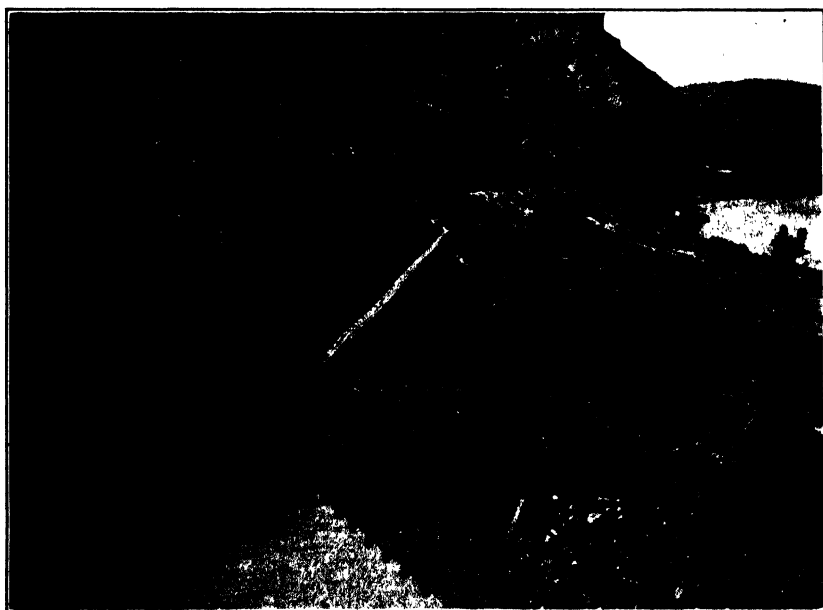

FIG. D.—Inlet to wooden flume. Orchard Mesa Power Canal, Palisade, Colo.

in a few cases and while they may be desirable in material subject to settlement, they are usually inferior to concrete structures. The warped wall when made of plain concrete changes from a comparatively thin sloping wall or lining to a heavier retaining wall section next to the flume. Reinforced concrete warped surfaces resting on, or anchored to, buttresses can often be used economically. The length of transition should be proportional to the change in water cross section or velocity, and should be sufficient to produce a gradual change with little impact and eddies; this can be obtained by using a comparatively small angle between the wing and the direction of flow; usually not greater than about 30 degrees. The construction of a warped wing requires a change from a flat canal slope to either the vertical or curved side of the flume; in making a concrete wing the slope of the warped surface next to the canal is sufficiently flat to permit placing the concrete without forms by spreading it on the surface of the trimmed earth, but the steep slope next to the flume requires that the concrete be placed back of forms. A very satisfactory method of construction is to divide the transition in two parts. The first part is that adjacent to the canal and extends from the end where it joins the canal and where it has about the same side slope as the canal to a point in the wing where the slope gets as steep as 1 to 1 or even $\frac{3}{4}$ to 1; this part can be built without forms. The second part is adjacent to the flume and is the continuation of the first part; it is built with the use of forms.

For wooden, rectangular flumes straight wings are commonly used. Straight vertical wings placed on an angle of 30 to 45 degrees to the axis of the canal with a floor between produce a better transition hydraulically than right-angle wings. Right-angle wings are cheaper and easier to construct, but unless riprap is used to form the inlet there is a sudden change in cross section which is objectionable. At the outlet riprap or other form of protection is often necessary to resist the erosion caused by the high exit velocity and by the eddies resulting from the sudden change in velocity.

The correct hydraulic design of the inlet and outlet structures is desirable, but is not as important as the design and installation of the structures so as to be safe against undermining and washing around the wings. The failures of flumes are often caused by defects in these end connections. The most im-

portant features which must be provided for are: *First*, the wings and cut-off walls must be designed to form water-tight connections. *Second*, the exit of the flume must be designed to prevent tendency of erosion produced by the high velocity and by the eddies resulting from the change in cross section.

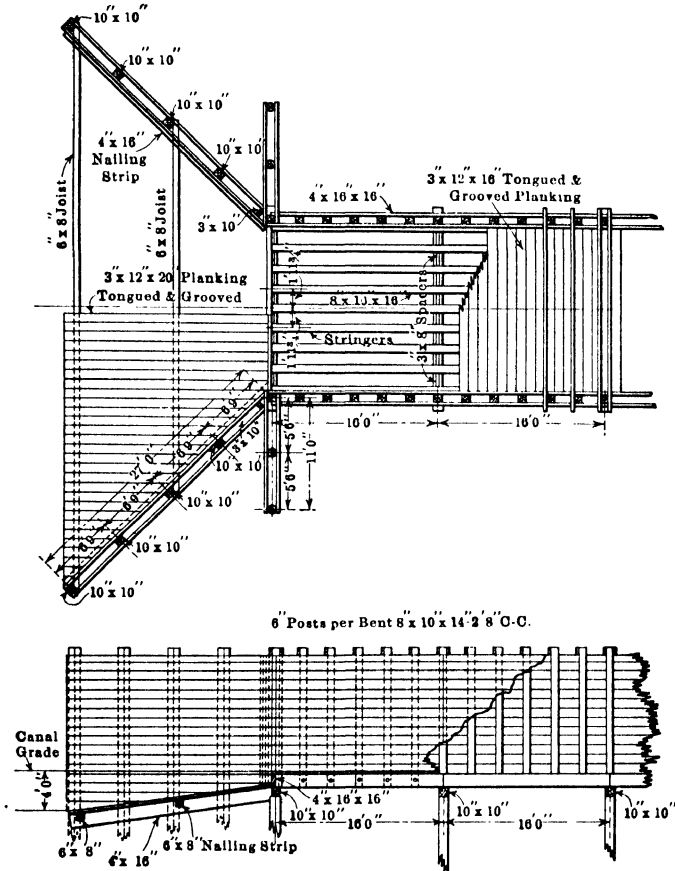

FIG. 50.—Inlet to wooden flume. Southern Alberta Land Co., Can.

Third, the cut-off walls must extend into impervious material where possible, and the connections when in earth must be very carefully puddled. To be safe against small leaks which may develop, the ends of flumes built across ravines must be extended well into firm material to obtain a good safe anchorage. With wooden construction it is difficult to be certain that leakage

will not occur through the joints of the wooden lining and for that reason various methods of assembling the wing walls have been used; the main object being to obstruct or increase the path of travel to leakage water around the structure.

The form of structure will depend on whether wood or concrete is used. A common form of flume end connection is illustrated by that used by the Southern Alberta Land Co. in Alberta, Canada (Fig. 50). This form, which may be called the double wing form consists of the transition wings and floor and a second set of cut-off wings and vertical apron. The transition wings are vertical wings, placed on an angle with the direction of flow and extending well into the canal banks; the floor in between slopes down from its connection with the flume floor, so as to extend to a depth below grade of about $\frac{1}{2}$ to 1 times the depth of water in the canal. The cut-off wings and vertical apron are at right angles to the axis of the flume and placed at the connection of the transition with the flume end. Well puddled earth between the two sets of wings forms a water-tight earth wedge and gives good anchorage with the natural earth. The transition wing and the cut-off wing on the same side of the flume may be connected by pieces across the top to brace the top of the walls against the pressure of the earth held in the wedge. Sometimes the floor of the transition is made level with the flume floor and a vertical cut-off apron is placed at the end where it connects with the canal bed. A simpler form of inlet and outlet, often used, is obtained by using the same form of transition wings with floor in between but omitting the right-angle cut-off wings and vertical apron. While this is satisfactory with good water-tight material not easily eroded by a small leak, it does not have the same degree of safety as the double wing type. Another form is obtained by omitting the transition wings and using only the right-angle cut-off wing and trenches; it is cheap to construct, but requires suitable material for riprap or a concrete lining to properly form the inlet transition and to provide protection against erosion at the outlet.

Another form which may be called the enlarged flume-box form, illustrated by the standard design of the United States Reclamation Service (Fig. 51), is obtained by extending the end of the flume with a short section of flume made sufficiently wide and deep so that the entire canal cross section may be carried inside of this enlarged flume up to the breast wall which connects

the two flumes together. The floor of the enlarged flume addition is covered with earth-filling by being depressed below the grade line of the canal, a depth equal to from $\frac{1}{2}$ to $\frac{2}{3}$ the depth of water in the canal, and a short cut-off vertical apron is placed at the canal end of the floor.

On the Crane Creek project in Idaho the type of flume end connection combines the enlarged flume-box form with the transition form (Fig. 52). The connection consists of the enlarged flume box next to the canal with a double breast wall filled with puddle, which gives the box additional weight and makes it safer against leaks, and of the transition wing walls with the floor in

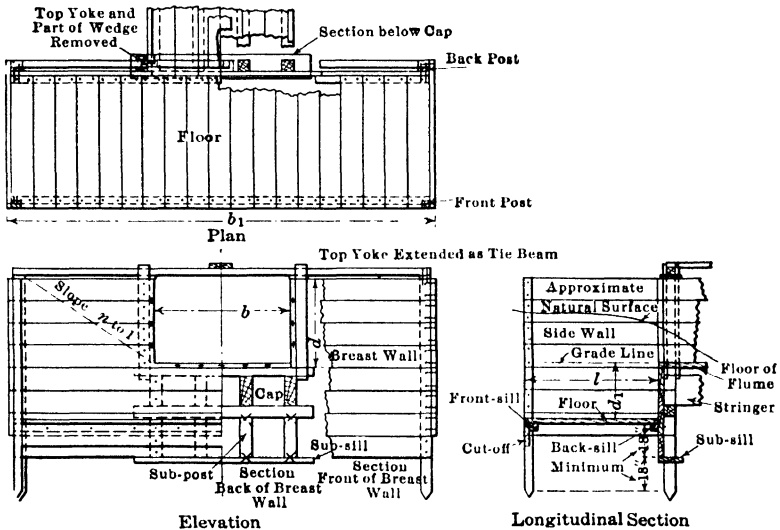

FIG. 51.—Standard design for inlet and outlet for wooden flume. U. S. Reclamation Service.

between, level with the floor of the flume. This design gives a very substantial structure, which is, however, more expensive than the double-wing form.

Concrete inlets and outlets of the simplest type consist of a breast wall formed by right-angle wings on each side and a vertical cut-off apron, all in one plane at right angles to the axis of the flume. This form is open to the same disadvantages as the wooden construction of the same type, except that there is no danger of water percolating through the concrete wall. A form commonly used consists of the straight wings, extending well

into the canal banks at an angle with the canal axis, with the floor in between provided with a cut-off apron where it connects with the earth, and an abutment wall or breast wall for the flume to

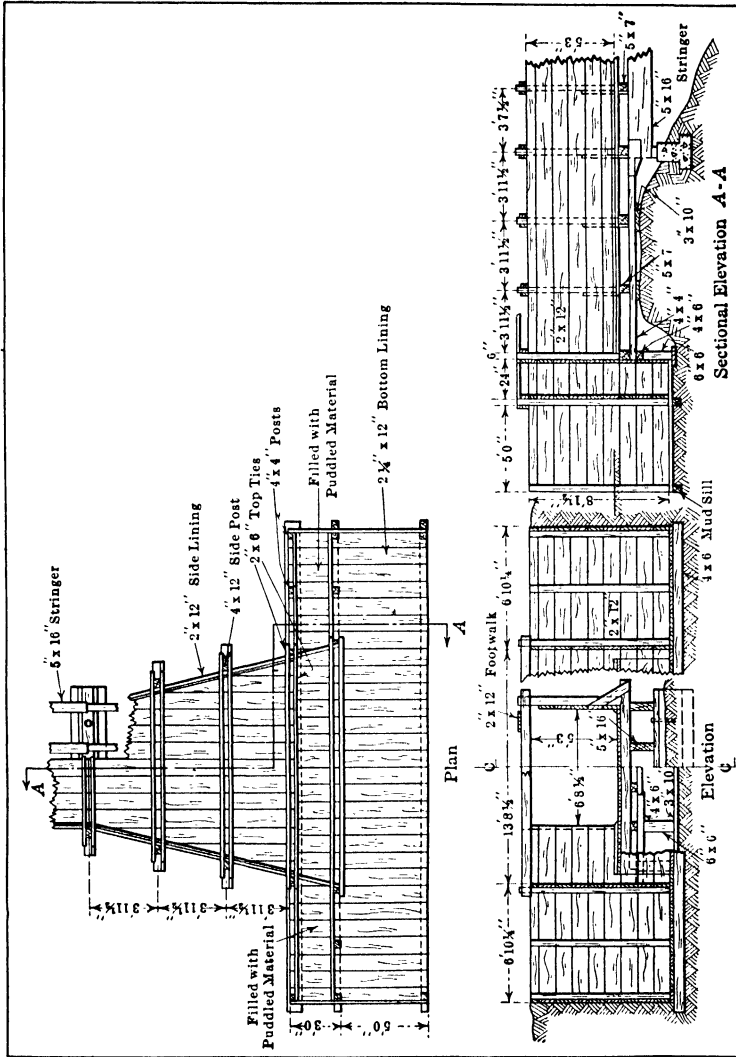

FIG. 52.—Inlet for flume. Crane Creek Irrigation Co., Idaho.

rest on. The floor may be omitted, as illustrated by the inlet to a flume on the Sunnyside project, Washington (Fig. 53), but the increase in velocity as the water enters the flume is liable to

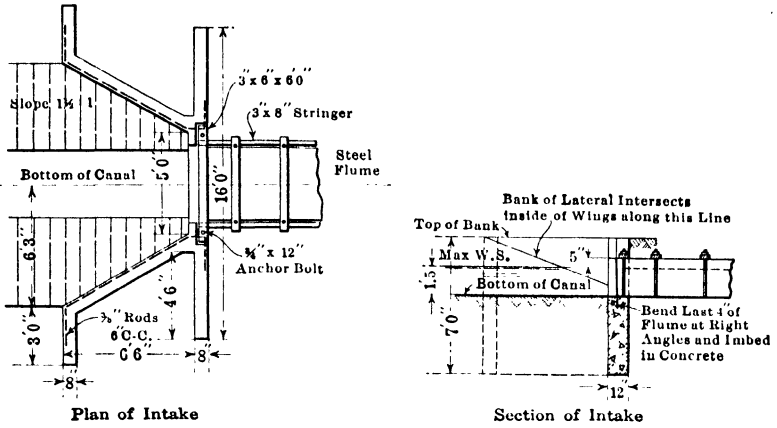

FIG. 53.—Inlet to steel flume on Sunnyside Project, Wash.

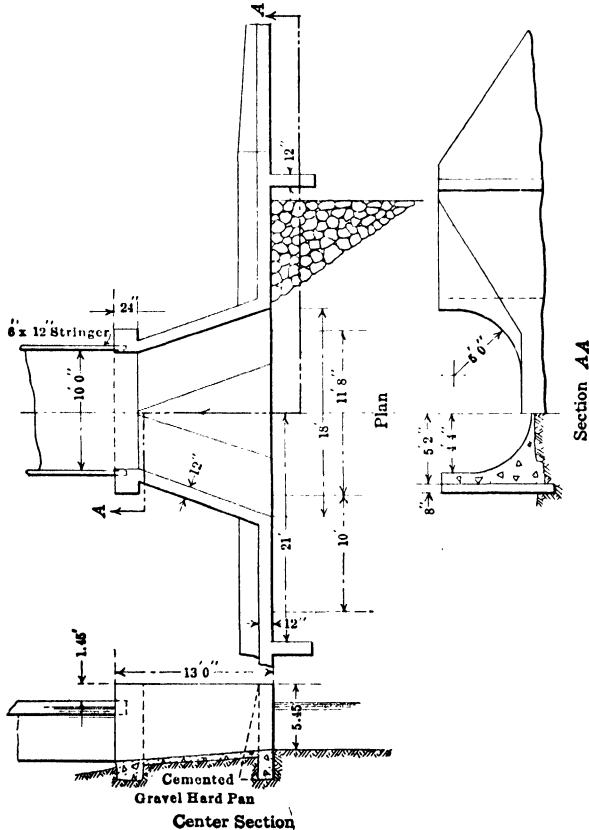

FIG. 54.—Inlet structure for steel flume. Twin Falls, Salmon River Land & Water Co., Idaho.

produce erosion of the earth in between the wings and wash out a cavity; this action is liable to occur to a greater extent at the outlet. With warped or curved wings, it is necessary to provide cut-off cross walls or aprons, extending well into the earth, where the transition connects with the earth canal, as illustrated by the inlet design for the flume of the Twin Falls Salmon River project in Idaho, where the side walls are curved on about the same radius as the semicircular metal flume (Fig. 54). This flume connects with a cemented gravel hardpan.

The inlet and outlet to the Spring Canyon draw flume on the North Platte project are formed of warped wings, as described and illustrated in connection with the discussion of the flume itself (Fig. 49). There is no cut-off apron in the end of the floor where it connects with the earth; this omission is objectionable, unless the material is very firm and water-tight. The concrete warped wings are supported and tied to buttresses, which act as cut-off walls and obstruct any seepage around the sides.

The inlet and outlet are frequently built alike. At the outlet there is a greater tendency for erosion caused by the high exit velocity and by the eddies resulting from the change in velocity, the extent of which will depend on the form of transition and the provision made in the difference in water level according to velocity heads. Frequently, except with a long warped transition, some protection against erosion is desirable. A good form of protection is made of a concrete lining, about 3' to 4 inches thick, with a cut-off wall and apron at the lower end extending into the earth to a depth equal to about $\frac{1}{2}$ the depth of water for a sandy soil and $\frac{1}{4}$ the depth of water for a clayey soil.

REFERENCES FOR CHAPTER IX

WOODEN FLUMES:

UBRICH, J. C., AND OTHERS—Discussion on Flumes and Fluming—Annual Report of the Am. Soc. of Irrig. Eng.—1892-93—Denver, Colo.

FORTIER, S.—Conveyance of Water in Irrigation Canals, Flumes, and Pipes—Water Supply Paper No. 43, U. S. Geological Survey, Washington, D. C.—1901.

The Irrigation System of Southern Alberta Land Co.—Engineering and Contracting—Apr. 10, 1912.

Cost of Constructing a Wood Flume, Klamath Project—Reclamation Record—May, 1909—U. S. Reclamation Service, Washington, D. C.

Cost of Constructing a Wood Flume, Klamath Project—Engineering and Contracting—May 26, 1909.

The Dulzura Conduit of the Southern California Mountain Water Co.—Engineering News—Nov. 26, 1908.

Section of Standard Timber Flume, Hydroelectric Power Station, Pacific Gas and Electricity—Engineering News—Aug. 10, 1905.

A Mexican Water Power Electric Plant—Engineering News—Aug. 13, 1903.

The Basic Co. Flume, Idaho—Engineering and Mining Journal, Vol. LXVI.

SPIRLING, GODFREY.—Longitudinal Expansion in Timber Flumes—Engineering and Contracting.—April 17, 1912.

Novel Features in Flumes and Penstock Design: the Puntledge River Power Development, Vancouver, B. C.—Engineering News—Oct. 23, 1913.

HALL, WM. HAM.—The Santa Ana Canal of the Bear Valley Irrigation Co.—Trans. Am. Soc. Civ. Eng., Vol. XXXIII, No. 2—1895.

BALFOUR, R.—Hints on the Design and Construction of Wooden Trestles—Engineering News—June 6, 1907.

STEEL FLUMES:

Two types of Metal Flumes for Irrigation Conduits.—Engineering and Contracting—Jan. 31, 1912.

Methods and Cost of Constructing Main Canals and Laterals for the Willow River Land and Irrigation Project, Malheur Co., Oregon (includes cost of steel flumes)—Engineering and Contracting—Aug. 2, 1911.

A Metal Flume Without Cross Ties—Engineering News—Dec. 28, 1911.

Semicircular Steel Fluming (Irrigation in Natal)—Proc. Inst. Civ. Eng.—1903-04, pt. 3.

HANNA, F. W.—Metal Flumes for Irrigation Canals—Engineering News—Nov. 27, 1913.

Life and Serviceability of Metal Flumes—Reclamation Record—Dec., 1913—U. S. Reclamation Service, Washington, D. C.

BURKY, R. C., FISHER, C. C.—Maintenance Problems: Earthwork Wooden Structures, Metal Flumes, Etc.—Report of 3rd Annual Conference of Operating Engineers, Boise, Idaho—1914.

REINFORCED CONCRETE FLUMES:

Concrete Flume on Los Angeles Aqueduct—Engineering Record—June 22, 1912.

Reconstruction of a Power Canal and Flume Under Service—Engineering Record—May 27, 1911.

MASSON, R. S.—Hydroelectric Development of the Arizona Power Co.—Engineering Record—Aug. 20, 1910.

Concrete Flumes that Did not Fail (Washington)—Engineering Record—Nov. 22, 1913.

El Canal de Aragon Y Calaluña—Revista de Obras Publicas—March, 1906—Madrid, Spain.

CHAPTER X

PIPES AND INVERTED SIPHONS

Uses of Pipes in Irrigation.—On most irrigation projects the use of pipe is limited to the conveyance of water across natural drainage channels or depressions, or along steep, rocky bluffs or hillsides (Plate XXI, Figs. A. B. C. D). The pipe line is then either an inverted siphon taking the place of a flume on trestle, or a gravity pressure pipe line used as substitute for a bench flume or difficult canal construction on steep side hills, in which case it may follow closely the route of an open canal or of a bench flume, or it may be located to shorten the route and avoid difficulties in construction. On a number of irrigation projects pipes have been used for the conveyance and distribution of water to the irrigable lands. These projects are mostly in southern California, in eastern Washington, southern Idaho, northeast Oregon, and British Columbia, where either the rolling character of the land or the high value of the water and the small volumes of water to be conveyed favored the installation of distribution systems in which the laterals and in some cases even the mains are built largely or entirely of pipe lines. This type of distribution system is considered in Vol. III. The use of pipes in farm distribution system for the application of water to the land has been described in Chapter VII, Vol. I. Pipes are also used for chutes, culverts, delivery gates, etc.

Kinds of Pipes Used.—The kinds of pipes used on irrigation systems are: wrought-iron, steel, wooden stave, concrete, and reinforced concrete. Cast-iron pipes, because of their high cost in the west and of transportation difficulties are practically never used, except in a few cases for culverts. Wrought-iron and steel pipes are used only to a limited extent; small size pipe up to about 12 inches in diameter have been used on smaller distribution systems, but their use in larger sizes is confined to a few cases where the pressure heads exceed those for which wooden stave pipe can be economically used. Wooden stave pipes have been used to a large extent. Under favorable conditions they are more durable than steel pipes and will usually cost

less for pressures under 200 or 250 feet. Plain cement concrete or cement mortar pipes have been used extensively in southern California and to a smaller extent elsewhere for the conveyance of water under low pressure, generally under 15 feet head. Reinforced concrete pipes have been used on a number of projects as inverted siphons, and on some projects as distributary pipe lines, notably on the Umatilla project, Oregon, where they have been used successfully for pressure heads as great as 110 feet. In cost they may compare favorably with wood stave pipes, with the additional advantage of durability when the wood pipe must be under low pressure head or under other unfavorable condition.

WROUGHT-IRON AND STEEL PIPES

Steel vs. Wrought Iron.—The main advantage of wrought-iron and steel pipes is their adaptability to high pressures. A serious disadvantage is the decrease in carrying capacity of steel or wrought iron with age; due to the greater frictional resistance and decrease in cross-sectional area produced by the growth of tubercles on the interior of the pipe. The use of wrought-iron pipes antedates the use of steel pipes. The development of the use of large size riveted iron pipes was initiated largely in the west, beginning about 50 years ago. The use of mild-steel pipes has been largely introduced during the past 30 years. The durability of several old wrought-iron pipes and the short life of a number of newer steel pipes have led many engineers to believe that wrought iron is preferable. The evidence is not conclusive, however, but steel costs less than wrought-iron, and the largest size of wrought-iron plates which can be successfully manufactured is much smaller than the steel plates used in large size steel pipes. For these reasons the use of steel pipes has largely superseded the use of wrought-iron pipes. The steel used is made by the open-hearth process; it has a tensile strength of 50,000 to 65,000 pounds per square inch, an elastic limit not less than 30,000 pounds per square inch, and a working tensile strength, usually taken at 15,000 to 20,000 pounds per square inch.

DESIGN OF STEEL PIPES

Stresses and Thickness of Pipe.—The stresses which may act on a steel pipe are:



FIG. A.—Steel pipe. Kelowna Irrigation Co., B. C.



FIG. B.—36-inch wooden stave continuous pipe.

(Facing page 240)



FIG. D.—72-inch continuous fir stave pipe, 120-foot head, for King's Hill Irrigation & Power Co., Boise, Idaho. (Pacific Tank & Pipe Co.)

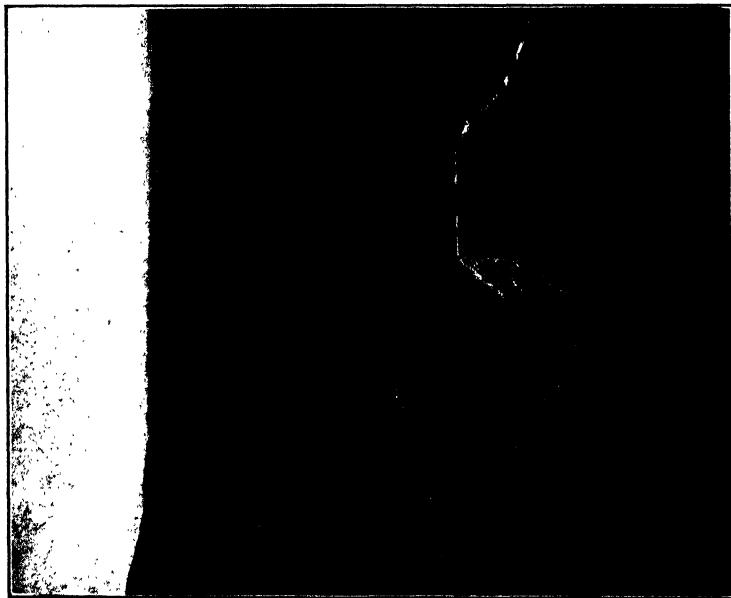

FIG. C.—66-inch continuous fir stave siphon for Wyoming Land & Irrigation Co. (Pacific Tank & Pipe Co.)

1. The tensile circumferential stress resulting from the internal water pressure, including when necessary an allowance for water-hammer.

2. The circumferential stresses produced by the weight of the backfill.

3. The longitudinal stresses due to the beam action of the pipe, when the pipe is supported on piers or when because of poor backfill it is not equally supported.

4. The longitudinal stress resulting from temperature changes.

5. The stress produced at bends.

The thickness of the pipe is usually determined only for the tensile stress resulting from the internal water pressure, by the formula:

$$t = \frac{pr}{Se}$$

p = total internal pressure in pounds per square inch.

r = radius of the pipe in inches.

S = working safe tensile strength on the steel per square inch of the net area.

e = efficiency of the joints.

The value of S when no allowance must be made for water-hammer ranges from 15,000 to 20,000 pounds per square inch; the value of 16,000 is commonly used.

Generally pipe lines used as inverted siphons on irrigation systems are not subject to water-hammer. Allowance for water-hammer is made only when variations in the velocity may be produced by the operation of gate valves or other cause, and is dependent on the velocity, the rate of variation, the length and size of the pipe. The allowance to be made can be obtained when all the conditions are known by the use of certain formulas based on theoretical considerations. E. Kuichling made a number of measurements on a 24-inch pipe line, and concludes that for long and large pipe conduits the water ram caused by closing a stop gate would not induce an internal pressure greater than 1.5 times the static pressure. In these experiments the gate valve was closed as rapidly as possible, in about 20 minutes. Allen Hazen has also suggested a 50 per cent. allowance for water-hammer.

The stress produced by the weight of the backfill is often neglected, especially in steel pipe lines placed in shallow trenches,

with only 2 or 3 feet of earth covering. The formula generally used is that obtained by Professor Talbot, and results from experiments on the strength of cast-iron pipes. The load is assumed distributed uniformly in a horizontal direction over the pipe and the upward pressure is similarly distributed. This produces a shortening of the vertical diameter and a lengthening of the horizontal diameter. The maximum resulting bending moment in inch-pounds is:

$$M = \frac{1}{16} Wd$$

where W is the total vertical load on the pipe in pounds and d is the diameter in inches.

Pressure on the sides reduces the bending moment. Experiments by Emil Kuichling indicate that when the depth of covering is from 3 to 7 feet and where a good support on the bottom is given by dry or well-tamped sand, the external load due to backfill may be taken at from $\frac{1}{5}$ to $\frac{1}{2}$ of the weight of the material; but he states that until further investigations have been made it will be prudent to assume that the total load, where not affected by moving loads, is at least $\frac{2}{3}$ of the weight of the backfill.

Using the above formula and the additional notation stated below, with a weight of earth of 100 pounds per cubic foot, the maximum circumferential stress is obtained as follows:

$$M = \frac{1}{16} h \times \frac{100}{12 \times 12} \times d^2 = \frac{1}{6} St^2$$

from which $S = 0.26 \frac{hd^2}{t^2}$ and $t = \frac{1}{2} d \sqrt{\frac{h}{S}}$

where S = stress in pounds per square inch
 t = thickness of pipe in inches.
 h = height of backfill in feet.

To allow for variations in the thickness of the metal and to increase the durability against corrosion the computed required thickness is often increased $\frac{1}{16}$ of an inch.

Expansion and Contraction and Temperature Stresses.—A steel pipe line, covered with earth is subject to changes in temperature, the range of which when the pipe is full of water will be intermediate between that of the soil and of the water. A short pipe line of large diameter when full will have a range of temperatures nearly equal to that of the water, while a long pipe line of small diameter will have a range of temperature nearly equal to that of the soil.

A short steel pipe line left uncovered, when full of water will have a range of temperature nearly equal to that of the water; but if of small diameter and of large length, with the water flowing slowly or stationary, the range of temperature may be much greater and approach that which the exposed pipe line would have when empty.

The range of soil temperatures as compared with that of atmospheric temperatures is illustrated by the following values obtained from daily measurements at Moscow, Idaho, in 1901 (Bull. 35, University of Idaho, Moscow, Idaho).

ATMOSPHERIC TEMPERATURES AT MOSCOW, IDAHO

Minimum atmospheric temperature at Moscow, Idaho, in 1901.....	7° Fahrenheit
Maximum atmospheric temperature at Moscow, Idaho, in 1901.....	99° Fahrenheit
Difference.....	92° Fahrenheit
Average of minimum daily atmospheric temperatures during coldest month in 1901	
	22.02° Fahrenheit
Average of maximum daily atmospheric temperatures during warmest month in 1901.....	
	84.84° Fahrenheit
Difference.....	62.82

SOIL TEMPERATURES AT MOSCOW, IDAHO, IN 1901

Depth of soil in feet	Minimum temperature, degrees Fahrenheit	Maximum temperature, degrees Fahrenheit	Range, degrees Fahrenheit
1	32	69	37
2	34	68	34
3	36	65	29
4	37	62	25
5	38	60	22
6	39	58	19

The temperature of the water as it enters the pipe line will range from a minimum temperature which may approach the freezing temperature of 32° Fahrenheit to a maximum temperature which will seldom exceed 80° Fahrenheit. The above considerations indicate that the range of temperature of a steel pipe,

covered with 2 feet or more of earth will seldom exceed 40° Fahrenheit.

The variations in temperatures, acting on a steel pipe, fixed so as to neither contract nor expand, will produce longitudinal compressive or tensile stresses, the magnitude of which is dependent on the temperature at which the pipe was laid; if laid at the maximum temperature which it will have when buried, then the maximum tensile stress will be:

$$\begin{aligned} S_t &= 40 \times 0.0000065 \times 30,000,000 \\ &= 7,800 \text{ pounds per square inch of the gross area of the metal.} \end{aligned}$$

This is considerably less than the strength obtained with a single-riveted lap joint.

The range of temperature of an uncovered pipe line will usually be considerably larger and in a pipe line held to prevent expansion and contraction may produce stresses greater than the working strength of the metal, which for the condition of expansion may result in the buckling of the pipe.

Types of Longitudinal and Circumferential Joints.—Steel pipes are made of curved sheets of metal, the edges and ends of which are joined in various ways. Small size pipes up to about 30 inches in diameter are commonly made in lengths of 12 to 15 feet, of one or more rings made of a single sheet with the edges overlapping to form a single longitudinal seam, double lap riveted.

Another type of pipe which has greater joint efficiency is the spiral riveted pipe. This pipe is made in sizes ranging from 3 inches to 42 inches in diameter, and in lengths up to 15 feet for galvanized pipe, and 30 to 40 feet for asphalt-coated pipe. The pipe length is made of a sheet rolled with overlapping edges forming a single-riveted spiral seam around the pipe. With the rivet holes placed on a spiral, the cross-sectional area of metal in any longitudinal section is reduced only to a small extent and greater strength is obtained than with any other type of riveted longitudinal joint. It is stated by the manufacturers that hydraulic tests carried to a bursting pressure show that the spiral seam is the strongest part of the pipe.

In recent years the manufacture of lap-welded steel pipe has been greatly developed. This kind of pipe is now made from 12 to 72 inches in diameter in lengths up to 20 feet. The ad-

vantages claimed for it are greater joint strength than when riveted and a perfectly smooth interior, and therefore greater carrying capacity than with a riveted pipe of the same size.

The lock-bar longitudinal joint pipe is another type of pipe, first used on a large scale for the Coolgardie pipe line in Australia, 30 inches in diameter and 370 miles in length, and since 1904 largely adopted in the United States. The pipe is ordinarily made of two plates bent to semicircles and of two double grooved locking bars to join the edges of the plates and make the longitudinal seams (Plate XXII, Fig. A). The edges of the plates are first upset, then inserted into the opened grooves of the locking bars, and the grooves are closed by pressure from a hydraulic press. For large size pipes, four quadrant plates and four bars would be used. The pipe is now made in almost any size from 16 inches to 10 feet in diameter, and in lengths up to 30 feet. The advantages of this kind of pipe over the usual riveted pipe are: joint strength, equal to the strength of the plate, and no protruding rivet heads in the length of the section. It is also stated to be cheaper.

The types of circumferential joints used for small size pipes depend on the size, the kind of pipe, and the pressure (Plate XXII, Fig. B). For pipes up to 40 inches in diameter and low pressures the slip joint may be used. This joint is made by a sleeve placed inside and attached to one end of the pipe. The projecting end of the sleeve is covered with canvas or burlap, soaked in red lead or liquid asphaltum, and then driven into the end of the adjoining pipe. For larger pressures the pipe ends may be riveted to forged steel flanges, which are connected together by bolting, with a gasket in between; or the pipe ends may be left plain and the joint made with a forged steel bolted joint, which consists of two angle flanges, between which is a central sleeve surrounding the joint and two rubber rings, one along each edge of the sleeve, which are compressed by drawing the flanges together with bolts. This latter joint allows slight deflection, which permits its use in making long radius bends, allows contraction and expansion, and is of special advantage if the pipe line is liable to settle. The sections of lock-bar pipe are connected together with either flange joints or bolted joints as described above or, for the larger sizes, with single or double riveted butt or lap joints.

Large size steel pipes are commonly riveted along the longi-

tudinal and circumferential seams. The pipes are usually built of rings, each made of a single sheet and riveted together in the shop to make sections 20 to 30 feet in length. These sections are then connected in place by riveting. The longitudinal seams are generally double-riveted lap joints for low pressures, and either triple-riveted lap or triple-riveted butt for high pressures. Circumferential seams are usually single-riveted or double riveted lap joints. When the pipe is supported above ground on piers, it is desirable to increase its strength against flexure by placing the longitudinal seams near the top of the pipe. After riveting is completed, the edges of the plates must be carefully driven in or calked to make the joints tight.

Design of Riveted Joints.—The design of riveted joints for steel pipes involves a consideration of the tensile stress on the net section of the plate, the shearing stress on the rivets, and the compressive or bearing stress of the plate upon the rivets; in addition the spacing of the rivets must insure water-tightness. Failure usually occurs either by rivet shearing or by tearing of the plate. The efficiency of the joint will depend on the type of joint, the diameter and spacing of rivets. The principles of design are presented in standard books on strength of materials. Special reference is recommended to Chapter XIII of "The Elasticity and Resistance of the Materials of Engineering," by Burr (Wiley & Sons, New York).

The longitudinal seams of riveted pipes are usually double-riveted lap joints. Triple-riveted lap joints will usually not be economical, for their efficiency is not much higher than that of double-riveted lap joints. For high pressures and large pipes double- or triple-riveted butt joints with double cover plates will often be economical.

The circumferential seams are usually single-riveted lap joints, except for pipes, in which the longitudinal seams are triple-riveted butt, when double-riveted circumferential joints are often used. For thick plates circumferential butt joints, with single outside cover plates, may be used to advantage to give an interior surface offering less obstruction to the flow.

The diameter of the rivets is usually determined empirically. Unwin gives the following rule:

$$d = 1.2 \sqrt{t}$$

where d = diameter of rivet in inches, t = thickness of plate in inches



Fig. A.—Details of lock-bar steel pipe.

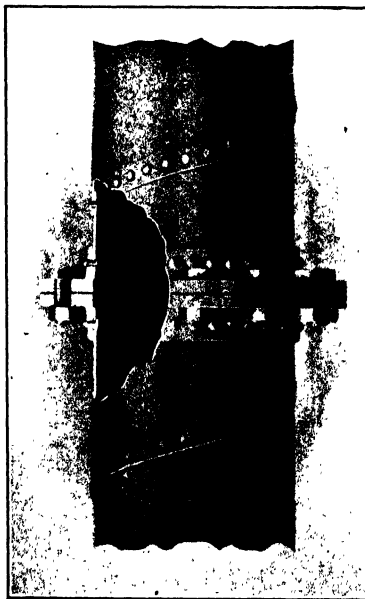
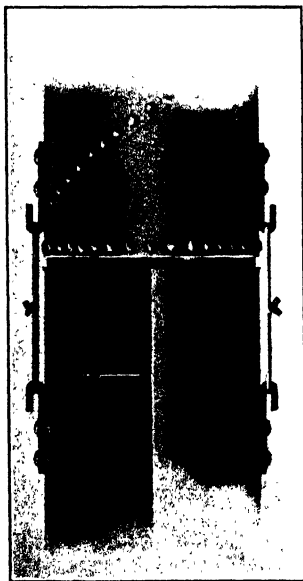
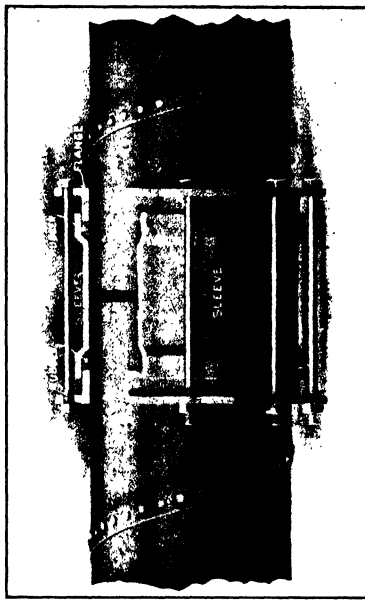
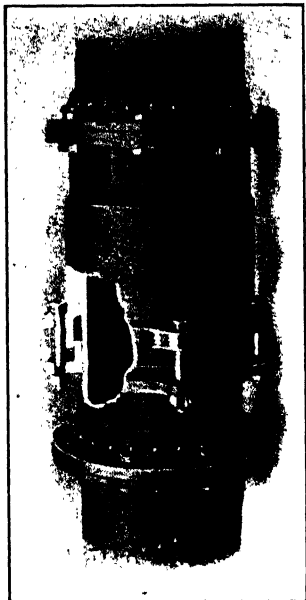

FIG. B.—Types of joints for steel pipes. (American Spiral Pipe Works.)

Burr suggests that the diameter will range between the following values:

$$d = 0.75 t + 0.375$$

$$d = 0.875t + 0.375$$

and states that for the heaviest plates the values obtained from these expressions are too large, the diameter rarely exceeding 1 inch. The following tables and accompanying diagrams (Fig.

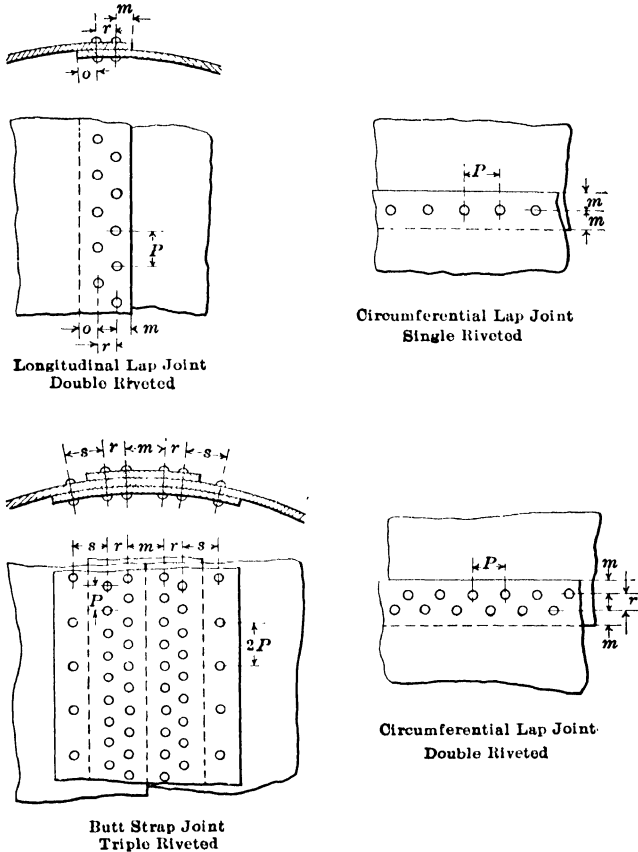

FIG. 55.—Details of types of riveted joints for steel pipes.

55) give the dimensions of riveted joints, obtained from the Hartford Steam Boiler Inspection and Insurance Co., and from recent designs and tables of the Pacific Gas and Electric Co., California. The Hartford designs were used on pipe lines of the Los Angeles aqueduct and are based on an ultimate tensile strength of 60,000 pounds per square inch and an ultimate shear-

ing strength of 38,000 pounds per square inch. The diameter of rivet hole is $\frac{1}{16}$ larger than that of the rivet.

DIMENSIONS IN INCHES OF RIVETED JOINTS FROM DESIGNS OF HARTFORD STEAM BOILER INSPECTION AND INSURANCE CO.

I. Longitudinal lap joint, double riveted, with circumferential lap joint, single riveted

Thickness of plates	Diameter of rivets	Longitudinal lap joint, double riveted				Circumferential lap joint, single riveted	
		<i>P</i>	<i>r</i>	<i>m = o</i>	Efficiency	<i>P</i>	<i>m</i>
$\frac{1}{4}$	$1\frac{1}{16}$	$2\frac{7}{8}$	$1\frac{15}{16}$	$1\frac{1}{8}$	0.74	$2\frac{1}{16}$	$1\frac{1}{8}$
$\frac{5}{16}$	$\frac{3}{4}$	$2\frac{7}{8}$	$1\frac{15}{16}$	$1\frac{7}{32}$	0.72	$2\frac{1}{8}$	$1\frac{7}{32}$
$\frac{3}{8}$	$\frac{7}{8}$	$3\frac{1}{4}$	$2\frac{3}{16}$	$1\frac{13}{32}$	0.70	$2\frac{3}{8}$	$1\frac{13}{32}$
$\frac{7}{16}$	$1\frac{5}{16}$	$3\frac{1}{4}$	$2\frac{3}{16}$	$1\frac{1}{2}$	0.70	$2\frac{1}{16}$	$1\frac{1}{2}$
$\frac{1}{2}$	1	3.32	2 2	$1\frac{19}{32}$	0.68	$2\frac{1}{2}$	$1\frac{19}{32}$

II. Longitudinal lap joint, triple riveted, with circumferential lap joint, double riveted

Thickness of plates	Diameter of rivets	Longitudinal lap joint, triple riveted				Circumferential lap joint, single riveted	
		<i>P</i>	<i>r</i> ¹	<i>m</i>	Efficiency	<i>P</i>	<i>m</i>
$\frac{1}{4}$	$\frac{5}{8}$	3	2	$1\frac{1}{32}$	0.77	$2\frac{1}{16}$	$1\frac{1}{32}$
$\frac{5}{16}$	$1\frac{1}{16}$	$3\frac{1}{8}$	$2\frac{1}{16}$	$1\frac{1}{8}$	0.76	$2\frac{1}{8}$	$1\frac{1}{8}$
$\frac{3}{8}$	$\frac{3}{4}$	$3\frac{1}{4}$	$2\frac{3}{16}$	$1\frac{7}{32}$	0.75	$2\frac{1}{8}$	$1\frac{7}{32}$
$\frac{7}{16}$	$\frac{7}{8}$	$3\frac{3}{4}$	$2\frac{1}{2}$	$1\frac{13}{32}$	0.75	$2\frac{13}{8}$	$1\frac{13}{32}$
$\frac{1}{2}$	$1\frac{5}{16}$	$3\frac{15}{16}$	$2\frac{5}{8}$	$1\frac{1}{2}$	0.75	$2\frac{1}{2}$	$1\frac{1}{2}$

DIMENSIONS IN INCHES OF RIVETED JOINTS FOR STEEL PIPES FROM STANDARD DRAWINGS OF PACIFIC GAS AND ELECTRIC CO., SAN FRANCISCO, CAL.

I. Longitudinal lap joint, double riveted, and circumferential lap joint, single riveted

Thick-ness of plates	Cold diameter of rivets	LONGITUDINAL JOINT, DOUBLE-RIVETED LAP					CIRCUMFERENTIAL JOINT, SINGLE LAP		
		<i>P</i>	<i>r</i>	<i>m</i>	<i>o</i>	Efficiency, per cent.	<i>P</i>	<i>m</i>	Efficiency, per cent.
$\frac{3}{16}$	$\frac{1}{2}$	2	$1\frac{1}{4}$	$1\frac{1}{8}$	1	66.0	$1\frac{3}{8}$	1	50.0
$\frac{1}{4}$	$\frac{5}{8}$	$2\frac{3}{8}$	$1\frac{1}{2}$	$1\frac{3}{8}$	$1\frac{1}{4}$	66.0	$1\frac{3}{4}$	$1\frac{1}{4}$	49.0
$\frac{5}{16}$	$\frac{3}{4}$	$2\frac{3}{4}$	$1\frac{3}{4}$	$1\frac{5}{8}$	$1\frac{3}{8}$	66.0	2	$1\frac{1}{2}$	51.0
$\frac{3}{8}$	$\frac{3}{4}$	$2\frac{7}{8}$	$1\frac{3}{4}$	$1\frac{5}{8}$	$1\frac{3}{8}$	67.5	2	$1\frac{1}{2}$	49.0
$\frac{7}{16}$	$\frac{7}{8}$	$3\frac{1}{8}$	2	$1\frac{3}{4}$	$1\frac{1}{2}$	66.0	$2\frac{3}{8}$	$1\frac{3}{4}$	46.5

¹ Center row of rivets is equally distant from inner and outer rows of rivets.

II. Longitudinal butt strap joints, triple riveted, and circumferential lap joint, double riveted

Thick-ness of plates	Thick-ness of strap	Cold di-am-eter of rivets	Longitudinal joint, triple-riveted butt						Circumferential joint, double lap				
			P	m	r	s	o	v	Effi-ciency	P	r	m	Effi-ciency
3/16	3/8	7/8	3 3/4	3	2	3 1/4	1 3/4	1 1/2	85.0	3	2	1 1/2	69.0
1/2	7/16	7/8	3 5/8	3	2	3 1/4	1 3/4	1 1/2	84.0	3 1/4	2	1 1/2	64.5
9/16	1/2	1	4	3 1/4	2 1/4	3 1/2	2	1 5/8	84.0	3 1/4	2 3/8	1 7/8	67.5
5/8	1/2	1	4	3 1/4	2 1/4	3 1/2	2	1 5/8	83.0	3	2 3/8	1 7/8	61.0
1 1/16	9/16	1	3 3/4	3 1/4	2 1/4	3 1/2	2 1/8	1 5/8	83.0	3	2 3/8	2	60.0
3/4	9/16	1	3 3/4	3 1/4	2 1/4	3 1/2	2 1/8	1 5/8	81.5	3	2 3/8	2	55.0
13/16	5/8	1 1/8	4 1/8	4	2 3/8	4	2 3/8	1 3/4	83.0	3 3/8	3	2 1/4	56.5
7/8	5/8	1 1/8	4 1/8	4	2 3/8	4	2 3/8	1 3/4	82.0	3 3/8	3	2 1/4	52.5
15/16	3/4	1 1/8	4 1/8	4	2 3/8	4	2 3/8	1 3/4	81.5	3 3/8	3	2 1/4	49.0
1	3/4	1 1/8	4 1/8	4	2 3/8	4	2 3/8	1 3/4	81.0	3 3/8	3	2 1/4	46.0

Examples of Steel-pipe Installations.—The most important riveted steel pressure pipes recently constructed in the west are the inverted siphons and pressure pipe lines of the new Los Angeles water supply system. On the Los Angeles aqueduct proper the aggregate length is 9.39 miles and the diameters vary from 7 feet 6 inches to 11 feet and from the end of the Los Angeles aqueduct to the city of Los Angeles the San Fernando siphon of the main city trunk line is 12 miles in length and from 72 to 62 inches in diameter. The specifications for chemical and physical properties of the metal were made to conform to the standard specifications of the American Society for Testing Materials, for boiler plate and rivet steel, which were known by years of experience to give a satisfactory class of steel.

The *Jawbone siphon* of the Los Angeles aqueduct crosses the deepest canyon on the aqueduct line; it is 7,096 feet long, and operates under a maximum pressure head of 850 feet below the hydraulic grade line. On account of the great pressure the siphon was designed to give a minimum weight of steel. To obtain this, the two legs of the siphon taper from a diameter of 10 feet at the upper ends to a diameter of 7 feet at the bottom of the canyon. The pipe line was laid above ground, as in this position it is open to inspection and deteriorates less rapidly than when buried, especially in alkali soil, as it would have been in this case. No water-hammer or possibility for shocks occur. The pipe is built of rings formed of a single plate; the thickness increases from 1/4 inch at the upper ends to 1 1/8 inches at the

bottom. Where the thickness is over $\frac{1}{2}$ inch the longitudinal joints are triple riveted, double cover plates, butt joints, and for $\frac{1}{2}$ inch or less lap joints were used. The pipe was built on concrete piers 2 feet thick, supporting one-quarter of the circumference of the pipe, spaced 36 feet center to center at the bottom of the canyon, and closer on the hillsides.

The Antelope siphon on the Los Angeles aqueduct is 4.11 miles long, 10 feet in diameter, with a maximum head of 200 feet. For 2,750 feet at the north end and 3,447 feet at the south end, the pipe is of reinforced concrete and extends down to a maximum pressure head of 80 feet; between these two sections the steel siphon is 15,597 feet in length, built of single plate rings, each 6 feet long. The pipe line is made up as follows:

Length	Safe head, feet	Thickness of plate	Longitudinal joint	Size of rivets, inch
2,690	100	$\frac{1}{4}$	Double riveted.	$\frac{5}{8}$
4,559	144	$\frac{1}{4}$	Triple riveted.	$\frac{5}{8}$
3,698	180	$\frac{5}{16}$	Triple riveted.	$\frac{5}{8}$
4,650	210	$\frac{3}{8}$	Triple riveted.	$\frac{3}{4}$

The circumferential seams are single-riveted lap joint. The pipe was built in a shallow trench and backfilled about $\frac{1}{3}$ of its circumference in the sand. The tensile stress on the gross section produced by the above stated safe heads is about 10,000 pounds per square inch for the double-riveted plates, and 15,000 pounds per square inch for the triple-riveted plates; assuming efficiencies of 72 and 80 per cent., respectively, for the double- and triple-riveted joints, the tensile stresses on the net steel section are about 14,000 and 18,750 pounds per square inch.

The San Fernando siphon, 12 miles in length, decreases from a diameter of 72 to 62 inches, and has a maximum pressure head of 260 feet. The thickness of the steel plates ranges from a minimum of $\frac{1}{4}$ -inch for the 72- and 62-inch pipe, to a maximum of $\frac{3}{8}$ -inch for 66- and 64-inch pipe. The longitudinal seams are lap joints, double riveted for the $\frac{1}{4}$ -inch plate, and triple riveted for the $\frac{5}{16}$ - and $\frac{3}{8}$ -inch plate. The circumferential seams are lap joints, single riveted, made with alternate inside and outside rings, each about 6 feet long. The riveting was done according to the Hartford Boiler Standard Specifications; $\frac{5}{8}$ -inch rivets were used on the $\frac{1}{4}$ - and $\frac{5}{16}$ -inch plate, and $\frac{3}{4}$ -inch

rivets on the $\frac{3}{8}$ -inch plate. The pipe line was built in a trench and was given an earth covering of 3 to 4 feet on the top of the pipe. The pipe is designed for a factor of safety of four, or 15,000 pounds per square inch on the net section. The efficiency of the riveted joints ranges from 72 to 80 per cent.

Ingot Iron Pipes.—Ingot iron is manufactured by the open-hearth process, in which it receives special treatment to remove practically all the impurities found in wrought-iron or steel. Its chemical composition is very nearly the same as the best wrought iron; the slag is practically all removed, and results of analysis show the pure-iron content to be over 99.8 per cent. Its ultimate tensile strength is from 40,000 to 50,000 pounds per square inch, and its physical properties regarding elongation and reduction of area are stated to be equal or superior to that of soft mild steel. The chief advantage claimed for ingot iron over steel or wrought iron is that the homogeneous composition and the lack of impurities produce a higher resistance to corrosion. This claim is backed by short time acid tests. That the results of these tests must not be taken as conclusive is indicated by the results of recent tests extending for a period of 12 months, in which samples of various brands of iron and steel were placed in different soils, periodically saturated with water, with little or no decided advantage in favor of ingot iron (*Tests of the Resistance to Corrosion of Various Brands of Iron and Steel*, by J. I. Campbell, p. 255, *Engineering News*, July 30, 1914). It is also reported that pure iron plates were considered for the Los Angeles aqueduct pipe lines, but that tests were made and showed that while it will resist deterioration from acids better than steel, it showed no advantage in the alkalis, such as are encountered in the southwestern soils of California. In these tests the rate of general corrosion is obtained by the loss in weight of the metal; but experience shows that the life of steel pipe is measured not by its resistance to general corrosion but by the local corrosion, and especially by the pitting or holes which result largely from the unequal dissemination of impurities. It is therefore safe to presume that the more homogeneous metal, as obtained with ingot iron, will give a more durable pipe.

The practical use of ingot iron has been developed only during the past few years. It has been largely used for steel flumes and corrugated pipe culverts. The writer knows of only one case where it has been used for large-size pressure pipes; this is on the

Uncompaghre U. S. Reclamation Service project, in Colorado. The pipe line, built in 1910, is an inverted siphon, which crosses a depression about 3,800 feet wide, with a maximum depth of about 200 feet. The diameter is 26 inches and the thickness of the plate $\frac{5}{16}$ inch, which gives a tensile stress on the gross area of the steel of only 3,600 pounds per square inch. The pipe line is in strong alkali soil, which probably accounts for the excess thickness of the pipe. The pipe line is formed of 30-foot sections, with bolted flange joints; each section is built of five rings about 6 feet in length, with double-riveted longitudinal seams and single-riveted circumferential joints. The pipe was coated with approved pipe coating, applied before leaving the factory, at a temperature of 400° Fahrenheit. The analyses and physical tests on twenty-eight samples gave the following results:

Ultimate strength in pounds per square inch.....	40,580-59,000
Elastic limit in pounds per square inch.....	22,800-46,750
Elongation in 8 inches length, per cent.....	10-37
Reduction of area, per cent.....	39-88
Carbon, per cent.....	0.01-0.02
Phosphorus, per cent.....	0.001-0.011
Sulphur, per cent.....	0.017-0.024
Manganese, per cent.....	0.01-0.02
Oxygen, per cent.....	0.020-0.037

Covering Steel Pipes.—In localities of winter temperatures much below freezing, pipe lines which are operated throughout the year, as for domestic water supply and in hydroelectric plants, must usually be covered. An earth covering is also desirable to prevent excessive temperature stresses resulting from extreme variations in temperatures, and may be necessary when the pipe line is in the way of traffic or exposed to external injury from falling rock or other cause. On the other hand a pipe line left uncovered is easily inspected and repaired and will be more durable than when covered, especially when the soil contains alkali salts. The danger of freezing can be eliminated with pipe lines used for irrigation by draining them empty, at the end of the irrigation season.

The depth of earth covering required for protection against freezing will seldom exceed 3 feet, except in very cold winter climates, where small pipes may have to be covered to a depth of 4 feet. An excessive depth of covering will cause distortion or flattening of the pipe, which may produce an undue stress in

the steel. Measurements made by D. D. Clarke on pipe lines of the Portland Waterworks, Oregon, 42 inches in diameter and 0.22 to $\frac{3}{8}$ inch thick showed that with a total depth of earth covering of $5\frac{1}{4}$ feet, with the lower part properly rammed in 6-inch layers up to the top of the pipe, the flattening was less than 1 inch. Mr. E. Kuichling states that steel pipes, 3 to 6 feet in diameter, $\frac{1}{4}$ to $\frac{1}{2}$ inch thick, laid in carefully graded trenches, backfilled with well-packed selected material under the lower half of the pipe, and with a total depth of compact earth covering to a depth of 5 to 8 feet, may produce a flattening of as much as 10 per cent. of the diameter. Much depends on the backfilling; if this be properly done, a depth of $3\frac{1}{4}$ to 4 feet for pipes as great as 6 feet in diameter and $\frac{1}{4}$ inch thick will not be excessive. Where additional stiffness is necessary, as for larger thin pipes or deeper trenches or for pipes subject to unusual loading, additional stiffness may be obtained by stiffening rings formed of angle irons riveted to the pipe or by placing the lower third of the pipe on a bed of lean concrete.

Expansion Joints in Steel Pipes.—Expansion joints are not generally used for covered pipe lines, and may not be necessary for exposed pipe lines properly anchored, when a continuous flow of water can be maintained to prevent excessive variations in temperature. This is well illustrated by the experience on the Antelope Valley siphon of the Los Angeles aqueduct. The upper ends of this siphon are of reinforced concrete, the central portion is of riveted steel, 2,750 feet in length, 10 feet in diameter, $\frac{1}{4}$ to $\frac{3}{8}$ inch thick, laid in a shallow trench and backfilled to about the lower third of its circumference. On account of the intense heat in the day time the pipe joints were riveted in the shallow trench at night. During construction, the expansion in this pipe amounted to 23 inches from the coolest part of the day to the hottest part, but as soon as the pipe was filled with water this movement ceased. This resulted from the pipe being held to a very nearly uniform temperature and from the weight of the water increasing the frictional resistance to sliding along the surface of contact between the lower third of the pipe and the earth surface. On this pipe line there are no expansion joints; each end of the pipe is fixed by the connection with the reinforced concrete pipe, and when in its contracted condition, mass concrete anchorages were built, incasing the pipe at intervals for a length of 27 feet. These anchors of rein-

forced concrete arc 15 feet wide, extend 10 feet beneath the pipe and cover the pipe to a thickness of $1\frac{1}{2}$ feet. On the other exposed inverted steel siphons of the Los Angeles aqueduct the same practice was adopted, no expansion joints being used.

There is considerable difference in opinion regarding the need for expansion joints for exposed pipe lines, in which a continuous flow is maintained. There is less need of them for large pipes and a high velocity of flow, which are both favorable to the maintenance of a uniform temperature. The need is greater for thin pipes than for thick pipes because of the smaller resistance of thin pipes against the buckling force, resulting from the compression produced by expansion, when the pipe is confined by anchorages. This was apparently considered in the design of a pipe line recently constructed by the Pacific Gas and Electric Co. of California for Power House No. 5 of Lake Spaulding Development. This pipe line, 6,712 feet in length, decreases from 84 inches in diameter at the upper end or forebay end to 66 inches at the lower end or power house end, and increases in thickness from $\frac{5}{16}$ inch at the upper to $1\frac{1}{16}$ inch at the lower end. The pipes were placed in a shallow trench carefully back-filled to a small depth above the horizontal diameter, leaving nearly all the upper half exposed. The pipe line was anchored at intervals, and on the upper section where the pipe is less than $\frac{1}{2}$ inch thick (about 6,100 feet in length) four expansion slip joints were installed. The expansion joints are of a standard type developed by the Company and are illustrated by Fig. 56, which explains the construction.

On steel pipes used for irrigation a continuous flow is not usually maintained, and even if the pipe line can be kept full with stationary water, when a continuous flow is not possible, the variations in temperature because of the still water will be much greater, especially if the pipe is exposed. It will then be necessary, for exposed pipes at least, to provide expansion joints. One of the few large steel pipe lines used for irrigation is that installed on the Uncompaghre Valley project in Colorado. This pipe line is an inverted siphon 3,800 feet long, 26 inches in diameter, built of ingot iron, and although entirely covered is provided with expansion joints of the same type as used by the Pacific Gas and Electric Co. Two other types of expansion joints used by A. B. Moncrieff in Australia are shown in Fig. 56. The expansion joint, used for the Bundaleer Water Works,

Western Australia, is formed of curved flanges, riveted to the ends of the pipe sections, and bolted together at abutting ends with a gasket of sheet lead in between and two outside rings. The expansion joint used for the Happy Valley Water Works, Australia, is formed of a corrugated flange, riveted along the edges to the abutting ends of the pipe sections. The pipe line is 6 feet in diameter, entirely exposed and subject to a change in

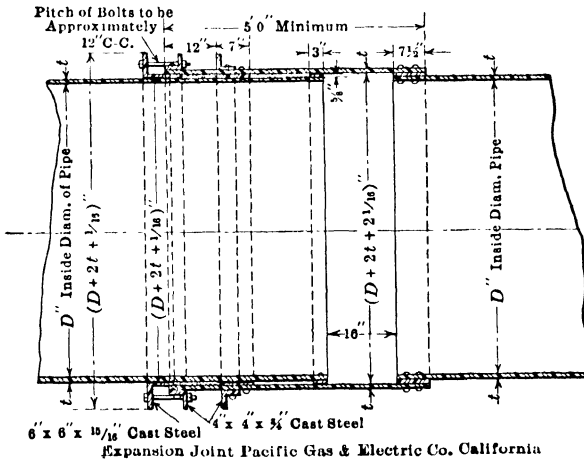
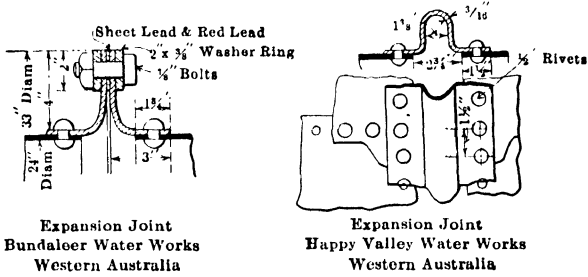

FIG. 56.—Standard type of expansion joint, developed by Pacific Gas & Electric Co., Calif.

temperature ranging from below freezing to over 170° Fahrenheit in the sun.

Special types of expansion joints are furnished by some of the manufacturers of steel pipes. The loose-bolted flange joint with compressible rubber rings, previously described in the type of joints used for connecting pipe lengths, allow limited expansion and contraction (Plate XXII, Fig. B). They can also

be used for the single purpose of expansion joint by inserting them at intervals on pipe lines where the other joints are riveted or rigid bolted flange joints. The American Spiral Pipe Works states that it is customary to use such expansion joints at intervals of about 400 feet.

The use and spacing of expansion joints must be based largely on experience and judgment and on a consideration of the factors affecting contraction and expansion. Where the pipe line is anchored and on a flat slope, expansion joints should be about halfway between anchors, in order that the resulting temperature forces acting on each side of the anchor blocks be about balanced. An exposed pipe line, of thin shell, subject to large changes in temperature, must be provided either with expansion joints or anchorages at close intervals, or the compressive stress induced by expansion will cause a tendency to buckle the pipe. The length of slippage to be provided for in an expansion joint must be determined from computations of the linear changes in length of the section of pipe line considered.

In general, unless the temperature of an exposed pipe line can be maintained fairly uniform, it will be preferable to cover the pipe entirely.

Supports for Steel Pipe Lines Built above Ground.—As indicated by preceding discussions, steel pipe lines may be entirely buried, partly exposed with the lower half or third embedded, or entirely exposed above ground. For above ground construction, the pipe is generally built on concrete piers, spaced according to the thickness of the pipe, by considering the beam strength of the pipe for the span between piers. This form of construction was used on the Jawbone siphon of the Los Angeles aqueduct; at the lowest part of the siphon where the pipe is 7 feet in diameter and $1\frac{1}{8}$ inches thick the piers were spaced 36 feet apart. The standard type of pier is shown in Fig. 57. The piers were built up to subgrade of the pipe with the reinforcement left projecting from the sides, and were completed after the pipe had been built on them and filled with water to give it the proper shape. The upper 1,600 feet of the San Fernando siphon where the pipe is 6 feet in diameter, $\frac{1}{4}$ inch thick, is supported on piers similarly constructed; 18 inches thick, 7 feet wide, with vertical sides and faces; spaced 24 feet on centers.

To carry the pipe line over a stream, the pipe is generally either supported on piers or carried on a bridge. In a few cases the

pipe is made a self-supporting arch, bridging the stream. A notable example is on a riveted steel-pipe penstock at the crossing over the River Arc in France. The pipe line is 10.8 feet in diameter, and at the crossing is $1\frac{1}{16}$ inch thick. The self-supporting arch has a span of 223 feet, an arc radius of 262 feet, and a rise of 19.7 feet. Further reference to stream crossings is considered in the discussion of wooden stave pipe.

Anchorage for Steel Pipe Lines.—Covered pipe lines obtain usually sufficient resistance against displacement by the surrounding backfill to need no anchorage. Pipe lines which are only partly backfilled or entirely exposed may need anchorages

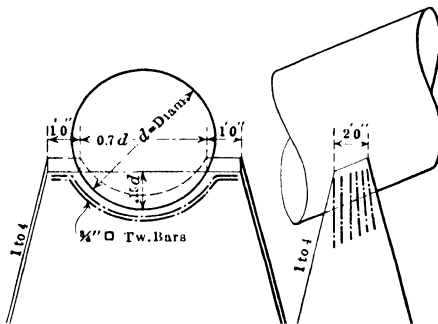

FIG. 57.—Standard piers for steel pipe. Jawbone Siphon, Los Angeles Aqueduct, Calif.

as follows. *First*, at horizontal bends to resist the outward push or resultant force. *Second*, at vertical convex bends to resist the outward or upward resultant force which tends to lift the pipe off of its base. *Third*, on steep side hills to resist the downhill sliding forces.

Vertical Convex Bends.—The forces acting on an anchor at a vertical convex bend include all those acting on the other types of anchor with certain additional ones. A consideration of a vertical anchor will, therefore, involve the principles of design applicable to the other types. The forces which may be acting on a convex vertical bend are illustrated in the accompanying sketch, they include:

1. The outward or vertical resultant internal force P_w due to water pressure, produced by the change in direction of the two internal water pressures P_1 and P_2 .

2. The outward or vertical resultant temperature force P_t produced by the compression due to expansion.

3. Counterbalancing inward or downward resultant temperature pull P'_t produced by tension due to contraction.

4. The outward centrifugal force P_c .

5. The resultant sliding force P_s produced by the tendency for the pipe line to slide downhill.

6. The counterbalancing inward or downward force P_a produced by the weight of the metal and water in the bend and of the backfill on the bend.

Forces (2) and (3) cannot act at the same time. Force (2) will act when the temperature of the pipe becomes greater than that obtained when the anchor was constructed, and its magnitude will depend on the difference in temperature which produces the expansion. It is the resultant of two forces acting similarly to the components P_1 and P_2 of the resultant pressure P_w . Force (2) will not often exist at the time that a continuous flow is maintained in the pipe, because the flow of water will usually keep the temperature of the pipe lower than the temperature at which the anchorage was constructed. When empty, the temperature of the pipe is more liable to produce expansion of considerable magnitude; in which case the anchorage must be designed for force (2) and not for force (1).

Force (4) is the resultant centrifugal force and is expressed by the equation $P_c = \frac{WV^2}{gR}$ where W is the weight in pounds of the water contained in the bend between the two end faces. V is the velocity in feet per second, and R is the radius of curvature of the bend in feet. This force will usually be comparatively small and in most cases may be neglected.

Force (5) is the resultant of two sliding forces, one uphill from the anchor producing a push on the anchor, and the other downhill from the anchor producing a pull. When the pipe is exposed, each of these forces will approach the component of the weight of the pipe in the direction of the axis of the pipe. When buried, each force is at least partly neutralized by the frictional resistance on the surface of contact.

Force (6) is a counterbalancing force, which if the pipe is buried will usually be sufficient to counterbalance all outward resultant pressure.

To simplify the following presentation of the elements of design, the pipe line shall be assumed to be exposed and only forces (1) and (6) considered. The diagram (Fig. 58) shows a

vertical convex bend. A_1 and A_2 are the end cross sections of the pipe bend in square inches. d is the diameter of the pipe in inches. P_w is the resultant outward water pressure produced by the pressures P_1 and P_2 acting on surfaces whose projected areas are respectively the cross sectional areas A_1 and A_2 . P_1 and P_2 are approximately equal. h is the pressure head on the center of the bend in feet. Therefore

$$P_w = P_1 \sin \frac{\theta}{2} + P_2 \sin \frac{\theta}{2} = \frac{2 \times 62.5}{144} \times \frac{\pi d^2}{4} \times \sin \frac{\theta}{2} \times h$$

or

$$P_w = 0.868 \frac{\pi d^2}{4} \sin \frac{\theta}{2} \times h$$

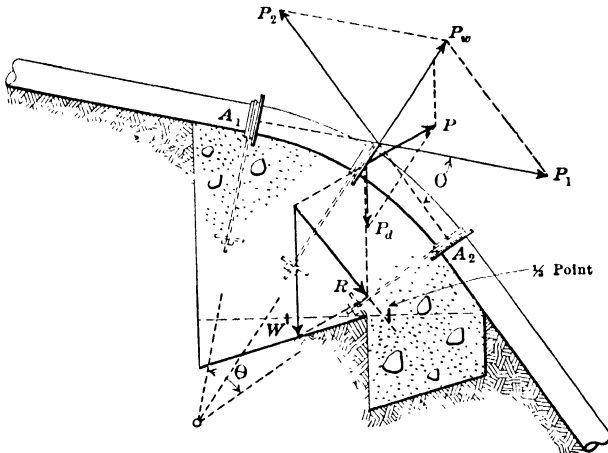

FIG. 58.

P_d is the downward force produced by the weight of the metal and water in the bend. P is the net outward force and is the resultant of P_w and P_d .

The pipe bend must be encased or anchored with tie bars to resist the outward pull P on the anchor, and the anchor block must be dimensioned to give a weight which with P gives a resultant R intersecting the base of the block within the middle third. Where some of the other forces exist, which may either increase or decrease the outer pressure, these may be considered in the manner suggested above.

Horizontal Bends.—These bends are subject to the same forces as vertical bends, with the following differences: *First*, no counterbalancing effect due to the weight of the metal and

water is obtained. *Second*, the tensile force due to contraction, which in vertical bends exerts a downward neutralizing pressure on the anchor, in horizontal bends may, if larger than the outward force due to water pressure, produce inward displacement of the pipe.

Anchors to Prevent Downhill Sliding.—Pipe lines built in trenches, either entirely covered or backfilled up to the horizontal diameter, usually obtain sufficient frictional resistance against sliding to need no anchorage, except on very steep slopes. The usual practice is to provide the necessary anchorage at the bends in the pipe line. Pipe lines which are entirely exposed above ground are usually supported on concrete piers, which act also as anchors and are designed to resist a downhill force equal to the component of the weight of the pipe full of water in the direction of the axis of the pipe.

Anchors to Prevent Buckling by Expansion of Exposed Pipes.—Thin steel pipe lines, either partly exposed or fully exposed and placed on free supports which allow free movement by expansion and contraction, may for certain conditions previously referred to require fixed anchorage at frequent intervals to prevent failure by buckling. The spacing of these anchors varies considerably in practice and is apparently generally based on experience and judgment. To establish a logical basis, it may be assumed that when no expansion joints are used, a straight pipe line between fixed anchors must be considered as a hollow column, in which compressive stress is induced by expansion. Based on this assumption, the following values, obtained from tests made on hollow columns by Christie for the Pencoyd Iron Works, to which has been added the corresponding increase in temperature required to produce the equivalent stress, may be applicable to pipe-line design:

Ratio of length to radius	=	100	180	220	280	320	360	400
Ultimate compressive strength in pounds per square inch	=	30,000	20,000	15,000	10,000	8,000	6,500	5,200
Increase in temperature for equivalent stress, deg. Fahr.	=	153	102	76	51	41	33	27

These values are for ultimate strength of straight columns, and should be applied to pipe lines with much caution. Unless the pipe line is supported for its entire length or is held on supports placed close together, the weight of the pipe will cause deflection and produce additional stresses. The efficiency of the circum-

ferential joints must also be considered. On the other hand, the frictional resistance along the bottom or on the intermediate supports will have a tendency to increase the strength of the column. Considerable expansion is also taken up by distortion.

Examples of Anchorages.—The riveted steel pipe line of the Pioneer Electric Power Co., Utah, 72 inches in diameter, about 4,600 feet in length, contains many steep grades, has 13 vertical convex and concave bends of 30-foot radius, and one of 40-foot radius. The pipe is buried with a depth of earth of 3 feet on the top. All of the bends are placed in anchor blocks, about 10 feet long and 8 by 10 feet in cross section, which entirely surround the pipe.

The Drum pipe line of the Pacific Gas and Electric Co., California, is 6,194 feet in length, from the forebay to the power house. The pipe line is 72 inches in diameter for the upper 4,100 feet and tapers at the lower end with sections of 66-, 60-, and 54-inch pipe. The thickness of the pipe increases from $\frac{1}{4}$ - to $1\frac{1}{4}$ -inch. Where the pressure head is smaller than 262 feet, the longitudinal seams are double-riveted lap jointed, and the circumferential seams are single-riveted lap jointed. For greater pressure heads the pipe is all butt and strap jointed. The pipe line is laid in a trench and for the greater part of its length is half buried. There are a few sections where the pipe is entirely on the ground surface. The lower third of the pipe is on a very steep grade, averaging about 40° with the horizontal, and includes two bends making both a vertical and a horizontal angle. Each bend is secured to a reinforced concrete anchor, built in the shape of an L, formed of a heavy reinforced concrete horizontal base or foundation, and of a vertical reinforced concrete wall, 4 feet thick, fixed at the bottom to the downhill end of the base. In this wall a circular opening, of the size of the pipe, is formed and the pipe is laid through this opening and secured to the wall by three angle bands riveted to the pipe. The vertical wall is tied or trussed against the downhill and upward resultant force by sixteen 2-inch bolt rods with turn-buckles, about 25 feet long, placed diagonally into two groups, on both sides of the pipe, with one end of each rod embedded in the side of the wall and the other in the uphill end of the foundation.

In the upper 4,000 feet of this pipe are placed four anchors of a simple type (Fig. 59). Each consists of a block of concrete 10 feet square and 8 feet thick, built under the pipe, to which the pipe is

anchored against displacement by two pairs of steel straps $\frac{3}{4}$ by 10 inches, placed diagonally in opposite directions, with the lower ends embedded in the concrete block and the upper ends riveted to the sides of the pipe. The lower part of each strap is bent to about a quarter turn and the overlapping ends of each pair riveted together. Close to the riveted joints with the pipe a stiffening rib or collar is formed of an angle placed around the pipe, and is used to give greater strength to the pipe against the tendency for deformation, which may result from the pull or push at the joints. These anchors were placed at intervals of 800

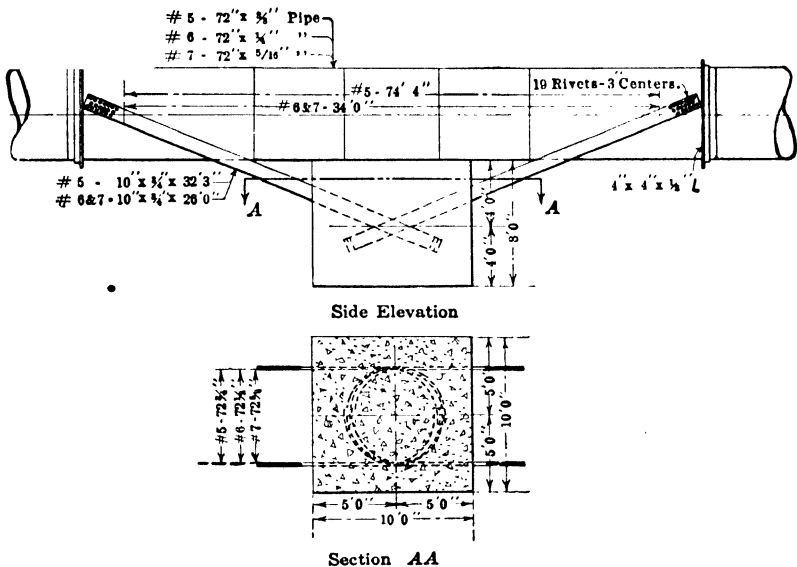

FIG. 59.—Anchorage on Drum pipe line. Pacific Gas & Electric Co., Calif.

to 900 feet. Three expansion joints of the type previously described were used.

Design of Air Vents for Steel Pipes.—Air vents are needed in pipe lines which cross two or more depressions with intervening summits or convex bend. An air vent usually serves the double purpose of air outlet and air inlet. Air outlets are required at summits and convex bends in the pipe line to discharge the air which may accumulate at these points and to give an outlet to the air when the pipe is being filled. Air inlets are necessary to prevent the collapse of the pipe from excessive external pressure. This may result when the following conditions are obtained: (1)

When the water in the pipe line is suddenly drawn out by a break or the sudden opening of a large blow-off valve. (2) When the blow-off valves are so large that when opened they cause the hydraulic grade line to fall below the summits. These conditions will produce a tendency for the formation of vacuum, which must be prevented by air inlets. They will usually be necessary at all summits and convex bends or points where the grade of the pipe changes from a flatter grade to a steeper grade. The design of air vents is controlled by their action as air inlets, and is ably presented in an article on Vents on Steel Pipes, by M. L. Enger and F. B. Seely, in the Engineering Record of May 23, 1914, from which the following discussion and results are mostly taken:

In the accompanying diagram (Fig. 60) a break at E will produce an accelerated flow in the pipe sections l_1 l_2 l_3 and l_4 ; this will result in a tendency for the formations of vacuums, at least at A and C , and also at B when, as in this case, the accelerated

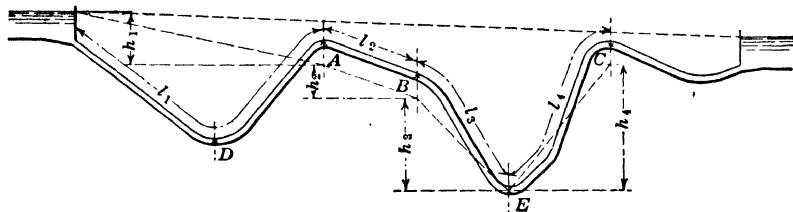

FIG. 60.

velocity in l_3 is greater than in l_2 . A large blow-off valve at E would also produce the same effect at A and C if its capacity is sufficient to lower the hydraulic grade line below these points. Air inlet valves are necessary at A , B and C . With a break at E the velocity of the flow of water towards each of these points will be smaller than the velocity of flow away from these points. The capacity of the air valve must then be designed to deliver a flow of air equal to the difference in the flow of water, with a difference in pressure inside and outside not greater than the pipe can stand without collapsing. It is therefore necessary to: *First*, determine the maximum difference between external and internal pressure ($p_2 - p_1$) which the pipe will stand without collapsing. *Second*, determine the velocities of flow in the pipe above and below the point, by obtaining the corresponding hydraulic grade lines to and between summits or bends, after fixing the position of the grade line at each point from the difference in

external and internal pressure. *Third*, obtain the required flow of air on the basis that this flow must be equal to the cross-sectional area of the pipe, multiplied by the difference in velocities ($v_2 - v_1$). *Fourth*, determine the area of air inlet opening required to give the desired flow of air when the pressure head which produces the flow of air is equal to $p_2 - p_1$.

The actual flow of water and air is more complicated than is indicated above, because in a pipe section below an air inlet or between two air inlets, there is a variable flow of a mixture of air and water; but the results of the method of computation indicated above are safe in that they give an area of air inlet opening somewhat greater than is actually required.

The following values of maximum difference of pressure head for various sizes and thicknesses of pipes are obtained by Messrs. Enger and Seely by using the formula $p_2 - p_1 = 50,200,000 \left(\frac{t}{d}\right)^3$, which is obtained from experimental results on boiler tubes and well casing and is of the same general form as the theoretical formula derived by Enger and Seely: $p_2 - p_1 = \frac{8E}{3} \left(\frac{t}{d}\right)^3$, in which E = modulus of elasticity of steel

$$\frac{t}{d} = \text{ratio of thickness in inches to diameter in inches.}$$

PIPES OF VARIOUS THICKNESSES AND DIAMETERS WHICH WILL FAIL UNDER GIVEN PRESSURE DIFFERENCE

$p_2 - p_1$ pounds per square inch	$\frac{t}{d}$	Least diameter of pipe which will collapse		
		$t = \frac{3}{4}$ inch	$t = \frac{5}{16}$ inch	$t = \frac{3}{8}$ inch
14.7	0.0066	38.0	47.5	57.0
10.0	0.0059	47.5	53.0	64.0
9.0	0.0056	44.5	56.0	67.5
8.0	0.0054	46.5	58.0	70.0
7.0	0.0051	48.5	61.3	73.0
6.0	0.0049	51.5	64.0	77.0
5.0	0.0046	54.5	68.0	82.0
4.0	0.0043	59.0	73.0	88.0
3.0	0.0039	64.5	80.0	97.0
2.0	0.0034	74.0	92.0	111.0
1.0	0.0027	93.0	116.0	139.0
0.5	0.0021	117.0	149.0	176.0

From this table the allowable partial vacuum at the summits or bends is obtained and the hydraulic lines are then established. If v_1 is the velocity of flow corresponding to the hydraulic grade line above the air inlet and v_2 is the greater velocity due to the steeper hydraulic grade line below it, then the required flow of air in cubic feet per second is

$$Q = A (v_2 - v_1) = AU$$

where A = cross-sectional area of the pipe in square feet. The required area of air inlet opening to give the above flow may then

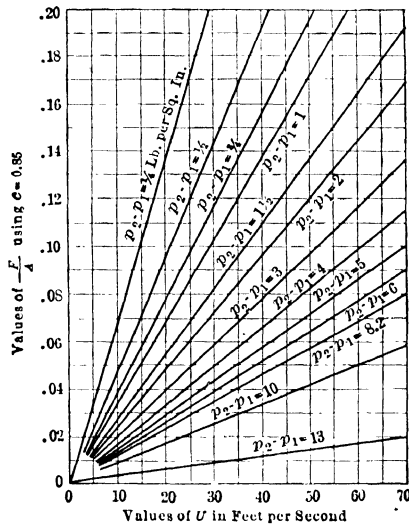

FIG. 61.

be calculated with the equations for flow of air through orifices. The accompanying diagram (Fig. 61) prepared by Enger and Seely gives the ratio of the area of the valve opening (F) to the cross-sectional area of the pipe A , for different values of U and various pressure differences ($p_2 - p_1$). The diagram is based on a coefficient of discharge through the air inlet valve equal to 0.85.

Air Valves.—Various designs of air valves are used. A type commonly used for large sizes is illustrated by that used on the riveted steel and wood stave pipe line of the Pioneer Power Plant, Ogden, Utah (Fig. 62). The air valve consists of a plunger or valve fixed to a stem which projects through the open cover of the valve box. The valve is held up against its seat, in the position shown

in the diagram, by the pressure of the water underneath. When the pipe is being emptied, the valve opens, allowing the air to rush in and prevent a vacuum. When the pipe is to be filled, the valve remains open and allows the air to escape until the water pressure closes the valve. An air cock is connected to the valve box just below the air valve to discharge any air which may collect in the valve box, while the pipe is in service. A gate valve is

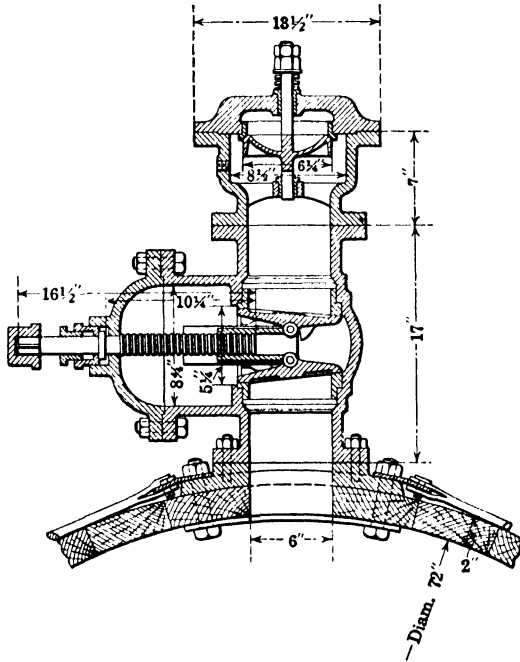

FIG. 62.—Air valve used on pipe line of Pioneer Power Plant, Ogden, Utah.

usually placed between the valve box and the main pipe to permit the removal of the air valve for repairs.

Corrosion and Durability of Steel Pipes.—Experience shows that the controlling factor in the life of a steel pipe properly coated is the occurrence of perforations or pit holes in the plate, which start in spots adjacent to small particles of impurities. Wrought iron is in general more homogeneous than steel, and is not as readily attacked. Pitting or local corrosion in steel is generally attributed to the unequal distribution of manganese, resulting from the ordinary practice in the manufacture of steel. There is apparently no reason to prevent the use of more careful methods

and the production of more homogeneous steel. The elimination of practically all manganese and impurities is the basis of the development of ingot iron.

The greater durability of wrought-iron over steel pipe has been indicated by a number of cases reported by E. Kuichling. A wrought-iron pipe line, of the waterworks system of the city of Rochester, N. Y., 9.6 miles in length, 36 inches in diameter, $\frac{3}{16}$ inch thick, coated with a mixture of equal proportions of refined Trinidad asphalt and coal-tar pitch, built in 1873-75, showed no perforations until 1894, when 26 holes were plugged. In 36 years only 56 perforations have occurred, all in about 25 or 30 plates out of a total of 11,300 plates. The pipe is laid mostly in clay soil. Another wrought-iron pipe line, of this waterworks system, 3,300 feet in length, 24 inches in diameter and only $\frac{1}{8}$ inch thick, laid in 1874 in soil rich in organic matter, was partly uncovered after 25 years and recoated, and was in good condition after 36 years. A steel pipe line, of the Rochester waterworks, 26 miles in length, 38 inches diameter, $\frac{1}{4}$ to $\frac{3}{8}$ inch thick, laid in 1893-94 in clay soil, showed beginning of serious corrosion in 1901. Up to the end of 1907 a total of 207 perforations were found and repaired. The steel was obtained from two manufacturers, and three kinds of coating were used. The majority of the perforations occurred in the steel containing the highest amount of manganese, protected with California and Trinidad asphaltic coatings. The other steel was protected with Sabin coating. A number of riveted steel pipe lines of the waterworks of Portland, Oregon, 33 inches in diameter, $\frac{1}{5}$ inch thick, coated with California asphalt or maltha, built in 1895-96, showed signs of leakage 9 years after, and an examination of the pipes in 1905 showed extensive pitting. The severest corrosion occurred in clayey soil and little injury was observed in sandy and gravelly soils.

On the other hand, there are numerous examples of steel pipes which have shown much better results. Allen Hazen, in the discussion of Mr. Kuichling's paper, states that some steel pipe lines 15 to 20 years old are still in service, in excellent order, with no apparent reason why they should not last for 20 years longer, and perhaps for an indefinite period.

The long life of a thin-riveted steel pipe is reported by H. M. Burwell in *Engineering Record* of November 8, 1913. This pipe line, near Vancouver, B. C., 16 inches in diameter, $\frac{1}{8}$ inch thick, coated by dipping in a bath of asphaltum compound, at 350°

Fahrenheit, was in a good state of preservation when over 22 years old, and apparently would last as long again.

The failure of steel pipes may result from either external corrosion or internal corrosion, or both.

External Corrosion.—External corrosion will depend largely on the character of the soil, especially its chemical composition, and may be very rapid. Experience seems to indicate that the action of alkali soils may be very detrimental. The effect of the alkali salts in the soil on steel pipe lines laid in the oil fields of California and the protective coatings used are more fully considered in the discussion of pipe coatings. An instance of rapid exterior corrosion is reported for the Coolgardie pipe line in Western Australia. This pipe line, 350 miles in length, 30 inches in diameter and $\frac{1}{4}$ to $\frac{5}{16}$ inch thick, is of the lock-bar type. The greater part of pipe, all except 85 miles, was coated with a mixture of coal-tar and Trinidad asphalt. The 85 miles were coated with a mixture of $2\frac{1}{2}$ parts of Trinidad asphalt and 1 part of liquid southern California maltha. The pipe was heated to 300° Fahrenheit, then dipped into a bath of the boiling mixture. Defective parts were repaired with a mixture applied hot, and the pipe was buried to a depth of 2 feet 3 inches, above the top. The first rust hole appeared about $2\frac{1}{2}$ years after the pipe was laid, and 151 leaks occurred in the 3 years following the time of the appearance of the first rust hole. Analysis showed that the soil contained from 0.1 to 1.33 of soluble salts, commonly called alkali. The poorest results were obtained with the coating used on the 85 miles of pipe. The metal was found to be in good order in sandy, gravelly, and non-retentive soils generally; only in low places where the soil was retentive of moisture was the metal attacked seriously. Repairs were made by scraping and re-coating with a mixture of 1 part of bitumen to 1 part of coal-tar, applied boiling hot on the thoroughly dry surface. Wherever possible, the repaired sections were left exposed, and where the trench had to be re-filled the pipe was protected with an additional wrapping of tarred hessian. The early appearance of these rust holes is not a proper measure of the general resistance to corrosion, for the 151 leaks reported as occurring during the 3-year period following the appearance of the first rust hole is at the rate of only 1 leak for each 7 miles per year.

The effect of alkali in accelerating corrosion is further illustrated by the experience of the South Utah Mines and Smelters

Co. of Newhouse, Utah. This company has had in use for 10 years 44,000 feet of 12- and 14-inch spiral riveted pipe, under heads grading to a maximum of 500 feet. The pipe is covered by about 2 feet of soil and about 3,000 feet of it is an alkali lime soil. During this time, eight 24-foot lengths have been renewed, and numerous leaks have been stopped. About half of the repairs were confined to the short section in alkali soil.

External corrosion, especially in dry climates, will be largely prevented when the pipe is left uncovered.

Internal Corrosion.—Internal corrosion depends largely on the quality of water, and is different from external corrosion. It results in the growth of knobs or tubercles, which form around and over small depressions or pittings. The pittings occur where the metal and coating are defective. The tubercles are largely ferric-hydrate; they start from the pittings and are formed by the deposit of the iron dissolved out by corrosion. The process of corrosion is complicated and not well understood; carbonic acid is usually supposed to be the attacking agent; but the rapid internal corrosion of the Coolgardie pipe line by a water which did not contain an excessive quantity of carbonic acid, but a comparatively large quantity of sodium and magnesium chloride, indicates that carbonic acid is not alone effective in producing corrosion. The depth of pittings seems to be limited; the maximum depths which have been reported are not over $\frac{1}{8}$ of an inch; the tubercles grow until the edges spread to adjoining tubercles or to a maximum diameter of $1\frac{1}{2}$ to 2 inches and a thickness not exceeding $1\frac{1}{4}$ inches. The growth of tubercles has a serious detrimental effect on the carrying capacity of the pipe. The occurrence of tubercles is not universal. The absence of tubercles is reported on a number of steel pipe lines of hydroelectric plants in California, and is probably due to the scraping action of sediment or sand carried by the water.

The extent of the growth of tubercles and its effect on the carrying capacity has been determined in a few cases. The riveted steel pipe water main of the New Bedford, Mass., waterworks, laid in 1896, $\frac{5}{16}$ inch thick and 48 inches in diameter, was free from tubercles in 1901. When examined again in 1908, the number of tubercles were estimated to range from 3 to 70 per square foot, and increased in number about 10 to 20 per cent. since then up to 1913. The greatest depth of pitting in 1913 was 0.11 inch, and was no deeper than found in 1908. The inside

asphalt coating had lost most of its original elasticity, but the outside coating was smooth and in excellent condition. The estimated assured life when constructed was 25 years, which the experience of 17 years indicated would be exceeded by many years.

The Coolgardie pipe line, in Western Australia, previously referred to, after only about 5 years of use, showed excessive tuberculation. The maximum depth of pitting was not over $\frac{1}{8}$ inch. The tubercles in the sections of the pipe line most affected covered nearly all the bottom and about 80 per cent. of the top of the pipe. The largest tubercles projected from the plate as much as $1\frac{1}{4}$ inches. Tests of the carrying capacity showed a reduction in the carrying capacity in some of the worst sections of 40 to 53 per cent., and in other sections of 12 to 31 per cent.

The rate and extent of tuberculation of steel pipe is probably about the same as that of cast-iron pipe. Arthur L. Adams, as member of a commission of engineers for the Los Angeles City Water Co., has reported that an exhaustive examination disclosed that all pipes were tuberculated after being in service 6 years. On the average the capacity of cast-iron pipe was diminished 10 per cent. in the first 10 years, and thereafter at the rate of $\frac{1}{2}$ per cent. per year. He also states that cast-iron pipe taken up in Oregon, which had carried mountain water for 9 years, was heavily tuberculated and had its carrying capacity reduced at least 25 per cent.

Ultimate Useful Life.—The life of steel pipe is dependent on so many factors, as is indicated above, that it can be stated only in very general terms. Thin sheet-steel pipes, $\frac{1}{8}$ inch or less in thickness, have been used to a considerable extent for distribution systems in southern California, and in general seem to have an ultimate useful life of 15 to 25 years. Steel pipes $\frac{1}{4}$ of an inch or more in thickness will probably have an ultimate useful life of 25 to 50 years.

Coating of Steel Pipes.—Experience shows that the life of steel pipe is largely dependent on the protective coating. A large number of different kinds of coatings have been tried, but the results obtained show that none of them have proven entirely satisfactory, and there is no uniformity of opinion to indicate the best type of coating. The quality of the coating depends not only on the material used, but also on the method of applying it and the workmanship. The types of coatings most commonly used are:

First.—Asphalt or tar mixtures heated to a temperature of 300 to 400° Fahrenheit, applied usually by dipping the heated pipe in the mixture.

Second.—Asphalt varnish or other paints applied with brushes at the ordinary atmospheric temperatures.

Third.—Enamels baked on the pipe.

The first and second types are most generally used. Small size pipes are usually coated by dipping. Baths of California or refined Trinidad asphalt, heated to 300 to 350° are often used, and in some cases two dippings are given. The American Spiral Pipe Works uses a bath of asphaltum or mineral rubber, made from Gilsonite (mined in Utah), kept at a temperature of 400°.

The San Fernando pipe line of the Los Angeles aqueduct was painted inside and outside with one coat of water-gas tar, on top of which was applied two coats of coal-tar. The tar was usually applied cold, excepting on cold days, when some little heating was necessary. Water-gas tar was used because it was found that it successfully attacked rust and even mill scale, that it hung well, and that chipping to reach clean material was not necessary. This tar is the residue of crude oil used in the manufacture of water-gas, the lampblack being heated to incandescency to decompose the steam. It was obtained from the Denver Electric Co., and its cost, laid down, was not over 11 cents a gallon. The coal-tar cost 10 cents per gallon in Los Angeles. One gallon of tar covered about 200 square feet.

The practice of the Pacific Gas and Electric Co. of California is to paint the pipe inside and outside with one coat of Dixon's graphite paint, and where not buried the outside is repainted every 2 or 3 years.

A process of applying an enamel coating is known as the Sabin process. The pipe, after being dipped in the heated asphalt mixture, is baked for several hours at a temperature of 400 to 600° Fahrenheit. The chief objections to an enamel coat are the greater cost, its brittleness, and the difficulty of repairs in the field.

Galvanizing is usually feasible for pipes under 30 inches in diameter, but on account of its cost its use is limited to small thin pipes.

Inside and outside protective layers of cement mortar or cement concrete have proven successful, but will usually be too expensive. A special form of this type of construction, consisting of a thin reinforced cement mortar interior lining and a thick outer shell of reinforced mortar, is illustrated by the Sosa and Ribabona siphon

constructed in Spain and described farther. This method of protection was used on a large scale for the protection of steel pipes recently constructed on the Catskill aqueduct of New York City water system. On this work there are fourteen siphons with a total length of 33,031 feet, made of pipes ranging from about 9 to 11 feet in diameter; the maximum pressure head ranges from 50 to 340 feet. The inside protection is a cement mortar layer, 2 inches thick, of one part of cement to two of sand, placed for most of the pipe by pouring it as a grout around an internal form, through holes cut in the top of the pipe. The outside protection is a layer or shell of plain concrete, nowhere less than 6 inches thick, made of one part of cement to three of sand and six of broken stone or gravel. This shell was constructed before the interior lining was applied and was formed on the steel pipe after the pipe had been filled with water to give it its normal shape under working condition.

To obtain satisfactory results with coatings or paints, certain precautions are usually taken, which are of more importance where corrosive agencies are strongest. The coating must be uniformly thick and must have absolute adhesion to the pipe. To prevent a layer of moisture beneath the coating, the mixture must be applied on a perfectly dry surface, which with smaller pipes is insured by heating the pipe before dipping it. The pipe may be cleaned of rust and mill scales by sand blast, scraping or chipping, or scrubbed with a wire brush and dilute acid, or may be dipped for about 15 minutes in a 5 per cent. solution of sulphuric acid at a temperature of 125 to 150° Fahrenheit, and then washed by dipping in hot water or lime water. To obtain a dense air and water-tight coating, the material must not contain impurities. Trinidad asphalts or other bitumen compound may contain impurities which are soluble in water or which may be attacked by alkali or acid salts and leave a porous coating.

The use of special precautions where the pipe lines are in contact with unusually strong corrosive agents is illustrated by the experience with the steel pipe lines placed in alkali soils in the California oil fields. Mr. C. P. Bowie states that the alkali salts average from 0.05 to 5 per cent., and that steel pipe lines $\frac{5}{16}$ inch thick and protected with three coats of asphaltum paint have corroded so badly that in 3 years' time pit holes extending entirely through the pipes have developed. Quick setting bituminous enamels which can be put on dry pipes in dry warm weather in a

layer $\frac{1}{8}$ - to $\frac{1}{4}$ -inch thick, promise to give good results. But the method most extensively used is that of winding spirally on the pipe previously coated with hot asphaltum and before the asphaltum has had time to set, specially prepared roofing papers; the edges of the wraps being coated with hot asphaltum and covered with a 3-inch strip. The asphaltum is a thin grade of ordinary refined product and is applied at about 200° Fahrenheit. The paper is usually that made of ordinary deadening felt, dipped into successive baths of hot asphaltum, rolled hot and under pressure and sprinkled with mica or soapstone before entering the last set of rolls.

Cost of Small Size Steel Pipes.—The approximate factory prices and weight are taken from quotations of a number of Western pipe manufacturing companies. They are for asphalt-coated riveted pipe with plain inserted or slip joints.

FACTORY PRICES AND WEIGHT OF ASPHALT-COATED RIVETED STEEL PIPES PER LINEAL FOOT

Diameter, inches	No. 16 gauge			No. 14 gauge			No. 12 gauge		
	Price	Weight, pounds per foot	Maximum safe head, feet	Price	Weight, pounds per foot	Maximum safe head, feet	Price	Weight, pounds per foot	Maximum safe head, feet
4	\$0.18	3.7	500	\$0.20	4.4	600			
6	0.26	5.3	400	0.30	6.3	500	\$0.45	9.0	700
8	0.32	7.0	300	0.38	8.4	400	0.55	11.6	550
10	0.40	8.6	250	0.45	10.4	325	0.65	14.3	450
12	0.48	10.3	200	0.55	12.4	250	0.75	16.9	350
	No. 14 gauge			No. 12 gauge			No. 10 gauge		
14	0.60	14.4	225	0.75	19.6	300	1.00	25.0	400
16	0.67	16.3	200	0.85	22.3	275	1.10	28.0	350
18	0.75	18.3	175	0.96	24.9	250	1.20	32.0	300
20	0.85	20.3	150	1.05	27.5	225	1.30	35.0	275
	No. 12 gauge			No. 10 gauge			No. 8 gauge		
22	1.20	30.0	200	1.45	38.0	250	1.85	46.0	300
24	1.30	33.0	185	1.55	42.0	235	2.00	50.0	285
26	1.40	35.0	170	1.75	45.0	220	2.25	54.0	270
	No. 10 gauge			No. 8 gauge			1 1/4 inch		
28	1.85	49.0	200	2.25	58.0	250	3.40	86.0	370
30	2.00	52.0	190	2.30	62.0	235	3.75	92.0	350

For flange joints, formed of flanged collars riveted to the ends of the pipe section and connected together by bolts with a gasket in between, the following prices must be added:

PRICE OF ONE PAIR OF CAST-IRON FLANGES RIVETED TO PIPE ENDS

Diameter of pipe in inches	4.0	6.0	8.0	10.0	12.0	14.0	16.0
Price of standard pattern, dollars	1.55	2.00	2.60	3.60	4.50	5.50	6.60
Price of heavy pattern, dollars	1.90	2.65	3.40	4.50	5.80	7.50	9.70

Diameter of pipe in inches	18.0	20.0	22.0	24.0	26.0	28.0	30.0
Price of standard pattern, dollars	7.50	8.50	10.00	11.50	13.00	13.75	14.50
Price of heavy pattern, dollars	11.50	13.50	15.50	18.25	20.25	22.50	25.00

Heavy pattern is used on pipes 4 to 12 inches in diameter, made of over No. 14 gauge, and on pipes 14 to 30 inches in diameter, made of over No. 10 gauge.

WOODEN PIPES

General Description.—There are two types of wooden pipes, both extensively used in irrigation work: the continuous stave type and the wire-wound machine-banded type (Plate XXIII, Figs. A and B).

The continuous stave type is built in place. It has been used for pipes ranging from 10 inches to 13½ feet in diameter, but usually for pipes not smaller than 18 inches in diameter. The pipe is formed of staves milled from lumber to form true radial edges and concentric inside and outside true circular surfaces, bound tightly together by means of steel bands (Fig. 63). The staves vary in length, and are assembled so as to break joints by about 2 feet. The joints between abutting ends of staves are generally made by inserting a thin metal tongue in saw kerfs or slits made in the ends of the staves; thus making the pipe continuous. The steel bands are separate hoops, made usually of one piece for pipes up to 54 inches inside diameter, and of two pieces for larger size. The one-piece band has a head on one end and usually cold rolled threads for a length of 5 inches at the other end; the two ends fit into a coupling shoe; the threaded end carries a washer and standard hexagonal nut, with which the band is



FIG. B.—24-inch machine banded wooden stave pipe. Eastern Washington (Washington Pipe & Foundry Co.).

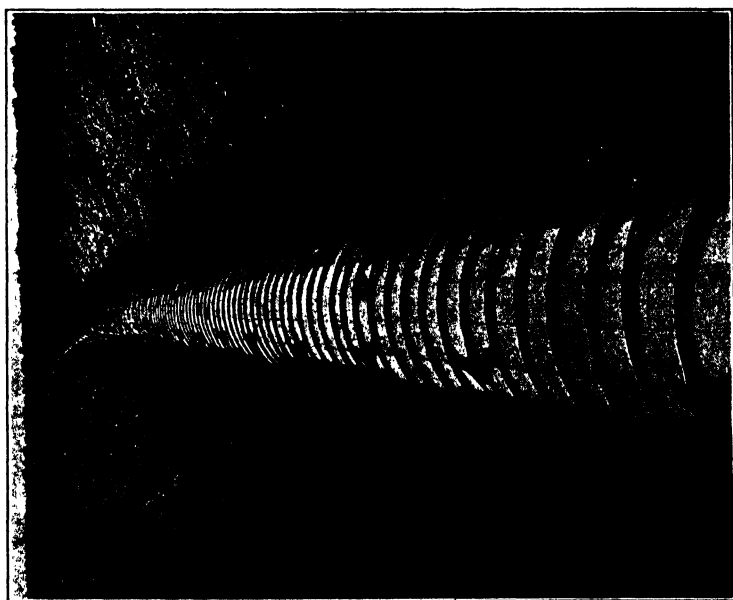

FIG. A.—36-inch continuous wooden stave pipe. Eastern Washington (Washington Pipe & Foundry Co.).

PLATE XXIII

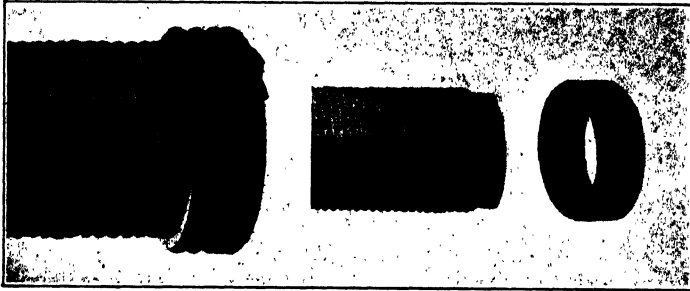
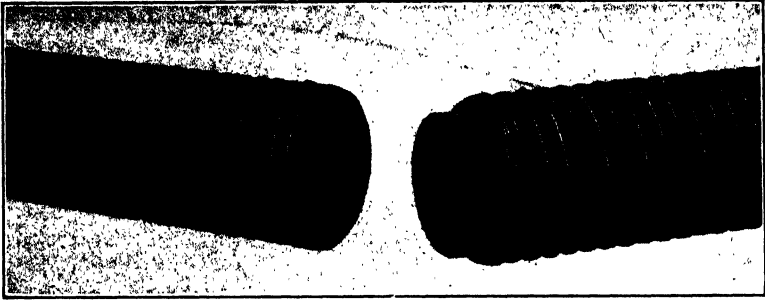

FIG. C.—Types of joints for wire wound machine banded wood stave pipes (not coated).

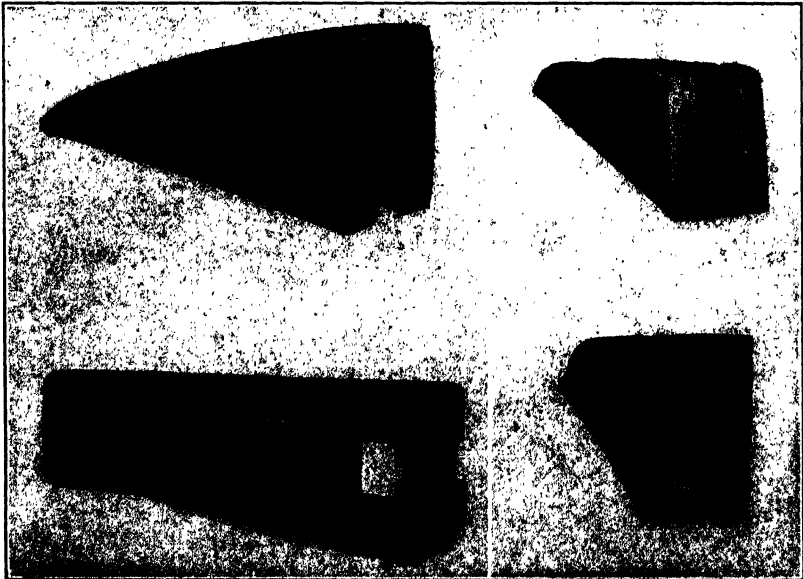

FIG. D.—Three types of shoes for wooden stave pipe. Marion Malleable Iron Works, Marion, Ind.

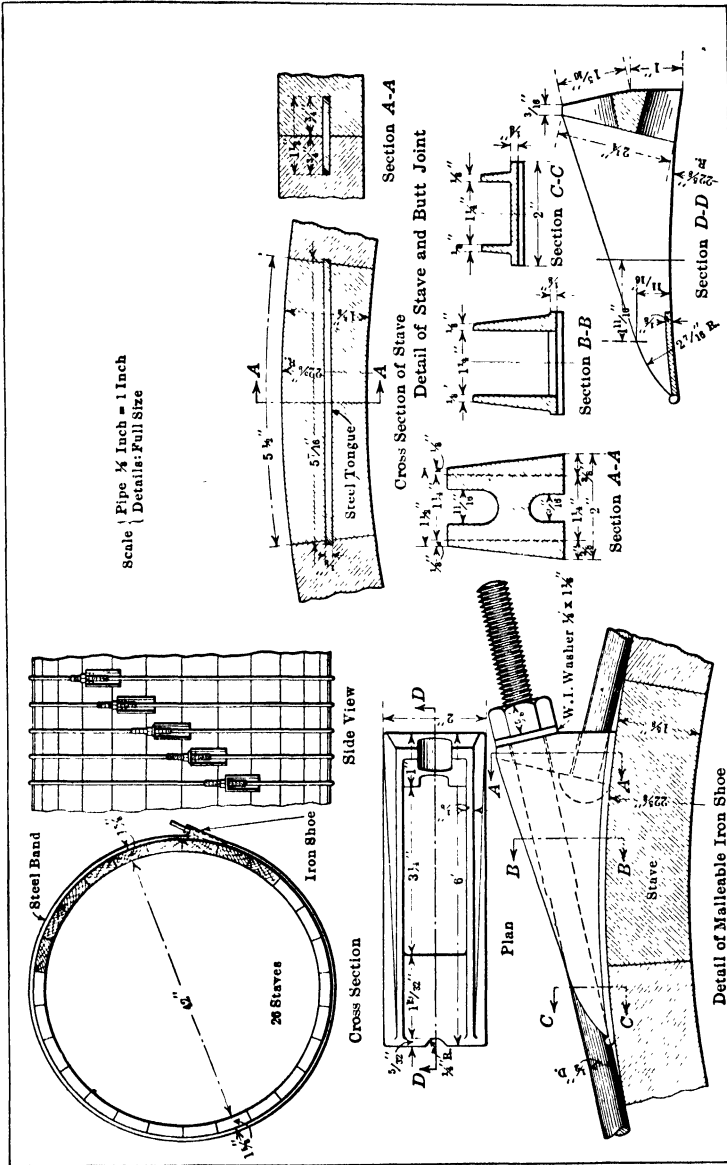

Fig. 63.—Details of continuous wooden stave pipe, Washington Pipe & Foundry Co., Tacoma, Wash.

cinched. The two-piece hoop is formed of a two-headed piece, a piece threaded at both ends, and two coupling shoes.

The machine-banded pipe is built in the factory in convenient lengths, generally from 8 to 20 feet, and in sizes ranging from 2 inches to 48 inches, but usually not over 24 inches (Fig. 64). The pipe is formed of staves banded with galvanized steel wire, wound spirally by machine, under high tension, which tightens the seams and seats the wire in the staves. The wire varies in size from about No. 8 (0.162 inch) for the smaller pipes to No. 0 (0.307 inch) for the larger pipes, and the spacing or pitch of the spiral is regulated according to the pressure. Two independent spirals are sometimes used; the advantage claimed is that if one wire breaks at a weak place the other will have sufficient strength to hold the pipe together. The ends of the wire are fastened with staples or steel clamps driven into the pipe. The edges of the staves are milled to form a small tongue and groove or beaded joints necessary to hold the stave in place when banding.

Different types of joints are used to connect the pipe sections (Plate XXIII, Fig. C). The inserted joint used for pipes 8 inches or smaller in diameter up to 200 feet pressures and for pipes 10 to 14 inches in diameter up to 100 feet pressure, is formed by milling a tenon at one end of the pipe and reaming out the other end. The wooden collar joint or wood sleeve coupling used for greater pressures is formed by milling a tenon at both ends of the pipe and joining abutting ends into a wooden collar, made in the same manner as the pipe for sizes up to 14 inches in diameter, and made with individual bands and shoes for larger diameters. For high pressures special cast-iron or steel collars are sometimes used; they are more expensive than wooden collars, but increase the durability of the pipe line.

After the pipe section is banded the ends are milled or turned to the true shape required to fit the joint or coupling. The pipe section is then dipped in a hot asphaltum preparation or a mixture of tar and asphalt to cover the wire and the outside of the pipe (except the tenon end) with a heavy coating of the mixture. Before the coating has cooled, the pipe is rolled down an incline in sawdust or shavings, which gives it a surface more resistant to abrasion and better to handle and ship. The process may be repeated to give a good coating $\frac{1}{4}$ to $\frac{3}{8}$ inch thick. A manu-

facturer of redwood pipe does not coat the pipe, but depends on a high quality of galvanizing to protect the bands against corrosion.

Use and Adaptability.—The use of modern wood stave continuous pipe dates from about 1884, when it was used by the Denver Union Water Co., Colorado. Machine-banded pipe dates from about the same time. Both types of pipe are the evolution of earlier uses of wooden pipes. The continuous wood stave pipe resembles the old wood stave pipes used for penstocks in the New England States and eastern Canada 50 or 70 years ago. The machine-banded pipe results from the development of machine-banded bored logs, first manufactured in Michigan in 1874. Prior to this time plain bored log pipe lines had been constructed in England as early as 1613; in Portsmouth, N. H., in 1798; in Philadelphia in 1799. It is reported that these pipes were in use over 200 years in England, over 70 years in Portsmouth, and over 100 years in Philadelphia.

The modern wood stave pipe is, therefore, of comparatively recent origin, and is quite different from the earlier types of pipe. The use of continuous stave pipe and machine-banded stave pipe has rapidly extended, and they are now widely used not only on irrigation systems, but on hydroelectric projects, for hydraulic mining and very largely for domestic water-supply systems. The greatest use has been in the Western States and especially in the states of California, Washington, Oregon, Idaho, Colorado, Montana, and British Columbia. For irrigation purposes alone many hundred, if not several thousand, miles have been installed.

The use of wooden stave pipe is best adapted to moderate pressures, ranging from a minimum of 15 to 20 feet for exposed pipe above the ground, and 40 to 50 feet for buried pipe, up to a maximum of about 200 to 250 feet. It is commonly used for lower pressures than stated above, but as its durability is then uncertain it may be desirable to use reinforced concrete pipe for the lower pressures and in some cases for pressures up to 50 to 100 feet. Higher pressures than 250 feet up to 350 or 400 feet have been used, and may be permissible where a pipe line has short sections of high pressure head for which it is not desirable or feasible to make a change in the kind of pipe.

The advantages claimed for wooden stave pipe are:

(1) Low cost as compared with steel or cast iron, especially for low pressure heads. (2) The life under favorable conditions is greater than that of steel. (3) The carrying capacity is greater

than that of new, smooth, riveted steel pipe, and does not diminish with age. (4) The material for continuous stave pipe is easily transported; this is of special advantage for locations which are accessible with difficulty. (5) Greater strength against deformation and to support external pressure than thin steel pipes. (6) Its elasticity makes it preferable where the foundation is subject to settlement and makes it better able to resist water-hammer. (7) Low conductivity and less liability to be damaged by freezing. (8) Vertical and horizontal bends up to a certain minimum radius can be easily made. (9) Repairs can be easily made. (10) Machine banded pipe is laid very cheaply.

Staves.—The materials most extensively used are California Redwood and Douglas Fir, commonly known also as Douglas Spruce, Oregon or Washington Yellow Pine. The staves are milled from stock lumber: usually from 2 by 4, 2 by 6, 3 by 4 4 by 6, and 4 by 8 lumber. The thickness of the milled staves will in general conform to the values given by A. L. Adams in the table presented farther for the Economic Proportions for Stave Pipe Design. These thicknesses will give sufficient rigidity for the usual conditions. Large pipes over 3 or 4 feet in diameter, covered with a depth of earth greater than 4 feet, may have to be built with specially thick staves, designed to resist the external load, without excessive deformations. With buried pipes, carefully tamped backfill, up to at least the lower third of the pipe and preferably for the entire depth of the trench, is desirable. An interesting discussion on the design of thickness of staves to resist external load is presented by Andrew Swickard in "Engineering Contracting," Jan. 6, 1915.

Curvature and Bends.—Sharp curves should be avoided. The minimum radius which may be obtained by deflecting the staves of continuous pipe varies with the diameter of the pipe and the thickness of the staves. A radius of 60 times the diameter of the pipe is usually stated as the minimum radius; but this is often exceeded. Examples of extremely sharp curves are two pipe lines, one 7 feet and the other 6 feet in diameter, with respective radius of 140 and 128 feet. R. E. Horton has suggested the following approximate rule:

$$\text{Minimum radius in feet} = 4 \text{ to } 5 \times (D + 4t^2)$$

where D = diameter of pipe in inches
and t = thickness of stave in inches.

It is desirable to avoid the use of vertical curves and horizontal curves in the same section of pipe, and to introduce a tangent between the curves.

Machine-banded pipe can be deflected from 2 to 6 degrees at each joint. The larger deflection is for the smaller size pipes and light pressures. For sharp curves short lengths of pipe are preferable. Well tamped backfilling is especially important to prevent displacement. Sharp sudden bends when not avoidable may be made by the use of special cast-iron fittings or specially made riveted steel elbows, strongly anchored.

End Butt Joints of Staves.—The type of end joint almost exclusively used consists of a metal tongue which fits tightly into the saw kerfs of the abutting ends of the staves. The saw kerf at each end is a little narrower than the thickness of the metal tongue. The width of the tongue is slightly larger than twice the depth of the saw kerf, and its length is about $\frac{1}{8}$ of an inch larger than the length of the saw kerf. When the staves are driven and cinched together, the edges of the tongue penetrate into the wood and insure a tight joint.

Bands and Shoes.—The general purpose of the bands and shoes has been briefly described above. The design of size and spacing bands is considered farther. The bands are usually made of Bessemer or preferably open-hearth steel, the physical properties of which are stated in the specifications presented farther. The shoes are preferably malleable iron castings. The principles of their design have been well presented in a paper by E. A. Moritz included in the list of references. The essential requirements are:

First.—The maximum bearing pressure of the shoe on the wood shall not exceed the maximum bearing strength of wood in crushing across the grain.

Second.—The shoe shall be capable of developing full strength of the band.

Third.—The parts of the shoe must be dimensioned to resist all strains induced by the tension in the band. A number of different types of shoes are made by manufacturers which will meet the above requirements, so that as a rule it will not be necessary for the engineer to design them (Plate XXIII, Fig. D). A thick protective coating on the bands and shoes is necessary. This is usually done by dipping them, when hot, in a mixture of asphalt and linseed oil, or other compound such as used for steel pipes.

DESIGN OF STAVES AND BANDS

Principles of Design.—The principles on which the design is based have been presented in a full and valuable paper by Arthur L. Adams and in discussions of this paper by D. C. Henny. The requirements which must be met are:

First.—The staves must be thin enough to secure complete saturation of the wood and to permit deflection to the extent required to construct the pipe on curves, and must be thick enough to prevent undesirable excessive percolation through the wood and especially to give the rigidity required to resist external pressure without excessive deformation.

Second.—The bands must be of such size and so spaced that they will resist all strains coming on them, not crush through the wood fibers beneath them, and give no sensible flexure in the staves.

When the pressure is so small that it does not determine the spacing of the bands, the spacing must not exceed a certain maximum, which in practice is taken usually at 10 inches and in some cases 12 inches.

The stresses which must be considered in the design of the bands are: (a) the stress due to water pressure; (b) the stress necessary to give a degree of compression per square inch between the staves in excess of the water pressure; (c) the stress due to swelling of the staves. The size and spacing of the band are related. For correct design the bands must be of such size and so spaced that each band is strained to its safe resisting value and that the bearing pressure on the stave is equal to the safe bearing value of the wood. When not properly designed, the spacing may be correct for the strain on the band but may produce an excessive bearing pressure on the stave. On the other hand, the band may be designed for correct bearing pressure, but the spacing may cause excessive strain on the band. The equations expressing these relations for correct design are obtained as follows:

Let R = internal radius of pipe in inches.

r = radius of the band in inches.

f = spacing of bands in inches.

t = thickness of stave in inches.

P = water pressure in pounds per square inch.

s = safe tensile strength per square inch of band steel.

S = safe strength of band = $\pi r^2 s$.

E = swelling force of wood per square inch of area between staves.

e = safe bearing power of the wood per lineal inch of band.

Size of Bands.—For a pipe of a given diameter there is a corresponding correct size of band; this is the one which, when strained to its safe strength, will sink sufficiently into the stave to produce a bearing pressure equal to the safe crushing strength of the wood. The band will sink into the wood to a depth depending on the stress in the band. The width of contact before the fibers are crushed beyond safety has been found to be about equal to the radius of the band. D. C. Henny suggested the following safe bearing loads for wet redwood, as deduced from experiments:

SAFE BEARING LOADS OF BANDS ON WET REDWOOD

Diameter of band in inches	Safe load in pounds	
	Per square inch	Per lineal inch
$\frac{3}{8}$	747	140
$\frac{7}{16}$	700	153
$\frac{1}{2}$	660	165
$\frac{5}{8}$	640	200
$\frac{3}{4}$	620	232
$\frac{7}{8}$	600	262

Arthur L. Adams has used an average value of 650 pounds per square inch. The corresponding safe bearing pressure per lineal inch of band is $e = 650r$, which induces a tensile stress in the band of $S' = (R + t)e = (R + t)650r$. S' should be equal to the safe strength of the band. Therefore:

$$\pi r^2 s = (R + t)650r$$

from which
$$r = \frac{(R + t)}{\pi s} \cdot 650$$

The ultimate strength per square inch of band steel is about 55,000 to 65,000 pounds; assuming a factor of safety of 4, the safe strength is about 15,000 pounds per square inch. For this value of s the equation is:

$$r = 0.0138 (R + t)$$

Arthur L. Adams has suggested the following table:

ECONOMIC PROPORTIONS FOR STAVE-PIPE DESIGN

Nominal diameter of pipe, inches	Stock sizes for staves, in inches	Thickness of finished staves, in inches	Economic sizes of bands, inches	Working stress in band, S, pounds	Factor of safety in band
			Oval		
10	1½ × 4	1¼ ₁₆	5¼ ₁₆ × 7¼ ₁₆	1255	5.26
12	1½ × 4	1¼ ₈	5¼ ₁₆ × 7¼ ₁₆	1475	4.47
14	1½ × 4	1¾ ₁₆	5¼ ₁₆ × 7¼ ₁₆	1650	4.0
16	2 × 6	17 ₃₂	5¼ ₁₆ × 7¼ ₁₆	1650	4.0
18	2 × 6	1¾ ₈	5¼ ₁₆ × 7¼ ₁₆	1650	4.0
20	2 × 6	1¾ ₈	5¼ ₁₆ × 7¼ ₁₆	1650	4.0
			Circular		
22	2 × 6	1¾ ₈	¾ ₈	1508	4.4
24	2 × 6	1¾ ₈	¾ ₈	1650	4.0
27	2 × 6	17¼ ₁₆	¾ ₈	1650	4.0
30	2 × 6	1½	½	2673	4.4
36	2 × 6	19¼ ₁₆	½	2950	4.0
42	2 × 6	1¾ ₈	½	2950	4.0
48	2 × 6	11¼ ₁₆	½	2950	4.0
54	2½ × 8	2¼ ₈	5 ₈	4600	4.0
60	3 × 8	2½ ₂	5 ₈	4600	4.0
66	3 × 8	29¼ ₁₆	¾ ₄	6600	4.0
72	3 × 8	2¾ ₈	¾ ₄	6600	4.0

The use of bands of oval cross section, while theoretically more economical, has not been adopted in practice, and its consideration is of small importance, as continuous stave pipes are seldom made less than 18 inches in diameter. Andrew Swickard gives the following sizes of bands as generally representative of the best practice:

Interior diameter of pipe in inches.....	Up to 20	22-26	28-44	46-66	68-108	108 up
Size of band in inches.....	¾ ₈	7¼ ₁₆	½	5 ₈	¾	7 ₈

Spacing of the Bands.—The determination of the spacing of the bands is best understood by a preliminary consideration of the actions involved. When the pipe is constructed, the bands must be cinched to give an initial compression between the edges of the staves, which must be greater than the intensity of water pressure in order to prevent leakage through the seams. When the pipe is filled an additional stress is brought on the bands by the water pressure. In addition to these two sources of stress, two separate different actions may result from the saturation of the wood, de-

pending on the initial degree of compression between the edges of the staves:

First.—When the initial degree of compression is comparatively small, the saturation of the wood will produce swelling which will increase the degree of compression up to the maximum compressive strength of wet wood; which experiments have shown to be considerably smaller than that of dry wood.

Second.—When the initial degree of compression is greater than the compressive strength of the wet wood, the swelling of the wood will be resisted by the greater initial compression, and when completely saturated the initial degree of compression will be reduced to a maximum which cannot exceed the compressive strength of the wet wood. In either case, therefore, the maximum ultimate compression between staves will not exceed the compressive strength of the wet wood, and it will be less when the internal pressure pushes the stave outward by causing the bands to sink deeper in the wood. D. C. Henny obtained from experiments on separate pieces of wood widely varying results, but states that he believes the value of 100 pounds per square inch, suggested by Arthur L. Adams, is sufficiently high. Andrew Swickard found from actual measurements of band strain on submerged short sections of pipe that the maximum compressive strain due to the swelling of the wood will seldom, if ever, exceed 125 pounds per square inch. The formulas for determining the correct band spacing are therefore based on either of the following assumptions:

First.—The strains which the bands must resist are:

- (a) The strain due to the water pressure, which is equal to PRf .
- (b) The strain due to an intensity of initial stave compression greater than the water pressure. The unit compression is usually taken as $\frac{3}{2}$ of the unit water pressure, producing a band strain of $\frac{3}{2} Pf t$.

Second.—The strains which the bands must resist are:

- (a) As stated above.
- (b) The strain due to swelling of the wood or corresponding to the ultimate compressive strength of the saturated wood. The strain is equal to Eft , in which E may be made equal to 125.

Two corresponding sets of equations can therefore be obtained for the spacing of the bands:

$$\text{First.}—S = \pi r^2 s = PRf + \frac{3}{2} Pft$$

$$\text{from which} \quad f = \frac{S}{P\left(R + \frac{3}{2}t\right)}$$

$$\text{Second.}—S = \pi r^2 s = PRf + 125 ft$$

$$\text{from which} \quad f = \frac{S}{PR + 125t}$$

For large size pipes and high heads the terms $\frac{3}{2}t$ and $125t$ are relatively small and the equation may be written: $f = \frac{S}{PR}$

The above formulas are based on the assumption that the band is of such size that the tensile strength of the band is either equal to or smaller than the safe bearing pressure of the band on the staves. If the band is of such size that its tensile strength is greater than the safe bearing pressure of the band on the stave, then the value of S to use in the above equations is $S = (R + t)e = (R + t)650r$.

Durability of Wood Pipe.—The durability of wood pipe is dependent on the resistance of the wood against decay and the resistance of the steel bands and shoes against corrosion. The decay of the wood has been found to be the more usual cause of failure, although in alkali soils the corrosion of the bands may be the determining factor. A brief consideration of the cause of wood decay and of the factors most favorable to it, is necessary to better understand the causes of failures. Wood decay results from the growth of fungi, which is most rapid for a certain combination of moisture, air and heat. A temperature of 70° to 80° Fahrenheit, moist but not saturated wood, and warm air are most favorable. Vegetable or organic matter in the soil containing the spores of fungous growth will also accelerate the decay.

The life of the wooden pipe is and may be very variable, depending on the quality of the wood, the workmanship, and the conditions under which it is used. Under most unfavorable conditions there are many cases of decay or failure in 4 to 6 years or less, while under most favorable conditions the ultimate life is not known, because the use of wood stave pipe is of comparatively recent origin. The oldest pipe lines of modern type are about 30 years old, and many of them are still in good condition. A

study of all the reported failures, partly included in the list of references at the end of this chapter, shows:

First.—Failures by wood decay are most numerous with pipe lines which are not kept constantly full, and where the pressure is not sufficient to keep the wood thoroughly saturated. Most failures occur with pressures under 30 feet, and practically none with pressures of 40 to 50 feet or more.

Second.—Pipe lines which are buried and under the smaller pressures indicated above will decay most rapidly in sandy or porous soils which give access to air, especially if the soil contains decaying vegetable or organic growth. For these conditions the rate of decay is much slower for pipes which are protected on the outside by a thick coating of asphalt or tar, as is well indicated by the greater durability of well-coated machine-banded pipe.

Third.—Pipe lines which are buried have a greater life when entirely covered with well packed or thoroughly tamped clay loam or fine silt, which retains the moisture and prevents the entrance of air. A depth of earth covering of at least 2 feet is required.

Fourth.—Pipe lines buried in alkali soils or in soils where organic acids are formed by the decay of vegetable matter are liable to fail by the corrosion of the bands.

Fifth.—Pipe lines which are supported entirely above ground on sills or cradles do not require a large pressure head to produce durability. A pressure head of 15 to 20 feet is apparently as satisfactory as a larger head. For pressures under 50 feet, and for greater pressures when the soil conditions are not favorable, an exposed pipe is preferable to a buried pipe. An outside coating on the staves of either red oxide paint or carbolineum has been used in a few cases for exposed pipes, and is probably beneficial for low pressures.

Sixth.—Pipe lines not provided with air valves at the summits, or at convex bends where air may accumulate, will decay more rapidly at these points.

Seventh.—The quality of the wood, especially the soundness of the fibers, and the condition of the sap may have a greater influence on the durability than any other factor. Staves taken from the butt end of logs are apparently more durable; the light lumber from the upper cuts should be excluded.

Eighth.—Bruising the staves in transportation or in construction, and cinching or hammering the bands too deeply in the

wood will accelerate decay; damage to the coating of machine-banded pipe or long exposure in the hot sun when empty will also accelerate decay.

Ninth.—Machine-banded pipe decays most rapidly at the joints or couplings, especially where the coupling is formed of a wooden collar not coated as the remainder of the pipe. The greater thickness at these collars produces imperfect saturation of the wood, which is favorable to earlier decay. Metal collars, although not generally used, will apparently give greater durability.

The conditions favorable for a long life are indicated by the above statements. These conditions cannot always be obtained on irrigation systems, because a flow of water in the pipe lines cannot generally be maintained continuously: In inverted siphons the lower part can usually be kept full, but the upper ends toward the inlet and outlet are under little or no pressure and will decay more rapidly. To obtain more favorable conditions, a number of pipe lines have been constructed with deep inlet and outlet wells connected at the bottom to the ends of the siphon, and in some cases the upper portions of the pipe line at the inlet and outlet have been built of reinforced concrete. In localities of very low winter temperatures, unless the pipes are buried below the depth of ground freezing, it may be necessary to empty them during the winter. It is claimed that on account of the elasticity of the wood, pipes made of wood are not damaged by the freezing of the water in them. While wood pipe does not have to be buried as deeply as metal pipe to prevent freezing, because of the low conductivity of wood, and while there are many instances where freezing of the water has not apparently damaged the pipe, the repeated occurrence of freezing, which pushes the staves out and results in the bands sinking deeper in the wood, is not desirable. Therefore, exposed pipes are usually emptied for the winter where there is danger of freezing; although this is unfavorable to durability, the low winter temperature will largely prevent the growth of decay fungi. With exposed pipes local decay of staves will develop where leaks occur. At these points the wet surface holds the earth deposited on it by the wind, and a growth of moss or algæ begins which produces decay. These leaks are more common at the joints between butt ends of staves, and should be stopped as soon as possible. Leaks are rapidly enlarged by erosion, especially if the water carries silt. In a few cases the flow

of water at a high velocity, through the leaks, has resulted in the cutting of the bands.

Average Useful Life.—From a careful consideration of the experience with wood stave pipes, the following conclusions indicate what may be expected of their durability.

First.—Continuous wood stave pipe, of either selected pine, fir or redwood, not coated, buried in tight retentive clay loam or fine silt soils, free from alkali and organic matter, constantly full, has a useful life of 40 to 50 years and probably greater when the pressure head is not less than 50 feet, and about 20 to 30 years when the pressure head ranges from 20 to 40 feet. For pressures under 20 feet, redwood, which is apparently more durable than fir or pine, has a useful life of about 15 to 20 years, and fir or pine about 10 to 15 years. Under unfavorable conditions, such as when the pipe is in sandy, dry soil, or in soil containing alkali or organic matter and allowed to dry out at times during the summer, the useful life will be considerably shorter. For low pressures it may be as short as 4 to 6 years for pine or fir and 6 to 8 years for redwood. For these conditions and pressures under 30 to 40 feet, a good coating of coal-tar and asphalt will probably give a useful life of 10 to 15 years for pine or fir and 15 to 20 years for redwood.

Second.—Continuous wood stave pipe, of either selected pine, fir or redwood, supported above the ground on sills or cradles, properly maintained and constantly full, except for a short period in the winter when it may be necessary to have it empty, will have a useful life of at least 25 to 30 years.

Third.—The durability of the bands is generally greater than that of the staves, except in alkali soils or soils rich in decaying vegetable matter, in which case the bands may have to be largely renewed after a period of 10 to 15 years.

Fourth.—Machine-banded pipe, made of selected material, with a good thick protective coating, with metal collars or well coated wooden collars, placed in good retentive soil, or through low irrigated lands which will insure moisture on the outside, kept full constantly except for a short period in the winter when it may be necessary to have it empty, and under pressure of at least 30 feet, will have a useful life of 20 to 30 years. For the same conditions as stated above, except that the pipe is in porous dry soil, the useful life is about 10 to 15 years. For smaller

pressures, fair coating, dry soil, and pipe empty for longer periods, the life is 5 to 10 years.

Covered Pipes vs. Exposed Pipes.—Machine-banded pipe is usually placed in a trench and entirely covered. The practice with continuous wood stave pipe varies. Many of the older pipe lines were built in a trench and entirely covered. Others have been built entirely above ground supported on sills or cradles, and some have been built with the lower half or third of the pipe embedded in a shallow trench to give the support required to prevent deformation of the pipe. The disadvantages claimed against exposed pipe lines are the possibilities of damage from fire, falling rocks, falling trees, land slides and freezing. In many localities some of these dangers will be absent. Except in timbered country the danger of injury by fire is small and can usually be taken care of by patrolling. The danger from falling rock is usually along steep rocky hillsides, where the cost of excavation is high and where the material suitable for backfilling is not easily obtained. In these locations the cost of a buried pipe will therefore be high, so that only if the danger is serious will it be economical to bury the pipe. The danger of freezing exists only in localities of low winter temperatures, and is less serious for large pipes in which a continuous flow at a comparatively high velocity is maintained throughout the cold period. Where it is not desirable or feasible to maintain the flow, the pipe line must be emptied. The advantages obtained by building the pipe entirely above ground are ease of inspection and repairs and less uncertainties regarding its durability than when buried. A buried pipe line under pressure heads of 50 feet or more, kept constantly full and covered to a depth of at least 2 feet with good, retentive, carefully backfilled soil, free from alkali and decaying vegetable or organic matter, will have a greater life than a pipe line supported above ground; but for less favorable conditions the reverse is true. The extra cost of cradles or sills to support a pipe line will often be less than the cost of excavation and backfill required to bury the pipe. Partial embedding of the pipe is more favorable to decay than either of the other two types of construction, and is therefore not desirable.

Painting or Coating of Staves and Bands.—Machine-banded pipe is generally coated on the outside by being dipped in a hot mixture of asphaltum or asphaltum and coal-tar, and then rolled in shavings or sawdust in the manner previously stated. The

wire is usually galvanized and is sometimes coated before winding around the pipe. The efficiency of a coating which can be applied to a freshly milled or planed surface is no doubt greater than that which, as with continuous wood stave pipe, can only be applied after the pipe has been erected, when spores of fungus may have had a chance to attach themselves to the surface. There is difference of opinion regarding the desirability of coating the staves of continuous pipe. In the majority of cases no coating has been used. Where the pipe line is under a pressure head of 50 feet or more, the wood is thoroughly saturated, and the movement of the moisture through the pipe will probably destroy the adhesion of the paint to the wood. For lower pressures the use of paints is probably more desirable, especially if the pipe is buried in dry soils or soils containing alkali or decaying vegetable matter. For buried pipes of Douglas fir the U. S. Reclamation Service has in recent specifications required a coating not less than $\frac{1}{16}$ inch thick, composed of one coat of refined water-gas tar, followed by a coat of refined coal-gas tar, thinned with distillate. Mr. S. O. Jayne reports that a buried 54-inch pipe of Texas pine, built at Pueblo, Colorado, in 1890, had about 1,500 feet subject to very light pressure or only partially filled, which produced early decay requiring replacement in 1895 of 1,100 feet with redwood pipe. All of this new pipe, except a section 100 feet long, was painted with hot coal-tar, and the remaining 100 feet with asphaltum. In 1910 the pipe coated with coal-tar was perfectly sound, while the 100-foot section was badly decayed and had to be replaced. For exposed pipes the U. S. Reclamation Service has used two coats of paint, consisting of 6 pounds of red oxid mixed with 1 gallon of boiled linseed oil. One gallon of paint was used for 125 square feet of surface. On two pipe lines, one 12 feet in diameter, constructed for the Erie Construction Co. of Oswego County, N. Y., a paint of Avernarius Carbolineum has been used.

The bands for continuous stave pipe are first bent to the proper curve and are then hot-dipped in a preparation of asphaltum and linseed oil or other mixture such as used for steel-pipe coatings.

Construction of Continuous Wood Stave Pipe Lines (Plate XXIV, Figs. A, B, C, D).—The construction of continuous wood stave pipe requires the supervision by men experienced in this kind of work: in the majority of cases this is best obtained by

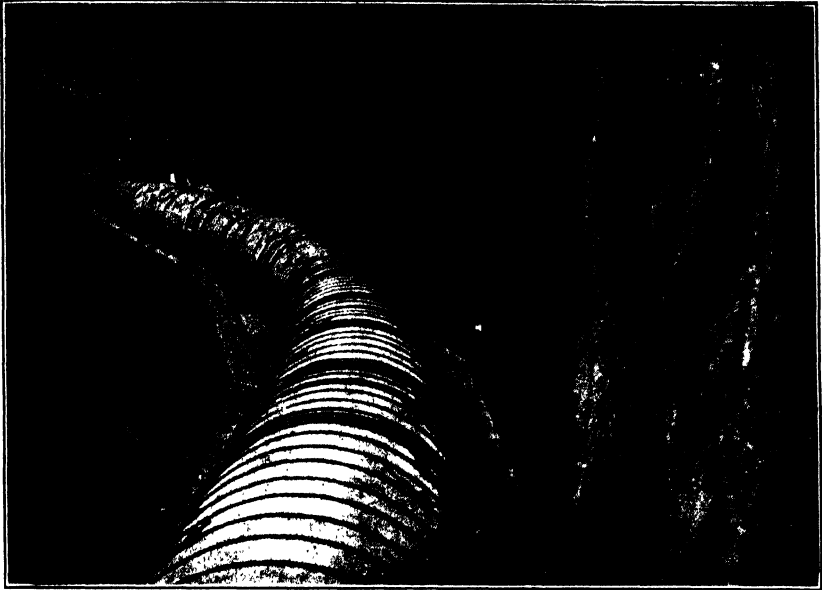

FIG. A.—48-inch wooden stave pipe along steep bluff. Walla Walla, Wash. (Pacific Tank & Pipe Co.)



FIG. B.—48-inch wooden stave pipe (same as Fig. A) showing difficult construction of a curve on a steep bluff.

(Facing page 290)

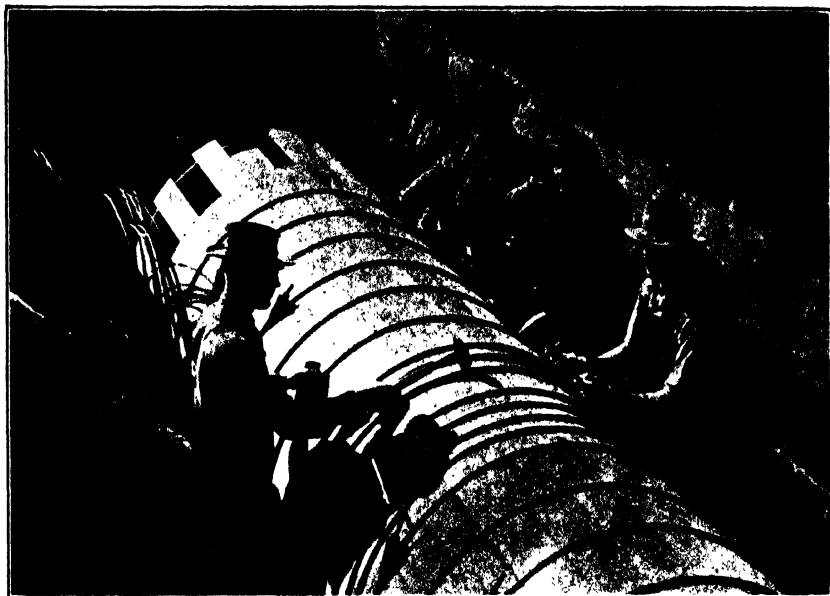

FIG. C.—Constructing a 45½-inch continuous wood stave pipe. Whittier, Calif.
Pacific Tank & Pipe Co.

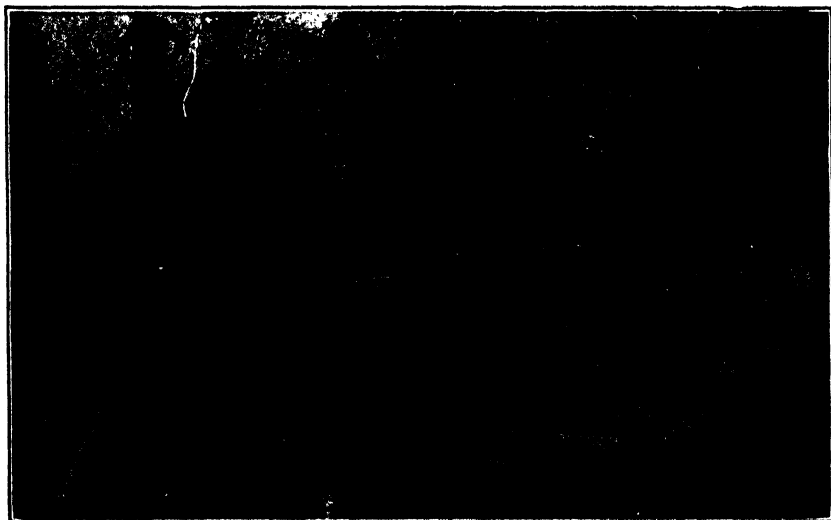

FIG. D.—Construction of wooden stave pipe on cradles.

having the construction done by the manufacturers of the pipe material. The staves for the lower half of the pipe are assembled on the wooden cradles where these are used to support the pipe, and otherwise on a U-shaped frame or form made of bent wrought-iron pipe. The staves for the upper half of pipes up to 4 or 5 feet in diameter are placed on a support formed of wrought iron pipe, bent into a circle with overlapping ends, which are spread to form a short spiral which will stand up. For pipes 5 feet or more in diameter, a wooden circular frame or templet is generally used. When the staves are assembled, a part of the bands are put on; these are partly cinched up to a degree such that when the staves are driven endwise, the second joint back is driven flush. Too hard driving will cause the staves to spring back. The other bands are then put on and final cinching is usually done a short time before the water is turned in. To give the bands the required bearing area, the bands are pounded into the wood with hammers; this must be carefully done to avoid crushing the wood. Careful construction is required to obtain a truly circular pipe. The greatest difference between two diameters, at any one section of a well-constructed 30½-inch diameter pipe on the Sunnyside project in Washington, measured 5⁄8 inch.

Connections and Fixtures.—Special cast-iron fittings with hub ends are made for machine-banded pipe. These consist of tees, elbows, angles and crosses for connection with branch pipes, reducers for making changes in the size of pipe, special gate valves, and saddles or split tees which can be clamped or banded to the pipe where it is desired to make a connection with a pipe line already installed. Small delivery or service connections are commonly made with either continuous or machine-banded pipe by screwing the end of a wrought-iron pipe or a corporation cock in a hole bored through the staves, about 1⁄16 or 1⁄32 inch smaller in diameter than the outside diameter of the pipe.

Branch connections with continuous stave pipes are made by special fittings of cast iron for the smaller size pipes and of riveted steel for larger sizes (Plate XXV, Figs. A and C). A special design of a saddle for connection with a blow-off valve used on the Prosser siphon, Sunnyside project, Washington, is shown in Fig. 65. This design is adaptable to a branch connection. The junction between wood stave and steel-riveted pipes is often made by inserting the end of the steel pipe for 12 to 18 inches inside the wood pipe, which is cinched up tight with extra bands (Plate

XXV, Fig. C). This method prevents the saturation of the ends of the staves outside of the steel pipe, which may accelerate decay. A method which is considered preferable consists in inserting the end of the stave pipe inside the steel pipe and calking the joint

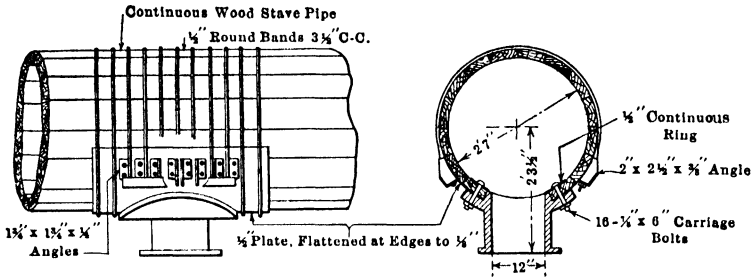

FIG. 65.—Saddle connection for blow-off. Prosser Siphon, Sunnyside Project, Wash.

with oakum or lead. This usually requires a special coupling collar riveted or bolted to the steel pipe to give the necessary rigidity and strength for calking, and a circular metal band or thimble on the inside edge of the wood staves to prevent them from being pushed in. A special design of coupling collar is

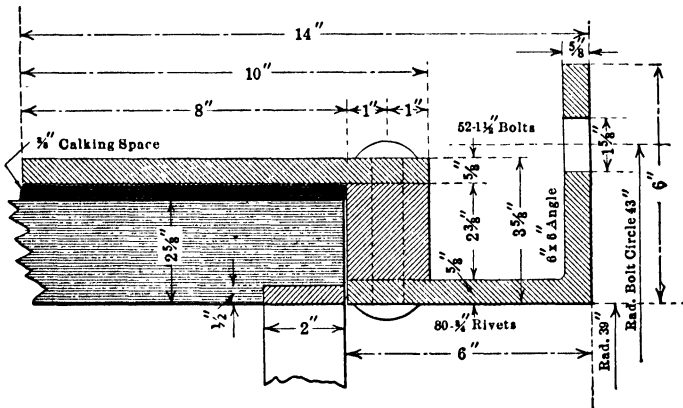

FIG. 66.—Riveted steel coupling collar to connect wood stave pipe with steel pipe. From Bull. No. 155, U. S. Dept. of Agr.

shown in Fig. 66. Air valves and blow-offs are considered in the general discussion of accessories to pipe lines.

Supports for Wood Stave Pipe Lines Built above Ground.—Stave pipe built above ground is supported on specially shaped sills or cradles, usually made of wood and less often of concrete. The



FIG. B.—Anchor well used at angles on 60-inch pipe line of Denver Union Water Co., Colo. (Eng. Rec., Jan. 18, 1913.)

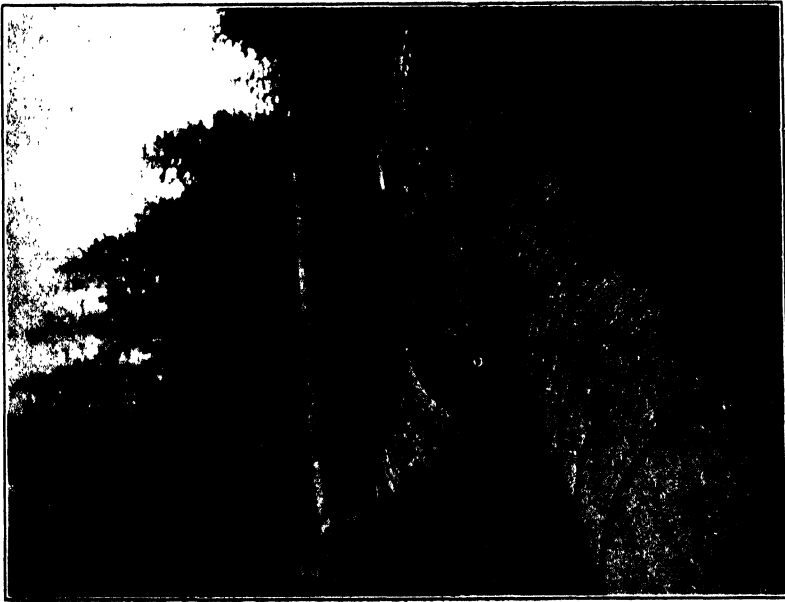

FIG. A.—48-inch continuous fir stave pipe, 180-foot head Southern Alaska. (Pacific Tank & Pipe Co.)

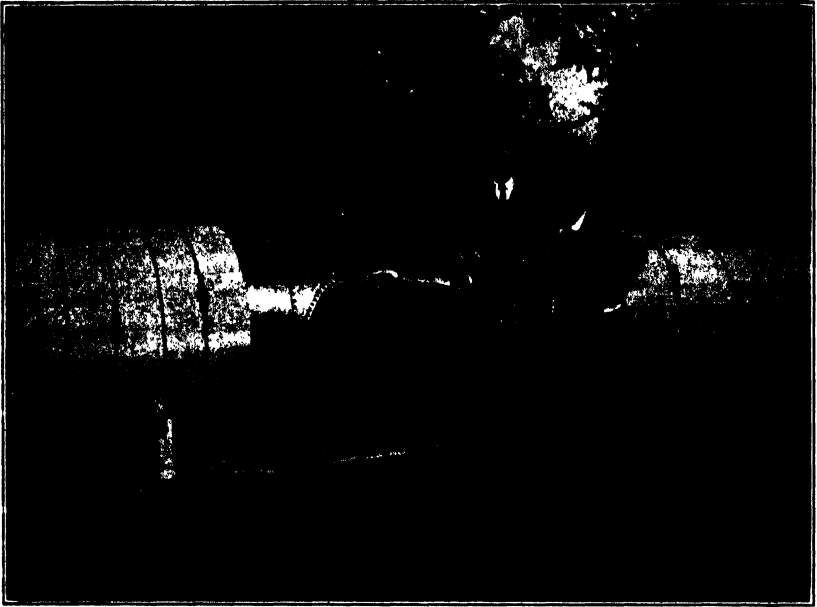

FIG. C.—48-inch \times 30-inch steel connection with wood stave pipe. Dayton, Wash. (Pacific Tank & Pipe Co.)



FIG. D.—Anchor on 42-inch pipe line. Tacoma, Wash. (Washington Pipe & Foundry Co.)

design and spacing vary considerably. For pipes up to about 6 feet in diameter, the simplest support consists of a timber sill, on which the pipe is placed with side blocks shaped to fit the outside of the face. Fig. 67A shows this form of sill, as used on the pipe line of the Pioneer Power Plant, Utah. For smaller size pipes, the side blocks may be omitted and the upper face of the sill milled to seat the pipe. Fig. 67B shows this form of sill, used on a pipe line of the Burbank Power and Irrigation Co., Washington. Each sill cost $35\frac{1}{2}$ cents. These sills may or may not be placed on top of subsills, depending on the required

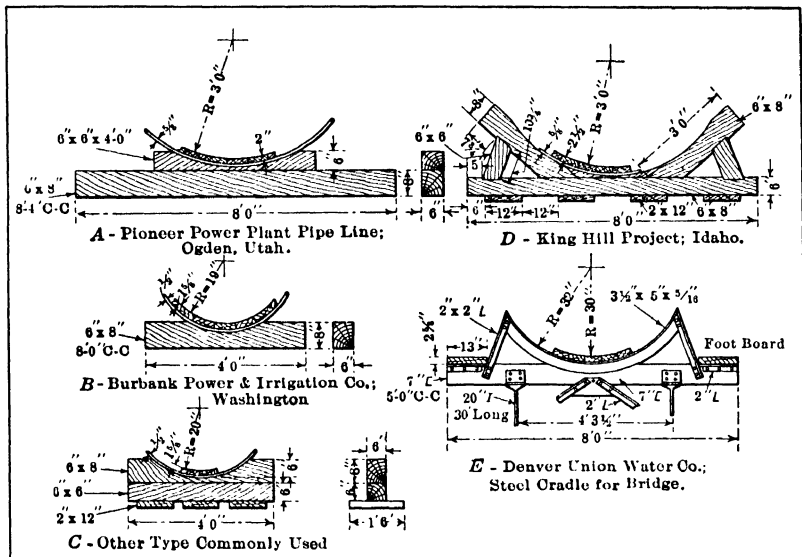

FIG. 67.—Supporting sills and cradles for wood stave pipe.

depth of milling to seat the pipe. Continuous or short pieces of mud sills may be used to protect the sills from decay (Fig. 67C). For larger size pipes framed cradles are commonly used (Plate XXIV, Fig. D). Fig. 67D shows the type of cradle used for several large pipes on the King Hill project, Idaho. Pipes which must be elevated at considerable height above the ground, such as for crossings over a drainage channel or small stream, are built on cradles which form the caps of trestle bents. Large stream crossings are often made by carrying the pipe line on a bridge, in which the cradles for pipe supports form the floor

sills. Fig. 67E shows the form of steel cradles used on a pipe line of the Denver Union Water Co., Colorado.

Special ingenious supports are sometimes required to carry a pipe line along steep or vertical bluffs. Two forms of such support, used on the Canyon City pipe line in Colorado, are shown in Fig. 68. The pipe line is supported in places on a narrow rock shelf, and at other places on an I-beam, one end of which is em-

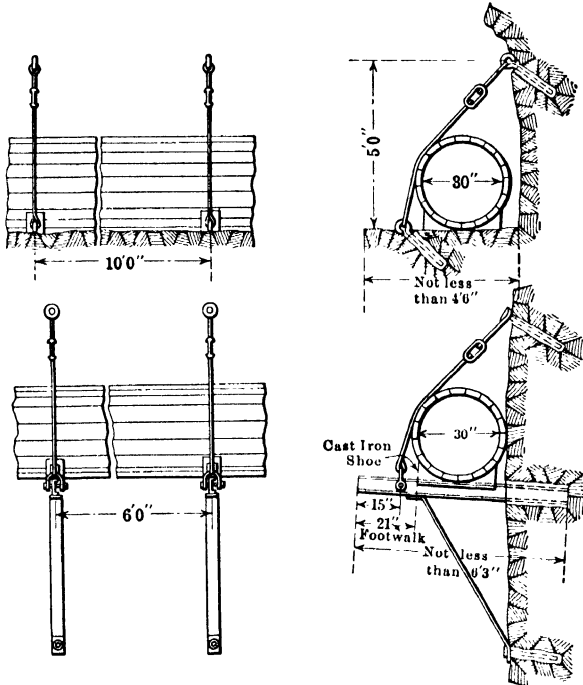

FIG. 68.—Method of supporting Canyon City pipe line on rock bench and vertical bluff. Colo.

bedded with concrete in the rock bluff. The pipe is held safe against outward displacement by anchor rods.

Overhead Stream Crossing vs. Undercrossing (Plate XXVI, Figs. A and B).—At stream crossings the selection must be made between an overhead crossing or an undercrossing by constructing the pipe under the river bed in a trench excavated in the river bed, in which case the pipe must be placed at sufficient depth to be beyond the depth to which the surface material may be eroded or displaced and may have to be anchored by piling to

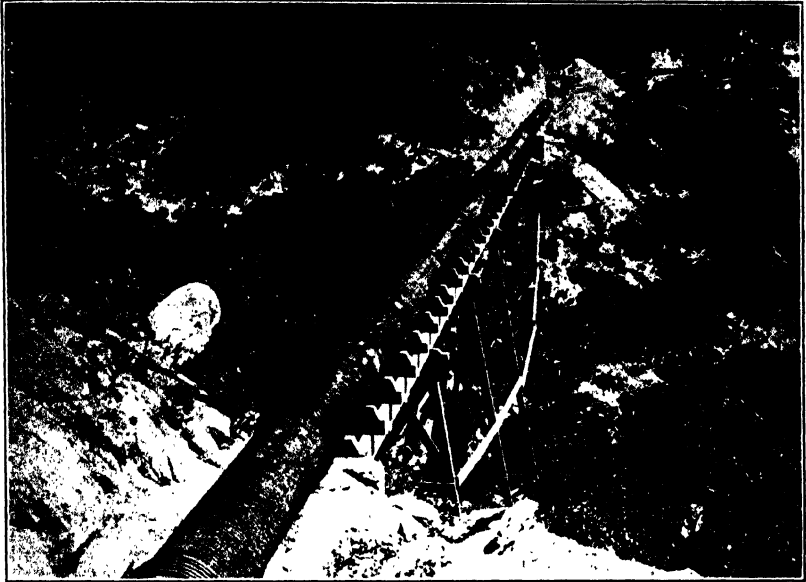

FIG. A.—24-inch machine banded wooden stave pipe on trestle. Southern Oregon (Washington Pipe & Foundry Co.).

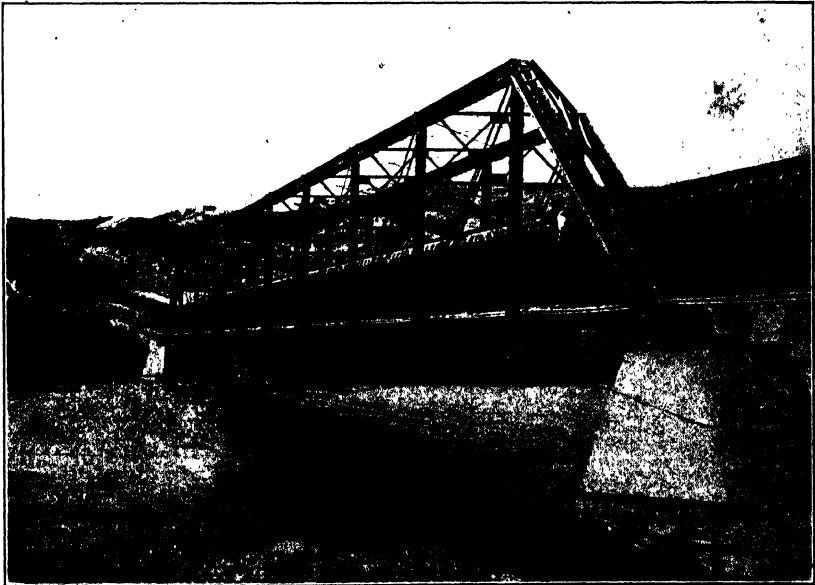

FIG. B.—60-inch continuous wooden stave pipe on bridge over Bear River, Oneida Irrigation District, Idaho. 300-foot head, $\frac{3}{4}$ -inch bands, $\frac{5}{8}$ -inch center to center. (Pacific Tank & Pipe Co.)



FIG. C.—Pipe yard. Kamloops Fruitlands Irrigation & Power Co., B. C.



FIG. D.—Moulds for making hand tamped cement pipe showing inside core in place.

prevent displacement and resist the buoyant force of the wood and pipe.

The selection will depend on the stream bed and stream flow conditions. When the stream flow is intermittent, with a small flow during the larger part of the time and sudden large flood flows at other times, it may be more economical to build the pipe line under the stream bed and leave an unobstructed channel. But when the stream flow is large at all times it will usually be preferable to carry the pipe line over the stream. This will usually be more economical in first cost, because an undercrossing will involve difficult and expensive diversion of the stream during construction, and it is preferable because repairs on a pipe carried under the stream bed can only be made with difficulty and at a great cost. This latter disadvantage was well illustrated by the experience on the Mabton siphon of the Sunnyside project, Washington. The wood stave pipe line of this inverted siphon is 12,676 feet in length; it tapers from a diameter of 55 inches at the upper ends to 48 inches for the lower portion, which is built in a trench in the bed of the Yakima River at a depth of 3 to 6 feet under the bed. Several bands were cut by the water and silt, escaping at a high velocity through a leak, and caused the ends of two staves to spring out and break off. This break was repaired by a diver, at a depth 15 to 20 feet under water, by clamping together steel plates with gaskets, at a cost of \$1,260.

Anchors for Wood Stave Pipes.—Anchors may be necessary on exposed wood stave pipes to prevent sliding on steep inclines, to prevent outward displacement at sharp curves, and to make sharp angles. Plate XXV, Fig. D shows a form of anchorage used on a 42-inch pipe line. Plate XXV, Fig. B, shows a special form of anchorage used on the 60-inch pipe line of Denver Union Water Co., Colorado. One such anchorage well was used at a sharp curve and three at angles of 27, 35, and 20 degrees. These angles were made at summits so that each well also acts as an air outlet. The well is made in the form of a boiler, 8 feet in diameter, 10 feet high, of $\frac{3}{8}$ -inch steel, and anchored at the base to a foundation slab 6 feet thick with eight $1\frac{1}{2}$ -inch bolts. It forms a collecting air chamber and also a sand trap $2\frac{1}{2}$ feet deep with an air valve at the top and a blow-off valve at the bottom connected to a discharge pipe.

Cost of Wood Stave Pipes.—The prices of machine-banded pipe vary slightly with the different manufacturers and are subject to

fluctuation. The following prices are approximate factory prices for either asphalt-dipped fir pipe or non-coated redwood pipe:

FACTORY PRICES AND WEIGHTS IN POUNDS OF MACHINE-BANDED PIPE PER LINEAL FOOT

Diameter, inches	Prices and weight for pressure head in feet of									
	50		100		150		200		250	
	Price	Weight	Price	Weight	Price	Weight	Price	Weight	Price	Weight
4	\$0.12	5.8	\$0.13	5.9	\$0.15	6.0	\$0.16	6.3	\$0.17	7.0
6	0.16	8.3	0.17	8.9	0.20	9.1	0.22	9.6	0.24	10.0
8	0.20	10.3	0.22	10.5	0.28	12.8	0.31	13.7	0.33	15.6
10	0.25	13.1	0.30	14.7	0.35	15.7	0.40	17.3	0.45	18.4
12	0.30	16.8	0.35	18.9	0.42	19.8	0.48	21.7	0.55	23.8
14	0.42	21.3	0.50	23.0	0.58	25.3	0.65	28.2	0.75	29.9
16	0.50	24.7	0.60	26.9	0.70	29.3	0.80	33.4	0.90	36.2
18	0.56	26.9	0.68	30.8	0.82	34.6	0.92	38.0	1.05	45.6
20	0.62	29.6	0.75	34.4	0.95	40.0	1.05	44.0	1.20	52.0
22	0.70	33.9	0.90	40.1	1.10	45.2	1.25	52.7	1.40	59.8
24	0.75	37.3	1.00	44.0	1.25	51.0	1.50	59.3	1.70	67.8

The prices for asphalt dipped redwood pipe are somewhat higher, especially for the smaller size pipes and for pressure heads of 150 feet or less.

These prices include inserted joints for pipes 4 to 12 inches in diameter and collar joints for 14 to 24 inches in diameter. The weights are for coated pipe. The weights for redwood non-coated pipe are about 60 per cent. of the above weights for the small sizes up to 12 inches in diameter, and about 70 per cent. for the larger sizes.

To obtain the cost of the pipe line in place, the following additional items must be considered: Freight and hauling, cost of laying, excavation and backfill. The freight cost for points in the Pacific Coast states is relatively small because of closeness to factories and the light weight of the pipe. The cost of hauling will also generally be small. The total cost of transportation will not usually exceed 5 to 10 per cent. of the factory price. The cost of laying and joining the pipe, exclusive of earthwork, and distribution of pipe along the trench ranges from about 1½ cents per lineal foot for 4-inch pipe up to about 6 to 8 cents per lineal foot for 24-inch pipe.

The cost of continuous wood stave pipe built in place is subject

to greater variations than that of machine-banded pipe, as it is dependent on the efficiency in field construction and on topographic conditions which may or may not be favorable. For purposes of preliminary estimates, the following cost values are obtained from a consideration of the actual cost of a number of pipe lines, mostly in Oregon, Washington, Idaho, and California. These values are the cost of the erected pipe line, including all material and labor, freight and hauling, but not earthwork, cradles or other special items of cost:

APPROXIMATE COST OF[•] ERECTED CONTINUOUS WOOD STAVE PIPE LINES
EXCLUSIVE OF EARTHWORK OR CRADLES

Diameter, inches	Fir pipe		Redwood pipe	
	50-foot head	100-foot head	50-foot head	100-foot head
24	\$1.40	\$1.75	\$2.00	\$2.50
30	1.50	1.90	2.45	3.00
36	1.60	2.00	2.70	3.25
42	1.75	2.25	3.10	3.75
48	2.25	2.80	3.75	4.50
54	2.75	3.25	4.30	5.25
60	3.30	4.00	5.50	6.75
66	4.00	5.00	6.50	7.75
84	5.25	6.50	9.00	11.00

SPECIFICATIONS FOR CONTINUOUS WOOD STAVE PIPE FOR
PIPES ON CENTRAL DIVISION OF U. S. RECLAMATION
SERVICE—SPECIFICATIONS NO. 275, JUNE 29, 1914

Diameter of Pipe.—The inside diameter of the pipe required shall be 60 inches for schedule 1, 24 inches for schedule 2, and 32 inches for schedule 3, after completion of the work. No diameter shall differ more than $1\frac{1}{2}$ per cent. from the average diameter of the pipe at any point, and the average of the vertical and horizontal diameters of the pipe at any point shall be not less than the specified diameter.

Staves.—All lumber used in staves shall be Douglas fir. It shall be sound, straight-grained, and free from dry rot, pitch seams, pitch pockets, checks, wind shakes, wane, bruised ends, and other imperfections that may impair its strength or durability. Sapwood will be allowed on the inside face of the stave for a thickness equal to one-fourth the thickness of the stave. No

through knots or knots on ends or at edges of staves will be allowed. Sound knots not exceeding $\frac{1}{2}$ inch diameter, not falling within the above limitations, nor exceeding three within a 10-foot length will be accepted. All lumber used shall be seasoned by not less than 60 days' air drying in open piles before milling or by thorough kiln drying. All staves shall have smooth planed surfaces and the inside and outside faces shall be accurately milled to the required circular arcs to fit a standard pattern provided by the contractor. Staves shall be trimmed perfectly square at ends and the slots for tongues shall be in exactly the same relative position for all ends and according to detail drawings furnished by the contractor. Staves shall have an average length of 16 feet or more and no staves shorter than 10 feet will be accepted. The finished thickness of staves shall be not less than $2\frac{1}{8}$ inches for schedule 1, $1\frac{1}{2}$ inches for schedule 2, and $1\frac{9}{16}$ inches for schedule 3. All staves delivered on the work in a bruised or injured condition will be rejected. If staves are not immediately used on arrival at the site of the work, they shall be kept under cover by the contractor until used.

Tongues.—Tongues shall be either of galvanized steel, iron or oak. The width shall be the same for all tongues and shall be at least $1\frac{1}{4}$ inches. The tongues and slot shall be so proportioned as to insure a tight fit of the tongue into the slot without danger of splitting the staves.

Bands.—All bands shall be of mild steel and shall have the following physical properties: Tensile strength, from 55,000 to 65,000 pounds per square inch; elastic limit as determined by the drop of the beam of not less than $\frac{1}{2}$ the ultimate strength; and a minimum per cent. of ultimate elongation in 8 inches of 1,400,000 divided by the ultimate tensile strength. The bands shall be capable of being bent cold without fracture 180 degrees around a diameter equal to the diameter of the test specimen. They shall be provided with button or bolt heads of ample dimensions. Bands shall be stronger in thread than in body and shall permit the nut to run freely the entire length of the thread. Nuts shall be of such thickness as will insure against stripping of threads. The diameter of bands shall be $\frac{5}{8}$ inch for schedule 1 and $\frac{1}{2}$ inch for schedules 2 and 3. Required band spacings are shown on the drawings.

Shoes.—There shall be two shoes to each band for schedule 1 and one shoe to each band for schedules 2 and 3. Shoes shall fit

accurately to the outer surface of the pipe and the type of shoe shall be subject to the approval of the engineer. On test, shoes shall be shown to be stronger than the bands on which they are to be used. Material for shoes shall be malleable iron and shall comply in all respects, with the "Standard Specifications for Malleable Castings" of the American Society for Testing Materials, adopted November 15, 1904.

Coating of Metal Work.—The bands and shoes shall be coated by being dipped, when hot, into a mixture of pure California asphalt or equivalent, and linseed oil. This coating shall be proportioned and applied so that it will form a thick and tough coating, free from any tendency to flow when exposed to sunshine or to become brittle when cold.

Blow-off Valve.—Each pipe shall be provided with an 8-inch diameter blow-off valve of standard design, with suitable saddle casting and all necessary fastenings and gaskets, and connected to the pipe as directed by the engineer. Detail drawings of, or catalogue references to, the gate valve proposed to be furnished shall be submitted with the proposal, and the neglect to furnish such drawings or references shall be sufficient cause for rejection of a bid. All flanges shall be machine-faced, and all parts intended to conform, one with another, shall have a true and accurate fit. The valves shall be designed to operate under the heads of water shown on the drawings and shall be guaranteed against any defect of design or workmanship for 1 year. As far as possible, all connections shall be of standard design. Castings must be of the best quality of tough gray iron, made either by the furnace or cupola process and shall be free from cold-shuts, blow-holes, porosity, or other injurious defects, and shall be finished true to pattern and free from excessive shrinkage, rough surfaces and ragged edges. All machined surfaces shall be coated with white lead and tallow as soon as they are finished.

Erection.—The contractor shall assemble and construct the pipe in place in the trench excavated by the United States. The ends of the staves shall break joints by at least 3 feet. Staves shall be driven in such a manner as to avoid any tendency to cause wind in pipe. Staves shall be well driven to produce tight butt joints, driving bars or other suitable means being used to avoid marring or damaging staves in driving. The pipe shall be rounded out to produce a perfectly smooth inner surface and care shall be exercised to avoid damage by chisels or other tools.

Bands shall be placed perpendicular to the axis of the pipe and shall be spaced as specified on the drawings. Shoes shall be placed to cover longitudinal joints between staves and bear equally on two staves. Shoes shall not be allowed to cover butt joints. All metal work shall be handled with reasonable care so as to avoid injury to coating as much as possible. After erection, the contractor shall have the coating of all metal work where abraded thoroughly retouched with an asphaltum paint, satisfactory to the engineer. All excavation of trenches, formation of embankment and backfilling will be done by the United States excepting that such small amounts of backfilling as the contractor may find necessary during the prosecution of his work to hold the pipe in place shall be done by him and the cost thereof shall be included in prices bid for furnishing and erecting pipe.

If more than one schedule is awarded the same bidder, the contractor may select the schedule he desires to begin work on, and when work is started on any one schedule it shall be continued without interruption and be prosecuted with such force and diligence as to insure its completion within the time agreed upon. The object of this section is to require that the erection superintendent shall stay on each siphon until it is completed and tested out, but nothing herein contained shall be construed to prevent the contractor from having a superintendent for each pipe and prosecuting the work on more than one schedule at the same time if he so desires. 'Thirty days' written notice shall be given by the contractor to the project manager on each project before erection is begun on that project in order that the trench excavation may be completed in time.

Painting.—After erection, and while the pipe is thoroughly dry, the entire outer surface of the pipe shall be given a coat of refined water-gas tar, followed by a coat of refined coal-gas tar, thinned with distillate, applied with air pressure or brushes. The combined thickness of coating shall be not less than $\frac{1}{16}$ inch. The cost of this work, including all materials and labor shall be included in the price bid for each schedule.

Inspection.—Final inspection of materials, as well as erection will be made on the work, but if the contractor so desires, preliminary inspection of staves may be made at the mill at the contractor's expense. Mill inspection, however, shall not operate to prevent the rejection of any faulty material on the work. Tests of metal work will be made at the point of manufacture by

the United States at its own expense; or they may be made at the plant by the contractor or his employees acting under the direction of the engineer or his representative; or certified tests may, at the option of the engineer, be accepted in lieu of the above-mentioned tests. The contractor shall provide, at his own expense, the necessary test pieces, and shall notify the engineer or his representatives when these pieces are ready for testing. All test bars and test pieces shall be marked for identification and shall be properly boxed and prepared for shipment if required.

Tests of Pipe.—On completion of the work, or as soon as possible thereafter, the contractor shall make a full pressure test of the pipe, water being furnished therefor by the United States. All leaks found at the time of the test shall be made tight by the contractor. If the leakage is not so large as to endanger the foundation of the pipe, the pipe shall be kept under full pressure for 2 days before plugging of leaks is started in order to allow the wood to become thoroughly saturated. The cost of making the test, except furnishing water, shall be borne by the contractor.

CEMENT MORTAR AND PLAIN CONCRETE PIPES

General Use of Pipe.—During the past 30 years cement pipes from 6 to 36 inches in diameter have been used extensively in southern California for the conveyance of water on the farm and the distribution of water to orchard furrows or alfalfa fields. They have also been used to a considerable extent in the place of open ditches for the laterals of irrigation systems. The use of cement pipes is largely the result of the high value of water, which has made it desirable to prevent losses of conveyance and distribution in order to obtain the most economical use of water. Many hundred miles of cement pipes have been used in southern California and in more recent years many miles of pipe lines have been used on irrigation systems and for farm distribution systems, at least in Arizona, Oregon, Washington, Colorado, Idaho and British Columbia.

The use of cement pipes for the conveyance and distribution of water on orchards and farms has been described in Chapters VI and VII of Vol. I. The use of cement pipe lines as laterals for an irrigation system is described in a chapter of Vol. III, in which the special conditions for this type of system are fully discussed.

Description of Pipe and Properties.—The cement pipe as commonly used in southern California and adopted elsewhere is made

in sections 2 feet long. One end of the pipe tapers in and the other end tapers out to form a bevelled lap joint when abutting ends are connected together with cement mortar. The pipe section is made with metal moulds, in which a moist mixture of cement and sand or cement and natural pit gravel or other aggregate is carefully tamped. The mixture is comparatively dry to permit the removal of the moulds immediately after the tamping is finished, and thus decrease the cost by obtaining a large output. With one set of moulds an experienced crew will make in 1 day as much as 100 feet of 30-inch pipe and 400 to 500 feet of 6 to 8-inch pipe. After the removal of the moulds, the pipe must be carefully cured by being kept moist for at least 1 week and allowed to harden for about a month before it is laid and joined. The sizes to use in any case are determined from the desired carrying capacity and the available grade. A table of carrying capacities is given on page 157, Chapter VII of Vol. I.

The cement pipe, as manufactured by this dry process, has not the strength of and is more permeable than a pipe made with wet concrete; it can only be used to cross shallow depressions and for moderately low pressures. The permeability of the pipe is dependent largely on the interior coating of the pipe; without this coating the pipe will leak considerably with practically no pressure on it. The pressure which a cement pipe line will safely stand in practice depends as much on the strength of the joints as it does on the quality and strength of the pipe. On account of the expansion and contraction, as explained further, contraction cracks can probably be seldom avoided. The results of the leaks through these cracks are more serious in clay or retentive soils which do not drain readily than in porous sandy soils. Extensive experience shows that the following values of maximum pressure heads are safe for pipes manufactured and joined with care, free from water-hammer or pulsations.

These maximum pressures are less than have been successfully used on many pipe-line laterals of the Fruitlands Irrigation system near Kamloops, British Columbia. With special care in making and laying the pipes, pressure heads 30 per cent. greater than those given in the above table may be used. Tests made by A. E. Wright in Oregon, by C. M. Elliott in southern California, and by students in the Civil Engineering testing laboratory of the University of California indicate that a pipe properly coated on the interior will not leak or sweat excessively for pressures at least

twice those given in the table, and that the bursting pressure is about 4 times the values given in the table.

SAFE PRESSURE HEADS FOR HAND-TAMPED CEMENT PIPE

Diameter of pipe in inches	Maximum safe head in feet		
	For 1 to 2 mixture	For 1 to 3 mixture	For 1 to 4 mixture
12	20	15	10
14	20	15	10
16	18	12	8
18	18	12	8
20	18	12	8
24	15	10	6
30	15	10	6

It is important that great care be used in planning and constructing pipe lines to avoid pulsations resulting from air accumulation or movement in the pipe line. Air outlets of ample capacity must be provided at all summits and sharp convex bends; these can usually be formed by cutting a hole in the pipe and cementing to it a vertical stand pipe made of sections of cement pipes, the lower end of which is cut to saddle around the hole and the upper end extending above the hydraulic gradient.

METHOD OF MANUFACTURING AND LAYING HAND-TAMPED CEMENT PIPES

Materials Used and Mixing.—The mixtures commonly used are 1 part of cement to 4 parts of a natural aggregate of pit gravel and sand for pipes up to 18 inches in diameter, and 1 part of cement to 3 parts of gravel and sand for larger pipes. If crushed rock or screened gravel is used, a good mixture is 1 part of cement to 2 of sand and 3 or 4 of gravel or rock. No gravel or rock larger than $\frac{1}{2}$ the thickness of the pipe should be used. To make the pipe more nearly water-tight, 5 per cent. of the weight of cement in hydrated lime is sometimes added. The sand and gravel must be free from dirt or organic matter. The mixing is often done by hand and in small batches, but for a large plant concrete mixers are advisable. While it is desirable to use as much water as possible, only sufficient water is added to the mixture to give the consistency of damp earth, such that it will retain its shape when squeezed in the hand. When too much water is added the mix will stick to the mould and the pipe will collapse when the moulds

are removed. In order to make the ends smoother, some manufacturers use for the ends a finer and richer mixture made of 1 part of cement to $2\frac{1}{2}$ or 3 of screened sand.

Method of Moulding.—The moulds consist of a set of base rings, bevelled to form the base of the pipe, an inside core, an outside jacket, a funnelled sheet-iron hopper, a rimmer or cast-iron ring which fits around the inside core and bevelled on the inside edge, a tamping bar and a feeding scoop. The pipe is usually made on a solid platform or levelled firm area. To set the mould in position, the inside core is placed inside the base ring and clamped tight to it by turning a lever, and the outside jacket is placed around the base ring and contracted by turning a lever (Plate XXVI, Fig. D). The hopper fits on the top of the outside. The mortar is fed in the moulds and spread in thin layers 1 to 2 inches thick. Each layer must be carefully and uniformly tamped all around the inside core in order that the core be not shifted, and make the pipe of unequal thickness (Plate XXVII, Fig. A). When the last layer has been tamped, a little extra material is placed all around the top and the hopper is removed; the rimmer is then placed around the inside core, is jammed down and revolved, at the same time pressing down on the pipe. The inside core is now contracted and removed, and then the rimmer taken off. If the pipe has been made on a platform, it is carried by means of lifting hooks with the jacket still clamped on the base ring and is placed on level ground. The jacket is then released and removed and the pipe left on the base ring until it has hardened. For large size pipe, to avoid lifting and carrying the pipe, the base rings are placed on the levelled ground instead of on the platform. Where the pipes have to be used for pressures slightly greater than those given and especially for pipes above 18 inches in diameter, it is advantageous to place in the moulds during the tamping process hoops of ordinary wire about 6 inches apart. This permits a slightly wetter mixture, and adds strength to the pipe without materially increasing the cost. Considerable practice is necessary before satisfactory pipe can be made, and many pipes will be broken before sufficient experience has been acquired.

Curing the Pipe.—When the process of moulding is completed, the pipe must be carefully cured. The dry mixture does not contain sufficient water for the cement to crystallize properly and additional water must be supplied by sprinkling during the curing period. The first sprinkling is done with a fine spray as soon as the pipe has set sufficiently to stand it without washing. After



FIG. A.—Tamping mixture in moulds to make cement pipe.

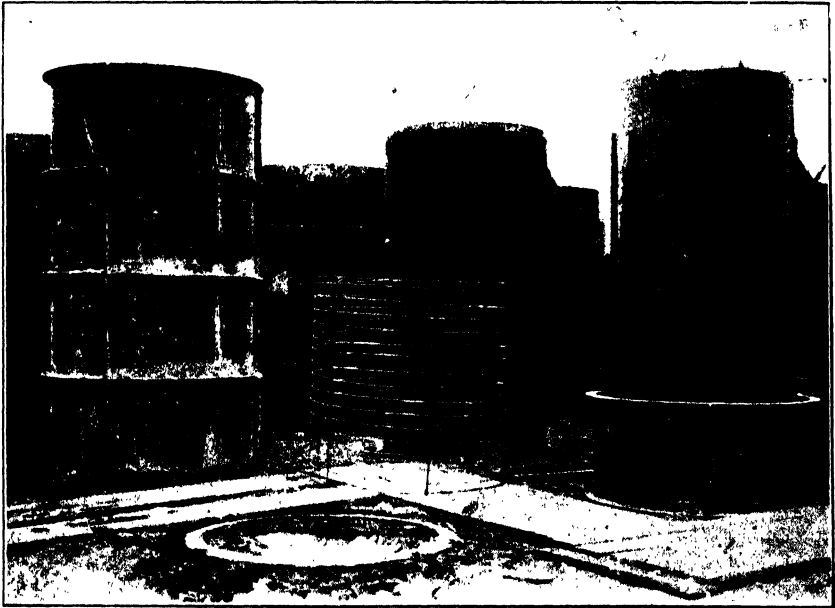

FIG. B.—Moulds for casting 47-in. reinforced concrete pipe. Umatilla Project, Ore.

(Facing page 304)

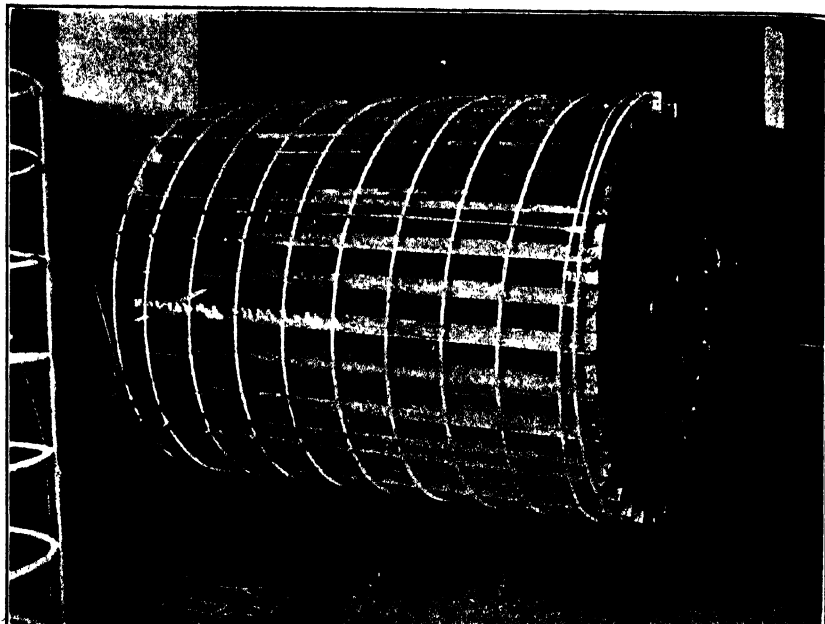

FIG. C.—Reel for making wire spiral reinforcement. Umatilla Project, Ore.

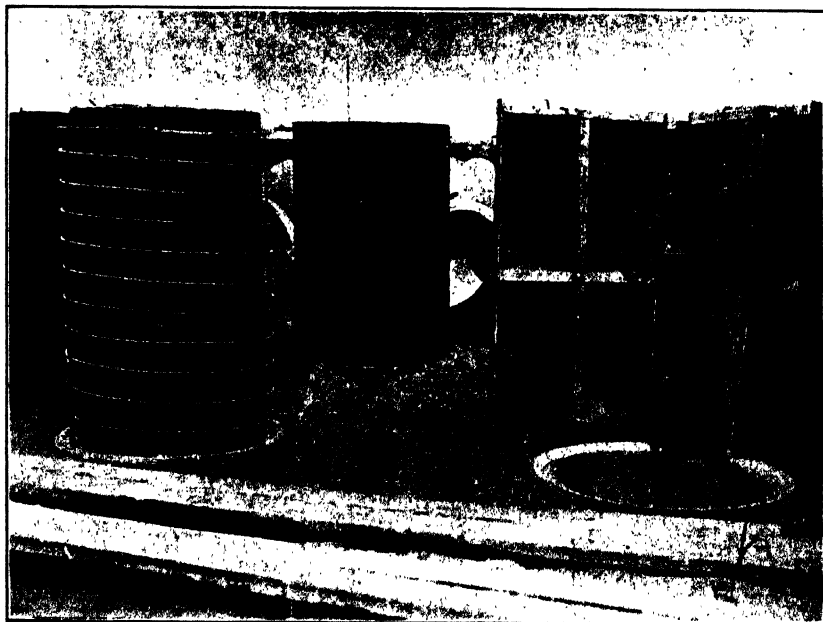

FIG. D.—Moulds for casting 30-inch reinforced concrete pipe. Umatilla Project, Ore

this, the pipe must be kept continually moist by frequent sprinkling or by covering with wet burlap or sacks for a period of at least 1 week and not allowed to become dry.

Coating the Pipe.—Interior coating is necessary to make the pipe less permeable. It is usually done with a thin paste of neat cement. Some prefer to use a cement lime mixture made of $\frac{2}{3}$ cement and $\frac{1}{3}$ lime. The coating of the smaller sizes of pipes, 6 to 12 inches in diameter, is often obtained by dipping the pipe in the liquid mixture and for the larger sizes of pipes is applied with a fiber brush. It is preferable to do this as soon as the pipe will stand the handling, usually when it is 24 hours old, at which time the base rings can be removed.

Cost of Moulds.—Moulds must be substantially made to withstand the tamping and must be easily and quickly set in position and removed. The largest manufacturer of the moulds used in southern California and supplied to the U. S. Reclamation Service for use on some of its projects is the Kellar and Thomason Co. of Los Angeles, California. Their list price in California of a set of moulds for 6-inch pipe with 100 base rings is about \$50; for 12-inch pipe with 100 base rings, \$82.50; for 18-inch pipe with 50 base rings, \$94.25; for 24-inch pipe with 25 base rings, \$107.50 and other sizes in proportion.

DIMENSIONS OF CEMENT PIPE AND RATE OF MANUFACTURE

Inside diameter of pipe, in inches	Thickness of pipe in inches	Number of feet of pipe made with 1 barrel cement		Men composing one crew	Number of feet made per day
		1 : 4 mixture	1 : 3 mixture		
6	$1\frac{1}{16}$	95	75	1 mixer, 1 or	400-500
8	$1\frac{1}{4}$	63	50	2 moulders,	350-400
10	$1\frac{3}{8}$	47	37	1 finisher	300-400
12	$1\frac{1}{2}$	36	28	and helper.	250-350
14	$1\frac{5}{8}$	28	22	1 or 2 mixers,	225-325
16	$1\frac{3}{4}$	23	18	2 moulders,	200-275
18	$1\frac{7}{8}$	19	15	1 finisher	150-225
20	$1\frac{7}{8}$	17	14	and helper.	125-175
22	2	15	$11\frac{3}{4}$		100-150
24	$2\frac{1}{4}$	$12\frac{1}{4}$	$10\frac{1}{2}$	3 or 4 mixers,	100-150
26	$2\frac{1}{4}$	$11\frac{1}{2}$	9	2 moulders,	90-120
30	$2\frac{1}{2}$	9	7	1 finisher	90-110
36	3	$6\frac{1}{4}$	5	and helper.	80

Cost of Making Pipe.—The table of cost given below is obtained from the above data, and the following prices of labor and material: Portland cement, \$3.50 delivered on the ground; gravel, \$1.00 a cubic yard; labor, tampers, \$3.00 a day, and mixers and sprinklers, \$2.50 a day. The figures given include all materials and labor and an allowance of about 10 per cent. for interest and depreciation on plant, administration, and supervision, and should not be exceeded with efficient workers.

COST OF MAKING CEMENT PIPES (IN CENTS) PER LINEAL FOOT

Diameter of pipe, inches	Cost for 1 : 2 mixture, cents	Cost for 1 : 3 mixture, cents	Cost for 1 : 4 mixture, cents
6	13	10	7
8	15	12	9
10	20	15	11
12	25	20	15
14	30	25	20
16	36	30	25
18	42	35	30
20	50	43	35
24	68	60	50
26	87	75	63
30	95	85	70
36	130	115	95

Construction and Laying of Pipe Line.—The trench for the pipe line must be sufficiently deep to give an earth covering on the top of the pipe of at least 12 to 18 inches and in regions of low winter temperatures the pipes should be placed preferably below the depth of ground freezing; this is necessary if the pipe lines are to be kept full of water in the winter. The bottom of the trench should be given an even grade to avoid short siphons or bends which may form air chambers in the pipe. The width of the trench should be larger than the outside diameter of the pipe by about 12 inches to allow the pipe layers sufficient space in which to work. The trench width and depth with the cost of excavation are given in the table below, based on an 18-inch depth of earth covering. The cost of excavation and backfilling is assumed at 20 cents a cubic yard.

COST OF EXCAVATION FOR CEMENT PIPE LINES, IN CENTS PER LINEAL FOOT

Size of pipe, inches	Depth of trench, inches	Width of trench, inches	Excavation in cubic yards per lineal foot	Cost of excavation in cents
6	26	20	0.13	2.6
8	28	22	0.16	3.2
10	31	25	0.20	4.0
12	33	27	0.23	4.6
14	35	29	0.27	5.6
16	38	32	0.32	6.4
18	40	34	0.35	7.0
20	42	36	0.38	7.6
24	47	41	0.50	10.0
26	49	43	0.55	11.0
30	54	48	0.66	13.2
36	60	54	0.83	16.6

After the trench excavation the pipe sections are stood on end in the trench with the bell or grooved end up; the laying and joining then proceeds, the sections being laid with the taper end forward, as follows: On the under side of the taper end of the pipe last laid enough soil is removed to form a bed of mortar around the joint about 1 inch thick and 4 inches wide and extending sufficiently far up on both sides to join with the upper part of the band. The ends of the pipe must be first cleaned with a wire brush and water and well wetted before making the joint. The bell end of the pipe is then filled with cement mortar, made of 1 part of cement to 2 of fine sand, and is jammed against the taper end of the previously laid pipe. The mortar, squeezed out on the inside of the joint, is wiped out with a wet brush to form a smooth surface. To complete the joint, a band of mortar about 3 inches wide and about $\frac{1}{2}$ inch thick is formed on the outside of the pipe. In order that the band be not broken by the jars in laying succeeding sections, the band must not be made before at least three joints have been laid ahead of it. On steep slopes where there is a choice between laying uphill or downhill, it is better to lay uphill to prevent any tendency for the pipe joints to separate by sliding downhill. The bands must be protected from the action of the sun and from the drying effect of a dry backfill by being covered with wet burlap, or tar paper, for at least 30 minutes before backfilling, and should be wetted again before covering. When necessary to raise a pipe and hold it on grade, tamped material and not clods must be used. Backfilling must be done carefully with selected material tamped up

to the top of the pipe. The pipe should not be filled for at least 2 or 3 days, and preferably longer if under pressure, to give sufficient time for the bands to harden.

In the accompanying table is given information regarding the laying and hauling of cement pipe, based on the wages and cost of material given above. Ten per cent. has been allowed for supervision, organization, breaking of pipe and miscellaneous.

COST OF LAYING AND HAULING CEMENT PIPE, IN CENTS PER LINEAL FOOT

Diameter in inches	Weight of pipe in pounds per foot	Number of feet laid per barrel of cement	Number of men in laying crew	Number of feet laid per day	Cost of laying exclusive of trenching and hauling, in cents per foot	Cost per foot of hauling 2 miles
6	20	500	3	600	2.25	0.9
8	32	400	3	600	2.50	1.4
10	42	350	3	500	3.00	1.9
12	56	300	3	450	3.50	2.5
14	69	225	3	400	4.00	3.1
16	85	200	3	300	5.00	3.8
18	100	175	4	300	6.25	4.5
20	110	150	4	300	6.60	5.0
24	160	100	6	300	10.00	7.2
26	175	85	6	250	12.00	7.9
30	220	75	6	200	14.00	9.9
36	320	60	7	200	17.00	14.4

The cost data given in the preceding tables are assembled and given below.

COST OF MAKING, LAYING, TRENCHING AND HAULING CEMENT PIPE, IN CENTS PER LINEAL FOOT

Diameter of pipe in inches	Cost of making		Cost of laying	Cost of trenching	Cost of hauling 2 miles	Total cost	
	1 : 3 pipe	1 : 4 pipe				1 : 3 pipe.	1 : 4 pipe
6	10	7	2.25	2.6	0.9	15.75	12.75
8	12	9	2.50	3.2	1.4	19.10	16.10
10	15	11	3.00	4.0	1.9	23.90	19.90
12	20	15	3.50	4.6	2.5	30.60	25.60
14	25	20	4.00	5.4	3.1	37.50	32.50
16	30	25	5.00	6.4	3.8	45.20	40.20
18	35	30	6.25	7.0	4.5	52.75	47.75
20	43	35	6.60	7.6	5.0	62.20	54.20
24	60	50	10.00	10.0	7.2	87.20	77.20
26	75	63	12.00	11.0	7.9	105.90	93.90
30	85	70	14.00	13.2	9.9	122.10	107.10
36	115	95	17.00	16.6	14.4	163.00	143.00

These cost values agree quite closely with those given below, which are those obtained for about 5 miles of pipe on the irrigation system of the Fruitlands Irrigation and Power Co. near Kamloops. On this project the concrete mixture was composed of 1 part of cement to 2½ of sand and 1½ of crushed rock. Cement cost \$3.00 a barrel, sand 75 cents a cubic yard, crushed rock \$2.50 a cubic yard, common labor \$2.50 a day, skilled labor \$3.00 to \$3.50 per day, and teams \$5.00 per day. The cost given includes all materials, labor, supervision, and depreciation on plant.

COST OF MAKING AND LAYING CONCRETE PIPE ON IRRIGATION SYSTEM OF FRUITLANDS IRRIGATION AND POWER CO., NEAR KAMLOOPS

Diameter of pipe, inches	Cost of making, cents	Cost of laying, cents	Total cost, cents
8	11.1
10	15.7
12	20.0	11.0	31.0
16	29.5	15.5	45.0
20	39.5	20.3	59.8
24	54.7	23.3	78.0

Other Methods of Making Cement Pipes.—The southern California method, described above, has the advantage of low cost, but it produces a pipe that is impermeable only for moderately low heads and the character and quality of the pipe is dependent for uniformity on the experience and skill of the laborers. This has led to the introduction of other methods, some of which are more or less experimental. Two methods at least have given good results.

Machine-tamped Pipe.—This pipe is made with a comparatively dry mixture much in the same manner as hand-made pipe, but the mixture is thoroughly tamped by a mechanical tamper of small cross section which tamps rapidly and gives a high degree of compression. The inside core is rotated during the tamping process, and this gives to the inside of the pipe a smooth semi-glazed surface. The pipe obtained by this process is very dense and is more uniform and superior to the hand-made pipe, especially when a pipe is desired for pressure heads greater than the hand-made pipe will stand. The pipe is usually made with a bell similar to sewer pipe. This requires more material than for the shiplap ends obtained with the hand-made pipe, and the pipe is

not as easily laid. The cost is usually considerably more than that of hand-tamped pipe, and may be prohibitive on account of transportation if the pipe is purchased from a distant plant. A number of manufacturing plants have during recent years been established in the west.

Wet Process Pipe.—The use of a wet mixture of cement mortar or cement concrete for pipe making has not been largely adopted in the past, because of the large number of moulds required for a large output. A modification of the dry hand-tamped pipe method, which permits the use of a comparatively wetter mixture, has been introduced, which does not require a much larger expense for moulds. The set of moulds are the same as used for the dry tamped pipe with the addition of a set of thin galvanized iron jackets. Each one of these thin jackets is used for an interior lining to the main outside collapsible jacket of the set of moulds. With this interior lining the inside core and outside jacket can be removed immediately, and the thin jacket is left on for about 2 hours or until the material has hardened sufficiently to permit its removal. The cost of these additional thin jackets is small and a better pipe is obtained. A similar method used by the Reclamation Service for the manufacture of small size reinforced pipe on the Tieton project is described in the discussion of reinforced concrete pipe.

REINFORCED CONCRETE PIPES

General Description and Use.—The pipe consists of a skeleton of iron or steel imbedded in a concrete shell. The metal is usually designed to take the entire tensile stress due to water pressure and water-hammer. The concrete serves as a protection to the steel and is made only thick enough to give the pipe rigidity and prevent percolation. For special conditions of heavy external loading, such as when the pipe is deeply buried, it may be necessary to design also for the external pressure. In a few cases the pipe has been built above ground, supported on piers, for which cases it must be designed also for the beam action between supports. There are two different kinds of pipe, depending on the method of construction:

1. Pipes cast in short lengths, laid and joined in the trench.
2. Pipes built in place in the trench.

The second type is generally used for large conduits and requires a thicker shell, usually not less than 5 or 6 inches.

Reinforced concrete pressure pipes, depending entirely on the concrete to prevent percolation, have been used successfully for heads as great as 110 feet and are guaranteed by some pipe manufacturers for pressures as great as 150 feet. But for pressures as great as these, very careful workmanship is necessary, and with the cast pipes built in short sections the joints demand special attention, in order to prevent excessive percolation through the contraction cracks at these joints, which may result in serious trouble, especially when the pipe line is in soil that does not drain readily. In general their use is limited to pressures under 100 feet. By using a metal shell, either as a lining or imbedded in the concrete, they have been used for pressure heads of 300 feet and more.

The use of reinforced concrete pipe is of comparatively recent origin in the United States. In Europe, notably in France, reinforced concrete pipes have been used extensively for at least 20 years. During the past 10 years their use in the United States has been introduced for domestic water supply and irrigation systems. On a number of projects many miles of reinforced concrete pipe lines have been installed for distributaries of the irrigation system, while on others the use may be limited to a few inverted siphons.

Reinforcement.—There are various kinds of reinforcement used for pipe construction. Those most generally used are round steel rods, corrugated bars, twisted bars, expanded metal, metallic cloth, etc. Two French constructors use special bars in the form of small I-beams and crosses, claiming for them greater rigidity and strength.

The circumferential reinforcement is the most important as it takes up the entire stresses due to water pressure and water-hammer. The safe working strength of the reinforcement is usually taken as 12,000 to 16,000 pounds per square inch. The longitudinal reinforcement is used either to hold the circumferential reinforcement or to resist temperature stresses due to contraction. When the pipe is built in sections, or if expansion joints are provided, little longitudinal reinforcement is necessary. When the pipe is built continuously the amount of reinforcement will depend on the extremes in temperature. To reduce the ultimate contraction it is advantageous to construct the pipe line at a comparatively low temperature and to cover the pipe when constructed with an earth covering. An amount of reinforcement

to resist temperature stresses of 0.2 to 0.3 per cent. of the concrete area is generally sufficient.

The circumferential reinforcement for pipes of small diameter is wound by machinery in the form of a spiral and kept to the proper spacing by means of longitudinal rods tied to the spiral with wire. For large diameters of pipes and for heavy reinforcement, which cannot be wound in spiral, the steel is bent into hoops by means of rolls. The ends of the hoops may be lapped and tied together with wire, or welded, or riveted, or each end bent into a hook and a longitudinal rod passed through the eye of the hooks. When the pressure is from the inside the longitudinal reinforcement is placed on the inside of the circumferential reinforcement, and for exterior pressure is placed on the outside. Frequently for interior pressure the reinforcement is placed nearer the outside of the shell and for exterior pressure nearer the inside. M. Bonna, a French constructor, does not rely on the imperviousness of concrete for heads above 50 feet and uses in addition to the ordinary reinforcement a thin steel shell, placed as a lining inside the pipe or imbedded in the concrete between two reinforcing skeletons.

Concrete.—To obtain an impermeable pipe the concrete must be carefully proportioned to obtain maximum density. The mixture must be rich. The Reinforced Concrete Pipe Co. of Los Angeles, California, uses a 1 : 2 : 4 mixture for 25-foot heads and 1:2:3 mixture for heads from 50 to 100 feet. On the Umatilla project, Oregon, the mixture varied from 1:1.8:3 to 1:2:4. On the Belle Fourche siphons, South Dakota, it was 1:2¼:3¾, and on the Albelda siphon, Spain, it was 1:1.28:2.56.

Reinforced Concrete Pipes Cast in Sections.—This kind of pipe is used for diameters generally not greater than 6 feet. The sections or pipe lengths are usually from 3 to 8 feet long, and occasionally as great as 10 to 12 feet. The thickness of the pipe seldom exceeds 3 to 4 inches, and smaller pipes under 12 inches in diameter are usually made 1½ to 2 inches thick.

Method of Casting Pipe Lengths Used on Umatilla Project, Oregon.—The pipes are cast vertically by placing a steel skeleton between the forms and filling the moulds with a wet concrete. The following description of the method used on the Umatilla project for casting pipe sections, 47 inches in diameter, 2½ inches thick and 8 feet long, is typical:

The moulds (Plate XXVII, Fig. B) consist of an interior collaps-

sible form 8 feet long, built of steel plate $\frac{1}{8}$ inch thick riveted on framed angle ribs, made of two main parts, each bent on a 47-inch radius, hinged together with a vertical joint 8 feet long, and of a third part or closing wedge 8 inches wide and 8 feet long, which, with the other two pieces, completes the inside circumference of the pipe and makes it possible to collapse the core. The outside form is made up of four sections, each 2 feet high, and each section is made of three parts, each part being $\frac{1}{3}$ of a circumference and 2 feet high. This form is made of $\frac{1}{8}$ -inch steel plate, strengthened with 2 by 3 by $\frac{3}{16}$ -inch angles riveted to the edges of each of the 12 parts. The rivets are countersunk on the inside. The parts can all be bolted together. The base ring is of cast iron and gives to the lower end of the pipe the proper shape. The reinforcement, which consists of round wire, is wound into spirals 4 feet long, two spirals being used for the pipe 8 feet long. The spirals are formed on a reel Plate XXVII, Fig. C, on which are hinged spacing bars with notches to receive the reinforcement and give it the proper spacing. After the spiral is wound, longitudinal rods 4 feet long are tied with wire to the spiral, to maintain the proper spacing. The spacing bars are then folded over and the spiral removed. The spiral is then made more rigid by cross lacing with wire.

The method of moulding is as follows: The moulds are well oiled and the base ring placed on the ground. The interior is placed in position and the reinforcing skeleton placed around the inside core. Then the lowest section of the outside form, which is formed of 3 parts bolted together, is placed around the skeleton. The base ring gives the proper spacing to the inside and outside form. The concrete is machine mixed and consists of 1 part of Portland cement, 1.8 parts of sand, 3 parts of gravel with enough water to give a wet concrete. The concrete is placed in the moulds and well stirred and worked down with thin tamping rods. When the first section of the mould has been nearly filled, the other sections are bolted in succession, each being filled nearly to the top before the next one is put on. To fill the fourth section, a funnel-shaped collar is placed around the inside core and bolted to the outside core. When filled, the collar is removed and the upper end of the pipe finished by hand. The forms are removed 24 hours after the pipe has been moulded and the base ring is left for 8 days.

For the 30-inch reinforced pipe the forms used are 4 feet long

and made of lumber lined with sheet steel. The interior core consists of 2 main parts and a third part or closing piece. The outside form consists of 4 parts, which are bolted together (Plate XXVII, Fig. D and Plate XXVIII, Fig. A).

The pipe lengths are kept from drying for a period of 10 days after they are cast, and the concrete allowed to harden for a period of about 30 days or more before they are transported and laid.

Method of Casting Small Diameter Pipe on Tieton Project, Washington.—On this project various methods were experimented with to find a method which would permit the use of a comparatively wet mixture for casting reinforced pipes from 8 up to 14 inches in diameter, and would eliminate the large number of moulds required for the method described above. The method finally adopted was similar to that used for making hand-tamped dry-mixture non-reinforced pipe, modified as follows, to allow the use of a wet mixture: *First*, a large enough number of interior cores were provided to allow the mixture to set for 1 hour before their removal. *Second*, a lining of tarred paper was slipped over the inside core, and a similar lining placed on the inside of the outside jacket (Plate XXVIII, Fig. B). By this means the mixture was poured between the two linings of tarred paper. The outside cylinder of tarred paper gave sufficient support to permit the removal of the outside jacket quickly after the mixture had been placed, and the inside cylinder of tarred paper gave the additional support required after the inside core had been removed. The concrete was made of 1 part of cement to $2\frac{1}{2}$ of sand and 3 of gravel for pressure heads under 80 feet, and 1 part of cement to 2 of sand and 2 of gravel for pressure heads greater than 80 feet. The pipes were 8, 10, 12 and 14 inches in diameter, the length for all sizes was $28\frac{1}{2}$ inches and the thickness 2 inches. The moulds were similar to those previously described for hand-tamped pipe, each set consisting of a number of inside collapsible metal cores, an outside metal jacket, a number of base rings, and a feeding hopper (Fig. 69). The reinforcement was made of triangular wire mesh from rolls 30 inches wide, formed on a drum by a machine into cylinders slightly tapering, and rewound with No. 12 wire. The reinforcement is designed for 14,000 pounds per square inch. The process of construction is as follows: A cylinder of tarred paper is slipped over the inside core, and this core is then expanded to fit tightly against the base ring at its lower end. This ring has

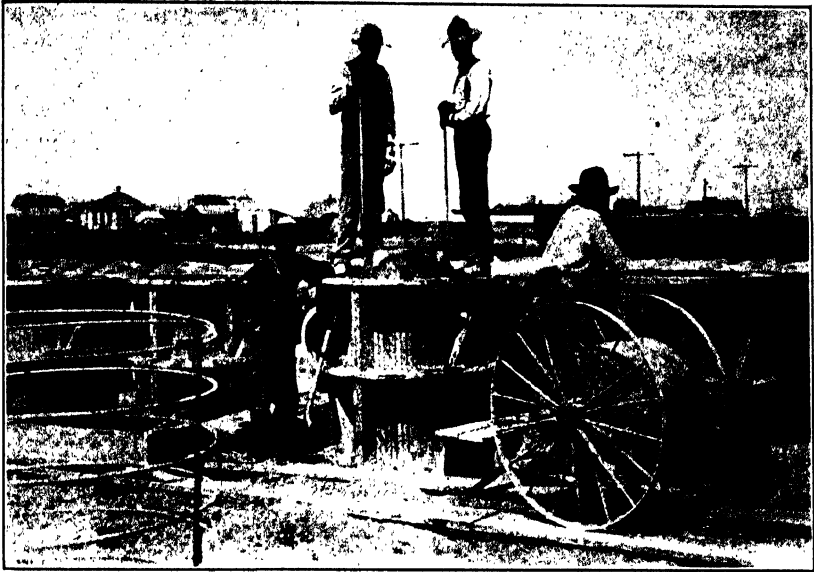

FIG. A.—Placing mixture in moulds, for 30-inch reinforced concrete pipe. Umatilla Project, Ore.



FIG. B.—Moulds for making small size reinforced concrete pipe. Tieton Project, Wash.

(Facing page 314)

PLATE XXVIII



FIG. C.—Placing reinforcement cage, surrounded with tarred paper cylinder, in moulds. Tieton Project, Wash.



FIG. D.—Laying and joining reinforced concrete pipe. Tieton Project, Wash.

flat surfaces. The outside jacket is next placed in position, and a small amount of wet sand is placed at the bottom of the moulds and spread along the outside edge of the base ring to form the taper end of the pipe. The reinforcement, surrounded with the outside cylinder of tarred paper, is next placed in the moulds, with the smaller end down (Plate XXVIII, Fig. C) and the concrete is then poured in, up to the top of the mould, where it ends in an approximately flat, square surface, purposely left rough, out of which projects about $1\frac{1}{2}$ inches of the mesh reinforcement near

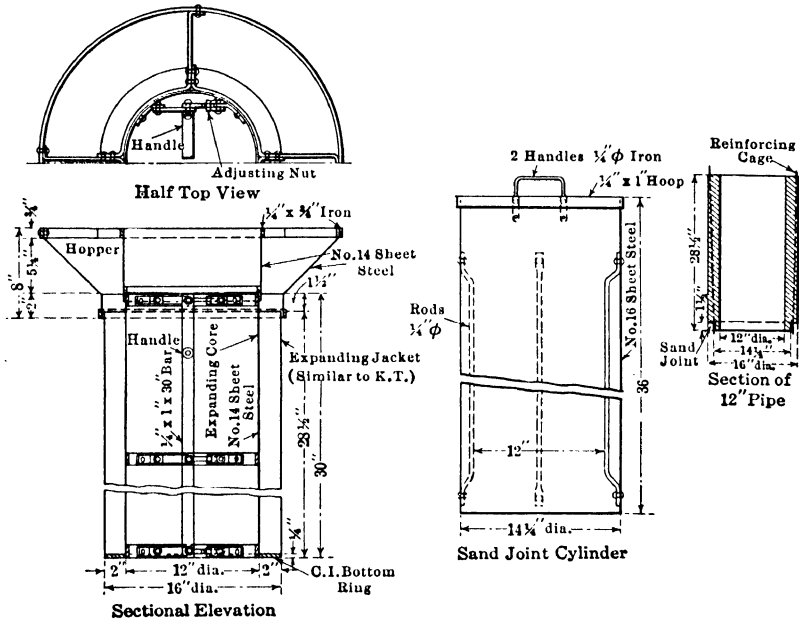

FIG. 69.—Moulds for making 12-inch reinforced concrete pipe. Tieton Project, Wash.

the outside rim. The outside jacket can be removed soon after the placing of the concrete, and the inside core is removed about 1 hour afterward. The bottom rings are removed 24 hours afterward, and the sand which forms the lower end is washed out with water from a hose. This forms a taper end, which, when joining the sections, slips into the projecting reinforcement of the adjacent section.

To make the joints when laying the pipe in the trench, the under half or three-quarters of the joint circumference is surrounded by a strip of tarred paper 8 inches wide, held against the

pipe by a length of belting, against which backfilling is placed, and a cement-mortar grout is poured to fill the space around the joint (Plate XXVIII, Fig. D). The joints are lightly backfilled after about 2 hours and kept moist for several days. Pipes of this kind were used for pressures as high as 115 feet.

Method of Making Wire-wound Concrete Pipe, Used on the Roeswell Project, Idaho.—This pipe was made of the dry-mixture hand-tamped pipe, previously described, around which steel wire reinforcement was wound and covered with a coating of rich cement-mortar grout. The method of winding the reinforcement, applying the grout coating, and laying the pipe is described as follows by Z. N. Vaughn:

“Two movable bulkheads, with crank-handles attached, are so arranged that the pipe length can be firmly clamped between them. At a distance back of this device a steel shaft, into which is cut a screw groove, works freely horizontally. Back of this, and horizontal to it, a wooden shaft is placed for regulating the tension of the wire, and still back of this is a vertical spindle, from which wire unwinds automatically. The wire used for reinforcing is a No. 12 gauge, galvanized wire, having a tensile strength between 500 and 600 pounds. A coil of this is placed vertically upon the spindle, the wire is passed around the tension shaft, thence into the screw groove, and is finally firmly attached to one end of the pipe length by soldering. The pipe is then revolved by two men at the crank handle, by which process the wire is wound upon the pipe under a high tension, the spacing of the laps of the wire being made even by the screw groove. Variation in spacing for different heads is accomplished by using pulleys of different diameters, to govern the rate of revolution of the grooved shaft as compared with that of the pipe length.

“When the reinforcing reaches the end of the pipe length, the last two or three laps being made parallel, it is again soldered, and the wire is severed. A steel trowel curved to conform to the shape of the pipe, and suspended above it, is then dropped into place, and cement mortar, $1\frac{1}{2}$ to 1, is run upon the pipe as it revolves, the trowel smoothing this down to a uniform thickness. The bulkheads are then unclamped by a lever at one side, the pipe is removed, and is carried away to be properly cured.

“In the trench the bell and spigot ends of the pipe are fitted together, as in the case of sewer pipe. Around the joint is placed a flexible form, made of very heavy canvas, attached to blocks of

wood, sawed out in such a way that a space of about 1 inch, measured transversely to the pipe and 6 inches longitudinally, is left vacant for the reception of the mortar. Along each edge of the form is run a 12-gauge wire, terminating at one end in an iron ring, at the other in a tongue pin, curved in shape, so that when clamped through the ring, it draws the wire to a high tension, firmly binding the form to the pipe. The form is then filled with cement mortar, and immediately afterward the interior of the joint is carefully pointed to insure water-tightness, independently of the collar, as far as practicable. As soon as the collar forms can be removed, the trench is backfilled, to protect the collars while curing." (Journal of Idaho Society of Engineers, pp. 40-41, Vol. I.)

The same method has been used in southern California and more recently on the Umatilla projects in Oregon. The cost of reinforcing hand-tamped pipe by this method, in southern California, was 10 cents per lineal foot for 10-inch pipe, 15 cents for 12-inch pipe, 25 cents for 20-inch pipe, and 35 cents for 26-inch pipe. This cost is for No. 12 wire spaced $1\frac{1}{2}$ inches apart and includes the cost of wire, labor and cement-mortar coat.

Methods of Joining Pipe Sections.—The pipes after they have hardened sufficiently are placed in the trench and joined. The best time to lay the pipe is in cold weather, in order that a rise of temperature will produce expansion and make the joints tighter. If they are laid in warm weather contraction due to lowering of the temperature will tend to produce shrinkage cracks. The joints may be made in three ways: (1) bell-and-spigot joints; (2) collar joint; (3) lock joint.

The bell-and-spigot joint is similar to that used for dry-mixture hand-tamped pipe, previously described. It has been used for pipes up to 30 or 36 inches in diameter, where the pressure is not great, usually under 20 feet. It requires that the pipe be built with a taper end and bell end to each section.

The collar joint is used for larger pipes and for greater pressures (Plate XXIX, Figs. A and B). It is the type of joint most generally used in Europe and that used for the larger pipes on the Umatilla project in Oregon, for a pipe line on the Boise project in Idaho and one on the Sunnyside project in Washington. In general the joint is made with a reinforced collar, 4 to 8 inches wide, reinforced in the same manner as the pipe. It may be cast in place around the joint or may be cast separately either in

one piece or in two or more segments. On the Boise pipe line, 36 inches in diameter, the collars were cast in place. Each collar was 8 inches wide, 3 inches thick, reinforced with three coils of $\frac{5}{16}$ wire, spaced away from the surface of the pipe by eight supports made of $\frac{1}{8}$ by $\frac{3}{4}$ -inch flat bars with the ends bent down $1\frac{1}{2}$ inches.

Collars or rings cast separately in one piece are used for pipes up to 24 or 36 inches in diameter. The inside diameter of the ring must be slightly larger than the outside diameter of the pipe. The ring is slipped over the end of the pipe last laid, the adjacent pipe is then laid in position. The ends of the pipe may butt close together, or may be placed to leave a space of $\frac{1}{4}$ to $\frac{3}{4}$ inch between the ends, and the open joint filled with cement mortar. The ring is then shifted over the joint; both sides of the ring are stopped with stiff mortar, and through two or more holes in the ring a cement-mortar grout is poured to fill the space between the interior of the collar and the outside of the pipe.

For the 47-inch pipe on the Umatilla project the collar was made in 3 parts. Each part is shorter than $\frac{1}{3}$ the outside circumference of the pipe, but the circumferential reinforcement in the collar projects beyond the end of each part, so that when the 3 parts are placed around the joint the reinforcements overlap and the collar is completed with cement mortar. The collar is 3 inches thick and 4 inches long, reinforced with two $\frac{5}{16}$ -inch rods. The collar type of joint gives greater strength than the bell-and-spigot joint, and forms a seat for the ends of the pipe, in which slippage by contraction may occur with less chance for leakage.

The lock joint is intended to make the longitudinal reinforcement continuous (Plate XXIX, Figs. C and D). In general it is formed with pipes in which the reinforcements project out beyond the ends of the pipes, so that when the pipes are laid the projecting reinforcements of adjacent ends will overlap or lock and are embedded in a band or collar of concrete. This type of joint is used by the Reinforced Concrete Pipe Co. of Los Angeles California, and the Lock Joint Pipe Co. of New York. The joint used for the pipe lines on the Tieton project, described above, is of the same general type.

Expansion and Contraction in Concrete Pipe Lines Built of Separately Moulded Sections.—The effects produced by expansion and contraction are of special importance in the construction of pipe lines made of pipe sections moulded separately and in the



FIG. A.—Laying and joining 30-inch reinforced concrete pipe. Umatilla Project, Ore.

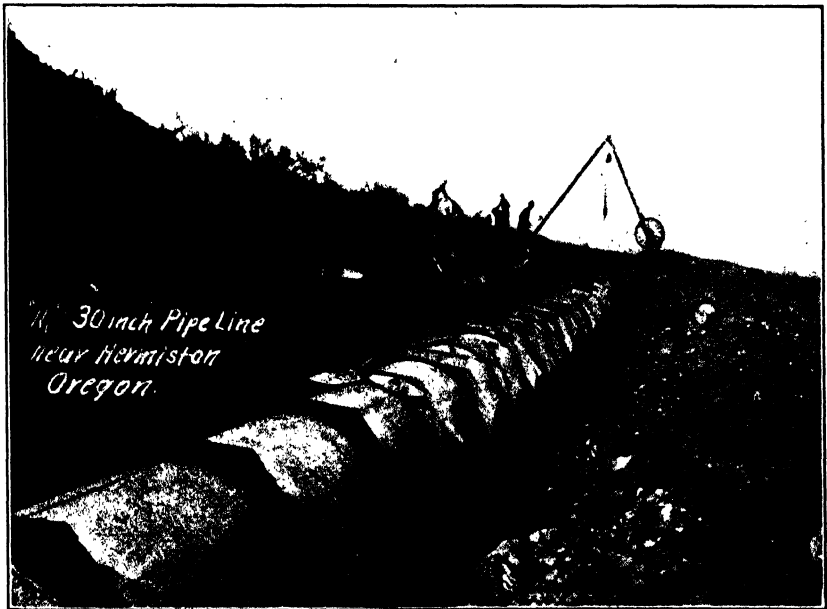

FIG. B.—Cast collars on 30-inch reinforced concrete pipe. Umatilla Project, Ore.

(Facing page 318)

PLATE XXIX

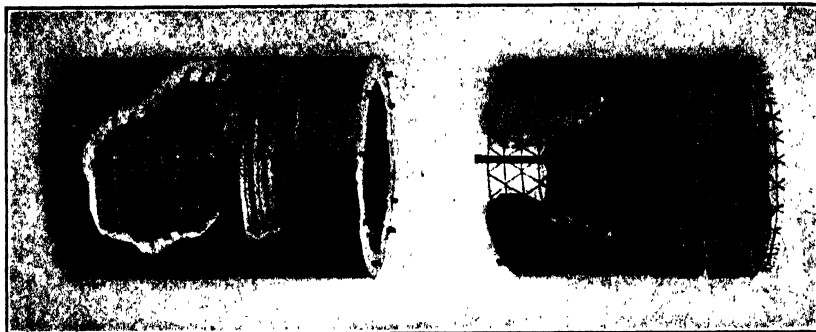

FIG. C.—Reinforced concrete pipe and lock joints made by Reinforced Concrete Pipe Co. of Los Angeles, Calif.

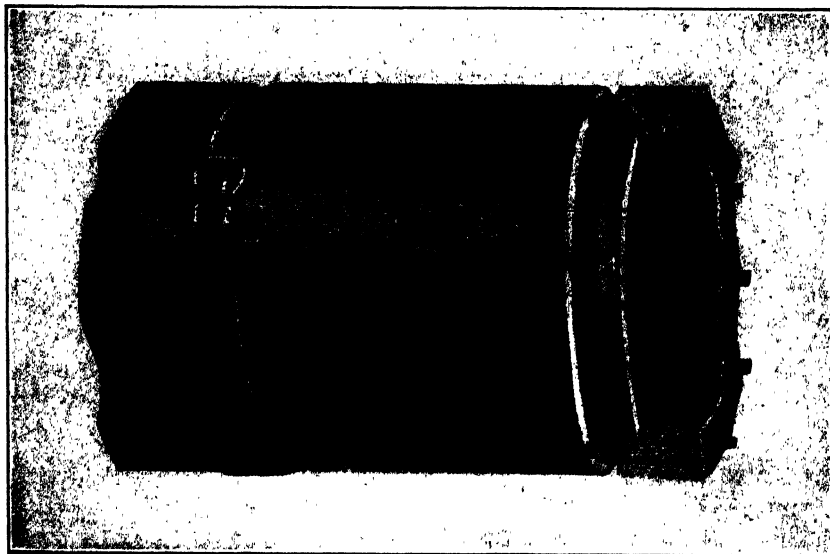

FIG. D.—Method of making lock joint. Reinforced Concrete Pipe Co., Los Angeles, Calif.

study of the different types of joints. The leakage through cracks at the joints, resulting largely from contraction is one of the main causes of difficulties. In pipe lines under low pressure and laid in sandy soil which drains freely, the leakage through contraction cracks will usually produce no harmful results, but in clay soil even a small leakage will soften the backfill and bed of the pipe, which may permit settlement and result in a break.

Causes and Extent.—Expansion and contraction are due to two distinct causes: *First*, to changes in temperature. *Second*, to alternate wetting and drying of the pipe. The range of temperature will depend on the variation in soil and water temperatures, and will be partly controlled by the depth of covering on the pipe. These factors are illustrated by the data presented in the discussion of steel pipes. When the pipe line is laid about a foot below the surface, a variation in soil temperature of probably at least 30° Fahrenheit may be expected, so that if the pipe line was laid and joined at a temperature not higher than that which it will have when buried the resulting contraction tensile stress, assuming a coefficient of contraction of 0.000006 and a modulus of elasticity of 3,000,000, will be at least $0.000006 \times 3,000,000 \times 30 = 540$ pounds per square inch. This tensile stress is greater than plain concrete pipe (especially the joints) can stand. Cracks will therefore occur, and the extent of contraction corresponding to the above variation in temperature would be about $\frac{1}{50}$ of an inch for 10 feet of pipe.

The expansion and contraction due to alternate wetting and drying of the pipe is of considerable magnitude, as is well demonstrated by the measurements and experiments described in the article "Destruction of Cement Mortars and Concrete through Expansion and Contraction," in the *Engineering Record* of July 8, 1911. Measurements made on bars, of 1 part of cement to 3 of sand, showed that bars hardening in air contract from 0.06 to 0.09 per cent. in a period of 3 months; and that on alternate wetting and drying, the linear expansion due to wetting was from 0.04 to 0.09 per cent. and the contraction due to drying was about equal. The expansion occurs much more quickly than the contraction. The above values of alternate expansion and contraction are equal to those resulting from a change in temperature of about 66° Fahrenheit for the lower value of 0.04 per cent. and 150° Fahrenheit for the higher value of 0.09 per cent.

Method of Construction to Decrease Contraction.—These results indicate the advantage of building a pipe line of pipe sections which have been air dried before joining them in the trench, and of making the joints at as low a temperature as is practicable, preferably at least as low as the temperature of the water to be conveyed and as near as possible to the lower temperature which the pipe will have when buried. When these conditions can be obtained, assuming that the pipe sections have been given at least a month to dry out before they are joined in the trench, then the pipe line when completed will be nearly at its limit of contraction, so that when filled with water expansion will result from the wetting of the pipe and from any rise which may occur in the temperature of the pipe above that at which it was joined in the trench. In practice it will not often be feasible to construct the pipe line at or near the lowest temperature which it will have later, and as the contraction corresponding to a lowering in temperature of only 10° Fahrenheit will produce a tensile stress of about 180 pounds per square inch, contraction cracks will seldom be avoidable. But the expansion resulting from the wetting of the pipe and the increase in temperature will close the cracks and produce compression. The expansion and resulting compression has in many cases been sufficient to cause the ends of the pipe lines to push through walls of the inlet and outlet structures. The elongation due to expansion must be at least partly prevented, in order that the pipe line when contracted will again be able to expand sufficiently to close the contraction cracks. The elongation will be resisted in part by the soil friction and by constructing the connections with inlet and outlet structures and the anchorages at sharp bends of sufficient strength to resist the expansion push.

The above discussion has shown that contraction cracks can seldom be avoided; also that certain effects of expansion will under proper conditions close these cracks when the pipe is in use.

Theoretical Consideration of Contraction Movement.—The linear movement of contraction must overcome the frictional resistance against sliding which exists along the surface of contact between the outside of the pipe and the soil, and is increased by the anchorage formed by the bands around each joint. The distance between contraction cracks will therefore be dependent on this frictional resistance, and may be determined from theoretical considerations as follows:

Let l = length of pipe between contraction joints in feet.

D_1 = outside diameter of the pipe in inches.

D_2 = inside diameter of the pipe in inches.

h = height or depth of earth fill on the top of the pipe in feet.

w = weight of earth in pounds per cubic foot.

C_f = coefficient of frictional resistance.

S_t = tensile strength of pipe line in pounds per square inch.

In the process of contraction and expansion the middle point of the pipe length between contraction joints remains stationary, and each half of the pipe expands and contracts as if fixed at this point. The tensile stress on the cross-sectional area of the pipe is therefore maximum at this middle point, and is produced by the frictional resistance on half the pipe length l .

From this consideration the length between contraction joints is obtained by placing the tensile strength of the cross-sectional area of the pipe equal to this frictional resistance. Assuming that the average intensity of earth pressure on the pipe is equal to $\frac{2}{3}$ of the intensity on the top, we then have:

$$\pi \left(\frac{D_1^2 - D_2^2}{4} \right) \times S_t = \frac{2}{3} \frac{hw}{144} \times \pi D_1 \times \frac{l \times 12}{2} \times C_f$$

which reduces to:

$$l = 9 \frac{D_1^2 - D_2^2}{D_1} \times \frac{S_t}{C_f \times h \times w}$$

The results obtained by the application of this formula to any special case can be only roughly approximated. There are little data to determine the average intensity of earth pressure on the pipe, but it will probably be less than that assumed. The value of the coefficient of friction will depend largely on the smoothness and thickness of the bands around the joints of the pipe sections. This coefficient could be determined by practical experiments, but there is no such information on which to base an estimate. The tensile strength of the pipe line will depend on the strength of the joints and a number of other variable factors, specially that of workmanship.

To determine the probable minimum distance between contraction cracks, we may substitute in the formula the following conservative values: $C_f = 1.00$; $S_t = 100$, and $W = 100$; we then have:

$$l = \frac{9 D_1^2 - D_2^2}{h D_1}$$

Applying this formula to a 24-inch concrete pipe with a 2-foot depth of backfill, the result is:

$$l = \frac{9}{2} \frac{\overline{28.5^2} - \overline{24^2}}{28.5} = 40 \text{ feet}$$

and for a 12-inch pipe $l = 30$ feet.

The above theoretical consideration and deductions are based on the assumption that several pipe sections will slide together in the soil. This occurs when the bands surrounding the pipe line at the joints are comparatively thin and smooth, but if these bands project out sufficiently to act as fixed anchors against sliding, then each pipe section is independent, and if the tensile stress produced by contraction is excessive a crack will occur either in the pipe section itself or at one of the joints. This action probably occurs in pipe sections joined with a thick collar, such as sometimes used for reinforced concrete pipe, in which case the section of weakness is at the joint inside the collar, and slippage of the pipe ends probably takes place in the collars.

Contraction Joints.—In practice expansion or contraction joints are not often used, and their need has not been apparent on a great many pipe lines constructed without them; however, this may be due to the fact that the most extensive use of cement pipes has been in southern California for gravity pipe lines under little or no pressure. Contraction cracks no doubt do occur, but they are usually so narrow that under low pressures the leakage through them is very small and drains away from the pipe without softening or washing away the surrounding soil. On the other hand, considerable trouble has been obtained on a number of pipe lines, which would seem to indicate the need of expansion joints, but as a rule trouble by leakage through contraction cracks is usually confined to heavy retentive soils, which with leakage become soft around the pipe and permit settlement, and to pipe lines formed of pipe sections not laid and joined in their contracted condition. Care in workmanship, especially in forming a continuous thick band around each joint, is of great importance. On the distribution system of the Kamloops Fruitland Irrigation and Power Co., British Columbia, over 30 miles of hand-tamped cement pipe from 12 to 24 inches in diameter were laid without expansion joints, except at a few sections in heavy soil. Several of these pipe lines are located across depressions which produce pressure heads of 15 to 20 feet. The climatic conditions are those

of the Northwest, with atmospheric temperatures ranging from a maximum of about 90° Fahrenheit in the summer to a minimum of about 20° Fahrenheit below zero or lower during very severe winters. At a depth of 12 to 18 inches below the surface, which was the minimum depth of covering used for the pipe lines, the soil temperatures vary probably from 70 to 32° Fahrenheit. Some of the pipe lines have been in operation since the summer of 1911, and all of them since the summer of 1913. During the first season considerable trouble was experienced with one of the pipe lines first constructed; close inspection showed that the majority of the leaks were in the lower half of the joints on the under side of the pipe, and were caused largely by carelessness in joining the pipe sections, in not forming a continuous band or collar around the lower half of the joints. The other pipe lines were carefully laid with well-formed bands around the joints and have been entirely satisfactory. A simple form of contraction joint devised for use on a few sections of pipe lines in heavy soil and at bends is shown by Fig. 70.

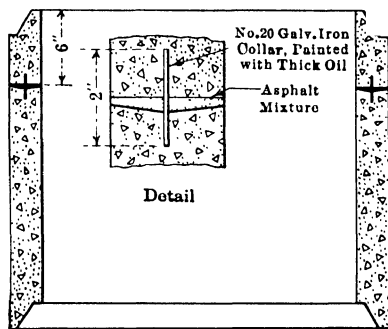

FIG. 70.—Contraction joint for hand-tamped cement pipe.

It is made with a metal collar, well coated with asphalt or oil to prevent adhesion of the concrete, placed in the ordinary hand-tamped pipe, to form a tongue extending about half way on both sides of a joint in the pipe separated by a coat of asphalt. This tongue-and-groove joint is easily formed by placing the collar in the moulds when the concrete mixture has been placed and tamped up to about 6 inches from the top of the mould, then placing additional mixture to imbed the lower half of the collar followed by the coating of asphalt and completed by forming the upper section of the pipe in the usual manner. The joint proved satisfactory for the thicker pipes when the metal collar was properly imbedded with equal thickness of concrete shell inside and outside.

Water-tightness, Durability, and Examples of Use of Reinforced Concrete Cast Pipe.—The early experience with thin reinforced concrete pipes in Europe showed that, while even com-

paratively rich concrete is more or less porous and subject to percolation under moderate heads when first constructed, the rate of percolation rapidly diminishes with time and the pipe becomes practically water-tight. The same results have been noted on pipe lines constructed in the United States. As a rule, waterproofing compounds have not been used. The increase in water-tightness and the durability of thin reinforced concrete pipe are illustrated by the following experiments and examples.

Tests of Water-tightness of Reinforced Concrete Pipe on the Umatilla Project, Oregon.—These tests were made on pipes cast in moulds as previously described. The separate pipe sections were 8 feet long, 46 inches in internal diameter and 3 inches thick, reinforced with a double coil of $\frac{5}{16}$ -inch wire with $1\frac{1}{2}$ -inch spacing. The concrete was composed of 1 part of cement to 1.44 of sand and 2 of gravel. To make the tests, two sections were joined and bulkheads placed at the two ends. Two types of joint were used. One consisted of a collar cast in three pieces, each a little smaller than $\frac{1}{3}$ the circumference, and placed around the pipe, then joined and cemented to the pipe. The other form of joint consisted of a collar cast in place around the pipe. The results obtained by collecting and measuring the seepage water and reducing the measurements to an equivalent loss per mile were as follows:

1. With joint made of collar built up of three segments: Pressures of 48 to 50 pounds per square inch caused an average seepage, equivalent to 0.31 cubic foot per second for 1 mile of pipe.

2. With collars cast in place: A pressure of 40 pounds per square inch gave an equivalent average seepage of 0.12 cubic foot per second per mile. A pressure of 50 pounds gave 0.42 cubic foot per second and a pressure of 55 pounds gave 0.56 cubic foot per second per mile.

The tension in the steel, corresponding to the range of pressures used, assuming that the steel takes all the stress, is:

Pressure in pounds per square inch.	40	45	50	55
Pressure head in feet.....	93	103	115	127
Tension in steel in pounds per square inch.....	9,000	10,125	11,250	12,375

These tests showed that properly made reinforced concrete pipes are practically water-tight for pressure heads as large as 100 feet.

M-line Siphon, Umatilla Project, Oregon (Fig. 71).—This pipe line, the first built on the project, was completed in the spring of 1908 and represents one of the earliest uses of this kind of pipe

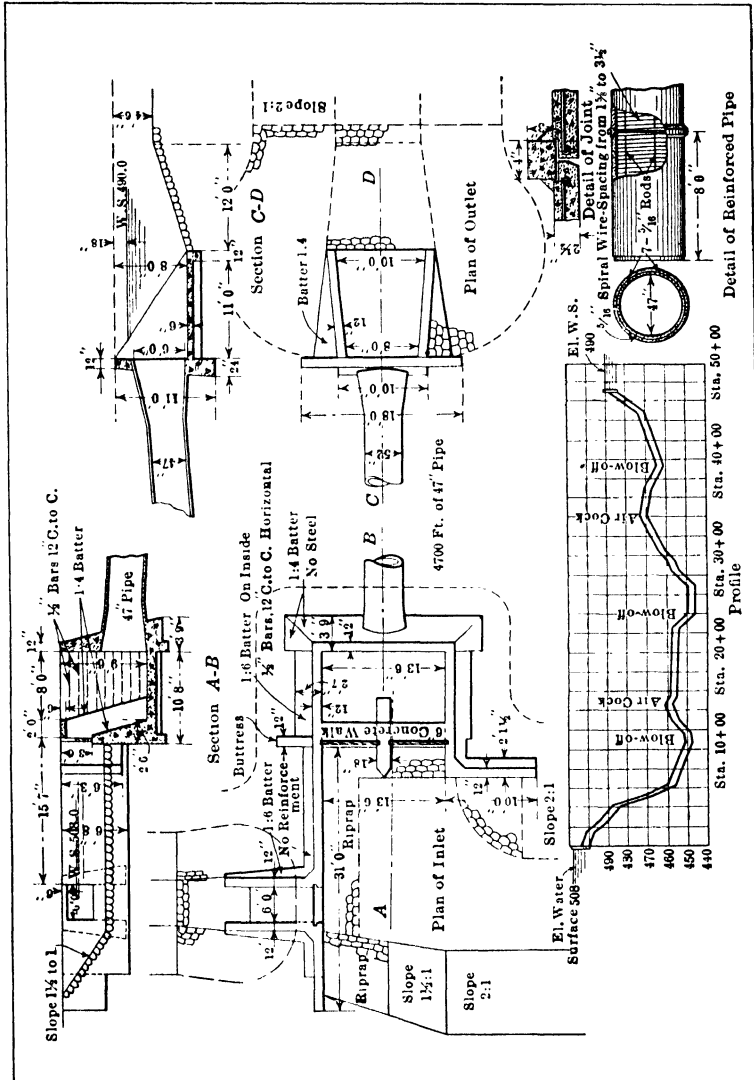

FIG. 71.—“M” line siphon. Umatilla Project, Ore.

for irrigation. The pipe line is an inverted siphon, 4,680 feet in length, made of pipe sections 8 feet long, 47 inches in diameter, 2 1/2 inches thick, designed to carry 70 second-feet and reinforced

for a maximum pressure head when running full of 55 feet. The pipe sections were made and laid as previously described. The siphon inlet structure forms an inlet chamber combined with a checkgate or division gate, which regulates and divides the flow between the siphon and the open-ditch lateral. The entrance to the pipe line is formed at the bottom of the inlet chamber with a tapered conical starting section. The pipe line is in sandy soil which drains readily. It has been entirely satisfactory, although subject to low winter temperatures; the lowest recorded atmospheric temperature has been $28\frac{3}{4}^{\circ}$ Fahrenheit below zero. Tests made soon after completion to determine its water-tightness gave a total loss of $\frac{1}{2}$ gallon per second. The cost of the siphon is as follows:

Intake, 58 cubic yards of concrete.....	\$1,019.99
Outlet, 22 cubic yards of concrete.....	495.52
Cement pipe at manufacturing plant, 4,680 feet at \$3.82.....	17,879.53
Hauling, excavation, backfill, joining, painting inside of pipe..	5,921.29
Miscellaneous.....	706.43
Engineering and administration.....	4,456.38
	\$30,479.14

The pipe sections had to be hauled for 2 miles on a loose sandy road. This successful installation and the results of the above tests of water-tightness led to the construction of a number of pipe lines on this project aggregating several miles in length and under pressure heads as great as 110 feet.

Pressure Pipe for the Aqueduct of Acheres, Paris, France.—

This pipe, which is part of a conduit used to carry the sewage water of Paris toward the agricultural gardens of Acheres, was constructed between 1892 and 1895. Where the pressure is above 72 feet, steel pipe was used; below 72 feet the pipe was built of reinforced concrete by the Bonna system. For pressures from 72 to 50 feet the pipe is lined on the interior with a steel shell 0.177 inch thick. For pressures from 45 to 50 feet the steel shell is 0.137 inch thick and below 45 feet the pipe has no lining of steel. The length of the reinforced pipe is 4,920 feet and was built of sections 8.20 feet long, 5.90 feet in diameter and 4 inches thick, joined with reinforced collars. The concrete used consisted of about 1 part of cement to 2 of sand. The cement was a mixture of quick-setting cement with slower-setting cement. When the water was first turned in,

it was found that where the pressure did not exceed 26 feet the pipe remained dry; for pressures from 26 to 41 feet there was a little sweating which stopped completely at the end of 2 months; and for pressures from 41 to 45 feet the sweating stopped at the end of 3 months. The price paid for the pipe in place was about \$12 a foot for the unlined pipe and \$18 a foot for the lined pipe.

Distributary Pipes for the Agricultural Park of Acheres, Paris, France.—The distributing system is about 21 miles long and all pipes are of the Bonna type. The diameters vary from 11.8 to 43.8 inches, all designed to resist a water pressure of 131 feet. The reinforcement consists of a steel shell 0.23 inch thick between two reinforced steel skeletons, the whole being embedded in a concrete shell from 1.37 to 2.75 inches thick. The prices paid for the pipes in place were: \$4.60 to \$5.50 per foot for 43.8-inch pipe, and 72 to 85 cents per foot for 11.8-inch pipe.

The strength of this type of pipe was tested in 1893 by M. Launay, Chief Engineer of Sanitary Works for the Department of Seine, France. The pipe tested was 20 inches in diameter, 1.37 inches thick, reinforced with Bonna's reinforcement and a steel lining 0.04 inch thick. The pipe was designed for a maximum pressure of 66 feet with a maximum tension in the steel of 11,400 pounds per square inch. It was submitted to a pressure of 409 feet without rupture, and after the test it was cut open and showed no indications of injury, the adherence between concrete and reinforcement being perfect.

Venice Pressure Pipe, Italy.—This conduit was constructed by M. Bordenave for the Water Co. of Venice in 1890. The total length is 4.05 miles, the diameter is $31\frac{1}{2}$ inches, the thickness 1.46 inches and the pressure head 23 feet. This pipe has not required any repairs since it was put in. The loss of water by percolation which was at first 195 liters per minute, decreased to 102 liters per minute the fifth day, 71 liters the ninth day, and 8.66 liters in 115 days.

Bone Pressure Pipe, Algeria.—This pressure pipe was constructed by M. Bordenave for the city of Bone, Algeria, in 1893 and in 1895-1896. The total length is $19\frac{3}{4}$ miles. The diameter is 1.97 feet and the pipe is under pressure heads of 28 to 79 feet. The reinforcement in both directions consists of steel I-bars of the Bordenave type, having a cross section of 0.042 square inch and a weight of 0.142 pound, with a safe stress of 19,200

pounds per square inch. For a pressure of 49 feet the thickness of pipe is 1.57 inches and the spiral bars are spaced 3.21 inches apart. For a pressure of 82 feet the thickness of the pipe is increased to 1.77 and the spacing is changed to 1.91 inches. In both cases the longitudinal rods are 3.38 inches apart.

Cost of Making and Laying Reinforced Concrete Pipe Cast in Sections.—On the Umatilla project in Oregon many miles of inverted siphons or pressure pipe-line laterals crossing depressions were necessary because of irregular topography of the irrigated lands. The method of constructing and laying the reinforced concrete pipe sections and the M-line siphon, the first pipe line on this project, has been already described. The M-line siphon was 47 inches in diameter and only 2½ inches thick. The other pipe lines have been built of 46- and 30-inch pipe, 8 and 4 feet in length, respectively, both 3 inches thick. The cost of a number of these pipe lines is tabulated below. The unit cost of material was as follows: Reinforcement, including labor, 4½ cents per pound for 46-inch pipe and 5½ cents for 30-inch pipe. Concrete mixture: 1 part of cement, 2.3 parts of sand, and 3.0 parts of gravel screened through 1-inch mesh and retained on ¼-inch mesh. Cement cost \$2.25 a barrel, sand \$1.00 a cubic yard, gravel \$2.65 a cubic yard.

COST OF MAKING AND LAYING REINFORCED CONCRETE CAST PIPE, UMATILLA PROJECT, OREGON (PER LINEAL FOOT)

Pipe line	Diameter, inches	Length, feet	Maximum head, feet	Cost of pipe at yard	Cost of laying and making joints, including material	Total cost, including hauling and earth-work
R ₁	46	9,831	110	\$2.97	\$0.59	\$4.43
O ₁	46	5,312	36	2.24	0.48	3.86
R ₂	46	1,284	15	2.24	3.26
D ₁	30	5,330	45	1.26	2.25
O ₂	30	3,556	26	1.26	2.45
R ₃	30	3,645	25	1.26	0.22	2.04
R ₄	30	1,622	18	1.26	1.96

On the Tieton project, Washington, several miles of reinforced pipes, 8 to 14 inches in diameter, have been made and laid in the manner previously described. The maximum pressure head for which the pipes have been used is 115 feet. The unit costs of materials and labor were as follows.

Concrete mixture: 1:2½:3 for heads under 80 feet; 1:2:2 for heads greater than 80 feet.

Cement \$2.50 a barrel, sand \$2.00 a cubic yard; aggregate \$2.00 a cubic yard.

Wire mesh 4 cents a pound, steel wire 3 cents a pound; common laborers \$2.00 a day, tampers, mixers, pipe layers \$3.00 a day.

COST OF MAKING AND LAYING REINFORCED CONCRETE CAST PIPE ON TIETON PROJECT, WASHINGTON (PER LINEAL FOOT)

Diameter, inches	Length, feet	Cost of pipe at yard	Cost of laying and joining and materials	Cost of excavation and backfill	Cost of hauling	Total cost
8	8,342	\$0.355	\$0.145	\$0.150	\$0.043	\$0.693
10	5,781	0.369	0.198	0.156	0.051	0.774
12	5,325	0.445	0.231	0.182	0.059	0.917
14	1,867	0.525	0.265	0.226	0.068	1.084

Cost of pipe at yard includes all material and labor to make the pipe and the plant charge. Cost of laying and making joints includes all material and labor to make joints. No general overhead or administration is included.

The prices in southern California for wire-wound, hand-tamped, dry-mixed pipe, with a coating of cement mortar, laid in the trench, including earthwork, is as follows:

Diameter of pipe, inches	6	8	10	12	14	20	26
Cost per lineal foot	\$0.20	\$0.30	\$0.40	\$0.60	\$0.75	\$1.20	\$2.00

Reinforced Concrete Pipe and Conduits Built in Place.—Conduits for the conveyance of water under pressure are nearly always circular. Square, rectangular, elliptical, and other special forms have been used, but only for low internal water pressures, and are then more nearly similar to culverts. In the following paragraphs large size reinforced circular concrete pipes, built in place are considered.

The determining size beyond which a pipe built in place is preferable to a pipe cast in sections is dependent on a number of factors; as a rule for diameters upward of 6 feet a pipe built in place will be more economical. But even for smaller diameters down to about 3 or 4 feet there may be certain conditions which will make it preferable to build the pipe in place.

The use of large-sized pipe on irrigation systems has been gen-

erally limited to inverted siphons. Several such siphons have been built on the Reclamation Service projects. Of these three large siphons on the Belle Fourche project, South Dakota, are good examples. Other notable examples are the Clay Creek siphon of the American Sugar Beet Co. in Colorado, and especially two unusually large siphons built in Spain; the Sosa siphon across the River Sosa and Ribabona depression, and the Albelda siphon. These siphons are described below to illustrate the construction and use of large-sized reinforced concrete pipe.

Belle Fourche Project Siphons.—On this project three siphons were constructed in the summer of 1908. The Belle Fourche River siphon is 5 feet inside diameter, 3,600 feet long and has a maximum pressure head of 65 feet. The Whitewood siphon has an inside diameter of 6 feet, is 395 feet in length, and has a maximum pressure head of about 16 feet. The Anderson siphon is 8 feet inside diameter, 477 feet long, with a maximum head of about 70 feet.

The siphons are all 8 inches thick and reinforced with square twisted steel bars (Fig. 72A). The circumferential bars vary in size and spacing according to pressure. The sizes are $\frac{1}{2}$ - and $\frac{5}{8}$ -inch bars and the spacing ranges from 12 inches for the maximum spacing to $4\frac{1}{4}$ inches. The longitudinal reinforcement in all three siphons consists of $\frac{1}{2}$ -inch twisted steel bars, spaced about 12 inches apart. The twisted steel bars for the circumferential hoops were bent and securely fastened by welding. The longitudinal rods were overlapped 20 inches at the ends and tied with wire. All intersections were wrapped with wire.

The concrete was a machine-mixed wet mixture composed of cement, sand and gravel in the proportion $1:2\frac{1}{4}:3\frac{3}{4}$, with 20 to 22 per cent. of water. The sand was screened to exclude pebbles larger than $\frac{1}{4}$ inch in greatest dimension. The gravel and crushed rock were screened to pass through 1-inch circular holes and were also screened to exclude sand and pebbles less than $\frac{1}{4}$ inch in greatest dimension. The pipe was built in a trench, excavated carefully to the shape required for the outside lower part of the pipe, and drained where necessary. The steel skeleton was built in the trench around the inside form. For one of the siphons, the Belle Fourche siphon, Blaw collapsible steel forms were used. For the other two siphons special forms designed by the project engineer were used. These forms, which proved very satisfactory, were made of lumber in sectional parts

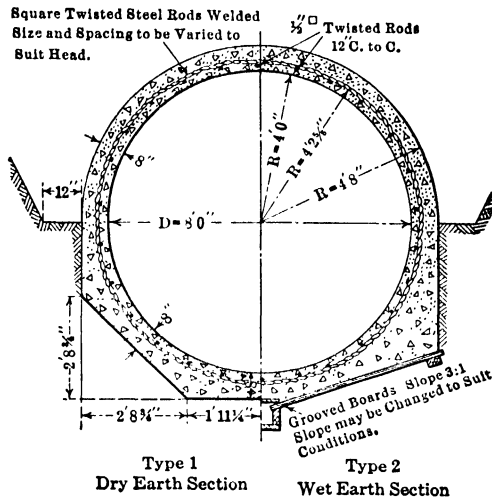

FIG. 72A.—Cross section of Anderson Siphon. Belle Fourche Project, S. D.

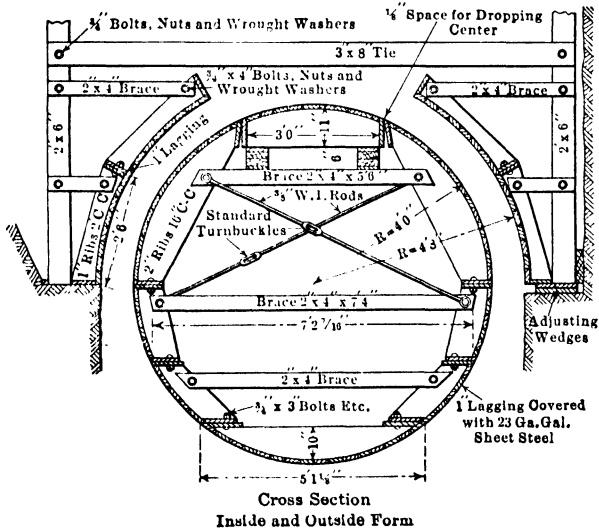

FIG. 72B.—Collapsible inside and outside forms for the construction of Anderson Siphon. Belle Fourche Project, S. D.

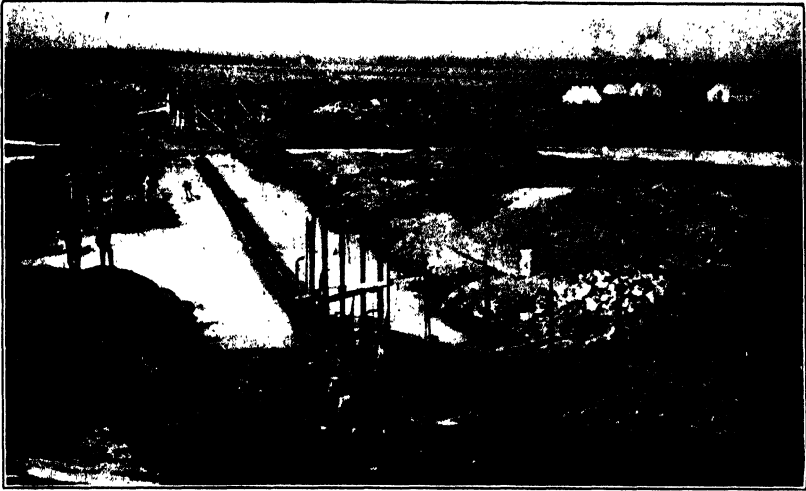

FIG. A.—Clay Creek Siphon during construction. American Sugar Beet Co., Colo.

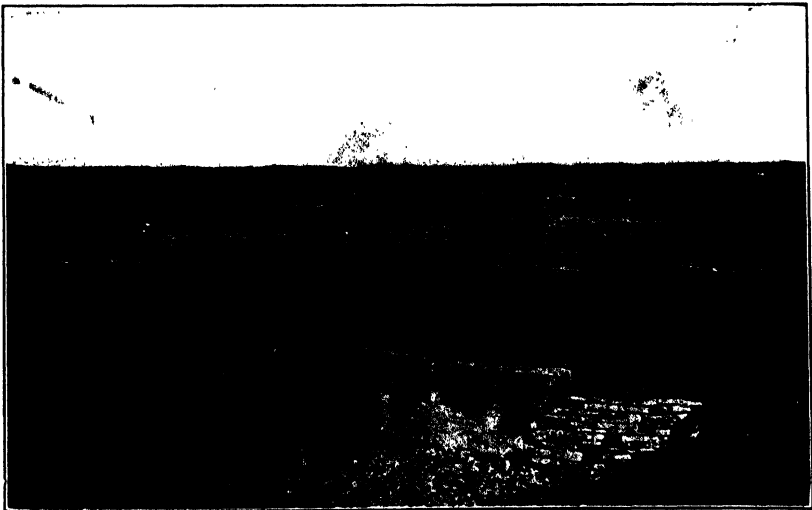

FIG. B.—Clay Creek Siphon, completed.

(Facing page 332)

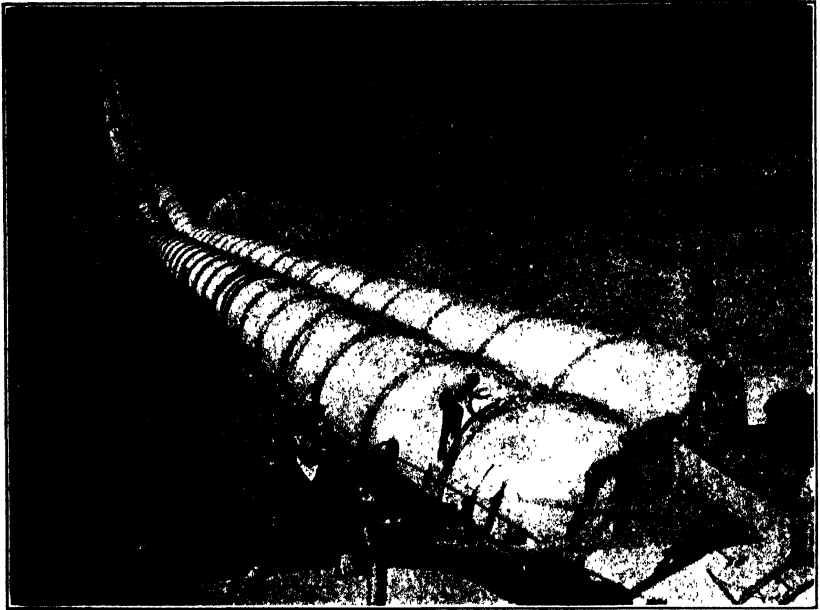

FIG. C.—Sosa Siphon, nearly completed. Spain.

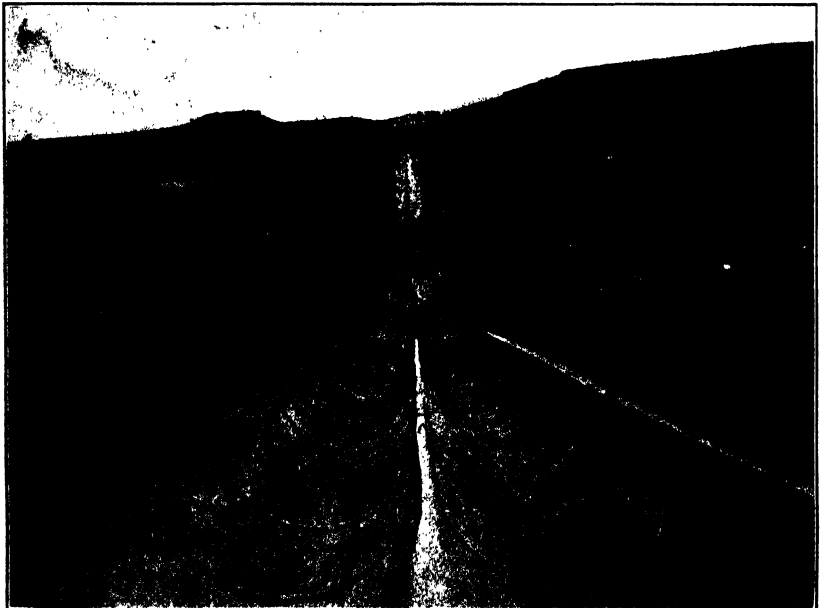

FIG. D.—Cradles of lean concrete to support reinforced concrete pipes of Sosa Siphon, Spain.

with an average head of nearly 50 feet, was \$59,310. The reinforced concrete work cost \$41,929 or \$18.92 a cubic yard, the remainder includes cost of excavation, trenching and back-filling, etc. Cement cost from \$2.15 to \$2.43 a barrel, f.o.b. Belle Fourche, and had to be hauled 16 miles. The haul of gravel was 1 mile. The steel cost was \$0.024 per pound, f.o.b. Belle Fourche.

Clay Creek Siphon, American Beet Sugar Co., Colorado (Plate XXX, Figs. A and B.)—This siphon consists of an inlet chamber and an outlet chamber, each formed of a circular well 7 feet in diameter, connected to the earth canal with buttressed wing walls, and of a reinforced concrete pipe 5 feet 8 inches in diameter, 6 inches thick and 325 feet long (Fig. 73). The flow through the pipe is regulated by three wooden gates above the inlet well, and may be shut to divert the flow through a sluiceway a short distance upstream. The inlet well is supported on rock and the outlet on earth; the wing walls of both structures are carried deeper below the canal grade than is usually considered necessary. The pipe is reinforced longitudinally with $\frac{1}{2}$ -inch corrugated bars and two old cables $1\frac{1}{2}$ inches in diameter. The circumferential reinforcement consists of hoops made with $\frac{1}{2}$ -inch corrugated bars 22 feet long, with the ends tied and lapping 21 inches. These hoops are spaced 12 inches from center to center. The longitudinal bars are spaced 15 inches center to center. The forms used for constructing the conduit were made in 2 parts, each slightly smaller than a half cylinder. The upper part was separated from the lower part on each side by wooden wedges and a key block, to which was fastened a strip of galvanized iron 4 inches wide, inserted to complete the circle.

Reinforced Concrete Siphons on Irrigation System of Aragon and Catalogne, Spain.—On this system, in the province of Huena, Spain, are two very important siphons: the Sosa siphon and the Albelda siphon. Although the Albelda siphon is a work of less magnitude than the Sosa siphon, it is technically more important and interesting because of the greater pressure, larger diameter, and the absence of a steel tube to insure water-tightness. The Sosa siphon is 3,340 feet long, consisting of twin pipes of reinforced concrete 12.47 feet in diameter and subject to a maximum pressure head of 85 feet. The Albelda siphon is 2,363 feet long and consists of a single pipe of reinforced concrete 13.12 feet in diameter and subject to a maximum pressure head of 97 feet

(Fig. 74). The most important difference between the two is in the design of the reinforcement. *The twin pipes of the Sosa siphon* consist of 158 sections, each 21.32 feet long, formed of a

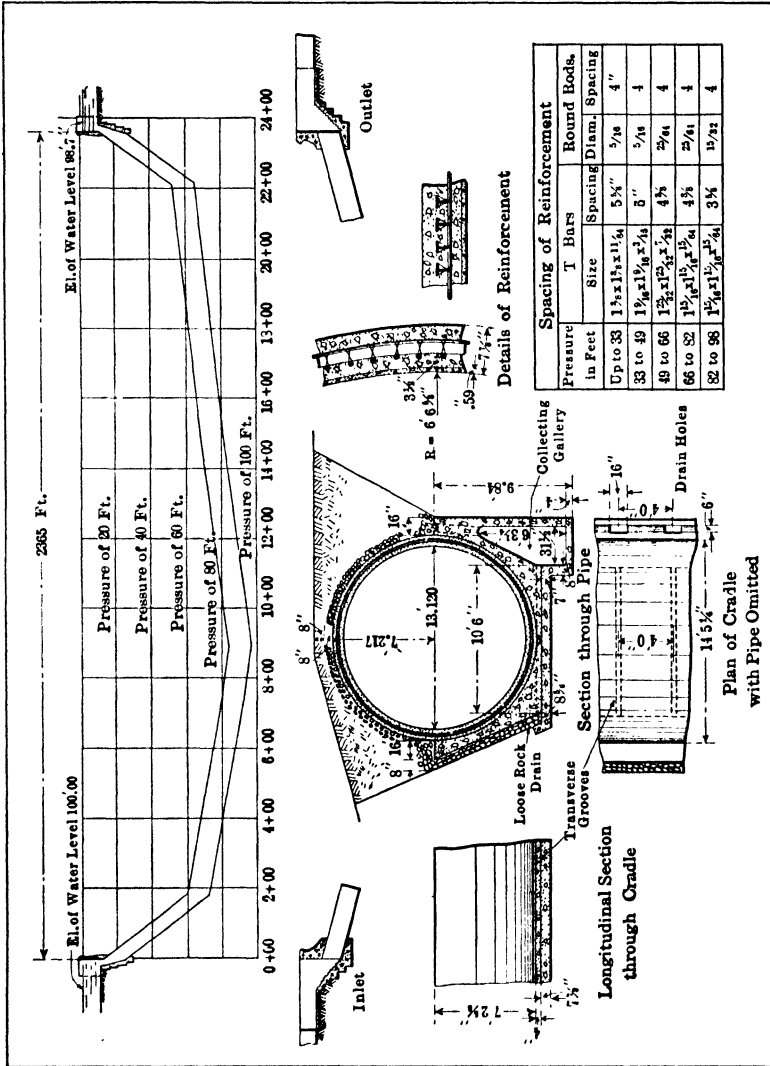

FIG. 74.—Albelda Siphon. Spain.

steel tube $\frac{1}{8}$ inch thick, on the outside of which are spaced hoops of T-bar reinforcement, surrounded with and embedded in a concrete shell 5.9 inches thick, and lined on the inside with reinforced



FIG. A.—Placing steel tubes surrounded with outside reinforcement, in cradles. Sosa Siphon, Spain.

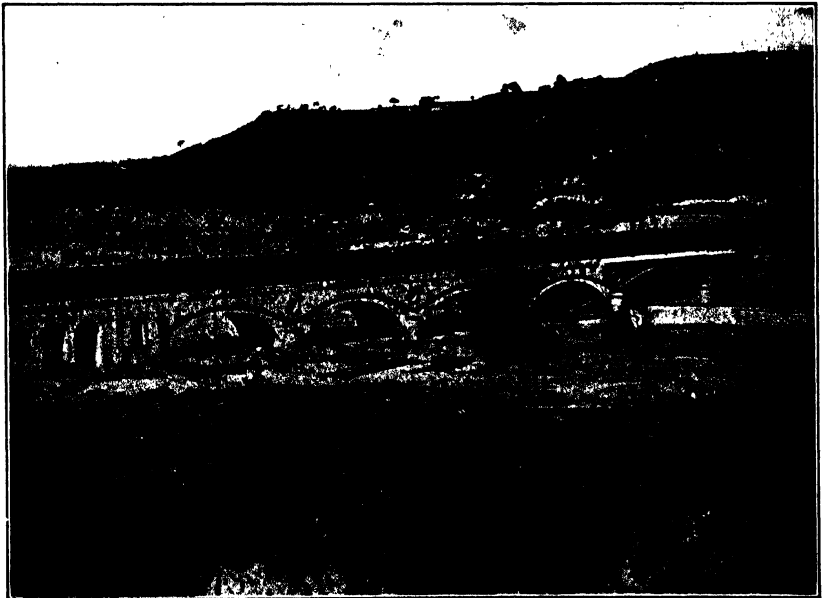

FIG. B.—Steel tubes in position on Sosa River Bridge, Spain.

(Facing page 334)

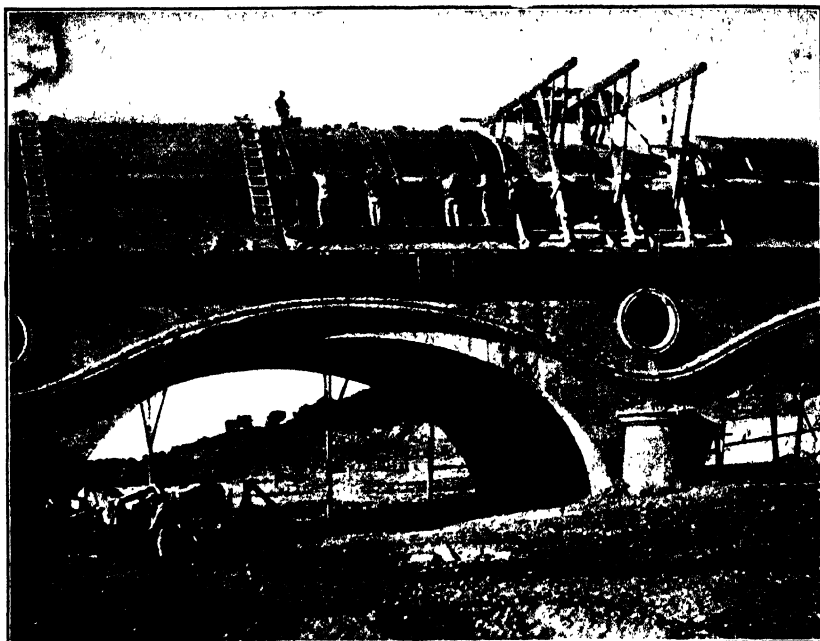
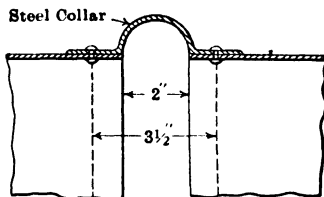

FIG. C.—Construction of concrete shell around steel tubes on bridge. Sosa Siphon, Spain.

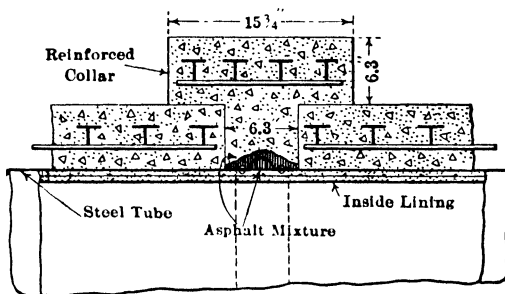

FIG. D.—Steel reinforcement in place for Albelda Siphon, Spain.

mortar, 0.87 inch thick. Each metal tube, with the surrounding hoops, was placed in position in a cradle of lean concrete and supported away from it by the required thickness of the concrete shell; the wet mixture of concrete was then placed with forms around the pipe, leaving a groove or space at the joints between abutting ends of pipe to permit the connection of the ends of the steel tubes with a riveted steel collar shaped with a corrugation to allow contraction or expansion. This collar was well coated with a hot mixture of tar and asphalt, and the groove was



Section of Steel Tube Joint



Section of Joint

FIG. 75.—Joint of pipes for Sosa Siphon.

filled and surrounded with a reinforced concrete collar projecting over the ends of the previously placed concrete (Fig. 75). The crossing of the Sosa River is made by carrying the pipelines on a substantial concrete arched bridge (Plate XXXI, Figs. A, B, C).

The Albelda siphon has no expansion joints and no steel tube to insure impermeability. The construction of this siphon was in charge of Mr. Mariano Luina, who was also engineer in charge of construction of the Sosa siphon. Mr. Luina has furnished the information given below (Plate XXXI, Fig. D):

The conduit of the Albelda siphon is a single reinforced concrete pipe, 7.87 inches thick, supported up to its horizontal diame-

ter on a concrete cradle. As it was expected that there would be more or less leakage through the pipe, the cradle was given a peculiar shape designed to collect the seepage water and prevent it from softening and washing away the foundation.

This cradle is made of porous concrete and comprises a system of drains intended to collect and carry away all water percolating through the pipe and through the porous concrete of the cradle. On the right side of the cradle is the main collecting gallery. In the upper part of this gallery drain holes 3 feet 6 inches deep, 16 inches long and 6 inches wide, spaced 4 feet apart connect the gallery with a longitudinal semicircular groove in the top of the cradle, in which the water percolating through the upper portion of the conduit collects. On the left side between the outer face of the cradle and the wall of the trench is a space of 10 inches filled with loose rock. The lower end of this loose rock drain rests on a concrete floor and is connected to the collecting gallery by a series of transversal grooves 4 inches wide and 3.14 inches high, running across the concrete floor and spaced 4 feet apart. This concrete floor slopes toward the collecting gallery and has a thickness varying from about 7 inches at the collecting gallery to about $8\frac{5}{8}$ inches at the foot of the loose rock drain. To keep the grooves opened when building the cradle, each groove was covered with a metal plate $\frac{5}{16}$ inch thick. To drain the upper half of the conduit, it is covered with an 8-inch layer of broken rock. The concrete cradle was made of very porous material, so that the water percolating through the lower half of the conduit would find an easy passage into the drains. The concrete used consisted of about 1 part of cement to $4\frac{1}{4}$ of sand and $8\frac{1}{2}$ parts of gravel passed through a $2\frac{3}{4}$ -inch screen. To examine the main collecting gallery, tubular openings were provided each 197 feet.

The shell of the pipe is made up of 7.28 inches of concrete, in which the reinforcement is imbedded, and of an inside plaster lining of cement mortar 0.59 inch thick, giving a total thickness of 7.87 inches. The reinforcement consists of 124 longitudinal round rods spaced about 4 inches apart, and of circumferential bars of T-shapes, tied at their intersection to the longitudinal rods with wire about $\frac{1}{16}$ inch in diameter. Each circumferential T-bar has an exterior diameter of 13.4 feet and is composed of two halves butt joined together with six rivets. The reinforcing steel has an ultimate strength of 37,000 pounds per square

inch and its working strength was assumed at 14,200 pounds per square inch. The concrete used for the conduit was a mixture of about 1 part of Portland cement to 1.28 parts of sand, 2.56 parts of gravel under $1\frac{1}{4}$ inches, and 0.53 to 1.00 part of water, all by volume. The interior lining was made of equal parts of cement and coarse sand.

The interior forms were made in collapsible sections and in several parts so designed that a section could be taken apart and passed through the interior of the erected forms ahead. When completed the upper half of the conduit was surrounded with loose rock and covered with an earth fill. The concrete work was commenced on the 26th of November, 1908, and the main part of the siphon was completed on the 6th of March, 1909. The interior lining and all accessory works were completed on the 4th of April, 1909. The water was turned into the siphon and the conduit was tested on the 24th, 25th, and 26th of May, 1909. The tests showed that the total seepage loss under the full head was only 0.105 gallon per second, and this diminished to $\frac{1}{24}$ the following days and continued diminishing.

Piers and Supports for Reinforced Concrete Continuous Pipe.—

Reinforced concrete pipes are usually built in a trench and entirely

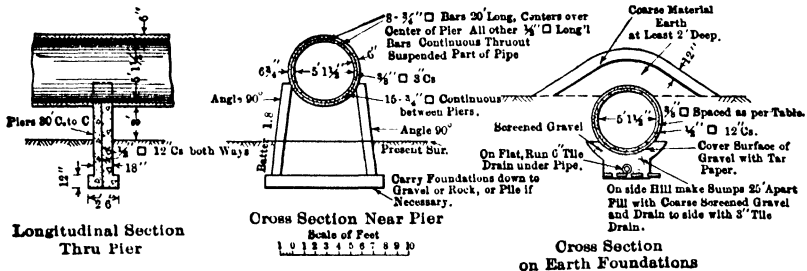

FIG. 76.—Sections of reinforced concrete pipe of Simms Creek Siphon, Sun River Project, Mont.

covered to make temperature changes a minimum. The lowest part of a pipe line at a stream crossing is usually carried under the stream bed, but in a few cases it has been carried over the stream bed either on a bridge, as in the case of the Sosa siphon in Spain, or on piers by reinforcing the pipe to develop the required strength to act as a beam between piers, as illustrated by the Simms Creek siphon on the Sun River project. This siphon is $61\frac{1}{2}$ inches in inside diameter, about 1,650 feet in length, under a

maximum pressure head of about 47 feet. The crossing over Simms Creek is made by carrying the pipe on ten piers spaced 30 feet on centers (Fig. 76). To develop beam strength in the pipe spans of 30 feet, the longitudinal reinforcement, which for the pipe-line section supported on earth consists of $\frac{1}{2}$ -inch square bars 12 inches center to center, is supplemented with top reinforcement to resist negative bending moments, consisting of eight $\frac{3}{4}$ -inch square bars, 20 feet long, placed with centers over the center of pier, and with bottom reinforcement to resist positive bending moment consisting of fifteen $\frac{3}{4}$ -inch square bars, continuous between supports.

ECONOMIC PIPE-LINE LOCATION AND DESIGN

The location and design of a pipe line will frequently present interesting economic problems which should be carefully considered by the engineer.

When the topographic conditions offer the selection between a number of locations, the most economic location will be determined from a cost comparison between a long line, adjusted to the contours and placed within a comparatively small distance below the hydraulic line, and shorter straighter lines. The longer line will produce a lower average pressure, but, if the difference in elevation between the upper and lower end is the same as for the shorter pipe, the greater length of pipe will require a larger diameter. The selection will then be between the longer pipeline of larger diameter and under smaller pressure, and the shorter pipe line of smaller diameter under greater pressure. The smaller pressure obtained with the longer pipe may also permit the construction of a reinforced concrete or wooden stave pipe where the greater pressure would require the use of more expensive steel pipes. In some cases where there is considerable variation in pressure it will be desirable to build the pipe in sections of different materials adjusted to bring each kind of pipe under conditions favorable to maximum durability and economy. For instance, the sections of pipe under least pressure may be built of reinforced concrete; those under somewhat greater pressure, of wooden stave; and those where the pressure exceeds that for which wooden stave is economical, of steel.

A further complication in the economic design of long pipe lines may occur where the conditions justify a variation in the diam-

eter of the different sections of the pipe line. The simplest case is when the pipe line crosses a broad depression which produces gradually increasing pressures from the two ends toward the lowest part of the depression. For these conditions, especially in the case of steel pipes, a lower total cost may be obtained by using in the place of a pipe of uniform diameter a pipe of variable diameter, decreasing from the upper ends toward the lower part of the pipe. The diameter of the lower part will be smaller than the diameter of a uniform size pipe line, and as the frictional loss in head in this part of the pipe will be greater than that in an equal length of the uniform size pipe line, the diameter of the upper part of the variable size pipe must be correspondingly larger than the uniform diameter to give the same carrying capacity with the same total loss of head. For such a pipe line the least amount of material will be obtained when the change in diameter is made gradually, the pipe tapering toward the bottom of the depression. In practice the change is made in sections. A theoretical analytical discussion of this principle of economic design and its application to a practical case is presented in the following article: *Economical Diameters of Pipes*, by E. W. Rittger, page 464, *Engineering Record* of October 24, 1914. A graphical solution of this economic problem and its application to the design of the Jawbone inverted siphon of the Los Angeles aqueduct, operating under a maximum head of 850 feet, is presented in the following article: *Designing Steel Pipe for Minimum Weight of Metal Consistent with Safety*, by E. R. Bowen, page 682, *Engineering Record*, Dec. 20, 1913. The siphon was built in accordance with the results obtained from the solution; it has a length of 7,096 feet, a maximum pressure head of 850 feet, and the pipe is built in sections of different diameters, adjacent sections differing 6 inches in diameter. The diameter is 10 feet at the upper ends and $7\frac{1}{2}$ feet at the lower part; the thickness increases from $\frac{1}{4}$ to $1\frac{1}{8}$ inches. A constant diameter pipe would have required a maximum thickness of $1\frac{1}{4}$ inches and 10 per cent. greater weight of steel.

The use of pipes of different materials to make up a pipe line, in which each kind of pipe is used under favorable conditions, is illustrated by the Prosser siphon and the Mabton siphon of the Yakima project, Washington. These siphons are used to cross the Yakima River; each siphon is made up of reinforced concrete pipe for the two ends and wooden stave pipe for the main central

portion in between. The Prosser siphon, at its lowest part, is carried across the Yakima River on a three-span Warren bridge. The pipe line is divided into 3 parts; the inlet part, 2,825 feet long, and the outlet part, 263 feet long, are both made of 30½-inch reinforced concrete pipe; the central part, 7,500 feet long, is made of 31-inch wooden stave. The maximum pressure on the reinforced concrete pipe, measured from the hydraulic grade line for full flow to the bottom of the pipe, is about 48 feet at the lower end of the inlet part and 20 feet at the lower end of the outlet part. These pressures are also the minimum pressures at the upper ends of the wooden stave pipe when the siphon is operating at full flow. When operated at partial flow, the hydraulic grade line drops, and when the flow is stopped with the pipe full up to the floor of the outlet structure, the pressure head at the inlet end and outlet end of the wooden pipe decreases to 23 and 18 feet, respectively. The maximum pressure head at the lowest part of the siphon is 102 feet. The Mabton siphon is carried under the bed of the Yakima River. The pipe line begins with an inlet section about 3,000 feet long of 54-inch reinforced concrete pipe, then a section 3,000 feet long of 55-inch wood stave pipe, then the lowest central part 1,500 feet long of 48-inch wood stave pipe, then a section of 8,175 feet of 55-inch wood stave pipe and an outlet section of about 100 feet of 54-inch reinforced concrete pipe. The maximum pressure head on the reinforced concrete pipe, measured from the theoretical hydraulic gradient, is 51 and 25 feet, respectively, at the lower ends of the inlet and outlet sections. With no flow in the pipe and the water level in the two legs of the siphon at the same level as the floor of the outlet structure, the pressure heads at the inlet and outlet ends of the wooden pipe decrease to 18.5 and 16.5 feet, respectively. The central section is subject to pressure heads ranging from 123.0 feet to a maximum of 167 feet.

SPECIAL CONSIDERATION OF INVERTED SIPHONS AND AUXILIARY WORKS

General Description and Design.—An inverted siphon is used for the crossing of a depression, which may be a natural drainage channel, a ravine, or a broad valley depression. For this purpose the selection will be between an inverted siphon, a canal run on a falling contour around the uphill rim of the depression, a canal in fill, when a moderately shallow depression, or an elevated flume.

The choice must be based on a consideration of the comparative first cost, ultimate cost, and safety of construction.

An inverted siphon consists of one or more lines of conduits connecting with inlet and outlet structures, to the canal sections at each end. Other accessory works are: A sand box and escape or wasteway at the inlet to permit the discharge of water in case of necessary repairs or break below and to remove heavier sand or gravel. Anchorages or collars used at elbows or bends. Air outlet valves at the convex bends and high places to permit the escape of air collecting at the bends and summits. Air inlet valves at the summits to permit the entrance of air when emptying the siphon conduit. Blow-off valves or discharge gates in the depressions to empty the siphon and in some cases to flush out silt or other material which may collect in the conduit.

Siphon Inlet Structure.—The inlet should be designed to meet some or all of the following requirements:

First.—The entrance to the pipe must be tapered or flared so as to decrease the loss of head resulting from irregular currents and eddies.

Second.—The entrance to the pipe must be placed below the low water level in the inlet structure, to prevent the entrance of air and floating bodies and, in the case of wooden stave pipe, to maintain the upper end of the pipe full at all times.

Third.—The inlet structure may be combined with a sand box and wasteway and designed to prevent the entrance in the pipe of débris or other transported material.

The importance of a properly shaped tapered entrance will depend on the available difference in elevation between inlet and outlet water levels and the length of the pipe line. In a long pipe line, the entrance loss of head is a small part of the total head, while in a short pipe line it may be a large part of the total head, so that where the total available difference in elevation is small, the extra cost of constructing a well-shaped entrance is justified. The extent to which the second requirement of entrance submergence can be obtained will depend on the difference in elevation between the inlet and outlet water levels for the different conditions of flow. When the flow in the pipe line is discontinued, the static water levels at the inlet and outlet will be at the same elevation, which will usually be the elevation of the canal bottom or of the sill at the outlet of the structure. From this lowest elevation the water level at the inlet will rise to a maximum elevation

when operated at full flow. When the pipe is wooden stave it is desirable to keep it entirely full at all times, which for the period of non-operation requires that the entrance end be placed below the lowest or static water level; this may not be obtainable when the difference in inlet and outlet elevation is large, but in many cases is obtainable by making the entrance connection at the bottom of a deep inlet well. For concrete or steel pipes it may be sufficient to provide entrance submergence only for the normal conditions of flow. A depth below the water level and the top of the entrance of at least 3 to 4 feet will usually be desirable. A screen is generally used and is necessary to stop all the larger transported material.

Sand Box and Wasteway.—The need or desirability of a sand box and wasteway, formed as part of the inlet structure, will depend on the character of material transported by the water, the relative velocities in the canal and in the siphon, and the grade of the upward inclinations in the pipe line. The velocity in the siphon will usually be larger than the canal velocity. This will help to prevent the deposition of the finer transported material in the pipe; but the heavier coarser material rolled along the bottom of the canal can only be lifted and carried, through that portion of the pipe which has an upward slope, with a much greater velocity. In general it will be desirable to provide a sand box of sufficient length and a large enough cross section to decrease the canal velocity before the water enters the pipe. This provision is especially necessary when the pipe-line velocity is not much greater than the canal velocity and where the pipe line has sections with steep upward slopes. The installation of a sand box is also desirable because it can be advantageously combined with a wasteway structure, for which the conditions are generally favorable, because of the nearness to a drainage channel. Such a structure is desirable to turn the water out of the canal down the wasteway channel, in case of a break or needed repairs to the siphon, or of a break in the canal below. To divert the flow from the pipe line to the wasteway channel through the waste gates, check gates or a raised sill may be required just below the waste gates and above the pipe inlet. Where special conditions exist which threaten to cause obstructions or breaks in the siphon, automatic spillways may be desirable. The design of sand boxes, wasteways and spillways is considered in Vol. III.

Siphon Outlet Structure.—The velocity of flow in the siphon is usually greater than that which can be safely used in an earth canal. The outlet must, therefore, usually be designed to decrease the pipe exit velocity. This may best be obtained by making the outlet connection at the bottom of a well or by forming a funnel-shaped outlet. In either case the water in the outlet above the conduit end forms a water cushion, in which the velocity of exit decreases as it passes from the smaller conduit section to the larger cross section of the outlet basin or well. The requirements for a satisfactory outlet structure may be obtained by making the outlet connection the same form and size as the inlet connection. This also simplifies the construction. When the outlet end is not properly submerged and the exit velocity is high, it may be necessary to protect the bed of the canal for considerable distance below the outlet structure with riprap or concretelining.

Pipe Line.—A single pipe line is generally used and in most cases will cost less than two or more parallel pipe lines of smaller diameter of equal total carrying capacity. Special conditions which may make it preferable to use two or more parallel pipe lines are: *First*, when a single pipe line would be of greater diameter than can be economically obtained or constructed. *Second*, when the canal on which the siphon is to be installed will be operated at a fraction of its ultimate capacity for several years during the period of development.

In domestic water-supply systems two or more parallel pipe lines are often installed, in order that an obstruction, failure or needs of repair in one pipe line will not result in a total interruption of flow. This practice is seldom warranted for irrigation systems.

The size of the pipe line is determined from the required capacity and the available fall between inlet and outlet. To decrease the cost of the pipe line, the velocity will generally be made as great as possible.

Examples of Inlet and Outlet Structures.—A number of examples have been presented above in the discussion of reinforced concrete pipes. Other examples illustrated by the accompanying drawings are the following:

Inlet and Outlet Structures of Wolf Creek Lateral Siphon, American Beet Sugar Co., Colorado (Fig. 77).—These structures, of the same size and design, are connected with a wooden stave pipe. Each structure consists of wing walls leading to

and surrounding a rectangular well, at the bottom of which is made the connection with the end of the pipe. A wrought-iron screen at the inlet structure prevents the entrance of large transported material.

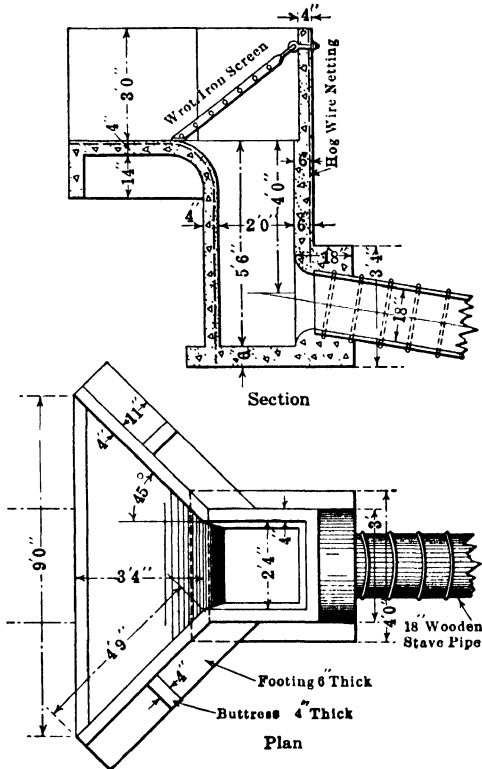

FIG. 77.—Inlet structure of Wolf Creek Siphon. American Beet Sugar Co., Colo.

Inlet to 48-inch Concrete Pipe Chute on Boise Project, Idaho (Fig. 78).—This structure, although not used on a siphon, presents a good form of simple tapering inlet, in which the pipe entrance is well submerged below the water level. Usually a screen and a roof or cover over the inlet would be added to prevent the entrance of transported material and to guard against the danger of persons or animals falling in.

Inlet to Anderson Siphon of Belle Fourche Project, South Dakota (Fig. 79).—This structure illustrates a form of well-shaped, tapering inlet for a large siphon. A contraction joint is formed in

the pipe within a short distance from the end wall of the structure to prevent excessive pull by contraction. The grooves formed in the side walls and piers provide for flashboard regulation of the depth of water in the upstream canal. This is often a desirable feature to prevent the drawdown of the water level and resulting erosion due to the corresponding increase in velocity which might otherwise occur. A greater depth of submergence of the pipe entrance would usually be desirable, especially with wood stave pipe.

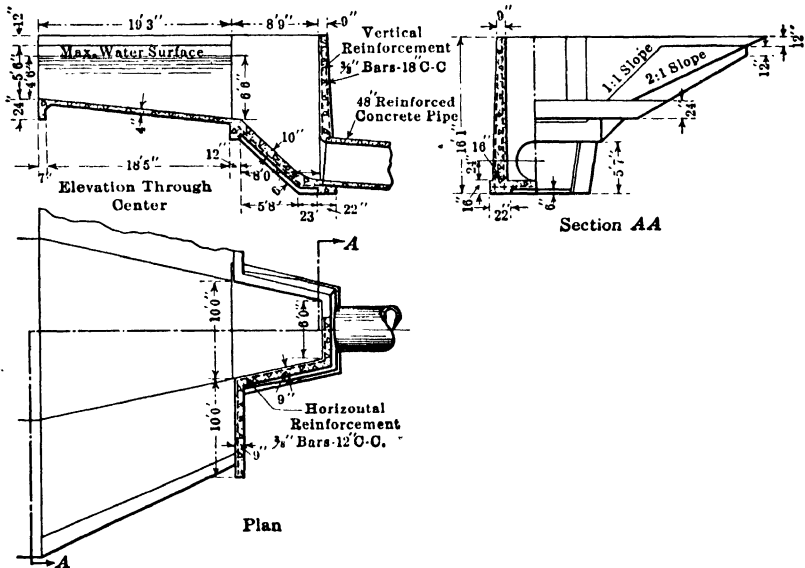

FIG. 78.—Inlet to reinforced concrete wasteway chute. Boise Project, Idaho.

Inlet Structure of a 4-foot Wood Stave Siphon, Kamloops Fruitlands Irrigation and Power Co., British Columbia (Fig. 80).—This inlet, structure built of plain concrete, combines with it a sand box and wasteway. The siphon is 3,700 feet in length, and is on the main concrete-lined canal of the system. It has a maximum full capacity of about 75 cubic feet per second. The water is clear, except for small rock, gravel and other material, which occasionally slides in or is washed in by uphill storm water. The main purpose of the sand box was therefore to stop coarser material from entering the siphon and to form a depressed basin for the wasteway opening in the downhill bank of the canal. The velocity in the canal for maximum supply is about 4.5 feet

per second, and in the siphon about 6 feet per second. When the full flow is discharged through the pipe, the water level at the pipe entrance was computed to be about 1.5 feet below the full water level in the sand box; the flow over the separating raised

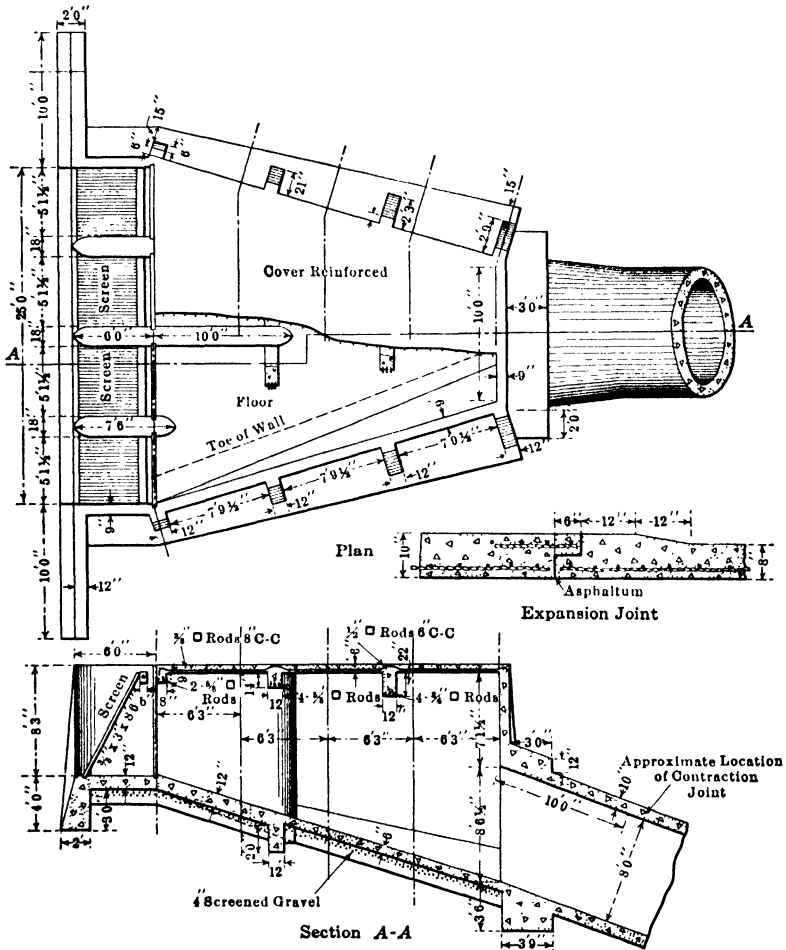

FIG. 79.—Inlet structure of Anderson Siphon. Belle Fourche Project, S. D.

sill is therefore that of a partly submerged weir. In order to maintain the full water depth in the sand box, the crest of the overpour sill is raised with flashboards an additional 12 inches, and the full flow passes from the sand box into the pipe entrance, with a 2-foot depth of overpour on the crest. With this provision,

the velocity at the full cross-sectional area of the sand box is reduced to 3.33 feet per second. The wasteway opening, when fully opened, is designed to divert the entire canal flow, with none pass-

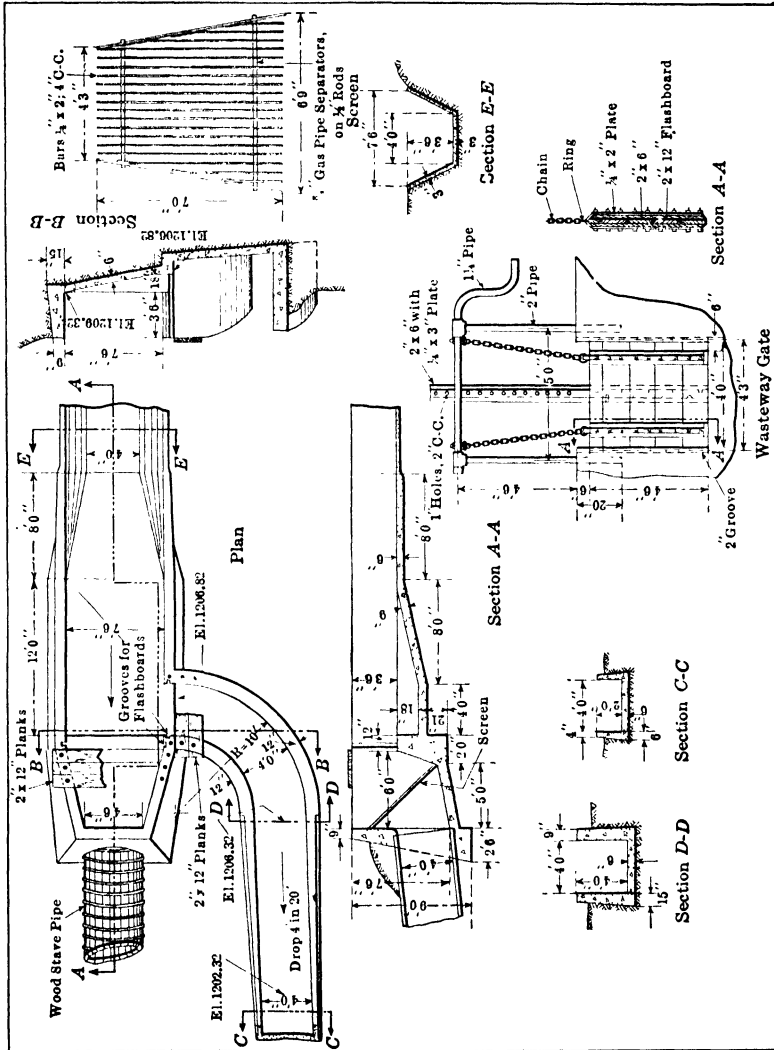

FIG. 80.—Inlet structure to 4-foot siphon. Kamloops Fruitlands Irrigation & Power Co., B. C.

ing over the overpour crest, when this crest has been raised 12 inches with flashboards. For these conditions the flow through the wasteway opening is about the same as that over the edge of a

drop, for which Bellassis' gives the formula $Q = 4.74LD^{3/2}$; in which Q = discharge in cubic feet per second.

L = length of overpour edge in feet.

D = depth of overpour in feet.

Therefore:

$L = \frac{Q}{4.74D^{3/2}} = \frac{75}{4.74 \times 2.5^{3/2}} = 3.95$ feet. If necessary, additional flashboards may be inserted in the grooves.

The wasteway gate is an undershot wood gate, which can be quickly lifted by the simple and cheap windlass formed of heavy wrought-iron pipe, and can be forced down if necessary with the lever arrangement formed between the gate stem and the pipe axle as a fulcrum.

In the wasteway channel accelerated flow increasing to a very high velocity is obtained. Minimum freeboard of 18 inches has been provided.

The outlet structure differs from the inlet in the omission of the sand box and wasteway; the form and dimensions are otherwise the same.

A desirable addition to an inlet structure, not provided in the above examples is an air standpipe connected to the upper end of the pipe a short distance below the inlet structure, to permit the escape of air which is drawn in the pipe by the turbulent entrance flow of the water.

Blow-offs and Mud Valves.—A blow-off consists of a takeout connection and a gate valve placed at or near the low point of the siphon. The blow-off may be used for the following purposes:

First.—To empty the pipe when necessary, to make repairs, or to prevent damage by freezing in the winter. This is the most common use of blow-offs and requires only a small blow-off valve. A diameter of valve equal to $\frac{1}{16}$ to $\frac{1}{10}$ the diameter of the pipe is commonly used.

Second.—To discharge the entire flow of the canal through the blow-off, using it in the place of a wasteway, in which case the discharge capacity of the blow-off, under a pressure head measured from the hydraulic grade line, must be equal to the carrying capacity of the canal. A blow-off for this purpose is desirable when no wasteway is provided at or a short distance above the inlet.

Third.—To scour out material deposited in the siphon. For this

purpose a very large blow-off is required to produce a scouring velocity in both branches of the siphon, draining toward the blow-off, at least equal to the normal velocity in the siphon. It is generally preferable to prevent the deposit by the use of a sand box at the inlet. The use of large blow-offs at the low points of a pipe line which crosses a series of depressions may be objectionable on account of the possibility of the formation of partial vacuums at the summits by the rapid opening of a blow-off valve.

Examples of blow-off connections and valves are shown by Figs. 81 and 82. The blow-off of the Simms Creek siphon, as

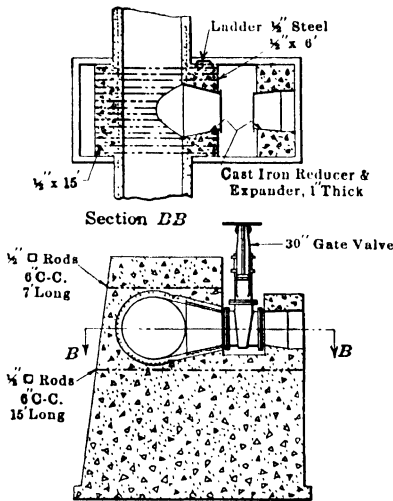

FIG. 81.—Blow-off, originally designed for Simms Creek Siphon. Sun River Project, Mont.

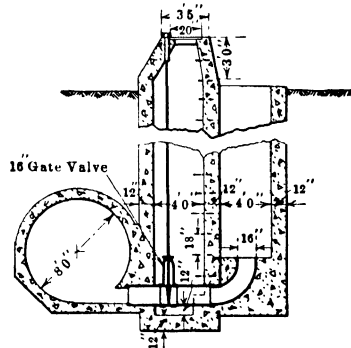

FIG. 82.—Blow-off for Anderson Siphon. Belle Fourche Project, S. D.

originally designed (Fig. 81), was apparently planned for a discharge capacity equal to capacity of the siphon. It is located on one of the piers which support the pipe over the creek crossing and is about 34 feet below the outlet elevation. With this pressure head and a coefficient of discharge of about 0.8, the capacity is 175 cubic feet per second, which is the capacity of the siphon. Presumably it was decided that the blow-off should not be used as a wasteway, because as actually constructed a smaller drain valve was substituted.

The blow-off of the Anderson siphon, Belle Fourche project, South Dakota, is housed in an operating well which gives access

to the valve below the ground surface (Fig. 82). The blow-off discharges at the bottom of an adjacent box compartment, in which the water rises and overflows.

The blow-off for the wooden stave pipe Prosser siphon, Sunny-side project, Washington, is placed on the pipe, where it is carried across Yakima River on a bridge, at one of the supporting bridge piers. The blow-off valve is bolted to the saddle connection, shown in Fig. 65.

Air Valves and Air Stands.—*Air outlets* are required at the summits and convex bends for the purpose of letting the air out when filling the pipe and to discharge the air which has a tendency to collect at these points. They are especially necessary where the pressure is low, because this permits the expansion of the collected air. At those points which are within a few feet of the hydraulic gradient the outlet may be made of standpipes. Air outlet valves, located where the pressure is considerable and where there is little tendency for air to collect, may consist of ordinary valves which are opened when the pipe is being filled and periodically to let out accumulated air. Automatic air outlet valves are required at all points where there is a tendency for air accumulation and where stand-pipes are not feasible. They may, if sufficiently large, serve the purpose of air inlets. An empirical rule which is commonly given for the size of air outlet automatic valves requires an air valve diameter of 1 inch for each foot in diameter of the pipe.

Air inlets are more commonly used on steel pipes. Their purpose is to let air into the pipe to prevent the collapsing of the pipe from exterior pressure when a vacuum is produced in the pipe by a break, sudden opening of a large blow-off valve or other cause. There is less need for them on wooden pipes because of the greater strength against external pressure, but it is a desirable precaution to provide air inlets at least at the summits of large wooden pipes. A fuller discussion of air inlets has been given in the consideration of steel pipes.

Anchorage and Expansion Joints.—These have been considered in connection with the discussion of steel pipe lines. Anchorages are generally required at bends and at regular intervals on exposed steel pipe lines; they are not usually required on buried steel pipes or on wood stave and concrete pipe lines, except at very sharp bends or on exposed wood stave pipe line built on a very steep incline.

REFERENCES FOR CHAPTER X

STEEL AND IRON PIPES:

- ADAMS, A. L.—Pipe Line of Astoria, Oregon, Waterworks—p. 10, Vol. XXXVI, Trans. Am. Soc. Civ. Eng.—1896.
- CLARKE, D. D.—The Distortion of Riveted Pipe by Backfilling—p. 93, Vol. XXXVIII, Trans. Am. Soc. of Civ. Eng.—1897.
- GOLDMARK, H.—The Power Plant, Pipe Line and Dam of the Pioneer Electric Power Co. at Ogden, Utah—p. 246, Vol. XXXVIII, Trans. Am. Soc. Civ. Eng.—1897.
- The 72-inch Steel Lock-bar Pipe of the Brooklyn Water Supply—p. 316 Engineering Record—Sept. 18, 1909.
- The Western Aqueduct Pipe Arch Over the Sudbury River, Mass.—p. 480 Engineering Record—April 16, 1904.
- HAZEN, A.—Of What Thickness Shall We Make the Walls of Our Large-size Pipe Lines?—Jour. N. E. W. W. Assn.—March, 1911.
- MURPHY, D. W.—Pure Iron Water Pipe to Resist Corrosion—p. 41 Engineering Record—July 8, 1911.
- HAZEN, A.—Steel and Cast-iron Pipes—p. 681 Engineering Record—June 17, 1911.
- HAZEN, A.—Steel and Cast-iron Pipe—p. 105 Engineering and Contracting—July 26, 1911.
- HURLBUT, W. W.—Antelope Valley Siphon, Los Angeles Aqueduct—p. 60 Engineering Record—July 19, 1913.
- Self-supporting Arched Penstock in France—p. 274 Engineering Record—Sept. 6, 1913.
- BOWEN, E. R.—Designing Steel Pipe for Minimum Weight of Metal Consistent with Safety—p. 682 Engineering Record—December 30, 1913.
- HEINLY, B. A.—San Fernando Inverted Siphon, Los Angeles Water Supply—p. 1145 Engineering News—May 21, 1914.
- HURLBUT, W. W.—Completion of San Fernando Siphon, Los Angeles—p. 48 Engineering Record—July 11, 1914.
- RETTGER, E. W.—Economical Diameters of Pipes—p. 464 Engineering Record—Oct. 24, 1914.

CORROSION AND DURABILITY OF STEEL AND IRON PIPES:

- The Rusting of Iron and the Rochester, N. Y., Steel Conduits—Engineering—August 27, 1909.
- KUICHLING, E.—Steel Pipes for Waterworks—Jour. N. E. W. W. Assn.—Dec., 1910.
- The Life of Wrought-iron and Steel Service Pipes.—A Discussion Before the New England Waterworks Association—p. 753 Engineering News—Dec. 21, 1911.
- The Corrosion of the 350-mile 30-inch Coolgardie Pipe Line, Western Australia—p. 221 Engineering News—Aug. 24, 1911.
- WALKER, W. H.—The Relative Corrosion of Iron and Steel Pipe as Found in Service—Jour. N. E. W. W. Assn.—March, 1912.

- BOWIE, C. P.—Protecting Pipe Lines Against Alkali—p. 119 *Western Engineering*—May, 1912.
- WHIPPLE, G. C. AND M. C.—Mill Scale as a Cause of the Pitting of Steel Pipes—p. 856 *Engineering News*—Nov. 7, 1912.
- Corrosion of a Long Steel Pipe Line, Port Elizabeth, South Africa.—p. 651 *Engineering News*—April 3, 1913.
- BURWELL, H. M.—Life of Water Pipe in Vancouver—p. 521 *Engineering Record*—Nov. 8, 1913.
- HATTON, T. C.—Unusual Features of a 48-foot Cast-iron Water Main Across a Salt Marsh to Atlantic City, N. J.—p. 1046 *Engineering News*—Nov. 20, 1913.
- Condition of the Interior of a 48-inch Riveted Steel Water Main After 17 Years' Service, New Bedford, Mass., Waterworks—p. 1254 *Engineering News*—June 4, 1914.
- METCALF, L.—The Protection of Riveted Steel Pipes—p. 598 *Engineering and Contracting*—Dec. 30, 1914.
- WOOD STAVE PIPES:**
- HENNY, D. C.—Wooden Stave Pipe vs. Riveted Pipe—p. 254, Vol. XXI, *Association of Engineering Societies*—1898.
- ADAMS, A. L.—Stave Pipe—Its Economic Design and the Economy of its Use—p. 27, Vol. XLI, *Trans. Am. Soc. Civ. Eng.*—1899.
- The Life of Wood Stave Pipe.—p. 639 *Engineering Record*—June 1, 1907.
- Diagrams for Spacing Bands on Wood Stave Pipe.—p. 255 *Engineering News*—Sept. 3, 1908.
- MORITZ, E. A.—Another Diagram for Spacing Bands on Wood Stave Pipe—p. 343 *Engineering News*—Sept. 24, 1908.
- Pipe Line Construction Canyon City Water Supply—p. 624 *Engineering Record*—Dec. 4, 1909.
- JARVIS, C. S.—Bidding Prices of Wood Stave Pipe, Provo, Utah—p. 92 *Engineering and Contracting*—Jan. 26, 1910.
- Intake to Wood Stave Pipe Line—Willow River Irrigation Project—p. 565 *Engineering Record*—May 20, 1911.
- Reinforced Concrete Inlet to Wood Stave Pipe—Reconstruction of a Power Canal and Flume Under Service—p. 579 *Engineering Record*—May 27, 1911.
- HATTON, T. C.—Characteristics of Wood Stave Pipe with Some Examples of its Use and Cost for Water Supply—p. 686 *Engineering and Contracting*—June 14, 1911.
- Wood Stave Pipe—p. 680 *Engineering Record*—June 17, 1911.
- The Manufacture of Machine-banded Stave Pipe—p. 53 *Engineering Record*—July 8, 1911.
- DICKERSON, H. L.—Methods and Cost of Constructing Main Canals and Laterals for the Willow River Land and Irrigation Project in Malheur County, Oregon—p. 136 *Engineering and Contracting*—Aug. 2, 1911.
- MORITZ, E. A.—Graphical Design of Shoes for Bands of Wood Stave Pipe—p. 427 *Engineering News*—Oct. 12, 1911.
- Inlet to Wood Stave Pipe Distribution System of Pueblo Rocky Ford Irrigation Project—p. 602 *Engineering Record*—Nov. 18, 1911.

- Continuous Wood Stave Pipe—p. 342 *Engineering Record*—March 30, 1912.
- Wood Stave with Concrete Inlet and Outlet—The Irrigation System of Southern Alberta Land Co.—p. 421 *Engineering and Contracting*—April 10, 1912.
- CAMPBELL, J. L.—The Design and Specifications of the Sacramento Water Supply Wood Pipe Line of the El Paso and Southwestern Railway Co. in New Mexico—p. 7 *Engineering and Contracting*—July 17, 1912.
- MORITZ, E. A.—Should Pipe Lines be Carried Under or Over Streams?—p. 528, Vol. LXIII, *Engineering News*—March 13, 1913.
- New 60-inch Water Supply Conduit at Denver—p. 60 *Engineering Record*—Jan. 18, 1913.
- A 13½-foot Wood Stave Pipe—p. 685 *Engineering News*—Oct. 9, 1913.
- Instructions for Laying Machine Banded Wood Stave Pipe—p. 396 *Western Engineering*—Nov., 1913.
- ALDERMAN, C. A.—Power Development at Saxon Falls—p. 253 *Engineering Record*—Feb. 28, 1914.
- EDWARDS, C. A.—Rebuilding an Old Wood Penstock—p. 1013 *Engineering News*—May 7, 1914.
- SWICKARD, A.—The Use, Design, Construction, Cost and Durability of Wooden Stave Pipe—p. 422, Part I, *Engineering and Contracting*—Nov. 4, 1914; p. 516, Part II, *Engineering and Contracting*—Dec. 2, 1914; p. 10, Part III, *Engineering and Contracting*—Jan. 6, 1915; p. 146, Part IV, *Engineering and Contracting*—Feb. 17, 1915.
- JAYNE, S. O.—Wood Pipe for Conveying Water for Irrigation—Bull. 155, U. S. Dept. of Agriculture—Dec. 23, 1914.

DURABILITY OF WOOD STAVE PIPES:

- ADAMS, A. L.—Additional Information on the Durability of Wooden Stave Pipe—p. 65, Vol. LVIII, *Trans. Am. Soc. Civ. Eng.*—1907.
- TIFFANY, R. K.—Experience with Wood Stave Pipe in Irrigation—p. 244 *Engineering News*—Feb. 6, 1913.
- Renewing Wood Stave Pipe—p. 729 *Engineering Record*—Dec. 27, 1913.
- CHANDLER, E. M.—Experiences with Wood Stave Pipe—p. 299 *Engineering Record*—March 14, 1914.
- EDWARDS, C. A.—Rebuilding an Old Wood Penstock—p. 1013 *Engineering News*—May 7, 1914.

CONCRETE AND REINFORCED CONCRETE PIPES:

- A Concrete Steel Penstock for a Water Power Plant near Grenoble, France—p. 74 *Engineering News*—Jan. 22, 1904.
- QUINTON, J. H.—Experiments on Reinforced Concrete Pipes Made for the U. S. Reclamation Service—p. 246 *Engineering News*—March 9, 1905.
- Methods and Cost of Building a Reinforced Concrete Pipe Line for a Water Main (France)—p. 128 *Engineering and Contracting*—May 9, 1906.
- WRIGHT, A. E.—Cost of Moulding and Method of Testing Small Cement Pipes—p. 312 *Engineering and Contracting*—Dec. 4, 1907.

- TEICHMAN, F.—A Travelling Mould for Making Reinforced Concrete Pipe—p. 185 *Engineering News*—Feb. 20, 1908.
- A Notable Ground-water Development at Pueblo, Colorado—p. 399 *Engineering Record*—Apr. 4, 1908.
- Reinforced Concrete Pipe Joint (Lock Joint Pipe Co.)—p. 643 *Engineering News*—Dec. 10, 1908.
- A 12-mile Concrete Pipe Conduit (36-inch Pipe, Colorado)—p. 514 *Engineering Record*—Nov. 6, 1909.
- Leakage Tests of an 11-foot Reinforced Concrete Pipe—p. 566 *Engineering Record*—April 23, 1910.
- MASSON, R. S.—Hydroelectric Development of the Arizona Power Co.—p. 214 *Engineering Record*—Aug. 20, 1910.
- NEWELL, H. D.—Reinforced Concrete Pressure Pipe on the Umatilla Project, Oregon—p. 208 *Engineering News*—Feb. 16, 1911.
- GRIFFIN, J. A.—Notes on Making and Laying Concrete Pipe—p. 505 *Engineering Record*—May 6, 1911.
- VAUGHN, Z. N.—Building a Reinforced Concrete Pipe Line in Alkali Soil—p. 787 *Engineering News*—June 29, 1911.
- VAUGHN, Z. N.—Reinforced Concrete vs. Vitrified Clay Pipe for the Roswell Park Pipe Line—p. 379 *Engineering News*—Sept. 28, 1911.
- Cement Lining for Steel Pipes on the Catskill Aqueduct, New York City Water Supply—p. 526 *Engineering News*—Nov. 2, 1911.
- MORITZ, E. A.—Description of the Prosser Division of the Sunnyside Unit, Yakima Project, U. S. Reclamation Service (Spec. and Constr., Cost)—p. 569 *Engineering News*—March 28, 1912.
- HANNA, F. W.—A Large Concrete Pressure Pipe—p. 248 *Engineering News*—Aug. 8, 1912.
- MILLS, E. C.—Concrete Pipe and Overflow Basins for Distributing Water Pipe—p. 652 *Engineering Record*—June 14, 1913.
- MÜLLER, R.—Spacing of Piers for Reinforced Concrete Pipe—p. 71 *Engineering News*—July 18, 1914

INDEX

- Absorption loss in canals, 96
- Air valves, 265
 - vents, 265
- Albelda reinforced concrete siphon, Spain, 333
- Alignment of canals, see Surveys
- Alkali, action on steel pipes, 251, 268
 - coating against, 272
- Anchorage for steel pipe lines, 257
 - wooden stave pipe lines, 295
- Anderson reinforced concrete siphon, 349
- Aquatic plants, growth in canals, 61, 102
- Asphalt canal linings, 141

- Backfill on pipes, stresses due to, 241
- Balanced cut and fill canal sections, computations for in level ground, 128
 - field method, for canal in side hill, 131
- Banks of canals, top width, 127
- Bear River Canal Co., steel flume, 214
 - wooden flume details, 206
- Belle Fourche project, reinforced concrete siphons, 330
 - tunnel, 182
 - cost of, 184
 - forms for, 183
- Bench flumes, 173
 - reinforced concrete, 189
 - Big Fork plant, 195
 - expansion and contraction joints, 191, 195
 - Kamloops Fruitlands Irrigation Co., 190
 - Naches Power Co., 194
 - Yakima Valley Canal Co., 191
 - cost of, 193
 - wooden, 188
- Bench-marks in canal location, 25, 27
 - in topographic surveys, 34
- Berms for canal cross sections, 125
- Big Fork plant, Montana, reinforced concrete bench flume, 195
- Blow-off valves for pipe lines, 348
 - Anderson siphon, 349
 - Simms Creek siphon, 349
- Boise project, Idaho, cost of steel flumes, 221
 - expansion joint for steel flumes, 217
 - inlet structure to pipe chute, 344
- Bottom width of canals, ratio to depth, 112, 119, 122
- Breaks, safety against in canal design, 116

- Canal cross sections, design of, 112
 - balanced cut and fill, 128
 - field method for, 131
 - berms and spoil banks, 125
 - change of cross sections, see Transition
 - depth of cut in level ground, 127
 - in side hill, 129
 - effect of form of construction, 121
 - location and purpose, 116
 - proportion of bed width to depth, 112, 119, 122
 - safety against breaks, 116
 - seepage, 107
 - side hill slopes, 117
 - silt problems, 79, 112, 121
 - unit cost of excavation, 121
 - empirical rules, 122
 - freeboard, 126
 - proportion of bed width to depth, 112, 119, 122
 - rates of conveyance loss for, 106

- Canal cross section with minimum seepage loss, 115
 most advantageous hydraulic elements, 113
 side slopes, 123
 top width of banks, 127
 erosive velocities in, 57
 flow of water in, 45; see also Flow of water
 grade lines, establishment of, 40
- Canal linings, asphalt, 141
 cement mortar, 139, 142, 144
 clay puddle, 140, 142, 144, 147
 comparative cost of, 145
 concrete, 139, 142, 144
 construction joints, 153
 contraction and expansion, 152, 154
 cost of, 146, 162
 drainage and effect of frost, 161
 durability of, 147
 economy of, 164
 form of cross section, 149
 methods of construction, 156
 special forms of, 166
 partial linings, 166
 reinforced concrete, 168
 semicircular, 167
 strength of, 147
 thickness of, 149
 cost of different types, 145
 efficiency of different types, 142
 masonry, 139
 oil, 140, 142, 144, 147
 sheet steel, 141
 strength and durability, 147
 types of, 139
 wooden, 141
 location, see Surveys
 seepage loss, see Seepage
 velocities, see Velocities
- Capacity of system, study of in preliminary investigations, 15
- Cement mortar canal lining, 139, 142, 144
- Chezy's formula, 47, 62
- Chezy-Kutter's formula, accuracy of, 55
 diagram for solution of, 55
- Clay Creek reinforced concrete siphon, 333
- Clay puddle canal lining, 140, 142, 144, 147
- Climatic conditions and crops, 8
- Coefficient of discharge, for gate openings, 72, 73
 for large tubes, 74
 for short pipes, 72
 for standard orifices, 70
- Coefficient of roughness "n" in Kutter's formula, 47
- canals, concrete lined, 50
 in earth, 48
 in rock, 49
 with retaining walls, 51
 effect of curvature on, 54
- flumes, concrete, 50
 sheet steel, 52
 wooden, 51
- pipes, cast-iron, 54
 concrete, 53
 steel, 54
 wooden stave, 53
- Concrete flumes, see Flumes
 pipes, see Pipes
- Concrete-lined canals, see Canal linings
- Concrete retaining walls for canal sections, 186
 Modesto canal, 186
 Turlock canal, 186
- Contour intervals for topographic maps, 36
- Contraction, see Expansion
- Conveyance losses in canals, 96
 extent of, 103
 for entire system, 104
 in cubic feet per square foot, 104
 in per cent. of flow per mile, 109
 methods of expressing, 103
 nature of, 96

- Conveyance rates for the design of canals, 106
 see also Seepage losses
- Coolgardie pipe line, 245
- Crane Creek Irrigation Co., flume inlet, 234
- Crops as affecting feasibility of project, character of, 7
 cost of marketing, 8
 producing, 8
 demand for, 8
 value of, 8
- Cross sections of canals, see Canals of tunnels, 180
- Curvature, in canals, 38
 effect on coefficient of roughness, 54
 in wood stave pipe lines, 279
- Deacon and Lechallas on transportation of sediment, 59
- Depth of canals, ratio of, to bottom width, 112, 119, 122
 of cut in canals, 127
 of water, effect on seepage, 99
- Development, method as affecting feasibility of project, 9
 period of an irrigation project, 10
- Distribution system, 3
 cost of, 17
 location of, 32
- Diversion canal, alignment and location, 22
 character of, 2
 effect on cost of project, 4
- Diversion works, 3
 silt problems at, 79
- Domestic water supply, 16
- Drainage system, 3, 4
 as affecting feasibility of project, 7
- Economic consideration in preliminary investigations, cost of project, 17
 method of colonization and settlement, 9
- Economic pipe line location and design, 338
- Economy of concrete linings, 164
- Efficiency of canal linings, 142
- Erosion of canals, 56
- Erosive velocities, 57
- Estimates of cost of irrigation systems, 17
- Evaporation loss in canals, 110
- Expansion and contraction, in concrete pipe lines, 318
 in concrete linings, 152
 in reinforced concrete pipe lines, 350
 in steel pipes, 242
 joints, for concrete linings, 154
 reinforced concrete flumes, 191, 195
 steel flumes, 217
 pipes, 253
 Pacific Gas and Electric, 254
- Faleva flume, Spain, 228
- Feasibility of an irrigation project, 5
- Field location, of canals, 31
 of distribution system, 38
 cost of, 38
- Financial development of an irrigation project, 9
- Flow of water in canals, 45
 Chezy-Kutter's formula, 47
 coefficient of roughness, 48
 diagram for solution of, 55
 form of cross section for maximum hydraulic radius, 113
 silt transportation theory of Kennedy, 60, 88
 in flumes, 50, 51
 in pipes, 62
 Chezy-Kutter's formula, 47
 coefficient of roughness, 53
 Chezy's formula, 53, 62
 computations for inverted siphons, 68
 exponential formulas, 63
 losses of head, 66

- Flow of water in pipes, Moritz
 formulas, 64
 diagram, 65
 Weisbach formula, 62
 in transitions, 135
 through gate openings, 72
 large tubes, 74
 short tubes, 71
 standard orifices, 70
- Flumes, 178, 198
 inlet and outlet structures,
 forms of, 230
 Alberta Land Co., 232
 Crane Creek Irrigation Co.,
 234
 design of, 230
 North Platte project, 229, 237
 Sunnyside project, 235
 Twin Falls Salmon River
 project, 236
 reinforced concrete, 223
 coefficient of roughness, 50
 expansion and contraction
 joints, 191, 195
 Faleva, Spain, 228
 Hamiz, Algeria, 227
 Kamloops Fruitlands Irriga-
 tion Co., 190, 225
 Naches Power Co., 194, 226
 North Platte project, 228
 Yakima Valley Canal Co.,
 191, 225
 sheet steel semicircular, 215
 coefficient of roughness, 52, 216
 cost of, 219, 221, 222
 durability and economy, 220
 expansion and contraction, 217
 Medina Irrigation Co., 218
 substructure for, 217
 Twin Falls Salmon River pro-
 ject, 219
 steel, rectangular, 214
 types of, 198
 wooden, rectangular, 198
 coefficient of roughness, 51
 cost of, 210
 design and economic pro-
 portioning, 208
- Flumes, wooden, details of framing,
 204
 framework of flume box, 201
 Kern River Power Co., 203
 Klamath project, 211
 life of, 211
 lining of, 199
 North Poudre Canal, 204
 South Alberta Land Co., 203
 substructure for, 206
 trestle for, 207
 Turlock Irrigation District,
 202
 U. S. Reclamation Service, 205
 wooden, stave, types of, 213
 Provo Power Co., 212
 Puntledge River Power Canal,
 213
 Santa Ana Canal, 212
- Freeboard in canals, 126
- Gate openings, flow through, 72
- General feasibility of an irrigation
 project, 5
 features of an irrigation project,
 1, 16
 investigations of an irrigation
 project, 5
- Gilbert, G. K., on transportation of
 sediment, 59
- Grade lines for canals, establishment
 of, 40
- Gunnison tunnel, 174
- Hamiz, Algeria, reinforced concrete
 flume, 227
- Haul of earthwork, 29
- Huntley project, tunnel, 184
 cost of, 185
- Hydraulic formulas, 45; see also
 Flow of water
- Impermeability, see Watertightness
- Inlet structure for flumes, 230
 for siphons, 341, 343
- Investigations, preliminary, for an
 irrigation project, 5
- Irrigation project, development
 period, 10

- Irrigation project**, elements of, 3
 financial policy, 9
 preliminary investigations, 5
 system, character of, 4
 cost of, earthwork and structures, 17
 per acre, 5, 17
 general features, 1
 items of cost, 17
 planning and location, 22
 pumping, 1
- Joints for canal concrete linings**, 152, 153
 concrete pipes, 306, 317
 reinforced concrete flumes, 191, 195
 reinforced concrete pipes, 317, 335
 steel flumes, 217
 pipes, 244
 wooden pipes, 291
 see also Expansion and contraction
- Kamloops Fruitlands Irrigation Co.**,
 concrete canal linings, 156
 reinforced concrete flume, 190, 225
 siphon, inlet structure, 345
- Kelowna Irrigation Co.**, cost of steel flumes, 222
- Kennedy on silt transportation**, 60, 88
- Kern River Power Co.**, wooden flume, 203
- Klamath project**, wooden flume, cost of, 211
- Kutter's formula**, 47
 accuracy of, 55
 diagram for solution of, 55
 see also Flow of water
- Land as affecting feasibility of project**, 5
 character of soil and subsoil, 6
 configuration of, 6
 drainage of, 7
 extent of, 5
- Land**, method of development, 8
 ownership of, 8
- Lap welded steel pipes**, 244
- Laramie Poudre tunnel**, 175
- Laterals of system**, 2
 construction of, 124
 form of cross sections, 117; see also Canal cross sections
 location of, 38
- Lining of canals**, see Canal linings
 of tunnels, see Tunnels
- Location of an irrigation system**, 22
- Lock bar steel pipes**, 245
- Los Angeles aqueduct**, riveted steel pipe lines, 247
 Antelope siphon, 250
 Jawbone siphon, 249, 256, 339
 San Fernando siphon, 250, 256
- Losses of head in flow of water in pipes**, 66
- Medina Irrigation Co.**, steel flume, 218
- Modesto for concrete retaining wall canal section**, 186
- Moritz diagram for flow in wood stave pipes**, 65
 formulas of flow in pipes, 64
- Naches Power Co.**, canal concrete lining, 154
 reinforced concrete flume, 194, 226
- North Platte project**, reinforced concrete flume, 228
 inlet structure to, 229
- North Poudre Canal**, flume, 204
- Oil canal linings**, 140, 142, 144, 147
- Orifices**, flow through, 70
- Pacific Gas and Electric Co.**, anchorage for steel pipe line, 261
 expansion joint for steel pipe line, 255
 riveted joints for steel pipe line, 247

- Paper location, of distribution system, 37
of diversion canal, 28, 30
scale of map, 28
- Percolation loss in canals, 96; see also Seepage loss
- Piers for pipe lines, see Supports
- Pipe line, economic location and design, 338
flow in, 62
hydraulic computations, 68
see also Pipes and Siphons
- Pipes, 239-350
cement mortar and plain concrete, 301
air stands, 350
coefficient of roughness, 53
construction of, 306
cost of, 306, 308
description of, 301
expansion and contraction, 318
flow in, 64
laying of pipe line, 306
machine tamped, 309
manufacture of, 303
properties of, 302
safe pressures, 303
wet process pipe, 310
- ingot iron, 251
effect of alkali on, 251
- reinforced concrete, built in place, 329
Albelda siphon, Spain, 333
Belle Fourche project siphons, 330, 344
blow-offs, 348
Clay Creek siphon, 333
description of and use, 310
piers and supports, 337
reinforcement for, 311
safe pressures, 311
Simms Creek siphon, 337, 349
Sosa siphon, Spain, 334
watertightness, 337
- reinforced concrete, cast or moulded in sections, 312
Aqueduct of Achères, France, 326
- Pipes, reinforced concrete, Bone, Algeria, 327
coefficient of roughness, 53
concrete mixture, 312
construction method on Roswell project, 316
Tieton project, 314
Umatilla project, 312
contraction joints, 322
cost of making and laying, Umatilla project, 328
Southern California, 329
Tieton project, 329
description of and use, 310
distributary pipes for agricultural park of Achères, 327
expansion and contraction, 318
causes and extent, 319
effect of method of construction, 320
theoretical consideration, 320
joining pipe sections, 317
" M " line siphon, Umatilla project, 325
reinforcement for, 311
safe pressure heads, 311, 328
Venice, Italy, 327
watertightness, 324, 326, 327, 337
wire winding, Roswell project, 316
- steel and wrought iron, 240
air valves, 265
air vents, design of, 265
anchors for, 257
at convex bends, 257
at horizontal bends, 259
examples of, 261
to prevent buckling, 260
to prevent downhill sliding, 260
- Antelope siphon, 250
backfill stresses, 241
coating pipe, 270
for alkali, 272
coefficient of roughness, 54

- Pipes, steel and wrought iron, corrosion and durability, 266
 alkali action, 268
 Coolgardie pipe line, 268
 external, 268
 internal, 269
 Rochester pipe line, 267
 cost of small pipes, 273
 covering with earth, 252
 design of, 240
 distortion of, 252
 expansion joints, 254
 flow of water in, 63
 Jawbone siphon, 249
 joints, lap welded, 244
 lock bar, 245
 riveted, 244
 spiral riveted, 244
 Los Angeles Aqueduct pipe lines, 247
 riveted joints, design of, 246
 details of, 247
 San Fernando siphon, 250
 stresses, 240
 supports for, 256
 temperature stresses, 243
 ultimate useful life, 270
 Uncompahgre project pipe line, 252
 water hammer, 241
 wrought iron, 240
 wooden stave continuous, 274
 adaptability, 278
 advantages of, 278
 anchors for, 295
 band and shoes, 280
 blow-off valve, 291, 299
 coating of staves and bands, 289
 coefficient of roughness, 53
 connections and fixtures, 291
 construction of pipe lines, 290
 cost of, 297
 covered vs. exposed, 289
 curvature and bends, 279
 description of, 274
 design of staves and bands, 281
 durability of, 285
- Pipes, wooden stave continuous,
 flow of water in, 63, 65
 life of, 288
 overhead stream crossing vs. undercrossing, 294
 painting staves and bands, 289
 pressures for, 278
 specifications, 297
 stave, 279, 297
 test of pipe line, 301
 use of, 278
 wooden stave, machine banded, 277
 adaptability, 278
 coating of staves and bands, 289, 299
 connections and fixtures, 291
 construction of pipe lines, 291, 299
 cost of, 296
 covered vs. exposed, 289
 description of, 277
 durability of, 285
 joints, 277
 life of, 285
 pressures for, 278
 use of, 278
- Preliminary investigations for an irrigation project, 5
 cost of system, 16
 crops, 5
 general features and character of system, 16
 land, 5
 miscellaneous considerations, 19
 water supply, 11
- Preliminary survey for diversion line, 25
 cost of, 41
- Profiles of canal lines, 28, 30, 40
- Provo Power Co., wooden stave flume, 212
- Pumping projects, 1
- Puntledge River Power Canal, wooden stave flume, 213
- Rainfall data, study of in preliminary investigations, 11

- Reconnaissance survey for diversion line, 22
- Reinforced concrete flumes, see Flumes
- pipes, see Pipes
- Retaining wall canal cross sections, 186
- coefficient of roughness, 51
- Modesto Irrigation District, 186
- Turlock Irrigation District, 186
- Right-of-way for canals, 17, 42
- Riveted joints for steel pipes, 245
- design of, 246
- tables for, 248
- Sand box at siphon inlet, 342, 345
- in silt problems, 79
- Santa Ana Canal, wooden stave flume, 212
- Scale of maps, for canal location, 28
- for topographic surveys, 36
- Sediment, see Silt
- Seepage losses in canals, 96
- cross section for minimum loss, 115
- extent of, 103
- factors influencing, 97
- effect of, age of canal, 99
- depth of water, 99
- position of water table, 98
- soil texture, 98
- temperature of water, 98
- vegetation, 102
- velocity of water, 100
- for entire system, 104
- form of cross section for minimum loss, 115
- formula for loss in cubic feet per second per mile, 107
- in cubic feet per square foot of wetted perimeter, 104
- in per cent. of flow per mile, 109
- method of expressing, 103
- prevention of, see Canal linings
- rates of for the design of canals, 106, 108
- Short tubes, flow through, 71
- Side hill canals, depth of cut for, 26, 129
- Side hill canals, form of cross section, 117
- Side slopes for canals, 123
- Silt, amount of in irrigation waters, 80
- carrying capacity of canal waters, 88
- content of river waters, 83
- of arid region, U. S., 85
- of India, 87
- critical velocities for transportation of, 90
- deposits in canals, 91
- prevention of, 92
- deposits in reservoirs, 84
- distribution of, in water, 86
- methods of determination of amount, 80
- problems in design of systems, 80
- specific gravity of, 81
- transportation, theory of, 58, 89
- velocities for, 58, 60, 90
- Simms Creek reinforced concrete siphon, 337
- Siphons, inverted, 340
- air stands, 350
- air valves, 350
- Albelda reinforced concrete siphon, Spain, 333
- anchorage, 257, 350
- Antelope steel siphon, 250
- Belle Fourche project, reinforced concrete siphons, 330, 349
- blow-offs, 348
- Clay Creek reinforced concrete siphon, 333
- expansion joints, 350
- flow in, 68
- general considerations, 340
- hydraulic computations, 68
- inlet and outlet structures, 341, 343
- Anderson siphon, 344
- Boise project, 344
- Clay Creek, 333
- Kamloops Fruitlands Irrigation Co., 345
- "M" line, 325
- Wolf Creek, 343

- Siphons, Jawbone steel siphon, 249
 "M" line reinforced concrete siphon, Umatilla project, 312, 325
 cost of, 326
 Mabton, 340
 Prosser, 340
 Sand box and wasteway, 342
 San Fernando steel siphon, 250
 Simms Creek reinforced concrete siphon, 337, 349
 Sosa reinforced concrete siphon, Spain, 334
- Soil and subsoil as affecting feasibility of project, 6
- Sosa reinforced concrete siphon, Spain, 334
- Southern Alberta Land Co., wooden flume, 203, 232
- Stave flumes, see Flumes
 pipes, see Pipes
- Steel flumes, see Flumes
 pipes, see Pipes
- Storage, study of in preliminary investigations, 15
- Strawberry Valley tunnel, 175
- Stream flow, study of in preliminary investigations, 12
- Structures, classification of, 3
- Supports for, pipe lines above ground, 337
 reinforced concrete pipes, 337
 steel pipes, 256
 wood pipes, 292
- Surveys, accuracy of, 37
 distribution system, paper and field location, 37
 cost of, 38
 topographic survey, 32
 cost of, 42
 diversion line, paper and field location, 30
 pivotal point method, 27, 131
 preliminary survey, 25
 cost of, 41
 profile of canal line, 40
 reconnaissance survey, 22
 cost of, 41
- Surveys, diversion line, trial line surveys, 22
- Temperature, effects on concrete pipe lines, 318
 stresses in steel pipes, 241, 242
- Test pits in canal location, 30
- Tieton project, canal concrete linings, 169
 reinforced concrete pipe, 314
 tunnels, 179
- Topographic maps for location of distribution system, 36
 survey for location of distribution system, 32
 cost of, 42
 plane table vs. transit, 36, 42
- Topography as affecting feasibility of project, 6
- Transition, for change of canal cross sections, 134
 flow of water in, 135
 for flume inlets, 230
- Transportation of silt or sediment, 58, 86
 velocities for, 57, 89
- Trial line surveys for diversion canal, 22
- Truckee Carson project, tunnels, 181
- Tubes, flow through large, 74
 through short, 71
- Tunnels, 173
 Belle Fourche project, 182
 forms for, 183
 cross section of, 180
 Gunnison, 174
 Huntley project, 184
 Laramie Poudre, 175
 lining of, 179
 size and form of, 177
 Strawberry Valley project, 175
 Tieton project, 179
 Truckee Carson project, 181
 velocity in, 177
- Turlock, concrete retaining wall for canal cross section, 186
 wooden flume, 202

- Twin Falls Salmon River project
steel flume, 219, 236
- Umatilla project, canal concrete lining, 167
reinforced concrete pipe, method of casting, 312
cost of, 328
"M" line siphon, 325
tests of watertightness, 324, 326
- Underground water supply for domestic use, 16
- U. S. Reclamation Service, specification for wood stave pipe, 297
standard wooden flume, 205
inlet and outlet to, 233
- Vegetation, in canals, effect on seepage loss, 102
effect of velocities on, 61
native, as in indication of character of soil, 7
- Velocities in canals, desirable maximum and minimum, 55
for transportation of silt and sediment, 57, 89
required to prevent aquatic plant growth, 61
- Velocities safe maximum, values of 57
- Water hammer, 241
- Water supply for an irrigation project, 11
appropriations and earlier water rights, 14
domestic water, 16
quality of water, 13
rainfall data study, 11
required supply, 14
stream flow study, 12
supplementing deficiency, 15
underground sources, 16
- Watertightness of canal linings, 142
of reinforced concrete pipe, 324, 327, 337
- Weisbach's formula for flow in pipes, 62
- Wooden flumes, see Flumes
stave pipes, see Pipes
- Yakima Valley Canal Co., canal concrete lining, 168
flumes, 191, 225

