

Birla Central Library

PILANI (Jaipur State)

(Engg College Branch)

Class No :- 666.9

Book No :- B654C

Accession No :- 31543

The Chemistry of
PORTLAND CEMENT

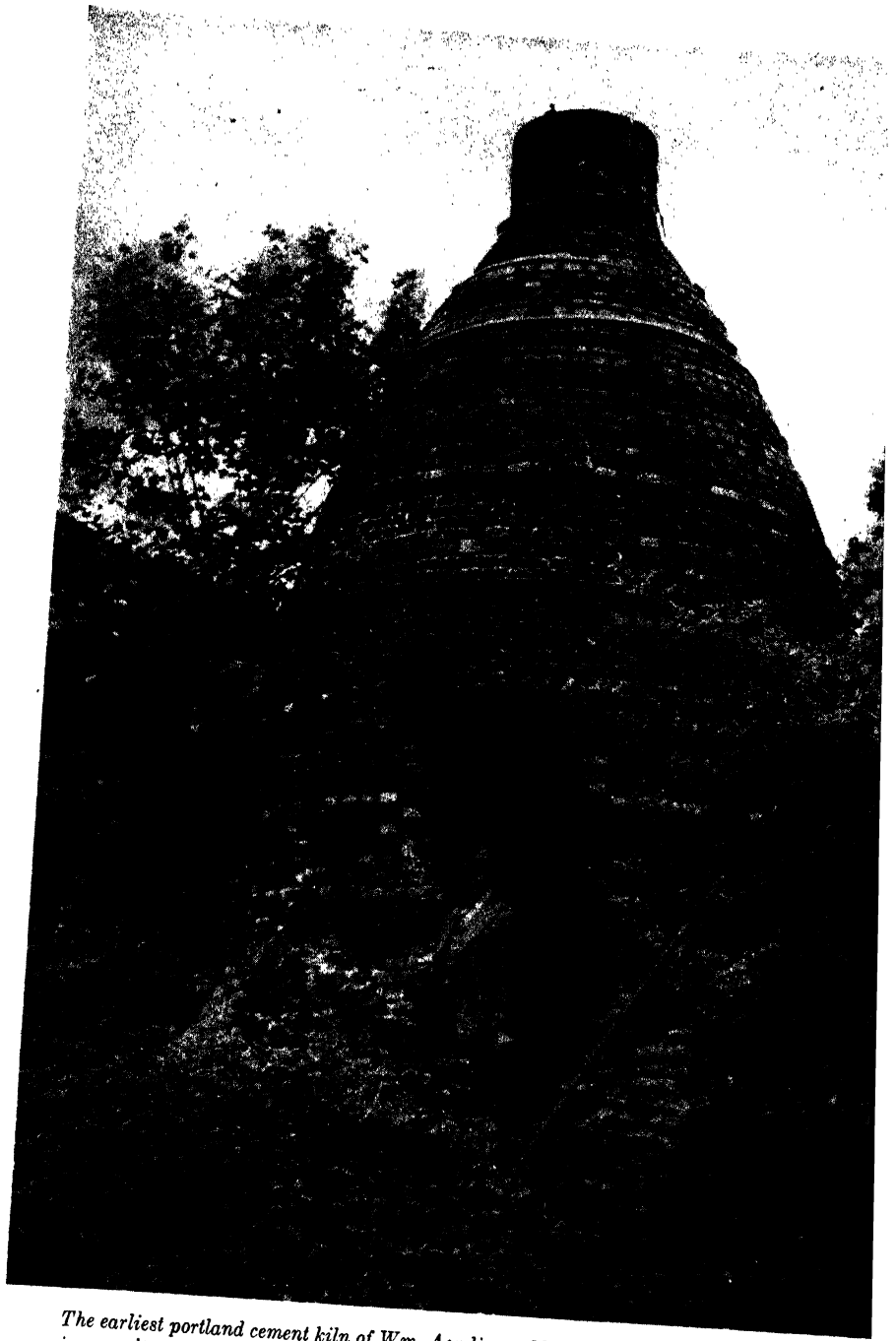

The earliest portland cement kiln of Wm. Aspdin, at Northfleet, Kent, England. Probably in operation in 1848. (Photograph by M. A. Swayze, 1938)

The Chemistry of
PORTLAND CEMENT

by

ROBERT HERMAN BOGUE

Research Director

Portland Cement Association Fellowship

National Bureau of Standards

Washington, D.C.

REINHOLD PUBLISHING CORPORATION

330 WEST FORTY-SECOND ST., NEW YORK

1947

Copyright 1947 by
REINHOLD PUBLISHING CORPORATION

All rights reserved

2

Printed in U. S. A. by
The Maple Press Company, York, Pa.

To my colleagues who, in nineteen thirty-eight
on the occasion of the Stockholm Symposium
on The Chemistry of Cements, dedicated

COMMITTEE ISLAND

in the interest of a better understanding
and continued cooperation
among the scientists of the world.

LENNART FORSEN, *of Finland*

THORBERGUR THORVALDSON, *of Canada*

FRED LEA, *of England*

STIG GIERTZ-HEDSTROM, *of Sweden*

MYRON SWAYZE, *of The United States of America*

Contents

Part I. The Chemistry of Clinker Formation

CHAPTER	PAGE
1. HISTORY OF THE CEMENT INDUSTRY	3
Cements in antiquity	3
The invention of portland cement	5
The development of the cement industry	11
2. CLASSIFICATION OF CEMENTS	20
3. THE MANUFACTURE OF PORTLAND CEMENT	27
Outline of operations	27
Source of raw materials	28
Proportioning of raw materials	29
Preparation of kiln feed	31
Flotation	35
The burning operation	38
Treatment of clinker	40
Testing of cement	42
Other aspects of manufacture	42
4. EARLY EXPERIMENTATION ON THE CONSTITUTION OF PORTLAND CEMENT	44
The period of speculation	44
Introduction of the scientific method	45
Microscopic studies	47
Other theories of the period	50
Hypotheses of solid solution	52
Constitutional formulas of cement compounds	57
5. METHODS OF INVESTIGATION	62
Petrographic technique	62
X-ray diffraction	68
Electron microscopy and diffraction	70
Chemical methods	71
Free CaO	71
Ca(OH) ₂ in set cement	73
Free CaO and Ca(OH) ₂ in cement	74
Determination of uncombined magnesia	75
Spectrographic analysis	77
Polarographic analysis	78
Heat of solution	79
Procedure	79
Estimation of glass content	80

CHAPTER	PAGE
6. HEAT TREATMENT IN MANUFACTURE	87
The burning process	87
Volatilization of alkalis	91
Thermal reactions of clinker formation	94
The cooling process	103
7. THE PRINCIPAL CONSTITUENTS OF CLINKER	108
Microscopic structure	108
Tricalcium silicate	111
Stability of C_3S	111
Final solution of the Alite problem	111
Dicalcium silicate	117
The α - β inversion	117
α - C_2S solid solution	118
The β - γ inversion	125
Free CaO and MgO	126
Interstitial material	128
Rectangular dark interstitial material	129
Prismatic dark interstitial material	129
Amorphous dark interstitial material	136
Light interstitial material	136
Crystal structure	140
8. THE COMBINATION OF THE CEMENT COMPONENTS	148
Reactions in the solid state	148
Effects of particle size	149
Effects of composition	152
Temperature of liquid formation	152
The amount of liquid formed	158
The addition of mineralizers	160
Effect of compound saturation	161
9. DESIGN AND CONTROL OF CEMENT COMPOSITION	168
Development of proportioning formulas	168
The principle of chemical control	176
Comparison of clinker compositions obtained by different methods	179
10. CALCULATION OF PHASE COMPOSITION	184
Equilibrium crystallization	184
Equilibrium mixture containing liquid	187
Classification of systems	188
Non-equilibrium cooling	192
Classification of crystallization areas	192
Independent crystallization of liquid	194
General equations	200
 Part II. The Phase Equilibria of Clinker Components 	
11. THE PRINCIPLES OF HIGH-TEMPERATURE PHASE RESEARCH	207
The phase rule	207
Binary systems	210

CONTENTS

ix

CHAPTER	PAGE
Polycomponent systems	215
No compound formation	215
Course of crystallization	216
Dahl's method for computing composition	217
Compound formation stable at melting point	219
Compound formation unstable at melting point	220
Stages followed with heat input	222
Crystallization in ternary systems containing solid solutions	224
12. THE TECHNIQUE OF HIGH-TEMPERATURE PHASE RESEARCH	228
General procedure	228
Furnace equipment	232
Temperature control	236
Calibration of thermocouples	236
Platinum strip furnace	236
Iridium furnace	238
Iridium button furnace	238
Resistance furnace	238
13. THE SYSTEM $\text{CaO-Al}_2\text{O}_3\text{-SiO}_2$	240
The oxides	240
The system CaO-SiO_2	242
Phase relations	242
Optical properties of the calcium silicates	245
Preparation of the calcium silicates	247
The system $\text{CaO-Al}_2\text{O}_3$	249
Phase relations	249
Composition of the "5-3" calcium aluminat	251
Optical properties of the calcium aluminat	251
Preparation of the calcium aluminat	252
The system $\text{Al}_2\text{O}_3\text{-SiO}_2$	253
The System $\text{CaO-Al}_2\text{O}_3\text{-SiO}_2$	253
Stability fields	253
Crystallization areas	257
Course of crystallization	258
The field of portland cement	262
14. SYSTEMS CONTAINING MgO WITH CaO, Al_2O_3 AND SiO_2	265
15. SYSTEMS CONTAINING FeO AND TiO_2	273
The ferrous oxide systems	273
The titania systems	278
16. SYSTEMS CONTAINING Fe_2O_3 WITH CaO AND SiO_2	282
17. SYSTEMS CONTAINING MgO AND Fe_2O_3 WITH CaO AND Al_2O_3	287
18. SYSTEMS CONTAINING MgO AND Fe_2O_3 WITH CaO, Al_2O_3 AND SiO_2	300
Crystallization in polycomponent systems	315
19. SYSTEMS CONTAINING K_2O	318
20. SYSTEMS CONTAINING Na_2O AND Li_2O	334

Part III. The Chemistry of Cement Utilization

CHAPTER	PAGE
21. EARLY STUDIES ON CEMENT HYDRATION	351
The crystallization theory	352
The colloid hypothesis	358
Discussion on the crystallization and colloid theories	359
The chemical nature of the setting and hardening processes	367
The chemical significance of rate of set	371
22. THE SYSTEM $\text{CaO-SiO}_2\text{-H}_2\text{O}$	378
The principles of hydrolysis and hydration	378
Hydrolytic reactions of the calcium silicates	380
Complete hydrolysis	381
Hydrolytic equilibrium	382
Interaction with excess water	383
Ionization constants	385
Interaction at higher concentrations	388
Chemical reaction, adsorption, and solid solution	391
Hydration in steam	393
23. THE SYSTEMS CONTAINING CaO AND H_2O WITH Al_2O_3 AND Fe_2O_3	399
Hydrolytic equilibria	399
The iron compounds	400
Action of water on the calcium aluminates	401
Action of $\text{Ca}(\text{OH})_2$ solution on the calcium aluminates	404
The C_3A hydrates	406
The C_2A and C_4A hydrates	408
Equilibrium in the system $\text{CaO-Al}_2\text{O}_3\text{-H}_2\text{O}$	410
Hydration of alumina and iron oxide compounds in steam	413
24. THE CALCIUM ALUMINATE AND FERRITE COMPLEX SALTS	417
Early history	417
The calcium sulfoaluminates	419
The calcium chloraluminates	423
The calcium sulfoferrites	424
The hydrogarnet solid-solution series	425
The sulfoaluminate solid-solution series	426
The system $\text{CaO-Al}_2\text{O}_3\text{-CaSO}_4\text{-H}_2\text{O}$	427
The sulfoaluminate-alkali systems	431
25. THE HEAT OF HYDRATION	434
Heats of complete hydration	434
Effects of composition	436
Effects of glass content	441
Correlation with strength	442
Comparison of methods	442
26. THE STRUCTURE OF HYDRATED CEMENTS	446
Microscopic structure of the hydrated compounds	446
Tricalcium silicate	447
Dicalcium silicate	448
Tricalcium aluminate	448

CONTENTS

xi

CHAPTER	PAGE
Tetracalcium aluminoferrite	450
$K_2O.23CaO.12SiO_2$	451
Mixed compounds and commercial cements	452
Effect of gypsum	452
Effect of saturated $Ca(OH)_2$ solution	452
Effect of alkali compounds	454
Microscopic structure of cement pastes	454
Electron micrographs of cement compounds	461
Physical characteristics of hydrated pastes	467
Gel structure	467
Adsorption studies	468
27. THE SETTING OF CEMENT PASTES	472
Theories of the setting process	472
Selective hydration	472
Crystallization of hydration products	473
Film formation	477
Mutual coagulation	479
False set	480
The control of set	481
The effect of gypsum	481
The effects of other materials	484
Phase equilibria in the presence of $CaSO_4$	486
28. THE HARDENING OF CEMENT PASTES	489
Hydrolysis and hydration of cement pastes	489
Hydration measured by depth of hydrated layer	493
The soundness of pastes	494
The effects of composition	498
The effects of cooling rate	502
The effects of steam treatment on strength	504
29. EXTERNAL REACTIONS OF HYDRATED PASTES	508
Reactions with sulfate solutions	508
The nature of sulfate corrosion	509
The effect of steam curing	510
The specific effects of the cement compounds	511
The alkali-aggregate reaction	515
The action of pozzolanas	517
30. TESTS FOR CEMENT QUALITY	522
Methods for predicting sulfate resistance	522
Visual observation	522
Strength change	523
Length change	525
Elastic modulus	529
Methods of calculation	531
Methods based on chemical action	531
Formation of calcium sulfoaluminate	531
A sulfate susceptibility test	532

CHAPTER	PAGE
The water test for durability	534
The disintegration index	535
The sugar-solubility test	536
<i>Appendix 1. X-ray Diffraction Patterns of Clinker Components and Compounds</i>	541
<i>Appendix 2. X-ray Diffraction Patterns of Cement Hydration Products</i>	544
<i>Appendix 3. Equations for Calculating the Phase Composition of Clinker</i>	548
AUTHOR INDEX	561
SUBJECT INDEX	567

Preface

The manufacture and utilization of portland cement involve several distinct fields of art and science. If the whole subject were to be treated comprehensively, a series of treatises would be required. One of these might cover the technology of cement manufacture, another the design and fabrication of concrete, another the design and building of concrete and reinforced concrete structures, and still another the nature of the chemical processes by which rock is made into cement, and cement is turned back to the synthetic rock we call concrete.

An adequate treatment of any one of these themes, however, cannot ignore their inter-relationship as the component parts of a finished product. Nor can a specialist or an operative in any of these fields be wholly proficient unless he embraces in his thinking the large-scale perspective derived from an intelligent apprehension of each of the other fields. The work is written, therefore, primarily for the cement chemist, and from the point of view of the research chemist concerned with the chemical problems of the industry, but with the thought constantly in mind that the treatment should be such that the executive, the engineer or the lay reader should be able to profit by its study.

An overlapping of subject matter is inescapable if a comprehensive picture is to be drawn. My theme is the chemistry of portland cement, but other aspects are touched upon. On the belief that the present can be appreciated only with knowledge of the past, I have dwelt at some length upon the history and development of the ideas which constitute the background for the conceptions which we call the modern viewpoint. I have outlined the processes of cement manufacture, but only in brief, dwelling especially upon the operations which are chemical in nature. I have touched upon the physics of cement pastes and the design of concrete only incidentally, as affected by the chemical processes taking place. I have avoided the discussion of concrete, except as its ingredients—cement paste, aggregate, water or admixture—may become involved in chemical reactions affecting the durability or quality of the structure. In order to avoid unduly increasing the size of the book, I have limited my treatment rigidly to cements of the portland class, and have refrained from including the routine chemical or physical methods of test, since these are readily available from other sources.

The subject matter naturally divides itself into the two classifications: the chemistry of clinker formation, and the chemistry of cement utilization. The former is concerned chiefly with high-temperature reactions in the dry state; the latter with reactions between cement and water or solutions. These two fields of study compose Parts I and III, respectively. Both fields, however, are intimately concerned with the nature and stability of the phases which are formed under given conditions. So important is a knowledge of the technique and results of such an approach to the problems of cement that a separate section, Part II, is devoted exclusively to the Phase Equilibria of the cement systems.

The cement chemist has long made use of an abbreviated system of chemical notation. The use of such a system serves the twofold purpose of conserving space and aiding the readability of formulas. I have used this system interchangeably with the more conservative notation.

While no attempt has been made to provide a complete bibliography, the references given at the end of each chapter will serve as a fair guide to the literature of the subjects covered.

Where statements of opinion or interpretation of research are given, they are to be construed as representing only my personal views, and not in any way to reflect the position of the Portland Cement Association or the National Bureau of Standards.

I am under obligation to the many authors and publishers who have kindly given me permission to reproduce photomicrographs and diagrams, to members of the Industry for specific information, and to the Portland Cement Association and the National Bureau of Standards for permission to include many references to hitherto unpublished material. I take pleasure in acknowledging my indebtedness of all of the above, and especially to my associates on the staff of the Portland Cement Association Fellowship:

Fred W. Ashton
W. C. Hansen
Wm. Lerch
L. T. Brownmiller
E. A. Harrington
Wm. C. Taylor
R. C. Briant
Alvin Ardan
Ed. G. Siggers

George W. Ward
Ira C. Bechtold
H. Olaf Nickelsen
A. C. Bonanno
Kenneth T. Greene
Armin W. Helz
Cecil Pinkerton
Wm. R. Eubank
Louis A. Dahl

R. H. Bogue

National Bureau of Standards
Washington, D. C.
Jan. 15, 1947

Notation

NBS = National Bureau of Standards, Washington

PCA = Portland Cement Association of the United States of America

PCAF = Portland Cement Association Fellowship at the National Bureau of Standards, Washington

RP = Research Paper of the Journal of Research of the National Bureau of Standards, Washington

Symposium = "Proceedings of the Symposium on the Chemistry of Cements," Stockholm, 1938. Published by the Royal Swedish Institute for Engineering Research, Stockholm, 1938.

All temperatures, unless otherwise noted, are expressed in degrees centigrade.

The following symbols for the cement components are used interchangeably with the conservative notation:

C = CaO
A = Al₂O₃
S = SiO₂
F = Fe₂O₃
M = MgO
N = Na₂O
K = K₂O
L = Li₂O
T = TiO₂
H = H₂O

Thus C₂S = 2CaO.SiO₂,
C₄AF = 4CaO.Al₂O₃.Fe₂O₃,
C₃AH₆ = 3CaO.Al₂O₃.6H₂O, etc.

PART I
The Chemistry of Clinker Formation

CHAPTER 1

History of the Cement Industry

Cements in Antiquity

The tradition of the monuments of Egypt is permanence, and insofar as the works of man are concerned there are none to match the pyramids along the Nile. Viewed by Herodotus in the fifth century before our era, they were more ancient to him than he is to us. Yet even in that remote age a cement was employed as a grout between the blocks of stone. We have no means of knowing when the discovery of a cementing material was first made, but it must have been discovered soon after the first intelligent use of fire. One can imagine an aborigine making his fire in a hole built around with limestone or gypsum rocks. The heat decarbonates or dehydrates a part of the rock, which falls to a powder between the stones. A light rain in the night soaks into the powder and the pieces of rock cohere to produce the first stone masonry.

The cement employed by the early Egyptians was a calcined impure gypsum; calcined limestone was not used until the Greek and Roman periods (9). Sometimes the quicklime so formed was mixed with water and used without other additions, but more generally it was mixed with sand, gravel, crushed stone, broken tile, or brick. Probably the earliest mixtures were of sand, lime and water and were used only as mortars to bind stone and brick structures; but crushed brick and tile at an early date became popular for incorporation into the mortar—and the first concrete was born. This was used for pavements and then for walls of buildings, and soon gravel and crushed stone also were introduced.

It was noticed in due time that some sands were of greater value than others, especially for producing mortars that would be resistant to the action of water for long periods. We may presume that all kinds of aggregate were incorporated into the cement at one time or another, and it was early discovered that certain volcanic earths produced superior strength and durability in either fresh or salt waters. The Greeks employed a volcanic tuff from the island of Santorin; this material, known as Santorin earth, has to the present day found high favor among builders. The Romans used a similar material, though darker in color, found extensively around the Bay of Naples and called pozzolana because it was first obtained in the neighborhood of Pozzuoli, near Mt. Vesuvius. Vitruvius (17) refers to this material as a species of sand which, "if mixed with lime and rubble hardens as well under water as in ordinary buildings." From such mixtures were constructed the Roman Pantheon, the Coliseum, the Basilica of Constantine, the Pont du Gard near Nimes in Southern France, (see Figure 1) and other structures which have survived to our day and have resisted to a remarkable degree the destructive agents of the ages.

The extraordinary durability of these structures has led some later authors to

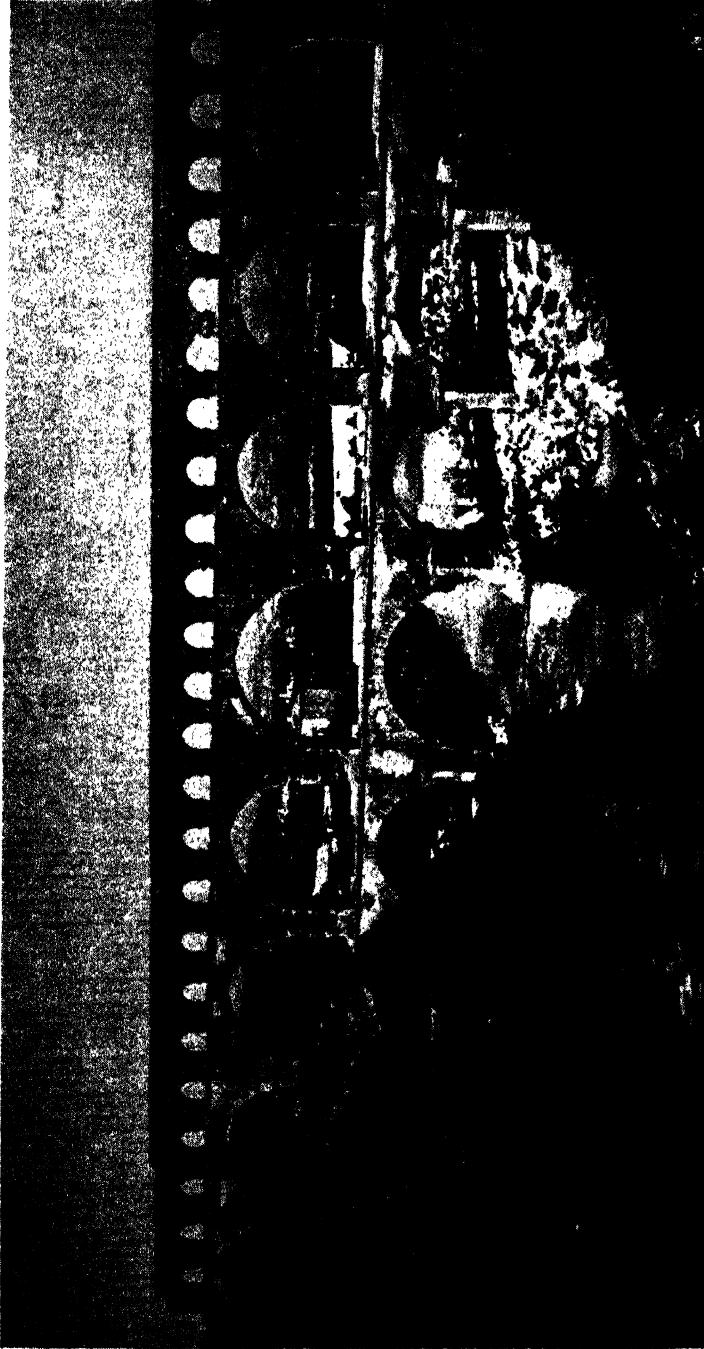

Figure 1. The *Pont du Gard*, a bridge and aqueduct near the city of Nîmes in Southern France built by the Romans in the first century of the Christian era. It is of stone masonry, bonded with cement, and the water trough in the upper tier was lined with cement which is still exceedingly hard and firm.

believe that the Romans were in possession of some secret of mixing or fabrication which has since been lost, for in the Middle Ages the quality of workmanship and its longevity were much inferior. But if we may judge the nature of the raw materials from the writings of Vitruvius (17) or Alberti (1), or from the present analysis of the products, (9) we must conclude that such was not the case. It is, however, important to observe that emphasis was placed, then as now, on the necessity of thorough consolidation. Thus Pliny (13) describes the construction of cisterns and says, "The bottom and sides should be well-beaten with iron hammers," and Rondelet (14) concluded that, "The excellence of Roman mortars depended, not on any secret in the slaking or composition of the lime, but on the thoroughness of mixing and ramming."

On the other hand, the poor quality of the mortars used during the Middle Ages appears to be due to the incomplete burning of the lime, carelessness in handling, and absence of the volcanic tuff. After the 12th to 14th centuries the quality improved and this again was noted to be accompanied by thorough burning of the lime and the use of some material similar in properties to the volcanic tuffs previously employed. The *trass* from Andernach on the Rhine near Koblenz was such a material, and in recent years blastfurnace slag and calcined shale have been used for the same purpose.

Perhaps the earliest attempted explanation of the reactions by which certain rocks become cementitious on burning is that given by Vitruvius (17) in the first century, A.D.:

Stones, as well as all other substances, are compounded of the elements; those which have most air are tender; those which have most water are, by reason of their humidity, tenacious; those which have most fire, brittle. If these stones were only pounded into minute pieces, and mixed with sand without being burnt, they would not indurate or unite; but when they are cast in the furnace, and these penetrated by the violent heat of the fire, they lose their former solidity; being calcined and deprived of their strength they are left exhausted and full of pores. The water and air, therefore, which are in the substance of the stones, being thus discharged and expelled, and the latent heat only remaining, upon being replenished with water, which repels the fire, they recover their vigor and the water entering the vacuities occasions a fermentation; the substance of the lime is thus refrigerated and the superabundant heat ejected.

The Invention of Portland Cement

The eighteenth century and the first years of the nineteenth have gone down into history as an era characterized by a wave of inquisitiveness and freedom from the scientific repressions of the earlier centuries. It was the age of Voltaire, who maintained, "My trade is to say what I think." The senses were no longer denied, as in the experiment of Galileo at the Leaning Tower of Pisa. Chemistry and physics stepped boldly to the explanation of natural phenomena. Profound discoveries were made. Priestley and Lavoisier solved the age-old riddle of combustion. Davy found that quick-lime was not an element. The laws of chemical combination were being established by Avogadro and Dalton. The electrical nature of matter was being urged by Berzelius. It was an age of breaking down of

traditions as ancient as the human race; it was an age of glowing achievement for the scientist.

It was inevitable that in this age the curiosity of many scholars was directed to the mystery of cement. Chemists, engineers, artisans and university professors each made important contributions. But at that period the means for the dissemination of scientific information were not well organized and the discoveries made in London might not be known in Holland or France. Thus it came about that many men, working independently, discovered the reason why some limes are hydraulic and others not. This discovery was announced by Smeaton in 1756, but was rediscovered at least six times between that date and 1830.

It had long been recognized that some limes, when prepared and mixed in the usual manner, produced mortars which hardened well under water, whereas other limes, similarly prepared and mixed, quickly crumbled to a powder under water and could be of no use whatsoever for structures that were exposed to water. The reason had long remained a mystery.

John Smeaton. John Smeaton was an engineer commissioned to rebuild the Eddystone Lighthouse off the coast of Cornwall, England. He was familiar with Dutch *tarras* (trass) and also with the high reputation of some of the local limestones. But he wanted to know the reason for their superiority in order to feel complete assurance that the mortar in his lighthouse would be the best that could be made, that "in spite of water almost continually driven against it with every degree of violence, it would become so firm a consistence in itself, and adhesion to the stone . . ." that it would remain permanent through the ages (15).

Obtaining limes prepared from many sources, and trass or pozzolanic material of various types, he proceeded to make tests using both fresh and salt water, and in the presence of varying amounts of burnt gypsum. His method may seem crude to us but it gave him the results he needed:

I took as much of the ingredients as altogether would ultimately form a ball of about 2 inches in diameter. This ball, lying upon a plate till it was set and would not yield to the pressure of the fingers, was then put into a flat pot filled with water so as to be covered by the water; and what happened to the ball in this state was the criterion by which I judged of the validity of the composition for our purposes.

It had formerly been generally believed that the best limes were obtained from the hardest limestones, but Smeaton found that the best limes for his purpose were obtained not from the relatively pure hard limestone but from impure soft rock. By crude methods of analysis he made the very important discovery that a hydraulic lime (one resistant to the action of water) could be obtained only from a limestone which contained a considerable proportion of clayey matter. Burned gypsum decreased rather than improved the quality, and a pozzolanic tuff from Italy was most beneficial. At the conclusion of his tests, Smeaton makes the most interesting observation:

With respect to these balls that were constantly kept under water, they did not seem inclined to undergo any change in form, only to acquire hardness .

gradually, insomuch that I did not doubt but to make a cement that would equal the best merchantable Portland stone in solidity and durability.

Davis (3) comments on this remark:

The substitution of this new hydraulic cement for, or its resemblance to, Portland stone no doubt laid the origin of the name of Portland cement, and this seems clearly due to Smeaton, but he patented neither the material nor the name.

The clear advance that Smeaton made was in the understanding that clay must be contained in, or added to, the limestone for the production of a hydraulic cement. He says:

An admixture of clay in the composition of a limestone might be the most certain index of the validity of a limestone for aquatic buildings.

Bry. Higgins. In 1780, Bry. Higgins (4), apparently unfamiliar with the work of Smeaton which was not yet published, investigated limes from the point of view of their carbon dioxide content. He writes:

I had already learned from the chaste and philosophic production of Dr. Black that calcareous stones which burn to lime contain a considerable quantity of the elastic fluid called fixable air or acidulous gas, which in combination with the earthy matter forms a great part of the mass and weight of these stones; and that the difference between limestone or chalk and lime consists chiefly in the retention or expulsion of that matter.

On this basis he explains the deterioration of lime:

Lime exposed a considerable time before it is made into mortar, and drinking in acidulous gas all the while, the quicker as it is the better burned, is incapable of acting like good lime when it is made into mortar.

Higgins recognized the necessity for using minimum quantities of water, and introduced the use of bone ashes and of leached wood ashes, mixed with lime, for making stucco.

The formation of a vitrified clinker was, however, carefully guarded against throughout this period. Higgins writes on this matter:

When limestone or chalk is suddenly heated to the highest degree . . . it vitrifies in the parts which touch the fire-vessels or furnace or fuel and the whole of it becomes incapable of slaking freely or acting like lime. Limestone is the more apt to vitrify in such circumstances as it contains more gypseous or argillaceous particles, and oyster shells or cockle shells vitrify more easily than limestone or chalk.

Bergmann. It was also in 1780 that Bergmann (7) a Swedish chemist, found manganese to be present to the extent of 2 percent in certain limestones which on burning made good hydraulic cements, and for no other reason attributed the excellence of this limestone to the manganese. G. de Morreau (11) seeking to confirm this idea, analyzed the principal hydraulic limes of France. He found that all contained clay and only one contained manganese but affirmed, on his

faith in the Swedish chemist, that manganese is the cause of the hydraulicity of limes. This view prevailed until 1860 when Vitalis (7), professor of chemistry and secretary of the Academy at Rouen, demonstrated that certain limestones which contained no manganese did nevertheless make good hydraulic limes.

Joseph Parker. But the young hydraulic-cement industry, like a heifer let loose in pasture, was finding other means of growth. There were found in some localities along the Kentish coast nodules of a stony material which separated from the limestone cliffs and rolled down to the base. These "Septaria Nodules" of tertiary strata were found by one Joseph Parker (12) in 1796 to produce an excellent hydraulic cement when burned in the usual manner. The name *Roman Cement* was given to the product because it resembled in its brownish color the ancient Roman cements which were made from limestone and pozzolana. This material became one of the best known cements of that period, and many attempts were made to imitate it. Indeed one such attempt proved to introduce a new source of excellent raw material. Old brick and tile were ground up, mixed with the chalk or limestone, and burned. The product was about the color of the popular Roman Cement, and often quite as satisfactory.

The importance of a siliceous constituent was advanced by Descotels (7), who wrote in 1813:

It appears very probable that the essential condition for a limestone to furnish good lean lime is that it contain a large quantity of siliceous material disseminated in very fine particles, for it seems little probable that the small amounts of alumina, magnesia and ferric oxide that are present could have any appreciable influence on these properties.

L. J. Vicat. The fragmentary chemical knowledge that had been obtained up to 1818 was coordinated by the eminent French engineer, Vicat (16), who emphasized what had been implied but not practiced by Smeaton, that, in the absence of the clay or shale occurring naturally in the rock, the same effect may be brought about by the artificial admixture of argillaceous rock with the limestone. Such a procedure had the further advantage that the proportions may be brought to any desired ratio, and hence the properties of the product can be kept under a more uniform and definite control. When the lime content was relatively high, the product after calcination slaked like ordinary quick-lime; but if sufficient argillaceous material was present, it was hydraulic and so was called *hydraulic lime*. When a considerable amount of magnesia, alumina or ferric oxide was present, the product did not slake but possessed a higher hydraulic value. This was called *natural cement*. Concerning this material he wrote:

In the present state of our knowledge regarding the different varieties of lime, it is impossible to say whether there exist certain determinate proportions of silica and magnesia, etc., which by their intimate association with the same quantity of calcareous matter are capable of producing limes of equal energy. But one thing is certain, and this is important to recollect, that no perfectly hydraulic mortar exists without silica, and all lime which can be so denominated is found by chemical analysis to contain a certain quantity of clay, made up of silica and alumina in proportions similar to those which constitute the ordinary clays.

In recognition of the value of clays in the raw mixture, Vicat proceeded to prepare hydraulic limes in two ways. The best of these, he states, was to mix clay in certain proportions with rich lime and calcine the mixture. This he called *artificial lime twice kilned*. A cheaper method, and one giving a somewhat poorer product, was to mix the clay with a crushed limestone or chalk. But as the mixing and pulverizing were less perfect than in the former case, the product was less uniform. And he adds with surprising modernism:

We see that, by being able to regulate the proportions, we can give to the facetious lime whatever degree of energy we please, and cause it at pleasure to equal or surpass the natural limes.

J. John. Quite independent of Vicat, a Dutch scientist had discovered the same thing. The Dutch lime makers had used oyster shells for making their cements, but had noted that the masonry made from such lime was inferior to that produced from certain limestones. The Dutch Society of Sciences offered a prize for the solution of the proposition:

What is the chemical reason that limestone produces generally a firmer and more durable masonry than lime from shells, and what means may be employed to improve, in this respect, the shell lime?

The prize was won by J. John (5) in 1819, who gave the same explanation which had been discovered by Smeaton sixty-three years before. The oyster shells were deficient in argillaceous materials; but, if clay or shale in the proper proportions were added to the shells before burning, a product was obtained that was equal to that made from the best limestones.

James Frost. An early manufacturer to apply these principles was James Frost (3), who in 1811 used two parts by weight of chalk to one of clay. The product he called *Frost's Cement*. But by 1822 he had discarded this procedure and in a new patent specified the use of "limestones or marls, or magnesian limestones or marls, as are entirely or nearly free from any mixture of alumina or argillaceous earth, and contain from 9 to 40 percent of siliceous earth or silica, or combinations of silica and oxides of iron, the silica being in excess and in a finely divided state." The product obtained from the calcination of this material he called *British Cement*.

Joseph Aspdin. The efforts of a number of these men, operating during the 68 years since the experiments of Smeaton to produce and improve a hydraulic cement, must have been known to Joseph Aspdin, who in 1824 first patented a product which he named *Portland Cement* (2). However, the evidence does not indicate that either the product or the name were wholly original with him. His cement, as indicated by the patent, does not reveal any material differences from some of the earlier cements, particularly the "twice-burned" product of Vicat, and the name appears to have originated from the comment of Smeaton that the cement he had produced would "equal the best Portland stone in solidity and durability." The specifications in Aspdin's patent are as follows:

My method of making a cement or artificial stone for stuccoing buildings, waterworks, cisterns, or any other purpose to which it may be applicable (and which I call *Portland Cement*) is as follows: I take a specific quantity

of limestone, such as that generally used for making or repairing roads, and I take it from the roads after it is reduced to a puddle, or powder; but if I cannot procure a sufficient quantity of the above from the roads, I obtain the limestone itself, and I cause the puddle or powder, or the limestone, as the case may be, to be calcined. I then take a specific quantity of argillaceous earth or clay, and mix them with water to a state approaching impalpability, either by manual labor or machinery. After this proceeding I put the above mixture into a slip pan for evaporation, either by the heat of the sun or by submitting it to the action of fire or steam conveyed in flues or pipes under or near the pan until the water is entirely evaporated. Then I break the said mixture into suitable lumps, and calcine them in a furnace similar to a lime kiln till the carbonic acid is entirely expelled. The mixture so calcined is to be ground, beat, or rolled to a fine powder, and is then in a fit state for making cement or artificial stone. This powder is to be mixed with a sufficient quantity of water to bring it into consistency of mortar, and this applied to the purposes wanted.

I. C. Johnson. It will be noted that the proportions of the limestone and the clay in the mixture are not stated, nor is the temperature higher than that of the lime kiln. The high repute of the cement, however, even though commanding a higher price than its competitors of presumably similar character, leads one to speculate on the possibility that Aspdin may not have revealed in his patent certain features of his operation, and that he may have used much higher temperatures than are indicated. Certain it is that secrecy attended the operation, for some twenty years later I. C. Johnson, who was trying to imitate the product, found the whole operation a profound mystery. His interesting account is worth quoting:

My employers, attracted by the flourish of trumpets then being made about the new cement, desired to be makers of it, and some steps were taken to join Aspdin in the enterprise, but no agreement could be come to, especially as I advised my employers to leave the matter to me, fully believing that I could work it out.

As I said before, there were no sources of information to assist me, for although Aspdin had works, there was no possibility of finding out what he was doing, because the place was closely built in, with walls some 20 feet high, and with no way into the works except through the office.

I am free to confess that if I could have got a clue in that direction I should have taken advantage of such an opportunity, but as I have since learned, and from one of his later partners, that the process was so mystified that anyone might get on the wrong scent, for even the workmen knew nothing, considering that the virtue consisted in something Aspdin did with his own hands.

Thus he had a kind of tray with several compartments and in these he had powdered sulfate of copper, powdered limestone, and some other matters. When a layer of washed and dried slurry and the coke had been put into the kiln, he would go in and scatter some handfuls of these powders from time to time as the loading proceeded so the whole thing was surrounded by mystery.

What did I do? I obtained some of the cement that was in common use and, although I had paid some attention to chemistry, I would not trust myself to analyze it but I took it to the most celebrated analyst of that day in London, and spent some two days with him. What do you think was the principal element according to him? Sixty percent of phosphate of lime. All right, thought I, I have it now. I laid all the neighboring butchers under contribution for bones, calcined them in the open air, creating a terrible nuisance by the smell, and made no end of mixtures with clay and other matters contained in the analysis in different proportions and burnt to different degrees, and all without any good result (6)(8).

But the portland cement of Aspdin, according to Johnson, (writing in 1911, his 101st year) was "no more like the cement that is made today than chalk is like cheese." In the course of experiments which Johnson carried on about 1845, he had made a product so highly calcined that it was largely vitrified and was discarded as a total loss. But some weeks later, when this material was made up into specimens for testing, it was found to give a product of superior hardness and color. By further experiments the proper proportions and temperatures were established, and this seems to be the beginning of the portland cement industry as we know it today. Johnson himself claimed to be the discoverer of the true (as at present understood) Portland Cement, and his claim was supported by the eminent German cement chemist, Michaelis (3) in 1905. Davis states, however, that this claim has not been acknowledged (3).

The Development of the Cement Industry

Robert Lesley (8) credits the origin and development of the cement industry in the United States to the sudden large demand for a good hydraulic cement created by the building of our canals. The first of these was the great Erie Canal, commenced in 1817. The locks, bridges, and aqueducts involved construction which required water-resisting mortar. The first discovery of cement rock in this country was made by Canvas White near Fayetteville in New York State. White took out a patent for the manufacture of natural cement from that rock in 1818, which was later sold by him to the State of New York for \$10,000, and this sale resulted in the removal of all manufacturing restrictions. The discovery of cement rock in other districts followed soon, and the natural cement industry became firmly established.

David Saylor. One of the pioneers in the development of natural cement was David Saylor. Lesley describes him as a farmer boy who experimented with cement rock which he found near Coplay, Pennsylvania. With two others he burned the rock in a little cook-stove in his home. When they found that cement was produced, they established a plant at Coplay. That was in 1850.

At that time no portland cement was brought into the United States. The first portland cement works to be established outside of England were in Belgium and Germany in about 1855. From that date European production grew rapidly, and importation into the United States began about ten years later. The engineering profession slowly came to recognize the excellent qualities of this new cement, and it came to be used for pavings, sidewalks, and structures as well as

for water-resistant mortars in competition with natural cement. In 1878 92,000 barrels of portland cement were imported.

After Saylor had been making natural cement for some twenty years, he obtained some of the imported portland cement and found by analysis that it was similar in composition to his own product. On further experimentation he found that he could sinter his rock by burning at a higher temperature. The ground clinker made excellent cement. Accordingly in 1871 Saylor took out a patent for the new cement and started manufacture. At first he had difficulty due to the uneven distribution of the clay and limestone in the rock, but he soon overcame



Figure 2. A battery of abandoned vertical cement kilns of the Giant Portland Cement Company, at Egypt, Pennsylvania.

this by grinding the rock to a powder, and making the powder into brick for burning. He made a vertical dome-kiln using a design obtained from England, and burned the brick to clinker. When this was ground, the cement was uniform, and equal in quality to the imported portland cement. This was the first manufacture of portland cement in America.

The new cement found favor among engineers, and in 1876 it received an award at the Centennial Exposition in Philadelphia. Many other companies soon began to experiment with this material and by 1890 seventeen plants in the United States were producing portland cement to the total of 331,500 barrels* per year.

Growth of the Industry. The importations of foreign portland cement in 1890 were about seven times the above amount, but from that period the manufacture of the domestic product gained rapidly on the importations. In 1895 the importa-

* A barrel of cement contains 376 lbs. net; a bag of cement contains 94 lbs. net.

tions reached a high mark with 2,997,395 barrels, after which they dropped steeply, while the domestic production has increased enormously. The production in the United States reached an all-time high mark of 185,341,609 barrels in 1942. Importations after 1918 again increased and in 1926 reached 3,250,000 barrels.

The great rise in the manufacture of portland cement also marked the decline of the manufacture of natural cement. The peak of production of natural cement was in 1899 when 9,868,179 barrels were produced. By 1918 that had dropped to 432,966 barrels. Some of these relations are shown graphically in Figure 3, from data obtained from the U.S. Bureau of Mines (10).

The early demand for portland cement and the competition between the domestic and foreign brands made it imperative that American producers develop the means for greatly increasing the output of their plants. The old vertical kilns were economical in fuel but required a large amount of labor. This condition was satisfactory in Europe where fuel was costly and labor was cheap. But in America coal was cheap and labor costly. The obvious solution was to devise a continuous type of kiln which would require little labor to operate, even though the coal consumption might be high. Several experiments in continuous vertical and horizontal kilns were made. The first successful rotary kiln was invented and used by an Englishman, Frederick Ransome, at Grays, on the Thames; in the United States it was first employed by the Keystone Portland Cement Company, which later became the Atlas Cement Company, at Coplay, Pennsylvania, in 1899. The kiln was 25 feet long by 5 feet in diameter. At first, rock crushed only to a size of one-half to two inches was used and the process was a failure. But when the rock was ground so that 95 percent passed a No. 50 sieve, the product was equal to the best foreign brands.

The advantages of this type of kiln for American production were so apparent that in the next decade the process of manufacture of portland cement in the United States was completely revolutionized. The size of the kilns increased, however. For a long time the standard size was about 60×6 feet. Kilns of 150 feet in length by 8 feet in diameter were first used by the Edison Portland Cement Works under patents granted to Thomas A. Edison. At present the length varies from about 150 to over 500 feet and the diameter from 8 to 15 feet. The capacity of a large kiln may be as great as 4000 barrels of clinker per day.

Increased efficiency in the crushing and grinding machinery was developed in this same period. The old type of coffee mill crushers and buhrstone pulverizers were constantly breaking down and, even when in operation, failed to produce the degree and uniformity of fineness demanded by the growing industry. The introduction of the Gates crusher and the Griffin mill became the forerunner of the efficient crushing and grinding machinery in use today.

The tremendous increase in the production of portland cement since about 1898 may be assigned to a favorable combination of several factors.

(1) The potential usefulness and dependability of portland cement rather suddenly became apparent. Extensive highway construction opened a market for enormous quantities, and this has been augmented by the introduction of reinforced concrete in bridges, dams and buildings. Less conspicuous uses have consumed large quantities of cement, as stucco for houses, concrete blocks and stone, farm uses, culverts, city streets, water and sewer pipe, tile, house founda-

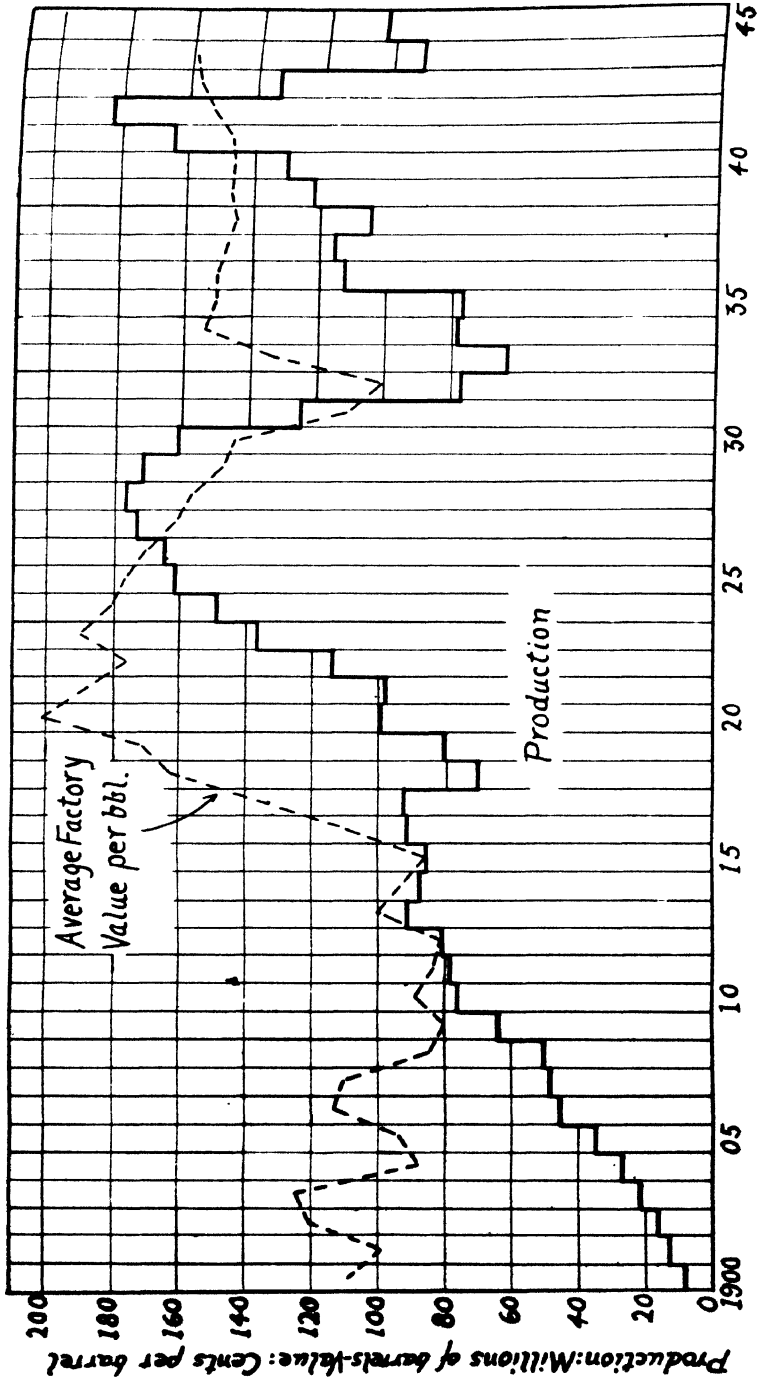

Figure 3. Production and average value per barrel of portland cement in the United States from 1900 to 1945. (U.S. Bureau of Mines)

tions and small dwelling construction. The military have been large consumers for roads, airports, housing, storage tanks, emplacements, etc.

(2) The resourcefulness of manufacturers in improving methods of operation began to result in mass production of quality cement. Efficient machinery took the place of inefficient labor.

(3) A standardization of the product, sold under a guarantee to be equal to or better than an accepted set of standard specifications, has inspired confidence in the cement and assured satisfactory performance if properly handled.

(4) An earnest effort on the part of manufacturers to meet the ever increasing demands of the architects, contractors and engineers by a constant upward trend in the quality, and advance in the standard specifications, was accomplished by conscientious observation and research.

(5) An intensive study of the process of making concrete, the successful determination of the underlying laws, and the extensive dissemination of that information among engineers and contractors, has insured a much smaller percentage of improperly made concrete.

One of the obstacles to universal confidence in concrete has been due to structural failures resulting from methods of using cement in the making and curing of concrete. Regardless of the quality of the portland cement, an improper system of making concrete may result in a bad structure. It was recognized by engineers that the laws of concrete design must be determined and that the knowledge of correct design and treatment must be made universally available if failures due to improper methods were to be avoided.

TABLE 1. *Statistics of cement production in the United States in 1940, 1942 and 1944* (10)

	1940	1942	1944
Production of finished cement			
Portland, bbls.	130,217,000	182,781,000	90,906,000
Masonry, natural, pozzolan, bbls.	2,535,000	2,560,000	1,247,000
Total production, bbls.	132,751,000	185,342,000	92,152,000
Capacity used at portland cement mills.	51.2%	73.5%	37.8%
Active plants			
Portland.	152	155	151
Masonry, natural, pozzolan.	12	11	9
Shipments from mills			
Portland, bbls.	130,350,000	185,301,000	94,272,000
Value.	\$190,078,000	\$283,237,000	\$150,358,000
Per barrel.	\$1.46	\$1.53	\$1.59
Masonry, natural, pozzolan, bbls.	2,515,000	2,508,000	1,320,000
Value.	\$3,387,000	\$3,668,000	\$1,639,000
Per barrel.	\$1.35	\$1.46	\$1.24
Total shipments, bbls.	132,864,000	187,809,000	95,592,000
Value.	\$193,465,000	\$286,905,000	\$151,997,000
Imports, bbls.	538,000	less than 1000 bbls.	
Exports.	1,668,000	1,101,000	4,040,000
Apparent consumption.	131,735,000	186,709,000	91,552,000

Research laboratories designed to study the chemical and engineering problems involved were established in government bureaus and state highway departments, in universities and in the associations of cement manufacturers, and societies were formed for study and the dissemination of technical knowledge. The laboratories of the Carnegie Institution, the National Bureau of Standards,

TABLE 2. *Portland cement produced and shipped in the United States in 1944, by types* (10)

	Plants	Production, bbls.	Shipments, bbls.	Total value	Average per bbl.
Types I and II.....	151	83,577,000	86,933,000	\$135,564,000	\$1.56
Type III.....	97	5,135,000	5,190,000	10,278,000	1.98
Type IV.....	4	441,000	401,000	555,000	1.38
Type V.....	4		2,000	3,000	1.99
Oil well.....	15	939,000	931,000	1,802,000	1.94
White.....	6	303,000	322,000	1,303,000	4.04
Pozzolan.....	4	290,000	245,000	337,000	1.38
Miscellaneous*.....	21	221,000	247,000	514,000	2.08

* Includes hydroplastic, plastic and waterproofed cements.

the Reclamation Bureau, the Bureau of Mines, the War and Navy departments, and the laboratories of the Portland Cement Association and of cement companies in the United States, the Building Research Station in England, the Kaiser Wilhelm Institute for Silicate Research in Germany, the Laboratories of Structures and Public Works of France and technical laboratories in other countries

TABLE 3. *Raw materials used in producing portland cement in the United States in 1942 and 1944* (10)

	Short tons	
	1942	1944
Cement rock.....	13,538,000	5,119,000
Limestone.....	36,193,000	19,958,000
Marl.....	903,000	643,000
Clay and shale.....	5,182,000	2,823,000
Blast-furnace slag.....	809,000	279,000
Gypsum.....	1,248,000	597,000
Sand and sandstone.....	568,000	230,000
Iron materials.....	252,000	123,000
Miscellaneous.....	159,000	22,000

have contributed notably to the growth of knowledge whereby cement may be better understood and more intelligently used.

A number of the salient data concerned with the production of portland and other cements in recent years are given in Tables 1 to 5. In Table 1 are listed the statistics of the production and value of cements produced in the United States in 1940, 1942 and 1944. Table 2 shows the cement produced and shipped in 1944

TABLE 4. Fuel used in the production of portland cement in the United States in 1944 (10)

	Cement produced			Fuel consumed		
	Plants	Barrels	Percent of total	Coal, short tons	Oil, bbls.	Natural gas, millions of cu. ft.
Coal.....	86	49,279,000	54.2	3,096,000		
Oil.....	11	8,155,000	9.0		1,758,000	
Natural gas.....	12	6,539,000	7.2			10,247
Coal and oil.....	9	7,627,000	8.4	478,000	415,000	
Coal and gas.....	14	7,798,000	8.6	150,000		11,547
Oil and gas.....	6	8,791,000	9.6		334,000	9,885
Coal, oil and gas.....	5	2,717,000	3.0	14,000	69,000	3,908
Total.....	143	90,906,000	100	3,379,000	2,576,000	35,588

in terms of the types handled. In Table 3 are given the quantities of raw materials used and, in Table 4 the amounts of various fuels consumed, in the 1944 production of portland cement in the United States. The world production is shown in Table 5.

TABLE 5. World production of all cements in 1938 (10)

	Barrels
North and Central America	
Canada.....	5,137,000
Cuba ^a	
Guatemala ^a	
Mexico.....	2,191,000
United States.....	107,177,000
South America	
Argentina.....	6,806,000
Bolivia.....	109,000
Brazil.....	3,623,000
Chile.....	2,134,000
Colombia.....	831,000
Ecuador ^a	
Peru.....	594,000
Uruguay.....	929,000
Venezuela.....	234,000
Europe	
Albania ^b	82,000
Austria.....	3,811,000
Belgium.....	17,908,000
Bulgaria.....	1,055,000
Czechoslovakia ^b	7,974,000
Denmark.....	3,752,000
Estonia.....	468,000
Finland.....	2,786,000
France ^b	24,947,000
Germany.....	91,468,000

TABLE 5. *World production of all cements in 1938 (10)—(Continued)*

	Barrels
Greece	1,806,000
Hungary	2,316,000
Italy	27,015,000
Latvia	907,000
Netherlands	2,674,000
Norway	1,944,000
Poland	10,082,000
Portugal	1,571,000
Rumania	2,629,000
Spain ^c	3,342,000
Sweden	5,822,000
Switzerland ^c	3,811,000
United Kingdom	46,321,000
U.S.S.R.	33,398,000
Yugoslavia	4,176,000
Asia	
China ^a	
Manchuria ^b	4,691,000
Chosen ^b	3,899,000
Hong Kong	645,000
India, British ^b	6,696,000
Indo-China	1,562,000
Iran ^a	
Japan	32,360,000
Levant	951,000
Netherland Indies ^a	
Palestine	577,000
Philippine Islands	982,000
Syria	469,000
Thailand (Siam)	481,000
Turkey	1,569,000
Africa	
Algeria ^b	381,000
Belgian Congo	97,000
Egypt	2,203,000
Morocco, French	967,000
Mozambique	142,000
Tunisia	403,000
Union of South Africa	5,149,000
Oceania	
Australia	5,057,000
New Zealand	1,290,000
Total	504,008,000

^a Data not available; estimate included in total.

^b Production in 1937.

^c Shipments.

References

1. Alberti, L., "Appeal to the Public," 1778.
2. Aspdin, J., British patent 5,022, Dec. 18, 1824.

3. Davis, A. C., "A Hundred Years of Portland Cement," London, Concrete Publications Ltd., 1924.
4. Higgins, B., "Experiments and Observations Made with the View of Improving the Art of Composing and Applying Calcarious Cements and of Preparing Quick Lime," London, 1780.
5. John, J. T., "Lime and Mortar in General, and the Difference between Mortar and Shell Lime and Limestone in Particular, and the Theory of Mortar," translated by Count Kerssenbroch, Hanover, 1925.
6. Johnson, I. C., *The Building News*, London, 1880.
7. Leduc, E., *Bull. soc. encour. ind. natl.*, 1911 (2), p. 280.
8. Lesley, R. W., "History of the Portland Cement Industry in the United States," Chicago, International Trade Press, 1924.
9. Lucas, A., "Ancient Egyptian Materials and Industries," London, 1934.
10. Minerals Yearbook, Chapter on Cement, U.S. Bureau of Mines, 1944.
11. Morreau, G. de, *Acad. Digon*, 1785.
12. Parker, J., British patent 1796.
13. Pliny, "Natural History," 34.52, about 70 A.D.
14. Rondelet, "L'Art de Batir," Paris, 1805.
15. Smeaton, J., "Narrative of the Building of the Eddystone Lighthouse," London, 1791.
16. Vicat, L. J., "A Practical and Scientific Treatise on Calcarious Mortars and Cements, Artificial and Natural," translated by J. T. Smith, London, 1837.
17. Vitruvius, P., "Archetecture," translated by John Weale, London, 1860.

CHAPTER 2

Classification of Cements

In the course of the development of the art of cement manufacture, many materials have been employed, many products obtained and many names given to the resulting cements. Some of these names are distinctive of the type or class of product; a much larger number are proprietary names granted as patents or trade-marks. Our interest is here chiefly in the former group and in a few trade names which have come to be used as representative of a type.

The term *cement* seems to have been used in Roman and early medieval times to indicate any bonding agent, and was applied to the mortar, or mixture of lime, pozzolana, ground brick, water, etc., which was used by them to bond the stones in their great structures. When the cement could be produced under water (by reaction with water) the term *hydraulic cement* was used. Sometimes the terms *pozzolana cement* or *Santorin cement* were employed to indicate the nature of the mixture, but more specific terms were not used. When Smeaton started his investigations, "Dutch Tarras," the volcanic tuffa found at Andernach on the Rhine, was in high favor, and mixtures of this material with lime were known as *tarras* or *trass cement*.

The forms of calcium carbonate used for making lime were limestone, marble, chalk and shells, but the limestone particularly was of various degrees of purity. When the pure rock was calcined, the product was nearly pure calcium oxide; in water this rapidly slaked to a fine putty, with considerable evolution of heat. Such a lime was known as a *fat lime*. With increasing amounts of impurity, which usually was argillaceous or siliceous in character, the product slaked less readily, the large lumps very slowly; it did not crumble readily in water, and heat was evolved so slowly that little rise in temperature was noted. Such limes were designated as *lean limes*.

Smeaton observed, however, that limestones which contained a large amount of argillaceous material (20 to 25 percent) had the property of hardening under water, a characteristic not possessed by purer limes. The latter harden in air by combination with carbon dioxide to reform the carbonate, but when placed in water they form only a putty of the hydroxide. The impure limes, however, combine in water with siliceous and aluminous compounds present to form hydrated calcium silicates and calcium aluminates, which are hard cementing agents and do not require carbon dioxide. Thus the pure limes cannot be used as cements under water, whereas the impure limes can be so used. To indicate the distinction, the former are called *non-hydraulic limes*, the latter *hydraulic limes*.

During the burning of the hydraulic limes, as practiced in vertical kilns, there were considerable variations in the temperature to which the rock was subjected, and the portions which were heated too high became sintered. Such lime was formerly discarded as useless, but it was learned that these sintered lumps, on

grinding, produced a somewhat superior hydraulic cement which the French used under the name of *Grappier cement*.

As a result of the investigations of Smeaton, it was learned that the hydraulic properties were improved by incorporating with the limestone before burning larger amounts of argillaceous material than were usually present in the rock; *eminently hydraulic limes* were so obtained. But deposits were found in which Nature had provided about the optimum ratio of these constituents and, as a distinctive term, the product made from such highly argillaceous rock came to be called *natural cement*. The temperatures employed were still sufficient to cause complete decarbonation, but not fusion. A limited amount of chemical combination occurred, and the cement won a high reputation for hydraulic uses. In the United States the name *Rosendale cement* was applied to such a product because of the early establishment of works at Rosendale, New York. Cements for masonry and brick mortars are sometimes made from this material. Up to the turn of the century, natural cements were produced in larger amounts than portland, but since that time they have become relatively unimportant and their production very limited.

Following the discoveries of Aspdin and Johnson, it became recognized that a cement, remarkably superior to the hydraulic limes, could be made by causing the lime-clay mixture (or the natural-cement rock) to be heated to such a temperature that practically the entire product was sintered. This was the revolutionary step from which was evolved the portland cement industry, and the term *portland cement* is used to designate such a sintered material as distinguished from the various limes and natural cements. More specifically, it has been defined in the Standard Specifications of the American Society for Testing Materials (1) as

the product obtained by pulverizing clinker consisting essentially of hydraulic calcium silicates, to which no additions have been made subsequent to calcination other than water and/or untreated calcium sulfate, except that not to exceed 1.0 percent of other materials may be interground with the clinker at the option of the manufacturer, provided such materials in the amounts indicated have been shown to be not harmful by tests carried out or reviewed by Committee C-1 on cement.

Five types are recognized in the United States:

Type I "For use in general concrete construction where the special properties specified for types II, III, IV, and V are not required."

Type II or *Moderate Heat-of-Hardening Cement*, "for use in general concrete construction exposed to moderate sulfate action, or where moderate heat of hydration is required."

Type III or *High Early-Strength Cement*, "for use when high early strength is required."

Type IV or *Low-Heat Cement*, "for use when a low heat of hydration is required."

Type V or *Sulfate-Resisting Cement*, "for use when high sulfate resistance is required."

The principal chemical and physical requirements of these cements, as of 1946, are given in Tables 6 and 7.

TABLE 6. Chemical requirements

	Type I	Type II	Type III	Type IV	Type V
Magnesium oxide (MgO), max., percent.....	5.0	5.0	5.0	5.0	4.0
Sulfur trioxide (SO ₃), max., percent..	2.0 ^c	2.0	2.5 ^c	2.0	2.0
Loss on ignition, max., percent.....	3.0	3.0	3.0	2.3	3.0
Insoluble residue, max., percent.....	0.75	0.75	0.75	0.75	0.75
Silica (SiO ₂), min., percent.....	21.0	24.0
Alumina (Al ₂ O ₃), max., percent.....	6.0	4.0
Iron oxide (Fe ₂ O ₃), max., percent.....	6.0	6.5	4.0
Ratio of Al ₂ O ₃ to Fe ₂ O ₃	0.7 to 2.0	0.7 to 2.0
Tricalcium silicate (3CaO.SiO ₂), ^b max., percent.....	50	35
Dicalcium silicate (2CaO.SiO ₂), ^b min., percent.....	40
Tricalcium aluminate (3CaO.Al ₂ O ₃), ^b max., percent.....	8	15	7	5

^b The expressing of chemical limitations by means of calculated assumed compounds does not necessarily mean that the oxides are actually or entirely present as such compounds.

The percentages of tricalcium silicate, dicalcium silicate, and tricalcium aluminate shall be calculated from the chemical analysis as follows:

$$\text{Tricalcium silicate} = (4.07 \times \text{percent CaO}) - (7.60 \times \text{percent SiO}_2) - (6.72 \times \text{percent Al}_2\text{O}_3) - (1.43 \times \text{percent Fe}_2\text{O}_3) - (2.85 \times \text{percent SO}_2)$$

$$\text{Dicalcium silicate} = (2.87 \times \text{percent SiO}_2) - (0.754 \times \text{percent } 3\text{CaO.SiO}_2)$$

$$\text{Tricalcium aluminate} = (2.65 \times \text{percent Al}_2\text{O}_3) - (1.69 \times \text{percent Fe}_2\text{O}_3)$$

Oxide determinations calculated to the nearest 0.1 percent shall be used in the calculations. Compound percentages shall be calculated to the nearest 0.1 percent and reported to the nearest 1 percent.

^c The maximum limit for SO₃ content for type I cement shall be 2.5 percent when the tricalcium aluminate content is over 8 percent; for type III cement it shall be 3 percent when the tricalcium aluminate content is over 8 percent.

In addition to the above types, a *white portland cement* is made by limiting the ferric oxide content to such a small value that the product is practically white. Also cements for special purposes are made by modifications in the composition or heat treatment, such as *oil-well cement*, *quick-setting cement*, etc.

The term *lime-slag cement* is used to indicate material produced by making a mechanical mixture of slaked lime and finely pulverized blast-furnace slag. Such products have found their greatest use in France where another type of cement known as *sursulfate cement*, made from slag and anhydrite, has also found high favor. These cements have about the following compositions:

<i>Ciment de laitier a base de chaux</i>	85 slag, 15 hydrated lime
<i>Chaux au laitier</i>	30 slag, 70 hydrated lime
<i>Ciment sursulfate</i>	70 slag, 30 anhydrite

TABLE 7. *Physical requirements*

	Type I	Type II	Type III	Type IV	Type V
Fineness, specific surface, sq. cm. per g.:					
Average value, min.	1600	1700	1800	1800
Minimum value, any one sample.....	1500	1600	1700	1700
Soundness:					
Autoclave expansion, max., percent.....	0.50	0.50	0.50	0.50	0.50
Time of setting (alternate methods): ^b					
Gillmore test:					
Initial set, min., not less than.....	60	60	60	60	60
Final set, hr., not more than.....	10	10	10	10	10
Vicat test:					
Initial set, min., not less than.....	45	45	45	45	45
Final set, hr., not more than.....	10	10	10	10	10
Tensile strength, psi.: ^c					
The average tensile strength of not less than three standard mortar briquets composed of 1 part cement and 3 parts standard sand, by weight, shall be equal to or higher than the values specified for the ages indicated below:					
1 day in moist air.....	275		
1 day in moist air, 2 days in water.....	150	125	375		
1 day in moist air, 6 days in water.....	275	250	175	175
1 day in moist air, 27 days in water.....	350	325	°	300	300
Compressive strength, psi.: ^c					
The average compressive strength of not less than three mortar cubes composed of 1 part cement and 2.75 parts fine testing sand, by weight, shall be equal to or higher than the values specified for the ages indicated below:					
1 day in moist air.....	1250		
1 day in moist air, 2 days in water.....	900	750	2500		
1 day in moist air, 6 days in water.....	1800	1500	800	1000
1 day in moist air, 27 days in water.....	3000	3000	°	2000	2200

^b The purchaser should specify the type of setting time test required. In case he does not so specify, the requirement of the Gillmore test only shall govern.

^c The purchaser should specify the type of strength test required. In case he does not so specify, the requirements of the tensile strength test only shall govern. The strength at any age shall be higher than the strength at the next preceding age. Unless otherwise specified, the compressive and tensile strength tests for types I and II cements will be made at 3 and 7 days. If, at the option of the purchaser, a 28-day test is required on type III cement, the strength at 28 days shall be higher than at 3 days.

When slag is mixed with portland cement, the product is known as *portland-slag cement*. These have found extensive use both in Germany and France, under the following designations:

	Clinker	Slag
In Germany		
<i>Eisenportland cement</i>	65-70	35-30
<i>Hochofen cement</i>	15-35	85-65
In France		
<i>Ciment metallurgique de fer</i>	70	30
<i>Ciment metallurgique de haut fourneau</i>	50	50
<i>Ciment de laitier a base de ciment artificiel</i>	15	85

When a pozzolanic material, as volcanic ash, tuffa, or sintered or unsintered shale is mixed with portland clinker, the product is referred to as *pozzolana cement* or *trass cement*. In Germany, cements made with the trass at Andernach are designated by their trass:clinker ratio:

	Trass	Clinker
<i>Trass cement 30:70</i>	30	70
<i>Trass cement 50:50</i>	50	50

Along the valleys of the Meuse and Ardennes in France is an extensive formation of soft siliceous sedimentary rock known as *gaize*. This material, either in its natural state or more commonly after burning at about 900°, is used as a pozzolanic admixture with portland clinker. This mixture is called *gaize cement*.

The *silikatcement* of Sweden is produced by grinding a siliceous admixture with portland clinker.

In Germany, iron ore is sometimes substituted for the clay or shale normally used in the manufacture of portland cement, and the product, high in ferric oxide and low in alumina, is known as *iron-ore cement* or *erz cement*. It is slow in setting and hardening but highly resistant to salt action. A somewhat similar product produced in France and Italy is known as *Ferrari cement*. Again, waste bauxite is sometimes substituted for the clay or shale, producing a cement high in alumina and ferric oxide but low in silica. This product, said to give high early strength, is known as *Kuhl cement* or *bauxitland cement*.

There are several cements which do not belong to the hydraulic-lime or the portland class, and will be mentioned only briefly. *Aluminous* or *high-alumina cement* contains a much higher percentage of alumina than the portlands. For that reason it cannot be made from limestone and clay, but requires bauxite, an impure hydrated alumina, to mix with the limestone. The chemical composition is quite different from that of portland cement. This cement hardens very rapidly, acquiring nearly its final maximum strength in about 24 hours. These cements fuse easily and so require a special form of furnace. In France the high-alumina cements are sometimes made in electric furnaces from which the fused material runs out in a liquid stream. For that reason it is called *ciment fondu*.

When gypsum ($\text{CaSO}_4 \cdot 2\text{H}_2\text{O}$) is heated at about 170°, it loses water to form the hemihydrate ($\text{CaSO}_4 \cdot \frac{1}{2}\text{H}_2\text{O}$), which is called *plaster of Paris* from its early preparation from gypsum obtained at Montmartre in Paris. This material hydrates rapidly in the presence of water to form a bonding medium. A solution of glue to the extent of a few pounds per ton is sometimes added by the manu-

TABLE 8. *Typical compositions of various cements*

	SiO ₂ %	Al ₂ O ₃ %	Fe ₂ O ₃ * %	CaO %	MgO %	SO ₂ %	Loss %	Insol. %
Portland Type I (8)	21.3	6.0	2.7	63.2	2.9	1.8	1.3	0.2
Portland Type II (8)	22.3	4.7	4.3	63.1	2.5	1.7	0.8	0.1
Portland Type III (8)	20.4	5.9	3.1	64.3	2.0	2.3	1.2	0.2
Portland Type IV (8)	24.3	4.3	4.1	62.2	1.8	1.9	0.9	0.2
Portland Type V (8)	25.0	3.4	2.8	64.1	1.9	1.6	0.9	0.2
Portland white (7)	25.5	5.9	0.6	65.0	1.1	0.1	n.d.	n.d.
Natural (6)	27.8	5.5	4.3	35.6	21.2	0.5	4.1	n.d.
Aluminous (7)	5.3	39.8	14.6	33.5	1.3	0.1	0	4.8
Pozzolana (7)	26.0	6.9	3.6	52.3	4.2	1.8	4.8	9.4
Trass 30/70 (9)	22.3	8.3	2.5	46.8	1.9	1.8	3.4	9.5
Trass 50/50 (9)	25.1	8.9	3.3	35.3	1.2	1.1	5.8	15.9
Gaize (5)	26.5	7.0	3.0	43.0	1.0	1.0	2.0	16.5
Eisenportland (3)	23.5	8.5	1.7	57.2	3.3	2.0	n.d.	n.d.
Hochofen (3)	31.3	R ₂ O ₃ = 13.5	47.2	2.2	0.7	n.d.	n.d.	n.d.
Metallurgique de fer (2)	26.0	8.0	3.0	58.0	2.5	1.0	1.5	n.d.
Metallurgique de laitier (2)	29.0	15.5	1.5	48.0	2.5	2.0	0.5	n.d.
Ferarri (7)	22.9	3.5	5.5	63.8	1.3	2.1	n.d.	n.d.

* Includes any FeO present, calculated as Fe₂O₃.

n.d. = Not determined.

facturer to delay the set. On heating the gypsum to about 330°, the water is completely driven off, leaving a *soluble anhydrite* which also hydrates rapidly. If the temperature is taken to 600° or higher, the resulting anhydrite is not readily acted upon by water unless an accelerator is added. *Keene's cement* and *Parian cement* are made of such an insoluble anhydrite to which has been added 1 or 2 percent of alum or potassium sulfate to accelerate the hydration.

When magnesia is mixed with a solution of magnesium chloride (about 20 percent), magnesium oxychloride (3MgO.MgCl₂.11H₂O) is formed which is known as *sorel cement*. The product is useful only in the absence of water.

Some typical compositions of cements of various types and classifications are shown in Table 8. The potential phase compositions of the five standard types, given at the top of Table 8, are indicated in Table 9. The compositions of a number of pozzolanic materials that have been used extensively are shown in Table 10.

TABLE 9. *Potential phase composition of type cements (average values)*

	C ₁ S %	C ₂ S %	C ₃ A %	C ₄ AF %	CaSO ₄ %	MgO %	Free CaO %
Type I	45	27	11	8	3.1	2.9	0.5
Type II	44	31	5	13	2.8	2.5	0.4
Type III	53	19	11	9	4.0	2.0	0.7
Type IV	28	49	4	12	3.2	1.8	0.2
Type V	38	43	4	9	2.7	1.9	0.5

TABLE 10. *Composition of pozzolanic materials*

	SiO ₂ %	Al ₂ O ₃ %	Fe ₂ O ₃ %	CaO %	MgO %	K ₂ O %	Na ₂ O %	SO ₂ %	Loss %
Santorin earth (4).....	63.2	13.2	4.9	4.0	2.1	2.6	3.9	0.7	4.9
Rhenish Trass (4).....	55.2	16.4	4.6	2.6	1.3	5.0	4.3	0.1	10.1
Pumicite (4).....	72.3	13.3	1.4	0.7	0.4	5.4	1.6	tr.	4.2
Burnt gaize (4).....	83.9	8.3	3.2	2.4	1.0	n.d.	n.d.	0.7	0.4
Burnt clay (4).....	58.2	18.4	9.3	3.3	3.9	3.1	0.8	1.1	1.6
Burnt shale (4).....	51.7	22.4	11.2	4.3	1.1	2.5	1.2	2.1	3.2
Blast-furnace slag (3)..	33.9	13.1	1.7	45.3	2.0	n.d.	n.d.	tr.	n.d.

References

1. Am. Soc. Testing Materials, Specifications C-150-46 (1946).
2. Dumesnil, P., *Rev. mater. constr. trav. pub.*, No. 296 (1934).
3. "Eisenportlandzement," Ver. deut. eisenportlandzement Werke, Dusseldorf, 1931.
4. Lea, F. M., *Symposium*, 462.
5. "Le Ciment Gaize," Soc. Ciment Francais, Paris, 1938.
6. Meade, R. K., "Portland Cement," p. 3, Easton, Chemical Publishing Co., 3rd ed., 1926.
7. PCAF analyses.
8. Res. Reports, PCA, April, 1941.
9. "Trass Zement," Tuffstein und Basaltlavawerke, Andernach, 1938.

CHAPTER 3

The Manufacture of Portland Cement

In the present chapter will be presented in outline only the chemical technology of portland cement manufacture. The purely mechanical problems of quarrying, of the flow of materials, of the design of machinery or of fuel and power economy will not be considered. The processes of manufacture will be presented as a matter of general information only, and the emphasis will be placed upon a sketch of the chemical problems of the modern cement plant. The manufacture of portland cement is distinctly a chemical industry and will be treated as a special problem in chemical control. Many of the essential details will be developed much more fully in subsequent chapters.

Outline of Operations

Stated briefly, portland cement is made as follows. An argillaceous material and a calcareous material are crushed, mixed and ground to a fine powder. The composition of this mixture must be kept constant within narrow limits, as any wide departure from the optimum may result in an inferior cement. The mixing and grinding may be done in the dry condition (the dry process) or it may be done in water (the wet process). It is essential, however, that regardless of the method of preparation the mixture before entering the kiln be correctly proportioned, finely ground and thoroughly intermixed.

The mixture then passes into rotary kilns where it is heated slowly to the sintering point. A photograph of typical modern rotary kilns is shown in Figure 4. The water and carbon dioxide are driven off before the clinkering zone is reached. As the hotter regions are approached, chemical reactions take place between the constituents of the raw mixture. In the course of these reactions new compounds are formed, and some of these melt to partially fuse the charge. The clinker then is caused to drop down into some form of cooler, or is conveyed to a clinker pile where it is cooled, sometimes with a spray of water. When cool, the clinker is mixed with a carefully controlled quantity of either calcined or uncalcined gypsum, and the mixture ground to a very fine powder. That powder is the portland cement of commerce.

The ground cement is conveyed to silos where it is stored until tested and shipped. All cement sold must conform to certain standard specifications as to composition, fineness, strength and other physical properties.

The cement usually is shipped in bags of 94 pounds net for transportation. Shipments are referred to, however, in terms of barrels of 376 pounds net. That is, a barrel of cement is equivalent to four bags.

Keeping this general outline of the process in mind, we will go over the several operations in somewhat greater detail.

Source of Raw Materials

Speaking generally, any materials may be used for making portland cement which, on burning, will give the proper chemical composition. But economically, the number of such materials is sharply limited.

The available sources of calcareous material are:

limestone	marl
cement rock	marine shells
chalk	alkali waste

However, certain constituents have been found to be undesirable in cement and so limit still further the deposits of limestone, marl, etc., which are satisfactory. Limestone or other calcareous deposits which are high in magnesium carbonate

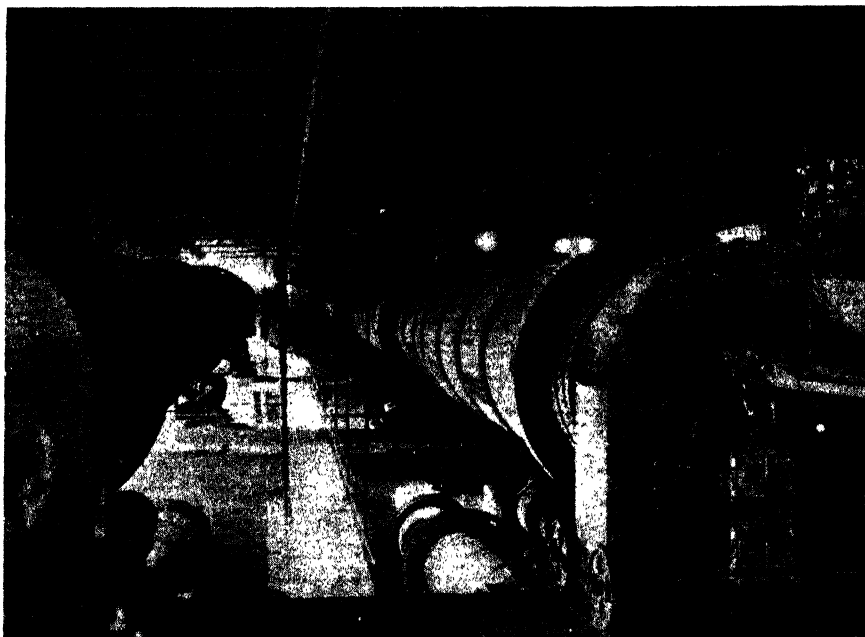

Figure 4. Modern rotary cement kilns, showing rotary coolers beneath the kilns.

are generally unsuitable because a magnesia content in portland cement of more than 5 percent is considered deleterious, and is not permitted by the standard specifications. Seams of gypsum or pyrite may cause the sulfate content of the product to be excessive. Chalk often contains flint pebbles which have to be removed, and marl may contain an excessive amount of silica sand.

High-grade limestone is hard and requires a great deal of power for grinding. But when intermixed with shale it is softer. Cement rock, found notably in the Lehigh Valley, is a limestone which contains such a quantity of argillaceous material that little or no additional shale or clay has to be added. In some cases,

additional limestone must be supplied, or a mixture taken of the high-lime and the low-lime rock.

Marl is a calcareous sedimentary deposit formed at the bottom of some lakes and is often mixed with an abundance of small shells. Important marl and marine-shell deposits are worked in Michigan and at Norfolk, Virginia.

In Texas and at Redwood, California, plants are in successful operation using ancient beds of oyster shells as the source of the lime.

Chalk is used in Louisiana and extensively in England and Europe.

In Michigan, the precipitated calcium carbonate obtained as a waste product in the manufacture of caustic soda by the Le Blanc process has been utilized for making portland cement.

The argillaceous materials available for making portland cement are:

clay	blast-furnace slag
shale	ashes
slate	cement rock

Clay, shale and slate are of about the same composition, but of different geologic ages and in different stages of consolidation. Each may be used in making portland cement, but a selection is sometimes desirable in order to favor intimate mixing.

Blast-furnace slag produced from high-grade ores, not too high in magnesia content, may be used satisfactorily as the source of the alumina and silica (10). The cement which results is not to be confused with portland-slag cement, for in the latter the slag is interground with the clinker, but not thereafter burned. In the true portland cement made with blast-furnace slag, the latter is used as the source of the silica and alumina, and the mixture burned to a clinker and ground.

Selected coal ashes also have been employed on a limited scale in making portland cement. Ashes of the proper composition may be mixed with limestone and burned in the usual way.

It has previously been mentioned that cement rock may be so high in argillaceous materials that no further additions of clay or shale are necessary. Thus the cement rock itself may constitute the source of silica and alumina in portland cement manufacture.

A number of sources of cement raw materials from industrial wastes are given by Ellis (13).

Proportioning of Raw Materials

Perhaps the most conspicuous difference between the procedure employed in the operation of a plant producing natural cement and one producing portland cement may be found in the great care required in the latter to control the composition exactly. In making natural cement, the native cement rock is calcined just as it comes from the quarry. But for portland cement a small variation in the established ratios of the principal components in the ground rock mixture may be sufficient materially to change the burning characteristics of the mix or the properties of the cement.*

The chemist is confronted with his two most serious problems before any rock

* See pages 152-166.

is taken from the quarry or any cement is made. First, what is the ideal composition range of a portland cement? Second, by what combination of the raw materials at his disposal can be most advantageously (from an economic point of view) and most successfully (from a quality point of view) produce cement?

The first question, the ideal composition range of portland cement, is the problem of the research chemist. But out of the experience of observant operatives and the formulation of experimentally demonstrated principles by engineers and chemists, there have been established certain rather definite limitations in the feasible composition of a cement. Within those limits experience has shown that the mixture behaves satisfactorily in the kilns and produces a good cement; outside of those limits experience has shown that trouble in burning may result or that the cement may be of inferior quality.

The proper lime content is limited due to the low early strength produced when the lime is too low, and unsoundness when it is too high. The old cements were lower in lime than the modern cements, but the strength developed by them, more especially the early strength, was lower also. In order to increase the strength it was necessary to raise the lime content, or grind finer, or both. But higher temperatures are required to burn the high-lime mixtures. There is no advantage in adding the extra lime unless it be brought into combination with the other constituents. If appreciable lime is left uncombined, it may cause expansion and cracking of the mortar or concrete. This property may be tested by an accelerated test consisting of exposure of a pat or bar of cement in steam or boiling water. If the specimen cracks, curls, or expands unduly it is designated as unsound; such cement is rejected by the standard specifications. When the lime content is raised too high, it becomes impossible to get all of it into combination, regardless of the temperature of burning, and the cement is unsound. There is a difference of opinion as to the amount of lime which should be optimum, but most chemists aim towards a product containing less CaO than is theoretically possible to combine. The high-lime mixtures give a cement which is more rapidly hardening, but the slightly lower-lime mixtures give a cement which continues to become stronger over a longer period of time.

The silica and the alumina and ferric oxide are likewise limited. If the lime content is fixed, and the silica becomes too high, which may be accompanied by a decrease in alumina and ferric oxide, the temperature of burning will be raised and the special influence of the high lime is lost. If the lime content is too low, which then means an increase in the alumina and ferric oxide, the cement may become quick-setting and contain a larger amount of alumina compounds, which appear to be of little value for their cementing qualities. Rapid setting is undesirable, and is not permitted by the standard specifications, because the cement sets up so rapidly that it cannot properly be worked in the forms before stiffening occurs.

The magnesia content is limited by the standard specifications not to exceed 5 percent because higher magnesia contents than that may be dangerous to the soundness of the cement, especially at late ages.

The customary method for expressing the relations that have just been described is by means of ratios of the several oxides. Numerous formulas have been proposed; many of these are very similar. Some are based only on the empirical

results of experience; some writers make every effort to base their formulas on a theoretical ideal composition in terms of the probable compounds formed. These formulas are treated at length in a later chapter.*

The second problem of the chemist is to determine the combination of raw materials at his command which will most advantageously satisfy the ideal-composition range formulas. By means of core drills from the rock and clay deposits he can determine the precise nature of the raw materials. By calculation he can ascertain the mixture which will give him a correctly proportioned mix. In some cases the correct proportions cannot be obtained with two types of rock, and a third or fourth may be required. Sandstone or iron ore is sometimes added.

Finally, trial runs must be made to learn if the physical characteristics of the mixture are such as permit economical handling of the material. Indeed, only when all these factors are adequately balanced can the process be successful.

Preparation of Kiln Feed

Having established the conditions of manufacture best adapted to the requirements of the particular plant, it then becomes necessary to direct the flow of rock that eventually finds its way into the kiln so that the desired composition shall be continuously and uniformly maintained.

Each cement plant of necessity uses materials that differ in some degree from those of every other plant. No two quarries are identical. In one, a limestone seam may be uniform in composition; in another, irregular and variable. A high magnesia rock may have to be blended with one that is low in magnesia. Cement rock from different parts of a quarry may have to be precisely mixed to produce the necessary composition. One plant may have to add sandstone to obtain the correct mixture; another may have to wash out from a marl an excess of sand.

It is also important that the materials be finely pulverized and uniformly mixed. If the different materials are not mixed intimately, the reactions will not take place in a uniform manner throughout the mass. An area of lime particles may be so far removed from a region of some acidic component that these particles will remain in the mixture as free lime. It must be remembered that portland cement is not completely melted, but only sintered, so some reaction has to take place by diffusion. The free lime remaining as the result of non-uniform mixing will be just as disastrous in producing unsoundness as similar free lime that might be left due to an excess of lime in the mixture. Only when the mixing is exceedingly intimate and the particles very small is it possible for the necessary reactions to go to completion during the sojourn in the kiln.

The fineness of raw materials usually is measured, in cement practice, as the percentage of material passing a No. 100 sieve or a No. 200 sieve (linear openings 0.0058 inch and 0.0029 inch respectively). It also is sometimes measured by turbidity or air-flow method, and expressed as surface area in sq cm per gram. It is especially important that all coarse material be returned to the mills, for a small amount of coarse grains will do much to destroy the beneficial effect of an otherwise finely ground mixture. †

* See Chapter 9.

† See pages 149-152.

These are the critical factors in the preparation of the raw mixture for the manufacture of portland cement: correct proportioning, fine grinding and intimate mixing; all of these are controlled by vigilant chemical inspection and rigid adherence to the predetermined ideal composition for that plant.

The Dry Process. The first step in blending the rocks may be made at once in the quarry by the steam shovels; one ladle of clay stripping and two ladles of rock, or two cars of this rock and three of that. Or the proper proportions may be weighed into the great crushers at the top of the runway. Through a battery of crushers the rocks wrench their way until they are only marbles. Then they are dumped into huge bins.

The chemist is intrusted with the all-important duty of keeping the feed to the kilns of precisely the correct composition. Usually this requires more than one point at which corrections in composition may be made. If the blending is done as described, then, by constant watchfulness of the lime content of the mixture, the chemist may direct slight changes in the amounts of shale or limestone, as they are dumped into the crushers, as such change is required to keep an approximately constant composition. But this is only a first approximation. As the finely crushed rock in the bins is found to be somewhat high or somewhat low in lime, the rock in two or more of the bins is mixed in such a ratio that the mixture will be very close to the correct composition. This mixing is usually done as the fine rock is fed into the pulverizing mills. And in many plants the pulverized raw feed is further blended by judicious selection from several bins in accordance with the analyses.

The methods of crushing and grinding which have just been described are a part of what is called the *dry process* method for preparing the raw material. By this process all the grinding and pulverizing is done on the rock in the dry condition. Indeed, the finely crushed rock is often passed through driers before pulverizing. The dry process is especially well adapted to cement rock and to the mixture of limestone and shale or slate.

The Wet Process. The *wet process* is the older of the two and was in use in Europe before portland cement was made in this country. The chalk, which is so abundant in Europe, contains numerous flint pebbles which are effectively separated by churning with water and allowing the pebbles to settle out, or by straining the slurry through screens. This same process has been found to be well adapted to working up clay, and has long been so employed in this country.

The finish raw grinding, by either the dry or the wet process, prior to 1929 was performed exclusively by open-circuit methods, that is, the finely crushed raw mixture was ground continuously until its mean fineness had reached the desired value. In 1928, Bogue* reported that little or no advantage was obtained by grinding the limestone or shale to very fine flour. Later pilot-scale tests confirmed these results and led to a recommendation to the industry in favor of closed-circuit grinding—a procedure by which the material which has attained a given minimum size is removed from the mills, while that not yet comminuted to such a size is returned for regrinding.

In the dry process, the separation is accomplished by means of air-separators

* See pages 149-152.

where a draft of air carries off the fines, leaving the coarse material in the circulating load. In the wet process, the separation is accomplished by the use of some form of classifier, presently to be described. The first installation of closed-circuit wet grinding in the finish mills was made at the Davenport plant of the Dewey Portland Cement Company in 1929, where the use of the process increased the capacity of the plant from 4500 to 6600 barrels per day, and decreased the fuel consumption from 135 to 120-130 lbs. of coal per barrel, with the expectation of reaching 100 lbs. per barrel (34). During the past 17 years the application of closed-circuit grinding methods has extended throughout the industry.

All the water added in the preparation of the kiln feed has to be removed at some stage in the process before clinker can be made. The water content of limestone-shale slurries may be from 32 to 40 percent and of limestone-clay slurries as high as 50 percent. If all this water were to be evaporated in the kilns, the coal consumption would be high. Slurry filters were introduced in the cement industry in about 1925. They consist of large rotating disks or drums covered with filter cloth, within which a reduced pressure is maintained. As the disks rotate slowly with the lower half immersed in the slurry, the latter forms a cake which is scraped off at the completion of the cycle. By this means the water content is reduced to about 20 or 30 percent. The cake is then fed into the kilns. It is claimed (29) that this process, as compared with feeding the original slurry into the kilns, has resulted in a saving of 25 to 45 lbs of coal per barrel of clinker, that the capacity of the kilns has been increased from 20 to 40 percent, that the resulting clinker was more uniform and ground more easily, and that mud rings in the kilns were eliminated.

More recently there has been introduced into common practice the use of hydro-separators, classifiers and slurry thickeners. Hydroseparators, rake (or spiral) classifiers and bowl classifiers comprise a class of hydraulic separators in which advantage is taken of the influence upon the settling rate in water of various particles according to their size or specific gravity, more or less modified by the rising velocity and the specific gravity of the pulp itself. They differ among themselves largely by the mechanical means used to separate the fine from the coarse particles. The field of each is governed by the type of material to be treated and the kind of products desired.

Thickeners are generally understood to refer to mechanical dewatering devices which receive a continuous feed of dilute pulp or slurry and by sedimentation, aided by mechanical removal of settled solids, yield an overflow free of solids and an underflow of higher solids content than the feed. The separated fractions are then ready for flotation to separate the mineral constituents further, as will presently be described. Any fractions not so treated, together with the concentrates from the flotation, adjusted to give the desired composition, are drawn into the slurry thickener. This is a large tank some 200 feet in diameter with a sloping bottom and a very slowly operated rake which works the settled and thickened slurry down to the center, where it is pumped, now containing from 35 to 40 percent of water, into the kiln-feed tanks. The overflow from the thickener is practically free of suspended solids.

A sketch of the raw-material flow sheet of the Leeds, Alabama, plant of the Universal Atlas Cement Company is shown in Figure 5, and a photograph of a

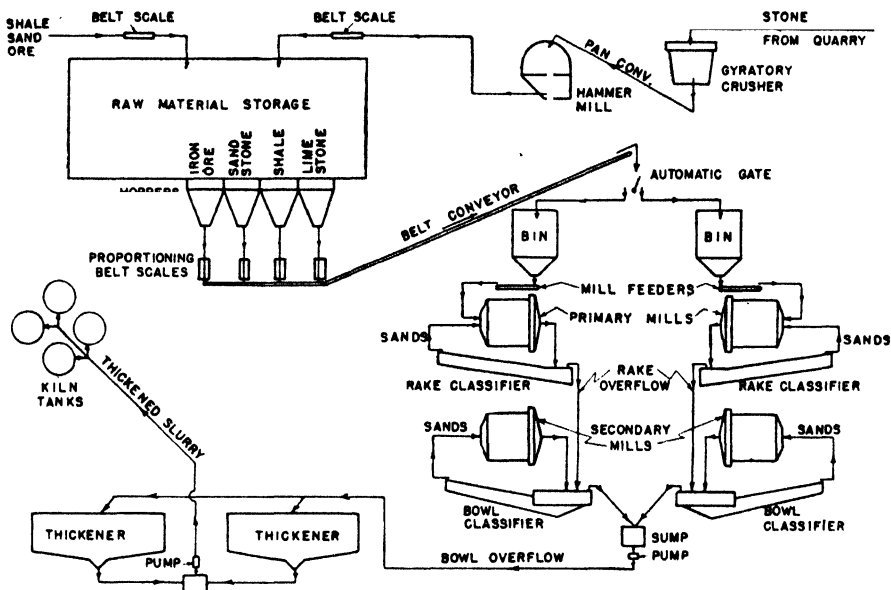

Figure 5. Raw mill flow sheet of the Leeds, Alabama, plant of the Universal Atlas Cement Company.



Figure 6. General view of the raw mill room at the Leeds, Alabama, plant of the Universal Atlas Cement Company. Shows primary and secondary mills and rake and bowl classifiers. (Courtesy of G. W. Lindsay)

part of the equipment, including the rake classifier, bowl classifier and primary and secondary mills, in Figure 6.

The chemical supervision in the wet process is generally regarded as more susceptible to accurate control than in the dry process. The customary procedure is to provide a number of large tanks for the receipt of the slurry as it comes from the pulverizers or the thickener. Each of these is provided with suitable devices of paddles and compressed air to keep the slurry in agitation to prevent settling or stratification. The CaO percentage of the slurry in each tank is determined and the contents of different tanks are blended for the final kiln feed. In some plants the slurry from the thickener is filtered, and the cake fed directly into the kilns.

Flotation

The range in compositions obtainable in a kiln feed is normally rather strictly limited by the compositions of the available raw materials. If an untreated cement rock is employed as the source of the lime, then the CaO cannot be increased beyond that of the rock unless a limestone of higher CaO content is provided. Or if the available clay or shale or cement rock contains a certain percentage of Al_2O_3 , a mixture (with the proper SiO_2 content) cannot be produced having an Al_2O_3 content below that resulting from the mixture of that material with the necessary limestone. However, modern demands upon the industry have imposed limiting compositions which sometimes are beyond these ranges which can be produced by any mixture of the available raw materials.

This problem has been met during the past decade by processes which bring about a separation of the undesirable from the desirable constituents of the raw material. Chief among these methods is the process of flotation first applied to cement technology by Breerwood (8)(14)(30). The details of the procedure will of necessity vary at each plant where the process is used, and may be varied at a given plant, due to changes in the character of the available rock and to the type of cement desired. By way of illustration, the process as employed at the Valley Forge Cement Company plant at Conshohocken, Pennsylvania will be described briefly (9)(35).

The rock at this plant is a metamorphosed argillaceous limestone, having a $CaCO_3$ content varying from 65 to over 85 percent, but averaging 75–76 percent. The balance is composed principally of quartz, mica containing more or less magnesia, and minor amounts of iron oxide, pyrite and pyrrhotite. The problem here is to produce a kiln feed lower in mica than the average rock. The net result of such an accomplishment is to lower the alumina, alkalies and magnesia, and to raise the lime.

The procedure employed, together with the analyses after each separation, are shown in the diagrammatic flow sheet in Figure 7. The first step consists of the separation of the tube-mill discharge into a fine and a coarse product by means of a hydro-separator or a centrifuge. Here the size point (particle size) at which the separation is made, and the proportion of each fraction, depend upon the particular slurry being treated and the final mix desired. The coarse fraction is always treated further, but the fine fraction may or may not be, depending upon the necessity or otherwise of removing large amounts of mica.

The coarse fraction is continuously passed through flotation cells where,

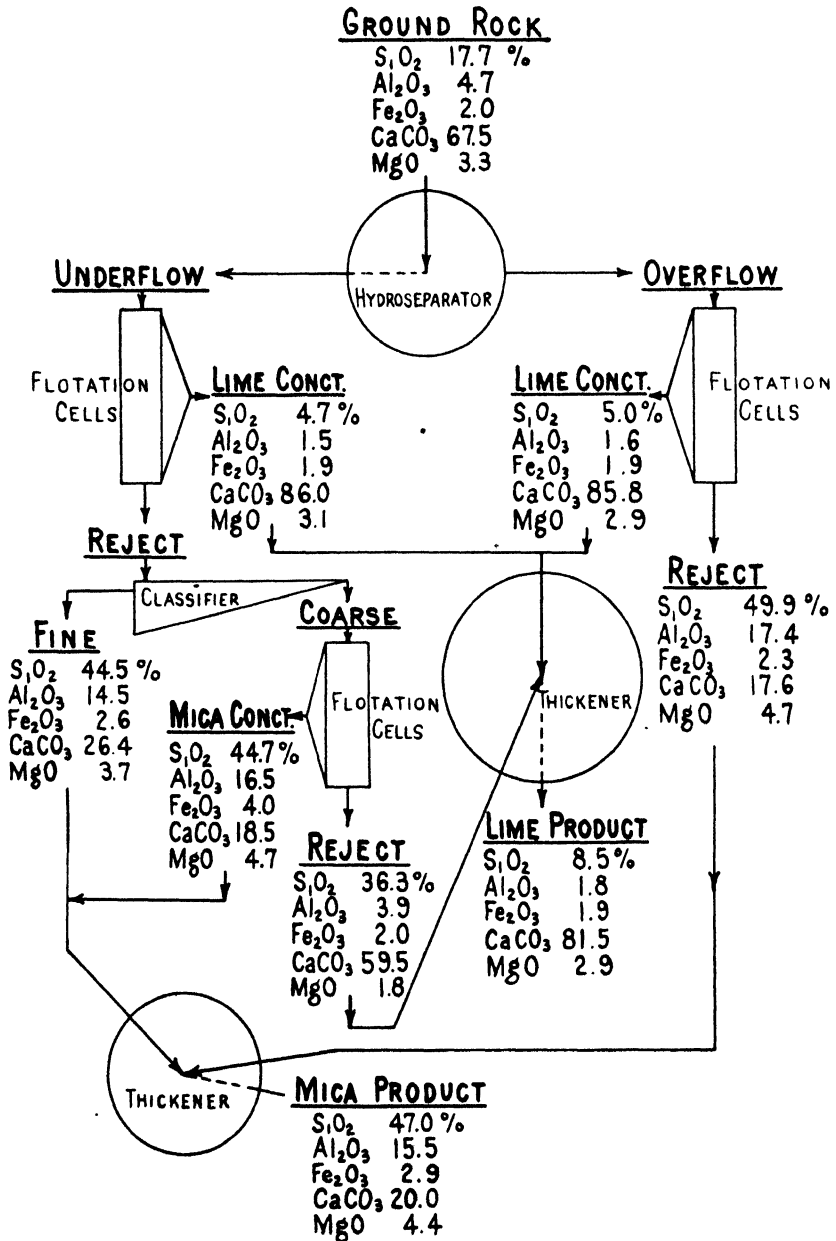

Figure 7. Flow sheet of the beneficiation department at the Conshohocken plant of the Valley Forge Cement Company. (Courtesy of C. H. Breerwood)

by the addition of a fatty acid (*e.g.*, oleic acid) or a soap and a frothing agent such as a synthetic alcohol, the calcite grains become attached to the bubbles of the froth and rise to the surface where they overflow. The quartz, mica, feldspar and other grains are preferentially wetted, do not float, and are continuously discharged with the liquid fraction. The agents used are so selected and proportioned that, for any given type of raw mixture, the desired separation can be effected. The froth containing the limestone concentrates is run into the thickener the slurry from which constitutes the kiln feed.

The rejects from the above cells are separated in a classifier. The overflow, consisting largely of mica, goes to the mica thickener, and the coarse lime-rich fraction is subjected to further separation in a cationic cell. In this cell the micaceous material is floated off and goes to the mica thickener, and the rejects are passed to the kiln-feed thickener. The mica products are recovered and sold as a by-product.

Where the overflow from the hydro-separator is also treated, as shown in the diagram, it is passed through a fatty-acid cell similar to that used for the coarse fraction. The lime concentrate is then passed to the kiln-feed thickener and the rejects, consisting principally of fine mica, are sent to the mica thickener.

The cationic cells operate on a different principle from the anionic or fatty-acid cells. It had been discovered that cationic reagents, in which the surface-active constituent is the positively charged cation, are effective as collectors of acidic or siliceous minerals. Hence, by the use of such reagents in very small quantities, the silicates of aluminum and magnesium could be floated off from the quartz, ferric oxide and calcite. The most satisfactory cationic reagent found by Breerwood for floating the mica minerals was a technical hydrochloride of laurylamine.

The presence of graphite carbon was found to interfere with successful operation of the cells above described, but this could be removed by a preliminary flotation with suitable reagents.

It may be noted from the analyses on the diagram that the raw material has been beneficiated by the removal of mica, as follows:

	Raw rock	Lime products	Rejects
SiO ₂	17.7	8.5	47.0
Al ₂ O ₃	4.7	1.8	15.5
Fe ₂ O ₃	2.0	1.9	2.9
CaCO ₃	67.5	81.5	20.0
MgO.....	3.3	2.9	4.4

A number of significant developments of flotation and centrifugation have been described by Franks (17) of the National Portland Cement Company. The particular problems of this plant required that the principal correction in composition be made, not on the coarse fraction of the mill slurry, but on the fine fraction, and at a fineness heretofore thought impossible in flotation. About half of the mill slurry was centrifuged, the cut being at about 15 microns, which process raised the CaO content about 2 percent in the coarse fraction. The fine low-CaO fraction was subjected to flotation and the CaO content raised to such

a value that, by blending, any of the cement types could be produced. Graphite was removed in the first three flotation cells, using a resinate, kerosene and an alcohol frother. The next three cells made a separation of CaO-rich from CaO-poor slurry to produce a concentrate of about 85 percent CaCO_3 . The last three cells were used to recover CaCO_3 which passed the previous cells. Dilute goulac was used in the fourth cell to depress natural flocculation and also to depress the residue of carbon in the lime-flotation circuit. By these means the difficult problem of floating a minus 15 micron slime was solved.

Advantages which could be gained by a proper cleaning or conditioning of the exposed surfaces of grains, to be subjected to flotation, have been stressed by Norman and Ralston (24).

The successful application of the differential flotation necessary to effect the various classes of separation called for by the many types of raw materials at hand and the various types of cements required, is one of the outstanding achievements in cement technology in the current decade.

The Burning Operation

The use of vertical or stack kilns, first employed in England, was continued in the early installations in the United States, and still are not uncommon in some parts of Europe. Various types of kilns are discussed by Martin (21), but for the most part they have been entirely superseded by the rotary kiln.

Since the burning operation is one of the greatest importance in the manufacture of clinker, the operator has many responsibilities (2). The trend in modern plants, however, is almost complete control by the use of automatical recording instruments (27).

In the usual American practice the raw mixture, (either in the form of a dry powder or a thin slurry, is fed at a uniform rate into the upper end of a long rotary kiln. These kilns vary from 100 to 500 feet in length and 8 to 15 feet in diameter. They are caused to revolve slowly (one turn in from one to two minutes) and, as they are set at a slight inclination (a few tenths of an inch to the foot), the charge slowly travels downward toward the hot end of the cylinder. The kilns are usually heated by a blast of powdered coal, and air is introduced through a pipe inserted a few feet into the lower end. Fuel oil or gas is sometimes used. The hottest temperatures are therefore developed in a rather narrow zone at the lower end of the kiln, and become less as the upper end is approached. The maximum temperatures are about 1400° to 1500° (2552° to 2732°F .). Special refractories are required, especially for the hot zone of the kiln (15)(33). —

As the raw mixture proceeds along the upper part of the kiln, the water is first evaporated. Somewhat further along, the organic matter burns away and the carbonates lose their carbon dioxide. A portion of the sulfates also is decomposed, liberating SO_3 , and chlorides and alkali salts are partially volatilized. Potash has been profitably extracted from the stack dust, especially during World War I, when potash was in great demand.* Due to the volatilization of the above materials about a third of the original weight of the dry raw mixture is lost in the burning process.

* See pages 91-94.

In the hotter regions of the kiln, about 20 to 30 percent of the mass is converted to liquid. The reactions of clinker formation take place chiefly in that liquid, several new compounds crystallizing out as the compounds of the original mixture disappear from the system. The value of the product as a cement depends upon the reaction of the several components of the raw mixture to produce those new compounds. Only in the degree that they are formed is the mixture of ground rocks converted into cement clinker. Hence it is important that the reactions proceed to completion.*

Multistage units have been described in which the raw mix is first calcined to drive off water and carbon dioxide, and then burned to clinker (25). Improved fuel economy is claimed, but such installations have not found favor in the industry.

If the temperature of burning has been too low, the cooled clinker will be dull and somewhat chalky in appearance; it has not been well sintered, and the reactions have not proceeded to completion. Such clinker is spoken of as underburned. It probably will be unsound due to the presence of some still uncombined lime, and it will not develop the normal strength as it is in reality a mixture of cement and incompletely combined materials. If the temperature is higher than necessary, the clinker will be more molten, and perhaps harder to grind, and under some conditions will contain free CaO.† There is no advantage in this overburned condition and it entails an unnecessary waste of fuel. A properly burned clinker presents the appearance of small, rounded irregular balls, velvety black or gray black, showing many tiny sparkling crystals.

The color of the ground clinker is due to a number of factors. If practically free of ferric oxide, the cement is white or nearly white. But if ferric oxide is present in the usual quantity, the color may be dark gray or light gray, or it may be any of a number of shades of brown. In pure form, the iron compound is darkened by small amounts of magnesia. Other elements, such as titanium and manganese, have been found to impart various shades of color.

Difficulty is sometimes experienced in obtaining a pure slate-gray color in the cement, which many markets prefer. A cement which shows a yellowish cast has been viewed with suspicion and referred to as discolored. The causes for the various shades of brown have been studied by many investigators. Some have claimed that discoloration is due to rapid quenching of clinker from a high temperature, and can be prevented by forcing more air into the kilns or allowing the clinker to air-cool somewhat before sprinkling with water (32). It has been pointed out (20) that dissociation of the iron compound with the formation of CaO and Fe₂O₃ at high temperatures may impart yellow or red tints if cooling is so rapid that recombination does not take place, as in water-quenching. The necessity of maintaining oxidizing conditions in the kiln has been stressed (6), and refuted (19), and the presence of sulfur with the iron oxide, under reducing conditions, has been offered as a contributing factor (26).

Color is also a function of the relative amounts of glass and crystallized liquid which are present in the clinker (18). Thus the crystalline iron compound, C₄AF, is

* See Chapter 6.

† See pages 161-167.

chocolate-brown, but in solid solution with MgO and cooled in air it is black. The glass resulting from the undercooling of a liquid containing such material is yellow or light brown. Consequently, a quenching of clinker by which very little crystalline C_4AF would be present may result in a brownish cement, whereas the same composition, similarly burned but cooled more slowly, may be a slate color, the depth of tone depending upon the amount of iron present.

The quality of discolored clinker has not been found to suffer in comparison with that of clinkers of the same composition and otherwise similar (32).

The kiln attendant under the direction of the chemist is charged with the responsibility of properly burning the mixture to obtain the maximum yield of good clinker. By a proper regulation of many variables he can obtain the optimum performance. The conditions for determining such performance are established by visual observation and temperature measurement of the clinker in the hot region of the kiln, by inspection of the cooled clinker for appearance, liter-weight, etc., and by a frequent or continuous observation of the temperature and analysis of the gases as they leave the kiln (7). Analysis and tests on the finished cement serve as a final check on the entire operation.

Treatment of Clinker

Shortly after the clinker has reached the position of maximum temperature in the kiln, it drops from the kiln and may be cooled by any of a number of processes. In the earlier installations the hot clinker was allowed to fall directly onto the clinker storage pile, or onto a drag conveyor or into bucket elevators which transported it to the storage pile. A spray of water was usually directed onto the hot clinker to aid in the cooling process. Although it was sometimes ground while still hot, it was believed by some that a clinker which had remained in the storage pile for a period of some days or weeks was improved both in grindability and soundness. By others this was roundly denied (10).

A simple rotary-type cooler (see Figure 4) has long been used to aid the cooling, consisting of a rotating steel shell fitted with baffles which lift and drop the clinker to effect the cooling. The heat of the clinker is lost. This heat amounts to about 200,000 Btu per barrel of clinker, equivalent to about 15 to 20 lbs. of coal. To recover this heat, various types of enclosed air-circulating coolers were designed and today are in common use. In all of these the air from the cooling clinker is utilized as the secondary or primary air of combustion in the kilns, or for heating waste-heat boilers from which power is derived. Advantages claimed for such treatment are fuel economy, better burning of the clinker, immediate availability of the clinker for grinding, improved grindability, higher strength and improved soundness of the cement (4)(22).

More recently, the advantages of avoiding the complete crystallization of the clinker melt have become known,* and the utilization of clinker-cooling equipment has advanced and has been designed with the purpose of controlling this process through an optimum rate of cooling (23).

Because of the high velocity of the air introduced into the kilns with the combustion mixture and the fine character of the raw mixture, the losses from

* See pages 103-105.

dust blown out at the upper end are considerable. It was early practice to allow this dust to pass out of the chimneys, but the nuisance resulting from large volumes of dust settling upon the country-side are such that measures were taken to separate it from the outgoing gases. The means are numerous; among them are settling chambers, cyclone collectors employing the principle of centrifugal action, and electrostatic precipitators where a silent electric discharge causes the dust particles to deposit on one of the electrodes (31)(16). The dust, combined with that collected from various other departments of the operation, is usually returned to the kilns, either directly or by mixing with the slurry in the kiln-feed tanks. During World War I some plants leached from it the potassium sulfate, which was sold as a fertilizer.

As the clinker passes to the mills it is mixed with a carefully adjusted amount of a "retarder" consisting of gypsum ($\text{CaSO}_4 \cdot 2\text{H}_2\text{O}$) or plaster ($\text{CaSO}_4 \cdot \frac{1}{2}\text{H}_2\text{O}$) as, without that, the cement on mixing with water to make concrete may set or stiffen too rapidly. The amount of the gypsum or plaster added is limited by the standard specifications. The amount of gypsum required to produce the most favorable "time-of-set" has been found to depend largely on the alumina content of the mixture.*

The time-of-set is a relative term which is used to designate the time-period required for a cement-water mixture to stiffen and to become hard. Initial set refers to the first stiffening, while final set refers to a hardening of the mass. For measuring these times-of-set, different kinds of weighted needles are used, and the time recorded when the needle fails to make a certain arbitrarily defined indentation.

Other approved materials, as grinding aids, air-entraining agents, etc. may be admixed with the clinker and interground in the final grinding operation.

The mixture of clinker and gypsum or plaster is ground to a surface area which is specified for each type of cement.† If the cement is too coarse, segregation or "bleeding" may occur, and the water will not be able to react with it rapidly enough to develop the greatest value in the cement. There is difference of opinion with respect to finer grinding, but it is usually maintained that the cement will develop its strength the more rapidly the finer it is ground; but that very quality may deprive the cement of a reserve of hydratable material which may be of great value.

The ground cement usually is stored in concrete silos and packed in cloth or paper bags, 94 pounds to the bag, for shipment. Storage of cement in the bins has been reported not to be harmful, but on the contrary to be possibly beneficial. If small amounts of lime have remained uncombined during the burning, the product may be slightly unsound. But on storing for a brief period, this lime hydrates and carbonates by reaction with the water and carbon dioxide of the air and may then be incapable of causing unsoundness. Prolonged storage in packages, however, under conditions where moist air may gain access to the cement, has been found to result in a decrease in strength of test specimens, especially at early ages. Under such conditions, a partial hydration takes place, as a result of which the ignition loss is increased, the cement appears to be coarser

* See pages 481-484.

† See page 23.

to the touch, the amount of water required to make up a neat cement paste of standard consistency increases and the setting time is generally increased (1)(28).

Testing of Cement

As a means of security to the manufacturer and a guarantee of quality to the consumer, portland cement is usually sold under the standard specifications of the American Society for Testing Materials, or of Federal or state agencies. The essential features of these specifications have already been given.* The technique for making these tests may be found in the Standard Specifications of the American Society for Testing Materials or in the Federal Specifications for portland cement and need not be repeated here.

Other Aspects of Manufacture

In the manufacture of portland cement, many by-products or co-products have been obtained, or applications of the cement-plant machinery or raw materials have been proposed or employed for supplemental uses. The manufacture of quick-lime or other hydraulic cements has long been associated with the portland cement industry. A method, known as the *Basset process*, has been adopted in France, Denmark, Spain and Japan by which, with small changes in composition of raw mix, in burning temperatures and technique, pig-iron is obtained and tapped from the kiln (5)(3). Sponge iron and nodulized iron ore have been investigated by the U.S. Bureau of Mines. Potash has been recovered from the flue dust† and mica from the flotation rejects. Phosphates have recently been treated for the fertilizer industry. Rock wool, alumina and magnesia have been produced. It would be beyond the scope of this work to examine these many diversities in manufacture.

The economics and labor relations of the cement industry have been discussed in a publication of the Works Projects Administration (36). The detailed statistics of the industry are compiled by the Bureau of Mines.

References

1. Abrams, D. A., *Structural Materials Res. Lab., Bull.* 6 (1924).
2. Anon., *Rock Products*, Sept., 1939.
3. Anon., *Rock Products*, July, 1936.
4. Anon., *Concrete, CMS*, Jan., 1935.
5. Anon., *Concrete, CMS*, March, 1936; April, 1941.
6. Blaise, H. H., *Rock Products*, Feb., 1929.
7. Blank, A. J., *Rock Products*, May, 1930.
8. Breerwood, C. H., *Rock Products*, Aug., 1934.
9. Breerwood, C. H., Personal Communication.
10. Bryant, N. L., *Rock Products*, July, 1931.
11. Bryant, N. L., *Rock Products*, April, 1929.
12. Elber, M., *Concrete, CMS*, April, 1928.
13. Ellis, E. T., *Concrete, CMS*, Nov. 1927; Apr. 1930.
14. Engelhart, G. K., *Ind. Eng. Chem.*, **32**, 645 (1940).

* See pages 22-23.

† See page 91.

15. Fisk, H. G., *Cement and Lime Mfg.*, **12**, 257 (1939).
16. Fraas, F. and Ralston, O. C., *Ind. Eng. Chem.*, **32**, 600 (1940).
17. Franks, F. B., *Rock Products*, Feb., 1941.
18. Hansen, W. C., *Res. Reports, PCAF*, Sept., 1928.
19. Koyanagi, K., *Rock Products*, Sept., 1931.
20. Kuhl, H. and Adam, W., *Zement*, **15**, 456 (1926).
21. Martin, G., *Rock Products*, July-Dec., 1930.
22. Nordberg, B., *Rock Products*, Nov., 1939.
23. Nordberg, B., *Rock Products*, May, 1941.
24. Norman, J. E. and Ralston, O. C., *Concrete, CMS*, March, 1940.
25. Pike, R. D., *Rock Products*, Feb., 1930.
26. Pool, A. J., *Rock Products*, Dec., 1931.
27. Reaser, W. E., *Rock Products*, Feb., 1942.
28. Reid, D. A. G., *Cement and Cement Mfg.*, **4**, 261 (1931).
29. Robinson, A. W., *Rock Products*, Jan., 1931.
30. Rockwood, N. C., *Rock Products*, Aug., 1941.
31. Schaffer, H. A., *Rock Products*, May, 1931.
32. Shroder, H., *Concrete, CMS*, Sept., 1927.
33. Tschirky, L., Address before PCA, Sept., 1944.
34. Tyler, H. F., *Rock Products*, Dec., 1930.
35. Williams, J. C., *Am. Inst. Mining Met. Eng.*, Tech. Pub. 1901 (1946).
36. Works Projects Administration, Report M3 (1939).

CHAPTER 4

Early Experimentation on the Constitution of Portland Cement

The manner of combination of the clay with the lime, by which process a hydraulic cement is formed, seems not to have interested many of the earlier engineers or manufacturers. They were concerned over the materials and the technique of manufacture and utilization, but not so greatly over the underlying causes of why certain combinations of materials and technique produced specific results. As stated by John Grant (8) in 1865:

The manufacture of portland cement is not one of complex character although it requires the exercise of extreme care in the admixture of its two simple and well-known ingredients, clay and chalk.

The ancients believed that the changes attending the heating of limestone consisted mainly in the discharge of the air and water contained in it, and that when the lime was again placed in water it recombined with the air and water by which process it again became firm. Even up to the nineteenth century this conception had been modified but little.

In the latter part of the nineteenth century, however, due to the utilization of the microscope and to a better comprehension of chemical principles, new discoveries were made and important contributions advanced on the constitution of portland cement. Some of these have, of necessity, been rejected but many have remained as the foundation for all later investigation.

The Period of Speculation

In a memoire published by the Academy of Sciences of The Hague in 1832, Fuchs (7) maintained that the only role of calcination was the dissociation of the clay and limestone whereby the silica of the clay was brought into a condition such that it could combine with the lime when the product should be gauged with water.

Rivot and Chatonney (20) in 1856 suggested for the first time that the hydraulicity of cement might be due to the formation of "a silicate of lime, an aluminate of lime and a silico-aluminate of lime forming hydrated salts under the action of water."

Pettenkoffer (19) (1849) supported the theory of Fuchs, and Feichtinger (14) speculated further:

After the calcination we have an amorphous mixture of the silica and much free lime. To effect the hardening in water a triple chemical action enters into play. First, there is a fixation of water by all the constituents. Following this, the combination of silica with lime. It is this which constitutes harden-

ing. Finally the free hydrated lime is carbonated by the carbon dioxide of the air.

Heldt (10) in 1853 claimed the formation of an active silicate and of an inert aluminate. In 1863 Zulkowsky (14) first referred to *hydraulicite*, which he regarded as a "basic pozzolan which, when mixed with free lime, forms cement."

Fremy (6) in 1866 published a paper which stands prominently among those of this period. He claims to have prepared a variety of calcium silicates, calcium aluminates, and double silicates of lime and alumina. He reported the silicates to be without hydraulic action, while the aluminates he found on gauging with water to "solidify almost instantly and produce hydrates which acquire in water a considerable hardness." Furthermore, when these aluminates were mixed with large amounts of sand, he obtained mortar which "acquired the hardness and solidity of the best stone." Fremy believed, as a result of these experiments, that portland cement contained calcium aluminates and silicates, a double lime-alumina-silicate and free lime. Hydration then consisted in the hydration of the aluminate, and the reaction of the free hydrated lime with the silicates and double silicates.

In 1876 Knapp (14) claimed that the solidification was due to a combination of both chemical and physical forces. Landrin (12) believed in the presence of a special product, probably similar to the *hydraulicite* of Zulkowsky, which he named *pozzo-portland*.

This brings us to the period of Henri Le Chatelier (13). The views held by investigators at this time were, for the most part, the product of speculation and those experiences of operative technique which gradually and inevitably bring out data and of which the inquisitive mind demands some explanation. There had been formulated very little research designed to solve definitely the problem of chemical constitution of clinker. The investigations attempted had been confined for the most part to engineering problems of manufacture and the chemical and engineering problems of setting and hardening. The theories on constitution were consequently those of speculation and not of intelligently directed experimentation. In general, these theories were of three types: (1) that clinker consists of a mixture of anhydrous lime and silica which combine when brought in contact with water; (2) that some of the lime and silica are caused to combine by the burning process forming a mono- or possibly a di-calcium silicate, and leaving an excess of free lime; and (3) that clinker consists of hydraulic calcium aluminate, silicates and free lime which combine during the hardening process.

Introduction of the Scientific Method

Henri Le Chatelier brought to the cement industry a hand of unusual experimental skill, a brain of marvelous perception, and a spirit of achievement which together have placed him at the front of all of his contemporaries, the Nestor of scientific investigators on portland cement. It is a subject of marvel that, with the very limited means for measurements of precision which were available in 1887, Le Chatelier succeeded in discovering and postulating so many points which today are acknowledged to be facts.

The publications of Le Chatelier began to appear in 1882, but his work of greatest merit was embodied in his thesis published in 1887. This was translated and published in the United States in 1905 (13).

In his earlier papers, Le Chatelier held that the orthosilicate, $2\text{CaO} \cdot \text{SiO}_2$ was the chief if not the only hydraulic constituent of portland cement. Other compounds which he believed to be present were $3\text{CaO} \cdot \text{Al}_2\text{O}_3$, occasionally with lime; $3\text{CaO} \cdot 2(\text{Fe}, \text{Al})_2\text{O}_3$, a deep brown-colored alumina-ferrite of lime; and certain very small crystals, probably magnesium compounds.

The versatility of Le Chatelier is noted in the adoption by him, even in these earliest studies, of the polarizing microscope as the means for the identification of the crystalline phases in his clinker. This work will presently be described. His procedure included also the synthetic preparation of the compounds which he believed that he had identified in the clinker.

The orthosilicate, $2\text{CaO} \cdot \text{SiO}_2$, was of especial interest to Le Chatelier because of the property it possessed of spontaneous disintegration, or dusting. He explained this as due to the presence of twinned crystals. The unequal contraction of the opposed faces of the twins during the cooling process he held to be responsible for the disintegration observed. This idea originated from a study of potassium sulfate which, at nascent redness, according to Mallard as quoted by Le Chatelier (13) shows:

an extremely clear reversible dimorphic transformation which is accompanied by numerous twin formations. These twin crystals bring into contact different reticular planes the proximity of which determines the internal molecular tensions which are augmented during the cooling as a result of the inequality of the coefficients of expansion. It is conceivable that these tensions may bring about the disintegration of crystals having sufficiently easy cleavage.

Other materials exhibiting similar disintegrations are discussed by way of support to the theory given.

This disilicate, however, he reported later to be essentially non-hydraulic:

After six months a sample of paste enclosed in a tube to protect it from carbonic acid crumbled immediately upon a simple pressure of the finger. However, I do not wish to say that at the end of a very long time water may not exert some action, because it is known that all the silicates, even the most acid ones, are slowly decomposed by water. These experiments nevertheless suffice to establish the fact that $2\text{CaO} \cdot \text{SiO}_2$ can only take a secondary part, if any, in the hardening of cements.

Thus in this thesis he attributes to the disilicate a negligible role among the constituents of clinker.

Le Chatelier later believed in the existence of a tribasic silicate, $3\text{CaO} \cdot \text{SiO}_2$, in clinker. This belief originated from the analysis of the *grappiers*, or nodules remaining on the hard burning of certain siliceous limestones. The ground *grappiers* were found to give a high quality of cement, and their analysis showed them to consist largely of lime and silica in the proportion to form $3\text{CaO} \cdot \text{SiO}_2$. Hence, Le Chatelier believed that the essential hydraulic constituent of portland cement was also this tricalcium silicate. But all attempts to prepare it syntheti-

cally proved futile. On heating together lime and silica in the proper ratio, only a mixture of calcium silicates and free CaO were formed. The use of calcium chloride as a flux gave him the crystalline compound, $2\text{CaO} \cdot \text{SiO}_2 \cdot \text{CaCl}_2$, but failed to effect the combination he desired. All further attempts to produce the trisilicate by fusion methods were unsuccessful, but he claims to have prepared it by decomposing the chlorosilicate with water vapor at a temperature above 450°C . He writes the reaction:



The reaction was incomplete, however, and the product could not be studied microscopically as it appeared amorphous, but it seems to have possessed properties of setting and hardening similar to those of cement. He found it to show no signs of swelling or cracking, which he regards as a certain indication of the presence of free lime, and adds,

This characteristic, together with the property of setting which none of the lower silicates possess, shows clearly that we have to do with a compound and not a simple mixture whose properties would simply be the sum of those of the mixed bodies.

He regards these experiments as sufficient evidence for the existence of $3\text{CaO} \cdot \text{SiO}_2$ in cement.

Tricalcium aluminate, $3\text{CaO} \cdot \text{Al}_2\text{O}_3$, was prepared synthetically, and found to be the most fusible of the aluminates. More basic aluminates were not formed. Le Chatelier was unable to obtain calcium ferrites but, in the presence of alumina, double compounds were reported to be formed and considerably to augment the fusibility of the corresponding lime salts. The compound $3\text{CaO} \cdot \text{Al}_2\text{O}_3 \cdot \text{Fe}_2\text{O}_3$ is described as a well crystallized salt consisting of long needles of a beautiful red color.

Microscopic Studies

Henri Le Chatelier. Le Chatelier was perhaps the first to appreciate that chemical analysis revealed little concerning the nature of the compounds formed during fusion and crystallization. He was the first to apply the microscope consistently to this problem. He prepared thin sections of clinker and describes the following constituents (13):

- (1) Colorless crystals, with weak double refraction, with square or hexagonal cross sections and very clear borders much resembling those of the cube. It is by far the most abundant constituent.
- (2) In the space between these crystals, a ground mass, the color of which is always dark and varies from a yellow red to a greenish brown. Its double refraction is stronger than that of the preceding material, but it does not possess any clear crystalline contours.
- (3) Beside these two essential elements, accessory elements are frequently found, varying in different samples:
 - (a) Crystalline sections of forms and dimensions analogous to those first given, but which are distinguished from them by a light brownish, slightly yellowish color, a complete absence of transparency, and by very fine striae inclined to each other at about 60° . This constituent,

although scarcely plentiful, is found, however, in almost all samples of cement of good quality.

- (b) Very small crystals of sufficiently strong double refraction to give polarization colors. This constituent is always in small quantity and is sometimes entirely absent. It is found especially in underburned cements.
- (c) Certain forms without action upon polarized light and of negative character which do not give any distinguishing test.

Since acids were found to attack all the constituents of clinker, as viewed under the microscope, Le Chatelier concludes that "the essential elements of cements are therefore siliceous."

He finds the iron oxide to be present mainly in the flux surrounding the crystals, and magnetic oxide only as accidental inclusions arising generally from emery used in grinding. The alumina is not identified in any compounds, but is assumed to be combined with the iron oxide and lime. To summarize:

The absence of free lime in portland cements of good quality is very certain; the existence of the aluminate is only probable.

This chemical study of the calcined portland cements shows, therefore, that they are formed essentially of a calcium silicate differing little from the formula $3\text{CaO} \cdot \text{SiO}_2$, which is the active element of hardening, and that the compound is produced by chemical precipitation in the midst of a molten double silicate, which has acted as a vehicle for the silica and lime to allow them to combine, but which remains sensibly neutral during their hardening.

A. E. Tornebohm. The important researches of Tornebohm (22) were published ten years after the thesis of Le Chatelier, but without knowledge of this thesis. The points of especial interest in the papers of Tornebohm were (1) the designation of characteristic names for the several constituents of clinker as seen under the microscope, and (2) the separation of these constituents by means of liquids of high specific gravity.

Tornebohm identified four crystalline constituents, and an isotropic colorless glass which he found always or nearly always to be present in clinker. The crystalline substances he named: *alite*, *belite*, *celite* and *felite*.

The most abundant constituent he found to consist of colorless crystals of weak birefracton, rectangular or hexagonal. They showed a high index and biaxial interference figures. This he called *alite*.

Belite was designated by a greasy yellow color and bright interference colors. He states that the index is high, that it forms in small rounded grains with no definite crystal form, and that the grains are biaxial and often striated.

Celite, he stated, is easily recognized by its dark orange-yellow color and its strong birefracton. He reports that it is often present in the form of rods, especially in underburned clinker, while in well-burned clinker it forms the filling material and magma from which the alite separates.

Felite he describes as a colorless biaxial compound with strong birefracton. He reports that the index is high, being nearly the same as that of belite. The grains are usually rounded, sometimes elongated, and usually striated perpendic-

ular to the elongation. It is found in variable quantity and often is entirely absent. It seems to replace belite.

The *isotropic residue* is described as a colorless amorphous material of an index as high or higher than that of alite. It constitutes a filling material which is not always easy to distinguish from alite.

A comparison of these compounds with those reported by Le Chatelier shows a passable agreement. The No. 1 of Le Chatelier appears to be the alite of Tornebohm. No. 2 corresponds to celite. No. 3a is similar to belite. No. 3b is probably the same as felite, and No. 3c seems to be the isotropic material of Tornebohm. The criteria for the identification of these constituents, however, are too inadequate to place great significance upon them.

Comparison of Researches. These conclusions of Le Chatelier and Tornebohm have constituted a foundation upon which have been erected many theories and hypotheses of structure, constitution and manufacturing technique.

But although Le Chatelier and Tornebohm find some agreement in their microscopic classification of cement constituents, they do not arrive at the same conclusions with respect to the chemical constitution of these substances. Le Chatelier regards the principal hydraulic constituent of cement as $3\text{CaO} \cdot \text{SiO}_2$, a formula arrived at through theoretical considerations, combined with studies on the composition of cement-like nodules obtained from the grappiers of hydraulic limes. Tornebohm on the other hand, believed alite to be a complex compound. He came to this conclusion by first making a separation of the alite from a cement consisting essentially of alite and celite. This he accomplished by making a fractional separation in heavy liquids, especially methylene iodide, but he admits that the separation was not complete, as some celite always remains with the alite. The product, essentially alite, then analyzed as follows:

	Percent
SiO ₂	20.33
Al ₂ O ₃	7.19
Fe ₂ O ₃	3.65
CaO.....	63.65
MgO.....	2.62
Na ₂ O.....	0.85
K ₂ O.....	1.04

By assuming that the product still contained 10 percent of celite, he deduced the composition of alite as:

	Percent
SiO ₂	19.48
Al ₂ O ₃	7.83
CaO.....	67.60
MgO.....	3.00
Na ₂ O.....	0.90
K ₂ O.....	1.19

By assuming, further, that the MgO and the alkalis play the same role as CaO, and substitute for it in equivalent proportions, the formula for alite was written:

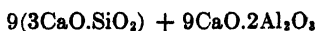

Formulas for the other constituents of clinker were more difficult to express, and could not be established by chemical means. They all appeared to contain both CaO and SiO₂ with the possible exception of felite. Alumina could not be identified with certainty and was believed to be associated with the Fe₂O₃ in the colored flux.

The belite was reported to be present only in clinker somewhat low in CaO or high in SiO₂. Celite was stated to be a double silicate of alumina, iron and lime, but was thought not to have a definite composition. Tornebohm regarded it not as a chemical compound, but as a crystallized mother-liquor, separating after the other phases had appeared. The composition varied according to the conditions surrounding each clinker and the rapidity of cooling. Felite was observed only in imperfectly burned cements. It was thought to be easily decomposed and to consist probably of a calcium aluminate. In well-burned and basic cements, the celite was believed to contain all of the alumina.

The isotropic material was thought to be a double silicate of CaO and Al₂O₃.

Other Theories of the Period

During the period from 1895 to 1900 several investigators carried out experiments by which they arrived at the conclusion that free lime in rather large quantities is present in portland cement clinker. Most of these investigations were directed primarily at the solution of the phenomena of hydration, setting and hardening, and the conclusions respecting the constitution of the original clinker were more or less incidental.

Zulkowski (24) believed cement clinker to be a mixture of free CaO and a double silicate of lime and alumina of the formula: 4CaO.Al₂O₃.2SiO₂. This ternary compound he called *hydraulicite* and believed it to be the alite of Tornebohm, the chief hydraulic constituent of clinker. The method used by Zulkowski for determining the free CaO consisted in treatment of the cement with a dilute solution of hydrochloric acid.

Hart (9) reported as much as 30 percent of free lime in cement clinker, obtained by extraction with a 10 percent alcoholic solution of iodine. Hart believed that the lime liberated in this manner was the active agent of hardening.

Wormser and Spanjer (23) reported large amounts of free CaO obtained first in alcoholic solution of aluminum chloride and, later, by a method using solid aluminum chloride and ammonium oxalate. Rebuffat (18) extracted CaO with sugar solutions. Many methods employing aqueous solutions have been used repeatedly, and these in spite of the admonitions by Michaelis (17) that such reagents could not give exact results, and the report of Rohland (21) that quantitative proof of the existence or non-existence of free CaO or Ca(OH)₂ could not be obtained by purely chemical means.

Meyer (16) conducted a brilliant study as a result of which he concurred with Le Chatelier in the essential points on constitution. In 1901 he wrote:

In fact we have no evidence to prove the existence of free lime in anhydrous cement. On the contrary we may conclude by microscopic examination, or by observing the effect of the addition of a small quantity of strongly calcined lime, or by noting the effect when such lime is present due to

were heated to various temperatures for various time periods and the extent of combination determined by finding the change in solubility of one or more of the constituents. Solubility was noted in hydrochloric acid and sodium carbonate solutions. Cobb found that reaction between CaO and SiO_2 began at about 800°C . With mixes high in SiO_2 , the $\text{CaO}\cdot\text{SiO}_2$ was believed to be formed, while with mixes high in CaO the $2\text{CaO}\cdot\text{SiO}_2$ was produced.

Compounds of alumina were also believed to be formed the composition of which depended on the original composition of the mixture. Cobb believed these compounds to have the formulas: $\text{CaO}\cdot 2\text{Al}_2\text{O}_3$, $\text{CaO}\cdot\text{Al}_2\text{O}_3$ and $2\text{CaO}\cdot\text{Al}_2\text{O}_3$. A sodium silicate of the composition $\text{Na}_2\text{O}\cdot 4\text{SiO}_2$ and an aluminate of the composition $\text{Na}_2\text{O}\cdot\text{Al}_2\text{O}_3$ were said to be produced. In the mixtures of three and four components, the difficulties of calculating compound formation became very involved.

The many views on the constitution and the setting processes of cements which had been proposed up to 1903 have been discussed by Jordis and Kanter (11). Apart from the excellent review and bibliography given by these authors, it is of especial interest to observe their own views, as occasionally expressed, which may be taken correctly to represent the state of the science at that time. Regarding constitution, they write:

While some investigators believe it possible exactly to determine the compounds in clinker, others contend that this is not the case. Thus the conflict over the free lime in cement, which was kindled by Winkler and Feichtinger in 1856, is today not one step nearer to a solution.

And again:

Our knowledge of the compounds formed by the burning of cement raw materials is very meager, and a great field for experimentation is open.

Hypotheses of Solid Solution

Clifford Richardson. Among the early studies postulating a condition of solid solution in the clinker of portland cement were those reported by Richardson (19) in 1904 and 1905. Richardson called attention to the existence in clinker, as revealed by the optical examination of thin sections, of two prominent constituents. These were always present, but the form, size of crystals, and distribution were very variable, due to several causes, as fineness of grinding of the raw material, chemical composition, temperature of burning and rate of cooling. One of the constituents was reported as a colorless mass of more or less crystalline form. The other constituent surrounding this, was a yellow material of lower melting point. This was devoid of all crystalline outlines.

In a carefully developed plan to study the major constituents of the cement, Richardson prepared and examined a number of pure synthetic compounds. He reports that he prepared tricalcium silicate by mixing the extremely fine materials and burning for 3 hours at 1650° to 1700° . He describes the product as snow-white, shrunken, sintered, porous, and non-dusting although it crushed readily under the fingers. The optical properties were very similar to those of alite, but Richardson did not believe them to be of a simple constitution as will

be shown later. Compositions corresponding to the dicalcium silicate and many other silicates and aluminates were similarly prepared. Products containing iron oxide and magnesia were included and also several ternary compositions of lime, alumina and silica. As a result of this last study Richardson concludes:

These substances, even as prepared in fixed molecular proportions, have in no case been found to be definite compounds, or even homogeneous. No such thing as a definite silico-aluminate of lime exists. The so-called silico-aluminates of lime are merely mixtures of silicates and aluminates which are mutually more or less soluble, and must be studied on the same lines as were applied by Roozeboom to mixtures of fused salts.

Richardson carefully calculated from exact analyses the combinations which appeared to be possible in two commercial cement clinkers, and the greatest basicity of the aluminate which could be present after the complete saturation of silica as $3\text{CaO}\cdot\text{SiO}_2$. The lime necessary to unite with the SO_3 was deducted, the Fe_2O_3 was calculated to Al_2O_3 , and all bases to CaO . In one cement he found sufficient base to convert all SiO_2 to the form $3\text{CaO}\cdot\text{SiO}_2$ and all alumina to $3\text{CaO}\cdot\text{Al}_2\text{O}_3$. But in the second cement there was not sufficient base present to convert all SiO_2 to $3\text{CaO}\cdot\text{SiO}_2$, except by assuming that the R_2O_3 remained as an acid compound. Since he regarded this as inconceivable, some of the SiO_2 was assumed to be in the form of $2\text{CaO}\cdot\text{SiO}_2$.

On making synthetic cements of these same compositions from Al_2O_3 , CaCO_3 , and SiO_2 , there were observed in both cases two well-segregated materials of different optical activity. This demonstrated that the product did not consist of a homogeneous solution of $3\text{CaO}\cdot\text{Al}_2\text{O}_3$ in $3\text{CaO}\cdot\text{SiO}_2$. The two substances resembled, in optical properties, alite and celite, and Richardson was convinced that they actually represented these two constituents of industrial clinker.

In his attempt further to identify these compounds, Richardson then prepared synthetic clinkers in which the ratio of $3\text{CaO}\cdot\text{SiO}_2$ to the aluminates varied. He observed that in the more basic mixtures the celite decreased and at a ratio of $6(3\text{CaO}\cdot\text{SiO}_2)$ to $1(3\text{CaO}\cdot\text{Al}_2\text{O}_3)$ the celite disappeared entirely. The product appeared to consist of only one constituent and Richardson believed this to be pure alite. His conclusion was, therefore, that alite consists of a solid solution of the above composition.

Following this, Richardson made a second synthetic preparation in which the same ratio of the dibasic compositions was employed. This mixture representing $6(2\text{CaO}\cdot\text{SiO}_2) + 1(2\text{CaO}\cdot\text{Al}_2\text{O}_3)$, was found to have the same properties as those of celite, and accordingly Richardson came to the belief that celite consists of a solid solution of these compounds in the above ratio.

His explanation of the constitution of a commercial clinker and the ratio of alite to celite was therefore as follows: When sufficient lime is present, there will be formed $3\text{CaO}\cdot\text{SiO}_2$ and $3\text{CaO}\cdot\text{Al}_2\text{O}_3$. The latter will dissolve in the tricalcium silicate to form alite, and no celite will be present. When there is a deficiency of lime for this process, there will be formed some $2\text{CaO}\cdot\text{SiO}_2$ and $2\text{CaO}\cdot\text{Al}_2\text{O}_3$ which likewise form a solid solution, celite. The relative proportions of alite and celite are dependent on two variables, the ratio of silica to alumina present, and the basicity.

In the clinkers mentioned above which were carefully analyzed, Richardson calculated a composition on this basis, and found, for No. 1,



and for No. 2,



Cement No. 2, being the less basic, contained, according to Richardson, a larger percentage of celite. For this reason it was less volume-constant. No. 1, being the less concentrated in aluminates, was quicker setting, and, being the richer in alite, was the stronger.

The normal alite-celite structure described above was found to be maintained up to the ratio

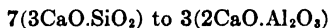

When the aluminate was increased above his point, Richardson states that there was a decided change in structure, and a new solid solution appeared to be formed consisting of dicalcium silicate dissolved in dicalcium aluminate. At this critical or "eutectic" point, Richardson believes that there exists an emulsion of four solid solutions: $3\text{CaO}.\text{SiO}_2$ in $3\text{CaO}.\text{Al}_2\text{O}_3$, $3\text{CaO}.\text{Al}_2\text{O}_3$ in $3\text{CaO}.\text{SiO}_2$, $2\text{CaO}.\text{SiO}_2$ in $2\text{CaO}.\text{Al}_2\text{O}_3$, and $2\text{CaO}.\text{Al}_2\text{O}_3$ in $2\text{CaO}.\text{SiO}_2$.

Wilhelm Michaelis. Michaelis (17) regarded as impossible the existence of tricalcium silicate, $3\text{CaO}.\text{SiO}_2$, but recognized the possibility of the existence of a homogeneous material having a composition as determined by chemical analysis, which could well be indicated by this formula. Since Michaelis could not recognize this as a definite compound, he regarded it as a solid solution of CaO in $3\text{CaO}.-2\text{SiO}_2$, for he considered it "very doubtful" if even the dicalcium silicate, $2\text{CaO}.\text{SiO}_2$ exists. He therefore wrote the following as the most general formula for all portland cements:

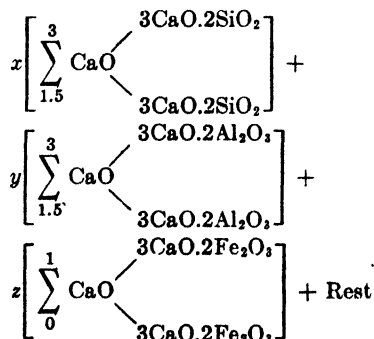

Here the ratio $\frac{\text{CaO}}{\text{SiO}_2 + \text{R}_2\text{O}_3} = 1.75 \text{ to } 2.35$

According to Michaelis, underburned cement contains uncombined calcium aluminate and calcium ferrite.

When vitrification begins from 1450° to 1600° as the case may be, the following takes place by diffusion, as a point of real fusion is not reached: The lime, which so far has remained uncombined, dissolves in the calcium silicate, and the dicalcium aluminate and tricalcium aluminate previously formed likewise dissolve in the calcium silicate, thus forming alite and celite. Alite is the constituent highest in lime; it is formed at white heat and crystallizes first on cooling. Alite therefore is an isomorphous mixture of calcium oxide, calcium aluminate and calcium silicate. . . . The amount of alumina contained in the alite depends upon the percentage of lime and alumina in the raw mixture.

Michaelis believed that so-called tricalcium ferrite is a solution of lime in dicalcium ferrite, because alite is "always entirely white."

Celite he regarded as consisting of "dicalcium compounds which are generally not perfectly crystallized nor completely separated from the molten mass." The glassy residue he regarded as "an alkali-lime glass containing magnesium ferrite, calcium ferrite, calcium sulfate, and calcium sulfide." But he pointed out that the conditions for oxidation or reduction in the kiln determine to a large degree the nature of the iron and manganese compounds in the product. In a reducing flame these elements form the lower oxides and act as bases while in an oxidizing flame they form the higher oxides and act as acids. Thus if a raw mixture is calculated to contain sufficient lime to combine with the iron oxide, and reducing conditions prevail in the kiln, this combination will fail to take place with the result that an excess of lime will remain and produce an inferior cement.

Belite, Michaelis believed to consist of calcium aluminate which has remained undissolved by the calcium silicate, and he gave it the formula $3\text{CaO} \cdot 2\text{Al}_2\text{O}_3$. This he did not find in cements when sufficient lime was present, that is, when the more easily fusing tricalcium aluminate could be formed which can be completely dissolved in the so-called tricalcium silicate.

Felite, he regarded as the calcium silicate which forms when the clinker is cooled slowly, and he believed its formation to be due to the dissociation of the solution of dicalcium aluminate in calcium silicate, which dissociation is preventable by rapid cooling.

E. D. Campbell and A. H. White. E. D. Campbell and A. H. White (2)(3) of the University of Michigan contributed extensively to the early literature in favor of a general theory of solid solutions in portland cement clinker.

In the course of experimentation, these authors observed that a crucible of pure magnesium oxide in which clinkers were being heated became stained. They attributed this staining to an absorption of a liquid phase produced during the heating of the clinker. This suggested the possibility of effecting a separation of the liquid and solid phases. Such a separation was attempted by heating a flat-surfaced clinker between two weighed disks of magnesium oxide. The authors believed that a complete separation of alite, remaining in the crystal form, from celite, the absorbed liquid, had been attained.

Complete chemical analyses were made of samples of the separated portions, obtained in this way, from commercial raw mixtures. These brought out a few interesting points, but particularly that "the contention that alite contains the bulk of the aluminate and celite contains all the iron is not sustained."

They found the ratio of Fe_2O_3 to Al_2O_3 to be a little higher in celite than in alite, but the difference was not marked and the assumption that Fe_2O_3 is molecularly equivalent to Al_2O_3 , so far as the formation of celite is concerned, seemed justifiable. With a given basicity the proportion of silica to alumina and iron oxide in the celite was found to increase with the temperature of burning. With a given temperature, the proportion of silica to alumina and iron oxide in the celite was found to decrease as the basicity of the clinker increased.

These results led Campbell and White to conclude that celite consists essentially of a calcium aluminate, fusible at a little above 1400° and, when liquid, capable of dissolving dicalcium silicate and lime, and furthermore, that the solubility of these substances follows laws analogous to those of ordinary solubility. Alite was thought to consist of either alpha or beta dicalcium silicate holding in solid solution lime with some calcium aluminate and ferrite. The concentration of the lime held in solution was thought to be dependent on the basicity of the mass and the temperature of burning, with the ratio 3CaO to 1SiO_2 representing the upper limit. Clinker formation was thus reduced to a problem in solubilities. At a little above 1400° calcium aluminate melts and, according to these authors, dissolves lime and dicalcium silicate. At 1410° the beta and the gamma dicalcium silicate change to the alpha form. During this change, the solution becomes supersaturated and crystals of alpha dicalcium silicate which have dissolved in them, lime and calcium aluminate separate. This is the formation of alite. A certain amount of lime dissolved in the alpha dicalcium silicate seems necessary, by this theory, to prevent the transformation of the alpha and beta to the gamma form, that is, the dusting of this silicate.

Mixtures of synthetic celite were prepared of the same composition as had been found to define this material in cements, except that Al_2O_3 was substituted for Fe_2O_3 . The petrographic examination of the crystals which were large and well defined was found to show properties identical to those already given by F. E. Wright for tricalcium silicate.* The chemical analysis was such that, if the SiO_2 were calculated to $3\text{CaO}.\text{SiO}_2$, there was left just enough CaO to combine with the small amount of Al_2O_3 present to form the compound $5\text{CaO}.3\text{Al}_2\text{O}_3$. This same result obtained in the case of the material absorbed by the magnesium oxide disks; when the SiO_2 was calculated to $3\text{CaO}.\text{SiO}_2$, the residue had the composition $5\text{CaO}.3\text{Al}_2\text{O}_3$. This work therefore postulates that celite consists of $5\text{CaO}.3\text{Al}_2\text{O}_3$ in which is dissolved $2\text{CaO}.\text{SiO}_2$ and CaO . The authors give a suggested formula for cement as

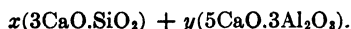

Many studies in which Fe_2O_3 was substituted for Al_2O_3 seemed to show that the iron oxide combined in an exactly analogous manner, forming the compound $5\text{CaO}.3\text{Fe}_2\text{O}_3$, in which Fe_2O_3 replaced Al_2O_3 in molecular proportions. This substance however, following the publication of the paper by Sosman and Merwin on the system lime-ferric oxide,† was later admitted by Campbell and White to be a mixture of $2\text{CaO}.\text{Fe}_2\text{O}_3$ and $\text{CaO}.\text{Fe}_2\text{O}_3$.

* See page 246.

† See page 282.

Constitutional Formulas of Cement Compounds

W. Asch and D. Asch. In 1911 W. and D. Asch (1) published a book on "The Silicates in Chemistry and Commerce" in which they presented an elaborate theory on the constitution of the silicates, aluminates, etc., of minerals and commercial products composed of these materials. To this scheme they applied the term *Hexite-Pentite Theory*.

It seems to have been the belief of the authors that their concept explained nearly all chemical phenomena. They attribute the classical studies of Kekule on organic structure, Erlich on side-chain structure, Guldberg and Waage on mass law, and even the laws of Newton as being, in part at least, consequences of the hexite-pentite theory. Concerning portland cement, they say:

The constitution of portland cement has been the subject of investigation for nearly a century, without any definitely satisfactory result. This is due to . . . the persistent maintenance of a pluralistic or mixture theory and the neglect or repression of all information or suggestions to the contrary.

Referring to criticisms made by Desch and by Allen and Shepherd, the authors say:

These critics believe that the microscopical investigations of cement have shown positively that cements are heterogenous substances. This is the sole argument which has been brought in opposition to the hexite-pentite theory.

The hexite-pentite theory is based on the hypothesis that six molecules of $\text{Si}(\text{OH})_4$ or SiO_2 combine to form a hexagonal ring structure as, for example:

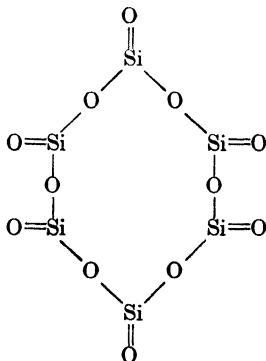

In a somewhat similar manner alumina is pictured as forming:

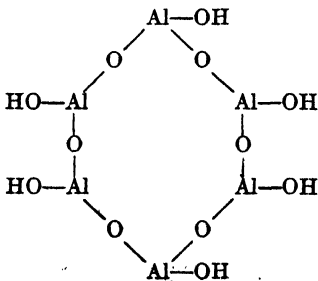

These are the hexite formulas. The pentite formulas are similarly produced from five molecules. The theory then consists in the assumption that all of the natural and artificial silicates and aluminates form compounds which are combinations of numerous hexite and pentite linkings, condensations, etc.

The belief of Asch and Asch on the constitution of portland cements is summed up as follows:

Portland cements are, theoretically, highly basic lime salts of aluminasilicic acids, i.e., they are basic salts of which clays are the corresponding acids. Their general properties are in entire agreement with this view of their constitution, and it is incomprehensible that, on treating clay with calcium carbonate in the manufacture of cement, the product should not be a lime salt, but a mixture of various silicates and aluminates.

As a demonstration of the universal application of their new theory, the authors are ready to create a structural formula for any composition that may be revealed by chemical analysis. They present forty-four empirical formulas, calculated from analyses, somewhat along the line:



where n may vary between 20 and 90, m between 1 and 6, and p between 10 and 18. Σ represents anything not considered in the formula, as SO_3 , H_2O , etc. A typical composition for which a formula is given is



No proof of the admissibility of these formulas appears to have been offered by Asch and Asch other than the ability of these authors to produce them from any composition presented by a chemical analysis.

Ernest Martin. Structural formulas for many silicates and hydrated silicates believed to occur in portland cement have been proposed by Martin (15). The assumptions are made at the start that (1) the normal silicic acid, $Si(OH)_4$, possesses a great affinity for itself, and (2) the silicon possesses valencies which may be acidic or basic depending on the conditions surrounding it.

Thus, if the acid valencies are represented by single dashes and the basic valencies by double dashes, the normal $Si(OH)_4$ is expressed:

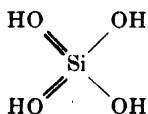

and the combination of two molecules:

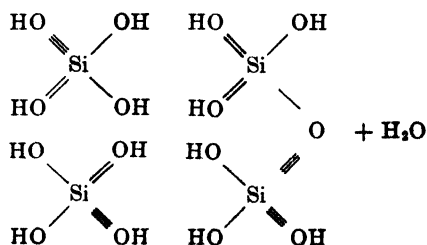

The oxygen possesses an indifferent valence, content "to transmit the valence which binds it." At high temperatures, however, "the affinity (of silica) changes completely; all the valencies become acid and they can then bind to the bases." This change in valence explains why "the silicates formed at high temperatures cease to be stable on cooling."

Martin then proceeded to build up a series of structural formulas intended to represent various compositions of the more or less hydrated silicic acids, and the hydrated and anhydrous calcium silicates. He assumed at all times that the water, shown by analysis to be present in various amounts depending on the method of drying or desiccation, is combined within the molecule in a very definite manner, and he presented formulas which he believed indicate the special properties of each. On treatment of these hydrates with lime water, and again drying in several ways, calcium silicates in several stages of hydration are produced. The solubility of these silicates in acids or alkalis or sugar solutions, dilute or concentrated, cold or hot, was found to vary, and Martin accounted for this variation by assuming that the position of the Ca or the Si in the molecule determines this solubility. He then wrote the formulas in such a manner that he believed these structural differences were brought out. Groups in certain positions were believed to be reactive to certain treatment. Those in other positions were assumed to be unreactive. By analogy, the more complex formulas were derived.

On this basis, Martin produced the dicalcium silicate, $2\text{CaO} \cdot \text{SiO}_2$, by heating CaCO_3 with SiO_2 in the correct proportion. He reported that sugar solution extracted the free lime, that acetic acid dissolved it completely, and that solutions of Na_2CO_3 dissolved three-fifths of the silica. With this information, correlated by analogy with the silicates previously prepared, he considered this silicate to be $10\text{CaO} \cdot 5\text{SiO}_2$, for which he wrote a complicated structural formula. Martin found this silicate to be non-hydraulic and therefore called it the *inactive silicate* of cement. He was unable to obtain a tricalcium silicate, and came to the conclusion that the active hydraulic compound of cement, called by him *cement silicate*, is $13\text{CaO} \cdot 5\text{SiO}_2$, to which he also assigned a complicated structural formula.

Martin claimed also, with Leduc (14), that, on heating the *cement silicate* to about 1000° for 24 hours, three molecules of CaO are liberated. He accounted for this by assuming a reaction in which the $13\text{CaO} \cdot 5\text{SiO}_2$ breaks down to $10\text{CaO} \cdot 5\text{SiO}_2$, but to this latter silicate he assigned a formula different from that assigned to the *inactive silicate*. This he found necessary as he claimed the new dicalcium silicate possesses some hydraulic properties, inferior, however, to those of the *cement silicate*.

Even a third dicalcium silicate, and also a silicate of the composition $8\text{CaO} \cdot 5\text{SiO}_2$, were reported and described as being somewhat hydraulic, but these were not believed by Martin normally to be present in clinker.

F. W. Clarke. The whole question of an application of structural formulas to the natural silicates has been treated at length by Clarke (4) of the United States Geological Survey. He sums up the matter in the following terse manner:

Suppose now that the empirical formula of a silicate has been accurately fixed, and that a mass of data such as I have indicated are available for

combination with it. Suppose the physical properties to be determined, the natural relations known, the alteration products observed, its chemical reactions and the results of fusion ascertained; what then? It still remains to combine these varied data into one expression which shall symbolize them all, and that expression will be a constitutional formula. To develop this, the established principles of chemistry must be intelligently applied, with due regard to recognized analogies. The grouping of the atoms must be in accord with other chemical knowledge; they must represent known or probable silicic acids; and any scheme which fails to take the latter consideration into account is inadmissible. Not merely composition, but function also is to be represented, and the atomic linking which leaves that disregarded may be beautiful to see but is scientifically worthless. A good formula indicates the convergence of knowledge; if it fulfills that purpose it is useful, even though it may be supplanted at some later day by an expression of still greater generality.

The difficulties experienced by the chemist in accepting such formulas as have been presented by Asch and Asch and by Martin lie in many points. Asch and Asch have developed formulas for 17 alumino-silicic acids, having from 6 to 24 replaceable hydrogen atoms, and with molecular weights ranging from 873 to 1693. It is from such complicated acids as these, and their anhydrides, that the alumino-silicates are believed by these authors to be derived. Most of these acids have no representatives in nature and are purely hypothetical. With so many replacements possible, an enormous number of salts can be predicted and, as Clarke states, isomorphous mixtures, altered or impure minerals, and even bad analyses may easily be given places in the system. Clarke doubts, however, if silicates of such complexity could exist in even the coolest magma, and adds:

A generalization which does too much may be worse than no generalization at all. Even for such substances as glass the authors of the hexite-pentite theory write structural formulas.

The complex formulas found in organic chemistry have been developed laboriously and each position, each type of linkage, even each stereoscopic orientation accounted for by the most searching of chemical and physical tests. But this has not been done in the case of the formulas presented in this chapter. Certain properties and analogies have indeed been studied, but there remains so much of speculation and so little of evidence that an acceptance of them is not possible without much further experimentation.

References

1. Asch, W. and Asch, D., "The Silicates in Chemistry and Commerce," translated by Searle, A. B., London, Constable and Co. Ltd., 1913.
2. Campbell, E. D., *J. Am. Chem. Soc.*, **24**, 969 (1902); **25**, 1103 (1903); **26**, 1143 (1904); *Technique*, May, 1905; *Ind. Eng. Chem.*, **5**, 627 (1913); **6**, 706 (1914); **7**, 835 (1915); **8**, 1101 (1916); **9**, 943 (1917); **11**, 116 (1919); *Trans. Am. Ceramic Soc.*, **17**, 66 (1915); *J. Am. Chem. Soc.*, **24**, 249 (1922).
3. Campbell, E. D. and White, A. H., *J. Am. Chem. Soc.*, **28**, 1273 (1906).
4. Clarke, F. W., *U.S. Geological Survey, Bull.* 588 (1914).
5. Cobb, J. W., *J. Soc. Chem. Ind.*, **29**, 69; 250; 335; 399; 608; 799 (1910).
6. Fremy, E., *Ann. chem. phys.*, **7**, 73 (1866).

7. Fuchs, J. N., *Acad. Sci. Hague*, 1832.
8. Grant, J., *Proc. Inst. Civil Eng.*, **25**, 66 (1865).
9. Hart, F., *Tonind. Ztg.*, **24**, 1674 (1900).
10. Hedlt, J. *Prakt. Chem.*, **94**, 129; 202 (1853).
11. Jordis, E. and Kanter, E. H., *Z. angew. Chem.*, **16**, 463; 485 (1903); *Cement Age*, **1**, 367; 450; 477 (1904-1905).
12. Landrin, M., *Compt. rend.*, **96**, 156; 1229 (1885); **98**, 1053 (1887).
13. Le Chatelier, H., *Compt. rend.*, **94**, 13 (1882); *J. Soc. Chem. Ind.* **1**, 151 (1882); "Experimental Researches on the Constitution of Hydraulic Mortars," translated by J. L. Mack, New York, McGraw Publishing Co., 1905.
14. Leduc, E., *Bull. soc. encour. ind. natl.*, 1911 (2), p. 280.
15. Martin, E., *Mon. Sci.*, **13**, 173 (1923).
16. Meyer, A., *Bull. Soc. Sci., Bucarest*, 9, No. 6 (1901); *Baumaterialienkunde*, **6**, 151; 159; 181; 212; 232; 248; 293; 309; 326; 347; 368 (1901); **7**, 72, 111; 140; 156 (1902).
17. Michaelis, W., *J. Prakt. Chem.*, 1867, p. 257; *Baumaterialienkunde*, **11**, 333; 352; 366; 381 (1906). *Protokoll deut. Portland Cement Fab.*, **32**, 206 (1909); *J. Soc. Chem. Ind.*, **28**, 836 (1909).
18. Rebuffat, O., *Gazz. Chem. Ital.*, **28** (1898); *Baumaterialienkunde*, **4**, 161; 205; 237 (1899).
19. Richardson, C., *Cement*, **4**, 276; 340; 422 (1903); **5**, 40; 87; 91; 117; 201; 261; 313 (1904); **6**, 18 (1905).
20. Rivot and Chatonney, *Compt. rend.*, **153**, 302; 785 (1856).
21. Rohland, P., *Tonind. Ztg.*, **24**, 1065 (1900).
22. Tornebohm, A. E., *Tonind. Ztg.*, **21**, 1148 (1897); *Baumaterialienkunde*, **6**, 142 (1910-11); *Zement*, **4**, 287 (1903).
23. WORMSER, S. and Spanjer, O., *Tonind. Ztg.*, **23**, 1785 (1899); **24**, 1027 (1900).
24. Zulkowsky, K., *Tonind. Ztg.*, **22**, 318 (1898).

CHAPTER 5

Methods of Investigation

There are a number of methods of investigation which are especially adaptable for research and for the special examinations of portland cement. In this chapter the more important of these methods will be discussed. It is not felt necessary however to take space for the repetition of procedures of chemical analysis which are routine operations, nor for the standard methods of test. These methods are under more-or-less continuous change in details, they differ in different countries, and are readily obtainable from the standard specifications of the responsible organizations which sponsor them.

The principles and technique of phase-equilibrium research, which is the most important of all methods for the investigation of the cement systems, is separately discussed in Chapters 11 and 12.

Petrographic Technique.

Three methods are commonly employed for the microscopic examination of portland cement clinkers: The examination of powdered specimens immersed in an oil of suitable refractive index, the examination of thin sections by transmitted light, and the examination of polished and suitably etched specimens by reflected light.

Powder Mounts and Thin Sections. The optical properties of crystal grains (refractive indices, birefringence, optical character, optic axial angle, pleochroism, and crystal habit) are best measured in powder mounts. The methods are described in standard text books on crystallography (66)(73)(54). To determine the refractive indices of some of the high-index compounds of portland cement, special media are required. Larsen and Merwin (34) recommended sulfur-selenium mixtures for index determinations between values of 2.05 and 2.75. These are prepared by mixing carefully-weighed portions in accordance with the index-composition curves of those authors, melting to a uniform material and after cooling, rechecking the index by some standard procedure.

In using this material, a small amount of the powdered medium is placed on the slide and the material whose index is to be determined is scattered on it. A cover glass is placed over the mixture and the slide is heated over a small flame until the medium is liquid. It can then be pressed readily into a thin film and the determination made. Brownmiller (10) found that the selenium often contained selenium dioxide which interfered with the precise determination of the indices, and proposed a method of distillation in an atmosphere of carbon dioxide by which the selenium is rendered practically optically clear.

For the determination of indices higher than 1.74, West (69) has recommended solutions of sulfur and methylene iodide in phosphorus.

For precision measurements it is necessary in making index determinations to take account of the temperature, for a liquid may change in index as much as 0.0007 per degree, especially when the index lies above 1.700. Siedentopf (55) suggested the use of a thermocouple for measuring the temperature of a liquid on a slide, but the method seems not to have been generally adopted. Ashton and Taylor (1) have developed a method making use of a differential thermocouple, one flattened junction of which is placed on the hemisphere of the Abbe refractometer and the other junction in an insulated jar adjacent to a thermometer of high precision and sensitivity. The couple is made of two pieces of No. 36 cotton-covered copper wire silver-soldered to the ends of a similar wire of constantan. A galvanometer having a sensitivity of about 3 micro-volts per scale division, placed in the circuit, serves to indicate the temperature differences. The same equipment is then employed at the microscope by attaching the flattened junction to the bottom of the cover glass, held in place with modeling clay.

Thin sections are particularly useful where it is desired to observe the relationship between the various constituents of a sintered preparation. By careful technique in grinding, sections may easily be ground down to a thickness of 20 to 30 microns, and an artist may consistently produce sections as thin as 5 to 10 microns (9). The section should be mounted in a suitable resin* to minimize relief and obtain a permanent mount. Quantitative determinations of the clinker phases have been made upon thin sections with the use of an integrating stage (49), but the indistinct outlines of the grains and overlapping of crystals makes such attempts usually unsatisfactory.

Polished Section. Etched polished sections for examination by reflected light were used by Stern (58) and Wetzel (70), but the method was generally abandoned until revived by Tavasci (59) and Insley (27). Tavasci employed both thin and polished sections, the former being ground down with silicon carbide or emery in water, and the latter in anhydrous alcohol. An important improvement of Insley and McMurdie (30) consisted in the preparation of polished thin sections by which a given field could be examined by either transmitted or reflected light. In this process, the clinker to be sectioned is heated in a resin of high refractive index† until the resin becomes tough but not brittle. After grinding one face to a plane surface with fine emery, it is cemented to an object slide with the same resin, and the other surface ground down with emery and alcohol until the section is 15–20 microns in thickness. It is then polished with jeweler's rouge and alcohol on a canvas-covered rotating lap and the polished surface etched. By use of a vertical illuminator and objective corrected for use without cover glass, attached to the tube of a petrographic microscope, the specimen can be examined either in reflected or transmitted light without changing its position on the stage of the microscope. The specimens are examined with a vertical illuminator using a plane glass reflector, yellow-green filter and an attached incandescent lamp. For photomicrography, an arc lamp is employed.

A comparison of photomicrographs of a clinker by different methods of

* Hyrax is suitable for this purpose.

† Hyrax or Aroclor No. 4465 are suitable.

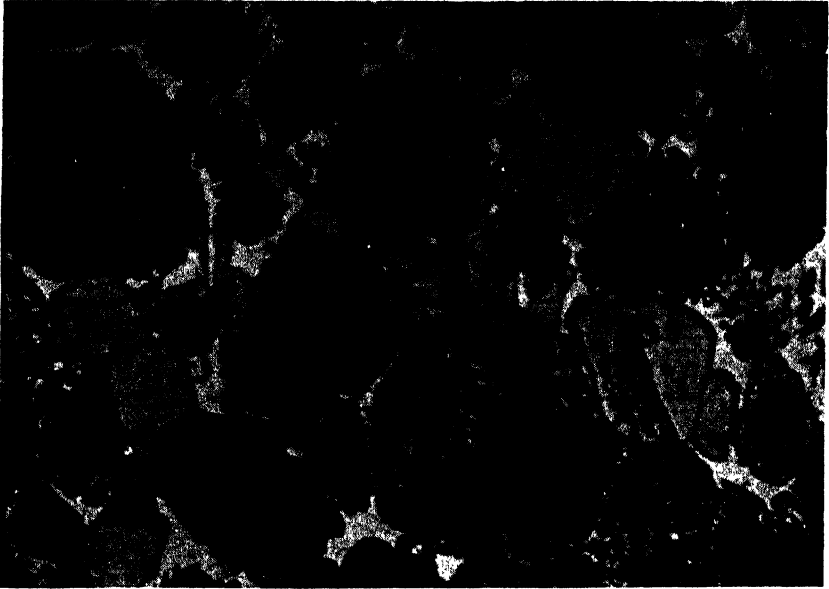

Figure 8. Photomicrograph of a low-heat clinker. An etched section shown in reflected light. $\times 500$. (Inaley)

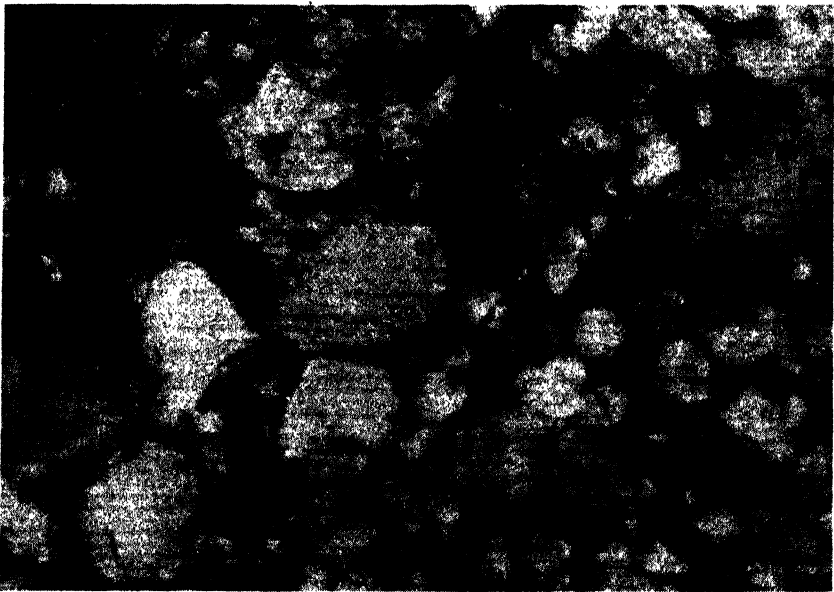

Figure 9. The same clinker as shown in Figure 8. A thin section shown in transmitted light with crossed nicols. $\times 500$. (Inaley)

illumination is shown in Figures 8 and 9: in Figure 8 by reflected light; in Figure 9 by transmitted light; under crossed nicols. The advantages of the polished section for use with reflected light are seen in the clarity and definition of the grains, and freedom from difficulties in identification due to overlapping. The usual optical properties, however, by which phases are often identified, can best be made in powder mounts or thin sections.

The method for making a quantitative determination of the clinker phases by microscopical means was later again improved by Insley and his coworkers (29). The polished sections are made by placing fragments of crushed clinker in a shell vial of 1.5 cm diameter immersed in a suitable resin.* After evacuation for 2 or 3 hours, it is heated at 80° for 15 hours and the temperature raised to 100° for 7 hours, when the resin is thoroughly hardened. The vial is then broken away and the section ground down with No. 150 silicon carbide and water on a rotating lap, and finally by hand with emery and alcohol on plate glass. It is polished with rouge and alcohol on a canvas-covered rotating disk, and etched. A Wentworth micrometer (68) with several micrometer screws, each assigned to a separate constituent, is used for measuring the linear distance traversed on passing the section across the cross-hair. Eleven traverses 1 mm apart are made on each section, and the fractional part of the complete distance traversed by each constituent calculated to obtain the volume percentage of each phase. Weight percentages are calculated by dividing by the densities, which were found to be as follows:

β C ₂ S	3.28
C ₂ S	3.13
C ₄ AF	3.77
Dark-interstitial material	3.00
CaO	3.32
MgO	3.58

Etching Technique. The polished specimens of cement clinker require different etching reagents and different techniques of exposure depending on the nature of the phases it is desired to examine. Upon this subject many investigators have contributed to our information. Tavasci (59) included among the reagents examined for specific effects on the cement compounds,

1. 1 ml HNO₃ in 100 ml isoamyl alcohol
2. 10 ml *N*-oxalic acid in 90 ml 95% ethyl alcohol
3. Concentrated HF
4. 1:10 HF in water
5. Distilled water
6. 1% borax in water
7. 0.4% borax in water
8. 8 ml 10% NaOH + 2 ml 10% Na₂HPO₄

Of the above etchants, the HNO₃-alcohol mixture (No. 1) proved to be most generally useful, especially for the calcium silicates. The C₂A he found to be

* Bakelite BR 0014 is suitable.

differentiated best by the oxalic acid-alcohol etchant (No. 2), which colored those crystals a reddish-brown in periods of 5 to 15 seconds, but did not color any other constituent. The only reagent found which etched C_1A_2 satisfactorily was the 0.4 per cent borax solution (No. 7), which attacked the crystals more or less intensely depending on the orientation with respect to the polished surface. A greater dilution attacked the C_2A preferentially, while both compounds were left unchanged when greater concentrations were used. A 2 percent solution of 9 parts $NaHCO_3$ and 1 part Na_2CO_3 also was tried with some success. CaO was attacked by all of the reagents except HF (Nos. 3 and 4) and oxalic acid (No. 2), whereas C_2F was attacked only by the HF (Nos. 3 and 4). The C_4AF also was etched by HF as well as by the $NaOH-Na_2HPO_4$ mixture (No. 8).

In his early studies, Insley (27) found that a 1 percent solution of nitric acid in ethyl alcohol was most generally useful for the compounds of cement clinker, the exposure time being about 5 seconds. In later studies Insley and his co-workers (29) exposed the specimen first to distilled water for 2 seconds, which served to differentiate MgO , CaO and crystalline dark-interstitial material. After examination for these constituents, the section was etched for 3 seconds in 1 percent HNO_3 in alcohol which served to differentiate between C_2S , C_3S , C_4AF and total dark-interstitial material. CaO and MgO were also found to be clearly revealed by a 1:1 water-alcohol mixture.

A short time later, interest became centered in the better differentiation of the phases in the interstitial matrix of clinker, which led to a number of investigations. Parker (45)(46) has pointed out that glass is etched by an exposure for 10 seconds to 1:3 water-alcohol followed by 5 seconds in .25 percent HNO_3 in alcohol, when its composition is low in Fe_2O_3 such as may occur when C_4AF has crystallized from the liquid, but that the glass ceases to be etched when its Fe_2O_3 content becomes higher. He found also that a solution of ethylene glycol in alcohol is a specific etching reagent for C_2S , but requires some hours to produce the necessary effect. Quicker results were obtained with a solution of $MgSO_4$. The C_2S was etched to a robin's-egg blue by exposure for 30 seconds to HF vapor. Longer etching periods converted the C_2S to a red color which was still distinctive, but not so effective as the blue.

Ward (67) found that a 5-second exposure to distilled water, rinsing in alcohol, drying, and using a yellow-green filter causes C_2A crystals to appear almost black whereas the glass is gray. Subsequent treatment for 2 seconds with 1 percent HNO_3 in alcohol virtually destroys the dark etch of the C_2A but leaves the glass still gray and distinctly outlined. For distinguishing between C_4AF and a high-iron glass, Ward found Tavasci's reagent for C_4AF (1 part 10 percent Na_2HPO_4 with 4 parts of 10 percent $NaOH$) to give best results.

Insley (28) confirmed the finding of Parker that nitric acid solution etches glasses which are relatively low in iron but not those high in iron. He found further, however, that the use of a 10 percent solution of KOH in water for 15 seconds at $29^\circ-30^\circ$ gave results which were equally satisfactory for all glasses irrespective of their iron content. The marked improvement in differentiation of the interstitial material due to the use of the latter etchant is shown by the photomicrographs of a polished section of a commercial clinker in Figures 10 and

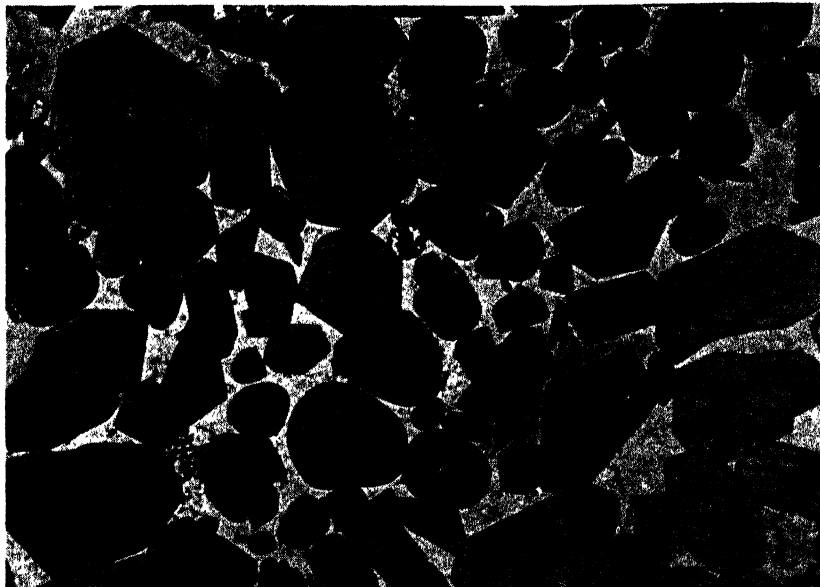

Figure 10. Photomicrograph of a commercial clinker after etching with water and a 1 per cent solution of HNO_3 in alcohol. Reflected light. $\times 500$. (Insley)

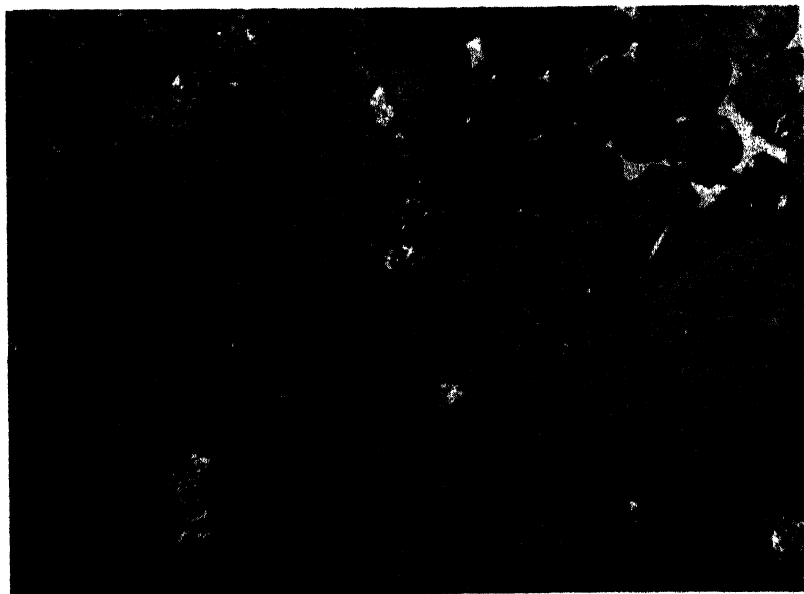

Figure 11. The same field as shown in Figure 10, after the same etching treatment and an additional etching with 10 percent KOH. Shows marked differentiation of interstitial material with intimate mixture of glass and small C_4AF crystals in deeply-etched interstitial areas.

11. The white areas in the latter figure consist of C_4AF , and the dark interstitial material is glass, a condition not resolved in Figure 10.

X-Ray Diffraction

X-ray diffraction methods have been employed in cement research for two distinctly different purposes. The interplanar spacings and intensities of the lines of the diffraction patterns have been used as a means for the identification of the crystalline phases both in experimental melts and in commercial clinkers. Next to the microscopical methods, these patterns provide the best means at present available for such identification. The analysis of these patterns, produced by various methods, also has been employed to a limited extent for a study of the crystal structure of some of the phases. This field of research merits much more intensive study than has yet been given it, for in an understanding of the crystal structure lies the solution of many problems of the industry which are not yet resolved. The X-ray technique for the identification of compounds is given below, and the treatment of crystal structure will be discussed on pages 140-146.

The positive identification of a crystalline compound by the microscope requires the measurement of a number of the optical properties, but in the case of portland cement this is not always possible. The crystals usually are very finely grained and often too small to permit of satisfactory measurements. They frequently are surrounded with glass or contain inclusions. For these reasons the microscopical examinations have not been adequate positively to identify all of the phases, and supplementary methods were needed.

Some years ago, the X-ray diffraction method was applied by the PCA Fellowship (21)(20)(12)(11) to the study of portland cement, and a number of the problems of constitution, which had long perplexed investigators, were solved by its means.

The theoretical considerations of this method have been described in various places (7)(74)(15). When a powdered material is subjected to X-radiation and the resulting spectrum photographed, there is obtained an X-ray diffraction pattern consisting of a series of lines in definite positions which are ordinarily measured from a fixed zero point and recorded as "interplanar spacings," (d_{hkl}). Each crystalline chemical compound has a characteristic diffraction pattern which appears always to be the same whether the compound is present in a pure state or intermixed with other compounds. Also different crystalline forms of the same composition can be distinguished by the method; thus β and γC_2S have entirely different diffraction patterns.*

The X-ray method has definite and well-understood limitations. Thus a diffraction pattern depends on the arrangement of the atoms of a substance in crystal planes. In a mixture of two compounds, it often happens that some of the lines of one pattern coincide with some of the lines of the other pattern. Hence, the greater the number of compounds, the greater the probability of coincidence of lines. Nevertheless, such coincidences cause differences in intensity of the resulting lines so that the identity of a pattern may not be entirely obscured.

* See page 541.

Of greater significance are the limitations due to the concentration of a material. As the quantity of one crystalline phase decreases, the general intensity of the pattern of that compound decreases. First the least intense lines of the pattern disappear, and then the stronger lines, until a certain maximum amount of the compound is reached when the strongest lines can no longer be observed. Under the most favorable conditions, quantities of material less than 2 or 3 percent of the total can rarely be identified. For the detection of such small amounts of material, the crystals should be well-developed, possess a high order of symmetry and a simple structure, and give rise to lines which do not conflict with those of the patterns of the other materials present. Only infrequently are these conditions fulfilled so that, ordinarily, greater amounts than those mentioned above are required for the recognition of a phase. The presence of a solid solution is usually revealed by a slight shift in the position of the lines, proportional to the concentration of the solute.

The relative intensities of the lines as well as their positions are significant in the identification of compounds. If one line of a diffraction pattern is twice as intense as another line of the same pattern, that relation obtains whether the compound is present in a pure state or in a mixture. In a mixture of two compounds, the pattern of one is superimposed on that of the other; the general intensity of each pattern is diminished because of dilution by the other, but the relative intensities of the lines of each pattern remains the same.

Analysis of a sample of an unknown material therefore depends upon the recognition, by position and relative intensity, of the lines of the diffraction pattern of a pure material in that of the unknown sample. Hence, before any such analysis can be undertaken, the diffraction patterns of the pure compounds which may occur in the sample must be known. Such information has been published for most of the pure compounds which occur in the oxide systems of portland cement.* Examples of X-ray diffraction patterns are shown in the photographs of X-ray films in Figure 26, page 116.

The precision of measurement of the interplanar spacings increases as the interplanar spacing decreases. The average deviations in a series have been found to vary from .004 to .001. The intensity of the lines is usually measured visually, but a photodensitometer has been developed for the more precise estimation of the line intensity (22). The interplanar spacings are measured directly by means of a special measuring scale. With the Phillips X-ray spectrometer, which employs a Geiger counter in place of the photographic film, the intensity and spacings may be recorded directly on a strip-chart of a recording potentiometer. The diffracting angles, θ , are computed from the known radius of the films and the measured distances of the lines from the "zero" or the position of the undeviated beam. The values of $\sin^2 \theta$ and the ratios of $\sin^2 \theta$ are calculated from these data. The Miller indices (hkl) corresponding to each line, and the relative spacing (d_{hkl}/a_0) of the atomic planes giving rise to the line are calculated from the system to which the crystal belongs, its axial angles and axial ratio and the ratio of $\sin^2 \theta$ in the manner described by Wyckoff (74). The lattice constant is determined at once from its planar spacing and its relative spacing.

* See pages 451-453.

In a study of the cement compounds by Brownmiller and Bogue (12), the following concentrations of each crystalline phase were found to be necessary in cement clinkers in order to be susceptible of resolution by the X-ray diffraction method:

C_3S	%
	8
βC_2S	15
C_2A	6
C_4AF	15
MgO	2.5
CaO	2.5

The X-ray diffraction patterns of the principal oxides and compounds of portland cement are given in Appendix 1.

Electron Microscopy and Diffraction

In the current decade the electron microscope has been developed into a compact and adaptable instrument, and already has been used extensively in the examination of various materials (44). A detailed description may be obtained from many sources (13)(75).

The purpose of the electron microscope is to produce high magnifications of minute objects for visual or photographic observation. By employing an electron beam in place of light waves, direct magnifications up to 25,000 diameters may be obtained, and resolutions at lower magnifications (as 1000) are much more detailed (2). Some instruments are also provided with means for obtaining magnified stereoscopic micrographs which give three-dimensional views of the specimen, and with the means for obtaining electron diffraction patterns of the material.

In principle, the electron microscope employs a beam of electrons, and the magnification is obtained by passing the beam through a powerful magnetic field. Operation must be conducted in a high vacuum because electrons are absorbed and scattered by air. Focusing is accomplished by adjusting the current flowing through the objective coil, and magnification is controlled by varying the current flowing through the projector coil. The specimens, instead of being mounted on glass slides, are obtained by dissolving or suspending the material to be examined in a volatile solvent containing an organic film-producing material. A drop of this is caused to be spread out on a suitable liquid, and a tiny section of the film, now containing portions of the material to be examined, is caught up on the fine wire mesh of the specimen holder. The evaporation of the solvent leaves the material in form for observation. Since most substances are opaque to electrons, the micrographs are shadow photographs, and are satisfactory only when the crystals or fibers are exceedingly thin and but little overlapping occurs.

Electron micrographs of some of the clay minerals, glasses, ceramics, lime and magnesia have been reported from various sources (44). The hydration of tricalcium silicate and tricalcium aluminate has been studied in this manner by Eitel and his coworkers (48) and the hydration products of portland cement have been examined by Katz and his associates (56). Some of these electron micrographs are given in Chapter 26.

The principle of electron diffraction was developed largely through the studies of Thompson (62), which were reported in 1927 and subsequent years. The equipment essential for the application of the principle to industrial uses has been described by Morgan and Smith (43) and by Finch and his coworkers (17). The method is not greatly different from that of X-ray diffraction. A spectrum is similarly obtained by allowing a beam of electrons to pass through a suitably-mounted specimen under examination. A photograph is obtained of the pattern of the resulting spectrum, and this pattern is characteristic of the material. Important differences in the two methods are noted, however, in that electron diffraction patterns may be obtained for liquids and vapors as well as solids, the time required for exposure is measured in seconds rather than in hours and, being less penetrating than X-rays, electrons may be employed for the study of thin films (26)(35)(65).

The application of electron diffraction research to portland cement clinker has been suggested by Miller (42) who believes that the method has an advantage over X-ray diffraction methods through the possibility of selecting the individual grains in a fragment of clinker which it is desired to examine. The surface area of the object subjected to electron diffraction may be of the order of 0.01 sq mm, but smaller areas might be possible of satisfactory examination. Thus a thin section might be mounted in such a way that the diffraction patterns of the several phases could be photographed without interference from surrounding phases. It is probable that the presence of solid solutions could be indicated by an effect produced upon the pattern.

The success of electron diffraction methods for examining thin films on solid objects suggests also that reactions of hydration or salt action might be studied with advantage by this means, allowing the reaction to take place only to the extent of forming a thin film, and subjecting the film produced to electron diffraction. The brief time period necessary for such reactions and the brevity of the necessary electron exposure would permit a greatly accelerated program of research undertaking such study.

Chemical Methods

The ordinary chemical methods of analysis will not be given, inasmuch as they may be obtained from any standard textbook on mineral analysis. The methods employed in the cement testing laboratories may be found in the standard and tentative methods of cement testing of the American Society for Testing Materials, and of the Federal Specifications Board.

A number of special chemical reactions involved in cement research are discussed below.

Free CaO. A convenient method for the qualitative observation of the presence of free CaO in cement was given by White (71) in 1909. A reagent is prepared consisting of a solution of 5 g of phenol in 5 ml of nitrobenzene to which two drops of water are added. A drop of this reagent is placed on a bit of the finely-powdered cement or clinker on a microscope slide and a cover glass pressed in place. The preparation is examined under crossed nicols. Long needle-like crystals of calcium phenolate, strongly birefringent and radiating out from the grains of CaO, develop in a few minutes if much free CaO is present, but if only traces are present

it may take an hour for the needles to become visible. About 0.1 percent free CaO may be detected by this test, but the reagent also acts upon $\text{Ca}(\text{OH})_2$.

A considerable number of methods have been suggested for the quantitative determination of free CaO, most satisfactory of which appears to be some adaptation of the glycerol-alcohol extraction process of Emley (16). The method was modified to make it applicable to portland cement by Lerch and Bogue (37).

The determination is based on the solution of the uncombined CaO in a hot solution of glycerol and alcohol, and the subsequent titration of the dissolved lime with an alcoholic solution of ammonium acetate, in accordance with the reaction:



A solution is prepared consisting of 1 part by volume of U.S.P. glycerol and 5 parts of absolute ethyl alcohol or anhydrous denatured alcohol.* To each liter of this solution is added 2 ml of an indicator prepared by dissolving 1 g of phenolphthalein in 100 ml of absolute alcohol. If the glycerol-alcohol solution is not neutral to the indicator, it is made so by the addition of a drop or two of a dilute alcoholic solution of KOH or NaOH, and just removing the pink color by a drop of alcoholic ammonium acetate.

A standard alcoholic solution of ammonium acetate is prepared by dissolving 16 g of crystalline ammonium acetate in 1 liter of absolute ethyl alcohol or anhydrous denatured alcohol, and is standardized by titrating against pure freshly-calcined CaO. About 0.1 g of this CaO, prepared by calcining pure calcite or calcium oxalate in a platinum crucible at 900° – 1000° to constant weight, is transferred to a 200 ml Erlenmeyer flask containing 60 ml of the neutralized glycerol-alcohol solution. The CaO is dispersed by shaking, a water or air reflux condenser inserted in the neck of the flask, and the solution boiled for 20 minutes. The flask is detached from the condenser and the solution titrated immediately, while near boiling, with the ammonium acetate solution. The condenser is replaced and the boiling continued for another 20 minutes. The titration and boiling are repeated at successive 20 min. intervals until no further color appears in the solution during continuous boiling for 1 hour. The value of the solution is then calculated in terms of CaO equivalent to each ml of ammonium acetate solution.

The cement to be tested is freshly ground to an impalpable powder. A 1 g sample is weighed into the Erlenmeyer flask and the same procedure repeated as used in standardizing the solution. The CaO content of the cement is then calculated from the known CaO-value of the ammonium acetate solution:

$$\text{CaO} = 100 \frac{vs}{w}$$

where v = ml standard ammonium acetate solution required

s = CaO value of standard solution in g CaO per ml.

w = weight of sample taken

If the sample contains any hydrated lime, $\text{Ca}(\text{OH})_2$, this also will be dissolved and appear in the results as CaO. Hence the test is strictly valid for free anhydrous

* Denatured by Formula 3-a or 2-b.

CaO only with freshly ground clinker. When applied to cements, where the possibility obtains for the presence of some hydrated lime, the test must be employed with reservations.

The above method has been widely used and found generally satisfactory. A number of modifications have, however, been suggested, designed chiefly to accelerate the procedure.

Meyers (41) makes use of an apparatus by which three simultaneous titrations are obtained. Air is excluded and the reagent added without disconnecting the reflux condenser. The claim is made that the time is reduced to $1\frac{1}{2}$ to 3 hours.

Brandenburg (8) found that the test could be materially accelerated by the addition of anhydrous barium chloride. About 1 g of BaCl_2 , dehydrated by heating to constant weight at 140° – 150° , is added to the sample, the mixture boiled vigorously, and the solution titrated at 2 to 5 minute intervals.

Rathke (50) proposed the use of an alcoholic solution of acetic acid for the titration in preference to alcoholic ammonium acetate, believing that the boiling out of the ammonia, formed during the reaction, may result in various errors. A modification of this process was suggested by Schindler (52).

The use of ethylene glycol as the solvent was thought to be preferable to glycerol by Schlapfer and Bukowski (53). The flask containing 0.5 to 1.0 g of sample and 40 ml of ethylene glycol is heated with constant shaking on a water bath at 65° to 70° for 30 minutes, and the solution filtered through a sintered-glass filter or hardened paper on a porcelain plate. The residue is worked with absolute alcohol and the solution titrated with 0.1*N* alcoholic benzoic acid or 0.1*N* HCl, using an indicator of 0.10 g phenolphthalein with 0.15 g α -naphtholphthalein dissolved in 100 ml of absolute alcohol.

Bessey (4) has found that the method of Lerch and Bogue is, in respect to accuracy, probably the most satisfactory, but that the modification of Brandenburg and the method of Schlapfer and Bukowski are satisfactory and rapid. The latter procedure was modified by Rordam (51) by the addition to the flask of 15 ml of absolute methyl alcohol, and boiling under an air-cooled reflux condenser on a hot plate. The solution is titrated with 0.1*N* HCl using 10 drops of bromothymol blue as indicator.

Several of the methods were examined by MacPhearson and Forbrich (40) who concluded that the ethylene glycol method is satisfactory for the determination of free CaO, and has the advantage of speed over the glycerol-alcohol method. The former method could not, however, be recommended for the determination of $\text{Ca}(\text{OH})_2$ because of incomplete solution of that compound and also because C_2A hydrate and calcium sulfoaluminate decompose in the presence of ethylene glycol. The use of BaCl_2 or NaCl were not recommended in connection with the glycerol-alcohol method because the results so obtained were found to be some 0.3 or 0.4 percent high.

Ca(OH)₂ in Set Cement. Bessey (5) has described a method for estimating $\text{Ca}(\text{OH})_2$ in hydrated cements which depends upon the fact that $\text{Ca}(\text{OH})_2$ does not dissociate below 350° whereas dissociation is nearly complete after ignition for a half hour at 550° . The method consists in the dehydration of samples of the cement, at each of the above temperatures, and measurement of the difference in the heat evolved on rehydration of the two ignited samples.

The sample is dried and crushed, preferably out of contact with CO₂-containing air, to pass a No. 100 sieve, and well mixed. About 10 g of sample is weighed into a narrow silica or porcelain crucible and ignited in an electric furnace for a half hour at 350° ± 10°. It is cooled in a desiccator, containing soda-lime and a desiccating agent (preferably P₂O₅), for a half hour and then brushed into the wide test-tube of the calorimeter apparatus. The tube is corked, placed in the calorimeter, the liquid stirred, and the temperature allowed to become steady. The bottom of the tube is then broken by a suitable rod and the contents of the calorimeter well mixed by stirring vigorously for four minutes. At the end of that period the rise in temperature is noted, corrections made for heat losses from the calorimeter, and the heat evolved calculated from the known constants of the latter. The specific heat of the sample may be taken as 0.20 for calculation of heat evolved.

This procedure is repeated with another sample of similar weight ignited to 550° ± 10°, and the heat evolved calculated as before. From these data the CaO content, present as Ca(OH)₂ in the sample, is calculated according to the formula:

$$\text{Ca(OH)}_2 \text{ in terms of CaO (\%)} = \left[\left(\frac{Q_2}{W_2} - \frac{0.7Q_1}{W_1} \right) \times \frac{100}{273} \times f \right] + c$$

where Q_1 and Q_2 are the quantities of heat evolved at 350° and 550° respectively.

W_1 and W_2 are the weights of samples used for estimations at 350° and 550°.

273 is the heat of hydration of CaO in calories per gram.

f is a correction factor for incomplete decomposition of Ca(OH)₂ at 550° and for carbonation of the sample. It may vary slightly with the furnace used; for the furnace employed by Bessey it was 1.07.

c is a correction factor for combination of lime with the other materials during ignition. For portland cement it was found to be 0.2 when the free CaO content was greater than 1 percent; at lower values it may be taken as zero.

The factor 0.7 applied to Q_1/W_1 is intended to allow for the fact that the heat evolved from the set cement compounds (aluminates and silicates) on immersion in water is less after heating at 550° than after heating at 350°.

The Ca(OH)₂ in set cements determined in this way is believed to be correct to about 0.5 percent CaO.

Free CaO and Ca(OH)₂ in Cement. By taking advantage of the dissociation of Ca(OH)₂ as described above, Bessey (6) has developed a method for differentiating between the free CaO and Ca(OH)₂ in cement prior to hydration. The experimental work consists in determining the losses in a sample of the cement when heated for a half hour at 350° and at 550°. The water that is combined in the hydrated cement compounds, other than Ca(OH)₂, is mostly given up at 350°, but a small additional amount from that source is released at 550°. Hence the loss between those two temperatures is not wholly due to dissociation of Ca(OH)₂, and a correction factor has to be introduced to account for the additional water lost from the hydrated compounds at 550°. This value has been found to vary between 1.07 and 1.12 but has a mean value of 1.09.

Thus the loss at 350° = loss from hydrated cement compounds (X_1), and the loss at 550° = loss from hydrated cement compounds (X_2) + loss from Ca(OH)₂. Putting $X_2 = KX_1$, where $K = 1.09$, the Ca(OH)₂ content (expressed as CaO) =

[loss at 550° - K (loss at 350°)] $\times \frac{56}{18}$. The factor $\frac{56}{18}$ is the ratio CaO/H₂O. Letting L = loss in weight, we may write the equation,

$$\text{Ca(OH)}_2 \text{ as CaO} = 3.11(L_{350^\circ} - 1.09L_{550^\circ}).$$

The "total free CaO" by the glycerol-alcohol method includes both free CaO and Ca(OH)₂. Hence, by subtracting the Ca(OH)₂ (expressed as CaO), obtained as above from the "total free CaO," obtained by the glycerol-alcohol method, the anhydrous free CaO is obtained.

In a method developed by Franke (19) free CaO, which includes any Ca(OH)₂ that may be present, is brought into solution by boiling with a mixture of acetoacetic ester and isobutyl alcohol. This ester alone, in its enol form, was found to dissolve also the CaS and hydrated calcium silicates, but the alcohol was found to retard that reaction.

The detail of the procedure calls for the boiling for an hour of a mixture of 3 ml of acetoacetic ester and 20 ml of isobutyl alcohol in a 200 ml flask containing 0.05 to 1.0 gram of cement or cement hydrate. The flask is fitted with a reflux condenser and protected from entry of moisture or CO₂ by tubes of soda lime and calcium chloride. The mixture is then cooled, filtered with suction through a close filter, washed with 20 ml of isobutyl alcohol, and the calcium in the filtrate determined by any convenient method.

The precision of the method is said to be high, and superior to the ethylene glycol method. An advantage claimed is that the CaO and Ca(OH)₂ may be determined in set cements without interference from the hydrated calcium silicates, a condition said not to be met with the other methods that have been described.

Determination of Uncombined Magnesia. A method for the determination of uncombined MgO in cement has been proposed by Taylor and Bogue (61). This consists in the separation of the uncombined magnesia from that present in the form of glass or other compounds by treatment with ammonium nitrate in solution in anhydrous alcohol and glycerol, and the subsequent determination of the MgO in the extract by the usual means. The solution of the MgO in NH₄NO₃ forms a double salt in accordance with the equation (64):



Water is not applicable for the extraction because the magnesia in the glass would also be partially dissolved. The mixture of alcohol and glycerol is advantageous because the determination may thus be carried out on the same sample and in the same solution as used for the determination of free CaO.

The study has shown that the method is accurate and reproducible to about 0.2 percent. High-burned and low-burned magnesia react equally well, but magnesia in a glass does not react under the conditions of the method. The hydroxide and the basic carbonate react positively. Hence a cement in which the magnesian glass has undergone some reaction with water or carbon dioxide will show a greater amount of free MgO by the method described than is indicative of the magnesia that originally was present as free MgO in the clinker. The sample should be ground to pass completely through the No. 300 sieve. Certain denatured alcohols may be substituted for the pure ethyl alcohol. The

observation that magnesia in a glass does not react is of particular interest. Since that is the case, the method may be employed advantageously as a measure of the degree to which a condition of equilibrium crystallization has been attained.

The detailed procedure is as follows: One gram of cement freshly ground to pass a No. 300 sieve is placed in a 250-ml Erlenmeyer flask equipped with a piece of glass tubing about 2 feet in length to serve as a reflux condenser. Fifty ml of absolute alcohol, 10 ml of glycerol, and about 4 grams of crystalline "C. P." ammonium nitrate are added. If it is desired to utilize the sample which has been used for a free lime determination, it is necessary to add only the ammonium nitrate and enough alcohol to make up for any deficiency due to evaporation. This mixture is gently boiled on a hot plate or steam bath until ammonia ceases to be expelled. This may be detected by holding a piece of moist red litmus paper to the mouth of the flask. The time required has been found to vary from 1 to 5 hours. When the paper no longer turns blue, the solution of the magnesia is complete.

The solution is separated from the solid residue by filtering the mixture through medium filter paper. The residue is washed upon the paper two or three times with hot absolute alcohol. The filtrate contains the magnesium as the double salt, and also some of the silicates, in solution. Any standard method for magnesia may be employed from this point. The method described below has been found to be satisfactory.

The beaker containing the solution is placed upon a hot plate or steam bath to evaporate the alcohol. When this is evaporated, about 100 ml of distilled water is added and the solution heated to boiling. It is made alkaline with ammonium hydroxide. Silica gel forms at this step. The calcium is precipitated with an excess of saturated ammonium oxalate solution and the boiling continued until the calcium oxalate is well coagulated. The precipitate is allowed to settle and the supernatant liquid is filtered through medium filter paper. The calcium oxalate is dissolved with dilute hydrochloric acid and then reprecipitated by making alkaline with dilute ammonium hydroxide. This is done to free any magnesium salts which may have been occluded. The precipitate is brought upon the filter paper and washed several times with water.

The combined filtrate is acidified with hydrochloric acid, concentrated to a volume of 250 ml and allowed to cool. When cool, 20 ml of a saturated solution of sodium-ammonium-hydrogen phosphate (microcosmic salt) is added, and dilute ammonium hydroxide, drop by drop, with constant stirring. Crystalline ammonium-magnesium orthophosphate is slowly formed. When this formation is apparently complete an excess, about 10 ml, of dilute ammonium hydroxide is added. The solution is set aside in a cool place for several hours, preferably over night, before filtering.

A Gooch crucible is recommended for the filtration and weighing of the precipitate. The ammonium-magnesium orthophosphate is washed several times with water containing about 1.5 percent NH_3 . The precipitate is ignited to constant weight over a flame which has a temperature of about 1100° . A Meeker burner or blast lamp is satisfactory. Magnesium pyrophosphate is formed. The weight of the pyrophosphate multiplied by the factor $\text{MgO}/\text{Mg}_2\text{P}_2\text{O}_7 \times 100$, (36.2), gives the percentage of uncombined magnesia in the sample.

Spectrographic Analysis

The use of the spectroscope for the quantitative analysis of the elements has experienced a rapid development in recent years. Its applications have been particularly important for the determination of elements for which the chemical methods are excessively time-consuming and where the concentrations are low. With the increased interest in this method have come improved techniques, greater accuracy and varied applications.

The spectrographic method is based upon the principle that light from a suitable source containing the elements to be determined produces, upon analysis with a spectroscope, a large number of lines characteristic of the elements in the source. The intensity of the spectrum of any element is a function of various conditions, chief of which is the concentration of the element. By establishing the relationship between the intensities of the lines in the spectrum and the known concentrations of the elements in the source, the bases are provided for the quantitative determination of the elements in an unknown source.

The general procedure for a spectrographic determination is about as follows. The sample is mixed with a fixed proportion, established by investigation, of some salt which will supply an element (known as the internal standard) in definite concentration, the lines in the spectrum of which are employed for the comparison of relative intensities. Another material (known as a buffer) is usually added to produce the optimum characteristics for a desirable spectrum. These are sometimes mixed with graphite and pressed or moulded into a form suitable for exposure to an arc or spark. A photographic exposure is made of the light from this source, the various conditions having been established. The blackening of the lines in the developed plate is measured with a microphotometer. The relative blackening of the lines of the reference element and of the element under study are then used for calculating, on a plate-calibration curve, a factor defined as the logarithm of the relative intensity of the two lines. By subsequent reference to an empirical relation, the concentration of the element under study is determined.

To apply the method to any material requires the development of the experimental procedure, reference element and buffer mixtures, best suited to the problem, and the determination of the analytical curve by the application of the adopted procedure to a series of samples containing the element sought in accurately known concentrations covering the desired range.

The percentage error of spectrographic analysis tends to remain constant regardless of concentration whereas, in chemical analysis, the absolute error tends to be constant. Thus for high concentrations the chemical methods are preferable whereas, for low concentrations, the spectrographic method often gives higher precision.

A spectrographic method has been reported by Helz (23) for the determination of sodium, potassium and lithium in portland cement or cement raw mixtures. In this study the direct-current carbon arc was used. Sodium and potassium were determined by mixing the cement with a mineral base containing silver for the internal standard, placing the powdered mixture in a recess of a graphite rod to be used as the lower electrode in an arc, and recording the red region of the spectrum. For lithium, a standard mixture of graphite and strontium carbonate

were mixed with the cement sample, and the violet region of the spectrum recorded. The Na-8194.81A, K-7698.98A, and Li-3232.61A lines were used for the quantitative calculations. The procedure requires about 4 hours for the determination of sodium and potassium in 6 samples, and about the same time for lithium.

The procedure was designed to minimize and control self-reversal (a line becoming broad, diffuse and anomalously weak), unequal rate of evaporation of the alkali and reference elements, unequal distribution in the arc of intensity of the spectrum of the alkali and reference elements, and the effect of extraneous elements.

An estimate of the reproducibility of the sodium and potassium determinations in terms of the probable error for the average of duplicate determinations was 4.0 percent of the Na₂O concentration and 5.8 percent of the K₂O concentration. The accuracy of the method cannot be expressed in such simple figures but is illustrated by a comparison of chemical and spectrographic analysis of 41 portland cements where the spectrographic results were found to differ from the chemical results by an average value of 0.06 percent of the sample.

In a later study, Helz and Scribner (24) developed the means for the simultaneous determination of eight elements in the cement: Na, K, Li, Mn, Ti, Mg, Fe and Al. In this later study, important improvements were introduced. The first had to do with the preparation of the specimen for test. It was found that better results could be obtained by compressing the test sample into a smooth, uniform pellet. The mixture found most satisfactory consisted of the cement, graphite and cobalt oxide in proper proportions. The graphite is necessary for the smooth burning of the charge in the electrode, and the cobalt oxide is employed as the internal standard for comparing the relative intensity of the spectrographic lines. The pellets, about $\frac{1}{4}$ inch in diameter and $\frac{1}{8}$ inch thick, weighing about 1 gram, are compressed in a steel mold designed for the purpose. These are used as the lower electrode, the upper electrode being a blunt $\frac{1}{8}$ inch graphite rod. Also, a "multisource" power unit was found to have distinct advantages over the D.C. arc.

It had been found that potassium interferes with the determination of sodium, but that the magnitude of such interference changes very little when the concentration of K₂O varies between 1 and 2 percent. Hence the difficulty could be overcome by adding 0.7 percent K₂O to all samples and, in the calculation, reducing by that amount the K₂O content observed to be present. Potassium nitrate was found most suitable for this purpose.

By this procedure it is now possible for one operator to determine in duplicate in one day the above eight elements in 10 to 16 cements. The accuracy is probably as good or better than that obtaining by the usual chemical methods of analysis. The probable errors, expressed as percentages of the concentration, are between 2 and 5 percent, except for potassium which is somewhat greater.

Polarographic Analysis

The polarographic method of chemical analysis was developed by Heyrovsky (25) in 1925 and has been fully described by Kolthoff and Lingane (33). A photoelectric recording polarograph has recently been described (39). The

method is based on the interpretation of the current-voltage curves that are obtained when solutions of electro-reducible or electro-oxidizable substances are electrolyzed in a cell in which an electrode consists of mercury falling dropwise from a very fine-bore capillary glass tube. From the unique characteristics of such current-voltage curves, both the species and concentration of the electro-reducible or electro-oxidizable substances present in the solution can be determined.

An application of this method to the determination of alumina in cement was made by Ford (18). The alumina as usually determined is obtained by subtracting the amount of ferric oxide, determined volumetrically, from the total amount of oxides obtained by precipitation with ammonium hydroxide, the latter value representing what is commonly known as R_2O_3 . The errors of this procedure are recognized as due to the contamination of the R_2O_3 with other materials, such as TiO_2 and P_2O_5 . Direct methods for the determination of Al_2O_3 have been proposed, (14)(72)(32) but have not been commonly adopted.

In order to prevent the silica from gelatinizing, the acid solution has to be adjusted to pH 3.50 ± 0.05 . The interference of hydrogen ions at higher acidities impairs the accuracy of the procedure, and at pH above 3.8 alumina separates out as the hydroxide. The alumina has to be adjusted to about 0.00005 g per ml, requiring a cement content of about 0.001 g per ml. The presence of manganese and phosphorous interfere with accuracy, and methods must be devised to depress or remove these effects.

Quantitative measurements of the alumina content are made by relating the height of the polarograms with that of curves obtained with the same samples mixed with known amounts of a solution containing a known amount of Al_2O_3 , by the equation

$$\% Al_2O_3 = \frac{h_1}{2h_2 - h_1} \cdot \frac{100C_1}{C_2}$$

where h_1 = height in mm of curve of sample,

h_2 = height in mm of curve of sample + standard Al

C_1 = concentration in g per ml of Al_2O_3 in the standard

C_2 = concentration in g per ml of cement in the sample.

The method has not proved wholly satisfactory and recommendations cannot yet be made with reference to its commercial application. For this reason the detailed procedure is not given. The time required for the determination is somewhat less than a day.

Heat of Solution

Procedure. The heat of solution of a material is one of its fundamental properties. In portland cement research and technology, heat-of-solution methods have been employed for determining the glass content of clinker and the heat of hydration of cements.

A simplified procedure for determining the heat of solution of anhydrous and hydrated portland cements was described by Pierce and Larmour (47), and modified by Lerch (36). The apparatus used by Lerch consists of a 1-pint open-mouth thermos bottle into which a solvent is introduced, consisting of a mixture of about 400–450 ml of 2N HNO_3 plus 8 ml of 48 percent HF. The mixture is

stirred for a few minutes to attain a uniform temperature, which is read by means of a Beckmann thermometer inserted through a cork stopper. The temperature is read to 0.001° and the cement sample slowly introduced through a funnel. Temperature readings are taken at 5-minute intervals until constant, which requires 10 to 25 minutes. The temperature rise, corrected for the heat of stirring and multiplied by the heat capacity of the calorimeter, previously determined, gives the heat of solution of the sample. The probable error is about 1 calorie per gram.

The use of this instrument has been found to give satisfactory results for calculating heats of hydration, where the differences between the heats of solution of anhydrous and hydrated cements are rather large. But for the determination of glass content, where the differences between the heats of solution of the original clinker and the annealed clinker (see below) are small, a high accuracy is required and a more precise calorimeter has been designed (3).

This calorimeter consists of a Dewar flask fitted with a stirrer, resistance thermometer and sample tube. This assembly fits inside a water-tight brass chamber which is immersed in a constant-temperature water bath. The Dewar flask is coated on the inside with acid-resistant material.* The cover of the flask, the stirrer, sample tube and thermometer assembly are made of Lucite. The stirrer is driven from above at a constant speed of 300 rpm. The thermometer consists of a coil of 0.1 mm pure platinum wire embedded in a hollow Lucite cylinder. The sample is held, below the surface of the solvent, in a tube which has a plug at the lower end that is ejected with the sample by means of a stout spiral platinum wire attached to a Lucite rod. The resistance of the thermometer, from which temperature measurements are calculated, is determined with a Mueller Bridge.

A sketch of the calorimeter assembly is shown in Figure 12. The accuracy of the heat-of-solution values obtained is indicated by a probable error for a single determination of ± 0.36 calories, and for the average of two determinations, ± 0.25 calories.

Estimation of Glass Content. A method for estimating the glass content of clinkers, which has been of great importance, is based upon an approximate determination of the latent heat of crystallization of the glassy phase. This method, reported by Lerch and Brownmiller (38), depends upon the principle that heat is released during the crystallization of a liquid; hence the heat of solution of a crystalline material is less than that of the same composition in the uncrystallized or glassy state. If this difference, referred to as the latent heat of crystallization, is known for any given composition, then the amount of the glass in a mixture containing such material may be learned by a determination of the heat of solution of that material and a similar determination of the heat of solution of the same material following its complete crystallization. The difference between these two values, per gram weight of sample, represents the latent heat of crystallization of the glassy phase. This value divided by the latent heat of crystallization of the pure glass, times 100, will then give the percentage of the glassy phase in the clinker.

The work of Lea and Parker on the system C-A-F-S had provided data by

* Vynilite or Stonite solutions are satisfactory.

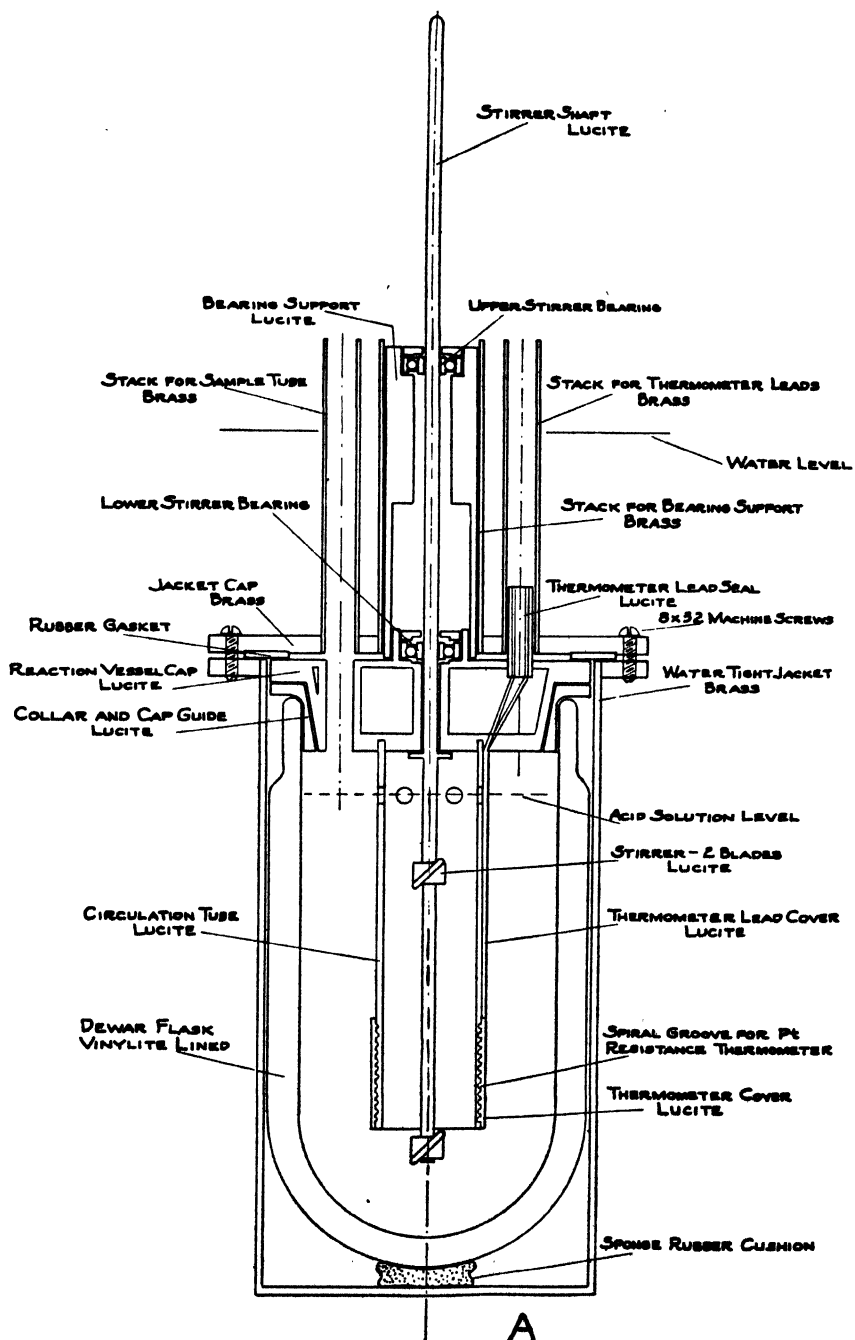

Figure 12. Calorimeter assembly. (Bechtold and Hels)

which the composition, as well as the amount, of liquid in equilibrium with the solid phases in the portland cement field of that system at any temperature, could be computed.* Accordingly, several of these liquid compositions of varying A:F ratio, falling on the C_3S - C_2S surface of the C-A-F-S system at 1400° , were prepared and given heat treatments such as to provide, in one case, complete absence of crystal formation and, in another case, complete crystallization. To some of these preparations 8 percent MgO was introduced (corresponding to 2.0 percent MgO in a clinker containing 25 percent liquid at 1400°) in order more closely to simulate the liquids of commercial clinker which always would contain some MgO in solution. The heats of solution of each pair were then determined, and the differences, agreeing to ± 3 cal/g, were noted. These values, denoted the latent heats of crystallization, are plotted against the A:F ratio in Figure 13, and are the values applied in the subsequent computations. The 8

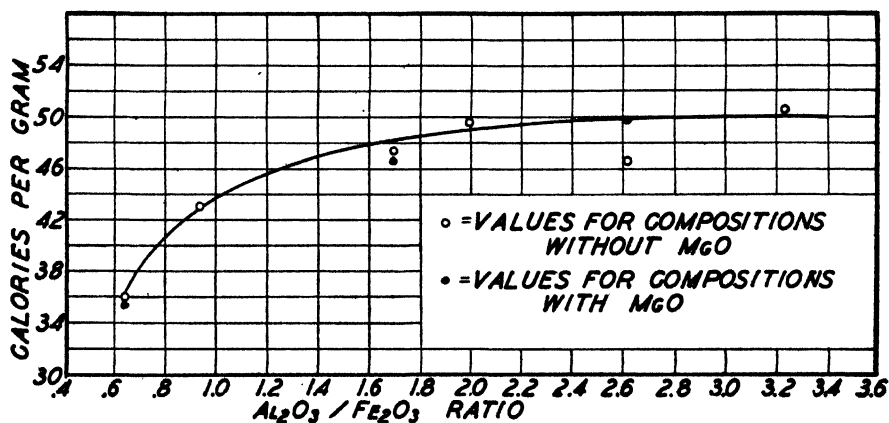

Figure 13. Latent heat of crystallization of liquid compositions of varying $Al_2O_3:Fe_2O_3$ ratios on the C_3S - C_2S surface at 1400° . (Lerch)

percent MgO did not materially change the latent heats of crystallization of these compositions.

The glass content of a clinker was then approximated by determining its heat of solution, and repeating the determination following an annealing by heating to 1400° , allowing the temperature to decrease to 1250° over a 2-hour period, and holding at $1250^\circ \pm 10^\circ$ for 15 hours.

The difference in the values obtained as above was corrected for the heat of inversion of β - C_2S to the γ form during the annealing process, for the C_2S of the original clinker was in the β form, but it inverted on annealing. This value, found by Johannson and Thorvaldson (31) to be 6 cal/g at 20° was confirmed by Lerch. Thus the observed heats of solution of the annealed clinkers were too low by 0.06 cal/g for each percent of C_2S present. The corrected difference in heats of solution, divided by the latent heat of crystallization of a liquid composition of the A:F ratio of that clinker as obtained from Figure 13, times 100, gives the

* See Chapter 10.

percentage of glass in the clinker. Such values are given and discussed in Chapter 9.

The solvent employed by Lerch in the heat-of-solution determinations consisted of 420 g 2N HNO₃ containing 5 ml of 48-percent HF. A 3-gram sample of clinker was used in each test. With this solvent, the heats of solution at 23° of the several crystalline cement compounds were found as given in the tabulation below, the probable error being ± 2.0 cal/g. Similar determinations were made by Insley and his co-workers (29) under slightly different conditions. An isothermal calorimeter was used, the determination being made at 25° in a solvent consisting of a mixture of 648.5 g of $2.500 \pm 0.002N$ HNO₃ and 11.5 g of reagent quality HF (48 percent). The values obtained are given below. The differences from those of Lerch and Brownmiller may be attributed to differences in the calorimeters and to the volumes and concentrations of the solvents used.

Compound	Heat of solution	
	Lerch and Brownmiller, cal/g, 23°	Insley <i>et al.</i> , cal/g, 25°
C ₂ A.....	783.3	799
C ₃ A.....	726.2	
C ₄ AF.....	586.8	592
C ₂ S.....	632.0	639
γ -C ₂ S.....	556.8	
β -C ₂ S.....	563.0	572
CaO.....	835.0	848
MgO.....	875.4	876

Thorvaldson and his co-workers (63) had previously reported the heat of solution of CaO in HCl.200H₂O at 20° as 829.1 cal/g at 20°, and Taylor and Wells (60) had found the heat of solution of CaO in 2.085M HCl to be 834.2 cal/g, and in 0.277M HCl to be 825.2 cal/g. The heat of solution was not found to be materially affected by the temperature of ignition.

Thorvaldson and his coworkers had also determined the heat of solution of C₂A in HCl.20H₂O at 20° and found it to be 736.4 cal/g. In HCl.200 H₂O the value was 732.8 cal/g.

It was pointed out by Lerch and Brownmiller that the above method gives only an approximation of the true glass content, for there appear to be several inherent sources of error or uncertainty in the application of the procedure which are not evaluated. Thus the method assumes the independent crystallization of the liquid from 1400°, but it is known that in some compositions the liquid on cooling may react with the solid phases by which a different percentage of the compounds will result. Likewise, during partial crystallization, the A:F ratio of the residual liquid may change, and, as shown in Figure 13, the latent heat of crystallization of the liquid, especially at low A:F ratios, changes materially. The method however, does not provide for such a change. Also, it is assumed that all of the C₂S in an undusted clinker is in the β form, and that all of the C₂S in the

TABLE 11. *Heats of solution of commercial clinkers (Insley et al) (29)*

No.	Observed	Calculated from microscopical analysis	Calculated from computed compound composition
1	632	621	629
2	625	610	620
3	603	610	598
4	616	625	613
5	615	618	618
6	630	619	621
7	634	624	634
8	635	619	629
9	627	623	619
10	628	618	626
11	643	627	634
12	624	613	615
13	619	616	617
14	626	616	622
15	613	610	613
16	629	620	623
17	638	628	633
18	632	629	632
19	647	651	629
20	638	643	642
21	646	658	651
22	652	649	644
23	639	656	644
24	641	646	630
25	660	661	654
26	631	637	619

dusted annealed clinker is in the γ form, but neither of these conditions may be strictly correct. Complete crystalline equilibrium may not be attained during the annealing process, and equilibrium at 1400° may not have been attained in the original clinker. Solid solutions of unknown character may be formed, and the thermal changes occurring in the compounds of the alkalis, titania, manganese, and other minor constituents are not considered. Some of these factors are reduced by the actual measurement of the heat of solution of the annealed sample as compared with the establishment of such values by calculation from the potential composition of the major components. Such differences have been found to be small, but their existence makes the actual measurement desirable.

Additional precautions which should be taken in the performance of the determination have been pointed out by Stenzel and Morris (57).

A comparison was made by Insley and his coworkers (29) of the observed

heats of solution of a number of commercial clinkers, and the heats of solution as calculated (a) from the microscopical analysis and (b) from the compositions as computed by the Bogue method under the assumption of complete equilibrium crystallization. The results are given in table 11.

In general the agreement between the observed heats of solution and the values calculated from the computed compositions is good. Somewhat greater differences are noted when the observed values are compared with those calculated from microscopical analysis.

References

1. Ashton, F. W. and Taylor, W. C., *Am. Mineralogist*, **13**, 411 (1928); PCAF Paper 16.
2. Barnes, R. B. and Burton, C. J., *Ind. Eng. Chem.*, **35**, 120 (1943).
3. Bechtold, I. C. and Helz, A. W., *Res. Reports, PCAF*, 1941.
4. Bessey, G. E., *Cement and Cement Mfg.*, **9**, 163 (1936).
5. Bessey, G. E., *Bldg. Res. Tech. Paper*, 9 (1930).
6. Bessey, G. E., *J. Soc. Chem. Ind.*, **52**, 219 (1933).
7. Bragg, W. H. and Bragg, W. L., "X-Rays and Crystal Structure," London, G. Ball and Sons, 1915.
8. Brandenburg, H. R., *Rock Products*, Nov. 1929, p. 76; Mar. 1931, p. 68.
9. Brown, L. S., *Proc. Am. Soc. Testing Materials*, **37**, 277 (1937).
10. Brownmiller, L. T., *Am. Mineralogist*, **12**, 43 (1927), PCAF Paper 7.
11. Brownmiller, L. T., *Am. J. Sci.*, **35**, 241 (1938); PCAF Paper 35.
12. Brownmiller, L. T. and Bogue, R. H., *Am. J. Sci.*, **20**, 241 (1930); PCAF Paper 24.
13. Burton, E. F. and Kohl, W. H., "The Electron Microscope," 2nd edition, New York, Reinhold Publishing Corp., 1946.
14. Chandler, W. R., *Rock Products*, Aug. 1936, p. 52.
15. Clark, G. L., "Applied X-Rays," New York, McGraw-Hill Book Co., 1927.
16. Emley, W., *J. Am. Ceramic Soc.*, **17**, 720 (1915).
17. Finch, G. I., Quarrel, A. G. and Wilman, H., *Trans. Faraday Soc.*, **31**, 1051 (1935).
18. Ford, C. L., *Res. Reports PCA*, July 1943; Aug. 1944.
19. Franke, B., *Z. anorg. allgem. Chem.*, **247**, 180 (1941).
20. Hansen, W. C., *J. Am. Ceramic Soc.*, **11**, 68 (1928); PCAF Paper 12.
21. Harrington, E. A., *Am. J. Sci.*, **13**, 467 (1927); PCAF Paper 8.
22. Harrington, E. A., *J. Optical Soc. Am. and Rev. Sci. Instruments*, **16**, 211 (1928); PCAF Paper 15.
23. Helz, A. W., *J. Res. NBS*, **34**, 129 (1945); RP 1633; PCAF Paper 46.
24. Helz, A. W. and Scribner, B. F., *J. Res. NBS*, in press.
25. Heyrovsky, J. and Shikata, M., *Rec. Trav. Chim.*, **44**, 496 (1925).
26. Hopkins, H. G., *Trans. Faraday Soc.*, **31**, 1095 (1935).
27. Insley, H., *J. Res. NBS*, **17**, 353 (1936); RP 917.
28. Insley, H., *J. Res. NBS*, **25**, 295 (1940); RP 1324.
29. Insley, H., Flint, E. P., Newman, E. S. and Swenson, J. A., *J. Res. NBS*, **21**, 355 (1938), RP 1135.
30. Insley, H. and McMurdie, H. F., *J. Res. NBS*, **20**, 173 (1938); RP 1074.
31. Johannson, O. K. and Thorvaldson, T., *J. Am. Chem. Soc.*, **56**, 2327 (1934).
32. Kampf, L., *Ind. Eng. Chem. anal. ed.*, **13**, 72 (1941).
33. Kolthoff, I. M. and Lingane, J. L., "Polarography," New York, Interscience Pub. Co., 1941.
34. Larsen, E. S. and Merwin, H. E., *Am. J. Sci.*, **34**, 42 (1912).
35. Lee, C. S., *Trans. Faraday Soc.*, **31**, 1102 (1935).

36. Lerch, W., *Eng. News Record*, **113**, 523 (1934); PCAF Paper 29.
37. Lerch, W. and Bogue, R. H., *Ind. Eng. Chem.*, **18**, 739 (1926), PCAF Paper 2; *ibid.*, *anal. ed.*, **2**, 269 (1930); PCAF Paper 23.
38. Lerch, W. and Brownmiller, L. T., *J. Res. NBS*, **18**, 609 (1937); RP 997; PCAF Paper 32.
39. Lykken, L., Pompeo, D. J. and Weaver, J. R., *Ind. Eng. Chem., anal. ed.*, **17**, 724 (1945).
40. MacPherson, D. R. and Forbrich, L. R., *Res. Reports, PCA*, 1937.
41. Meyers, S. L., *Rock Products*, Nov. 1929, p. 76.
42. Miller, L. B., *Rock Products*, Sept. 1939.
43. Morgan, R. and Smith, N., *Rev. Sci. Instruments*, **6**, 316 (1935).
44. Morton, C. and Sass, S., *J. App. Physics*, **14**, 522 (1943); **15**, 55 (1944).
45. Parker, T. W., *Symposium*, 113.
46. Parker, T. W. and Nurse, R. W., *J. Soc. Chem. Ind.*, **58**, 255 (1939).
47. Pierce, S. C. and Larmour, H. M., *Eng. News Record*, **113**, 114 (1934).
48. Radczewski, O. E., Muller, H. O. and Eitel, W., *Naturwiss.*, **27**, 807; 837 (1939).
49. Radczewski, O. E. and Schweite, H. E., *Zement*, **27**, 246; 275; 287 (1938).
50. Rathke, H., *Tonind. Zty.*, **32**, 1318 (1928).
51. Rordam, S., *Rock Products*, Aug. 1937, p. 72.
52. Schindler, K., *Zement*, **20**, 389 (1931); *Concrete*, Aug. 1931, p. 65.
53. Schlapfer, P. and Bukowski, R., *Lab. Fed. Polytech. Zurich*, **63** (1933).
54. Short, M. N., "Microscopic Determination of the Ore Minerals," *Geological Survey Bull.*, 914 (1940).
55. Siedentopf, H., *Z. Electrochem.*, **12**, 596 (1906).
56. Slipecevich, C. M., Gildart, L. and Katz, D. M., *Ind. Eng. Chem.*, **35**, 1178 (1943).
57. Stenzel, R. W. and Morris, S. B., *Ind. Eng. Chem. anal. ed.*, **6**, 246 (1934).
58. Stern, *Mitt. Materialpruf.*, 1907, p. 7.
59. Tavasci, B., *Gior. Chim. Ind. Appl.*, **16**, 538 (1934).
60. Taylor, K. and Wells, L. S., *J. Res. NBS*, **21**, 133 (1938); RP 1121.
61. Taylor, W. C. and Bogue, R. H., *Res. Reports, PCAF*, Jan. 1928.
62. Thompson, G. P., *Nature*, **120**, 802 (1927); *Trans. Royal Soc.*, **117A**, 600 (1928); **119A**, 652 (1928); **128A**, 641 (1930); *Trans. Faraday Soc.*, **31**, 1049 (1935).
63. Thorvaldson, T., Brown, W. G. and Peaker, C. R., *J. Am. Chem. Soc.*, **51**, 2678 (1929).
64. Treadwell, F. P. and Hall, W. T., "Analytical Chemistry," New York, vol. 1, p. 50, John Wiley and Sons, 1915..
65. Trillat, J. J. and Motz, H., *Trans. Faraday Soc.*, **31**, 1127 (1935).
66. Wahlstrom, E. E., "Optical Crystallography," New York, John Wiley and Sons, 1943.
67. Ward, G. W., *Symposium*, 134.
68. Wentworth, C. K., *J. Geol.*, **31**, 228 (1923).
69. West, C. D., *Am. Mineralogist*, **21**, 245 (1936).
70. Wetzel, E., *Ver. Deut. Portland Cement Fab.*, 1913, p. 5.
71. White, A. H., *Ind. Eng. Chem.*, **1**, 5 (1909).
72. Willard, H. H. and Ning Kang Tang, *Ind. Eng. Chem., anal. ed.*, **9**, 357 (1937).
73. Winchell, A. N., "Elements of Optical Mineralogy," New York, John Wiley and Sons, 5th ed., 1937.
74. Wyckoff, R. W. G., "The Structure of Crystals," New York, Chemical Catalog Co. (Reinhold Publishing Corp.), 2nd ed., 1935.
75. Zworykin, V. K., Morton, G. A., Ramberg, G. E., Hillier, J. and Vance, A. W., "Electron Optics and the Electron Microscope," New York, John Wiley and Sons, 1945.

CHAPTER 6

Heat Treatment in Manufacture

By the heat treatment given a mixture of raw materials, ground rock is converted to cement clinker. All of the chemical reactions of clinker formation take place as a result of that treatment. By the same token, variations in the character of the heating cycle may affect greatly the degree to which the reactions have been completed and the nature of the products formed. Since a part of the mixture is liquified, and a liquid may crystallize on cooling or freeze to a glass, the rate of cooling becomes an important part of the heat treatment, affecting favorably or adversely the qualities of the finished cement. Much of the original weight of the raw mix is lost by volatilization, and in the very processes of reaction heat is absorbed or evolved. This entire cycle is the heart of every cement plant.

The Burning Process

Le Chatelier (28) describes the calcination or burning process as follows: The first reaction is the decomposition and dehydration of the clays at about 600°. From 800° to 900° the limestone is decomposed to CaO and CO₂. At this time the clay begins to react with the lime, and the action becomes the more complete as the temperature rises and the time increases.

At the points of contact of the grains of lime and the particles of clay, fusible products are formed which are diffused in opposite directions, becoming more basic on the one hand and more acid on the other. If we break up a nodule of clay, we will have in the center the elements of clay, infusible silica and alumina. Then the slightly calcareous fused glasses, afterwards a fused mixture of double silicates analogous to slags, with the mono- and dicalcium silicates, all fusible at the temperature of calcination of cements; lastly, the most basic salts, the active constituent of cement, infusible tricalcium silicate, and fusible calcium aluminates; and in the last place of all, quicklime. The proportion of these diverse elements varies in a continuous manner with the degree of advancement of the calcination, tending towards a limit dependent only upon the relative proportions of the elements present.

With a large excess of lime, the final products will be quicklime, tricalcium silicate and tricalcium aluminate. By diminishing the quantity of lime, we would have these two salts and no quicklime. Afterward the calcium aluminate will disappear and will be replaced by a multiple silicate of a composition analogous to that of the basic slags from blast furnaces.

This will be followed in turn by the disappearance of tricalcium silicate, which will be replaced by dicalcium silicate with spontaneous pulverization; then by the monosilicate.

Finally, glasses analogous to the acid slags of blast furnaces will be produced.

Following Le Chatelier a number of important contributions have been made to the study of the course of reactions taking place in the kiln. In 1900, W. B. Newberry (43) collected samples of material taken from various locations in a kiln following a shutdown and reported that, contrary to opinion, the loss on ignition takes place continuously throughout the length of the kiln, being, in a 60 foot kiln,

At 12 ft. from discharge end, 4.3 percent loss
 At 8 ft. from discharge end, 1.1 percent loss
 At 4 ft. from discharge end, 0.9 percent loss

The vapor pressures of calcium carbonate at various temperatures were given by Johnston (21) as follows:

Temp. (°C.)	Pressure (mm.)
500	0.11
700	25.3
750	68.0
800	168.0
850	373.0
898	760.0 (atmospheric pressure)
900	773.0
950	1490.0

From this it is seen that at temperatures as low as 500°, the carbonate will decompose if a pressure below 0.11 mm is maintained or if a current of air free from CO₂ is passed over the specimen. But at a temperature of 898° the vapor pressure of the calcium carbonate is equal to one atmosphere and decomposition proceeds rapidly. Rankin (45) observed that the resulting CaO retained the same shape and general appearance as the grains of limestone from which they were produced, provided the material was not heated above temperatures of about 950°, but that at higher temperatures the structure changes and the grains of CaO break up into a number of smaller spherical particles. Upon holding at such or higher temperatures, the size of the grains increases while their number diminishes. This change in form has been used to explain the observation, made by numerous investigators, that the rate of the reactions in a cement kiln is greatest when the limestone is so treated that the disintegrated structure (hard-burned) is not allowed to form.

The course of the reactions in a cement kiln was examined by Rankin by means of a determination of the ignition loss of samples collected every 10 feet from a 125-foot kiln which had been shut down. His results as shown in the table at the top of page 89 show the values. From these data it appears that two-thirds of the CO₂ is driven off as the charge travels some 95 feet, and the remaining third is expelled in the next 10 feet of travel. Microscopic examinations showed gradually increasing amounts of isotropic CaO from the 45 foot to the 75 foot location, but all of the original limestone grains still retained their shape. At 85 feet the change to rounded grains has only begun, while at 95 feet

Distance from feed end (ft.)	Ig. loss (%)	Kiln loss (%)	Kiln loss (Percent of total loss)
0	36.0	0.0	0.0
15	35.0	1.4	3.8
25	34.0	2.0	5.4
35	33.4	2.6	7.0
45	31.3	4.7	13.0
55	28.9	7.1	19.6
65	28.5	7.4	20.6
75	23.8	12.1	33.7
85	17.2	18.7	52.1
95	12.7	23.3	64.3
105	.2	35.8	99.3
115	.3	35.7	99.1
125	.6	35.4	98.3

the reactions which produce clinker are nearly completed. The sudden plunging of the charge from about 950° (at 90 feet) to 1425° in the clinking zone (at 100 feet) permits the reactions of compound formation to take place directly with lime while still in the structure of the carbonate, which assures a higher degree of efficiency in the process than if the lime were raised slowly in temperature through the range given.

The retardation in rate of reaction which may be brought about by allowing the lime to form the "hard-burned" structure was further shown by an experiment where CaCO_3 and Al_2O_3 were heated together under various conditions. When heated at 1425° for 15 minutes, 95 percent of the mixture had reacted to form C_3A but when the charge had previously been heated to 1400° for an hour, and then at 1425° for 30 minutes, only 80 percent of C_3A was formed. The same sort of phenomena obtains also with silica, in its various forms, during the formation of C_2S . The reaction with powdered quartz is slow; when a precipitated silica ignited at 1400° is used the action is more rapid; and if the latter is ignited at 700° the action is further accelerated. It seems probable, therefore, that the more porous the structure in which the constituents of the mix may be retained up until the temperature is reached at which the chemical reactions take place, the more rapid will be those reactions.

The formation of C_2S from CaCO_3 and SiO_2 (precipitated silica ignited at 700°) was found to take place even more slowly:

Temp. (°C)	Time (hrs.)	C_2S formed (%)
1400	.5	10
1500	1.0	50
1540	.5	70

But when the mixture is composed of an argillaceous rock (cement rock) and limestone, the reactions are much more rapid:

Temp. (°C)	Time (hrs.)	Combination (%)	Remarks
1000	1	0	
1100	1	10	No fusion
1200	1	25	No fusion
1250	1	50	No fusion
1300	1	75	Fusion started
1325	1	90	
1375	1	98	
1400	0.5	99	
1425	0.25	99	

The above mix started to fuse at 1300°, and as the temperature was raised above that point the rate of chemical combination was greatly increased until, at 1375°, the reactions were nearly complete in one hour.

Many additional investigators have reported results very similar to those given above, among whom may be mentioned Monath (38), who pointed out that the formation of the silicates, aluminates and ferrites of calcium begins at temperatures as low as 750°, long before the calcium carbonate has been completely decomposed; the Ernst brothers (10) who extended their analyses to include MgO, R₂O₃, insoluble and soluble silica, specific gravity, ignition loss and CaO; Blank and Williams, (2), who noted particularly a high concentration of total sulfur appearing in the calcining zone but disappearing in the last few feet of the burning zone; Kuhl (22) who again called attention to the rapid reaction of lime, stating that "almost half of the lime has formed new compounds with the constituents of the argillaceous ingredient by the time all carbon dioxide is driven off"; Hashimoto and Akiyama (15), who noted the dependence of the reaction-rates on the type of firing method used; and Ludgate (34) who emphasized the sudden rise in reaction rates contiguous with the location of a persistent ring-formation of semi-fused material in the kiln. Akiyama (1) found that, even with raw materials high in sulfates, no SO₂ whatever remained in the clinker provided (a) the mixture was burned in an oxidizing flame and (b) the dust, upon which the sulfuric acid condensed, was not returned to the raw mixture. By returning the dust, a sulfate concentration is established which leaves a rather constant SO₂ residue in the clinker.

Lacey and Woods (24) devised an ingenious means for sampling the material at various locations in the kiln during regular operation, and made determinations for free CaO and ignition loss of the resulting samples. Twelve locations were established in a kiln measuring 9 by 102 feet. The results are given in Figure 14 and show, according to the authors, that comparatively little calcination occurred in the upper 45 feet of the kiln's length, as indicated by the small decrease in ignition loss and small increase in free lime. During the passage of the next 25 feet calcination occurred rapidly. After this stage recombination of the lime had become rapid, lowering the free lime, although calcination continued to take place, as indicated by the ignition-loss curve. The authors conclude that, under the

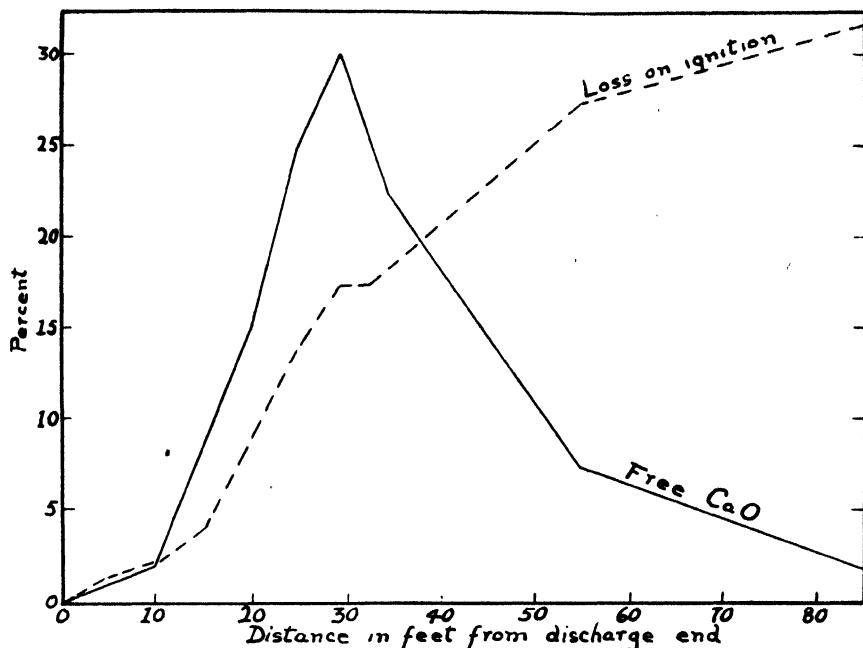

Figure 14. Free CaO and loss on ignition at various points in a cement kiln. (Lacey and Woods)

prevailing conditions, the calcination reaction may well be the one which limits the approach to equilibrium, since ignition loss persists in appreciable amount to within 5 feet of the kiln front, whereas the lime free to recombine becomes low several feet farther back.

Volatilization of Alkalies

Although it had early been recognized that potash is to some extent volatilized from cement mixtures during the burning process, and could be recovered from the dust (47), no use was made of that knowledge until the time of the first World War when imports of potash from Germany were discontinued in 1914. At that time some cement companies collected the flue dust and recovered the potash by agitating the dust in tanks of water heated with steam to the boiling point. The slurry was separated by a filter press and the solution evaporated until the salt, largely K_2SO_4 , crystallized out. After drying and grinding it was ready for the market. The average loss of K_2O per barrel of cement was about 2 lbs., but Meade (36) increased this to 6 or 7 lbs. by using a potash feldspar in the raw mix in place of clay and adding some iron ore.

After the war when potash was again available from other sources, its recovery from cement was discontinued. Recently, however, it has been pointed out that the soda or potash in cement might react with some constituents of siliceous

aggregates in concrete* in such a manner as to damage the structure (53)(3). This has again, but for a different purpose, raised the question of means by which both of the principal alkali elements might be reduced in the clinker.

The problem has been investigated by Woods (56). Cement raw mixes were (a) subjected to heat treatments in a laboratory kiln at temperatures from 1100° to 1350° for periods of 0.5 to 2.0 hours, and (b) modified by the addition of various amounts of chemicals and treated as before. The Na_2O and K_2O contents of the mixtures and the clinkers were determined.

The results of this study are shown in part in Figures 15, 16 and 17. In Figure 15 the effects of temperature and time of heating on one mixture are given. It is seen that the Na_2O is reduced from 0.88 to 0.41 percent by a 2-hour heating at 1350°, but at 1100° the reduction is much less. The K_2O is affected but little at

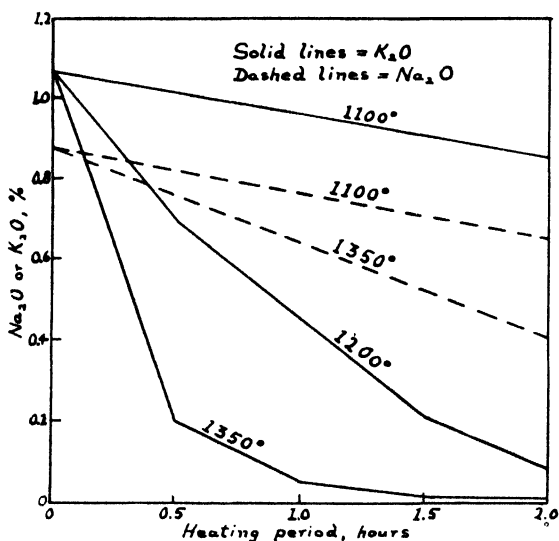

Figure 15. Alkali content of clinker as affected by heat treatment. (Woods)

1100° even at 2 hours, but at higher temperatures is reduced very greatly. At 1350° it drops from 1.07 to 0.2 percent in a half hour, and to about 0.01 percent in 1.5 hours. Woods states that it is his belief that one hour's heating at 1250° in his laboratory furnace results in driving off about the same proportional amounts of alkalis that are driven off in the normal operation of his plant kilns.

In Figure 16 are shown the effects of 2-percent additions of NaCl , CaSO_4 and CaF_2 on the volatilization of the alkalis on heating for 1 hour at 1250° or 1350°. The CaSO_4 is shown to increase both the Na_2O and the K_2O contents of the clinker. CaF_2 has almost no effect. NaCl lowers the K_2O content but markedly increases the Na_2O content, resulting in little net change in the total alkali content of the clinker. The effect of $\text{CaCl}_2 \cdot 2\text{H}_2\text{O}$ is shown in Figure 17. This salt was added to the raw mix in amounts from 0.5 to 2.63 percent, and the mixture heated for 1 hour at 1250°. In the amount of 0.5 percent the K_2O content was reduced sharply, but this amount of the chloride had little effect on the Na_2O content.

* See pages 515-517.

When added in the amount of 2.63 percent, the Na_2O content was reduced from about 0.7 percent to about 0.15 percent. So large an addition is felt, however, to be beyond the reasonable economic limit.

A method developed by Larmour and his associates (26) for the reduction of the alkalis in clinker consists in a further heat treatment. The clinker is dropped into a converted rotary cooler fitted with a burner at the feed end. A reducing

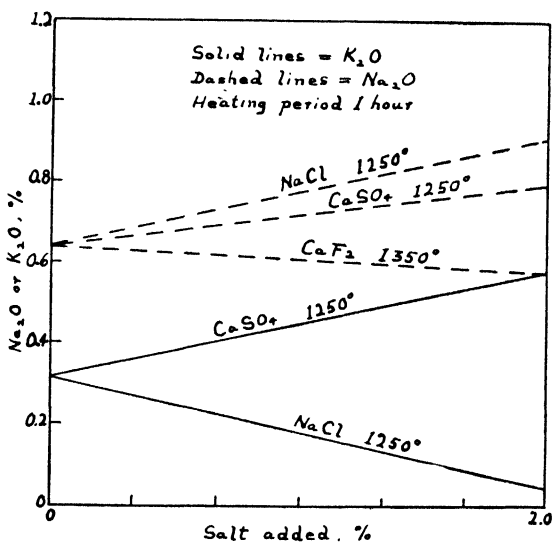

Figure 16. Effect of additions to the raw mix on the alkali content of clinker. (Woods)

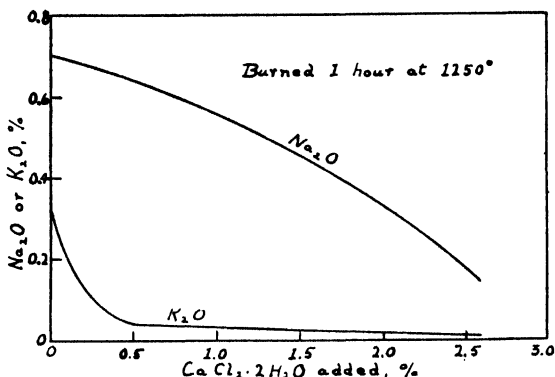

Figure 17. Effect of $\text{CaCl}_2 \cdot 2\text{H}_2\text{O}$ on the alkali content of clinker. (Woods)

flame is used and the clinker, reheated nearly to clinkering temperatures, cools slowly in passing through the treatr. By this process the K_2O in a 40-percent C_3S clinker was reduced 18 percent below that obtained in the normally burned clinker, and the Na_2O was reduced 15 percent.

The means which may be considered for lowering the total alkali content of the clinker seem, therefore, to be the following:

(1) The use of raw materials of lower alkali content. Where the source cannot readily be changed, a washing process (as applied to shells dug out of salt water)

or a leaching process (where the alkalis are in the form of soluble salts) may sometimes be used.

(2) Discarding the flue dust or leaching out of soluble salts before returning the dust to the raw mix.

(3) Increasing the temperature or time-period of the burning process, or modifying the cooling process.

(4) The addition of certain materials to the raw mix. The most effective agent that has been found for such use is $\text{CaCl}_2 \cdot 2\text{H}_2\text{O}$.

Thermal Reactions of Clinker Formation

A number of studies have been directed primarily at an understanding of the mechanism of clinker formation through the agency of heat reactions. There are obviously several methods available from which approximations may be obtained, but the possible methods which consider all factors are very limited. If the whole purpose of the problem be to figure heat requirements and kiln efficiencies, it should suffice to start with cement raw materials and measure by some means the heat reactions of clinker formation. But if the object be to gain a more intimate understanding of the exact nature and sequence of the reactions taking place during the burning period, then pure compounds must first be employed. Nor is it sufficient then to proportion these in the ratio found in cements, and heat to fusion, if we are to learn the nature of each reaction. For the number of independent and dependent reactions is so great that an intelligent interpretation of data so obtained would be difficult. Indeed, to arrive at a complete knowledge of these reactions requires independent studies on the heats of formation of each of the binary and ternary compounds or other phases present in the clinker. Also, it should be remembered that the heats of crystallization may be opposite in sign to the heats of formation, and yet dependent on a saturated solution in the molten magma. To explain the entire process adequately, each of these factors must be considered, both independently and in conjunction with each other.

A few of the earlier writers (52)(42)(41) who speculated on the heats of reaction of cement and cement raw materials assumed that there was an exothermic reaction, but that it was negligible. In 1904, Richards (46) published a paper in which he attempted to calculate the thermal efficiency of a cement rotary kiln. This work was based on a number of assumptions. He used Berthelot's figures for the heats of formation of the silicates and the aluminates, deriving 591 gram calories per gram for CaO and 827 gram calories per gram for MgO , liberated as a result of these reactions. No account was taken of the manner of combination of the silica, but the lime and magnesia were assumed to be present in the raw mixture entirely as carbonates. His calculations on a cement containing

	Per cent
SiO_2	21.27
Al_2O_3	6.42
Fe_2O_3	3.18
CaO	66.70
MgO	2.43

indicate a very large exothermic reaction, 414 g. cal. per gram, and Richards affirmed that when the raw materials are heated to about 1000° ,

they ignite and combine, like a pile of anthracite coal when heated to redness, and become, by their own heat of chemical reaction, much hotter than the temperature to which the gases heated them.

These results were vigorously attacked by Le Chatelier (29) on the basis that the heats of combination of silica and alumina with lime were not accurately known. Le Chatelier calculated values for the exothermic reaction, and found them to be about half those obtained by Richards.

Shortly after this, Soper (51) published a report on the thermal efficiency of a kiln at Iola, Kansas, in which he made use of Richards' values for the exothermic reaction.

An important contribution on the heats of formation of the silicates was made by Tschernobaeff (54) in 1905 and rechecked in 1911. This work represents the first serious effort to determine the heats of formation of the silicates of cement and of cement clinker by direct methods. The procedure employed consisted in mixing the silica with charcoal and chalk in an oxygen bomb calorimeter. The heat of combustion of the charcoal caused the combination of the silica and lime. This procedure was checked by burning (a) the raw materials with silica and (b) the clinker obtained from these raw materials with silica, and assuming that "the difference of the heat values of the two reactions must be an expression of the heat values of the reaction which takes place on converting the raw material to clinker." Results by the above methods checked very well, and Tschernobaeff concluded:

- (1) Cement formation is attended by an important evolution of heat, the heat value of the reaction per gram of calcium carbonate becoming smaller as the amount of the basic constituents of the raw material increases.
- (2) For a cement of the usual composition resulting from a raw material containing about 75 percent calcium carbonate, the value of this exothermic reaction is 115 to 118 gram calories per gram of calcium carbonate in the raw material. We calculate from this that the total heat of formation of cement under works conditions (i.e., under constant pressure) is $+115 - 435 = -320$ gram calories per gram of calcium carbonate in the raw mixture, this being the sum of the exothermic reaction and the heat of dissociation of calcium carbonate.

These results were later modified somewhat, but the order of magnitude was not affected (55). The average value obtained for the reaction between CaCO_3 and SiO_2 was 107.9 kilogram calories absorbed per mol of C_2S . Assuming that 42.7 kg. cal. per mol are absorbed on dissociation of CaCO_3 , the heat of formation of C_2S from CaO and SiO_2 is found to be 20.2 kg. cal. per mol, or 88.5 g. cal. per gram of C_2S . The heat of formation of C_2S was similarly found to be 28.7 kg. cal. per mol of C_2S .

Tschernobaeff determined also the heat of dehydration of clay, and gives the value as 112 gram calories per gram, but Mellor and Holdcroft (37) found, by a calculation from heating curves, a value of only 41.9 gram calories per gram. The latter authors deduce from their heating curves that the following reactions take place on heating kaolin:

- (1) Endothermic decomposition near 500° , probably corresponding with the formation of free SiO_2 , Al_2O_3 and H_2O .

(2) An exothermic reaction near 800° , probably due to a polymerization of the Al_2O_3 .

(3) An exothermic change near 1200° probably corresponding with a recombination of the silica and alumina.

The findings of Mellor and Holdcroft have been confirmed by Satoh (48). Insley and Ewell (18) also reported an exothermic reaction upon the heating of the kaolin minerals alone. An endothermic reaction first occurs over a wide temperature range beginning at 450° in kaolin and at 580° in dickite, and "is associated with the loss of water and the dissociation into an exceedingly intimate mixture of amorphous alumina and amorphous silica." This is followed at about 925° by an exothermic reaction which "is associated with the formation of $\gamma\text{-Al}_2\text{O}_3$ from amorphous Al_2O_3 ." At still higher temperatures Mullite is formed.

Dormann (7) and Helbig (16) used Tschernobaeff's figures for calculating the heat of formation of clinker. Using 165 gram calories as the value of the heat of formation of $2\text{CaO}\cdot\text{SiO}_2$, and 125 for $3\text{CaO}\cdot\text{SiO}_2$, and regarding the heat of formation of $3\text{CaO}\cdot\text{Al}_2\text{O}_3$ and the ferrites as negligible, and assuming further that the two silicates are present in equal amounts, Dormann finds for a cement assumed to contain 77.5 percent of calcium silicates and 22.5 percent calcium aluminates and ferrites, that the heat of formation of clinker is 112 to 114 gram calories per gram of clinker. This heat is sufficient, according to Dormann, to raise the temperature of the raw mass from 1100° to 1643° . The latter temperature is not reached due to losses by radiation, but he finds a surface temperature on the clinker, by the use of an optical pyrometer, of 1550° . The temperature of 1100° is required, in Dormann's opinion, to release the last traces of carbon dioxide and start the sintering action. Once started, this proceeds by itself, at increasing temperatures, to completion.

Calculations made on this same principle, but using slightly different compositions, have been suggested by other authors. Coghlan (5) made calculations giving values for the heat of formation of 99 and 108 gram calories per gram of clinker, depending on the data used.

The method of heat curves was initiated by Dittler and Jesser (6) in 1910. Dittler used an electric resistance furnace and crucibles of graphite and porcelain containing 30 to 40 grams of finely powdered portland cement raw material. Platinum platinum-rhodium thermocouples protected by tubing were inserted in the crucible and in the furnace. The furnace was heated at a uniform rate of about 30° each ten minutes. Time-temperature data were taken.

From 1100° to about 1350° the curve was found to be a straight line, but at 1350° a lag was observed which bent the curve downward. This was broken suddenly at 1430° by a sharp rise which again flattened out at about 1500° . By examining the heating process with Doelter's heat microscope, it was noticed that at 1375° a pronounced sintering took place throughout the mass and, at 1425° to 1450° , a sudden crystal formation. These crystals were later identified as "alite." Dittler concludes that the elimination of carbon dioxide, and also the chemical reaction between the lime and the clay, are completed below 1100° .

The clinkering of the incompletely burnt material commences with endothermic melt formation which suddenly changes into a distinct exothermic reaction coinciding with the predominant period of crystal formation.

While this method does not permit of a measurement of the amount of heat involved, Dittler calculated that the latter is not large.

The National Physical Laboratory of Great Britain (12) studied this problem by heating-curve methods, and reported an indication of an exothermic reaction between 1100° and 1200°.

Janecke (19) observed a sudden evolution of heat at 1381° which he believed to be due to the formation of a ternary compound, $8\text{CaO} \cdot \text{Al}_2\text{O}_3 \cdot 2\text{SiO}_2$.

Endell (9) found an endothermic reaction at 930° corresponding probably to the evolution of carbon dioxide from the limestone, and an exothermic reaction at 1200°.

Another method was introduced by Jesser, in 1910, based on the heats of solution of raw materials and of clinker, respectively, in hydrochloric acid. By measuring the difference in the heats evolved in solution, Jesser concluded that the conversion of slurry, from which the carbon dioxide already had been expelled, into clinker was attended with a slight absorption of heat, that is, was endothermic. He says:

On considering that, on cooling, the plastic clinker solidifies in the crystalline form, while in the unburnt mass there is no fused phase present, we see that more heat will be given up on cooling the clinker than on cooling the unclinkered mass. It follows that the addition of heat will be necessary to convert the unburnt mass into clinker and the reaction of clinkering is endothermic.

Nacken (39) believed that the method used by Jesser was correct in principle but he could not agree with Jesser that the essential reaction of clinker formation was endothermic. Nacken accordingly made a study of the reactions. He used a calorimeter consisting of a platinum beaker immersed in a copper vessel, the whole set in a thermostatically controlled bath. In the beaker he placed (a) a sample of powdered raw mixture which had been heated to 900° to drive off carbon dioxide and water, and (b) a sample of the same composition which had been heated to various higher temperatures so that combination had been partially or completely effected. A mixture of hydrochloric and hydrofluoric acids was added to dissolve the powder completely, and the rise in temperature of the solvent noted with a Beckmann thermometer, graduated to 0.01°. The difference in the heats of solution was taken as the heat of combination of the lime with the silica and alumina.

Nacken found that an exothermic reaction took place soon after the removal of the carbon dioxide, that is, at about 1000°, and that further heating to incipient fusion, or harder burning, "only gives a cement good mechanical properties, but is not necessary to the formation of clinker mineral."

By comparing these data with those obtained using a mechanical mixture of oxides of the same composition, Nacken calculated the exothermic reaction to be 100 gram calories per gram of clinker. From this value the increase in temperature of the clinker due to the exothermic reaction is calculated to be about 25°.

In a later paper, Nacken (40) reports the heat of formation of $\gamma\text{-C}_2\text{S}$ as 209.396 g. cal. per gram or 36.109 kg. cal. per mol. On the basis of a mean specific heat of 0.27 for all the substances, and disregarding the effect of the change in

temperature, he produced a diagrammatic representation (Figure 18) of the heat-temperature relations starting with 1.54 kg. of raw mixture (CaCO_3 plus SiO_2) in a closed vessel which was heated and allowed to cool again. In describing the diagram he says:

From line *AB* it is seen that in heating to 900° , not quite 400 cal. of heat is required; at 900° about 500 cal. is required for calcination (*BC*); and finally the continued heating of the system, which still consists of 1.54 kg. $\text{CaO} + \text{CO}_2$ plus other materials, to 1300° requires about 140 cal. The effect of the changes in the aluminous materials has not been ascertained. At 1300° the

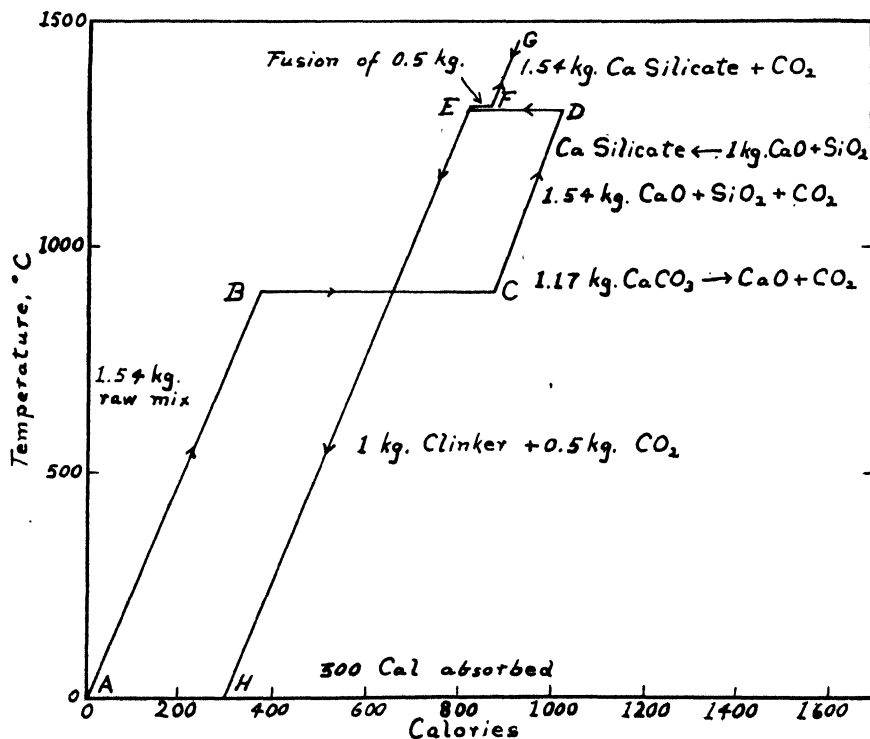

Figure 18. Heat-temperature relations obtained on heating 1.54 kg of cement raw mixture, and cooling. (*Nacken*)

exothermic effect sets in. By giving off about 200 cal. the system goes back to *E*. A slight amount of heat (50 cal.) brings the system to point *F*, by fusing 0.5 kg. of the clinker, and on further heating it reaches *G*, at 1450° . It must be emphasized that in reality the reactions overlap each other, and that therefore the curve is not made of straight lines, and in reality is not so angular. This, however, does not affect the end-point. If the system is cooled from 1450° we obtain the heat of crystallization as well as the quantity of heat liberated during cooling. Since the specific heat of the clinker is not the same as that of the raw mixture, a slight error is introduced by drawing line *EH* parallel to *AB*. Thus there remains 300 cal. of heat which has

been added to the system during the whole process. This quantity of heat is the loss accompanying the burning process.

Schwiete and von Gronow (50) in 1932 reported the amount of heat liberated during the formation of portland cement from limestone and blast-furnace slag as determined by three different methods. By use of the method of Dittler and Jesser and of Nacken the value obtained was 168 g. cal. per gram. By calculation from the heats of solution of the raw mix and of the clinker, they obtained 169 g. cal. per gram. From the separate determination of the heats of solution of the limestone and the slag, they obtained 170 g. cal. per gram.

Johansson and Thorvaldson (20) determined the isothermal heats of decomposition of samples of β - and γ - C_2S and C_3S in $HCl.20H_2O$ and calculated the heats of decomposition of the same substances in $HCl.200H_2O$. They calculated from these data (a), the isothermal heats of formation at 20° of β - C_2S , γ - C_2S and C_3S from CaO and SiO_2 gel, (b), the isothermal heat of formation of C_3S from CaO and the two above forms of C_2S , and (c), the heat of transition at 20° of β to γ - C_2S . The values obtained were as follows:

(1) Heat of formation at 20° of β - C_2S from CaO and SiO_2 gel, 33.24 kg.cal. per mol or 193.0 g.cal. per gram.

(2) Heat of formation at 20° of γ - C_2S from CaO and SiO_2 gel, 34.27 kg.cal. per mol, or 199.0 g.cal. per gram.

(3) Heat of transition at 20° of β - to γ - C_2S from above: 1.03 kg.cal. per mol or 6 g.cal. per gram; value obtained directly, 5.5 g.cal. per gram.

(4) Heat of formation at 20° of C_3S from CaO and SiO_2 gel, 32.77 kg.cal. per mol or 143.5 g.cal. per gram.

Lea (27) sets down what he believes to be the best values for the heats of formation of the cement compounds at 20° as follows:

Compound	Kg. cal. per mol	G. cal. per gram
C_3S	29.4	129
β - C_2S	29.8	173
γ - C_2S	30.9	179
C_2S	2.0	7
C_4A_3	3.6	6
C_4AF	10.0	21

In addition to the researches above mentioned, Martin and Cooper (35) have tabulated several further sources of exothermic reaction as follows:

- (1) Combustion of adventitious fuel, carbonaceous matter present.
- (2) Oxidation of ferrous compounds.
- (3) Oxidation of sulfides.
- (4) Combination of oxidized sulfur with lime.

The experimental work on the value of the exothermic reaction is summarized in Table 12.

In terms of coal value, these reactions are found by Martin and Cooper to be equivalent to from 5.92 to 1.43 tons of "standard coal," (12,600 Btu per lb.), per 100 tons of clinker.

An interesting discussion of the reactions of clinker formation has been contributed by Hendrickx (17). He says:

Clinker formation is not a phenomenon, it is a process. It is not solely a chemical combination, and the heat phenomena noted are not exclusively the off-spring of thermochemical reactions. Simultaneously or successively there are produced a series of phenomena, chemical and physical, endothermic and exothermic, which are superposed and of which the resultant heat transfer may be positive or negative, determined perhaps by the conditions of the experiment.

TABLE 12. Heat evolved during the exothermic reaction of clinker formation

Authority	Date	Gram calories per gram clinker
Richards (46)	1904	414
Le Chatelier (29)	1905	186
Soper (51)	1905	159
Tschernobaeff (54)	1911	134
Dormann (7)	1914	113
Coghlan (5)	1920	99
Nacken (39)	1922	100
Schwiete (50)	1932	169

Hendrickx urges that the course of clinker formation, that is, the *velocity of succession* or the *degree of simultaneity* of the several phenomena, or reactions which constitute them, is infinitely variable depending on the molecular homogeneity of the mix, its content of quartzose silica, the proportion of flux, the temperature of the kiln, etc. From this it follows that

The resultant heat transfer of all of the reactions taken together, which theoretically should be constant for a mix of a given composition, is, in practice, a value not only variable but extremely difficult to establish experimentally because of the complexity and the variability of its factors.

Hendrickx separates the process of clinker formation into three groups:

The first takes place at increasing temperatures. The second takes place at constant temperatures. The third takes place at decreasing temperatures.

Each of these groups contains a series of phenomena unfolding themselves successively under ideal conditions. But in practice the reactions superpose on each other because of the imperfect homogeneity of the mix and the irregularity in the heating.

The first phase, which takes place at rising temperatures, consists of combinations of iron oxide, of alumina, and of ingredients more active than silica, with the lime, in proportions that are most variable, dependent on chance contact and the fineness of the particles.

The second phase begins as soon as any flux has become liquefied. During this period the chemical reactions are completed through diffusion made possible by the flux. The quartzose silica is assimilated, and all of the lime combinations are brought to the maximum basicity. Following this, the constituents are dissolved in each other, the more refractory in the more fusible, forming supersaturated solutions.

The third phase accomplishes the crystallization of alite during the cooling process, and finally the crystallization of the other constituents.

The first phase is regarded as consisting partly of exothermic and partly of endothermic reactions. The fusion of the flux and solution of alite in the second phase are believed by Hendrickx to be endothermic, while the crystallization taking place in the third phase is exothermic.

Hendrickx is convinced that only the crystalline products have hydraulic properties and that any compounds of identical composition, if amorphous, are entirely devoid of hydraulicity. The first products to enter into solution are the aluminates of lime. These, he believes, act as solvent for the silicates which later separate out as large crystals with the finer-grained aluminates, imbedded in a film of glass from the flux. This film causes hydration to be very slow unless, by grinding, the crystals are fractured and separated from their glassy envelope. When very fine, grinding is practically without influence. Therefore, he states, very fine-grained clinker will be very slow-setting. He believes this to be the condition in so-called overburned cement. The temperature at which there is the maximum tendency of a crystallizing material to form nuclei is not the same, according to Hendrickx, but is lower than the temperature of maximum speed of crystallization. It results on cooling, therefore, that when the number of nuclei are increasing most rapidly, the rate of crystal growth is already on the decline, and at times, as with glass, the nuclei may not grow appreciably but remain as very minute crystals. Such a clinker, according to Hendrickx, is very slow-setting as, for example, the fused cements, or may be practically worthless, as the highly overburned cements. However, if a fused cement is allowed to cool very slowly, the crystals may grow to such a size that, on grinding, they become shattered and give an instantaneous set.

In the technical burning of cement the raw material is not completely fused in the kiln. It is merely heated up to the sintering point. Dyckerhoff (8) has shown that the sintering process during the burning of cement is due to the complete fusion of some (the aluminates and ferrites) of the raw materials. The two upper curves in Figure 19 give the kiln temperature and the crucible temperatures during the heating of a cement raw mix. It is seen from the form of the lower curve, which gives the temperature of the raw mix, that at *A* there occurs an absorption of heat due to the expulsion of carbon dioxide. At *B*, as a result of the reaction between lime and the acidic components, there occurs a marked exothermic reaction, which is shown by the fact that the temperature of the raw mix rises above the temperature of the kiln. The exothermic reaction also causes the raw mix in the kiln to glow noticeably, whereby the correct location of the so-called burning zone is obtained. Dyckerhoff also plotted the heating curve of a raw material that differed from a commercial raw mix in that it contained neither silica nor its calculated equivalent of lime. The heating curve of this residual melt was identical with the curve for the commercial raw mix. While observing the consistency of the raw mix, Dyckerhoff found that after heating to the exothermic break (at *B*) the raw mix had the color of cement clinker, whereas the raw mix without the calcium silicate (the residual melt) had been fused to a thin fluid at this temperature. Thus in the burning of cement, the easily fusible components of the raw mix are completely melted; the viscous consistency is caused by unfused raw materials and by the crystallization of calcium silicates from the melt.

According to Dyckerhoff, the fusion of part of the raw mix occurs at 1,285°,

as discussed in the preceding paragraph; the temperature naturally varies somewhat for different raw materials. The cement-burning process is not concluded with the formation of the residual melt, however. From the lower curve, indicating the way lime combines during the technical burning process according to Kuhl (23), it follows that considerable quantities of lime are still present as free lime after the formation of the residual melt, or after the beginning of sintering; this free lime is combined only after prolonged heating. Lime and silica, or β -dicalcium silicate which has already been formed in the solid state, are then dissolved in the melt; thereupon tricalcium silicate and alpha dicalcium silicate crystallize

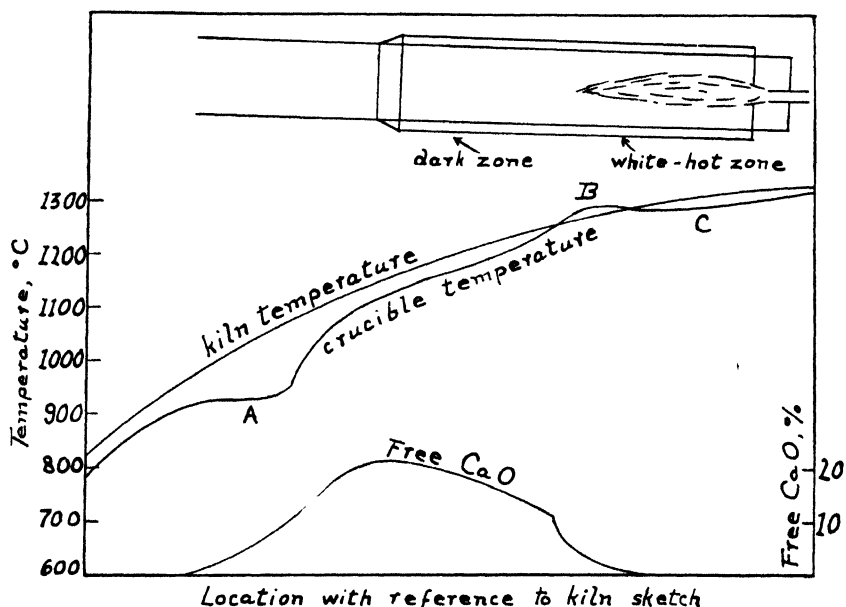

Figure 19. Heating-diagram of commercial burning process. (Dyckerhoff)

from the melt or from the solution. On cooling, the ground-mass, or melt, solidifies apparently in an amorphous "vitreous-like" form. Furthermore, on cooling, some of the components of the melt may also crystallize, *e.g.*, tetracalcium aluminoferrite in celite, and in certain cases perhaps also tricalcium aluminate. For the most part however, these last-named components, particularly the aluminates, occur in well burned and quickly cooled rotary-kiln clinker in the yellow amorphous ground-mass (11).

Jander (18a) found the heat of formation of C_3S from C_2S and CaO to be exothermic only between the temperatures 1300° and 1900° . Below and above that range, the heat of formation was found to be endothermic. It is only within that temperature range that C_3S is stable, for it tends to dissociate above and below those temperatures into C_2S and CaO .*

* See page 242.

The Cooling Process

For one reason or another, it has long been operating practice to exercise some control over the process of clinker cooling. The first reasons probably were that difficulty was experienced by the grinding of hot clinker, that due to the slow transfer of heat from the ground cement the latter retained a high temperature in the bins, and that the use of hot cement in the fabrication of concrete was regarded by engineers as conducive to poor quality in the structure. Hence a spray of water often was introduced upon the clinker as it issued from the kilns, or a blast of air was ejected upon it, which might thereafter be used as preheated secondary air for the kilns, or the clinker was cooled in rotary or other types of coolers.

But in more recent years various investigators have found that the quality of the clinker might vary widely depending upon the method or rate of the cooling which was employed. Chandler (4) found that the use of a water spray on the clinker produced a condition of false set* in the resulting cement. On the other hand he reported that the grindability of the clinker was improved by rapid cooling, as was also the strength up to seven days, but at later ages the slowly cooled product gave the higher results. These conclusions were confirmed by Schwachem (49) who also noted that the rapidly cooled clinker was reddish in color whereas the slowly cooled product was dark blue.

Larmour (25) investigated the cooling procedure as a means for controlling the formation of the desirable compounds and preventing the formation of undesirable compounds which he felt were sometimes produced as a result of improper burning conditions. Not only the rate of cooling but the relative condition of oxidizing or reducing atmosphere in which the cooling took place were believed by him to be critical. As a result of his studies Larmour concluded that the optimum conditions for cooling clinker required that the clinker be cooled slowly from sintering temperatures in a reducing atmosphere. But such slow cooling must not be long continued at the lower temperatures because a "toughening" took place on prolonged treatment which rendered the clinker difficult to grind. The advantages claimed for the process, which was incorporated into the operating practice of the Yosemite Portland Cement Co., were a markedly improved grindability, an improvement in strength, and the development of a more pleasing color. The normally cooled cement was gray in color but the new cement could be varied through grayish tans to dark brown. The heats of solution of the new cement were found also to be materially lower than those of the normal cement, which were accounted for by Larmour as due to a more complete crystallization.

A study by Lerch and Taylor (30) aimed to examine systematically various properties of the clinker and the cement which would be affected by the manner or rate of cooling. Mixes of normal portland cement composition were made both from pure and from commercial raw materials, and burned both in a gas-fired 8-foot laboratory-rotary kiln and in a 16-inch square up-draft gas-fired furnace.

* A condition wherein the cement paste quickly stiffens on mixing with water, but thereafter may be brought again to a fluid state and finished normally. See pages 480-421.

Various burning temperatures and cooling rates were employed, but in the tests described only those clinkers were used which showed complete combination as indicated by the absence of free CaO in the alcohol-glycerol test (31).

Dusting of the product occurred with all clinkers which were obtained by slow cooling from a high temperature and with all clinkers burned at temperatures below that at which liquid could be formed. These clinkers dusted to such fineness that 40 to 85 percent passed the No. 200 sieve. But dusting did not occur in any of the clinkers which were cooled rapidly or at an intermediate rate. Microscopic examinations made on these clinkers showed that, in the slowly cooled and low-temperature burns, no glass was present and the C_2S was in the gamma form whereas, in the quickly or intermediately cooled clinkers, glass was present and the C_2S was in the beta form. This lends support to the hypotheses of Dyckerhoff (8) and of Hansen and Bogue (14) that the inversion of the C_2S is prevented or retarded by the presence of glass surrounding the crystals of the dicalcium silicate.

The time required to grind the quickly cooled glass-containing clinkers was found, contrary to Chandler, to be much greater than that required for the slowly cooled or low-temperature glass-free clinkers. However, since the gamma form of the C_2S which was the form present in the latter clinkers is much less hydraulic than the beta form, methods which allow the formation of the gamma form cannot be recommended.

Cements were prepared by Lerch and Taylor (30) from the clinkers by grinding all charges with gypsum such as to give 1.8 percent SO_3 in the products. The fineness was such that 90-92 percent passed the No. 200 sieve. A number of tests were made on these cements to learn the effect of the cooling method or glass content.

The cements prepared from clinkers that had been cooled quickly showed no evidence of a flash set,* but the cements prepared from the slowly cooled or low-temperature clinkers gave a flash set with an appreciable heat effect characteristic of C_3A . This suggests that the occurrence of such a set may be dependent upon the presence of a certain amount of crystalline C_3A , for as that compound is reduced, due to its solution in the liquid and subsequent occurrence in the form of glass, flash set does not occur. The early strengths of plastic mortar cubes, perhaps as a result of the harsh consistency due to the flash set, were also low with those cements which showed that condition.

Of perhaps greater significance was a relationship found between the cooling method used and the expansion of neat pastes made of the cements when exposed either to water storage for a period of five years or to an accelerated treatment in an autoclave.† The latter treatment was varied but usually consisted of a 24-hour treatment at 177° ($350^\circ F$). When the MgO content of the cements was below about 2.5 percent, the expansions were low in all cases. But with MgO contents between 2.5 and 5.0 percent, there was a great difference in the expansion depending on the cooling method which had been employed with the clinkers. Those cements prepared from quickly-cooled clinker, and containing relatively high glass content, showed low expansions, but those prepared from slowly-cooled

* A condition wherein the neat paste sets rapidly to a harsh non-plastic mixture, difficult to work.

† See pages 502-504.

clinker, or from clinker burned at low temperatures, and hence containing little or no glass, showed high expansions.

The explanation of this phenomenon appears to lie in the property of crystalline MgO (periclase) to hydrate, slowly in water at normal temperatures but rapidly at higher temperatures, with a considerable increase in volume. But when liquid is formed the MgO will dissolve in it up to about 6 percent, and if this liquid is frozen the MgO remains in the glass. In this form, the magnesia appears to be incapable of producing high expansions in specimens of neat cement. Hence a high-MgO clinker, quickly cooled, will not give rise to excessive expansions (in an accelerated autoclave test or in water storage after a year or more) whereas the same clinker, slowly cooled, would produce such expansions.

This investigation indicated, therefore, that the rate of cooling clinker from sintering temperatures determines the glass which will remain in the clinker. A later investigation (32) showed that such treatment may cause the glass content to vary between 0 and 22 percent. And the presence of the glass affects a number of the properties of the clinker or the cement. In the absence of glass, the clinker may dust, the crystalline C_3A may cause flash set and hence give low early strengths, and the crystalline MgO may give rise to excessive expansions in structures at late ages. The presence of glass tends to remove the causes for these effects. It was later shown (33) that the heats of hydration at 7 and 28 days were consistently higher in the cements of a given composition the higher the glass content.* The explanation may lie in the effects of non-crystallization of the liquid upon the actual and relative amounts of the crystalline phases present. This subject is considered elsewhere.†

A somewhat similar study was made by Parker, (44), who examined a number of the properties of cements prepared from clinkers which were identical except for the rapidity of cooling from sintering temperatures. He found that the crystalline clinkers were easier to grind in his laboratory mills, were more difficult to control in the time of set, had the lower heats of hydration, had somewhat the lower strengths at 28 days, gave somewhat the higher drying shrinkage, and were much the less resistant to attack by sulfate solutions. These results, as also those previously reported, point to the glass-containing clinker as producing, in general, the better cement. The tendency to produce a yellowish or brownish color, however, as a result of freezing the iron-containing liquid to glass, has been mentioned.‡ A cooling process sufficiently slow to allow at least a part of the iron to crystallize as C_4AF or solid solution of MgO in C_4AF , will produce the more generally favored slate-colored cement.

References

1. Akiyama, K., *Bull. Waseda App. Chem. Soc.*, **17**, 8 (1932).
2. Blank, A. J. and Williams, W. B., *Rock Products*, March 1928, p. 74.
3. Blanks, R. F., *Eng. News Record*, **126**, 46 (1941).
4. Chandler, W. R., *Rock Products*, Apr. 1934, p. 48.
5. Coghlan, R. R., *Concrete CMS*, **16**, 39 (1920).

* See page 441.

† See pages 192-200.

‡ See pages 39, 40.

6. Dittler, E. and Jesser, L., *Zent. chem. anal. hydr. Zemente*, 1910, p. 72.
7. Dormann, O., *Tonind. Ztg.*, **38**, 150; 405; 1741 (1914).
8. Dyckerhoff, W., *Dissertation, Leipsig*, 1925.
9. Endell, K., *Zement*, **10**, 201 (1921).
10. Ernst, E. S. and Ernst, W. A., *Rock Products*, Feb. 1927, p. 62.
11. Forsen, L., *Concrete*, **45**, 231; 250 (1937).
12. Gilbert, W., *Arch. British Portland Cement Res. Assoc.*, R167, 60 (1915); R103 (1915); W. G. 65.
13. Gronow, H. E. von, *Zement*, **26**, 25; 437 (1936); **27**, 453 (1936).
14. Hansen, W. C. and Bogue, R. H., *J. Am. Chem. Soc.*, **48**, 1261 (1926); PCAF Paper 1.
15. Hashimoto, T. and Akiyama, K., *Soc. Chem. Ind. Japan*, **34**, 130 (1931).
16. Helbig, A. B., *Tonind. Ztg.*, **38**, 1305; 1666 (1914).
17. Hendrickx, J., *Chemie et Industrie*, **8**, 196 (1922); "The Manufacture of Artificial Portland Cement," Paris, 1932.
18. Insley, H. and Ewell, R. H., *J. Res. NBS*, **14**, 615 (1935); RP 792.
- 18a. Jander, W., *Z. angew. Chem.*, **51**, 696 (1938).
19. Janecke, E., *Z. anorg. Chem.*, **89**, 355 (1914).
20. Johannson, O. K. and Thorvaldson, T., *J. Am. Chem. Soc.*, **56**, 2327 (1934).
21. Johnston, J., *J. Am. Chem. Soc.*, **32**, 938 (1910).
22. Kuhl, H., *Concrete, CMS*, July 1929, p. 123.
23. Kuhl, H., *Tonind. Ztg.*, **53**, 1397 (1929).
24. Lacey, W. N. and Woods, H., *Rock Products*, Jan. 1930, p. 54.
25. Larmour, H. M., *Rock Products*, July 1934, p. 40.
26. Larmour, H. M., McMaster, E. L. and Jacques, W., *Rock Products*, July 1943.
27. Lea, F. M., *Royal Inst. Chem.*, 1945.
28. LeChatelier, H., "Constitution of Hydraulic Mortars," translated by J. L. Mack, p. 91, New York, McGraw Publishing Co., 1905.
29. LeChatelier, H., *Ciment*, **10**, 12 (1905).
30. Lerch, W. and Taylor, W. C., *Concrete, CMS*, **45**, 199; 217 (1937); PCAF Paper 33.
31. Lerch, W. and Bogue, R. H., *Ind. Eng. Chem., anal. ed.*, **2**, 296 (1930); PCAF Paper 23.
32. Lerch, W., *J. Res. NBS*, **20**, 77 (1938); RP 1066; PCAF Paper 34.
33. Lerch, W., *J. Res. NBS*, **21**, 235 (1938); RP 1127; PCAF Paper 36.
34. Ludgate, T. G., *Rock Products*, Nov. 1931, p. 50.
35. Martin, G. and Cooper, W., *British Portland Cement Assoc. Res. Assoc. Pamphlet* 3 (1923).
36. Meade, R. K., "Portland Cement," p. 332, Easton, Chemical Publishing Co., 1926.
37. Mellor, J. W. and Holdcroft, A. D., "Collected Papers," **1**, 277 (1914).
38. Monath, E., *Concrete, CMS*, June 1928, p. 111.
39. Nacken, R., *Zement*, **11**, 245; 257 (1922).
40. Nacken, R., *Zement*, Nos. 35-36, 1930.
41. Naske, C., *Tonind. Ztg.*, **27**, 1733 (1903).
42. Newberry, S. B., *Cement Eng. News*, **12**, 68 (1900).
43. Newberry, W. B., *Cement Eng. News*, **12**, 68 (1900).
44. Parker, T. W., *J. Soc. Chem. Ind.*, **58**, 203 (1939).
45. Rankin, G. A., *Concrete*, Nov. 1922, p. 72.
46. Richards, J. W., *J. Am. Chem. Soc.*, **26**, 80 (1904).
47. Richardson, C., *Proc. Am. Soc. Testing Materials*, **4**, 465 (1904).
48. Satoh, S., *J. Am. Ceramic Soc.*, **4**, 182 (1921).
49. Schwacheim, O., *Zement*, **25**, 291 (1936).

50. Schweite, H. E. and von Gronow, H. E., *Zement*, **21**, 497 (1932).
51. Soper, E. C., *Eng. News*, **54**, 664 (1905).
52. Stanger, W. H. and Blount, B., *Proc. Inst. Civil Eng.*, **145**, 44 (1901).
53. Stanton, T. E., *Proc. Am. Soc. Civil Eng.*, **66**, 1781 (1940).
54. Tschernobaeff, D., *Memoires*, **2**, 729 (1905); *Z. angew. Chem.*, **24**, 337 (1911).
55. Tschernobaeff, D. and Wologdine, *Compt. rend.*, **154**, 206 (1912).
56. Woods, H., *Rock Products*, Feb. 1942, p. 66.

CHAPTER 7

The Principal Constituents of Clinker

The visual character of the principal compounds or phases of clinker is best revealed by examination with the petrographic microscope. But the explanation of some of these observations, the interpretation of structures, of inversion characteristics, of chemical potential for reactivity, require other means of approach. One of these having promise of high significance is that of crystal analysis, as accomplished by X-ray methods. The application of these procedures to the understanding of clinker structure and character is discussed below.

Microscopic Structure

The principal constituents of commercial clinker are shown in the photomicrographs (23)(38) of polished sections of clinkers, magnified 1200 and 500 times respectively, in Figures 20 and 21. The grains labelled *A* are usually large well-defined hexagonal crystals, the *alite* of Tornebohm, now identified as substantially tricalcium silicate, $3\text{CaO}\cdot\text{SiO}_2$. A zoned structure has often been observed on these crystals, as noted in the photomicrographs and, in thin sections of commercial clinker, interference figures frequently depart considerably from perfect uniaxiality, while sections of crystals oblique to the optic axis often exhibit a change in extinction angle from interior to exterior of the crystal (13). Also the index of refraction of C_3S crystals obtained from basic open-hearth slags has been found to be variable (1), and Insley has noted a slight shift in the position of the X-ray diffraction pattern of the lines of C_3S in commercial cement from their position in the pure compound. All of these findings point to a solid solution of some kind in the C_3S grains of commercial clinker.

Constituent *B* is present as relatively large grains of rounded outline, usually striated in one or two directions by fine polysynthetic twinning bands, as shown in the photomicrographs. This material, depending on its type, has been designated as *belite* or *felite* and identified as dicalcium silicate, $2\text{CaO}\cdot\text{SiO}_2$. As described later, Insley has differentiated these crystals into several groups: Type I, showing the usual polysynthetic twinning in different directions; Type II, showing only a single set of twinning bands; and Type III, which is untwinned, but often occurs as overgrowths on grains of Type I. In some cases, C_3S crystals form a fringe around C_2S grains, as shown in Figures 20 and 22.

Constituent *C* is a highly reflecting material occurring in the ground mass surrounding grains of *A* and *B*, sometimes spoken of as the light interstitial phase. Its crystal form is often difficult to distinguish. It is the *celite* of Tornebohm and has been identified as the iron phase, $4\text{CaO}\cdot\text{Al}_2\text{O}_3\cdot\text{Fe}_2\text{O}_3$, or a member of the solid-solution series $\text{C}_2\text{A}_2\text{F}-\text{C}_2\text{F}$. By reflected light it appears as highly reflecting grains, relatively unaffected by the etching reagent. It sometimes occurs as crystals with prismatic habit, but usually as aggregates of irregular shape. The



Figure 20. Photomicrograph of polished and etched section of a commercial clinker of normal composition. Note well-formed crystals of C_2S (A), irregular crystals of C_3S (B), white areas of C_4AF (C), and grey areas of C_1A or glass (D). $\times 1200$. (*Le Cour Grandmaison*)

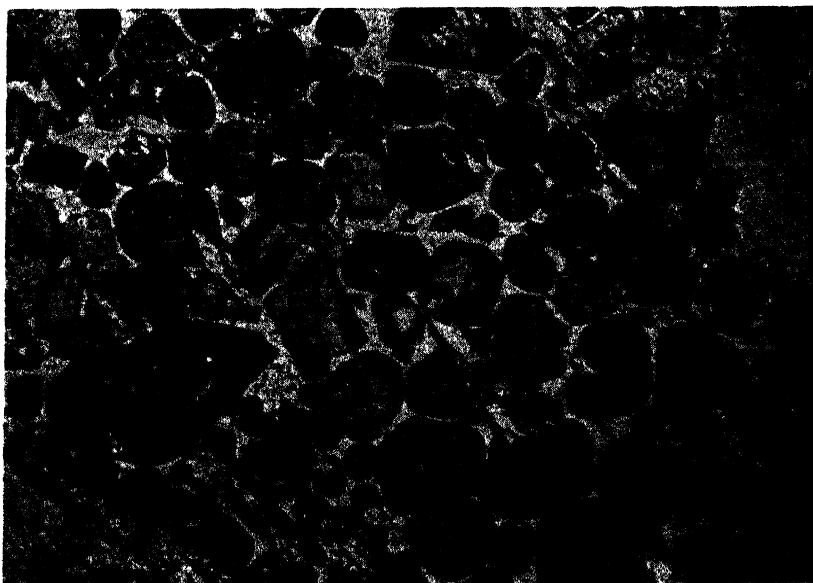

Figure 21. Photomicrograph of a commercial low-heat clinker. *The notation is the same as in Figure 20.* $\times 500$. (*Insley*)

crystalline habit, however, depends in part on the A:F ratio of the clinker and the cooling treatment it has received. Where the ratio is low and the cooling slow, the prisms tend to be large and broad. With higher ratios, the crystals may be small and needle-shaped. As McMurdie (53) has shown, the C_4AF may take up 2.5 to 5.0 percent of C_3A in solid solution, and this also would change its appearance.

Schweite and zur Strassen (59) noted that MgO increases the pleochroism of C_4AF , and concluded from X-ray diffraction measurements that MgO enters into solid solution with C_4AF to the extent of about 2 percent. Insley and McMurdie however found residual MgO in preparations of $99C_4AF + 1MgO$



Figure 22. Photomicrograph showing grains of C_2S fringing C_3S . Other phases shown are prismatic C_3A , C_4AF and glass. Water- HNO_3 etch, 3 seconds. $\times 500$. (Ward)

after heating to temperatures near the liquidus, cooling to 1340° just below the solidus, and maintaining at that temperature for a half hour and quenching. This indicates that such solid solution must be less than 1 percent MgO in C_4AF .

Among the most interesting phases observed in polished sections of clinker are those which have been called collectively the dark interstitial material. This has been shown to be separable into three distinct types, closely allied but resolvable by microscopic methods. They may be designated as the rectangular, the prismatic and the amorphous types. The first two will be shown presently to consist essentially of tricalcium aluminate, $3CaO \cdot Al_2O_3$, and the latter of the undercooled liquid, usually referred to as glass. Constituent *D* in Figure 20 is C_3A or glass, and is characterized by a low reflecting power. Other phases commonly observed in polished sections are free CaO and free MgO. All of these phases will be described in greater detail below. Their optical properties will be discussed in Chapter 13 and in subsequent sections on phase equilibria.

Tricalcium Silicate

Stability of $3\text{CaO}\cdot\text{SiO}_2$. Rankin and Wright (58) noted that C_3S does not occur as a primary phase at any point on the liquidus curve of the binary system $\text{CaO}\text{-SiO}_2$. It was found to dissociate at $1900^\circ \pm 20^\circ$ into CaO and C_2S , and since that temperature is below the eutectic temperature for CaO and C_2S (2065°), it explains why C_3S does not occur in contact with the melt in the binary system.

It also has long been known that C_3S exists at ordinary temperatures only in a metastable state, and that it dissociates into CaO and C_2S when held at temperatures between 1000° and 1300° for long periods (51)(55)(63). Carlson (22) found the rate of decomposition to reach a maximum at about 1175° , the rate at that temperature being about fifteen times greater than at 1000° . The decomposition rate was found to be greatly accelerated by the presence of either of the decomposition products, C_2S or CaO . Consequently the break-down is more rapid upon a material which has been exposed to moist air, since $\text{Ca}(\text{OH})_2$ is formed in that way, or upon a commercial clinker which contains uncombined CaO . The presence of gypsum, as in cement, also was found to accelerate the action, probably due to the formation of CaO by interaction of the gypsum with ingredients of the clinker. Lea and Parker (50) approached the problem from the point of view of establishing equilibrium conditions and concluded that the lower decomposition of C_3S occurs at a temperature of $1250^\circ \pm 25^\circ$.

The possibility was pointed out by Janecke (41) that, with a suitable third component, a ternary system with CaO and C_2S might be obtained in which the field of C_3S would narrow to a point at both ends, meeting the boundary curve between CaO and C_2S at an invariant point. This prediction was confirmed by Eitel (25) who found that, with the use of CaF_2 , the reactions were so rapid that on cooling a mixture from 1450° to 1200° in one hour, there was a quantitative decomposition of the C_3S into C_2S and CaO . The temperature of this invariant point was established at 1250° . Greene and Bogue (30) found that the same thing occurred in the system $\text{CaO}\text{-C}_2\text{S}\text{-NA}$, but in this system the temperature of the invariant point for $\text{C}_3\text{S}\text{-C}_2\text{S}\text{-CaO}\text{-liquid}$, is somewhat above 1355° .

The Final Solution of the Alite Problem. From the time that Le Chatelier first designated the major constituent of portland cement clinker to be tricalcium silicate, and Tornebohm gave to the major constituent the name of alite, there occurred up until 1931 perhaps the most interesting and prolific controversy on constitution that the cement industry has ever experienced. The question to be solved was, "what is alite?"

In 1911 Shepherd and Rankin (60) reported results of their phase equilibria studies indicating the existence of C_3S , and demonstrated by comparisons with clinker that this compound was identical with the alite of Tornebohm. Janecke (43) at once published the results of a still-incomplete investigation in which he believed that he had demonstrated the non-existence of C_3S , and the identification of alite as a ternary compound having the formula $3\text{CaO}\cdot\text{Al}_2\text{O}_3\cdot 2\text{SiO}_2$. The principal reason for disbelieving in the existence of C_3S was that it was reported as not being formed in the pure binary system, but only in the presence of alumina. By this Janecke meant that it was not formed in equilibrium with the liquid phase, and he regarded it as most improbable that a phase of CaO and SiO_2 ,

capable of existence only in the presence of Al_2O_3 , could be in reality a binary compound. He concluded on this basis that the phase reported as C_3S must be a ternary compound which contains Al_2O_3 . Making use of thermal and microscopic data, Janecke postulated C_3AS_2 , which he said melted congruently at 1382° , as the alite of clinker, and attempted to show that the experiments of Shepherd and Rankin not only permitted its existence but were better explained by that assumption.

Bates (3) assumed the correctness of the phase work of Shepherd and Rankin and in conjunction with Klein (4) proceeded in 1917 to prepare C_3S in pure form, describing several methods, and to examine its various properties.

Dyckerhoff (24) entered into the controversy in 1924 by publishing results by which he thought to confirm the existence both of C_3S and C_3AS_2 , but believed that neither of them could be the alite of cement. These compounds, he asserted, could be formed only at very high temperatures, and the latter had a structure which had not been observed in portland cement clinker. He affirmed that a congruent melting point of 1382° does not exist for the compound, but that it dissociates into CaO and liquid at about 1900° . The optical properties were so close to those of C_3S that differentiation by those means was difficult. Preparations of $8\text{CaO} + \text{Al}_2\text{O}_3 + 2\text{SiO}_2$ heated to temperatures up to 1200° showed only C_2S , C_3A and CaO . At 1400° the C_2S was found to "dissolve" CaO . The C_3S was not formed until a temperature of about 1600° was reached, and at 1800° the entire mass consisted of C_3AS_2 . Thus in commercial clinker, argued Dyckerhoff, the temperatures are inadequate to permit the formation of either C_3S or the ternary compound (Janeckite), and the alite consists of a solid solution of CaO in $\beta\text{-C}_2\text{S}$.

Kuhl (47) found that he could agree with neither the Americans, Janecke, nor Dyckerhoff. Portland cement, he says, cannot contain C_3S , C_2S and C_3A , or mixed crystals of these compounds as the alite of clinker, for five reasons: (1) there are no regular crystals of aluminates to be found, which shows the absence of C_3A ; (2) there is no dusting in normal clinker, hence C_2S cannot be present; (3) neither the di- or tricalcium silicate possesses hardening qualities analogous to that of portland cement; (4) analyses of alite crystals show the presence of at least 4 percent Al_2O_3 ; and (5), if the readily soluble C_3A were present, it would dissolve first, leaving behind undissolved silicates, which is not the case. Alite therefore, according to Kuhl, is a solid solution of the silicates and aluminates and is subject to rather wide fluctuations. It tends to approach C_3S , "and perhaps in certain cases is tricalcium silicate (in the absence of Al_2O_3)," but normally is not free of alumina.

In 1926 an opportunity was had for Dyckerhoff to work with some of us in America, which resulted in an entire unanimity of opinion and the publication of a joint paper (35). A mixture was prepared having the composition $8\text{CaO} + \text{Al}_2\text{O}_3 + 2\text{SiO}_2$. When fused in an oxy-hydrogen flame the long needle-like structure described by Janecke and Dyckerhoff was obtained (see Figure 23). X-ray diffraction photographs of this material and of a mixture of C_3S , $\beta\text{-C}_2\text{S}$ and C_3A in equal molecular proportions were found to be identical except for additional lines of CaO in the fused drops. When the fused material was subjected to a heat-treatment consisting of holding at 1600° for one hour followed by

1400°–1450° for 15 hours, the long needles showed a breaking up into shorter crystals, but along their edges were fringes having a much higher birefringence, (see Figure 24), indicating that the liquid had been reacting with the aggregates to form C_2S . On prolonging the heat-treatment at 1400°–1450° for 30 hours the reactions appeared to be complete and the mixture consisted of a nearly uniform mixture of grains of C_3S , C_2S and C_3A (see Figure 25).

Guttman and Gille, (31) in 1928, came to the defense of the solid solution hypothesis. Zone structures, they say, can be shown, which cannot be due to reaction layers, for even the highest magnification fails to resolve them. Under

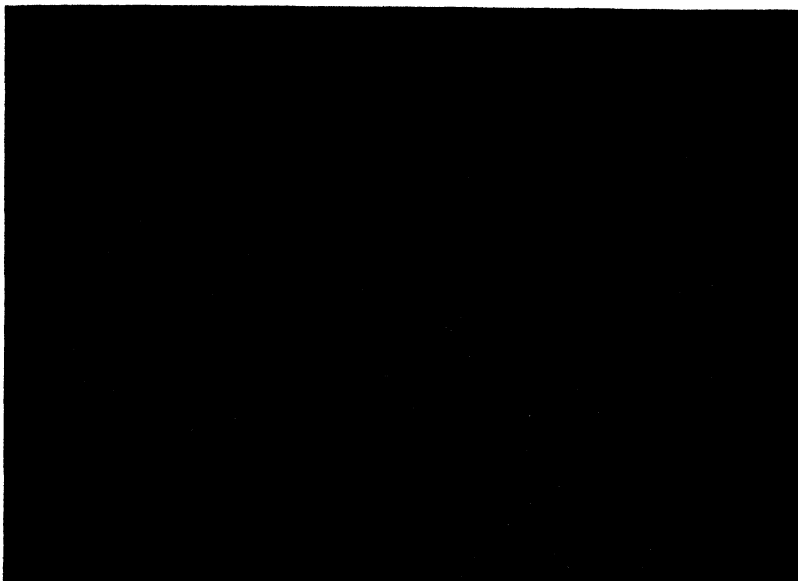

Figure 23. The composition $8 CaO + Al_2O_3 + 2SiO_2$. Thin section under crossed nicols. $\times 85$. Shows characteristic fiberlike structure observed in drops prepared in the oxy-hydrogen flame. (Hansen, Dyckerhoff, Ashton and Bogue)

crossed nicols the edges show a higher double refraction than the centers of the grains. Furthermore, Harrington (36) had reported that the C_3A is not cubic but is pseudo-cubic, which would remove the objections of Kuhl and Janecke against the possibility of solid solution between that compound and C_3S , on the basis of an incompatible mineralogical structure. But whether alite is a solid solution of C_3S and C_3A or of C_3S and C_3AS_2 , Guttman and Gille were not prepared to say.

In the same year Hansen (34) confirmed the work of the Geophysical investigators and of Bates, suggested several methods for preparing the pure C_3S , and reported the X-ray diffraction pattern which indicated that it was not a solid solution of CaO and C_3S .

Janecke (43) however was still unable to find the lines of C_3S in X-ray diffraction photographs, but on examining the lines produced on the one hand by synthetic alite (C_3AS_2) clinker, and on the other hand by a synthetic mixture of β - C_3S , C_3A and CaO , he discovered to his surprise that they were identical.

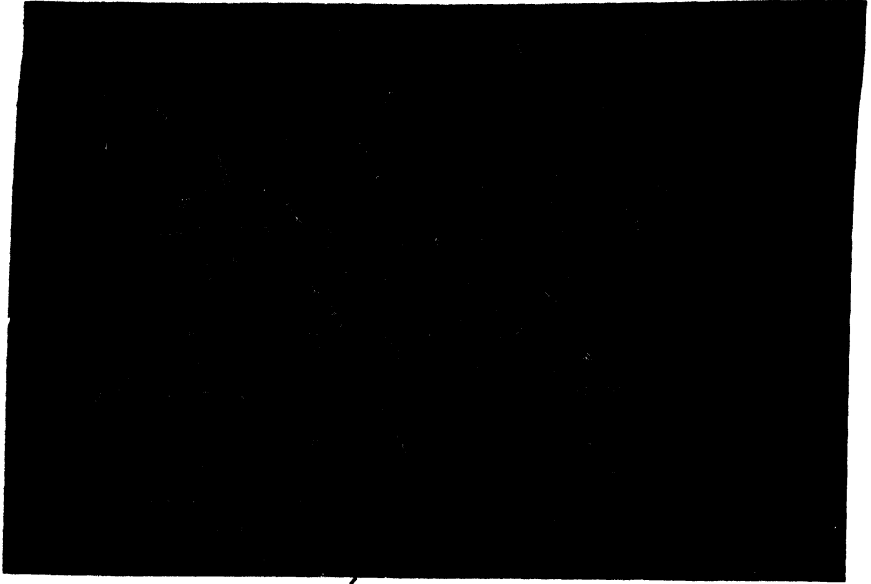

Figure 24. *The same mixture as shown in Figure 23, held at 1400°-1450° for 15 hours. Crossed nicols, $\times 95$. The higher birefracton on edges of large crystals show formation of C_3S .*

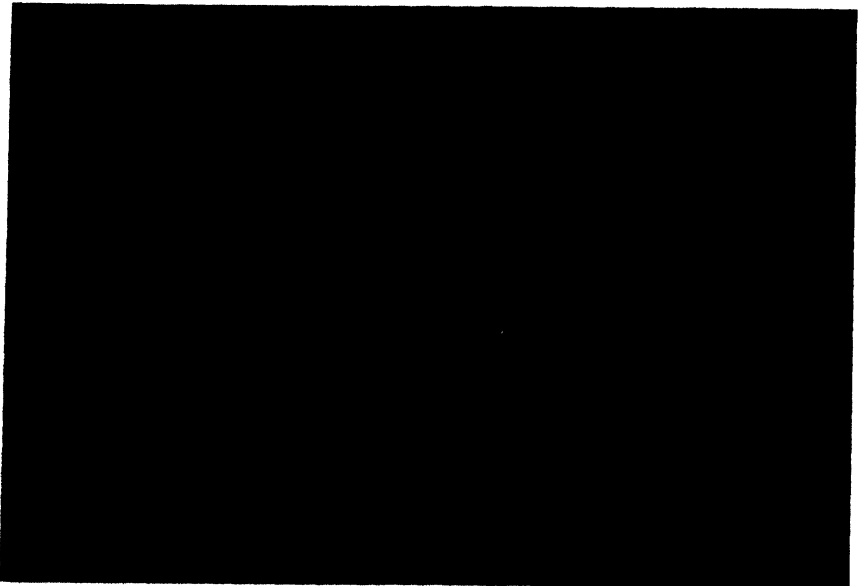

Figure 25. *The same mixture as shown in Figures 23 and 24, held at 1400°-1450° for 30 hours. Crossed nicols, $\times 105$. The charge has reached a state of equilibrium.*

The only explanation he could reach was that the ternary compound must be isomorphous with β - C_2S and hence its X-ray pattern be identical with the latter. And with such close similarity in space groupings that the X-ray lines cannot be differentiated, the compounds must form solid solutions. But since both phases are commonly observed in commercial clinkers, the solution must be discontinuous. Thus alite was again asserted to consist of the ternary compound, which under certain conditions entered into solid solution with β - C_2S with which it was isomorphous.

Furthermore, Janecke (44) felt that the X-ray pattern of C_3S published by Hansen proved that "tricalcium silicate" was in reality only a mixture of CaO in β - C_2S , and that the data of Guttman and Gille proved alite to be a solid solution of C_2S in C_3AS_2 . The latter authors however pointed out errors in Janecke's interpretation of the X-ray diagrams and agreed with Hansen that the X-ray patterns prove C_3S to be a compound.

The same year Guttman and Gille (32) made remarkably good separations of the alite fraction from two commercial clinkers, by centrifuging the finely pulverized material in liquids of high specific gravity, and made positive identifications of the alite fraction with C_3S , both by optical and by X-ray diffraction methods. Since there was no appreciable Al_2O_3 in these crystals, as noted by analysis, Guttman and Gille were forced to revise their earlier conclusion, that alite is a solid solution, and assumed that the zoned structure previously observed must have been due to certain conditions imposed by the heat treatment.

In 1930 the entire subject was reviewed in a critical X-ray study by Brown-miller and Bogue, (18) in which each of the several contentions above described was treated systematically. The identity of C_3S as a crystalline phase distinct from β - C_2S , and definitely not a solid solution of CaO in β - C_2S , was established in the following manner. Specimens of CaO plus SiO_2 were prepared in several proportions from 2 to 1 up to 3 to 1, and subjected to repeated heatings at 1500° until, in each sample, no CaO remained uncombined. The X-ray diffraction pattern of each was photographed. In the $2CaO + SiO_2$ preparation, only the lines of γ - C_2S were obtained. In preparations richer in CaO , the γ - C_2S pattern was replaced by the lines of the β - C_2S , and the lines of a new pattern appeared, which increased in intensity as the percentage of CaO increased in the original preparation. The lines of uncombined CaO were not present in any pattern. When the preparation $3CaO + SiO_2$ was examined, the lines of β - C_2S were found to be entirely absent and only the new pattern was present. This was the pattern of C_3S . If a solid solution of CaO in β - C_2S had resulted, the pattern of β - C_2S would have remained, but in a shifted position. A casual examination of a pattern of the C_3S on one half of a film (see Figure 26) and of a mixture of β - C_2S and CaO on the other half, the two being in precise alignment, leaves no possibility of doubt as to the basically different character of the two patterns.

In another series, the patterns were compared of the fused drops (prepared as above described by Hansen, Dyckerhoff, Ashton and Bogue) of the composition $8CaO + Al_2O_3 + 2SiO_2$ with a mixture of the compounds C_3S , β - C_2S and C_2A . The patterns were found to be identical except for lines in the pattern of the fused drops which were easily identified as due to free CaO . This indicates that the so-called Janeckite is a mixture of the above compounds.

The belief of Kuhl with reference to the existence of a solid solution between C_2S and C_3A also was subjected to critical examination. A preparation was made up consisting of 47 percent each of C_2S and β - C_2S , and 6 percent C_3A . This was burned twice with interim grinding, at temperatures above 1500° and showed no free CaO , indicating complete combination. Simultaneous X-ray diffraction photographs were made with this preparation and the same mixture which had not been heated following mixing. If C_3A enters into solid solution, during the heat treatment, with either of the calcium silicates, the pattern will show the lines of that silicate in a uniformly shifted position with reference to the location they would occupy if the compound were in pure state. Likewise, if either silicate entered into solid solution with the aluminate, the pattern of the latter would occupy a shifted position. The two patterns however appeared to be identical, both in position and intensity of the lines and each compound was definitely identified. This would indicate that appreciable solid solutions are not formed

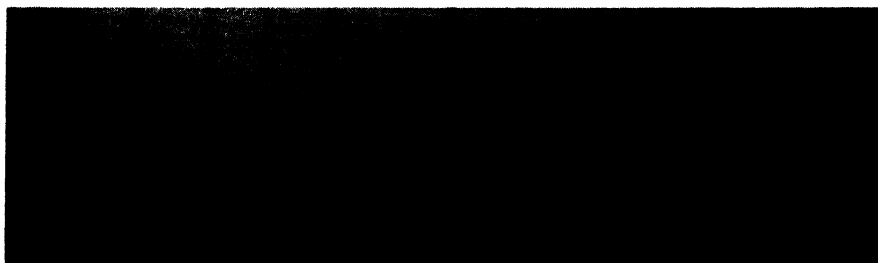

Figure 26. *Upper*: X-ray diffraction pattern of equimolar mixture of β - C_2S and CaO . *Lower*: pattern of pure C_2S .

between these compounds.* The difficulty of finding C_3A in clinker by optical means, which was the basis of Kuhl's argument, was pointed out to be due to close similarity in refractive index between that compound and C_2S , especially when the presence of iron-containing systems would be expected to raise the index of the C_3A .

In 1930 Weyer (68) also made precise measurements on the optical and X-ray diffraction patterns of the cement compounds very carefully prepared, and demonstrated the separate existence, rather than solid solution, of C_2S and C_3A in pure preparations after long treatment at temperatures as high as 1600° .

In 1932, after an exchange with the PCAF of prepared compounds, Janecke (45) acknowledged the existence of C_2S , pointing out that a volatilization of SiO_2 by heating in the electric arc had so altered the concentrations in his products that his interpretations had been in error. But he added that there remain many aspects of cement constitution which have not yet been explained and which will require much further intensive and unprejudiced research,—a conclusion to which no investigator on cement will take exception.

* X-ray data obtained by H. F. McMurdie (personal communication) confirm those of W. Jander and J. Wuhler, *Zement*, 27, 73 (1938), which indicate some solid solution of C_3A in C_2S .

In a closing word on the alite problem, Guttmann and Gille (33) summarize the work of the previous twenty years with the statement that

Alite, the chief constituent of high-lime portland cement, is neither

- (a) a lime-enriched dicalcium silicate (Dyckerhoff), nor
- (b) a solid solution of a lime-rich aluminate, as Janeckite and $3\text{CaO}\cdot\text{SiO}_2$ (Kuhl) nor
- (c) a solid solution chiefly of $3\text{CaO}\cdot\text{SiO}_2$ and $3\text{CaO}\cdot\text{Al}_2\text{O}_3$ (Guttmann and Gille), nor
- (d) a solid solution of Janeckite and $2\text{CaO}\cdot\text{SiO}_2$ (Janecke), nor
- (e) essentially $2\text{CaO}\cdot\text{SiO}_2$ (Nacken), but

Alite is tricalcium silicate. Thus, after fifty years, the question "what is Alite?" has been answered.

Dicalcium Silicate

The α - β Inversion. Specimens of C_2S were prepared by Hansen (34) from CaCO_3 and SiO_2 , both by quenching in mercury from 1550° and by heating at 1350° for an hour and quenching. The α - β inversion temperature as given by Rankin and Wright (58) is 1420° . Hence, if the α form can exist at room temperatures, it should be present in the former, whereas only the β form would be present in the latter charge. The X-ray diffraction patterns in the two preparations however were identical and it seemed probable to Hansen that the inversion from the α to the β form is so rapid that it is impossible to prevent the inversion by quenching, and that the α modification has never been obtained. The twinning he thought to be accentuated by the strains set up by inversion, so that twinning is characteristic of the samples subjected to high temperature, and untwinned crystals sometimes appear in samples which have not been heated to temperatures above 1420° .

In the course of a study made on polished and etched sections of portland cement clinker, Tavasci (63) noted that the appearance of the grains, and particularly their twinning striations, varied depending on the temperature employed and the manner of cooling. He gave these forms the designations *Belite I*, *II* and *III* respectively. The α form of C_2S , Tavasci considers to be free from twinning, but thinks this cannot be obtained by quenching in mercury clinker that has been heated to 1500° . But such quenching produces a transition form, indicated as *Belite I*, which shows a thick furrowed structure with striations at times like twinning lamellae, prevalently in two directions, and not generally close together. But when the clinker has been cooled slowly from sintering temperatures, the striations are consistently those which are characteristic of the β form, and designated *Belite II*. These striations are usually close together. The third modification, *Belite III*, also is found in the β form, but the appearance differs from *Belite II* by the presence of inclusions easily resolvable with the microscope, appearing as bright bands on a dark background. These, he thinks, may be due to ex-solution of a dissolved substance.

Lea and Desch (49) believe that the inversions of the high-temperature forms of dicalcium silicate usually do not take place because of the rapid rate of cooling; and that the α form, once quenched from above 1420° , is more resistant to inversion to the γ form than is the β form. Hence a clinker is more apt to be stable and

not dust to the γ form (which is non-hydraulic) if it is quenched from above 1420° than if quenched from below that temperature.

Insley (38) pointed out that considerable error may be introduced in the measurement of indices of refraction and optic axial angle of C_2S grains due to exceedingly narrow twinning bands, often less than a micron in width, upon which the measurements are made. He confirms Hansen in the belief that the crystals formerly thus identified as α - C_2S may in fact all be in the β state and that the complex twinning often cited as indicative of the α state may, in reality, only be an indication that the crystal has at some time been in the α state, the production of the twinned structure being caused by the passing from the one polymorphic state to the other. In support of this view, Insley found that X-ray diffraction photographs made on several preparations of C_2S , stabilized by either Cr_2O_3 , C_3A , C_3S or B_2O_3 , all showed complete identity regardless of whether the melts were quenched rapidly from 1450° or cooled from 1375° .

Insley also observed several forms of C_2S but, in view of his X-ray investigations, his interpretations are quite different from those of Tavasci. All of the observed forms (exclusive of the γ - C_2S) are believed by Insley to be in the β state. The usual form, designated *Type I*, consists of at least two and sometimes three sets of interpenetrating striations, each set being composed of parallel bands (see Figure 27). This structure may be obtained by quenching a melt from above 1420° . But when the charge is heated below 1420° the dicalcium silicate frequently occurs as grains having a single set of polysynthetic bands. This structure is designated *Type II*. Commercial clinkers rarely contain this type. A third structure, designated *Type III*, sometimes appears in both synthetic and commercial clinker as untwinned grains, frequently found as overgrowths on grains of Type I. They often appear as irregular grains with what seem to be veinlets or cracks running through them. These appear to be due to crystallization during cooling. Types II and III are shown in Figure 28.

In a later investigation, Insley and his co-workers (39) describe a variant of Type I, which they call *Type Ia*. It is distinguished from Type I by the presence of discrete particles along what are apparently traces of twinning planes. This structure is believed to be caused, following Tavasci, by the unmixing during cooling of a material in solid solution in C_2S .

Zerfoss and Davis (71) made use of heating curves in studying the inversions, and found that consistent data could not be obtained unless some third component was present in the charge. With CaF_2 or P_2O_5 the results were more uniform but still not wholly satisfactory. The temperature of the α - β inversion was raised from 1420° to about 1435° by CaF_2 and lowered to about 1385° by P_2O_5 . The lowering by P_2O_5 , as also by B_2O_3 and Fe_2O_3 , is believed to be associated with a solid solution formation, and the rapidity of the inversion makes it improbable that the alpha form is preserved at room temperature.

α - C_2S Solid Solution. The concept of the presence of other materials dissolved in the dicalcium silicate at high temperatures, and their expulsion from solution in the transition of the C_2S to the β form, was not a new idea. Rankin and Wright (58) had found a variation of as much as 25° in the α - β inversion temperature depending on the composition; Bowen, Schairer and Posnjak (6) had observed a solution of $2FeO.SiO_2$ in C_2S and noted the difficulty in distinguishing between

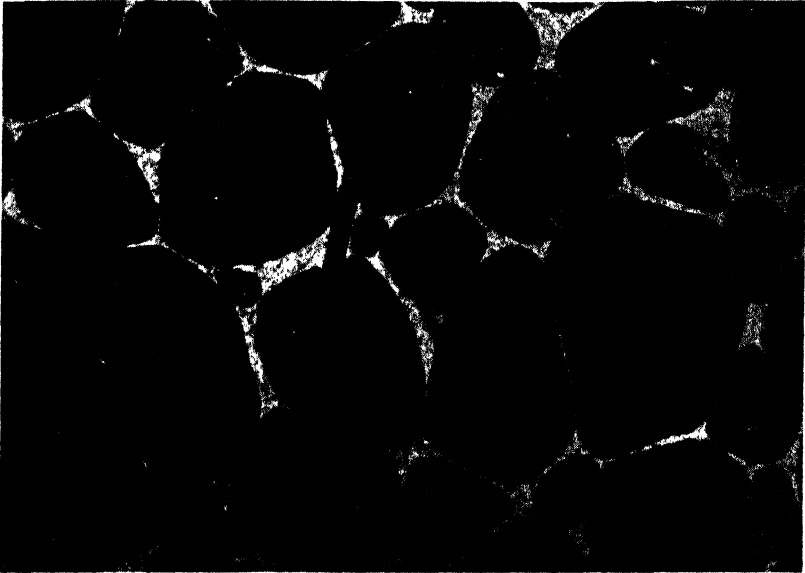

Figure 27. Crystals of C_2S in a low-lime clinker. Reflected light, $\times 1000$. Shows Type I twinning. (*Insley*)

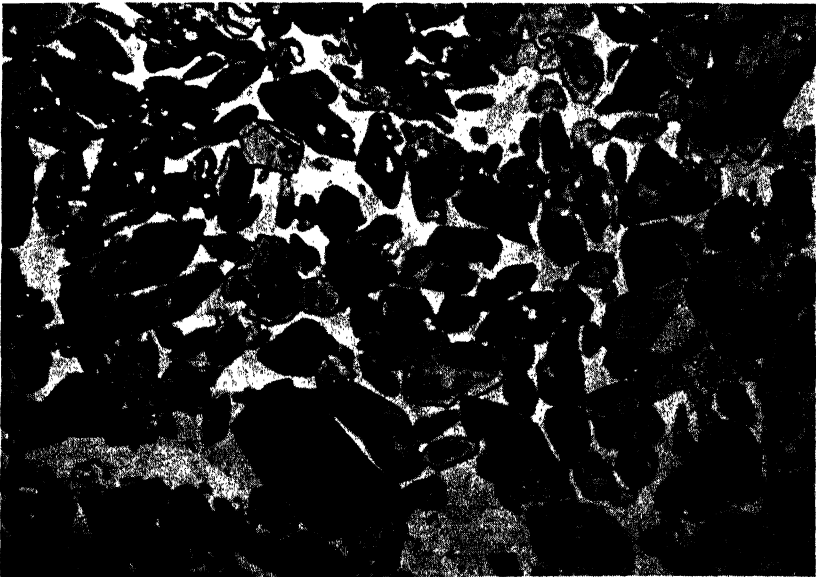

Figure 28. Crystals of C_2S in laboratory-prepared low-heat clinker, quenched after cooling slowly from 1375° to 1275° . Reflected light, $\times 500$. Shows Types II and III twinning. (*Insley*)

the α and β forms of the latter; Flint and Wells (26) had found a solution of calcium borate in C_2S to such an extent that the α - β inversion temperature was lowered 190° ; and Burdick (20) had observed a similar lowering of 60° due to the solution of Fe_2O_3 . Insley, Flint, Newman and Swenson (39) agreed with Tavasci (63) and Sundius (62) that the inclusions often observed in the C_2S of commercial clinker are due to the ex-solution of dissolved materials. Dyckerhoff (24) and Gillson and Warren (27) had observed crystal grains in portland cement which closely resembled β - C_2S but which had small optic axial angles. This had led them to believe that the crystals in question were not β - C_2S . Hansen (34) concluded from these and other studies that the size of the optic axial angle alone is not a safe criterion to use in identifying a crystalline phase in such mixtures as portland cement.

More recently Greene (29) has observed that C_2S can take into solid solution small amounts of Na_2O and Fe_2O_3 , or Na_2O and Al_2O_3 . When charges, consisting of C_2S with 5.6 percent Fe_2O_3 and 4.2 percent Na_2O , were quenched very rapidly from temperatures of 1450° - 1500° , the resulting clear crystals produced lines in their X-ray diffraction patterns which are absent in the pattern of β - C_2S , and a simpler structure was indicated. Bredig (10) previously (in connection with studies on solid solutions of C_2S and $3CaO.P_2O_5$) had presented evidence for the existence at high temperatures of a hexagonal crystal structure of C_2S which, he contended, would be expected normally to revert to a low-temperature form on cooling but which might be maintained at low temperatures by quenching such a preparation containing certain foreign material in solid solution. Greene likewise found that the interplanar spacings of his solid solution of Na_2O and Fe_2O_3 in C_2S , prepared as above indicated, were in excellent agreement with calculated values based on a hexagonal lattice,* as seen in Table 13.

Microscopically, the crystals differ from those of the β - C_2S (or α - C_2S as described in the literature) by being clear and unmarked by twinning striations or overgrowths or inclusions; by having lower refractive indices, the mean value being 1.713 ± 0.003 ; and a low birefringence, probably not greater than 0.005, the interference color of the crystals being a low-order gray in some fragments and in others an anomalous Berlin blue.† An interference figure suitable for the determination of the optical character could not be obtained.

A similar solid solution was obtained with Na_2O and Al_2O_3 , the optimum results being obtained when 2.8 percent Na_2O and 3.8 percent Al_2O_3 were added to C_2S containing an excess of 3.6 percent CaO . The resulting X-ray diffraction pattern was similar (see Table 13), but the optical properties slightly different from the solid solution obtained with Na_2O and Fe_2O_3 . The refractive indices were $\omega = 1.702 \pm 0.003$ and $\epsilon = 1.712 \pm 0.003$. The birefringence was 0.01, the optical character positive, and uniaxial or possibly biaxial with a very small axial angle. Photomicrographs of these crystals, magnified 900 times, with ordinary transmitted light and with crossed nicols, are shown in Figures 29 and 30. These

* That α - C_2S is hexagonal, as reported above, has recently been confirmed by H. F. McMurdie (personal communication) by X-ray patterns of pure C_2S taken at a temperature of about 1500° .

† It may be noted that these properties are similar to those reported by Rankin and Wright for β - C_2S (see Chapter 13).

may be compared with similar compositions, cooled slowly, shown in Figures 31 and 32 where the usual inversion to the β form had occurred.

TABLE 13. Planar spacings of α -C₂S together with values calculated for a hexagonal lattice (29)

A. Prepared with Na ₂ O and Fe ₂ O ₃ ; quenched from 1450°			
Hexagonal indices <i>hk.l</i>	Estimated intensity	<i>d_{hk.l}</i>	
		Experimental	Calculated
10.2	ss	2.81	2.81
11.0	ss	2.70*	2.70
20.1	m	2.218	2.219
20.2	s	1.945	1.946
00.4	w	1.749*	1.749
12.2	m	1.579	1.578
30.0	m	1.559	1.559
11.4	m	1.470	1.471
22.0	m	1.350	1.350
13.2	w	1.217	1.216
30.4	w	1.164	1.166
B. Prepared with Na ₂ O and Al ₂ O ₃ ; quenched from 1500°			
10.2	ss	2.81	2.81
11.0	ss	2.71	2.72
20.1	m	2.238	2.233
20.2	s	1.955*	1.955
00.4	1.755
12.2	m	1.588	1.588
30.0	m	1.569	1.570
11.4	w	1.469	1.474
22.0	m	1.361*	1.361
13.2	ww	1.226	1.224
30.4	1.170

* = Values used in calculation of a_c and c_c .

From these results it seems rather convincingly demonstrated that the material previously described as α -C₂S is in reality the β form of that compound, the twinning commonly observed being caused by the stresses set up during the inversion from the α to the β form during cooling. In some cases where twinning does not occur, or where the structure of the crystals differ, it is probable that the material may never have been in the α form, due to temperatures remaining below 1420°. The slight differences reported in refractive indices between the



Figure 29. Preparation consisting of C_2S , Na_2O and Al_2O_3 , quenched from 1500
Ordinary transmitted light, $\times 900$. (*Greene*)

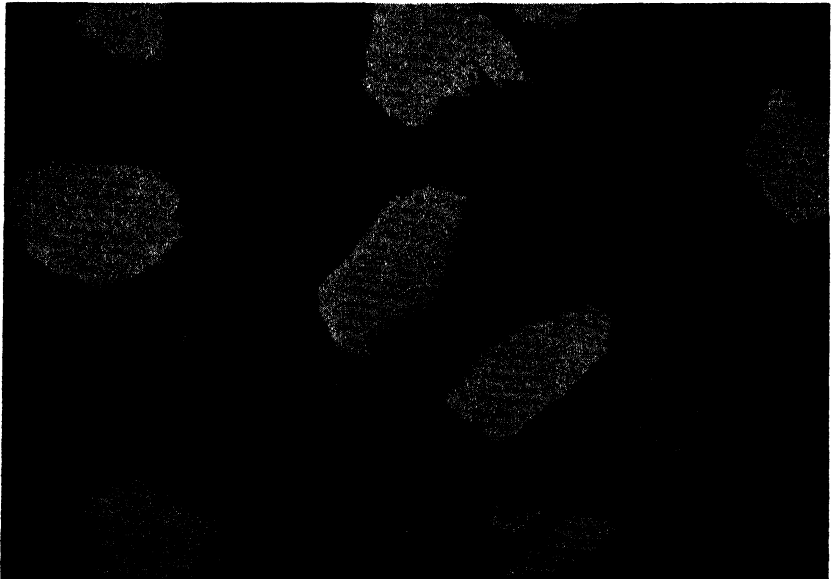

Figure 30. *The same field as shown in Figure 29, under crossed nicols.*



Figure 31. *The same preparation as shown in Figure 29, cooled slowly from 1450° to 1150° and quenched. Ordinary transmitted light, $\times 900$.*

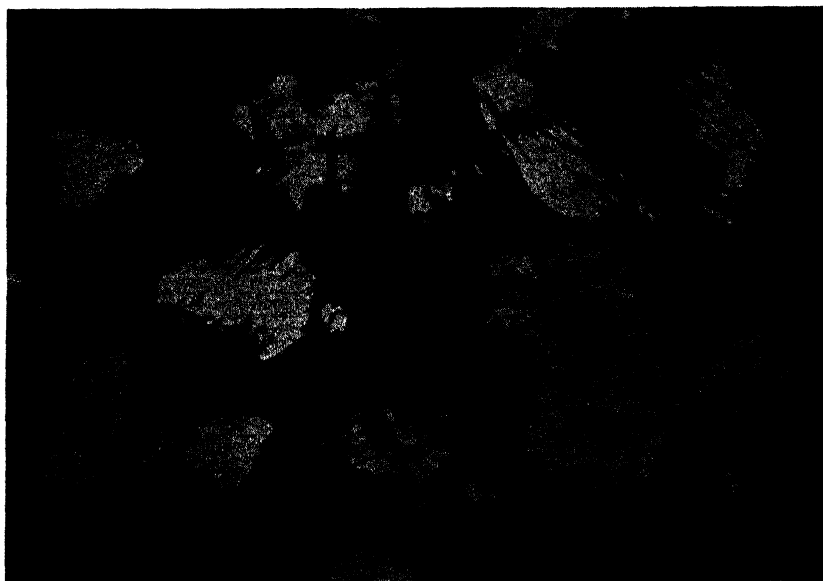

Figure 32. *The same field as shown in Figure 31, undercrossed nicols.*

α and β forms are within the experimental error of the measurements. However, the α - C_2S is able to take up Na_2O , with either Fe_2O_3 or Al_2O_3 , in solution, and this solid solution is capable of being quenched to room temperatures without inversion, when its properties may be examined. But if this solid solution is cooled slowly through the inversion temperature, the inversion will take place and in doing so the twinned structure of the β form is produced. Also, the components of the solid solution are found to be less soluble in the β than in the α - C_2S , hence during the slow cooling ex-solution occurs which gives rise to the inclusions commonly observed in the β - C_2S in commercial clinker. It is probable that the types of β - C_2S , as observed by Tavasci and Insley, are related to the character of the α - β inversion and ex-solution that has occurred.

The degree of temperature, however, at which the inversion takes place is found to be lowered by the Na_2O with Fe_2O_3 by 245° , that is, from 1420° (as reported by Rankin and Wright) to 1175° (as reported by Greene); and by Na_2O with Al_2O_3 by 240° , that is, from 1420° to 1180° . The pure α - C_2S may be described therefore as a hexagonal crystal, untwinned, mean refractive index probably below 1.707, low birefringence, and not obtainable at room temperatures in pure form because of its very rapid inversion to the β form on cooling.

In commercial clinker it might appear as a possibility that, under some conditions of composition and cooling, the α - C_2S , in solid solution with other components, might occur, but this involves some difficulties. Thus the concentration of Na_2O observed to be optimum in Greene's study is far beyond that found in portland cement clinkers. The reduction in inversion temperature is a function of the concentration of the foreign components in solid solution, so with lower Na_2O concentrations there will be less reduction in the inversion temperature; consequently a greater speed of temperature drop will be required to prevent the inversion. It is possible that other components not yet investigated (as K_2O , TiO_2 , Mn_2O_3 , P_2O_5 , FeO , etc.) may be found to enter solution with the α - C_2S and produce the required reduction in inversion temperature. But considering the very rapid rate of quenching required to preserve the α form in the laboratory preparations, it seems unlikely that, in commercial production as now carried out cooling would ever be sufficiently rapid for this effect, even with a degree of solid solution comparable with those studied by Greene.

Recognizing the importance of the α - β inversion temperature as a means for measuring the extent of solid solution, Newman and Wells (56) made a study, first, to locate precisely the α - β - C_2S inversion temperature and, second, to observe the changes resulting from the introduction of various oxides. The principle is expressed that, if a foreign material is more soluble in a high-temperature enantiotropic form (as α - C_2S) than in a low-temperature form (as β - C_2S), the inversion temperature will be lowered. After saturation is reached, however, no further change in inversion temperature takes place upon the addition of more of the solute. Hence, by plotting inversion temperature against increasing concentration of solute added, the limiting solubility is noted as the concentration beyond which the inversion temperature remains sensibly constant. The appearance of any new phase is an indication that the limit of solubility has been exceeded at the temperature employed.

The inversion temperatures were noted by the use of differential heating

curves.* The temperatures of maximum galvanometer deflection were considered as representing the temperatures of inversion, and these temperatures were more sharply defined by drawing tangents to the curves and reading the points of intersection.

By this procedure, the α - β inversion temperature of C_2S was found to be $1456^\circ \pm 2.2^\circ$, as compared with the value 1420° given by Rankin and Wright (58). The addition of an excess of CaO did not change this value, but the addition of an excess of 0.19 percent of SiO_2 lowered the inversion temperature to 1438° . This value was not changed by further additions of SiO_2 . Since this small difference in SiO_2 content is not precisely defined by chemical analysis, the authors recognize that the inversion temperature may be considered to be either 1456° , which by a little SiO_2 is lowered to 1438° ; or 1438° , which by a little CaO is raised to 1456° . The former was selected as the more probable.

Upon the addition of other materials, the inversion temperature was lowered in all cases. The solubility of the oxides examined, together with the lowering of the invariant-point temperature, α - β - C_2S , are as follows:

Oxide	Solubility in α - C_2S %	Lowering in temperature of invariant point ($^\circ C$) below 1456°
Al_2O_3	0.5	14
MgO	0.5	20
Fe_2O_3	1.0	20
CaF_2	0.7	2
TiO_2	1.0	21
BaO	Greater than 20	
Cr_2O_3	2.5	61
V_2O_5	0.5	29
P_2O_5	1.0	66
B_2O_3	8.0	151
Mn_2O_3	8.0	73
K_2O	?	?
Na_2O	1.3	110

The β - γ Inversion. The change from the β - to γ - C_2S takes place, according to Rankin and Wright, at 675° . It is accompanied by a 10 percent increase in volume which causes the crystal mass to fall apart into a fine powder, known in the cement industry as *dusting*. The specific gravity changes from 3.4 to 3.1 and the mean refractive index from 1.715 to 1.645. The optical character becomes negative. These changes make the gamma form easily distinguishable from the other forms of C_2S .

It has been observed (24) that if a charge of this composition is cooled slowly from sintering temperatures, dusting takes place at once, but if the charge is quenched rapidly, especially from very high temperatures, then no inversion occurs even after many months. Different suggestions have been made as to the cause for the stability of the compound on quenching rapidly from high temperatures. Nacken believed that the α to β inversion takes place slowly, so that on quenching a charge from above the α - β inversion temperature, the α form is brought down to room temperatures without change. But the β - γ inversion,

* See Chapter 12.

being rapid, cannot be prevented by rapid quenching. Thus if the β form is present before cooling, the change to the γ form is unavoidable.

In commercial clinker there are many other materials present which form liquids during the burning operation, and these are believed by some investigators to form a layer of glass around the grains of β - C_2S and so prevent the inversion by the mere physical pressure exerted upon the crystal grains. This might explain the advantages which have been found, in the preparation of β - C_2S , of the use of a very small percentage of B_2O_3 or Cr_2O_3 (4).

Zerfoss and Davis (71) examined the effect of several oxides in the melt upon the β - γ inversion. These included: P, As, Sb, V, Ba, Sr, Zn, Cr, W, Mo, and Ti. They found that one mol percent of P_2O_5 , As_2O_5 , V_2O_5 and Cr_2O_3 inhibit the inversion and allow the β - C_2S to be stable at room temperature. To the above list, including B_2O_3 , Mn_2O_3 , should be added (56). In every case, the optical properties of the C_2S were changed, indicating the formation of a solid solution. Zerfoss and Davis conclude that the β - γ inversion can be inhibited in two ways: chemically through formation of a solid solution, and physically through the restraining and isolating influence of surrounding phases. The solid solution does not invert because of the high energy requirement necessary to force out the dissolved ion and allow the silicate to assume the stable form. In physical inhibition, the surrounding phases restrain the β from expanding to the γ form, and isolate the grains so as to disturb and block the inversion wave. The inversion, according to Zerfoss and Davis, involves an increase in the coordination number of the calcium, and any means by which the low coordination of the calcium in β - C_2S can be preserved will prevent inversion. Thus they argue that we may consider the operation of the inversion as a stage in the competition of calcium and silicon for oxygen. Hence, by inserting other highly-charged atoms into the silicate structure, they with the silicon will compete with the calcium for the oxygen and will assist in preserving the low coordination of the calcium.

Free CaO and MgO.

The presence of free CaO in clinker may readily be observed by the use of polished sections etched in a 1:1 water-alcohol mixture for 1 to 3 minutes. This material is seen to occur as rounded grains, either singly or in clusters, as shown in Figure 33. For the reasons given elsewhere,* they are often seen embedded within crystals of C_2S or C_1A .

The magnesia of cement clinker has been shown to exist as free MgO (periclase), except that a small amount may enter solution in the liquid and so be a constituent of the glass. In polished sections it may be observed either in the unetched specimen or in one etched with a water-alcohol mixture, and is noted by a very high reflectivity. Polishing must be done with great care, however, because the MgO grains are easily fragmented and secondary scratches extend from these points over the surface of the specimen. The MgO occurs almost entirely in the interstitial constituents and is therefore one of the last phases to crystallize. A photomicrograph showing the MgO phase is given in Figure 34.

The fact of solution of a part of the magnesia in the liquid is confirmed by the

* See Chapter 18.



Figure 33. Typical rounded grains of free CaO in clinker. Water etch, $\times 1000$. (Ward)

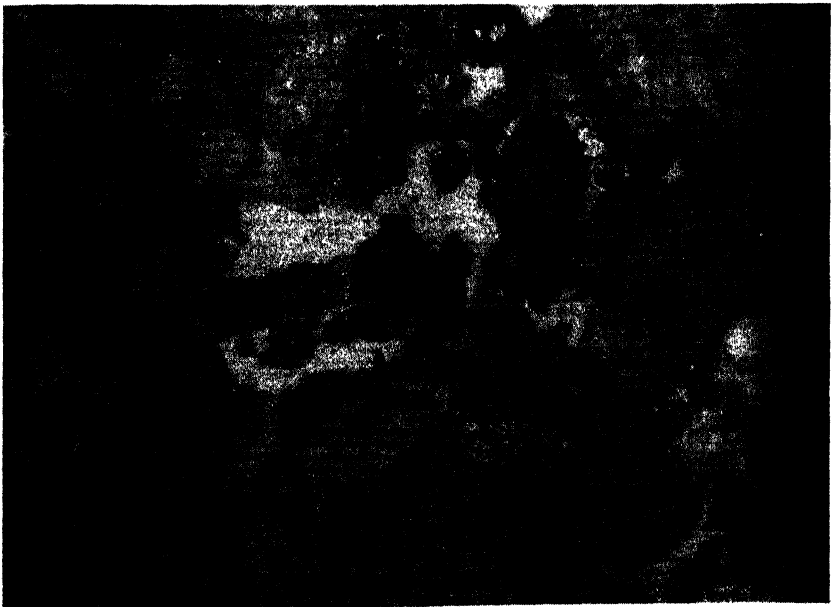

Figure 34. Grains of MgO in clinker. Water etch, $\times 500$. (Ward)

finding that the amounts of periclase observed in polished sections of clinker has been found to be less than the total MgO content as found by chemical analysis. Furthermore, the average grain size of the periclase in quickly cooled clinkers, high in glass, is notably smaller than in the slowly-cooled clinker, low in glass.

Further confirmation of the solution of MgO in the liquid was obtained through the observation and examination of the residue obtained following the treatment of the clinker with the nitric and hydrofluoric acid solution employed in the estimation of glass by the heat-of-solution method (5). The residue was identified by Lerch as periclase. A systematic examination has revealed that in the high-MgO compositions, the slowly-cooled clinkers showed consistently a higher residue than the corresponding quickly-cooled clinkers. These data are shown in Figure 35 where the periclase remaining undissolved after a 10-minute treatment

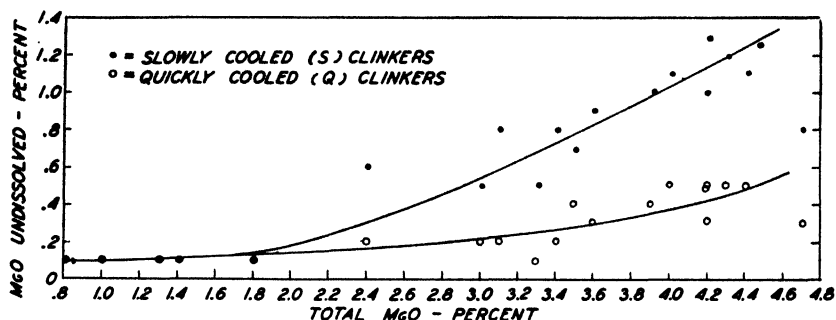

Figure 35. Relation between total MgO and the MgO remaining undissolved (in 420 g 2N HNO₃ containing 5ml 48 per cent HF) after 10 minutes. (Lerch)

is plotted against the total MgO for both slowly and quickly cooled clinkers. It may be observed that, with compositions containing more than 2 percent MgO, the periclase residue increases with increasing total MgO much more rapidly in the slowly-cooled than in the quickly cooled clinkers. This may be interpreted as indicating either that less periclase is present in the quickly cooled clinkers (the MgO being dissolved in the glass) or that it is present in a finer state of subdivision permitting more rapid solution in the acid mixture. The evidence given indicates that both conditions actually obtain.

Interstitial Material

The matrix of interstitial material within which the crystals of tri- and dicalcium silicate appear is composed essentially of the phases which were liquid at the clinkering temperature. If the liquid freezes without crystallization, it is glass but, to the extent to which the liquid crystallizes, there may be present C₃A and C₄AF. In general, this matrix is not readily differentiated in polished sections by the appearance of crystal boundaries, but in some cases such crystals appear. More commonly it is observed that some parts are attacked readily by the etching solution, becoming dark in appearance, whereas other parts are not attacked and so possess high reflectivity and appear light in color. Considerable

work has been done in the attempt to identify the constituent phases. A rectangular, a prismatic and an amorphous material have been observed.

Rectangular Dark Interstitial Material. In a study of tricalcium aluminate in clinker, Brown (14) prepared and examined charges in the pure systems and in commercial clinker. When pure C_3A was heated to the dissociation temperature, 1535° , substantial amounts of free CaO appeared as clear yellowish rounded grains. On cooling, the C_3A crystallized very rapidly as cubes, octahedrons and rhombic dodecahedrons, in which the grains of CaO were embedded. This condition is shown in Figure 36. It is of especial importance commercially because the grains of CaO thus separated from the liquid are protected from resolution by the liquid, so that on cooling they are not readily converted to the state represented by true equilibrium.

The above effect is further revealed by a mixture consisting of $40C_3A$ and $60C_3S$, after heating to 1490° and cooling slowly to 1450° . The invariant-point composition of $CaO-C_3S-C_3A$ melts at 1470° , so grains of CaO and C_3S were produced. At 1450° , C_3A began to crystallize, embedding the grains of CaO and C_3S , so further reaction with the liquid was prevented and instead of crystallization becoming complete at that point, the liquid moved up to the invariant point $C_3S-C_2S-C_3A$. Here C_2S began to form and to produce alteration borders upon the grains of C_3S which had not become embedded in the crystalline C_3A . Equilibrium could not be established because of the embedded grains of CaO and C_3S , so the final product contained those crystals in addition to C_2S and C_3A .

A variable in the tendency of large crystals of C_3A to enclose CaO and C_3S was noted in the case of a composition consisting of C_3A 70, C_2S 30. Here the CaO and C_3S became embedded in very large fibrous-appearing crystals of C_3A and, at the invariant point $C_3S-C_2S-C_3A$, C_2S formed while C_3S was decomposed. The C_2S crystallized intimately with the C_3A yielding fibrous birefringent areas in which the C_3S crystals showed heavy alteration borders. Such structures have occasionally been observed in commercial clinkers. (See Figure 22, page 110.)

The rectangular type of dark interstitial material in commercial clinkers has been shown to consist of crystalline C_3A . It is not readily observed, however, except in slowly cooled clinkers having an A:F ratio of 1.63 or higher (65). In such cases the material encloses crystals of the earlier formed C_2S and C_3S , as observed by Brown, and sometimes MgO . The phase is readily etched by exposure to water for 2 or 3 seconds, and less readily by a 1 percent solution of HNO_3 in alcohol. A photomicrograph showing this material is reproduced in Figure 37. An unusually fine crystal of C_3A , approximately 200 microns long, a combination of the cube, octahedron and dodecahedron, was obtained by Brownmiller embedded in glass in the region of primary crystallization of C_3A in the system $K_2O-CaO-Al_2O_3$ (15). A photomicrograph of this crystal is shown in Figure 38.

Prismatic Dark Interstitial Material. A second form of dark interstitial material occurring as prismatic crystals has been observed in a large proportion of clinkers in which the A:F ratio is relatively high, greater than 1.8. These crystals, usually associated with C_4AF , have a low but distinct double refraction (about 0.005) with parallel extinction. Their mean refractive index was found to be 1.72. They are etched readily by water, and less readily by the HNO_3 -alcohol solution.

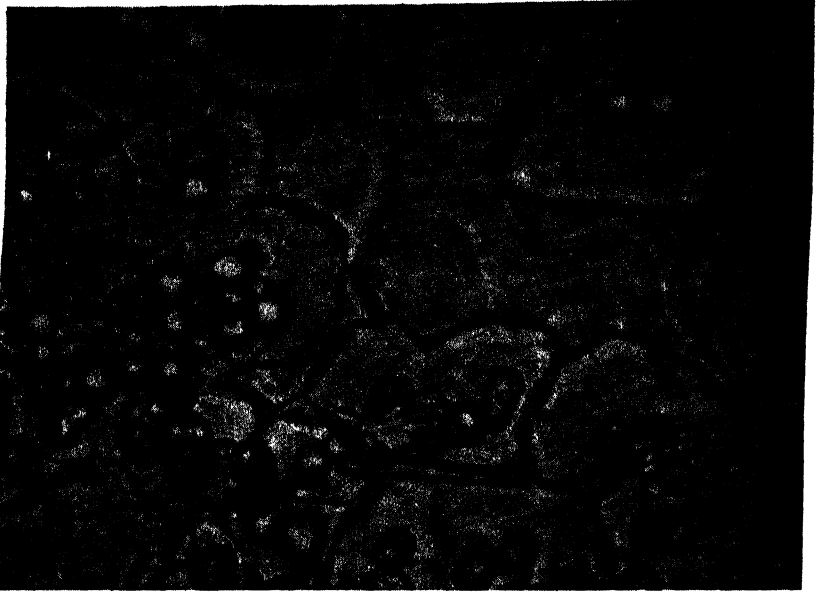

Figure 36. C_2A heated to dissociation temperature and recrystallized. Ordinary transmitted light, $\times 300$. (*Brown*)

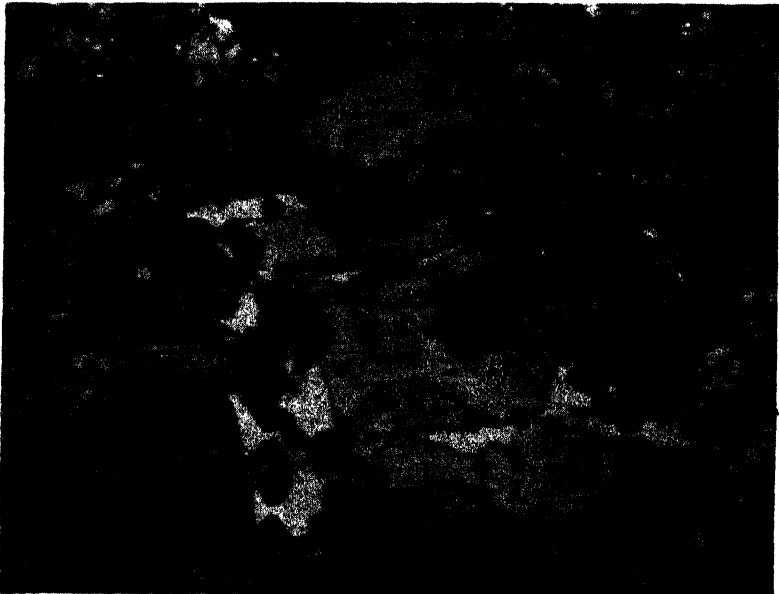

Figure 37. C_2A in commercial clinker, seen as light grey areas tending towards cubes, enclosing crystals of C_3S . White areas are C_4AF . Water etch 5 seconds followed by HNO_3 -alcohol 2 seconds. $\times 500$. (*Ward*)



Figure 38. Crystal of C_2A occurring in glass in the system $K_2O-CaO-Al_2O_3$ (*Brown-miller*)

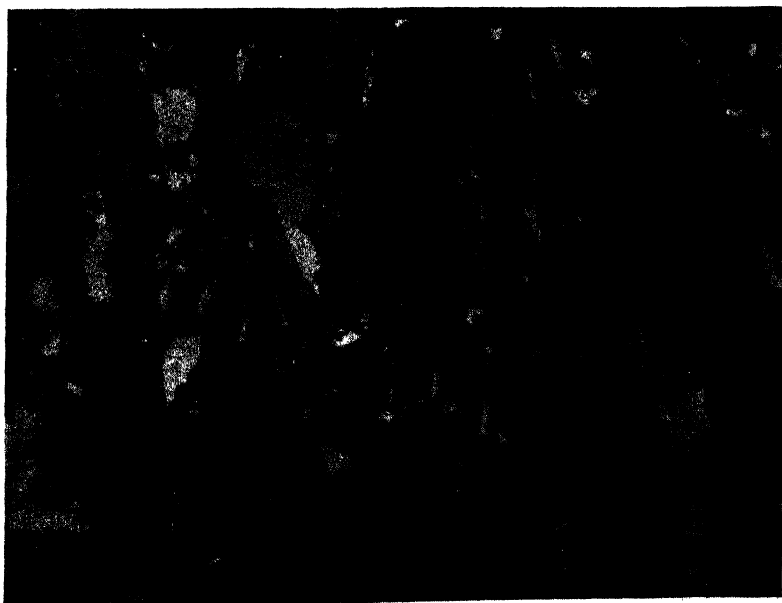

Figure 39. Prismatic dark interstitial C_2A crystals. The C_3S crystals are fringed with C_2S . Also shown are C_4AF and glass. (*Ward*)

A photomicrograph showing this material in a commercial clinker is given in Figure 39.

In an attempt to arrive at an understanding of the chemical nature of the prismatic phase, Insley and McMurdie (40) prepared burns in the cement field of the system $\text{CaO-Al}_2\text{O}_3\text{-Fe}_2\text{O}_3\text{-SiO}_2$, to portions of which Na_2O and K_2O separately in the amount of 1.5 percent were introduced. An examination of polished sections of the resulting clinkers showed that in the burn without alkalis, no trace of the prismatic phase was present, but in those burns containing either alkali the prismatic phase appeared and in every respect seemed to be identical with that observed in commercial clinker. A photomicrograph of the clinker containing Na_2O is shown in Figure 40.

Brown (14) in 1937 had observed a bladed form of C_3A in thin sections of some laboratory clinkers prepared from commercial mixes. This was explained as due to a directional crystallization of the C_3A conferred by the crystallizing C_3S . A similar form of C_3A had also been observed by Taylor (64) in preparations free of alkali and is distinguished from the prismatic dark interstitial material by an undulatory extinction and the absence of sharp parallel extinction.

In continuing this study, Taylor pointed out that although the prismatic phase has not been produced except in the presence of alkalis, yet no relationship appears to exist between the amount of alkalis present in commercial clinkers and the amount of the prismatic phase observed. The pure compound $\text{KC}_{23}\text{S}_{12}$ has no resemblance to the prismatic phase as shown by the photomicrograph in Figure 41. On the other hand, there does seem to be a relationship between the prismatic phase and the potential C_3A of the clinkers. Also it was noted that commercial clinkers which had been reheated and cooled either quickly or slowly contained less of the prismatic phase than those same clinkers in which the phase was originally found. This suggests that rapid cooling may act to prevent the crystallization of the prismatic phase and, since the slowly-cooled clinkers contained rectangular C_3A , the latter tended to form in slow cooling at the expense of the prismatic phase. It seemed that the prismatic material is not a stable phase and that an intermediate rate of cooling may be a requisite for its formation. If the cooling rate is slow, the stable rectangular C_3A is formed regardless of the alkali content of the clinker.

Charges in the system $\text{KC}_{23}\text{S}_{12}\text{-CaO-C}_6\text{A}_3$ which were heated and cooled under various conditions confirmed this hypothesis. Thus a charge in the field of $\text{KC}_{23}\text{S}_{12}$ which was heated to 1490° and cooled slowly showed the presence of rectangular C_3A but no prismatic material, whereas a similar charge cooled more rapidly showed no rectangular C_3A but prismatic material was abundant. The mean refractive index was 1.70 with a birefringence of 0.008 to 0.010.

A similar result was obtained in the field of C_6A_3 , but in no case was the prismatic material observed except the composition was such that C_3A should be present and the charge was cooled fairly rapidly.

In the CaO field a charge was cooled under these conditions, photomicrographs of polished sections of the clinkers being shown. When quenched from above the temperature of the C_3A liquidus only CaO , $\text{KC}_{23}\text{S}_{12}$ and glass were found (Figure 42); when slowly cooled to a temperature below the C_3A liquidus and quenched, the C_3A appears as large rectangular crystals (Figure 43); and when quickly

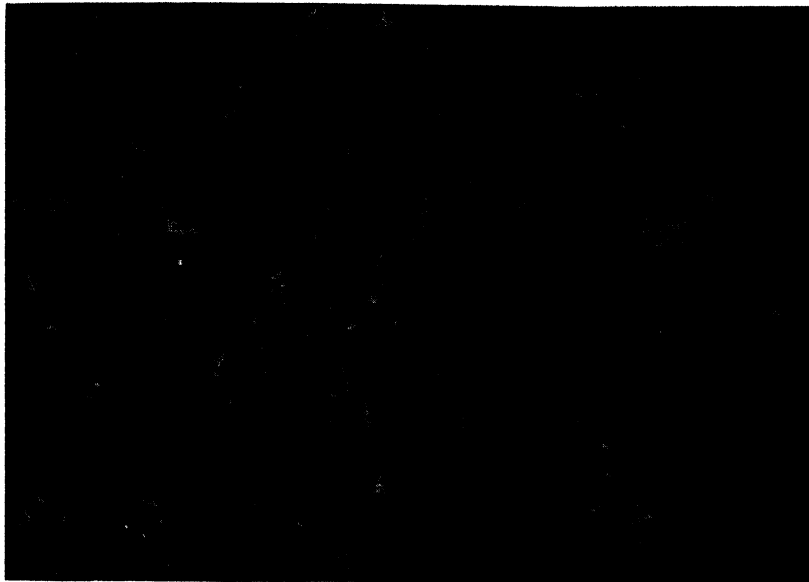

Figure 40. Laboratory-prepared clinker containing 1.5 percent Na_2O . Water etch 2 seconds followed by 1 percent HNO_3 in alcohol. Reflected light, $\times 500$. (*Insley and McMurdie*)

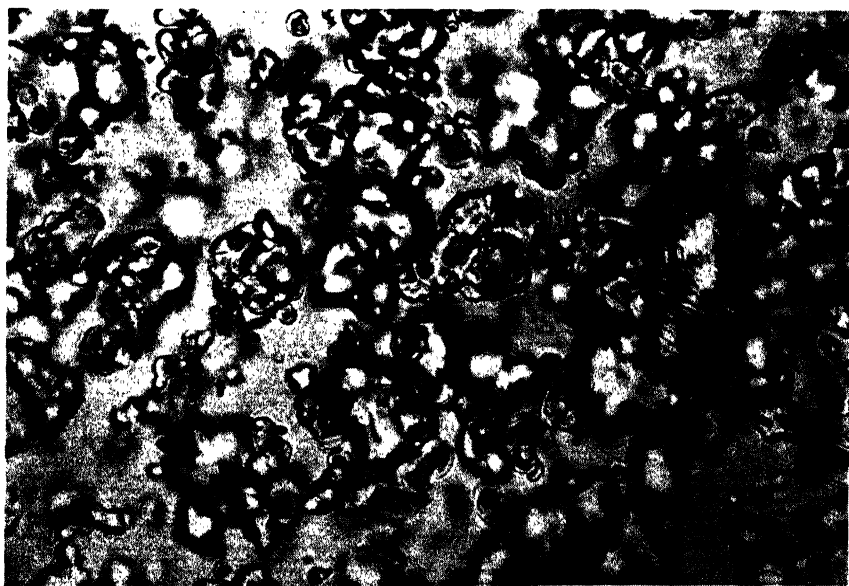

Figure 41. Crystals of $\text{K}_2\text{O} \cdot 23\text{CaO} \cdot 12\text{SiO}_2$. Ordinary transmitted light, $\times 500$. (*Taylor*)

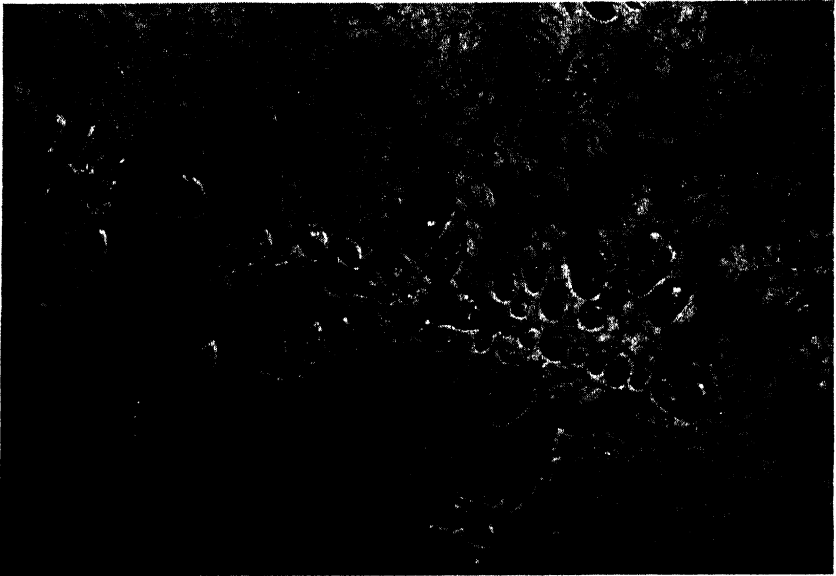

Figure 42. Polished section of charge consisting of 38 $KC_{23}S_{12}$, 47 C_1A_1 , 15 CaO . Water etched 2 seconds. Reflected light, $\times 500$. Rapidly-cooled charge quenched from temperature above C_2A liquidus. Shows clusters of CaO in high relief, $KC_{23}S_{12}$ and glass. (Taylor)

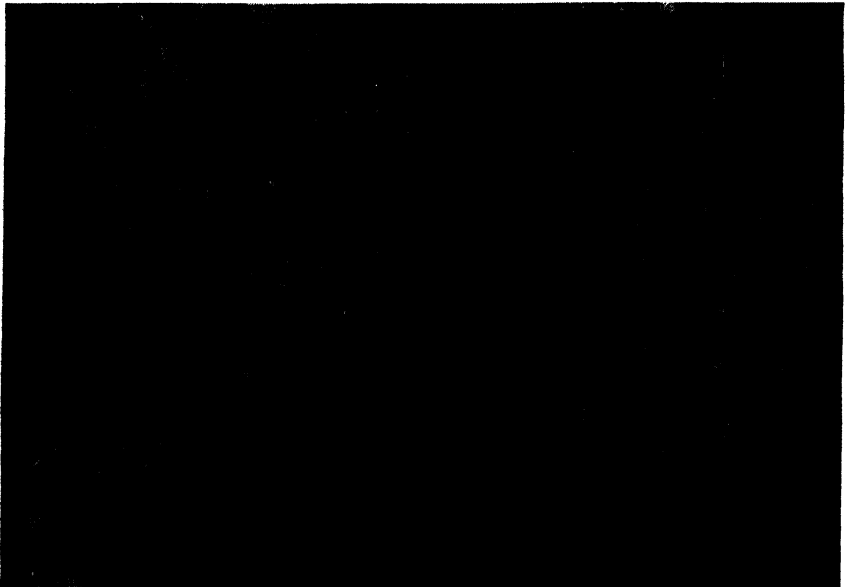

Figure 43. The same preparation as shown in Figure 42, slowly cooled and quenched from temperature below C_2A liquidus. Shows large rectangular crystals of C_1A , some $KC_{13}S_1$, and glass.

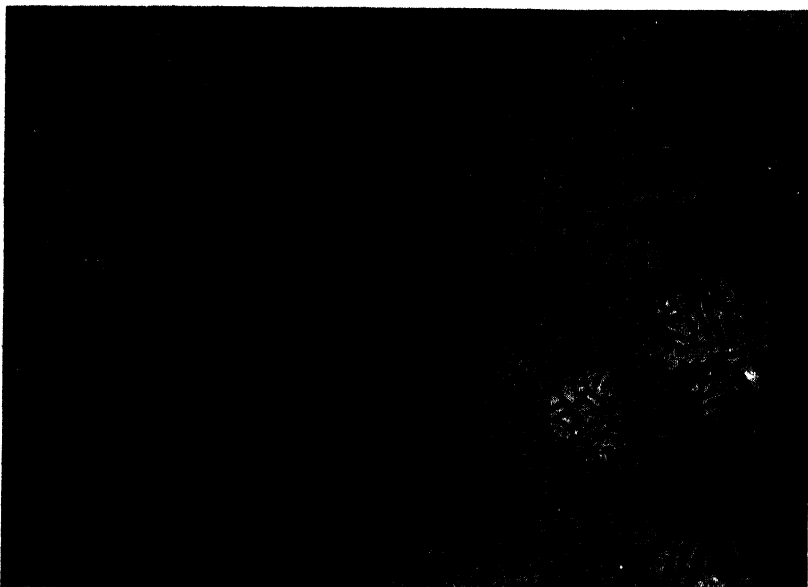

Figure 44. *The same preparation as shown in Figure 42, rapidly cooled and quenched from temperature below C_2A liquidus. Shows prismatic crystals, globular crystals of $KC_{23}S_{12}$, and glass.*

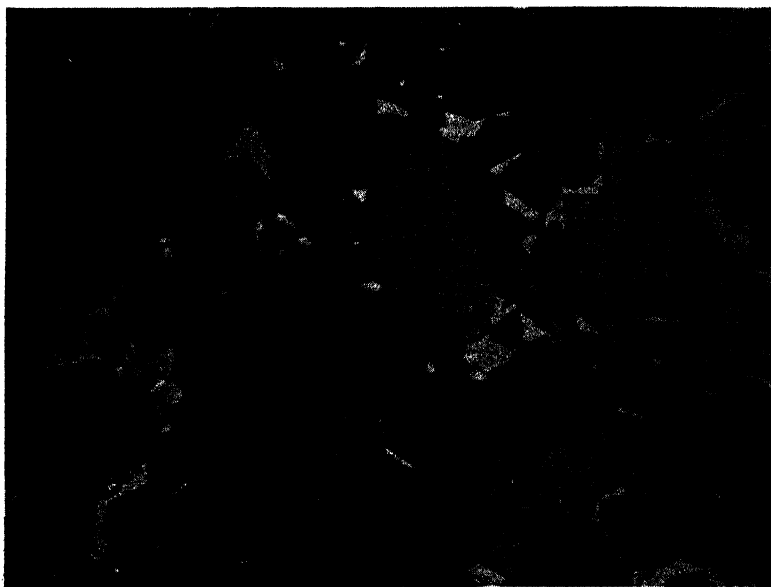

Figure 45. *Typical slowly-cooled clinker. 1, C_2S ; 2, βC_2S ; 3, C_2A ; 5, MgO . No glass or prismatic C_2A . Water- HNO_3 etch. Reflected light, X500. (Ward)*

cooled from the same temperature and quenched, the prismatic crystals were formed (Figure 44). Entirely similar results were obtained when C_4AF was present in the mix.

All of the data obtained by Taylor indicate that the composition of the prismatic phase is at least very close to C_3A . No measurable reductions in the amounts of the calcium silicates were observed upon the formation of this phase. This and the close relation between the amounts of prismatic material and the potential C_3A in clinker indicate that if any components other than those of C_3A are contained in the prismatic material, or if any solid solution exists, the amount is so slight that consideration of the phase as C_3A introduces no significant error in the computations.

Amorphous Dark Interstitial Material. The amorphous constituent of the dark interstitial material is the undercooled liquid or glass which results from the cooling of clinker at such a rate that complete crystallization cannot occur. Since the composition of the glass will vary, particularly with the A:F ratio and the temperature from which the liquid is frozen, so likewise the properties of the glass will vary. When the A:F ratio is high, the refractive index may be as low as 1.70, and when the reverse is the case, the index will be higher, up to 1.74.

The glass content of a clinker is obviously dependent chiefly upon the rate with which the clinker is cooled through the critical temperature range within which the liquid may crystallize. In Figures 45, 46 and 47 are shown photomicrographs prepared by Ward (65) from a commercial cement which had been cooled from clinkering temperatures (1) slowly, (2) normally in the commercial kiln, and (3) quickly, respectively. The interstitial material in the slowly cooled clinker consists of rectangular C_3A and C_4AF ; in the quickly cooled clinker the C_3A has disappeared and been replaced by glass. In the plant-cooled clinker the C_3A is in the prismatic form, but in this sample glass was not observed in the field shown.

The glass content of a group of 21 commercial clinkers, and of the same clinkers which had been reheated to 1400° and cooled in one case slowly and in another case quickly, was determined by the heat-of-solution method by Lerch (52). The glass was found to vary in the commercial clinkers between 2 and 21 percent. In the corresponding slowly-cooled clinkers the values ranged between 0 and 3 percent, whereas in the quickly-cooled clinkers the values ranged between 8 and 22 percent. In Figure 48 these results are plotted in the order of increasing glass found in the plant-cooled clinker. The rapid cooling is seen to have markedly increased the glass content of nearly all of the clinkers, and the slow cooling to have produced nearly complete crystallization.

Light Interstitial Material. In polished sections of clinker there is usually observed an interstitial phase of high reflectivity, closely associated with the various more readily etched constituents of the matrix. It is sometimes observed as crystals with definite prismatic habit, but more frequently as aggregates of irregular shape. By an observation of its optical properties and diffraction pattern it is identified as the iron phase, C_4AF , or C_4AF solid solution. In thin sections it is seen to have a high refractive index, mean about 2.03, moderately strong double refraction, weak to strong pleochroism, and frequently prismatic habit. When the A:F ratio is low, these prisms have been noted to be large and broad,

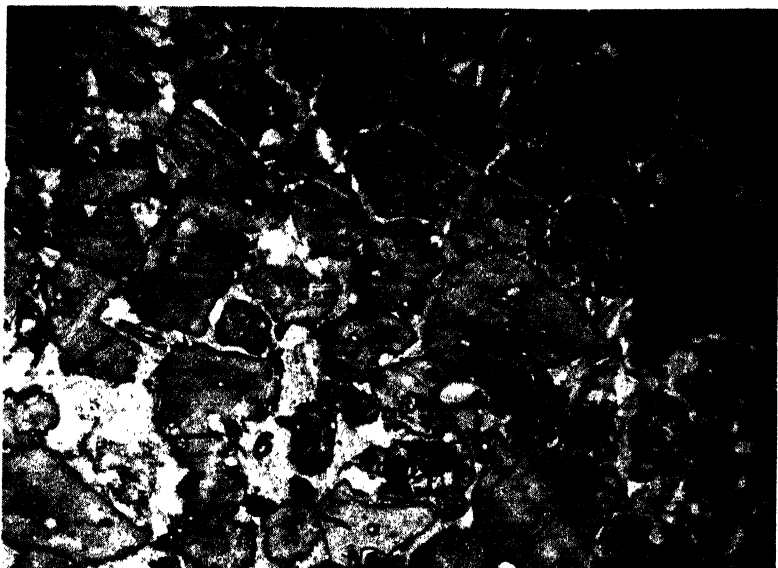

Figure 46. Typical plant-cooled clinker (*the same clinker as shown in Figure 45 before heat treatment*). 1, C_2S ; 2, β - C_2S ; 4, C_4AF ; 6, prismatic C_3A ; arrows point to unknown phases. The C_3A here is noted to be in the prismatic form. Water- HNO_3 etch. Reflected light, $\times 500$.

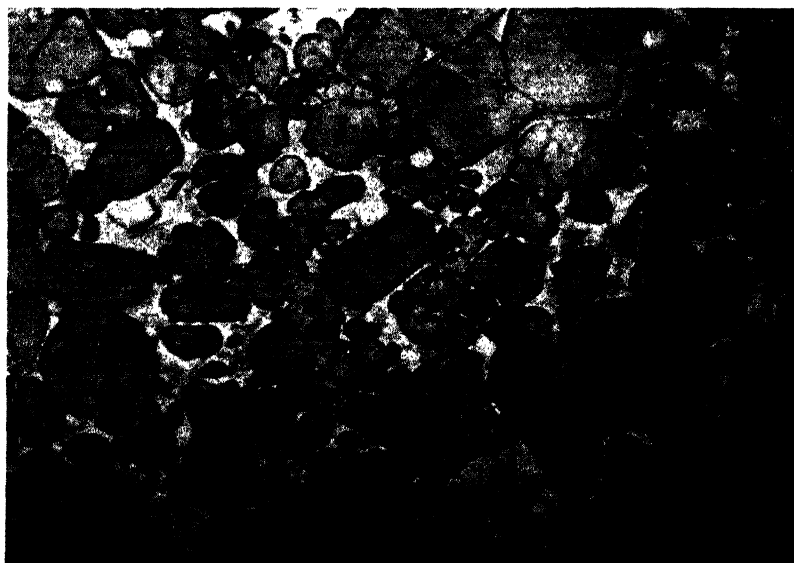

Figure 47. Typical quickly-cooled clinker (*the same clinker as shown in Figure 46 after heat treatment*). 1, C_2S ; 2, β - C_2S ; 5, MgO ; 7, glass and C_4AF . Glass is abundant here, but C_3A is not observed. Water- HNO_3 etch. Reflected light, $\times 500$.

but when the ratio is high, the prisms were small and needle-like in form. Rapid cooling also favored the formation of the long, narrow type of crystals (65).

Parker (57) has pointed out that high-iron glasses behave towards etchants much as the crystalline iron phase, and differentiation is not readily obtained. Thus in a low-iron mixture, heat-treated to produce a clinker consisting of C_3S , C_2S , C_3A and glass, all the iron was in the glass and this phase was left unattacked by an etching consisting of 1:3 water-alcohol 10 seconds followed by 0.25 percent HNO_3 in alcohol 5 seconds. The C_3A was etched dark. In another mixture of high iron content, heat-treated to produce a clinker consisting of C_3S , C_2S , C_4AF and glass, the latter phase contained relatively little iron and was attacked by the etchant, whereas the C_4AF was not attacked. Thus in one case the dark interstitial material was C_3A ; the light, glass. In the other case, the dark interstitial material was glass; the light, C_4AF .*

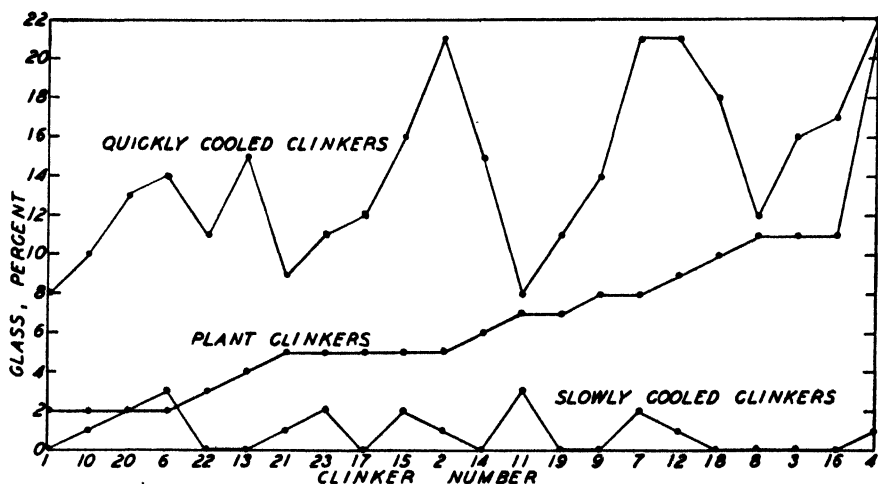

Figure 48. Approximate glass content of clinkers, arranged in order of increasing glass content of the plant clinkers. (Lerch)

An interesting relation between the presence of C_3A crystals in a clinker, and their effect upon the orientation of C_4AF crystals has been reported by Brown (14). In a laboratory preparation, Fe_2O_3 was added to the ternary system, C-A-S, to produce a potential composition

C_3S	45.58
C_2S	2.29
C_3A	23.00
C_4AF	29.13

The A:F ratio was 1.55. The preparation was heated to 1420° and cooled slowly to 1330° . The C_4AF crystallized in fern-like structures outlining the cubic crystals of C_3A which enclosed grains of CaO and C_2S . But the C_4AF crystals were observed to display a mass birefringence around the cubes of C_3A , extinguishing

* See pages 65-67 for a further discussion of the action of other etching reagents.

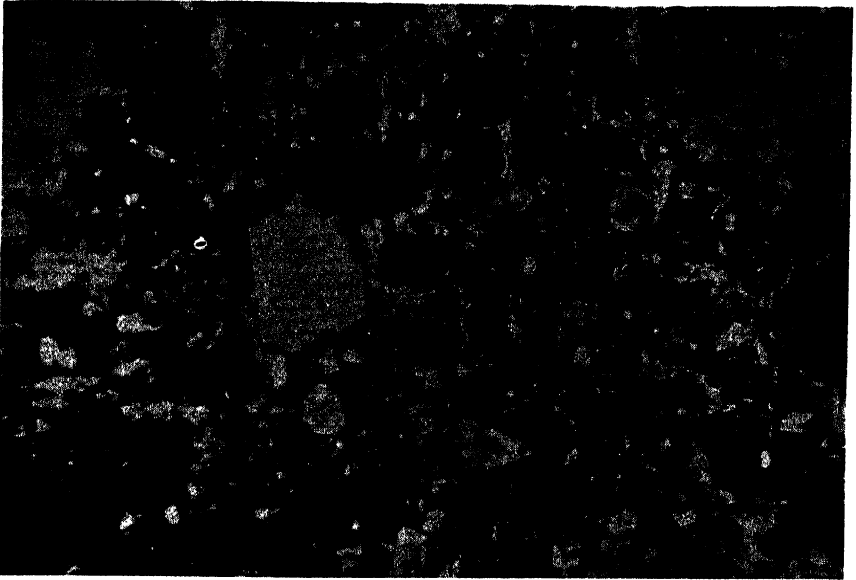

Figure 49. Commercial clinker showing C_4AF at maximum illumination. Transmitted light, crossed nicols, $\times 40$. (Brown)

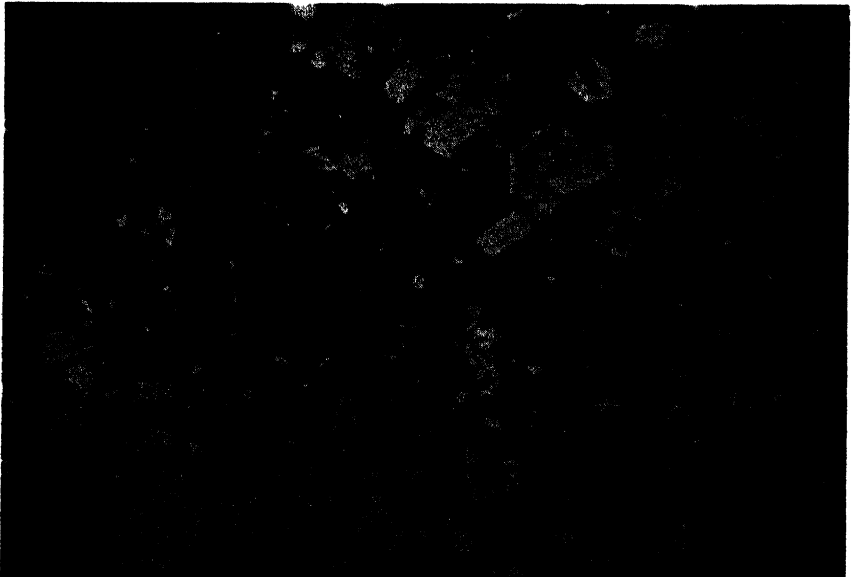

Figure 50. The same field as shown in Figure 49, but with nicols rotated 45° to show C_4AF at extinction.

when the sides of the cubes were parallel to the vibration directions of the nicols. This indicates, according to Brown, that the presence of C_3A in a clinker with A:F ratio above 1.38 may be demonstrated by the presence of a mass birefringence of C_4AF over large areas.

Such a condition has commonly been observed by Brown in commercial clinkers, even when the characteristic large cubes of C_3A are not found. This is illustrated in the accompanying photomicrographs obtained on a commercial clinker. In Figure 49 the nicols are adjusted to show the C_4AF crystallites covering a large part of the field. In Figure 50, the nicols have been rotated 45 degrees and extinction of the C_4AF is complete.

Crystal Structure

The crystal structure of the compounds of portland cement has not yet received a comprehensive and adequate treatment, although several investigations have indicated its importance and suggested an avenue of approach to many of the problems concerned with the cement industry. These compounds are in general so complicated in their stoichiometric composition and symmetry that it is not possible to predict their structure. Good single crystals are very difficult to obtain upon which wholly satisfactory X-ray observations can be made. But such experimentation as has been made warrants an intensive study. Thus Brandenberger (9) propounded a hypothesis that the reactivity of the cement compounds with water is connected with a dual role played by calcium, being in an active form as a coordinating center at high temperatures, and in an inactive interstratification at lower temperatures. At the higher temperatures, according to Brandenberger, the tendency to a lower coordination number, and therefore a more active manifestation, is indicated, whereas at lower temperatures such coordinations are unstable and may become manifest in a polymorphic transformation by which the compound becomes substituted by a modification more stable at the lower temperatures. A modification of this hypothesis by Bredig (11) will be discussed below.

In 1927 Harrington (36) first obtained X-ray diffraction patterns of C_3A from which he noted that the position of most of the lines indicated a cubic structure, with a unit cell of $a_0 = 7.623A$. By calculation, the number of molecules per unit cell was indicated to be three, but the data were not sufficient to establish the atomic arrangements. Cubic indices could not be assigned to six of the lines. Since most of the lines fitted the pattern of a body-centered cube, he called the compound "pseudo" cubic.

Steele and Davey (61) made measurements from which they reported the cell of C_3A as cubic, with $a_0 = 7.624A$. The structure postulated contained one Ca atom with no surrounding O atoms, and one group of six O atoms without a central cation, AlO_6 octahedrons and planary AlO_4 groups. This gives a condition of interatomic distances and of valency saturation which has met with criticism by other investigators. Hermann (37) suggested that the six O atoms in the middle of the cell be removed and grouped with the Ca atoms at the corners. This improves the valency saturation but leaves the atomic distances still unusual. A further improvement was made by Lagerquist, Wallmark and Westgren (48) who concluded that the length of the unit cell should be twice the former figure,

assigning it a value of 15.22A. This increases the volume eight times, giving 24 molecules to a unit cell. From Laue diagrams obtained from the isomorphic tristrontium aluminate, Bussem and Eitel (21) obtained the unit cell value of 15.79A and concluded that it belonged to the symmetry group T_h . The unit cell of 15.22A was later confirmed by Brady and Davey (7).

All the above data were reviewed by McMurdie (54) and new patterns prepared of C_3A and of several materials which had been found to give patterns in which the strong lines were similar to those of C_3A . These compounds included perovskite ($CaO.TiO_2$) reported by Bussem (21), $Na_2O.8CaO.3Al_2O_3$ reported by Brownmiller and Bogue (19), $Na_2O.CaO.SiO_2$ reported by Barth and Posnjak (2), and $3SiO.Al_2O_3$, reported by Lagerquist and his co-workers. The unit cell of C_3A was confirmed at a value of $a_0 = 15.24A$, and having 24 molecules. By comparison with the other compounds having similar patterns, it was concluded that the cations are arranged at or near the centers and corners of 3.81A cubes. No deductions could be drawn, however, about the oxygen arrangement from a consideration of the strong lines only.

The X-ray data on other compounds and hydration products of portland cement is less complete than upon C_3A , due in large part to the difficulties encountered in obtaining single crystals. A number of data have however been obtained, although structural analyses are still to be made. The crystal systems and unit cell sizes of the principal compounds are given in Table 14.

In the course of the examination of charges representing liquid compositions

TABLE 14. *Crystal-structure data on compounds of interest in portland cement*

Compound	System	Unit cell size, Angstroms	Authority
CaO	Cubic	$a = 4.797$	Wyckoff (69)
MgO	Cubic	$a = 4.203$	Wyckoff (69)
$Ca(OH)_2$. .	Hexagonal	$a = 3.58, c = 5.03$	Bussem (21)
$Al(OH)_3$. .	Monoclinic	$a = 8.624, b = 5.060, c = 9.70,$ $\beta = 85^\circ 26'$	Bussem (21)
C_3A	Cubic	$a = 15.2$	Bussem (21)
C_3NA_3 . . .	Ps. cubic	$a = 15.2$	Bussem (21)
C_2F	Orthorhombic	$a = 5.34$	Bussem (21)
C_4AF	Orthorhombic	$a = 5.34, b = 14.44, c = 5.52$	Bussem (21)
$C_{12}A_7$	Cubic	$a = 11.95$	Bussem (21)
C_3S	Hexagonal	$a = 7, c = 25.0$	Anderson and Lee (1)
$\alpha-C_2S$	Hexagonal	$a = 5.40, c = 7.00$	Greene (29)
C_2AH_6	Cubic	$a = 12.56$	Brandenberger (9)
C_2AH_8	Hexagonal	$a = 8.8, c = 10.6$	McMurdie (67)
C_4AH_{13} . . .	Hexagonal	$a = 8.8, c = 8.2$	McMurdie (67)
$C_3S_2H_3$. . .	Monoclinic	$a = 11.39, b = 5.47, c = 13.09,$ $\beta = 98^\circ 26'$	Gottfried (21)
C_3FH_6	Cubic	$a = 12.71$	Eiger (21)

at 1400° in the system C-A-F-S, anomalous variations in refractive indices were found which led to an X-ray study by Brownmiller (16) of the so-called glasses of cement clinker. In this investigation the effect of cooling rate was studied on about 20 compositions in the ternary and quaternary systems involving CaO, Al₂O₃, SiO₂ and Fe₂O₃.

The experimental results showed that a true glass, optically clear and giving rise to no X-ray diffraction lines, was obtained only upon the most rapid quenching of very small charges. The mean refractive indices of these glasses were found to vary in a regular manner with the composition, in mixtures of C₄AF-C₂S. Upon slow cooling, the equilibrium compounds were obtained. But upon cooling at a rapid but not instantaneous rate, metastable intermediate products were formed, having properties which were dependent on the rate of cooling, viscosity of the melt, and composition of the original liquid. The refractive indices of these metastable products were found to be higher than those of the pure glasses and, like the latter, to vary with the iron content of the original composition. But

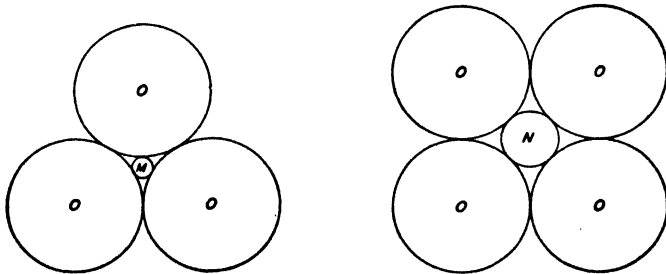

Figure 51. Two-dimensional models of polyhedra present in glasses. (Goldschmidt)

they all produced an X-ray diffraction pattern which, in position and intensity of the lines, appeared to be identical with the pattern of C₃A. This was true even in compositions which contained no Al₂O₃.

In explanation of this condition, consideration was given to the atomic structure of glasses and of the rearrangements necessitated upon their change to crystalline entities.

Brownmiller pointed out that in liquids and glasses of silicates, certain groups of elements may be preserved. Thus oxygen polyhedra are believed to be present in those glasses which contain "glass-forming" cations at the centers of the polyhedra. This condition was represented by Goldschmidt (28) in a two-dimensional model as in Figure 51. It will be seen that the type of polyhedron, as tetrahedron, cube, octagon, etc., will be determined by the size of the cation contained within the structure of the oxygen atoms. Thus if we have two cations of approximately the same size, the type of polyhedra formed around them may be the same. And if the polyhedra are of the same dimensions, then these polyhedra may be substituted for each other in the formation of crystal structures.

The relative sizes of some of the more important cations occurring in silicates, as given by Bragg (8) are illustrated in Figure 52. From the relative similarity in size of the cations Si and Al, it might be expected that they would form the same kind of polyhedra and so substitute for each other. This is known to occur

in many almino-silicates, as the ultramarines. Likewise Al and Fe can substitute for each other, as in the spinels.

That oxygen polyhedra may be preserved in glasses has been shown by various investigators. Thus Zachariassen (70) and Warren and Loring (66) have developed fundamental principles for the formation of glasses, and have presented two-dimensional models illustrating their structure.

Since there is no periodicity in the arrangement of the atoms in a true glass, the X-ray diffraction pattern will show no sharp lines, but the optical properties will vary with the composition, as was found to be the case in the true glasses studied. But the arrangement by which the glass becomes differentiated into two or more separate crystalline phases (we are not here considering the case of a glass crystallizing to a single phase of its own composition), may assume an interior orientation representing a higher order of atomic periodicity than obtains with the true glass, but yet short of the equilibrium crystal formation.

In such a structure, according to Brownmiller, we would expect the developing polyhedra to give rise to X-ray diffraction patterns, the denser packing to give rise to higher refractive indices increasing with the iron content, and heats of

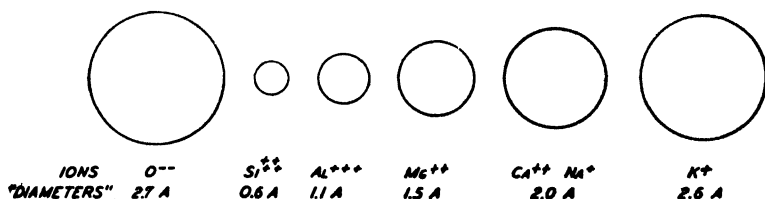

Figure 52. Diameters of ions occurring in silicates. (Bragg)

solution differing from those of the two extreme states of glass and crystal by an amount proportional to the changes in state involved. All of these expectations were met in the metastable phases which were studied. It appears to be only a coincidence that the structure of this phase, irrespective of the presence of Al_2O_3 , gives rise to an X-ray diffraction pattern practically identical with that of C_2A . On continuation of the orientation process, the separation of the phases becomes complete and crystals are formed by the building up of the distinct polyhedra of the two phases.

From the results of this study, it appears that the X-ray diffraction pattern produced by C_2A is not exclusively characteristic of that compound, but is produced also by a metastable phase which has been prepared from mixtures of C_2S or C_3S with C_4AF or C_2F . Since this phase was found to be present in all clinkers cooled rapidly but not instantaneously, and since portland cement clinker commercially produced always contains some glass, it would seem probable that the metastable phase is normally present in commercial clinkers. Its presence, furthermore, would tend to give rise to the lines in the X-ray diffraction pattern which have been assigned to C_2A . Such a pattern cannot, therefore, be employed as evidence of C_2A in the clinker.

Concerning the structure for the metastable phase suggested by Brownmiller, Brandenberger (9) pointed out the probability that Ca becomes active at high

temperatures and assumes a position as an active center of coordination, just as Si, Al and Fe, that is, in the center of the oxygen polyhedron. This possibility was acknowledged by Brownmiller (17) who conceded that the existence of oxygen polyhedra surrounding calcium ions in silicate liquids at high temperatures would introduce a new conception in the theory of the ultimate structure of glasses.

The development of an X-ray pattern similar to that of C_3A in suitably treated mixtures of CaO , SiO_2 and Fe_2O_3 was confirmed by Keyes (46) who found also that a similar pattern was formed when Mn_2O_3 was substituted either in part or in whole for the Fe_2O_3 .

Preparations similar to those used by Brownmiller were also made and studied by McMurdie (54) who confirmed the earlier experimental results. McMurdie noted particularly, however, that the pattern of the metastable phase consists of sharp but weak lines. Their sharpness led him to conclude that they could not have been produced by a structure which had the degree of randomness or the different atomic distances of Fe-O, Ca-O, Si-O, and Al-O postulated in the structure suggested for the metastable phase. Such a condition, he believes, would result in a low degree of periodicity and a pattern consisting of broad lines. He therefore suggests that the pattern is the result of submicroscopic quench growths of a crystal phase. Since it has been shown that several compounds give essentially this same pattern, and since compounds may exist at high temperatures which would not be present under equilibrium conditions at lower temperatures, he suggests as a possibility that an iron compound, C_3F , isostructural with C_3A , may be formed and be the cause of the pattern. He agrees with Brownmiller that it is a metastable phase, but considers it a submicroscopic quench growth rather than a pseudo-crystalline intermediate phase.

In studies originating from a need to understand better the structures of the calcium phosphates, Bredig (10) developed the characteristic structures of the group of compounds which may be represented by the formula A_2XO_4 . These compounds (as K_2SO_4 , Na_2SO_4 , $CaNa_2PO_4$, $CaKPO_4$) occur in more than one modification; in their high-temperature (α) form, they are isomorphous with hexagonal symmetry. The structure of glaserite [$K_2Na(SO_4)_2$] being similar to the α form of the simple sulfates was therefore considered to indicate a solid solution of the two alkali sulfates in the high-temperature form.

By applying this line of reasoning, a number of other phases, formerly designated as compounds, were classed by Bredig as solid solutions. Thus $7CaO.P_2O_5.2SiO_2$ was shown to possess the simple crystal lattice of the α - A_2XO_4 group, and was therefore considered to be, not a ternary compound, but a solid solution of $3CaO.P_2O_5$ in $2CaO.SiO_2$. A similar structure obtained by Greene* with specially heat-treated mixtures of Na_2O and Fe_2O_3 , or Na_2O and Al_2O_3 , with C_2S led him to conclude that solid solutions had been formed of Na_2O , with Fe_2O_3 or Al_2O_3 , in C_2S . In both of these cases, the structure is that of the α - A_2XO_4 group, and so the C_2S of these solid solutions is considered to be in the α form. It is accordingly postulated that a pure α - C_2S of hexagonal symmetry occurs in some temperature range;† that ordinarily it is impossible to prevent inversion during

* See pages 120-124.

† This was confirmed by H. F. McMurdie by direct observation at a temperature of about 1500°.

cooling; but that the presence of substances in solid solution may cause the α form to be retained at room temperature. A slow cooling through the transition-temperature range, however, brings about the inversion, as may be noted by a change in symmetry and the appearance of the typically twinned β - C_2S .

Likewise, $27CaO.P_2O_5.12SiO_2$ and $K_2O.23CaO.12SiO_2$ * which have been considered as compounds, were shown by Bredig (11) to be similar in crystal structure to the β or low-temperature orthorhombic form of K_2SO_4 . Hence Bredig considers them to be solid solutions, the former of $3CaO.P_2O_5$ and the latter of KCS in C_2S of lower symmetry than that of the α form. Since these solid solutions of $3CaO.P_2O_5$ and KCS in a large excess of C_2S possess this A_2XO_4 structure of β - K_2SO_4 , it is assumed that pure C_2S also must possess the same structure in some temperature range. This new form is designated by Bredig α' - C_2S . Its temperature of stability is believed to be immediately above the transition point, usually indicated as the α - β point at 1420° . It then became necessary to assign for the hexagonal α structure, isotypic with α - K_2SO_4 , the temperature range of stability from that of the new transition point for α - α' - C_2S up to the melting point of C_2S , about 2200° .

As already has been stated, Brandenberger (9) believes that the calcium ion at room temperatures tends to surround itself with more oxygen ions than at high temperatures. Thus the coordination number of Ca for O in γ - C_2S is believed to be 6, but the β - C_2S , stable at higher temperatures, is postulated to be 4. This would mean that a decrease from a coordination of CaO_6 to CaO_4 would result in a greater activity of the dicalcium silicate. Such a condition was postulated on the premise that, with rising temperatures, the Ca ions exert a loosening influence upon the state of polarization of the O ions, increasing the distance between them and the Si ions, and so diminishing the bond between them. This action is referred to as contrapolarization.

A number of arguments have been advanced by Bredig (11) to indicate that such an effect cannot occur with rise in temperature but, on the contrary, that it is at low heat contents that the weaker Ca cation may approach the SiO_4 radical close enough to exert increased attraction upon the electron shell of the O ions, and be able thereby to repulse the Si ions. Hence, if the coordination number of Ca for O in γ - C_2S is 6, as there is reason to believe, the number will increase in the polymorphic forms stable at the higher temperatures. In the highest-temperature forms (α and α') it is equal to about 10. It has not been determined in the β - C_2S , but is believed by Bredig to be probably 8.

Bredig points out a number of theoretical justifications for this stand. Thus in $Ca(OH)_2$, the Ca ion establishes around itself a shell of 6 oxygen ions. In γ - C_2S , in which the shell already consists of CaO_6 , there is no potential to afford the chemical exchange in reaction with water. But in the case of the unstable coordination CaO_8 of the β - C_2S , the tendency to revert to CaO_6 must be so great that the change in free energy may well account for the activation energy of the hydration reaction.

It is felt that further intensive work in this field offers promise of highly fruitful results, both in an understanding of the nature of the reactions of hydra-

* See Chapter 19.

tion and in the development of findings which may be directly applicable in the industry.

References

1. Anderson, O. and Lee, H. C., *J. Wash. Acad. Sci.*, **23**, 338 (1933).
2. Barth, T. F. W. and Posnjak, E., *Z. Krist.*, **81**, 370 (1932).
3. Bates, P. H., *Concrete and Cement Age*, **2**, 3 (1913).
4. Bates, P. H. and Klein, A. A., *Tech. Paper NBS*, **78**, (1917).
5. Bogue, R. H., *Symposium*, **81**.
6. Bowen, N. L., Schairer, J. F. and Posnjak, E., *Am. J. Sci.*, **25**, 273 (1933).
7. Brady, L. J. and Davey, W. P., *J. Phys. Chem.*, **9**, 663 (1941).
8. Bragg, W. L., *Trans. Faraday Soc.*, **25**, 291 (1929).
9. Brandenberger, E. B., *Symposium*, 122; *Schweizer Archiv.*, **2**, 45 (1936).
10. Bredig, M. A., *J. Phys. Chem.*, **46**, 747; 801 (1942); **47**, 587 (1943).
11. Bredig, M. A., *Am. Mineralogist*, **28**, 594 (1943); *J. Phys. Chem.*, **49**, 537 (1945).
12. Brill, R., *Zement*, **19**, 796 (1930).
13. Brown, L. S., Personal communication.
14. Brown, L. S., *Proc. Am. Soc. Testing Materials*, **37**, 277 (1937).
15. Brownmiller, L. T., *Am. J. Sci.*, **29**, 260 (1935); PCAF Paper 30.
16. Brownmiller, L. T., *Am. J. Sci.*, **35**, 241 (1938); PCAF Paper 35.
17. Brownmiller, L. T., *Symposium*, 137.
18. Brownmiller, L. T. and Bogue, R. H., *Am. J. Sci.*, **20**, 241 (1930); PCAF Paper 24.
19. Brownmiller, L. T. and Bogue, R. H., *Am. J. Sci.*, **23**, 501 (1932); PCAF Paper 25.
20. Burdick, M. D., *J. Res. NBS*, **25**, 475 (1940); RP 1340.
21. Bussem, W., *Symposium*, 141.
22. Carlson, E. T., *J. Res. NBS*, **7**, 893 (1931), RP 381.
23. Cour Grandmaison, J. Le, Personal communication.
24. Dyckerhoff, W., *Zement*, **13**, 455; 467 (1924); Dissertation, Leipzig, 1925.
25. Eitel, W., *Symposium*, 123-124.
26. Flint, E. P. and Wells, L. S., *J. Res. NBS*, **17**, 727 (1936); RP 941.
27. Gillson, J. L. and Warren, E. C., *J. Am. Ceramic Soc.*, **9**, 783 (1926).
28. Goldschmidt, V. M., *Trans. Faraday Soc.*, **25**, 253 (1929).
29. Greene, K. T., *J. Res. NBS*, **32**, 1 (1944); RP 1570; PCAF Paper 45.
30. Greene, K. T. and Bogue, R. H., *J. Res. NBS*, **36**, 187 (1946); RP 1699; PCAF Paper 47.
31. Guttmann, A. and Gille, F., *Zement*, **17**, 296 (1928).
32. Guttmann, A. and Gille, F., *Zement*, **18**, 912 (1929).
33. Guttmann, A. and Gille, F., *Zement*, **20**, No. 7, (1931).
34. Hansen, W. C., *J. Am. Ceramic Soc.*, **11**, 68 (1928); PCAF Paper 12.
35. Hansen, W. C., Dyckerhoff, W., Ashton, F. W. and Bogue, R. H., *J. Phys. Chem.*, **31**, 607 (1927), PCAF Paper 6.
36. Harrington, E. A., *Am. J. Sci.*, **13**, 467 (1927); PCAF Paper 8.
37. Hermann, C., *Z. Krist.*, **2**, 60 (1936).
38. Insley, H., *J. Res. NBS*, **17**, 353 (1936); RP 917.
39. Insley, H., Flint, E. P., Newman, E. S. and Swenson, J. A., *J. Res. NBS*, **21**, 355 (1938); RP 1135.
40. Insley, H. and McMurdie, H. F., *J. Res. NBS*, **20**, 173 (1938); RP 1074.
41. Janecke, E., *Zement*, **21**, 377 (1932).
42. Janecke, E., *Z. anorg. Chem.*, **73**, 200 (1912); *Z. anorg. allgem. Chem.*, **93**, 271 (1915).
43. Janecke, E., *Tonind. Ztg.*, **52**, 757 (1928).
44. Janecke, E., *Zement*, **18**, 1345 (1929).

45. Janecke, E., *Zement*, **20**, 26 (1931); **21**, 380 (1932).
46. Keyes, F. W., Dissertation, U. Illinois, 1938.
47. Kuhl, H., *Prot. deut. Portland Cement Fab.*, **44**, 109 (1921); **45**, 981 (1922); *Zement*, **13**, 512 (1924).
48. Lagerquist, K., Wallmark, S. and Westgren, A., *Z. anorg. allgem. Chem.*, **234**, 1 (1937).
49. Lea, F. M. and Desch, C. H., "The Chemistry of Cement and Concrete," p. 47, New York, Longmans Green and Co., 1935.
50. Lea, F. M. and Parker, T. W., *Phil. Trans. Royal Soc.*, 234, No. 731, 1 (1934) A.
51. Leduc, E., *Internatl. Assoc. Testing Materials*, **3**, (1901).
52. Lerch, W., *J. Res. NBS*, **20**, 77 (1938); RP 1066; PCAF Paper 34.
53. McMurdie, H. F., *J. Res. NBS*, **18**, 475 (1937); RP 987.
54. McMurdie, H. F., *J. Res. NBS*, **27**, 499 (1941); RP 1437.
55. Meyers, S. L., *Rock Products*, Aug. 1930, p. 78.
56. Newman, E. S. and Wells, L. S., *J. Res. NBS*, **36**, 137 (1946); RP 1696.
57. Parker, T. W., *Symposium*, 113.
58. Rankin, G. A. and Wright, F. E., *Am. J. Sci.*, **39**, 31 (1915).
59. Schweite, H. E. and zur Strassen, H., *Zement*, **23**, 511 (1934).
60. Shepherd, E. S. and Rankin, G. A., *Z. anorg. Chem.*, **71**, 19 (1911).
61. Steele, F. A. and Davey, W. P., *J. Am. Chem. Soc.*, **51**, 2283 (1929).
62. Sundius, N., *Geol. Landesanstalt*, Stockholm, Dec. 1934, p. 101.
63. Tavasci, B., *Gior. Chim. Ind. Appl.*, **16**, 538 (1934).
64. Taylor, W. C., *J. Res. NBS*, **30**, 329 (1943); RP 1536; PCAF Paper 44.
65. Ward, G. W., *J. Res. NBS*, **26**, 49 (1941); RP 1358; PCAF Paper 39.
66. Warren, B. E. and Loring, A. D., *J. Am. Ceramic Soc.*, **18**, 269 (1935).
67. Wells, L. S., Clarke, W. F. and McMurdie, H. F., *J. Res. NBS*, **30**, 367 (1943), RP 1539.
68. Weyer, I., Univ. Kiel, Dissertation, 1930; *Zement*, **20**, No. 1 (1931); **21**, Nos. 3 and 5 (1931).
69. Wyckoff, R. W. G., "The Structure of Crystals," New York, Chemical Catalogue Co. (Reinhold Publishing Corp.) 2nd ed., 1935.
70. Zachariasen, W. H., *J. Am. Chem. Soc.*, **54**, 3841 (1932).
71. Zerfoss, S. and Davis, H. M., *J. Am. Ceramic Soc.*, **26**, 302 (1943).

CHAPTER 8

The Combination of Cement Components

In the manufacture of portland cement, as in the study of many of the systems in the cement field, the temperatures available are not sufficiently high to bring all of the material into the liquid state. In such case some of the reactions by which the compounds are produced must take place between solids and liquids, or even between adjacent solids. Time is required for such reactions to become completed and the duration of the time requirement will be dependent upon several factors, such as the chemical composition or nature of the raw materials, the amount of surface provided by the grains, the perfection of the dissemination obtained of the several phases of the pulverized mixture, and the temperature. Likewise, since reactions may continue during cooling as indicated in several of the phase-systems studied, the rate of cooling necessary for the maintenance of equilibrium will differ with the composition. Finally, rapid cooling will cause a portion of the liquid to solidify as a glass which, by slower cooling, would crystallize.

Reactions in the Solid State

The velocity of reactions in the solid state has been expressed by Hedvall (16) by the equation

$$v = A \cdot e^{-\frac{q}{RT}}$$

where A is a constant depending on the texture of the material, but relatively independent of temperature; R is the gas constant; T is the absolute temperature; and q is a quantity which can be called the energy of loosening the lattice for the phase in question. It is the energy necessary to detach a particle from its neighbors in the crystal lattice, and to bring it to a state of reactivity. The constant A is used to express the influence, for example, of change in particle size, conditions of contact, etc.

The factor q is of especial significance, and it is evident that whatever can be caused to decrease q will tend to increase the activity. The surface of a solid, which constitutes the primary reaction area, is generally in a crystallographically imperfect state, where the particles of the lattice are not completely stable but may be conceived as having loose ends that are unattached. Consequently this surface film is characterized by a low value of q . Under isothermic conditions, the layer of reaction product increases according to the formula

$$y^2 = 2k\theta$$

where k is a constant, the magnitude of which is determined by mobility and diffusion factors in the system, and θ is the time of the reaction.

In applying these formulas to components of cement, Jander and Hoffmann (20) showed that in a system of CaO and SiO₂ up to a 2:1 proportion, the C₂S is formed first, whatever the original composition of the mixture. This action they showed to be related to the diffusion velocity of the CaO. If the original mixture has the composition of CS or C₃S₂, those compounds are formed through secondary reactions of the C₂S with SiO₂.

Hedvall has pointed out that reaction velocities in the solid state are remarkably influenced by changes in state which the solids undergo at given temperatures. Thus reactions of exchange, as

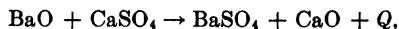

occur very slowly up to the temperature where the compound (as CaSO₄) begins to dissociate, but at that temperature the reaction becomes very rapid.

Likewise, a crystal that is undergoing a transition from one modification to another, as SiO₂ passing from α -quartz to cristobalite, has a low q value and, in this interval, possesses abnormally great reactivity. In reaction with CaO, for example, the breaks in the reaction-velocity curve below the liquidus occur sharply at the transition temperatures of the SiO₂. This effect of faulty lattices, according to Hedvall, is frequently so great that it surpasses by far the influence of surface area. A coarse powder of crystals with faulty lattices may therefore react much better than a fine powder of stable crystals. If the lattices of both solid phases can be made to become faulty at the same temperature, as by a transition of form, the acceleration of the reaction may become enormous. Artificial means may sometimes be employed to bring about this condition, as a reduction or oxidation of an iron oxide component of a system, the employment of compounds as carbonates or sulfates or hydrates which decompose at suitable temperatures, or the use of solid solutions.

The different crystal forms or faces have been found to have different q values and hence to enter reaction at different rates, and impurities in the lattice usually lower the value of q . Thus pure C₃S possesses a considerable stability (27) which does not appear in the impure solid-solution phase (19) of that compound as found in cement. It seems that the loosening of the lattice through admixture with C₂A may have lowered the q value and produced a weakened stability (21).

No complete coordination has yet been made of the reaction velocities of the components of portland cement in terms of the basic principles here briefly sketched. Since the amount of solid phases in a mixture in the burning zone of the cement kiln is usually about 70 to 75 percent of the total mixture, the reaction velocities must be influenced to a large extent by the laws governing the lattice conditions of those phases. Such reactions cannot indefinitely be ignored.

Effects of Particle Size

Many studies have, however, been directed to an understanding of the effects upon the products due to variations in the several factors upon which the composition and state of the clinker depend. In the laboratory, the facility of combination of the components of any particular system, or of portland cement raw mixture (commonly designated the *burnability*), may be most readily ascertained by noting the percentage of uncombined CaO which remains in the product

following a heat treatment. The "free CaO" may be determined by the method of Lerch and Bogue.*

Rankin (26) in 1922 had demonstrated the difference in reactivity of various forms of silica in the formation of C_2S , and pointed out that the silica as found in cement raw materials might be in a much more reactive state than any which he used. The problem both of the effects of surface area and of the nature of the raw materials was further investigated by the PCA Fellowship (3). There was first examined the effect of particle size of pure raw materials on the temperatures required for burning to complete combination. Fractionated sizes of limestone, crystalline alumina and quartz were employed, and free CaO determined following each burning. Further tests were made to determine the effect on the extent of combination of substituting shale for alumina and quartz, and flint for quartz, and of employing amorphous rather than crystalline materials. The base mixture consisted of

CaO	66
Al ₂ O ₃	11
SiO ₂	23

The effects of burning-temperature on combination of the CaO, when the limestone fraction varied in size and the other crystalline raw materials were uniformly so fine as to pass the No. 300 sieve, are shown in Figure 53. It is seen that when the limestone had been reduced until it passed the No. 200 sieve, combination was essentially complete at all temperatures above 1400°. As the particle size increased, higher and higher temperatures were required to bring about essentially complete combination.

In another experiment, the composition was

CaO	64
MgO	3
Al ₂ O ₃	7
Fe ₂ O ₃	3
SiO ₂	23

and the limestone, alumina and quartz were introduced separately, and in combination, in varying sizes, the balance of the materials being uniformly finer than the No. 300 sieve. The data in Figure 54 show the results of burning these mixtures at 1350°. It is seen that only slight effects were obtained by increasing the coarseness of the alumina and the limestone, but large effects by similarly increasing the coarseness of the quartz. The reason appears to be that the alumina enters into the liquid state and the limestone is left in a porous condition with high surface area due to the expulsion of the CO₂. But the quartz reacts in large part by a solid-liquid reaction, the rate of which is a function of the surface area of the original grains.

The substitution of flint for quartz, or of precipitated CaCO₃, precipitated Al₂O₃, or silica gel for the very finely-ground crystalline materials, resulted in little change in burnability, but some improvement was noted when the Al₂O₃ and SiO₂ were introduced in the form of shale. This is due to the intimate association of the oxides in that material.

* See pages 71-73.

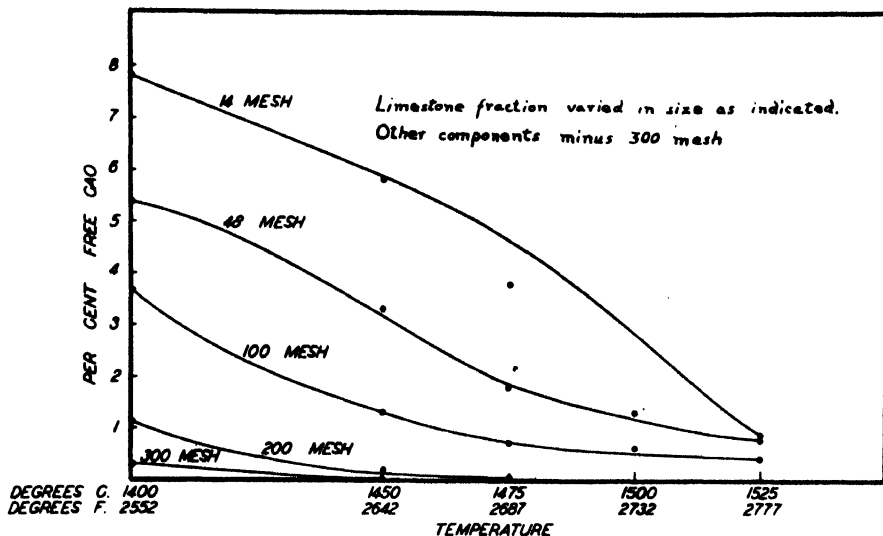

Figure 53. Relation of fineness to combination. Fractional sizes. Composition: CaO 66; Al₂O₃ 11; SiO₂ 23 percent. (Bogue)

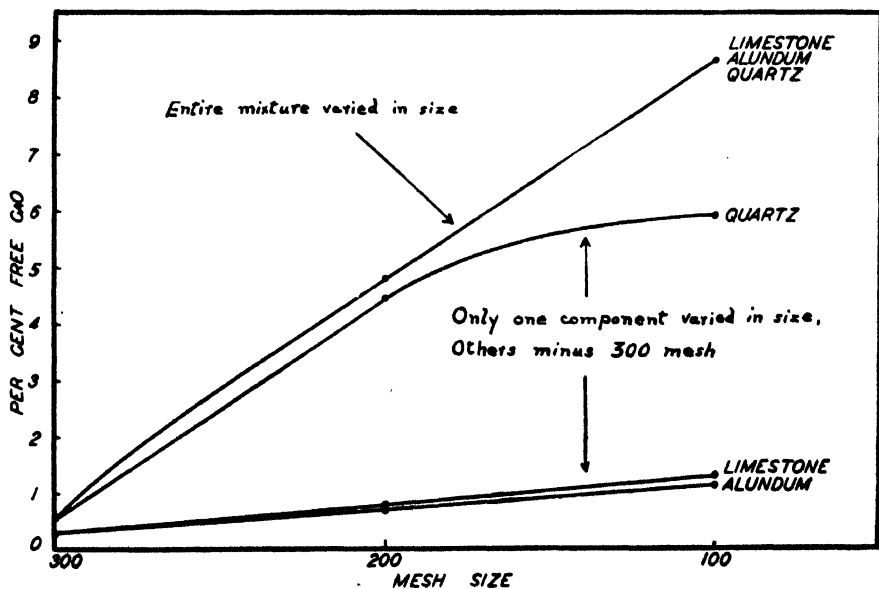

Figure 54. Curves showing effect of varying fineness of three components separately and simultaneously. Composition: CaO 64; MgO 3; Al₂O₃ 7; Fe₂O₃ 3; SiO₂ 23. Temperature 1350°. (Bogue)

These experiments and many others have established the effect of surface area on the burnability of cement mixtures, but it remains to examine the effect of composition.

THE EFFECTS OF COMPOSITION

In the burning of any mixture, the composition may be expected to have a three-fold influence on the heat treatment required to bring about a given degree or rate of combination. First, the composition will determine the temperature at which liquid will first be formed in the mixture. Second, it will determine the amount of liquid that will be formed at any temperature. The above effects usually are grouped together and referred to as the fluxing action, but a full understanding of the behavior of the different components can be had only by treating them separately. In this connection, the effects of special materials called mineralizers, added for the purpose of increasing the fluxing action, constitute a special case. A third effect of composition on burning requirements has to do with the nature of the crystalline compounds that will be produced, and the rates of such formation as established by the mass law. This is referred to as the effect of compound saturation.

Temperature of Liquid Formation

In an early study by Hansen and Bogue, (15) the effects on burnability were noted which were brought about by the replacement of small amounts of MgO, Na₂O or K₂O for CaO, and of Fe₂O₃ for Al₂O₃. The horizontal electric furnace described elsewhere* was employed, and a uniform maximum temperature was maintained in each series. Since the temperature was constant to about $\pm 10^\circ$ for a distance of about 4 inches in the furnace, and the boats were passed through at a rate of 1 inch in 2 minutes, the charges were subjected to the maximum temperature for a period of about 8 minutes. The base composition in this series consisted of

CaO	67
Al ₂ O ₃	10
SiO ₂	23

In this composition, the burnability may be indicated by the free CaO content, which was found at different temperatures to be as follows:

Maximum temperature (°C)	Free CaO (percent)
1350	8.2
1380	7.5
1410	5.8
1420	3.9
1500	0.0

The replacement was made of CaO or Al₂O₃ by the several oxides above indicated, to the extent of 2 to 5 percent, and the burns repeated at appropriate temperatures. Some of the results are given in Figures 55 to 58. Figures 55 and 56 show the manner in which the burnability of the mix was changed by small replacements of MgO for CaO or of Fe₂O₃ for Al₂O₃. Thus the free CaO content of

* See page 232.

the mixture burned at 1350° is shown to be reduced from 8 to nearly 0 percent by the substitution of 4 percent MgO for CaO, and from 6 to nearly 0 percent, at 1410°, by the substitution of 3 percent Fe₂O₃ for Al₂O₃. Figures 57 and 58 show that replacements of 0.5 to 2 percent of K₂O or Na₂O for CaO resulted in a first small decrease in free CaO content, followed by an increase. This failure of alkalis as an aid in burnability had previously been noted by Newberry and Newberry (25), but was not explained until the alkali systems of cement were investigated.*

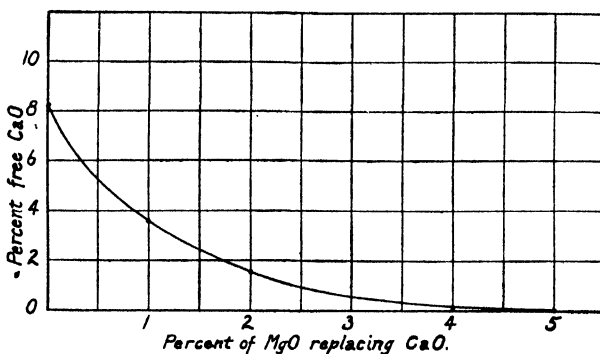

Figure 55. Effect on the combination of CaO due to the replacement of CaO by MgO up to 5 percent. Initial composition: CaO 67; Al₂O₃ 10; SiO₂ 23 percent. Maximum temperature 1350°. (Hansen and Bogue)

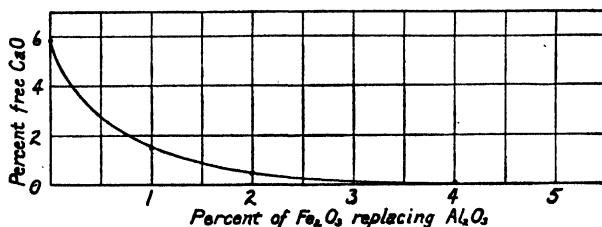
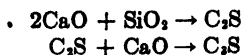

Figure 56. Effect on the combination of CaO due to the replacement of Al₂O₃ by Fe₂O₃ up to 4 percent. Initial composition: CaO 67; Al₂O₃ 10; SiO₂ 23 percent. Maximum temperature 1410°.

Reactions of compound formation can take place in the absence of liquid, as has been shown, but the rates of reaction are greatly accelerated if liquid is present. The basic reactions involved in portland cement manufacture are those leading to the formation of C₂S and C₃S. Thus



The first reaction is rapid at temperatures around 1400° to 1500°, but the second reaction is very slow at those temperatures, when only the two components are

* See Chapters 19, 20.

present. Melting does not take place below 2065°. But when a third component is introduced which permits the presence of liquid at temperatures below 1500°, the formation of C_3S is greatly accelerated.

The influence of certain oxides added to the system $CaO-SiO_2$ is discussed in later chapters. Thus the addition of Al_2O_3 produces a eutectic mixture melting at 1455°. A systematic study of the lowest melting temperatures in various mixtures approaching portland cement in composition was made by Hansen (14). The heating-curve method was employed for noting the

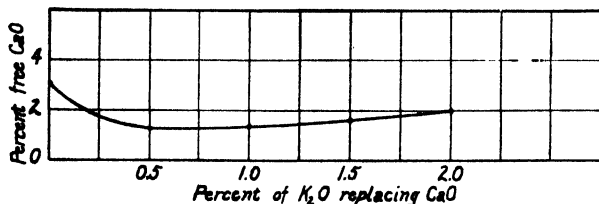

Figure 57. Effect on the combination of CaO due to the replacement of CaO by K_2O up to 2 percent. Initial composition: CaO 67; Al_2O_3 10; SiO_2 23 percent. Maximum temperature 1425°.

temperature of energy changes, and the nature of the phases produced was determined by the examination of separate quenched and slowly cooled charges under the petrographic microscope or by X-ray diffraction measurements.

In Figure 59 are shown the results in the $CaO-Al_2O_3-SiO_2$ system in the field of portland cement. An energy change* is seen to occur at 1455°. Charges quenched from 1450° showed no evidence of any liquid, but the three compounds C_3S , C_2S and C_3A were present. Charges quenched from 1460° showed C_3S and

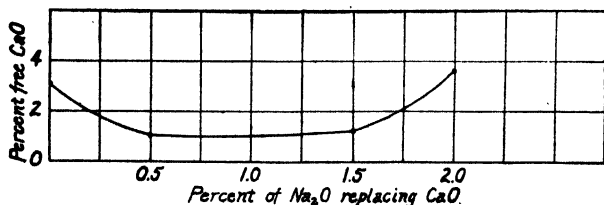

Figure 58. Effect on the combination of CaO due to the replacement of CaO by Na_2O up to 2 percent. Initial composition: CaO 67; Al_2O_3 10; SiO_2 23 percent. Maximum temperature 1425°.

C_2S with glass but no C_3A . Melting therefore begins at 1455° and C_3A disappears as a solid phase at that temperature.

The effects due to the introduction of MgO to the system $CaO-Al_2O_3-SiO_2$ are shown in Figures 60 and 61. The MgO additions and Al_2O_3 contents were the same in both cases, but a change in the $CaO:SiO_2$ ratio involved a change in the $C_3S:C_2S$ relations of the system. In both cases an energy change indicating first liquid formation occurred at 1375°, and charges quenched from 1370° consisted of C_3S , C_2S , C_3A and MgO . In the low- CaO mixture (Figure 60), charges quenched

* More strictly, a change in rate of energy change.

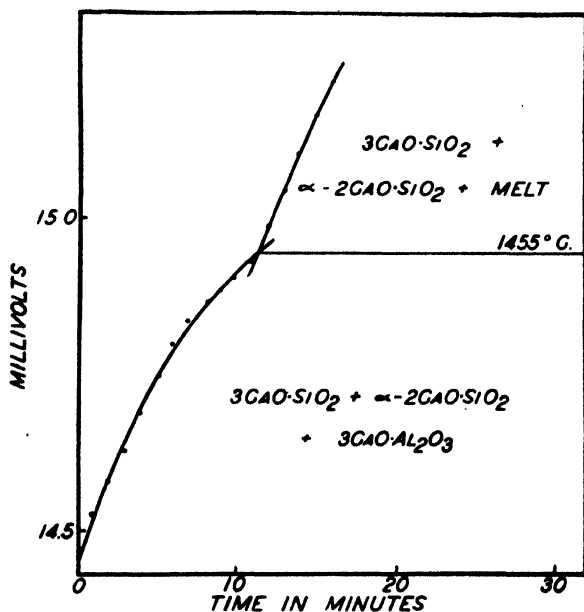

Figure 59. Heating-curve diagram from the mixture CaO 69.5; Al₂O₃ 6.8; SiO₂ 23.7. (Hansen)

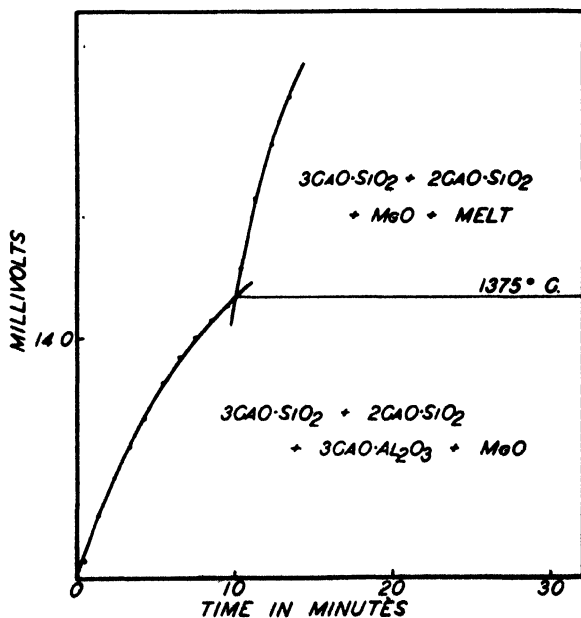

Figure 60. Heating-curve diagram from the mixture CaO 65.7; Al₂O₃ 6.5; SiO₂ 22.5; MgO 5.3.

at 1380° showed only that C_2A had disappeared and liquid had formed, but in the high-CaO mixture quenched from that temperature (Figure 61) C_2A and CaO were present, together with C_2S and MgO, but C_2S had disappeared. The C_2S in this case partially dissolved and partially reacted with C_2A to form C_3S . There was not sufficient C_2S however to react with all of the C_2A , and the latter disappeared at 1390° by partially dissolving and partially dissociating, forming CaO.

This reaction of C_2A is one of importance. The SiO_2 and Al_2O_3 of a cement raw mixture can combine with a certain maximum amount of CaO. When conditions are such that difficulty is had in getting this CaO into combination, an increase

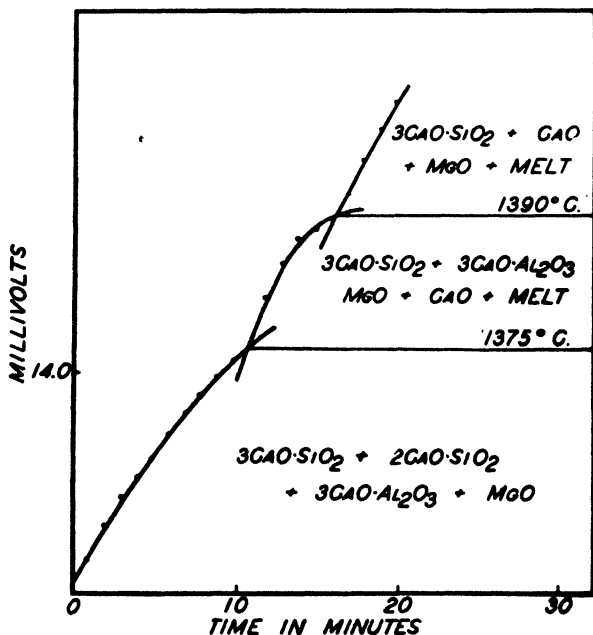

Figure 61. Heating-curve diagram from the mixture CaO 67.3; Al_2O_3 6.5; SiO_2 20.9; MgO 5.3.

in the time or temperature of burning will not be of help if CaO is being formed by dissociation of C_2A . If the cooling conditions are then not such as to allow of its recombination by interaction with the liquid to form C_2A , the final product must inevitably contain free CaO.

The effect of Fe_2O_3 on the CaO- Al_2O_3 - SiO_2 system is shown in Figure 62. An energy break appears at 1340° where the first liquid is formed and C_4AF disappears; another at 1360° where C_2A disappears, and either CaO or C_2S remains with C_2S in the liquid. By introducing MgO and Fe_2O_3 simultaneously, the temperature of liquid formation is further dropped, as shown in Figure 63, to 1300°. At that temperature the C_4AF disappears, and at 1340° the C_2A disappears, leaving CaO or C_2S with the C_2S and MgO in the liquid.

The effect of Na_2O was noted by introducing that component, as Na_2CO_3 , to the extent of 2.2 percent Na_2O in mixes of CaO- Al_2O_3 - SiO_2 , CaO- Al_2O_3 - SiO_2 -

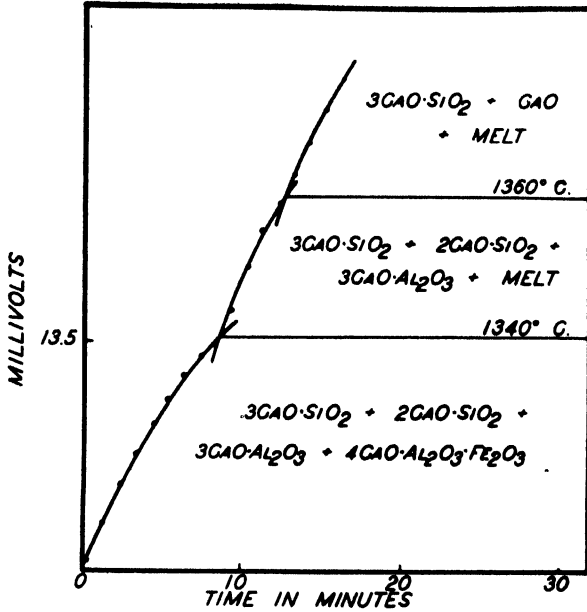

Figure 62. Heating-curve diagram from the mixture CaO 69.2; Al₂O₃ 6.6; SiO₂ 20.9; Fe₂O₃ 3.3.

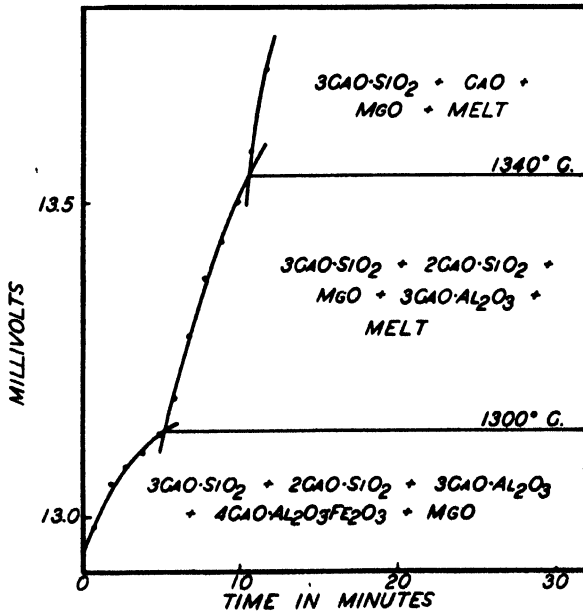

Figure 63. Heating-curve diagram from the mixture CaO 65.6; Al₂O₃ 6.3; SiO₂ 19.8; Fe₂O₃ 3.1; MgO 5.2.

MgO, CaO-Al₂O₃-SiO₂-Fe₂O₃ and CaO-Al₂O₃-SiO₂-MgO-Fe₂O₃. The temperatures of liquid formation were lowered in these cases successively to 1430°, 1365°, 1315° and 1280°.

Similarly, the temperatures of liquid formation of four commercial clinkers were determined and found to vary from 1290° to 1300°. Dyckerhoff (8) had found a temperature of 1285° for this point in a laboratory clinker produced from commercial raw materials. The presence of various minor elements in the commercial product will result in differences in the temperature of liquid formation. Also an inhomogeneity in the mixture may cause wide differences in the first temperature at which liquid appears. Thus, all mixtures of C₃S, C₂S and C₂A start to melt at 1455°, but mixtures of C₂S, C₃A and C₃A₃ start to melt at 1335°. Hence, if parts of the mixture, due to inhomogeneity, fall in the latter system, a liquid will form at such localized spots at 1335°, but if the mixture is uniform and finely pulverized, and if its composition is in the cement field of the CaO-Al₂O₃-SiO₂ system, no liquid will form below 1455°.

The following tabulation summarizes these data:

Components	Temperature of liquid formation (°C)
C-S	2065
C-S-A	1455
C-S-A-N	1430
C-S-A-M	1375
C-S-A-F	1340
C-S-A-N-M	1365
C-S-A-N-F	1315
C-S-A-M-F	1300
C-S-A-N-M-F	— 1280

The Amount of Liquid Formed

In experiments upon a raw mixture high in alumina (7.6 percent Al₂O₃ in clinker) and low in ferric oxide (2.9 percent), Blank (2) found that ferric oxide added to give an Fe₂O₃ content in the clinker of 4.0 percent was of marked value as a fluxing agent; it promoted fuel economy, increased the kiln output, improved the grindability of the clinker, and raised the quality of the cement. Koyanagi (22), suggested, however, that the benefits obtained were possible only because of the high Al₂O₃ content of the original mixture. Experiments showed that such advantages may be obtained by adding Fe₂O₃ as a fluxing agent when the cement is high in Al₂O₃ and low in SiO₂, but when the cement is low in Al₂O₃ and high in SiO₂, a better advantage can be had by increasing the Al₂O₃ content.

Hutton (18) recalls that the Al₂O₃:Fe₂O₃ ratio may vary over wide ranges without producing unsound cement, and argues that troubles attributed to deficiency in fluxing agents are more likely the result of inadequate grinding or mixing, and troubles attributed to excess of fluxing agents are due to operative difficulties or the use of coal producing a too-fusible ash. Gottlieb (13) notes that the physico-chemical state of the raw materials is of profound importance in determining the burnability of the mixture.

Results confirming the limitations of fluxing action of the C₃A and C₄AF were reported by Bogue and Taylor (5) in 1932, who found that the maximum fluxing action occurred at a composition of C₄AF:C₃A ratio between 1.5 and 2.0.

Results such as the above can be explained only by an application of the data of phase equilibria which are discussed fully in later chapters. From these data it may be learned that in mixtures of CaO , Al_2O_3 , Fe_2O_3 and SiO_2 , in the proportions found in portland cement, there are formed, upon heating to sintering temperatures and cooling slowly, only C_3S , C_2S , C_3A and C_4AF . The first melting, whether we start with the oxides or with any combinations to give only those four compounds, always occurs at 1338° , assuming that the mixture is thoroughly disseminated so that local areas of different composition are not present. So long as we remain within the composition ranges where only those compounds are formed, the temperature and composition of the first liquid formed is always the same. The composition of this liquid is CaO 54.8, Al_2O_3 22.7, Fe_2O_3 16.5, SiO_2 6.0 percent. In terms of potential compounds,* the composition is C_3S 1.4, C_2S 16.2, C_3A 32.2, C_4AF 50.2.

From the above it may be seen that the ratio of C_4AF to C_3A in the liquid is 1.56:1. As more heat is delivered to the mixture, the temperature will remain constant until all the liquid of this composition that can form has been produced. This amount depends upon the composition of the mixture, for as long as the compounds which the liquid contains are potentially available in the mixture, they will enter the liquid state with input of heat. Thus the amount of liquid that can be formed at a given temperature is limited by the compound which will first disappear from the mixture as a potential crystalline phase.

This explains why sometimes C_3A , and sometimes C_4AF , acts as a flux, as had been found in practice by Blank and Kayanagi. Suppose we assume a mixture of our four compounds but with a very small amount of C_4AF . The amount of liquid that can be formed at 1338° is then limited by the amount of C_4AF . If we double the C_4AF content, we double the liquid produced. In this case, the C_4AF acts as a flux. In this case, also, any change in the other compounds would not change the amount of liquid formed, (except as they changed the percent of C_4AF) because it is the C_4AF which limits the amount that can be produced.

But when the C_4AF has been added in such amount as to give a ratio 1.56 $\text{C}_4\text{AF}:\text{C}_3\text{A}$, then further additions of C_4AF will cause no further increase in liquid, because now the C_3A has become a limiting compound.

If the original mixture contained the four compounds, but a very small amount of C_3A , then by the same reasoning additions of C_3A would increase the liquid up to the point where the above ratio prevailed, but not beyond.

In compositions which contain the four compounds, but in which the C_2S is very low, the C_2S will act as a fluxing agent, as has been pointed out by Dahl (7). In this case, the amount of liquid which can be formed is proportional to the potential C_2S , and will not be affected by changes in the other compounds except as they change the percentage of C_2S . Increases in C_2S will increase the liquid up to the point where the C_2S is no longer the limiting compound, and then one of the other compounds will be the critical fluxing agent.

The low- C_2S compositions are obviously those in which the C_3S is high, and hence the compositions where C_2S can act as a flux are those high in C_3S . An increase of 1 percent of CaCO_3 in a mixture will usually lower the C_2S about 13

* See pages 200-203.

percent and raise the C_2S proportionately. When clinker of high potential C_2S is being manufactured, it is thus important, for smooth operation (uniform burnability), that the CaO content be controlled very precisely.

The Addition of Mineralizers

The use of fluorspar was known to be useful as a fluxing agent to facilitate the burning of portland cement (10) as early as 1882 and Carlson (6) has shown that this material markedly reduces the uncombined CaO content of various cement mixtures heated between 1300° and 1450° . The effects of various oxides on the combination of CaO and SiO_2 were studied by Bates and Klein (1) and by Flint and Wells (12). In continuation of this program, Flint (11) examined the mineralizing activities of magnesium fluosilicate, calcium fluoride, calcium phosphate, boric oxide and cryolite, the purpose being to find a fluxing agent which would replace the Al_2O_3 and Fe_2O_3 which might be deficient for satisfactory manufacture, especially with respect to mixtures meeting the specifications for sulfate-resistant cements. The above materials were added, in amounts to give 1 percent of the active ingredient, to mixtures of pure $CaCO_3$ and silica gel weighed out to give a $CaO:SiO_2$ ratio of 2.5 and 3.0. In some cases Al_2O_3 and ferric oxide were also added. Following a preliminary heat treatment to drive off CO_2 , the mixtures were brought to temperatures of 1350° to 1450° , held there for one hour, and cooled in the furnace. Examinations of the products were made microscopically and the free CaO determined by the alcohol-glycerol method.

Calcium fluoride was found to reduce the uncombined CaO in all mixtures, but had the disadvantage of increasing the γ - C_2S at the expense of the β form. Cryolite, Na_3AlF_6 , behaved in a similar manner to CaF_2 but appeared to be somewhat more effective. Boric oxide completely prevented the β - γ inversion of the C_2S , but was not effective in promoting combination of the CaO . In some experiments, the addition of the B_2O_3 resulted in an increased amount of free CaO in the clinkers. The phosphate behaved somewhat similarly to the boric oxide as a mineralizer, in that its presence increased the free CaO content of several of the clinkers, but showed no advantage in reducing the C_2S inversion.

The magnesium fluosilicate, $MgSiF_6$, (introduced as the hexa-hydrate) showed outstandingly superior qualities both in respect to an improved combination and to a diminished C_2S inversion. In mixtures of composition $2.5CaO:SiO_2$, the free CaO was reduced to about one tenth of its value in the corresponding untreated samples, and in mixtures of composition $3CaO:SiO_2$, to about one fifth. Even at temperatures below those of the lowest melting points (1455° in the system $CaO-Al_2O_3-SiO_2$), the presence of the mineralizer produced nearly complete combination. The microscopic examinations showed that the large increases in C_2S , indicated chemically by the decreases in free CaO , were realized. Markedly improved resistance of the β - C_2S against inversion could also be observed.

The merits of calcium fluoride in clinker production have been discussed by Eitel (9) in connection with a study on the system $CaO-CaF_2-2CaO.SiO_2$. Although the calcium fluoride was found to promote the formation of C_2S by lowering the clinkering temperature as much as 200° , yet its presence was found to accelerate the decomposition of C_2S below 1250° . Also, it greatly increased the tendency of the β - C_2S to invert to the γ form. For these reasons Eitel cautioned

that, when CaF_2 is used, the clinker must be cooled as rapidly as possible to temperatures below 1250° . The mechanism of the action of the CaF_2 , he ascribed to the formation of SiF_4 -groups which enter into an exchange equilibrium with the SiO_4 -groups, activating them and facilitating their combination with CaO . Flint points out that this action would explain the favorable effect of the MgSiF_6 , for the latter loses SiF_4 on ignition and is immediately available for the activation of the SiO_4 . In addition, there is left a residue of MgF_2 which is also probably active in a similar way.

Nagai (23) believed the CaF_2 to be superior to the MgSiF_6 in his experiments on the thermal synthesis of the silicates. In collaboration with Kosaki, Nagai (24) found that the addition of 1 percent CaF_2 was distinctly favorable to the formation of tricalcium silicate, especially at the low temperatures of 1000° to 1100° . Above 1300° or 1400° the action was less favorable. These investigators found that 75 to 80 percent of the added CaF_2 remained in the clinker. The use of cryolite as a flux in the manufacture of white cement was mentioned by Holland (17) as early as 1911.

Effect of Compound Saturation

Within definite limits, therefore, the introduction of new components to the $\text{CaO-Al}_2\text{O}_3\text{-SiO}_2$ system in the region of portland cement lowers the temperature of liquid formation.

The third influence of composition on burnability has to do with the formation of specific compounds. As already stated, the determining reaction in the production of modern cement is the essentially complete interaction of the CaO with C_2S to form C_3S . But the rate of that reaction may vary in accordance with the relative amounts of the reacting phases present, in accordance with the mass law. Thus a small amount of CaO may be taken up readily when a large relative proportion of C_2S is present, but with decreasing rate as the C_2S is decreased in the melt. When the C_2S is in large excess and only a little CaO is present, the rate with which the latter combines with the additional CaO may become so slow that equilibrium is attained with difficulty.

From the above considerations, we may expect that, as Fe_2O_3 or MgO are introduced into the system $\text{CaO-Al}_2\text{O}_3\text{-SiO}_2$, in the composition range of portland cement, there will result on burning (a), a fluxing action due to liquid formation, which will accelerate the reactions, and (b), a change in the relative amounts of the compounds formed, that may accelerate or may retard the reactions. When the addition of the new component increases the C_2S at equilibrium, the acceleration brought about by the first process, or the retardation brought about by the second process may predominate, depending on the potential equilibrium composition.

In a study directed upon this problem, Bogue and Taylor (4) employed the following three compositions:

	Series		
	A	C	D
CaO	66	68.8	70
Al_2O_3	11	9.0	11
SiO_2	23	22.2	19

In each of these compositions Fe_2O_3 and MgO were substituted for Al_2O_3 and CaO respectively up to 5 percent, and the resulting mixtures burned at appropriate temperatures to reveal the effects of the substitution. A few of the results are given in Figures 64 to 67. In Figure 64 are shown the results obtained by thus introducing Fe_2O_3 in the presence of 1, 3 and 5 percent MgO in Series A, at 1275° . In this group of low- CaO composition, increasing quantities of Fe_2O_3 tend markedly to decrease the free CaO of the products (improve burnability), and this condition was observed at a temperature (1275°) below that (1300°) at which liquid is first formed under equilibrium conditions.

In order to obtain comparable results, it was necessary to burn the high- CaO series C and D at higher temperatures, 1375° and 1500° respectively. These data

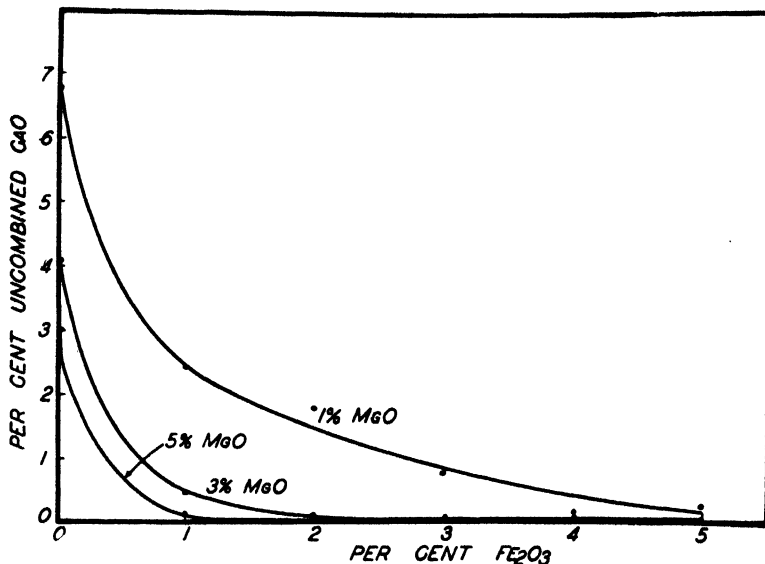

Figure 64. Effect of Fe_2O_3 on rate of combination. Series A at 1275° . (Bogue and Taylor)

are shown in Figure 65. But in series C the introduction of Fe_2O_3 had very little effect on the free CaO of the clinkers and, in series D, even increased it a little. Thus the introduction of Fe_2O_3 is shown to be beneficial or otherwise upon burnability depending on the composition of the raw mixture.

The reason for this effect of composition will be more clearly grasped by referring to the potential equilibrium composition of the several mixtures, as given in Table 15. It will be seen that, as Fe_2O_3 replaces Al_2O_3 , there results in all series a consistent increase in C_3S and decrease in C_2S . This is because a dibasic compound, C_4AF , is formed in place of the tribasic C_2A , which process releases CaO . This CaO then is available for combination with C_2S to form C_3S . As long as there is an abundant supply of C_2S available for such combination, the CaO will readily form the C_3S , as shown in the case of Series A. In Series C, however, the Fe_2O_3 in some cases brings the C_2S down to low values at equilib-

TABLE 15. Potential compositions of clinkers produced by substituting MgO for CaO, and Fe₂O₃ for Al₂O₃

Total MgO	Total Fe ₂ O ₃	Series A						Series C						Series D								
		Potential composition																				
		C ₁ S	C ₂ S	C ₃ A	C ₄ AF	MgO	C ₁ S	C ₂ S	C ₃ A	C ₄ AF	MgO	C ₁ S	C ₂ S	C ₃ A	C ₄ AF	MgO	C ₁ S	C ₂ S	C ₃ A	C ₄ AF	MgO	C ₃ O
0	0	21	50	29	0	0	25	24	0	0	67	4	29	0	0	0	0	29	0	0	0	0
0	1	26	46	25	3	0	21	20	3	0	72	0	25	3	0	0	25	3	0	0	0	0
0	3	36	38	16	9	0	13	11	9	0	72	0	16	9	0	0	16	9	0	0	0	2.7
0	5	47	30	7	15	0	5	2	15	0	72	0	7	15	0	0	7	15	0	0	0	5.4
1	0	16	54	29	0	1	28	24	0	1	63	7	29	0	1	1	29	0	1	1	0	0
1	1	22	50	25	3	1	24	20	3	1	68	3	25	3	1	1	25	3	1	1	0	0
1	3	32	42	16	9	1	16	11	9	1	72	0	16	9	1	1	16	9	1	1	1.7	0
1	5	43	34	7	15	1	8	2	15	1	72	0	7	15	1	1	7	15	1	1	4.4	0
3	0	8	60	29	0	3	34	24	0	3	55	13	29	0	3	3	29	0	3	3	0	0
3	1	14	56	25	3	3	30	20	3	3	60	9	25	3	3	3	25	3	3	3	0	0
3	3	24	48	16	9	3	22	11	9	3	71	1	16	9	3	1	16	9	3	3	0	0
3	5	35	40	7	15	3	14	2	15	3	72	0	7	15	3	0	7	15	3	3	2.4	0
5	0	0	66	29	0	5	40	24	0	5	47	18	29	0	5	5	29	0	5	5	0	0
5	1	5	62	25	3	5	36	20	3	5	52	14	25	3	5	5	25	3	5	5	0	0
5	3	16	54	16	9	5	28	11	9	5	62	6	16	9	5	6	16	9	5	5	0	0
5	5	27	46	7	15	5	20	2	15	5	72	0	7	15	5	0	7	15	5	5	0	0.4

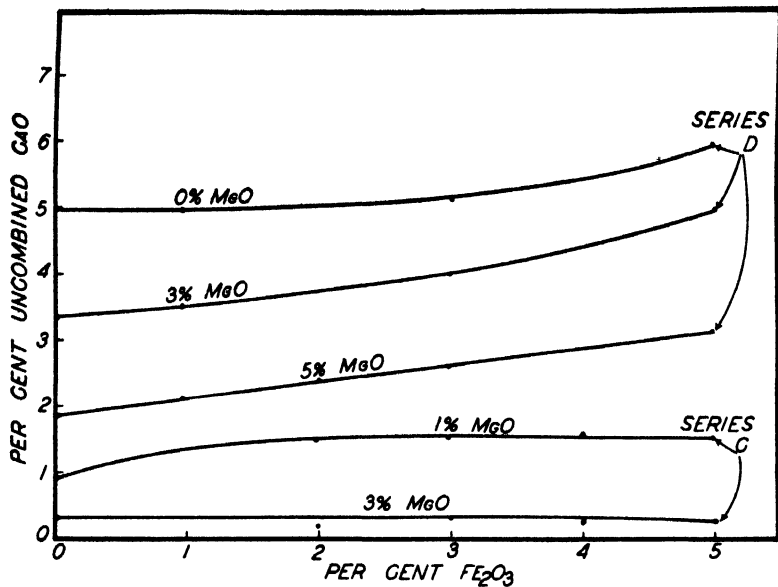

Figure 65. Effect of Fe_2O_3 on rate of combination. Series C at 1375° and Series D at 1500° .

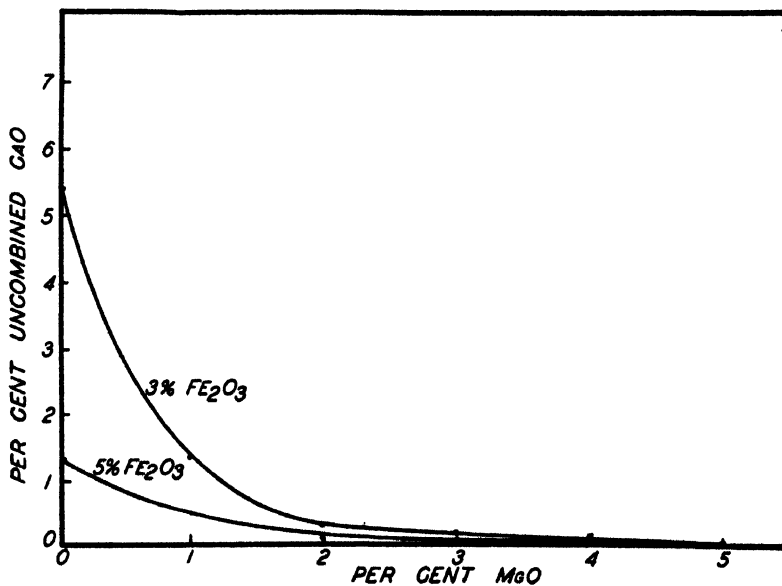

Figure 66. Effect of MgO on rate of combination. Series A at 1300° .

rium, and the reaction by which the released CaO is brought into combination becomes slowed to a point where it balances the accelerating action due to the increased liquid formation.

In Series D, the potential compositions before introducing the Fe_2O_3 are such that, at equilibrium, nearly all the silica is combined as C_3S , and very little as C_2S . As the Fe_2O_3 is substituted for Al_2O_3 , a condition is soon reached where no C_3S remains at equilibrium. In this case, increasing increments of Fe_2O_3 result in increasing amounts of free CaO in the clinkers, even at equilibrium. The action of the Fe_2O_3 in increasing the liquid formation is apparent, however, for the rate of increase of free CaO in the clinkers is less rapid than the rate of increase of free CaO at equilibrium.

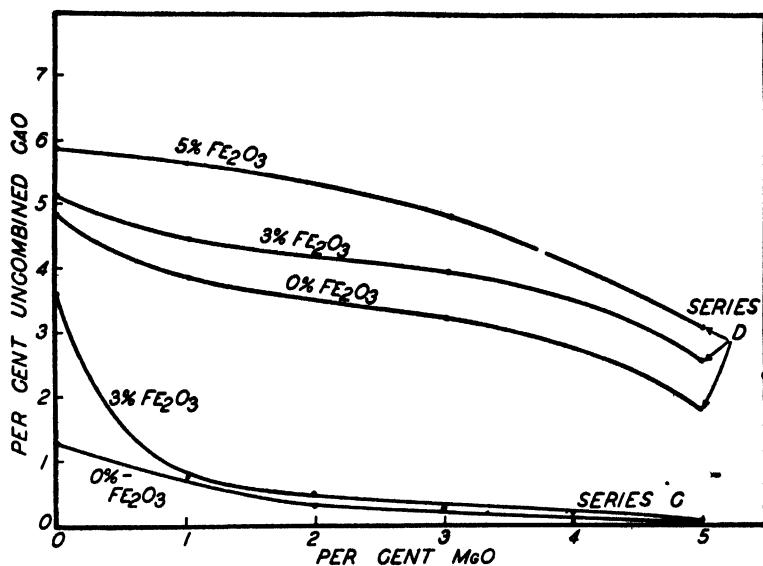

Figure 67. Effect of MgO on rate of combination. Series C at 1400° and Series D at 1500° .

Some of the data obtained when MgO was substituted for CaO are shown in Figures 66 and 67. In every case, and with each series, the introduction of the MgO produced a decrease in the amount of free CaO in the clinkers. The introduction of MgO by substitution for CaO increases the C_3S at equilibrium, and this effect as well as the fluxing action tends to accelerate the reaction. The combined effect is seen to be pronounced in Series A and C, but is less marked in Series D. This would be expected because of the relatively low concentrations of C_3S in all the members of this series. The greatest influence due to both Fe_2O_3 and MgO appears, however, to be associated with the lowering in the temperature of liquid formation. This is shown by the maximum effect being produced by the first increment of the new components and, in further studies, by the finding that similar improvements in burnability were obtained when the experiments were so designed that the potential $\text{C}_3\text{S}:\text{C}_2\text{S}$ ratio remained constant throughout the tests.

To summarize briefly the extensive data on the rate of combination, or burnability of silicate or cement mixtures, it may be said that several factors are shown to be involved. These include (1) the physical nature of the materials, as the state of the crystal lattice, the fineness of the grains, and the uniformity of the mixture; (2) the chemical nature of the materials, as the constitution of the raw mixture, formation of dissociation or inversion products at the temperatures used, the formation of liquid, and the character of the reactions which will be involved; and (3) the temperatures employed and the rate of cooling.

Little application has been made of the state of the crystal lattice, but it offers a field of research which should be pursued. The fineness of the charge has been shown to be variously important for the several constituents of the mixture, the alumina and limestone reacting more readily than quartz. But if the silica is in the form of a silicate, it also reacts more readily. If the mixture is not uniform, some portions will melt at lower temperatures than other portions, and some regions may not react at all under the heat-treatment employed.

Application of unstable forms of crystals at the clinkering temperatures has not been consistently attacked, but could yield results of importance. The value attached to the fluxing action of certain components is found to involve three distinct activities: the lowering of the temperature of liquid formation, the increase in liquid formed at a given temperature, and the effects of those components upon the proportions of the compounds which are formed in the kiln. The presence of liquid accelerates the reactions but, when the addition of the fluxing components changes the ratio of C_3S to C_2S in the product at equilibrium, that change is reflected in burnability. The mean result may be favorable or otherwise, depending upon the balance between the two effects.

Up to a certain point the rate of the reactions will increase with increasing temperatures of burning. But with some compositions free CaO is formed at a high temperature which, under equilibrium cooling, will recombine with liquid to form C_3A or C_3S . Other interactions of a similar nature may occur, which are described elsewhere. But such recombination of CaO is attained with difficulty, and especially if the CaO grains have become large in size or quantity, as may happen when the temperatures are too high. In cement operations, this condition is recognized and is spoken of as "over-burning." Likewise, the rate of cooling will determine the amount of undercooled liquid, or glass, which will appear in the clinker. And since the liquid consists largely of the alumina and ferric oxide components, with a proportionate amount of CaO and SiO_2 , a high-glass clinker will contain very little crystalline C_3A or C_4AF . A control over those crystalline compounds can therefore be had by a control of the rate of cooling from maximum temperatures.

References

1. Bates, P. H. and Klein, A. A., *Tech. Paper NBS*, 78 (1917).
2. Blank, A. J., *Rock Products*, May, July, Sept., 1928.
3. Bogue, R. H., *Proc. PCA*, 1928, p. 196.
4. Bogue, R. H. and Taylor, W. C., *Res. Reports, PCAF*, Dec., 1930.
5. Bogue, R. H. and Taylor, W. C., *Res. Reports, PCAF*, Dec., 1932.
6. Carlson, E. T., Unpublished data, NBS, 1938.
7. Dahl, L. A., *Res. Reports, PCA*, Aug., 1944.

8. Dyckerhoff, W., *Univ. Frankfort, Dissertation*, 1925.
9. Eitel, W., *Zement*, **30**, 455; 649 (1938).
10. Erdmenger, *Tonind. Ztg.*, **8**, 27 (1882).
11. Flint, E. P., *Rock Products*, Oct., 1939.
12. Flint, E. P. and Wells, L. S., *J. Res. NBS*, **17**, 727 (1936); RP 941.
13. Gottlieb, S., *Rock Products*, May-July, 1940.
14. Hansen, W. C., *J. Res. NBS*, **4**, 55 (1930); RP 132; PCAF Paper 22.
15. Hansen, W. C. and Bogue, R. H., *Ind. Eng. Chem.*, **19**, 1260 (1927); PCAF Paper 10.
16. Hedvall, J. A., "Reaktionsfähigkeit fester Stoffe," Leipzig, 1938; *Symposium*, **42**.
17. Holland, A. S., *Ind. Eng. Chem.*, **3**, 65 (1911).
18. Hutton, S. E., *Rock Products*, Nov., 1939.
19. Insley, H., *J. Res. NBS*, **17**, 353; (1936) RP 917.
20. Jander, W. and Hoffmann, E., *Z. anorg. allgem. Chem.*, **218**, 211 (1934).
21. Jander, W. and Wuhrer, J., *Zement*, **27**, 73; 86 (1938).
22. Koyanagi, K., *Rock Products*, May, 1930.
23. Nagai, S., *J. Soc. Chem. Ind. Japan.*, **39**, 130 (1936).
24. Nagai, S. and Kosaki, Y., *Cement and Cement Mfg.*, Sept., 1935; *Rock Products*, Feb., 1936, p. 43.
25. Newberry, S. B. and Newberry, W. B., *J. Soc. Chem. Ind.*, **16**, 887 (1897).
26. Rankin, G. A., *Concrete*, **21**, 72 (1922).
27. Thorvaldson, T., *Can. J. Res.*, **14**, 27 (1936).

CHAPTER 9

Design and Control of Cement Composition

It is a simple matter to compute the proportions of component oxides or compounds from a mixture of three or four pure constituents which, upon a heat treatment designed to result in complete combination and complete crystallization, will give a product having a desired phase composition. But a portland cement raw mix consists of a large number of constituents, they are not of constant percentage or purity, the heat treatment will rarely give complete combination, and the cooling rate will never give complete crystallization. Furthermore, the large tonnages handled and the industrial procedures required preclude the use of such precision methods of control as could be employed in the laboratory.

Many devices and formulas have been suggested for the ultimate production of a uniform clinker having a designed composition. The chemical bases for these controls are considered below.

The validity of the methods employed for the final identification and measurement of the phases produced has been variously studied, but is not yet a matter free of dispute. Some of the methods for estimating the phase composition of clinkers are discussed and their results compared in this chapter.

Development of Proportioning Formulas

Le Chatelier (14) was among the first to propose definite formulas for proportioning the raw mixture in terms of the principal oxides, CaO , MgO , SiO_2 , Al_2O_3 and Fe_2O_3 . On the basis of his previous investigations on constitution, it seemed altogether justifiable that the composition of clinker should be rigorously defined by two limits for lime. The clinker should not, he argued, contain any free lime, as this produces unsoundness in the product. That is, the molecular ratio CaO/SiO_2 must not be greater than 3, since the tricalcium silicate is the most basic of the silicates in cement. On the other hand, the presence of too great an amount of the dicalcium silicate seemed undesirable to Le Chatelier since he believed that he had found this compound to disintegrate spontaneously (dust) and to be non-hydraulic. When an excess of lime is present, he believed the compounds formed to be $3\text{CaO}\cdot\text{SiO}_2$ and $3\text{CaO}\cdot\text{Al}_2\text{O}_3$. Thus the upper limit for CaO in which the assumption is made that MgO may replace CaO , is expressed by: $\text{CaO} + \text{MgO}/\text{SiO}_2 + \text{Al}_2\text{O}_3$ not greater than 3.

But as CaO decreases, Le Chatelier assumed that silico-aluminates of unknown composition separate out. Following this, the $2\text{CaO}\cdot\text{SiO}_2$ appears. If the formula for the silico-aluminate is assumed to be $3\text{CaO}\cdot\text{Al}_2\text{O}_3\cdot 2\text{SiO}_2$, then the lower limit for CaO , in which $3\text{CaO}\cdot\text{SiO}_2$ will just fail to appear will be

$$\frac{\text{CaO} + \text{MgO}}{\text{SiO}_2 - (\text{Al}_2\text{O}_3 + \text{Fe}_2\text{O}_3)} = \text{not less than 3.}$$

Here the Fe_2O_3 is assumed to be capable of replacing Al_2O_3 . Hence in the formula $3\text{CaO} \cdot \text{Al}_2\text{O}_3 \cdot 2\text{SiO}_2$, $\text{SiO}_2 - (\text{Al}_2\text{O}_3 + \text{Fe}_2\text{O}_3) = 1$, $\text{CaO} + \text{MgO} = 3$, and the ratio expressed = 3. If this falls below 3, therefore, Le Chatelier argued that the "undesirable" $2\text{CaO} \cdot \text{SiO}_2$ would be formed. In numerous cements examined, those of good quality were found consistently to conform with these formulas, while those of poor quality departed from them.

As a matter of fact, the ideal condition of a clinker consisting exclusively of $3\text{CaO} \cdot \text{SiO}_2$ and $3\text{CaO} \cdot \text{Al}_2\text{O}_3$ is probably never attained in practice due to a lack of fineness or homogeneity of the raw mix, and insufficient temperature or duration of burning. The additional cost necessary to attain the ideal cement appears to be out of proportion to the advantage gained. It is therefore preferable, according to Le Chatelier, in order to avoid the presence of free lime, to increase the content of silica and alumina, forming some inert silico-aluminate. Even with these precautions, he believes that some free lime may remain in the clinker, due to large grains of limestone or inhomogeneity of mixing. He advises that this free lime should be slaked prior to use by exposure to air or other means.

S. B. and W. B. Newberry (16) point out, however, that while the formulas of Le Chatelier conform closely with the practical results of cement manufacture, they fail to distinguish between the lime requirement of a clay rich in silica and that of a clay rich in alumina.

The Newberrys attacked the problem in an empirical manner rather than by deduction from theory. They determined the upper limit for CaO by means of the *hot test*. They claimed to be able to observe an excess of lime as small as 1 per cent by noting if expansion or cracking occurred on placing a pat of set neat cement in steam for 4 or 5 hours.

Mixtures of pure chalk, ground quartz and alumina were mixed and burned at "white heat." The mixture $2\text{CaO} + \text{SiO}_2$ dusted completely when cooled slowly but did not dust when quenched in water. The non-dusted portion gave a sound, slow-setting product of satisfactory hardness in 1 and 7 days.

The mixture $2\frac{1}{2}\text{CaO} + \text{SiO}_2$ did not dust, gave a sound pat, but set slowly and hardened very slowly.

The mixture $3\text{CaO} + \text{SiO}_2$ did not dust, gave a sound pat, set fairly in one day, but did not harden for several weeks.

The mixture $3\frac{1}{2}\text{CaO} + \text{SiO}_2$ did not dust, and the pat set hard but left the glass and cracked. The Newberrys believed combination to have been complete in all cases, but concluded that the slow setting and hardening qualities of the more basic mixtures rendered them somewhat inferior. The $2\text{CaO} + \text{SiO}_2$ product alone was satisfactory from the point of reasonably rapid hardening, but its presence made dusting probable.

The mixture $2\text{CaO} + \text{Al}_2\text{O}_3$, heated strongly with water, set in a few seconds and was sound.

The mixture $2\frac{1}{2}\text{CaO} + \text{Al}_2\text{O}_3$ gave a pat that left the glass and cracked and did not harden well.

The mixture $3\text{CaO} + \text{Al}_2\text{O}_3$ also gave a pat which curved and cracked and disintegrated slowly in water.

On the basis of these investigations, the Newberrys concluded that $3\text{CaO} \cdot$

SiO_2 and $2\text{CaO}.\text{Al}_2\text{O}_3$ are the most basic compounds which can exist in good cements. They accordingly proposed the formula:



in which x and y vary in accordance with the relative amounts of SiO_2 and Al_2O_3 present. On preparing synthetic cements in accordance with the above formula, in contradistinction to that of Le Chatelier,

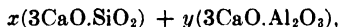

they found their own to apply, while, by the latter, the excess of CaO required to combine with the Al_2O_3 as $3\text{CaO}.\text{Al}_2\text{O}_3$ over that required to combine as $2\text{CaO}.\text{Al}_2\text{O}_3$ was found to remain in the free state so far as could be inferred from the steam test. The product was unsound in all cases, and increasingly so as the Al_2O_3 , and consequently the excess CaO , was increased.

Le Chatelier had contended that mixtures of CaO and Fe_2O_3 , on burning, gave products that were not at all hydraulic. Schott, on the other hand, had found that Al_2O_3 could be replaced completely by Fe_2O_3 without detriment to the hydraulic character of the cement. Newberry burned a mixture of $2\text{CaO} + \text{Fe}_2\text{O}_3$ and found the product to be inactive in the cold, but to harden rapidly in steam and to be sound. A mixture of the composition $3\text{CaO}.\text{SiO}_2 + 2\text{CaO}.\text{Fe}_2\text{O}_3$ containing 7 percent Fe_2O_3 was found to be slow setting, sound, and hard.

A number of mixes were burned in which the Fe_2O_3 was proportioned as follows:

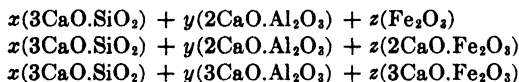

The percentages of Al_2O_3 and Fe_2O_3 were 4 and 3 respectively. The first two mixtures gave entirely satisfactory products and no difference was observed between them. This demonstrates, according to the Newberrys, that in cements of ordinary low-iron clays, no account need be taken of the Fe_2O_3 content in calculating the lime requirement. This was a confirmation of the view held by Le Chatelier. The third mixture gave an unsound product indicating that it contained an excess of lime.

The influence of Na_2O and K_2O was studied by burning mixtures analogous to the compositions $3\text{CaO}.\text{SiO}_2 + \text{Na}_2\text{O}$ and $3\text{CaO}.\text{SiO}_2 + \text{Na}_2\text{O}.\text{SiO}_2$, using 5 percent Na_2O . In neither case did the Na_2O render more complete the combination of the CaO and SiO_2 , as shown by the unsoundness of the pats. The Newberrys conclude that the alkalis are incapable of aiding combinations containing a large proportion of CaO .

Magnesia was studied to determine if it could replace lime in cements and if account need be taken of it in calculating the mixture. Pure silica and alumina with various amounts of MgO were burned but in all cases the products were lacking completely in hydraulic properties. They failed to harden in water, air or steam.

A mixture was next prepared in accordance with the formula:

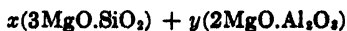

After burning at a high temperature, a product was obtained which contained 10.14 percent insoluble residue (Lunge's method*) while the same mixture prepared with CaO in this formula in place of MgO left only 0.4 percent insoluble residue. From this, the Newberrys conclude that MgO combines with the silica and alumina of clay to a much less extent than does CaO.

A mixture was then prepared, using dolomitic lime, in which enough CaO was present to combine with the SiO₂ and Al₂O₃, leaving the MgO unaccounted for. This product was sound, hardened well and appeared quite satisfactory although the ratio CaO + MgO/SiO₂ + Al₂O₃ was 4.16, a value greatly in excess of the maximum permitted by Le Chatelier's formula in which the MgO is assumed to act as CaO.

The hydraulic index,

$$\frac{\text{SiO}_2 + \text{Al}_2\text{O}_3}{\text{CaO} + \text{MgO}} \times 100 = 42 \text{ to } 48,$$

had been proposed by Vicat but the Newberrys point out that it is not consistent with the dissimilarity of CaO and MgO. Objection is also raised to the hydraulic modulus of Michaelis,

$$\frac{\text{CaO}}{\text{SiO}_2 + \text{Al}_2\text{O}_3 + \text{Fe}_2\text{O}_3} = 2.2$$

on the basis of the incorrect assumption that SiO₂, Al₂O₃ and Fe₂O₃ combine with CaO with equal avidity. Le Chatelier and others had shown that, in actual practice, the most basic silicate of constant volume contains 2.8 parts by weight of CaO to 1 of SiO₂ and the most basic aluminate 1.1 of CaO to 1 of Al₂O₃. Hence the *ideal* formula was suggested:



If we substitute 1 for 1.1 Al₂O₃, and substitute 2.7 for 2.8 CaO, since the latter represents a maximum value, the Newberrys obtain their *practical* formula, expressed as percentage by weight:

$$\frac{\text{CaO} - \text{Al}_2\text{O}_3}{\text{SiO}_2} = 2.7.$$

Close agreement with practice was found to obtain by this formula.

In 1916 S. B. Newberry (17) modified slightly the above formulas in accordance with his acceptance of the work reported by Rankin.† Thus the formula giving the maximum lime content, and assuming that all of the lime, silica and alumina are in the form of tricalcium silicate and tricalcium aluminate, would be:

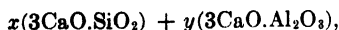

and substituting weights for equivalents,



* This method consists in digesting the product of the calcination alternately with 20 percent hydrochloric acid and 20 percent sodium carbonate solutions. By this treatment the lime, and the silica which has been rendered soluble, are dissolved, while the uncombined silica remains unattacked.—*Tonind. Ztg.*, 655 (1894).

† See pages 253-257.

Newberry states that this formula, applied to ordinary cement materials, gives almost exactly the same proportions as the original formula given above. Under working conditions, Newberry finds it safer to reduce the CaO slightly below the factor 2.5, in order to counter-balance defective grinding of the raw material or unavoidable variations in composition. The final practical formula is thus given:



He urges that a *lime factor*, expressed by the relation

$$\frac{\text{CaO} - 1.6\text{Al}_2\text{O}_3}{\text{SiO}_2} = 2.5$$

“will give cements of practically maximum quality with any materials, whether silicious or aluminous, provided the mix is finely ground and properly burned.”

Hendrickx (8) takes exception to the formulas of earlier investigators on the ground that they represent a rather special case where complete combination is effected, and fail to consider the very important distinction between fusion and clinkerization. Michaelis had previously urged the necessity for making this distinction.

Hendrickx maintains that there exists an upper limit for lime representing the theoretical maximum based on the absolute combining capacity of the lime for the silica and other constituents. But this limit, which he calls the *upper limit of affinity* is not always attainable in commercial kilns, due to the high temperature which may be required, except the content of flux be just right. He therefore defines a second limit which he calls the *upper limit of burning* as that beyond which normal burning becomes difficult, if not impossible, under ordinary conditions of operation. He claims that a conformance of the first limit gives rise to a cement always perfect if the burning has been suitably conducted, but that under ordinary conditions the second limit must be observed.

The major problem of the cement chemist, therefore, becomes that of causing the first limit to coincide with the second. There are some clays, he states, in which the affinity limit is higher than the burning limit; after burning with the theoretical amount of limestone they still contain free lime. But there also are clays in which the two limits are identical. These burn easily and in extreme cases fuse in the kiln.

In consequence of these postulations, Hendrickx concludes:

All systems of proportioning must include two categories of tests, entirely distinctive. First, those which are concerned with the composition of the mix from the point of view of the proportions of the constituents, and second, those which deal with the efficiency of the burning of the mix thus proportioned. . . . It is essential that the two categories of tests go together and that their results balance and compensate each other.

Hendrickx appears not to be at all concerned over the exact manner of combination of the CaO and SiO₂, but believes that solid solutions are easily formed. He thinks it probable that the principal constituent of clinker is a compound intermediate between the di- and the tricalcium silicates. He states:

The compound $2.5\text{CaO}\cdot\text{SiO}_2$ may be regarded as underburned calcium silicate, $1.5\text{CaO}\cdot\text{SiO}_2$, with one molecule of CaO in solution, or as dicalcium silicate with one-half molecule CaO in solution, or as a mixture of equal parts of di- and tricalcium silicates, or as a mixture of two molecules of tricalcium silicate and one molecule of underburned calcium silicate, or as still other combinations.

The essential thing to Hendrickx is not the manner of combination, but the ratio in which the silica and lime must be proportioned. And according to him this appears to be in the ratio of the hypothetical compound $2.5\text{CaO}\cdot\text{SiO}_2$. The alumina and iron oxide he believes to be present as the tribasic salts. He accordingly writes the general formula for cement:



In applying the formula it is necessary to multiply the weights of "soluble silica" by 2.33, of alumina by 1.65 and of iron oxide by 1.05 to obtain the quantity of lime required, as these factors represent the ratios indicated in the formulas. Finally there should be made the necessary corrections for the presence of magnesia and sulphuric anhydride. This he does by deducting, from the total of lime already obtained, $\frac{5}{10}$ of the magnesia and adding $\frac{5}{8}$ of the sulfuric anhydride, in accordance with the hypothesis that the SO_3 combines with the lime as CaSO_4 and that the MgO substitutes for the CaO in proportion to their molecular weights. If it is desired to convert the factors for CaO into factors for CaCO_3 in the raw mixtures, there is obtained, for silica, the factor 4.1; for alumina, 2.94; and for iron oxide, 1.87. Since the oxides R_2O_3 are rarely considered separately in the raw mix, one may take for the sum of the two oxides a factor proportionate between 2.94 and 1.87 such that there is expressed the most usual relation between the alumina and the iron oxide; he gives this the value 2.6 corresponding to two parts of alumina to one of iron oxide.

Thus there is obtained the formula:



These formulas were found by Hendrickx to be entirely satisfactory when applied to a large variety of materials.

A formula developed by J. L. Duchez (4) is similar to that of Hendrickx except that the former considered the ratio of lime to silica in the silicate to be 2.35 to 1. Thus the formula:

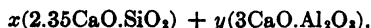

Duchez obtains this figure and evaluates x and y from the analysis of a large number of cements. By considering the iron oxide as alumina and the magnesia as lime, the sum of the substances gave:



If the Al_2O_3 goes to $3\text{CaO}\cdot\text{Al}_2\text{O}_3$, the $0.99\text{Al}_2\text{O}_3$ will require $0.99 \times 3 = 2.97\text{CaO}$ and there will remain $11.96 - 2.97 = 8.99$ CaO available to combine with SiO_2 . The coefficient for SiO_2 being 3.84, that for CaO will be $8.99/3.84 = 2.35$, so

the formula for the silicate becomes $2.35 \text{ CaO} \cdot \text{SiO}_2$, and the cement so obtained would have the formula:

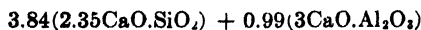

On the other hand, if the silicate is regarded as dibasic, there would result the formula:

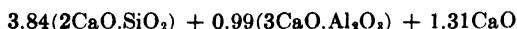

and if tribasic, the formula:

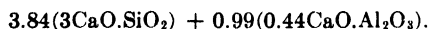

In the one case there seems to be an excess of lime remaining free in the cement and, in the other case, an insufficiency of lime to form $3\text{CaO} \cdot \text{Al}_2\text{O}_3$. Duchez prefers to believe that free lime may be present, and that this may dissolve in the $2\text{CaO} \cdot \text{SiO}_2$ to form a substance of a composition approximating $2.35\text{CaO} \cdot \text{SiO}_2$.

Newberry's formula was modified by Eckel (5) who considers that the iron compound forms $2\text{CaO} \cdot \text{Fe}_2\text{O}_3$, requiring 0.7 parts of CaO per unit weight of Fe_2O_3 . The CaO was also believed to be replacable by MgO in the cement compounds, and since the molecular ratio of MgO to CaO is 40:56, one part of MgO is equivalent to 1.4 parts of CaO. Hence Eckel writes the formula

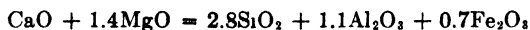

The ratio

$$\frac{2.8\text{SiO}_2 + 1.1\text{Al}_2\text{O}_3 + 0.7\text{Fe}_2\text{O}_3}{\text{CaO} + 1.4\text{MgO}}$$

was called the *cementation index*, and in a properly proportioned cement this index must be 1.0 or slightly higher for purposes of safety.

Kuhl (11) proposes the ratio

$$\frac{\text{CaO} - (\text{CaO in CaSO}_4)}{2.8\text{SiO}_2 + 1.1\text{Al}_2\text{O}_3 + 0.7\text{Fe}_2\text{O}_3} = 1$$

as the correct value, and calls it the *lime saturation* of the mixture. Guttman and Gille (7) suggest that Mn_2O_3 when present be calculated as equivalent to Fe_2O_3 .

Spohn (19) believes that in the system $\text{CaO} \cdot \text{Al}_2\text{O}_3 \cdot \text{SiO}_2$, the maximum CaO limit is given by a line joining C_3S with the invariant point for $\text{CaO} \cdot \text{C}_3\text{S} \cdot \text{C}_2\text{S}$, which corresponds closely to a line from C_3S to a point represented by the composition $2\text{CaO} \cdot \text{Al}_2\text{O}_3$. This was derived from a study of the paths taken by the crystallization of liquids in the system. Likewise, in the system $\text{CaO} \cdot \text{Al}_2\text{O}_3 \cdot \text{Fe}_2\text{O}_3 \cdot \text{SiO}_2$, Spohn suggests that the line $\text{C}_3\text{S} \cdot \text{C}_4\text{AF}$ gives the maximum CaO contents for the system $\text{CaO} \cdot \text{C}_2\text{S} \cdot \text{C}_4\text{AF}$.

Forsen (6) writes the ideal composition of portland cement of highest lime content:



But in practice he believes that some aluminates of lower basicity are formed, so that the correct formula should be



which gives the composition

$$\text{CaO} = 2.8\text{SiO}_2 + 1.4\text{Fe}_2\text{O}_3 + f(\text{Al}_2\text{O}_3 - 0.64\text{Fe}_2\text{O}_3)$$

If the value of $n = 3$, then $f = 1.65$, but since n is usually less than 3, f varies between 1 and 1.65. The reason is that the liquid formed during clinkering does not usually have time to react completely with the other phases and on crystallization may form C_3A_2 or some other unsaturated aluminate. In clinker of comparatively low A:F ratio, f could be as high as 1.65, but for high A:F clinkers it might be as low as 1.0.

The limiting CaO content has also been examined by Lea and Parker (12), who start with the criterion that at the clinkering temperature the liquid composition shall fall on the low-lime side of the $\text{CaO-C}_2\text{S}$ boundary surface in the C-A-F-S system. This avoids the possibility of free CaO in the solid at clinkering temperatures. The surface of limiting compositions on this basis conforms very closely to a plane in the tetrahedron connecting C_2S and C_4AF with the invariant point, D , for $\text{CaO-C}_2\text{S-C}_2\text{A}$ on the C-A-S side of the tetrahedron. The compositions of these three points are:

	CaO	Al ₂ O ₃	SiO ₂	Fe ₂ O ₃
C_2S	73.6	26.4	
D	59.7	32.8	7.5	
C_4AF	46.1	21.0	32.9

The equation for the plane is

$$2.18\text{Al}_2\text{O}_3 + 3.80\text{SiO}_2 + 1.65\text{Fe}_2\text{O}_3 = 1$$

which gives a CaO content in the plane of

$$\text{CaO} = 2.80\text{SiO}_2 + 1.18\text{Al}_2\text{O}_3 + 0.65\text{Fe}_2\text{O}_3$$

The equation is applicable to all portland cements with A:F ratios greater than 0.64. It is notable that many of the earlier equations, derived from practical considerations, approach this theoretical equation very closely. Some amplifications of the equation have been speculated upon by Lea (13) in an effort to predict and take into account the additional effects on the CaO requirements brought about by the addition of other minor components, as MgO , TiO_2 , K_2O and Na_2O . The incomplete state of the information available makes a precise statement impossible at this time.

Dahl (1) has pointed out that, since the plane represented by Lea's equation passes through the C_2S and C_4AF points, an equation for the plane expressed in terms of components of the system $\text{C}_2\text{S-C}_2\text{S-C}_2\text{A-C}_4\text{AF}$ will lack the C_2S and C_4AF terms, and express only a relation between C_2S and C_2A . Thus he sets the equation up in determinant form:

$$\begin{vmatrix} \text{C}_2\text{S} & 100 & 0 & -34.35 \\ \text{C}_2\text{S} & 0 & 0 & 47.42 \\ \text{C}_2\text{A} & 0 & 0 & 86.93 \\ \text{C}_4\text{AF} & 0 & 100 & 0 \end{vmatrix} = 0$$

The second, third and fourth columns are the potential compound compositions of C_3S , C_4AF and the $CaO-C_2S-C_3A$ invariant point respectively. Evaluating the determinant,

$$86.93C_3S - 47.42C_3A = 0$$

which reduces almost exactly to

$$11C_2S - 6C_3A = 0$$

This shows that a composition is on the plane representing Lea's technical lime limit if the potential C_2S is $\frac{6}{11}$ of the potential C_3A , regardless of what the values of C_3S and C_4AF may be. If the C_2S is less than $6C_3A/11$, the technical lime limit is exceeded.

From the above, Dahl derives an expression for estimating the amount by which the lime content of a mixture falls short of the technical lime limit by multiplying the above equation by a factor which will make the coefficient of C_2S equal to (mol. wt. CaO)/(mol. wt. C_2S). This factor is 0.0296. Hence the equation is obtained:

$$\text{Lime deficiency equals } 0.3256C_2S - 0.178C_3A.$$

This is convenient to employ when potential compositions are calculated for other purposes, and serves to show that, as the C_3A is reduced, the minimum C_2S which is safe is also reduced. Thus, in low C_3A compositions, a higher C_2S may be secured, without passing the technical lime limit, than is possible in high C_3A compositions.

The Principle of Chemical Control

The necessity for accurate control of the constituent materials in a cement raw mixture has been stressed by Dahl (2). Thus an increase of 12.2 percent in potential C_3S and a decrease of 11.6 percent in potential C_2S were found to result from each 1.0 percent increase in the proportion of a typical limestone, in a mixture of limestone and shale such as would be used for the manufacture of portland cement. Stated differently, if the $CaCO_3$ content of the mix is raised 1 percent, the potential C_3S is increased 14.2 percent and the potential C_2S is decreased 13.5 percent. Likewise, the addition of 1 percent of a typical coal ash is shown to lower the C_3S and raise the C_2S by about 6.5 and 5.6 percents, respectively. If dust losses are also considered, the combined effects of such losses and the addition of coal ash may be sufficient in commercial practice to reduce C_3S and increase C_2S by as much or more than 15 percent. All of these factors must be taken into consideration in such a way that the finished clinker shall have uniformly the desired composition.

Still another factor which may cause large changes in the potential composition of a raw mixture is a variable MgO content of mixtures which are held to a constant $CaCO_3$ constant. Thus the substitution of 1 percent MgO for CaO in the composition of a limestone which is used in preparing the raw mixtures of constant CaO content, on an unignited basis, is shown to make possible an increase of 16.4 percent C_3S and a corresponding decrease in C_2S . The reason in this case is due to the changed CaO requirement of the mixture, that is, the changed CaO

content required to produce a desired potential C_3S or C_2S . This is due to the lowered SiO_2 , Al_2O_3 and Fe_2O_3 resulting from the substitution. If the $CaCO_3$ content were reduced in accordance with the lowered CaO requirement, the effect of the substitution would be very small.

Since 1 percent increase in $CaCO_3$ produces an increase of 14.2 percent in potential C_3S (the ratio is not strictly constant but may be considered so for practical purposes), each percent increase in C_3S is equivalent to $1/14.2 = 0.07$ percent $CaCO_3$. Thus, if it is desired to produce a mixture having a potential C_3S content of A percent, and a particular mixture shows the C_3S to have a value of a , the $CaCO_3$ required (P) is lower than the $CaCO_3$ present (p) by an amount equal to $(a - A) \times 0.07$, and the $CaCO_3$ requirement will be

$$P = p - 0.07(a - A)$$

Thus if the desired C_3S is 50, the potential C_3S of a mixture 60, and the $CaCO_3$ present 75, then $CaCO_3$ required is $75 - 0.07(60 - 50) = 74.3$, indicating a necessary reduction in $CaCO_3$ of 0.7 percent.

By a similar procedure, the $CaCO_3$ may be designed to maintain a constant C_2S content. Thus, since 1 percent increase in $CaCO_3$ produces a decrease of 13.5 percent in C_2S , each percent decrease in C_2S is equivalent to $1/13.5 = 0.074$ percent $CaCO_3$. If P and p have the same significance as before, B the desired C_2S , and b the potential percent C_2S in the mixture, then the lime requirement can be expressed:

$$P = p - 0.074(B - b)$$

The above equations suggest that the $CaCO_3$ content of a raw mixture may be controlled on the basis of the *lime requirement* for maintaining a constant C_3S or C_2S content in the clinker. The usual means for accomplishing this end would involve the chemical analysis of raw-mixture samples taken at intervals from some point in the continuous flow of the mixture, and corrected in accordance with the trend of the swing above or below the established requirement. A method has been proposed by Dahl, however, by which the lime requirement may be obtained for a specified potential C_2S content, or for a "lime deficiency" which does not necessitate such analysis.

The amount of CaO (or $CaCO_3$) which must be added to any given raw mixture in order to cause all of the SiO_2 to combine as C_3S , leaving zero C_2S , is the *lime deficiency*, and the total CaO then represents the theoretical lime limit to form the compounds of maximum lime content from all the oxides capable of combining with lime. If lime is added in excess of that amount it must remain in the clinker as free CaO .

It will be seen that the higher the C_2S of a clinker burned to equilibrium, the higher also is the lime deficiency, and since the C_2S is the only compound capable of taking up more CaO , the C_2S formed is proportional to the lime deficiency. Thus the ratio of C_2S formed to the lime deficiency, d_s , is equal to the ratio of the molecular weights of C_2S/CaO . That is,

$$\begin{aligned} \% C_2S &= 172.22d_s/56.08 = 3.071d_s, \text{ or} \\ d_s &= 56.08C_2S/172.22 = 0.3256C_2S \end{aligned}$$

Hence control to a constant d_s is equivalent to control to a constant C_2S .

The potential lime deficiency may be determined without analyses by burning a sample of raw mixture to equilibrium and cooling slowly to permit complete crystallization. The free CaO is determined and represents the excess of lime above the theoretical limit of lime saturation. When this is subtracted from the total CaO added, the remainder is that which has combined with C_2S to form C_3S , and thus is the theoretical lime deficiency.

It has been shown above, however, that the practical or technical lime deficiency, d_r , is not proportional solely to the potential C_2S , but may be expressed by the equation

$$d_r = 0.3256C_2S - 0.178C_3A$$

This equation differs from that for the theoretical lime deficiency,

$$d_s = 0.3256C_2S$$

by a function of the potential C_3A . But since the potential C_3A is nearly constant in most plants, Dahl proposes that a substantially constant C_2S can be maintained by aiming at a constant lime deficiency as above determined.

From the equation

$$d_s = 0.3256C_2S$$

it may be noted that a change of 1.00 percent in d_s is equal to a change of $1/0.3256 = 3.071$ percent in C_2S , and that d_r is nearly the same when the potential C_3A is fairly constant. Making use of this relation, the equation for lime requirement, P , by control of C_2S , derived above,

$$P = p - 0.074(B - b)$$

may be converted to one involving lime deficiency instead of C_2S . Thus if d is the lime deficiency of a raw mixture, and D is the desired lime deficiency, then $B - b$ above is equal to $3.071 D - d$, and we may write the equation:

$$P = p - 0.074 \times 3.071(D - d), \text{ or}$$

$$P = p - 0.23(D - d)$$

Dahl points out that the value of the method will be greater as the time is shortened between the moment of taking the sample from the raw-mixture stream and the moment when the results of the test can be applied in adjusting the composition. One time-consuming aspect of the test is the period required for burning the sample to complete equilibrium and cooling sufficiently slowly to obtain complete crystallization. Dahl suggests that it might prove advantageous to choose a constant temperature for burning the sample, and a burning period which would be less than that required for equilibrium. This would result in a higher free-CaO content, giving rise to a constant error, together with certain deviations from that constant error. The constant error may be taken care of by aiming at a lower lime deficiency, D . Time may be saved also in the free-CaO determination by the addition of $BaCl_2$ to accelerate the reaction or by the use of the ethylene-glycol method.*

The principal advantage of the lime-deficiency method of control over the

* See page 73.

method based upon control of the potential C_3S or C_2S is considered by Dahl to be due to the fact that, in the former, all of the constituents including the minor constituents react at the clinking temperature and so are accounted for by the test procedure. By the control of C_3S or C_2S , as calculated from the percentages of the major constituents, only the major constituents are taken into account.

Comparison of Clinker Compositions Obtained by Different Methods

For a number of years following the publication of methods for calculating the phase composition of clinkers,* studies were made testing the validity of the methods. Swenson and Flint (18) made separations of 13 commercial cements into the size fractions 0-7, 7-22, 22-40, 40-55 and +55 microns. Chemical analyses were made of each fraction and the phase compositions calculated by the Bogue method. The results showed that, in general, the different size fractions differed considerably in composition. The C_2S especially tended to be more concentrated in the coarser fractions and the C_3S to be more concentrated in the finer fractions. Of the other phases there was little consistent variation except that the $CaSO_4$ was contained almost entirely in the two finer fractions.

In continuing the study, heats of hydration at 3, 7 and 28 days were made on a number of the fractions. The heat liberated decreased regularly at all ages as the grain-size of the fractions increased, as would be expected since the rate of hydration must be a function of grain size. But attempts to correlate the heats of hydration as determined on the size fractions and as calculated from the potential compositions were not successful. In order to note if the discrepancies could be accounted for by taking glass into consideration, the glass contents of five of the cements were determined by the microscopic examination of polished sections. The water- HNO_3 -alcohol etch was employed. An improvement in the correlation was observed in four of the five cements.

Making use of a water etch (2-sec.) followed by 1 percent HNO_3 in alcohol (3-sec.), Insley and his co-workers (9) made a comparison of results obtained on 26 commercial cements by the microscopic method and those obtained by calculation and heat-of-solution procedure. Glass was determined by Lerch's method, and heat of solution calculated on the basis of the potential composition by the Bogue method and also from the microscopical composition, using a value of 700 cal./g. for the glass, an approximate mean for glasses in the A:F range of the clinkers used. The results showed that the C_3S was greater and the C_2S less by the microscopic method than by calculation, except for the very low A:F ratio cements. The C_4AF was greater by the microscopical method, and the total dark interstitial material was less than the calculated values. A comparison of observed heats of solution with those calculated from chemical or microscopical analysis showed fairly close correspondence.

In a later paper (10), after Insley had developed the 10 percent KOH etch for differentiating the constituents of the dark interstitial material, a repetition of the microscopical analyses on these cements gave consistently higher results for glass and lower results for C_4AF for all samples with A:F ratios less than 2.00. For ratios greater than 2.00, the values for the two methods were approximately

* See Chapter 10.

TABLE 16. Comparison of clinker compositions (Ward) (20)

No. ^a	A/F	C ₂ S		C ₃ A		C ₄ AF		MgO		CaO		Glass	
		Nor. ^b	Mic. ^c	Nor.	Mic. ^d	Nor.	Mic. ^e	Nor.	Mic.	Chem.	Mic.	Chem.	Mic. ^o
4S	0.65	65	5	0	2	22	20	4.2	4.3	0.3	0.2	2	0
4P	0.89	45	10	0	2	4	18	3.0	4.3	4.2	2.9	21	6
4Q	0.81	56	4	0	0.2	4	21	3.0	2.7	1.6	1.6	23	6
11S	0.87	66	13	2	3	14	15	0.7	0.8	0.1	0.1	2	1
11P	0.90	64	14	2	0	12	15	0.4	0.6	0.2	0.1	6	4
11Q	0.95	67	10	1	0	10	10	0.4	0.2	0.3	0.1	7	7
2S	0.97	62	15	4	3	15	17	1.6	1.3	0.1	0.1	1	0
2P	1.01	56	11	4	3	14	20	1.5	2.2	0.8	1.0	5	6
2Q	1.12	58	13	0.2	0	6	11	0.7	0.7	0.9	1.2	20	8
8S	1.63	54	27	8	7	9	8	3.9	2.9	0.1	0	0	0
8P	1.64	51	25	5	1	4	6	2.8	2.2	0.6	0.4	11	8
8Q	1.65	52	21	4	0	3	5	2.7	1.8	0.8	0.5	13	10
10S	1.68	49	39	8	4	8	9	1.2	0.9	0.2	0.2	1	2
10P	1.68	41	41	7	3	8	7	1.2	0.9	2.1	1.9	2	2
10Q	1.68	42	36	5	0.2	4	3	1.0	0.4	2.0	1.6	11	12
6S	1.88	63	9	9	6	8	11	1.2	0.4	0	0.1	4	2
6P	1.89	61	16	10	8	9	10	1.3	0.9	0.4	0.7	2	3
6Q	1.88	61	10	6	0	2	2	0.6	0.2	0.5	1.0	15	17
3S	1.88	51	25	9	11	8	4	4.1	4.0	0.2	0.2	0	2
3P	2.40	49	17	7	10	1	1	3.3	4.1	0.4	0.4	12	8
3Q	2.60	56	17	0	5	0	tr	3.0	2.1	0.4	0.1	18	11

TABLE 16. (Continued)

No. ^a	A/F	C ₃ S		C ₁ A		C ₂ AF		MgO		CaO		Glass	
		Nor. ^b	Mic. ^c	Nor.	Mic. ^d	Nor.	Mic. ^e	Nor.	Mic.	Chem.	Mic.	Chem.	Mic. ^e
9S	2.51	46	45	11	10	7	5	4.2	2.8	0.1	0.2	0	0
9P	2.51	43	49	8	2	2	6	3.6	2.5	0.8	0.7	9	7
9Q	2.84	45	52	5	0	0	tr	3.2	2.5	0.9	0.8	16	13
1S	2.70	55	45	12	12	7	7	3.1	2.4	0.4	0.4	0	0
1P	2.71	50	55	12	13	6	4	2.9	2.5	1.2	0.9	3	1
1Q	3.00	52	58	9	2	1	6	2.5	1.1	1.5	0.3	10	14
7S	2.82	53	55	13	12	6	5	3.3	2.8	0	0.1	2	2
7P	2.91	50	46	11	9	3	2	2.9	4.1	0.4	0.5	9	12
7Q	3.47	58	61	0	0.2	0	tr	1.9	1.7	0.6	2.0	26	18

^a S = Slowly cooled; P = plant clinker; Q = quickly cooled.

^b Nor. = calculated from normal crystallization (see Chapter 10).

^c Mic. = microscopically determined.

^d Includes rectangular and prismatic dark interstitial material.

^e KOH etch.

the same. These new results showed much closer agreement between the microscopical and the calculated values for C_4AF , and between the microscopical and the heat-of-solution values for glass, than those first reported.

There remained, however, a number of important difficulties which were improved in a later study by Ward (20). Chief among the revised procedures was the employment of a new basis for the calculation of compositions, taking into consideration the glass as determined by the heat-of-solution method. The method for such calculation, developed by Dahl (3), is described elsewhere.* By this method the assumption is made that the clinker is at equilibrium down to a temperature where the liquid remaining is equal to the glass content as determined by the heat-of-solution method. The computed composition thereby includes the determined glass, as also the determined free CaO. It is also assumed that MgO enters into the solution to the extent of 6 percent, and only the MgO in excess of that value appears as periclase in the clinker (15). In making the calculations, free CaO was subtracted from total CaO; TiO_2 from Al_2O_3 ; and FeO as Fe_2O_3 was subtracted from total iron as Fe_2O_3 , to give the amounts of CaO, Al_2O_3 and Fe_2O_3 , respectively, which were assumed to participate in the reactions. The values for determined glass content were revised values based on heats of solution of glass on the T_2W-T_2E boundary curves (Lea and Parker) and the 1400° and 1450° isotherms as discussed by Dahl. The microscope values were obtained by the method described by Insley, using the KOH etch for the C_4AF and dark interstitial phases.

The results of Ward's study are condensed in Table 16. It will be seen that the calculated and microscope values for C_3S and C_2S for the slowly-cooled clinkers are in fair agreement, but the calculated values for C_3S tend to be lower, and those for C_2S higher, than the microscope values. This suggests that crystalline equilibrium has not been completely attained, or that the phase identified as C_3S has been augmented by solid solution. This tendency is greater in the other clinkers.

Rectangular C_3A was observed in all slowly-cooled clinkers having A:F ratios of 1.63 or greater. It was not found in the quickly-cooled clinkers. The prismatic C_3A was highest in the plant clinkers and lowest in the quickly cooled clinkers. The C_4AF observed was often greater than that calculated, but the differences decreased as the A:F ratio increased, and increased as the cooling became more rapid. The amount of glass observed was usually less than that derived from heat-of-solution data, especially in the low A:F ratio cements. It may be noted that where the microscope showed markedly higher values than the calculated values for C_4AF , it showed markedly lower values for glass (see especially 4P and 4Q). This suggests a difficulty in the microscopical procedure of differentiating between these phases in the high-iron cements. Agreement between the values for CaO and MgO was usually good.

References

1. Dahl, I. A., *Symposium*, 138.
2. Dahl, L. A., *Res. Reports, PCA*, March, 1936; Feb., 1946.
3. Dahl, L. A., *Rock Products*, 41-42 (1938-39); *PCA Res. Bull.*, 1 (1939).

* See Chapter 10.

4. Duchez, J. L., *Rock Products*, Nos. 16, 18, 20 (1923); 7, 14, 22, 25 (1924); 1, 8, 16, 20 (1925).
5. Eckel, E. C., "Cements, Limes and Plasters," New York, John Wiley and Sons, 2nd. ed., 1922.
6. Forsen, L., *Zement*, 24, Nos. 2, 3, 6, 10, 13 (1935); *Concrete, CMS*, 45, 231; 250 (1937); *Symposium*, 132.
7. Guttman, A. and Gille, F., *Zement*, 18, 500; 571; 912 (1929).
8. Hendrickx, J., *Chem. Ind.*, 8, 196 (1922); "The Manufacture of Artificial Portland Cement," Paris, 1922.
9. Insley, H., Flint, E. P., Newman, E. S. and Swenson, J. A., *J. Res. NBS*, 21, 355 (1938); RP 1135.
10. Insley, H., *J. Res. NBS*, 25, 295 (1940), RP 1324.
11. Kuhl, H., *Zement*, 18, 833 (1929).
12. Lea, F. M. and Parker, T. W., *Bldg. Res. Tech. Paper*, 16 (1935).
13. Lea, F. M., *Symposium*, 125.
14. LeChatelier, H., *Compt. rend.*, 94, 13 (1882); "Experimental Researches on the Constitution of Hydraulic Cements," translated by J. L. Mack, New York, McGraw Publishing Co., 1905.
15. Lerch, W. and Brownmiller, L. T., *J. Res. NBS*, 18, 617 (1937); RP 997; PCAF Paper 32.
16. Newberry, S. B. and Newberry, W. B., *Cement Age*, 2, 76 (1905).
17. Newberry, S. B., Chapter 5 in "Concrete, Plain and Reinforced," by Taylor, F. W. and Thompson, S. E., New York, John Wiley and Sons, 3rd ed., 1917.
18. Swenson, J. A. and Flint, E. P., *J. Res. NBS*, 17, 261 (1936); RP 910.
19. Spohn, E., *Zement*, 21, 702 (1932).
20. Ward, G. W., *J. Res. NBS*, 26, 49 (1941); RP 1358; PCAF Paper 39.

CHAPTER 10

Calculation of Phase Composition

One of the significant results evolving through information on the manner of crystallization of the clinker constituents is the ability to calculate the potential phase composition of the clinkers produced from raw mixtures of any known oxide composition. This treatment is restricted however to mixtures of those components of which such information has been obtained, and to certain particular limiting types of crystallization as determined by the cooling process. When other components are present, they have to be ignored, or their behavior implied. And a crystallization path has to be assumed in the commercial clinker parallel to one of the idealizations mentioned above. Despite the ultimate uncertainties, however, the methods of calculation have been of the utmost value, both in directing the thinking of the Industry to composition in terms of clinker phases, and to the design and control of composition in plant operation.

Equilibrium Crystallization

Following investigations on the phase relations in the portland cement field in the presence of the five major components CaO , MgO , Al_2O_3 , Fe_2O_3 , SiO_2 , it was ascertained that the manner of interaction of these components under equilibrium conditions was approximately as follows:

- (1) The Fe_2O_3 reacts with Al_2O_3 and CaO to form C_4AF .
- (2) The Al_2O_3 remaining from combination as C_4AF reacts with CaO to form C_3A .
- (3) The CaO remaining from the above combinations reacts with the silica. C_2S is first formed with the SiO_2 , and any CaO left over reacts with the C_2S to form C_3S . If CaO remains after converting all of the C_2S to C_3S , it remains as uncombined CaO .
- (4) The MgO remains essentially uncombined.

It was recognized that equilibrium conditions are not likely to be obtained in commercial manufacture of portland cement due to a number of factors: Coarse particles may not be completely converted to equilibrium products, since some of the reactions are between solid-liquid phases. Re-solution during cooling, of previously crystallized phases, may not be complete in some compositions, or they may be embedded in other phases where the liquid cannot act upon them. Cooling is usually at such a rate that some of the liquid undercools to a glass. The liquid may crystallize independently without attainment of equilibrium products. The minor components will have an effect which cannot yet be evaluated. But recognizing these anomalous factors, it seemed certain that decided benefits would attend the attempt to present to the industry the means for computing the phase composition of clinkers in the C-M-A-F-S system under crystal-

line equilibrium, and to urge the consideration, in the design of mixes and the investigation of properties, of the expression of composition in terms of the potential phase composition of the clinker under these hypothetical conditions. It would constitute a first approximation, and modifications could then be introduced into the calculations as new information developed.

With this purpose the first paper was written on the computation of phase composition of portland cement (1). By the method proposed, the free CaO was determined and deducted from total CaO. The insoluble residue was recorded as such except, when greater than 0.2 percent, it would be analyzed and the SiO₂ found deducted from total SiO₂. The ignition loss was recorded as such. The SO₃ was calculated to CaSO₄ and the CaO so combined deducted from total CaO.

Each percent of SO₃ enters into combination with 0.70 percent CaO to form 1.70 percent CaSO₄:

$$\frac{\text{CaO}}{\text{SO}_3} = \frac{56.07}{80.065} = 0.70\% \text{ CaO} \dots (c_1)$$

Each percent of Fe₂O₃ enters into combination with 0.64 percent Al₂O₃:

$$\frac{\text{Al}_2\text{O}_3}{\text{Fe}_2\text{O}_3} = \frac{101.92}{159.68} = 0.64\% \text{ Al}_2\text{O}_3 \dots (a_1)$$

and with 1.40 percent CaO:

$$\frac{4\text{CaO}}{\text{Fe}_2\text{O}_3} = \frac{224.28}{159.68} = 1.40\% \text{ CaO} \dots (c_2)$$

to form 3.04 percent C₄AF.

The total MgO is recorded as uncombined MgO.

The total Al₂O₃ minus (a₁) gives the Al₂O₃(a₂) available for combination as C₂A. Each percent of (a₂) will enter into combination with 1.65 percent CaO to form 2.65 percent C₂A:

$$\frac{3\text{CaO}}{\text{Al}_2\text{O}_3} = \frac{168.21}{101.92} = 1.65\% \text{ CaO} \dots (c_3)$$

The amount of CaO available for combination with SiO₂ is obtained by subtracting from the total CaO the sum of the uncombined CaO, the CaO (c₁) combined as CaSO₄, the CaO(c₂) combined as C₄AF, and the CaO(c₃) combined as C₂A:

$$\begin{aligned} \text{Total CaO} - (\text{uncombined CaO} + c_1 + c_2 + c_3) \\ = \text{CaO available to combine with SiO}_2 \dots (c) \end{aligned}$$

The total SiO₂(s), unless corrected for silica in the insoluble residue, is calculated first to combine with CaO to form C₂S. Each percent of SiO₂(s) will combine with CaO to form 2.87 percent C₂S:

$$\frac{\text{C}_2\text{S}}{\text{SiO}_2} = \frac{172.20}{60.06} = 2.87\% \text{ C}_2\text{S}$$

This first approximation to the value of C₂S is subtracted from the SiO₂ (s) + CaO(c), which gives the CaO(c₄) available to combine with C₂S to form C₃S.

Each percent of $\text{CaO}(c)$ combines with C_2S to form 4.07 percent C_3S :

$$\frac{\text{C}_2\text{S}}{\text{CaO}} = \frac{228.27}{56.07} = 4.07\% \text{ C}_2\text{S}$$

The C_3S subtracted from the total $\text{SiO}_2(s) + \text{CaO}(c)$ gives the true amount of C_2S present.

If the compound C_3S is greater than $s + c$, no C_2S is present. In that case, each percent of $\text{SiO}_2(s)$ combines with CaO to form 3.80 percent C_3S :

$$\frac{\text{C}_3\text{S}}{\text{SiO}_2} = \frac{228.27}{60.06} = 3.80\% \text{ C}_3\text{S}$$

This amount of C_3S subtracted from $\text{SiO}_2(s) + \text{CaO}(c)$ gives the percentage of uncombined CaO . The above condition can obtain only when the CaO is in excess of that which can go into combination at equilibrium, and the uncombined CaO has not been determined and deducted as previously described.

Dahl has shown how a slide rule may be prepared from an application of the principles involved in these equations (2), and has derived simple equations by which the several compounds in the 3-component system C-A-S (3), or the 4-component system C-A-F-S (4), may be computed directly from the chemical analyses of the oxide components.

By letting a , b , c and d represent the percent of CaO , SiO_2 , Al_2O_3 and Fe_2O_3 respectively in a mixture of C_3S , C_2S , C_3A , and C_4AF , and w , x , y and z represent the compounds C_3S , C_2S , C_3A , and C_4AF respectively in that product, the terms may be related by the following procedure:

C_3S contains 73.69% CaO and 26.31% SiO_2 . Hence the proportions of the oxides expressed as fractional parts of the compound compositions may be set down:

		$\text{C}_3\text{S}(w)$	$\text{C}_2\text{S}(x)$	$\text{C}_3\text{A}(y)$	$\text{C}_4\text{AF}(z)$
(a)	CaO	0.7369	0.6512	0.6227	0.4616
(b)	SiO_2	0.2631	0.3488		
(c)	Al_2O_3	0.3773	0.2098
(d)	Fe_2O_3	0.3286

Hence, in any mixture of the four compounds, the CaO in the C_3S is equal to 0.7369 times the percent of C_3S ; the CaO in the C_2S is equal to 0.6512 times the percent of C_2S ; the CaO in the C_3A is 0.6227 times the percent of C_3A ; the CaO in the C_4AF is 0.4616 times the percent of C_4AF . The total CaO is then the sum of these values, or

$$\begin{aligned} a &= 0.7369w + 0.6512x + 0.6227y + 0.4616z \\ b &= 0.2631w + 0.3488x \\ c &= 0.3773y + 0.2098z \\ d &= 0.3286z \end{aligned}$$

By solving for w , x , y , and z

$$\begin{aligned} w &= 4.0710a - 7.6024b - 6.7187c - 1.4297d \\ x &= 8.6024b + 5.0683c - 3.0710a + 1.0785d \\ y &= 2.6504c - 1.6920d \\ z &= 3.0432d \end{aligned}$$

More generally, the above may be expressed for the system $C_2S-C_2S-C_2A-C_4AF$:

$$\begin{aligned} C_2S &= 4.0710CaO - 7.6024SiO_2 - 1.4297Fe_2O_3 - 6.7187Al_2O_3 \\ C_2S &= 8.6024SiO_2 + 1.0785Fe_2O_3 + 5.0683Al_2O_3 - 3.0710CaO \\ &= 2.8675SiO_2 - 0.7544C_2S \\ C_2A &= 2.6504Al_2O_3 - 1.6920Fe_2O_3 \\ C_4AF &= 3.0432Fe_2O_3 \end{aligned}$$

By a similar procedure, the compounds in other systems may be calculated:

For the system $CaO-C_2S-C_2A-C_4AF$:

$$\begin{aligned} CaO &= CaO - 2.8012SiO_2 - 0.3512Fe_2O_3 - 1.6504Al_2O_3 \\ C_2S &= 3.8012SiO_2 \\ C_2A &= 2.6504Al_2O_3 - 1.6920Fe_2O_3 \\ C_4AF &= 3.0432Fe_2O_3 \end{aligned}$$

For the system $C_2S-C_2A-C_2A_3-C_4AF$:

$$\begin{aligned} C_2S &= 2.8675SiO_2 \\ C_2A &= 3.6133CaO - 6.7478SiO_2 - 3.3130Al_2O_3 - 2.9610Fe_2O_3 \\ C_2A_3 &= 4.8803SiO_2 + 4.3130Al_2O_3 + 0.9178Fe_2O_3 - 2.6133CaO \\ C_4AF &= 3.0432Fe_2O_3 \end{aligned}$$

Equilibrium Mixture Containing Liquid. The composition of a mixture of solid phases in equilibrium with a liquid may be calculated at any stage in the process. At an invariant point this may be done by a consideration of the following relations, as developed by Dahl (4). If A, B, C etc., represent the phases which may be present in a system, the subscripts $s, p,$ and q , the solid state, the potential state of complete equilibrium crystallization, and the liquid state, respectively, and Q the fractional proportion of liquid at any stage of fusion, then

$$\begin{aligned} A_s &= A_p - A_q \cdot Q \\ B_s &= B_p - B_q \cdot Q, \text{ etc.,} \end{aligned}$$

which reads, the percent of A in the solid state is equal to the potential percent of A in the mixture minus the percent of A in the liquid times the fractional proportion of liquid in the mixture.

Any solid phase will disappear when the percent of that phase in the liquid times the fractional proportion of liquid has become, through the process of fusion, equal to the potential percent of that phase in the mixture, that is, when

$$\begin{aligned} A_p - A_q \cdot Q &= 0, \text{ or} \\ B_p - B_q \cdot Q &= 0, \text{ etc.} \end{aligned}$$

Thus A_s will disappear when $Q = A_p/A_q$; B_s will disappear when $Q = B_p/B_q$, etc. If A_p/A_q is less than B_p/B_q , some B_s will be present when A_s disappears. Fusion stops at this point because there is no more A_s to enter into the formation of the liquid. In other words, with increasing heat input at the invariant-point temperature, solid A is the only disappearing phase. Thus, in any system, the practical proportion of liquid formed when one or more of the solid phases disappears is found by noting the smallest value of Q in the above series of equations, that is, the value obtained by dividing the percent of any disappearing phase or

phases in the total mixture by the percentage of that phase, or the sum of the percentages of the several phases, in the liquid.

As an illustration of the above principles, the compositions are given below at the invariant point where C_3S , C_2S , C_3A , C_4AF and liquid exist together in equilibrium at 1338° :

	Complete crystallization %	Liquid %
C_3S	53.6	1.4
C_2S	19.8	16.2
C_3A	14.4	32.2
C_4AF	12.2	50.2

By applying the above equations,

$$\begin{aligned}
 53.6/1.4 &= 38.3 && \text{(for } C_3S) \\
 19.8/16.2 &= 1.2 && \text{(for } C_2S) \\
 14.4/32.2 &= 0.45 && \text{(for } C_3A) \\
 12.2/50.2 &= 0.243 && \text{(for } C_4AF)
 \end{aligned}$$

from which the last value is seen to be the lowest and thus represents the fractional proportion of liquid in the system at the moment of disappearance of solid C_4AF . The composition of the mixture at that moment is then found by subtracting from the percentage of each phase present at complete crystallization the percentage of that phase in the liquid multiplied by 0.243. Thus:

$$\begin{aligned}
 C_3S &= 53.6 - 1.4 \times 0.243 = 53.3 \\
 C_2S &= 19.8 - 16.2 \times 0.243 = 15.9 \\
 C_3A &= 14.4 - 32.2 \times 0.243 = 6.6 \\
 C_4AF &= 12.2 - 50.2 \times 0.243 = 0 \\
 \text{Liquid} &= && 24.3
 \end{aligned}$$

In considering equilibrium at other than invariant points, a similar process may be used. In such cases, the disappearing phases are in the same relative proportions in the total composition and in the composition of the liquid.

Classification of Systems. When a system has been defined, it is important that means be readily available for ascertaining the location of any composition in the system with reference to the boundaries which determine the final products of equilibrium crystallization. In a two-component system, all that is necessary to know is the range of percentages of one of the components in each region of crystallization. When three components are present, use of the triangular diagram permits the geometric location of composition points, and the notation by observation of the secondary triangular fields within which such points fall. With four components, the use of a tetrahedron has been suggested (7) but the difficulties of precise and certain location of composition points within the secondary tetrahedra and upon binary surfaces make the process tedious and unsatisfactory.

A method for accomplishing this end has been developed by Dahl (5), by which analytical geometry is eliminated and points are located by reference to boundaries expressed in terms of algebraic equations of limiting compositions. The method has the additional advantage that it can be employed with systems

of any number of components, whereas geometrical relations cannot be expressed in systems exceeding four components. Dahl's method is illustrated below, making use of the diagram in Figure 68, which shows the secondary fields of final crystallization in the C-A-S system.

The usual geometric method of locating a point within a secondary field in such a ternary system would be to observe the position of such a point with reference to the small triangle within which it is found to be located. Dahl's method defines each line by an equation and the point is located by reference to its position within areas so defined.

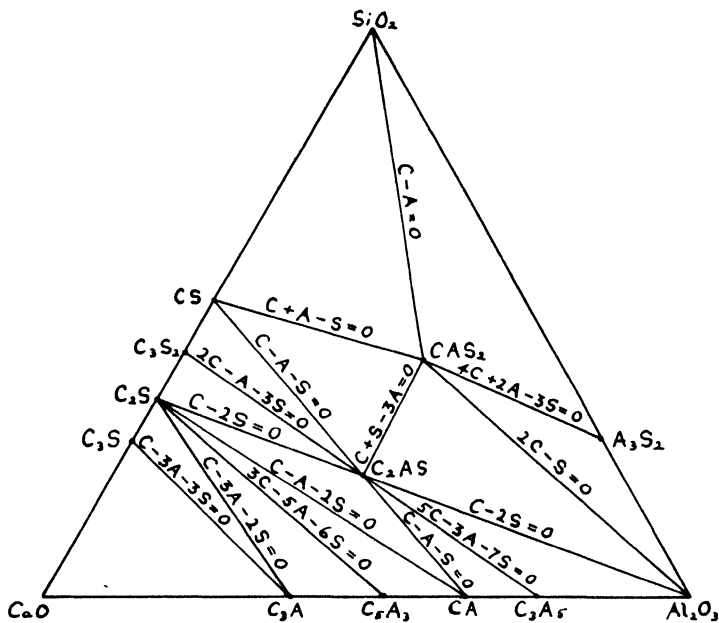

Figure 68. Classification of compositions in CaO-Al₂O₃-SiO₂ system. (Dahl)

Each line in the diagram represents either a true or pseudo binary system upon which the final products of equilibrium crystallization are indicated by the two end compositions of the line. The equation of the line can thus be expressed in terms of CaO, Al₂O₃, and SiO₂, rather than distances from coordinate axes. A given composition then lies on or above or below that line, and by a succession of comparisons, the area within which the point falls can be determined.

By way of illustration, the line C₂AS-CS represents a binary system, the equation for which may be set up either in determinate form or by simple algebraic means. Thus:

$$\begin{array}{c|c|c|c}
 & C_2AS & CS & \\
 C_m & 2 & 1 & \\
 A_m & 1 & 0 & = 0 \\
 S_m & 1 & 1 &
 \end{array}$$

where C_m , A_m and S_m are the mols of CaO , Al_2O_3 and SiO_2 respectively in a given quantity of mixture. The composition of 1 mol of C_2AS , that is, 2 mols of CaO , 1 mol of Al_2O_3 and 1 mol of SiO_2 , as obtained from the formula, is inserted in the second column, and the composition of one mol of CS , 1-0-1, similarly inserted in the third column. By expanding,

$$C_m \begin{vmatrix} 1 & 0 \\ 1 & 1 \end{vmatrix} - A_m \begin{vmatrix} 2 & 1 \\ 1 & 1 \end{vmatrix} + S_m \begin{vmatrix} 2 & 1 \\ 1 & 0 \end{vmatrix} = 0$$

the equation is obtained

$$C_m - A_m - S_m = 0$$

Since C_2AS is a member of the system CS-CA , the equation satisfies the entire line CS-CA , or $\text{C}_2\text{AS-CS}$, or $\text{C}_2\text{AS-CA}$.

The same equation may be derived by considering a ternary system involving the side $\text{C}_2\text{AS-CS}$. If we choose C_3S_2 as the third component, we may express the composition of any mixture of the three components:

$$\begin{aligned} x &= \text{mols } \text{C}_2\text{AS} \\ y &= \text{mols } \text{CS} \\ z &= \text{mols } \text{C}_3\text{S}_2 \end{aligned}$$

Then the total mols of each oxide will be

$$\begin{aligned} C_m &= 2x + y + 3z \\ A_m &= x \\ S_m &= x + y + 2z \end{aligned}$$

Solving, we obtain

$$\begin{aligned} x &= A_m \\ y &= 3S_m + A_m - 2C_m \\ z &= C_m - A_m - S_m \end{aligned}$$

Since $x =$ the mols of C_2AS , the C_2AS will be zero when $x = 0$, that is when $A_m = 0$. This will be the equation for any point on the line CaO-SiO_2 , and has no significance in classifying compositions in the ternary system. Since $y =$ mols of CS and $= 3S_m + A_m - 2C_m$, then the equation

$$3S_m + A_m - 2C_m = 0$$

will be the equation for the condition where no CS is present, that is for the line $\text{C}_2\text{AS-C}_3\text{S}_2$ of the small ternary system under consideration. Since $z =$ mols of C_3S_2 , then the equation

$$C_m - A_m - S_m = 0$$

represents the condition where no C_3S_2 is present, that is, it is the equation for the line $\text{C}_2\text{AS-CS}$, as previously derived. The significance of a boundary equation is not changed by multiplying or dividing by any constant. Thus, if CAS_2 had been used in the above illustration instead of C_3S_2 , the equation for CAS_2 would be

$$z = \frac{-C_m + A_m + S_m}{2}$$

which simplifies to $C_m - A_m - S_m$ on multiplying by -2 . In Figure 68, the equations are given for each line, the subscripts being dropped for convenience.

In making use of the values obtained as above, the diagram is no longer required, but its use is instructive in showing the method. It will be seen that the equation for the line CS-CA is $C - A - S = 0$. If a given composition contains CaO in excess, the value $C - A - S$ will no longer be zero but will be positive; if it contains less CaO, the value will be negative. Therefore a quick inspection will place the composition above or below that line. By repeating the process with the equations for the additional lines in the portion of the system where the composition falls, the final location may be established very quickly and certainly. Thus a classification key is established, as given in Table 17 for the 14 secondary systems of the system $\text{CaO-Al}_2\text{O}_3\text{-SiO}_2$, as shown in Figure 68.

TABLE 17. Classification of compositions in $\text{CaO-Al}_2\text{O}_3\text{-SiO}_2$ system

C - A - S positive		System	C - A - S negative		System
C - A - 2S	+		C - 2S	+	
C - 3A - 2S	+		5C - 3A - 7S	+	8
C - 3A - 3S	+	1	5C - 3A - 7S	-	9
C - 3A - 3S	-	2	C - 2S	-	
C - 3A - 2S	-		2C - S	+	
3C - 5A - 6S	+	3	C + S - 3A	+	
3C - 5A - 6S	-	4	C + A - S	+	10
C - A - 2S	-		C + A - S	-	11
C - 2S	+	5	C + S - 3A	-	12
C - 2S	-		2C - S	-	
2C - A - 3S	+	6	C - A	+	11
2C - A - 3S	-	7	C - A	-	
			4C + 2A - 3S	+	13
			4C + 2A - 3S	-	14

The above expressions are given in terms of mols, but percentages by weight may be converted to a form suitable for substitution in these expressions by multiplying each percentage by a constant divided by the molecular weight. For convenience, the constant in this system, and for portland cement systems in general, may best be taken as the molecular weight of CaO, 56.08. Then C is the percent of CaO; A is $56.08/101.94$, or 0.5501 times the percent of Al_2O_3 ; and S is $56.08/60.06$, or 0.9337 times the percent of SiO_2 . For example, if a composition is used of 65CaO, 10Al₂O₃, 25 SiO₂, $C = 65.00$, $A = 10 \times 0.5501 = 5.50$, $S = 25 \times 0.9337 = 23.34$. It will then be observed that $C - A - S$ is positive, $C - A - 2S$ is positive, $C - 3A - 2S$ is positive, and $C - 3A - 3S$ is negative, which finally locates the composition in system 2, which is the secondary system of $\text{C}_2\text{S-C}_2\text{S-C}_2\text{A}$.

The location of the composition within the secondary triangle may be done either geometrically or mathematically, but here also it is difficult to accomplish that geometrically in a system of more than three components, and impossible in a system of more than four components. The geometric method consists in treating the small triangle, whatever its shape, in the same manner as is commonly

employed with the larger equilateral triangle. That is, lines may be drawn parallel to each side at any desired interval representing 0 to 100 percent divisions with respect to the compound at the apex, and the percentage of the three compounds estimated in the same way as the percentage of the components in the large triangle.

To perform the calculations mathematically Dahl has given a series of equations for each of the 14 secondary systems of the system C-A-S. These equations for the systems of interest in connection with portland cement, —CaO-C₂S-C₃A, C₂S-C₂S-C₃A, and C₂S-C₃A-C₅A₃,— are given below:

System CaO-C₂S-C₃A

$$\text{CaO} = 1.000(\text{C} - 3\text{A} - 3\text{S})$$

$$\text{C}_2\text{S} = 4.0710\text{S}$$

$$\text{C}_3\text{A} = 4.8178\text{A}$$

System C₂S-C₂S-C₃A

$$\text{C}_2\text{S} = 4.0710(\text{C} - 3\text{A} - 2\text{S})$$

$$\text{C}_2\text{S} = 3.0710(3\text{A} + 3\text{S} - \text{C})$$

$$\text{C}_3\text{A} = 4.8178\text{A}$$

System C₂S-C₃A-C₅A₃

$$\text{C}_2\text{S} = 3.0710\text{S}$$

$$\text{C}_3\text{A} = 1.2044(3\text{C} - 5\text{A} - 6\text{S})$$

$$\text{C}_5\text{A}_3 = 2.6133(3\text{A} + 2\text{S} - \text{C})$$

Non-equilibrium Cooling

Classification of Crystallization Areas. In any system, as CaO-Al₂O₃-SiO₂, the compositions of the liquids produced from any mixture at any temperature are primarily established from the invariant point compositions and temperatures, supplemented by the location of isothermal lines. Thus all compositions falling within a secondary triangle of a ternary system, as in the triangle C₂S-C₂S-C₃A, start to melt at a uniform temperature, and the liquid formed has a uniform composition, which will be that of the invariant point of those three compounds, *i.e.* CaO 58.3, Al₂O₃ 33.0, SiO₂ 8.7, melting at 1455°. The isotherms, as shown in Figure 95 (page 259), indicate the composition of the liquid in equilibrium with the solid phases at the stated temperatures. Thus the composition of the liquid formed at 1500° or 1600° from mixture *O* will be seen to be indicated by points *f* and *g* respectively. But from mixture *m* the compositions of the liquid at those temperatures will be *i* and *j* respectively. Likewise, the amount of liquid formed and the composition of the solid phases can be computed by the methods described.

In the considerations given up to this point, it has been assumed generally that the products on cooling are maintained in a state of equilibrium. It has been pointed out that, in many cases in the systems of portland cement, such equilibrium could be maintained only by the interaction of a solid, stable at same high temperature, with the liquid during cooling by which new solid phases would appear. Such a reaction may be rapid or slow, but rarely would be expected to be

complete in the time available during the cooling of commercial clinker through the critical temperature range where the reaction may occur.

This being the case, there are certain limiting hypothetical conditions of cooling of the liquid which may be considered. At one extreme is the very slow cooling by which equilibrium crystallization is complete. At the other extreme is the very rapid cooling by which the liquid is frozen completely to a glass. But such freezing can be assumed to occur either from the highest temperature reached in the kiln, or at any intermediate temperature down to that of the lowest melting invariant point. A third limiting method of cooling may be considered, namely, that the liquid present at some temperature crystallizes upon cooling but, because of the brief time period available, it does so independently of the solid phases already present by reaction with which equilibrium could be maintained.

Since commercial clinkers always contain some glass, but this glass is not equal in amount to the liquid computed to be present at the clinkering temperature, it is certain that none of these limiting conditions prevails. It is probable that there is some interaction during cooling between the liquid and solid phases, that some liquid crystallizes independently, and that some freezes to glass. The conditions of composition and cooling rate determine the exact relationships in every case, but there is no way known by which all of these factors can be predicted precisely, by means of which the exact phase composition may be computed. A computation including values obtained by chemical means for certain factors, as glass and free CaO, has been found to show a relationship with the phase determinations obtained by microscopic means. Those relationships are considered in a later section of this chapter.

In the quaternary system C-A-F-S, the invariant point where C_3S , C_2S , C_3A and C_4AF can exist together has the oxide composition given below. The potential compound composition of this liquid is indicated in the last column.

CaO.....	54.8	C_3S	1.4
Al_2O_3	22.7	C_2S	16.2
SiO_2	6.0	C_3A	32.2
Fe_2O_3	16.5	C_4AF	50.2

It already has been shown that in any mixture where this particular liquid is formed, the composition of the solid phases would be represented by the equations:

$$\begin{aligned}(C_3S)_s &= (C_3S)_p - 1.4Q \\ (C_2S)_s &= (C_2S)_p - 16.2Q \\ (C_3A)_s &= (C_3A)_p - 32.2Q \\ (C_4AF)_s &= (C_4AF)_p - 50.2Q\end{aligned}$$

Making use of these values and the data on the C-A-F-S system provided by Lea and Parker, (6), Dahl (4) has classified compositions in the system for the computation of solid and liquid phase compositions, as follows:

Type A compositions, in which C_4AF is the disappearing phase as the temperature is raised above the temperature of the invariant point, 1338°. The liquid here leaves T_2 to follow T_2E (see Figure 146, page 309).

Type B compositions, in which C_3A is the disappearing phase. The liquid leaves T_2 to follow T_2W .

Type *C* compositions, in which C_2S is the disappearing phase. The liquid leaves T_2 to follow T_2T_1 .

A fourth condition where C_2S is the disappearing phase is possible, but such compositions are not encountered in commercial portland cements.

In the type *A* compositions, the liquid will follow T_2E , but may leave T_2E to enter the C_2S-C_2S surface when the A:F ratios in the mixture and in the liquid are identical. Or the liquid may enter the C_2S-C_2A surface when the $C_2S:C_4AF$ ratios in the mixture and the liquid are identical. In order to clarify these two conditions, Dahl has projected the compositions from the C_2S point to the $C_2S-C_2A-C_4AF$ plane, as shown in Figure 69, in the area $C_2S-(T_2)_p-C_2A$. In this area, all compositions to the left of the line $(T_2)_p-E_p$ produce liquids which leave T_2E to

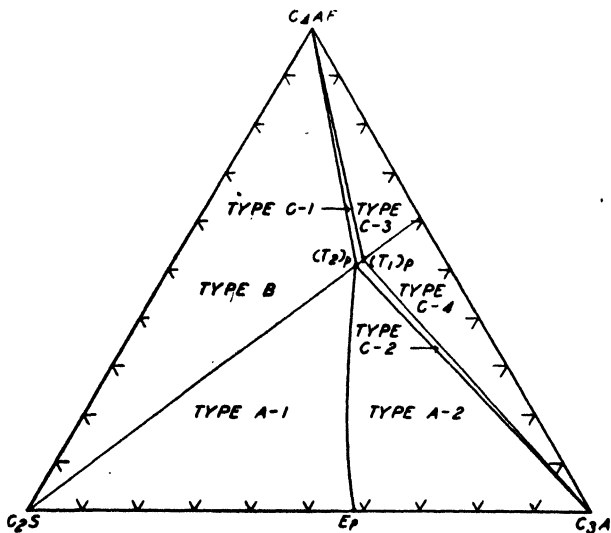

Figure 69. Diagram showing composition types. (Dahl)

follow the C_2S-C_2S surface, and all compositions to the right of that line leave T_2E to follow the C_2S-C_2A surface. Type *A* compositions are therefore divided into two classes, designated *A-1* and *A-2* respectively to indicate the course of the liquid on leaving T_2E .

A similar procedure was used for classifying compositions with reference to the surface followed by the liquid upon leaving T_2W or T_1T_1 , providing the complete classification shown in Figure 69.

Independent Crystallization of Liquid. The compositions of the liquid in terms of the oxides or the compounds may be obtained by the use of diagrams, derived from the phase-equilibrium study, by which percent compositions are indicated for each composition-type at all relevant ratios of the compounds which determine the course taken by the liquid. Thus Lea and Parker (6) give the composition of liquids on the C_2S-C_2S surface at 1400° as follows:*

* The values for A:F 0.64 have been corrected in accordance with a personal communication to the author from Dr. Lea.

A/F	CaO	Al ₂ O ₃	SiO ₂	Fe ₂ O ₃
6.06	56.6	30.3	8.0	5.0
2.62	56.4	26.2	7.4	10.0
0.94	55.1	18.8	6.1	20.0
0.64	53.9	15.3	6.8	24.0

From these data the curves in Figure 70 have been drawn showing the potential composition of the liquid, in type A-1 and B compositions, at equilibrium with solid phases at 1400°. In this diagram the compositions are expressed in

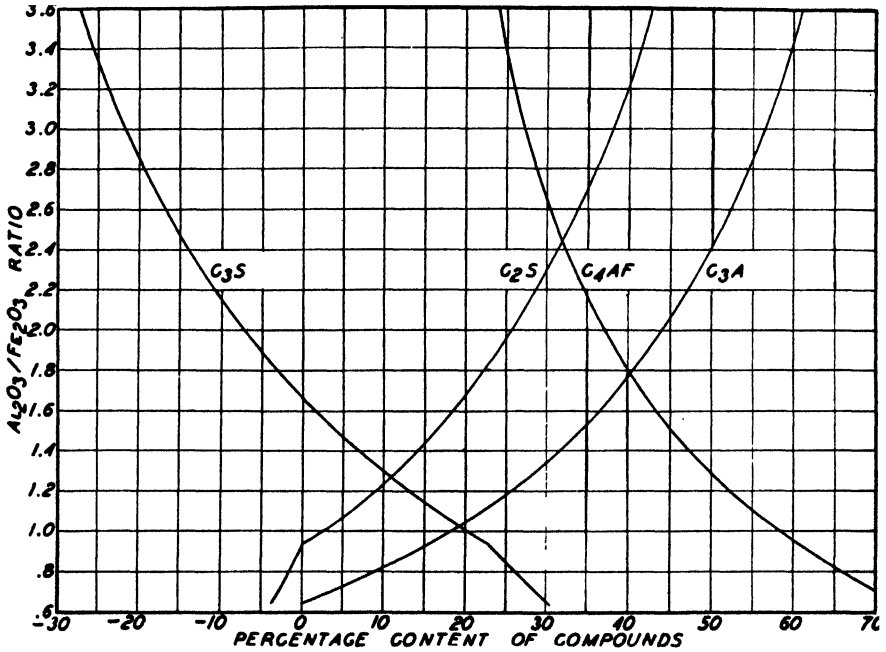

Figure 70. Potential composition of liquid at equilibrium with solid phases at 1400°. Types A-1 and B. (From data by Lea and Parker)

terms of the compounds, and are plotted against the A:F ratio. Thus in the mixture:

Oxides		Potential composition	
CaO.....	67.70	C ₂ S.....	54
SiO ₂	22.92	C ₃ S.....	25
Al ₂ O ₃	6.42	C ₂ A.....	12
Fe ₂ O ₃	2.96	C ₄ AF.....	9

the classification of type is obtained from Figure 69 by converting the last three compounds to a 100 percent basis, and noting its position in the diagram. This

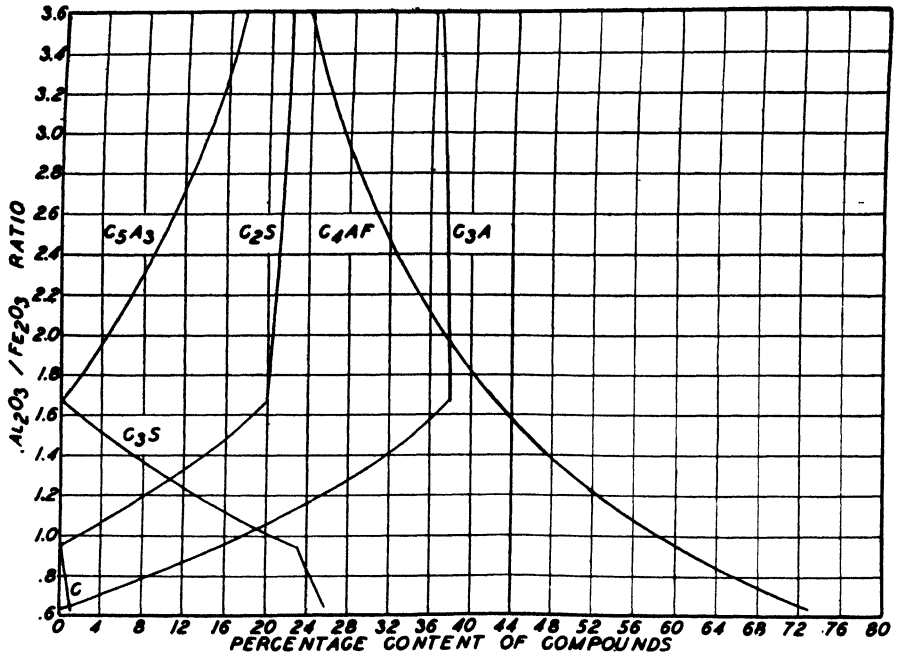

Figure 71. Products of independent crystallization of liquid originally in equilibrium with solid phases at 1400°. (From data by Lea and Parker)

gives the composition C_3S 54.3, C_2A 26.1, C_4AF 19.6, which locates it in the region of type A-1. The A:F ratio of the mixture is 2.17. From Figure 70 it can then be observed that the liquid will have the potential composition:

C_3S	-10.5
C_2S	28.5
C_2A	47.0
C_4AF	35.0

Hence the potential composition of the mixture at 1400° will be

$$\begin{aligned} (C_3S)_L &= 54 + 10.5Q \\ (C_2S)_L &= 25 - 28.5Q \\ (C_2A)_L &= 12 - 47.0Q \\ (C_4AF)_L &= 9 - 35.0Q \end{aligned}$$

No C_2A or C_4AF are present in the solid phases at this temperature. In accordance with the proposition that the proportion of liquid is equal to the sum of the percentages of the disappearing phases in the total composition divided by the sum of the percentages of those phases in the composition of the liquid, $Q = (12 + 9)/(47 + 35) = 0.256$. Applying this value to the above equations,

$$\begin{aligned} C_3S &= 54 + (10.5 \times .256) = 56.7 \\ C_2S &= 25 - (28.5 \times .256) = 17.7 \\ \text{Liquid} &= \quad \quad \quad 25.6 \end{aligned}$$

Similar diagrams have been drawn to show the liquid compositions of mixtures in the other fields represented by the several types at various stages of the heating process.

In these diagrams, the compositions have been expressed in terms of the compounds C_2S , C_3S , C_3A and C_4AF , or of CaO , C_2S , C_3A and C_4AF , even though in most cases the C_3S or CaO have negative values. This was necessary in applying the potential composition of the liquid as an increment to be subtracted from, or added to, that of the potential composition of the mixture in order to obtain the resulting composition of the solids plus liquid. In all such cases, the liquid, if allowed to crystallize independently, would have a compound composition involving the additional compound C_5A_3 . This is because its composition lies not in the field of the mixture as a whole, but instead in the field $C_2S-C_3A-C_5A_3-C_4AF$.

Under conditions of cooling where the liquid is assumed to crystallize independently of the solid phases, the reactions by which the C_3S or CaO dissolve to produce the equilibrium compounds will not take place, and the liquid will crystallize with the formation of the compounds of the less basic system. The percentages of compounds resulting from the independent crystallization of liquid, in types *A-1* and *B* compositions, originally in equilibrium with solid phases at 1400° , are shown in the diagram of Figure 71. Equations have been given by Dahl for transforming the potential composition of a liquid, expressed in terms of a system of higher basicity (as $C_3S-C_2S-C_3A-C_4AF$ or $C-C_3S-C_3A-C_4AF$) to the actual composition which it will attain on independent crystallization in the system of lower basicity ($C_2S-C_3A-C_5A_3-C_4AF$). These are expressed as follows:

From the system $C_3S-C_2S-C_3A-C_4AF$:

$$\begin{aligned}(C_2S)_2 &= (C_2S)_1 + 0.7544(C_3S)_1 \\ (C_3A)_2 &= (C_3A)_1 + 0.8876(C_3S)_1 \\ (C_5A_3)_2 &= -0.6419(C_3S)_1 \\ (C_4AF)_2 &= (C_4AF)_1\end{aligned}$$

From the system $CaO-C_3S-C_3A-C_4AF$:

$$\begin{aligned}(C_2S)_2 &= 0.7544(C_3S)_1 \\ (C_3A)_2 &= (C_3A)_1 + 3.6133(CaO)_1 + 0.8876(C_3S)_1 \\ (C_5A_3)_2 &= -2.6133(CaO)_1 - 0.6419(C_3S)_1 \\ (C_4AF)_2 &= (C_4AF)_1\end{aligned}$$

The subscripts 2 and 1 refer to the compositions in the less basic system and the more basic system, respectively, as taken from the diagrams. To illustrate, the mixture is used, as before:

C_3S	54
C_2S	25
C_3A	12
C_4AF	9

which at 1400° was found to consist of:

C_3S	56.7
C_2S	17.7
Liquid	25.6

The liquid has the potential composition:

C_2S	-10.5
C_3S	28.5
C_3A	47.0
C_4AF	35.0

By applying the above equations for determining the potential composition of the liquid (or making use of the curves in Figure 71), we have:

$$\begin{aligned} C_2S &= 28.5 + 0.7544(-10.5) = 20.6 \\ C_3A &= 47.0 + 0.8876(-10.5) = 37.7 \\ C_4A_3 &= -.6419(-10.5) = 6.7 \\ C_4AF &= 35.0 \end{aligned}$$

The liquid being 25.6 percent of the mixture at 1400°, the percentages above are multiplied by 0.256 to obtain the percentages of products of independent crystallization which are to be added to the solid phases,

$$\begin{aligned} C_2S &= 56.7 \\ C_3S &= 17.7 + 0.256 \times 20.6 = 23.0 \\ C_3A &= .256 \times 37.7 = 9.6 \\ C_4A_3 &= .256 \times 6.7 = 1.7 \\ C_4AF &= .256 \times 35.0 = 9.0 \end{aligned}$$

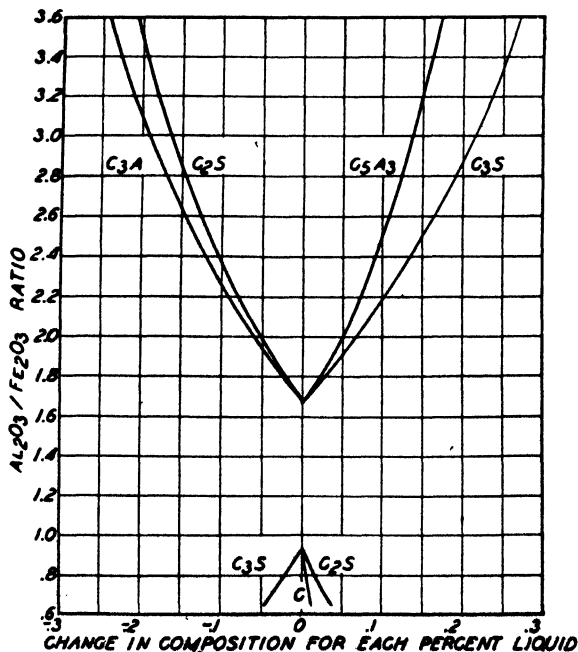

Figure 72. Change in composition of system through complete crystallization of liquid independently from 1400°. (From data by Lea and Parker)

TABLE 18. Comparison of compositions computed under various suppositions (Lea and Parker)

	Complete equilibrium crystallisation	Cryst. at eutectic liquid gives glass	Cryst. at quin-tuple line liquid gives glass	Cryst. at quin-tuple line liquid crystal's independently	Cryst. at 1400° liquid gives glass	Cryst. at 1400° liquid crystal's independently	Cryst. at 1450° liquid gives glass	Cryst. at 1450° liquid crystal's independently
CaO 68.0, SiO ₂ 23.0, Al ₂ O ₃ 7.0, Fe ₂ O ₃ 2.0, A/F 3.5								
C ₂ S	52.2	52.1	59.5	59.5	60.6	60.6	59.4	59.4
C ₂ S	26.5	24.5	15.7	21.0	15.4	20.9	15.3	21.4
C ₄ A	15.2	11.2	0	8.6	0	9.4	0	9.7
C ₄ AF	6.1	0	0	6.2	0	6.1	0	5.9
CaO	0	0	0	0	0	0	0	0
C ₄ A ₃	0	0	0	4.7	0	3.8	0	3.8
Glass	0	12.2	24.7	0	25.1	0	25.5	0
CaO 68.0, SiO ₂ 23.0, Al ₂ O ₃ 6.0, Fe ₂ O ₃ 3.0, A/F 2.0								
C ₂ S	57.5	57.3	60.6	60.6	59.6	59.6	59.6	59.6
C ₂ S	22.5	19.5	15.8	20.3	16.2	21.2	15.6	21.0
C ₄ A	10.8	4.9	0	8.6	0	8.9	0	9.8
C ₄ AF	9.1	0	0	9.1	0	9.1	0	9.1
CaO	0	0	0	0	0	0	0	0
C ₄ A ₃	0	0	0	1.5	0	1.0	0	0.5
Glass	0	18.3	23.4	0	24.3	0	24.8	0
CaO 67.0, SiO ₂ 23.0, Al ₂ O ₃ 4.0, Fe ₂ O ₃ 6.0, A/F 0.67								
C ₂ S	62.7	62.3	58.9	63.6	54.6	60.9	55.1	61.5
C ₂ S	18.6	18.4	18.1	18.1	20.2	20.2	19.4	19.4
C ₄ A	0.5	0	0	0.4	0	0.4	0	0.5
C ₄ AF	18.2	17.6	0	18.2	0	18.2	0	18.2
CaO	0	0	0	0.2	0	0.3	0	0.7
C ₄ A ₃	0	0	0	0	0	0	0	0
Glass	0	1.5	22.6	0	25.0	0	25.5	0

It will be noted that, if the liquid crystallized independently, some C_5A_3 would be present in the clinker. Since this phase is rarely observed it is probable, as already pointed out, that complete independent crystallization does not occur. Some reaction probably takes place, and the last portions of the liquid, from which C_5A_3 would separate, solidify as glass.

A study of the phase-equilibrium data show, however, that the changes in composition of the system due to the independent crystallization of the liquid (as compared with equilibrium crystallization) vary with the composition of the system. At A:F ratios above 1.66, the C_3S is increased, the C_2S and C_4A are decreased, and C_5A_3 appears. At A:F ratios below 0.94, the C_3S is decreased, C_2S is increased, and free CaO appears. At A:F ratios between 1.66 and 0.94, no change in composition results through the independent crystallization of the liquid. These changes in the composition of the system caused by the complete independent crystallization of the liquid from 1400° are shown graphically in Figure 72.

In Table 18 a comparison is shown of the computed compositions of three cements, assuming several different methods of cooling from clinkering temperatures, as reported by Lea and Parker.

General Equations

By making use of the derivations described in the preceding pages, Dahl has produced a general classification key and a series of equations by which the compositions of mixtures may be determined at various stages of the heating or cooling process. These tables are given in Appendix 3. The potential composition must first be ascertained, as by the equations in Table A. (The lettered tables refer to those in Appendix 3.) Throughout the Tables, A, B, C and D represent the potential percentages of C_3S , C_2S , C_3A and C_4AF respectively in any mixture or cement clinker under consideration. By reference to the key in Table B, which is more convenient to use than the diagram in Figure 69, the mixture is classified as to type. The equations in Tables C to F are then applied in accordance with the type, and further in accordance with the $C_3A:C_4AF$ ratio, for whatever condition is desired. In the last column of some sections, equations are given for estimating the approximate temperature at which the state of equilibrium represented in that section occurs. (See pages 548-559.)

To illustrate, the composition is taken

C_3S	52
C_2S	24
C_3A	15
C_4AF	9

The classification key shows it to be type A-1. The $C_3A:C_4AF$ ratio is 1.67; thus the equations in Series 8, Table C, are those which will apply. The percent liquid is $1.12 \times 15 + 1.27 \times 9 = 28.2$ percent. The temperature is $1436 - 195 \times 9/28.2 = 1374^\circ$. This is therefore the temperature at which the liquid in this mixture leaves the quintuple line T_2E to follow the C_3S - C_2S surface. The composition of the mixture at 1374° will be found to be

C ₃ S	57.7
C ₂ S	14.0
Liquid	28.2

and if quenched from that temperature, the composition will be the same, glass taking the place of liquid. But if it is assumed that complete independent crystallization of the liquid occurs, the use of the second column of equations in Series 8 will give the composition:

C ₃ S	57.7
C ₂ S	19.7
C ₁ A	9.9
C ₁ A ₂	3.7
C ₁ AF	9.0

Since the glass content of clinker may be estimated either by a heat-of-solution method or microscopically, it becomes possible by making use of such values in the equations to arrive at a more probable phase composition of any given clinker than is possible without such information. The precise course of the crystallization is still not possible to predict, but the assumption may be made that the system is in a state of equilibrium down to the temperature where the liquid remaining solidifies to glass. This is referred to as *normal crystallization*. Thus if the glass found is more than that calculated for liquid at 1400° but less than that calculated at 1450°, it is assumed that the path of the liquid between those two temperatures is a straight line, and the composition of the glass found is assumed to have a composition upon that line. Equations in which the glass found is thus introduced into the computations are given in Tables D and E for types A-1 and B, respectively. The series to be used is found by selecting the one which includes the estimated value of glass (G).

The component magnesia, MgO, may be introduced into the computations very readily, (1) from the information obtained in the phase-equilibrium studies that the crystalline form of that component in cement systems is MgO, and (2) the finding of Brownmiller that the liquid *T*₂ is capable of dissolving about 6.0 per cent MgO. Thus, when MgO is present, the estimated percentage of glass, containing MgO, is not G (which applies only to the system C-A-F-S) but may be designated P. Then G may be calculated from P and M (MgO):

Let P = Glass containing dissolved MgO.

G = Glass in the C-A-F-S system.

M = Total MgO

If M is greater than 0.06P,

$$G = 0.94 P$$

$$\text{Free MgO} = M - .06P$$

If M is less than 0.06P

$$G = P - M$$

$$\text{Free MgO} = 0$$

In the application of the equations for converting oxide analysis of a clinker to potential composition, it is important to determine free CaO and subtract it from the total CaO entering into the reactions. In order to attain the highest degree of refinement possible at this time, it is further suggested that the insoluble

residue, which consists mostly of silica, be subtracted from SiO_2 ; that titania (TiO_2) be subtracted from Al_2O_3 ; and that ferrous oxide (FeO) be calculated to Fe_2O_3 and that quantity subtracted from total iron expressed as Fe_2O_3 . Corrections could also be made for other oxides, as manganese and phosphorus, when it seems advisable.

As suggested earlier, it is probable that the liquid may crystallize independently down to some temperature where it freezes abruptly and glass appears. Such a condition is referred to as *partial independent crystallization*. Equations for type *A-1* compositions are given in Table F for estimating the phase composition with such assumed crystallization.

An illustration of the computations, assuming equilibrium, independent and normal crystallization of a clinker having a known glass content is given in the tabulations of Tables 19 and 20.

TABLE 19. Regular and corrected analysis of a clinker

No. K-2, 19 P	Chemical analysis	Additional analysis	Analysis corrected for minor components
CaO	63.41	62.84
SiO_2	22.06	21.96
Al_2O_3	5.45	5.13
Fe_2O_3	2.81	2.81
MgO	4.73	4.73
SO_329		
K_2O80		
Na_2O28		
Loss.....	.22		
TiO_232	
FeO		0	
Insoluble.....		.10	
Free CaO57	.57
Glass.....		7.0	
Total.....	100.05	98.04

The values obtained for equilibrium crystallization, obtained by use of the equations in Table A, are given in the second column of Table 20. The values shown for partial independent and normal crystallizations in columns 3 and 4, respectively, are obtained by reference to the Tables F and D, respectively.

By reference to the classification key (Table B) it will be seen that $\text{C}_2\text{A}/\text{C}_4\text{AF}$ exceeds 0.64, $\text{C}_2\text{S}/\text{C}_4\text{AF}$ exceeds 0.32, $\text{C}_3\text{A}/\text{C}_4\text{AF}$ is less than 3.3, and C_2S exceeds $(0.77\text{C}_2\text{A} - 0.17\text{C}_4\text{AF})$. This places the composition in type *A-1*. Partial independent crystallization is considered in Table F. Clinkering temperature will be assumed to be 1400° . $\text{C}_3\text{A}/\text{C}_4\text{AF}$ lies between 0.86 and 3.33, so our equations are in Group 12. The glass found, since MgO is present, is designated P, and M is greater than 0.06 P. Hence $G = 0.94 \times 7 = 6.58$. Since G is between $(0.79\text{C}_2\text{A} - 0.68\text{C}_4\text{AF})$ which is 1.17, and $(0.31\text{C}_2\text{A} + 1.73\text{C}_4\text{AF})$ which is 17.53, we use equa-

TABLE 20. Calculated phase composition under different conditions of cooling

	Potential equilibrium crystallization	Partial independent crystallization	Normal crystallization
C ₃ S.....	50.39	51.35	50.30
C ₂ S.....	24.96	23.10	23.89
C ₃ A.....	8.84	6.14	6.72
C ₄ AF.....	8.55	5.56	5.25
MgO.....	4.73	4.31	4.31
CaO.....	.57	.57	.57
Glass.....	0	7.0	7.0
Total.....	98.04	98.03	98.04

tions b, Group 12. Applying these equations, the values shown in the third column of Table 20 are obtained. The free MgO is $M - 0.06P = 4.31$.

The equations for normal crystallization are given in Table D. The C₃A/C₄AF ratio places them in Group 2, but since G is less than 1.99C₄AF, the equations to be used are those of Group 1. The application of these equations gives the values shown in column 4 of Table 20. It should be understood that these equations apply strictly only to compositions within the quaternary system CaO-Al₂O₃-Fe₂O₃-SiO₂. Their application to commercial clinker must be made with definite reservations and the recognition that the other minor constituents play a role which is not herein evaluated.

References

1. Bogue, R. H., *Ind. Eng. Chem. anal. ed.*, **1**, 192 (1929); PCAF Paper 21.
2. Dahl, L. A., *Rock Products*, Nov. 1929, p. 50.
3. Dahl, L. A., *Rock Products*, June to Dec., 1942.
4. Dahl, L. A., *Rock Products*, Sept. to Dec., 1938; *PCA Res. Bull.*, **1**, 1939.
5. Dahl, L. A., Paper presented before the Lehigh Valley Section of the American Chemical Society, Jan. 16, 1942.
6. Lea, F. M. and Parker, T. W., *Bldg. Res. Tech. Paper*, **16**, 1935.
7. McCaffery, R. S., Oesterle, G. E. and Schapiro, L., *Am. Inst. Mining Met. Eng., Pamphlet 1603 C* (1926); abstracted in *Mining Met.*, **7**, 450 (1926).

PART II

The Phase Equilibria of Clinker Components

CHAPTER 11

The Principles of High-temperature Phase Research

Before presenting the various systems of the cement components, it is essential to have a working knowledge of the basic principles underlying the methods of phase equilibrium research. In this chapter, following a development of the concept of the Phase Rule, descriptions are given of the types of systems commonly encountered, the methods used for expressing the results of phase studies, and the interpretation of phase diagrams.

The Phase Rule

Usefulness of the Phase Rule. Basic to an understanding of the reactions which give rise to portland cement clinker, and to a knowledge of the chemical nature of the product, is the concept of high-temperature phase equilibria. By an application of the laws of thermodynamics to the conditions of a heterogeneous system, Gibbs (4) was able to show how, "in a perfectly general manner, free from all hypothetical assumptions as to the molecular condition of the participating substances, all cases of equilibrium could be surveyed and grouped into classes, and how similarities in the behavior of apparently different kinds of systems, or differences in apparently similar systems, can be explained." (3)

Thus it became possible to define the compounds or phases which would be produced from a given mixture of raw materials subjected to a given heat treatment, provided a condition of equilibrium were attained. Without the aid of this rule, the effect of variations in temperature, pressure and concentration would have to be separately considered for every condition investigated, but by the use of the rule "a very large number of previously unrelated phenomena, dealing with changes involving several phases, have been clearly and intelligibly related . . . and predictions of countless reactions not yet investigated may be made in complete safety." (5)

The principles of the phase rule apply only to systems that are in a condition of *true equilibrium*. Such a condition implies two criteria: first, at equilibrium there can be no change in the system with passage of time and, secondly, the same result must be effected when the condition is reached by other procedures. Thus if a salt is dissolving in a liquid, equilibrium is not reached at any temperature until the rate of solution is balanced by the rate of crystallization. And exactly the same concentration of dissolved salt is reached, at true equilibrium, if we start with a dilute solution and allow the liquid to evaporate. But by the latter process, a more concentrated solution *may* be obtained than in the former case, due to failure of the salt to separate. The liquid is then supersaturated, and the system is in *metastable equilibrium*. The addition of a crystal of the salt may bring about the exsolution of the excess salt, and true equilibrium be attained.

In commercial practice, difficulties due to minor components, and to failure to attain a condition of true equilibrium during burning or cooling, require a special treatment but a knowledge of the underlying principles of heterogeneous equilibria is basic to all means that may be employed for the designing and producing of cements to meet the needs of the industry.

Derivation of the Phase Rule. The simplest statement of the phase rule is expressed by the equation

$$F = C - P + 2$$

where F is the variance or degrees of freedom of the system, C the number of components, and P the number of phases present. These terms require a more explicit definition.

A *phase* is a homogeneous body which is bounded by a surface which separates it from another phase. Thus a gas or vapor in any system is a single phase because all gaseous compositions are completely miscible. Liquids are not always miscible so we may have more than one liquid phase present at one time. And we may have several solid phases distinctive in composition or structure. Discrete particles of a solid body, even though separated, are by definition a single phase.

The *components* of a system are the least number of independently variable constituents which can completely define the composition of every phase in the system. Thus in the application of heat to CaCO_3 , every possible composition at any given temperature and pressure can be expressed mathematically in terms of CaO and CO_2 ; hence these are the components of the system.

The *variance* or *degrees of freedom* are the independently variable conditions of concentration, temperature and pressure. Other effects—electrical, optical, etc.—are arbitrarily excluded, because in the usual equilibrium studies their effects are negligible. Furthermore, when the study is of high-temperature equilibria and conducted at one atmosphere pressure, the vapor pressure of the materials is usually negligible and pressure may be excluded as a variable. Such systems are spoken of as *condensed systems*.

Energy of all forms contains a capacity factor and an intensity factor, but if the intensity factor is identical in two bodies they will be in a state of equilibrium with reference to the energy under consideration, irrespective of the differences that may obtain in the capacity factor. A liter of water in a beaker will be in hydrostatic equilibrium with the ocean, when connected by a syphon, provided the "head" is the same, *i.e.*, they are at the same level; but if the head of one is higher than the other, then the one will flow into the other in the effort to establish a uniform potential. The same principle applies to heat, to electricity, to chemical reactivity. If there is an unbalance in the intensity factor, or chemical potential, between two adjacent bodies, then there will be a tendency to a chemical reaction by which it becomes equalized. A solid cannot remain unchanged in contact with a liquid unless the potentials of solution and of crystallization are identical.

The chemical potential of any phase will be determined by the three factors: temperature, pressure and concentration. In a system at equilibrium there is one variable due to temperature and one due to pressure, so the variables due to those factors equal 2. The concentration of each phase may be expressed by one less

than the number of components of that phase; that is, the composition of AB is defined by the fractional content of either A or B ; and the composition of ABC by the fractional content of any two of its three components. Hence the concentration variables of each phase are given by $C - 1$, and of P phases by $P(C - 1)$. Adding to this the two variables of temperature and pressure, the total variables in any system equal $P(C - 1) + 2$.

The above variables are related thermodynamically to the chemical potential by the equation:

$$vdp = \eta dt + m_1 d\mu_1 + m_2 d\mu_2 + \dots + m_n d\mu_n$$

in which v , p , η , and t represent the volume, pressure, entropy, and temperature, respectively, $m_1, m_2 \dots m_n$ the masses of the n components, and $\mu_1, \mu_2 \dots \mu_n$ the chemical potentials of these components. This is the fundamental equation of the phase rule. In condensed systems the volume-pressure component may be ignored, and the equation is then written:

$$-\eta dt = m_1 d\mu_1 + m_2 d\mu_2 + \dots + m_n d\mu_n$$

The equilibrium of any one component distributed among several phases is defined by one less than the number of such phases, because when two phases are in equilibrium the chemical potential is the same in the two phases. So for each component there are required $P - 1$ equations, and for C components, $C(P - 1)$ equations, to define the chemical potential or equilibrium. Since there are $P(C - 1) + 2$ variables, and $C(P - 1)$ equations are necessary to define the system, then the number of undefined variables in any given condition is expressed by the difference between these values, or

$$F = [P(C - 1) + 2] - [C(P - 1)] = C - P + 2$$

From the above equation a number of important deductions can be made. Suppose we consider a system of two components (a binary system), as CaO-SiO_2 . It will be seen that the maximum number of phases possible is 4, in which case $F = 0$. That is, in a binary system, we may have two solid phases in equilibrium with liquid and vapor but under these conditions there is no variable of either composition or temperature. Such a condition is stable at only one composition and one temperature, and so is spoken of as invariant. But if only one solid phase is in equilibrium with liquid and vapor, $F = 1$ and either composition or temperature (but not both) may be changed without disturbing the equilibrium. Or if only liquid is in equilibrium with vapor, $F = 2$ and both composition and temperature may be changed. This much is known from the phase rule, but the composition and temperature at the invariant point of the first condition mentioned, or the range of variation permissible under the other two conditions, can be ascertained only by experimentation.

Likewise in a system of three components (ternary system), as $\text{CaO-Al}_2\text{O}_3\text{-SiO}_2$, we have an invariant condition when three solid phases are in equilibrium with liquid and vapor, a monovariant condition when two solid phases, and a bivariant condition when one solid phase are similarly in equilibrium with liquid and vapor. The experimental work then consists in ascertaining the com-

positions and temperature range of stability of the stable or metastable phases, and the course of liquefaction or crystallization from the location of boundary curves between phases, and of invariant points.

Such study is usually carried out by heating together mixtures of systematically varying composition in the system at various rigidly controlled temperatures until a state of equilibrium is reached, and observing the characteristics of the products formed. Or the thoroughly disseminated mixture may be heated at a constant slow rate (or similarly cooled) and the changes in energy observed by plotting temperature against time. These procedures will presently be described.

Binary Systems

The simplest type of phase equilibrium is one in which no compounds are formed by interaction between the components of the system. We shall consider first the binary systems, proceeding from the simpler types, and make use of hypothetical conditions for the illustration of characteristic courses of crystallization. In Figure 73A is shown a concentration-temperature diagram for the system AB , in which no compounds are formed. Such diagrams may indicate either weight percent or mol percent of the components. The former is more commonly employed. This diagram reveals a great deal of information. If a composition represented by b (on the abscissa) is heated to a temperature above b (on the ordinate), only liquid will be present. On cooling to a temperature of b , solid A will separate out. Since the composition of the separating solid is different from that of the liquid, the composition of the latter, during the separation of the solid, will move in a direction away from the A ordinate. The diagram shows that, as A separates with falling temperatures, the composition of the liquid moves down the curve bk . Thus the curve ak is the solubility curve of A in liquids of composition ranging from d to k , and shows both liquid compositions and melting temperatures. Likewise the curve yk shows the solubility relations of B in liquids of compositions e to k . At point k , the liquid has reached a condition of saturation with respect to both A and B , so both solids are here in equilibrium with liquid and vapor. By the principle of the phase rule, k is therefore a quaternary invariant point, the composition and temperature being fixed.

The diagram also indicates the quantitative relationship between the solid and liquid phases at any temperature. This relationship is always a linear function of the section of the composition axis that is involved in the period referred to. Thus at the moment when the liquid, originally of composition b , has reached k , the solid phase consists solely of A , the amount of which is found by noting the fractional distance of the composition interval dk that has been traversed by the liquid in passing from b to k . Thus the fraction of A separated is ck/dk (c is the composition of b projected onto the isotherm of the invariant-point temperature, de). Likewise, the fraction of liquid remaining is dc/dk .

The above calculations are for the condition of *maximum* heat content at temperature k . But, as heat is removed at this temperature, B begins to separate out and continues to do so, with simultaneous continued separation of A , and without change in temperature, until the material is wholly solid. The relative amounts of A and B in the mixture at this condition of *minimum* heat content at temperature k can be computed from the fractional part of the compositional line

de which is referred to the two compounds in reference to the original composition: A separated = ec/ed , and B separated = cd/ed .

The simplest condition of a binary system where a compound is formed is shown in Figure 73B. Here the compound AB is formed, which is shown to have

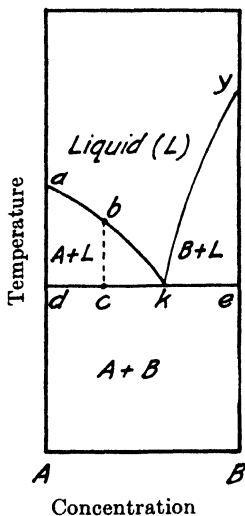

Figure 73A. Form of binary system, with one compound or solid solution formation.

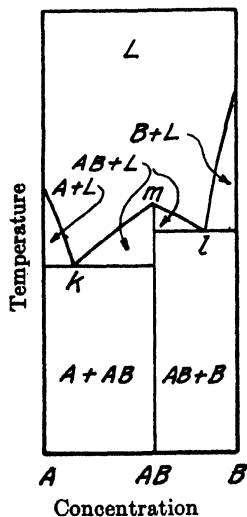

Figure 73B. Form of binary system, with formation of a compound melting congruently.

a melting point of m . Each section of the diagram, $A-AB$ and $AB-B$, can then be considered as a separate binary system, the compound forming with A an invariant composition at k , and with B at l .

Another important condition which may occur is the formation of a compound which dissociates at its melting point into liquid and a solid phase of composition

differing from its own. Such a phase, dissociating at its melting point, is spoken of as melting incongruently, or having an *incongruent melting point*, in distinction to the phases which melt into a liquid of their own composition, spoken of as melting congruently, or having a *congruent melting point*.

Such a condition is shown in the compound AB of Figure 73C, which is seen to dissociate at temperature f into liquid, and solid A . Thus if a sample of composition AB were heated to fusion and cooled, A would appear at temperature g . On further cooling, A would continue to separate until a temperature and liquid composition of h were reached. But upon further removal of heat at temperature h , AB would form and A would dissolve, until only AB remained. During this process, the mean composition of the solid phases would move along the line dh , and when point f was reached, the original composition, solidification would be complete. Likewise, for any compositions between A and AB , the liquid would proceed down the curve ah to h , and final solidification of the liquid would be at that temperature, the solid moving along dh until it reached the original composition between d and f . If the original composition were between AB and that represented by point h on the abscissa, then again A would first appear, and when the liquid reached h , AB would separate and A dissolve as before. But when the mean composition of the solids had reached point f , only AB would remain in solid form but there would still be liquid left. From that moment, with reduction in heat content, the temperature would drop and the liquid follow the curve hr to r , while solid AB separated alone. At r , B also would appear and the final solidification take place at that temperature with separation of AB and B .

This introduces the condition of two invariant points, at h and r , at either one of which the mixture may complete solidification depending on the original composition. Point r differs from point h in being the lowest temperature at which the liquid phase can be formed without remainder from the solid phases, and consequently is intermediate between the two separating solids (AB and B). Such an invariant point is known as a *eutectic*, and applies to points k and l in Figures 73A and 73B. But point h , Figure 73C, lies beyond the composition line connecting the two separating solids (A and AB), and is therefore not a eutectic. Invariant points which are not eutectics are sometimes referred to as *peritectic points*.

Still another condition often met in phase studies is that of the formation of *solid solution* between two of the compounds. Under this condition, the composition of the solid phase varies in a regular manner with the composition of the liquid as the temperature is raised or lowered. This condition is represented in Figure 73D. A limited solid solution is assumed to be formed of A in B . Thus if a composition m were heated to fusion and cooled to temperature m , the solid phase to separate would not be that of pure B but rather would be a solid solution of A in B . In order to indicate the composition of this solid solution, a different type of curve is required. In the previous diagrams of Figure 73, the curves have represented the relation between composition and the temperature of complete fusion. These are spoken of as *liquidus* curves. But when solid solution occurs, it is necessary also to produce a curve which represents the composition of the solid phase in equilibrium with the liquid at any temperature. These are spoken of as *solidus* curves. The composition of the solid solution which will separate from a liquid at any temperature is then found by the intersection on the solidus curve of a hori-

zontal line drawn from the point on the liquidus curve at the temperature under consideration.

Thus in Figure 73D, the solid separating from the liquid of composition m at temperature m , is seen to have the composition n . On further cooling, the composi-

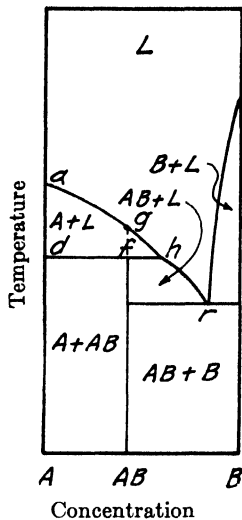

Figure 73C. Form of binary system, with formation of a compound melting incongruently.

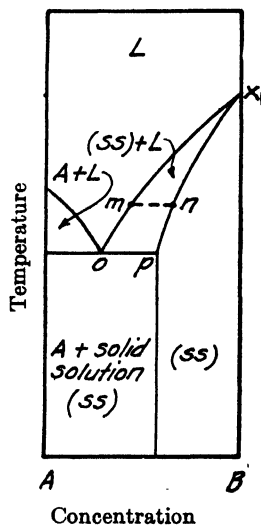

Figure 73D. Form of binary system, with formation of a limited solid solution series.

tion of the liquid will move away from that of the separating phase, toward o , and that of the solid solution will follow the solidus curve from n to p . At the eutectic point o , solid A will appear, and the two phases, A and solid solution of composition p will separate together until crystallization is complete.

The condition of a continuous series of solid solutions between two components is represented by the diagram in Figure 73E. If a mixture of composition c were heated to fusion and cooled, the first solid to separate at temperature c would have the composition r . As cooling continued, the composition of the liquid would move down the curve cs , and the composition of the solid phase separating would move down the curve rs . Under conditions of complete equilibrium at every moment, the solid solution compositions represented along the solidus curve indicate not only the composition of the solid phase separating at that moment, but the composition of the entire solid phase which has separated up to that moment. That is, in order to maintain complete equilibrium, the composition of the solid phase previously crystallized must, by continued interaction with the

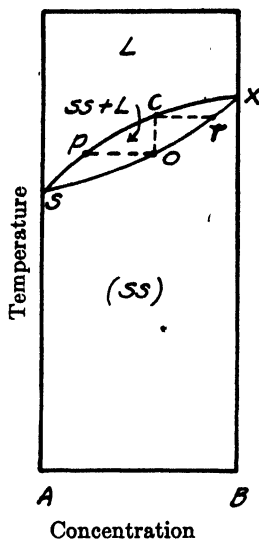

Figure 73E. Form of binary system, with formation of a continuous solid solution series.

liquid, change its composition so that it is uniform throughout. In such case, the last portion of liquid will disappear when the composition of the solid phase reaches that of the original composition of the mixture; in this case (Figure 73E), point o . The composition of the last increment of liquid at that temperature will be represented by point p .

Long periods of very slow cooling or heating are usually required for such a condition to be attained. Otherwise, the newly formed solid crystallizes around the core of previously separated solid. In this case, the solid phase is not uniform in composition, but varies from an inner zone of composition r (Figure 73E) to an outer layer of composition s . The final solidification would then occur with both liquid and solid compositions converging at point s . Such a character of separation is spoken of as *independent crystallization*. In practice there probably usually obtains some intermediate condition between complete equilibrium and independent crystallization. For that reason, the calculation of phase compositions where solid solution occurs is often uncertain.

Polycomponent Systems

The most convenient method for representing the relationships in a ternary system is by use of a diagram produced on an equilateral triangle. Every possible composition can readily be indicated by causing the three vertices to represent the three components of the system. The three sides of the triangle then indicate the compositions throughout the binary systems of the major components. Temperatures cannot be so advantageously indicated on the ternary diagram, but it has become usual practice to consider temperatures as vertical heights above the plane of the diagram. Thus a solid model can be constructed on which the various surfaces represent the bivariant composition areas where a solid and liquid phase are in equilibrium at the temperatures represented by the vertical height of the surface. The lines of convergence between surfaces represent the monovariant compositions where two solid phases are in equilibrium with liquid at the indicated temperatures. The points where three surfaces meet represent the invariant compositions where three solid phases are in equilibrium with liquid at the temperature indicated. The composition limitations and locations of these areas (fields of primary crystallization), lines (boundary curves), and points (invariant points) may be indicated adequately on the triangular diagram, and the temperatures are best indicated by isothermal lines.

Binary systems within the ternary system are represented by joins between the two compounds constituting such systems: that is, where all combinations of those compounds may be represented by compositions along the join. In addition, lines commonly are drawn between each pair of compounds which have a common boundary curve. In that way the diagram is caused to be divided into a number of small triangles, the compounds at the vertices of which represent the phases which will be produced by any composition within that triangle on final complete equilibrium crystallization.

No Compound Formation. The simplest type of condition which may be met in a ternary system is that in which no reactions occur between the three components of the system. A diagram for such a system is shown in Figure 74. The components *A*, *B* and *C* are shown at the apices of the triangle. The line *AB* thus represents the concentration diagram for the binary system *A-B*. No compound formation is shown, and a eutectic appears between the phases *A* and *B* at *d*. Temperatures are indicated, and the directions of falling temperature are shown by the arrows along the line, always arriving at a minimum value at the eutectic. Likewise, the system *AC* shows a eutectic at *f*, and the system *BC* at *e*.

Now if we make mixtures of the three components, heat to complete fusion and cool slowly, we will find on quenching these charges from various temperatures (provided crystallization is not too rapid), that we can freeze the liquid to a glass (undercooled liquid) and so prevent the further crystallization which would follow if the cooling were done more slowly. When quenched from temperatures above the point of complete fusion, the entire mass will be glass. But at some temperature a single crystalline phase will appear, and this temperature is the melting point of each particular composition. The phase which separates is spoken of as the *primary phase*. By repeated tests of similar character, we can define the entire range of compositions within which the primary phase will consist of *A* or of *B*

or of C , and likewise establish the melting temperatures from which may be drawn isotherms of melting points, as indicated.

The Course of Crystallization. Suppose we start with a composition h (Figure 74). From the diagram it will be seen that this occurs in the primary phase region of B . As we cool a melt of composition h , B will appear at a temperature of about 975° and the composition of the liquid, with further cooling and separation of B , will of necessity move in a direction directly away from B , that is along the line hk , and at a temperature of about 920° will reach the composition of point k . At this moment, the proportion of solid B and of liquid, stable indefinitely at the temperature of k , can be computed readily by noting the relative linear proportion of the composition line Bk which has been affected by the crystallization. That is, the fraction of B at that point is kh/kB and of liquid hB/kB . In a similar manner we may compute the proportions of these two phases present at any given tem-

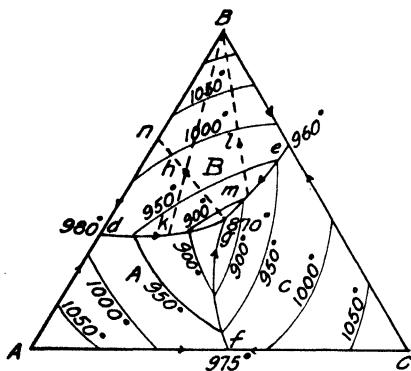

Figure 74. The ternary system with no compounds formed, showing isotherms.

perature by making the computation from the intersection of the isotherm of that temperature with the line Bk .

Now at the temperature representing the melting point of k , about 920° in the diagram, the phase A also has reached its state of saturation in the liquid and, with further reductions in temperature, will separate out simultaneously with B . Consequently, the composition of the liquid will now be away from both B and A , along the line of their identical melting points, that is along a line which represents the compositions of the liquid at reducing temperatures, as these two phases separate from it. Such a line is spoken of as the *boundary curve* between A and B . Along such a curve, as pointed out by Dahl, (2) the escaping tendencies of A and of B from the melt are identical. At length, a temperature will be reached, 870° on the diagram, where the saturation point of C has been reached (its escaping tendency equal to that of A and B), which is designated as point g . At the moment of arriving at this temperature, only A , B and liquid are present, and the relative amounts of each phase may be computed. The mean composition of the solid phases at this moment must be at a point on the line AB , connecting the two solid phases which have separated, which point is located by extending the line passing from the composition of the liquid, g , through the composition of the original mixture, h . This will be point n . The fraction of solids will be shown by the relative proportion of the composition line ng which has been concerned in the

separation of the solids, that is, total solids = gh/gn and of liquid, hn/gr . And the fraction of A in the solids will be seen to be Bn/BA , and of B , nA/BA .

As heat is removed from the melt at 870° , the temperature of g , the three phases A , B and C will separate together, and continue to do so until the entire mixture is solid. The percentage of the three phases can then be noted directly from the composition of the original mixture at h , that is, 32 percent A , 55 percent B and 13 percent C . Point g is seen to indicate a composition and temperature where three solid phases, liquid and vapor can coexist. Hence it is a quintuple invariant point. And since the temperature is a minimum for the coexistence of three solid phases with liquid, it is also a ternary eutectic.

If the composition l were used, instead of h , B would still be the primary phase to separate out, but on cooling to a temperature of about 920° , the composition of the liquid would have arrived at m , where it would be saturated with respect to C instead of A , and then C would crystallize together with B . In such case, the liquid would move away from B and C until the saturation point of A were reached, at 870° , where the three solid phases would separate together. Thus the liquid composition would move from l to m and thence again to g . Thus, regardless of the composition in the entire system $A-B-C$, the last liquid to crystallize on cooling, and also the first to be formed on heating, will be that of the ternary eutectic. If located in the field bounded by $Adgf$, the primary phase will be A ; if bounded by $Bdge$, it will be B ; if bounded by $Cfge$, it will be C . If the composition falls exactly on a boundary curve, as dg , then the two phases separated by that curve, A and B in this case, will separate simultaneously. If located at the ternary eutectic, in this case g , then the three phases will separate together.

Dahl's Method of Computing Composition. Another method for the computation of the relative percentages of the several phases which will be present at any given temperature of a specified composition in equilibrium, has been suggested by Dahl (2). For the purpose of illustrating this method, the points g and h of Figure 74 have been transferred to Figure 75. Let us assume the condition where the mixture of composition h has been cooled from fusion until the temperature of 870° has just been reached. The solid phases separated then consist, as already shown, of A and B , and the liquid has the composition of g . Lines are drawn, gA and gB , connecting the composition of the liquid with those of the solid phases which have separated out. Thus the triangle gAB contains all possible mixtures which are composed of liquid g and solids A and B at equilibrium when 870° is just reached (that is, at the condition of maximum heat content). Lines hp and hs are then drawn from the original composition h , parallel respectively to gB and gA , intersecting the composition line AB at p and s . Now taking the line AB as unity, the segment Bp is the fractional proportion of solid A , the segment As is the fractional proportion of solid B , and the segment ps is the fractional proportion of liquid g which are at equilibrium under the specified conditions.

From what has been said, it will be seen that, on cooling liquids in the primary phase region of B , the second phase to crystallize may be either A or C depending on whether the original composition of the mixture is on one side or the other of the line connecting B with that of the eutectic composition, g . This is seen from the observation that the liquid of all compositions in the section of B bounded by Bdg will, on separation of B , fall to meet the line dg which separates the field of

B from that of A . Hence the second phase to separate from compositions in the area Bdg will be A . But it also will be observed that all compositions in the section Beg will, on separation of B , fall to meet the line eg , which separates the field of B from that of C . Hence the second phase to separate from compositions in the area Beg will be C . Similarly, lines connecting the eutectic, g , with each of the other separating phase compositions, A and C , will divide that primary field into two parts which indicate the nature of the second phase to crystallize. Thus the triangle ABg represents the region of compositions in which A and B may separate together; the triangle ACg , that in which A and C may separate together; and BCg , that in which B and C may separate together.

Also it has been noted that, with composition h , the phases present in equilibrium at the eutectic temperature of 870° under conditions of maximum heat content were B , A and liquid g . This same condition will then be seen to prevail for all compositions in the triangle ABg . But, for compositions in the triangle ACg , the phases present in equilibrium at 870° under conditions of maximum heat

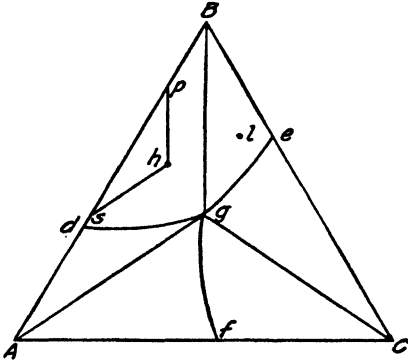

Figure 75. Same as Figure 74, illustrating Dahl's method of calculation.

content will be A , C and liquid g . And for compositions in the triangle BCg they will be B , C and liquid g . In other words, there may be any of the three possible combinations of the two solid phases in equilibrium with liquid g at the moment when the temperature of 870° is just reached on cooling. This is the condition referred to by Dahl as that of maximum heat content. But on the removal of heat at this point, there will result a crystallization of the third solid phase without drop in temperature until only the three solid phases remain. That condition, also at 870° , is therefore the condition of minimum heat content. Since changes in the relative proportions of the phases occur at the eutectic between the conditions of maximum and minimum heat content without change in temperature, the phase composition can be defined within this range only by a knowledge or measurement of heat content.

It should be pointed out that the conditions cited have all assumed a rate of cooling such that a state of equilibrium is always maintained. With some mixtures, however, especially in high-silica compositions, the crystallization is very sluggish. In such cases it is necessary for prolonged heating at the desired temperature to bring about equilibrium and even by such treatment there may be much uncertainty as to the actual attainment of that condition. When equilibrium

is not reached on cooling, the liquid will undercool to a greater or lesser degree, and (to use an illustration from Figure 74) the liquid from composition l may cool below 920° (point m) without phase C separating out. In such cases there will be produced metastable phases and the true boundary curves may be difficult to establish.

Compound Formation, Stable at Melting Point. Where a binary compound is formed between two of the components in a ternary system, there may result various aspects of crystallization which require special treatment. The simplest case is shown by the diagram in Figure 76. Here the compound AB is formed, stable at its melting point, and having with A a binary eutectic at t and, with B , a binary eutectic at u . The field of primary crystallization of AB in the ternary system is defined by the area $turo$. This compound is shown to exist in equilibrium with A and liquid along the boundary curve to , with C and liquid along ro and with B and liquid along ur .

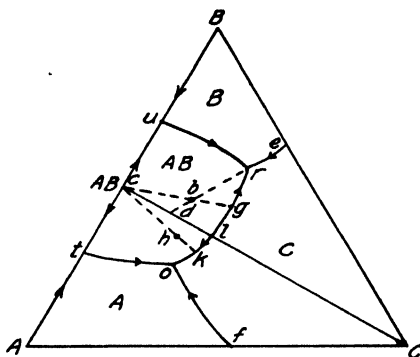

Figure 76. Ternary system with one compound, melting congruently.

It is of especial importance to observe the conditions of crystallization in the field of the new compound because it brings out points not heretofore observed. If we start with a composition b and cool from a fused condition, the phase AB will first separate out. The composition of the liquid will then follow the extension of cb until it reaches ro at g , the temperature where the liquid is saturated with respect to C , and the two phases AB and C separate together. Since that happens, the composition of the liquid must move away from both AB and C , that is, by following the boundary curve ro in the direction of r . It cannot follow the curve toward o because it would then be approaching the composition of the very phases which are separating from it, which is obviously impossible. As the liquid approaches r , and AB and C are separating as solid phases, the mean composition of the solids must follow the line connecting the original solid phase, AB , with the second solid phase, C . At the moment when the liquid reaches point r , the mean composition of the solid phases will then be represented by the intersection of the line rb extended with $AB-C$, which is point d . At this temperature the phase B also appears and the three phases separate together to complete crystallization. The point r is therefore a ternary eutectic and quintuple point for the phases AB , C and B . During this last period of crystallization between the conditions of maximum and minimum heat content at the temperature and liquid composition

of r , the mean composition of the solid phases will move from point d to b , and the final phase composition can be noted by one of the methods already given.

It will also be seen that if the composition h were used, still in the field AB , the boundary curve ro would be met by the liquid at k , and since it must then proceed away from the line of the separating phases, $AB-C$, it must follow the curve this time in the direction of o , and final solidification will now occur with AB , C and A at the ternary eutectic and quintuple point, o .

From the above it will be noted that the line $AB-C$ divides the triangle $A-B-C$ into two fields, in one of which final solidification occurs at r between AB , C and B ; and in the other of which final solidification occurs at o between AB , C and A . It may be noted further that the temperatures along $AB-C$ fall from both end members towards the intersection with the boundary curve ro at l . Hence the compounds AB and C may be considered as the components of a binary system $AB-C$, forming no compounds but having a binary eutectic at l .

The intersection of the boundary curve ro with the tie-line $AB-C$ at l represents, however, a high-point on the boundary curve. This is a necessary relationship in phase equilibria, as has been pointed out by von Alkamade (1).

Compound Formation Unstable at Its Melting Point. The condition is shown in Figure 77 of a binary compound, AB_2 , having an incongruent melting point,

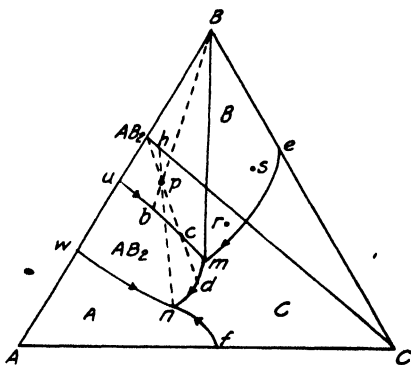

Figure 77. Ternary system with one compound, melting incongruently.

in this case dissociating at its melting point into B and liquid. It is shown however to have a field of stability in equilibrium with the liquid both in the binary and in the ternary systems. The course of crystallization here brings out some interesting effects. If we start with a composition p in the primary field of B and below the tie-line AB_2-C , the liquid will proceed to b while solid B separates out. Here AB_2 appears, and as the liquid follows down the boundary curve um between B and AB_2 , the mean composition of the solids will proceed from B toward AB_2 . But when the liquid has reached the composition of c , the solid phase has arrived at AB_2 , and the phase B has entirely disappeared. This represents a condition met in certain parts of the system where compounds having incongruent melting points are involved. A phase separating at one temperature may, in the course of a given reduction in temperature, be completely dissolved and a new phase appear as primary. The liquid having arrived at c can then no longer follow the boundary curve um , for only one solid phase, AB_2 , is separating from it. Hence with reduc-

tions in temperature the liquid will cut across the field of AB_2 , the composition of the solid remaining fixed at AB_2 , until the former meets the boundary curve separating the fields of AB_2 and C at d . Here C will appear as a solid phase and the liquid will follow the boundary mn between these two phases until it reaches n . Meanwhile, since both AB_2 and C have been separating, the mean composition of the solids will follow the line connecting those phases, AB_2-C . When the liquid reaches n , the solids will have reached point h . At this temperature phase A appears and the composition of the solids follows down the line hn until it reaches the original composition of the mixture at point p , where the last of the liquid of composition n has crystallized. Point n is therefore the quintuple point and ternary eutectic for the phases AB_2 , C and A .

It will be observed also from Figure 77 that if composition r were considered, located to the right of the line Bm and below the tie-line AB_2-C , B would separate until the liquid reached the boundary curve em , following which B and C would separate together until point m were reached where AB_2 also appeared. Then as AB_2 and C separated, B would dissolve until only AB_2 and C were left. The liquid would then leave m and proceed to n , at which point crystallization would be concluded with the appearance of A . In this case we find that point m , though a quintuple point for AB_2 , B and C , is not a eutectic point, but that falling temperatures will take the liquids of certain compositions along a boundary curve to another quintuple point which is a eutectic.

If the starting composition were above the tie-line AB_2-C , as at s , it will be noted however that the conclusion of crystallization takes place at m , for the solid phases, on departing from the line BC while the liquid is at m , will reach the original composition, s , before the phase B has disappeared, and there crystallization is complete. In this process it will be observed that one solid phase in equilibrium at an invariant point which is not a eutectic will decrease, and may disappear entirely, as crystallization proceeds. The diminishing or disappearing phase is obviously that which would not be represented along the boundary curve to be followed were the liquid to proceed to the eutectic. The manner of computing the phase compositions of these various points, both at maximum and at minimum heat contents, has been described.

The above treatment will again illustrate the principle that tie-lines connecting phases which have a common boundary curve, where they are in equilibrium with liquid and each other, as AB_2-C , will divide the triangle of the whole system in triangular areas within which the final products of equilibrium crystallization will be indicated by the components at the vertices of these small triangles.

It was noted in the consideration of Figure 76 that the tie-line $AB-C$ represented a true binary system, since every composition of the solid phases in equilibrium with liquid throughout the composition range of the entire line could be indicated by a point on the line. But this is not true for the line AB_2-C in Figure 77, since a part of the line passes through the primary-phase region of B , and the composition B cannot be indicated by any point on the line AB_2-C . Such a system is sometimes spoken of as a *pseudo-binary* system.

Other forms of crystallization will be met in the course of phase investigations, but the illustrations given will serve as a working basis for the interpretation of most cases, except those of solid solution, which will require a special treatment.

Stages Followed with Heat Input. The above consideration of the states of equilibrium have been developed from the point of view of crystallization from liquid because the argument is easier to follow with reducing temperatures. In the manufacture of portland cement, however, the application is more often to the state of a mixture at some given temperature. To follow the necessary reasoning we will assume that we have a mixture of *A*, *B* and *C* represented by point *h*

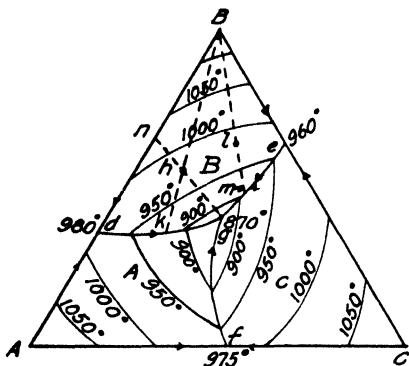

Figure 74. The ternary system with no compounds formed, showing isotherms.

in Figure 74. As the temperature is raised, liquid will appear at 870° , the composition of which is that of point *g*. As heat is added, more liquid will be formed without change in temperature until all of the material *C* has been dissolved, and the composition of the solid phases remaining is indicated by point *n*. The methods for calculating the relative amounts of *A*, *B* and liquid at this moment have already been given. With the application of further heat the temperature will rise and the phase *A* will go into solution until at a liquid composition of *k* and a

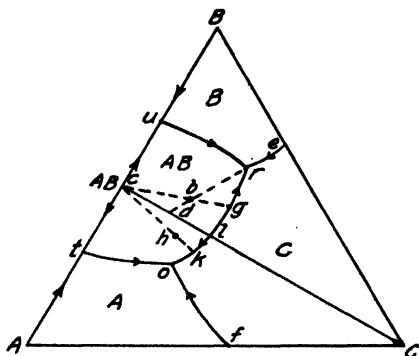

Figure 76. Ternary system with one compound, melting congruently.

temperature of about 920° only the phase *B* will remain in solid form. With further application of heat the temperature will rise until with increasing solution of *B*, at a temperature of about 975° , the last solid disappears.

Usually the melting relations are more complicated. Suppose we have a mixture of *A*, *B* and *C* represented by point *b* in Figure 76. When the temperature is raised to that of the eutectic *r*, we have arrived at a condition where *AB*, *B*

curve, there is a condition of equilibrium which the components or compounds tend to approach and, if given sufficient time and the individual grains are sufficiently intimately mixed, will attain. The tracing of these solid-solid reactions is often difficult because of the time period usually required.

Crystallization in Ternary Systems Containing Solid Solutions

As we have already seen in the discussion of binary systems, the separation of a solid solution introduces one important change in the process of crystallization: the solid phase separating no longer has a constant composition over a temperature range within which the liquid is changing, but on the contrary the solid phase has a continuously varying composition with each change in the liquid as the temperature rises or falls. This fact necessitates a different method for representing the course of crystallization of a ternary system.

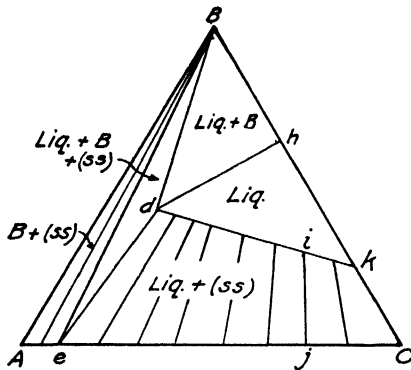

Figure 78. Phase relations with solid solution at temperature T_2 .

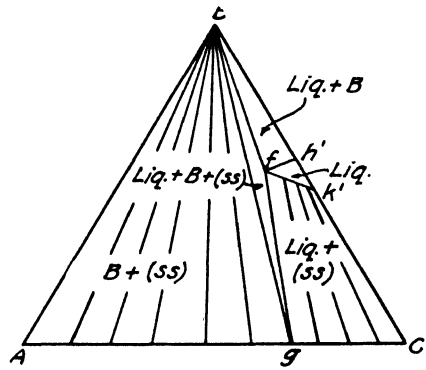

Figure 79. Phase relations with solid solution at temperature T_1 .

Suppose we start with a ternary system, $A-B-C$ in which A and C form a continuous series of solid solutions, and make a study of the phases present in various compositions at some temperature, T_2 , at which we have liquid present in a considerable part of the system. We may obtain results which can be represented by the phase relations indicated in Figure 78. At this temperature we find that the region of compositions represented by hdk consists solely of liquid. The region Bdh consists of solid B and liquid. In all other areas we find a solid solution phase of A and C together with some other phase or phases. Thus in the area ABe we find B and solid solution (indicated by ss); in area Bed , we have B , ss and liquid; in area $edkC$, we have ss and liquid. But it will be noted that the composition of the solid solution phase varies in accordance with the composition of the original mixture. Thus any point on the line ij will consist, at this temperature, of liquid of composition i and ss of composition j . In order to indicate these solid-solution compositions which are in equilibrium with liquid or other solids, the three-phase (solid-liquid-vapor or solid-solid vapor) lines are drawn in, of which ij is an example.

If now we repeat the process at some lower temperature, T_1 , we may obtain results as shown in Figure 79. Here the area in which liquid is present is much

less, and the area of $B + ss$ is much larger. The region of complete melting, $fh'k'$ has been moved over to a very small area. The area at T_2 (Figure 78) in which two solid phases were in equilibrium with liquid, Bed , has been shifted, at T_1 , far toward the BC axis (Figure 79) to the position Bgf , and the composition of the solid solution within that range of composition has moved from e to g .

By several repetitions of this procedure we are able to locate the loci of points which represent the compositions at which B , ss and liquid are in equilibrium at various temperatures, that is, the liquidus boundary curve separating B and ss , upon which d in Figure 78 and f in Figure 79, are two points at T_2 and T_1 respectively. When these are plotted we obtain the boundary curve xy shown in Figure 80, with d and f appearing upon it. In like manner, we may plot upon the solid solution line AC the corresponding compositions with which d, f and similar points were in equilibrium. Thus from Figure 78, d was in equilibrium with solid

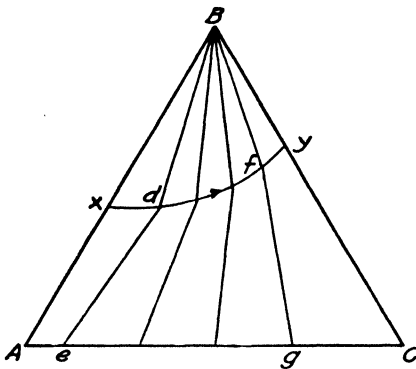

Figure 80. Three-phase boundaries with solid solutions.

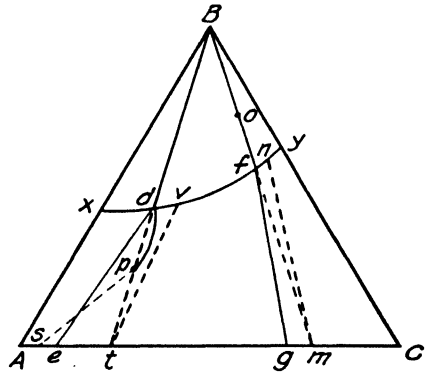

Figure 81. Course of crystallization with solid solutions.

solution e . Hence in Figure 80, d and e are joined. Likewise f and g are joined, and other points similarly identified. This gives a diagram showing the boundary curve and the conjugation, or solid-phase-indicating lines, which indicate the composition of the solid phase in equilibrium with every possible liquid composition in the system.

The actual course of crystallization may now be indicated. If we start with a composition o , Figure 81, solid B will separate out when the temperature of a melt has been reduced to the isotherm representing the liquidus temperature of that composition. As the temperature is lowered, and B continues to separate out, the composition of the liquid will follow the extension of the line Bo until it reaches the boundary curve at f . At this temperature solid solution of $A + C$ will appear, and from the three-phase lines of Figure 80 we observe that the composition of the ss separating at that moment will be indicated by point g . With further cooling, the liquid will move along the boundary curve xy toward y , and with each increment of that change in liquid composition, the composition of the ss will move along AC toward C . Crystallization will be complete when the composition of the ss has reached a point, indicated by m , which is an exten-

sion on AC of the line Bo . At this moment the composition of the last liquid to solidify will have reached point n . The mixture will then consist of ss of composition m , and B , the relative amounts of which may be noted by the increments $om/Bm = B$ and $oB/Bm = ss$.

If we start with a composition in the ss primary-phase region, $AxyC$, the course of crystallization is a little more complicated. Starting with a mixture p , Figure 81, and cooling a melt, the first solid to form will be a solid solution of composition which may be indicated by point s . The liquid on cooling follows the curve pd and, in the course of this cooling, the composition of the ss changes along the line AC toward C . When the liquid reaches the boundary curve xy at d , the composition of the ss will be noted, from the three-phase boundaries of Figure 80, to have reached e . With further cooling, solid B separates with ss and the liquid follows xy toward y , the ss following AC toward C . Crystallization will be complete when the composition of the ss has reached a point, indicated by t , which is an extension on AC of the line Bp . At this moment the composition of the last liquid to solidify will have reached point v . The mixture then will consist of ss of composition t , and B , the relative amounts of which may be noted by the increments $pt/Bt = B$ and $Bp/Bt = ss$.

In the foregoing treatment, it has been assumed that a sufficient length of time has been allowed for the condition of equilibrium to be fully attained at every increment of temperature change. In such case, as the composition of the ss changes along AC , the ss formed at one temperature will have been changed completely into the ss of a different composition at succeeding diminishing temperatures. Often however, as indicated above, this change is sluggish and with dropping temperatures solid solutions of different compositions separate without, however, the conversion of earlier-formed ss into the new equilibrium product. In that case there is a zoned structure of ss of more or less continuously varying composition. When this happens, the crystallization process is unbalanced. At true equilibrium any point on Bt , Figure 81, would, as we have seen, complete its crystallization when the ss had reached point t and the liquid point v . But if the composition of ss is not converted completely to t , the effect will be to leave an excess of C in the liquid, which will then proceed further along the boundary curve xy before solidification is complete, and may almost reach point y . The zoned ss will then vary over a considerable portion of the range from A with only a small amount of C , to C with only a small amount of A . The temperature of final solidification would likewise be lowered.

The procedure adopted for the determination of quaternary or more complex systems has been handled in various ways, but usually by some scheme whereby either true or pseudo-binary or ternary systems may be separately explored. Usually a number of arbitrary planes are indicated in a quaternary tetrahedron, and these set up as pseudo-ternary systems. They may be parallel to one of the surfaces of the tetrahedron, as in the study of Lea and Parker of the system $C-C_2S-C_3A_2-C_4AF$, or they may be so designed as to hinge on one of the axes, as in the study of a part of the system $N-C-A-S$ by Greene and Bogue. Or they may be planes which have for their apices three significant compounds, as in many of the Geophysical Laboratory studies. The nature of the phase relations at the different levels may thus be ascertained, and the sextuple points then

placed more precisely by the separate study of supplementary compositions. Since the methods followed are then the usual ones for ternary systems, no special exposition is necessary.

Other types of diagram also have been employed for representing the results of phase-equilibrium studies, such as the use of right-angled coordinates in which the percentages of two components are indicated along the axes, and that of the third obtained by subtracting from 100 the sum of the other two. Or a triangular diagram may be represented by opening out the angle opposite one side from 60° to 90° , giving a distorted right-angled diagram (7)(6).

References

1. Bancroft, W. D., "The Phase Rule," p. 149, New York, Published by *The Journal of Physical Chemistry*, 1897.
2. Dahl, L. A., *J. Phys. Chem.*, **50**, 96 (1946).
3. Finley, A., "The Phase Rule," p. 5, New York, Longmans Green and Co., 1923.
4. Gibbs, J. Willard., *Trans. Connecticut Acad.*, 1874-1878; "Scientific Papers," New York, Longmans Green and Co., 1906.
5. Hill, A. E., in "A Treatise on Physical Chemistry," edited by Taylor, H. S., vol. 1, p. 368, New York, D. van Nostrand Co., 1925.
6. Morey, G. W., *Glass Industry*, **12**, 69 (1931).
7. Roozeboom, H. W. B., "Die heterogenen Gleichgewichte," (1911), Heft 3, Teil 1.

CHAPTER 12

The Technique of High-temperature Phase Research

The principle involved in high-temperature phase studies is the application of the laws of heterogeneous equilibria, particularly the phase rule, to the establishing of the phases which will form in any given mixture of raw materials subjected to any given heat treatment, and the conditions determining the stability of those phases. It is necessary to start with simple systems of high purity. The method involves the bringing of the materials to a condition of equilibrium at critical temperatures, identifying the phases formed and defining the temperatures of fixed points. The experimentation requires high temperatures subject to rigid control, and the means for the precise measurement of temperatures. These will be considered.

General Procedures

Preliminary Operations. In studies of high-temperature phase equilibria a few conditions of operation are axiomatic. The raw materials must be of the purest obtainable, because small amounts of impurities may seriously affect the temperatures of liquid formation, the nature of the equilibrium products, and the location of boundary curves and invariant points. Precise analyses should be had of all materials employed, and where impurities are appreciable these materials should be treated to improve their purity.

The charge used in the determination should be thoroughly uniform and a special treatment is required to attain this condition. Even though only a few tenths of a gram may be used, a batch of several grams should be weighed out with great care, allowance being made for moisture content and impurities. The mixing may be by a dry or wet method. If the dry method is used, the finely pulverized mixture may be shaken vigorously for several minutes in a clean dry bottle, ground in an agate mortar to break up lumpy material, and reshaken. If the wet method is used, a little water is added in a porcelain dish sufficient to make a thin paste, and stirred for several minutes with a spatula. The paste is dried, ground in an agate mortar, the paste again made and stirred, and again dried and ground.

The mixture thus prepared by either method is then heated in an electric muffle furnace in platinum dishes to a temperature of about 1200° to drive off the water and carbon dioxide. It is then ground in an agate mortar, placed in platinum boats, and heated in an electric furnace to a temperature, dependent upon the composition, which will produce a little sintering. This may be from 1400° to 1500°. The product is ground in an agate mortar to pass the No. 150 sieve and the heating process repeated. Final grinding should pass all of the material through the No. 200 sieve.

The Quenching Method. Three methods are commonly employed for determining the phase and temperature relations in high-temperature equilibria studies. These are the methods of *quenching*, of *annealing* and of *heating curves*.

The primary phase regions and their boundaries are most conveniently determined by the quenching method when the rate of crystallization of the liquid is not so rapid as to make this impossible. The principle involved is that at certain high temperatures the entire mixture will be in the liquid state but at some particular lower temperature the limit of solubility will be reached for one crystalline phase and it begins to separate out. This material is then the primary phase at that composition point. At another composition point a different material may first reach its limit of solubility in the liquid, and so will become the primary phase. By a systematic regulation of composition of the samples, a point will be reached where two phases separate together, on one side of which one phase separates first and on the other side of which the other phase is first to appear. This point is then, in a binary system, the invariant quadruple point where two solid phases, liquid and vapor co-exist in equilibrium, and the temperature may be established. It may or may not be a eutectic. If it is the lowest temperature at which the crystalline phases can exist together in equilibrium with liquid and vapor, and no lowering of the temperature can occur without complete solidification, it is a eutectic; but if one of the solid phases may disappear on further reduction of the temperature while the other phase continues to exist in equilibrium with liquid and vapor, it is not a eutectic.

In the ternary system, the condition where two solids separate together is a point on a monovariant quadruple line, the precise location of which must be established by the use of a number of different compositions.

By following the compositions down that line in the direction of falling temperatures, a third phase will reach its limit of solubility in the liquid and the three phases will then be in equilibrium with liquid and vapor. This is the quintuple invariant point, and again it may or may not be a eutectic.

In order to apply this principle, the charge must be held in the furnace at a rigidly controlled temperature until no further changes would result by further holding at that temperature. Then the charge must be instantaneously frozen so that the liquid present will be wholly undercooled to a glass. This is accomplished by causing the charge to be dropped into mercury or water, by fusing with an electric current the fine platinum wire on which the charge is suspended in the furnace. The charge is then immediately dried, crushed in a steel mortar, and examined under the petrographic microscope.

The Annealing Method. The products of complete crystallization are best obtained by the annealing method. This differs from the quenching method only in that the charge, after holding at a required temperature for the progress of certain reactions, is cooled slowly to a temperature somewhat below that at which the last liquid disappears, and held there until crystallization is complete. It is then removed and cooled in the air. In cases where crystal growth is very slow, or where a phase first formed must redissolve and give place to other crystalline phases, a considerable period of time is necessary for completion of the process. This may be a matter of hours or weeks or even years.

The charge, either quenched or annealed, is dried at once, placed in a steel

mortar, the pestle tapped lightly, and the platinum foil separated out. A portion of the powder of the proper size is then examined under the petrographic microscope in a liquid of the proper refractive index to reveal the phases of interest in the examination. The resin "Hyrax" is suitable for most preparations in the cement field, having a refractive index of about 1.714. With this material, permanent mounts may easily be made, and it is the best practice to make such permanent mounts of every burn, for future reference. For some purposes, X-ray diffraction photographs also are very useful.

Various devices have been employed for the attainment of equilibrium in systems containing the oxides of iron. Many compositions attain equilibrium very slowly, and high temperatures may be prohibitive because of an undesired change in the state of oxidation. Platinum as well as most refractories react with iron oxides, especially when in the liquid state. A procedure developed by Roberts and Merwin (11) in a study of mixtures of Fe_2O_3 and MgO was to heat the disseminated mixture in alundum thimbles at about 1250° . After a day or two a thin layer of the charge was found to be tightly adherent to the inside of the thimble, forming a coating which protected the rest of the charge from contamination. New charges were placed in the thimble daily and ground. The process was continued with longer intervals between grindings until microscopic examination showed that a steady state had been reached.

In other studies (6) it was found that silicate melts containing iron oxide could be heated for long periods at 1200° in sealed and evacuated tubes of clear silica glass without significant passage of air through the walls of the tube. This provides a satisfactory method for heating such materials in their own vapor, following which the tubes can be quenched or cooled as desired. The usual quenching furnace was placed in a horizontal position and the silica vials placed in a cradle cut from the end of an alundum tube which was slipped into one end of the furnace. This tube also carried three thermocouples distributed to provide a satisfactory measurement of the temperature. The alundum tube was then packed with magnesia, and a similar tube inserted in the opposite end to close the furnace. The tube containing the vials could be quickly withdrawn and the vials dropped into water.

The Heating-curve Method. The liquids of some compositions crystallize so rapidly that the most rapid quenching is still too slow to prevent the growth of crystals from it. In such cases recourse must be had to the observation of energy changes occurring during the heating or the cooling of the charge. The material is heated or cooled in a rigidly controlled furnace in such a manner that the temperature of the furnace is rising or falling at a constant and very slow rate, and the difference in temperature read, by means of a differential thermocouple, between the charge and an inert material placed adjacent to it in the furnace. The inert material will change in temperature with the furnace, but where an energy change occurs in the charge a break will appear in its uniform rise or fall of temperature. The differential thermocouple will at such points register differences in temperature in proportion to the magnitude of the energy change.

Since liquids are often susceptible of considerable undercooling before a phase, for which the liquid is then supersaturated, begins to separate, and since such crystallization is often delayed by the high viscosity of certain melts, the noting

of energy changes by use of cooling curves is subject to a considerable amount of error. For that reason the measurements usually are made with rising temperatures. This heating-curve method is particularly useful for locating precisely the temperatures of invariant points and the melting relations in the systems.

For heating-curve procedure, about 1 or 2 grams of the charge are placed in one section of a $97\frac{1}{2}\text{Pt}-3\frac{1}{2}\text{Rh}$ thimble, about 1" deep, $\frac{1}{2}$ " in diameter, 0.125" thick, as illustrated in Figure 82. It is divided into two chambers by a partition wall, and into the second section is placed fused alumina or some other inert material, pure and non-melting at the highest temperatures used. One junction of the double thermocouple* may be placed directly in the neutral material; the other

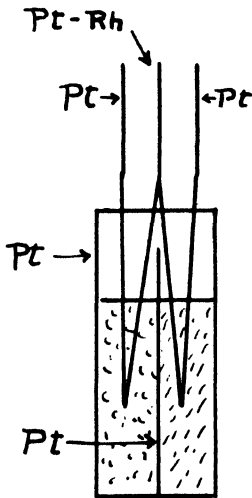

Figure 82. Divided platinum crucible and assembly used for differential thermal analysis. (Hansen)

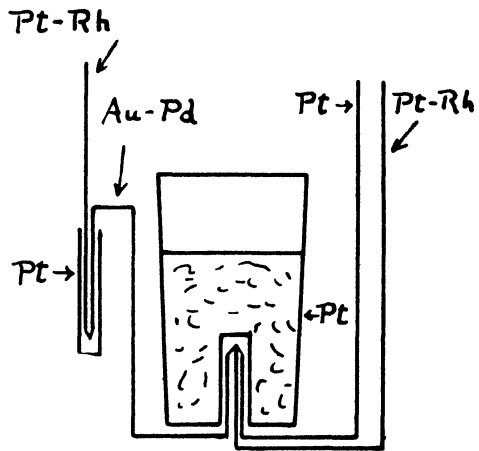

Figure 83. Container and assembly used for differential thermal analysis. (Kracek, Bowen and Morey)

junction is placed in the charge, or in a platinum sheathing to protect it from the flux. The suspended thimble is then caused to heat, within the region to be explored, at a rate of about 5° per minute, and at critical points of about 1° or 2° per minute, and the temperatures read at one minute intervals or less by means of a potentiometer, and recorded against time. Usually the thermocouples are arranged so that the temperature of the neutral material or of the charge is read directly, and the difference in temperature, or emf, between the two is noted simultaneously. A melting point is then noted on the plot of temperature against time by a leveling off in the regular rate of rise, and on the plot of differential temperature (ordinate) against temperature of the charge (abscissa), by a sharp break in the curve.

A different assembly has been used at the Geophysical Laboratory (8) for the thermal analysis of reactions in the crystal phases of the alkali silicates, as shown

* There are three wires: two Pt. and one 90% Pt-10% Rh. The two Pt wires lead to the two junctions, the other wire divides and thus connects with each junction.

in Figure 83. A measuring element was used of Pt-90Pt 10Rh and the differential element consisted of 90Pt 10Rh-40Pd 60Au-90Pt 10Rh. The container was a platinum crucible provided with a reëntrant nipple fitting snugly over the triple junction of the measuring and differential elements. The neutral body was placed in a separate platinum capsule.

Furnace Equipment

Electric Muffle. A satisfactory furnace for the preliminary heatings is shown in Figure 84; it consists of a horizontal alundum tube 36'' long by $1\frac{1}{2}$ '' bore and $\frac{1}{4}$ '' wall, wound with 0.8-mm wire composed of 80Pt and 20Rh of 90Pt and 10Rh. The tube is placed in a fire-brick box packed with magnesia. A sketch of the furnace is shown in Figure 85. The wire, totalling about 330 g, is wound in

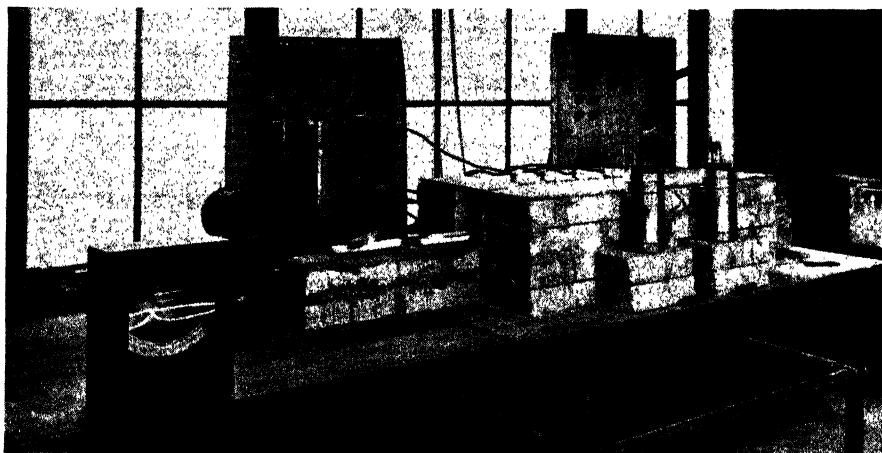
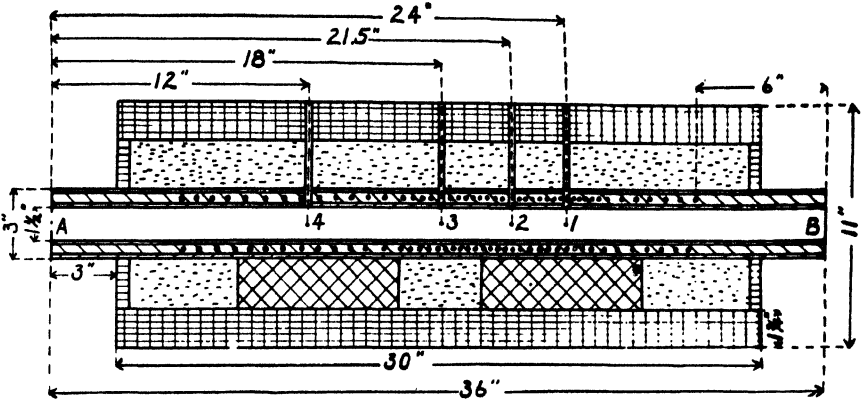

Figure 84. Horizontal furnace used at PCAF laboratory.

three sections, separately connected through 16-ohm rheostats to a 110-volt current so that the temperature gradient within the furnace may be more rigidly controlled. The wire, drawn tightly into a narrow groove cut spirally in the tube, is cemented onto the tube with alundum cement.

The temperature is read by the emf on a millivoltmeter connected by a multiple switch to four thermocouples of Pt-90Pt 10Rh 0.6-mm wire, previously calibrated by a standard couple or against the melting point of certain pure materials. It should be noted here that frequent checks on the accuracy of the thermocouples must be made and correction for errors incorporated in the data. When the error becomes more than one or two degrees, the tips of the couple should be clipped and a new junction made by welding in an oxy-hydrogen flame. When alkalis or other volatile oxides are being investigated, contamination of the couples is especially rapid and checks must be made every few days. A curve showing the temperature gradients in the furnace when points 2 and 3 are held constant at 1420° is shown in Figure 86.

Containers for Charges. The boats used for containing the charges are made of $96\frac{1}{2}$ Pt- $3\frac{1}{2}$ Rh, about $5\frac{1}{2}$ '' long, 1'' wide, $\frac{1}{2}$ '' deep, with walls 0.125 mm thick.









- 1,2,3,4 *Platinum-Platinumrhodium Thermocouples*
-  *Fire Clay Cylinder*
-  *0.8 mm. Platinum 10%Rhodium Wire*
-  *Alundum Tubes*
-  *Alundum Cement*
-  *Transite*
-  *Magnesite*
-  *Magnesite Brick*

Figure 85. Diagrammatic sketch of horizontal furnace.

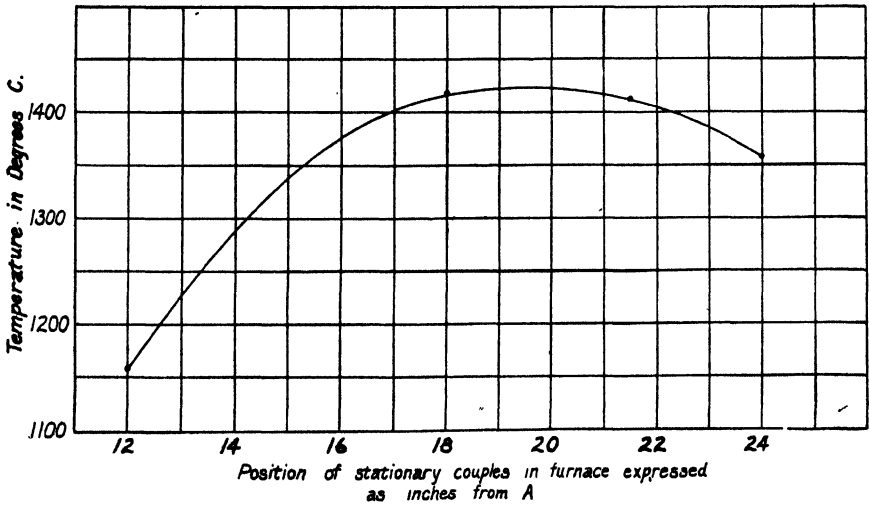

Figure 86. Representative curve obtained by maintaining the thermocouples at center of furnace at a constant temperature.

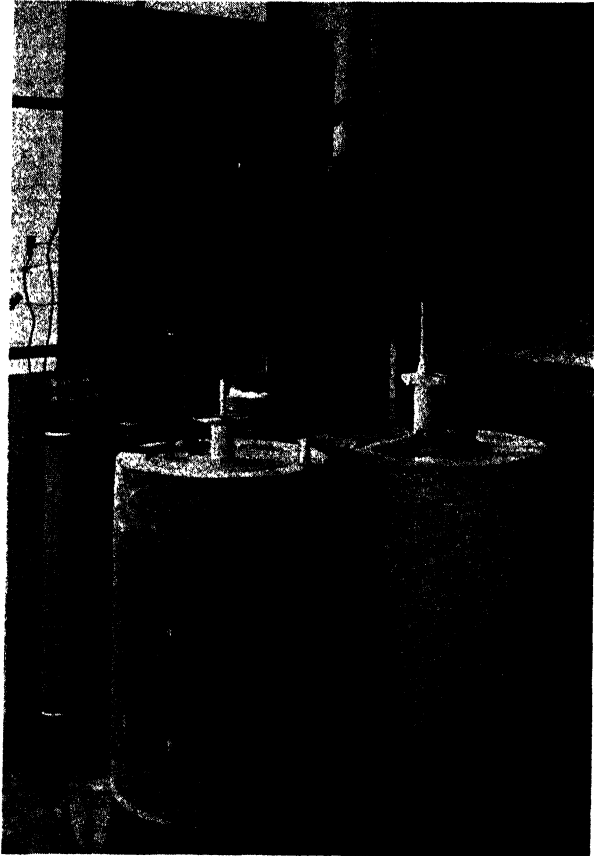

Figure 87. Quenching furnaces used at PCAF laboratory.

They are supported in boats of alundum or cast clay. The body of the latter may be made up of the following ingredients:

- 2½ lbs Kentucky ball clay
- 2½ lbs Tennessee ball clay
- 7½ lbs Georgia kaolin
- 7½ lbs Fused Al_2O_3 grog
- 5 lbs Sillimanite
- 100 ml Sodium silicate (water glass)
- 4 l Water

The materials are ground together, and then the water and water glass added in proportions to produce a "slip" of a creamy consistency, suitable for casting. The slip is poured into a plaster-of-Paris mold, and when the walls of the boat have attained the desired thickness by absorption of the water from the slip, the excess is poured off. In a few minutes the boat will have pulled away from the mold and is sufficiently rigid to remove. After drying out in the air, the boats are fired, first at low temperatures and finally at about 1450° .

The boats with their charges are passed through the tube of the furnace at a rate of about 1 inch in 2 minutes, either by hand, or by a screw impelled by a small electric motor.

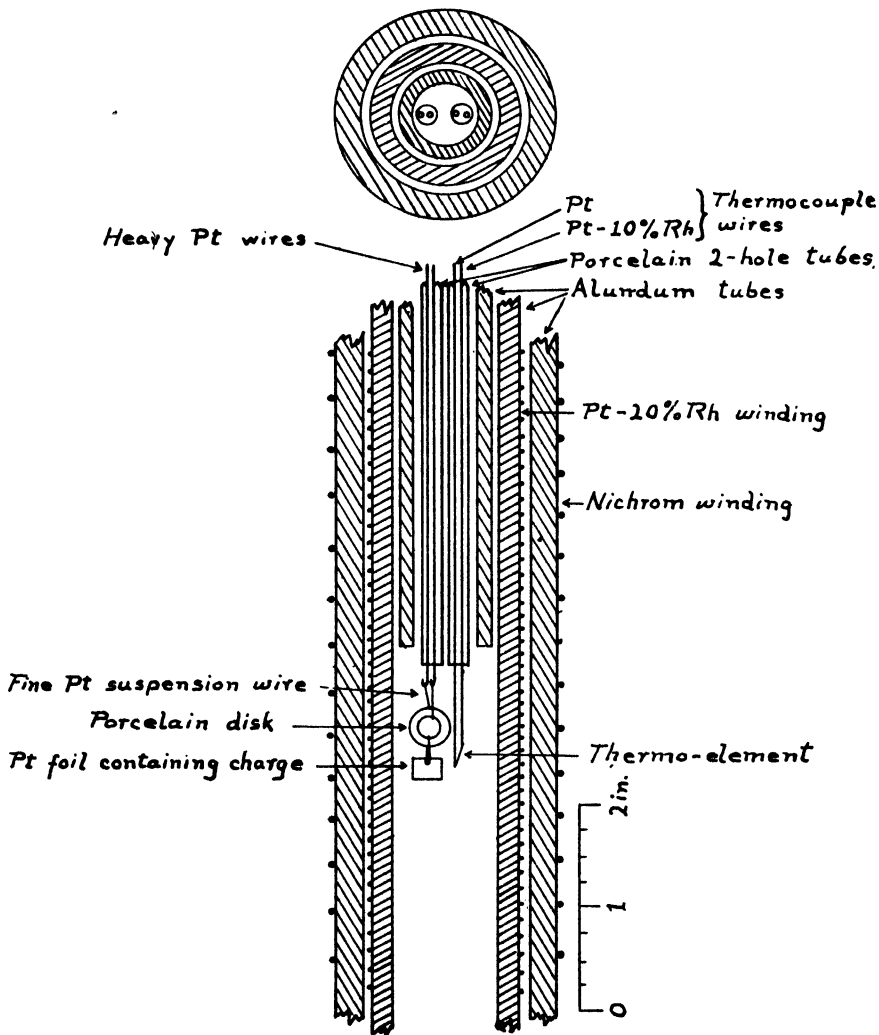

Figure 88. Sketch of principal parts of quenching furnace. The assembly is set up in a fire brick or steel shell packed with magnesia.

Quenching Furnace. A type of furnace satisfactory for final heatings, spoken of herein as a "quenching furnace," is shown in Figure 87, and a diagrammatic sketch in Figure 88. The original design was made by investigators of the Geophysical Laboratory (14). It consists of an alumundum tube (RA 98) about 14 to 18" long having a $\frac{1}{8}$ " bore and $\frac{3}{16}$ " wall, wound with about 120 g of 80Pt-20Rh,

0.8-mm wire cemented onto the tube with alundum cement (RA 162). A better uniformity of temperature is attained by the use of a "booster" coil of Nichrome wire wound on an outer tube, as indicated in Figure 88. The assembly is packed in magnesia enclosed in a fire-clay cylinder or other container.

The charge, prepared as previously described, may be wrapped in a small envelope, about 6 mm square, made from pure platinum foil, about 0.01 mm in thickness. About 0.1 to 0.2 g of material is used in the charge. Or a piece of foil 0.025 mm thick may be cut, about 6 mm square, formed into a saucer shape, and 2 to 15 mg of the charge placed in it (15). The envelope or saucer containing the charge is then attached by means of 0.1-mm platinum wire to a porcelain disk about 0.5 mm thick, and the latter attached with similar wire to two heavy lead-wires of commercial platinum extending from the bottom of the furnace plug-tube (see Figure 88).

The plug-tube is an alundum tube of some 10 to 12" in length, $\frac{9}{16}$ " bore, and $\frac{1}{8}$ " wall which slips easily into the furnace tube. Cemented into it are two (or for heating-curve work, three) porcelain 2-hole tubes. Through the holes of one of these porcelain tubes are passed the heavy platinum wires used to support the washer which in turn supports the charge. Through the holes of the other tube are passed the two wires of the Pt-PtRh thermoelement, the hot junction of which is adjusted to lie as close as possible to the charge. The cold junction is connected by copper wires to an ice bath in a Thermos bottle. The plug-tube with its prepared assembly is placed in the furnace tube and supported at the proper height by a small slab of transite cemented around the tube. After the required heating period, the charge may be dropped into a beaker of mercury or water, placed below the furnace, by passing a 110-volt current through the lead-wires, which fuses the fine suspension wire.

Temperature Control

Temperature control of the furnace may best be accomplished by means of the circuit designed by Roberts (9) (1) or by some modification of it. The principle is that of the Wheatstone bridge, the furnace being in one arm of the bridge. Changes in temperature produce an unbalanced emf, and an appropriate mechanism regulates the current through the furnace to maintain the temperature at a constant value. A circuit which has permitted a control to $\pm 2^\circ$ over an indefinite period is shown in Figure 89. The measurement of temperature is made by means of a precision potentiometer.

Calibration of Thermocouples. The thermocouples, made of 0.6 mm pure Pt and 90 percent Pt-10 percent Rh wire, may be calibrated against pure metals or salts. Standard values are given in Table 21.

The usual procedure is to note the break in a time-temperature curve, the salt being packed in a small Pt crucible, about 10 by 18 mm, in which the junction of the couple is carefully centered. The temperature is raised slowly, about 3° per minute near the melting point, and readings in this range taken every 15 seconds. It is essential that the salts or metals be of high purity, as otherwise the curve will be altered in position and the exact location of the break be indefinite.

Platinum Strip Furnace. Melting temperatures of charges which required temperatures in excess of 1600° were made by Roberts and Morey (12) with a

TABLE 21. Standards for colibration of thermocouples

Substance	Source	M.P.	Authority
Lead.....	Bur. Std. sample No. 49	327.3°	Roeser and Wensel (13)
Zinc.....	Bur. Std. sample No. 43a	419.4	Roeser and Wensel (13)
Aluminum.....	Bur. Std. sample No. 44	660.1	Roeser and Wensel (13)
Gold.....		1063.0	Roeser and Wensel (13)
Palladium.....		1555.0	Roeser and Wensel (13)
Platinum.....		1773.0	Roeser and Wensel (13)
KCl.....		770.3	Roberts (10)
NaCl.....		800.4	Roberts (10)
Na ₂ SO ₄		884.7	Roberts (10)
K ₂ SO ₄		1069.1	Roberts (10)
Li ₂ O.SiO ₂		1201.0	Kracek (7)
2CaO.B ₂ O ₃		1304.0	Kracek (7)
Anorthite.....		1550.0	Roberts and Morey (12)
BaO.2SiO ₂		1418.0	Greene and Morgan (5)

furnace consisting of a strip of an alloy of 60Pt-40Rh. The strip was 8 mm wide and 0.01 mm thick, bent in the form of a U, 10 mm deep and about 1.2 mm wide. This uninsulated strip was heated by an alternating current of 20 to 30 amperes. Temperatures were read with an optical pyrometer standardized at the melting

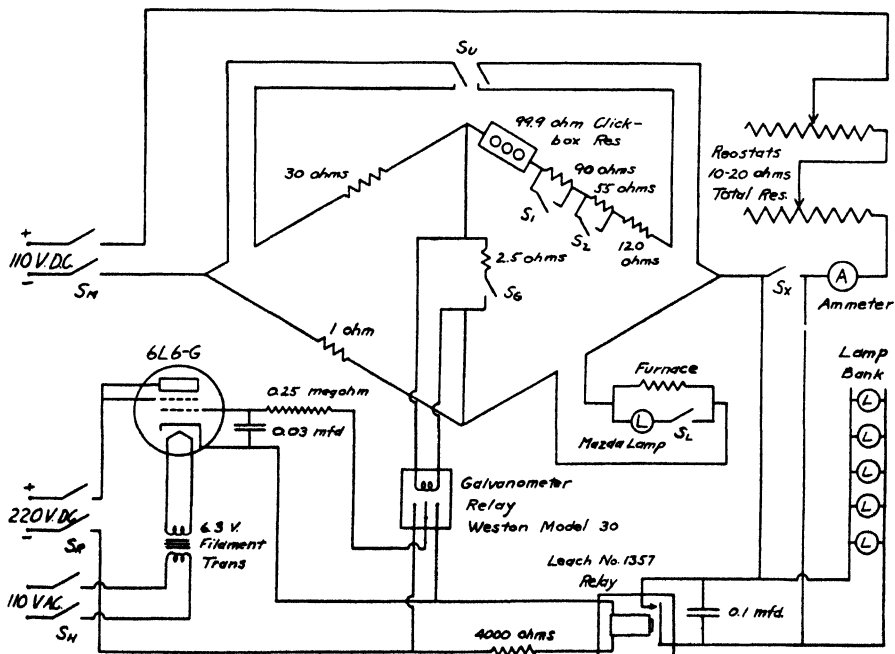

Figure 89. Electric furnace control diagram.

point of anorthite, 1550°, and of a mixture of 15 percent MgO and 85 percent SiO₂, 1695°. The precision was within 10°. A small amount of the charge was then placed on the strip and raised to a temperature somewhat below melting, cooled and examined under a microscope. By repeating the process in steps of 10°, the melting temperature could be ascertained.

A similar strip of iridium had also been employed by Day and Shepherd (3).

Iridium Furnace. The furnace employed by Day and Shepherd (3) for obtaining temperatures between 1600° and 2100° consisted of a vertical tube of iridium 18 cm long and 4 cm in diameter, fed by an alternating current of low voltage, led in through platinum and silver flanges at the ends. Fused MgO was used as the insulating material and as a support, projected into the tube from the bottom, for a small iridium crucible containing the charge. The temperatures were read by means of an optical pyrometer focused, through a small opening in a plug of MgO placed in the top of the tube, upon a small strip of iridium on the charge.

Iridium Button Furnace. The melting points of materials melting at temperatures from 1700° to 2000° were obtained by Bunting (2) by the use of a button of 73Ir-27Pt in which a depression was made for the insertion of the charge. The button was then heated in a high-frequency induction furnace. The temperatures were measured by a disappearing-filament optical pyrometer. Although the determinations could be duplicated to $\pm 5^\circ$, the accuracy was probably to $\pm 10^\circ$ or 20°, since the material would not be visible under exact blackbody conditions.

Resistance Furnace. A furnace of the resistor type, suitable for use in an oxidizing atmosphere and capable of attaining temperatures between 1600° and 2000° controllable to $\pm 10^\circ$, has been described by Geller (4). The resistors were made of rods, 9 cm long by 0.6 cm diameter, cast from various mixtures of thoria (ThO₂), zirconia (ZrO₂), yttria (Y₂O₃), ceria (CeO₂), beryllia (BeO), magnesia (MgO) and alumina (Al₂O₃). Since the resistors did not begin to conduct the electric current until they had been raised to a temperature of 1000° to 1400°, the elements were placed within a 22-in i.d. alundum tube wound with 80 percent Pt, 20 percent Rh wire for the preliminary heating. Outside of this was another tube in which the temperature was boosted with a winding of nickel-chromium wire. The resistors, which were 3 in the furnace used, were set in contact blocks consisting of 85 percent ZrO₂ and 15 percent Y₂O₃, into which the metal conductors (60 percent Pt, 40 percent Rh) were also cast. The inner container of the furnace is a block made of thoria, and this is separated from the alundum tube by a sheathing of zirconia. The current through the resistors was controlled with a step-up transformer, delivering 220 or 440 volts, connected in series with a Variac transformer delivering from 0 to 270 volts. Close voltage control is necessary since the current through the resistors (3 to 8 amperes) must be held within ± 0.05 ampere to hold the temperature within $\pm 5^\circ$. In addition, rheostats are connected in series with each resistor to balance inequalities in the resistance of the heating units, and tungsten-filament lamps to act as ballast to improve stability of the heating current. With 6 amperes at 80 volts passing through the Ni-Cr coil, and the current turned off from the Pt-Rh coil, the specimen temperature was held at 2000° $\pm 10^\circ$ with a total of about 7 amperes, and a voltage drop of 130, through the resistors, when the latter were made of 90ThO₂-10Y₂O₃.

References

1. Adams, L. H., *J. Opt. Soc. Am.*, **9**, 599 (1924).
2. Bunting, E. N., *J. Res. NBS*, **4**, 131 (1930); RP 136, *ibid.*, **11**, 719 (1933), RP 619.
3. Day, A. L. and Shepherd, E. S., *Am. J. Sci.*, **22**, 265 (1906).
4. Geller, R. F., *J. Res. NBS*, **27**, 555 (1941); RP 1443.
5. Greene, K. T., and Morgan, W. R., *J. Am. Ceram. Soc.*, **24**, 111 (1941).
6. Greig, J. W., Psonjak, E., Merwin, H. E., and Sosman, R. B., *Am. J. Sci.*, **30**, 239 (1935).
7. Kracek, E. C., *J. Phys. Chem.*, **34**, 2648 (1930).
8. Kracek, F. C., Bowen, L. N., and Morey, G. W., *J. Phys. Chem.*, **41**, 1183 (1937).
9. Roberts, H. S., *J. Wash. Acad. Sci.*, **11**, 401 (1921); *J. Opt. Soc. Am.*, **11**, 171 (1925).
10. Roberts, H. S., *Phys. Rev.*, **23**, 386 (1924).
11. Roberts, H. S. and Merwin, H. E., *Am. J. Sci.*, **21**, 145 (1931).
12. Roberts, H. S. and Morey, G. W., *Rev. Sci. Inst.*, **1**, 576 (1930).
13. Roeser, W. F., and Wensel, H. T., *J. Res. NBS*, **14**, 274 (1935); RP 768.
14. Shepherd, E. S., Rankin, G. A., and Wright, F. E., *Am. J. Sci.*, **28**, 308 (1909).
15. Swayze, M. A., *Am. J. Sci.*, **244**, 1; 65 (1946).

CHAPTER 13

The System $\text{CaO-Al}_2\text{O}_3\text{-SiO}_2$

The classic investigations on the lime, alumina and silica series of minerals were made by a number of scientists at the Geophysical Laboratory, portions of the work being released between 1906 and 1915, when the System $\text{CaO-Al}_2\text{O}_3\text{-SiO}_2$ was published by Rankin and Wright (27). Since that time a few corrections and additions have been made. Inasmuch as these three oxides constitute over 90 percent of commercial portland cements, they are obviously the basic and most important trio of components necessary to the understanding of the phase composition of that material. The binary systems will first be considered, followed by a study of the ternary system in its application to portland cement. A detailed consideration of the characteristics of the compounds formed in this system have been given in Chapter 7, but the optical properties are given below. The interplanar spacings of the X-ray diffraction patterns of the oxides and cement phases are given in Appendix 1.

The Oxides

Calcium oxide (Lime, CaO). Calcium oxide was reported by Rankin and Wright as transparent, colorless or pale yellow crystals, observed only in unmodified cubes of the isometric system. Cleavage is perfect after the cube (100). The crystals are isotropic; occasionally individuals show optical anomalies due probably to internal strain. In the preparations the free lime usually appeared in fine isotropic grains, usually rounded in outline and of very high refractive index (about 1.83). The grains were almost always recognizable, even when only a few thousandths of a millimeter in diameter.

The melting point of CaO was reported by Kanolt (20) as 2570° . When prepared by heating calcium carbonate, it appears first as a white, amorphous material having a specific gravity ranging from 3.08 to 3.30; but on prolonged heating at higher temperatures it becomes more dense, the specific gravity of the crystalline variety rising to 3.32. The friable amorphous form reacts rapidly with water (slakes) to form Ca(OH)_2 with a considerable liberation of heat, but the high-burned form reacts very slowly unless pulverized.

The optical properties of Ca(OH)_2 , as given by Ashton and Wilson (2) on specially prepared crystals, are as follows: the Ca(OH)_2 crystallizes in the hexagonal system, usually as plates or short hexagonal prisms, with perfect cleavage parallel to the face (0001). Refractive indices are $\omega = 1.574 \pm 0.003$, $\epsilon = 1.545 \pm 0.003$ for sodium light. Birefractance is 0.029. Specific gravity 2.230 ± 0.005 . Interference figure is uniaxial negative. Lattice constants are $a_o = 3.579\text{A}$, $c_o = 5.028\text{A}$. The unit cell contains one molecule. The X-ray diffraction pattern is given on page 541. The crystals have been found in the natural state by Tilley (33) and the mineral name Portlandite has been suggested.

Silicon dioxide (Silica, SiO_2). Silica may occur in a variety of aspects which have been studied by many investigators (28). Among the better-known modifications are the following:

Low quartz.....	Stable up to 573°
High quartz.....	Stable 573° to 870°
Low tridymite.....	Capable of existence up to 117°
Lower high-tridymite.....	Capable of existence 117° to 163°
Upper high-tridymite.....	Stable 870° to 1470°
Low cristobalite.....	Capable of existence up to 275°
High cristobalite.....	Stable 1470° to 1710°
Vitreous silica.....	Capable of existence to 1000° or above

Ordinary quartz (low quartz) crystallizes in the hexagonal system, doubly terminated with the unit prism and rhombohedrons as bounding faces. It is slightly birefracting, $\omega = 1.544$, $\epsilon = 1.553$, uniaxial, optically positive. It has a specific gravity of 2.651. It may be readily distinguished from the other varieties of silica by the higher refractive indices and especially the higher birefractance, the indices of low tridymite being 1.469 and 1.473, and those of low cristobalite 1.484 and 1.487. The index of vitreous silica is much less, 1.459. The observation of changes of form in systems high in silica is difficult and tedious because of the very high viscosity of the liquids and the sluggish character of the inversions. Thus vitreous silica is capable of existence at ordinary temperatures and up to 1000° or above, where it begins to crystallize, but is an unstable, undercooled liquid (glass) at all temperatures below 1710° where it melts. The high tridymite melts at 1670° but is unstable above 1470°. The high cristobalite melts at 1710°.

Aluminum oxide (Alumina, Al_2O_3). Rankin and Wright (27) report that the optical properties of artificial corundum, $\alpha\text{-Al}_2\text{O}_3$, agree well with those of the natural mineral. Grains crystallized from a melt of pure Al_2O_3 rarely show crystal habit; they are rounded in outline and less than 0.05 mm in diameter. Minute cavities were found to be abundant and characteristic. Hardness is 9. Refractive indices are $\omega = 1.768 \pm 0.003$; $\epsilon = 1.760 \pm 0.003$; birefringence is fairly weak, about 0.009. It is uniaxial, optically negative. It usually crystallizes, from mixtures, as thin, sharply defined hexagonal plates. The melting point as determined by Kanolt (20), is 2050°, and according to Bunting (11) 2040°.

The β form of Al_2O_3 was found by Rankin and Merwin (26) to occur occasionally in charges of pure alumina which had been melted and cooled slowly. It was not found possible to cause this form to revert to the β form. The presence of 0.5 percent MgO was found to aid in the formation of the β form, whereas the presence of small amounts of either CaO or SiO_2 caused the Al_2O_3 crystallizing from melts to appear in the α form. The $\beta\text{-Al}_2\text{O}_3$ is described as hexagonal, often appearing in groups of overlapping triangular plates with perfect basal cleavage. The refractive index, ϵ , was reported as appearing to vary, the values found ranging from 1.635 to 1.650. In these preparations $\omega = 1.677 \pm 0.003$ but in the presence of MgO, ϵ was found as low as 1.629 and ω varied between 1.665 and 1.680.

Brownmiller and Bogue (9) found $\beta\text{-Al}_2\text{O}_3$ to be the stable modification in the system $\text{Na}_2\text{O-CaO-Al}_2\text{O}_3$ at high temperatures in samples containing as much as

96.5 percent Al_2O_3 . They report the $\beta\text{-Al}_2\text{O}_3$ as uniaxial negative, crystallizing as hexagonal plates with the optic axis parallel to the c -crystallographic axis. A sample of $\beta\text{-Al}_2\text{O}_3$ prepared by the Norton Company showed refractive indices of $\omega = 1.678 \pm 0.003$ and $\epsilon = 1.635 \pm 0.003$.

Ulrich (34) has reported the existence of a $\gamma\text{-Al}_2\text{O}_3$ which, by Hansen and Brownmiller (18), was obtained on heating a sample of $\text{Al}_2\text{O}_3 \cdot 3\text{H}_2\text{O}$ for 6 hours at 900° to 950° . It was isotropic with a refractive index of 1.696 ± 0.003 . Its specific gravity was 3.47.

The System CaO-SiO_2

Phase Relations. When lime and silica are heated together there are four possible compounds which may be produced, two of these being capable of existing in more than one form. Of the four compounds, CS , C_3S_2 , C_2S and C_3S , only the latter two are capable of existence in the high-lime mixtures of portland cement, so in this discussion they alone will be considered at length.

A temperature-concentration diagram (15)(27) of the system C-S is shown in Figure 90. An examination of this figure will reveal a number of points of special interest to the cement chemist. The primary phase to crystallize on cooling any liquid richer in lime than C_3S (the condition met in all portland cements) is seen to be CaO or $\alpha\text{-C}_2\text{S}$. CaO , melting at 2572° and $\alpha\text{-C}_2\text{S}$, melting at 2130° , form a eutectic (C67.5, S32.5 percent) at 2065° , below which temperature, down to 1900° , $\alpha\text{-C}_2\text{S}$ and CaO exist together. But at 1900° C_3S forms by a combination of some of the lime and dicalcium silicate. If the CaO is in excess of that which will be consumed by all the C_2S reacting in this manner, that is, in excess of the composition $3\text{CaO} + \text{SiO}_2$, then the phases resulting will be C_3S and CaO . On the other hand, if the C_2S is in excess, all the CaO will be consumed and the resulting phases will be C_3S and $\alpha\text{-C}_2\text{S}$. If the composition should be exactly that of C_3S , that compound alone will result when equilibrium is established. No further change is noted to occur until a temperature of 1420° is reached, where the dicalcium silicate, when present, undergoes an inversion from the high-temperature α form to the intermediate-temperature β form.*

At 1250° it is observed that the C_3S again becomes unstable, decomposing once more into its components lime and dicalcium silicate, the latter remaining in the β form. Still another change, not shown in the diagram, occurs at 675° , where the β form of the dicalcium silicate becomes unstable and inverts to the γ form.

The above relations may be read from the phase diagram, and the complete course of crystallization from a melt of any given composition, or conversely the changes resulting upon heating a charge, may be computed, but always with the understanding that the condition depicted is that of complete equilibrium. Nothing is revealed of the technical requirements for attaining such a state of equilibrium nor of the condition of a system where equilibrium is not reached.

It should be emphasized also that no liquid is present in this system, with CaO contents higher than that represented by C_2S , at any temperature under 2065° . Thus all the reactions indicated in the formation and dissolution of C_3S , and the

* See discussion on $\alpha\text{-}\beta\text{-C}_2\text{S}$ inversion temperature, pages 117-118.

inversions of C_2S , take place in this system between solids alone. (It will be found later that when other components are present, the temperatures of liquid formation are lowered and some of these same reactions may take place in the presence of liquid.)

In order to follow the course of crystallization of a charge in this system, let us assume a mixture of 72.5 percent CaO and 27.5 percent SiO_2 , heated to complete fusion at say 2200° , and slowly cooled. When the temperature has dropped to 2140° , CaO first appears as a solid phase. At this moment the liquid has the original composition of the mixture and is indicated by point *b* on Figure 90. But on

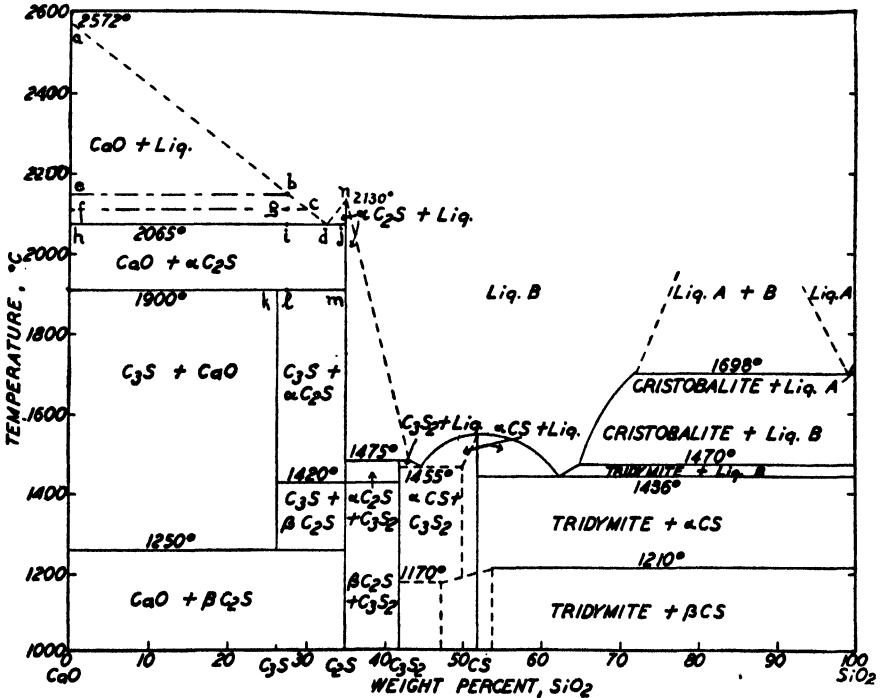

Figure 90. The system $\text{CaO}-\text{SiO}_2$. (Rankin and Wright)

dropping the temperature ever so slightly, CaO appears which, at that temperature, must be represented by point *e*. As CaO is withdrawn from the liquid, the composition of the latter must be changed in a direction directly away from CaO , that is, along a projection of the line *ab*. But it cannot move to the right of the line *ad* because in that region the liquid is unsaturated and would dissolve CaO to bring its composition back to the line *ad*. So as long as the temperature remains at 2140° , only an infinitesimal amount of CaO can form. But on cooling say to 2100° , CaO has continued to be withdrawn from the liquid, so the composition of the solid phase at 2100° is shown by point *f*. The composition of the liquid, in turn, must have moved away from *f* and be somewhere on the isotherm at 2100° , that is, on or beyond the line *fc*. But for the reasons given above this can be only at point *c*. When this temperature is reached, therefore, an amount

of CaO will have separated out which is proportional to the increment gc of the total compositional range fc . That is, gc/fc = fractional part of total mass crystallized as CaO, and fg/fc = fractional part of total mass remaining as liquid. The composition of the liquid at this point is of course indicated by the scale of abscissa, and is seen to be 70 percent CaO, 30 percent SiO₂.

When the cooling is continued to 2065°, a new phase, α -C₂S, begins to appear, and since the two solid phases then separate together without further change in the composition of the liquid, that composition is a eutectic composition, and that temperature is the eutectic temperature; since changes in phase take place without change in temperature, it is also, of course, an invariant point. The composition of the liquid is then at point d , 67.5 percent CaO and 32.5 percent SiO₂. At the moment of reaching this point, only CaO and liquid are present, the relative amounts being, by the use of the previous argument, CaO = id/hd and liquid = hi/hd . So long as no heat is taken from the system, only CaO and liquid remain in the amounts above indicated. But as heat is abstracted from the system, solid α -C₂S and CaO separate together, with no reduction in temperature, until the whole mass becomes solid. When that condition is reached, then the relative proportions of the two solid phases are indicated by the increments adjacent to the composition of the separating phases. Thus the relative proportions of CaO and α -C₂S which separate from any liquid *after* it has reached the eutectic composition d is dj/hj = CaO and hd/hj = α -C₂S. But since we started with a composition which would be represented by i on the 2065° isotherm, and CaO has been separating out before the liquid reached d , the overall composition of the solids at 2065° when crystallization is complete is given by ij/hj = CaO and hi/hj = α -C₂S.

No further change occurs on cooling until a temperature of 1900° is reached, where C₃S first begins to form by a combination of CaO and α -C₂S. Just as that temperature is reached, only the latter two phases are present and, if no heat were removed from the system, they would so remain. But now, with the removal of heat, CaO and α -C₂S combine, without change in temperature, until only C₃S and CaO, or C₃S and C₂S remain. Since our composition, now at point l , is on the C₂S side of the C₃S composition at k , the new mixture must contain no CaO but be made up alone of C₃S and C₂S. The fractional parts will obviously be C₃S = lm/km and C₂S = kl/km .

The next change occurs at 1420° where the α -C₂S that is present inverts to the β form.

At 1250° the C₃S again becomes unstable and dissociates, (25)(14)(24) this time into CaO and β -C₂S. The amounts formed are of course the same as we noted for the condition between 2065° and 1900°, and could readily be determined from the diagram.

A further inversion of the β -C₂S to the γ form occurs at 675°, not shown in the figure.

Since the compositions of all liquids containing up to 32.5 percent SiO₂ follow (as has been shown) the line ad on cooling, and likewise the compositions of liquids containing between 32.5 and 35.0 percent SiO₂ follow the line nd on cooling, both culminating at the eutectic composition d , the line adn is the liquidus curve for the system C-C₂S. The solid phase separating out as the liquid is

following the line ad will be CaO and, at its various temperature levels, may be represented by the line ah . Likewise, the solid phase separating out as the liquid is following the line nd will be $\alpha\text{-C}_2\text{S}$ and is represented by the line nj . But when the liquid composition has reached d , the mean solids composition moves either from h or j towards d along the lines hd or jd respectively, ending at a projection on one of those lines of the original composition of the mixture. Hence the lines $ahjn$ is the solidus curve for the system $\text{C-C}_2\text{S}$. The remaining changes of C_3S formation and dissociation, and of C_2S inversions, all take place in the solids alone, in this binary system. Hence C_3S does not appear as a primary phase (in equilibrium with liquid) nor on the liquidus curve.

Optical Properties of the Calcium Silicates. Dicalcium silicate exists, as already noted, in three forms, the α form melting at $2130^\circ \pm 20^\circ$ inverting to the β form at $1420^\circ \pm 2^\circ$, (or 1456° according to Newman and Wells) and the latter inverting to the γ form at 675° . *Alpha-dicalcium silicate* is described (27) as occurring in an intricately twinned form showing occasionally prismatic development with good cleavage parallel with the prism axis. The twinning lamellae often occur at various angles, although sometimes only one set of polysynthetic twinning lamellae is present. The crystal system is given as either monoclinic or triclinic; refractive indices $\alpha = 1.715 \pm 0.002$, $\beta = 1.720 \pm 0.003$, $\gamma = 1.737 \pm 0.002$; birefracton fairly strong, about 0.023; optic axial angle large; plane of optic axis nearly parallel with the elongation of the crystals; optical character positive. The validity of this early information with respect to $\alpha\text{-C}_2\text{S}$ is now considered very doubtful.*

The *beta-dicalcium silicate* is described as occurring in rounded grains, often prismatic in shape with cleavage parallel with the prism axis. The crystal system is thought to be orthorhombic, but the presence of twinning lamellae with low extinction angles suggests a possible lower symmetry. Refractive indices are $\alpha = 1.717 \pm 0.002$, $\gamma = 1.735 \pm 0.002$; birefringence medium, the interference colors in the finely powdered grains rarely exceeding blue of the second order; optic axial angle large; optical character positive; plane of optic axis parallel with the elongation. The specific gravity is 3.28. Rankin and Wright note that it is difficult to distinguish between the α and β forms, but state that the intricate twinning of the α form does not appear in the β form, which makes that the best criterion for distinguishing between them. A naturally occurring calcium orthosilicate (larnite) has been described by Tilley (32).

Gamma-dicalcium silicate results from the inversion of the β form with an increase in volume of about 10 percent, which disintegrates the crystals, resulting in a fine powder. In the cement industry, this is known as *dusting* of the clinker. It is described as colorless, prismatic in habit, with perfect cleavage along the prism axis. Occasional twinning lamellae parallel to the cleavage are observed. The extinction is usually parallel. Refractive indices: $\alpha = 1.642 \pm 0.002$, $\beta = 1.645 \pm 0.003$, $\gamma = 1.654 \pm 0.002$; birefringence medium, about 0.015; optic angle 2ϵ , approximately 52° ; plane of optic axis normal to cleavage direction; optical character negative. The specific gravity is 2.974. It is readily distinguished from the α and β forms by its lower refractivity, the position of its plane of optic axis, and its optical character.

* See pages 118-125.

Another form of C_2S was also described as the β' form, said to be unstable, being obtained only by quenching an old hydrated sample from a temperature of about 1425° . The average refractive index was given as about 1.715 and the birefringence very weak. Its existence was not considered as definitely proved. From crystal-structure studies, Bredig (7) also has postulated the existence of an α' form of C_2S .*

Sundius (29) has measured the optical properties of the α and β forms of C_2S as they occur in portland cement clinker, and reports refractive indices which are compared with those given by the Geophysical investigators as follows:

	Rankin and Wright	Sundius
α - C_2S	$\alpha = 1.715 \pm 0.002$	1.719 ± 0.001
	$\gamma = 1.737 \pm 0.002$	1.733 ± 0.001
β - C_2S	$\alpha = 1.717 \pm 0.002$	1.717 ± 0.001
	$\gamma = 1.735 \pm 0.002$	1.736 ± 0.001

The optic axial angle was also reported as 36° for the α form and 64 – 69° for the β form.

Tricalcium silicate is described by Rankin and Wright (27) as occurring in small, equant colorless grains, apparently without cleavage, having an average refractive index of approximately 1.715 and a very weak birefringence, not over 0.005. The grains appear uniaxial or biaxial with small optic axial angle; optical character negative. In some of their preparations of ternary mixtures, fine twinning lamellae with low extinction angles were observed on some of the grains, indicating that the crystal system is possibly monoclinic. The specific gravity is 3.15.

Weyer (35) in 1931 took great pains in preparing the pure cement compounds and in measuring their optical and X-ray properties. He reported that the strongest double refraction observed on C_2S was established with the wedge-shaped crystals. Interference colors showed maximum white 1.0 (first order) while the crystals with undefined boundaries were very weakly double-refracting and the six-sided leaflets were quasi-isotropic. With all the preparations, gamma prime was always distinctly found to be greater than 1.720 and equal to or slightly less than 1.724 measured perpendicular to the primary axis of the leaflets, and at the borders. The value for alpha prime, which could only be measured on the most strongly double-refracting crystals, was less than 1.720, frequently equal to 1.719; also, however, occasionally less than 1.719, but always distinctly greater than 1.716. The indices in sodium light are therefore given as

$$\begin{aligned}\alpha_{Na} &= 1.718 \pm 0.001 \\ \gamma_{Na} &= 1.723 \pm 0.001\end{aligned}$$

The optical character of the double refraction Weyer reported as negative. The crystals were weakly biaxial, the axial angle $2V$ very small, so that the material can be considered practically as uniaxial.

Lea and Parker (24) very closely confirm the results reported by Weyer, giving for the refractive indices of C_2S $\alpha = 1.718 \pm 0.003$ and $\gamma = 1.724 \pm 0.003$. No appreciable change was observed in the presence of Fe_2O_3 in the melts. In

* See pages 144–145.

melts of 20 percent Fe_2O_3 content, C_2S frequently occurred as small tabular crystals with well-defined faces. Anderson and Lee (1) have reported, from measurements made on large crystals of C_2S obtained from a basic open-hearth slag, that the compound belongs to the trigonal system.

X-ray diffraction photographs of the calcium silicates have been reported by a number of investigators, the first one being by Hansen (17). The principal lines as determined by Brownmiller and Bogue (10) are given on pages 541-542.

Preparation of the Calcium Silicates. From the above discussion and that given in Chapter 7, it seems probable that $\alpha\text{-C}_2\text{S}$ has not been obtained in the pure state due to its unavoidable inversion to the β form on cooling below the inversion temperature. In the form of a solid solution containing a few percent of Na_2O with either Fe_2O_3 or Al_2O_3 , as described above, Greene succeeded by very rapid quenching in bringing it to room temperature without inversion, and the temperature of inversion was lowered by this solid solution some 240 to 245°.

The gamma form of C_2S is easily prepared by heating a finely pulverized mixture of CaCO_3 and SiO_2 in the ratio 2CaO to SiO_2 to temperatures of about 1400 to 1450° and cooling slowly. The product formed is $\beta\text{-C}_2\text{S}$, but on cooling it dusts completely by inversion to the γ form.

There is much greater difficulty attached to the preparation of $\beta\text{-C}_2\text{S}$ because of its decided tendency to invert on cooling. Bates and Klein (4) solved the problem in a practical way by introducing a "mineralizer" or mineral catalyzer. Following a study in which were added oxides of nickel, vanadium, molybdenum, tin, magnesium, potassium, tungsten, boron and chromium to mixtures of silica and lime, only the two latter oxides were found to be satisfactory. Accordingly, boric acid and chromium oxide were each separately employed in amounts of less than 1 percent and entirely prevented dusting when the mixture was heated for one hour at 1550° and cooled in air.

Hansen (17) has prepared nearly pure $\beta\text{-C}_2\text{S}$ by heating a mixture of CaCO_3 and SiO_2 in the ratio of 2CaO to SiO_2 in an electric furnace at about 1450°, and reheating the dusted product at the same temperature and cooling in air. No explanation is given for the failure of this preparation to dust, and repetitions of the process never attained the same result. On heating small specimens to 1350° for an hour and quenching in mercury the β form came down regularly in nearly pure state.

Weyer (35) found that by repeated heating of $2\text{CaCO}_3 + \text{SiO}_2$ at 1400° for $\frac{3}{4}$ hour periods and cooling in air, the proportion of the $\beta\text{-C}_2\text{S}$ to $\gamma\text{-C}_2\text{S}$ continuously increased until, after 5 burns, there remained about 15 percent of the latter form. This product was then centrifuged in a methylene iodide-acetylene tetrabromide mixture and the two forms of different specific gravity were cleanly separated.

Nearly pure $\beta\text{-C}_2\text{S}$, free of the gamma form, was prepared by Johansson and Thorvaldson (19) by employing an intimate mixture of pure calcium carbonate and very light silica gel. On quenching from a single firing at 1500 to 1600° a product was obtained containing no free lime and only traces of $\gamma\text{-C}_2\text{S}$ and free SiO_2 . A similarly pure product was obtained by heating a sample of $\gamma\text{-C}_2\text{S}$, ground to pass the No. 200 sieve, at about 1000° for several hours and cooling rapidly to room temperatures. The success of these methods is attributed to the decrease in the

rate of inversion due to the less intimate contact of the crystals in this fluffy material.

Keevil and Thorvaldson (21) found that pure β - C_2S could be prepared from the hydrated material at relatively low temperatures. Pure lime and silica gel in a 2:1 ratio were autoclaved in saturated steam at 220°, followed by an ignition at 900°. The autoclave treatment brought about a combination of the lime and silica to form a hydrate, first reported to have the composition $C_2S \cdot H_2O$. The ignition dehydrated this compound with the formation of β - C_2S . The failure of the compound to invert to the gamma form was attributed to its finely divided form.

Burdick (12), in partial confirmation of the above, found that the hydrate $10CaO \cdot 5SiO_2 \cdot 6H_2O$, which was later reported to be formed on the steam treatment of C_2S , (21) (16) produces upon a heat treatment to 1450° only the β form of pure C_2S . The product was found to consist of irregular large crystals having the normal refractive indices and X-ray diffraction pattern of β - C_2S , and to be entirely free of the γ form on cooling.

Tricalcium silicate is difficult to prepare in the pure state because it cannot be crystallized from a melt of its own composition, and the reactions of $3CaO + SiO_2$ or $CaO + C_2S$ are slow even at temperatures as high as 1600°. Bates and Klein (4) desired to obtain the pure compounds of cement in amounts as large as 30 lbs each in order to be able to examine their cement-making qualities, and found it necessary to introduce small amounts of mineral oxides which would accelerate the desired reactions and prevent the inversion of the β to the γ - C_2S . Several oxides were tried, but only B_2O_3 and Cr_2O_3 were found satisfactory. These were accordingly used in amounts of less than 1 percent in the preparations. Even with these oxides, separately, the first burnings produced a product which dusted to γ - C_2S and CaO . A reburning showed an improvement, and further improvements obtained with each reburning, following regrinding, until after six reburnings the product in which B_2O_3 was used showed microscopically 90 percent C_2S , 8 percent β - C_2S and 2 percent CaO . The product containing Cr_2O_3 showed 95 percent C_2S , 4 percent β - C_2S and 1 percent CaO .

In 1928 Hansen (17) noted the observation of Rankin (27) that CaO becomes less reactive when it is heated to high temperatures, and so designed his preparation of C_2S in such a way as to avoid this decrease in reactivity of the CaO . He used two different procedures:

- (1) Calcium carbonate and silica ground to pass the No. 200 sieve were mixed in the ratio $2.3 CaO + SiO_2$ and heated in the electric furnace in platinum for 1 hour at 1500°. The product was reground and a little more $CaCO_3$ added and reheated, and this process repeated with additional increments of $CaCO_3$ until the ratio 3 to 1 had been reached and five burns made. This product contained only traces of free CaO .
- (2) An excess of $CaCO_3$ in the ratio of $4CaO + SiO_2$ was heated for an hour at 1500°. The product was ground with enough water to form a stiff paste and reheated. After five reheatings, the free CaO was dissolved out in hot absolute alcohol and glycerin and neutralized with alcoholic ammonium acetate. The sample was washed once with absolute alcohol and reheated. The same extraction was again repeated and a sixth

heating given the charge, following which the product showed only traces of CaO and of grains of C_3S .

The procedure employed with the first sample was also found to be applicable for producing relatively large quantities in a gas-fired furnace.

Weyer (35) found it possible to prepare pure C_3S starting with a ratio of $3\text{CaO} + \text{SiO}_2$. The oxides were elutriated with water, dried, powdered, and the process repeated twice more to insure a homogenous mixture. The final product was packed damp into a platinum boat, experiments having shown that the reaction was more rapid when the raw materials were packed damp. The mixture was then heated to 1650 to 1750° for 2 or 3 hours and the temperature lowered slowly over a period of several hours. After this heating, the product dusted and about 50 to 60 percent of C_3S had formed. It was again pulverized in water, packed damp and reheated. After four such cycles the product was practically homogeneous and showed only traces of free CaO and C_2S . It was burned a fifth time at 1705° for 4 hours and cooled to 1300° over a 4-hour period. Microscopic examination showed complete homogeneity.

The System $\text{CaO-Al}_2\text{O}_3$

Phase Relations. When CaO and Al_2O_3 are heated together, there are four possible compounds that may be formed: C_3A , C_5A_3 or C_{12}A_7 ,* CA and C_3A_5 . Of these, only the first two are capable of existence in the high-lime mixtures of portland cement, so only these compounds will be discussed here.

The temperature-concentration diagram of the system C-A is shown in Figure 91. From this diagram it will be seen that the compound C_3A melts incongruently, dissociating at 1535° into CaO and liquid. Thus if a mixture of CaO and Al_2O_3 in the ratio of 3 to 1 is heated to complete fusion, and cooled, CaO will appear as a primary phase at 1730° (point *a*). On further slow cooling (following the procedure developed in the consideration of the system CaO-SiO_2), it will be noted that CaO will continue to separate until a temperature of 1535° is reached. Just as this temperature is attained, the composition of the liquid will have reached point *b*, which is the quadruple point where CaO and C_3A exist in equilibrium with liquid. It can be noted that the composition of the liquid at that moment is 57 percent CaO and 43 percent Al_2O_3 , and the weight fraction of CaO that has separated up to that time is bd/bc , the fraction of liquid remaining being dc/bc . As heat is withdrawn from the system, C_3A now begins to crystallize from the liquid, but with each increment of C_3A removed from the liquid of composition *b*, there is left an excess of Al_2O_3 from that liquid which immediately dissolves some of the CaO that already has separated out. The net result therefore, on the removal of heat without change in temperature at 1535° , is the formation of C_3A and the disappearance of CaO , as the relative amount of liquid to solids decreases. Thus the mean composition of the solids moves from *c* toward *d*. When the last portion of liquid disappears, the last of the CaO also has just been dissolved, and there is left only C_3A , at point *d*, the temperature still being 1535° .

If the original composition had been on the lime side of C_3A , the same course of crystallization would have been followed, but the compositions would have

* See page 251.

been different. Thus if the mixture had contained 30 percent Al_2O_3 and 70 percent CaO , the CaO would have appeared at point g , about 1930° . When 1535° were reached, the fraction of CaO separated would be bh/bc , and the liquid remaining hc/bc . When the last drop of liquid had solidified at that temperature, there would still have remained some CaO undissolved, and the amount of CaO would be dh/dc and the C_2A hc/dc .

If the original composition had been on the alumina side of C_2A , an excess of liquid would have remained after all of the CaO had been dissolved at 1535° . Thus if we started with a mixture containing 40 percent Al_2O_3 , CaO would separate out at about 1650° , point k , and when 1535° were reached the amount of CaO

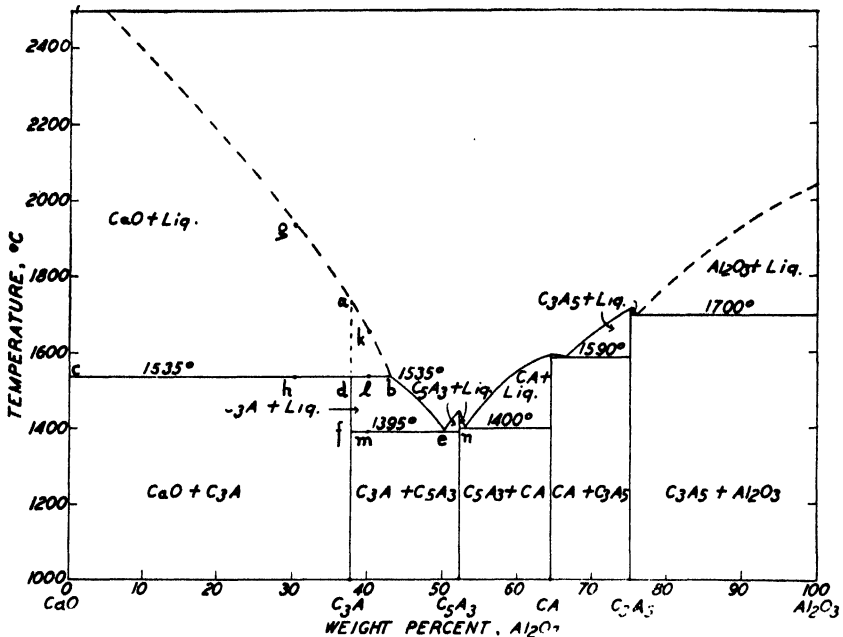

Figure 91. The system $\text{CaO}-\text{Al}_2\text{O}_3$. (Rankin and Wright)

present would be bl/bc , the liquid being lc/bc . But on removal of heat CaO would dissolve in the liquid and C_2A would separate out until all of the CaO were dissolved. At this moment the fraction of C_2A present would be bl/bd and of liquid remaining ld/bd . With further removal of heat the temperature would drop and C_2A continue to separate out until the temperature of 1395° were reached. During this period the composition of the liquid has changed along the curve be , and when e is reached at 1395° the percentage of C_2A present is em/ef and of liquid remaining mf/ef . At this temperature and concentration of liquid, being a eutectic invariant point for C_2A , C_5A_3 and liquid, the above two compounds crystallize together from the liquid, on removal of heat, until the whole mass is solid. The phase composition can then be computed, the C_2A will be nm/nf and the C_5A_3 , mf/nf .

From what has been given, the course of crystallization of any composition can easily be followed, and the relative amounts of solid and liquid phases at any

temperature calculated. At the invariant temperatures, however, the relative proportions of the two solid phases in the mixture can be calculated *only* for the conditions of the maximum heat (at the moment when the temperature has just reached the invariant point on cooling and only one solid phase is present), and of the minimum heat (at the moment when the reactions occurring at that temperature have just been completed).

Composition of the "5:3" Calcium Aluminate. Since Rankin and Wright (27) reported the existence in the C-A-S system of the compound C_5A_3 , some investigators have found that this formula does not satisfy all the known characteristics of the compound, and have suggested other formulas. Koyanagi (22) thought the formula should be C_3A_2 , but Bussem and Eitel (13), following a complete structural analysis of the compound, concluded that it should be C_{12}A_7 . A revised determination of the density gave it a value of 2.69, which does not permit of a whole number of molecules being calculated per unit cell by the formula C_5A_3 . Westgren and his co-workers (23) thought the formula C_9A_5 would equally well satisfy the structure as derived from X-ray patterns of crystallized melts, but Bussem pointed out a number of reasons why this was not possible, chief of which being that a density of 2.62 would be required which was so far from their value of 2.69 as not to appear tenable.

Thorvaldson and Grace (30) had found that $\text{C}_3\text{A} \cdot 6\text{H}_2\text{O}$ decomposes when dehydrated at temperatures above 275° , liberating 26.6 percent CaO and forming a less basic aluminate. By calculation from the equation



27.67 percent of CaO must be liberated, but from the equation

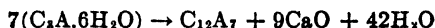

only 26.9 percent CaO would be formed.

The amount of CaO liberated by the reaction was again studied by Thorvaldson and Schneider (31) who obtained values which confirmed the earlier results. It seems possible, therefore, on the basis of both X-ray structural analysis and thermal experiments, that the true formula for the compound in question is C_{12}A_7 . The actual difference in composition is not great:

	CaO	Al ₂ O ₃
C_5A_3	47.78	52.22
C_{12}A_7	48.53	51.47

In order to avoid confusion due to the large number of systems which have been studied and expressed by the use of the composition represented by the formula C_5A_3 , and the still uncertain molecular structure of the compound, the usual formula C_5A_3 will be used in this work.

Optical Properties of the Calcium Aluminates. Tricalcium aluminate is described by Rankin and Wright as being unstable at its melting point, dissociating into CaO and liquid at $1535^\circ \pm 5^\circ$. Hence it is best obtained by crystallization from a glass of its own composition at a temperature below 1535° . It occurs, however, as primary phase on the liquidus curve of compositions containing between 43 and 50 percent Al_2O_3 . With C_5A_3 it forms a eutectic having the compo-

sition 50 percent CaO and 50 percent Al_2O_3 , which melts at $1395 \pm 5^\circ$. It does not form a eutectic with CaO, but the composition containing 43 percent Al_2O_3 is the quadruple invariant point at which these two compounds are stable in contact with liquid and vapor, at 1535° .

The compound, according to Rankin and Wright, occurs in equant colorless grains 0.1 mm or less in diameter, often hexagonal or rectangular in outline with indications of imperfect cleavage after the octahedron or rhombic dodecahedron. The crystal system is isometric; refractive index $n = 1.710 \pm 0.001$; hardness, 6; fracture, conchoidal; luster, vitreous. Occasionally faint gray interference colors were observed, due evidently to strain. Specific gravity is 3.04. A beautiful crystal occurring in glass in the system K-C-A is shown in Figure 38 (page 131).

The compound C_4A_3 was reported by Randin and Wright as occurring in both a stable form and an unstable form. The stable form melts at $1455^\circ \pm 5^\circ$, forms with C_2A the eutectic mixture noted above, and with CA a eutectic mixture having the composition 47 percent CaO and 53 percent Al_2O_3 , melting at $1400^\circ \pm 5^\circ$. The stable form crystallizes in rounded grains without definite crystal outline or distinct cleavage; luster, vitreous; fracture, conchoidal and often interrupted; hardness, 5; crystal system, isometric with refractive index $n = 1.608 \pm 0.001$. The refractive index of glass of the same composition is approximately 1.662.

The unstable form was reported as having neither a definite melting point nor any temperature range of real stability. It is obtained only under special methods of cooling and is usually not well developed in single crystallinities, but occurs as radial spherulites or aggregates of overlapping, and often approximately parallel fibers. Crystal habit, fibrous and prismatic; luster, vitreous; color, usually pale green; hardness, about 5; crystal system, probably orthorhombic. Refractive indices: $\alpha = 1.687 \pm 0.002$, $\gamma = 1.692 \pm 0.002$; birefringence weak. Optic axial angle apparently large; plane of optic axis and extinction are parallel with the fiber direction; optical character apparently negative but difficult to determine because of overlapping fibers. The more deeply colored grains were found to be pleochroic; $\alpha =$ blue-green; $\gamma =$ olive-green; absorption $\alpha > \gamma$.

Preparation of the Calcium Aluminates. Bates and Klein (4) found that free CaO and C_6A_3 were produced when high temperatures were used with a composition of 3CaO to Al_2O_3 , but that a satisfactory product of C_2A resulted when the mixture was twice heated at 1350° for several hours. Hansen (17) prepared the pure compound C_2A by heating a mixture of $3\text{CaCO}_3 + \text{Al}_2\text{O}_3$ in platinum in an electric furnace to 1375° . The heating was twice repeated with intermediate grinding. The product contained only a trace of CaO, but many very small isotropic spots were observed which appeared to be inclusions. On heating small charges in platinum foil up to 1530° for an hour, and quenching in mercury, the inclusions diminished, and were accordingly attributed to gas bubbles (page 406).

The C_4A_3 was prepared by Hansen by melting a mixture of $5\text{CaCO}_3 + 3\text{Al}_2\text{O}_3$ in platinum in an electric furnace, grinding the product, remelting and cooling slowly. The resulting material showed only occasional grains of C_2A .

The interplanar spacings of the X-ray diffraction patterns of these two calcium aluminates are shown on pages 541-542.

The difficulty of recognizing C_2A in portland cement clinker has been pointed out by Brown, (8) and a study made by him to determine its mode of occurrence

and relation to the structure of clinker. Synthetic preparations and commercial clinkers variously heat-treated were examined microscopically by transmitted light through thin sections.

It was found that C_3A has a tendency to crystallize readily in large units, enclosing crystals of C_3S and CaO . This gives to the C_3A the role of a matrix or interstitial phase; and, since its optical properties are closely similar to those of C_3S , and the amount present is always small in comparison with the latter, its presence in the mixture of silicates is difficult to establish.

A result of the presence of C_3A , however, which makes possible a demonstration of its presence, is its effect upon the orientation of the ternary iron compound. Crystallites of the iron compound are caused, by the C_3A crystals, to show over-large, roughly equidimensional areas, a common mass- or field-birefringence, not found where C_3A is absent.*

In a rapidly cooled clinker, the under-cooled liquid (glass) is the interstitial phase, whereas, in a slowly cooled clinker, the matrix is C_3A . Since most clinkers are so cooled that neither process is complete to the exclusion of the other, the real problem of C_3A visibility becomes one of distinguishing between C_3A and glass. This matter is discussed elsewhere.†

The System $\text{Al}_2\text{O}_3\text{-SiO}_2$

Rankin and Wright (27) reported in 1915 that the system $\text{Al}_2\text{O}_3\text{-SiO}_2$ included one compound having the composition AS. This compound occurs in nature in three forms: as sillimanite, andalusite and cyanite. Rankin and Wright, however, found only the sillimanite, and reported that the other two forms were not observed with certainty, and that nothing bearing on their relation to sillimanite was established beyond the fact that on heating they pass into that form. The evidence all pointed to the probability that they are monotropic with respect to sillimanite.

More recently Bowen and Greig (5) found that none of the above compounds is stable but that a compound of a different composition, A_3S_2 , having optical properties and X-ray diffraction patterns very similar to those of sillimanite, is the only stable compound in the system. This new compound was found, shortly thereafter, to occur in rock from the Island of Mull and was accordingly named mullite (6).

The diagram of the system A-S is shown in Figure 92. Since A_3S_2 does not occur in the field of portland cement, little need be said here about the system or about mullite. That compound and sillimanite have found extensive use in alumina-silica refractories.

The System $\text{CaO-Al}_2\text{O}_3\text{-SiO}_2$

Stability Fields. The three binary systems of the components CaO , Al_2O_3 and SiO_2 have now been examined, together with such of the binary compounds as are of interest in connection with portland cement compositions. We may now consider the ternary system.

* See pages 137-140.

† See pages 63-65.

In Figure 93 is shown a projection of the concentration-temperature diagram for the system (indicated by solid lines), together with triangular areas (indicated by broken lines) within which the final products of crystallization are the com-

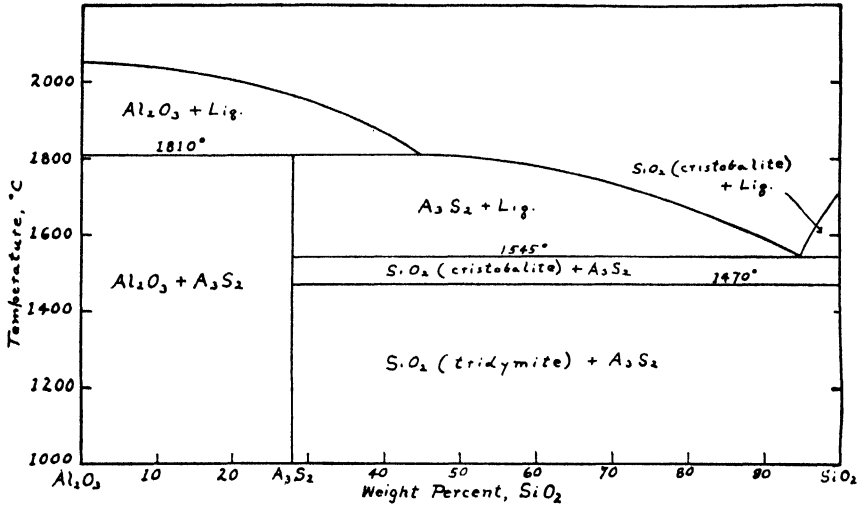

Figure 92. The system $\text{Al}_2\text{O}_3\text{-SiO}_2$. (Rankin and Wright, as modified by Bowen and Greig)

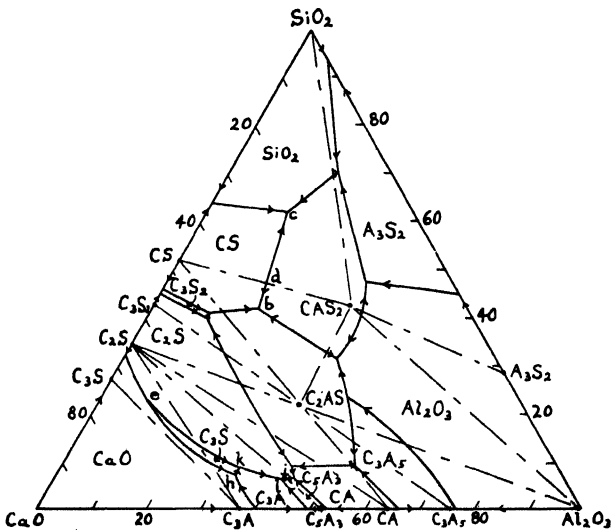

Figure 93. The system $\text{CaO-Al}_2\text{O}_3\text{-SiO}_2$. (Rankin and Wright)

pounds shown at the vertices of the triangles. There are shown to be 14 stability fields in this system where a single compound is in equilibrium with liquid and vapor. Two ternary compounds were found, CAS_2 and C_2AS , and their stability

fields are indicated. A photograph of a solid model is shown in Figures 94, where temperature is the vertical dimension.

Where the composition of a compound lies within the region of its stability, as C_2S , the compound of course melts congruently, that is, the compound is stable at its melting point. But where the composition of a compound lies outside the region in which it occurs as a primary phase, as C_1A , it melts incongruently, that is, the compound is not stable at its melting point but dissociates into liquid and the compound within whose primary-phase field it is located. In the case of C_1A , that field is seen to be in the stability field of CaO . Yet throughout the area of the C_2A stability field, that compound is stable and in equilibrium with liquid and vapor.



Figure 94. Photograph of a solid model of the system $\text{CaO-Al}_2\text{O}_3\text{-SiO}_2$. (Rankin and Wright)

A third condition is indicated in connection with the compound C_2S . Here the composition of the compound is outside the field where it appears as a primary phase, indicating that it dissociates at a temperature below its melting point into CaO and C_2S . But of equal importance is the finding that, in the ternary system, there is a region where it exists in equilibrium with liquid and vapor.

The areas of the stability fields are seen to be bivariant: that is, both concentration and temperature may be changed without affecting the equilibrium of solid-liquid-vapor.

The stability fields are separated by boundary curves. At the compositions represented by these curves, the liquid is saturated with respect to both of the solid compounds whose primary-phase regions it separates. Thus on these curves we have an equilibrium between two solid phases, liquid and vapor, and the system is monovariant; that is, either concentration or temperature may be varied without upsetting this equilibrium, but not both.

The direction of temperature change along the boundary curves may be

ascertained by the application of certain principles. The simplest case is that wherein the two compounds whose fields are separated by the curve form a true binary system, *i.e.*, where all mixtures of the two compounds at the liquidus may be expressed in terms of those compounds, not forming any phases which lie outside of the boundaries of the components. Such a condition is not found in the region of cement (in the triangle $C_3S-C_2S-C_3A$), but may be illustrated by the curve bc , (Figure 93) which separates the fields of CS and CAS_2 . The line joining those two compounds is seen to lie wholly within the fields of the compounds, and hence is a true binary system. According to the theorem of Alkemade (3), the temperature along the boundary curve bc will be at a maximum at the point where it crosses the join, *i.e.*, at point d , and will fall from d to c and from d to b . Along the join, however, the temperature will be at a minimum at the point of intersection, and rise from d as it approaches the composition of either compound.

In the case of the curves in the region of portland cement there are no true binary systems involved and the solution is somewhat more complicated. The curve eh separates the fields of C_3S and CaO , but the line joining these two compounds does not intersect the curve. However, the direction of falling temperatures along the curve must be away from that line, *i.e.*, in the direction of e toward h . By similar reasoning, the direction of falling temperatures along the curve ek , separating the fields of C_3S and C_2S must be away from the join uniting the compositions of those two compounds, *i.e.*, in the direction of e toward k . The fields of C_3S and C_3A are separated by the curve hk . An extension of the curve would intersect the join between those compounds, which would be a maximum point, hence the direction of falling temperatures will be away from that point, that is, in the direction of h toward k . The fields of C_2S and C_3A are separated by the curve kl . An extension of the curve would intersect the join between those two compounds, and the direction of falling temperatures will accordingly be away from that intersection, that is, in the direction of k toward l . In the case of C_2S and C_3A , we again have a true binary system, the join intersecting the boundary which separates the fields. Hence on the curve li , a high point will appear at that intersection, and drop toward both l and i .

It will be seen that CaO , C_3S and C_3A can exist together in equilibrium with liquid and vapor at point h , a composition where the liquid is saturated with all the three solid phases; but any change either in the concentration or the temperature will upset the condition of equilibrium, causing one of the solid phases to dissolve or the liquid to solidify. Hence this point is an invariant quintuple point. It is not, however, a eutectic point, for it is not the lowest melting temperature on the three boundary curves of which it is a common point. In some compositions, as will be shown later, CaO will dissolve with removal of heat at this temperature, and with further drop in temperature the liquid will follow the curve hk to k .

The point k is seen to be a quintuple invariant point at which C_3S , C_2S and C_3A are in equilibrium with liquid and vapor. But, for the same reasons developed above, it is not a eutectic point, and with some compositions C_3S will dissolve and the liquid proceed along the curve kl to l , which is the quintuple invariant point where C_2S , C_3A and C_4A_3 are in equilibrium with liquid and vapor. Point l , however, is a eutectic point because it is the lowest melting temperature on the three boundary curves of which it is a common point. Hence any liquid reaching

this point cannot proceed further, but will complete solidification at that composition and temperature.

The invariant points in this system of interest to the cement chemistry are given in Table 22.

TABLE 22. The invariant points in the system C-A-S in the portland cement region of the diagram (Rankin and Wright (27))

Phases	Reaction	Composition			Temp. (°C)
		CaO	Al ₂ O ₃	SiO ₂	
CaO.....	Melting	100	2570
Al ₂ O ₃	Melting	100	2050
SiO ₂	Melting	100	1625
C ₃ S.....	Dissociation	73.59	26.41	1900 ± 20
C ₂ S.....	Melting	65.00	35.00	2130 ± 20
C ₂ S.....	α-β inversion	1420 ± 2**
C ₂ S.....	β-γ inversion	675 ± 5
C ₃ S ₂	Dissociation	58.2	41.8	1475 ± 5
CS.....	Melting	48.2	51.8	1540 ± 2
C ₃ A.....	Dissociation	62.22	37.78	1535 ± 2
C ₅ A ₃	Melting	47.78	52.22	1455 ± 5
CA.....	Melting	35.44	64.56	1600 ± 5
C ₃ A ₅	Melting	24.78	75.22	1720 ± 10
C-C ₂ S.....	Eutectic	67.5	32.5	2065 ± 10
C ₂ S-C ₃ S ₂ *.....	Reaction	55.32	44.68	1464 ± 3
C-C ₃ A.....	Reaction	57	43	1535 ± 2
C ₃ A-C ₅ A ₃	Eutectic	50	50	1395 ± 5
C-C ₂ S-C ₂ S.....	Reaction	68.4	9.2	22.4	1900 ± 20
C-C ₃ S-C ₃ A.....	Reaction	59.7	32.8	7.5	1470 ± 5
C ₃ S-C ₂ S-C ₃ A.....	Reaction	58.3	33.0	8.7	1455 ± 5
C ₂ S-C ₃ A-C ₅ A ₃	Eutectic	52.0	41.2	6.8	1335 ± 5

* Values corrected by E. F. Osborn, *J. Am. Ceramic Soc.*, **26**, 321 (1943).

** This value changed to 1456° by Newman and Wells (see Chapter 7).

Crystallization Areas. A further word may be said with reference to the joins between the compounds in the ternary system. It will be recognized that these are not mere arbitrary lines, but that they indicate a particular relationship within the system. Where two compounds share a common boundary curve, and only in such a case, a join may be drawn between the two compounds. The significance, as will be shown later, is that these two compounds may crystallize together through certain concentration and temperature ranges. And, wherever the fields of three solid phases meet at an invariant point, there are certain compositions which may complete their crystallization at that point. Those compositions are

then represented by the area within the triangles formed by connecting the compositions of the three compounds.

By way of illustration of these principles, the curve bc indicates that the compounds of which it is the common boundary, CS and CAS_2 , may crystallize together; hence we may draw a join between those two compounds. For the same reason we draw joins between CS and SiO_2 , and between CAS_2 and SiO_2 . The invariant point c indicates that these three compounds may crystallize together, and the triangle formed by connecting the three compounds shows the area within which such crystallization will be complete.

In a similar way, the curve eh shows that CaO and C_2S may separate together; hence we may draw a join between those two compounds. Likewise for CaO and C_2A , and for C_2S and C_2A . The invariant point h shows that these three compounds may crystallize together, and the triangle $C-C_2S-C_2A$ then indicates the area within which crystallization will be complete at that point. Likewise, it will be seen that all compositions within the area $C_2S-C_2S-C_2A$ will complete their crystallization at point k , where those compounds are in equilibrium with liquid and vapor. But we cannot, for example, draw a line between C_2S and C_2A , because there is no boundary curve upon which those two compounds are mutually stable.

It will be seen that some joins represent true binary systems, as $CS-CAS_2$ and C_2S-C_2A , which lie entirely within the fields of the compounds whose compositions they connect; hence all equilibrium mixtures may be expressed in terms of those components. But other joins do not represent true binary systems. Thus on the join C_2S-C_2A , the primary phase throughout its length is CaO , and this cannot be expressed by any combination of the two components. The join C_2S-C_2A passes through three primary-phase regions, two of which, CaO and C_2S , cannot be expressed in terms of the components. The join C_2S-CA passes through three primary-phase regions, one of which, C_2AS , cannot be expressed in terms of the components. These joins, therefore, do not represent true binary systems.

Where the join is a true binary system, it is, in effect, the horizontal projection of the melting curve of the components, the eutectic point being indicated by the intersection with the boundary curve. But where the join passes partially or wholly outside of the fields of its components, it represents in those areas the melting curve of the compound, whose field it is traversing, in the mixture of the components represented at the extremities of the line. Thus $CS-CAS_2$ is a projection of the melting curve of those two compounds, with a eutectic point at d . But the join C_2S-C_2A represents the melting curve of CaO in solutions of C_2S and C_2A . The join C_2S-C_2A indicates the melting curve of C_2S in solutions of C_2A from the composition of C_2S up to the point of intersection with the boundary curve ek . In the region where it traverses the field of C_2S , it represents the melting curve of C_2S in solutions of C_2S and C_2A . And in the region where it traverses the field of CaO , it represents the melting curve of CaO in solutions of C_2S and C_2A .

Course of Crystallization. The course of crystallization will be illustrated by use of the diagram in Figure 95, which shows the high-lime portion of the $C-A-S$ system with isothermal lines drawn in. A simple case is that of composition m . On cooling a liquid of this composition, the first phase to separate, at about

2080°, is CaO , and the liquid moves toward the boundary eh where, at 1795°, the liquid has become saturated with respect to C_2S . At this moment the amount of CaO that has separated can be computed by noting the proportionate parts of the line cn that has been involved in the crystallization, e.g., mn/cn is the fraction of CaO separated and cm/cn the fraction of liquid remaining. As C_2S now appears, the composition of the liquid on cooling moves down the boundary curve separating the two solid phases and the composition of the solid moves from CaO toward C_2S . When the liquid reaches 1473°, the temperature of the invariant point h , it has become saturated with respect to C_3A . At this moment the compo-

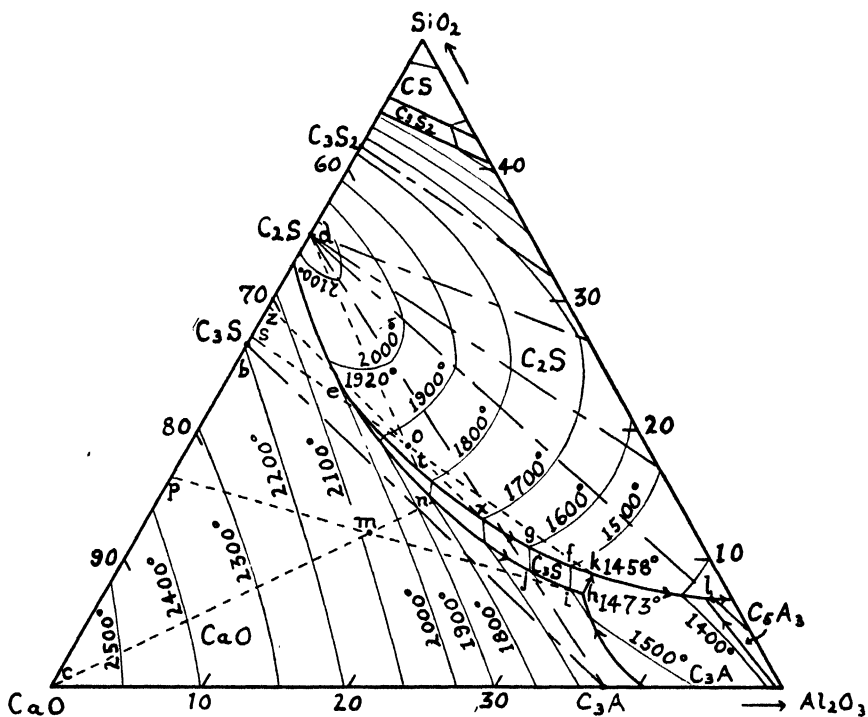

Figure 95. A part of the system $\text{CaO-Al}_2\text{O}_3\text{-SiO}_2$, showing isotherms.

sition of the solid will be represented by point p , the fraction of CaO in the crystallized material being bp/bc and of C_2S , pc/bc . The fraction of solids crystallized will, of course, be mh/ph , and of liquid mp/hp . The C_3A now separates with the other two solid phases without change in temperature, the composition of the liquid remaining constant, and that of the solids moving along the line ph until it reaches m , the original composition, where solidification becomes complete.

Another case which may be shown from Figure 95 is the composition o . This being in the field of C_2S , that compound first separates at about 1865°, and the liquid moves along the projection of the line do until at about 1810° it has become saturated with respect to C_2S . At this point the fraction of C_2S separated will be ot/dt , and of liquid, do/dt . On further cooling, C_2S separates with C_3S , the liquid

moves down the boundary curve, and at 1458° , the temperature at which the liquid becomes saturated with C_3A , the composition of the solids is that of point s . In the solids, the C_3S will be represented by ds/db , and the C_2S by bs/bd . The total solids will be ko/ks , and the liquid will be os/ks . At 1458° the three solid phases will crystallize together without change in temperature or composition of the liquid, and the composition of the solids will change along the line sk until point o is reached, where crystallization will be complete.

From such a diagram as Figure 95, where the isotherms are shown, one may compute also the percentages of the solid phases and liquid at any temperature. Thus with composition o at 1700° , the liquid will have reached point x and the solids will lie at point z . Then the composition of the solids will be $C_3S = dz/db$ and $C_2S = bz/bd$. The fraction of solids will be xo/xz , and of liquid oz/xz .

A few additional courses of crystallization are shown in Figures 96, 97, 98 where the fields are somewhat distorted in order to show the route to better advantage. In Figure 96, a composition, o , is selected in the CaO field of the

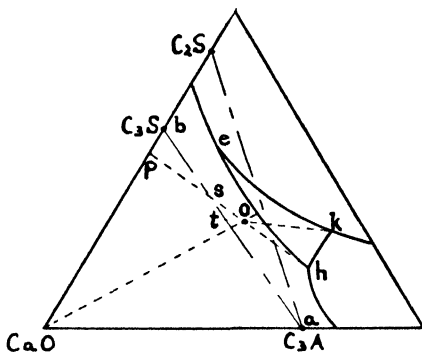

Figure 96. Distorted section of system $CaO-Al_2O_3-SiO_2$.

triangle $C_3S-C_2S-C_3A$. As CaO separates out, the liquid moves to the $C-C_3S$ boundary and thence down to the invariant point h . At this temperature the solid, first having the composition p , moves toward h with separation of C_3A . But when the solid has reached the join between C_3S and C_3A at s , it consists only of those two phases in the amounts $C_3S = as/ab$, and $C_3A = sb/ab$. This illustrates the observation that a solid phase which separates out, as CaO , may on further cooling dissolve in or react with the liquid so as to cause its partial or complete disappearance.

Upon the removal of all the CaO in the solid phases, the liquid then moves along the boundary curve hk , while C_3S and C_3A separate together. When point k is reached, at which the liquid is saturated with C_2S , the composition of the solids has moved from s to t , and the relative amounts of the two solid phases may be computed in the usual manner. At the temperature of k , C_2S then separates and the composition of the solids moves from t towards k until, at point o , crystallization becomes complete.

Another composition, m , is shown in Figure 97, also in the CaO field in the $C_3S-C_2S-C_3A$ triangle. Lime is first to separate out, as before; but when the liquid has reached the temperature and composition of point p , the solid phase is seen to consist wholly of C_3S . The liquid then must leave the boundary between those

two phases, and follow the extension of the line bp , while C_3S alone separates until point n is reached, where the liquid is saturated with C_2A . As that compound crystallizes, the liquid follows the boundary separating C_3S and C_2A and the composition of the solids follows down the line ba joining C_3S and C_2A . When the liquid arrives at k , it is saturated with respect to C_2S , and the solids have reached point r . The C_2S then separates without change in temperature, and the composition of the solids changes from r to m where crystallization is complete.

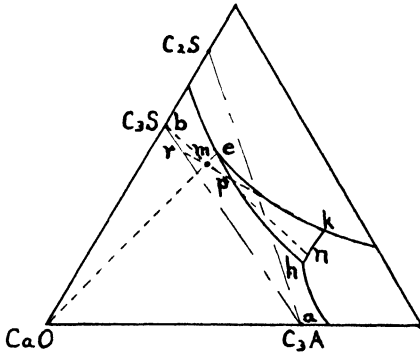

Figure 97. Distorted section of system $\text{CaO}-\text{Al}_2\text{O}_3-\text{SiO}_2$.

In Figure 98, a point u is selected in the C_3S field of the triangle $\text{C}_3\text{S}-\text{C}_2\text{S}-\text{C}_3\text{A}$. Here C_3S first separates, and the liquid follows the projection of bu to v , where C_2A appears. As the liquid proceeds to k , the solids change along the join ba to y , and then, as C_2S separates out, the solids change along the line yk to complete crystallization at u .

It should be pointed out here that in any triangular area of a system, representing the final products of crystallization, the relative percentages of each of the

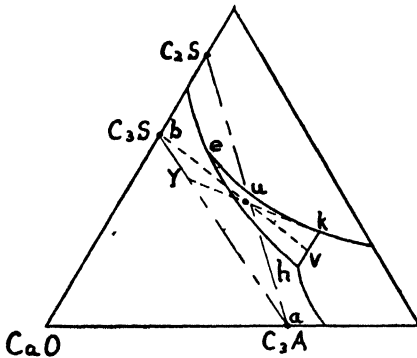

Figure 98. Distorted section of system $\text{CaO}-\text{Al}_2\text{O}_3-\text{SiO}_2$.

three compounds indicated at the vertices, which will be present at equilibrium at the minimum heat content of the invariant-point temperature, may be read directly. Thus in the triangle $\text{C}_3\text{S}-\text{C}_2\text{S}-\text{C}_3\text{A}$, the line $\text{C}_2\text{S}-\text{C}_3\text{A}$ represents all compositions which contain 0 percent C_3S . Only C_2S and C_3A occur along the line. At point y , for example (Figure 98), the amount of C_3S will be indicated by the ratio, ya/ba and the amount of C_2A by yb/ba .

By drawing lines in the triangle parallel to C_2S-C_2A , we obtain the loci of all compositions of equi-percentage of C_2S . That is, if we divide the line C_2S-C_2S into ten segments of equal length, and draw lines from these points parallel to C_2S-C_2A , then the percentage of C_2S is constant along each line, and is established by the location of the composition point with respect to these lines. The principle is identical with that employed for establishing the composition of points in the usual equilateral triangle. Thus we may read the composition of point *c*, Figure 99, in terms of oxides, as 66.7CaO, 5.7Al₂O₃ and 27.6SiO₂; and in terms of compounds, as 15C₂A, 60C₂S and 25C₃S.

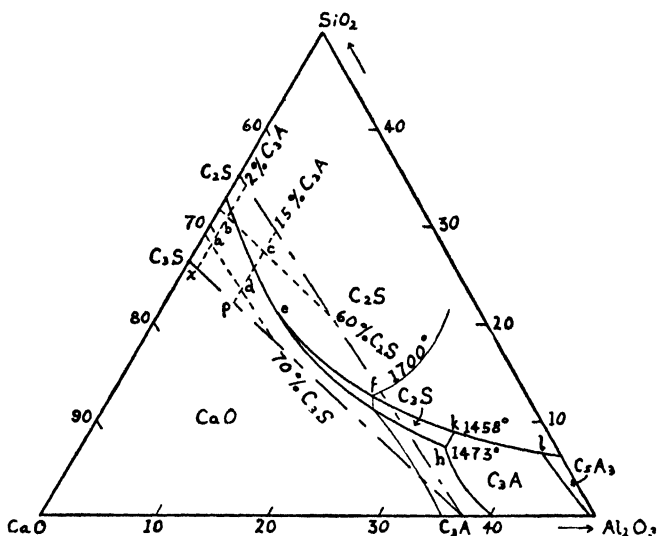

Figure 99. The area of portland cement in the system CaO-Al₂O₃-SiO₂.

The Field of Portland Cement. It may be noted that the general area of portland cement, when referred to the C-A-S system, occurs within the triangle $C_2S-C_2S-C_2A$. By using the rather wide limits of composition of C_2S not in excess of 70 percent, C_2S not in excess of 60 percent, and C_2A between 2 and 15 percent, the area inclosed by the dashed lines *abcd* (Figure 99) is obtained. A part of this area is seen to be located in the primary-phase region of CaO, a part in that of C_2S , and none of it in the region of C_3S . Since the entire area *abcd* is located in the triangle $C_2S-C_2S-C_2A$, these compounds are the ones stable at the lowest temperature at which liquid can be present, and final equilibrium crystallization will consist of those compounds and none other. In commercial practice, however, there is not time for attainment of equilibrium, and several other conditions could obtain.

If a mixture CaO, Al₂O₃ and SiO₂, represented by any point in the area *abcd* is heated, the first liquid will appear at the temperature of the quintuple point *k*, which is 1458°. The composition of the liquid at that temperature will also be that of the quintuple point. The reactions of combination will take place and, given sufficient time, with no further heat input, will reach the equilibrium

quantities of C_2S , C_3S and C_4A , as noted from its original composition in the area $abcd$. With increase in temperature, the C_2A dissolves and the ratio of C_3S and C_2S changes. If we stopped at say 1700° , the liquid would be at point f , and the solids would consist of the two silicates in amounts which could be calculated for any composition by the method already given. But on the assumption that the time is inadequate for the attainment of equilibrium, the nature of the products is indeterminate.

In the first place, if the reactions of combinations have not been completed, there will remain one or more of the uncombined oxides, usually silica or lime. Where relatively coarse quartz or flint is used, there are frequently observed under the microscope cores or areas characterized by an aura of highly birefracting C_2S . Lime has been found to react readily with SiO_2 to form C_2S , but much more slowly with the latter to form C_3S . So in mixtures relatively high in lime,⁵ the last portions of it combine very slowly with the C_2S , and usually the reaction is still incomplete when the clinker emerges from the cement kiln. This is reflected in the difficulty of preparing pure C_3S , which have been described.

If we assume complete equilibrium at point k , the heating between that point (1458°) and 1700° (which we are considering arbitrarily as our maximum temperature) may still be too rapid to allow the changing ratios of the two silicates to occur as required by the provisions indicated in the diagram. It may be noted that as the liquid changes from k to f , the mean composition of the solids from any point within the area $abcd$ rises along the line C_3S-C_2S in the direction of the latter compound. Hence, if heating and subsequent cooling are too rapid, the product may contain an excessive amount of the C_2S above that which would obtain at 1700° under equilibrium conditions. On the other hand, if the reactions have been completed at 1700° , but the cooling is then too rapid to allow the reverse process to follow the curve on the diagram, there will be an excessive amount of C_2S in the product. Finally, the liquid may undercool by rapid cooling, being frozen from any point on the curve, resulting in the presence of glass in the product, and no or only partial crystallization of the C_3A .

It will also be noted that a rigid control of the raw mixture must be had to keep it within the area assigned. Thus if the composition were brought on the CaO side of the line C_3S-C_2A , then no amount of burning or care in cooling could produce a product free of CaO . And likewise if the composition were allowed to go to the C_2S side of the line C_3S-C_2A , the crystallization would not stop at k , but would proceed to l where C_4A_3 would appear.

CaO is undesirable in cement because it causes the mortar to expand unduly, and C_4A_3 because of its nonhydraulic character. C_2A may have no useful function in cement, but by lowering the temperature of liquid formation it accelerates the combination of the CaO with SiO_2 , and so is important in the manufacturing operation. Perhaps pure C_3S would be the ideal cement, but the difficulties of producing it would be so great as to be economically prohibitive. Even a cement of only the three components of this system is impracticable for commercial purposes, because the abundant native rocks and materials which must constitute the raw materials contain also iron, magnesia and other minor constituents. These will be discussed presently. But the problem of the chemist is well illustrated by this

ternary system, the components of which comprise the greater part of commercial portland cement.

References

1. Anderson, O., and Lee, H. C., *J. Wash. Acad. Sci.*, **23**, 338 (1933).
2. Ashton, F. W., and Wilson, R., *Am. J. Sci.*, **13**, 209 (1927); PCAF Paper 5.
3. Bancroft, W. D., "The Phase Rule," p. 149, New York, Published by *The Journal of Physical Chemistry*, 1897.
4. Bates, P. H., and Klein, A. A., *Tech. Paper, NBS*, 78 (1917).
5. Bowen, N. L., and Greig, J. W., *J. Am. Ceram. Soc.*, **7**, 238 (1924).
6. Bowen, N. L., Greig, J. W., and Zeis, E. G., *J. Wash. Acad. Sci.*, **14**, 183 (1924).
7. Bredig, M. A., *J. Phys. Chem.*, **46**, 747 (1942); *Am. Mineral.*, **28**, 594 (1943).
8. Brown, L. S., *Proc. Am. Soc. Testing Materials*, **37**, 277 (1937).
9. Brownmiller, L. T., and Bogue, R. H., *Am. J. Sci.*, **23**, 501 (1932); PCAF Paper 25.
10. Brownmiller, L. T., and Bogue, R. H., *Am. J. Sci.*, **20**, 241 (1930); PCAF Paper 24.
11. Bunting, E. N., *J. Res. NBS*, **5**, 325 (1930); RP 203.
12. Burdick, M. D., *J. Res. NBS*, **25**, 475 (1941); RP 1340.
13. Bussem, W., and Eitel, A., *Z. Krist.*, **A95**, 175 (1936); *Symposium*, 149.
14. Carlson, E. T., *J. Res. NBS*, **7**, 893 (1931); RP 381.
15. Day, A. L., Shepherd, E. S., and Wright, F. E., *Am. J. Sci.*, **22**, 256 (1906).
16. Flint, E. P., McMurdie, H. F., and Wells, L. S., *J. Res. NBS*, **21**, 617 (1938); RP 1147.
17. Hansen, W. C., *J. Am. Ceram. Soc.*, **11**, 68 (1928); PCAF Paper 12.
18. Hansen, W. C., and Brownmiller, L. T., *Am. J. Sci.*, **15**, 225 (1928); PCAF Paper 14.
19. Johannson, O. K., and Thorvaldson, T., *J. Am. Chem. Soc.*, **56**, 2327 (1934).
20. Kanolt, C. W., *J. Wash. Acad. Sci.*, **3**, 315 (1913).
21. Keevil, N. B., and Thorvaldson, T., *Can. J. Res.*, **14**, 20 (1936); *Concrete, CMS*, July, 1936, p. 38.
22. Koyanagi, K., *Zement*, **20**, 72 (1931).
23. Lagerquist, K., Wallmark, S., and Westgren, A., *Z. anorg. allgem. Chem.*, **234**, 1 (1937).
24. Lea, F. M., and Parker, T. W., *Phil. Trans. Royal Soc.*, **234**, No. 731, 1 (1934) A.
25. Meyers, S. L., *Rock Products*, April 1930, p. 78.
26. Rankin, G. A., and Merwin, H. E., *J. Am. Chem. Soc.*, **38**, 568 (1916).
27. Rankin, G. A., and Wright, F. E., *Am. J. Sci.*, **39**, 1 (1915).
28. Sosman, R. B., "The Properties of Silica," New York, Chemical Catalog Co. (Reinhold Publishing Corp.), 1927.
29. Sundius, N., *Z. anorg. Chem.*, **213**, 343 (1933).
30. Thorvaldson, T., and Grace, N. S., *Can. J. Res.*, **1**, 36 (1929).
31. Thorvaldson, T., and Schneider, W. G., *Can. J. Res.*, **19**, 109 (1941).
32. Tilley, C. E., *Mineral. Mag.*, **22**, 77 (1929).
33. Tilley, C. E., *Mineral. Mag.*, **23**, 419 (1933).
34. Ulrich, F., *Norsk. Geol. Tidsskrift.*, **8**, 115 (1925).
35. Weyer, J., *Zement*, **20**, 692 (1931).

CHAPTER 14

Systems Containing MgO with CaO, Al₂O₃, SiO₂

MgO

Periclase (MgO) occurs in cubes or octahedrons, having cubic cleavage, hardness 6. Specific gravity has been reported for the natural mineral from 3.64 to 3.90, and of the fused oxide from 3.47 to 3.64. The melting point is 2800°, it is isometric and has a refractive index of 1.737. The X-ray diffraction pattern is given on page 541.

CaO-MgO

The binary systems containing MgO are usually quite simple because of the relative unreactivity of the magnesia. The system C-M was studied by Rankin and Merwin. (10) A concentration-temperature diagram is shown in Figure 100.

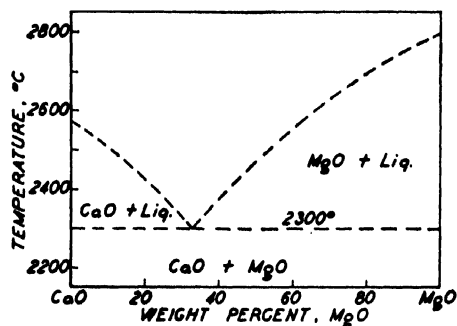

Figure 100. The system CaO-MgO. (Rankin and Merwin)

No compounds are formed, but a eutectic appears at a composition C 67, M 33 percent, which melts at 2300° ± 50°.

MgO-Al₂O₃

The system M-A was studied by the same investigators; the concentration-temperature diagram is shown in Figure 101. One binary compound, MA, was found, melting congruently at 2135°. Three eutectics were defined:

Phases	Composition		Temp.
	M	A	
M-MA.....	45	55	2030
MA-βA.....	8	92	1925
MA-αA.....	2	98	1925

The X-ray diffraction pattern of MA is given on page 543.

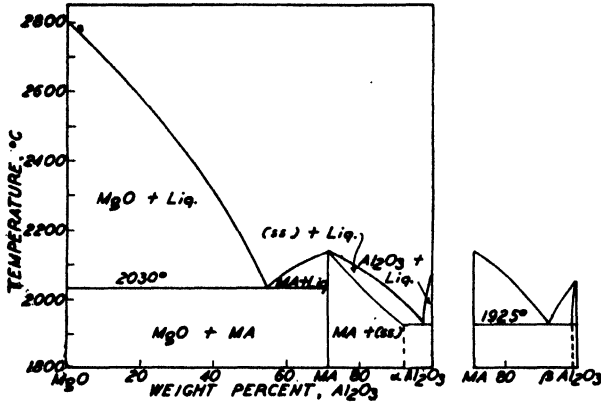

Figure 101. The system MgO-Al₂O₃. (Rankin and Merwin)

MgO-SiO₂

In the system MgO-SiO₂, (2) (1) (4) two compounds were found, M₂S (forsterite), having the composition M 57.31, S 42.69, and MS (clineenstatite) having the composition M 40.17, S 59.83. The concentration-temperature diagram

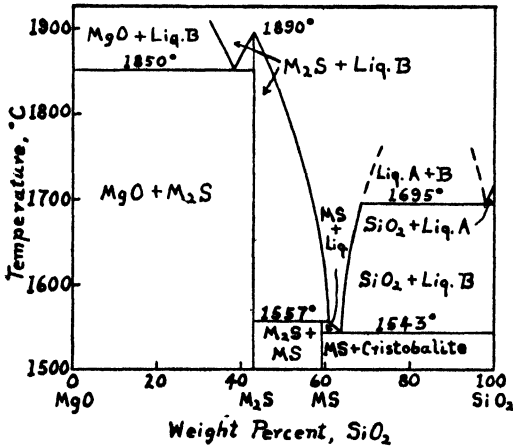

Figure 102. The system MgO-SiO₂. (Bowen and Anderson)

is shown in Figure 102. M₂S melts congruently at 1890°, and MS melts incongruently at 1557° into M₂S and liquid. The invariant points found were as follows:

Phases	Reaction	Composition		Temp.
		M	S	
M-M ₂ S	Eutectic	63.3	36.7	1850
M ₂ S-MS	Melting	39.2	60.8	1557
MS-S	Eutectic	35.2	64.8	1543

CaO-MgO-Al₂O₃

The system C-M-A was studied by Rankin and Merwin. (10) A diagram of the system is shown in Figure 103. No ternary compounds were found. Six invariant points were established, two of which were eutectics, as follows:

Eutectics

Phases	Composition			Temp.
	C	A	M	
M-C ₂ A-C ₃ A ₃	46.0	47.7	6.3	1345 ± 5
M-C ₃ A ₃ -CA.....	41.5	51.8	6.7	1345 ± 5

Not eutectics

C-M-C ₂ A.....	51.5	42.3	6.2	1450 ± 5
M-MA-CA.....	40.7	52.4	6.9	1370 ± 5
MA-CA-C ₃ A ₃	33.3	63.2	3.5	1550 ± 5
MA-C ₃ A ₃ -A.....	21	74	5	1680 ± 20

It may be noted that MgO is the primary phase in by far the greater part of the system.

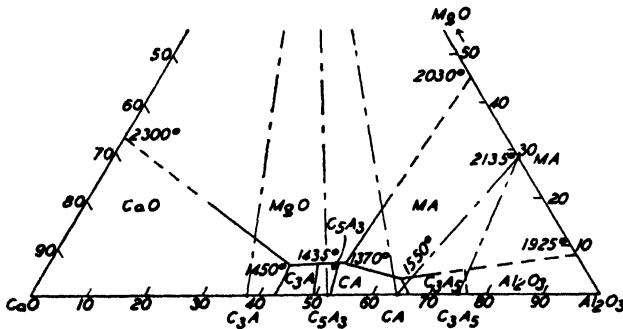

Figure 103. The system CaO-MgO-Al₂O₃. (Rankin and Merwin)

CaO-MgO-SiO₂

The system CaO-MgO-SiO₂ was investigated by Ferguson and Merwin (3) in 1919 and by Greig (4) in 1927. The compound monticellite, CMS, was the most basic of the ternary compounds found, but its field of stability is far removed from the high-lime region of portland cement. The composition is C 35.84, M 25.77, S 38.39. The invariant point for CaO, C₂S and MgO was not established precisely because of the high melting temperatures in this region, but the melting point was above 1900°. For the same reason, the boundary curves separating the fields of CaO from MgO and C₂S, and of MgO from C₂S, were only approximated.

Recently Osborn (9) re-examined the more basic part of this system and found that merwinite (C₂MS₂) has a field of stability on the liquidus surface. A partial

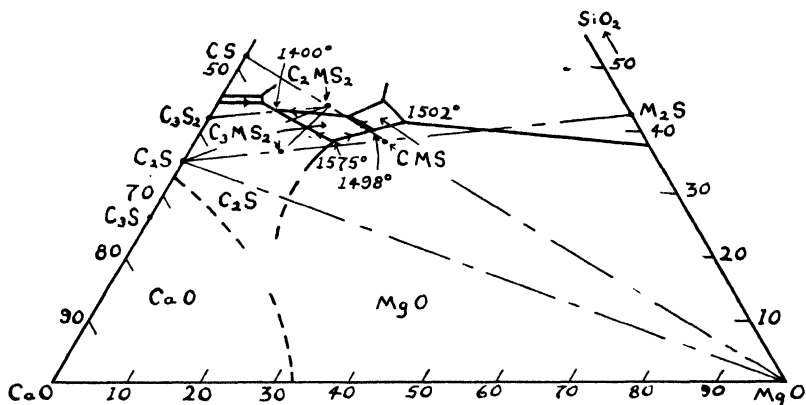

Figure 104. Part of the system CaO-MgO-SiO_2 . (Ferguson and Merwin)

diagram of the system as revised by Osborn is shown in Figure 104. The compound C_3MS_2 has the composition C 51.19, M 12.27, S 36.54. It melts incongruently at $1575^\circ \pm 5^\circ$ to MgO , C_2S and liquid of the composition C 43.0, M 18.2, S 38.8. The study suggested that a limited solid solution exists of C_3MS_2 in C_2S . A second ternary invariant point was found at $1400^\circ \pm 5^\circ$ at the composition C 49.5, M 6.8, S 43.7, the solid phases being C_2S , C_3MS_2 and C_2MS_2 (akermanite). Because of the close resemblance of crystals of C_2S and C_3MS_2 , differentiation is difficult. Their fields were located by indirect methods, such as the use of conjugation lines and slopes of liquidus curves.

$\text{C}_2\text{S-MgO-C}_3\text{A}_2$

In 1912 Klein and Phillips (6) made a number of preparations in which MgO replaced CaO in C_2S , their compositions falling on the line $\text{C}_2\text{S-CMS}$ (Figure 105). In another series they made replacements of CaO by MgO in such a way that their compositions fell in the triangle $\text{C}_2\text{S-CMS-MgO}$. From the microscopic examina-

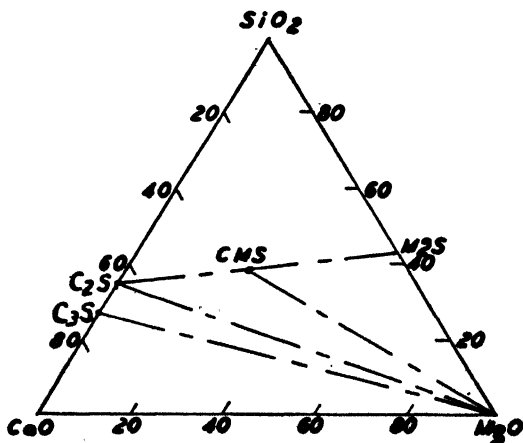

Figure 105. Composition fields in the system CaO-MgO-SiO_2 .

tion of their preparations, they concluded that C₂S and CMS form a series of solid solutions and that a small amount of MgO could be so combined with C₂S in portland cement.

Hansen (5) has pointed out that the preparations of Klein and Phillips contained some SiO₂ in excess of that required to form C₂S with all of the CaO, but that, in portland cement, there is more than sufficient CaO to convert all of the SiO₂ to C₂S, so the compositions of portland cement fall in the triangle C₂S-C₃S-MgO. Hence, if a solid solution of C₂S with CMS exists in cement, the MgO must be capable of combining with CaO and SiO₂ to form CMS under conditions where sufficient CaO is present to convert all of the SiO₂ to C₂S.

In order to establish if this would be the case, Hansen investigated the system C₂S-M-C₃A₂. The results of his study are shown in Figure 106. In the slowly

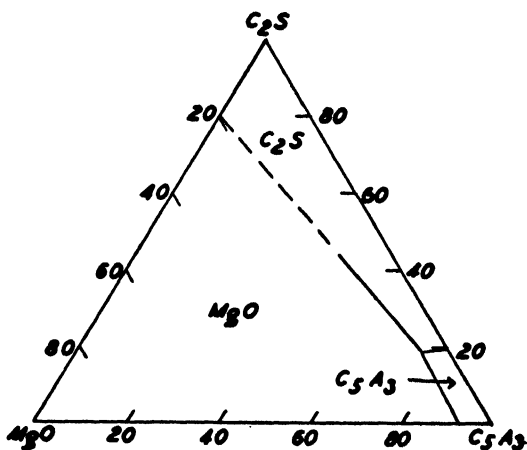

Figure 106. The system C₂S-MgO-C₃A₂. (Hansen)

cooled samples of all preparations there was found only γ -C₂S, C₃A₂ and MgO; in no case was there found CMS or any material that showed optical evidence of being a solid solution of MgO with either the C₂S or the C₃A₂. Furthermore, if MgO had replaced any CaO from C₂S to form CMS then CaO would be released which would tend to combine with C₂S to form C₃S, or with C₃A₂ to form C₃A. In no preparations however were either of those compounds observed, nor was uncombined CaO found. These studies indicated, therefore, that MgO does not combine with CaO to form CMS, or solid solutions of that compound with C₂S, in the field of portland cement where CaO is present in sufficient quantity to convert the SiO₂ to C₂S.

CaO-MgO-C₂S-C₃A₂

A further important study in this connection is the investigation by McMurdie and Insley (8) of the quaternary system C-M-C₂S-C₃A₂. The system is indicated diagrammatically as a tetrahedron in Figure 107, the C₂S apex lying beyond the plane of the paper. The only details included in the figure are the boundaries of the plane for MgO and the intersection of that plane with the primary phase fields of CaO, C₂S, C₃S, C₃A, and C₃A₂. The boundaries of the MgO plane are

indicated by the area *ABCDEFGG*. The volume above that plane is the primary-phase field of MgO . In the volume below that plane are shown the primary-phase fields of the compounds above listed. The light dotted lines show the corresponding areas of those compounds in the system $\text{C-C}_2\text{S-C}_3\text{A}_2$. Thus the field of C_3S in the ternary system is recognized by its characteristic slender triangle, and, in the 4-component system, is seen to extend up into the tetrahedron until it reaches the boundary surface of MgO .

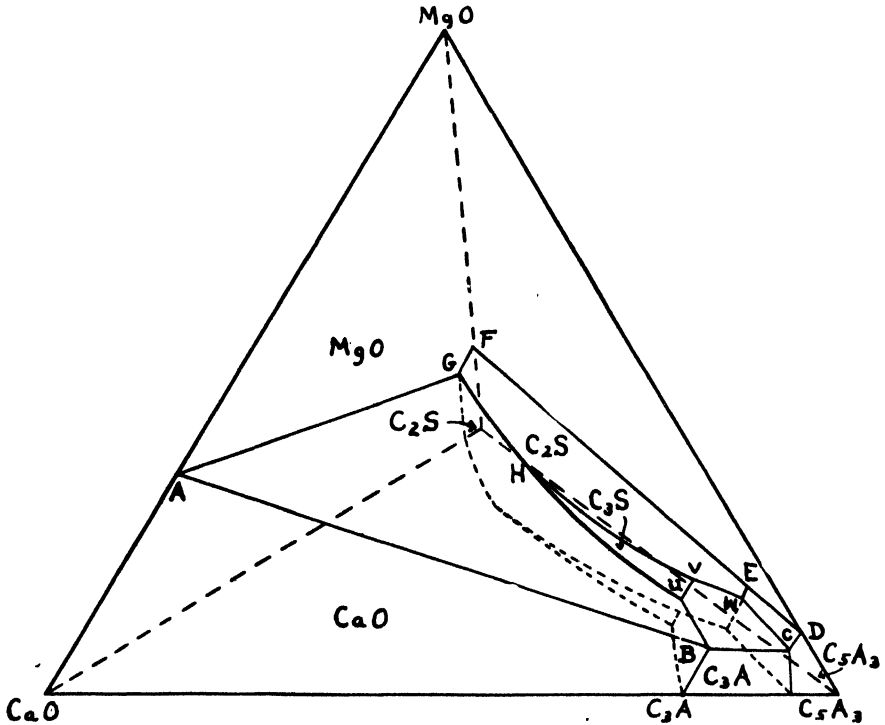

Figure 107. The system $\text{CaO-MgO-C}_2\text{S-C}_3\text{A}_2$. (McMurdie and Insley)

The invariant sextuple points are shown at *U*, *V*, and *W*. Point *V* is thus seen to be the composition of the invariant sextuple point where the volumes of C_3S , C_2S , C_3A , MgO , liquid and vapor are in equilibrium, and was found to have the composition $\text{MgO } 5.5$, $\text{SiO}_2 \text{ } 7.5$, $\text{Al}_2\text{O}_3 \text{ } 34.0$ and $\text{CaO } 53$ percent. The temperature of this point was placed at $1380^\circ \pm 5^\circ$. It is, of course, not a eutectic because it lies outside the tetrahedron bounded by the conjunction planes formed by joining the composition points of the four compounds at equilibrium at the respective points. The eutectic is point *W*.

The value of 5.5 percent MgO found for the solubility of that phase in the liquid of this system at the invariant point *V* is in excellent agreement with the value of 4 to 6 percent MgO found by Brownmiller (7) at 1400° to 1450° in the liquid of the system $\text{CaO-MgO-Al}_2\text{O}_3\text{-SiO}_2\text{-Fe}_2\text{O}_3$ having $\text{Al}_2\text{O}_3 : \text{Fe}_2\text{O}_3$ ratios between 0.68 and 3.0, and with the value of slightly less than 5 percent found by

Brown and Swayze (11) in liquids formed on the burning of portland cement clinker in the range of Al₂O₃ : Fe₂O₃ ratios of 1.35 to 1.80 at temperatures where the C₂A and the ternary iron phase had just disappeared. This carries for the cement technologist the meaning that the liquid of clinker during burning may contain up to about 5 percent of MgO in solution at the temperature of final solidification. If the clinker is cooled so rapidly that the MgO does not have an opportunity to crystallize, it will remain in solution in the glass. But if cooling is sufficiently slow, the MgO will separate out uncombined, as periclase (MgO).

A portion of the plane of CaO-C₂S-C₃A, as modified by the presence of 5 percent MgO, and on an enlarged scale, is shown in Figure 108, in solid lines. The dotted lines are the boundary curves for the system without the addition of MgO.

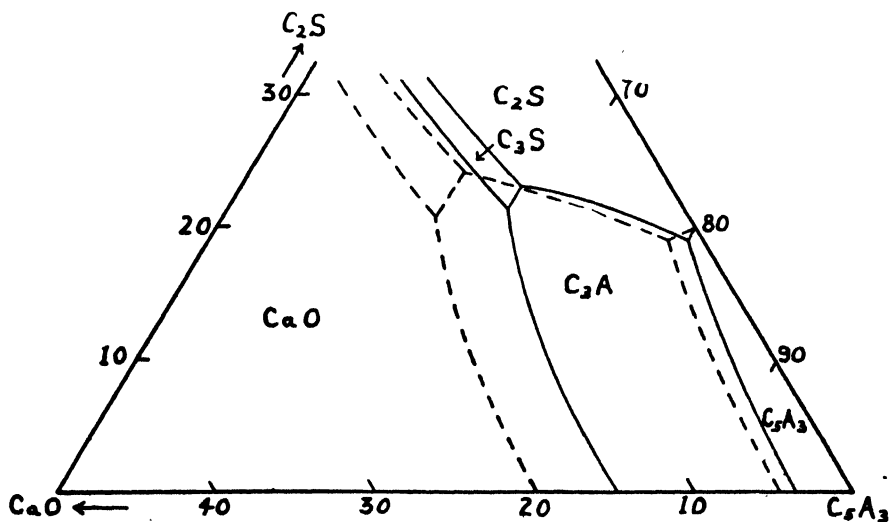

Figure 108. Portion of plane of CaO-C₂S-C₃A, as modified by 5 percent MgO. Dotted lines show boundaries unmodified by MgO. (McMurdie and Insley)

This shows the manner in which the position of the stability fields is changed by the presence of MgO. The fields of CaO, C₂S, and C₃A are all shifted toward the higher silica region of the diagram. Thus a mixture of these four components in the cement field will begin to show liquid at 1380° instead of at 1458°, and with rising temperatures the C₃A, formed at that temperature with C₂S, C₂S and MgO, will disappear leaving the latter three compounds in equilibrium with liquid up to the highest temperatures which would be reached in a commercial kiln. The liquid will, during this process, dissolve increasing amounts of MgO, if available, and will be richer in SiO₂ at all temperatures than it would be in the absence of MgO. The primary-phase region of CaO is extended and, if this were the only factor involved, would make complete combination of the CaO more difficult. But the greater amount of liquid present at any temperature appears in practice to give a net result, due to the MgO, of improved burnability.

The invariant points established or employed in producing the diagram in the MgO field are given in Table 23.

TABLE 23. Invariant points in the system $\text{CaO-MgO-C}_2\text{S-C}_3\text{A}$

Phases	Point (Fig. 107)	Reaction	Composition				
			MgO	SiO ₂	Al ₂ O ₃	CaO	Temp.
CaO, MgO.....	A	Eutectic	33	67	2300
C ₂ S, MgO.....	F	Eutectic	20	28	52	1925
C ₃ A, MgO.....	D	Eutectic	6.5	44.5	49	1832
CaO, C ₂ S, MgO.....	G	Eutectic	19	23	58	1990
C ₂ S, C ₃ A, MgO.....	E	Eutectic	5	6.5	39.5	49	1315
C ₂ A, C ₃ A, MgO.....	C	Eutectic	6.3	47.7	46	1345
CaO, C ₃ A, MgO.....	B	Melting	6.2	42.3	51.5	1452
CaO, C ₂ S, C ₃ A, MgO.....	U	Melting	5.5	7.0	33.5	54.0	1395
C ₂ S, C ₃ S, C ₃ A, MgO.....	V	Melting	5.5	7.5	34.0	53.0	1380
CaO, C ₂ S, C ₃ S, MgO.....	H	Melting	14	19	10	57	
C ₂ A, C ₃ A, C ₂ S, MgO.....	W	Eutectic	5.0	5.0	41.5	48.5	1295

References

1. Bowen, N. L., *Am. J. Sci.*, **38**, 207 (1914).
2. Bowen, N. L., and Anderson, O., *Am. J. Sci.*, **37**, 487 (1914).
3. Ferguson, J. B., and Merwin, H. E., *Am. J. Sci.*, **48**, 81 (1919).
4. Greig, J. W., *Am. J. Sci.*, **13**, 1; 133 (1927).
5. Hansen, W. C., *J. Am. Chem. Soc.*, **50**, 3081 (1928); PCAF Paper 18.
6. Klein, A. A., and Phillips, A. J., *8th Int. Congress Appl. Chem.*, **5**, 73 (1912).
7. Lerch, W., and Brownmiller, L. T., *J. Res. NBS*, **18**, 617 (1937); RP 997, PCAF Paper 32.
8. McMurdie, H. F., and Insley, H., *J. Res. NBS*, **16**, 467 (1936), RP 884.
9. Osborn, E. F., *J. Am. Ceram. Soc.*, **26**, 32 (1943).
10. Rankin, G. A., and Merwin, H. E., *J. Am. Chem. Soc.*, **38**, 568 (1916).
11. Swayze, M. A., *Am. J. Sci.*, **244**, 1; 65 (1946).

CHAPTER 15

Systems Containing FeO and TiO₂

The Ferrous-oxide Systems

Studies of systems involving one or more of the oxides of iron have been carried on by many investigators. In the mineral formation of rocks, the iron is usually in the ferrous state, and for that reason the major emphasis of the Geophysical Laboratory, in its studies on the iron systems, has been with FeO or Fe₃O₄ rather than with Fe₂O₃. In the manufacture of portland cement, however, it has usually been agreed that the product suffers when a reducing atmosphere is employed during burning. An excess of air is commonly used and the product is shown by analysis usually to contain only traces of FeO.

This fact, however, does not preclude interest in the ferrous oxide systems for the cement chemist. Up to the present time these systems have not been explored, in the regions of importance in cement technology, to an extent which can define precisely the effects on the constitution of clinker due to reducing conditions in the kiln.

Fe₃O₄-Fe₂O₃. The system Fe₃O₄-Fe₂O₃ has been the subject of several investigations of the Geophysical Laboratory (16)(12)(1)(8). There appears to exist in this system, at atmospheric pressure and for any given oxygen pressure, a narrow temperature interval below which the stable oxide contains less oxygen than Fe₂O₃ and above which it contains more oxygen than Fe₃O₄. Magnetite (Fe₃O₄) and hematite (Fe₂O₃) were found to coexist in stable equilibrium with oxygen in dry air under a pressure of one atmosphere at $1388^\circ \pm 3^\circ$. The limits of the solid solution have not been completely defined but, at the temperature of 1452° , a magnetite phase containing 30 percent Fe₂O₃ is in equilibrium with a hematite phase containing less than 1 percent Fe₃O₄, and oxygen at 1 atmosphere. As the temperature drops, the Fe₂O₃ content of the magnetite decreases, the Fe₃O₄ content of the hematite drops a little and the oxygen pressure decreases. At 1075° , a magnetite phase containing 8 percent Fe₂O₃ is in equilibrium with a hematite phase containing less than 0.5 percent Fe₃O₄, and oxygen under a low pressure.

Fe₃O₄ melts to a liquid of the same composition at $1591^\circ \pm 5^\circ$ under a small but undetermined pressure of oxygen. Magnetites containing more oxygen melt at slightly lower temperatures, the liquid in such cases being richer in oxygen than the crystals. The melting point of hematite under reduced pressure has not been determined, but it appears to be below that of platinum. A eutectic is formed between the magnetite solid solution and hematite, but the exact compositions of the phases and the temperature and oxygen pressure have not been determined.

Roberts and Merwin (12) found that the amount of dissociation of Fe₂O₃ to lower oxides upon heating was markedly reduced, especially at the higher temper-

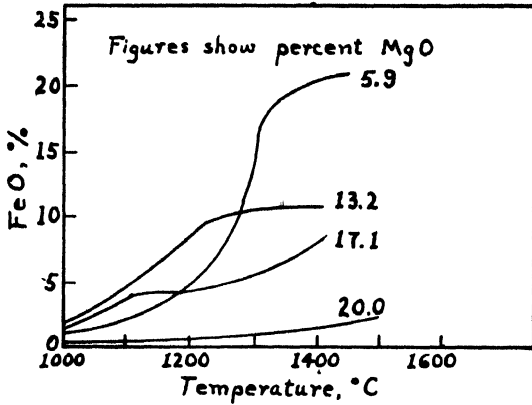

Figure 109. Dissociation of Fe_2O_3 with increasing temperature as affected by MgO admixed with the Fe_2O_3 . (Roberts and Merwin)

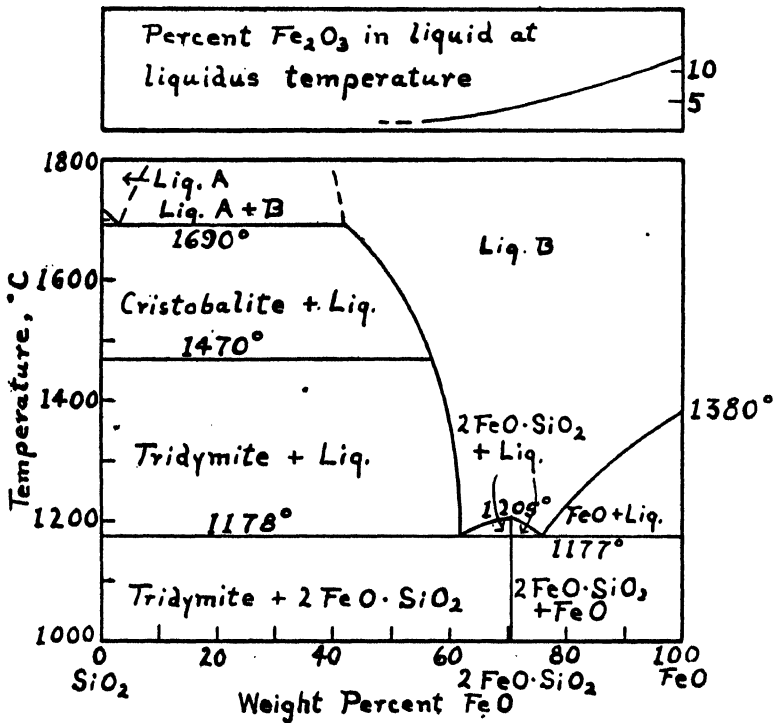

Figure 110. System SiO_2 - FeO , calculating all iron oxides in the liquids to FeO . (Upper figure) Shows Fe_2O_3 in liquids, indicating extent of departure from binary character. (Bowen and Schairer)

atures, by the presence of increasing amounts of MgO mixed with the hematite. This relationship is shown in the diagram of Figure 109. A somewhat similar effect was noted also by Burdick (5). He found that as much as 3 percent of FeO formed on heating mixtures rich in Fe₂O₃ and SiO₂ for 15 minutes at temperatures around 1400°, but in mixtures lower in Fe₂O₃ and higher in CaO, the extent of the reduction was much diminished.

SiO₂-FeO. The system SiO₂-FeO was explored by Bowen and Schairer (1). The temperature-concentration diagram is shown in Figure 110, constructed by

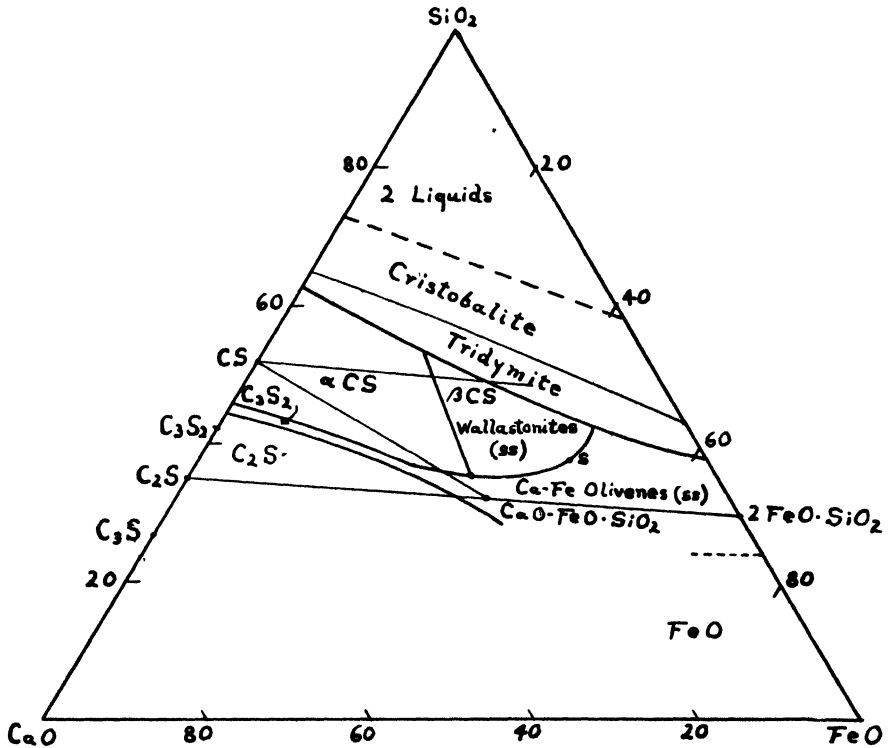

Figure 111. Part of system CaO-FeO-SiO₂. (Bowen, Schairer and Posnjak)

calculating all iron oxides in the liquids to FeO. In some liquids, however, some of the ferrous iron is oxidized to Fe₂O₃, and the actual amounts of Fe₂O₃ in the liquids at liquidus temperatures are shown in the upper part of the diagram. One compound, fayalite (2FeO·SiO₂), occurs in the system, having the composition FeO 70.5, SiO₂ 29.5 percent, and melting congruently at 1205° ± 2°. This compound forms a eutectic with SiO₂ (tridymite) at a composition of FeO 62.0, SiO₂ 38.0 percent, and a temperature of 1178° ± 2°, and a eutectic with wustite (FeO) at a composition of FeO 76, SiO₂ 24 percent, and a temperature of 1177°. The melting point of FeO was found to be 1380° ± 5°.

It has been found that many oxides are but partially miscible in the liquid state with silica, and hence siliceous mixtures of these oxides form two liquids on

melting (6). On the other hand, several oxides do not exhibit this behavior, and the presence of such oxides, even in small amounts, is sufficient to prevent the formation of the two immiscible liquids. It has further been found that mixtures of silica with iron oxides having a ferrous:ferric ratio of about 1:1 have a greater range of immiscibility than has been observed in any other case (7). The diagram of the system FeO-SiO_2 (Figure 110) reveals this immiscibility. It was discovered that alumina could offset this condition. The amount of Al_2O_3 necessary to cause

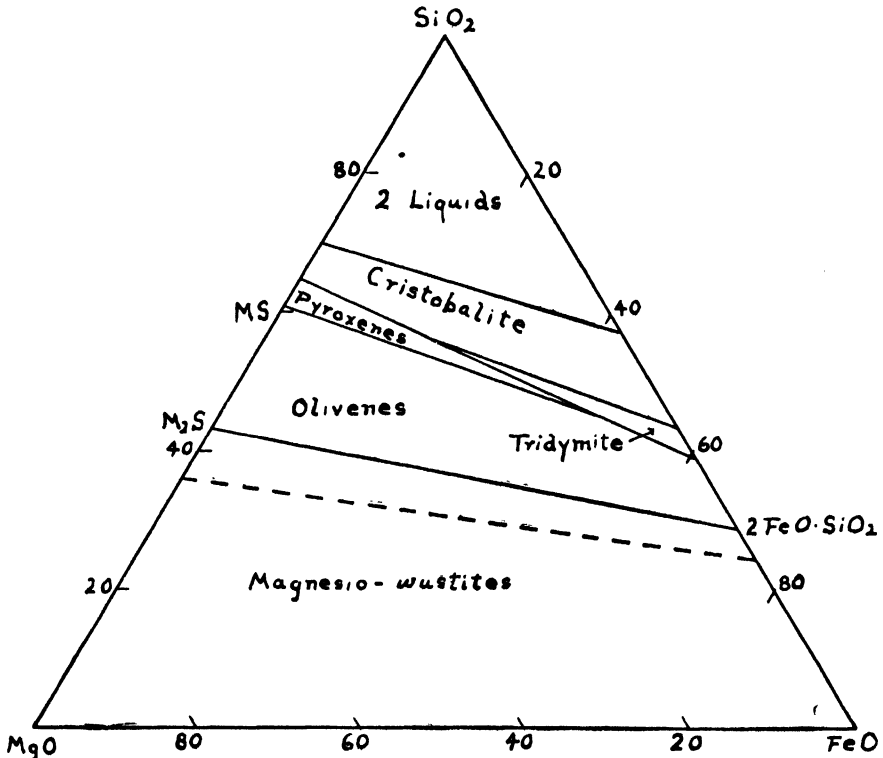

Figure 112. Part of system MgO-FeO-SiO_2 . (Bowen and Schairer)

a single liquid to result from the melting of the mixtures varies with the SiO_2 content and the ferrous:ferric ratio, a maximum of 6.5 percent being necessary when the ferrous:ferric ratio is about unity.

CaO-FeO-SiO_2 . The system CaO-FeO-SiO_2 was explored by Bowen, Schairer and Posnjak (3), but their studies were confined to the high-silica region and so have little of direct significance to the portland cement industry. A diagram of the system is shown in Figure 111. Three compounds were found: $\text{CaO} \cdot \text{FeO} \cdot 2\text{SiO}_2$ (hedenbergite), $2\text{CaO} \cdot \text{FeO} \cdot 2\text{SiO}_2$ (iron-akermanite), and $\text{CaO} \cdot \text{FeO} \cdot \text{SiO}_2$. Only the last of these is stable above the liquidus temperatures in this system. The first is stable below 965° and the iron-akermanite below 775° . About 30 invariant points occur in the system, seven of which are ternary, but none is a eutectic. The lowest

temperature of liquid formation is 1093° (point *S*, Figure 111), where two solid solutions are in equilibrium with liquid and vapor. Several solid solution series occur, principal among which are the metasilicates or wollastonites, a partial series extending from $\text{CaO}\cdot\text{SiO}_2$ to 76 percent $\text{FeO}\cdot\text{SiO}_2$; hedenbergites from $\text{CaO}\cdot\text{FeO}\cdot 2\text{SiO}_2$ to 80 percent $\text{FeO}\cdot\text{SiO}_2$; and the orthosilicates or Ca-Fe olivines, extending from $2\text{FeO}\cdot\text{SiO}_2$ through $\text{CaO}\cdot\text{FeO}\cdot\text{SiO}_2$ to 59 percent $2\text{CaO}\cdot\text{SiO}_2$.

MgO-FeO-SiO₂. The system MgO-FeO-SiO₂ was studied by Bowen and Schairer (2). The diagram of the system is shown in Figure 112. No ternary

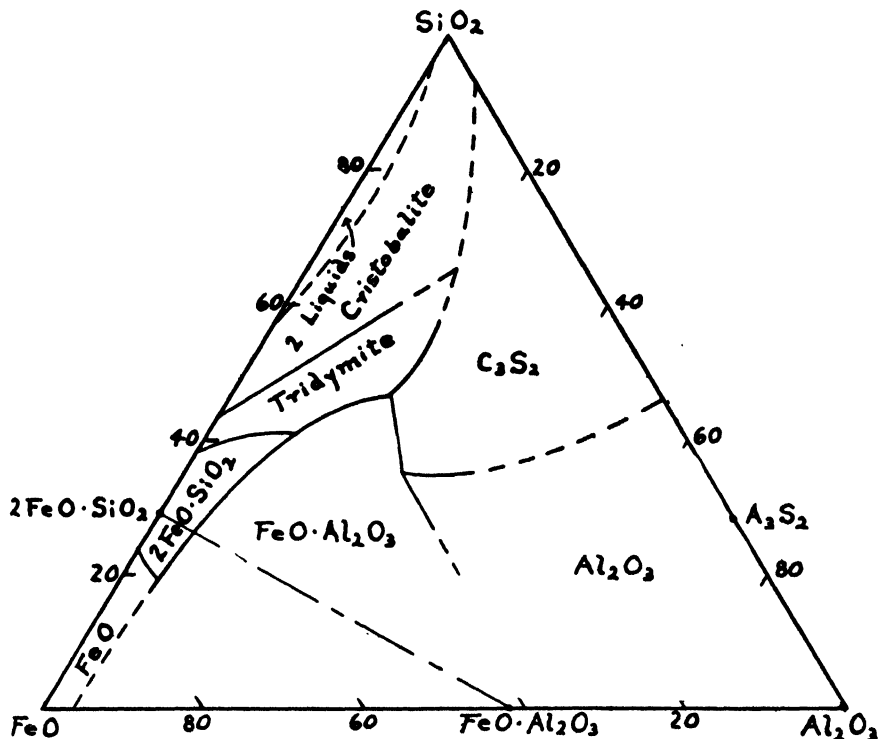

Figure 113. The system $\text{FeO}\text{-Al}_2\text{O}_3\text{-SiO}_2$. (Schairer)

compounds were found but the system is dominated by three series of solid solutions: the MgO-FeO which is complete; the orthosilicate or olivine series, $2\text{MgO}\cdot\text{SiO}_2\text{-}2\text{FeO}\cdot\text{SiO}_2$, also complete; and the metasilicate or pyroxine series, $\text{MgO}\cdot\text{SiO}_2\text{-FeO}\cdot\text{SiO}_2$, which is only partial since $\text{FeO}\cdot\text{SiO}_2$ does not exist as such, although solid solutions with nearly 90 percent of that molecule are formed. These three solid solutions, together with the fields of SiO_2 , occupy the whole liquidus surface of the system. For this reason the system offers a particularly favorable opportunity for the study of the course of crystallization in ternary solid-solution systems.

In distinction to the low-melting temperatures prevailing in the $\text{CaO}\text{-FeO}\text{-SiO}_2$ system (a wide range of compositions melting below 1150°), the compositions in

the analogous MgO system, having as much as 17 percent MgO, all melt at temperatures above 1400°.

FeO-Al₂O₃-SiO₂. The system FeO-Al₂O₃-SiO₂ has been studied by several investigators (10)(15)(13). The diagram according to Schairer is shown in Figure 113. No ternary compounds were found. The fields of primary crystallization of the component oxides and of the three binary compounds were established and the boundary curves and invariant points determined through the greater part of the system.

CaO-FeO-Al₂O₃-SiO₂. A portion of the quaternary system CaO-FeO-Al₂O₃-SiO₂ was studied by Schairer (13) along five planes as indicated in Figure 114. All of these planes had FeO as one apex, and in every case extended through the

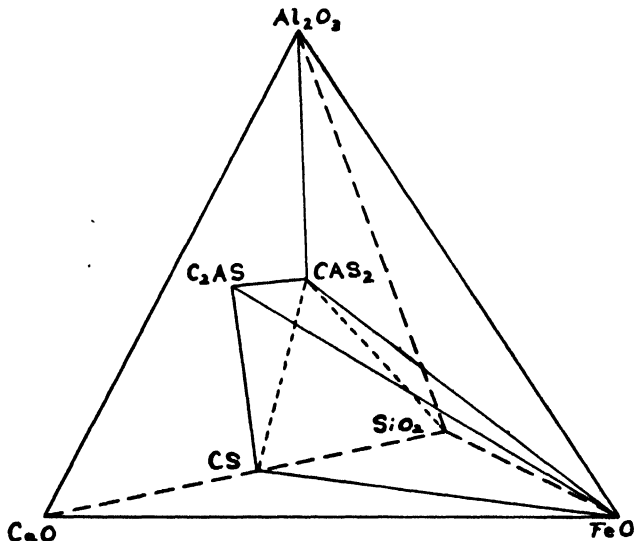

Figure 114. Showing the portion of the system CaO-FeO-Al₂O₃-SiO₂ studied by Schairer.

tetrahedron to two other compounds on the surface of the CaO-Al₂O₃-SiO₂ system. The planes studied were FeO-SiO₂-CAS₂, FeO-Al₂O₃-CAS₂, FeO-CS-CAS₂, FeO-C₂AS-CAS₂, and FeO-CS-C₂AS. No quaternary compounds were found. Eleven quaternary invariant points were located and the direction of change of composition of the liquid phase during crystallization established throughout a large part of the tetrahedron.

Since the work on the ferrous systems has been confined almost wholly to the lime-poor regions of the respective systems, they have little of direct application to the chemistry of portland cement, and hence are not herein considered in detail. Intensive study might profitably be made in the CaO-rich areas of these systems.

The Titania Systems

TiO₂. Titania (TiO₂) is found in natural minerals in three crystalline forms: anatase, brookite and rutile. The characteristics given by Larsen (11) are as follows:

Anatase, tetragonal system, octahedral in habit, uniaxial negative, hardness 6, gravity 3.84, refractive indices $\omega = 2.554$, $\epsilon = 2.493$, color brown passing into indigo blue and black, pleochroic in thick sections, $\omega =$ pale blue or yellowish, $\epsilon =$ dark blue or orange.

Brookite, orthorhombic, biaxial positive, hardness 6, gravity 3.9, refractive indices $\alpha = 2.583$, $\gamma = 2.741$, $\beta = 2.586$, color brown, yellowish, reddish, iron black, pleochroism weak.

Rutile, tetragonal, prismatic, uniaxial positive, hardness 6, gravity 4.24, refractive indices $\omega = 2.616$, $\epsilon = 2.903$, color reddish brown, red, blue, violet, black, pleochroism faint.

The stable form above about 400° is rutile, which melts at $1825^\circ \pm 20^\circ$. Anatase may be produced in the laboratory by dehydrating at 400° titanium hydroxide produced by the hydrolysis of $TiCl_4$. On heating above 1000° pure rutile is produced.

TiO_2 - SiO_2 . The system TiO_2 - SiO_2 was found by Bunting (4) to be of the simplest character, no compounds or solid solutions being formed. A temperature-

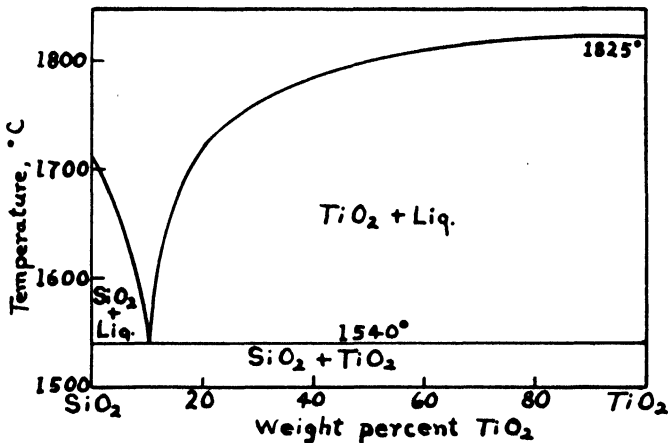

Figure 115. The system TiO_2 - SiO_2 . (Bunting)

concentration diagram is shown in Figure 115. A eutectic for the phases TiO_2 , SiO_2 and liquid was found at a composition of 10.5 percent TiO_2 , 89.5 percent SiO_2 and a temperature of $1540^\circ \pm 10^\circ$.

TiO_2 - Al_2O_3 . The temperatures in this system were too high for exploration in the Pt-Rh furnace, so observations were made by Bunting (4) in an iridium button heated in a high-frequency induction furnace, using an optical pyrometer for the measurement of temperature. The fusion temperatures could be duplicated to $\pm 10^\circ$ and are believed to be correct to $\pm 25^\circ$. The concentration-temperature diagram is shown in Figure 116. One compound was found, $TiO_2 \cdot Al_2O_3$, having the composition TiO_2 43.94, Al_2O_3 56.06 percent melting at about 1860° . The eutectic of TA with TiO_2 was found to have the composition 80 percent TiO_2 , 20 percent Al_2O_3 and a temperature of about 1715° . The eutectic between TA and

Al_2O_3 had a composition 38 percent TiO_2 and 62 percent Al_2O_3 , and a temperature of about 1850° .

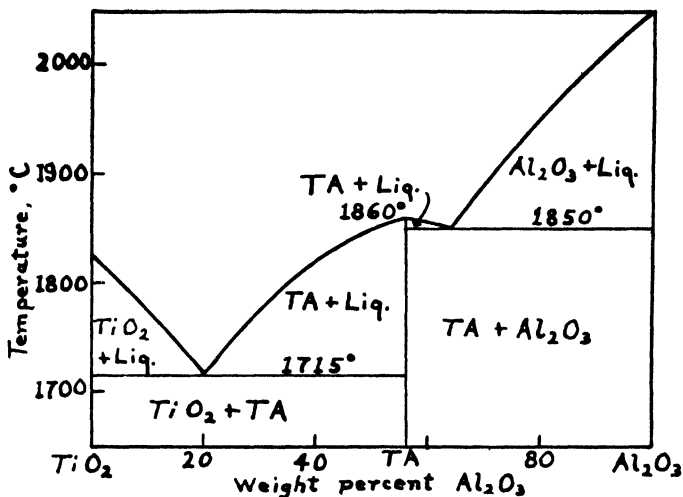

Figure 116. The system TiO_2 - Al_2O_3 . (Bunting)

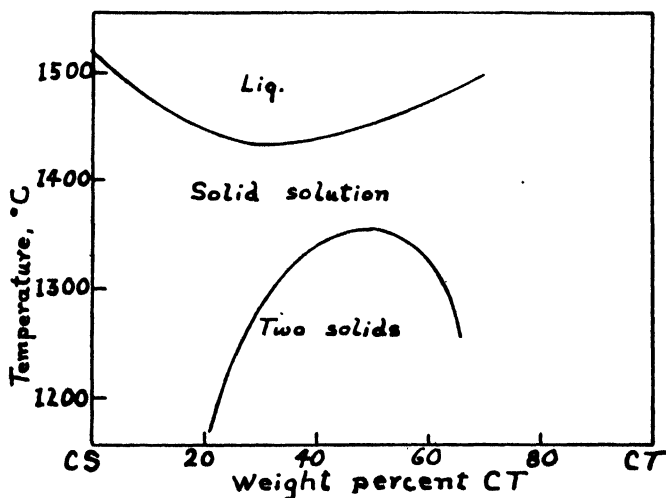

Figure 117. The system CS-CT. (Smolensky)

An earlier study on this system by Wartenberg and Reusch (17) indicated a compound $2\text{TiO}_2 \cdot \text{Al}_2\text{O}_3$ but the data are inconclusive, and no such compound was observed by Bunting.

Na_2O - TiO_2 . Mixtures in the system Na_2O - TiO_2 were found by Washburn and Bunting (18) to crystallize so rapidly that the quenching method could not be employed, and the heating curve method was used. The study was not com-

pleted but the results indicated the formation of three compounds with congruent melting points as follows: Na₂O.TiO₂ melting at 1030°, Na₂O.2TiO₂ melting at 985° and Na₂O.3TiO₂ melting at 1128°.

CaO-TiO₂-SiO₂. A brief study of the system CS-CT was made by Smolensky (14) in 1912, from which the diagram shown in Figure 117 was adapted by Hall and Insley (9). A solid solution of the two compounds CS and CT was found to be continuous at all temperatures between 1350° and 1425°, but below 1350° two phases separated out between certain compositions, these phases being solid solutions the compositions of which varied with the temperature.

A tentative survey of compositions in the system CaO-TiO₂-SiO₂, made at the laboratory of the Portland Cement Association Fellowship of the National Bureau of Standards in 1931, showed a binary compound, CaO.TiO₂, and one ternary compound, CaO.TiO₂.SiO₂. Some inconsistencies between the petrographic and X-ray examinations of preparations in the field C₂S-CT-CaO suggest the possibility of a second compound of TiO₂ and CaO which may be unstable and dissociate below the liquidus temperatures.

References

1. Bowen, N. L., and Schairer, J. F., *Am. J. Sci.*, **24**, 177 (1932).
2. Bowen, N. L., and Schairer, J. F., *Am. J. Sci.*, **29**, 151 (1935).
3. Bowen, N. L., Schairer, J. F., and Posnjak, E., *Am. J. Sci.*, **26**, 193 (1933).
4. Bunting, E. N., *J. Res. NBS*, **11**, 719 (1933), RP 619.
5. Burdick, M. D., *J. Res. NBS*, **25**, 475 (1940); RP 1340.
6. Greig, J. W., *Am. J. Sci.*, **13**, 133 (1927).
7. Greig, J. W., *Am. J. Sci.*, **14**, 473 (1927).
8. Greig, J. W., Posnjak, E., Merwin, H. E., and Sosman, R. B., *Am. J. Res.*, **30**, 239 (1935).
9. Hall, F. P., and Insley, H., *J. Am. Ceram. Soc.*, **16**, 504 (1933).
10. Hay, R., White, J., and Caulfield, T. H., *J. Soc. Glass Tech.*, **21**, 270 (1937).
11. Larsen, E. S., *U.S. Geol. Survey Bull.*, 679 (1921).
12. Roberts, H. S., and Merwin, H. E., *Am. J. Sci.*, **21**, 145 (1931).
13. Schairer, J. F., *J. Am. Ceram. Soc.*, **25**, 241 (1942).
14. Smolensky, S., *Z. anorg. Chem.*, **73**, 294 (1912).
15. Snow, R. B., *J. Am. Ceram. Soc.*, **25**, 151 (1942).
16. Sosman, R. B., and Hostetter, J. C., *J. Am. Chem. Soc.*, **38**, 1188 (1916).
17. Wartenberg, H. V., and Reusch, H. J., *Z. anorg. allgem. Chem.*, **207**, 1 (1932).
18. Washburn, E. W., and Bunting, E. N., *J. Res. NBS*, **12**, 239 (1934); RP 648.

CHAPTER 16

Systems Containing Fe_2O_3 with CaO and SiO_2

Fe_2O_3

Hematite (Fe_2O_3) occurs as rhombohedral crystals, hardness 5.5 to 6.5, specific gravity 4.9 to 5.3, steel-gray to iron-black in color but blood-red by transmitted light. It dissociates at atmospheric pressure, without melting, into Fe_3O_4 and FeO , the dissociation becoming measurable at 1100° . Fe_2O_3 is uniaxial negative, refractive indices $\omega_{\text{Li}} = 3.01$, $\epsilon_{\text{Li}} = 2.77$ birefracton high (3). A precipitate prepared by reaction of ammonium hydroxide with ferric chloride, washed free of chlorides and heated for one hour at 300° , gave the X-ray diffraction pattern of hematite (5). The pattern obtained from a specimen of hematite obtained from the Island of Elba is given on page 541.

$\text{CaO-Fe}_2\text{O}_3$

Of the binary systems: $\text{CaO-Fe}_2\text{O}_3$, $\text{Al}_2\text{O}_3\text{-Fe}_2\text{O}_3$ and $\text{Fe}_2\text{O}_3\text{-SiO}_2$, only the first has been completely explored. Some work however has been done on the other systems which gives us information on their character.

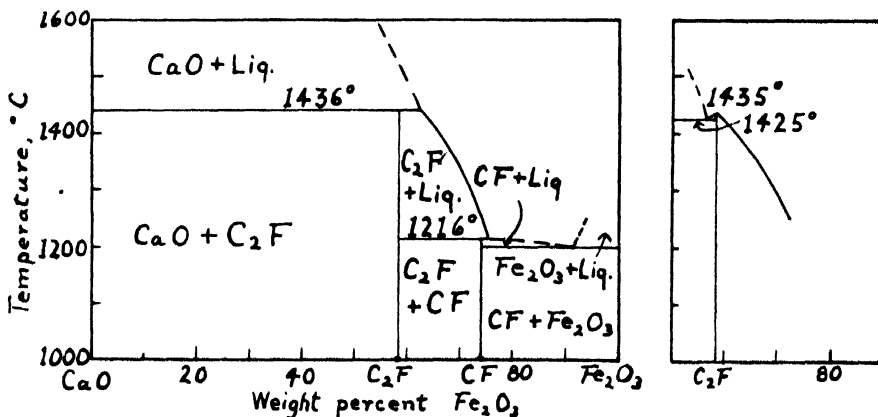

Figure 118. (Left) The system $\text{CaO-Fe}_2\text{O}_3$. (Sosman and Merwin) (Right) Modification by Swayze.

The concentration-temperature diagram of the system $\text{CaO-Fe}_2\text{O}_3$ according to Sosman and Merwin (7) is given in Figure 118. Two binary compounds were found, C_2F , having the composition CaO 41.26, Fe_2O_3 58.74 percent, and CF , having the composition CaO 25.99, Fe_2O_3 74.01 percent. Both compounds melt incongruently, according to these investigators, the C_2F dissociating into CaO and liquid at 1436° , and the CF dissociating into C_2F and liquid at 1216° . Swayze

(8) has reported, however, that C_2F melts congruently at 1435° . The invariant point for CaO , C_2F and liquid is given by Sosman and Merwin at CaO 38.4 percent, Fe_2O_3 61.6 percent, and a temperature of 1436° . Swayze records a eutectic for this invariant point at a composition of C_2F 97 and CaO 3 percent (CaO 43.0, Fe_2O_3 57.0), at a temperature of 1425° . The invariant point given by Sosman and Merwin for C_2F , CF and liquid has the composition CaO 24.5 and Fe_2O_3 75.5 percent, and a temperature of 1216° . Tavasci (9) claims to have found a compound having the molecular composition of CF_2 , dissociating incongruently at 1227° into Fe_2O_3 and liquid. Martin (6) has reported the existence of several other compounds of CaO and Fe_2O_3 but his criteria appear to be inadequate.

The dicalcium ferrite forms readily as crystals which are black by reflected light but yellow-brown by transmitted light. The refractive indices are $\alpha_{LI} = 2.200$, $\beta_{LI} = 2.220$, $\gamma_{LI} = 2.290$; $\alpha_{Na} = 2.261$, $\gamma_{Na} = 2.274$. It is biaxial positive with a moderate axial angle. The monocalcium ferrite likewise forms readily as crystals

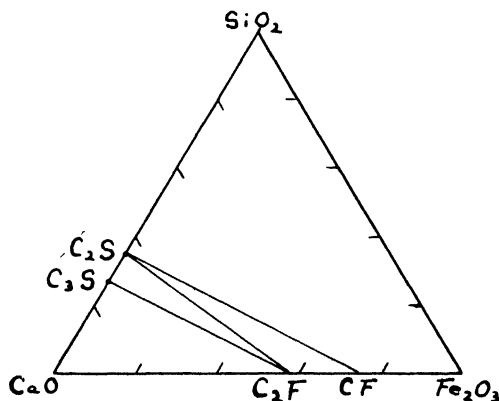

Figure 119. Composition triangles in the system $CaO-Fe_2O_3-SiO_2$. (Hansen and Bogue)

which are black by reflected light and deep red by transmitted light. The refractive indices are $\omega_{LI} = 2.465$, $\epsilon_{LI} = 2.345$; $\omega_{Na} = 2.58$, $\epsilon_{Na} = 2.43$. It is nearly or quite uniaxial, negative. The X-ray pattern of the C_2F is given on page 543.

$CaO-C_2S-CF$

The system $CaO-Fe_2O_3-SiO_2$, in the high-lime region, was first explored in 1926 by Hansen and Bogue (4). Since any iron compound with lime in portland cement would fall on the CaO side of the join between C_2S-CF (Figure 119) the investigation was confined to that area.

It was found that, in this region, the crystallization of the iron compounds was so rapid that even the most rapid quenching failed to prevent the formation of the crystalline compounds from the liquid. In only a few cases could traces of the undercooled liquid be observed. This very rapid crystallization makes difficult the establishment by quenching methods of the stability fields of the primary phases, and the temperature relations, in the system. Recourse to the use of heating curves could be had but it was felt that the immediate objectives of the study were met without that procedure.

Mixtures of $CaCO_3$, Fe_2O_3 and SiO_2 , in the regions indicated, were heated to

temperatures of 1200° to 1400° until no free CaO was found by White's test, (10)* and allowed to cool slowly. Melting was avoided because, at the high temperatures required for this, the ferric oxide is to some extent reduced to ferro-ferric oxide, Fe_3O_4 , as previously shown.

The products, observed microscopically, showed that no ternary compound was formed, and that the three compounds representing the apices of the three triangles, (Figure 119) were formed upon the slow cooling of all charges within those respective triangles.

CaO-C₂S-C₂F

In a later study of the system CaO-Fe₂O₃-SiO₂ by Burdick, (1) the area examined covered a much larger field, extending from 15 to 65 percent CaO and up to 65 percent Fe₂O₃. In the region of the C₂S field, the temperatures were

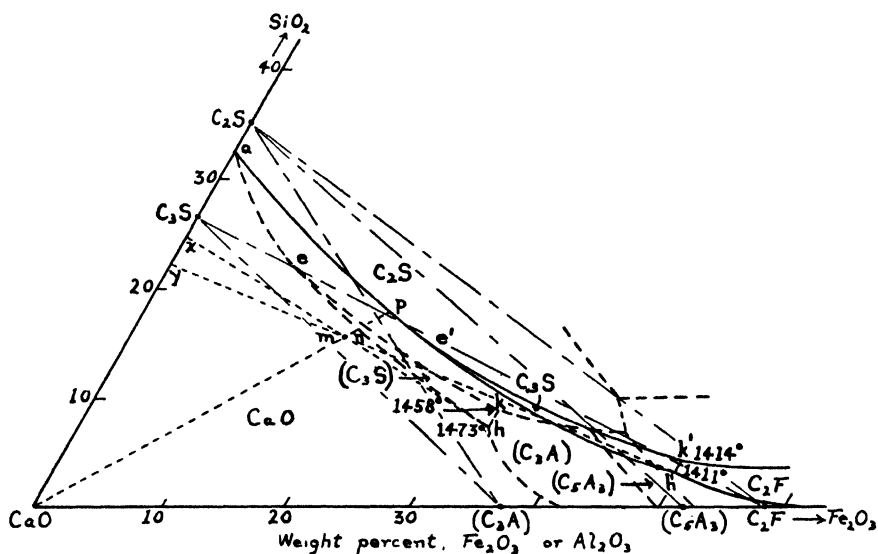

Figure 120. Part of system CaO-Fe₂O₃-SiO₂ (Burdick) superimposed upon the analogous portion of the system CaO-Al₂O₃-SiO₂, shown by dashed lines.

determined by noting the breaks in heating curves, but the compositions could not be determined precisely, either of the quintuple invariant points or the phase boundaries.

The approximate location of the primary-phase fields and invariant points is shown in Figure 120, superimposed, to facilitate comparison, upon the analogous portion of the diagram for the system CaO-Al₂O₃-SiO₂, shown by dashed lines.

It will be noted that a conspicuous effect of substituting Fe₂O₃ for Al₂O₃ is the moving of the C₂S primary-phase field away from the CaO apex,—that is, the field of CaO is considerably extended. This means that a lower lime-limit for complete combination would have to be maintained in the mixture CaO, SiO₂,

* See page 71.

R_2O_3 when the latter component consists entirely of Fe_2O_3 than when it consists entirely of Al_2O_3 . Thus, in the $CaO-Al_2O_3-SiO_2$ system, uncombined CaO will not be present in a clinker, which has been allowed to cool from sintering temperatures under equilibrium conditions, when the composition falls above the join C_3S-C_2A . Compositions in the region of portland cement, falling in the triangle $C_3S-C_2S-C_3A$ will contain only those compounds in the slowly-cooled clinker. Nor will free CaO in that system be formed at any temperature, above the boundary curve eh , separating the fields of CaO and C_3S .

But when Fe_2O_3 is substituted completely for Al_2O_3 , uncombined CaO will be present in the slowly cooled clinkers of all compositions on the CaO side of the join C_3S-C_2F , and this includes practically the entire primary-phase field of C_3S . Cement compositions as now made (assuming R_2O_3 to be completely Fe_2O_3) fall mostly on the CaO side of that join, as well as in the CaO field in the $CaO-Fe_2O_3-SiO_2$ system, hence all such compositions must contain free CaO regardless of cooling procedure. To be rid of free CaO in slowly cooled equilibrium clinker would require moving the composition above the join C_3S-C_2F , and to be rid of free CaO under all conditions of cooling would require still further moving of the compositions towards SiO_2 , above the boundary curve ae' , separating the fields of CaO and C_2S , or far toward the Fe_2O_3 , above the boundary curve $e'h'$, separating the fields of CaO and C_3S .

It is further noted that the join C_3S-C_2F intersects the boundary ($h'k'$) separating those two phases, and consequently a maximum temperature of melting occurs on that boundary at that intersection. This point has the composition CaO , 46; SiO_2 , 4; Fe_2O_3 , 50 percent, and a temperature of $1428^\circ \pm 5^\circ$. The temperature falls to 1411° at h' and to 1414° at k' , which makes the invariant point $C-C_3S-C_2F(h')$ a eutectic. This also is a difference from the system $CaO-Al_2O_3-SiO_2$ for the invariant point $CaO-C_3S-C_3A(h)$ is not a eutectic.

It is also noted that the melting temperature at the invariant point for C_3S , C_2S , $C_2F(k')$ is lower by 44° than the corresponding point for C_3S , C_2S , $C_2A(k)$, and that the invariant point for C_3S , CaO , $C_2F(h')$ is lower by 62° than the corresponding point for C_3S , CaO , $C_3A(h)$. It may readily be seen however, by a graphic computation, that the amount of liquid produced at the maximum heat content of these invariant points is greater in the $CaO-Al_2O_3-SiO_2$ system than in the $CaO-Fe_2O_3-SiO_2$ system, for all compositions. Thus if we consider a composition of point m , in the system $CaO-Al_2O_3-SiO_2$, CaO will be first formed on cooling the liquid. The composition of the latter will move back to intersect the boundary eh at n , when C_3S will appear. As CaO and C_3S separate together, the composition of the solid phases will move from CaO toward C_3S as the liquid moves down the boundary curve toward h . When h is reached the solids will have the composition x , and the amount of solids will be represented by mh/xh . The amount of liquid will be mx/xh . This is about 52 percent at the maximum heat content at 1473° .

But if we consider point m in the $CaO-Fe_2O_3-SiO_2$ system, CaO will be formed until the boundary ae' is reached at p , after which the liquid will follow the boundary $ae'h'$ to h' , at which point the solids will have the composition y . The amount of solids will then be represented by mh'/yh' and the liquid by my/yh' . This is about 35 percent at the maximum heat content at 1411° .

The crystallization in the $\text{CaO-Al}_2\text{O}_3\text{-SiO}_2$ system will be noted to be completed at k , for while the liquid is at h the solids move along xh to the intersection with the join $\text{C}_2\text{S-C}_2\text{A}$, but the liquid then moves from h to k while the solids follow down the join. While the liquid is at k , the solids leave that join and proceed to the original composition at m . Thus the final solids consist of C_2S , C_2A and C_2S . But in the $\text{CaO-Fe}_2\text{O}_3\text{-SiO}_2$ system, crystallization will be completed at h' , for while the liquid is at h' the solids move along the line yh' , but reach the original composition, m , without intersecting any join in the system. So the final solids consist of CaO , C_2S and C_2F .

The C_2S was found to take up Fe_2O_3 in solid solution to an extent which was placed approximately at 0.5 percent, and by this process the inversion temperature of the C_2S from the α to the β form was found to be reduced 60° , from 1420° to 1360° . No variation was noted in the refractive indices, but the X-ray diffraction patterns showed a slight shift. The upper limit of the solid solution was indicated by the observation that 0.5 percent Fe_2O_3 produced the maximum lowering of the inversion temperature, and by the finding that some liquid was formed when a mixture of C_2S containing 0.5 percent Fe_2O_3 was heated to 1360° , a temperature far below the melting point (2130°) of C_2S . In an earlier study by Flint and Wells, (2) a similar effect had been shown with the calcium borates, where C_2S was found to form a partial solid solution, as a result of which the α - β inversion temperature was lowered a maximum of 190° .

It must be emphasized that the comparisons made here between the $\text{CaO-Al}_2\text{O}_3\text{-SiO}_2$ and the $\text{CaO-Fe}_2\text{O}_3\text{-SiO}_2$ systems are confined to complete substitution of Fe_2O_3 for Al_2O_3 . No deductions can be drawn from these data of the effects of partial substitution, for in such case a fourth component is introduced the result of which cannot be predicted. The system $\text{CaO-Al}_2\text{O}_3\text{-Fe}_2\text{O}_3\text{-SiO}_2$ will be discussed later.

References

1. Burdick, M. D., *J. Res. NBS*, **25**, 475 (1940), RP 1340.
2. Flint, E. P., and Wells, L. S., *J. Res. NBS*, **17**, 727 (1936), RP 941.
3. Greig, J. W., Posnjak, E., Merwin, H. E., and Sosman, R. B., *Am. J. Sci.*, **30**, 239 (1935).
4. Hansen, W. C., and Bogue, R. H., *J. Am. Chem. Soc.*, **58**, 1261 (1926); PCAF Paper 1.
5. Hansen, W. C., and Brownmiller, L. T., *Am. J. Sci.*, **15**, 225 (1928); PCAF Paper 14.
6. Martin, G., *Mon. Sci.*, **15**, 97 (1925).
7. Sosman, R. B., and Merwin, H. E., *J. Wash. Acad. Sci.*, **6**, 532 (1916).
8. Swayze, M. A., *Am. J. Sci.*, **244**, 1; 65 (1946).
9. Tavasci, B., *Ann. chim. app.*, **26**, 291 (1936).
10. White, A. H., *J. Ind. Eng. Chem.*, **1**, 5 (1910).

CHAPTER 17

Systems Containing MgO and Fe₂O₃ with CaO and Al₂O₃

Al₂O₃-Fe₂O₃

The system Al₂O₃-Fe₂O₃ was first examined by French investigators (3) who reported that Fe₂O₃ takes up about 12 percent of Al₂O₃ in solid solution, as determined by a thermal dilatometric method upon mixtures of the precipitated oxides which had been heated to 900°. The nature of the products thus heated was not determined.

Hansen and Brownmiller (5) found that the precipitated hydrous oxides, formed by the action of ammonium hydroxide on the chlorides, were converted, the precipitated alumina to corundum (Al₂O₃) by heating for one hour at 1200°, and the precipitated ferric oxide to hematite (Fe₂O₃) by heating for one hour at 300°. The latter investigators confirmed by X-ray methods the solid solution of Al₂O₃ in Fe₂O₃, but could not define the amount of such solution between 10 and 15 percent. The Al₂O₃ was also found to take up a very little Fe₂O₃ in solid solution.

MgO-Fe₂O₃

The system MgO-Fe₂O₃ was investigated by Roberts and Merwin (11) by heating the composition of magnesioferrite (MgO-Fe₂O₃) for 32 days at the low temperature of 1050° in order to avoid reduction of the iron. Combination was practically complete, giving a product having a refractive index of 2.39. It was concluded that the compound MF lies in the middle of a short series of solid solutions extending towards MgO and Fe₂O₃. The compound MF dissociates on heating, and the resulting ternary solid solution begins to melt in air at 1750° ± 25°. Solid solutions of about 1 percent of MgO in MF are reported to be possible from 1750° to 1000° and below.

CaO-C₂A₃-CF

As early as 1882, Le Chatelier (8) expressed the belief that a ternary compound of CaO, Al₂O₃ and Fe₂O₃, exists, to which he assigned the formula 3CaO·Al₂O₃·Fe₂O₃. Nearly thirty years later the investigators at the Geophysical Laboratory (12) observed that C₂F and C₂A₃ may enter into a reaction, but the nature of the product was not determined. Campbell (2) noted that Al₂O₃ and Fe₂O₃ were capable of replacing each other in certain combinations with CaO.

The ternary system CaO-Al₂O₃-Fe₂O₃ was first investigated by Hansen, Brownmiller and Bogue in 1928. (6). As in the systems CaO-Fe₂O₃-SiO₂, crystallization of the melts was so rapid that undercooled liquids (glasses) could not be

obtained by quenching methods. Hence it was necessary to make use of heating-curve technique for determining the melting temperatures and to deduce the phase relations from the microscopic and heating-curve data with the aid of the phase rule. The primary-phase diagram is shown in Figure 121.

One ternary compound was found in the system, which was believed to have a composition represented by the formula $4\text{CaO}\cdot\text{Al}_2\text{O}_3\cdot\text{Fe}_2\text{O}_3$. As will be shown later, Swayze has reported that this compound is a member of a solid-solution series $\text{C}_6\text{A}_2\text{F}-\text{C}_6\text{AF}_2$, extending probably to the binary compound C_2F , indicating that the iron phase may have a composition containing either less or more Fe_2O_3 than is represented by the formula C_4AF , depending on the composition of the

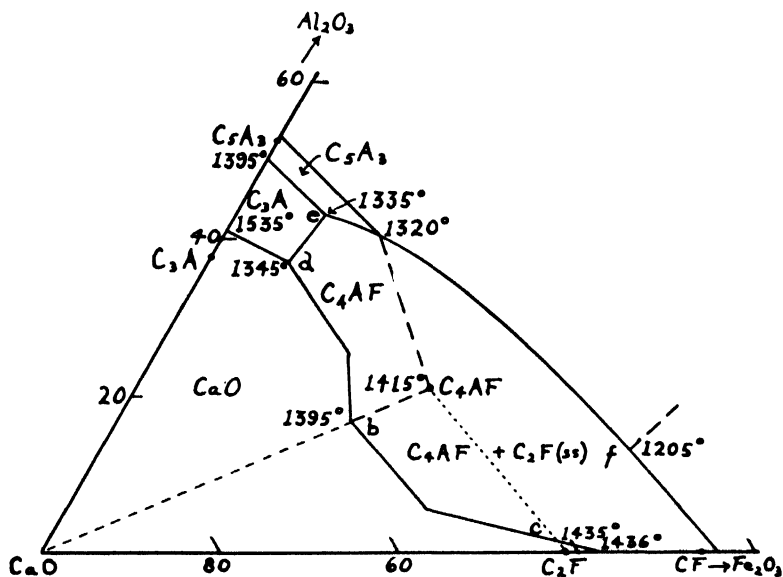

Figure 121. Part of system $\text{CaO}-\text{Al}_2\text{O}_3-\text{Fe}_2\text{O}_3$. (Hansen, Brownmiller and Bogue)

liquid in the system from which the iron phase is separating. Inasmuch as C_4AF is intermediate between $\text{C}_6\text{A}_2\text{F}$ and C_6AF_2 , and all of the investigations involving the phase have, up to now, identified it as C_4AF , it will be convenient to indicate it by the use of this formula or, in certain cases, as $\text{C}_4\text{AF}(ss)$.

The compound melts congruently at $1415^\circ \pm 5^\circ$ and forms readily from the finely powdered components at temperatures well below its melting point. Density is 3.77. It was found to be biaxial, negative, with a medium optic axial angle. Refractive indices are $\alpha_{Li} = 1.96 \pm .01$, $\beta_{Li} = 2.01 \pm .01$; $\gamma_{Li} = 2.04 \pm 0.1$. The indices for the yellow mercury line ($\lambda = 578$) are $\alpha = 1.98 \pm .01$; $\beta = 2.05 \pm .01$; $\gamma = 2.08 \pm .01$. Occasional polysynthetic twinning is observed. The compound often occurs as prismatic grains with extinction angle against the prismatic faces very small. Pleochroism $\gamma =$ brown and $\alpha =$ yellow-brown. The X-ray diffraction pattern is given on page 543.

A eutectic mixture of C_4AF with CaO is found (point *b*, Figure 121) which

melts at 1395° . The partial temperature-concentration diagram for the system $C_4AF-CaO$ is shown in Figure 122.

A complete series of solid solutions forms between C_4AF and C_2F , but the latter compound was found by Sosman and Merwin to dissociate at 1435° into CaO and liquid.

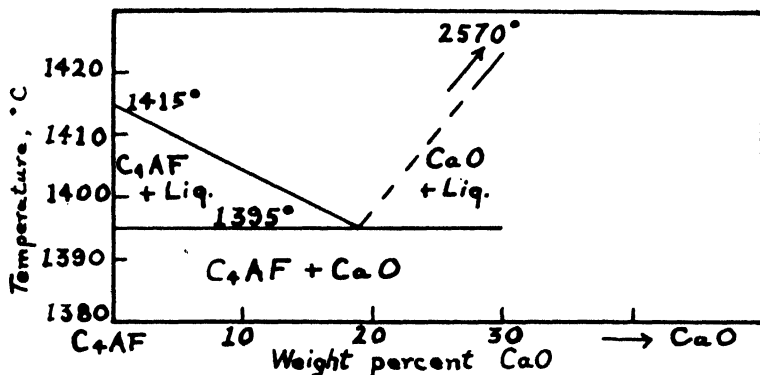

Figure 122. Part of system $C_4AF-CaO$. (Hansen, Brownmiller and Bogue)

A quintuple invariant point where C_4AF , C_2F and CaO are in equilibrium with liquid and vapor (point *c*, Figure 121) was found having a phase composition at maximum heat content (where CaO just disappears from the liquid) of C_4AF 7 and C_2F 93 percent. The temperature is 1435° . The temperature-concentration diagram showing the melting relations in this solid-solution series is shown in Figure 123.

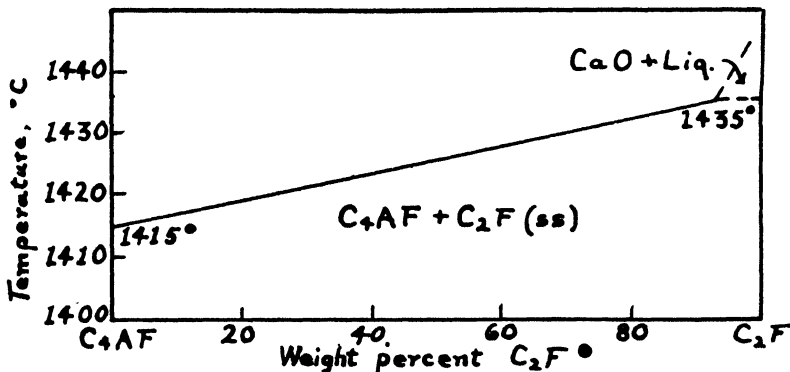

Figure 123. Solid solution series C_4AF-C_2F . (Hansen, Brownmiller and Bogue)

The refractive indices of members of this solid solution series vary on passing from C_4AF to C_2F in the manner shown in Figure 124 and there seems to be the possibility that by careful work, the composition of a member could be ascertained approximately by index methods.

Limited series of solid solutions also were found of CF in CA and of CA in CF .

The fields of the final products of crystallization are indicated in the diagram of Figure 125, in which the solid lines represent joins between solid solutions. Thus C_4AF-C_2F is shown to be a continuous solid solution series. The segment $CA-b$ is a solid solution of CF in CA ; the segment $CF-c$ is a solid solution of CA in CF ; and the segment bc is a mixture consisting of the above two solution phases.

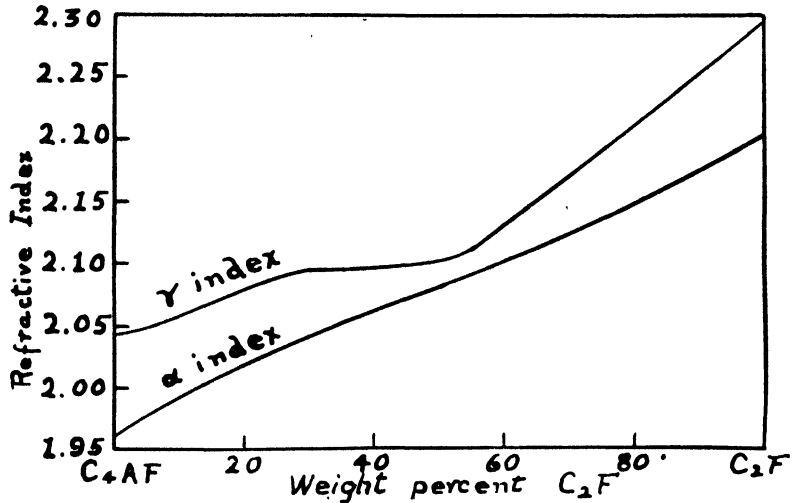

Figure 124. Refractive indices of solid solution series C_4AF-C_2F . (Hansen, Brownmiller and Bogue)

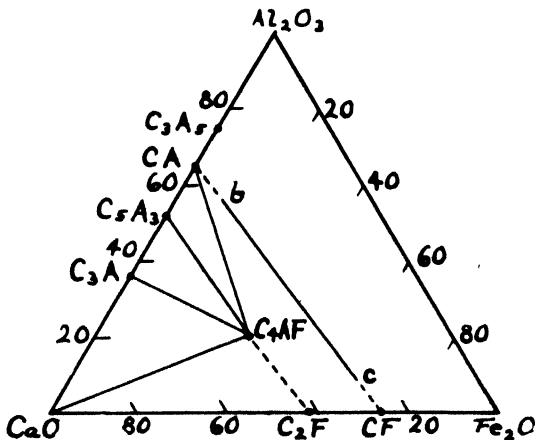

Figure 125. Products of crystallization in a portion of the system $CaO-Al_2O_3-Fe_2O_3$. Solid solution indicated by dotted lines. (Hansen, Brownmiller and Bogue)

The region above the line $CA-CF$ was not explored. It will be noted that the triangle $CaO-C_4AF-C_2F$ will contain, when crystallization is just complete, not a mixture of those three phases but only of the two phases: CaO and a solid solution of C_4AF with C_2F . And the area $CA-CF-C_2F-C_4AF$, under similar conditions will contain the three phases, each a solid solution: (1) $C_4AF + C_2F$; (2) CA in CF ; and (3) CF in CA .

The primary-phase regions are shown in Figure 121 together with the temperature of the invariant points. Immediately below the quintuple invariant point for CaO , C_2A and C_4AF (point d), the primary phase is CaO , but the final products of crystallization may be seen (compare Figure 125) to be C_2A , C_4AF and C_5A_3 .

The compounds C_4AF and C_5A_3 form a eutectic which melts at 1335° , as shown in the temperature-concentration diagram of Figure 126. No reduction in temperature could be noted at the quintuple invariant point (point e , Figure 121), where these two compounds are in equilibrium with C_2A , liquid and vapor, and the composition appears to be the same.

About 15 percent of CF was found to be taken into solution by CA , and about 10 percent of CA was taken into solid solution by CF . In this process the refractive

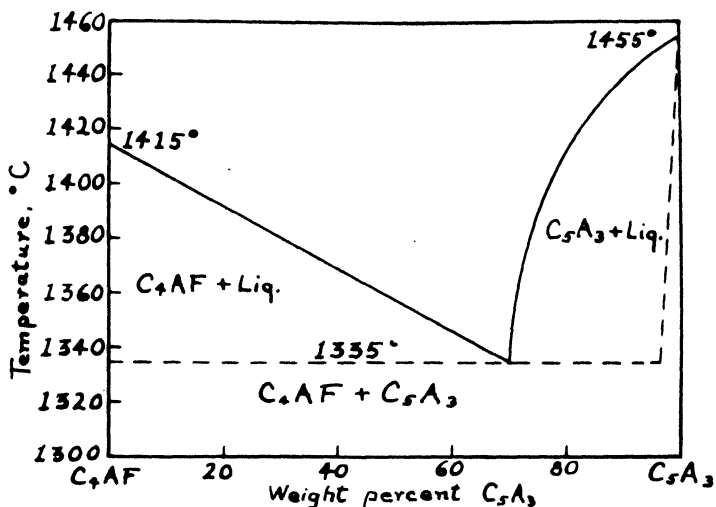

Figure 126. The system C_4AF - C_5A_3 . (Hansen, Brownmiller and Bogue)

indices of CA were increased from $\alpha_{Na} = 1.643$ and $\gamma_{Na} = 1.663$ to about 1.70 for α and 1.72 for γ . Those of CF decreased from $\omega_{Li} = 2.465$ and $\epsilon_{Li} = 2.345$ to about 2.25 for ω and 2.13 for ϵ . The melting relations existing between CA and CF are shown in Figure 127. A eutectic mixture is found (point f , Figure 121) melting at 1205° . This melting condition was found in all compositions in the area CA - CF - C_2F - C_4AF (Figure 125) and is, therefore, the invariant point at which the three solid solutions are in equilibrium with liquid and vapor.

In the compositions falling on the line CA - C_4AF (Figure 125), the CA was found to take up some CF in solution, which varied its indices somewhat. This allowed some C_5A_3 also to be formed and the C_4AF to take up a small amount of C_2F . It is also indicated that the latter solid solution is capable of taking a small amount of CA into solution, but the exact amounts were not determined. Thus the line CA - C_4AF (Figure 125) is not precisely drawn.

It was found in a later study (5) that Fe_2O_3 is capable of replacing about 2 percent of Al_2O_3 in C_2A and in C_5A_3 , the refractive indices being raised from

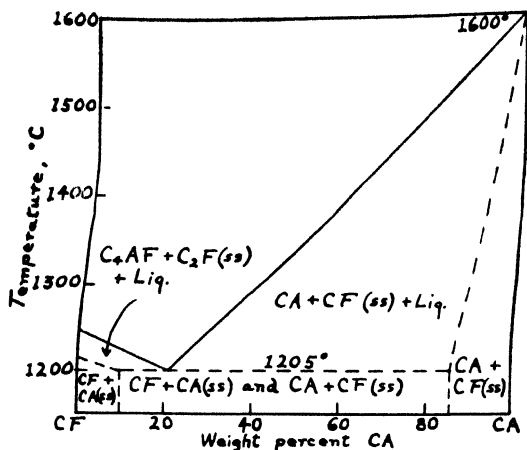

Figure 127. Melting relations between CF and CA. (Hansen, Brownmiller and Bogue)

1.710 \pm 0.002 to 1.715 \pm 0.003, and from 1.608 \pm 0.002 to 1.613 \pm 0.003, respectively. Since a greater change in index had been noted in the first study, it seems probable that the above aluminates, on separating as primary phases in the ternary system, change in composition as the crystallization proceeds, the amount of solid solution decreasing with lowered temperatures.

C₄AF-MgO

The system C₄AF-MgO was examined by Hansen and Brownmiller (5) who obtained data which suggested that MgO is taken up in solid solution with C₄AF to the extent of about 2 percent; but later study showed that the amount of solid

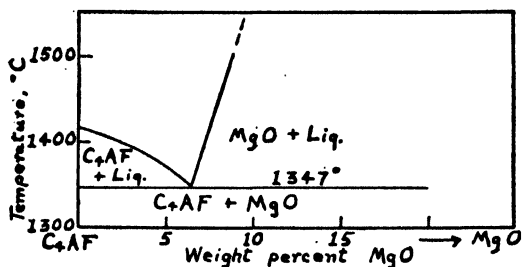

Figure 128. Part of system C₄AF-MgO. (Inasley and McMurdie)

solution is probably much less than that first indicated (4). The introduction of the MgO to C₄AF reduced the refractive indices from $\alpha_{Li} = 1.96$ to 1.92 and $\gamma_{Li} = 2.04$ to 1.97, and the γ pleochroism was intensified from brown to dark brown, almost opaque. Specific gravity was reduced from 3.77 to 3.72. The color of the compact or powdered product was changed from a chocolate brown to jet black.

Inasley and McMurdie (7) investigated the system C₄AF-MgO, with the results shown in the concentration-temperature diagram of Figure 128. It was found to be a simple binary system having a eutectic at 93.5 C₄AF and 6.5 MgO, melting at 1347° \pm 3°. The possibility of solid solution was explored. The presence of periclase in the melt from a 99C₄AF-1MgO mix after prolonged heat treatment,

and the absence of an observable shift in the lines of either C_4AF or MgO in a heat-treated 50:50 mixture, indicated that, in the system C_4AF - MgO , solid solution of MgO in C_4AF must be less than 1 percent.

CaO-CA- C_4AF

A later study on a part of the system CaO - CA - C_4AF was made by McMurdie (9) in which the quenching method was employed for determining the phase boundaries, but difficulties in determining the precise limits of the primary-phase field of C_4AF were encountered due to the rapid crystallization of that compound. Insignificant reduction of the Fe_2O_3 was shown by the absence of compounds other than those known to be present in the CaO - Al_2O_3 - Fe_2O_3 system, and by the simi-

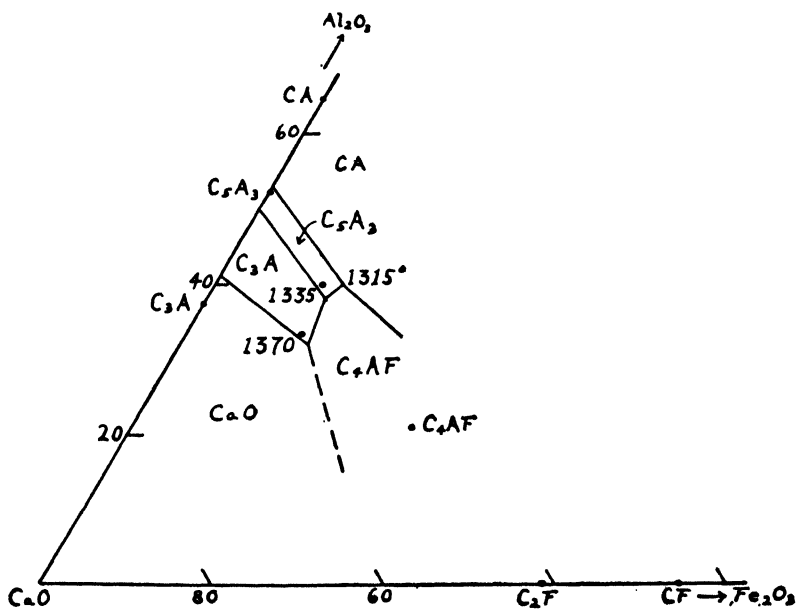

Figure 129. Liquidus relations in the area CaO - C_4AF - CA . (McMurdie)

ilarity in the phase composition of specimens of the same mix heated for long and for short periods at high temperature.

The liquidus relations and boundary curves obtained are shown in the diagram of Figure 129 drawn in the same manner and to the same scale as Figure 121 in order that comparisons can better be shown. It may be noted that the fields of C_2A and C_3A are shifted in such a way that their boundaries with C_4AF are closer to the composition of that compound. The invariant points obtained are given in Table 24, which show for the fields CaO - C_2A - C_4AF and C_3A - C_4AF - C_2A , a higher percentage of Fe_2O_3 and a lower percentage of Al_2O_3 , than those reported by Hansen, Brownmiller and Bogue.

A special study was made by McMurdie of the nature and amount of solid solutions which were encountered in the system he studied. The results are shown

in Figure 130. C_2A was found to take up to 5 percent of C_4AF in solution, and the latter compound to take between 2.5 and 5 percent of C_2A in solution. By this process the index of refraction of the C_2A was raised from 1.71 to $1.720 \pm .002$, but that of the ternary compound was lowered very little. Thus any mixture on the join C_2A-C_4AF (Figure 130) between the above limiting amounts of solubility would consist of those two solid solutions.

The other cases were found to be more complex. Thus mixes on the join $C_2A_3-C_4AF$ were found to take up Fe_2O_3 and CaO into solution in a ratio indicated by point D , leaving the liquid deficient in CaO for the formation of C_4AF and

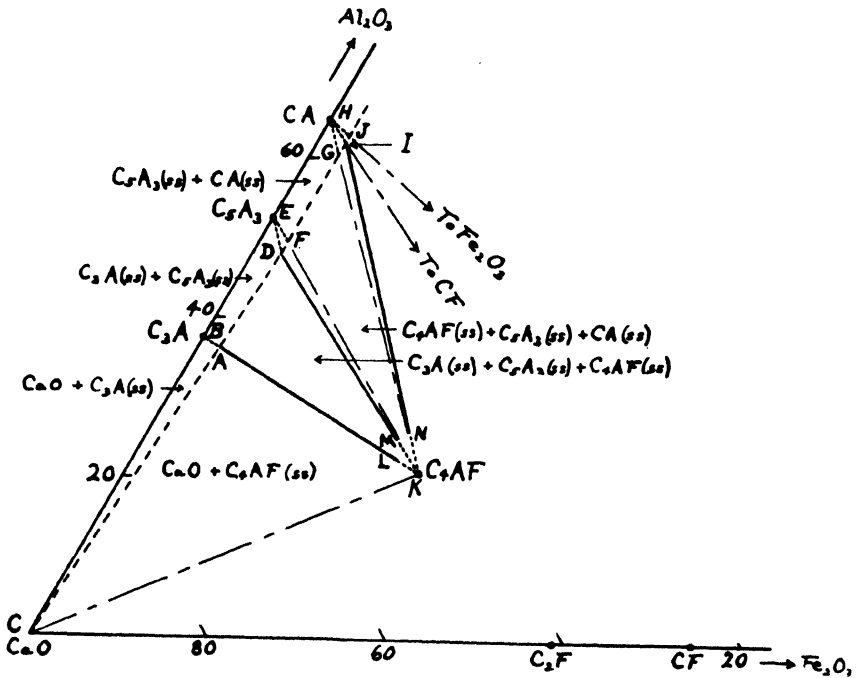

Figure 130. Solidus relations in the area $CaO-C_4AF-CA$. (McMurdie)

$-C_2A_3$, so that some CA separates from it. A single phase will form from mixes between E and D , having at D a refractive index of 1.620 ± 0.002 as compared with 1.608 for pure C_2A_3 . But a mix on the join EF will crystallize to two phases: a solid solution of C_2A_3 having a composition between E and D , and a solid solution of CA having a composition between H and I , as developed presently. About 5 percent of C_2A_3 also is taken up by C_4AF , the solid solution at M having indices of refraction of $\alpha = 1.94 \pm 0.01$, $\gamma = 1.99 \pm 0.01$ as compared with pure C_4AF of $\alpha = 1.98$ and $\beta = 2.07$. Compositions between M and F will give, on complete crystallization, $C_4AF(ss)$ of composition M , $C_2A_3(ss)$ of composition D , and $CA(ss)$ of composition I .

In the third case, mixes along the join $CA-C_4AF$ also yield products of crystallization different from those represented by the indicated compounds. The CA

takes up Fe_2O_3 and CaO into solution in the ratio 1:1 as indicated by the line HI . The liquid will then be depleted in Al_2O_3 , causing C_5A_3 to be formed. A single phase will form between H and I having indices of $\alpha = 1.650 \pm 0.002$, $\gamma = 1.667 \pm 0.002$ instead of those of pure CA : $\alpha = 1.643$, $\gamma = 1.663$. But mixes on the join $CA-Fe_2O_3$ (the line HJ) having less than 2.5 percent Fe_2O_3 , also produce a single phase, so that any composition in the triangle IHK forms a single phase consisting of a solid solution of CF and Fe_2O_3 in CA . Then mixes on the join $CA-C_4AF$ between H and G will form two phases, a $CA(ss)$ of composition between H and I , and a $C_5A_3(ss)$ having a composition between E and D . The C_4AF also takes about 5 percent of CA into solid solution, lowering the index about as does the C_5A_3 . McMurdie thinks it probable that only one phase, $C_4AF(ss)$ is formed throughout the area $KNML$ near the C_4AF apex. The dashed line $CADG$ indicates the limit of compositions which form only two phases on complete crystallization. Mixtures to the right of that line contain, up to the region NML , three phases, one of which is $C_4AF(ss)$.

From a purely qualitative study, Tavasci (16) believed that he had discovered in the system $CaO-Fe_2O_3$ the compound CF_2 , and in the system $CaO-Al_2O_3-Fe_2O_3$ the compound CAF_2 . An examination of phases produced in various compositions led him to postulate the existence of several series of solid solutions: α between C_2F and C_4AF , β between CA_2 and CF_2 , and γ between CF and C_2F , with small amounts of Al_2O_3 . Tavasci believes the Al_2O_3 -rich compound in the system $CaO-Al_2O_3$ is CA_2 .

$CaO-C_5A_3-C_2F$

In an important work begun in 1937 by Swayze and Brown, the difficulties of obtaining satisfactory quenches noted by earlier investigators was overcome by the use of very small charges of about 0.010–0.015 g placed in open concave platinum-foil "saucers" about 6 mm square, and quenching in water, followed by immediate drying. With such a technique, charges containing up to 75 percent C_4AF could be completely frozen as glass from temperatures 5 to 10 degrees above those for burns showing stable crystalline phases.

In the preliminary report (14) it was noted that the invariant point for $CaO-C_5A_3-C_4AF$ is even closer to C_4AF than found by McMurdie, and that it lies slightly on the CaO side of the $C_5A_3-C_4AF$ point. The temperature was given as 1380°.

Another point was noted, that in all mixes in the C_5A_3 primary-phase field, the C_5A_3 crystals were surrounded by a border zone of more or less birefringent material, the thickness of which increased as the CaO content increased at a constant $A:F$ ratio, and as the invariant point was approached. This material was also observed in the C_4AF field around the C_4AF grains in mixes near the $C_5A_3-C_4AF$ boundary. This material exhibited a wavy birefringence, and the refractive index was variable, but always higher than the liquid and lower than the crystalline iron phase. It was not identified, but was thought to resemble the "metastable phase" reported by Bogue (1), which is described elsewhere.

The final report on this work was published in 1946 (15). The results are shown in the diagram of Figure 131. A new compound was reported having the formula $6CaO \cdot 2Al_2O_3 \cdot Fe_2O_3 (C_5A_3F)$. The $A:F$ ratio is 1.277. It is described

as melting incongruently at 1365° into a liquid (point *a*, Figure 131) and a crystalline ternary compound, with a lower A:F ratio along a line of solid solutions extending from C_6A_2F to C_4AF . Complete melting occurs at 1390° at which temperature the vestigial solid phase has an A:F ratio of about 0.72.

In the diagram for the pseudo-system $CaO-C_3A_3-C_2F$ (Figure 131) the line *ab*, separating the field of C_6A_2F from the solid solution field, is not a true boundary curve, but indicates approximate limits of the field where C_6A_2F occurs as a pure phase and (below the line) where the iron phase appears as a solid-solution containing increasing amounts of C_2F . The pure C_6A_2F was found to have an α refractive index of approximately 1.94 and to be orthorhombic in crystal habit.

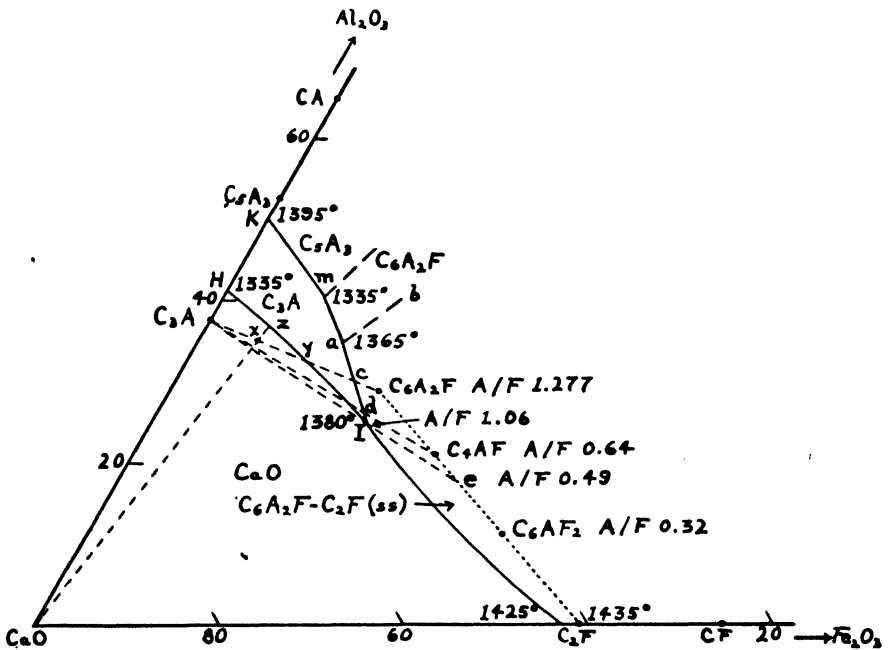

Figure 131. The pseudo-system $CaO-C_3A_3-C_2F$. (Swayze)

Basal sections show low birefringence and yield interference figures which are biaxial negative with a small optic angle. The X-ray diffraction pattern of C_6A_2F was found to be identical with that of C_4AF except for a slight shift in the position of the lines. A complete series of solid-solutions is indicated by the X-ray patterns throughout the entire range of compositions from C_6A_2F to C_2F . The compound C_6A_2F can be prepared easily by a few sinterings of the proper mixture of oxides with regrindings to absorb inequities in the mix.

Swayze found that the compound C_2F melts congruently, rather than incongruently as reported by Sosman and Merwin. The melting temperature found was 1435° . A eutectic between CaO and C_2F having the composition C_2F 97; CaO 3 percent was found, at a temperature of 1425° . Between this binary compound and C_6A_2F there appeared to be a continuous series of solid solutions, but the

composition C_6AF_2 , having an A:F ratio of 0.32, was the highest-iron composition in the series where an accurate estimate of liquidus temperature could be made.

The quintuple invariant point for CaO , C_3A , the iron phase, liquid and vapor (I in Figure 131) was located, having an A:F ratio of 1.06, and a temperature of 1380° . The ternary phase in this eutectic had an α index slightly above 2.00,

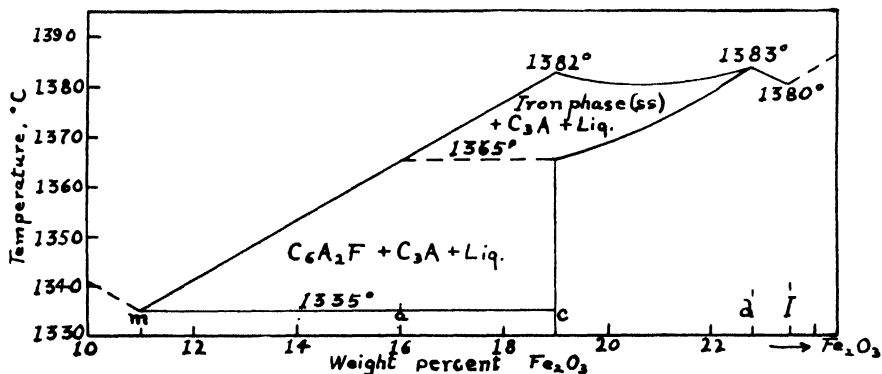

Figure 132. Solid solution-temperature relations along C_3A -iron phase boundary KI . (Swayze)

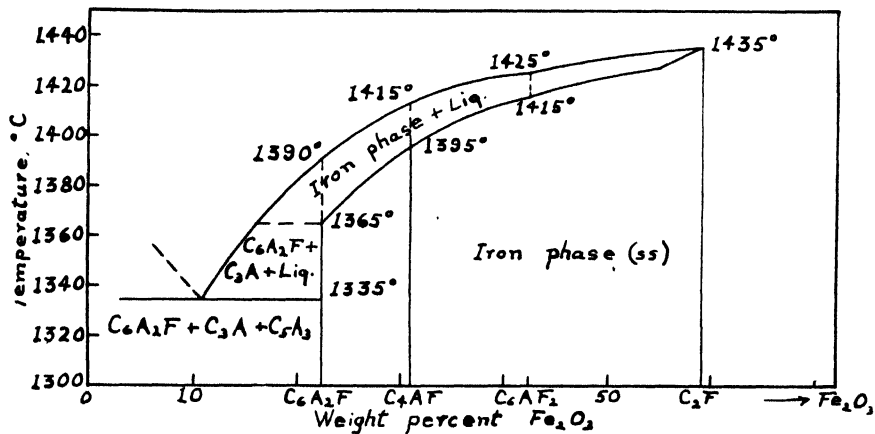

Figure 133. Liquidus-solidus temperature relations along the solid-solution line $C_6A_2F-C_2F$. (Swayze)

corresponding to an A:F ratio of 0.49, a composition indicated on the solid solution line $C_6A_2F-C_6AF_2$ by the intersection upon it (point e) of a projection of the line passing from C_3A through point I , the composition of the eutectic.

Intersections on the boundary curve KI (separating the fields of C_3A and the iron phases) with joins connecting C_3A with the iron phases C_6A_2F (point c) and C_4AF (point d), showed points of maximum temperatures of fusion. This is the condition which obtains on boundary curves intersected by joins between

the respective adjoining phases. The adherence to this rule in the present case points to a similarity of these members of a solid-solution series with true compounds. The melting relations along the curve *KI* are shown in the diagram of Figure 132.

The quintuple point for the fields of C_2A , C_3A_2 and C_3A_2F (point *m*, Figure

TABLE 24. *Compounds and eutectics in the system CaO-Al₂O₃-Fe₂O₃*

Compounds					
Phases	Author-ity	Composition %			Temp. ± 5°*
		CaO	Al ₂ O ₃	Fe ₂ O ₃	
C_3A	(10)	62.22	37.78	1535(i)
C_3A_2	(10)	47.78	52.22	1455(c)
CA	(10)	35.44	64.56	1600(c)
C_2F	(13)	41.26	58.74	1436(i)
Same.....	(15)	41.26	58.74	1435(c)
CF	(13)	25.99	74.01	1216(i)
C_4AF	(6)	46.1	21.0	32.9	1415(c)
C_3A_2F	(15)	48.07	29.12	22.81	1365(i)
C_3AF_2	(15)	44.4	13.4	42.1	
Quadruple points					
$CaO-C_3A$	(10)	59	41	1535
$C_3A-C_3A_2$	(10)	50	50	1395
C_3A-CA	(10)	47	53	1400
$CaO-C_2F$	(13)	38.4	61.6	1436
Same.....	(15)	43.0	57.0	1425
C_2F-CF	(13)	24.5	75.5	1216
$CaO-C_4AF$	(6)	56	17	26	1395
$CaO-(C_4AF + C_2F_{ss})$	(6)	41.5	1.5	57.0	1435
Quintuple points					
$CaO-C_3A-C_4AF$ (or <i>ss</i>).....	(6)	54	37	9	1340
Same.....	(9)	53	32	15	1370
Same.....	(15)	51.4	25.0	23.6	1380
C_3A-C_4AF (or <i>ss</i>)- C_3A_2	(6)	47	43	10	1335
Same.....	(9)	48	38	14	1335
$C_3A-C_3A_2F-C_3A_2$	(15)	48.5	40.5	11.0	1335
$C_4AF-C_3A_2-(CA + CF_{ss})$	(6)	42	40	18	1320
$C_3A_2-C_4AF$ (or <i>ss</i>)-(CA + CF_{ss}).....	(9)	45	40	15	1315
($C_4AF + C_2F_{ss}$)-(CA + CF_{ss})-(CF + CA_{ss}).....	(1)	28	13	59	1205
$CaO-C_4AF-C_2F$	(6)	41.5	1.5	57.0	1435
$C_3A_2F-C_4AF_{ss}-C_3A$	(15)	49.4	35.0	15.6	1365

* (c) Congruent; (i) incongruent.

131) was established at a temperature of 1335° . The temperature relations along the solidus and liquidus curves of $C_6A_2F-C_2F$ are shown in Figure 133.

A summary of the compounds and invariant points in the system $CaO-Al_2O_3-Fe_2O_3$ is given in Table 24.

References

1. Bogue, R. H., *Symposium*, 72.
2. Campbell, E. D., *Ind. Eng. Chem.*, **11**, 116 (1919).
3. Forestier, H., and Chaudron, G., *Compt. rend.*, **180**, 1264 (1925).
4. Hansen, W. C., *J. Res. NBS*, **4**, 55 (1930); RP 132; PCAF Paper 22.
5. Hansen, W. C., and Brownmiller, L. T., *Am. J. Sci.*, **15**, 225 (1928); PCAF Paper 14.
6. Hansen, W. C., Brownmiller, L. T., and Bogue, R. H., *J. Am. Chem. Soc.*, **50**, 396 (1928); PCAF Paper 13.
7. Insley, H., and McMurdie, H. F., *J. Res. NBS*, **20**, 173 (1938); RP 1074.
8. LeChatelier, H., *Compt. rend.*, **94**, 13 (1882).
9. McMurdie, H. F., *J. Res. NBS*, **18**, 475 (1937); RP 987.
10. Rankin, G. A., and Wright, F. E., *Am. J. Sci.*, **39**, 1 (1915).
11. Roberts, H. S., and Merwin, H. E., *Am. J. Sci.*, **21**, 145 (1931).
12. Shepherd, E. S., Rankin, G. A., and Wright, F. E., *Ind. Eng. Chem.*, **3**, 212 (1911).
13. Sosman, R. B., and Merwin, H. E., *J. Wash. Acad. Sci.*, **6**, 532 (1916).
14. Swayze, M. A., *Symposium*, 99.
15. Swayze, M. A., *Am. J. Sci.*, **244**, 1; 65 (1946).
16. Tavasci, B., *Ann. chim. appl.*, **27**, 505 (1937).

CHAPTER 18

Systems Containing MgO and Fe_2O_3 with CaO , Al_2O_3 , and SiO_2

$\text{CaO-C}_2\text{S-C}_3\text{A}_3\text{-C}_4\text{AF}$

The quaternary system $\text{CaO-Al}_2\text{O}_3\text{-Fe}_2\text{O}_3\text{-SiO}_2$ has not been investigated in full, but the portion of it which is of importance to portland cement has been determined by Lea and Parker of the Building Research Station of England (1). The region explored consists of the quaternary system $\text{CaO-C}_2\text{S-C}_3\text{A}_3\text{-C}_4\text{AF}$, the relation of which to the larger system is shown in Figure 134.

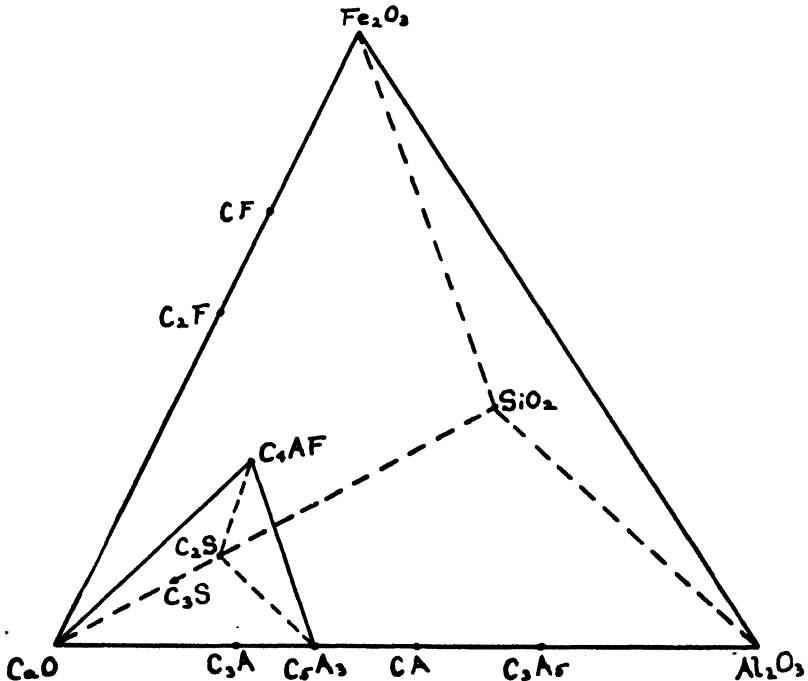

Figure 134. Location of the system $\text{CaO-C}_2\text{S-C}_3\text{A}_3\text{-C}_4\text{AF}$ in the system $\text{CaO-Al}_2\text{O}_3\text{-Fe}_2\text{O}_3\text{-SiO}_2$. (Lea and Parker)

Of the four ternary systems which constitute the surfaces of this tetrahedron, it will be noted that two already have been described. Thus the system $\text{CaO-C}_2\text{S-C}_3\text{A}_3$ is a part of the system $\text{CaO-Al}_2\text{O}_3\text{-SiO}_2$. For purposes of better comparison with the description to follow, the system $\text{CaO-C}_2\text{S-C}_3\text{A}_3$ is laid out in the usual manner as a complete system in Figure 135.

Likewise, the system $CaO-C_3A_3-C_4AF$ is a part of the system $CaO-Al_2O_3-Fe_2O_3$ previously described. This also is set down as a complete ternary system in Figure 136.

The system $CaO-C_2S-C_4AF$ had not been explored but was investigated by Lea and Parker as a preliminary to the study of the quaternary system. Quenching methods were generally employed and identifications of phases made by examination of the powdered charges under a petrographic microscope. The determination of invariant points was generally made by means of heating-curves. The phase

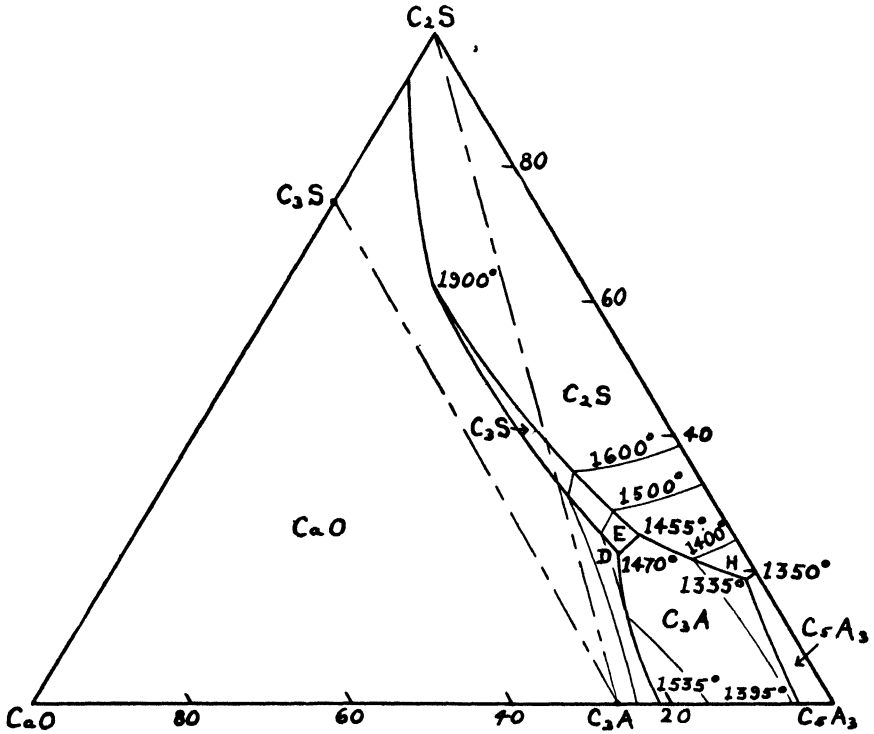

Figure 135. The system $CaO-C_2S-C_3A_3$. (Rankin and Wright)

relations obtained are shown in Figure 137, the boundary curves which are dashed being estimated because the melting temperatures above 1600° were beyond the limits of the furnace. For this reason, the location of the C_3S phase region was not established precisely.

The system $CaO-C_2S-C_4AF$ is seen to bear a striking resemblance to the system $CaO-C_2S-C_3A_3$ (Figure 135). However, in the latter, the field of C_3S lies wholly on the C_2S side of the line C_2S-C_3A , whereas in the present system that field lies wholly on the CaO side of the line C_2S-C_4AF . This means that the substitution of C_4AF for C_3A_3 , though not greatly changing the location of the primary-phase regions of CaO and C_3S , yet greatly extends the region within which CaO will be present when crystallization is just complete under equilibrium

cooling. This is similar to the effect of substituting Fe_2O_3 for Al_2O_3 in the system C-A-S, as previously described (pages 285-286).

The side of the triangle $\text{C}_2\text{S}-\text{C}_4\text{AF}$ (Figure 137) is shown as a binary system, the melting relations of which are expressed diagrammatically in Figure 138. The eutectic was found to occur at a composition of C_2S 18.5, C_4AF 81.5 percent, and a temperature of $1350^\circ \pm 10^\circ$.

An inspection of Figure 137 will show that the join $\text{C}_2\text{S}-\text{C}_4\text{AF}$ does not intersect the boundary between those two phases (XW), but that the primary

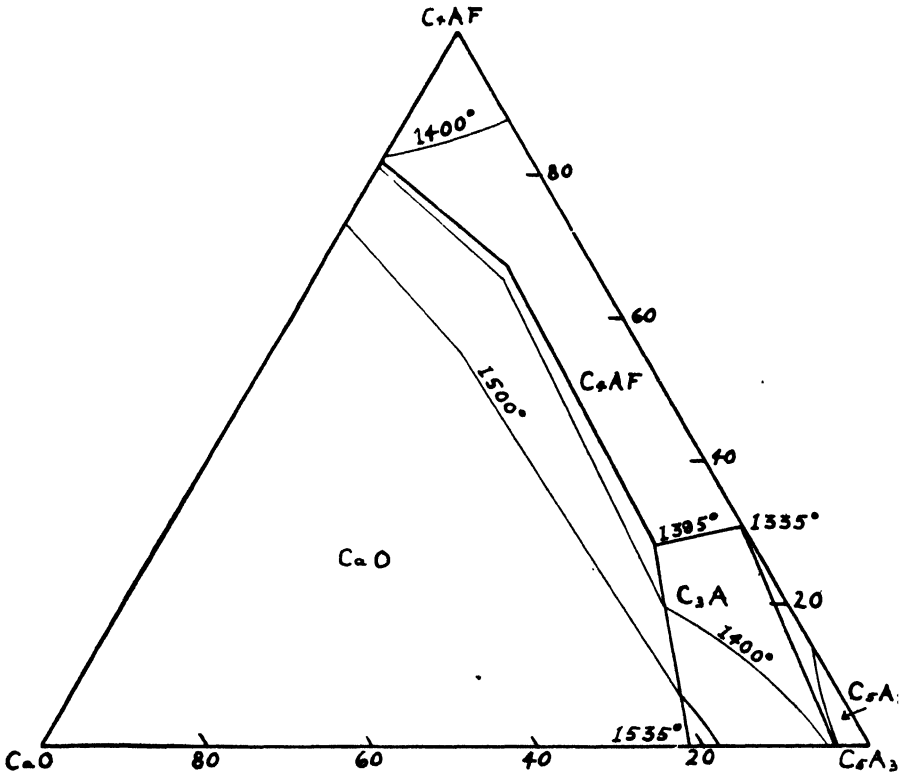

Figure 136. The system $\text{CaO}-\text{C}_4\text{AF}-\text{C}_3\text{A}_3$. (Hansen, Brownmiller and Bogue)

phase crystallizing along the join is CaO , C_2S or C_4AF . Hence the join does not represent a true binary system. The melting relations in mixes of C_2S and C_4AF are shown in Figure 139. The quintuple point for CaO , C_2S , C_4AF (point X , Figure 137) was deduced, from a consideration of the course of crystallization, to be a eutectic. It has the composition CaO 6.8, C_2S 16.0, C_4AF 77.2 percent. The invariant point for C_2S , C_3S , C_4AF (point W) is not a eutectic. It has the composition CaO 6.0, C_2S 16.5, C_4AF 77.5. The temperatures of both points were found to be between 1345° and 1350° , and since the eutectic must melt at the lower temperature the value assigned to point X is 1347° and to point W 1348° .

The fourth ternary system of the tetrahedron (Figure 134) is the system

C₂S-C₃A₂-C₄AF. The diagram is shown in Figure 140. No compounds appear other than those of the three components. The quintuple point between C₃A₂,

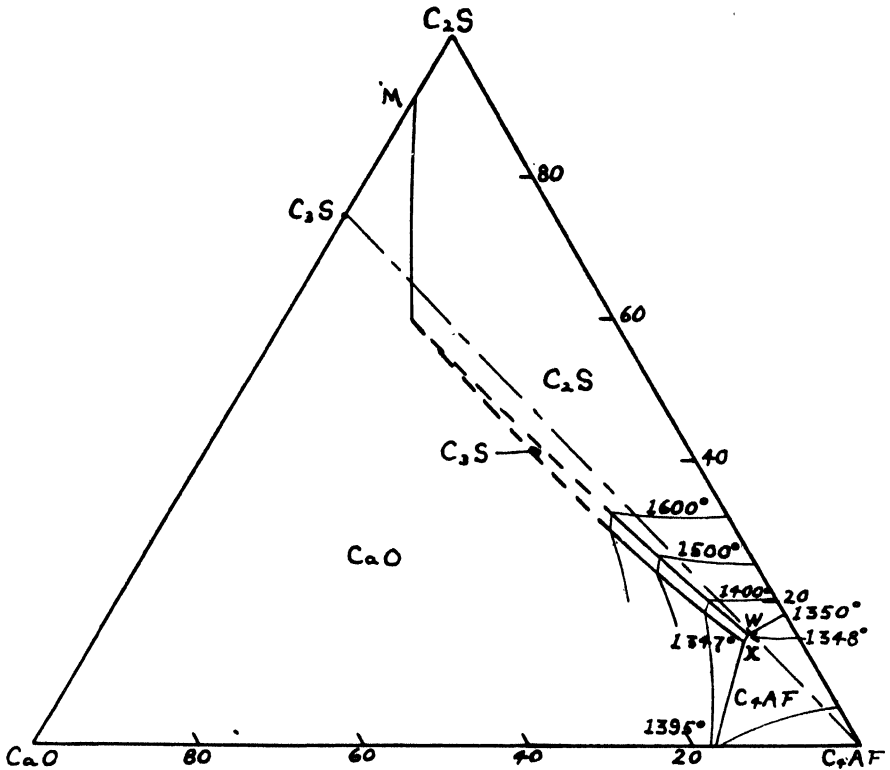

Figure 137. The system CaO-C₂S-C₄AF. (Lea and Parker)

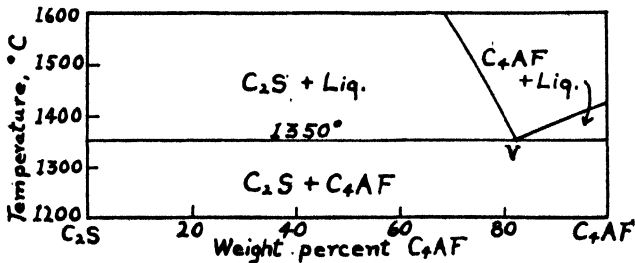

Figure 138. The system C₂S-C₄AF. (Lea and Parker)

C₂S, C₄AF (point R) is a eutectic having the composition C₃A₂ 54, C₂S 16, C₄AF 30 percent and a temperature of 1280° ± 5°.

The quaternary system CaO-C₂S-C₃A₂-C₄AF was explored by the examination of compositions falling on a series of four planes passing through the tetrahedron parallel to the base CaO-C₂S-C₃A₂. Thus all compositions in each plane contain a

constant percentage of Fe_2O_3 or, in terms of the components indicated at the apices, a constant percentage of C_4AF . The percentages of Fe_2O_3 in the four

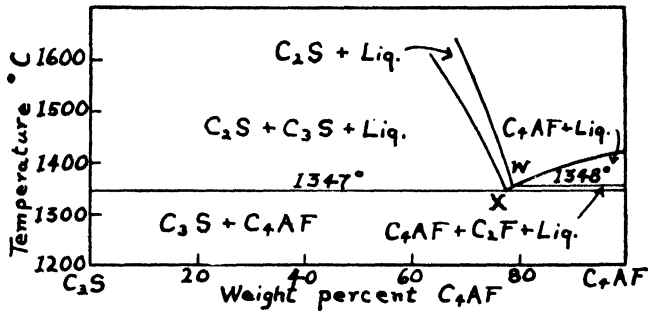

Figure 139. Melting relations in mixés of C_2S and C_4AF . (Lea and Parker)

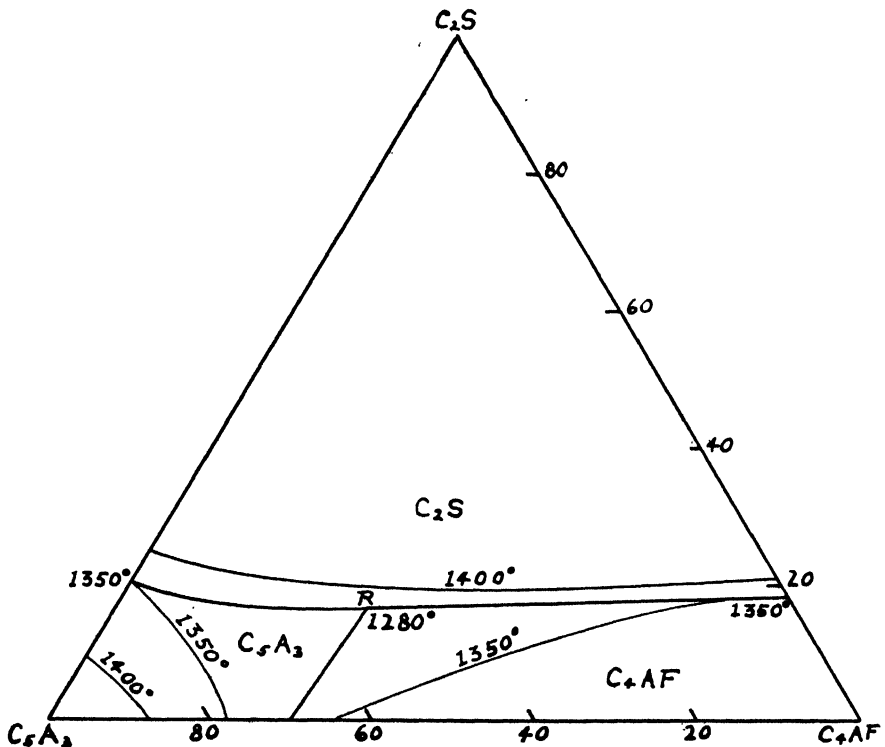

Figure 140. The system C_2S - C_4AF - C_5A_3 . (Lea and Parker)

planes were 2, 5, 10 and 20; the equivalent values of C_4AF were 6.1, 15.2, 30.4 and 60.8 percent, respectively.

The base plane of the region investigated of the system CaO - C_2S - C_5A_3 is shown in Figure 141 on the same scale as the diagrams to follow. In Figures 142

to 145 are shown the phase and temperature relations in the four planes containing successively increasing amounts of Fe₂O₃.

From these diagrams it may be noticed that the general location of the C₃S primary-phase field does not change greatly, except to move towards the C₅A₃ apex, but becomes narrower with increasing Fe₂O₃ content. That is, the C₃S volume rises as a narrowing strip on proceeding towards the C₄AF apex. It will be noted also that C₃A continues to be the phase bordering C₃S towards the C₅A₃ apex through the 10 percent Fe₂O₃ addition (Figures 142-144), but that

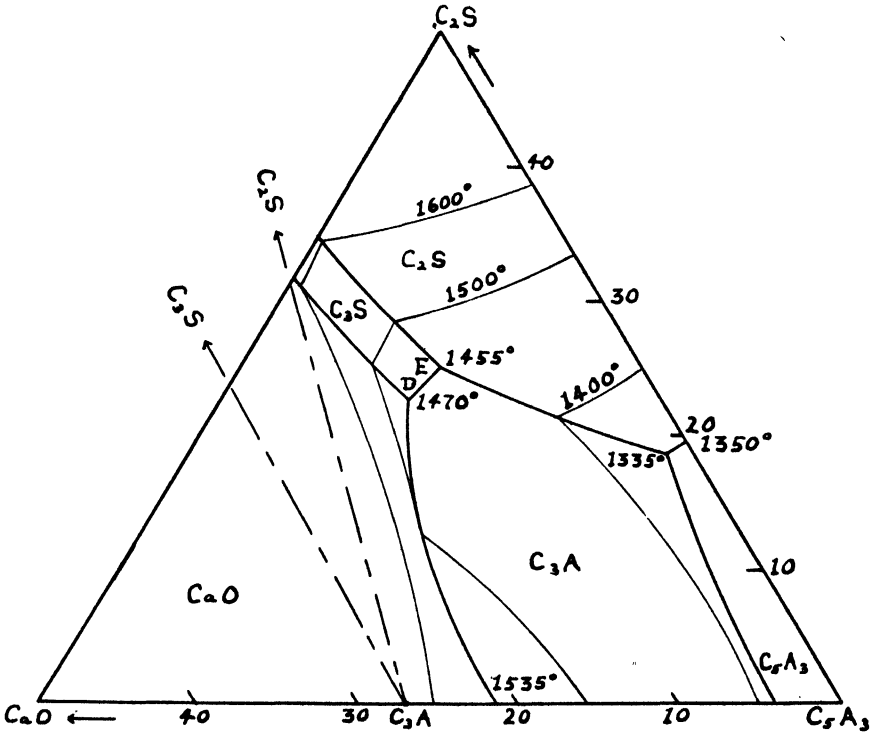

Figure 141. Portion of system CaO-C₂S-C₅A₃. (Rankin and Wright)

when 20 percent Fe₂O₃ is present (Figure 145) the phase below that boundary is C₄AF. The latter phase does not appear at all along these planes until 10 percent Fe₂O₃ is added, but on passing from that amount (Figure 144) to the 20 percent addition (Figure 145) C₃A has disappeared and C₄AF appears adjacent to C₃S. Hence, the sextuple points for CaO, C₃S, C₃A, C₄AF and for C₃S, C₂S, C₃A, C₄AF (Points T₁ and T₂, respectively, Figure 146) must be between these two planes. To establish these points, compositions were made up along the line joining C₄AF with a point midway between the quintuple points for CaO, C₂S, C₃A and C₃S, C₂S, C₃A (points D and E, Figure 146). From observations of the quenched charges it was concluded that the Fe₂O₃ content of the sextuple points was 16.5 ± 0.5 percent. The compositions were as follows: For CaO-C₃S-C₃A-

C_4AF (point T_1) CaO 55.0, Al_2O_3 27.7, SiO_2 5.8, Fe_2O_3 16.5 percent; for C_2S , C_2S , C_3A , C_4AF (point T_2), CaO 54.8, Al_2O_3 22.7, SiO_2 6.0, Fe_2O_3 16.5 percent. The temperature of T_1 is $1341^\circ \pm 5^\circ$ and of T_2 is $1338^\circ \pm 3^\circ$. T_2 is believed to be a eutectic; T_1 quite definitely is not a eutectic.

The quintuple point for C_3A_3 , C_2A , C_4AF , C_2S (point R , Figures 144 and 146) was found to have the composition CaO 50.0, Al_2O_3 34.5, SiO_2 5.5, Fe_2O_3 10.0 percent, and a temperature of $1280^\circ \pm 5^\circ$. It could not be established if this were a eutectic point, but the composition is identical with that of the ternary eutectic for C_2S , C_3A_3 and C_4AF .

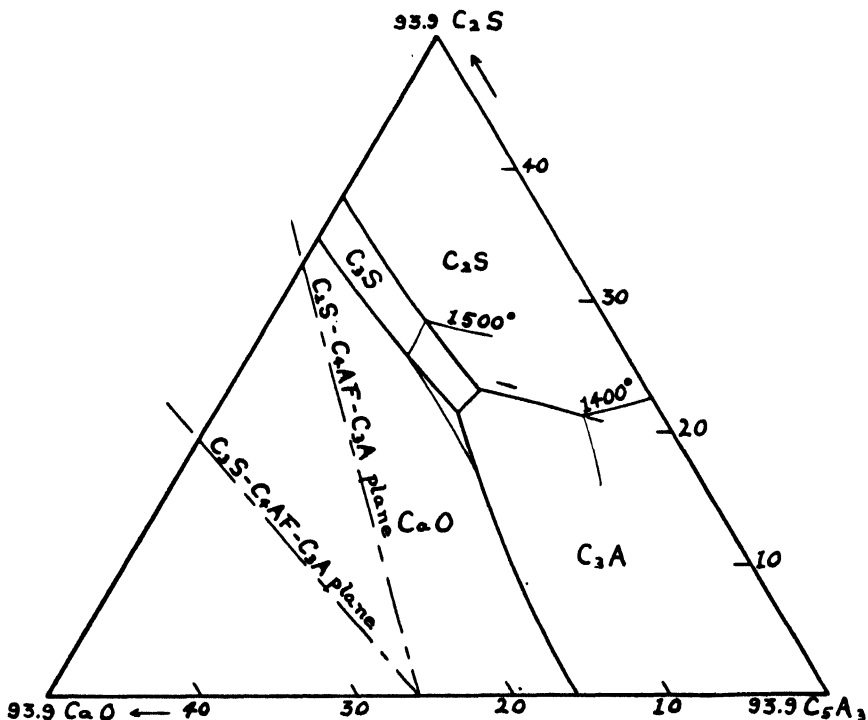

Figure 142. The system $CaO-C_2S-C_3A-C_4AF$. Plane through tetrahedron containing 6.1 percent C_4AF (2 percent Fe_2O_3). (Lea and Parker)

The complete three-dimensional diagram could now be constructed for the quaternary system, and is shown in Figure 146. Of greatest interest is the field of C_2S . In the $CaO-C_2S-C_3A$ system it is shown in the area KDE , and in the $CaO-C_2S-C_4AF$ system in the area LXW . This primary-phase volume extends up through the quaternary system, on one side in equilibrium with CaO and on the other side with C_2S . The outer limit of this wedge of C_2S is a narrow surface, the portion DET_2T_1 being in equilibrium with C_3A , and the portion XWT_2T_1 being in equilibrium with C_4AF . Hence the area of equilibrium between C_3A and C_4AF is defined by the surface T_1T_2RQP . The line T_1T_2 is then the monovariant quintuple line of compositions along which C_2S , C_3A and C_4AF may exist together

in equilibrium with liquid and vapor. In a similar manner C_3S , CaO and C_2A exist together along the line T_1D ; C_3S , C_2S and C_2A along T_2E ; C_3S , C and C_4AF along T_1X ; and C_3S , C_2S and C_4AF along T_2W .

The course of crystallization in the quaternary system is often complex because the plane of C_2S , C_2A , C_4AF cuts across the primary-phase volume of C_3S , and the invariant point for CaO , C_2A , C_4AF (point T_1) lies outside of the region in which the four components in equilibrium at that point are the final products of crystallization. Thus there are several regions where a phase is formed at some

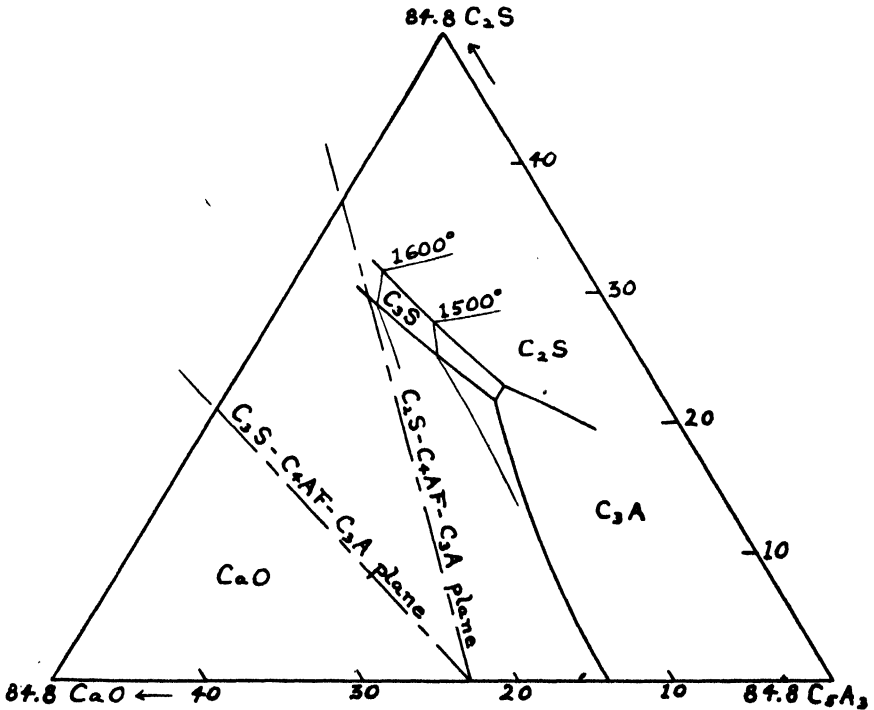

Figure 143. The system $CaO-C_2S-C_3S-C_2A-C_4AF$. Plane through tetrahedron containing 15.2 percent C_4AF (5 percent Fe_2O_3). (Lea and Parker)

temperature, but disappears as the temperature is lowered. The tetrahedron may, however, be divided into three regions in any one of which the final products of crystallization are the same. These regions may be defined on the tetrahedron (Figure 146) as follows:

1. CaO , C_2A , C_4AF , C_3S
2. C_3S , C_2S , C_4AF , C_2A
3. C_3S , C_4AF , C_2A , C_2S

Thus, from a composition a little on the CaO side of the C_3S phase volume, in region 2 above, CaO will first separate. If a projection of the line connecting the original composition with CaO then falls on the C_3S phase volume, C_3S and

CaO will separate together until the line XD is reached. If the intersection falls on the portion XT_1 the CaO becomes less as C_3S and C_4AF separate. If it falls on the portion T_1D , the CaO becomes less as C_3S and C_2A separate. When T_1 is reached at 1341° the CaO disappears and C_3S separates with C_2A and C_4AF . At T_2 , (1338°), the crystallization is completed with the separation of C_3S , C_2A , C_4AF and C_2S . Or, for other compositions, CaO will disappear before the line XD is reached, in which case C_3S separates alone until the C_3S - C_2S surface is reached and the liquid then follows that surface, with separation of those two phases,

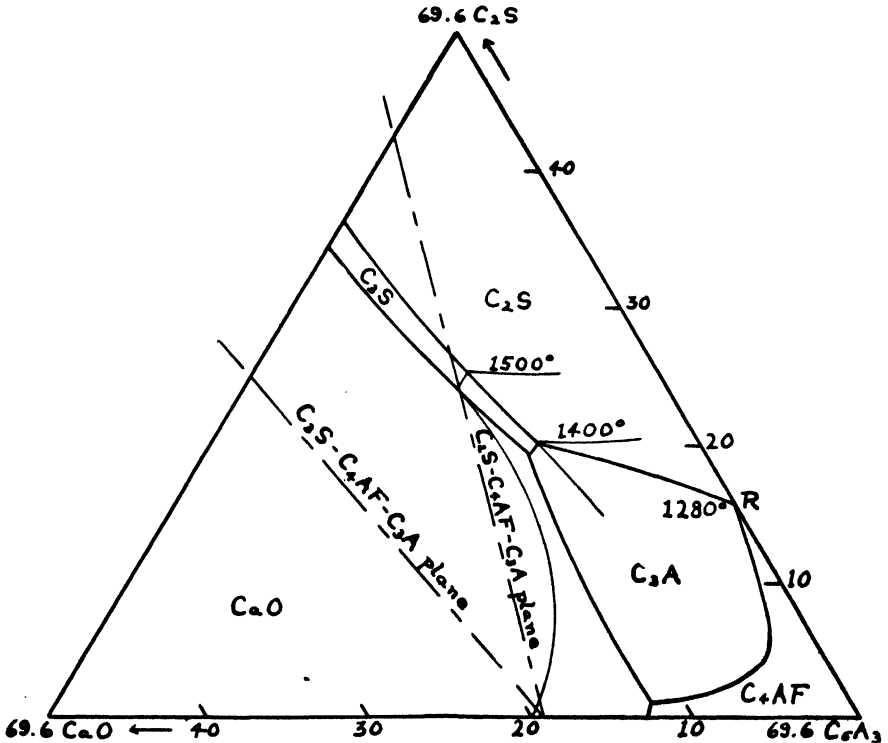

Figure 144. The system $CaO-C_2S-C_3A-C_4AF$. Plane through tetrahedron containing 30.4 percent C_4AF (10 percent Fe_2O_3). (Lea and Parker)

until it reaches the line WT_2 , where C_4AF separates with C_3S and C_2S , or the line T_2E where C_2A separates with C_3S and C_2S . When T_2 is reached, C_3S , C_2S , C_3A and C_4AF complete crystallization together.

Again, if the composition is such that the projection of the line passing from CaO through the composition falls on the C_4AF or C_2A phase volumes, then C_4AF or C_2A will separate with CaO until the line XD is reached when the CaO will become less as the other two phases separate with C_3S until T_1 is reached, and the course will proceed as above.

The invariant points in the system, in addition to those previously listed in connection with other systems, are given in Table 25.

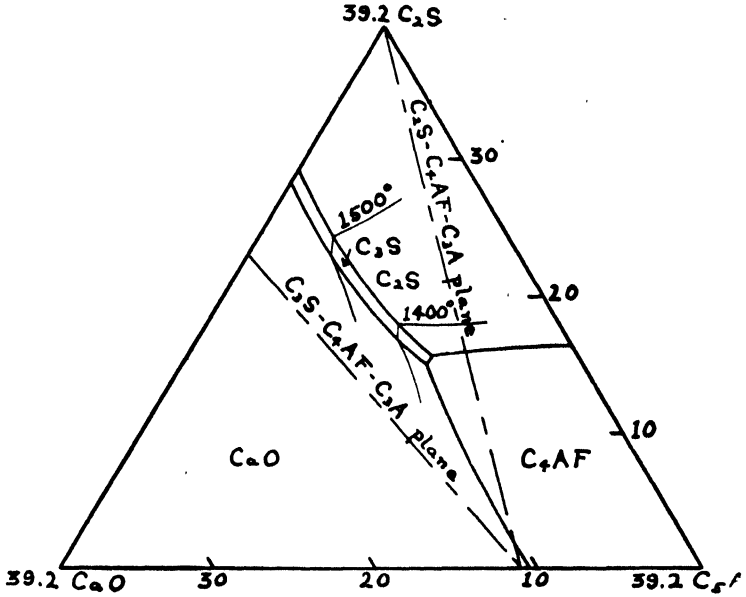

Figure 145. The system CaO-C₂S-C₃A-C₄AF. Plane through tetrahedron containing 60.8 percent C₄AF (20 percent Fe₂O₃). *Lea and Parker*

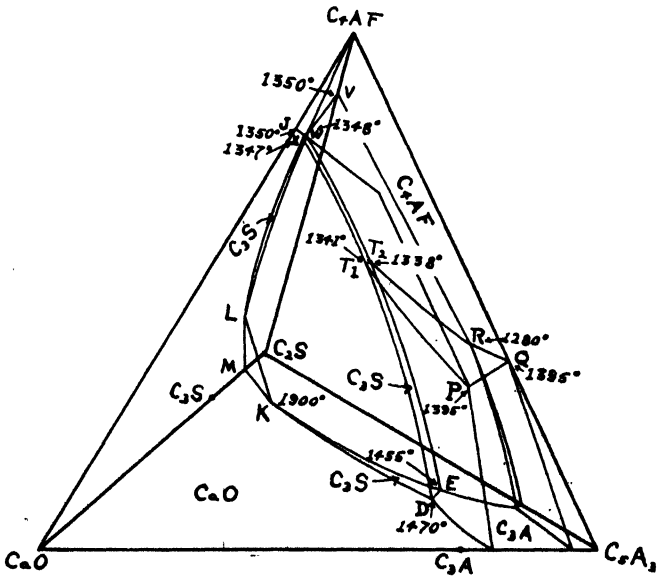

Figure 146. The system CaO-C₂S-C₃A-C₄AF. (*Lea and Parker*)

TABLE 25. Principal invariant points in the system $\text{CaO-Al}_2\text{O}_3\text{-Fe}_2\text{O}_3\text{-SiO}_2$, and the same modified by 5 percent MgO

Point	Authority	Phases	Nature	Composition					Temp. (°C)
				CaO	Al_2O_3	SiO_2	Fe_2O_3	MgO	
V	(1)	$\text{C}_2\text{S-C}_4\text{AF}$	Eutectic	49.6	17.1	6.5	26.8	0	1250
R	(1)	$\text{C}_2\text{S-C}_3\text{A}_2\text{-C}_4\text{AF}$	Eutectic	50.0	34.5	5.6	9.9	0	1280
X	(1)	$\text{CaO-C}_2\text{S-C}_4\text{AF}$	Eutectic	52.8	16.2	5.6	25.4	0	1347
W	(1)	$\text{C}_2\text{S-C}_2\text{S-C}_4\text{AF}$	Not eut.	52.4	16.3	5.8	25.5	0	1348
R	(1)	$\text{C}_2\text{S-C}_3\text{A-C}_4\text{AF-C}_2\text{A}_3$?	50.0	34.5	5.6	10.0	0	1280
T_1	(1)	$\text{CaO-C}_2\text{S-C}_3\text{A-C}_4\text{AF}$	Not eut.	55.0	22.7	5.8	16.5	0	1341
1	(2)	$\text{CaO-C}_2\text{S-C}_3\text{A-iron phase}$	Not eut.	53.9	21.2	5.8	19.1	0	1342
A	(2)	do. + MgO	Not eut.	50.9	22.7	5.6	15.8	5.0	1305
T_2	(1)	$\text{C}_2\text{S-C}_2\text{S-C}_3\text{A-C}_4\text{AF}$?	54.8	22.7	6.0	16.5	0	1338
2	(2)	$\text{C}_2\text{S-C}_2\text{S-C}_3\text{A-iron phase}$	Not eut.	53.5	22.3	6.0	18.2	0	1338
B	(2)	do. + MgO	Not eut.	50.5	23.9	5.9	14.7	5.0	1301

 $\text{CaO-C}_2\text{S-C}_3\text{A}_2\text{-C}_2\text{F}$

The study initiated by Swayze on the system $\text{CaO-C}_3\text{A}_2\text{-C}_2\text{F}$, (see pages 295-299), was extended (2) into the quaternary system $\text{CaO-C}_3\text{A}_2\text{-C}_2\text{F-C}_2\text{S}$ for the purpose of determining the influence of the phase relations found in the ternary system on the formation of the major cement compounds, especially with reference to the ternary iron compound, and the effect of its variable A:F ratio on the other normal phases. The area of greatest interest in cement technology is the C_2S surface (see Figure 146) where C_2S is in equilibrium with C_3A or with the iron phase at melting temperatures, since it shows the compositions of the liquid at temperatures where the Al_2O_3 and Fe_2O_3 have just entered the liquid state. All crystallization which takes place from this condition occurs on one of the boundaries of this C_2S surface.

The study of this C_2S surface is simplified by the fact that it is nearly parallel to the $\text{CaO-C}_3\text{A}_2\text{-C}_2\text{F}$ face of the quaternary model, permitting a projection of points on this surface upon a plane parallel to the $\text{CaO-C}_3\text{A}_2\text{-C}_2\text{F}$ face. The system, drawn as a tetrahedron, is shown in Figure 147. The two principal invariant points, corresponding to T_1 and T_2 of Lea and Parker, are shown at points 1 and 2, respectively. These are given in table 25.

Neither of these invariant points was found to be a eutectic, although Lea and Parker had thought it probable that the latter was. The temperatures agree with those found by the latter investigators. Their compositions differ materially however, especially in being richer in Fe_2O_3 and poorer in CaO. The SiO_2 contents are identical, and the Al_2O_3 contents are slightly less.

In the figure, the solid solution series between $\text{C}_3\text{A}_2\text{F}$ and C_2F is drawn in,

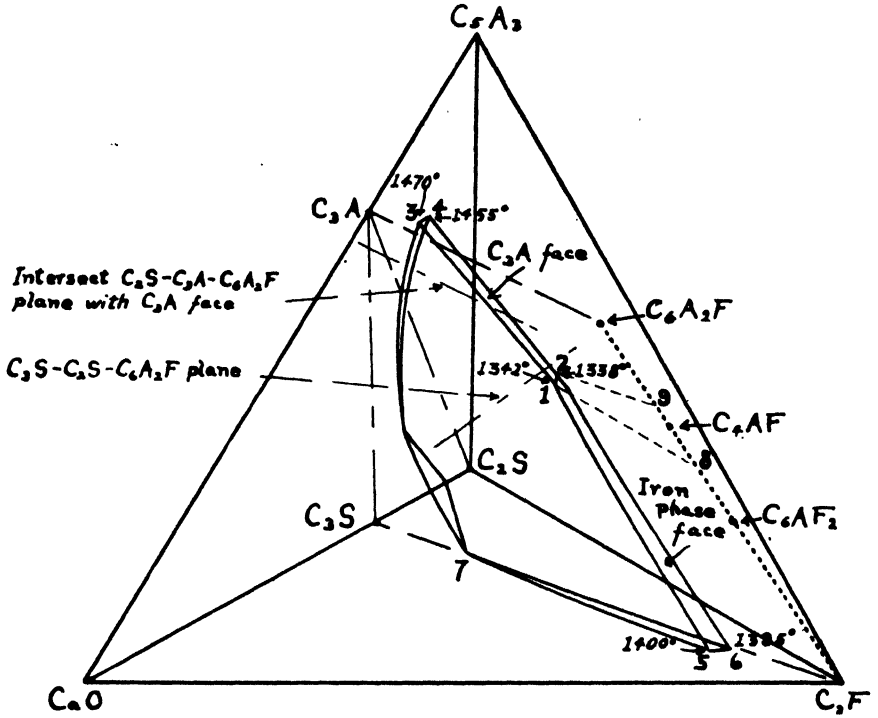

Figure 147. The C_2S phase volume in the system $CaO-C_3A_2-C_2F-C_2S$. (Swayze)

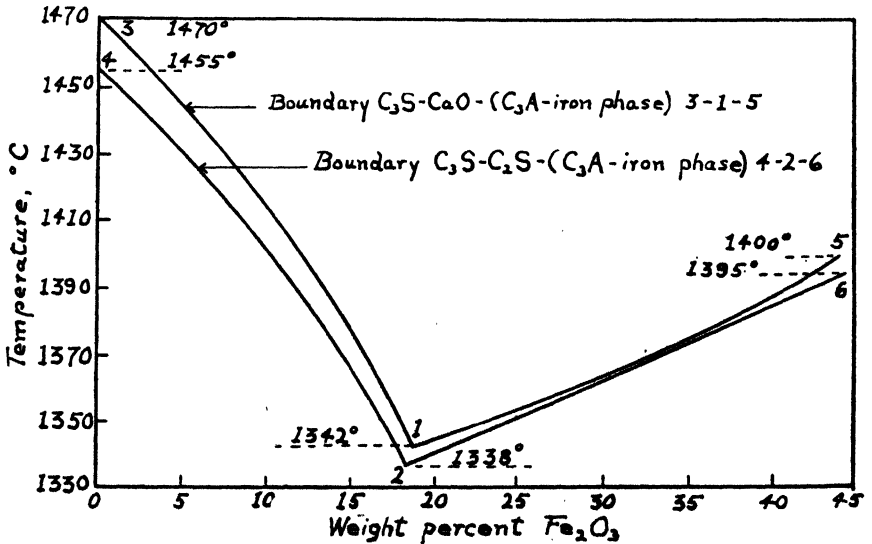

Figure 148. Melting temperatures along C_2S phase boundaries. (Swayze)

and the intersections of several composition planes with the C_3A or iron solid-solution faces of the C_3S volume (or with planes at the same depth in the tetrahedron as these faces) are shown.

Of especial significance, it is indicated that the invariant points 1 and 2 are both outside the tetrahedron $C_3S-C_2S-C_3A-C_6A_2F$. Hence the iron phase which will be in equilibrium in the final products of crystallization of compositions 1 and 2 will be members of the solid-solution series. Calculations from the data indicate that the A:F ratio of the solid solution formed at point 2 should be about 0.85; shown by the intersection at point 9 of a tie-line from point 2. Likewise, the A:F ratio of the solid solution formed at point 1 should be about 0.5, shown by the intersection at point 8 of a tie-line extending from point 1. The temperatures of final melting along the boundary curves 3-1-5 and 4-2-6 are shown in Figure 148.

The System $CaO-C_2S-C_3A_3-C_2F$, Modified by 5 percent MgO

The introduction of MgO into the above four-component system is important and necessary in the application of the data from phase studies to the technology of portland cement. All commercial cements contain MgO , and its presence in the liquid during burning will have a definite effect upon the melting relations in the system. Swayze has accordingly studied the compositions along the C_3S surface, adjoining the fields of C_3A and the iron solid-solution, with MgO added in all cases to approximate saturation of the liquid. It had previously been learned that liquids in this region, having A:F ratios from 1.35 to 1.60, take up slightly less than 5 percent MgO at temperatures where C_3A and the iron phase have just disappeared. Accordingly, 5 percent MgO was added to all mixes in this study. That saturation was effected was shown by the presence of a small amount of periclase (MgO) in most glasses examined.

Since a quinary system cannot be adequately represented by a diagram of 2 or 3 dimensions, some form of simplification is necessary for establishing a program of study and for expressing the results. Swayze employed the strategem of ignoring the 5 percent MgO , and of thereby drawing his diagram as a pseudo-quaternary model, projected onto a triangular plane. The sum of the major components is then 95 percent in all cases, and the liquids are assumed to be saturated with MgO , an assumption confirmed by the usual presence of periclase in the glasses.

The diagram so produced is shown in Figure 149, analogous to the diagram of the system $CaO-C_3A_3-C_2F-C_2S$ (Figure 147), but with the modified location of the C_3S surface and invariant points brought about by the MgO . The composition points for C_3S and C_3A , the C_3S field in the $CaO-Al_2O_3-SiO_2$ and $CaO-Fe_2O_3-SiO_2$ systems, and the solid-solution series $C_2F-C_6A_2F$, are shown in the positions they occupy in the unmodified system.

Some attack on the platform pans containing the charges was noted by the liquids in the composition field high in Fe_2O_3 , *i.e.*, having an A:F ratio of 0.6 or less, but such attack was kept at a minimum by the use of short-time periods of burning, which was feasible because of the low viscosity of the melts. With increasing A:F ratios, the viscosity increased.

The shifts in the invariant points brought about by the MgO are shown by

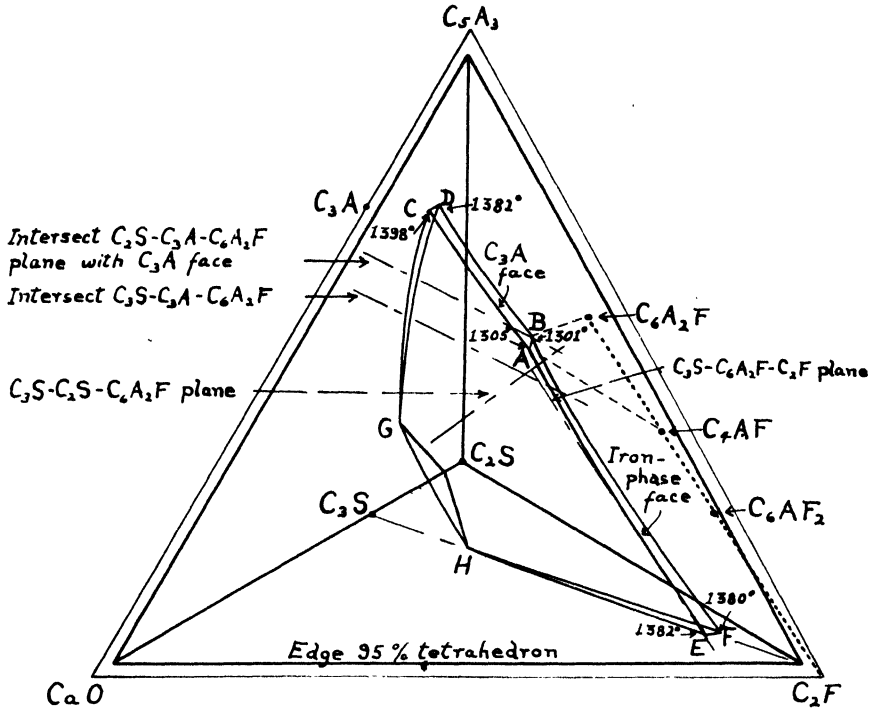

Figure 149. The C₃S phase volume in the system CaO-C₃A₂-C₂F-C₂S, modified by 5 percent MgO. (Swayze)

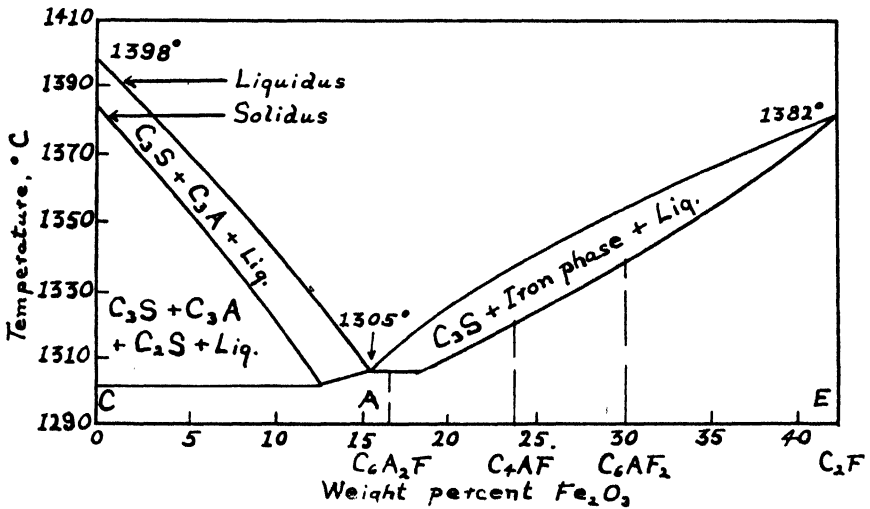

Figure 150. Melting temperatures along C₃S-CaO-(C₃A-iron phase) boundary in presence of 5 percent MgO. (Swayze)

the new values, *A* and *B*, which are compared in Table 25 with the values, *1* and *2*, obtained in the absence of MgO.

The principal character of the change due to the MgO is seen to be a raising in both invariant compositions of the Al₂O₃ content, and a corresponding but greater diminishing of the Fe₂O₃ and CaO. This lengthens the field of the iron solid-solution and shortens that of the C₃A on the C₃S surface to such an extent

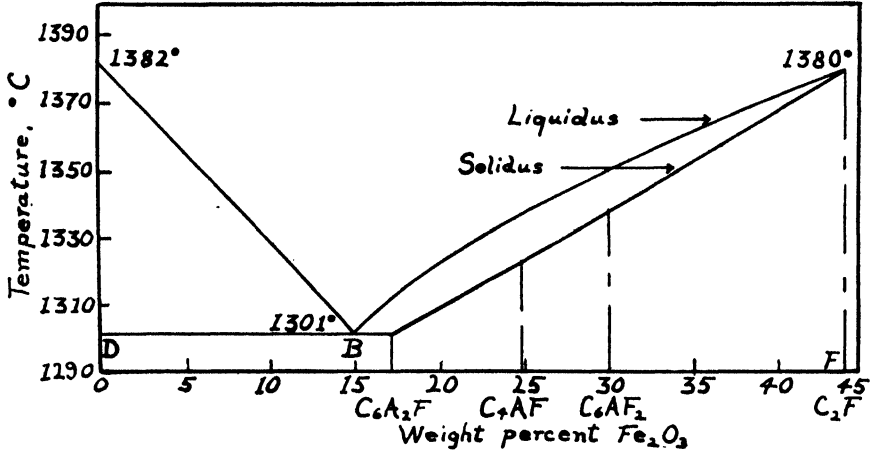

Figure 151. Melting temperatures along C₃S-C₂S-(C₃A-iron phase) boundary in presence of 5 percent MgO. (Swayze)

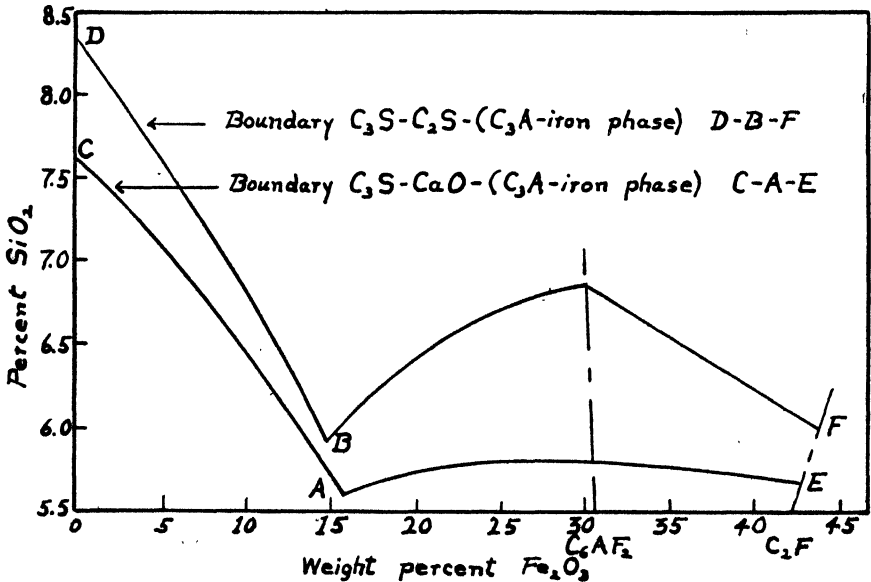

Figure 152. The SiO₂ contents of liquids along C₃S phase boundaries in presence of 5 percent MgO. (Swayze)

that the invariant points are brought to the high-alumina side of the plane which passes through C_2S , C_2S and C_6A_2F . This brings these points within the tetrahedron $C_2S-C_2S-C_2A-C_6A_2F$, and makes possible the formation of C_6A_2F in the presence of C_2A , C_2S and liquid. Neither of these invariant points was found to be a eutectic.

From noting the intersection of the planes of $C_2S-C_2A-C_6A_2F$ and of $C_2S-C_2A-C_6A_2F$ with the C_2S surface adjacent to C_2A or the iron phase, it will be seen that above the former there is a CaO deficiency, and below it there is neither a deficiency nor an excess of CaO . Liquids located between these planes will form C_2S and C_2S together with C_2A and the iron phase. But on the CaO -poor side of the C_2S surface, (low in Fe_2O_3) C_2A_3 will separate out, and the crystallization will move away from point B toward some other invariant point more distant from CaO . On the CaO -rich side of the C_2S surface (high in Fe_2O_3) the liquids can complete crystallization at points A or B or at some point on the lines AE or BF . The melting temperatures along the $CaO-C_2S$ -(C_2A -iron phase) boundary curve (CAE) are shown in Figure 150, and those along the C_2S-C_2S -(C_2A -iron phase) boundary curve (DBF) are shown in Figure 151.

On Figure 152 are plotted the SiO_2 contents of liquids along the boundaries CAE and DBF . The minimum occurs at the invariant points and increases beyond those points with increasing Fe_2O_3 content to the composition C_6AF_2 , beyond which it again drops to the composition C_2F .

Crystallization in Polycrystalline Systems

A point of considerable practical interest which developed in the studies by Swayze was that a phase might be so protected by becoming embedded in another phase that the theoretical course of equilibrium crystallization could not obtain even on very slow cooling. Thus on cooling a molten composition of point x (Figure 131), CaO will first be formed and the liquid will move back until it reaches point z where C_2A appears. Theoretically, as the liquid now follows the boundary curve from z toward I , the composition of the solids will pass from CaO to C_2A , and when point y is reached by the liquid the solid will consist wholly of C_2A . The liquid should then pass across the field of C_2A to c where the iron phase appears and thence towards the invariant point m . But in practice the CaO first formed is only slightly resorbed because it becomes occluded within the rapidly-forming large crystals of C_2A . In that condition it is prevented from coming into contact with liquid and remains as inclusions in C_2A crystals. Thus in effect the reactive solid phase consists only of C_2A very quickly after C_2A starts to form, and the liquid immediately leaves the CaO boundary to cross over to the iron-phase boundary, and a higher $A:F$ iron phase will appear than would be the case if the cooling occurred under equilibrium conditions. Free CaO also will be in the final product. Final crystallization occurs at m .

In like manner it was shown that, since the members of the solid-solution series $C_6A_2F-C_6AF_2$ are stable in the presence of each other, there will be practically no redistribution of Fe_2O_3 and Al_2O_3 within the growing crystals, which would be necessary under equilibrium cooling. Hence we may have crystals with a low $A:F$ core and a higher $A:F$ exterior separating in the ternary solid-solution field. Also, it has been observed by Brown, Ward (3) and Swayze that C_2S

crystals, formed during the initial cooling of overlimed mixes, may occlude grains of CaO, MgO and C₃S. Phases thus protected from further action by the liquid have been appropriately designated "protected phases" by Swayze.

The formation of protected phases, as shown above, may radically change the course of crystallization from that which the liquid would follow under theoretical equilibrium cooling, and calculations based on the latter assumption will accordingly not apply to such conditions. An example may be taken of a composition (see Figure 149) on the CaO-C₃S interface below the line AC. As the melt is cooled to a point where the liquid meets the boundary AC, CaO and C₃S will

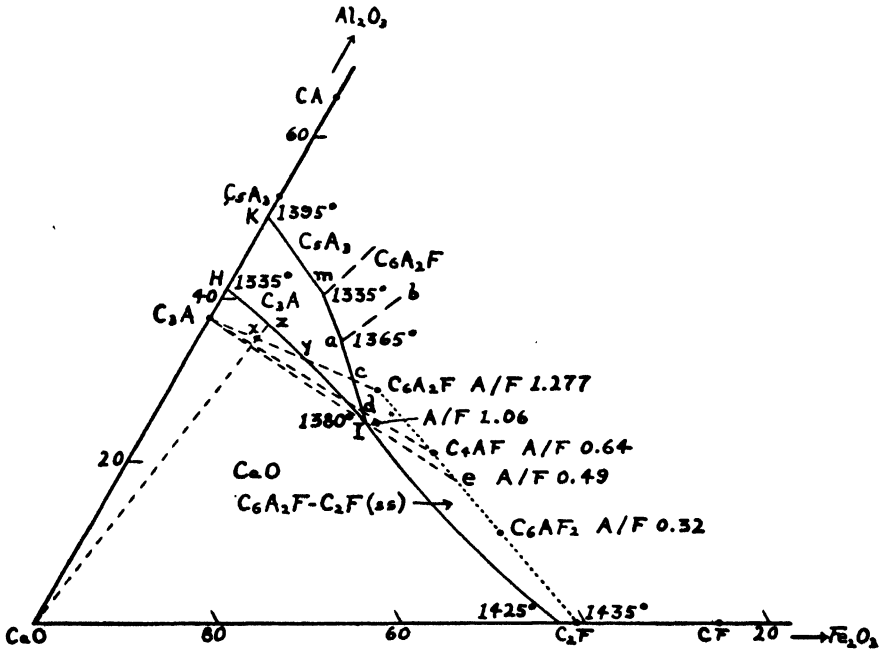

Figure 131. The pseudo-system CaO-C₁A₁-C₂F. (Swayze)

separate out and, on further cooling along AC towards A, C₃S and C₃A will separate out while, theoretically, CaO goes into solution. When the CaO has disappeared, the liquid would then move across the C₃S-C₃A surface to the curve BD where C₂S would appear, and thence down to B where those three phases with C₆A₂F would complete crystallization. In practice, however, the CaO first formed is found to be partially occluded in the C₃S and later in the C₃A crystals, which form as the curve AC, is reached, so the liquid composition at once moves across the C₃S-C₃A face to BD. As the liquid moves down BD, C₃A is formed by using CaO taken from C₃S, which is changed to C₂S. But the C₃S may disappear before B is reached, in which case the liquid will leave the C₂S phase volume and C₁A₁ will appear. The final products are then C₃A with occlusions of CaO, C₂S and C₁A₁.

In cement compositions, high in Al₂O₃ and overlimed, point B will be reached

before all of the C_2S is exhausted, but the CaO necessary for forming C_3A will still come from C_2S , rather than the CaO occluded in both C_3A and C_2S , so the C_2S in the product will be lower than calculated. The iron phase in this case will be close to C_6A_2F in composition.

Liquids along the curve AE showed C_3A to be formed from compositions having an A:F ratio as low as 0.56. The iron phase solid-solution which separated had a refractive index around 2.00, denoting an A:F ratio of not over 0.50. Along the curve BF , however, where CaO was not present, the amount of C_3A in the products was less, even zero in some cases, and the iron phase had a lower index, indicating a composition approaching C_6A_2F . That is, the Al_2O_3 instead of forming C_3A went into the higher-alumina iron phase. This indicates that mixes having an A:F ratio of 0.84 or less, and a composition such that free CaO is not present at the temperature where the iron phase begins to crystallize, may produce clinkers free of C_3A . Likewise, with A:F ratios between 0.84 and 1.43, less C_3A is produced than would be indicated by assuming that the iron phase consisted only of C_4AF . On the other hand, in compositions where CaO is present when the iron phase begins to crystallize, the reverse is the case: the iron phase will contain less Al_2O_3 than the composition C_4AF , and more C_3A will be formed.

Swayze points out that the establishment of a solid-solution series ranging from C_2F to C_6A_2F may explain some anomalies which have been observed in the constitution of portland cement. Thus the petrographic examination of clinkers has sometimes shown an excess of C_2S and a deficiency of C_2S and C_3A from the amounts calculated on the assumption that the iron is completely in the form of C_4AF . If the iron goes into combination as C_6A_2F , more Al_2O_3 is taken into that compound, and less into C_3A . This leaves an excess of CaO to combine with C_2S , reducing the latter and increasing the C_3S . Quantitatively, each percent of Al_2O_3 combining as C_6A_2F will release 0.55 percent CaO , allowing for the formation of 2.24 percent more C_3S and 1.69 percent less C_2S than if the iron formed C_4AF . Likewise, the heat of solution of C_6A_2F may be expected to differ from that of C_4AF , and this would affect the calculated values for glass content as obtained by heat-of-solution methods.

The use of compositions in which CaO may be present at the temperatures at which C_3A begins to crystallize may, by occlusion of the CaO in the C_3A and C_2S , result in clinkers wherein, at theoretical equilibrium, CaO would not be present. Under such conditions prolonged burning or methodical cooling is ineffective for the removal of the CaO .

References

1. Lea, F. M., and Parker, T. W., *Phil. Trans. Royal Soc.*, **234**, No. 731, 1 (1934) A.
2. Swayze, M. A., *Am. J. Sci.*, **244**, 1; 65 (1946).
3. Ward, G. W., *J. Res. NBS*, **26**, 49 (1941); RP 1358; PCAF Paper 39.

CHAPTER 19

Systems Containing K_2O

The Alkalies

The introduction of alkali oxides into the high-temperature studies of phase equilibria necessitates special precautions for the prevention of volatilization, which is much more marked with the potash than with the soda compounds. Also, with low-silica compositions, the last traces of CO_2 are difficult to drive out, or to keep out of the cooled melt. The blends of alkali carbonate and SiO_2 are best mixed in the required proportions and heated gently in a platinum crucible to drive off the CO_2 . After initial sintering, the temperature is raised slowly to complete melting, but excessive temperatures are avoided to prevent volatilization. A repetition of the process with grinding, and a holding for 24 hours at 1000° – 1100° will permit the crystallization of $K_2O \cdot SiO_2$ or $Na_2O \cdot SiO_2$ and all CO_2 will be expelled. Such a preparation makes a satisfactory starting mixture for making up other compositions.

Since alkali oxides absorb oxygen, being converted to the peroxides, the release of this oxygen on heating in platinum causes a reaction with the platinum, the alkali-rich mixtures being turned to a rose or brown color. For this reason also, the use of higher temperatures than necessary, or of long heating periods, are to be avoided. The volatility varies with the composition and, in maintaining correct compositions, a few analyses will establish the excess of K_2O or Na_2O to be added in order to retain the desired percentage in the final melt. The latter must be analyzed, however, in charges which are of critical importance.

K_2O - CaO

In connection with a study of the system K_2O - CaO - Al_2O_3 , Brownmiller (2) found no evidence of the existence of any binary compounds of CaO and K_2O . No liquid was present at temperatures up to 1550° , and all samples quenched or cooled from that temperature contained only one phase, CaO , having grains of normal appearance and refractive index. The K_2O appeared to have been almost completely volatilized, and no evidence was observed of any solid solution between those components.

K_2O - SiO_2

A portion of the system K_2O - SiO_2 in the high-silica region KS - SiO_2 was studied by Kracek, Bowen and Morey (5). The liquidus was determined by the quenching method and the thermal analysis of reactions in the crystal phases by means of heating curves obtained with the differential thermo-element

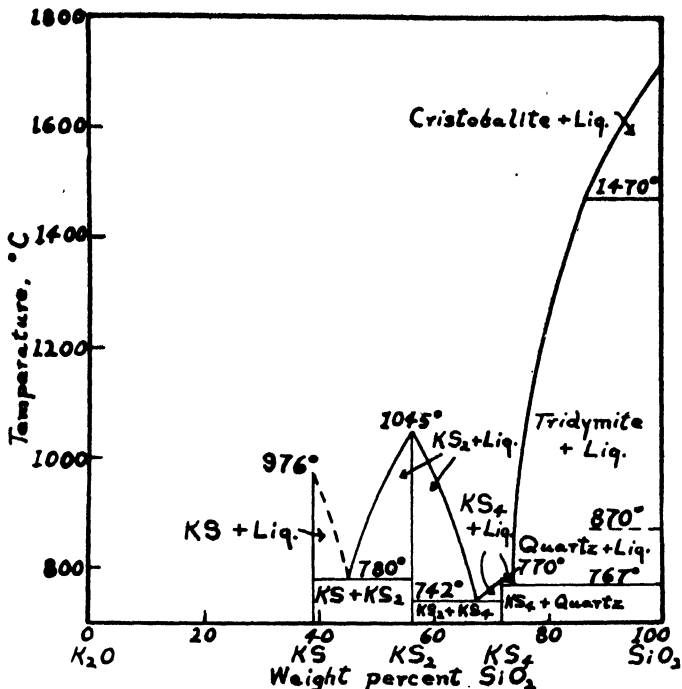

Figure 153. The system K_2O-SiO_2 . (Kracek, Bowen and Morey)

assembly shown in Figure 83 (page 231). The temperature-concentration diagram is shown in Figure 153.

Three compounds were found, KS , KS_2 and KS_4 all melting congruently. The fixed points in the system are given in Table 26.

TABLE 26. Fixed points in the system K_2O-SiO_2

Crystalline phases	Reaction	% SiO_2	Temp. ($^{\circ}C$)
Cristobalite.....	Melting	100	1713
Cristobalite-tridymite.....	Inversion	89.7	1470
Tridymite-quartz.....	Inversion	74.9	870
Tridymite- KS_4	Eutectic	73.6	767
Quartz- KS_4	Eutectic	(72.5)	(769)
KS_4	Melting	71.84	770
KS_4 - KS_2	Eutectic	67.6	742
KS_2	Melting	56.05	1045
KS_2 - KS	Eutectic	45.5	780
KS	Melting	38.94	976

An incidental point of some importance reported by the investigators was that preparations in this system containing less than 56 percent SiO_2 , when kept

in the apparatus at temperatures up to 500°, continue to absorb water vapor from the atmosphere. It is slowly driven out only by heating to temperatures above 700°.

$K_2O-Al_2O_3$

A few compositions were examined in the binary system $K_2O-Al_2O_3$ by Brownmiller (2), but complete exploration could not be made because of the high temperatures required to reach the liquidus. No melting occurred in any

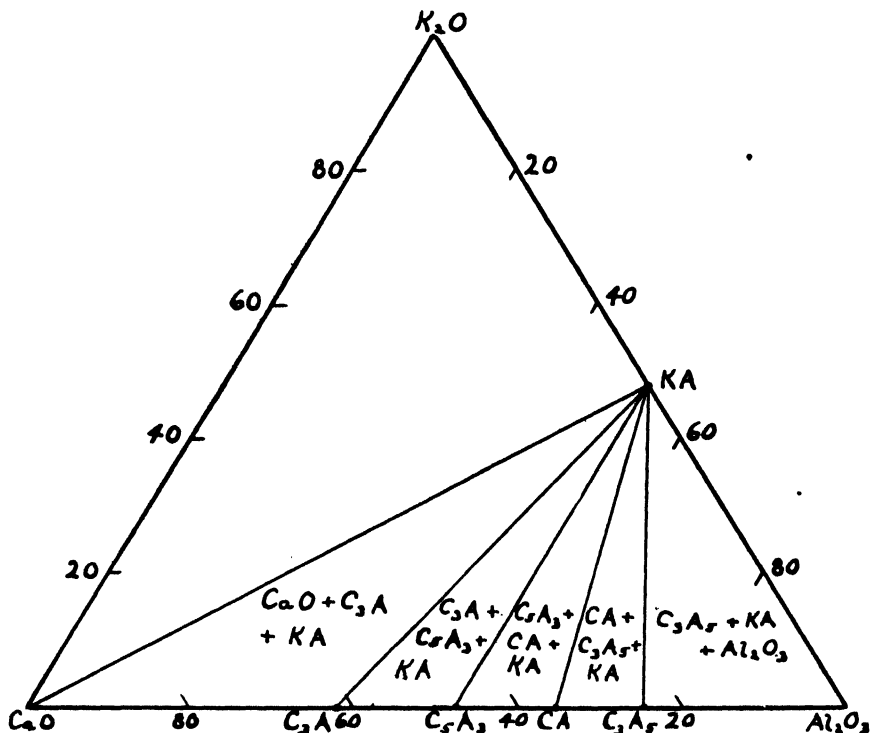

Figure 154. Final products of crystallization in the system $CaO-K_2O-Al_2O_3$. (Brownmiller)

mixture when tested to 1600°, which precluded the determination of the compositions and temperatures of the invariant points in the system. One binary compound having the formula KA was found, and this was stable and existed as the sole phase when a mixture, designed to have that composition, was heated to 1650°. At compositions between KA and Al_2O_3 , those two phases were found, the later being in the α form.

KA was found to crystallize in the isotropic system; the refractive index is 1.603 ± 0.005 for artificial white light. The grains were colorless and rounded; occasional grains, crystallized from melts in the system $K_2O-CaO-Al_2O_3$, were perfect octahedrons. The compound was found to be extremely hygroscopic.

The X-ray diffraction pattern is given on page 543. Samples of Al_2O_3 containing 3.5 percent K_2O heated to 1550° contained both α - Al_2O_3 (corundum) and β - Al_2O_3 , the latter being highly birefringent and having a platy crystal habit. The mean refractive index is 1.663, it is uniaxial negative, and belongs to the hexagonal system. Refractive index determinations on a sample furnished by the Norton Company gave values: $\omega = 1.678 \pm 0.003$, $\epsilon = 1.635 \pm 0.003$. The X-ray diffraction pattern is given on page 541.

K_2O - CaO - Al_2O_3

A survey of a portion of the system K_2O - CaO - Al_2O_3 in the low- K_2O region was made by Brownmiller (2). The K_2O was introduced as the oxalate to base mixtures previously prepared of the CaO and Al_2O_3 which had been heated to

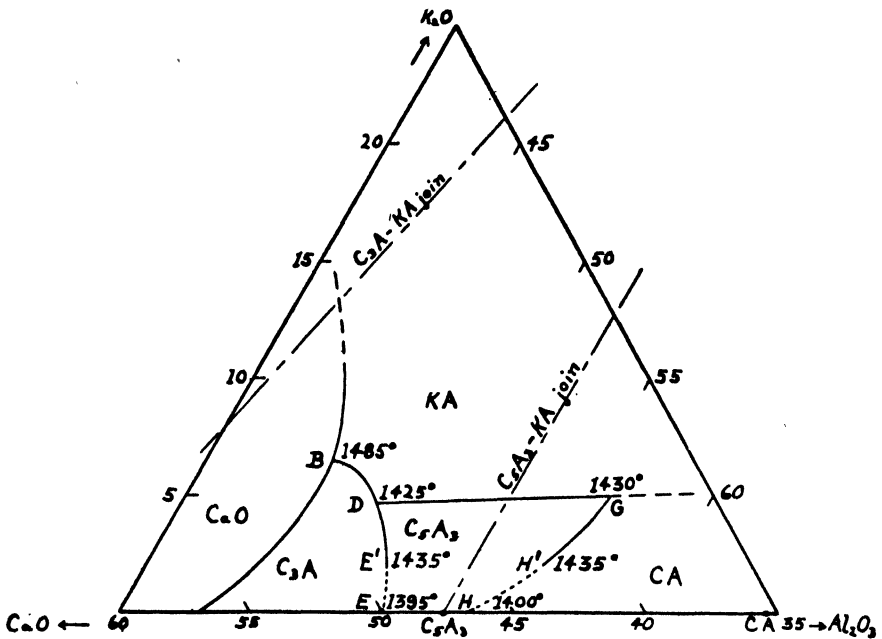

Figure 155. Part of system CaO - K_2O - Al_2O_3 . (Brownmiller)

1350° and pulverized. The ternary composition was dry-mixed and heated in an open platinum crucible at about 1200° , a temperature sufficiently low to avoid excessive loss of K_2O by volatilization. The loss in weight was noted, from which the amount of K_2O in the mixture was calculated. Final heating was done in closed envelopes of platinum foil at temperatures of about 1500° for the briefest time (15–20 minutes) required for the attainment of equilibrium. Losses in weight were noted, and frequently checked by analysis, to indicate the K_2O in the final charges.

No ternary compounds were found in the region examined. The products of final crystallization from melts are shown in the diagram of Figure 154, from

which it will be seen that in all regions KA is one of the end products. The stability fields are shown in Figure 155.

The C_2A crystallized as well-developed polyhedrons, usually with octagonal outline. Some of the largest and most perfect crystals of the compound ever observed were obtained in this system; a photomicrograph of such a crystal about 200 microns long is shown in Figure 38 (page 131).

The C_3A_2 in this system was found to take K_2O into solid solution up to about 2 percent, the refractive index thereby being lowered from 1.608 to 1.593.

Three quintuple invariant points were found, two of which were eutectics: point *D*, a eutectic where the phases C_2A , $C_3A_2(ss)$, and KA are in equilibrium at $1425^\circ \pm 5^\circ$, point *G*, a eutectic for $C_3A_2(ss)$, CA and KA at $1430^\circ \pm 5^\circ$, and the invariant point *B*, not a eutectic, for CaO, C_2A and KA at $1485^\circ \pm 5^\circ$.

A point of some interest is observed along the boundary curve *ED*, separating C_2A and $C_3A_2(ss)$, in that the ternary eutectic at *D* has a higher temperature than the binary eutectic at *E*. This is not, however, a contradiction of the theorem of van Alkemade, for the phase in equilibrium with C_2A is not pure C_3A_2 but $C_3A_2 + K_2O$ in solid solution. The point of maximum solid solution (2 percent K_2O) at *E'* melts at 1435° , and from that point the temperatures drop along the curve *E'D* toward *D*. A similar condition obtains along the boundary *HG* separating the fields of $C_3A_2(ss)$ from CA, where a maximum melting temperature occurs at *H'*.

The invariant points involving K_2O in the system are the following:

Phases	Point	Reaction	Composition			Temp. ($^\circ C$)
			CaO	Al_2O_3	K_2O	
KA.....	...	Melting	51.94	48.06	Over 1650
C_2A -KA- C_3A_2	<i>D</i>	Eutectic	48.0	47.2	4.8	1425
CA- C_3A_2 -KA.....	<i>G</i>	Eutectic	39.0	56.0	5.0	1430
CaO- C_2A -KA.....	<i>B</i>	Melting	48.8	44.7	6.5	1485

KA- C_4AF - C_2F

Having found that KA is the only compound of K_2O which is stable at the liquidus in the system K_2O -CaO- Al_2O_3 , it was necessary to examine the stability of that compound in the presence of the iron phase of cement clinker.

For this purpose KA was introduced by Taylor (7) in proportions by weight of 0 to 25 percent in four base mixtures of C_4AF and C_2F . These four mixtures contained 100, 90, 70, and 50 percent, respectively, of C_4AF .

The results are expressed in the form of a series of concentration-temperature diagrams in Figure 156, only the first of which (C_4AF -KA) can be considered as a true binary system. No evidence was obtained of the formation of any new compounds in this series. A binary eutectic was found for C_4AF -KA consisting of 81 C_4AF , 19 KA, melting at $1343^\circ \pm 5^\circ$. The C_4AF appears to take up some KA in solid solution, as indicated by a change in the pleochroism of the C_4AF , but the amount is small as shown by only a slight change in the refractive indices. Also, the KA takes up some C_4AF in solid solution, as shown by an increase in refractive index from 1.603 to 1.625.

In the successive members of this series, where the percentage of C_2F increased in the base mix up to 50 percent, as shown in Figure 156, there was observed no significant change other than a regular shift in the location and temperature of the eutectic point. This is given in the following tabulation:

Base mix		Composition of eutectic			Temp. (°C)
C_4AF	C_2F	C_4AF	C_2F	KA	
100	0	81	0	19	1343
90	10	73.35	8.15	18.5	1347
70	30	57.4	24.6	18.0	1354
50	50	41.25	41.25	17.5	1357

The diagram of the ternary system $KA-C_4AF-C_2F$, in the region studied, is shown in Figure 157. Since no compounds are formed between the components, and C_4AF forms a complete solid-solution series with C_2F , no ternary eutectic

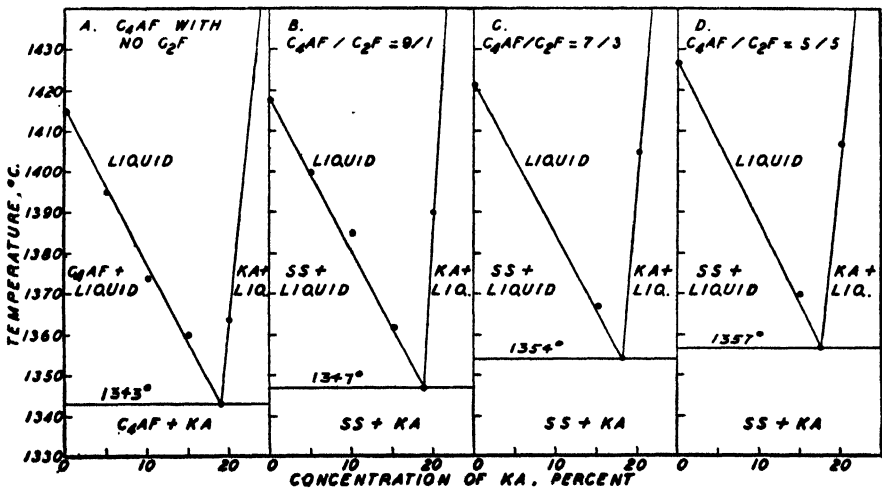

Figure 156. Temperature-concentration diagrams showing the melting relations of C_4AF with KA , and of solid solutions of $C_4AF + C_2F$ (designated SS) with KA . (Taylor)

can be shown. The boundary curve is shown separating the field of KA from that of the C_4AF-C_2F solid solution, and the temperatures of the four minimum values along the curve are indicated. The diagram expresses all of the data indicated in the study.

$K_2O-CaO-SiO_2$

The high-silica region of the system $K_2O-CaO-SiO_2$, but extending a little beyond to include the compound KCS , was studied by Morey, Kracek and Bowen (6). Seven ternary compounds were discovered, having the formulas

KCS, K_2CS_3 , KC_3S_6 , K_4CS_{10} , K_2CS_8 , KC_3S_6 , and KC_2S_9 , most of which dissociate on melting. C_2S was found to occur as a primary phase in a field adjacent to KCS, and there was some indication, by a lowered refractive index of the C_2S , that a solid solution was formed between those compounds.

C_2S -KCS

The first study in the high-CaO region of the system K_2O -CaO-SiO₂ was made by Taylor (8) on the join connecting C_2S and KCS. The results are shown

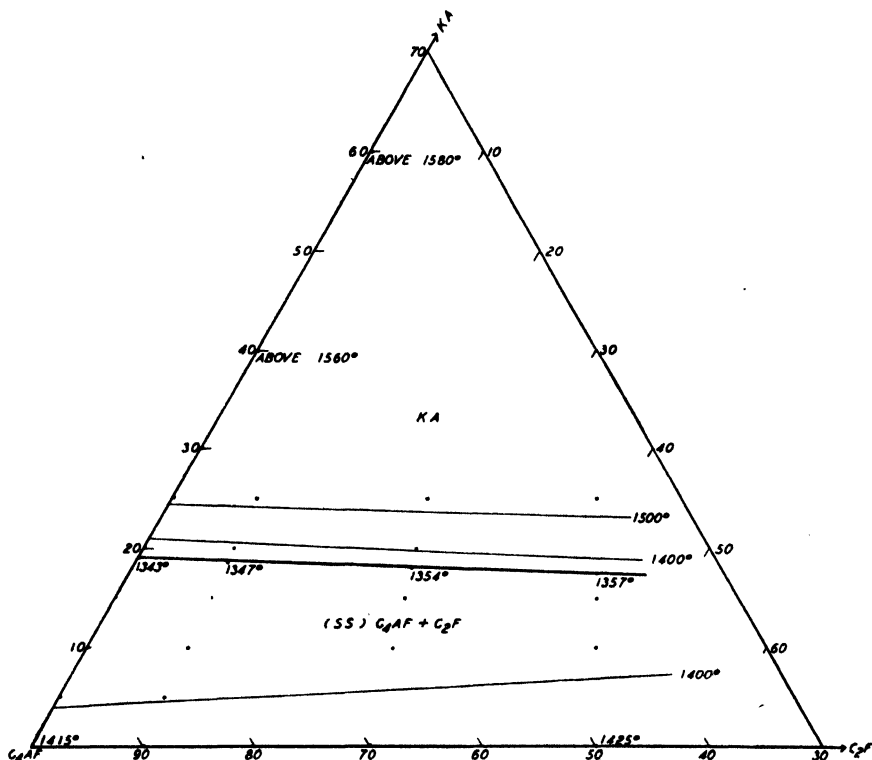

Figure 157. Diagram showing fields of primary crystallization and isotherms in the system C_4AF - C_2F -KA. (Taylor)

as a concentration-temperature diagram in Figure 158. As the percentage of C_2S was increased in the raw mixture, there appeared, following a heat-treatment in the neighborhood of 1600° and quenching, increasing quantities of a new phase having optical and X-ray characteristics which distinguished it from either C_2S or KCS. The new compound was found to form a eutectic with KCS at a composition of 8.0 C_2S , and 92.0 KCS and a temperature of $1598^\circ \pm 10^\circ$. Below that temperature the new phase existed side by side with KCS until a weigh ratio of C_2S :KCS of 9:1 was reached, equivalent to a molar ratio of 11:1. The temperatures attainable with the furnace were inadequate to produce any liquid in the charge of these high- C_2S compositions, so a precise allocation of the

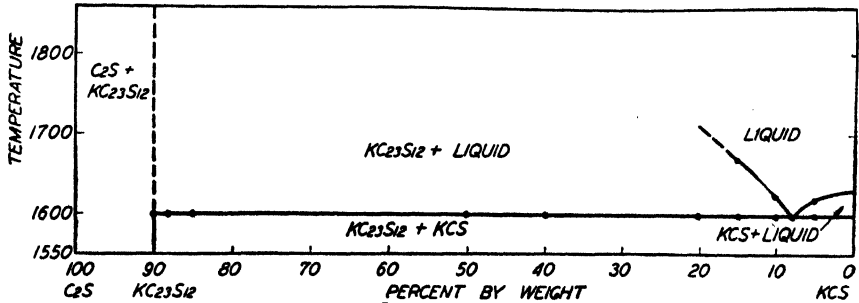

Figure 158. The system C_2S - KCS . (Taylor)

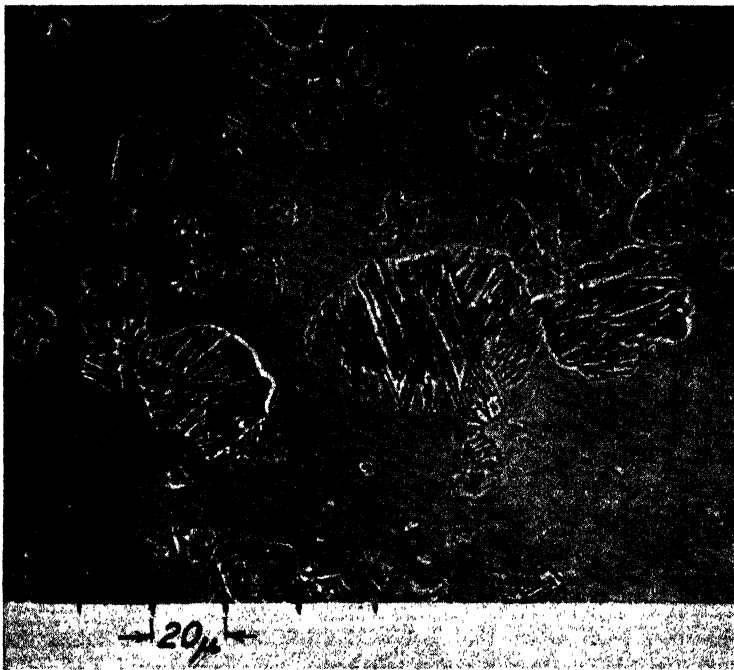

Figure 159. Crystals having the probable composition $K_2O.23CaO.12SiO_2$. Ordinary transmitted light. (Taylor)

composition of the new compound was not possible; but assuming this to be correctly placed at the above molar ratio of 11 C_2S : KCS , the new phase would have the formula $11C_2S.KCS$, or $KC_{23}S_{12}$, containing 4.48 K_2O , 61.28 CaO and 34.25 SiO_2 . Bredig considers this phase to be a solid solution of KCS in C_2S .*

The new phase was found to occur in irregular rounded grains with poly-synthetic twinning similar to that often observed with C_2S ; it is uniaxial positive, refractive indices $\alpha = 1.695$, $\gamma = 1.703$, birefringence 0.008. Only a single phase

* See pages 144-145.

was observed on the C_2S side of the $KC_{23}S_{12}$, which might indicate a continuous solid solution series between those two compounds, but the X-ray diffraction patterns showed the presence of both compounds. The inability of identifying the two compounds in those charges optically was attributed to the similarity of their optical properties and their probable intimate crystallization. Photo-

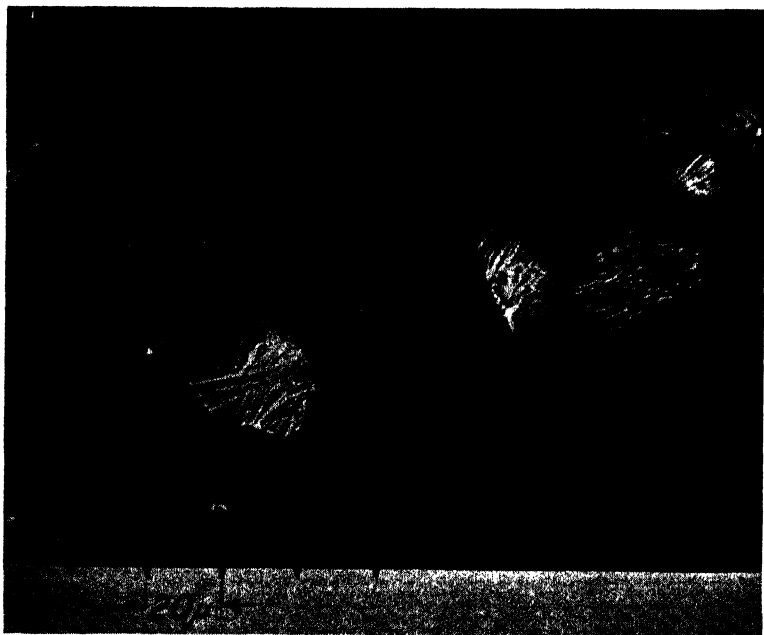

Figure 160. *The same field as shown in Figure 159, under crossed nicols.*

micrographs of the new phase in ordinary and polarized light are shown in Figures 159 and 160.

C_2S -KA

It has now been shown that KA is the only compound of potash that is stable at the liquidus in the high-CaO portion of the system K_2O -CaO- Al_2O_3 , and also that KA is stable in the presence of $C_4AF(ss)$ or C_2F . In the system C_2S -KCS, the stable compound of potash in the high- C_2S region has been shown to be $KC_{23}S_{12}$. In the further attempt to define the compounds of K_2O stable in portland cement, Taylor (8) examined the stability of KA and $KC_{23}S_{12}$ in the presence of C_2S , C_3S and C_4AF .

Mixtures of C_2S with KA were prepared containing from 1 to 15 percent KA, heated to 1450° (at which temperature liquid was formed), and cooled slowly. It was observed that KA, which would be present in the K_2O -CaO- Al_2O_3 system, was not found in any of the charges where it had been added in amounts less than 12.5 percent, but a large percentage of a birefringent phase, having a mean index of about 1.70 was present, which was identified as $KC_{23}S_{12}$. Consider-

able C_3A and CaO were also observed, and C_3S was absent except in charges which had originally contained in excess of 95 percent of that compound. It was accordingly concluded that the C_3S and KA undergo a reaction by which $KC_{23}S_{12}$, C_3A and CaO are formed, in accordance with the equation



C_2S - KA

A similar treatment of compositions along the join between C_2S and KA produced nearly similar results, except that C_3A and CaO were not observed, and in their place some KA was found in charges originally relatively high in the latter compound. An unidentified material of low index occurred as veinlets, which could be CA and residual KA , in accordance with the reaction:

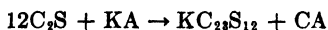

C_3S - C_2S - KA

If the above equations correctly indicate the course of the reactions between KA and the calcium silicates, C_3A and CaO being products of the reaction between C_3S and KA , and CA being formed by the reaction between C_2S and KA , then at some intermediate composition between C_3S and C_2S there will be just sufficient CaO in the mixture to form C_3A , with no CaO remaining. Various mixtures of C_3S and C_2S were accordingly treated with KA as above, and when the theoretical quantities were employed to give the complete reaction, only $KC_{23}S_{12}$ and C_3A were observed. The equation may be written:



These results appear to establish the probable formation of $KC_{23}S_{12}$ in the general region of portland cement clinker.

C_3S - C_2S - KA - Fe_2O_3

Having found that $KC_{23}S_{12}$ is stable in the presence of the calcium silicates and aluminates, it remained to examine its stability in the presence of Fe_2O_3 . A mixture, prepared according to the theoretical calculation by which no C_3A or CaO would remain, was found following the heat treatment to consist of only two phases, indicated by the equation:



The refractive indices of the potash compound, however, were raised from $\alpha = 1.695$ to 1.713 and $\gamma = 1.703$ to 1.722 , probably due to some solid solution of an iron compound.

From the foregoing, it appears that, in a system consisting only of CaO , Al_2O_3 , SiO_2 , Fe_2O_3 and K_2O , in the region of portland cement, the K_2O will not exist as KA but rather as $KC_{23}S_{12}$. Such formation can be considered as the replacement of 1 molecule of CaO by K_2O in 12 molecules of C_3S :

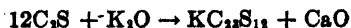

This reaction would be expected to be of considerable significance in burning operations, because the available CaO determines the ratio between the C_3S and

TABLE 27. Effect of the substitution of K₂O for CaO on the combination of CaO in laboratory cement mixtures

Mixture No.	Oxide composition of raw mixture (clinker basis)						Oxide composition based on 30-per-cent loss of K ₂ O during heating*						Potential compound composition						Uncombined CaO after being heated at			
	CaO	Al ₂ O ₃	Fe ₂ O ₃	SiO ₂	K ₂ O	CaO	Al ₂ O ₃	Fe ₂ O ₃	SiO ₂	K ₂ O	C ₂ S	C ₃ S	C ₂ S	K ₂ Si ₂ O ₇	C ₁ A	C ₂ A,F	CaO	1400°C	1450°C	1500°C	1525°C	
1	66.0	11.0	0	23.0	0	66.0	11.0	0	23.0	0	19.5	51.3	0	29.2	0	0	0	0.7	0.7	0.0	0.0	
2	65.0	11.0	0	23.0	0	65.20	11.03	0	23.07	0.7	17.3	37.8	0	29.2	0	0	0	0.2	0.2	0.1	0.0	
3	64.0	11.0	0	23.0	0	64.39	11.07	0	23.14	1.4	15.0	24.4	0	29.3	0	0	0	3.5	3.5	2.6	2.6	
4	63.0	11.0	0	23.0	0	63.57	11.10	0	23.21	2.1	13.0	10.6	0	29.4	0	0	0	5.3	5.3	2.8	2.8	
5	62.0	10.0	0	23.0	0	67.0	10.0	0	23.0	0.7	30.5	43.0	0	26.5	0	0	0	7.7	1.8	0.3	0.0	
6	61.0	10.0	0	23.0	0	66.20	10.03	0	23.07	0.7	28.2	29.6	0	26.6	0	0	0	6.7	0.7	0.3	0.0	
7	60.0	10.0	0	23.0	0	65.39	10.08	0	23.14	1.4	25.8	16.2	0	26.7	0	0	0	7.4	5.4	4.5	3.1	
8	67.0	7.5	2.5	23.0	0	64.58	10.09	0	23.21	2.1	23.3	3.0	47.0	26.7	0	0	0	8.0	7.5	7.0	4.3	
9	66.0	7.5	2.5	23.0	0	66.20	7.52	2.51	23.07	0.7	41.5	19.6	0	15.6	0	0	0	2.0	1.1	0.4	0.0	
10	65.0	7.5	2.5	23.0	0	65.39	7.54	2.52	23.14	1.4	39.2	6.1	0	15.7	0	0	0	2.0	1.6	0.9	0.7	
11	64.0	7.5	2.5	23.0	0	64.58	7.56	2.53	23.21	2.1	27.2	0	47.0	15.7	0	0	0	6.2	4.3	3.7	3.6	
12	63.0	9.0	0	22.2	0	68.8	9.0	0	22.2	0	50.7	25.5	0	15.7	0	0	0	9.7	7.3	6.9	6.8	
13	62.0	9.0	0	22.2	0	68.0	9.0	0	22.27	0.7	48.2	12.3	0	23.9	0	0	0	3.4	3.4	2.3	0.1	
14	61.8	9.0	0	22.2	0	67.20	9.08	0	22.34	1.4	44.2	0	31.3	24.0	0	0	0	1.9	1.9	1.0	0.5	
15	66.8	9.0	0	22.2	0	66.40	9.08	0	22.40	2.1	24.1	0	47.0	24.1	0	0	0	6.6	6.6	5.4	3.5	
16	65.8	9.0	0	22.2	0	66.40	9.08	0	22.40	2.1	24.1	0	47.0	24.1	0	0	0	9.8	9.8	8.4	7.9	

* Amounts of K₂O volatilized in 5 representative clinkers are as follows:

Mix No.	K ₂ O in clinker calcined at indicated temperature		Percentage loss of K ₂ O	
	%	°C	%	°C
1	1.0	0.75	25	1,450
2	3.0	1.96	35	1,500
8	3.0	1.87	38	1,500
12	3.0	2.15	28	1,500
15	2.0	1.52	24	1,450

C₂S of the clinker, and any excess will remain as free CaO, an undesirable constituent. Thus it may be readily computed that 1 percent K₂O reacts, as by the above equation, with 21.9 percent C₂S to form 22.3 percent KC₂₃S₁₂, with the liberation of 0.6 percent CaO. This 0.6 percent CaO may combine with 1.9 percent additional C₂S to form 2.5 percent C₃S; hence 23.8 percent C₂S will have been removed from the product by the introduction of 1 percent K₂O. But if the mixture contained a potential C₂S content less than 23.8 percent, the liberated CaO could not all be combined and must increase in the clinker. When the reaction of the K₂O is with the C₃S, 1 percent K₂O will react with 29.1 percent C₃S and thereby liberate 7.7 percent CaO.

These reactions clear up the discovery, made much earlier, that the addition of increasing amounts of K₂O to a raw mixture resulted in progressively increased amounts of free CaO in the clinkers (3). The effects of the potash compound on the potential compound composition and on the observed free CaO in the clinkers is shown for a few preparations in Table 27.

The observed free CaO was always greater than that which would remain at equilibrium, but this is the usual experience in the burning of calcium silicates and is due to the sluggishness of the reaction by which the last portions of CaO are consumed in the formation of C₃S:



KC₂₃S₁₂-CaO-C₅A₃

It may now be concluded that KA, stable in the system K₂O-CaO-Al₂O₃-Fe₂O₃, reacts with C₃S or C₂S to form the ternary compound KC₂₃S₁₂, and that this compound is stable in the presence of C₃A and C₄AF. A further study was made by Taylor (9) on the system KC₂₃S₁₂-CaO-C₅A₃ to learn if other compounds of K₂O might be formed in the region of portland cement and to extend the knowledge on the region of stability of the ternary potash compound.

In the system KC₂₃S₁₂-C₅A₃, no compounds were found, but a binary eutectic was established at 21.5 KC₂₃S₁₂ and 78.5 C₅A₃, melting at 1330° ± 5°. No evidence of solid solution between KC₂₃S₁₂ and C₅A₃ was observed. The crystals of KC₂₃S₁₂ did not exhibit the twinning observed in the earlier study, but appeared as spherical grains having refractive indices of α = 1.695, γ = 1.703.

No new compounds were observed in the ternary system, the products of final crystallization being the components of the ternary system and C₃A. The fields of primary crystallization are shown in Figure 161. A ternary eutectic was found for KC₂₃S₁₂-C₃A-C₅A₃ (point B), melting at 1450° ± 5°. The invariant-point data are given below:

Phases	Point	Reaction	CaO	Al ₂ O ₃	SiO ₂	K ₂ O	Temp.
KC ₂₃ S ₁₂	61.28	34.25	4.48	?
KC ₂₃ S ₁₂ -CaO.....	E	Eutectic ?	?	?	?	?
KC ₂₃ S ₁₂ -C ₅ A ₃	H	Eutectic	50.68	41.00	7.36	0.96	1330
KC ₂₃ S ₁₂ -C ₃ A-C ₅ A ₃	G	Eutectic	51.5	40.7	6.9	0.90	1310
KC ₂₃ S ₁₂ -C-C ₃ A.....	B	Melting	58.3	31.3	9.3	1.2	1450

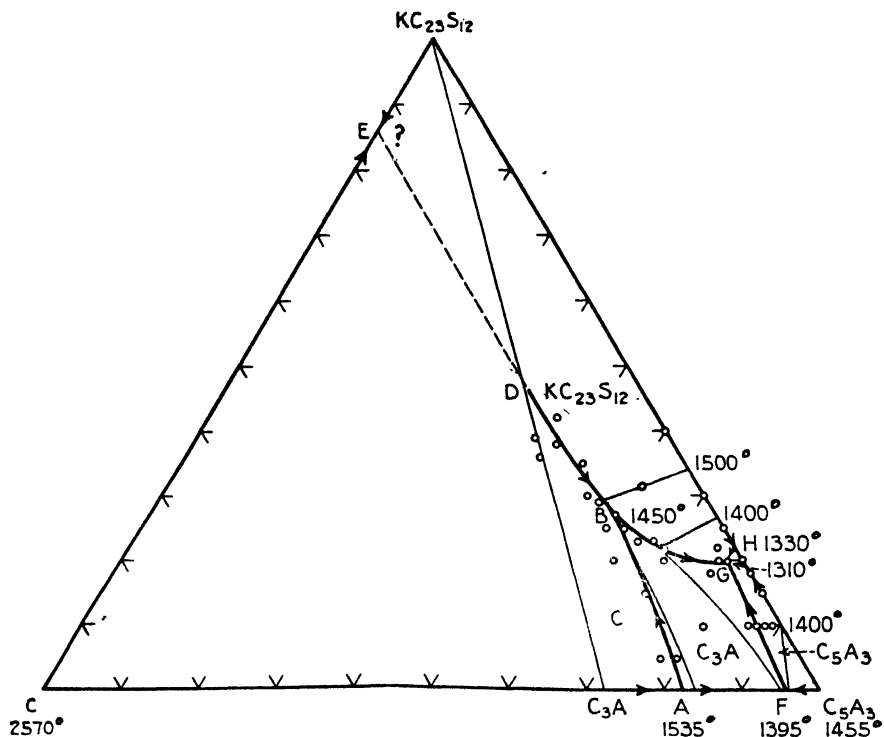

Figure 161. The system $\text{CaO-KC}_{23}\text{S}_{12}\text{-C}_3\text{A}$. (Taylor)

$\text{KC}_{23}\text{S}_{12}\text{-MgO}$

The stability of $\text{KC}_{23}\text{S}_{12}$ in the presence of MgO was determined by making a mixture of 99 $\text{KC}_{23}\text{S}_{12}$ and 1 MgO , and heating at 1525° for 1 hour. The resulting charge showed no evidence of melting and was found to consist of only the two original phases, unchanged. By the same method, upon heating a mixture of 99 K_2SO_4 and 1 MgO to 1400° for 1 hour, MgO was found to be unreactive with K_2SO_4 .

$\text{KC}_{23}\text{S}_{12}\text{-CaSO}_4$

It has now been shown that the compound of potash stable in the region of portland cement in mixtures containing CaO , Al_2O_3 , SiO_2 , Fe_2O_3 , MgO is $\text{KC}_{23}\text{S}_{12}$. There remained the possibility however that acidic constituents present in clinker in small amounts might react with the ternary compound. The stability of the compound in the presence of SO_3 was examined by a series of experiments (9).

A mixture of $\text{KC}_{23}\text{S}_{12}$ and CaSO_4 in equal molar quantities was found, after heating to various temperatures between 1300° and 1500° , cooling slowly to temperatures between 850° and 1300° , and quenching, to contain only β' and γ C_2S and K_2SO_4 . The reaction could be written:



On repeating the same tests using a mixture of KC_2S_{12} and K_2SO_4 , no changes were observed. Similar tests were made using mixtures of C_3S , C_2S , C_3A , C_4AF and K_2SO_4 , and in every case the original compounds were observed, apparently unchanged, in the products.

The possibility of K_2SO_4 being contained for the most part in the undercooled liquid (glass) of clinker, since K_2SO_4 melts at 1076° , was examined by making a mixture consisting of the liquid composition for an A:F ratio of 2.62 on the C_3S - C_2S surface at 1400° in the system $CaO-Al_2O_3-Fe_2O_3-SiO_2$, (C_3S 21.2, C_2S 17.0, C_3A 31.4, C_4AF 30.4), to which 10 percent of K_2SO_4 was added. The mixture

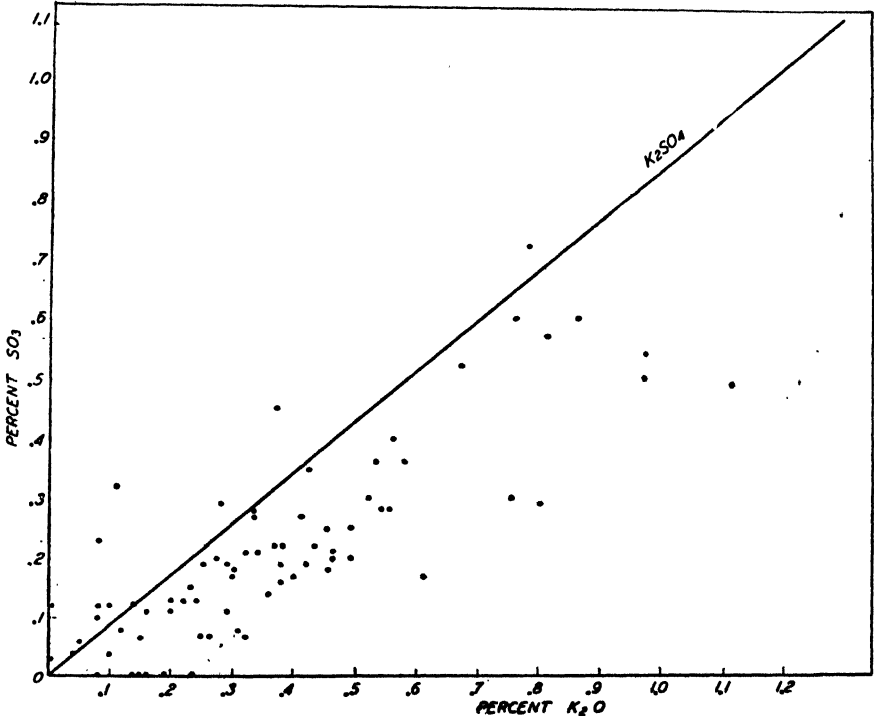

Figure 162. Relationship between K_2O and SO_3 in clinkers. (Taylor)

heated at 1400° for 15 minutes and quenched showed in the top portion an abundance of K_2SO_4 crystals, and in the lower portion pure glass. This indicates that molten K_2SO_4 is immiscible with the clinker liquid, and that K_2SO_4 crystallizes so readily that it is not likely to appear as glass in the clinker.

A similar test was made using 99 percent of the above base mixture to which 1 percent K_2O was added (in the form of the oxalate). In this case, about 4 percent crystalline CaO was found in the resulting glass.

These tests indicate that K_2O combines preferentially with SO_3 , when it is present, to form K_2SO_4 which crystallizes readily. But when SO_3 is not present, K_2O combines as KC_2S_{12} , which is likely to be found in the glass when cooling is such that crystallization is not complete. This conclusion was confirmed by the

following experiments: A mixture of 90 C_3S and 10 KA was heated to 1400° , cooled slowly to 1300° , and quenched. About 20 percent CaO and 70 percent $KC_{23}S_{12}$, together with some C_2A and KA were observed in the product. In a second mixture, an amount of $CaSO_4$ was added which was calculated to be sufficient to combine with the K_2O to form K_2SO_4 . In this case, following the heat treatment, no free CaO or $KC_{23}S_{12}$ were observed, the phases present being C_3S , C_2S , C_1A and K_2SO_4 . In a third mixture, 1 percent K_2O was added in excess

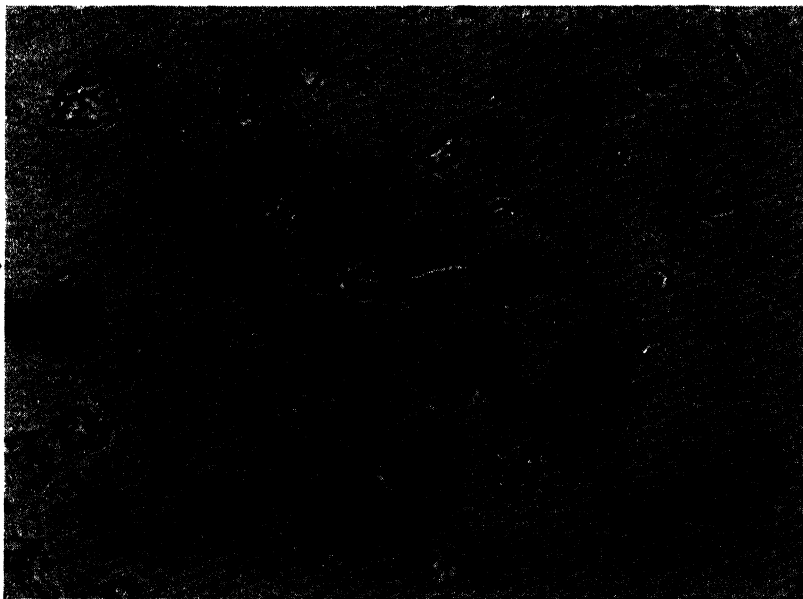

Figure 163. Powdered cement clinker immersed in oil of refractive index 1.52, showing grain of K_2SO_4 . (Taylor)

of that which could be combined as K_2SO_4 . In the product were found CaO and $KC_{23}S_{12}$ in addition to C_3S , C_1A and K_2SO_4 .

K_2SO_4 in Clinker

The presence of K_2SO_4 in commercial clinker had been suggested by previous investigators. Brown (1) in 1936 had observed a low-index phase, tentatively identified as an alkali sulfate, in dust taken from between a kiln coating and the underlying brick. Kalousek, Jumper and Tregoning (4) had found a correlation between the amounts of water-extractable K_2O and the available SO_3 in clinkers, suggesting the presence of K_2SO_4 in clinker. Woods (10) had observed that the introduction of $CaSO_4$ to cement raw mixtures inhibited the volatilization of potash.

To study this relationship further, the K_2O and SO_3 contents of 26 commercial clinkers, together with portions of them which had been subjected to various heat treatments, were determined. The K_2O of these 78 clinkers, plotted against SO_3 ,

is shown in Figure 162. In general, the K_2O is seen to increase with the SO_3 , and furthermore the K_2O generally lies to the right of the K_2SO_4 line, indicating that the potash in clinker is usually in excess of that required for the formation of K_2SO_4 from the SO_3 available. This means that K_2O is usually present in amounts somewhat greater than that which can combine as K_2SO_4 , and the excess will be expected to appear as $KC_{23}S_{12}$ or in the glass.

Nineteen clinkers of the above lot were examined microscopically for K_2SO_4 , and K_2SO_4 was found in 11 of these. In general, that compound was observed in the clinkers containing over 0.24 percent potential K_2SO_4 , and not when the value fell below that amount. A photomicrograph of one of these clinkers, showing K_2SO_4 is reproduced in Figure 163.

References

1. Brown, L. S., Personal communication.
2. Brownmiller, L. T., *Am. J. Sci.*, **26**, 260 (1935); PCAF Paper 30.
3. Hansen, W. C., and Bogue, R. H., *Ind. Eng. Chem.*, **19**, 1260 (1927); PCAF Paper 10.
4. Kalousek, G. L., Jumper, C. H., and Tregoning, J. J., *Rock Products*, April, 1941.
5. Kracek, F. C., Bowen, N. L. and Morey, G. W., *J. Phys. Chem.*, **33**, 1857 (1929); *ibid.*, **41**, 1183 (1937).
6. Morey, G. W., Kracek, F. C., and Bowen, N. L., *Trans. Soc. Glass Tech.*, **14**, 149 (1930); **15**, 57 (1931).
7. Taylor, W. C., *J. Res. NBS*, **21**, 315 (1938), RP 1101; PCAF Paper 37.
8. Taylor, W. C., *J. Res. NBS*, **27**, 311 (1941); RP 1421; PCAF Paper 40.
9. Taylor, W. C., *J. Res. NBS*, **29**, 437 (1942); RP 1512; PCAF Paper 43.
10. Woods, H., *Rock Products*, Feb. 1942, p. 66.

CHAPTER 20

The Systems Containing Na_2O and Li_2O

$\text{Na}_2\text{O}-\text{CaO}$

The system $\text{Na}_2\text{O}-\text{CaO}$ was examined by Brownmiller and Bogue (3) in connection with their study of the system $\text{Na}_2\text{O}-\text{CaO}-\text{Al}_2\text{O}_3$. No evidence was obtained of the existence of any binary compound in the system. Charges of the components after heat-treatment showed only CaO , the Na_2O having been nearly completely volatilized. Temperatures were too high to permit establishing the eutectic.

$\text{Na}_2\text{O}-\text{SiO}_2$

The temperature-concentration diagram of the system $\text{Na}_2\text{O}-\text{SiO}_2$, as modified by Kracek (6) from an earlier study by Morey and Bowen (11), is shown in Figure 164. Three compounds were found: N_2S melting incongruently by dissociation probably into Na_2O and liquid, and NS and NS_2 both melting congruently. The fixed points of the system are given in Table 28.

TABLE 28. Fixed points in the system $\text{Na}_2\text{O}-\text{SiO}_2$

Crystalline phases	Reaction	% SiO_2	Temp. (°C)
Cristobalite.....	Melting	100	1713
Cristobalite-tridymite.....	Inversion	88.7	1470
Tridymite-quartz.....	Inversion	75.5	870
NS_2 with excess SiO_2	Unmixing	780
NS_2 with excess Na_2O	Unmixing	706
αNS_2 - βNS_2	Inversion	678
NS_2 -tridymite.....	Eutectic	74.6	782
NS_2 -quartz.....	Eutectic	73.9	793
NS_1	Melting	65.96	874
NS_2 - NS	Eutectic	62.1	846
NS	Melting	49.21	1089
$\text{NS}-\text{N}_2\text{S}$	Eutectic	43.1	1022
$\text{N}_2\text{S}-\text{Na}_2\text{O}$	Reaction	40.7	1118

The NS_2 was found to exist in two forms, the reversible inversion point between the α and β forms being 678°. At temperatures above 706° the compound takes up an excess of Na_2O , and above 768° an excess of SiO_2 to form solid solutions.

$\text{Li}_2\text{O}-\text{SiO}_2$

The system $\text{Li}_2\text{O}-\text{SiO}_2$ was studied by Kracek (7), through the composition range from 46 to 100 percent silica. The concentration-temperature diagram is

shown in Figure 165. In this system, also, three binary compounds were found, having the formulas: L_2S , LS , and LS_2 . Of these, only LS melts congruently at 1201° , the L_2S decomposing at 1255° into Li_2O and liquid, and the LS_2 decomposing into LS and liquid at 1033° . The melting point of the LS is one of the best

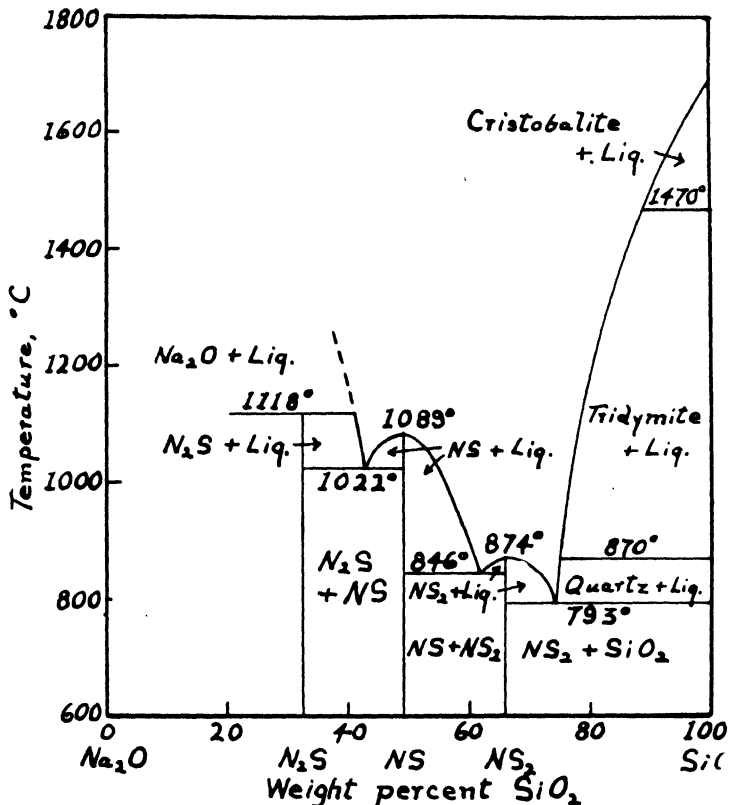
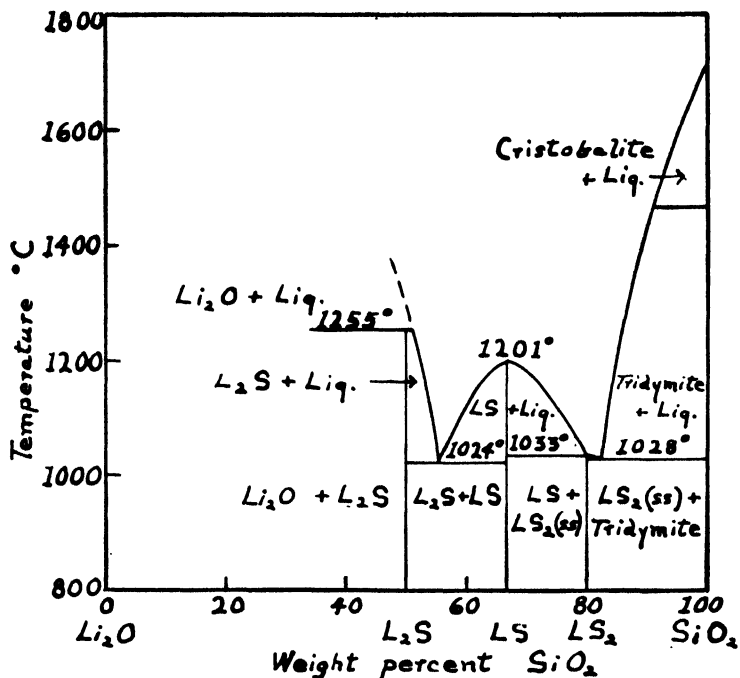

Figure 164. The system $\text{Na}_2\text{O}-\text{SiO}_2$. (Morey, Bowen and Kracek)

known and useful standard points for the calibration of thermocomplexes. The fixed points of the system are given in Table 29.

TABLE 29. Fixed points in the system $\text{Li}_2\text{O}-\text{SiO}_2$

Crystalline phases	Reaction	% SiO_2	Temp. ($^\circ\text{C}$)
$\text{Li}_2\text{O} + \text{L}_2\text{S} + \text{liq.}$	Reaction	50.9	1255
$\text{L}_2\text{S} + \text{LS.}$	Eutectic	55.3	1024
LS.	Melting	66.78	1201
$\text{LS} + \text{LS}_2 + \text{liq.}$	Reaction	80.1	1033
$\text{LS}_2 + \text{tridymite.}$	Eutectic	82.2	1028
$\text{Tridymite} + \text{cristobalite.}$	Inversion	91.0	1470
Cristobalite.	Melting	100.0	1713

Figure 165. The system $\text{Li}_2\text{O}-\text{SiO}_2$. (Kracek) **$\text{Na}_2\text{O}-\text{Al}_2\text{O}_3$**

The system $\text{Na}_2\text{O}-\text{Al}_2\text{O}_3$ was examined by Matignon (10) who found one binary compound having the composition NA, melting at 1650° . The system was later studied by Brownmiller and Bogue (3) who found no evidence of melting at any temperature up to 1650° . The compound NA was found to crystallize in colorless rounded grains, biaxial negative, with refractive indices: $\alpha = 1.566 \pm 0.003$, $\beta = 1.575 \pm 0.003$, $\gamma = 1.580 \pm 0.003$. The optic axial angle is medium small, about 30° . Twinning occurs frequently. The X-ray diffraction pattern is given on page 543.

No other binary compounds were observed, but $\alpha\text{-Al}_2\text{O}_3$ (corundum) and $\beta\text{-Al}_2\text{O}_3$ were found in specimens containing 3.5 percent Na_2O after heating to 1100° . On further heating to 1500° , $\beta\text{-Al}_2\text{O}_3$ and NA were present and $\alpha\text{-Al}_2\text{O}_3$ absent. In this system, the β form is the stable modification at high temperatures in samples containing up to 96.5 percent Al_2O_3 .

 $\text{KS}-\text{NS}-\text{SiO}_2$

This system was studied by Kracek (8), who found no ternary compounds. A unique type of solid solution formation was encountered in the disilicate region, both KS_2 and CS_2 taking up a varying limited excess of the three constituents, K_2O , Na_2O , SiO_2 , dependent upon the composition of the liquid in equilibrium with the crystals.

NS-LS-SiO₂

This system also was studied by Kracek (9), who found one ternary compound having the formula NLS_2 , which is an end-member of the solid-solution series NS-NLS_2 , melting congruently at 847° . At the liquidus in this system, the primary phases are $\text{NLS}_2(ss)$, LS, NS_2 and LS_2 , in all of which there is some solid solution.

NS-Fe₂O₃-SiO₂

The system $\text{NS-Fe}_2\text{O}_3\text{-SiO}_2$ was studied by Bowen, Schairer and Williams (2), who found two ternary compounds, NFS_4 (acmite), melting incongruently with separation of Fe_2O_3 at 990° , and N_2FS_3 , melting congruently at 838° . A third

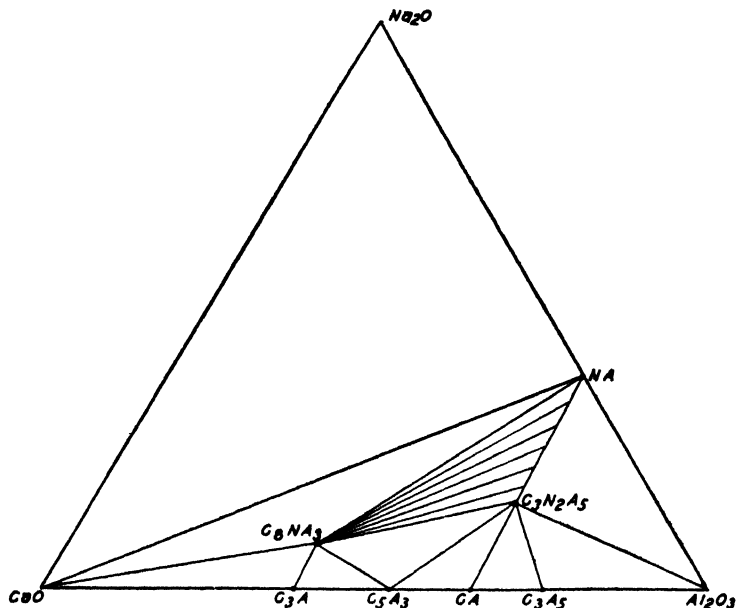

Figure 166. Diagram of the system $\text{Na}_2\text{O-CaO-Al}_2\text{O}_3$. (Brownmiller and Bogue)

compound, $\text{N}_6\text{F}_4\text{S}_5$, whose composition lies outside of the triangle, has a stability field extending into the triangle of this system. The unusual phenomenon of crystallization is observed of a phase (hematite) appearing at an early stage, being completely resorbed by reaction with the liquid at an intermediate stage, and again crystallizing at a late stage.

 $\text{Na}_2\text{O-CaO-Al}_2\text{O}_3$

The system $\text{Na}_2\text{O-CaO-Al}_2\text{O}_3$ was examined in the region below the join connecting CaO with NA , by Brownmiller and Bogue (3). Essentially the same technique was employed as with the system already described of $\text{K}_2\text{O-CaO-Al}_2\text{O}_3$, the soda being introduced to base compositions of CaO and Al_2O_3 , previously burned, in the form of Na_2CO_3 . Following the introduction of the Na_2CO_3 , the mix was burned twice in open Pt boats at about 1400° . The Na_2O content was

then determined by noting the loss in weight, which was checked frequently by analysis. Final heat treatments were made in envelopes of Pt foil, and quenched in water or mercury.

The final products of crystallization in the system are shown in the diagram of Figure 166, and the fields of primary crystallization in Figure 167. Two ternary compounds were found, as shown in the diagram, having the formulas NC_3A_3 and $\text{N}_2\text{C}_3\text{A}_5$. The NC_3A_3 was found to dissociate into CaO and liquid at 1508° , its

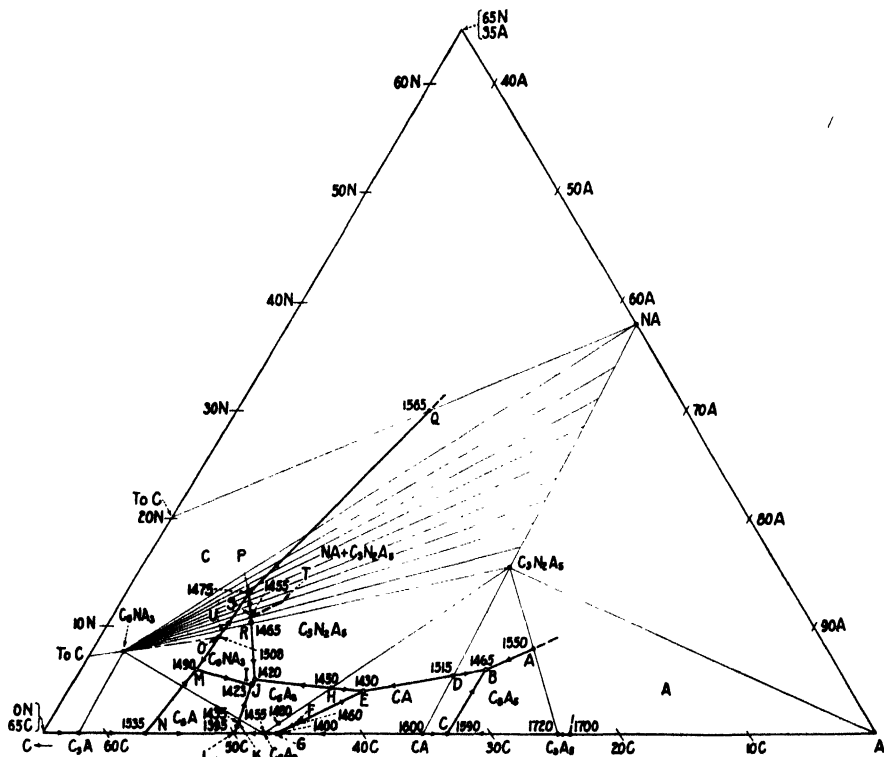

Figure 167. Diagram showing fields of primary crystallization and the binary systems within the ternary system $\text{Na}_2\text{O}-\text{CaO}-\text{Al}_2\text{O}_3$. (Brownmiller and Bogue)

composition lying outside of its primary-phase field. It is biaxial negative with a medium optic angle; refractive indices: $\alpha = 1.702 \pm 0.003$; $\gamma = 1.710 \pm 0.003$. The compound crystallizes readily as polyhedrons with hexagonal or octagonal outline. Twinning is characteristic in slowly-cooled samples. The X-ray diffraction pattern is given on page 543.

From the composition NC_3A_3 , the compound may be considered as consisting of 3 molecules of C_2A in which one CaO has been replaced by Na_2O . The similarity in the X-ray diffraction patterns of NC_3A_3 and C_2A indicates a similarity of structure which would make such substitution in the unit cell of C_2A seem to be quite possible. Although C_2A has been reported as isometric, yet it often

shows a faint birefracton. This has been attributed to strain, but Brown-miller and Bogue found the birefringence to persist even upon large grains, and Harrington found that the X-ray pattern does not conform to the cubic system. The structure of this compound is discussed elsewhere (see page 140-143).

The compound $\text{N}_2\text{C}_2\text{A}_5$ was found not to dissociate or melt at any temperature up to 1630° . It crystallizes as rounded grains, biaxial positive, mean refractive index $1.592 \pm .005$, birefringence very weak, about 0.005. This compound appears to form a continuous solid solution series with NA , for no boundary could be located separating these two phases, and the primary phase in the region $\text{NA-N}_2\text{C}_2\text{A}_5\text{-R-P-Q}$ (Figure 167) consisted of a single phase varying through insensible gradations from those of NA to those of $\text{N}_2\text{C}_2\text{A}_5$. Also in this region, and extending to include the whole triangle $\text{NC}_3\text{A}_3\text{-NA-N}_2\text{C}_2\text{A}_5$, the final products of crystallization consist not of three but of two phases: NC_3A_3 and $\text{NA-N}_2\text{C}_2\text{A}_5$ solid solution.

As in the system $\text{K}_2\text{O-CaO-Al}_2\text{O}_3$, C_5A_3 also takes up some alkali in solid solution, the maximum in this case being about 1 percent Na_2O . The refractive index of C_5A_3 is thereby reduced from 1.61 to 1.59. Both stable and unstable forms of C_5A_3 were formed, but regions of stability of the two forms were not distinguished.

The C_3A and NC_3A_3 crystallized together in well-formed crystals, and no indication of solid solution was observed.

Six quintuple invariant points were located, three of which are eutectics. The eutectics:

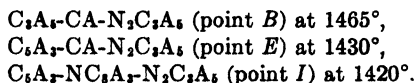

The invariant points not eutectics:

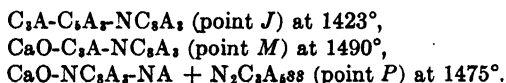

In addition, a possible invariant point occurs on the boundary PI , separating the fields of NC_3A_3 and $\text{NA-N}_2\text{C}_2\text{A}_5\text{ss}$, at S . This would indicate the origin of a boundary ST , separating the fields of $\text{N}_2\text{C}_2\text{A}_5$ from the solid solution.

As in the system $\text{K}_2\text{O-CaO-Al}_2\text{O}_3$, the points of maximum solid solution of Na_2O in C_5A_3 (points F and K), have a higher melting temperature than the binary eutectics at G and L respectively, from which the temperatures fall to the quintuple points E and J (see page 322).

Several of the joins between compounds in the ternary system were found to be true binary systems:

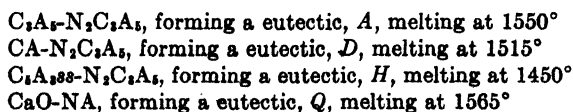

On the other hand, a number of the joins do not represent true binary systems, since they do not lie wholly within the fields of the primary crystallization.

Such is the join: $NC_3A_3-(N_2C_3A_5 + NA_{55})$. On the CaO side of point U , NC_3A_3 dissociates into CaO and liquid; between U and R , NC_3A_3 appears at the liquidus, and between R and $N_2C_3A_5$ the latter compound is the primary phase. Since NA and $N_2C_3A_5$ form a continuous solid solution, this pseudo-binary system may be regarded as extending from NC_3A_3 to any point on the NA- $N_2C_3A_5$ join.

On the join $C_3A_2-NC_3A_3$ the latter compound does not appear at all, and on the join $C_3A-NC_3A_3$, neither compound appears. No evidence of solid solution was observed between C_3A and NC_3A_3 at the liquidus, in spite of the similarity in structure and habit. Insley, however, found evidence of such solution provided

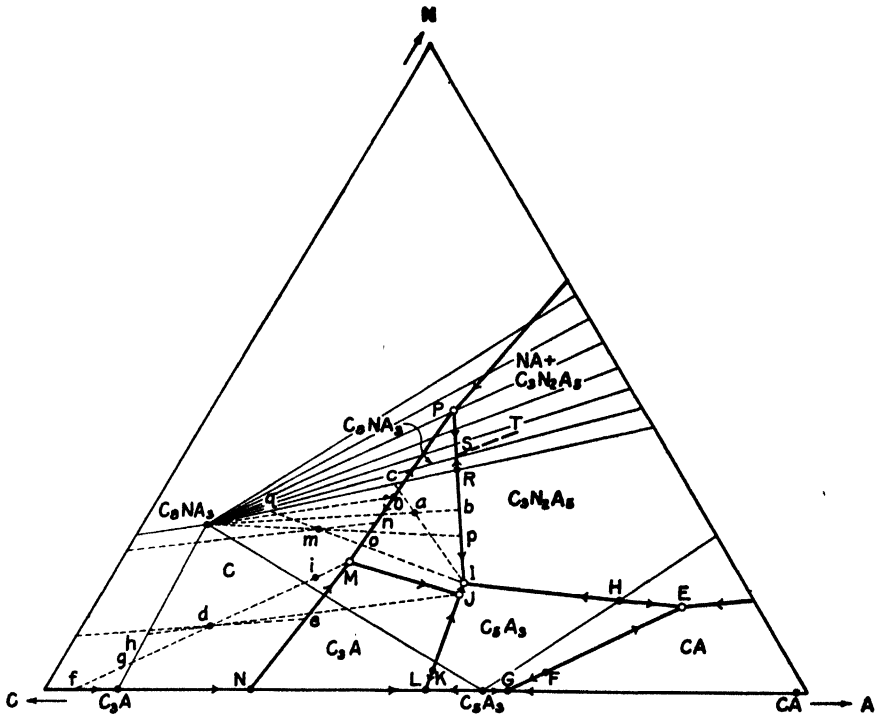

Figure 168. Diagram showing course of crystallization in a part of the system $Na_2O-CaO-Al_2O_3$. (Brownmiller and Bogue)

ample time is allowed for the action to take place, and Taylor found that in charges which are cooled slowly and contain little or no glass, C_3A crystals are not observed, but instead a single solid-solution phase in which the birefractance decreases as the calculated amount of C_3A increases (1). The systems $CaO-NC_3A_3$ and $(NA + N_2C_3A_5)-Al_2O_3$ were not investigated.

This ternary system includes a number of rather complicated courses of crystallization which may be followed by referring to Figure 168. If we have a melt of composition a in the NC_3A_3 field, NC_3A_3 will first appear and the liquid will move away from that composition along the line ab to b where $N_2C_3A_5$ appears. As the two solid phases separate together, the liquid follows down the boundary

PI while the mean composition of the solids follows the join connecting the two solid phases. When the liquid reaches the quintuple point *I*, the solids will have reached point *C*. At that moment C₅A₃ also appears and the mean composition of the solids follows *CI* to complete crystallization at *a*.

If we start with a composition *d*, CaO separates out until the liquid reaches *e* where C₂A appears, and follows the boundary to the invariant point *M* where NC₅A₃ also is formed. The solids at that moment have arrived at point *f* and, with separation of NC₅A₃, proceed to *g* where the CaO will have completely disappeared. The liquid then leaves *M* and proceeds along the boundary *MJ* while the solids proceed to *h*. At *J*, C₅A₃ appears and the crystallization is completed with the solids proceeding from *h* to *d*.

Still a third type of crystallization is shown by a composition of point *m*. CaO is first formed, and when the liquid has reached point *n*, NC₂A₃ appears. By the time the liquid has followed the boundary to *o*, the solids have reached NC₂A₃ and CaO has disappeared. The liquid then cuts across the NC₂A₃ field to *p* where N₂C₂A₅ appears, and down the boundary to *I*, at which point the solids have reached *q*. Crystallization is completed at *I* with the simultaneous formation of C₅A₃, the solids moving down to point *m*. The principal invariant points are shown in Table 30.

TABLE 30. The invariant points involving Na₂O in the system Na₂O-CaO-Al₂O₃

Phases	Point	Reaction	Composition			Temp. (°C)
			CaO	Na ₂ O	Al ₂ O ₃	
NA.....	..	Melting	37.8	62.2	Over 1650
N ₂ C ₂ A ₅	Melting	20.9	15.5	63.6	Over 1650
NC ₅ A ₃	Dissociation	54.9	7.6	37.5	1508
CaO-NA.....	<i>Q</i>	Eutectic	20	30	50	1565
N ₂ C ₂ A ₅ -C ₂ A ₅	<i>A</i>	Eutectic	23	8	69	1550
N ₂ C ₂ A ₅ -CA.....	<i>D</i>	Eutectic	30.5	5	64.5	1515
N ₂ C ₂ A ₅ -C ₅ A ₃	<i>H</i>	Eutectic	40	4.5	55.5	1450
N ₂ C ₂ A ₅ -NC ₅ A ₃	<i>R</i>	Eutectic	43.2	10.3	46.5	1465
CaO-NC ₅ A ₃	<i>O</i>	Melting	46.8	9	44.2	1508
C ₂ A ₅ -CA-N ₂ C ₂ A ₅	<i>B</i>	Eutectic	27.5	6	66.5	1465
CA-C ₂ A ₅ -N ₂ C ₂ A ₅	<i>E</i>	Eutectic	38	4	58	1340
C ₂ A ₅ -NC ₅ A ₃ -N ₂ C ₂ A ₅	<i>I</i>	Eutectic	46	5	49	1420
C ₂ A ₅ -C ₂ A-NC ₅ A ₃	<i>J</i>	Melting	46.5	4.5	49	1423
C ₂ A-CaO-NC ₅ A ₃	<i>M</i>	Melting	50	6	44	1490
CaO-NC ₅ A ₃ -(NA+N ₂ C ₂ A ₅) <i>ss</i>	<i>P</i>	Melting	42.5	13	44.5	1475

Na₂O-CaO-SiO₂

The ternary system Na₂O-CaO-SiO₂ was explored in the high-silica region, and down to about 50 percent Na₂O and 50 percent CaO on the binary sides, by Morey and Bowen (12). Three ternary compounds were found, N₂CS₂, NC₂S₂, and NC₅S₆. This study is of great value to the glass industry for the field covers substantially the important commercial glasses, but it is removed from the fields

of interest to the cement industry, so will not be further developed at this place. It serves as a background, however, for the later studies which have been made in the fields of cement, as will be discussed presently.

$\text{Na}_2\text{O}-\text{CaO}-\text{Al}_2\text{O}_3-\text{SiO}_2$

The compound NC_3A_3 was shown to be the stable soda-containing phase in the portland-cement region of the system $\text{Na}_2\text{O}-\text{CaO}-\text{Al}_2\text{O}_3$. It was necessary, however, to examine the stability relations of the compound in the presence of the calcium silicates, C_2S and C_3S , before any knowledge could be had of the nature of the soda phase in cement. To accomplish this, Greene and Bogue (5)

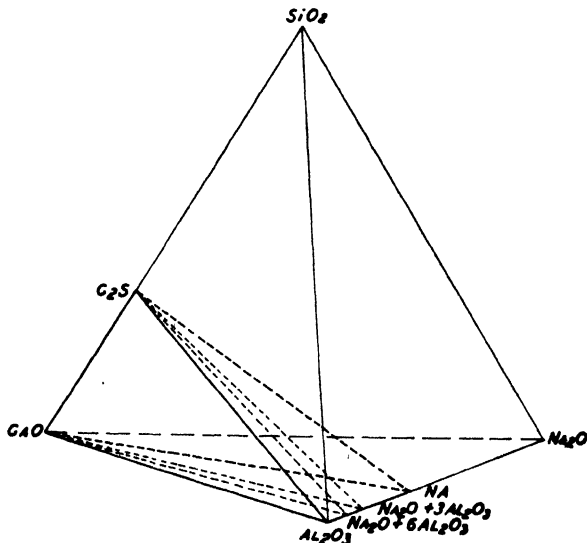
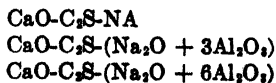

Figure 169. The tetrahedron $\text{C}_2\text{S}-\text{CaO}-\text{NA}-\text{Al}_2\text{O}_3$ in relation to the system $\text{Na}_2\text{O}-\text{CaO}-\text{Al}_2\text{O}_3-\text{SiO}_2$. (Greene and Bogue)

studied a section of the four-component system $\text{Na}_2\text{O}-\text{CaO}-\text{Al}_2\text{O}_3-\text{SiO}_2$ represented by a volume (see Figure 169) in the tetrahedron having as apexes $\text{CaO}-\text{C}_2\text{S}-\text{Al}_2\text{O}_3-\text{NA}$.

In this tetrahedron, four planes were considered as necessary to define adequately the stability relations and primary-phase volumes of the system. One of these planes, $\text{CaO}-\text{C}_2\text{S}-\text{Al}_2\text{O}_3$, was already known through the publications of the Geophysical Laboratory, and has been described. Another bounding plane of the figure, $\text{CaO}-\text{C}_2\text{S}-\text{NA}$ could be considered tentatively (later confirmed) as a true ternary system. Two additional planes of intermediate location were selected for study, still hinging on the axis $\text{CaO}-\text{C}_2\text{S}$, but extending to cut the $\text{Al}_2\text{O}_3-\text{NA}$ axis at points represented by $\text{Na}_2\text{O} + 3\text{Al}_2\text{O}_3$ and $\text{Na}_2\text{O} + 6\text{Al}_2\text{O}_3$, respectively. Thus the systems investigated were:



The quenching method was employed and the usual means for avoiding volatilization of Na_2O were rigidly followed.

The results of the study are shown in the phase diagrams of Figures 171–173. The system $\text{CaO}-\text{C}_2\text{S}-\text{Al}_2\text{O}_3$ is given for comparison in Figure 170, and the following figures show progressively increasing ratios of $\text{Na}_2\text{O}:\text{Al}_2\text{O}_3$. In any one plane the ratio $\text{Na}_2\text{O}:\text{Al}_2\text{O}_3$ is constant.

With the smallest addition of Na_2O (Figure 171), the areas of primary-phase

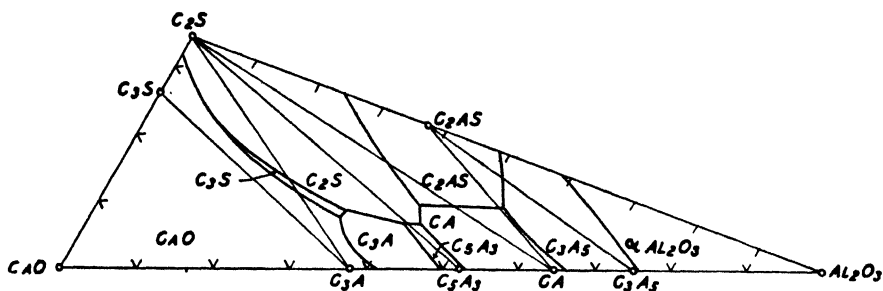

Figure 170. Part of the system $\text{CaO}-\text{Al}_2\text{O}_3-\text{SiO}_2$. (Rankin and Wright)

crystallization appear much as in the absence of Na_2O (Figure 170), except that two new ternary phases appear: NC_3A_3 and $\text{N}_2\text{C}_3\text{A}_3$. The area we are most interested in is that of NC_3A_3 , which is seen to occupy a narrow strip between C_3A and C_5A_3 . In the neighborhood of points A and B (Figure 171), the above three phase-volumes very nearly meet at a point. They actually meet in a plane of slightly lower $\text{Na}_2\text{O}:\text{Al}_2\text{O}_3$ ratio, and this is the sextuple invariant point for $\text{C}_3\text{A}-\text{NC}_3\text{A}_3-\text{C}_5\text{A}_3-\text{C}_2\text{S}$, melting at $1365^\circ \pm 10^\circ$. This temperature, being higher than that of the

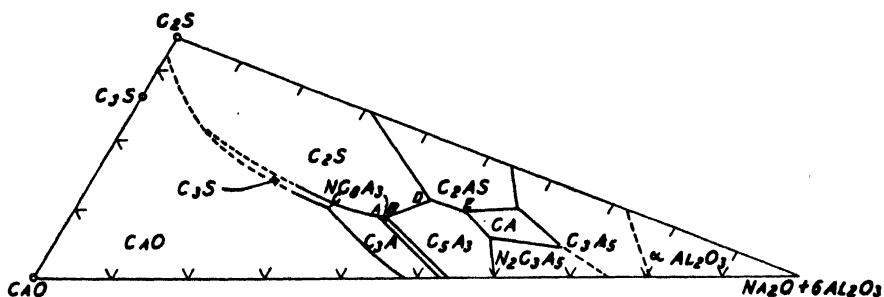

Figure 171. The composition plane $\text{C}_2\text{S}-\text{CaO}-(\text{N}+6\text{A})$. (Greene and Bogue)

corresponding invariant point for $\text{C}_3\text{A}-\text{C}_5\text{A}_3-\text{C}_2\text{S}$ in the ternary system (1335°), is probably explained by a raising of the latter temperature due to solid solution of Na_2O in the C_3A .

On passing to the plane of $\text{Na}_2\text{O}:\text{Al}_2\text{O}_3$ ratio of 1:3 (Figure 172), it is noted that C_3A no longer has a region of stability at the liquidus. CA also has disappeared, and the volume of C_5A_3 has been reduced to a very small region. The field of NC_3A_3 has increased, and a sextuple point for $\text{C}_2\text{S}-\text{C}_3\text{S}-\text{CaO}-\text{NC}_3\text{A}_3$ is almost reached at point F. But since C_2S and NC_3A_3 were not observed to exist

together in equilibrium with liquid in any of the quenched charges, it is probable that the C_3S in this plane decomposes into CaO and C_2S just before crystallization of NC_3A_3 begins. The four phases would be expected to meet at a point of slightly lower $Na_2O:Al_2O_3$ ratio, at a temperature of $1445^\circ \pm 10^\circ$.

At slightly higher $Na_2O:Al_2O_3$ ratios, the field of C_2A_3 will disappear, and the invariant point for $NC_3A_3-C_2A_3-N_2C_3A_5-C_2S$ be reached at a eutectic of about

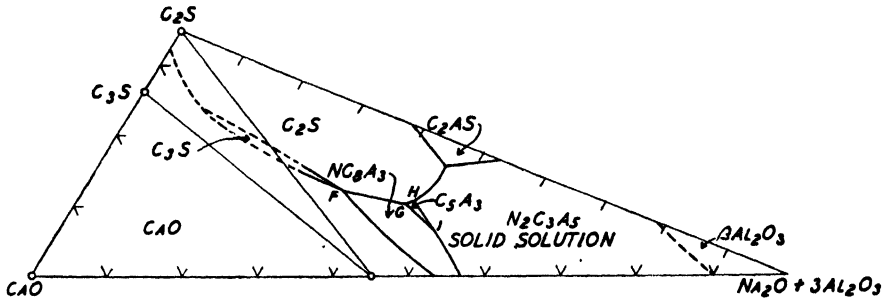

Figure 172. The composition plane $C_2S-CaO-(N + 3A)$. (Greene and Bogue)

$1340^\circ \pm 10^\circ$. Due to the solid solution of Na_2O in C_5A_3 , and of NA in $N_2C_3A_5$, the composition of this invariant point could not be calculated with precision.

The plane for the system $CaO-C_2S-NA$ is shown in Figure 173. The ternary phases have here disappeared, together with C_5A_3 , and the soda exists as NA . The ternary eutectic, K , between $CaO-C_2S-NA$ was established at 1355° , and the invariant point, L , was found for $CaO-C_2S-C_2S$ at a temperature which could not be determined precisely because of the sluggishness of the reaction, but is close to 1355° . In this plane, the field of CaO also has been considerably extended. The principal invariant points are given in Table 31.

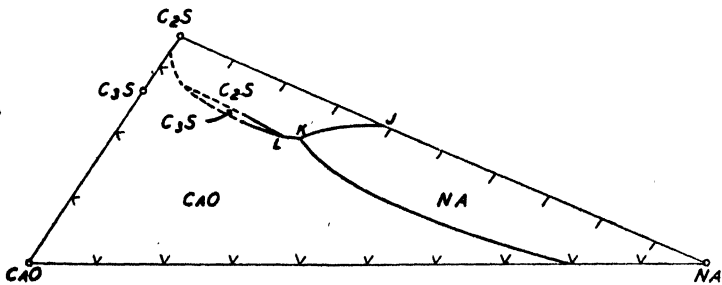

Figure 173. The system $CaO-C_2S-NA$. (Greene and Bogue)

Of the quaternary invariant points listed, only point δ is a eutectic; consequently melts of those compositions when completely crystallized will consist of solid phases differing from those in equilibrium with liquid at the respective invariant points. Thus a melt of the composition of point δ when cooled under equilibrium conditions becomes completely crystalline at 1365° , the temperature of point δ , and consists of C_3S , C_2A , C_2S , and NC_3A_3 . Melts of compositions of

TABLE 31. The principal invariant points in the system $\text{Na}_2\text{O}\cdot\text{CaO}\text{-}\text{Al}_2\text{O}_3\text{-}\text{SiO}_2$

Phases	Point	Reaction	Composition				Temp. (°C.)
			Na_2O	CaO	Al_2O_3	SiO_2	
$\text{C}_2\text{S}\text{-}\text{NA}$	<i>J</i>	Eutectic	14.7	39.7	24.3	21.3	1405
$\text{C}_2\text{S}\text{-}\text{CaO}\text{-}\text{NA}$	<i>K</i>	Eutectic	11	52	17	20	1355
$\text{C}_2\text{S}\text{-}\text{C}_2\text{S}\text{-}\text{C}_2\text{A}\text{-}\text{NC}_3\text{A}_3$	<i>1</i>	Melting	3.5	55.2	31.0	10.3	1440
$\text{CaO}\text{-}\text{C}_2\text{S}\text{-}\text{C}_2\text{A}\text{-}\text{NC}_3\text{A}_3$	<i>2</i>	Melting	3.5	56.0	31.0	9.5	1442
$\text{CaO}\text{-}\text{C}_2\text{S}\text{-}\text{C}_2\text{S}\text{-}\text{NC}_3\text{A}_3$	<i>3</i>	Melting	5.0	54.1	28.6	12.3	1445
$\text{C}_2\text{S}\text{-}\text{C}_2\text{A}\text{-}\text{C}_3\text{A}\text{-}\text{NC}_3\text{A}_3$	<i>4</i>	Melting	3.5	50.2	37.6	8.7	1365
$\text{C}_2\text{S}\text{-}\text{C}_2\text{A}\text{-}\text{NC}_3\text{A}_3\text{-}\text{N}_2\text{C}_3\text{A}_5(ss)$	<i>5</i>	Eutectic	8.0	46.1	35.5	10.4	1340

points *1*, *3* and *4* become completely crystalline at 1340° , the temperature of point *5*, and consist of C_2S , C_3A , NC_3A_3 and $\text{N}_2\text{C}_3\text{A}_5(ss)$.

In compositions within this system approaching that of portland cement clinker, in the tetrahedron $\text{C}_2\text{S}\text{-}\text{C}_2\text{S}\text{-}\text{C}_2\text{A}\text{-}\text{NC}_3\text{A}_3$, the first melting occurs at 1440° and, on complete equilibrium crystallization, will consist of those four compounds. The course of the crystallization however may be complex. In some cases the liquid composition passes through point *2* before point *1* is reached, in which case C_2A appears before NC_3A_3 when the $\text{Na}_2\text{O}:\text{Al}_2\text{O}_3$ ratio is less than that of point *1*. But since the $\text{Na}_2\text{O}:\text{Al}_2\text{O}_3$ ratio of points *1* and *2* are practically identical, 0.11, this means that C_2A appears first from mixtures having $\text{Na}_2\text{O}:\text{Al}_2\text{O}_3$ less than 0.11, and NC_3A_3 appears first from mixtures having $\text{Na}_2\text{O}:\text{Al}_2\text{O}_3$ greater than 0.11.

The possibility, referred to in the consideration of the system $\text{Na}_2\text{O}\text{-}\text{CaO}\text{-}\text{Al}_2\text{O}_3$, of the combination of the C_2A and NC_3A to form a continuous solid-solution series at temperatures below the liquidus, was confirmed by the X-ray and optical examination of a preparation containing potentially 39.9 C_2A , 40.1 NC_3A , 20.0 C_2S , subjected to two 30-minute heat-treatments at 1425° . No distinct grains of C_2A or NC_3A could be identified in the product, but besides C_2S there was a large amount of material having a mottled-gray interference color, showing a birefringence appreciably less than that of NC_3A .

In a study of compositions along the join $\text{C}_2\text{S}\text{-}\text{NCS}$, a single phase was observed on adding increasing amounts of C_2S to NCS up to a molar ratio of $\text{NCS}:-14\text{C}_2\text{S}$. X-ray diffraction patterns showed for this phase the spacings of $\beta\text{-C}_2\text{S}$ with a slight shift in some of the lines, which indicated a solid solution rather than a new compound.

The nature of the Na_2O in portland cement cannot yet be stated with certainty, because studies have not been completed on soda systems containing Fe_2O_3 , MgO , SO_3 or other minor components. But from the information available from the above studies it would appear that Na_2O may be present in clinker in several forms. Thus in the liquid near the invariant point *1* of the present system, Na_2O may be present to about 3.5 percent. By independent crystallization of this liquid, the latter approaches point *5* in composition, and as much as 8 percent Na_2O may be retained in glass quenched from that point. Hence Na_2O may be present in the glass of clinker.

On slower cooling, some of the Na_2O may crystallize as NC_3A_3 or as a solid solution of that compound with C_3A , which may be related to the "prismatic dark interstitial" material often observed in commercial clinker, as discussed in Chapter 7. Again, some Na_2O may be present in solid solution with C_2S . Finally it may be noted that the introduction of Na_2O into the system $\text{CaO}-\text{Al}_2\text{O}_3-\text{SiO}_2$ results in an extension of the CaO field, so that certain compositions in the presence of Na_2O will contain free CaO , at equilibrium cooling, which would not contain that oxide in the absence of Na_2O . In this way Na_2O may affect adversely the combination of CaO in cement mixes.

$\text{CaO}-\text{C}_4\text{AF}-(\text{Na}_2\text{O} + 3\text{Al}_2\text{O}_3)$

The system $\text{CaO}-\text{C}_4\text{AF}-(\text{Na}_2\text{O} + 3\text{Al}_2\text{O}_3)$ has been studied (4) as the first step in extending the system $\text{Na}_2\text{O}-\text{CaO}-\text{Al}_2\text{O}_3-\text{SiO}_2$ to include the component Fe_2O_3 . More especially it was hoped to learn of the stability of NC_3A_3 in the pres-

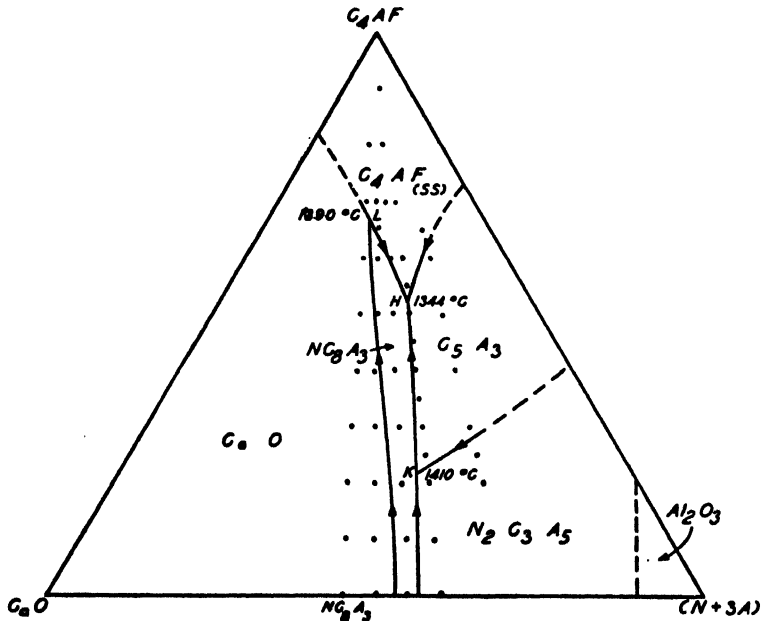

Figure 174. Phase equilibrium studies in the system $\text{CaO}-\text{C}_4\text{AF}-(\text{N} + 3\text{A})$. (Eubank)

ence of C_4AF , and to observe any solid solution behavior between the two compounds.

The phase diagram is shown in Figure 174. The region of stability for NC_3A_3 was found to be a long, narrow field running well up toward C_4AF . Only the phase boundaries near this field were closely located, and the portions of the boundary curves not investigated are shown by dotted lines. Three invariant points were located as follows:

Point	Phases	Reaction	Composition				Temp. (°C)
			CaO	Al_2O_3	Fe_2O_3	Na_2O	
H	$\text{C}_2\text{A}_3\text{-C}_4\text{AF-NC}_3\text{A}_3$	Eutectic	44.0	34.2	17.1	4.7	1344 ± 5
K	$\text{C}_2\text{A}_3\text{-NC}_3\text{A}_3\text{-N}_2\text{C}_3\text{A}_3$	Melting	42.2	42.8	7.2	7.8	1410 ± 10
L	$\text{CaO-C}_4\text{AF-NC}_3\text{A}_3$	Melting	48.4	26.8	22.3	2.5	1390 ± 10

The refractive indices of the crystalline pleochroic iron phase in this system were found to decrease progressively with the lowering of the iron content. The refractive index α varied from 2.03 to 1.91 for percentages of C_4AF between 90 and 30, respectively. This indicates that the iron phase consists of a series of solid solutions varying with the iron content. The indices, and hence the composition of the soda phase, NC_3A_3 , were however found to be constant throughout the system.

References

1. Bogue, R. H., *Symposium*, 65.
2. Bowen, N. L., Schairer, J. F., and Williams, H. W., *Am. J. Sci.*, **20**, 405 (1930).
3. Brownmiller, L. T., and Bogue, R. H., *Am. J. Sci.*, **23**, 501 (1932); PCAF Paper 25.
4. Eubank, W. R., *Res. Reports, PCAF*, July, 1945.
5. Greene, K. T., and Bogue, R. H., *J. Res. NBS*, **36**, 187 (1946); RP 1699; PCAF Paper 47.
6. Kracek, F. C., *J. Phys. Chem.*, **34**, 1583 (1930).
7. Kracek, F. C., *J. Phys. Chem.*, **34**, 2641 (1930).
8. Kracek, F. C., *J. Phys. Chem.*, **36**, 2529 (1932).
9. Kracek, F. C., *J. Am. Chem. Soc.*, **61**, 2863 (1939).
10. Matignon, C., *Compt. rend.*, **177**, 1290 (1923).
11. Morey, G. W. and Bowen, N. L., *J. Phys. Chem.*, **26**, 1167 (1924).
12. Morey, G. W. and Bowen, N. L., *Trans. Soc. Glass Tech.*, **9**, 226 (1925).

PART III

The Chemistry of Cement Utilization

CHAPTER 21

Early Studies on Cement Hydration

When water is added to portland cement, there follow a series of reactions by virtue of which the product attains such hardness and resistance to stresses of compression and tension that it has become, in the form of concrete, one of the great structural materials of this industrial age. Its uses in the building of the great systems of highways (Figure 175), of huge dams (Figure 176), of bridges and reinforced concrete structures of many kinds (Figure 177) have become a part of our daily life and experience. Perhaps less well known is the fabrication from concrete of structures of rare architectural beauty, like the incomparable

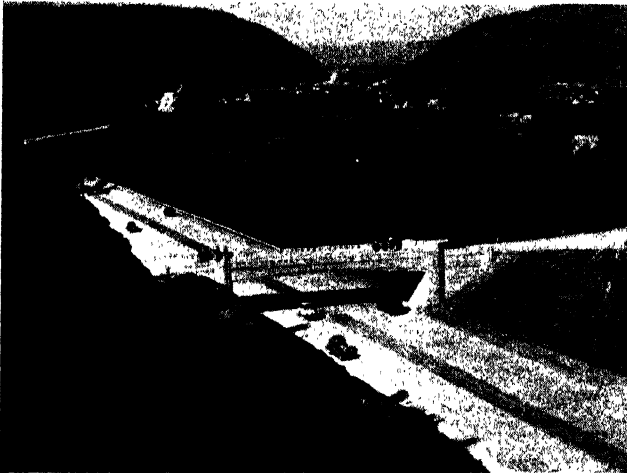

Figure 175. The Pennsylvania Turnpike.

temple of the Baha'i near Chicago (Figure 178), of houses of many types, of silos, floors and buildings on the farm, of runways or fields for airplane traffic, of swimming pools and walks and accessories about the home, of railway ties and filling under the rails in water-pocketed soils, of piles and poles and fences.

The purpose here, however, is not to elaborate upon the uses of concrete but to explain the reactions by which cement is transformed into this synthetic rock.

Concrete is made from a mixture of portland cement, fine and coarse aggregate usually in the form of sand and gravel or crushed stone, and water. Small amounts of other materials are sometimes added to promote or retard the reactions or to give desired qualities to the paste.

The explanations for these reactions, in order the better to make use of and control them, have been sought by chemists for a great many years. Many theories have been developed, each of which has contributed to a fuller under-

standing of the processes involved. These theories have been modified and restated in our own day, but not wholly discarded. In order to apprehend the bases of our views today it is important to reach back to the earlier beginnings. Much indeed of our modern discoveries was fore-shadowed before the turn of the twentieth century.

The Crystallization Theory

Perhaps the first careful study of the hardening of mortars is due to Lavoisier (31). In 1765 he published the following brief note on the setting of gypsum:

If gypsum, which has been deprived of its water by heating, is again treated with water, it takes up the latter with avidity, a rapid and irregular crystallization occurs and the small crystals which are formed are so entangled with each other that a very hard mass results.

In this case, the partially dehydrated gypsum, $\text{CaSO}_4 \cdot \frac{1}{2}\text{H}_2\text{O}$, was believed merely to return to its original composition, $\text{CaSO}_4 \cdot 2\text{H}_2\text{O}$. This idea was extended by Vicat (57) to the setting generally of all types of cements which produced, on treating with water, a hard and strong material. According to Vicat, setting and hardening take place as a direct consequence of a chemical reaction between the lime or other material and the water to form a hydrate.

The reason why this should be so, however, and the nature of the hardening process following such reactions of hydration, were not considered seriously until Le Chatelier (32) studied the problem, which was reported in complete form in 1887.

The mere felting together of rigid crystals was shown by Le Chatelier to be inadequate to explain the hardening observed in cements. To demonstrate this he recalled that the precipitation of calcium sulfate from an aqueous solution of this salt by alcohol gives a deposit of fine crystals showing excellent felting of the crystals, but that the mass shows no cohesion or resistance to rupture.

In order to treat the whole subject in a systematic manner, the processes of hardening were divided into three rather distinct phases:

The chemical phenomenon of hydration,
The physical phenomenon of crystallization, and
The mechanical phenomenon of hardening.

Hydration. It was accepted as a premise that the underlying requirement for the development of a set and hardness in the materials under consideration is the interreaction of these materials with water to form hydrated compounds. The classic example of this type of reaction may be used to indicate the chemical nature of hydration. Gypsum on moderate heating is decomposed as follows:



On treating the product with water, gypsum is again formed:



The exact nature of the hydration of cement compounds was not so well understood, but it was assumed that somewhat similar reactions take place.

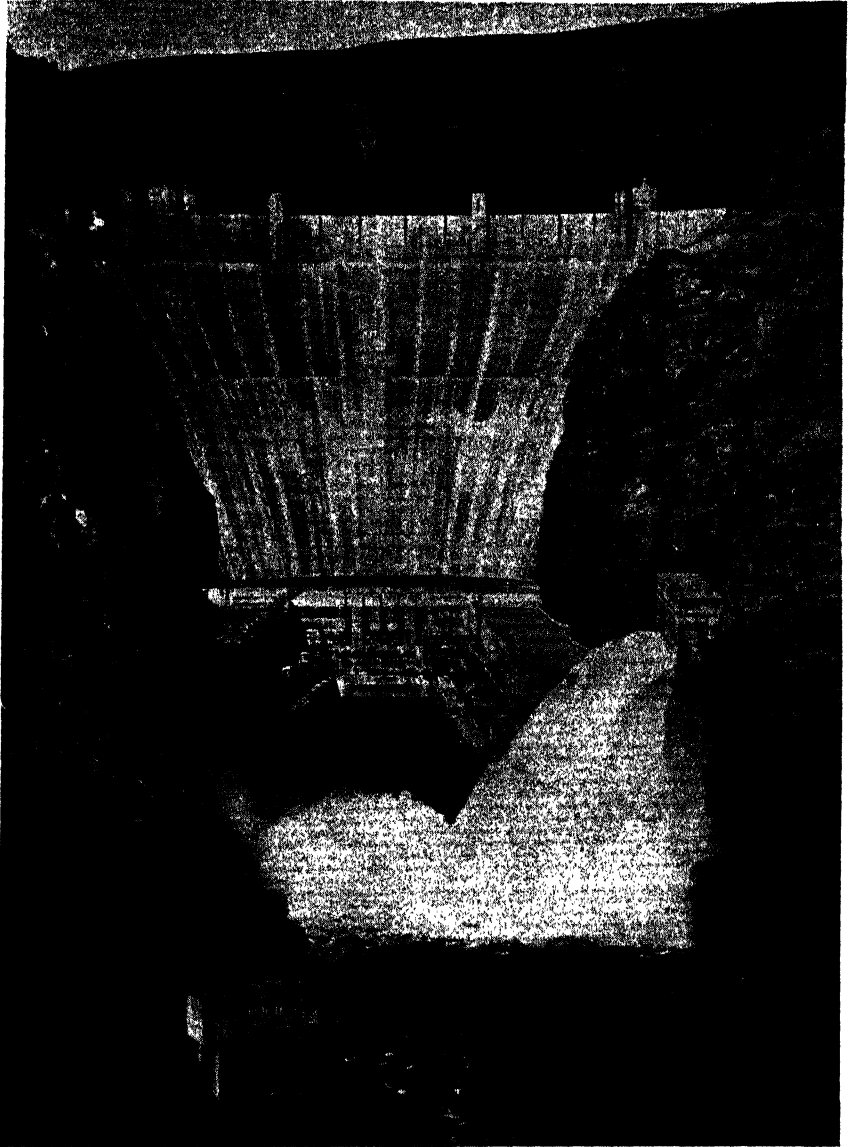

Figure 176. Boulder Dam on the Colorado River.

Crystallization. In a solution which is just saturated, crystallization cannot take place. But if some change in condition is brought about whereby a temporary metastability or supersaturation is obtained, then equilibrium normally is reestablished by crystallization. The slow evaporation of the solvent, a change in temperature (in the direction of decreasing solubility), or the introduction of some other phase which competes for the solvent may each produce a condition of

supersaturation with respect to the initial solute, and result in crystallization. In order to explain the formation of a crystalline precipitate from an aqueous solution, one of these phenomena or some other agency of similar effect must manifest itself.

Landrin (30) had suggested that the set of plaster is due to supersaturation with calcium sulfate brought about by evaporation, but Le Chatelier showed that evaporation could have practically no influence in the process since the set takes place equally well when the mixture of plaster and water is placed in sealed containers.

Marignac (37) observed however that there was a marked difference between the solubility of the hemihydrate, $\text{CaSO}_4 \cdot \frac{1}{2}\text{H}_2\text{O}$, and that of the dihydrate, $\text{CaSO}_4 \cdot 2\text{H}_2\text{O}$. He found that:

If a solution of calcium sulfate is prepared by agitating calcined plaster with a certain quantity of water and filtering the liquid at the end of about five minutes, a solution about five times as concentrated is obtained as if it had been prepared from calcium sulfate hydrated with two molecules of water. But this solution quickly becomes cloudy, deposits crystals of gypsum, and at the end of a longer or shorter time returns to its normal concentration. The saturated solution of dehydrated calcium sulfate is therefore supersaturated by comparison with the hydrated sulfate.

A theoretical solubility ratio of $\text{CaSO}_4 \cdot \frac{1}{2}\text{H}_2\text{O}$ to $\text{CaSO}_4 \cdot 2\text{H}_2\text{O}$ of 7 was found by Le Chatelier by an application of the thermodynamics of solutions, but the ratio of 5 found experimentally by Marignac is in satisfactory agreement considering the instability of the hemihydrate.

Similar differences in the solubility of these hydrated and anhydrous salts have been noted. Thus Coppet (12) has shown that anhydrous sodium sulfate gives solutions which are strongly supersaturated with respect to the hydrate, even when care is taken to prevent any rise in temperature.

As a result of these studies, Le Chatelier concluded that the crystallization of plaster and also cements takes place from supersaturated solutions, and that this metastable state is the result of marked differences between the solubility of the anhydrous (or only partially hydrated) salts and the hydrated salts. He believed that this reaction may approach completion because, as the hydrate separates out, the solution is left unsaturated with respect to the anhydrous material. Hence more of this will continue to dissolve, and eventually all of it will have passed through the solution phase into the crystalline hydrate. This general theory was shown by Le Chatelier to apply not only when the reaction is between some salt and water but also when the reaction is between one salt held in solution and another in the solid state, provided the solubility of the solid in the aqueous solution is greater than that of a product which would result from the interaction of the two.

The rate of set under this hypothesis should be determined by the degree of supersaturation attained and the latter in a large measure is dependent on the difference in solubility of the two phases. Hence the more soluble salts will go into solution more rapidly and the set will be accelerated. Thus, according to Le Chatelier, calcium sulfate hemihydrate is more soluble than the calcium alumi-

nates and these more soluble than the calcium silicates. Consequently the set will be most rapid with the calcium sulfate and slowest with the calcium silicates. It follows also that the introduction into the solution of some material which changes the solubility will change in the same direction the degree of supersaturation attained, and hence the rate of set. All of these considerations were verified by Le Chatelier.

The form of crystals is known to be subject to modification which depends on the conditions surrounding precipitation. Le Chatelier found that crystals precipitating from highly supersaturated solutions frequently were abnormally devel-

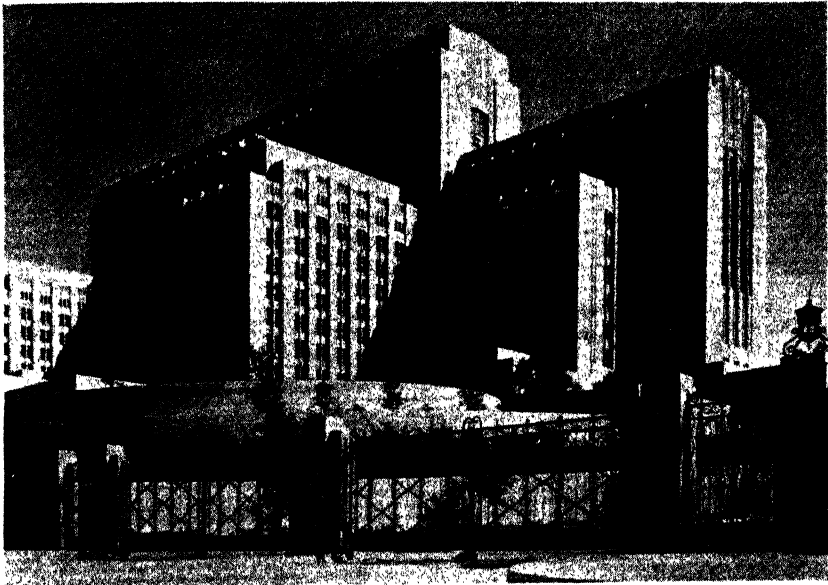

Figure 177. Los Angeles County General Hospital. A modern structure of architectural concrete.

oped along the principal axis, resulting in "long, extremely slender prisms, true threads whose length may exceed one hundred times their thickness." These usually grow in spherulitic form about a nucleus. This condition was found to be true of many salts (*e.g.*, sodium acetate, sulfate and hyposulfite) which normally crystallize equally developed in all directions.

Hardening. The final hardness or strength of the set mass, according to Le Chatelier, will depend upon the cohesion of the crystals and upon their mutual adhesion. He defined cohesion as "an ultimate quality of matter, which we are not able in the present state of our knowledge to connect with any more simple and more general fact." He regarded adhesion as "a very complex and consequently very variable phenomenon." The latter property is found to vary with a number of conditions, such as the surface exposed, the distribution of voids, the nature of the solvent and the temperature. A high development of both cohesion

and adhesion seemed necessary to Le Chatelier for the production of a strong cement.

Application to Portland Cement. On applying the above theory of hardening to portland cement, Le Chatelier concluded that the fundamental reaction which

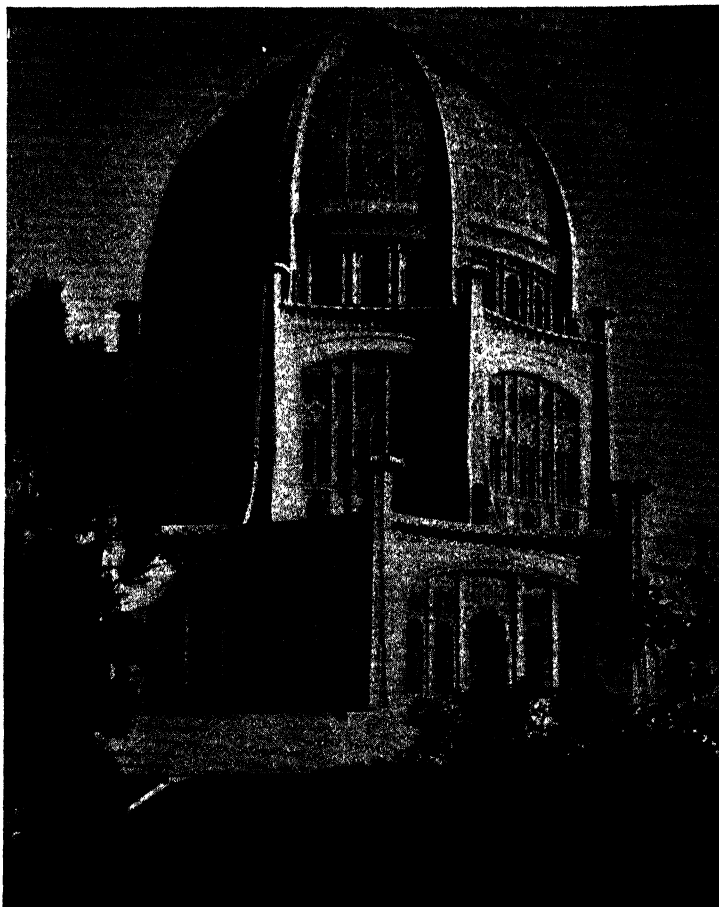
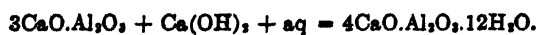

Figure 178. The Baha'i Temple, at Wilmette, Illinois. (Courtesy of the National Assembly of the Baha'i)

brings about the hardening in these cements is a splitting up of the basic tricalcium silicate giving monocalcium silicate hydrate and calcium hydroxide:



The tricalcium aluminate he at first believed to form a tetracalcium aluminate hydrate:



Later, as a result of the investigations of Candlot, he conceded that the product in this instance was tricalcium aluminate hydrate. The latter reaction appeared to be rapid and so was held to be responsible for the development of the "set." The real hardening however was held to be occasioned "almost exclusively by the slow and progressive hydration of the calcium silicate, which, after having begun during the setting, continues entirely alone."

The strength and hardness developed by the crystallization of these hydrates from their supersaturated solutions (due to greater solubility of the anhydrous than of the hydrated compounds), according to the theory of Le Chatelier, is dependent upon the cohesion within the crystals themselves and the adhesion between the individual crystals and between these and the other bodies present.

Since cohesion is regarded by Le Chatelier as a specific property of each crystalline material, he considered that nothing further need be said about this except that the maximum ultimate strength of any crystalline mass is limited by the cohesion of that particular crystal material.

In mortars and concretes, the adhesion becomes a property of importance and, according to Le Chatelier, depends on many factors. The *chemical nature* of the bodies in contact is important, for certain crystals will adhere to one material and not to another. Thus the addition of sand to plaster is not permissible as the adhesion between these is very low, while lime silicates may advantageously be mixed with sand since in this case the adhesion is high.

The extent of the *surfaces of contact* determines the degree to which adhesion exerts its influence. This will vary with the form and size of crystals, and with the volume and manner of distribution of the voids. Le Chatelier held that "a very weak adhesion, per unit of surface, if it is multiplied by a considerable extent of surface, will give as the result a very great total force of adhesion, which may even equal the internal cohesion of the crystals." Since the surface of crystals increases in proportion as they are more elongated, (as formed by crystallization from supersaturated solutions) and as they are sharper (as contrasted with rounded sand grains) it follows that cement mortars with ground sand are eminently suited to produce high adhesive strength.

Voids are caused by the presence of an excess of water in the original mixture above that which is necessary for hydration. Since any increase in the volume of voids results in a corresponding decrease in the surface of contact of the crystals, the presence of these voids, and hence the amount of excess mixing water, should be reduced to the minimum. Here again, elongated crystals maintain contact and hence develop strength even with a much higher percentage of voids than would cubic crystals; or, conversely, with a given percentage of water or voids, a higher percentage surface of contact will be maintained and hence higher strengths will be developed, when the crystals are elongated than when they are cubic. Furthermore, any method of removing the excess water after placing, would diminish the voids proportionately and consequently increase the surface of contact and the strength.

To sum up the generalizations of Le Chatelier, he believed that setting and hardening of cements are due to:

- (1) The solution in water of an anhydrous or but partially hydrated salt.
- (2) Reaction of the dissolved salt with water, to form a higher hydrate.

(3) The precipitation of this hydrate due to its lower solubility and consequent development of a supersaturated solution.

(4) The formation of very small but elongated crystals during precipitation which favors interlacement and large contact surface.

(5) The specific properties of high cohesive and adhesive qualities on the part of the precipitated crystals.

The Colloid Hypothesis

Michaelis (40) conducted a considerable number of experiments from time to time, extending over a period of more than 45 years beginning in 1864, which culminated in the development of a theory that the hardening and water resistance of cements were due almost exclusively to the formation of colloidal hydration products.

Michaelis believed that "approximately monocalcium compounds" remain after hydrolysis and that thereby the residue is enriched in anions and charged electronegatively, while the cations Ca^{++} , Na^+ and K^+ are partly or entirely removed from it. As soon as the concentration of the limewater is sufficient, the cations wander to the anions "somewhat as iron filings wander to a magnet" and form the difficultly soluble compounds, especially the hydrated calcium silicate, and separate "as a gel, hydrogel or colloid."

The whole process is illustrated by referring to the several things which take place when a few grains of cement, with the usual 2 percent gypsum, are added to an equal volume of water. The mixing water is said immediately to dissolve lime, calcium aluminate, calcium sulfate, alkali silicates and calcium ferrite. There is formed a supersaturated solution of CaO , $3\text{CaO}\cdot\text{Al}_2\text{O}_3$ and CaSO_4 which form calcium sulfoaluminate until all of the CaSO_4 is used up. Crystals may also form of calcium aluminate and $\text{Ca}(\text{OH})_2$.

The crystalloidal product, according to Michaelis, will set and harden, but is never a hydraulic mortar. Water will easily penetrate and soften it. The colloid forces now come into play:

Suddenly the whole saturated solution which surrounds the cement particles coagulates. A gel is formed, and that is the instant when we see the water disappear from the surface of a pat of cement, leaving it dry and dull; or in short when setting has been completed.

The hydrogel at first is found to be low in lime and to behave like a gel of silicic acid. However, more lime is taken up by adsorption. The water is soaked up by the interior of the grain in hydrating, and thereby "the hydrogel becomes denser and denser on the surface until finally it is absolutely impermeable to water." This withdrawing of water by the "inner suction" is used as the basis of the argument to explain hardening under water. When hardened in air, the evaporation of the water contributes to the hardening of the gel, but also causes shrinkage cracks.

The later increases in strength are said to be due to "slow recrystallization of calcium hydroxide, calcium aluminate, and calcium sulfoaluminate (if gypsum is still present) from a supersaturated solution; and even calcium sulfate crystallizes in large-faced crystals."

The hydraulic mortars were not regarded by Michaelis however as especially stable compounds. "They represent," he says, "the first compounds formed by the reaction of water on the cement. The permanent state for all hydraulic cements is only reached when all the lime has been changed to CaCO_3 and all anions changed to hydrate."

The colloid theory of Michaelis may be summarized as follows:

The action of water on cement brings about two types of reaction. First the solution of lime, aluminates, sulfates and other compounds of the cement. From this solution there are precipitated various crystalline products, as calcium aluminates, calcium sulfoaluminate and calcium hydroxide. This gives a material possessing some strength but not at all resistant to further disintegrating action of the water. As soon as the limewater has reached a definite concentration it acts on the calcium-impooverished silicates, through electrochemical forces, and forms the hydrated calcium silicate. Because of the difficult solubility of the silicate it forms a gel which fills the pores of the cement and makes the latter impermeable to water. The gel is soft, but the inner mass of the cement grains eagerly withdraws the water from the gel and in that way the surface becomes hard. The great strength and water resistance of the cement are thus explained as due almost entirely to this gel formation and its drying out by the inner suction of the cement grains.

Discussion of the Crystallization and Colloid Theories

After the advancement of the crystallization theory by Le Chatelier and the colloid theory by Michaelis, there followed a long-continued debate upon the special merits of the rival hypotheses. Most of the writers who have essayed to explain the nature of the setting or hardening processes have championed one or the other of these theories. Many authors have suggested modifications of the original theories and a few have suggested that the two differ but little, or not at all, in their fundamental characteristics.

Le Chatelier (32) claimed that the principal difficulty in reconciling the two theories lay in the definition:

People evade defining what they call a colloid, but they seem to take the word in the sense of a body capable of hardening. And then the explanation comes down to this: cements harden because they have the property of hardening.

Le Chatelier then discusses the nature of the colloid state and deduces that the only singular properties possessed by colloids are insolubility and fineness. These properties go together, because if the substance were not highly insoluble it could not remain finely divided in a liquid. The small particles would tend to dissolve and the larger particles would grow to greater dimensions, as takes place on heating, for example, suspensions of barium sulfate or calcium oxalate. The surface energy of colloids however is far greater than that of crystalloids, and becomes of greater significance than the energy of evaporation, crystallization or chemical reaction.

Le Chatelier points out that even in the case of plaster, the set material shows no crystal development under the highest power of the microscope, but that does not prove that no crystals are formed. After a number of weeks crystals may

appear. Calcium aluminates behave in a similar manner. No crystals can be seen for some time, but eventually the characteristic long needle crystals appear. In the case of the calcium silicates no crystals appear even after many years. But Le Chatelier insists that "numerous analogies prevent us from denying their existence." He refers to the barium silicates and calls attention to the observation that in this case crystals can always be found of barium silicate together with barium hydroxide. The greater insolubility of the lime silicate is given as the cause of the greater fineness. He concludes,

It is not impossible that, initially, the dimensions of these crystals are of colloidal order, as in the moment of formation of the precipitates of barium sulfate and calcium oxalate. I have shown, in fact, that this calcium silicate precipitate absorbs, in the moment of its formation, a certain quantity of lime which varies with the concentration of the liquid. In the course of time the dimensions of the crystals must increase considerably, as in all similar instances. The mechanical resistance does not diminish with time, quite the contrary. Consequently the colloid state, which was possible at the beginning, has nothing to do with the hardening of the cement.

Schott (54) has agreed with Le Chatelier that the strength of portland cement is due to the development of crystals, but believes that the crystallization of $\text{Ca}(\text{OH})_2$ is the determining factor. He states:

The setting of cements is chiefly due to the binding action of the slowly crystallizing, difficulty soluble $\text{Ca}(\text{OH})_2$, which fills the pores and binds the grains of the cement. The finer the cement the larger the surface exposed to the water, therefore, the quicker the separation of $\text{Ca}(\text{OH})_2$ and the stronger the cement. Upon exceeding a certain lime content cracks appear. An excessive crystallization of $\text{Ca}(\text{OH})_2$ cracks cement. Where this limiting point is located is still to be discovered.

The crystallization theory, so far as it applies to plaster, has been confirmed by many investigators. The general opinion of these authors is similar to that expressed by McVay (36) who writes: "The setting of plaster of Paris depends upon the $\text{CaSO}_4 \cdot \frac{1}{2}\text{H}_2\text{O}$ going into solution and crystallizing out as $\text{CaSO}_4 \cdot 2\text{H}_2\text{O}$. This process goes forward until at least enough of the plaster has crystallized to form a bond."

The colloid theory also has had a number of able supporters.

The process of setting was believed by Rohland (51) to proceed as follows: When cement is mixed with water, colloids are formed and calcium hydroxide is split off hydrolytically. This later changes to calcium carbonate. Radiating needles of monocalcium silicate are formed rapidly after the water is added, and around these a dark non-crystalline mass "which forms by far the greatest amount." The nature of this colloidal material was not determined.

Nearly all of the properties of cement were attributed by Rohland to the colloid. The swelling was said to be due to the absorption of water by the colloid particles. The increase in temperature was thought to be due to the coagulation of the colloids, accompanied by a volume decrease. Since "colloids are poor conductors of heat, . . . the fire resistance of reinforced concrete is due to the low heat conductivity of the concrete." Workability was attributed to the colloids

since "workability is dependent on plasticity. In order to have plasticity the proper amount of water must be added since the colloids are only formed after mixing with water. When the colloids are coagulated, the plasticity is lost." Adhesion of concrete to the reinforcing iron, he said, is due to the colloids, for "the colloids coagulate on the iron . . . and inclose it with great force." Finally, salts attack concrete only in inverse ratio to the denseness and hardness of the coagulated colloid net.

Kuhl (28)(29) has made some interesting comparisons of the two major theories of setting, and has further developed the colloid theory of Michaelis. It is assumed that there is formed at the start a highly dispersed colloidal solution of hydrated calcium silicate. The solution is precipitated or coagulated by electrolytes which are present. The initial set where the water disappears from the surface of the mortar is the result of this coagulation. The electrolytes are derived from the alkalis, the $\text{Ca}(\text{OH})_2$ and the calcium aluminate, all of which are formed quickly on the addition of water. Less importance is attached to the crystalline calcium aluminates and $\text{Ca}(\text{OH})_2$ in the setting process because these are less likely to form an interlocked mass than colloidal precipitates.

The conspicuous difference between the ideas of Kuhl and the theory of Michaelis lies in the origin of the gel. Whereas Michaelis believed the gel was due to a swelling of an insoluble material, Kuhl attempted to show that it was due to a precipitation from a supersaturated solution.

Kuhl believes that the greatest hardness and strength depend upon the formation of colloidal and crystalloidal products at the same time.

This condition is fulfilled in the calcium silicates only if they are lime-rich, for only then is it possible that crystalline lime hydrate forms besides lime-poor hydrated silicates.

The opposite is true in the aluminates. Lime-rich aluminates yield only crystalline products and produce proportionate strength. Low-lime aluminates yield besides crystalline hydrated tri- or tetra-calcium aluminate, the necessary gel in the form of alumina gel, and thereby give good strengths. In portland cement the formation of alumina gel is not necessary because sufficient gel is produced by the silicates. On that account the high-lime aluminates, in spite of their low strength when pure, are better in portland cement than low-lime aluminates.

The ideas of Kuhl have been largely confirmed by Pulfrich and Linck (44) who studied the processes of hydration on slides under a microscope, using in a series of experiments various quantities of water. They concluded that in the presence of a large excess of water hardening is due to the formation and interlocking of needle-like crystals, but in the presence of less water (26 percent) only gels form. In this case hardening depends upon the development of the gel and the withdrawal of the water. Neither hydrated crystalline calcium silicate nor hydrated calcium aluminate can form under these conditions.

The significance of the colloid state in explaining the behavior of mortars has been stressed by White (58). He maintains that the ability of plain concrete to resist water is dependent on "the development of sufficient colloid to fill the pores." If the curing has not been sufficiently extended, there will be an inade-

THE CHEMISTRY OF PORTLAND CEMENT

quate amount of colloid. Hence, on drying out, a porous structure will result which permits the ready passage of water. The favorable action of soaps as waterproofing agents was attributed to their ability to function as colloidal material and fill the capillary spaces.

The alternate swelling and contracting of mortars which were placed alternately in water (or moist air) and in dry air was explained also by the colloid hypothesis. White states:

Water continues to act on the clinker until the gel becomes packed so tightly that no more water can force its way through. The cement or concrete will retain this condition unchanged so long as it is immersed in water. If the water is removed by evaporation, the dehydrated gel shrinks and the mass becomes porous. When it is again immersed in water, capillary action carries the water rapidly through the shrunken colloid to the particles of unchanged clinker with the result that additional hydration products are formed.

White adds that the gel retains this reversibility at atmospheric temperature for at least twenty years, "and there is nothing to indicate that it may not continue indefinitely."

The colloidal behavior of tricalcium aluminate has been described by Phillips (43). This investigator states that tricalcium aluminate, with a large excess of water, forms a suspension most of which is dispersed to a degree comparable to those colloidal suspensions which pass through a filter, do not diffuse or dialyze, show the Tyndall cone, and are positively charged. In the limited amounts of water in cement pastes, it is converted into and remains a gel during the first 24 hours at least.

Even calcium hydroxide is regarded as functioning as a colloid by Justin-Mueller (11), who states that calcium hydroxide forms "unctuous colloid gels containing varying amounts of water." The hardening of lime mortars, he writes, cannot be attributed alone to the formation of calcium carbonate, but depends very largely upon the gel-forming power of calcium hydroxide. "The desired hardening is the result of carbonate formation in the calcium hydroxide gel; on subsequent evaporation of the water, the calcium carbonate is left in a form retaining the gel structure."

Colony (11) states that a reaction takes place between the gelatinous material and the other constituents of the cement, forming a secondary amorphous product which hardens by desiccation.

The greater number of competent investigators have recognized in the mechanism of setting and hardening of cements a combination of both crystalloidal and colloidal phenomena. Each appears to play a distinct role, the absence of either of which would modify seriously the resultant effect and the consequent nature and properties of the product.

The significance of the two processes has been stressed even in the setting of plaster of Paris. Traube (56) observed that a gel was first formed on the addition of water, and that this gel slowly changed into needle-shaped crystals of gypsum. Also, the hardness of the set plaster was found to be a function of the cation of any salt which was present in the mixing water.

Neville (41) obtained similar results but went further in observing the temperature-time phenomena during the set. He noted that the initial set took place before any appreciable evolution of heat had begun. Since the hydration was found to be an exothermic reaction:

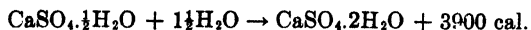

it appeared that the set took place before the hemihydrate had begun to hydrate. Thus it seemed that the set was due to an adsorption of water with the formation of a gel rather than to a chemical reaction with the water to form a hydrate. After the gel is formed, hydration and crystallization take place.

This conclusion was further confirmed by noting the volume changes with time during set. Contraction obtained up to the completion of the set, followed by expansion during hydration. Neville attributed the contraction to adsorption of water and the expansion to the formation of gypsum crystals. Davis (14) had noted that, on heating gypsum, the monoclinic crystals changed to rhombic gypsum before dehydration commenced, and assumed the process to be entirely reversible. He attributed the initial contraction during set to the formation of the rhombic gypsum, and the later expansion to the change in these crystals to the monoclinic form. The results of Neville seem to contradict this view however for in his experiments the contraction occurred only during the period up to the occurrence of the set, at which point no hydration, and consequently no formation of gypsum, had taken place.

Glaserapp (20) has reviewed the theories of setting with respect to the formation of colloids and of crystalline hydration products. Of the colloid products which form when water acts on cement, he lists three classes of material:

- (a) those which retain the gel state for a long time,
- (b) those which solidify by becoming crystalline, and
- (c) those which retain the gel form but which must be considered as crystals because of their optical behavior.

Each of these forms is believed by Glaserapp to appear in the setting cement, but he attributes to crystallization forces a large share of the hardness, especially the increase in strength on aging. This latter he thinks is due to the change from the colloid to the crystalline state. In fact the chief value of the colloids is associated with their tendency to assume a crystalline form (as liquid crystals) and eventually to crystallize completely.

Rankin (46) finds that the aluminates react to form hydrated tricalcium aluminate which may be amorphous when formed, but crystallizes easily. The silicates are thought to form an amorphous material which may be a hydrated low-calcium silicate, but may hydrolyze to form hydrated silica if sufficient water is present.

Rankin lays especial emphasis on the "gelatinous silicate" or "gelatinous silica" which terms he seems to use interchangeably. He attributes the high cementing value of tricalcium silicate to the circumstance that gelatinous silica is released with readiness when tricalcium silicate is mixed with water:

Apparently no crystalline hydrate of the calcium silicates is formed. The gelatinous mixture of lime and silica first formed seems ultimately to become

a mixture of gelatinous silica and crystalline lime hydrate. . . . From this it is evident that tricalcium silicate is the most essential constituent of portland cement, its cementing value being apparently due to the fact that it readily releases gelatinous silica when mixed with water.

Rankin admits that his discussion "which tends to prove that gelatinous silica is the most essential constituent of the cement mortar," is somewhat speculative but he is inclined to believe in the truth of the assumption and suggests that some method by which the silica of dicalcium silicate could be released during hydration would be of immense interest to the production of better concrete.

Desch (15) is inclined to accept the crystallization theory for the setting of plasters, but points out a few observations which indicate that the process is not altogether simple. He recalls that Cloez (10) found the heat evolved during the setting to appear at two different stages, the initial rise in temperature on mixing the plaster with water being followed by a stationary period and then again by a rise in temperature. He continues:

Moreover, the density of the hydrated plaster is different from that which might be expected from the known properties of calcium sulfate and its hydrates. The hemihydrate has a density of 2.75 and the dihydrate of 2.32, and a calculation shows that the latter compound is formed from its components with a contraction of 7 percent, whilst in practice an expansion is observed, and it is in part on account of this property that plaster of Paris finds its application in the making of casts, the expansion enabling it to fill the mould completely, and therefore to take an impression sharply.

Desch observes that the experiments of Davis (14) led him to the conclusion that the crystals of the dihydrate which at first separate are not identical with gypsum, but consist of a second, rhombic modification, which subsequently passes into the stable form.

Desch pointed out that the difference between the theories of Le Chatelier and Michaelis was due to the fact that one worked with dilute and the other with concentrated solutions. Hatschek (24) contended that this indeed was the whole difference, and that "the two theories are not only compatible but even complementary." He says:

It is perfectly possible that the first product of a reaction may be a gel consisting of ultramicro-crystalline elements, and that this may gradually assume a coarser crystalline structure owing to the intermediate true solution of the reaction product.

In concluding the discussion on this subject at the symposium of the Faraday Society in 1919, Desch added:

I think it is very clearly established . . . that we are dealing largely with a difference of terms; that whether one regards the jelly as a mass of extremely minute interlacing particles or not is not of very much importance. At any rate, the essential point is that in the colloidal substance the particles are extremely small, and therefore the surface forces are very important. When you come to crystals of perceptible size, such as in the crystallization of sodium sulfate, the surface forces are very small relatively to the forces of

cohesion. In the case of the ultramicroscopic particles in the colloid, the surface forces are large in proportion to the forces of cohesion, and when that fact is fairly grasped it is seen that there is no great question of fact at issue between the two views.

Perhaps the latest attitude of Le Chatelier on the theory of hardening may be inferred from a paper by Baykoff (4) presented to the French Academy of Sciences by Le Chatelier in 1926.

According to Baykoff, the first hydration of the anhydrous constituents of cement yields colloidal hydrates. Following this the gel crystallizes producing aggregates of large crystals. Even with plaster of Paris, the formation of "a gelatinous mass resembling silica gel" is recorded. In order to explain the formation of colloidal calcium sulfate in the presence of water which can dissolve it,

It suffices to remark, that all substances are insoluble in their saturated solutions and that the condition necessary for the formation of colloids is therefore realized.

Baykoff accordingly regards the hardening of cements as taking place in three successive stages:

The first is that of solution, during which the liquid is saturated progressively with the different soluble elements.

The second is the "colloidation" during which all the products of the chemical reaction form in the colloidal state. That corresponds to the beginning of set.

The third is that of crystallization, during which the gels are transformed into crystalline aggregates. This is the period of hardening, properly speaking.

Practically the same view with respect to the setting of calcium sulfate cements was expressed by Haddon (23) in 1924.

Rosenhain (52) introduced the suggestion that cements may set in much the same manner as metals solidify from fusion. According to the theory of Rosenhain the adhesion of crystals in metals is due to the presence between them of a film of amorphous material—undercooled liquid. He adds:

We may regard cement as consisting, at one stage, of solid grains or crystals lying surrounded by a liquid solution of certain constituents. This liquid then undergoes solidification as the result of the removal of water—either by percolation or by the chemical action, such as the hydration of some of the solid material present. If the film of liquid is thick enough, this solidification may take place by crystallization but if it is very thin it may—by analogy with the phenomena in metals—congeal in an amorphous condition. Even if there is crystallization, in the last resort the final thin films of liquid between the crystals will still solidify as "undercooled" or supersaturated liquid. It is these amorphous films or layers which give to the whole mass its great stiffness and strength, since strength and hardness appear to be essential properties of undercooled liquids.

The basic laws governing the solution and crystallization of matter were ably applied by Le Chatelier in his original theory of crystallization, but a clear understanding of these laws in their application to the setting of cements is sometimes lacking in the discussions found in the literature. Donnan (16) has concisely summarized four postulations setting forth certain fundamental principles of physics in their bearing of this phenomenon:

- (1) *Unequally distributed stress.* If the solid, but not the liquid, be subjected to compressive stress, the solubility will increase. The material thus dissolved will be precipitated in contact with unstressed portions of the solid. In this way granules become cemented together by the formation of crystalline "bridges" of precipitated material. Gravitation may suffice to produce the stress.
- (2) *Unequal size of granules.* Very small particles have a higher solubility than larger particles. Consider a mass of granules of very different sizes, with their surfaces covered with a thin layer of saturated solution. The spaces between the larger granules will be filled with the "fines." The result is that the layer of solution on a fine particle is not in equilibrium with the layer on a neighboring large particle, so that resolution and precipitation (re-crystallization) occur. In this way cementing bridges are formed and the mass sets (cakes).
- (3) *Existence of unstable or metastable forms.* At any given temperatures and for any given solvent an unstable (metastable) crystalline form has a higher solubility than a stable, or more stable, form. Suppose that the granular mass consists of a metastable form which is slowly changing into a more stable form. Imagine a metastable and a stable particle in contact. Resolution occurs at the surface of the former and recrystallization at the surface of the latter, with the result that cementing is produced, just as in the previous cases.
- (4) *Sheared or "flowed" crystal surfaces.* We may call this the "Beilby effect." Owing to grinding or other shearing actions the surface layers of some of the crystalline granules may become "amorphous." Such surface layers will possess a higher solubility than the stable crystalline surfaces. Here we have another action which will tend to produce recrystallization and consequent agglomeration.

Both theories for the setting and hardening of cements have had their champions, and likewise serious difficulties have been shown to follow the too rigid adherence to either of these unmodified theories. The present tendency seems to be to accept the general principles of the crystallization theory as set forth by Le Chatelier and by Donnan, but to recognize likewise the important part played by the amorphous material, as shown by Michaelis and by Kuhl. A large part of the difficulty in the mutual understanding of the two points of view is dispelled by a close examination of the theories and of the behavior of the products in question. As emphasized by Desch and by Hatschek, a closer definition of the exact significance of our terms "colloid" and "crystalloid" leads to the assurance that in the end the same forces and processes are implied, but only that the emphasis is perhaps placed on different aspects of the phenomena.

The Chemical Nature of the Setting and Hardening Processes

In the researches of Le Chatelier (32), it was concluded that:

The fundamental reaction which brings about the hardening is the splitting up of a basic calcium silicate into monocalcium silicate and calcium hydroxide:



There is formed accessorially, a basic calcium aluminate, the rapidity of hydration of which intervenes in the more or less rapid set of different cements:

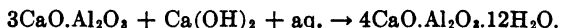

The tetracalcium aluminate was later changed by Le Chatelier to tricalcium aluminate as the product formed under these conditions, but he still believed that the tetracalcium aluminate may be formed under special conditions in a state of metastable equilibrium. "The iron," he stated, "certainly takes no part in the set of portland cements."

Reactions of Hydration. Rich basic slags constituted the subject matter of research by Zulkowski (61), and largely by analogy he arrived at a theory for the setting and hardening of portland cement. Basic slags rich in alumina resembled portland cement in that they hardened without the addition of lime. Hence, Zulkowski argued that portland cement is only a highly basic silica-alumina slag, $4\text{CaO}.\text{Al}_2\text{O}_3.2\text{SiO}_2$, in which there is an excess of free lime present in a "dead-burned" condition.

In order to develop this hypothesis he prepared what he called *hydraulicites* which were believed by him to consist of the pure hydraulic compounds of clinker. He regarded the amount of water taken up in the setting process as the most significant criterion upon which to base the constitution of the products. By such a procedure, Zulkowski came to the conclusion that the dicalcium silicate, and this only in one modification, was a true hydraulicite.

The theory of Zulkowski was disputed, especially by the editors of *Tonindustrie Zeitung* (2) who carried on a most interesting debate with him on these theories for some time.

Rebuffat (48) believed that setting consisted chiefly in the hydration of $2\text{CaO}.\text{SiO}_2$ with the formation of the hydrate $2(2\text{CaO}.\text{SiO}_2).\text{H}_2\text{O}$. Any additional CaO , which might come from a hypothetical composition of $3\text{CaO}.\text{SiO}_2$, was converted into $\text{Ca}(\text{OH})_2$. The alumina he believed to combine with lime in some form less basic than $3\text{CaO}.\text{Al}_2\text{O}_3$ and to hydrate in an indefinite manner. The other constituents, compounds of Fe_2O_3 or MgO were thought to form small amounts of "indifferent slag-like substances." In cements rich in silica, some $\text{CaO}.\text{SiO}_2$ was believed to be present and to react with the aluminates to form a double silicate of lime and alumina. The resistance of such cements to sea-water was attributed to these compounds.

Feret (18), on the other hand, agreed with Le Chatelier that $3\text{CaO}.\text{SiO}_2$ is the essential constituent of clinker. He believed that hardening is due to hydration of the tricalcium silicate, forming $\text{Ca}(\text{OH})_2$ and "more or less of calcium silicate." Feret regarded as impossible the definite identification of this network of fine, unordered crystals.

As a result of an analysis of the various theories that had been presented up to 1901, Meyer (39) came to the following conclusions as the most compatible with the experimental information then available:

The initial set is caused by the hydration and crystallization of the calcium aluminate.

The final set is caused by the beginning of the decomposition of tricalcium silicate.

Hardening is caused by:

- Continuation of the decomposition of tricalcium silicate,
- Crystallization of hydrated dicalcium silicate,
- Slow transformation of hydrated C_3S into anhydrous CS and lime,
- Decomposition of calcium silico-aluminate into hydrated silicate and aluminate, followed by combination of the hydrated aluminate with the CS , and partial carbonation of hydrated lime.

Leduc (33), however, was convinced that dicalcium silicate was the essential hydraulic material of portland cement as well as of some natural cements. An interesting observation was made that on long-continued heating at relatively low temperatures, certain changes were effected in the appearance and volume constancy of the subsequently-prepared set cement, and were attributed to a breaking down of the more basic compounds to $2CaO.SiO_2$ and $2CaO.Al_2O_3$, with liberation of CaO . The free CaO produced swelling and checking of the set cement.

Solid Solutions. Richardson (50) suggested that cements be classified as mild, medium or hard (referring to the Al_2O_3 content) of high, medium or low basicity. Thus "mild cement of high basicity will set very slowly and have great tensile strength. All hard cements will set very rapidly and heat on mixing with water. Between these two extremes the cements will have properties dependent both on the concentration of the aluminates and on the basicity." When the aluminate concentration becomes higher than that represented by $2(3CaO.SiO_2):(2CaO.Al_2O_3)$ a pronounced change in structure results and Richardson regards this as the formation of a eutectic of four solid solutions:

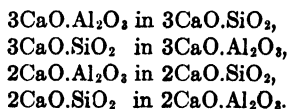

When water is introduced, the equilibrium between these solid solutions is disturbed and calcium hydroxide is liberated. The set is attributed to the crystallization of the calcium hydroxide from the aluminates, and the subsequent hardening to crystallization of calcium hydroxide from the silicates. Thus Richardson believes that the strength of a cement mortar or concrete is due almost entirely to the crystallization of calcium hydroxide and not at all to the hydration of the silicates or aluminates.

Rohland (51) believes that portland cements may contain as much as 30 percent of free CaO and that the hydraulic activity of the cement is due to a reaction of this with undissociated silicic acid, in the colloidal form, which also he believes must be present.

Identification of Phases. Keisermann (25) felt that previous investigations of the processes of hydration had not yielded satisfactory results because the hydration products had not been definitely identified. Accordingly, he studied the staining of various silicates and aluminates and as a result claimed "it was easy to distinguish with absolute certainty the various formations of Al_2O_3 , CaO and SiO_2 ." The reagent for Al_2O_3 was patent-blue; for CaO , alcoholic anthrapurpurine; for free amorphous SiO_2 , neutral methylene blue; for combined silicates, acetic acid solutions of methylene blue.

Keisermann found that in the hydration of calcium silicates, needle crystals were formed which were monocalcium silicate hydrate. There was formed at the same time as a result of the above hydration, and likewise in the hydration of portland cement, a colloidal mass which he believed also consisted of monocalcium silicate hydrate, free from Al_2O_3 .

Large hexagonal crystals were found to consist of $\text{Ca}(\text{OH})_2$. Small hexagonal plates were found to consist of $3\text{CaO} \cdot \text{Al}_2\text{O}_3$.

The hardening of the cement was explained as being due entirely to the hydration of the $2\text{CaO} \cdot \text{SiO}_2$, the fine needles of the $\text{CaO} \cdot \text{SiO}_2 \cdot \text{aq}$ becoming interlaced and penetrating the gel of the same composition. The gel, on hardening, further cemented the crystals together. The $3\text{CaO} \cdot \text{Al}_2\text{O}_3$ was thought to play no part in the hardening process, but by its action as a flux prevented the dusting of the clinker on cooling and accelerated the hydration of the silicate.

Ambrohn (1) studied the behavior of cement during set by placing a small portion of powdered cement on a microscope slide with water, and keeping under a bell jar containing water to prevent evaporation. During the first few days the individual particles of cement were seen to become surrounded by a large number of very fine needles and hexagonal plates, both of which showed negative double refraction. These crystals were not identified. Calcium hydroxide crystals consisting of large hexagonal plates developed after a few days and, if carbon dioxide were not excluded, "biscuit-shaped" crystals of calcium carbonate appeared. After some time these were clouded over with a colloidal film which obscured the crystals.

Read (47) studied the hydration of cements in a similar manner on a microscope slide, but he cemented a cover glass onto the slide to exclude carbon dioxide and prevent evaporation. There were observed three types of crystal formation which he claimed to be as follows:

- (1) Tetracalcium aluminate. These crystals twinned readily through the center of two opposite sides of the hexagon forming complex star-shaped aggregates.
- (2) Calcium sulfoaluminate. These crystals were believed to result from added gypsum or from sulfate present in some of the stack-kiln cements.
- (3) Calcium hydroxide hexagonal plates.

Kuhl (28) believed that a tetracalcium aluminate was formed in the hydration of the aluminates in cement, but Radeff (45) could find no evidence for the existence of such a highly basic aluminate. The end product of hydration of $3\text{CaO} \cdot$

Al_2O_3 , and also of $CaO.Al_2O_3$ and $5CaO.3Al_2O_3$, was found to be a hydrated tricalcium aluminate, provided, in the latter cases, there was sufficient lime in the system.

Malgrain (35) has attempted to define the factors which cause a cement to set and harden. He lists (1) hydration, which takes place rapidly and is complete in a few hours (corresponding to set); (2) desiccation, which occurs when the hardening takes place in air and is complete in a few weeks; (3) carbonation, during which period the lime preëxisting in the cement and that liberated in the reaction becomes carbonated, and which lasts several months; (4), recrystallization, in which process the hydraulic products are said to change in structure forming a much harder material.

The researches on the setting of cements which were conducted at the Bureau of Standards (27)(3) from 1914 to 1917 have been summarized by Klein (26) as follows:

The hydration of cements is brought about by the formation of amorphous hydrated tricalcium aluminate with or without amorphous alumina, the aluminate later crystallizing. At the same time sulfoaluminate crystals are formed, and low-burned or finely ground lime is hydrated. The formation of the above compounds begins within a short time after the cement is gauged. The next compound to react is tricalcium silicate, whose hydration begins within twenty-four hours. Between seven and twenty-eight days the amorphous aluminate commences to crystallize and beta-orthosilicate begins to hydrate. Although the latter is the chief constituent of the American portland cements, it is the least reactive compound.

The early strength (twenty-four hours) of cements is probably due to the hydration of free lime, the aluminates, and the beginning of tricalcium silicate hydration. The increase in strength between twenty-four hours and seven days depends upon the hydration of tricalcium silicate, although the further hydration of aluminates may contribute somewhat. The increase between seven and twenty-eight days is due to any further hydration of tricalcium silicate and to the beginning of hydration of beta-calcium ortho-silicate, but here are encountered opposing forces, in the hydration of any high-burned free lime present and in the crystallization of the aluminate. It is to this hydration that the falling off in strength between seven and twenty-eight days of very high-burned high-limed cements is due, whereas the decrease shown by the high alumina cement is due to the crystallization of the aluminate.

The dicalcium silicate hydrates to a very granular porous mass which allows of ready egress of solutions, and while it is chemically more resistant to the actions of solutions than the tricalcium silicate, yet it furnishes a great number of voids in which salts may crystallize out of solution, and it is consequently very little able to resist the mechanical action of the "freezing out" (crystallization) of salts from solution.

On the other hand, the hydrated tricalcium silicate with its very dense structure, composed of gelatinous (colloidal) silicate interspersed with crystals of lime hydrate, is probably very susceptible to strains produced by alternate wettings and dryings, colloidal material of this kind being subject to considerable volume change resulting from slight moisture changes.

The Chemical Significance of Rate of Set

When portland cement clinker is ground without the addition of any foreign substance, the resulting cement is usually too quick-setting to allow of its being properly mixed and placed before setting takes place. It is therefore common practice to grind with the clinker 2 to 3 percent of gypsum, or its equivalent in SO_3 content of plaster of Paris. This retards the set, giving the cement a reasonably long working life before the set takes place.

Introduction of Retarders. The early history connected with the use of retarders in portland cement has been set forth in a most interesting manner in a personal communication from Robert W. Lesley (34).

The rotary-kiln cements, when first made at the Atlas plant, were so quick-setting as to be almost unsalable and for a time almost destroyed the value of the new method of burning. Somewhere along in the early 90's, the exact date I cannot give you offhand, there was brought to the Atlas Company a French chemist by the name of P. I. Giron, who was made assistant superintendent, I think, and whose business it was to straighten out this quick-setting difficulty of the rotary clinker.

Giron, it appeared, had seen some pavements laid with concrete in France, and the workmen mixed with their water some gypsum, which is very plentiful as you know in that country, and in this way retarded the setting, which gave Giron an idea of using it to make cement slow setting. In some way this information got to the Atlas people, who brought Giron to the U. S., and he did make a rotary cement slow setting, and really made the rotary kiln what it is in our industry.

Lesley himself had been interested in the use of sulfuric acid as a retarder, and took out a patent for such use. Because of the low cost of gypsum as compared with that of the acid, the patent was not an economical success, and as Lesley says, "it died aborning."

Another method which was early used for slowing the set was the introduction of dry steam into the tube mills. This process, writes Lesley, has been used to a limited extent both in this country and in England.

Solubility Studies. Candlot (8) was among the first of the investigators to examine the nature of the action of retarding agents. He studied particularly calcium chloride and calcium sulfate.

Dilute solutions of calcium chloride were found to retard the set; concentrated solutions to accelerate the set. Cements which contained very little aluminate were not affected, whereas those containing large quantities of aluminate were markedly affected by the calcium chloride. Hence, it was argued, the influence of the salt is dependent for its action on the calcium aluminates in the cement. Experiment showed that finely pulverized calcium aluminate ($1.5\text{CaO} \cdot \text{Al}_2\text{O}_3$) entered into solution much more slowly in the calcium chloride solution than in water. The initial set was attributed to the calcium aluminates. Therefore, the delay in the solution of the latter was assigned as the reason for the delay in the time of set in the cement.

With concentrated solutions of calcium chloride the aluminate was found to dissolve more rapidly. If a cement were agitated for a few minutes in a concen-

trated solution of calcium chloride, and filtered, an abundant deposition of crystals resulted, which were believed by Candlot to be calcium oxychloride. This precipitation is more abundant as the cement is less burned, and is nearly absent in well-burned cement. This was believed to explain the acceleration of set by concentrated calcium chloride solutions.

When calcium sulfate is added to cements, experiments by Candlot indicated that the sulfate and aluminates of lime combine in solution with the formation of a flocculent precipitate of calcium sulfoaluminate crystals. The mechanism of the delay in set by the calcium sulfate is given by Candlot as follows:

In the best-made portland cements there always exists a little free lime, and as there is present a little alumina, the free lime rapidly dissolving retards the hydration of the aluminate. The calcium sulfate which goes into solution is insufficient to precipitate out the aluminate, and adds its action to that of the lime to annul the role of the aluminate. Since it is this salt that determines the set, we will therefore have a slow set. If the free lime is carbonated by long exposure to the air, then when water is added the solution of lime is less abundant, and does not retard the solution of the aluminate. Combination with the calcium sulfate can then take place with the formation of calcium sulfoaluminate. Thus the excess of aluminate crystallizing out determines the rapidity of the set.

Meyer (39) expressed nearly the same idea in a very comprehensive paper written in 1901. By calculation, Meyer found that the quantity of gypsum commonly used (2 to 3 percent) can combine with only 0.76 percent Al_2O_3 in the formation of the calcium sulfoaluminate. Since this amount of gypsum satisfactorily retards the set, it is argued that less than one percent of calcium aluminate is present in the "free state" in a normal cement, and that it is this free calcium aluminate which, without the addition of gypsum, would suffice to produce the rapid set. The greater part of the alumina in a normal cement was thought by Meyer to be in the form of a calcium aluminosilicate, which hydrates slowly.

Michaelis (40) maintained that uncombined aluminates are not responsible for the set in well-sintered cements because such cements have all of the alumina in combination as solid solutions in the silicates of lime. This solid solution (the *alite*), therefore governs the setting time,

as it is the first acted upon and decomposed by water; the more *alite* a cement contains and the more alumina this *alite* contains, the more quick-setting is the cement.

The action of the calcium sulfate in retarding the set was attributed entirely to the formation of a voluminous mass of crystals of the calcium sulfoaluminate, which Michaelis referred to as "Cement Bacilli."

Alkali Action. Rohland (51) attributes all changes in the time of set to the formation of catalysts, which may be either positive or negative. Even the part played by the aluminates in determining the set is explained in that manner:

Hydration really is no function of the aluminates, but they may act as positive catalysts during hydration. Such a statement is supported by the fact that Al_2O_3 -rich portland cements hydrate more rapidly than those containing less Al_2O_3 .

Likewise the influence of the degree of fineness of the cement, the kind of storage, the evolution of heat during storage, the light and the moisture content of the air "may assist in the formation of a positive catalyst."

Rohland cites a number of cases where the period of set had changed with time, and where two cements of practically the same ultimate composition had very different times of set. In explanation, Rohland quotes a sentence from a letter written to him by Le Chatelier, "There are some portland cements manufactured from limestones containing potash, and this potash is in the caustic state and accelerates the set." The potash is believed by Rohland to function as a positive catalyst, but his argument is not altogether clear.

The retarding action of gypsum is then explained as due to a neutralizing of the positive catalytic action of the alkalies, or to a lowering of the solution pressure. The change in set with time is said to be due to a chemical reaction taking place slowly which permits the formation of the positive catalyst, resulting in a shorter time of set, or to secondary reactions between the positive catalyst (alkali) and the carbon dioxide or moisture of the air, resulting in the removal of the active catalyst and consequent extending of the time of set.

The function of the alkalies on the set of cement was studied by Erdahl (17) who found that the alkali sulfates and silicates had but little accelerating action on the set, whereas the alkali carbonates tended to produce a flash set if present in amounts greater than a half of one percent.

Grimm (22) reported that all cements contain potassium salts which are converted to the carbonate by the action of moist air, and hence become rapid setting. A sufficient amount of calcium sulfate must then be present to convert all of the potassium carbonate to potassium sulfate and calcium carbonate. This tends to explain the earlier work of Schindler (53) who found that dry carbon dioxide had but little effect on the time of set of cement, but moist carbon dioxide greatly accelerated it. Others (9)(42), however, have found practically no difference in the set or hardness of a cement which had been cured in an atmosphere of carbon dioxide or in the absence of carbon dioxide.

Electrolytic Effects. Reibling (49) believed that on solution of the plaster in cement, the ionized calcium sulfate reduced the solubility of other calcium ions present, causing the lime to be less rapidly dissolved, and the aluminate less rapidly hydrated. The slow hydration of the calcium aluminate brought about a retardation of the set.

Klein and Phillips (27) called attention to the observation that had also been made by other investigators that plaster exhibits its greatest retarding action on the set when present in certain rather small amounts (2 or 3 percent) whereas at lower or higher concentrations, the effect is less. This was used as evidence against Reibling's theory for, according to the latter, increasing amounts of plaster should give continuously slower set. Also, according to Klein and Phillips, the formation of calcium sulfoaluminate in the presence of calcium sulfate is only incidental to the initial set and not the cause of its retardation. The amount of these crystals was at all times small, and increasing the amount of plaster, though increasing the amount of calcium sulfoaluminate crystals, did not retard the set. Furthermore, they write,

The formation of sulfoaluminate needles is not sufficient to account for the retarding action of salts, such as calcium chloride, sodium borate, potassium bichromate, sugar, or other carbohydrates, which, so far as is known, do not form insoluble compounds with aluminates at the concentration used.

Klein and Phillips maintain that

The problem of the retardation of the setting of cement appears to be one involving the action of electrolytes carrying positive or negative charges.

These authors admit however that

Although the action of electrolytes offers the best explanation so far found, nothing has been definitely proven, and much work must be done on the problem.

In a later paper Bates and Klein (3) observed the setting properties separately of tricalcium aluminate, dicalcium silicate and tricalcium silicate, alone and in the presence of gypsum. The tricalcium aluminate was observed to hydrate so rapidly and with the liberation of so much heat "that the mass boils." It was found to agglomerate quickly into balls "which hydrate on the exterior to hard masses which prevent penetration of the water to the interior; consequently, large masses of unhydrated material are present." The addition of plaster of Paris up to 10 percent failed to effect any marked difference in the amount of heat evolved or in the other general properties of the aluminate on mixing with water.

Dicalcium silicate, on kneading with water either alone or with plaster, "produced no more plasticity than would have resulted from the substitution of ground quartz of equal fineness for the silicate."

The tricalcium silicate with water "had all the properties of normal portland cement, excepting a slightly inferior plasticity." With 3 percent of plaster "it even had the plasticity of portland cement, but its initial set was considerably quicker" than without the addition of the plaster.

It will be recalled that Kuhl's theory for the setting of cements required the flocculation of a colloidal precipitate of hydrated calcium silicate from a highly dispersed colloidal solution. The coagulation is stated to be dependent on the concentration of the sol or on the presence of an electrolyte. Kuhl continues his discussion of the set by maintaining that the electrolyte solutions which hasten gelatinization are formed (1) by the alkalis which split off during hydration; (2) by the calcium hydroxide liberated; and (3) by the calcium aluminates which are readily soluble. The aluminates are regarded of especial importance because they form trivalent ions and "the ability of ions to form gels and to coagulate them is dependent on the valence."

This action of the aluminate ions is believed by Kuhl to explain the action of calcium sulfate on the time of set. Concerning this, he writes:

The more calcium aluminate that goes into solution, the more CaSO_4 is required, and both of these constituents disappear from solution as the insoluble salt. As long as there is a supply of CaSO_4 present, which can replace any of the CaSO_4 that has combined to form the insoluble salt, then there is no appreciable concentration of tricalcium aluminate formed and accordingly the

tricalcium aluminate cannot exert its coagulation effect on the gradually forming colloidal solution of the calcium silicate.

Since we have assumed that the set is due to the gelatination of the calcium silicate solution and that this process of gelatination is due to the occurrence of a definite concentration of calcium aluminate, we find an explanation of the action of CaSO_4 in the non-formation of the necessary concentration of the tricalcium aluminate. Thus, when CaSO_4 is present, setting can occur only after the CaSO_4 is used up, or when it is present in very small quantities so that it goes into solution too slowly, . . . or setting may take place in the presence of CaSO_4 if the colloidal hydrated calcium silicate solution is so concentrated that gelatination takes place without the influence of dissolved tricalcium aluminate.

Tippmann (55) takes exception to the theory that the set is due to the coagulation of a colloid, and affirms that it is essentially a crystallization process, and that the function of gypsum is to check the crystal formation and at the same time assist in the formation of colloid material. The very fact that a normal cement without the presence of any retarder sets rapidly (flash set) is offered as evidence that the process must be a crystallization from a supersaturated solution, for the formation and coagulation of a colloid would require much greater time.

Miscellaneous Retarders. Other retarders than the various forms of calcium sulfate have occasionally been suggested and used, but have not become serious competitors of gypsum or plaster. Calcium chloride has been investigated, for example, by Dautrebande (13) and by Ferrari (19). According to Dautrebande a dilute solution of calcium chloride will function to retard the set, but in a concentrated solution, crystalline calcium chloraluminat will be formed, and this hastens the set. Ferrari found that calcium chloride retards the set of calcium silicates, and explained it as due to the extreme rapidity of hydration of CaO in the presence of calcium chloride.

Burchartz (7) claims that sugar delays crystalline formation during hydration, and therefore favors colloidal processes. Hence sugar retards the processes of setting and hardening.

Certain organic substances (5) have been found to form insoluble compounds with the lime of cement, thus retarding the final set, although sometimes accelerating the initial set. This is believed to account for the influence on the set of cement of such organic materials as may be present in the sands used in making the mortars. No evidence was obtained for catalytic action, but the retarding action was believed to be due to a disturbing of the equilibrium.

Various chemicals were employed by Zimmerman (60), but the results did not permit of general conclusions being drawn.

There have been some attempts to determine the relative effectiveness of plaster of Paris, gypsum and anhydrite as retarders of the set of portland cement. Berger (6) and Goslich (21) report that plaster of Paris is the most effective material, and that anhydrite has practically no effect. On the basis of economy and safety, however, mixtures are recommended, as plaster of Paris is said to produce quick setting if used in slight excess. Other investigators (38) however have found no essential difference in the effect of the three forms of calcium sulfate.

It has been generally conceded that the alumina-containing compounds present in cements constitute the one important group of substances upon which the rate of set depends. Some authors regard these as solid solutions of one type or another, some as distinct compounds.

It is seen that the mechanism by which calcium sulfate determines the hydration of the calcium aluminate has received various explanations. Chief among these may be mentioned the following:

(1) The solubility of the aluminate is decreased in the presence of calcium salts. Hence hydration is retarded.

(2) The dissolved aluminate combines with the calcium sulfate to form crystalline calcium sulfoaluminate. This prevents the normal hydration of the calcium aluminate.

(3) Rapid set, induced by alkali carbonates, is eliminated by neutralizing with calcium sulfate.

(4) The set is caused by precipitation of colloidal silicate, induced by ions, especially, trivalent aluminate ions. Calcium sulfate keeps the ion concentration too low to function as above by precipitation of calcium sulfoaluminate.

(5) The set is caused by precipitation of crystalline substances. Calcium sulfate retards the set by checking crystal formation and aiding in colloid formation.

References

1. Ambronn, H., *Tonind. Ztg.*, **3**, 270 (1909); *J. Soc. Chem. Ind.*, **28**, 366 (1909).
2. Anonymous, *Tonind. Ztg.*, **94**, 1579 (1901); **96**, 1345 (1902).
3. Bates, P. H., and Klein, A. A., *Tech. Paper, NBS*, 78 (1917).
4. Baykoff, M., *Compt. rend.*, **182**, 128 (1926).
5. Benson, H. H., Newhall, C. A., and Tremper, B., *J. Ind. Eng. Chem.*, **6**, 795 (1914).
6. Berger, E. E., *Rock Products*, **28**, No. 22 (1925).
7. Burchartz, H., *Zement*, **13**, 11; 509 (1924).
8. Candlot, E., *Bull. soc. encour. ind. natl.*, 1890, p. 682 "Cements and Hydraulic Limes," Paris, 1906.
9. Cartiaux, J., *Rev. materiaux const. trav. pub.*, **184**, 1 (1925).
10. Cloez, C., *Bull. soc. chim.*, **29**, 171 (1903).
11. Colony, R. J., *School Mines Quarterly*, **36**, 1 (1914).
12. Coppet, *Compt. rend.*, **63**, 1324 (1866).
13. Dautrebande, J., *Le Cement*, **26**, 291 (1921).
14. Davis, W. A., *J. Soc. Chem. Ind.*, **26**, 727 (1907).
15. Desch, C. H., *Trans. Faraday Soc.*, **14**, 1; 67 (1919).
16. Donnan, F. C., *Trans. Faraday Soc.*, **14**, 12 (1919).
17. Erdahl, B. F., *Concrete, CMS*, **15**, 17 (1919).
18. Feret, R., *Ann. ponts. chauss.*, **19**, 313 (1890).
19. Ferrari, F., *Atti. cong. naz. chim. pura app.*, 294 (1923).
20. Glasenapp, M. von, *Prot. Ver. deut. Portland Cement, Fab.*, **37**, 245 (1914).
21. Goslich, K., *Tonind. Ztg.*, **50**, 995 (1926).
22. Grimm, R., *Zement*, **15**, 775 (1926).
23. Haddon, C. L., *J. Soc. Chem. Ind.*, **43**, 34 (1924).
24. Hatschek, E., *Trans. Faraday Soc.*, **14**, 53 (1919).
25. Keisermann, S., *Kolloid chem. Beihefte*, **1**, 423 (1910); *J. Soc. Chem. Ind.*, **29**, 1383 (1910); *Cement Eng. News*, **23**, 6; 56 (1911).

26. Klein, A. A., *Trans. Faraday Soc.*, **14**, 14 (1919).
27. Klein, A. A. and Phillips, A. J., *Tech. Paper, NBS*, 43 (1914).
28. Kuhl, H., *Prot. Ver. deut. Portland Cement Fab.*, **45**, 98 (1922); *Zement*, **13**, 362; 374 (1924).
29. Kuhl, H. and Thuring H., *Zement*, **13**, 243 (1924).
30. Landrin, M., *Compt. rend.*, **94**, 1054 (1882); *Ann. phys. chem.*, **3**, 441 (1882).
31. Lavoisier, A. L., *Compt. rend.*, Feb. 17 (1765).
32. Le Chatelier, H., *Compt. rend.*, **94**, 13 (1881); "Experimental Researches on the Constitution of Hydraulic Mortars," translated by J. L. Mack, New York, McGraw Book Co. 1905; *Trans. Faraday Soc.*, **14**, 9 (1919).
33. Leduc, E., *Int. Assoc. Testing Materials*, 1902.
34. Lesley, R. W., Personal communication. Also "History of the Portland Cement Industry in the U. S.," Chicago, International Trade Press, 1924.
35. Malgrain, H., *Rev. materiaux const. trav. pub.*, **186**, 57 (1925); **187**, 91 (1925).
36. McVay, T. N., U. Ill. Eng. Exp. Sta. *Bull.* 163, p. 40 (1927).
37. Marignac, *Ann. chim. phys.*, **10**, 427 (1844).
38. Meade, R. K., "Portland Cement," p. 602, Easton, Chemical Publishing Co., 3rd. ed., 1926.
39. Meyer, A., *Baumaterialienkunde*, **6**, 141; 159; 181; 212; 232; 248; 293; 309; 326; 347; 368 (1901); **7**, 75; 111; 140; 156 (1902).
40. Michaelis, W., *Tonind. Ztg.*, **16**, 105 (1892); *Chem. Ztg.*, 982 (1893); *Baumaterial.*, **11**, 333; 352; 366; 381 (1906); *Protokoll Ver. deut. Portland Cement Fab.*, **32**, 206; 244 (1909); *J. Soc. Chem. Ind.*, **28**, 836 (1909).
41. Neville, J., *J. Phys. Chem.*, **30**, 1037 (1926).
42. Nitzsche, H., and Gundel, W., *Zement*, **14**, 484 (1925).
43. Phillips, A. J., *J. Am. Ceram. Soc.*, **2**, 708 (1919).
44. Pulfrich, H., and Linck G., *Kolloid Z.*, **34**, 117 (1924).
45. Radeff, K., *Zement*, **14**, 177 (1925).
46. Rankin, G. A., *Trans. Faraday Soc.*, **14**, 23 (1919); Chap. 15 in "Chemistry and Industry," edited by H. E. Howe, New York, 1925.
47. Read, E. J., *J. Soc. Chem. Ind.*, **29**, 735 (1910).
48. Rebuffat, O., *Gazz. chem. ital.*, **28**, 209 (1898); *Tonind. Ztg.*, 782 (1899); *Baumaterialienkunde*, **4**, 161; 205; 237 (1899); *Tonind. Ztg.*, **117**, 1579 (1902).
49. Reibling, W. C., and Reyes, J. D., *Philippine J. Sci.*, **5**, 367 (1911); **6**, 207 (1911).
50. Richardson, C., *Cement*, **4**, 276; 340; 422 (1903); **5**, 40; 87; 91; 117; 201; 261; 311 (1904); **6**, 18 (1905); *Eng. News*, **53**, 84 (1905).
51. Rohland, P., *Baumaterialienkunde*, **5**, 116; 134; 321; 361 (1900); *Z. anorg. Chem.*, **21**, 28; *Kolloid Z.*, **4**, 233 (1909); **8**, 251 (1911); "Portland Cement from the Physico-Chemical Standpoint," Leipzig, 1903.
52. Rosenhain, W., *Trans. Faraday Soc.*, **14**, 52 (1919).
53. Schindler, D., *Prot. Ver. deut. Portland Cement Fab.*, **30**, 103 (1907).
54. Schott, O., *Zement*, **10**, 294; 306; 328 (1921).
55. Tippmann, F., *Zement*, **13**, 135; 147 (1924).
56. Traube, J., *Kolloid Z.*, **25**, 62 (1919).
57. Vicat, L. J., "A Practical and Scientific Treatise on Calcareous Mortars and Cements," translated by J. T. Smith, London, 1837.
58. White, A. H., *Proc. Am. Soc. Testing Materials*, **14**, 203 (1914); *5th Colloid Symposium Monograph*, Chemical Catalog Co. (Reinhold Publishing Corp.) 1927.
59. White, A. H. and Bateman, J. H., *J. Am. Concrete Inst.*, **22**, 535 (1926).
60. Zimmerman, L., *Bauingenieur*, **5**, 416 (1924).
61. Zulkowski, K., *Chem. Ind.*, **21**, 69; 96 (1898); **24**, Nos. 10-16 (1901); *Tonind. Ztg.*, **96**, 1725 (1902).

CHAPTER 22

The System CaO-SiO₂-H₂O

Studies looking into the nature of the reactions between cements or cement compounds with water have been made by a great many investigators, as shown in the previous chapter. Many different theories have been developed. In this chapter the more modern concepts will be reviewed of the reactions between the calcium silicates and water or, more broadly, of the system CaO-SiO₂-H₂O.

The interactions of the cement compounds with water may be considered as of two kinds, which are referred to as reactions of hydrolysis and reactions of hydration. In practice both types of reaction occur in connection with most of the constituents of cement simultaneously, but for purposes of a better understanding it is important to distinguish between them and to treat them separately. The qualities of a cement in the production of a mortar or concrete* are determined in large measure by the character of these reactions, the rate with which they take place, and the nature of the resulting end-products.

The Principles of Hydrolysis and Hydration

A reaction of *hydrolysis* may be defined as an interaction with water such that the H ion of the water becomes associated with the anion of the compound, and the OH ion becomes associated with the cation. Thus 3CaO·Al₂O₃ may be written as a salt Ca₃Al₂O₆. By a reaction of complete hydrolysis, we could write the hypothetical equation

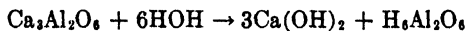

The Ca(OH)₂, being a strong base, remains in the solution, in ionized form, as Ca⁺⁺ + 2(OH)⁻ or, from saturated solutions, may precipitate as Ca(OH)₂. But the H₆Al₂O₆, being a very weak acid, is scarcely at all ionized and, being nearly insoluble in water, precipitates out. It is usually written Al₂O₃·3H₂O or Al(OH)₃.

Hence the actual equation of complete hydrolysis in this case would be

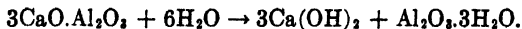

A hydrolytic reaction, however, does not always proceed to completion. Thus when 3CaO·SiO₂ is completely hydrolyzed we have

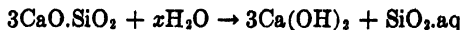

but if only one mol of CaO were removed by such a reaction, we would have



* A *mortar* is distinguished from a *concrete* by being made from a mixture of cement and water with fine aggregate (sand) only. A *neat cement* contains no aggregate, whereas a *concrete* contains both fine and coarse aggregate.

and, if two mols of CaO were removed, we would have

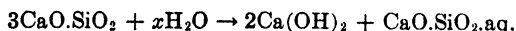

The actual course of a hydrolytic reaction will be determined by an application of the mass law and solubility product. According to the *mass law*, the velocity of any chemical reaction is proportional to the molecular concentrations of the reacting components. Hence, at a state of equilibrium, the product of the concentrations of the active components on one side of a chemical equation, divided by the product of the concentrations of the active components on the other side of the equation, is a constant. Thus carbonic acid may ionize in two stages:

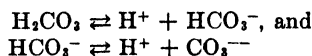

By application of the mass law (brackets indicating concentrations)

$$\begin{aligned} \frac{[\text{H}^+] \times [\text{HCO}_3^-]}{[\text{H}_2\text{CO}_3]} &= k_1 \text{ (primary ionization constant), and} \\ \frac{[\text{H}^+] \times [\text{CO}_3^{--}]}{[\text{HCO}_3^-]} &= k_2 \text{ (secondary ionization constant).} \end{aligned}$$

By combining these equations, we have

$$\frac{[\text{H}^+]^2 \times [\text{CO}_3^{--}]}{[\text{H}_2\text{CO}_3]} = k \text{ (ionization constant)}$$

The separate values obtained for k_1 and k_2 reveal that the ionization constants for the primary and secondary ionizations of polybasic acids or polyacidic bases are different and have to be separately considered. This will be found to apply also to the cement compounds.

The *law of heterogeneous equilibrium* states that, when a compound exists in two phases, equilibrium is reached when the ratio of the concentrations of the substance in the two phases is a constant. Thus the solubility of BaSO_4 in water may be expressed

$$\frac{[\text{BaSO}_4]_{\text{solution}}}{[\text{BaSO}_4]_{\text{solid}}} = k \text{ (molecular solubility)}$$

But since the concentration in the solid phase is fixed and constant, the concentration of the BaSO_4 in the solution in equilibrium with the solid phase is also constant, and this value is the molecular solubility of the material.

The BaSO_4 in the solution will be ionized according to the equilibrium

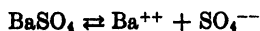

and the ionization constant would be written

$$\frac{[\text{Ba}^{++}] \times [\text{SO}_4^{--}]}{[\text{BaSO}_4]} = k$$

Any increase in Ba^{++} (as by the addition of BaCl_2) would have to result in a decrease in SO_4^{--} , and any increase in SO_4^{--} (as by the addition of Na_2SO_4)

would have to result in a decrease in Ba^{++} , either effect resulting in an increase in un-ionized $BaSO_4$ in the solution. But, since the solution is saturated, the excess $BaSO_4$ must precipitate out of solution. This principle may be generalized in the *law of solubility products* which states that, in saturated solutions, the product of the ion concentrations (each raised to the power corresponding to the number of that kind of ion formed from the ionization of one molecule of the salt) is a constant. The application of these principles to the hydrolysis of the cement compounds will be apparent as we proceed.

It will be obvious that the state of equilibrium in a hydrolytic reaction will be established by the concentrations which are allowed or caused to be built up in the solution. If the soluble products of the reaction are removed, hydrolysis may become complete; if they are not removed, an intermediate state may be reached at which no further action will take place.

Hydration, as contrasted with hydrolysis, implies only the direct addition of the elements of water to the anhydrous or partially hydrated compound. Thus $CuSO_4$ is a white material, but takes up water very rapidly to form the blue vitreol, $CuSO_4 \cdot 5H_2O$. It should be understood that hydration is not an absorption of water, or a surface condensation, but a taking up of the elements of the water into the crystal structure of the compound.

Hydrolytic Reactions of the Calcium Silicates

It was noted by Forsen (10) and Hedin (13) that the rate of solubility of CaO varies greatly depending on its source. Thus when 3-g portions of CaO (passing a 4900-mesh sieve) were shaken with 1-liter portions of CO_2 -free water at 20° , the quantities of dissolved CaO at various time periods were found to be as follows:

Source of CaO	CaO dissolved, g/liter			
	1 min.	5 min.	15 min.	25 min.
Burned $Ca(OH)_2$, 600°	1.091	1.245	1.256	1.256
Hard-burned CaO	1.022	1.078	1.162	1.203
Light-burned CaO	0.952	1.049	1.152	1.203
Precipitated $Ca(OH)_2$	0.895	0.952	1.006	1.035

Since a saturated solution at this temperature contains 1.26 g per liter of CaO , it is seen that the lime produced by burning $Ca(OH)_2$ at 600° goes into solution very rapidly, attaining near saturation in 5 minutes, whereas none of the other forms reached saturation in 25 minutes.

None of these limes, however, gave a supersaturated solution, but such solutions are readily obtained by shaking C_3S or alkali-free cement clinker with water. Thus Forsen (10) and Hedin (13) obtained a solution having a CaO content of 1.7 g per liter by a 5 minute stirring of 600 g of alkali-free cement with 1 liter of water. On continuing the stirring for 2 hours, the CaO dropped to 1.45 g per liter, so that the solution was still strongly supersaturated. This tendency of cements to form solutions supersaturated with respect to $Ca(OH)_2$ has often

been noted and must be borne in mind in considerations of the behavior of cement solutions. It is due to the speed of solution of the CaO formed on hydrolysis of the C_3S being greater than the speed of crystallization of the Ca(OH)_2 . Hedin (13) reports that if no Ca(OH)_2 crystals are present, the lime solution remains unchanged up to concentrations of 1.5–1.6 g CaO per liter.

Complete Hydrolysis. Experiments were undertaken by Lerch and Bogue (17) to determine the nature of the hydrolysis of calcium silicates which would result on the removal of the Ca(OH)_2 as it was formed in the solution. Molar equivalent weights of the three calcium silicates were used (5 g of C_3S , and 3.67 g each of β and $\gamma\text{-C}_2\text{S}$), these being placed in 1-liter quantities of water. The flasks were

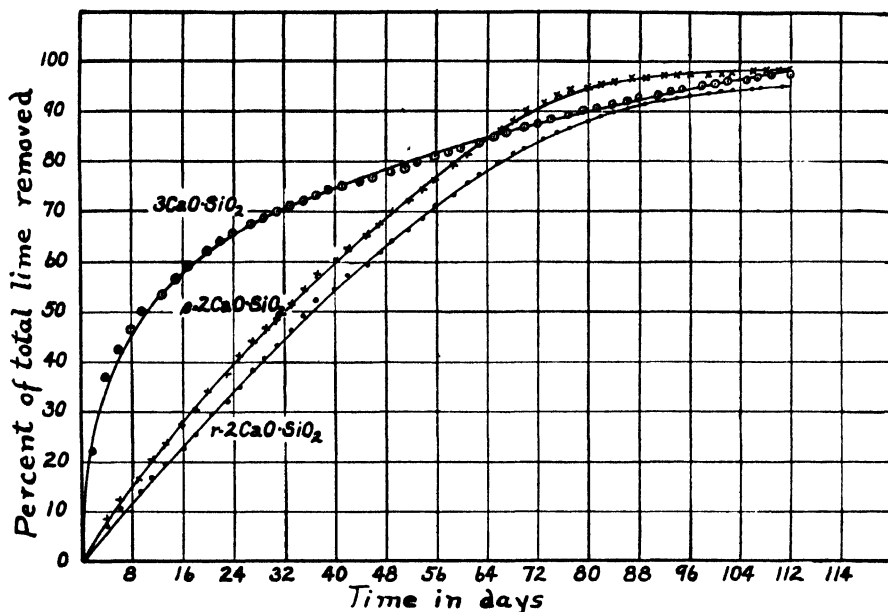

Figure 179. Percent of lime removed from the calcium silicates at various time periods by intermittent extraction with water removed every two or three days. (Lerch and Bogue)

shaken frequently and every second or third day 900 ml of the supernatant solutions was siphoned off and replaced by 900 ml of distilled water. The amounts of lime removed in this manner were determined. The percentages of the total CaO removed in solution, plotted against time, are shown in Figure 179.

The hydrolysis of the C_3S proceeded so rapidly at first that, in 4 days, the amount of lime extracted was more than a third of the total lime in the original compound. This is equivalent to about 1 mol. After this period the extraction proceeded much more slowly. The rate of extraction of the lime from the $\beta\text{-C}_2\text{S}$ slightly exceeded, in this experiment, that from the $\gamma\text{-C}_2\text{S}$, but both of these rates were far below that for C_3S at early periods. After 112 days the titration curves indicated that 95 to 98 percent of the lime had been extracted in all cases. An analysis of the residues showed that they consisted of nearly pure hydrous silica.

Hydrolytic Equilibrium. To learn the limit of hydrolysis that could occur when the soluble products were not removed, it was necessary to ascertain the ion concentrations at which each of the several compounds reaches a state of equilibrium, neither combining with water in reactions of hydrolysis nor with base in the formation of compounds of higher basicity. The method employed by Lerch and Bogue (17) consisted in noting the change in pH* resulting upon adding the compounds to solutions of $\text{Ca}(\text{OH})_2$ and NaOH .

The pH of equilibrium of the compounds in $\text{Ca}(\text{OH})_2$ solution at 30° was determined by placing 4 g of the compounds separately in 200 ml of $\text{Ca}(\text{OH})_2$ solutions of various concentrations from zero to saturated. At the end of a week the pH measurements showed the values:

Original $\text{Ca}(\text{OH})_2$ solution		C_2S pH	$\beta\text{-C}_2\text{S}$ pH	$\gamma\text{-C}_2\text{S}$ pH
Conc. g/l	pH			
1.152 ^a	12.37	12.45	12.40	12.39
0.568	12.18	12.45	12.35	12.31
0.210	11.83	12.43	12.35	12.19
0.000	6.72	12.44	12.12	12.02

^a Saturated solution.

The three calcium silicates showed, in each case, increases in the pH of the solutions to which they were added, indicating that hydrolysis was taking place with the formation and ionization of $\text{Ca}(\text{OH})_2$, and this occurred even in the presence of saturated $\text{Ca}(\text{OH})_2$. This action was further confirmed by the formation of crystals of $\text{Ca}(\text{OH})_2$ on the sides of the flasks. The C_2S formed such crystals within 24 hours, and the β and $\gamma\text{-C}_2\text{S}$ in 10 to 12 weeks. The development of an OH-ion concentration in excess of that of a saturated solution of $\text{Ca}(\text{OH})_2$ indicates an activity of hydrolysis at a rate sufficient to cause a supersaturation of $\text{Ca}(\text{OH})_2$, or the presence of very fine crystals in the process of formation, during which period the solubility is increased, as later confirmed by Forsen (10) and Hedin (13).

Since hydrolysis occurs, even of the dicalcium silicates, the final product of hydrolysis, under the conditions of the test, must be lower in CaO than is indicated by the ratio $2\text{CaO}:\text{SiO}_2$. Le Chatelier (16) believed the stable silicate to have the formula $\text{CaO}.\text{SiO}_2.2.5\text{H}_2\text{O}$. Newberry and Smith (21) found values ranging from 1.5–2.0 CaO to SiO_2 . Rankin (23) thought a hydrous silica might be formed. Lerch and Bogue (17) showed that hydrous silica could not be formed by hydrolysis in saturated limewater by noting that freshly-precipitated hydrous silica combined with $\text{Ca}(\text{OH})_2$, when stored in a saturated solution of lime-water for a period of 12 months, to such an extent that 97 percent of the SiO_2 had become acid-soluble. The soluble residue had the composition $1.07\text{CaO}:\text{SiO}_2$.

$$* \text{pH} = \log_{10} \frac{1}{[\text{H}^+]}$$

Since the OH-ion concentrations obtainable with Ca(OH)_2 are limited by its low solubility, NaOH also was employed as before. The results are given below:

NaOH pH	C_2S pH	$\beta\text{-C}_2\text{S}$ pH	$\gamma\text{-C}_2\text{S}$ pH
13.72	13.72	13.74	13.71
12.94	13.03	13.01	13.00
12.58	12.67	12.63	12.64
12.20	12.61	12.28	12.25
11.93	12.58	12.15	12.07

The calcium silicates were found to react in NaOH very much as in Ca(OH)_2 solutions. In low concentrations of NaOH, hydrolysis took place, producing an increase in pH and the formation of Ca(OH)_2 crystals. But, as the concentration of the NaOH increased, the pH changes decreased. This would be expected on the basis of hydrolytic equilibria, for as the OH ion increases the hydrolytic reaction potential decreases and, at some value, will be zero. At a pH of 13.7 there appeared to be no hydrolysis, there was no increase in pH, and no crystals of Ca(OH)_2 appeared.

The above work indicates that hydrolysis occurs with the calcium silicates of portland cement. In the presence of an excess of water, these compounds appear to hydrolyze to Ca(OH)_2 and a hydrous silicate of a composition lower in CaO than $2\text{CaO}\cdot\text{SiO}_2$ and higher in CaO than $\text{CaO}\cdot\text{SiO}_2$. The probable composition appears to be close to $3\text{CaO}\cdot 2\text{SiO}_2\cdot\text{aq}$.

The OH-ion concentrations of the solutions necessary to prevent hydrolysis of the silicates at 30° were found to be, in all cases, about pH 13.7. The pH of saturated Ca(OH)_2 solution at 30° is 12.4.

Interaction with Excess of Water. Thorvaldson and his co-workers (27) found that hydrolysis takes place on shaking portland cement with water until a definite OH-ion concentration is reached but, as the cement is extracted with successive portions of water, the rate of hydrolysis gradually decreases and reaches a constant value indicating that the hydrolysis takes place in several steps, the compounds which are formed being in equilibrium with successive concentrations of OH ion. Shelton (26) found that, on shaking 2.5 g portions of cements and cement compounds with 30 ml of water, Ca(OH)_2 crystals appeared only from portland cement, white portland cement and tricalcium silicate. Bates and Klein (1) found that, with smaller proportions of water, Ca(OH)_2 crystals are formed also from hydrating C_2S .

In order to clarify the different results which had been reported, Lerch and Bogue (17) agitated the pure cement compounds with water at 30° in such proportions that, if all of the lime entered the solution as Ca(OH)_2 , it still would be insufficient to saturate the solution. The OH-ion concentrations of each sample were determined at definite time intervals until no further change in pH with time was observed. These determinations served, therefore, both as a measure of the rate of hydrolysis and as a measure of the total hydrolysis which had taken place. In these experiments, 200 ml of water, free from carbon dioxide, was used, and

such a quantity of each compound as would result in the formation of 0.29 g $\text{Ca}(\text{OH})_2$ if the lime which each contained were converted completely to $\text{Ca}(\text{OH})_2$.

The results are shown in Figure 180. It will be seen that, under the conditions of the experiment, the amount of lime liberated by hydrolysis of the C_3S and C_4A (as indicated by the pH) is greater than that liberated by the other compounds (which included also $\beta\text{-C}_2\text{S}$, $\gamma\text{-C}_2\text{S}$, C_6A_3 and C_2F), even though the total amount of lime present in the system was the same in each case. The calcium aluminates reacted very rapidly and reached an apparent equilibrium in about one day, whereas the calcium silicates and calcium ferrite required 8 to 12 days to reach this condition. When the solution is allowed to remain in contact with the solids,

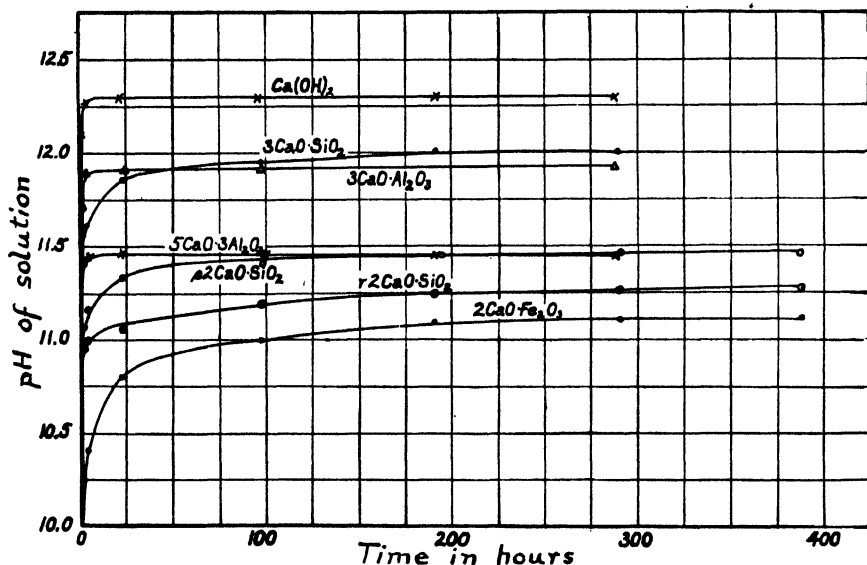

Figure 180. Hydrolysis of cement compounds as measured by pH at varying time intervals, the total $\text{Ca}(\text{OH})_2$ content in each case being 0.145 percent. (Lerch and Bogue)

as in this case, equilibrium is eventually established between the solid phase and the $\text{Ca}(\text{OH})_2$ in solution.

The foregoing conclusions were confirmed in large measure by Thorvaldson and Vigfusson (29) who shook various quantities of C_3S and $\beta\text{-C}_2\text{S}$ in water in steel and gold tubes for various periods of time and measured pH and CaO in solution. The hydrolysis of C_3S was found to proceed rapidly and smoothly, reaching a maximum pH and CaO content in 5 or 6 days, and thereafter to fall off slightly. The C_2S , however, hydrolyzed slowly for about 2 days and then became rapid for a few days, after which it slowly increased. This was found to be characteristic for $\beta\text{-C}_2\text{S}$ and suggests that the hydrolysis takes place in two steps.

The data showed further that both silicates liberate CaO by hydrolysis until a supersaturated solution is produced, and that the final residue in equilibrium with saturated or unsaturated solutions of $\text{Ca}(\text{OH})_2$ never has a lime-silica ratio

greater than $3\text{CaO}:2\text{SiO}_2$. There was no indication of a stable hydrated C_2S . With decreasing concentrations of dissolved $\text{Ca}(\text{OH})_2$, the composition of the hydrated material changed almost as a direct function of the concentration until the lime-silica ratio was about 1:1.

Nacken (19) reported later that from a mixture of 1.24 g C_2S with a liter of water, the hydrolysis proceeded only to C_2S hydrate. At lower concentrations, however, the C_2S_2 and CS hydrates were formed.

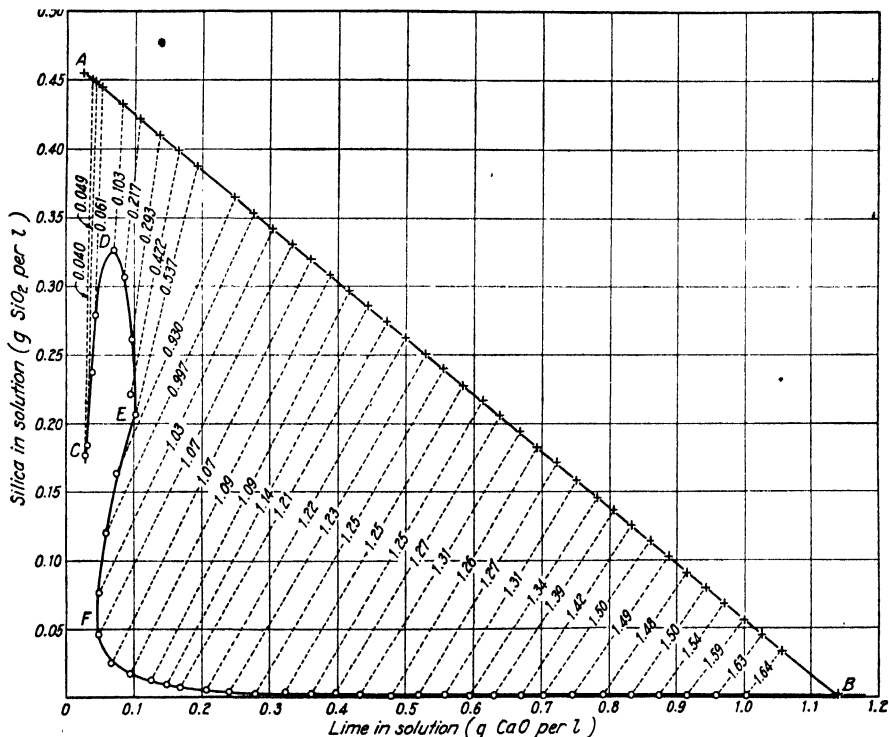

Figure 181. Showing the quantity of silica at 30° in solutions of increasing lime concentration which are saturated with respect to hydrated solid phases containing lime and silica in the molar proportions shown. (Flint and Wells)

In most of the investigations on the action of lime and silica with water at ordinary temperatures, the hydrated silica has appeared as a gel, but crystals have been reported in a few cases. Pulfrich and Linck (22) noted the formation of needles having refractive indices of $\alpha = 1.498$ and $\gamma = 1.500$ during the hydration of C_2S . Bessey (4) noted the formation of crystals on the hydration of $\beta\text{-C}_2\text{S}$ on slides with a large excess of water and, since no $\text{Ca}(\text{OH})_2$ was observed, it was concluded that these crystals were hydrated C_2S . The mean index was 1.590. C_2S similarly treated gave only an amorphous gel and $\text{Ca}(\text{OH})_2$.

Ionization Constants. A study of the system $\text{CaO-SiO}_2\text{-H}_2\text{O}$ by Flint and Wells (9) was carried out by mixing a silica sol with $\text{Ca}(\text{OH})_2$ solution containing 1.15 g CaO per liter and noting the ratio of CaO to SiO_2 in the resulting pre-

precipitates after a period of a month at 30°. The silica sol was prepared by boiling a purified silica gel with dilute limewater for several days. The resulting sol contained 0.4 to 0.5 g SiO₂ and 0.02 to 0.05 g CaO per liter. CaO and SiO₂ were determined in the filtrates, and the CaO:SiO₂ ratios in the precipitates were noted by differences between the compositions of the solutions before and after precipitation.

The results of these tests are shown in Figure 181, where the curve *CDEFB* represents the solubility of SiO₂ in solutions containing increasing concentrations of CaO. The initial compositions of the unstable lime-silica solutions are represented by points on the diagonal line *AB*. Broken lines from these points connect the initial and final compositions. The figures accompanying these lines give the molar ratios of CaO to SiO₂ in the precipitates.

It will be seen that the concentrations of SiO₂ in the solutions rise sharply from *C* to *D*, and then decrease to *E*, where the direction changes to *F*. Between *F* and *B* the amount of SiO₂ in solution decreases to very low values. The authors consider that the solid phases in equilibrium with solutions along *CD*, since they contain only a few hundredths of a mol of CaO per mol of SiO₂, may consist of hydrated silica with a small amount of adsorbed CaO. Hence the segment *CD* represents, according to Flint and Wells, the compositions of solutions saturated with respect to hydrated SiO₂, at increasing concentrations of CaO. The solid phases along *DE* vary in CaO:SiO₂ from 0.2 to 0.5 but are believed to be correctly considered as 0.5, that is 1CaO:2SiO₂, and the segment *DE* thus represents the compositions of solutions saturated with respect to CaO.2SiO₂.aq. The solid phases along *EF* have a CaO:SiO₂ ratio of 1 and this segment represents the compositions of solutions saturated with respect to CaO.SiO₂.aq. The highest ratio of CaO:SiO₂ obtained in the solid phase along *FB* was 1.64 but supplementary experiments gave values up to 1.85. The authors conclude that the molar ratio of 2CaO.SiO₂.aq is approached when the solid phase is in equilibrium with saturated lime solution.

From the above relationships, Flint and Wells consider that the calcium silicates present in the system CaO-SiO₂-H₂O at 30° are salts not of meta-silicic acid (H₂SiO₃), but of orthosilicic acid (H₄SiO₄), of which four replacements are possible: Ca(H₂SiO₄)₂, CaH₂SiO₄, Ca₃(HSiO₄)₂ and Ca₂SiO₄, having molar CaO:SiO₂ ratios of 1:2, 1:1, 3:2 and 2:1. The hydrolytic reactions and the corresponding mass-action equilibrium expressions, assuming complete dissociation of Ca(OH)₂ and of the calcium silicates, may be written as follows, where *K*_{A1}, *K*_{A2}, *K*_{A3} and *K*_{A4} are the equilibrium constants for the successive stages in the hydrolysis of Ca₂SiO₄:

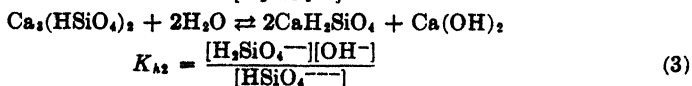
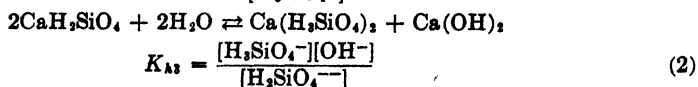
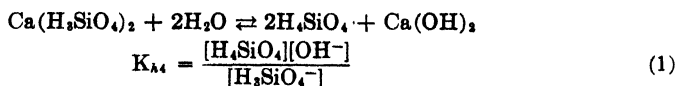

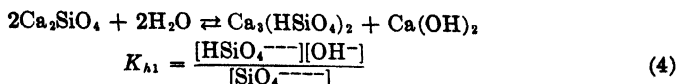

The values for the four hydrolysis constants were obtained experimentally by determining the potentials, against calomel half-cells, of solutions prepared in the regions of the system (as indicated above and shown in Figure 181) where the ionizations indicated obtain. An example of the data recorded for the determination of K_{A4} is given in Table 32.

TABLE 32. Data used in calculating hydrolysis constant K_{A4} (Equation 1)

No.	Composition of solutions		Emf of cell, volts	CaO corresponding to emf g/l	pH	Molar ratio of combined CaO to total SiO ₂ in solution	SiO ₂ in excess of Ca(H ₂ SiO ₄) ₂ g/l	$K_{A4} \times 10^4$
	CaO g/l	SiO ₂ g/l						
2	0.0846	0.3136	0.82872	0.00267	9.73	0.280	0.1324	7.44
4	.0720	.2668	.82802	.00261	9.72	.279	.1126	7.40
6	.0584	.2226	.8241	.00229	9.66	.270	.0975	6.96
8	.0467	.1781	.8219	.00215	9.62	.268	.0781	6.82
10	.0292	.1113	.8191	.00196	9.57	.262	.0488	6.51
12	.0175	.0668	.8183	.00191	9.56	.250	.0293	6.81
14	.0058	.0223	.8079	.00138	9.39	.213	.0099	6.68

From the above, and similar data in the other regions of the system, the hydrolysis constants were obtained as follows:

$$K_{A4} = 6.8 \times 10^{-5}$$

$$K_{A3} = 6.0 \times 10^{-3}$$

$$K_{A2} = 1.5 \times 10^{-3}$$

$$K_{A1} = 1.2 \times 10^{-3}$$

From these hydrolysis constants the ionization constants of orthosilicic acid can be obtained by a simple relationship. The acid is assumed to ionize in four stages represented by the equations:

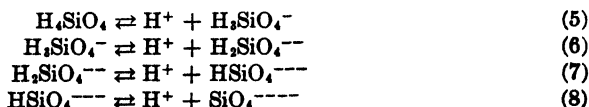

The mass law expression for equation 5 would be:

$$K_{A1} = \frac{[\text{H}^+][\text{H}_3\text{SiO}_4^-]}{[\text{H}_4\text{SiO}_4]}$$

but from equation 1,

$$[\text{H}_3\text{SiO}_4^-] = \frac{[\text{H}_4\text{SiO}_4][\text{OH}^-]}{K_{A4}}$$

hence, by substitution,

$$K_{A1} = \frac{[\text{H}^+][\text{OH}^-]}{K_{A4}} = \frac{K_w}{K_{A4}}$$

where K_w is the ionization constant for water. In a similar manner,

$$Ka_2 = \frac{[H^+][H_2SiO_4^{--}]}{[H_3SiO_4^-]} = \frac{K_w}{K_{A3}}$$

$$Ka_3 = \frac{[H^+][HSiO_4^{---}]}{[H_2SiO_4^{--}]} = \frac{K_w}{K_{A2}}$$

$$Ka_4 = \frac{[H^+][SiO_4^{----}]}{[HSiO_4^{---}]} = \frac{K_w}{K_{A1}}$$

Using the value $K_w = 1.47 \times 10^{-14}$, the ionization constants are obtained:

$$Ka_1 = 2.2 \times 10^{-10}$$

$$Ka_2 = 2.0 \times 10^{-12}$$

$$Ka_3 = 1.0 \times 10^{-12}$$

$$Ka_4 = 1.0 \times 10^{-12}$$

These values may be compared with those obtained by other investigators. Harmon (12) obtained for Ka_1 , 1.6×10^{-10} , and for Ka_2 , 5.1×10^{-17} . Bogue (5) found $Ka_1 = 4.8$ to 18.3×10^{-10} , and $Ka_2 = 5.2$ to 16.7×10^{-12} . Hagg (11) found $Ka_1 = 1.0 \times 10^{-9}$, and $Ka_2 = 1.0 \times 10^{-13}$.

Interaction at Higher Concentrations. A study of the action of water on the pure calcium silicates using somewhat higher concentrations was investigated by Flint and Wells (9). The powdered material was shaken with water, 20 grams per liter, for various periods following which the solutions were filtered, analyzed for CaO and SiO₂, and pH measurements made. The compounds CS, C₃S₂, γ-C₂S, β-C₂S and C₃S were thus examined.

The most significant results of this study were the various rates and amounts of liberation of CaO to the solution as shown by the different compounds. These data are given in Figure 182, where it will be seen that the CS, C₃S₂ and γ-C₂S give very little CaO to the solution during a period of 8 hours, the β-C₂S gives a larger amount, and the C₃S gives very large amounts even during the first hour. As shown by Lerch and Bogue (17), saturation of Ca(OH)₂ is quickly reached and passed. The amounts of SiO₂ liberated to the solution also were found to vary with the several compounds. In the case of the CS, there was no evidence obtained of the formation of a metastable solution, but with all of the other compounds the amount of dissolved silica first increased to a maximum with time and then dropped off sharply with the gradual increase in the concentration of lime. The pH measurements indicate that the CS solution contains a mixture of CaH₂SiO₄ and Ca(H₂SiO₄)₂; the γ-C₂S, principally CaH₂SiO₄; the β-C₂S, CaH₂SiO₄ with increasing amounts of Ca₃(HSiO₄)₂ being formed as the lime concentration increases; and the C₃S, Ca₂SiO₄, each with water of hydration.

A commercial portland cement treated in the same way, gave a solution supersaturated with respect to Ca(OH)₂ at 8 hours, and which contained concentrations of silica in metastable condition comparable to those supplied by C₃S and β-C₂S at corresponding lime concentrations. A calculation of the CaO:SiO₂ molar ratio showed this value to increase from 1.21 at 1 minute to 1.74 at 30 minutes, and indicates that C₃S.aq. and Ca(OH)₂ are products of the reaction of portland cement with water under usual conditions, the hydrolysis of the C₃S.aq being repressed by the supersaturated solution of the Ca(OH)₂. Such a reaction,

involving the formation of supersaturated solutions from the anhydrous cement compounds, followed by the rapid precipitation of the less soluble hydrated compounds, is in agreement with the theory of hydraulic reactions formulated by Le Chatelier. The subsequent hardening may then take place by the withdrawal of water from the hydration products in accordance with the theory advanced by Michaelis.*

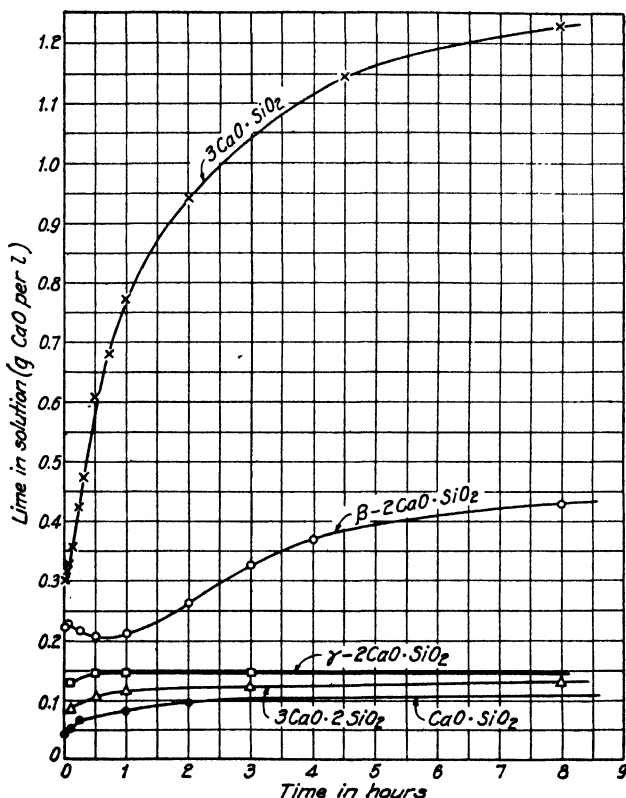

Figure 182. Showing the relative rates of liberation of lime to solution by the anhydrous calcium silicates. (Flint and Wells)

A treatment of the atomic structure of the calcium silicate hydrates (as also of the hydrates involving alumina and iron oxide), as revealed by a study of their X-ray characteristics, has been given by Bussem (6) and Bessey (3).

It was found by Forsen (10) and Hedin (13) that when 0.2-g portions of C_2S or $\beta\text{-C}_2\text{S}$ were shaken with liter quantities of water, the compounds went into solution congruently, that is, the same molar proportions of CaO and SiO_2 entered the solution as occurred in the original compounds. But after a period of about 24 hours, in the case of the C_2S , a cotton-like precipitate formed which on analysis was found to have the composition $\text{CaO}\cdot\text{SiO}_2\cdot\text{H}_2\text{O}$.

* See pages 352-359.

At such dilutions as the above, the concentration of CaO in the solution never can reach high values, so in order to simulate the conditions which would obtain in the high-CaO concentrations of cement pastes, 500 ml of C_3S solution was added to 2 liters of saturated $Ca(OH)_2$ solution. From this mixture a precipitate soon formed which was found to have the composition C_2SH_4 . An X-ray examination of this material by Bussem showed it to be crystalline.

Thus it appears that the composition of the hydrosilicate is determined by the concentrations of the components in the solutions. Further experiments were made by shaking lime solutions with an alcoholic tetraethyl-silicate solution, selected in order to avoid difficulties due to the presence, in aqueous silicic acid

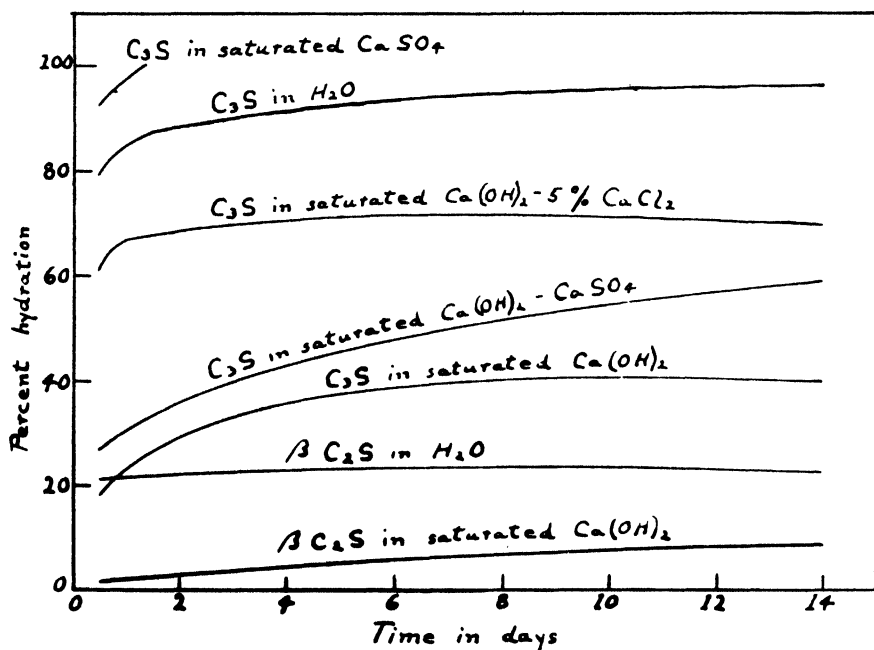

Figure 183. Hydration of C_3S and $\beta-C_2S$. (Forsen and Hedin)

solutions, of silica in a colloidal form. With saturated $Ca(OH)_2$ solution, a precipitate was produced of the composition $C_2S_2H_2$. With a supersaturated $Ca(OH)_2$ solution (1.55 g CaO/liter), the precipitate had the composition C_2SH_2 . At intermediate concentrations of $Ca(OH)_2$ solution, the composition of the precipitates varied within those limits, indicating to Hedin either a mixture of the above phases or a solid solution of CaO in $C_2S_2H_2$. With yet higher $Ca(OH)_2$ concentrations, $Ca(OH)_2$ crystals also appeared in the precipitate. The hydrosilicates were believed to be submicrocrystalline. From these and other experiments it was concluded that C_2SH_4 is formed during the normal reactions of cement with water.

The course of the hydration of the cement compounds in various solutions revealed that the rate of the reaction was affected greatly by the presence of other

ions in the solution. Some of these effects are shown in the diagrams of Figure 183. The ordinates, called percentage of hydration, represent the percentages of the original material which had been converted to a hydrated form (the weight of original material minus the weight of unreacted material remaining after stated periods of time) when 0.5-g portions were shaken with 100-ml portions of water or solution. It will be seen that the C_3S is converted rapidly, and the C_2S slowly, in water, but that the conversion is greatly depressed in both cases in saturated Ca(OH)_2 solution. When a saturated solution of Ca(OH)_2 plus gypsum is used, the depression is less than with Ca(OH)_2 alone. A 5 percent solution of CaCl_2 in the limewater causes still less depression. The significance of these effects will be discussed later.

Chemical Reaction, Adsorption, Solid Solution

From the foregoing account, it will be noted that most investigators are in agreement upon the formation of CSH_x as a definite compound, formed either by the reaction of Ca(OH)_2 upon silica (gel or sol) or by the hydrolysis of the more basic calcium silicates. Opinion has been widely divided however upon the character of the aqueous phases having compositions lying between those of CaO:SiO_2 ratios 1 and 2. Le Chatelier (16) obtained precipitates by interaction of limewater and silica sol having CaO:SiO_2 ratios varying from 1.0 to 1.7 but, from the ease of separation of the CaO in excess of the ratio of 1.0, he concluded that this excess was held by adsorption. Others, as already brought out, hold that the Ca(OH)_2 enters into solid solution with hydrated calcium silicate. And still others believe that a series of distinct hydrosilicate compounds exist, as CSH_x , $\text{C}_3\text{S}_2\text{H}_x$ and C_2SH_x .

The solution of this problem is difficult for many reasons. If the solid phases consisted of pure compounds, uniform and immiscible, a typical stepwise series of curves would be obtained. A single uniform phase would occur with increasing (or decreasing) Ca(OH)_2 in the solution over a given range of concentration, but at certain concentrations two phases would occur. At these invariant points, additions (or reductions) of Ca(OH)_2 would only change the ratio of those two compounds, until finally only a single phase would remain. This phase would then continue over another range of Ca(OH)_2 concentration.

On the other hand, if adsorption or solid solution occurred, the composition of the solid phase would change in a continuous manner with the concentration of the Ca(OH)_2 , producing a curve identified as the Freundlich adsorption isotherm. In adsorption, the molecules of Ca(OH)_2 would be attached to the surfaces of the hydrosilicate (CSH_x), whereas in solid solution the molecules of the Ca(OH)_2 would enter into the lattice structure of the hydrosilicate.

The curves obtained in experimentation are usually of the Freundlich type, as shown below. Baylis (2) found, on adding CaO to suspensions of silica gel in water, that there appears to be formed a compound of CaO and SiO_2 corresponding to the hydrated CaO.SiO_2 . Upon adding more CaO to the suspension, the CaO appeared to be taken up by adsorption to the extent of 30-45 percent of the CaO combined as CS . These conclusions were drawn from experiments in which the pH value of the solutions and the total alkalinity toward H_2SO_4 were determined after each addition of lime to the suspended gel. The points of minimum pH and alkalinity

corresponded approximately to the monocalcium silicate, but increasing additions of CaO caused these values to increase rapidly up to that of saturated Ca(OH)₂. No evidence was obtained, according to Baylis, of the existence of compounds of a higher lime content. On the other hand, the equilibrium between the solution of Ca(OH)₂ and the adsorbed Ca(OH)₂ was found to be reversible, for the same condition was reached by the extraction as by the addition of Ca(OH)₂.

A similar study by Shaw and MacIntire (25) indicated a reaction between Ca(OH)₂ and SiO₂ by which a series of calcium silicates of varying degrees of solubility and varying CaO:SiO₂ ratios was formed, depending upon the ratios of CaO to SiO₂ in the reacting medium, and the resulting OH-ion concentration. An adsorption formula was derived:

$$\text{Molar ratio } \frac{\text{CaO}}{\text{SiO}_2} = 2.34 [\text{final } (\text{CaOH})_2 \text{ concentration}]^{0.1818}$$

This formula was found to be limited in its application to equilibrium concentrations above 0.005*N*.

As Ca(OH)₂ was added in small successive increments to a given amount of hydrated SiO₂, from a CaO:SiO₂ ratio of 0.1:1 up to a ratio of 1:1, the first stage was characterized by the formation of a calcium silicate in the solution, the CaO:SiO₂ ratios of which varied between 1:4 and 1:2, while the pH changed from 9.6 to 10.5. This was followed by a precipitation stage characterized by a change in the CaO:SiO₂ ratio of the solution from 1:2 to 3:4, the pH value changing from 10.5 to 11.25. A third stage of precipitation ensued which was characterized by a CaO:SiO₂ ratio of the solution greatly in excess of 1:1, and pH values above 11.25. The dissolved silica, during these changes, had been reduced from a maximum of about 0.007*N* to 0.001*N* and less.

According to Shaw and MacIntire, adsorption of Ca(OH)₂ by the solid phase was manifested over the entire experimental range of CaO:SiO₂ ratios, although variant in extent. No acid-soluble silica appeared in the residue, however, as long as the CaO:SiO₂ ratio of the solution remained 1:2 or less. It could not be ascertained whether this was because solid residues having CaO:SiO₂ ratios below 1:2 were not acid-soluble, or because such products were not formed. As the ratio exceeded 1:2, there followed a uniform increase in acid-soluble silica. Since the solid phase was in equilibrium with a soluble calcium silicate of the composition 3CaO.4SiO₂ between CaO:SiO₂ experimental ratios of 0.5 and 0.6, it was assumed that the solid phase also had that composition. With increasing ratios of CaO:SiO₂ to 0.75, the solid phase was in equilibrium with a calcium silicate that was only slightly soluble and that was likewise in equilibrium with an excess of lime-water. In this case, the hydrated product was assumed to be CaO.SiO₂. aq. No other compositions of the solid phase were indicated.

The system CaO-SiO₂-H₂O was studied by Cummins and Miller (7) by adding 10-g quantities of diatomaceous earth (washed free of electrolytes with conductivity water and dried at 105°) to 1 liter portions of saturated limewater at 30°. The reactions were followed by the measurement of electrical conductivity and, at final equilibrium, the hydrogen-ion concentrations were determined and the necessary chemical analyses made.

As the interaction proceeded, the pH dropped below 12.4 (that of saturated

lime solution), and from values below 11.0 the calcium silicates were appreciably soluble. When equilibrium was reached, with the silicious diatomite always present in excess, the solution was found to consist of a saturated solution of a slightly hydrolyzed but highly ionized calcium silicate having the molar composition $2\text{CaO}\cdot 3\text{SiO}_2$. The pH of this saturated solution was 9.6, and as the pH increased to about 11.2 the calcium silicate in solution decreased to near the vanishing point, leaving mostly hydrated lime. The solid phase, after extraction from the unreacted residue of diatomite, was found to have a $\text{SiO}_2\text{:CaO}$ ratio of 1.2, corresponding to a composition $5\text{CaO}\cdot 6\text{SiO}_2$.

The rates of the reactions, investigated as indicated above, showed a rapid initial reaction during which process a coating of highly hydrated calcium silicate gel was thought to be formed on the surface of the diatom particles, accompanied by large volume increase of these particles. A period of inhibited reaction followed for several hours, due perhaps to the coating of the gel, and then a rapid reaction, not explained, gradually tapering off as equilibrium was approached. After about four days, the reactions had nearly reached the equilibrium state. The rates of reaction were affected, however, by the nature (source) of the diatomite, the heat-treatment given it, and the fineness. Bentonite reacted more slowly, and tripoli (a cryptocrystalline form of silica) and quartz powder reacted very slowly.

The above types of reaction, suggestive of adsorption or solid solution, do not however prove the case against the existence of compounds of the $\text{C}_3\text{S}_2\text{H}_x$ type, because such compounds conceivably could each be susceptible of adsorbing or taking into solid solution additional $\text{Ca}(\text{OH})_2$ molecules. And since both adsorption and solid solution give this type of curve, no criteria are found in the curves of themselves for a distinction. The evidence of X-ray diffraction patterns is inconclusive because the patterns are broad and diffuse, but Stratling (6) concludes with Keevil and Thorvaldson (15) that the evidence indicates a strong probability of the separate existence of $\text{C}_3\text{S}_2\text{H}_x$. Bessey (4) has noted consistently a sharp rise in the $\text{CaO}:\text{SiO}_2$ ratio of the solid phase, upon increasing the $\text{Ca}(\text{OH})_2$ concentration, between concentrations of 1.1 and 1.3 g CaO per liter. Since these values correspond to $\text{CaO}:\text{SiO}_2$ ratios of 3:2 and 2:1 respectively, Bessey believes it probable that a C_2SH_x exists over this narrow range. Much additional rigidly controlled experimentation is required before the character of these interactions can be conclusively determined.

Hydration in Steam

Important investigations on the synthesis of the hydrosilicates of lime were published by Schlapfer and Niggli (24) in 1914. Mixtures of lime and amorphous silica with small amounts of calcium chloride were heated with water in a silver crucible within a steel bomb for various periods at temperatures up to 470° . The formation of hillebrandite (C_2SH) was reported when mixtures of C:S ratio of 1:1 were used. The crystals were orthorhombic, positively elongated needles with parallel extinction, with the highest refractive index between 1.609 and 1.623, and slight birefringence. When the C:S ratio was 2:1, weakly birefringent orthorhombic crystals of index about 1.64 were formed which were thought to be a hydrated C_2S , together with small, rod-like monoclinic crystals of index about 1.657 and slight birefringence, believed to be a hydrated CS.

It was found by Thorvaldson and Shelton (28) in 1929 that when a portland cement mortar, prepared from quartz sand and a cement high in C_2S , was subjected to the action of saturated steam at 150° there were formed, in addition to hexagonal plates of $Ca(OH)_2$, birefringent crystals in the form of thin lath-like plates which increased in number and size as the treatment progressed, while the amount of $Ca(OH)_2$ reached a maximum and then decreased until it disappeared completely. These lath-like crystals could not be satisfactorily separated from the mortar for identification, but in a later study (30) their nature was established and their properties described.

These crystals were prepared in pure form by hydrothermal synthesis from various preparations of CaO and SiO_2 in the presence of saturated steam at temperatures between 150° and 300° . They consisted of lath-like prisms showing parallel extinction, positive elongation and moderate birefringence. The crystals were optically positive with a fairly large optic angle, $2V = 68^\circ$. The indices of refraction in sodium light were $\alpha = 1.614 + 0.002$, $\beta = 1.620 + 0.002$, $\gamma = 1.633 \pm 0.002$. The composition was $2CaO \cdot SiO_2 \cdot H_2O$. In order to distinguish it from other C_2S hydrates, it is herein designated "A."

A second crystalline calcium hydrosilicate was obtained by hydrothermal synthesis from excess lime and silica gel. It appeared as very small needle-like prisms, showing parallel extinction, positive elongation, and very low birefringence with an index of refraction of 1.597 ± 0.003 . The composition was C_2SH_x , where the water was uncertain but at least equal to 1. This hydrate will be designated "B."

In 1932, Nagai (20) reported studies on the hydrothermal synthesis of the calcium silicates in which CaO and powdered quartz were heated in nickel crucibles with water in an autoclave at temperatures from 133° to 212° for periods up to 10 days. The more basic mixtures were found to give a hydrate, C_2SH , which corresponded to hillebrandite. Less basic mixtures treated at the lower range of temperatures gave hydrates, as $C_3S_2H_8$, similar to afwillite, but at higher temperatures these changed over to hydrates having C:S ratios of 1:1, among which was a $CSH_{0.25}$, corresponding to xonotlite.

Keevil and Thorvaldson (15) in 1936 reported results of a further investigation on the hydration of the calcium silicates in saturated steam. The general technique consisted of exposing the pure compounds to water and saturated steam at different temperatures, and noting the progress of the reactions by the weight of water absorbed, the microscopic appearance and X-ray diffraction patterns of the products, and the free CaO produced. These experiments were followed by dehydration at various temperatures.

On treating the β and γ forms of C_2S with saturated steam at 350° , water was absorbed without appreciable hydrolysis, but at 110° a small amount of free CaO was usually formed. No marked difference was noted in the action of the two forms of the C_2S . At 110° to 170° the maximum hydration was reached in about 2 weeks, but at higher temperatures the absorption of water was much slower. After drying the product, when the action appeared to be complete, the composition of the product corresponded with the formula C_2SH .

Microscopic and X-ray examinations of the products revealed that three distinct crystalline materials were produced depending on the conditions of the

experiment. Between 170° and 350° there was produced the most common product, different from those above described, which consisted of very small irregular grains and composite masses of finely crystalline anisotropic material of medium to low birefringence. The water content varied from 1.0 to 0.3 mol per mol of C_2S , and the mean index of refraction from 1.62 to 1.64. The X-ray patterns, however, did not vary with changing water content or index, which indicated a constant structure. The X-ray pattern of this material, designated "C," as later obtained by McMurdie and Flint (18) is given on page 545. It is seen not to be similar to that of the mineral hillebrandite (C_2SH) nor to that of any other known hydrate of C_2S .

The second form of hydrate, similar to "A" above, was formed most readily at 150° to 170° , but sometimes was present at 220° to 350° . The water absorbed was 1 mol per mol of C_2S and no free CaO was formed. The crystals were well-developed orthorhombic plates having refractive indices $\alpha = 1.610 \pm 0.002$ and $\gamma = 1.633 \pm 0.002$. The X-ray pattern was distinctive. (See pattern for $\text{C}_{10}\text{S}_5\text{H}_6$, "A," obtained by McMurdie and Flint, page 545).

The third form of the hydrate, similar to "B" above, was never obtained as a homogeneous product of hydration of C_2S but was thus obtained by the steam-treatment of 2:1 mixtures of CaO and silica gel at 160° to 220° . A small amount (0.65 percent) of free CaO remained on heating for 2 weeks at 220° and the water absorbed was 1 mol per mol of C_2S . The product consisted of small needle-like crystals of low birefringence and a mean refractive index of 1.598 ± 0.003 . The X-ray pattern was different from the others described. (See pattern for C_2SH , "B," obtained by McMurdie and Flint, page 545.)

On dehydrating the preparations at 900° , no free CaO was formed and the mean index of the product was $1.692\text{-}1.693 \pm 0.005$. The X-ray diffraction pattern was similar to that of $\beta\text{-C}_2\text{S}$. A sample of the mineral hillebrandite similarly treated produced a mixture of β and $\gamma\text{-C}_2\text{S}$. On re-exposure to steam for 11 days at 160° and drying over lime, the original amount of water was reabsorbed, but the X-ray pattern showed a greater similarity to the hydrate "C" than to the original hillebrandite.

When C_3S was treated with steam at temperatures up to 350° , the violent reaction characteristic of its hydration in water at room temperature did not occur, the amount of $\text{Ca}(\text{OH})_2$ formed was negligible, and the amount of water taken up was more than that required to hydrate the CaO and corresponding C_2S . Hydrolysis decreased with increasing temperatures. Between 110° and 175° , approximately 1.5 mols of water were absorbed per mol of C_3S in 2 to 5 days, but this amount increased with time up to a maximum of 2 mols. Between 225° and 375° , 1 mol was taken up readily and further amounts very slowly to a maximum of about 2 mols. The $\text{Ca}(\text{OH})_2$ formed was rarely more than 0.2 mol. Thus it appears that C_3S hydrates in steam to the composition C_3SH_2 .

The resulting crystals were very fine, of low birefringence, and of mean refractive index 1.59. Sometimes there were observed intergrown sheaves of very small anisotropic prismatic crystals with parallel extinction having indices $\alpha = 1.589$ and $\gamma = 1.597 \pm 0.003$. The X-ray diffraction pattern differed from those of the hydrated C_2S . (See pattern for C_3SH_2 obtained by McMurdie and Flint, page 546). Hydrolysis was found to be favored by low temperatures and

moistening of the sample with limewater before treatment. On heating at a temperature of 900° for 7 hours, however, the $C_3S_2H_2$ decomposed to β - C_2S and CaO .

Exposure of the hydrated silicates to a large excess of water was found to result in hydrolysis in a manner similar to that of the anhydrous silicates, but equilibrium was attained much more rapidly. The end product in all cases, in the presence of saturated $Ca(OH)_2$, was of the composition $C_3S_2H_2$. The first step in the hydrolysis of C_3S thus appears to be the exchange of 1 mol of H_2O for 1 mol of CaO , a very rapid reaction. The further hydrolysis of this hydrated C_2S to hydrated C_3S_2 is then much more rapid than the similar hydrolysis of anhydrous C_2S .

In a study of the formation of hydrated calcium silicates by steam treatment, Flint and his associates (8) treated a number of naturally-occurring and synthetic calcium silicates in a bomb with water at a number of high temperatures and pressures for various periods of time, and noted the chemical, optical and X-ray characteristics of the products. By this means the identity of a number of the hydrated calcium silicates was established.

Amorphous CS hydrate crystallized at 150° to CSH , which had a distinctive X-ray pattern. At temperatures between 165° and 395° (70 to 225 atmospheres) C_6S_5H (xonotlite) was formed. Above 395°, CS (wollastonite) crystallized out.

Amorphous C_3S_2 hydrate treated between 150° and 400° did not yield the mineral afwillite ($C_3S_2H_3$) but instead crystallized partially to CSH at the lower temperatures and to the mineral xonotlite (C_6S_5H) at the higher temperatures. Anhydrous C_3S_2 was converted at 250° to an unidentified hydrate. At 500° (380 atmospheres) for 2 weeks, it was converted to a low-temperature or β form of the anhydrous compound.

A glass of the composition C_6S_3 was converted at 300°–350° to a product having an X-ray pattern identical with that of the mineral foshagite ($C_6S_3H_3$).

The hydrate $C_{10}S_8H_6$ was formed from β and γ - C_2S , C_3S , and mixtures of CaO and silica gel at temperatures between 100° and 200°. The properties of this hydrate were similar to those of Thorvaldson's hydrate "A." Attempts to prepare a hydrate identical with the mineral hillebrandite (C_2SH) were unsuccessful. Other hydrates of C_2S were obtained similar to Thorvaldson's hydrates "B" and "C." When C_2S was treated with water between 200° and 450°, it hydrated directly to C_3SH_2 . No hydrates of higher lime content than this were obtained.

The X-ray patterns of these hydrates (18) are given on pages 544–546.

A study of the system $CaO-SiO_2-H_2O$ was also made by Jander and Franke (14) at temperatures between 250° and 350°, the pressure at the latter temperature being 163.2 atmospheres. The conditions of the experiments provided the presence of liquid water at all temperatures. The raw materials consisted of pure lime, silicic acid gel and CO_2 -free water.

Only four hydrated calcium silicates were found, although the time period extended in some cases to 49 days. These compounds were C_2SH , $C_2SH_{0.5}$, C_3S_2H and $CSH_{0.25}$. With original mixtures having $CaO:SiO_2$ ratios from 9:1 down to 2:1, only the C_2SH was formed, in the presence of liquid water, at temperatures up to 300°, but at 350° that compound lost water and was transformed into $C_2SH_{0.5}$. From a mixture having the $CaO:SiO_2$ ratio of 3:2, there was formed

TABLE 33. The optical properties of the principal artificial hydrated calcium silicates (4)

Compound	Form	Character	Refractive Indices			Authority	Ref.	
			α	β	γ			
$\text{C}_2\text{SH}_{1.5-3}$	Prismatic needles	Parallel ext. and + elongation	1.589	1.597	Keovil & Thorvaldson	(15)	
			1.589	1.598		Bessey	(4)
			1.614	1.620	1.633		Vigfusson, Bates & Thorvaldson	(30)
$\text{C}_2\text{SH(A)}$	Orthorhombic prisms	Parallel ext., + elongation, biaxial positive	1.614	1.621	1.635	Bessey	(4)	
			1.597		Vigfusson, Bates & Thorvaldson	(30)
			1.590		Bessey	(4)
$\text{C}_2\text{SH(B)}$	Fine needles	+ elongation	Keovil & Thorvaldson	(15)	
			1.62-1.64		Bessey	(4)
			1.585-1.60		Bessey	(4)
$\text{C}_2\text{SH(C)}$	Irregular grains	+ elongation	1.575-1.580	Bessey	(4)	
		
		

first a mixture of C_2SH , $C_2SH_{0.5}$ and $CSH_{0.25}$, but this was slowly converted to C_3S_2H , as indicated by X-ray analysis.

The following schematic diagram is used to illustrate the character of the system, but no attempt is made to allocate precisely the boundary temperatures or compositions.

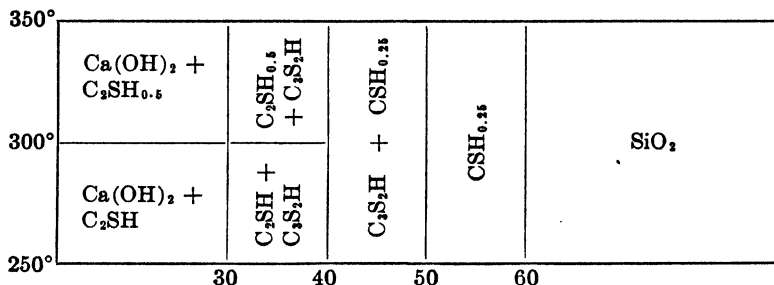

The optical properties of the principal artificial hydrated calcium silicates, as listed by Bessey (4), are given in Table 33.

References

- Bates, P. H., and Klein, A. A., *Tech. Paper NBS* 78 (1917).
- Baylis, J. R., *J. Phys. Chem.*, **72**, 1236 (1928).
- Bessey, G. E., *Symposium*, 169.
- Bessey, G. E., *Symposium*, 178.
- Bogue, R. H., *J. Am. Chem. Soc.*, **42**, 2575 (1920).
- Bussem, W., *Symposium*, 141.
- Cummins, A. B., and Miller, L. B., *Ind. Eng. Chem.*, **26**, 688 (1934).
- Flint, E. P., McMurdie, H. F. and Wells, L. S., *J. Res. NBS*, **21**, 617 (1938); RP 1147.
- Flint, E. P., and Wells, L. S., *J. Res. NBS*, **12**, 751 (1934); RP 687.
- Forsen, L., *Symposium*, 298.
- Hagg, G., *Z. anorg. allgem. Chem.*, **155**, 21 (1926).
- Harmon, R. W., *J. Phys. Chem.*, **31**, 616 (1925).
- Hedin, R., *Proc. Swedish Cement and Concrete Inst.*, **3** (1945).
- Jander, W., and Franke, B., *Z. anorg. allgem. Chem.*, **247**, 161 (1941).
- Keevil, N. B., and Thorvaldson, T., *Can. J. Res.*, **14**, 20 (1936); *Symposium*, 246.
- Le Chatelier, H., *Bull.*, **42**, 82 (1900).
- Lerch, W., and Bogue, R. H., *J. Phys. Chem.*, **31**, 1627 (1927); PCAF paper 11.
- McMurdie, H. F., and Flint, E. P., *J. Res. NBS*, **31**, 225 (1943); RP 1560.
- Nacken, R., *Zement*, **24**, 183 (1935); **25**, 145; 565 (1936).
- Nagai, S., *Z. anorg. allgem. Chem.*, **206**, 117; 321 (1932); *Cement and Cement Mfg.*, **5**, 205 (1932).
- Newberry, S. B., and Smith, M. M., *J. Soc. Chem. Ind.*, **22**, 94 (1903).
- Pulfrich, H., and Linck, G., *Kolloid Z.*, **34**, 117 (1924).
- Rankin, G. A., *Trans. Faraday Soc.*, **14**, 23 (1918-19).
- Schlapfer, M., and Niggli, P., *Z. anorg. allgem. Chem.*, **87**, 52 (1914).
- Shaw, W. M., and MacIntire, W. H., *Soil Science*, **29**, 429 (1930).
- Shelton, G. R., *Ind. Eng. Chem.*, **17**, 589; 1267 (1925); **18**, 1854 (1926).
- Thorvaldson, T., Harris, R. H. and Wolochow, D., *Ind. Eng. Chem.*, **17**, 467 (1925).
- Thorvaldson, T., and Shelton, G. R., *Can. J. Res.*, **1**, 148 (1929).
- Thorvaldson, T., and Vigfusson, V. A., *Trans. Royal Soc. Canada*, **22**, 423 (1928).
- Vigfusson, V. A., Bates, G. N., and Thorvaldson, T., *Can. J. Res.*, **11**, 520 (1934).

CHAPTER 23

Systems Containing CaO and H₂O with Al₂O₃ and Fe₂O₃

In continuation of the exposition of the water reactions in cement pastes, the present chapter treats of such reactions in the presence of CaO, Al₂O₃, and Fe₂O₃.

Hydrolytic Equilibria

A study by Shelton (29) of the action of water on the cement compounds indicated that the C₃A after hydration was composed only of hydrated C₃A, whereas C₄A₃ produced both hydrated C₃A and amorphous hydrated alumina. Lerch and Bogue (22) found, however, that C₃A liberated CaO by hydrolysis, as measured by pH, when the anhydrous compound was shaken in an excess of water at 30°. The data on these experiments are shown on page 384. Both C₃A and C₄A₃ reacted very rapidly and reached an apparent equilibrium in about one day, which was in contrast to the slower reactions of the silicates and C₂F. When extractions were made in Soxhlet thimbles which allowed the continuous removal of the dissolved material, it was found that C₃A had been decomposed completely, leaving only Al₂O₃.aq as a solid residue, in about 8 months, whereas the C₄A₃ produced the same product in 5 months. C₂F hydrolyzed completely leaving a solid residue of Fe₂O₃.aq, in 3 months.

The OH-ion concentrations at which C₃A, C₄A₃ and C₂F reach a state of equilibrium where hydrolysis is just avoided in solutions of Ca(OH)₂ and NaOH were determined as with the silicates. The results obtained are shown in Table 34.

TABLE 34. *Hydrolysis of C₃A, C₄A₃ and C₂F in solutions of Ca(OH)₂ and NaOH*

Ca(OH) ₂ pH	C ₃ A pH	C ₄ A ₃ pH	C ₂ F pH
12.37	12.33	11.91	12.36
12.18	12.24	11.75	12.32
11.83	12.23	11.73	12.11
6.72	12.07	11.61	12.06

NaOH pH	C ₃ A pH	C ₄ A ₃ pH	C ₂ F pH
13.72	13.72	13.55	13.72
12.94	12.95	12.52	13.01
12.58	12.59	12.33	12.65
12.20	12.37	12.03	12.40
11.93	12.20	11.79	

The C_3A_2 was found to undergo hydrolysis in all solutions of pH 11.6 or less, but in solutions of pH 11.8 or above this aluminate enters into reaction with the solution which causes the pH to decrease. This is due to the combination of C_3A_2 with CaO. The C_3A was found to undergo hydrolysis in solutions of pH 12.2 or less, but hydrolysis did not proceed to the pH of saturated $Ca(OH)_2$. On the other hand, when C_2A was placed in saturated $Ca(OH)_2$, the pH was lowered slightly. Similar reactions observed by Kuhl and Thuring (16) and by Lafuma (18) were attributed to the formation of C_4A , but Radeff (27) attributed the change to the adsorption of $Ca(OH)_2$ by the C_3A .

The C_2F was found to hydrolyze in all concentrations of $Ca(OH)_2$, less than saturated, but appeared to be unchanged in saturated $Ca(OH)_2$ solution.

In the presence of an excess of water, it appears, therefore, that the calcium aluminates hydrolyze slightly in water but are held at $C_3A.aq$ or slightly more basic compositions in saturated lime water. The C_2F appears to hydrolyze in solutions of low OH-ion concentration, but to remain unchanged in saturated limewater. The OH-ion concentrations necessary to prevent hydrolysis at 30° were found to be, for these compounds,

C_2F	13.0
C_3A	12.3
C_3A_2	11.7

The pH of saturated $Ca(OH)_2$ is 12.4.

The Iron Compounds

No reaction was found to occur by Kuhl and Wang (17) when finely ground cement clinker containing C_2F was shaken with saturated limewater at room temperatures. But, under the same conditions, C_4AF was found to form hydrated C_2A and hydrated CF. Bogue and Lerch (7) further found that a paste of C_2F at room temperature hydrates slowly to an amorphous C_2F hydrate with no liberation of free CaO. Under similar conditions, C_4AF formed C_2AH_6 and an amorphous phase believed to be hydrated CF.

Hoffmann (14) reported that C_2F produced tetracalcium ferrites on shaking with limewater. At 20°, the composition assigned was C_4AH_{14} , and at 50°, C_4AH_7 . At lime concentrations below 1,060 mg CaO per liter, the ferrihydrate was of a lower C:A ratio. This was not in agreement with the findings of Eiger (8) who concluded that the hydrate C_2AH_6 was the stable phase in saturated limewater.

Flint and his associates (9) found that, on shaking C_4AF with water, the concentration of the Al_2O_3 in solution increased rapidly with time for about 30 minutes, after which it gradually decreased. A similar change occurred with the CaO in solution, but higher concentrations were reached. At 3 months the precipitate consisted of the hexagonal form of hydrated calcium aluminate with a small amount of C_2AH_6 and an amorphous iron phase. At 10 years, such a preparation was found to contain only a trace of Al_2O_3 in solution, and the CaO was slightly less than that of a saturated solution. The hexagonal calcium aluminate hydrate had disappeared and been replaced by the isometric C_2AH_6 . The iron phase consisted of finely divided reddish material which was not identified.

Schlapfer (28) noted also that hardened specimens of C₄AF gave up Ca(OH)₂ to the solution, but found that the solid residue in limewater could enter into combination to form a hydrated C₄A.

Action of Water on the Calcium Aluminates

A study of the action of water on the calcium aluminates was made by Wells (35) in 1928. The pure compounds C₂A₃, CA, C₃A₂ and C₃A were prepared, and 50-gram portions of the powdered material were shaken in 1-liter quantities of water for fixed time periods at 30°. They were then filtered rapidly and samples taken at once for chemical analysis and pH determinations. The remainders of the filtered solutions were set aside for stated periods, and the precipitates which formed were filtered off and the solutions again subjected to analysis and pH determination. The precipitates also were analyzed and examined with the petrographic microscope.

Although the tricalcium aluminate is probably the only aluminate of calcium of immediate interest in connection with portland cement, the attempt to examine its reactivity with water in these studies was not successful because of the very rapid character of the reaction. When finely-powdered C₃A was added to water, it quickly agglomerated into balls which hydrated on the exterior to hard masses which prevented the penetration of water to the interior. Consequently, large masses of unhydrated material remained. From previous studies by Bates (4) and by Klein and Phillips (15) it was believed that useful analogies could be obtained through a study of the reactions with the less basic aluminates. The

TABLE 35. *Composition and pH of solutions of CA in water*
(Columns A give data obtained directly upon filtering; columns B give data after 2 or 3 weeks when equilibrium has been approached)

No.	Time of contact of CA with water before filtering	Al ₂ O ₃ in solution g per liter		CaO in solution g per liter		Molar ratio CaO/Al ₂ O ₃ in solution		CaO in solution in excess of CA g per liter		pH of solutions	
		A	B	A	B	A	B	A	B	A	B
1	15 min.	2.1850	0.2500	1.2930	0.4455	1.08	3.21	0.0912	0.3080	11.19	11.72
2	30 min.	2.3655	.2550	1.3970	.4320	1.08	3.08	.0912	.2917	11.22	11.73
3	1 hour	2.3500	.2460	1.3730	.4135	1.07	3.06	.0805	.2872	11.21	11.72
4	2 hours	2.2000	.2415	1.2880	.4005	1.06	3.01	.0780	.2677	11.21	11.72
5	4 hours	2.2350	.2420	1.2910	.4155	1.05	3.08	.0617	.2824	11.18	11.69
6	5 hours	2.0910	.2530	1.1960	.4060	1.04	2.84	.0459	.2668	11.21	11.70
7	6 hours	0.9445	.2445	0.6085	.4320	1.17	3.21	.0891	.2975	11.32	11.74
8	1 day	.45004165	1.681690	11.56	
9	3 days	.31704560	2.612816	11.67	
10	7 days	.26804620	3.133148	11.73	
11	14 days	.24005165	3.903746	11.74	
12	28 days	.25505050	3.213648	11.76	
13	420 days	.16004715	5.363835	11.76	

examination of these compounds was therefore made in such a manner that the trend of the effects of increasing basicity could be observed.

The solutions prepared as above, following a contact period of 15 minutes to 6 hours, were found in all cases to be metastable, that is, on further standing the clear solutions became cloudy and a precipitate separated out, usually beginning within a few hours after filtering. The nature of the changes taking place is indicated in Table 35 for CA in water.

Some of these results are shown to better advantage in Figure 184. From these data it will be seen that the quantity of both Al_2O_3 and CaO dissolved by the water attained a maximum in 30 minutes and then gradually decreased for

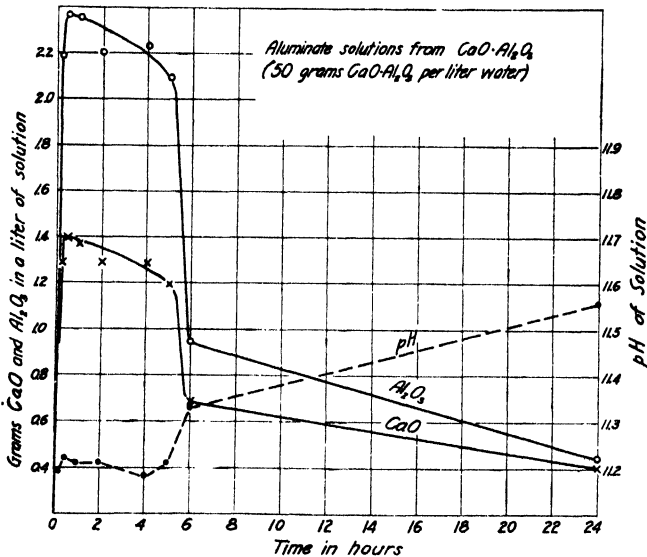

Figure 184. Showing the composition and pH of aluminate solutions from $\text{CaO}-\text{Al}_2\text{O}_3$, as functions of the time of contact with water. (Wells)

about 5 hours. This condition was followed by a very rapid decrease in dissolved oxides for a few hours, after which the decrease gradually became less with time. Of particular interest is the observation that the molar ratio of CaO to Al_2O_3 in the solution for the first 5 hours was approximately 1, and the pH 11.20. At later periods the molar ratio increased and the pH rose to about 11.76, even though the actual quantities of both CaO and Al_2O_3 in solution decreased. The increase in pH, however, was accompanied by a corresponding increase in the CaO in solution in excess of that calculated to be in combination with the Al_2O_3 in solution as CA.

An amorphous precipitate began to form in the first six filtered solutions within 2 or 3 hours after filtering and, in a day, covered the bottom of the flasks to a depth of a half a centimeter. A few days later small spherulites of crystals appeared on the walls of the flasks. Microscopic and chemical examination showed the amorphous material to be hydrated alumina, and the crystalline spherulites

to be hydrated calcium aluminate. The latter occurred as flat hexagonal plates, uniaxial negative, having refractive indices of $\omega = 1.535 \pm 0.004$, $\epsilon = 1.515 \pm 0.005$. These indices may be compared with values given by Klein and Phillips (15) for hydrated C₂A:

$$\begin{array}{ll} \text{original values } \omega = 1.535 \pm 0.003; & \epsilon = 1.552 \pm 0.003 \\ \text{revised values } \omega = 1.520 \pm 0.003; & \epsilon = 1.504 \pm 0.003 \end{array}$$

and with values given by Pulfrick and Linck (26) for a composition assigned the formula C₂AH₇.

$$\omega = 1.538 \pm 0.0015; \quad \epsilon = 1.523 \pm 0.0015$$

The study of the C₂A₅ in water gave results quite similar to those obtained with CA except that the rapid reduction in CaO and Al₂O₃ contents of the solutions occurred in about 2 hours instead of 5 hours. The ratio of CaO to Al₂O₃ in solution during this period, however, was about 1, as with the CA solution, and at later periods increased to give a pH of about 11.75. Likewise, in the precipitates from the filtered solutions, the anhydrous alumina and the spherulites of hydrated C₂A appeared.

The more rapid reaction of the C₂A₅ with water made the results obtained with this compound somewhat erratic. Vigorous shaking failed to prevent some agglomeration of the material into small lumps, and this in turn prevented complete reaction. In general, however, the character of the reaction was similar to that observed with CA and C₂A₅. The CaO and Al₂O₃ dissolved rapidly for 30 minutes, then more slowly, and reached maximum values at about 2 hours, after which they decreased rapidly for 6 hours and then more slowly. The molar ratios of CaO to Al₂O₃ were somewhat higher than in the previous studies, but still were close to 1, indicating that initially the CaO and Al₂O₃ are dissolved as the calcium salt of monobasic aluminic acid. At later periods the ratio again increased to a pH of about 11.75. Again, also, hydrated Al₂O₃ and spherulites of hydrated C₂A were formed, and in addition a small amount of an unidentified phase, consisting of isotropic, isometric crystals with an index of refraction very close to 1.605.

A subsequent study of a high-alumina cement (containing CaO 40.8, SiO₂ 5.1, Fe₂O₃ 10.9, Al₂O₃ 39.0 percent) gave results entirely analagous to those found for the CA, C₂A₅ and C₁A₃ pure compounds. Metastable and supersaturated solutions of the monocalcium aluminate were formed, from which were precipitated amorphous hydrated alumina and crystalline hydrated tricalcium aluminate.

The bulk of the evidence in the investigation by Wells is in agreement with the conclusions of other investigators (6)(28)(11) based on the solubility ratio, the freezing point, conductivity, and emf measurements, that the alkali and alkaline-earth aluminates exist in solution as salts of monobasic aluminic acid, HAlO₂. Thus the stable aluminate formed in solution from all of the compounds was the calcium salt of this acid, Ca(AlO₂)₂, or CaO.Al₂O₃. The pH of the solutions is shown, furthermore, to be very closely related to the CaO in excess of that calculated to be combined as CaO.Al₂O₃.

Assarsson (1) concluded, from an extensive study on the hydration of the calcium aluminates and aluminous cements, that the principal reactions of the pure compounds followed the pattern:

At low temperatures: CA (dissolved) $\rightarrow C_2AH_2 + AH_3$

At high temperatures: $C_2AH_2 \rightarrow C_3AH_6 + AH_3$

No reaction formulas of the course of hydration of the aluminous cements could be drawn up, however, at the present state of knowledge upon these products.

Action of $Ca(OH)_2$ Solution on the Calcium Aluminates

A further study by Wells (35) was made on the action of $Ca(OH)_2$ solution on calcium aluminate solutions. The results are shown in Figure 185. As the relative proportion of CaO to Al_2O_3 in the solutions increased, there resulted a precipitation of increasing proportions of the total alumina and an increase in pH. At a

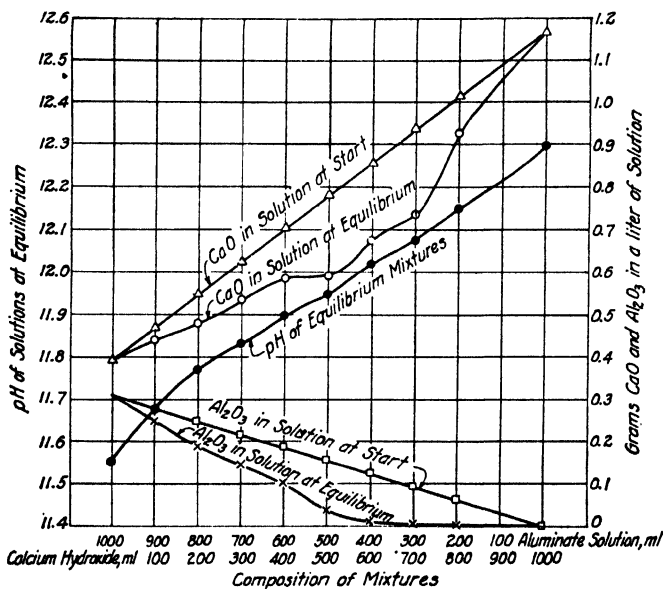

Figure 185. Showing the changes in the composition and pH of an aluminate solution attended by increasing concentrations of calcium hydroxide. (Wells)

pH of 12 and above the alumina was almost completely precipitated from the solution, taking with it a portion of the lime, presumably as hydrated calcium aluminate. The molar ratio of CaO to Al_2O_3 in the precipitate also increased until, at pH above 12, it had reached a value of about 4, indicating a tetracalcium aluminate hydrate. A chemical analysis showed this to have the composition $4CaO \cdot Al_2O_3 \cdot 12H_2O$.

Such a compound also had been suggested by Le Chatelier (21) as formed on the setting of cement by a reaction between C_2A and $Ca(OH)_2$, and a similar compound had been found by Lafuma (18) upon the reaction of lime on a calcium aluminate solution. A microscopic examination by Insley of the preparation of Wells showed it to be composed of very minute crystals, apparently plates which often appeared as fibers or fine needles when turned on edge. These fibers showed positive elongation. Index of refraction measurements were difficult, but the

omega (or gamma) index was about 1.532 ± 0.005 and the epsilon (or alpha) index was about 1.505 ± 0.005 .

It was later shown by Assarsson (3) that the various calcium aluminates dissolve in water at first congruently, that is, in such proportions that the CaO:Al₂O₃ ratio in the solution is the same as that in the original material. This was confirmed by Forsen (10) and Hedin (12) by shaking small amounts (0.2 g) of the calcium aluminates in a large excess (1 liter) of water at 20°. The materials used by these investigators included crystalline C₃A and C₄AF, and glasses of C₂A (CaO 51.7, Al₂O₃ 48.1), CAS (Rankin's point 17, CaO 55.8, SiO₂ 7.4, Al₂O₃ 36.8), KCA (CaO 39.3, Al₂O₃ 56.1, K₂O 4.6), and C₄AF glass.

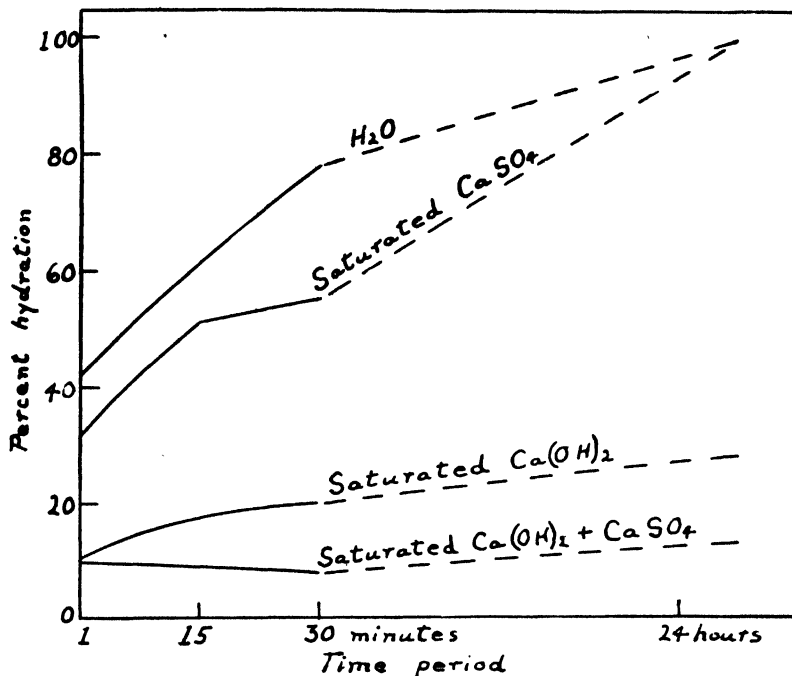

Figure 186. Hydration of C₃A crystals. (Forsen and Hedin)

The rates of hydration of the crystalline C₃A in water and certain solutions, in concentrations of 0.5 g per liter, are shown in the curves of Figure 186. It is seen that the C₃A becomes hydrated rapidly in water and saturated gypsum solution, the conversion being complete in 24 hours. The rate of hydration is greatly depressed in saturated Ca(OH)₂ solution and to a somewhat greater extent in a saturated solution of Ca(OH)₂ and gypsum. Hydration in KOH solution was somewhat greater than in Ca(OH)₂ solution. The C₂A glass hydrated more rapidly in water than did the C₃A crystals but the action was repressed to a greater degree in the other solutions. The crystalline C₄AF was only slightly hydrated in water at all ages up to a month, and was not much affected by Ca(OH)₂ solution or gypsum. The other glasses showed intermediate values, and in all cases a marked depression by the lime and gypsum solutions.

In general, it was found with these aluminate preparations that the rate of hydration follows the same progress as the solution of their components, and that considerable repression is effected by a saturated lime or lime-gypsum solution. Rapid reaction prevailed in those solutions in which quick set occurred, whereas the reactions were slow and the solubility low in solutions where the set was normal. Where the solubility was low, the reaction appeared to be repressed due to a coating of the grains with an insoluble film of a hydration product which hindered the penetration of the solution. The significance of these reactions on the set of the cement is discussed in Chapter 27.

The C_3A Hydrates

The products resulting from the hydration of C_3A at room temperature were studied by Thorvaldson and Grace (31) in 1929. A freshly ignited sample of C_3A was placed in a platinum dish, distilled CO_2 -free water added, and the dish placed in a desiccator over water to prevent absorption of CO_2 . The lumps were broken up and the material mixed thoroughly from time to time for 15 days. The dish was then transferred to another desiccator containing freshly ignited lime where it was kept until its weight became constant. A second period of contact with water was given for 9 days, followed by the same drying period, and it was noted that there was no increase in weight during the second period. The percentage of water taken up was then determined from loss on ignition. It was found that the average molar ratio of H_2O to C_3A was 6.04. The composition of the hydrate was therefore established as C_3AH_6 . The crystals were isotropic, having a refractive index $n_{Na} = 1.604 \pm 0.002$.

Additional properties of the C_3AH_6 were reported in the same year by Thorvaldson and his students (32). It was noted that the pure hexahydrate could be produced not only by hydrating C_3A , either at room temperature or at 150° , but that the same hydrate was formed when a mixture of $3CaO + Al_2O_3$ was subjected to steam at 150° . Also, since ignition of the hydrate at about 1100° produced anhydrous C_3A , the method may likewise be used to prepare C_3A , a process much simpler than the usual procedure.

It was found that when pure C_3A is exposed to steam at 150° , the crystals of the hexahydrate take the form of trapezohedrons but, when the hydrate is prepared by exposing a mixture of lime and alumina to saturated steam at the same temperature, cubes or less commonly dodecahedrons are formed.

The solubility of the C_3AH_6 was determined in gold-lined tubes in an atmosphere free of CO_2 . At temperatures of 21° to 40° it was found that the quantities of lime and alumina in solution at equilibrium were in all cases in the original ratio of $3CaO$ to Al_2O_3 . The saturated solution at 21° had a pH of 11.00. The solubility at 21° and at 40° , respectively, was found to be equivalent to 0.0246 and 0.0268 g of anhydrous C_3A per 100 ml of solution.

The X-ray diffraction pattern was determined, and is shown on page 546. This pattern shows lines corresponding to the requirements of a body-centered lattice. The lattice constant was determined to be $12.576A \pm 0.02$, and there were calculated to be 8 molecules in the unit cube. From these values, the density was computed to be 2.53, which corresponded very well to the value 2.522, found directly by the displacement method in purified and redistilled kerosene.

Hexagonal crystals believed to be hydrated tricalcium aluminate were prepared by slowly introducing C₃A into CO₂-free ice water and holding at a temperature not above 21° for about 2 weeks. At higher temperatures the hexagonal plates, needles or spherulites changed over to the isometric form. When the hexagonal crystals were held over various salts of differing vapor tension, the molar ratios of H₂O to C₃A varied between 8.0 and 12.5, and it was concluded that a number of hydrates probably exist, having 6, 8, 10½ and 12 mols of water of hydration. The heats of solution of these hydrates were determined to be, at 20°,

C ₃ AH ₆	519 cal/g C ₃ A
C ₃ AH ₈	498 cal/g C ₃ A
C ₃ AH _{10.5}	482 cal/g C ₃ A
C ₃ AH ₁₂	472 cal/g C ₃ A

The optical data obtained on these hydrates, together with those previously reported, are given in Table 36.

TABLE 36. Optical data on hydrates of C₃A

Authority	Composition	Description	Refractive indices		Optical character
			ω	ϵ	
Klein and Phillips in paper by Wells (35)	C ₃ AH ₈	Hexagonal plates, needles and spherulites	1.520	1.504	Uniaxial negative
Pulfrich and Linck (26)	C ₃ AH ₇	Hexagonal plates	1.538	1.523	Uniaxial negative
Wells (35).....	C ₃ AH ₈	Hexagonal plates, needles and spherulites	1.535	1.515	Uniaxial negative
Thorvaldson <i>et al</i> (32)...	C ₃ AH ₁₂	Hexagonal plates	1.527	1.505	Uniaxial negative
do.	C ₃ AH _{10.5}	Hexagonal plates	1.530	1.510	Uniaxial negative
do.	C ₃ AH ₈	Hexagonal plates	1.538	1.520	Uniaxial negative
do.	C ₃ AH ₆	Rounded grains and trapezohedrons	$n = 1.604$		

The change from C₃AH₁₂ to C₃AH₈ resulted in no change in optical properties except a gradual increase in the refractive indices. Nor was there found to be any change in the shape of the crystals. The change in heat of solution, as shown above, was not large. Furthermore, the X-ray diffraction patterns of the three hexagonal hydrates were almost identical (see page 547). The hexagonal form of the C₃A hydrate was found to have a closely packed hexagonal crystal lattice having a unit cell of the dimensions:

a_0 (side of equilateral triangle)	= 5.711A
c_0 (height of prism)	= 6.453A
C or c_0/a_0 (axial ratio)	= 1.13

If the height c_0 of the prism is doubled, in order that the unit cell may contain an integral number of molecules, the axial ratio becomes 2.26. The density calculated on this basis for C_3AH_6 is 2.07. The value determined directly for C_3AH_6 is 2.13, and that for $C_3AH_{10.5}$ is 2.04.

The C_3A and C_4A Hydrates

Continuing their study of the system $CaO-Al_2O_3-H_2O$, Wells and his associates (36) investigated particularly the forms of the hydrated calcium aluminates stable at 21° and at 90° . Proceeding in the same manner as previously, metastable solutions of monocalcium aluminate were prepared containing up to 2.4 g of Al_2O_3 and 1.4 g of CaO per liter. Portions of these solutions were mixed in various proportions with solutions of $Ca(OH)_2$ of known concentration and the changes which occurred were followed by occasional examinations. When solid phases appeared other than the hexagonal hydrated calcium aluminates, the solutions were filtered and the examinations completed.

The general character of the results is shown in Figure 187, where the curve ABD represents the composition of the solutions remaining at equilibrium with a large number of original mixtures, the latter being indicated by solid circles. The molar ratios CaO to Al_2O_3 of the solid phases in equilibrium with the final solutions are given on the broken lines connecting the original compositions of the solutions with the equilibrium compositions, indicated by open circles. In general, the increase in CaO in solution is accompanied by a decrease in Al_2O_3 , and a more or less gradual increase from 2 to 4 in the molar ratio $CaO:Al_2O_3$ in the solid phases. It is noted that there were no extensive sections along the curve ABD where the molar ratios $CaO:Al_2O_3$ of the solid phases were exactly 2, 3 or 4, such as would characterize a series of separate and distinct solubility curves of a hydrated di-, tri-, or tetra-calcium aluminate.

Such a gradual increase from 2 to 4 in the molar ratios $CaO:Al_2O_3$ of the precipitates, which formed as the molar ratios of the initial solutions increased, might imply either overlapping solubility curves of a series of separate hydrated calcium aluminates, or the solubility curve of a solid-solution series of varying $CaO:Al_2O_3$ ratio. From later experiments, the authors postulated the former supposition to obtain.

By approaching the equilibrium from the state of undersaturation, the same equilibrium solutions were obtained. In these experiments crystalline hydrated calcium aluminates of 2:1 and 4:1 $CaO:Al_2O_3$ ratios were placed in $Ca(OH)_2$ solutions of increasing concentration. It was found that the 2:1 composition dissolved congruently, the composition of the solution being the same as that of the original solid. This was not true of the 4:1 composition except in solutions originally high in $Ca(OH)_2$.

The molar ratios of $H_2O:Al_2O_3$ in the hexagonal hydrated calcium aluminates were determined by washing the precipitates with alcohol and ether, followed by drying at room temperature in a desiccator over $CaCl_2$, and measuring the loss on ignition. It was found that the molar ratios of $H_2O:Al_2O_3$ increased generally with an increase in the ratio $CaO:Al_2O_3$. These results, as also those of various other investigators, limited the overall composition between $2CaO.Al_2O_3.5-9H_2O$ and $4CaO.Al_2O_3.12-14H_2O$.

Optical properties could not be determined precisely because the individual crystals were too small for satisfactory interference figures. No marked differences were observed in the refractive indices, especially those of ϵ . The ω indices of the dicalcium aluminates were, however, lower than those of the tetracalcium aluminates. The 4:1 composition with 12H₂O was found to be biaxial negative and to have indices, $\gamma = 1.542$, $\beta = 1.538$ and $\alpha = 1.522$; 2V calculated from

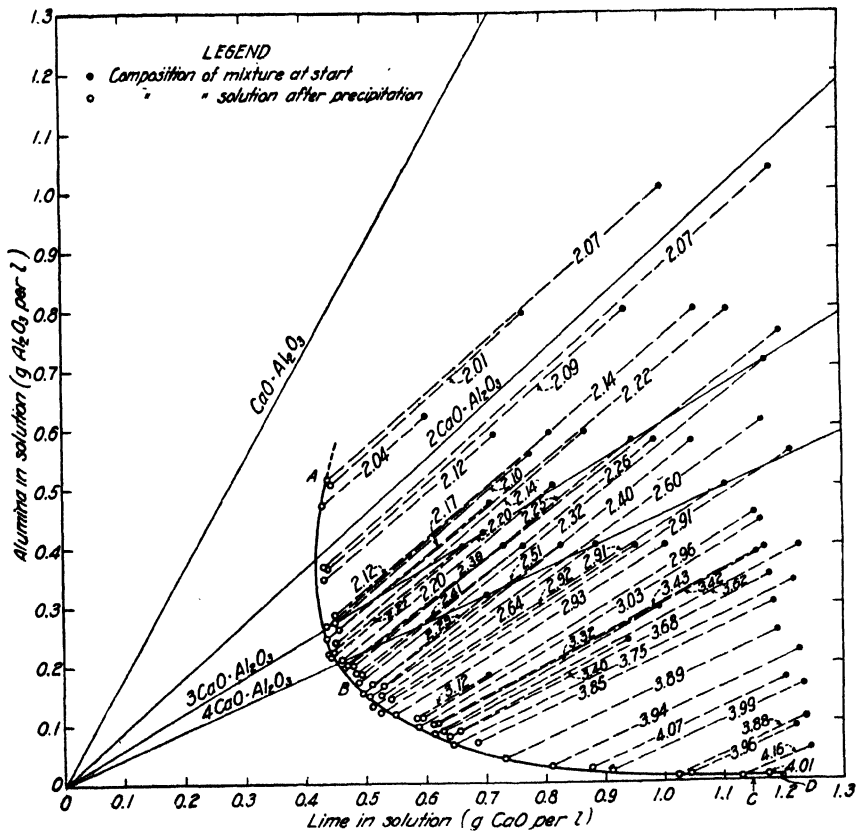

Figure 187. Quantity of alumina in solutions of increasing lime concentration that are saturated with respect to metastable hexagonal calcium aluminate hydrates containing lime and alumina in the molar proportions shown. Temperature 21°. (Wells, Clarke and McMurdie)

2E was 38°; calculated from the indices, it was 25°. Indices given by other investigators have varied from $\omega = 1.519$ and $\epsilon = 1.506$ for plates having 8.4 mols of H₂O(1) to $\gamma = 1.535$ and $\alpha = 1.520$ for plates having 14.0 mols of H₂O(3).

The metastable invariant point for C₂AH₆ and C₄AH₁₂ was found to lie somewhere between 0.5 and 0.6 g CaO per liter and 0.10 and 0.15 g Al₂O₃ per liter. At lower lime concentrations, the 2:1 compound predominated; at higher lime concentrations the 4:1 compound predominated.

Further evidence upon the character of these hydrated aluminates was obtained by means of X-ray diffraction patterns. The patterns of composition $2\text{CaO}\cdot\text{Al}_2\text{O}_3\cdot 8\text{H}_2\text{O}$ and $4\text{CaO}\cdot\text{Al}_2\text{O}_3\cdot 13\text{H}_2\text{O}$ are given on page 547. In both preparations, the lines appear to be those of a compound having a hexagonal unit cell in which $a = 8.8\text{A}$. The value of c for the 2:1 compound was 10.6A , and for the 4:1 compound was 8.2A . The patterns for compounds intermediate between the 2:1 and the 4:1 compositions gave intensities of the 001 lines (at 10.6 and 8.2A) which indicated the presence in all cases of appropriate proportions of the two compositions, C_2AH_6 and C_4AH_{13} . From these observations, Wells and his associates concluded that the so-called hexagonal tricalcium aluminate hydrate is in reality not a separate compound but a mixture of the hexagonal hydrated C_2A and C_4A in equal molar proportions. Since these hydrates are of very similar structure parallel to the a axis, they are believed capable of intercrystallization, and to be made up of layers of the one compound so intimately mixed with layers of the other that the average indices of refraction are obtained.

The examination of specimens stored in sealed vials for 2 to 3 years showed an increase in refractive indices in the low-CaO compositions to values similar to those of the high-CaO compositions, and the X-ray patterns in all cases were those of the 4:1 compound. This indicated to the authors that the 2:1 compound decomposes to give the 4:1 composition:



This is in agreement with the prior finding of Bessey (5).

Equilibria in the System $\text{CaO}-\text{Al}_2\text{O}_3-\text{H}_2\text{O}$

All the hexagonal forms of hydrated calcium aluminate were found by Wells (36) to be metastable at temperatures of 21° or higher, and to revert more or less slowly to the isometric C_3AH_6 , readily recognized by its form and refractive index of 1.605. By allowing the solutions to stand for longer periods than employed in the study of the hexagonal forms, the isometric crystals were produced. In this process, the composition of the solid phases approached closely the 3:1 composition, and the solubility curve was displaced closer to the axes. The same curve was obtained by placing C_3AH_6 in solutions containing various concentrations of $\text{Ca}(\text{OH})_2$. The results from both procedures are shown in Figure 188 on the dot-dash curve. The broken line is the curve of solubilities of the hexagonal calcium aluminates, transferred from Figure 187. The diagonal broken lines show the changes in composition obtained by allowing metastable solutions to stand until equilibrium was approached, the figures upon them being the $\text{CaO}:\text{Al}_2\text{O}_3$ ratios of the final precipitates. It is seen that in all cases this is close to 3:1. The lower solid curve is that obtained by Lea and Bessey (19) at 25° , slightly revised from that shown by Lea and Desch (20) at an earlier date. The point L locates the solubility of C_3AH_6 as given by Bessey, which is also the invariant point ascribed by him to the invariant point $\text{C}_3\text{AH}_6-\text{Al}_2\text{O}_3\cdot\text{aq}$. Point T represents the solubility of C_3AH_6 , found by Thorvaldson and his associates (32) at 21° . Values obtained by Nacken and Mosebach (25) are shown at N_1 , N_2 and N_3 .

At 90° the solubility of the C_3AH_6 was found to be somewhat greater than at 21° .

Assarsson (2) found that hydrated alumina separated from calcium aluminate solutions, and that it showed variable indices of refraction, the index of the outer layers of concentric shells of the spherulites being higher than that of the inner layers. On aging, the hydrated alumina showed the X-ray pattern of gibbsite (Al₂O₃·3H₂O). Wells and his associates also found that hydrated alumina was formed slowly as one of the products of hydration of the calcium aluminate solutions, and that this material, at first apparently amorphous, aged to crystals showing the pattern and indices of gibbsite. It was concluded that gibbsite is the

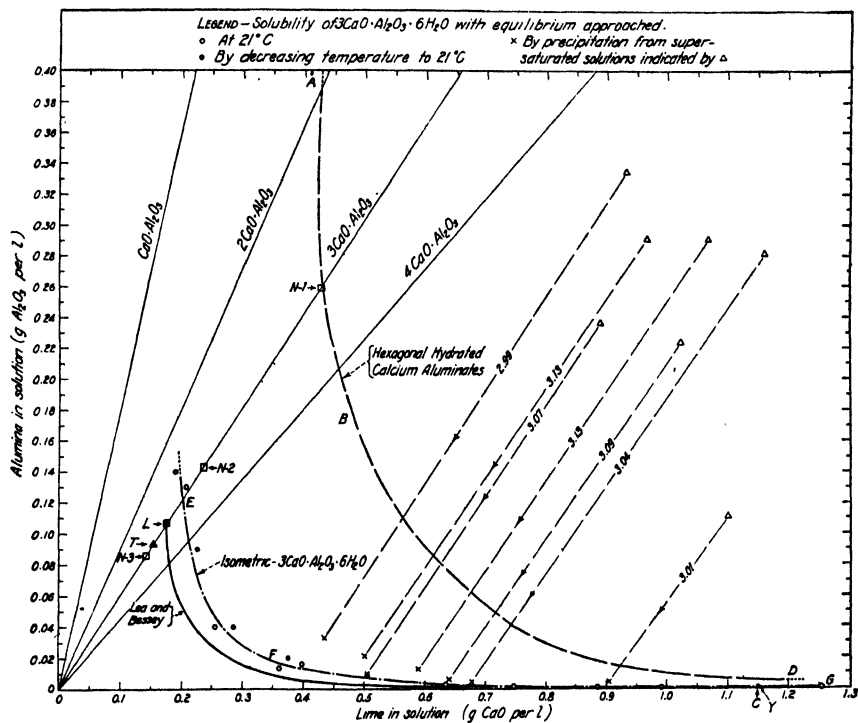

Figure 188. Solubility relationships of isometric tricalcium aluminate hexahydrate, 3CaO·Al₂O₃·6H₂O, in the system CaO-Al₂O₃-H₂O at 21°. (Wells, Clarke and McMurdie)

stable phase in the system CaO-Al₂O₃-H₂O at 21° up to a concentration of 0.33 g CaO per liter, and that isometric C₃A·6H₂O is the stable phase beyond that point. The Al₂O₃ content of this composition, which is the invariant point for C₃A·6H₂O-AH₃, contains 0.02 g Al₂O₃ per liter. At 90° this invariant point was found to be at a composition of 0.33 g CaO and 0.11 g Al₂O₃ per liter.

The final diagram of the system CaO-Al₂O₃-H₂O as developed by Wells and his associates is shown in Figure 189 for temperatures of 21° and 90°. There can be no stable equilibrium curves for the two metastable hexagonal aluminates, but diagrams for these metastable solubility curves were drawn from their data, supplemented by those of other investigators. The experimental curve *ABD* shows the composite solubility of mixtures of the metastable forms. The point *Q* indi-

icates the solubility of C_2AH_6 in water, as reported by Bessey (5). The curve for the solubility of C_2AH_6 with increasing $Ca(OH)_2$ concentrations is then drawn through the invariant point R , for $C_2AH_6-C_4AH_{13}$, to S where the C_4AH_{13} is the stable phase. By analogy, the curve TRV is drawn to indicate the approximate solubility curve for C_4AH_{13} . The point V represents the approximate metastable invariant point for $C_4AH_{13}-CH$.

The curve EFG represents the solubility curve of isometric C_2AH_6 and HFJ that of $Al_2O_3 \cdot 3H_2O$ at 21° . F is the stable invariant point for those two solid

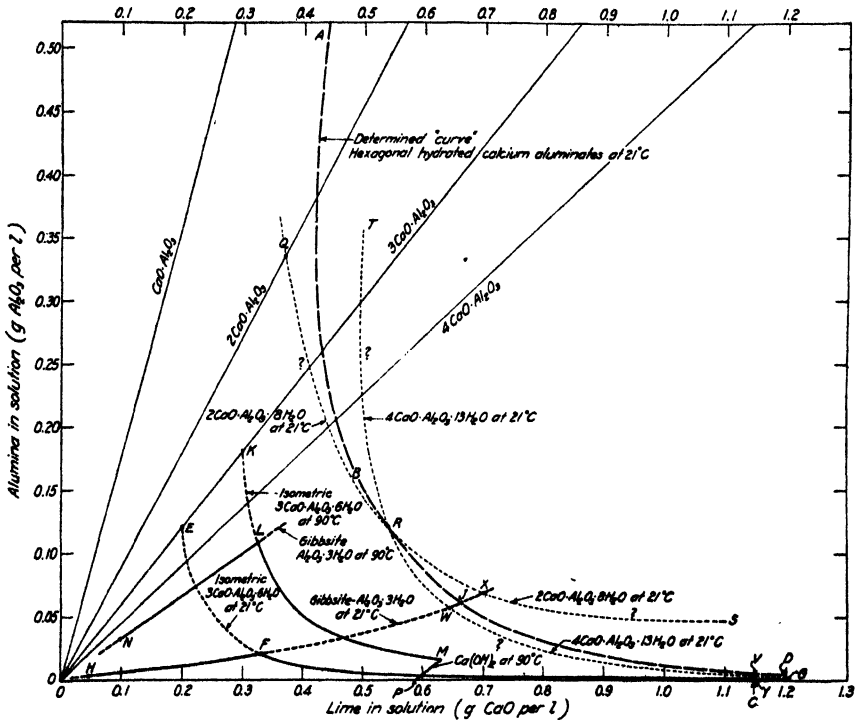

Figure 189. The system $CaO-Al_2O_3-H_2O$ at 21° and at 90° . (Wells, Clarke and McMurdie)

phases with solution. W is the metastable invariant point for $C_4AH_{13}-AH_3$, and X the metastable invariant point for $C_2AH_6-AH_3$. These latter points are only hypothetical and were not established. Thus if CaO is in excess of 0.33 g per liter at 21° , the stable phase is seen to be C_2AH_6 . The invariant point for C_2AH_6-CH is shown at Y , and contains 1.15 g CaO and 0.0005 g Al_2O_3 per liter. The very short line YC represents the solubility of $Ca(OH)_2$ at 21° .

The corresponding curves for 90° are shown: KLM for C_2AH_6 , NL for AH_3 , and PM for $Ca(OH)_2$.

Other compounds which have been reported, as C_2AH_{11} by Travers (34) and Mylius (24), and C_2AH_{14} and CAH_{10} by Assarsson (2) are believed by Wells not

to exist in the system CaO-Al₂O₃-H₂O or, if they exist, to be very unstable. It was concluded that the only stable phases are Al₂O₃·3H₂O, C₂AH₃ and Ca(OH)₂.

Hydration of the Alumina and Iron Compounds in Steam

Specimens of CA, C₁A₂ and C₃A were treated by Klein and Phillips (15) with steam both at atmospheric pressure and with an excess of water in an autoclave at 300 lbs. pressure. The hydration at 105° gave incomplete hydration, the products consisting of amorphous material and fine anisotropic needles which were identified as C₂A.aq. In the autoclave, hydration was complete in 2 hours with no free CaO being formed. The CA and C₁A₂ gave amorphous material, and needles and hexagonal plates of C₂A.aq. The C₃A gave some of these crystal forms but was mostly amorphous.

On treating the C₃A, or CaO and Al₂O₃ in a 3:1 mixture, in saturated steam in an autoclave at 150°, Thorvaldson and Grace (31) and Thorvaldson, Grace and Vigfusson (32) found that isotropic cubes and trapezohedrons were formed. These were identified as C₂AH₃, having an index of refraction of 1.604 ± 0.002 .

A further study on the hydration of the cement compounds in saturated steam was made by Mather and Thorvaldson (23). Pure CaO in saturated steam at 150° to 300° was found to hydrate to CaO·H₂O, and pure Al₂O₃ to Al₂O₃·3H₂O. A precipitate of ferric hydroxide which had a composition, after drying at 105°, of Fe₂O₃·1.12H₂O was found to lose water, on steaming at 100° to 170° and subsequent drying over lime, to a molar ratio H₂O:Fe₂O₃ of 0.20. The X-ray pattern was similar to that of hematite, and it was concluded that the steam treatment of Fe₂O₃ leaves the material unchanged. The product obtained on the steam treatment of C₂A has already been described as the isometric C₂AH₃. Temperatures of steam up to 300° left the product unchanged.

When dicalcium ferrite, C₂F, was subjected to steam treatment at 100° and 300°, water was taken up in the amount of 2 mols per mol of C₂F. A microscopic examination showed plate-like crystals which were identified as Ca(OH)₂, and the X-ray patterns revealed only the lines of Ca(OH)₂ and hematite (Fe₂O₃). The free-CaO test showed that 2 mols of CaO had been liberated per mol of original C₂F. These results indicated that the C₂F dissociates, on steaming for 5 days at 300°, or 46 days at 100°, into Ca(OH)₂ and Fe₂O₃. Subsequent experiments indicated that the reaction takes place in two or three stages. During the first hour or two a large amount of hydration takes place before any lime is liberated. The progress of the reactions is believed to be

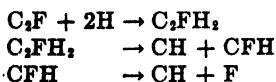

Samples of C₄AF exposed to saturated steam for 5 days or longer at temperatures from 100° to 300° were found in all cases to take up 7 mols of H₂O per mol of C₄AF. Microscopic examination showed the presence of crystalline Ca(OH)₂ and C₂AH₃. A free-CaO test showed that 1 mol of CaO had been liberated per mol of C₄AF. Thus the hydration of C₄AF in steam for long periods followed the reaction:



A shorter period of steaming showed, however, as with C_2F , a sequence of reactions. Seven mols of water were absorbed very rapidly but the liberation of CaO was much slower. It seems probable that C_4AF reacts rapidly with steam at 100° to 300° to form C_2AH_3 and CFH , and the latter then decomposes slowly to $Ca(OH)_2$ and hematite:

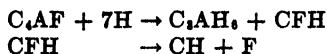

The slowness of the reaction and the marked effect of temperature in increasing the rate of liberation of CaO suggests that, on hydration of the C_2F and C_4AF at room temperatures with a limited quantity of water, the CFH may be sufficiently stable to represent an end product, as suggested by Bogue and Lerch(7).

TABLE 37. The Principal hydrolytic products of the alumina and iron compounds

Original material	Treatment	Products	Authority
3C:A.....	Removal of dissolved material	Al_2O_3 .aq.	Lerch and Bogue (22)
5C:3A.....	Removal of dissolved material	Al_2O_3 .aq.	Lerch and Bogue (22)
C:A.....	Precipitated from solution 5 hrs.	C_2A .aq. + Al_2O_3 .aq.	Wells (35)
5C:3A.....	Precipitated from solution 2 hrs.	C_2A .aq. + Al_2O_3 .aq.	Wells (35)
3C:A.....	In excess $Ca(OH)_2$	C_4AH_{12}	Wells (35)
C_2A	In water at 30° - 150°	C_2AH_3 isometric	Thorvaldson et al (32)
C_2A	In water at 0° - 21° , held over salts of various vapor tensions	C_2AH_3 hexagonal C_2AH_3 hexagonal $C_2AH_{10.5}$ hexagonal C_2AH_{12} hexagonal	Thorvaldson et al (32)
C:A variable..	Precipitated from solution	C_2AH_{11} hexagonal C_4AH_{12-14} hexagonal	Wells et al (36)
C_2A	Steam 100° - 150°	C_2AH_3 isometric	Thorvaldson et al (32)
	Steam 150° - 200°	Birefringent crystals, mean index 1.58	Thorvaldson et al (32)
	Steam 205° - 350°	Prismatic plates, mean index 1.627 C:A less than 1.5	Thorvaldson et al (32)
C_2F	Removal of dissolved material	Fe_2O_3 .aq.	Lerch and Bogue (22)
	Paste	C_2F .aq.	Bogue and Lerch (7)
	Steam at 100° - 300°	$Fe_2O_3 + Ca(OH)_2$	Mather and Thorvaldson (23)
C_4AF	Paste	$C_2AH_3 + CF$.aq.	Bogue and Lerch (7)
	Steam at 100° - 300°	$C_2AH_3 + Fe_2O_3 + Ca(OH)_2$	Mather and Thorvaldson (23)

The deleterious effect on the strength of cement mortars, produced by prolonged treatment in steam under pressure, and the existence of an optimum time interval for steam curing which becomes shorter as the temperature is raised (33), is possibly at least partially explained by the slow second reaction.

In a later paper by Harris, Schneider and Thorvaldson (11) it was found that although the isometric C₂AH₆ was the stable phase of hydrated tricalcium aluminate in the temperature range around 150°, a prolonged treatment in steam at higher temperatures resulted in the segregation of birefringent crystalline phases. At temperatures below 200° this material had a refractive index of 1.58. Between 205° and 350° a product was obtained containing crystals of calcium hydroaluminate in the form of rectangular prismatic plates with a CaO:Al₂O₃ ratio of less than 1.5, as well as crystals of Ca(OH)₂, but no free hydrated alumina. Two of the refractive indices of the crystalline hydroaluminate were close to 1.627.

Thus it appears that under conditions favoring hydrolysis at least one and possibly two birefringent hydroaluminates may be formed, one at temperatures below approximately 200° having a mean refractive index of 1.58, and one at higher temperatures with a refractive index of 1.627. It was felt that the formation of these birefringent hydroaluminates may be an important factor in the improvement of sulfate resistance of cements subjected to steam curing.

The principal hydrolytic products of the alumina and iron compounds discussed above are summarized in Table 37.

References

1. Assarsson, G., *Z. anorg. allgem. Chem.*, **200**, 385 (1931); **205**, 335 (1932); **214**, 158 (1933).
2. Assarsson, G., *Z. anorg. allgem. Chem.*, **222**, 321 (1935); *Symposium*, 441.
3. Assarsson, G., *Sveriges Geol. Undersokn.*, 399 (1936).
4. Bates, P. H., *Tech. Papers, NBS*, 197 (1921).
5. Bessey, G. E., *Symposium*, 141.
6. Blum, Wm., *J. Am. Chem. Soc.*, **35**, 1499 (1913).
7. Bogue, R. H., and Lerch, W., *Ind. Eng. Chem.*, **26**, 837 (1934); PCAF Paper 27.
8. Eiger, A., *Rev. materiaux const. pub.*, **32**, 141 (1937).
9. Flint, E. P., McMurdie, H. F. and Wells, L. S., *J. Res. NBS*, **26**, 13 (1941); RP 1355.
10. Forsen, L., *Symposium*, 298.
11. Harris, G. M., Schneider, W. G. and Thorvaldson, T., *Can. J. Res.*, **21**, 65 (1943).
12. Hedin, P., *Proc. Swedish Cement and Concrete Inst.*, **3** (1945).
13. Heyrovsky, J., *J. Chem. Soc.*, **117**, 1013 (1920).
14. Hoffmann, H., *Zement*, **25**, 113 (1936).
15. Klein, A. A., and Phillips, *Tech. Papers NBS* 43 (1914).
16. Kuhl, H., and Thuring, H., *Zement*, **13**, 243 (1924).
17. Kuhl, H., and Wang, T., *Zement*, **21**, 105; 120; 134 (1932).
18. Lafuma, H., *Ciment*, **30**, 174 (1925).
19. Lea, F. M., and Bessey, G. E., *Symposium*, 178.
20. Lea, F. M., and Desch, C. H., "The Chemistry of Cement and Concrete," p. 153, New York, Longmans Green & Co., 1935.
21. Le Chatelier, H., "Experiments on the Constitution of Hydraulic Mortars," New York, McGraw Publishing Co., 1905.
22. Lerch, W. and Bogue, R. H., *J. Phys. Chem.*, **31**, 1627 (1927); PCAF Paper 11.

23. Mather, D. T., and Thorvaldson, T., *Can. J. Res.*, **15**, 331 (1937).
24. Mylius, C. R. W., *Acta Acad. Aboensis Math. Phys.*, **7**, 3 (1933).
25. Nacken, R., and Mosebach, R., *Z. anorg. allgem. Chem.*, **225**, 289 (1935); **227**, 328 (1936).
26. Pulfrich, H., and Linck, G., *Kolloid Z.*, **34**, 117 (1924).
27. Radeff, K., *Zement*, **14**, 177 (1925).
28. Schlapfer, P., *Symposium*, 270.
29. Shelton, G. R., *Ind. Eng. Chem.*, **17**, 589; 1267 (1925); **18**, 1854 (1926).
30. Slade, R. E., and Polack, W. G., *Trans. Faraday Soc.*, **10**, 150 (1914).
31. Thorvaldson, T., and Grace, N. S., *Can. J. Res.*, **1**, 36 (1929).
32. Thorvaldson, T., Grace, N. S. and Vigfusson, V. A., *Can. J. Res.*, **1**, 201 (1929).
33. Thorvaldson, T., Vigfusson, V. A., and Wolochow, D., *Can. J. Res.*, **1**, 359 (1929).
34. Travers, A., and Sehnoutka, J., *Ann. Chim.*, **13**, 253 (1930).
35. Wells, L. S., *J. Res. NBS*, **1**, 951 (1928); RP 34.
36. Wells, L. S., Clarke, W. F., and McMurdie, H. F., *J. Res. NBS*, **30**, 367 (1943); RP 1539.

CHAPTER 24

The Aluminate and Ferrite Complex Salts

The existence of a calcium sulfoaluminate and a calcium chloraluminat has long been known to cement chemists, but within the past fifteen years a considerable number of complex salts of calcium aluminates have been discovered. In addition to the high-sulfate form of calcium sulfoaluminate, $C_3A \cdot 3CaSO_4 \cdot 31-33H_2O$, there was found (33) a low-sulfate form, $C_2A \cdot CaSO_4 \cdot 12H_2O$. And in place of the SO_4 radical it was found that a large number of bivalent or monovalent radicals could be introduced into the molecule (14) (15) (38) (2). These include CrO_4 , SeO_4 , MnO_4 , CO_3 , $(ClO_3)_2$, $(IO_3)_2$, $(HCO_3)_2$, $(CH_3CO_2)_2$, $(C_2H_3CO_2)_2$, Cl_2 , Br_2 , I_2 , $(NO_3)_2$, $(NO_2)_2$ and $(OH)_2$. Most of the above have little or no interest to the cement chemist, but a few are of much importance and will be treated below. An excellent summary has been presented by Jones (19).

In addition to the above, it has been found that Fe_2O_3 may replace Al_2O_3 continuously, forming the solid-solution series $C_2AH_6-C_2FH_6$, and that SiO_2 may replace H_2O in the above, forming the series $C_2AH_6-C_2AS_2$ and $C_2FH_6-C_2FS_2$. Since the above anhydrous compounds are found in the mineral garnets, these compounds are referred to as the hydrogarnet series (10).

Finally, solid solution is indicated between the trisulfate and the monosulfate salts, as also between the corresponding substituted salts containing SiO_2 and $(OH)_2$. This is referred to as the sulfoaluminate solid solution series (24) (25) (12).

Early History

Candlot (6) appears to have been the first to establish the formation of a definite compound by the interaction of a calcium aluminate with calcium sulfate. He mixed saturated solutions of a calcium aluminate and calcium sulfate and observed the formation of small crystalline spherulites 2 to 3 mm in diameter. The addition of a saturated solution of calcium hydroxide caused a more abundant precipitation of the crystals as they seemed to be less soluble in calcium hydroxide solutions. From analysis of a sample of these crystals, Candlot ascribed to them the composition $3CaO \cdot Al_2O_3 \cdot 2.5CaSO_4 \cdot 59H_2O$. He describes the crystals as being only slightly soluble in water, and insoluble in alcohol or in limewater containing more than 0.2 g of CaO per liter.

Because of the wide-spread interest in the disintegrating action of sulfate waters on concrete, the identification of a calcium sulfoaluminate immediately attracted the attention of cement chemists. Michaelis (37) prepared the compound by the reaction of a solution of aluminum sulfate on limewater. The crystals resembled bacilli in size and shape and so were called by him "Cement Bacilli," Michaelis describes the crystals as broad, needle-shaped prisms belonging to the tetragonal system, some with and some without truncated ends. From

analysis of a sample dried to constant weight over sulfuric acid he derived the formula $3\text{CaO} \cdot \text{Al}_2\text{O}_3 \cdot 3\text{CaSO}_4 \cdot 30\text{H}_2\text{O}$. Although this formula is different than that ascribed by Candlot to the sulfoaluminate, yet from the descriptions given it seems probable that the two preparations were the same compound. The formula of Michaelis for the anhydrous material, $3\text{CaO} \cdot \text{Al}_2\text{O}_3 \cdot 3\text{CaSO}_4$, was soon confirmed by Deval (8), Poirson (40), Klein and Phillips (26), Kuhl and Albert (28) Lafuma (30) and McIntire and Shaw (34). There was, however, a difference of opinion on the number of combined molecules of water, due to different methods of procedure in the preparation and drying of the samples.

Different authors have believed that they obtained still other calcium sulfoaluminates. Thus Klinkenberg (27) claims to have obtained three definite compounds by adding to a sintered mixture, which he believed to be dicalcium aluminate, 1, 2, and 3 equivalents of gypsum, and allowing the reaction to proceed for six months. He assigned to them the formulas:

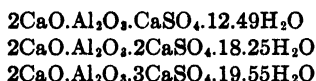

However, there is no evidence given that the products were definite chemical compounds and not mixtures.

On determining the quantity of water fixed by mixtures of "dicalcium aluminate" and calcium sulfate, in variable proportions, Schott (43) believed he demonstrated the existence of the compound $2\text{CaO} \cdot \text{Al}_2\text{O}_3 \cdot 2\text{CaSO}_4 \cdot 18\text{H}_2\text{O}$. Rebuffat (41) criticized the work and conclusions of Schott, and claimed to have produced two sulfoaluminates. To one of these he gave the formula $3\text{CaO} \cdot \text{Al}_2\text{O}_3 \cdot 3\text{CaSO}_4 \cdot 10\text{H}_2\text{O}$. This, he said, is formed when a solution of calcium sulfate is mixed with an aqueous solution of any aluminate, or when either tricalcium aluminate or so-called dicalcium aluminate in the solid form is shaken with a solution of calcium sulfate. The second sulfoaluminate, to which he gave the formula $\text{CaO} \cdot \text{Al}_2\text{O}_3 \cdot \text{CaSO}_4 \cdot 10\text{H}_2\text{O}$, was said to be formed when the solid monocalcium aluminate was shaken with calcium sulfate solution.

In a later paper, from a study of his own work and that of Candlot, Deval and others, Rebuffat (42) concludes that the formula for the first sulfoaluminate should be $3\text{CaO} \cdot \text{Al}_2\text{O}_3 \cdot 2.5\text{CaSO}_4 \cdot 7\text{H}_2\text{O}$. This he says is formed from any calcium aluminate and calcium sulfate in the presence of calcium hydroxide.

Klein and Phillips, however, found that monocalcium aluminate, 5-3 calcium aluminate and tricalcium aluminate all react with calcium sulfate to give the same sulfoaluminate. They give the formula for the compound as $3\text{CaO} \cdot \text{Al}_2\text{O}_3 \cdot 3\text{CaSO}_4 \cdot x\text{H}_2\text{O}$, the value of x varying with the method of drying. The crystals are described as long slender needles showing very low interference colors and a biaxial, positive interference figure, with a large optic axial angle. Elongation was negative and extinction parallel. Refractive indices were less than 1.48. Twinning was not noted, but occasional irregular intergrowths were observed. The ends of the needles were said to be flat and perpendicular to the long axis of the needles, an observation differing from that of Michaelis.

Shelton (44) has shown that all the calcium aluminates react with magnesium sulfate, when present in dilute solution (less than 0.1M), or with sodium sulfate

in all concentrations, to form the same calcium sulfoaluminate. In higher concentrations of magnesium sulfate than 0.1M, the only crystalline product was gypsum. The sulfoaluminate is said by Shelton to occur usually as fine needles, but sometimes as coarse prisms, frequently with short needles growing parallel to each other from opposite ends of a prism. Optical properties were determined on the coarse prisms, after separating them from the solution, washing with water and drying in a desiccator until just dry, usually less than an hour. The optical character was positive and axial angle large, but the interference figure was indistinct. Elongation was negative and refractive indices were $\alpha = 1.461 \pm 0.003$, $\gamma = 1.463 \pm 0.003$.

Deval (8) attempted to show, by a rather indirect method, that the amount of calcium sulfate fixed by a cement may greatly exceed that required to convert all of the alumina to calcium sulfoaluminate. Lafuma (30) reported similar results and suggested the formation of a calcium sulfo-silico-aluminate.

The action of calcium sulfoaluminate in the disintegration of concrete has been a question of controversy for many years. Michaelis was among the first to advance the theory that the destructive action of sulfate solutions on concrete is due to the formation of this salt, with its large amount of water of crystallization and consequent large increase in volume. This theory was supported by Le Chatelier (32), Candlot (6) and others, but met with much opposition mainly because the crystals had not been observed in disintegrated concrete. Rebuffat (42) strongly denied the formation of the calcium sulfoaluminate in sea water, for he believed that sea water, as well as dilute solutions of sodium or magnesium salts, decompose the calcium sulfoaluminate rapidly. Later, however, Nitzsche (39) found the calcium sulfoaluminate crystals in concrete, and stated that it is because the salt is readily decomposed by water, solutions of magnesium sulfate, or sea water, that it had not been discovered previously in concrete.

The Calcium Sulfoaluminates

In a study by Lerch, Ashton and Bogue (33), two forms of calcium sulfoaluminate were prepared and their properties and compositions established. One of these forms was found to have the composition $C_2A \cdot 3CaSO_4 \cdot 31H_2O$ and is referred to as the high-sulfate form or trisulfate. The other had the composition $C_2A \cdot CaSO_4 \cdot 12H_2O$, and is referred to as the low-sulfate form or monosulfate.

The most satisfactory method for the preparation of the high-sulfate form consisted in the interaction of solutions of $CaSO_4$ and calcium aluminate, preferably with added $Ca(OH)_2$. By the use of dilute solutions of $CaSO_4$, crystals of the sulfoaluminate were obtained containing as little as 2.5 mols $CaSO_4$ per mol of C_2A . Thus the molar ratio was found to vary with the concentration of $CaSO_4$ in the solution, and was explained as due to an equilibrium mixture of $C_2A \cdot 3CaSO_4 \cdot 31H_2O$ and $C_2A \cdot aq$. As the concentration of $CaSO_4$ increases, the amount of the hydrated C_2A decreases and finally disappears. This may explain the difference in composition assigned to this compound by different investigators.

Microscopic examination showed the crystals to consist of long hexagonal needles, uniaxial negative in character and showing negative elongation. The refractive indices in sodium light are $\omega = 1.464 \pm 0.002$ and $\epsilon = 1.458 \pm 0.002$, birefracton 0.006. The specific gravity is 1.48 at 20°. A photomicrograph of these

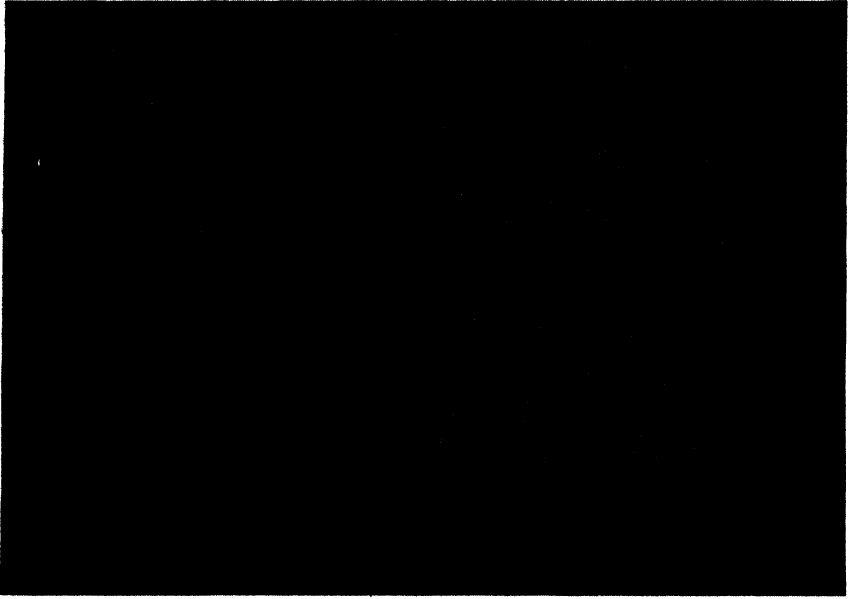

Figure 190. Calcium sulfoaluminate needles, high-sulfate form. Analyzer out. $\times 200$. (Lerch, Ashton and Bogue)

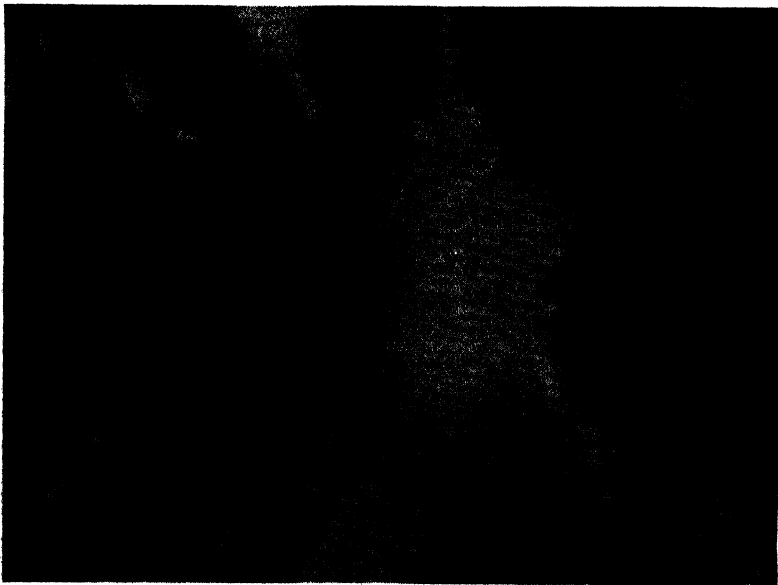

Figure 191. Calcium sulfoaluminate spherulite from an old briquet. High-sulfate form. Reflected light. $\times 75$. (Lerch, Ashton and Bogue)

crystals is shown in Figure 190. In Figure 191 is shown a spherulite of similar crystals which had formed in an old briquette.

The high-sulfate crystals were found to be slightly dissociated in water, the dissociation being somewhat repressed by solutions of $\text{Ca}(\text{OH})_2$ and CaSO_4 , and slightly increased by solutions of NaCl and Na_2SO_4 . In all these cases, however, the amounts of CaO , Al_2O_3 or SO_3 going into solution were far less than the amounts which would be dissolved from C_2A or from CaSO_4 .

When carbonates are present, the CaO liberated by hydrolysis of the calcium sulfoaluminate appears to be converted to the more insoluble compound, CaCO_3 ,

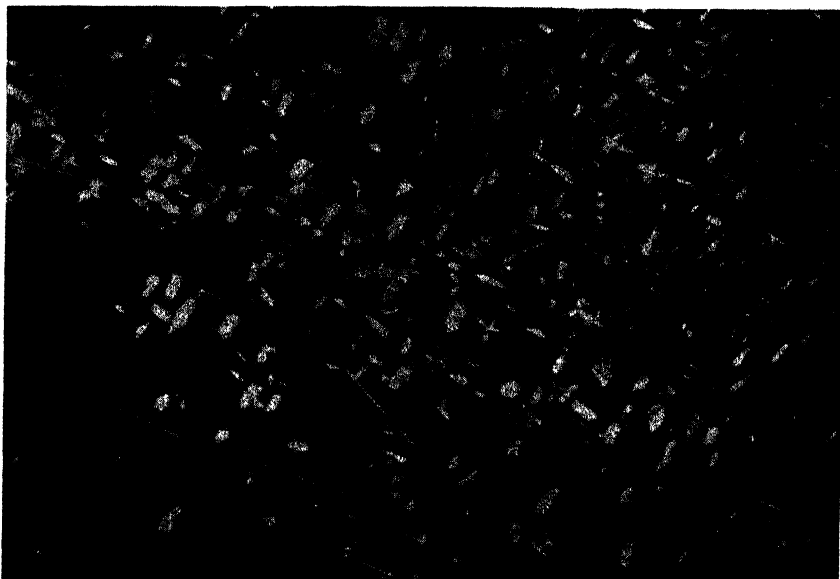

Figure 192. A mixture of calcium sulfoaluminates. Crossed nicols. $\times 130$. The needles are the high-sulfate form, and the star-shaped aggregates are the low-sulfate form. (Lerch, Ashton and Bogue)

and the sulfoaluminate is thereby decomposed. If a magnesium salt is present, the OH -ions of $\text{Ca}(\text{OH})_2$ are removed by precipitation as $\text{Mg}(\text{OH})_2$. Thus the sulfoaluminate is unstable in the presence of soluble carbonates or magnesium salts.

The low-sulfate form of calcium sulfoaluminate was found to be a metastable form which tended to precipitate in the presence of a high concentration of $\text{Ca}(\text{OH})_2$. It was best prepared by adding a saturated solution of CaSO_4 to the clear filtrate obtained by adding 200 ml of saturated limewater to 500 ml of calcium aluminate solution prepared from C_2A . A chemical analysis of the precipitate at 2 hours gave the formula $\text{C}_2\text{A} \cdot \text{CaSO}_4 \cdot 12\text{H}_2\text{O}$. The crystals show hexagonal platy habit, distinctly different from the high-sulfate compound. Refractive indices are $\omega = 1.504 \pm 0.002$ and $\epsilon = 1.488 \pm 0.002$, birefracton 0.016. The radiating needles (or edges of plates) seen in the star-shaped aggregates

TABLE 38. Comparison of optical data on the calcium sulfoaluminate

	Klein and Phillips		Shelton	Leroh, Ashton and Bogue	
				High-sulfate form	Low-sulfate form
Formula.....	3CaO.Al ₂ O ₃ .3CaSO ₄ .sq			3CaO.Al ₂ O ₃ .3CaSO ₄ .31H ₂ O	3CaO.Al ₂ O ₃ .CaSO ₄ .12H ₂ O
Habit.....	Long slender needles often in spherulitic form		Not given Long needles and coarse prisms	Long lath-shaped needles often in spherulitic form	Hexagonal plates, often in star-shaped groups of 4 to 8 plates joined at edge Uniaxial negative
Optical character.....	Biaxial positive. Large optic axial angle		Biaxial positive. Large optic axial angle	Uniaxial negative	
Extinction.....	Parallel		Parallel	Parallel	Parallel
Elongation.....	Negative		Negative	Negative	Positive
Refractive indices.....	Less than 1.48		$\alpha = 1.461 \pm .003$ $\gamma = 1.463 \pm .003$	$\omega = 1.464 \pm .002$ $\epsilon = 1.458 \pm .002$	$\omega = 1.504 \pm .002$ $\epsilon = 1.488 \pm .002$
Birefracton.....	Low		0.002	0.006	0.016

show parallel extinction and positive elongation. The specific gravity is 1.95 at 20°. These several properties readily distinguish the low-sulfate from the high-sulfate form. A photomicrograph of a mixture of the two forms is shown under crossed nicols in Figure 192, where the needle-like high-sulfate crystals are seen together with the star-shaped low-sulfate crystals. The platy form of the low-sulfate crystals is shown to good advantage in Figure 193.

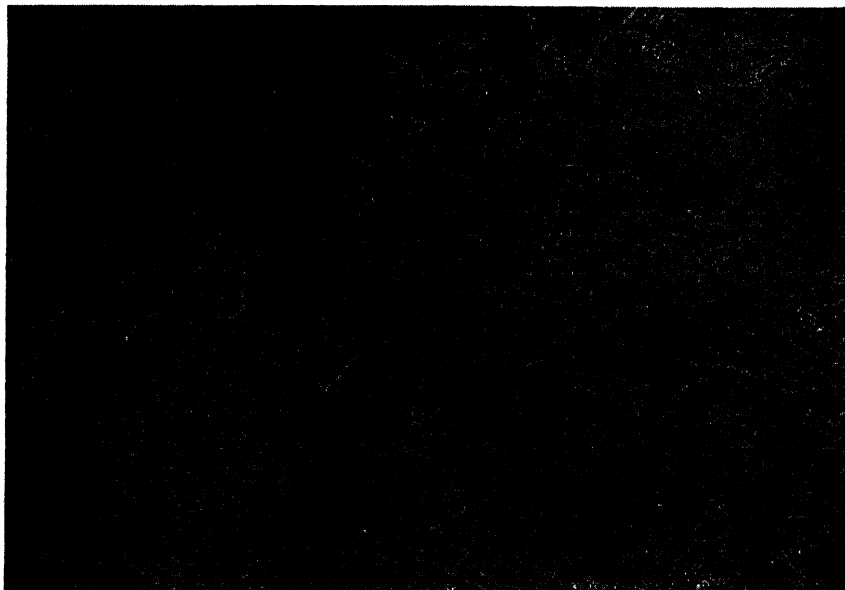

Figure 193. Low-sulfate calcium sulfoaluminate showing the platy form. Analyzer out. $\times 200$. Note the star-shaped aggregates on several of the plates. (Lerch, Ashton and Bogue)

A comparison of the optical data which have been reported on the calcium sulfoaluminates is shown in Table 38.

The Calcium Chloroaluminates

As early as 1897 Friedel (16) had investigated the interaction between the calcium and aluminum chlorides, and separated a precipitate from the analysis of which he assigned to it the composition $C_2A.CaCl_2.10H_2O$. Some years later, Poirson (40) obtained a similar compound, but the $CaCl_2$ portion was less and he gave it the formula $C_2A.0.5CaCl_2.aq$. Lafuma (31) believed that Poirson's salt had been partially decomposed, and raised the $CaCl_2$ component back to 1, but assigned a higher water content as indicated by the formula $C_2A.CaCl_2.18H_2O$.

A variable $CaCl_2$ content was assigned to the compound by Kuhl and Ulbrich (29), which suggested to Wells (45) the probability of a decomposition according to the reaction



This supposition was confirmed, for increasing concentrations of CaCl_2 prevented the decomposition and established a fixed composition of $\text{C}_2\text{A} \cdot \text{CaCl}_2 \cdot 10\text{H}_2\text{O}$.

The calcium chloraluminat was found by Wells to consist of thin hexagonal plates, uniaxial negative, having indices of refraction: $\omega = 1.550 \pm 0.003$ and $\epsilon = 1.535 \pm 0.003$.

An electrometric titration carried out by Wells (45) indicated the course of the reaction as $0.043N \text{Ca(OH)}_2$ was added to $0.043N \text{AlCl}_3$. The pH of the AlCl_3 solution was 3.71, and increased but slightly until about 2.8 mol equivalents of CaO had been added. Between the addition of 2.8 and 3.2 mols of CaO , the pH rose sharply and a flocculent precipitate of Al(OH)_3 appeared. The solution became clear again at 4.2 to 5.3 mols of CaO , but with further additions of Ca(OH)_2 , and at pH values from 11.5 to 12.0, the calcium chloraluminat separated out.

The addition of MgCl_2 to a solution of calcium aluminat was found to lower the pH from 11.5 to 7.1 when 24 g/liter were added, and to be accompanied by the precipitation of a mixture of aluminum and magnesium hydroxides. Ammonium chloride also reduced the pH sharply and caused the precipitation of aluminum hydroxide. When sodium chloride or barium chloride were added, the pH was reduced but slightly and a small amount of calcium chloraluminat was precipitated. The pH was dropped to about 9.8 by calcium chloride, and the chloraluminat formed readily. This is in agreement with the results obtained by Hedin (17) who found that the addition of an excess of CaCl_2 to a cement-water mixture dropped the pH to about 11. But the hydrated aluminates were more soluble in such a solution than Al(OH)_3 , so the latter compound precipitated, binding the cement grains together, and causing what Hedin referred to as a false quick set.

The Calcium Sulfoferrites

Very little work has been reported on aqueous systems in which Fe_2O_3 has been substituted for Al_2O_3 , but there is reason to believe that equilibria similar to those herein reported with alumina may obtain also with the iron systems. Eiger (9) obtained a cubic compound, C_2FH_6 , when ferric oxide gel was shaken with saturated Ca(OH)_2 . MacIntire and Shaw (34) believed they produced the compound $\text{C}_2\text{F} \cdot 3\text{CaSO}_4 \cdot 32\text{H}_2\text{O}$, and a probably similar compound was obtained by Bogue and Lerch (3) allowing C_2F to stand in Ca(OH)_2 solution for a year. Colorless crystals of short broad hexagonal prisms appeared having refractive indices $\alpha = 1.486 \pm 0.003$, $\gamma = 1.492 \pm 0.003$, which showed parallel extinction and positive elongation and which were uniaxial positive. Analysis could not be made because of difficulty in obtaining them in a pure state. The same product, together with $\text{C}_2\text{A} \cdot 3\text{CaSO}_4 \cdot 32\text{H}_2\text{O}$, appears to have been obtained by Malquori and Cirilli (36) by the action of CaSO_4 on the hydration products of C_2AF in the presence of lime. Jones (22) prepared the pure compound, $\text{C}_2\text{F} \cdot 3\text{CaSO}_4 \cdot 32\text{H}_2\text{O}$, by shaking at 25° a solution of iron alum, $(\text{NH}_4)_2\text{SO}_4 \cdot \text{Fe}_2(\text{SO}_4)_3 \cdot 24\text{H}_2\text{O}$, with lime in suitable proportions for 2 days. The crystals consisted of very small short needles, birefringence too slight to observe elongation, refractive index 1.490 ± 0.003 .

The low-sulfate compound, $\text{C}_2\text{F} \cdot \text{CaSO}_4 \cdot \text{H}_2\text{O}$ has been described by Malquori and Caruso (35), but the existence of a solid solution series, similar to that of the

alumina series, has not been demonstrated. Jones (22) considers it probable that the $C_3F \cdot 3CaSO_4 \cdot 32H_2O$ is formed in hydrated cement.

The Hydrogarnet Solid Solution Series

The hydration products of the glasses in the portland cement field of the C-A-F-S system formed in water and steam at high temperatures and pressures were studied by Flint and his associates (10). Treatment at 200° to 250° for periods of 4 to 9 days gave a product consisting of isotropic crystals, finely striated, having refractive indices which varied from 1.615 in an iron-free glass to 1.655 in a glass containing 23.7 percent Fe_2O_3 . The latter crystals were of a deep yellow color which indicated a solid solution. The refractive index was intermediate between that of C_2AH_6 , $n = 1.605$, and the isomorphous compound C_2FH_6 , $n = 1.710$, reported by Eiger (9), which also suggested that the crystals consisted of solid solutions of those two compounds. This supposition was confirmed by the preparation and examination of hydrated products of those components prepared in the absence (or near absence) of silica. There was noted, however, the strong tendency for these solid solutions to take up SiO_2 , and when silica was available it always was incorporated into the hydrated crystals.

Analyses of garnets (13) show the existence of a continuous series of solid solutions from C_2AS_2 to C_2FS_2 , and an intensive investigation, making use of X-ray evidence, established the existence of a complete and continuous four-way solid solution series, which may be represented:

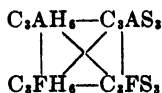

Each end member was found to be capable of forming complete mixed crystals with the other three members. Each mol of Fe_2O_3 is replaceable by 1 mol of Al_2O_3 and each mol of SiO_2 is replaceable by 2 mols of H_2O .

The principal products of hydration at elevated temperatures and pressures of various glasses, representative of compositions of the liquid phase of cement clinker at 1400°, appear to belong to this solid-solution series, as does also the principal hydration product of C_4AF . Investigations reported by Bussem (4) also indicate that hydrates of the calcium aluminosilicate series may be formed during the reaction of mixtures of C_3S and C_2A with water.

It was later shown by Flint and Wells (11) that the members of the hydrogarnet series are nearly unreactive to sulfate solutions. Whereas the C_2AH_6 placed in a solution of Na_2SO_4 in saturated limewater reacted at once to form calcium sulfoaluminate crystals, and was completely converted in 2 days, the hydrogarnets which contained some silica and ferric oxide either were unaltered or contained only small amounts of the sulfoaluminate over a period of 6 months.

These experiments suggested that the improvement observed in the sulfate resistance of cements which have been subjected to a steam treatment may be due to the removal of C_2AH_6 and the corresponding formation of the unreactive hydrogarnets. Subsequent tests showed that a steaming of the hexahydrate with hydrated tri- or dicalcium silicate resulted in the near quantitative transformation of the C_2AH_6 to C_2ASH_4 and $Ca(OH)_2$. The same reaction appears to take place

also at room temperature, but at a greatly reduced rate. Similar reactions were found also to take place upon the steam treatment of mixtures of kaolin with lime or calcium silicates.

The above experiments were believed to explain the improved resistance to sulfate action of cements which (a) are steamed, (b) contain increasing amounts of C_2A F or glass at the expense of C_2A , or (c) contain pozzolanic materials. In all of these cases hydrogarnets appear to be formed which are unreactive, or but slightly reactive, to sulfate action.

The Sulfoaluminate Solid-Solution Series

The existence of the low-sulfate form of calcium sulfoaluminate ($C_2A.CaSO_4.12H_2O$) was confirmed by Kalousek (24) (25), who found this form to appear as a metastable phase in contact with solutions of varying $Ca(OH)_2$ concentrations, and in contact with solutions nearly saturated with respect to $Ca(OH)_2$ and $CaSO_4$. In the absence of excess sulfate, it persisted for weeks as a compound of variable composition before converting to the stable high-sulfate form, $C_2A.3CaSO_4.31H_2O$. In the presence of nuclei of the high-sulfate form, the monosulfate failed to appear.

In order to obtain a better understanding of the behavior of the sulfoaluminates in pastes prepared from commercial cements, Kalousek examined the stability of these products in the presence of increasing concentrations of NaOH and KOH. The results showed that the molar ratio of SO_3 to Al_2O_3 of the solid phase diminished with increasing NaOH content. The high-sulfate form was not obtained when the NaOH was above 0.25 equivalent per liter, while the $SO_3:Al_2O_3$ ratio varied from 0.68 to 0.22 and the $CaO:Al_2O_3$ ratio remained at about 4. These results, together with a gradual change in the refractive indices, suggested the formation of a solid-solution series between $C_2A.CaSO_4.12H_2O$ and $C_2A.Ca(OH)_2.13H_2O$. This assumption was corroborated by finding from X-ray measurements that the cell size decreases with decreasing number of SO_4 ions in the molecule. The amount of the displacement toward the compound $C_2A.Ca(OH)_2.13H_2O$ was found to increase as the OH-ion concentration was increased in the aqueous phase above 0.27*N*.

In view of these observations it was suggested as probable that a complete series of solid solutions exists which may be represented:

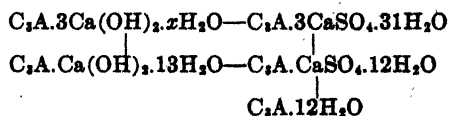

Kalousek noted that the conversion of the monosulfate form to the trisulfate form is, theoretically, accompanied by an increase in volume. Since he showed that the monosulfate may first be formed in cement pastes, changing later to the trisulfate, the supposition was advanced that this conversion, if it occurs in concrete, could give rise to undesirable expansions.

A few years later, Flint and Wells (12) succeeded in replacing the $CaSO_4$ of the calcium sulfoaluminates by $CaSiO_3$ and $Ca(OH)_2$. Thus the compound $C_2A.CS.H_{11}$ was prepared by shaking mixtures of calcium silicate and calcium

aluminate solutions with lime. The crystals which formed in a month consisted of hexagonal plates, uniaxial negative, refractive indices $\omega = 1.538 \pm 0.003$, $\epsilon = 1.523 \pm 0.003$. The X-ray diffraction pattern was similar to that of $C_2A \cdot CaSO_4 \cdot 12H_2O$ and of $C_2A \cdot Ca(OH)_2 \cdot 13H_2O$ (which may be written C_4AH_{14}).

When these preparations were allowed to stand for 3 years, the above crystals changed slowly to a high-silica form having the composition $C_2A \cdot 3CS \cdot H_{31}$. These appeared as long, thin needle-like prisms, uniaxial negative, with indices $\omega = 1.487 \pm 0.003$ and $\epsilon = 1.479 \pm 0.003$. Both of these silico aluminates were also found to be formed in mixtures of C_2S or C_3S with C_2A or C_4AF in saturated lime solution on long standing, the low-silica form appearing first and changing slowly to the high-silica form.

Assarsson (1) had previously prepared a hydrate to which he assigned the formula C_4AH_{34} , but thought that some SO_3 was necessary for its formation. Flint and Wells, however, succeeded in preparing a hexacalcium aluminate by using a sugar solution of lime in order to attain the necessary high concentrations. Upon shaking this with a calcium aluminate solution for 5 days, needle-like prisms were obtained similar in appearance to the high-sulfate form of calcium sulfoaluminate. The crystals were uniaxial negative, with indices $\omega = 1.475 \pm 0.003$ and $\epsilon = 1.466 \pm 0.003$. The X-ray diffraction pattern was almost identical with that of $C_2A \cdot 3CaSO_4 \cdot 31H_2O$. The formula assigned to these crystals is $C_2A \cdot 3Ca(OH)_2 \cdot 30H_2O$ (or C_6AH_{33}). This study confirms and extends the findings of Kalousek that a series of solid solutions may exist between these three types of complex hydrated compounds. The solid-solution series may be indicated:

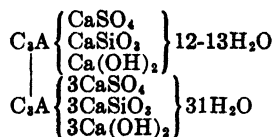

The System $CaO-Al_2O_3-CaSO_4-H_2O$

A study of the system $CaO-Al_2O_3-CaSO_4-H_2O$ at 25° was reported by Jones (20) in 1939 in which investigation alumina gel was employed for the alumina component. The system was considered as being formed of reciprocal salt pairs, $Ca(OH)_2 + Al_2(SO_4)_3 \cdot aq$, and $Al_2O_3 \cdot aq + CaSO_4 \cdot aq$. The data were plotted, as shown in Figure 194, by placing the four salt pairs at the corners of a square forming the base of a pyramid which represents the quaternary system. At the apex of this pyramid is H_2O . The composition points are then projected from the H_2O apex through points in the interior of the pyramid to give corresponding points on the base. The amount of water on such a diagram must be given as supplementary data.

The only quaternary compound found by Jones in this system at 25° was the high-sulfate calcium sulfoaluminate, $C_2A \cdot 3CaSO_4 \cdot 32H_2O$. Other crystalline phases occurring were $CaSO_4 \cdot 2H_2O$, $Ca(OH)_2$, C_2AH_6 , C_2AH_5 (metastable and containing CaO and $CaSO_4$ in solid solution), and $Al_2O_3 \cdot aq$ (probably in general also containing CaO and SO_3). The low-sulfate calcium sulfoaluminate, $C_2A \cdot CaSO_4 \cdot 12H_2O$, was not encountered in this system at 25° . Jones thinks that the appearance of the monosulfate, sometimes observed in hydrated cement pastes, may be

due to higher CaO concentrations and to local high temperatures at the surface of the C_2A grains.

The trisulfate, $C_3A \cdot 3CaSO_4 \cdot 32H_2O$, was found to be incongruently soluble in water and in dilute solutions of lime and $CaSO_4$. Above a certain concentration of $CaSO_4$, it was found to be stable, but in lime solutions it was observed to be congruently soluble only within a limited range of concentrations.

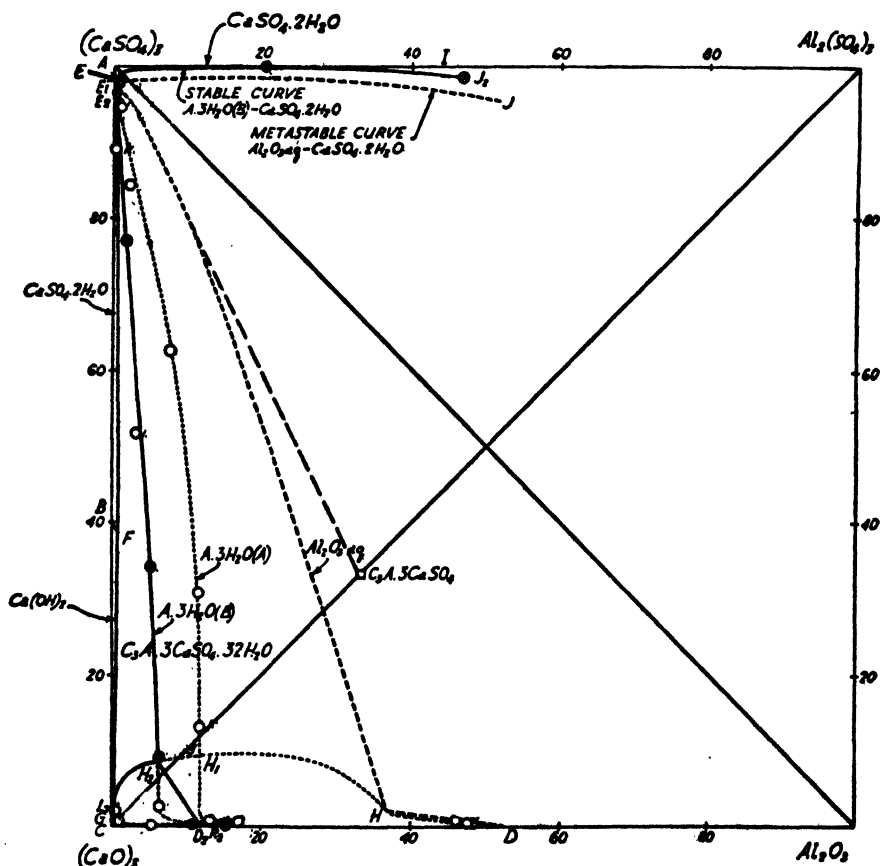

Figure 194. The quaternary system $CaO-Al_2O_3-CaSO_4-H_2O$. Projection on base of pyramid. (Jones)

Point E is the invariant point for gypsum-alumina gel-trisulfate, and EH is the boundary curve for alumina gel-trisulfate.

In a later study, Jones (21) used two other forms of hydrated alumina, both of which were crystalline. These he designated A and B. Preparation A gave an X-ray pattern similar to that of bayerite, or $\alpha-Al_2O_3 \cdot 3H_2O$, whereas the pattern of preparation B appeared to be intermediate between that of bayerite and of gibbsite, $\gamma-Al_2O_3 \cdot 3H_2O$. The results with preparation B were considered to approach those which would have been obtained with pure gibbsite, which is the most stable form of hydrated alumina.

The data obtained with these crystalline forms of hydrated alumina are also plotted in Figure 194. The same lettering is used as with the alumina gel, but subscripts indicate the form of hydrated alumina employed:

No subscript = alumina gel
 Subscript 1 = crystalline hydrate A
 Subscript 2 = crystalline hydrate B.

Thus E_1 is the invariant point for gypsum- $AH_3(A)$ -trisulfate, and E_2 is the invariant point for gypsum- $AH_3(B)$ -trisulfate. The boundary curve for $AH_3(A)$ -trisulfate is E_1H_1 , and the boundary curve for $AH_3(B)$ -trisulfate is E_2H_2 . The shifts in the position of these boundaries, due to the use of the different forms of hydrated alumina will be discussed presently.

The compositions of the invariant points are given in Table 39. It should be recalled that these are isothermal invariant points, that is, the temperature is constant at 25°. Hence, for the quaternary system, there are only three solid phases in equilibrium with solution at any point, instead of four.

As in the case of Al_2O_3 gel in the first investigation, only the high-sulfate form of calcium sulfoaluminate, $C_2A \cdot 3CaSO_4 \cdot 32H_2O$, occurs as a stable quaternary compound. Study of metastable equilibria involving crystalline $Al_2O_3 \cdot 3H_2O$, however, showed that the low-sulphate form $C_2A \cdot CaSO_4 \cdot 12H_2O$ may occur as a metastable phase as a terminal member of a solid-solution series. It was found that with respect to the B preparation of crystalline $Al_2O_3 \cdot 3H_2O$, $C_2A \cdot 3CaSO_4 \cdot 32H_2O$ is fundamentally incongruently soluble in any concentration of calcium sulfate or lime up to the saturation point. It is inferred that this must be true also for gibbsite, the most stable form of $Al_2O_3 \cdot 3H_2O$.

On comparing the boundary curves for AH_3 -trisulfate (EH , E_1H_1 , E_2H_2), it may be seen that the curve E_2H_2 , representing the most stable form of hydrated alumina, lies in a region of lower $CaSO_4$ and CaO and greater Al_2O_3 concentration than the curves for the other less stable forms of hydrated alumina. The points H , H_1 and H_2 are the invariant points for hydrated alumina-trisulfate- C_2AH_3 . It is seen that a series of such invariant points may be obtained as we proceed from the most stable form of hydrated alumina at H_2 to the least stable form at H . Thus H and H_1 are to be considered as metastable with respect to H_2 .

In the region along the metastable prolongation H_2R_2 of the curve E_2H_2 , an abrupt increase in the Al_2O_3 dissolved occurs at a CaO concentration of about 0.3 g CaO per 1000 g of solution, while at the same time the $CaSO_4$ concentration becomes very small. Solid solutions first appear at lime concentrations greater than that of R_2 . At this point the solid solution has a composition close to that of the monosulfate, $C_2A \cdot CaSO_4 \cdot 12H_2O$ but, with increasing lime concentrations, it has a composition which may be interpreted as a mixture of $C_2A \cdot CaSO_4 \cdot 12H_2O$ and $C_2A \cdot Ca(OH)_2 \cdot 12H_2O$, ending at a composition very close to that of the latter compound alone, as previously suggested by Kalousek (24).

Thus the data indicate that at low concentrations of $CaSO_4$ and high concentrations of CaO , a metastable solid solution may occur, whose composition appears to be contained within the limits imposed by combinations of C_2AH_3 , $C_2A \cdot CaSO_4 \cdot 12H_2O$, $C_2A \cdot Ca(OH)_2 \cdot 12H_2O$ and, to a limited extent, $Ca(OH)_2$. It is concluded that the low-sulfate form of calcium sulfoaluminate is only one

TABLE 39. Invariant-point compositions in the system $\text{CaO-Al}_2\text{O}_3\text{-CaSO}_4\text{-H}_2\text{O}$ at 25° (Jones)

Point	Solid phases	Composition of solids (mol percent)			Total salts in solution (mol percent)
		(CaO):		Al ₂ O ₃	
		(CaSO ₄):	(CaO):		
D ₂	AH ₃ (B)-C ₂ AH ₆	87.8	12.2	0.00324
E ₂	CaSO ₄ .2H ₂ O-AH ₃ (B)-C ₂ A.3CaSO ₄ .32H ₂ O	95.3	4.3	0.5	0.00945
E ₁	CaSO ₄ .2H ₂ O-AH ₃ (A)-C ₂ A.3CaSO ₄ .32H ₂ O	96.5	3.3	0.3	0.00940
E	CaSO ₄ .2H ₂ O-Al ₂ O ₃ .aq-C ₂ A.3CaSO ₄ .32H ₂ O	98.1	0.85	1.15	0.00966
F	CaSO ₄ .2H ₂ O-C ₂ (OH) ₇ -C ₂ A.3CaSO ₄ .32H ₂ O	38.8	60.6	0.6	0.01907
G	C ₂ (OH) ₇ -C ₂ AH ₇ -C ₂ A.3CaSO ₄ .32H ₂ O	0.95	99.0	0.15	0.01153
H ₂	C ₂ A.3CaSO ₄ .32H ₂ O-C ₂ AH ₇ -AH ₃ (B)	10.0	82.8	7.2	0.00226
H ₁	C ₂ A.3CaSO ₄ .32H ₂ O-C ₂ AH ₇ -AH ₃ (A)	10.2	76.3	13.5	0.00213
H	C ₂ A.3CaSO ₄ .32H ₂ O-C ₂ AH ₇ -Al ₂ O ₃ .aq.	1.55	61.2	37.2	0.00348
R ₂	C ₂ A.3CaSO ₄ .32H ₂ O-C ₂ A.3CaSO ₄ .12H ₂ O-AH ₃ (B)	0.15	88.2	11.8	0.00557

member of this solid-solution series, and its formation as a pure phase could occur only under special conditions.

In a discussion of the formation of calcium sulfoaluminates in hydrated portland cement, Jones concludes that, in an alkali- and iron-free cement, $C_2A \cdot 3CaSO_4 \cdot 32H_2O$ is first formed, but may change over partly, or eventually completely, into the metastable solid solution. The explanation given is that the solution becomes rapidly supersaturated with respect to $Ca(OH)_2$, and as long as solid $CaSO_4 \cdot 2H_2O$ remains, an equilibrium represented by point *F*, Figure 194, will be maintained, with $C_2A \cdot 3CaSO_4 \cdot 32H_2O$, $Ca(OH)_2$ and $CaSO_4 \cdot 2H_2O$ present.* The gypsum will eventually be used up, causing the equilibrium to shift along the boundary *FG* towards *G*. Since C_2AH_6 , which should appear at *G*, is very slow to form, the system will pass into a metastable region where the solid solutions may exist. The evidence suggests to Jones that in a cement containing 2 percent SO_3 and 2.6 percent or more of Al_2O_3 , complete conversion of the trisulfate, $C_2A \cdot 3CaSO_4 \cdot 32H_2O$, to solid solution would be possible.

With regard to the attack of calcium sulfate waters on concrete, it is concluded that as long as metastable equilibria persist, formation of the trisulfate can occur in calcium sulfate attack at $CaSO_4$ concentrations in excess of 0.004 g $CaSO_4$ per 1000 g of solution.

The Sulfoaluminate-Alkali Systems

Jones (21) also investigated the quinary systems $CaO-Al_2O_3-CaSO_4-K_2O-H_2O$ and $CaO-Al_2O_3-CaSO_4-Na_2O-H_2O$ at 25°. In each case the alkali was restricted to 1 percent as KOH or NaOH, and the form of hydrated alumina used was Al_2O_3 -gel.

The results obtained with both systems were similar. The presence of alkali was found to result in a greatly increased solubility of alumina and a greatly decreased solubility of lime as compared with the quaternary equilibria. Nevertheless the compound $C_2A \cdot 3CaSO_4 \cdot 32H_2O$ was the only stable quaternary solid phase obtained, as in the system $CaO-Al_2O_3-CaSO_4-H_2O$ at 25°. There was no evidence of any change in the optical properties of the $CaSO_4 \cdot 2H_2O$, $Ca(OH)_2$, C_2AH_6 or $C_2A \cdot 3CaSO_4 \cdot 32H_2O$ solid phases to suggest the taking up of alkali by these compounds. It was concluded that, except for different solubilities of the various solid phases, the equilibria in the two quinary systems are similar to those in the quaternary system $CaO-Al_2O_3-CaSO_4-H_2O$ at 25°. Further work was still necessary on the metastable relations of the solid-solution series of which the low-sulfate form of calcium sulfoaluminate, $C_2A \cdot CaSO_4 \cdot 12H_2O$, is probably a member.

The results of Jones differ in some respects from those of Kalousek, already described. The latter investigator found the low-sulfate solid solutions to be stable above certain concentrations of NaOH in this system, but Jones found only the high-sulfate form to be stable. This may be explained by the use of higher NaOH concentrations in Kalousek's work. Kalousek also reports that he did not find the isometric tricalcium aluminate hydrate, C_2AH_6 , in any of his precipitates, whereas Jones reports it as a stable phase and describes its relations with the other phases.

* See also Figure 232 and discussion on pages 486 and 487.

In a discussion of the conclusions of Jones, Kalousek (23) suggests that, in view of the evidence given, the question arises of the possibility of the hexagonal structure being stabilized by the sulfate ion in the presence of certain concentrations of NaOH, and that in reality the solid solution is the stable phase.

The double salt of lime and potassium sulfate, $\text{CaSO}_4 \cdot \text{K}_2\text{SO}_4 \cdot \text{H}_2\text{O}$, was found by Cameron and Breazeale (5) to occur at 25° in the system $\text{CaSO}_4\text{-K}_2\text{SO}_4\text{-H}_2\text{O}$, and by D'Ans and Schreiner (7) in the system $\text{CaO-CaSO}_4\text{-K}_2\text{SO}_4\text{-H}_2\text{O}$. Hein (18) further found indication that the double salt was precipitated when gypsum and Ca(OH)_2 were shaken at 17° with KOH solutions when the concentrations of the latter exceeded 0.353 equivalent K_2O per liter (about 2 percent). Jones (22) points out that, in high-alkali cements, the concentration of K_2O in the liquid phase may reach this value, in which case the double salt would precipitate out.

References

1. Assarsson, G., *Sv. Geol. undersokn.*, **27**, 39 (1933); *Symposium*, 220.
2. Bessey, G. E., *Symposium*, 178.
3. Bogue, R. H., and Lerch, W., *Ind. Eng. Chem.*, **26**, 837 (1934); PCAF Paper 27.
4. Bussem, W., *Symposium*, 163; 497.
5. Cameron, F. K., and Breazeale, J. F., *J. Phys. Chem.*, **8**, 335 (1904).
6. Candlot, E., *Bull. soc. encour. ind. nat.*, 1890, p. 682.
7. D'Ans, J., and Schreiner, O., *Z. anorg. Chem.*, **67**, 437 (1910).
8. Deval, *Bull. soc. encour. ind. nat.*, **5**, 49 (1900); *J. Soc. Chem. Ind.*, **21**, 971 (1902).
9. Eiger, A., *Rev. mat. const. trav. pub.*, **33**, 141 (1937).
10. Flint, E. P., McMurdie, H. F., and Wells, L. S., *J. Res. NBS*, **26**, 13 (1941); RP 1355.
11. Flint, E. P., and Wells, L. S., *J. Res. NBS*, **27**, 171 (1941); RP 1411.
12. Flint, E. P., and Wells, L. S., *J. Res. NBS*, **33**, 471 (1944); RP 1623.
13. Ford, W. E., *Am. J. Sci.*, **40**, 33 (1915).
14. Forest, J., *Compt. rend.*, **191**, 52 (1930); "Compounds of Calcium Salts and Calcium Aluminates," Paris, 1935.
15. Forsen, L., *Zement*, **22**, 73; 87; 100 (1933).
16. Friedel, *Bull. Soc. Franc. Mineral.*, **10**, 122 (1897).
17. Hedin, R., *Proc. Swedish Cement Concrete Inst.*, **3** (1945).
18. Hein, H., *Tonind. Ztg.*, **56**, 203 (1932).
19. Jones, F. E., *Symposium*, 231.
20. Jones, F. E., *Trans. Faraday Soc.*, **35**, 1484 (1939).
21. Jones, F. E., *J. Phys., Chem.*, **48**, 311; 356; 379 (1944).
22. Jones, F. E., *J. Phys. Chem.*, **49**, 344 (1945).
23. Kalousek, G. L., *J. Phys. Chem.*, **49**, 405 (1945).
24. Kalousek, G. L., *Univ. Maryland, Dissertation*, 1941.
25. Kalousek, G. L., *J. Am. Concrete Inst.*, **37**, 692 (1941).
26. Klein, A. A. and Phillips, A. J., *Tech. Paper NBS*, 43 (1914).
27. Klinkenberg, *J. Soc. Chem. Ind.*, **14**, 365 (1895).
28. Kuhl, H., and Albert, *Zement*, **12**, 279 (1923).
29. Kuhl, H., and Ulbrich, *Zement*, **14**, 859; 880; 898; 917 (1925).
30. Lafuma, H., *Ciment*, **30**, 174 (1925).
31. Lafuma, H., "Researches in the Calcium Aluminates," *Dissertation, Paris*, 1925.
32. Le Chatelier, H., *Compt. rend.*, **128**, 661 (1899).
33. Lerch, W., Ashton, F. W., and Bogue, R. H., *J. Res. NBS*, **2**, 715 (1929), RP 54; PCAF Paper 19.

34. MacIntire, W. H., and Shaw, W. M., *Soil Sci.*, **19**, 125 (1925).
35. Malquori, G., and Caruso, E., *Atti X Congr. intern. chim.*, **2**, 713 (1938).
36. Malquori, G., and Cirilli, V., *Ricerca sci.*, **11**, 244 (1940).
37. Michaelis, W., *Tonind. Ztg.*, **16**, 105 (1892).
38. Mylieus, C., *Atca Acad. Aboensis*, **7**, 3 (1933).
39. Nitzsche, H., *Z. angew. Chem.*, **32**, 21 (1919).
40. Poirson, *Zent. hydraul. Zement*, **1**, 151 (1910); *Ciment*, **6**, 108 (1910).
41. Rebuffat, O., *Rend. Acad. Sci. Fis. Mat. Napoli*, **35**, 280 (1896).
42. Rebuffat, O., *Gazz. chim. ital.*, **31**, 55 (1901); **32**, 158 (1902).
43. Schott, O., *Tonind. Ztg.*, **18**, 819 (1894).
44. Shelton, G. R., *Ind. Eng. Chem.*, **17**, 1267 (1925).
45. Wells, L. S., *J. Res. NBS*, **1**, 951 (1928), RP 34.

CHAPTER 25

The Heat of Hydration

In the course of the reactions which take place between the cement compounds and water, which result in the setting and hardening of the paste, a considerable amount of heat is liberated. Under the usual conditions of concrete construction, the heat is dissipated rapidly by radiation, and the temperature changes within the structure are relatively slight and probably of little consequence. But in concrete structures of large mass, the low thermal conductivity of the concrete prevents the rapid radiation of heat and the mass of concrete may then attain high temperatures. These temperature rises cause expansion while the cement is hardening, and may result in contractions and cracking when the eventual cooling to the surrounding temperature takes place.

During construction in cold weather, special care must be exercised in the placing of concrete to insure that the grout does not freeze. Since the reactions of hydration evolve heat, they are capable of producing a degree of auto-protection against an outside temperature which might otherwise cause freezing or an inhibition of the hardening process.

For both of these conditions of construction, it is important that information be available on the total quantity of heat which may be evolved from cement, and especially on the rate at which this heat is liberated.

The heat of complete hydration can be obtained by noting the difference between the heat of solution of the anhydrous compound or phase, and the heat of solution of the same material after it has been completely hydrated. Such information is of importance especially for calculating the degree of hydration which has been effected in a paste at any stated age, and for following the course of the reactions. In practice, it is usually more significant to know the amount of heat liberated at given ages. This may be learned by measuring the rate of heat liberation continuously up to the age in question. Such measurements are not practicable, however, over a period of more than a few days. Another method, and more generally applicable, is to note the difference between the heat of solution of the unhydrated material and of the paste following hydration for the time period required.

In the design of cement compositions for purposes where heat liberation is a factor of importance, it is necessary to know the amount of heat contributed per unit weight of each compound or phase at given ages of the paste. With such knowledge, the heat of hydration of a cement at given ages may be computed.

Heats of Complete Hydration

The principal sources of thermal changes which occur during the hydration of cement are the heats of solution of the several constituent anhydrous com-

pounds and the heats of precipitation of the several hydrates from solution. The algebraic sum of these heat values is the heat of hydration of the cement at any given age. (See pages 79-85 for treatment of "Heat of Solution.")

Thorvaldson and his associates (11) in 1929 determined the heat exchange for the solution and hydration of CaO and C₂A. The heat of solution of CaO in HCl.200H₂O at 20° was found to be 828.9 (later revised to 829.2) calories per gram, and was found not to be materially affected by the temperature of ignition between 800° and 1200°.

Calcium hydroxide prepared by various methods gave heats of solution at 20° in HCl.200H₂O which varied from 550.8 to 554.0 cal. per gram of CaO. The heats of wetting in saturated limewater varied from 0.5 to 3.3 cal. per gram of CaO, and by correcting the corresponding heats of solution for the heats of wetting, an average value of 550.3 cal. per gram of CaO was obtained as the most reliable value for the isothermal heat of solution of Ca(OH)₂ in HCl.200H₂O at 20°. The value of 276.3 cal. per gram was obtained for the heat of hydration of CaO in saturated limewater at 20°. This value is 2.6 cal. per gram lower than the value (278.9 cal. per gram) obtained by calculation from the heats of solution of CaO and Ca(OH)₂ in HCl.200H₂O. This small discrepancy was attributed to changes in the energy of surface and of crystal lattice which appear to continue for a long time after the temperature of the calorimeter has come to apparent constancy.

The heat of solution of C₂A was found to be 736.4 cal. per gram in HCl.20H₂O or 732.8 cal. per gram in HCl.200H₂O at 20°. The heat of solution of the isotropic C₂AH₆ was found to be 523.1 cal. per gram in HCl.20H₂O or 518.8 cal. per gram in HCl.200H₂O at 20°. By subtraction, the calculated heat of hydration of C₂A to C₂AH₆ is 214.0 cal. per gram at 20°. The specific heat of HCl.20H₂O was determined between 16° and 20°, as compared with water over the same temperature interval and found to be 0.8507. The value of 77 cal. per gram was obtained for the calculated heat of formation of C₂A from CaO and Al₂O₃ at 20°.

The amounts of heat liberated upon the complete hydration of the major cement compounds were reported by Lerch and Bogue (8) in 1934. By the use of these values and of the values observed of the heat liberated from a paste at any age, the percentage of the total available heat that had been liberated at that age could be computed.

Complete hydration of specimens was attained by mixing the compounds with water to form a plastic paste, allowing the pastes to hydrate in sealed containers for a month, and grinding and regauging and hydrating in a similar manner for several periods until microscopic and X-ray examinations failed to reveal the presence of any unhydrated material, and the heat-of-solution values remained constant. By "complete hydration" was implied the state of hydration and hydrolysis beyond which the compounds would not go under the conditions of the test, which were made similar to those encountered in concrete practice.

The complete hydration of the major cement compounds gave the values, in calories per gram:

C ₂ A	207 ± 3
C ₂ S	120 ± 3
C ₂ AF	100 ± 3

β -C ₂ S	62 ± 3
CaO	278.9
MgO	203

The values for CaO (11) and MgO (10) were taken from earlier investigators. The value obtained for C₃A, 207, compares with the value found by Thorvaldson et al of 214.0 cal. per gram for the hydration of C₃A to C₃AH₆. The calculated values for the complete hydration of four commercial clinkers agreed with the observed data within values ranging from -8.3 to +3.1 cal. per gram.

If gypsum has been dehydrated in the grinding mills, the heat liberated on rehydration, CaSO₄· $\frac{1}{2}$ H₂O to CaSO₄·2H₂O, would be 46 cal. per gram of SO₃(4) which, with the usual percentages of calcium sulfate in cement, would amount to about 1 cal. per gram of cement. The smallness of this value and the uncertainty of the dehydration process during grinding makes the introduction of a correction factor, when cements are employed, of doubtful significance.

The formation of C₃A·3CaSO₄·31H₂O by the gypsum through the reaction

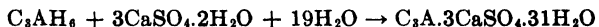

was computed to be 149 cal. per gram of SO₃. The magnitude of this value suggests the desirability of introducing a correction factor for such a reaction when the calculations are applied to cements. This amounts to about 3 cal. per gram of cement.

Effects of Composition

The heat evolved during the setting and hardening of a number of cements of various composition was determined at ages from 3 days to a year by Woods, Steinour and Starke (12) in 1932. The cements were mixed neat with 40 percent of water and stored at 35° in sealed vials. The heat of hydration at any age was measured by noting the difference between the heat of solution of the original unhydrated cement and that of the paste at the specified age.

It was found that portland cements continue to evolve heat during hardening for a period of at least 6 months, but that a considerable portion of the heat has been evolved at the end of 3 days. The rate of heat liberation was found to be dependent chiefly upon the chemical composition of the cement. Thus the range in heat evolution of 14 cements (C₃A 0.6 to 21.3 percent, C₂S 16.7 to 71.3 percent, C₄AF 3.6 to 22.7 percent, β -C₂S 6.2 to 61.1 percent) was, at 3 days, from 41 to 91 cal. per gram and, at 6 months, from 73 to 116 cal. per gram. The contribution in heat evolution due to each of the four major compounds was calculated by the method of least squares and found to be greatest for the C₃A, followed successively by C₂S, C₄AF and β -C₂S. A fair estimate of the relative heat-evolving capacity of various cements was found possible by the use of the function: Percent C₂S + 2.1 × percent C₃A. Good correlation was obtained with this function at all ages from 3 days to 1 year. The correlation at 1 year is shown in Figure 195. The heat evolution was found to be possible of estimation with fair accuracy either from the calculated percentages of the various compounds or directly from the analysis of the cements expressed in terms of the oxides. The constants in terms of compounds and oxides at the several ages are given in Table 40, expressed as the

contribution, in calories, of each percent in the cement to the heat evolution of 1 gram of cement. This relationship is shown graphically for the compounds in Figure 196.

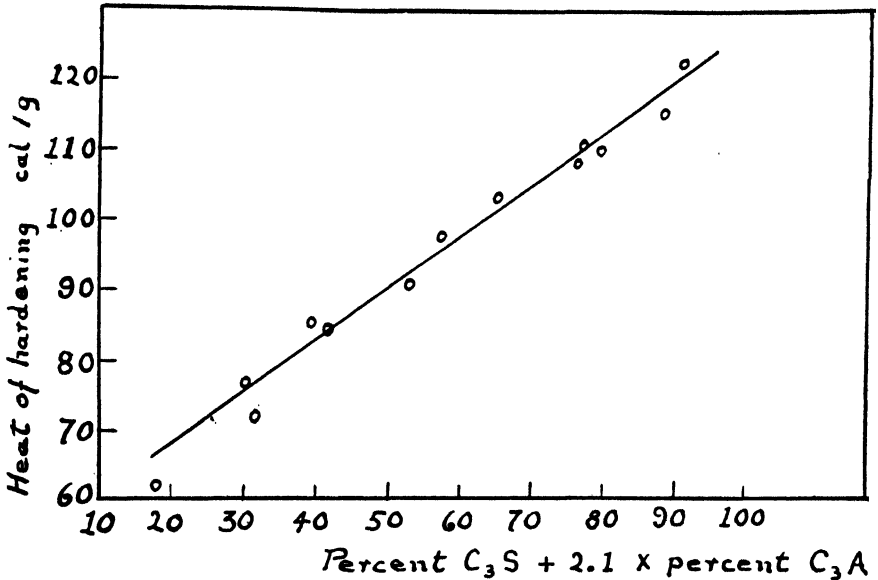

Figure 195. One-year correlation between heat of hardening and a function of the tricalcium compounds. (Woods, Steinour and Starke)

At the Building Research Station in England (3), a method was developed in 1933 for curing concrete adiabatically, and so simulating the conditions at the center of a large mass, such as a concrete dam. From the record of the rise in temperature of the concrete cured under this condition, it was possible to predict,

TABLE 40. Contribution of the cement compounds and components to the heat of hydration at various ages. Calories per percent of compound or oxide per gram of cement

Compounds	3 days	28 days	1 year
C_3A	1.70 \pm 0.02	2.02 \pm 0.20	2.00 \pm 0.12
C_3S	0.983 \pm 0.054	1.142 \pm 0.054	1.362 \pm 0.033
C_4AF	0.29 \pm 0.18	0.48 \pm 0.18	0.30 \pm 0.11
C_2S	0.195 \pm 0.046	0.436 \pm 0.045	0.621 \pm 0.028
Oxides			
CaO	+3.40	+3.31	+3.64
SiO_2	-5.79	-4.93	-5.01
Fe_2O_3	-3.2	-3.1	-3.8
Al_2O_3	-1.1	-0.1	-0.7

with reasonable accuracy, the temperature rise likely to occur in a mass of similar concrete when size, shape and boundary conditions were definitely defined. By such means it became possible to select the type of cement most suitable for any particular job.

In this process, the water in a bath surrounding the concrete, placed in a container inside a Dewar flask, is maintained at the same temperature as the concrete, so that little or no flow of heat from the concrete occurs. The temperature of the specimen rises steadily to a maximum and remains there, imitating the conditions at the center of a large mass of concrete. Thermocouples are connected with a temperature recorder which plots a continuous time-temperature curve.

By use of this equipment, it was shown that both the total amount of heat liberated and the rate of heat liberation varied greatly with the type or com-

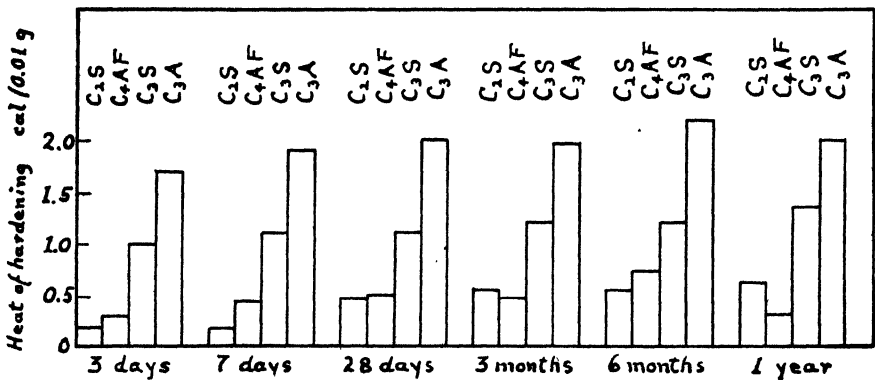

Figure 196. Contribution of the individual compounds to the heat of hardening at various ages. (From data by Woods, Steinour and Starke)

position of the cement employed. Thus the amounts of heat liberated by a high-alumina cement and a rapid-hardening portland cement were nearly the same at 48 hours, but the former liberated its heat much more rapidly. A normal cement, however, liberated markedly less heat at all ages up to 3 days. This relationship is shown in the curves of Figure 197. The rates and amounts of heat liberated also increased as the cement content of the mix was increased and as the temperature of curing increased.

Through a mathematical treatment of the laws of heat flow, and the development of a theory of temperature rise in a heat-evolving medium with special reference to the conditions obtaining in concrete practice, formulas were derived by which the temperature rises could be calculated for given types of specimens. Comparisons of temperature rises as observed and as calculated were generally satisfactory, and led to the recommendation of the method for use whenever an estimate was required of the probable temperature rise in a mass of concrete.

A large number of cements were examined by Lerch and Bogue (8) in 1934 for their direct heat of hydration by measuring the heat evolved from pastes over a period of 48 hours after mixing. Some of the results on a group of cements in

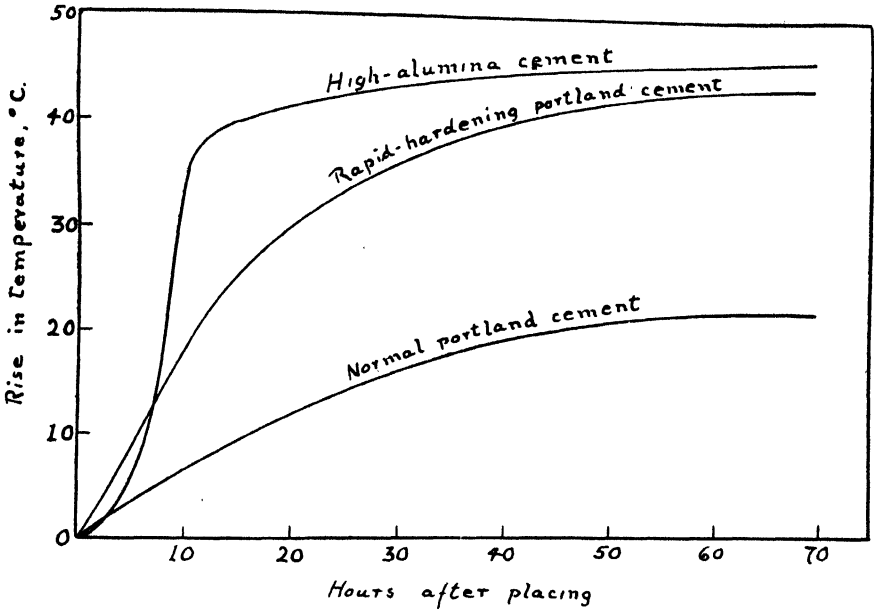

Figure 197. Temperature rise in adiabatically-cured 1:2:4 concrete prepared with various types of cement. Mix temperature 16°. Water: cement = 0.60 by weight. (Davey and Fox)

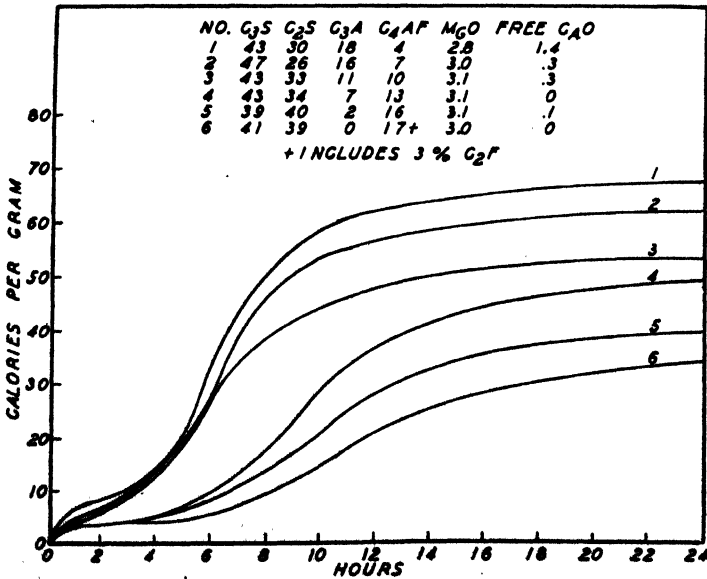

Figure 198. Heat evolution from cements in which C₃A and C₄AF are the major variables. (Lerch and Bogue)

which the C_2A : C_4AF ratio was the principal variable are shown in Figure 198, and on a group in which the C_3S : C_2S ratio was the principal variable in Figure 199. From Figure 198 it will be seen that an increase in the C_2A content provides marked increases in the rate and amount of heat liberation and, from Figure 199, that increases in C_3S also provide increased heat evolution. The sharp rise in heat of No. 57 may be ascribed to the high free CaO content, 2.1 percent. Changes in the MgO content provided relatively small changes in heat evolution. Increasing the fineness of the cement increased the rate but not the final amount of heat liberated.

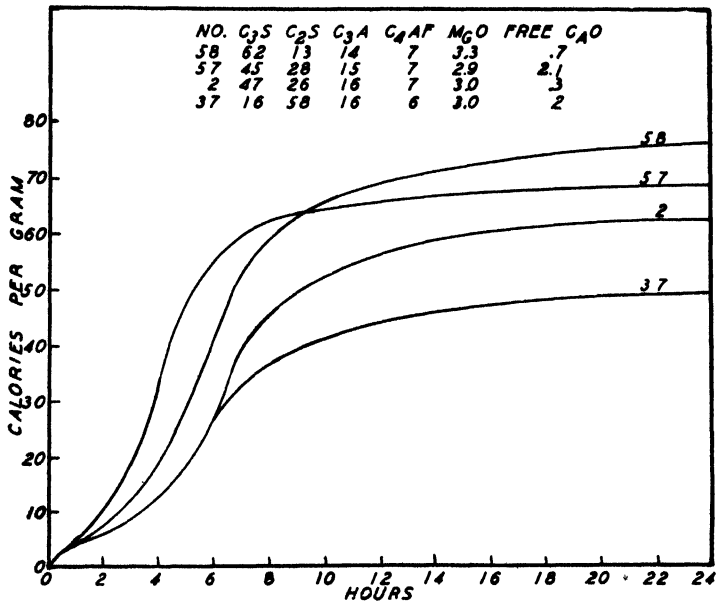

Figure 199. Heat evolution from cements in which C_3S and C_2S are the major variables. (Lerch and Bogue)

Calculations of the contribution of the C_2A , C_3S and C_4AF to the heat liberated at 48 hours, by each percent per gram of cement, gave the values:

C_2A	1.50 cal.
C_3S	1.00 cal.
C_4AF	0.40 cal.

which could be expressed in terms of the oxides:

CaO	+4.08 cal.
SiO_2	-7.61 cal.
Al_2O_3	-2.75 cal.
Fe_2O_3	-2.76 cal.

An application of these values to 61 cements showed an agreement between calculated and observed values at 48 hours to within ± 3 cal. per gram of cement.

Pastes at various ages were also examined for their heats of hydration by determinations of heats of solution of the pastes at the required ages and of the original unhydrated cements. The results confirmed the findings of Woods, Steinour and Starke, and the calculated values obtained by the factors proposed by those investigators were in good agreement with the values obtained at 35°.

By calculation from the total calculated heats of hydration, it was noted that, in general, about half of the total heat is liberated between 1 and 3 days, about three quarters in 7 days, and from 83 to 91 percent in 6 months, when the pastes are cured at 35°. At 25° the amounts of heat liberated are consistently lower than at 35°, but the magnitude of the differences is not large.

Effects of Glass Content

The effects of varying glass content on the heat of hydration were investigated by Lerch (6), by the heat-of-solution method using the vacuum-flask calorimeter (5). The cements used were prepared from commercial clinkers, one portion of which had been reheated and cooled slowly to give a minimum of glass, and another portion of which had been reheated and cooled quickly to give a maximum of glass. The glass content ranged from 0 to 3 percent in the slowly cooled clinkers and from 8 to 22 percent in the quickly cooled clinkers. The heats of hydration were determined at 3, 7 and 28 days.

It was found that the heats of hydration up to 28 days were dependent chiefly upon the composition of the clinker and the glass content. The heats of hydration of the untreated clinkers ranged from 77 to 111 cal. per gram, a difference of 34 cal. per gram, which compares with a difference of 59.0 cal. per gram obtained by Woods, Steinour and Starke (12).

At ages of 7 and 28 days, the cements of highest glass content had greater heats of hydration than the corresponding cements of lower glass contents; at 3 days this relationship was uncertain. At 28 days this difference ranged from 3 to 16 cal. per gram, averaging 7.9 cal. per gram. An absence of strict proportionality between the glass content and the change in heat of hydration was explained as due to the different compositions of the glass in different clinkers, and to the absence of an equilibrium condition during cooling of the clinker, a change in glass content not always being accompanied by the same change in content of crystallized compounds. The average difference of 7.9 cal. per gram was shown, however, to be equivalent to rather large changes in composition; for example, to an increase of 11.2 percent in C_2S at the expense of C_3S , or to an increase of 5.1 percent in C_2A at the expense of C_4AF .

The effects of fineness were measurable, especially at early ages, but were relatively small. Meyers (9) had previously noted that, although the total heat-generating capacity of cement during hydration is independent of its surface area, and is little affected by prehydration within practical limits, yet these factors affect markedly the rate of heat liberation.

An analysis of the results led Lerch to the conclusion that estimates of the heat of hydration based upon composition and fineness were subject to variables which, at the present state of our knowledge, cannot be completely evaluated. Thus the effect of gypsum will be different with a clinker of high glass content than with the same clinker cooled slowly to give a low glass content. The C_3S

content of a medium or high A:F ratio cement will be higher in a clinker containing glass than in the same clinker cooled slowly to give a low glass content, but with cements of a low A:F ratio this condition will be reversed. Finally, the end products of hydration of a clinker of high and of low glass contents may not be identical. For these reasons Lerch believes it advisable that, when a cement must meet a specified heat-of-hydration requirement, the heat of hydration should be determined and not estimated.

Correlation with Strength

A correlation of the heat-evolution data with the strengths developed over a period of a year led Woods, Steinour and Starke (12) to the conclusion that, at early ages, the strength decreases most when only the C_2S is lowered, provided the C_2S plus C_3S is held constant. The strength in their experiments did not decrease at all when the drop in heat evolution was brought about by a decrease in the C_1A content. At the later age of 3 months, a decrease in heat evolution brought about by a decrease in C_2S caused less decrease in strength, and at 1 year a similar decrease in heat evolution brought about by a decrease in C_2S did not result in any decrease in strength. Thus, by decreasing the C_1A content, a decrease in heat evolution results at all ages without materially decreasing the strength development at any age. To effect greater decreases in heat evolution, the C_2S may be lowered. This lowers the early strength but, if the C_2S increases proportionately with decrease in C_2S , the late strength will not be affected.

Comparison of Methods

Various methods for measuring the heat of hydration of cements were examined by Carlson and Forbrich (2), who pointed out a number of reasons for disagreement among investigators. Thus the specific heat of a neat cement paste was found to vary materially with the water:cement ratio (w/c) and the temperature. This is shown by the following tabulation.

Temp. (°C)	$w/c = 0.25$ (cal/g)	$w/c = 0.60$ (cal/g)
21	0.265	0.380
32	.277	.408
43	.303	.455
54	.340	.505
65	.400	.580

The effect of the water:cement ratio on the heat of hydration at different ages was shown also to be considerable, as indicated in the following values.

w/c	3 days (cal/g)	7 days (cal/g)	28 days (cal/g)
0.30	45.7	58.3	74.3
0.40	49.2	61.8	82.9
0.50	52.3	69.8	91.4

Also, a change in the curing temperature was found to affect the rate of heat liberation of the cement. The heat liberation at higher temperatures is generally greater at early ages, but about the same at later ages as at lower temperature. This is shown in the following values, for a cement of $w/c = 0.40$:

Temp. (°C)	8 days cal/g	7 days cal/g	28 days cal/g	90 days cal/g
4.4	29.5	43.5	78.4	88.8
23.3	52.4	72.4	83.6	90.8
40.0	72.3	80.3	86.8	93.1

The effects of carbonation of test samples on the heat of hydration determined by the heat-of-solution method were noted by allowing comparative specimens to be ground in the presence and in the absence of CO₂. The effects, as shown below, are very marked.

w/c	Age (days)	Condition	CO ₂ absorbed %	Heat of hydration	
				Observed, cal/g	Corrected for CO ₂ , cal/g
0.40	60	Protected	0.9	65.1	59.9
		Not protected	2.2	75.1	62.3
0.60	75	Protected	2.0	106.9	95.3
		Not protected	4.5	120.2	94.1
0.40	90	Protected	0.8	107.1	102.5
		Not protected	3.9	126.3	103.7

The heat of solution of CaCO₂ was found to be 102 cal. per gram as compared with 557 for Ca(OH)₂. Since each percent of CO₂ corresponds to 1.27 percent of transformed Ca(OH)₂ (ignited basis), each percent of CO₂ would be expected to cause an error of $(5.57 - 1.02) \times 1.27 = 5.8$ cal. per gram. By applying this correction factor to the above cements, the results are in fair agreement. It was found that the hydrated specimens commonly absorbed during grinding more than 0.5 percent of CO₂, which would produce an error of about 3 cal. per gram.

The drying of a sample during grinding would, on the other hand, increase the heat of solution, and hence the heat of hydration obtained by this method would be too low. Drying at 50° was found, for example, to increase the heat of solution by about 3 cal. per gram.

The relative merits of the adiabatic, the heat-of-solution, the vane, and the conduction calorimeters require consideration. The adiabatic calorimeter maintains the temperature of the container the same as that of the hydrating cement, and the temperatures are recorded against time. A diagram of this calorimeter is shown in Figure 200. The heat-of-solution calorimeter of different designs has already been described.*

The vane calorimeter (1) employs neat cement specimens, but avoids high temperatures by conducting the heat away through metal vanes almost as fast as it is liberated. The rate at which the heat is conducted away is determined by measuring accurately the small temperature difference that develops between the specimen and the outer edge of the vanes. When a continuous record of the rate of heat removal from the specimen is obtained, the total amount of heat removed up to any age can be computed. Because the specimen varies so little in

* See pages 79-81.

temperature that only a small amount of heat is stored in the specimen, the total amount of heat removed becomes a measure of the heat of hydration.

An improved form of the vane calorimeter has been designed which has a copper tube replacing the vanes for the conduction of the heat, and is known as

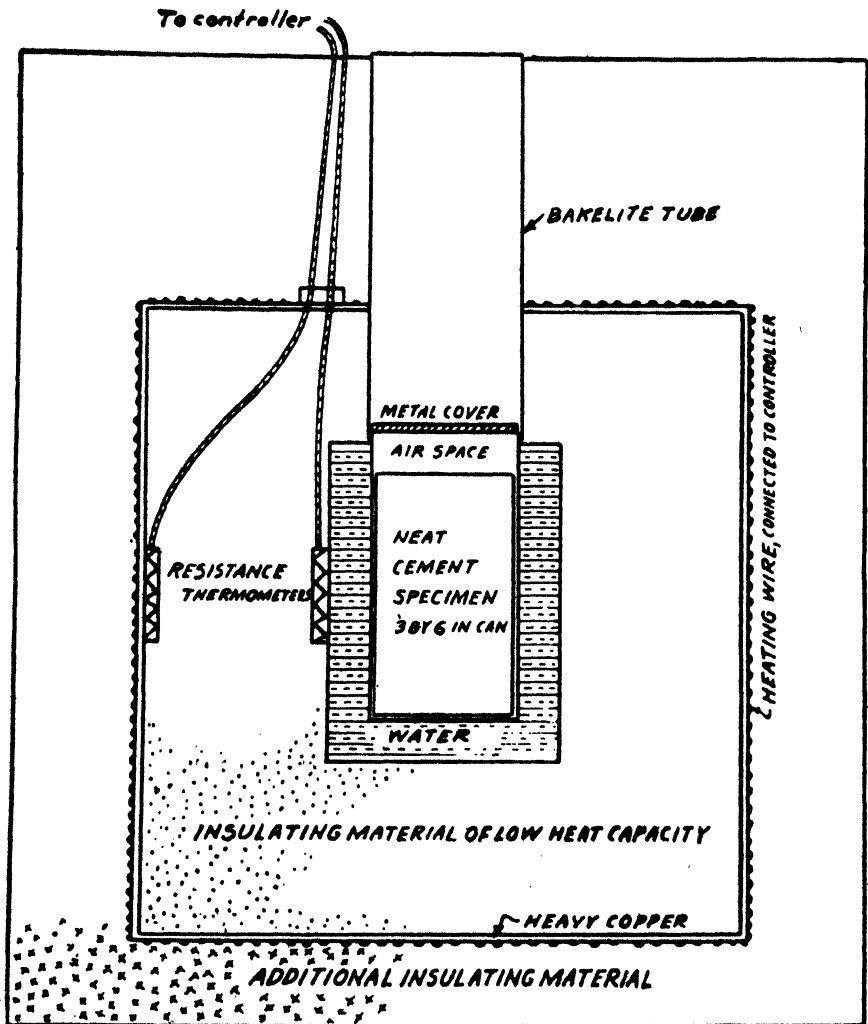

Figure 200. Adiabatic calorimeter in which concrete is simulated by neat cement and water. (Carlson and Forbrich)

the conduction calorimeter. In this instrument, the heat is removed from the specimen by a tapered copper rod and substantially all the heat is caused to flow in the direction of the metal tube by reason of the surrounding Dewar jar.

A conduction calorimeter was employed by Lerch (7) for determining the rate of hydration of cement pastes as measured by the rate of heat liberation

over a period of about 72 hours. This calorimeter, designed according to recommendations of R. W. Carlson, consists of four essential parts, as shown in Figure 201. These are a copper cup to contain the cement paste, a brass tube to conduct the heat away from the specimen cup, resistance thermometers intimately secured to the two ends of the conduction tube, and a heat-dispersing base immersed in a water bath. The specimen cup is placed on the copper pedestal and a vacuum flask is placed over the apparatus to minimize loss by radiation and by air convection. Thus virtually all the heat generated by the hydration of the cement

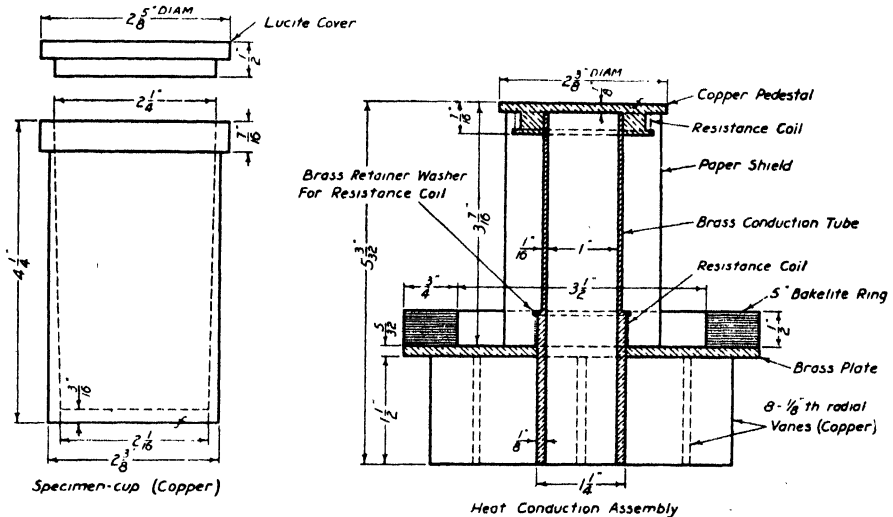

Figure 201. The conduction calorimeter. Specimen-cup and heat-conduction assembly. (Carlson and Lerch)

is conducted to the water bath. The difference in temperature between the specimen cup and the water bath is measured, which indicates the rate at which heat is conducted away from the specimen, and hence the rate of hydration.

References

1. Carlson, R. W., *Proc. Am. Soc. Testing Materials*, **34**, 322 (1934).
2. Carlson, R. W., and Forbrich, L. R., *Ind. Eng. Chem. Anal. ed.*, **10**, 382 (1938).
3. Davey, N., and Fox, E. N., *Bldg. Res. Tech. Paper* 15 (1933).
4. "International Critical Tables," Vol. 5, p. 196, New York, McGraw-Hill Book Co., 1933.
5. Lerch, W., *Eng. News Record*, **113**, 523 (1934); PCAF Paper 29.
6. Lerch, W., *J. Res. NBS*, **21**, 235 (1938), RP 1127; PCAF Paper 36.
7. Lerch, W., *Res. Reports, PCA*, May, 1942; March, 1945.
8. Lerch, W., and Bogue, R. H., *J. Res. NBS*, **12**, 645 (1934), RP 684; PCAF Paper 26.
9. Meyers, S. L., *Rock Products*, Sept. 1932, p. 22.
10. Roth, W. A., and Chall, P., *Z. Electrochem.*, **34**, 185 (1928).
11. Thorvaldson, T., Brown, W. G., and Peaker, C. R., *J. Am. Chem. Soc.*, **5**, 2678 (1929); **52**, 80; 910; 3927 (1930).
12. Woods, H., Steinour, H. H., and Starke, H. R., *Ind. Eng. Chem.*, **24**, 1207 (1932); *Eng. News Record*, **109**, 404; 435 (1932); **110**; 431 (1933).

CHAPTER 26

The Structure of Hydrated Cements

The various properties of cement pastes upon which their value depends are, in the last analysis, determined by their chemical composition and their physical structure. Interactions with water and with other liquids or solutions or gases are dependent on the composition of the phases which make up the cement. These are discussed elsewhere. But the physical characteristics, as strength, volume constancy, permeability, plasticity, density, et cetera, are determined largely by the structure of the paste.

By structure, one may have in mind a number of physical characteristics. The term may refer to the appearance of the crystalline and amorphous phases as viewed by the optical microscope or the electron microscope; the capacity of the paste to absorb water or allow the passage of water or other liquids; the rigidity and constancy of volume under various conditions; the dimensional characteristics and the contents of the pores and walls which make up the amorphous gel; or the atomic arrangement of the constituent compounds. Some of these characteristics have already been treated but a number require a special development.

Microscopic Structure of the Hydrated Compounds

The early investigators of the microscopic structure of cement pastes employed powder mounts which were examined microscopically with transmitted light. Such studies were reported by Le Chatelier (20), Michaelis (22), Bates and Klein (1), Rodt (30), Pulfrich and Linck (28) and Kuhl (18). More recently improvements have been developed by Forsen (13), Eiger (10) and Ward (35), which have enhanced the value of the method. Thin sections present an unusual difficulty in preparation, but have been employed successfully by Brown and Carlson (6). The use of polished sections examined by reflected light was shown to be applicable to cements by Tavasci (33), and this method was employed by Brown-miller (7) in his study of cement hydration. Finally, the electron microscope was adapted for this purpose by Eitel and his co-workers (12)(29) and was used by Katz and his associates (31).

The hydration of the pure cement compounds in water and various solutions as investigated by Ward (35) involved the use of a special technique by which the liquid was introduced into the powder preparation under vacuum. The powdered compound was dusted onto a microscope slide, a cover glass partially sealed on by means of glycol phthalate, and the slide placed under the liquid and exhausted by means of a faucet aspirator. Upon breaking the vacuum the liquid entered the preparation and, by the use of a heated, flattened wire, the remaining opening was sealed with glycol phthalate. Such preparations could be kept indefinitely without loss of moisture. The following observations are given as being typical of the action of water upon the cement compounds.

Tricalcium Silicate. Hydration in water of tricalcium silicate started instantaneously as a fuzzy growth which quickly changed into worm-like or vermiform particles. These particles had a mean index of refraction of about 1.620 and were identified as C_3SH_5 . The vermiform structures altered in a few hours to round gel-like globules having a refractive index varying from 1.430 to 1.490 and of uncertain composition. These particles at first were completely isotropic, but after several weeks a faint birefringence was discernible. Due to the development of these globules, the preparations of low water content soon had the appearance of a gelatinous mass, with many small and large voids. Rhombic crystals of $Ca(OH)_2$ began to appear 3 to 4 hours after the start of hydration and within a

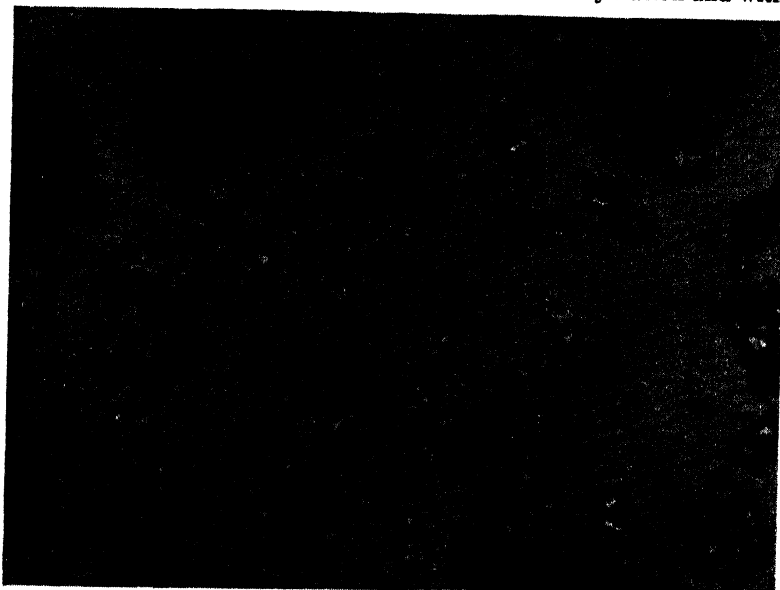

Figure 202. Tricalcium silicate hydrated on slide with water 6 hours. $\times 900$. All particles show marked hydration. (*Ward*)

few hours approximated 30 microns in diameter. As hydration continued they grew larger and thicker and at later ages they sometimes inclosed hydrating tricalcium silicate.

At the time of precipitation of $Ca(OH)_2$, the tricalcium silicate grains were surrounded either by individual globules or by a more or less continuous gelatinous coating. This coating, which was identical with the globules described above, had a refractive index varying from 1.430 to 1.490 and constituted a major hydration product. Within 3 hours a new phase, a thin groundmass gel with a refractive index of 1.540 and resembling an etch, appeared on the slide and cover glass. At the conclusion of 7 days many of the smaller tricalcium silicate particles were completely hydrated having been converted into globules of the type first described. For the most part, at the conclusion of 1 year, all the preparations seemed to have ceased hydrating. Figure 202 illustrates the hydration of tricalcium silicate at 6 hours.

Dicalcium Silicate. Hydration of dicalcium silicate was extremely slow in comparison with that of tricalcium silicate. At the end of 10 minutes a very few vermiform particles were observed attached to sharp points and corners. These had low birefringence and a mean refractive index of 1.620 ± 0.002 and were identified as C_2SH_4 . These particles slowly increased in number but the extent of hydration was slight at the end of 14 days. There was at that time a slight tendency for the vermiform particles to form round gel-like masses of refractive index 1.430 to 1.490 such as were observed in the tricalcium silicate preparations.

It was not unusual to find grains of dicalcium silicate shattered during the process of hydration. The grain would swell and subsequently break into frag-

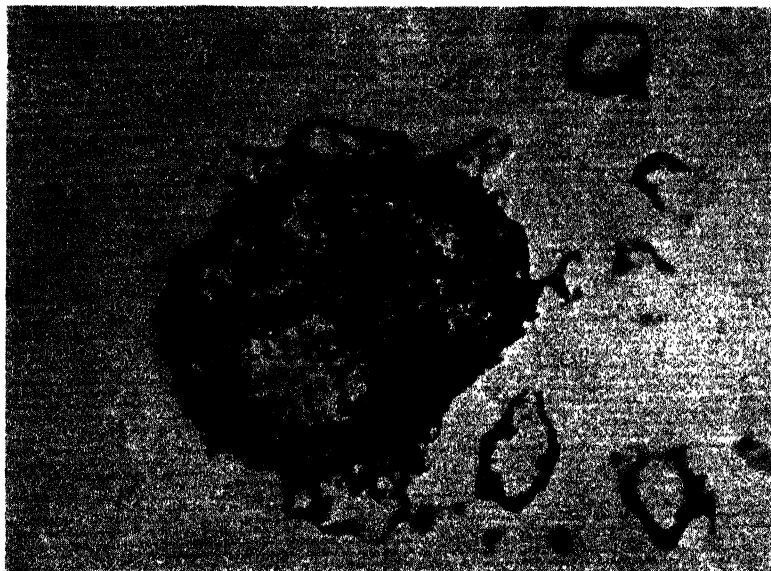

Figure 203. Dicalcium silicate hydrated on slide with water 14 days. $\times 900$. The dark area in the center is the result of a particle of C_2S shattered during hydration. (Ward)

ments. Inasmuch as the C_2S used showed a tendency to dust, the shattering procedure just described and which is illustrated in Figure 203, may have been due to an inversion to γ - C_2S . Crystalline $Ca(OH)_2$ did not appear, irrespective of the water content, up to periods of 1 year, the maximum time of observation. In dry areas of the denser preparations, spherulites formed with a mean refractive index of 1.550 and a birefringence of from 0.005 to 0.010. This material was not identified.

Tricalcium Aluminate. Immediately upon contact with water each tricalcium aluminate particle bristled with very small plates which, on edge, had the appearance of needles. These crystals had indices of refraction $\omega = 1.550 \pm 0.002$ and $\epsilon = 1.529 \pm 0.002$ and parallel extinction. Quite probably they correspond to the compound C_4AH_{12-18} (3). At the same time a few hexagonal plates with

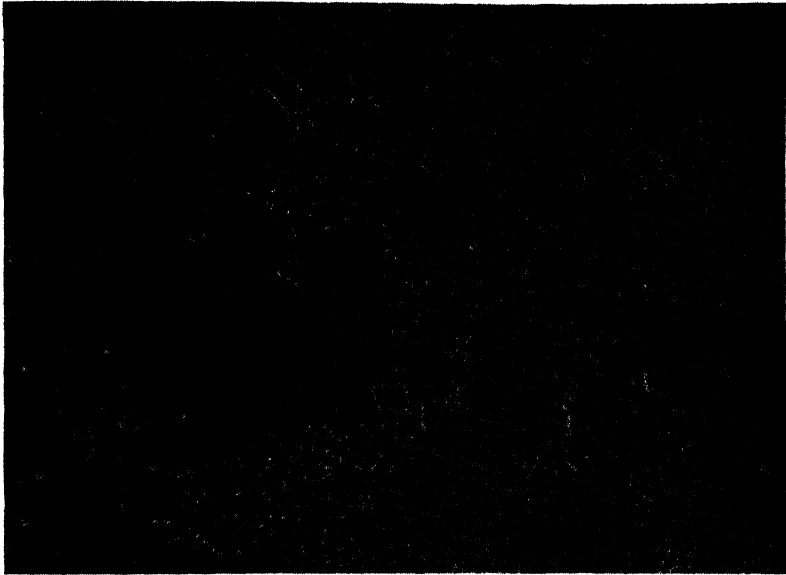

Figure 204. Tricalcium aluminate hydrated on slide with water 2 hours. $\times 900$. Shows hexagonal plates and spherulites. (Ward)



Figure 205. Same field as shown in Figure 204, under crossed nicols. (Ward)

low birefringence and a mean index of refraction of 1.580 ± 0.002 appeared which were not identified. The former plates continued to increase with time so that at about twenty minutes every particle of tricalcium aluminate was covered. These hexagonal crystals are shown in ordinary light in Figure 204 and under crossed nicols in Figure 205.

At about this time, small, round, isotropic particles appeared which later had good isometric habit. These isometric particles had an index of refraction of 1.605 and were identified as C_3AH_6 . Simultaneously botryoidal, gelatinous masses of C_2AH_6 appeared around the anhydrous C_3A . After two hours the hexagonal plates diminished and the original C_3A grains became entirely botryoi-

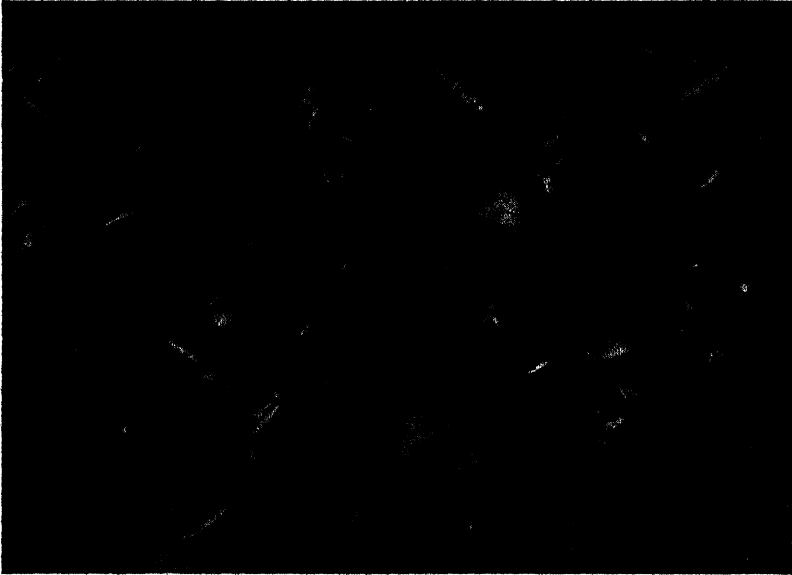

Figure 206. Tetracalcium aluminoferrite hydrated on slide with water 2 hours. $\times 900$. Crossed nicols. Shows hexagonal crystals of hydrated calcium aluminate. (Ward)

dal with massive C_2AH_6 . There was a marked tendency for the botryoidal gel to fill voids and pores. When the preparations were 3 hours old the plates had disappeared almost entirely. After 2 days the isometric particles had increased in size to about two microns and showed a tendency toward agglomeration. At 14 days this agglomeration had increased markedly, and individual anhydrous tricalcium aluminate grains could no longer be recognized because of the masses of botryoidal gel surrounding each original grain. No further changes were observed up to 1 year except for an apparent increase in the density of the preparations.

Tetracalcium Aluminoferrite. Water reacted quickly with C_4AF . After ten minutes, in all preparations regardless of their water content, numbers of hexagonal plates, which were similar to those observed when C_3A hydrated, appeared

attached to the C_4AF . These are shown in Figure 206. In about 20 minutes small trapezohedrons of C_2AH_6 were apparent. These were perfect crystal forms, about 2 microns in diameter, which grew to 10 microns and more in 48 hours. These are shown in Figure 207. As the preparations aged the C_2AH_6 developed into perfect cubes, octahedrons, dodecahedrons, trisoctahedrons and other isometric forms, increasing in size and number. Some retained perfect crystal form and others became complex groups of twinned crystals eventually forming a mass surrounding C_4AF . Certain of these isometric crystals showed a slight yellow color indicating the presence of iron.

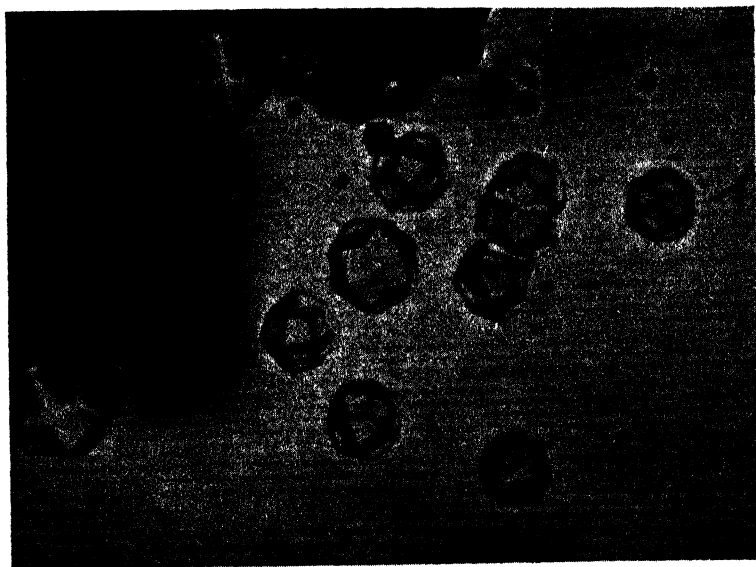

Figure 207. Tetracalcium aluminoferrite hydrated on slide with water 48 hours. $\times 900$. Excellent trapezohedrons of C_2AH_6 are shown. (Ward)

Usually the isometric crystals were well scattered and only in the more dense preparations were the voids filled at the conclusion of 48 hours. A few C_4AF particles became surrounded with yellowish, vermiform particles with a refractive index greater than 1.730, which were believed to be $C_2FH_6(11)$. In areas where C_4AF was crowded, and in low water-content preparations, a reddish-brown gel covered the slide. Since X-ray work has not shown the existence of monocalcium ferrite hydrates (9) it is probable that this material is a hydrated ferric oxide.

$K_2O.23CaO.12SiO_2$. Upon the addition of water to $KC_{23}S_{12}$, hydration started at once with a few small, attached globules and occasionally long, thin needles appearing. The globules, with an index of refraction of 1.550 and low birefringence, were not identified. The needles were found to have a mean index of refraction close to 1.620, parallel extinction, and to be biaxial, optically positive. They were identified as C_2SH_2 . Needles and globules increased so that at 10 days the $KC_{23}S_{12}$ was almost entirely obscured. At this time small crystals of $Ca(OH)_2$

began to appear. The addition of gypsum retarded hydration and tended to produce more needles than globules. At 48 hours $\text{Ca}(\text{OH})_2$ precipitated as large crystals. Hydration was decidedly less at 10 days than for the preparation without gypsum. Very little change was noted up to 3 months when the examination was discontinued.

Mixed Compounds and Commercial Cements. Various mixtures of the known compounds in cement clinker were hydrated with excess water. Certain portland cements were similarly hydrated. The results up to one year, did not differ materially from those for the components hydrated alone. All the various hydration products observed during the hydration of the individual components appeared. New hydrated compounds involving combinations of the various constituent parts of the mixed compounds were not detected.

Effect of Gypsum. The addition of 5 percent gypsum to the silicates resulted in an earlier appearance of the products of hydration. However, at the end of 1 year, no differences could be observed, in the amounts of hydration products, between the preparations with and without gypsum.

About 30 percent gypsum was added to the tricalcium aluminate preparations. The course of hydration in the presence of a relatively large amount of gypsum was, chronologically, the formation of anisotropic hexagonal plates of calcium aluminate hydrates, the rapid alteration to isotropic C_2AH_6 , the subsequent precipitation of calcium sulfoaluminate, and finally the reappearance of anisotropic calcium aluminate hydrates which altered to isotropic C_2AH_6 . Apparently the C_3A reacted at first as in water alone. Subsequently gypsum dissolved in sufficient proportions to prevent the continuance of the normal reactions and calcium sulfoaluminate precipitated. When the gypsum was exhausted, hydration again became normal. There was no precipitation of $\text{Ca}(\text{OH})_2$. The appearance of the preparations after 2 hours is shown in Figure 208.

The addition of 20 percent gypsum to C_4AF resulted in reactions similar to those observed with C_3A . The reactions were slower and were characterized by better-formed crystals. Hexagonal plates were formed first and this action was followed by the appearance of a few isometric crystals of C_2AH_6 . Calcium sulfoaluminate then precipitated followed by hexagonal plates which eventually gave way to C_2AH_6 .

Effect of Saturated $\text{Ca}(\text{OH})_2$ Solution. When C_3S and C_2S were hydrated in a saturated solution of $\text{Ca}(\text{OH})_2$, the reactions were similar to those for water alone. There was, however, a noticeable decrease in the rate of hydration. This was illustrated by the delayed precipitation of $\text{Ca}(\text{OH})_2$ from C_3S which occurred after 4 to 5 hours' exposure, and was about an hour later than when the same concentration of C_3S was exposed to water. The addition of gypsum had no visible effect upon the hydration products of either silicate.

Tricalcium aluminate in the presence of a saturated solution of $\text{Ca}(\text{OH})_2$ hydrated in a manner similar to that in water alone. A greater portion of the aluminate became botryoidal during the early stages of hydration and a smaller number of hexagonal plates were formed. In 4 days the preparations became so opaque from hydration products that further observation was unprofitable. The addition of 30 percent gypsum delayed all visible reaction for about 10 minutes, at which time a few small needles became apparent and the C_3A showed a tend-

ency to become botryoidal. This tendency increased and after 24 hours it was marked. Calcium sulfoaluminate was slower to appear than with water, but precipitated very rapidly within 15 minutes accompanied by C_3AH_6 , which showed vigorous Brownian movement. After 2 weeks the preparations were obscured by the C_3AH_6 which formed a general groundmass. Compared to the behavior of C_3A plus gypsum in water, the reactions here were depressed. Particularly lacking was the wealth of hexagonal plates of the hydrates of tricalcium aluminate. $Ca(OH)_2$ crystals did not appear either in the presence or absence of gypsum.

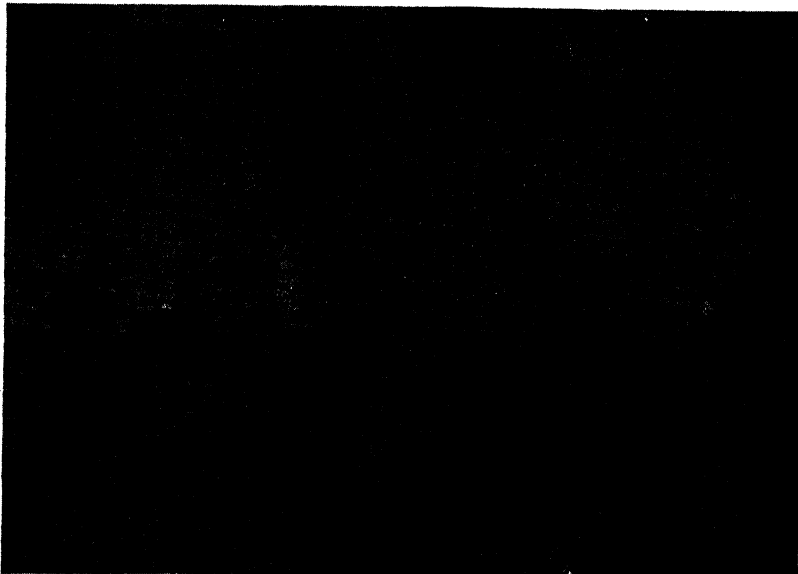

Figure 208. Tricalcium aluminate hydrated on slide with gypsum and water 2 hours. $\times 900$. Shows needle clusters of calcium sulfoaluminate. (*Ward*)

Tetracalcium aluminoferrite hydrated quickly in the presence of a saturated solution of $Ca(OH)_2$, but slower than in water. Radiating aggregates of short blades of the hydrated calcium aluminates appeared in about 5 minutes, many occurring in open spaces indicating their precipitation from solution. Small isometric crystals of good habit commenced to appear at about 2 hours. The reactions continued, the major product being excellent crystals of C_3AH_6 . These crystals increased up to 14 days when the reactions slowed markedly. Further changes were not noted. The addition of 15 to 20 percent gypsum delayed hydration and it was not until after 40 minutes that plates of the hydrates appeared. At the end of 3 hours calcium sulfoaluminate precipitated, and at the same time the presence of C_3AH_6 was noted. At 14 days the small isometric crystals of the hexahydrate were so numerous that many joined to form an open groundmass. The C_4AF lost its birefringence and then appeared as a reddish brown residual sludge with no distinct properties. Calcium hydroxide did not appear, either with or without gypsum.

Effect of Alkali Compounds. Potassium sulfate added to the cement compounds had much the same effect as gypsum but accelerated the reactions, possibly because of its greater solubility. The addition of 0.5 percent KOH, NaOH or $K_2S_2O_8$ produced an acceleration of the hydration of the silicates, particularly the dicalcium silicate, which was unaffected by the presence of gypsum. The alkali hydroxides appeared to depress the hydration of the C_3A and C_4AF .

Microscopic Structure of Cement Pastes

An important contribution to the structure of the cement paste was made by Brown and Carlson (6) in 1936, by the microscopic examination of thin sections. By removal of the absorbed water and impregnation by a resin,* sections could be made of 20 microns in thickness which permitted satisfactory examinations.

The set cement was observed to consist essentially of three constituents: unhydrated grains, crystalline calcium hydroxide and an amorphous gel. Especial attention was given to the gel, which appeared to be porous and to fill substantially old intergranular spaces. The porosity of the gel was found to increase with increasing coarseness of the cement and with increasing water:cement ratio of the paste. The strength of the specimen appeared to be greater as the amount of the gel, termed the "void-filling glue," increased in the paste. This was noted to be in agreement with the observations that greater strengths are obtained with the finer cements, with the cements of higher C_2S content (at early ages), with greater ages of hydration, and with higher curing temperatures.

Curing in steam was noted to produce a denser paste, and when a siliceous material was present that material appeared to react with the $Ca(OH)_2$ resulting in increased gel formation and increased strengths.

Of especial interest was the observation that the porous gel tended to fill the large intergranular spaces, even though the hydration was slight. By this process, spaces up to 50 or 100 microns in diameter were rapidly filled. Such gel is very porous and is rapidly carbonated on exposure to carbon dioxide.

The composition of the gel from C_2S or C_3S was found to be close to that of C_2S_{aq} , and produced in a neat cylinder a compressive strength of 10,000 pounds per square inch at 1 year, even though the hydration at that age was probably less than a fourth complete.

Thin sections of neat portland cement were studied also by Ward (35). These pastes, containing 40 percent water and cured in water, when viewed microscopically presented a general overall or groundmass gel, irrespective of the age of the paste. This gel appeared to be made up of small globules less than one micron in diameter. It had a general index of refraction between 1.530 and 1.540. The gel was interrupted by partially hydrated clinker grains, by calcium hydroxide and by channels and pores. The gel itself had scattered throughout small, crystalline particles of low birefringence which closely resembled $Ca(OH)_2$ but might have been C_2SH .

The hexagonal plates derived from pure C_3A and C_4AF could not be found at any age. It was with great difficulty that C_3AH_6 was detected and then only in

* Canada balsam or the synthetic resin Kollolith, of index 1.5354, were found suitable.

small amounts when the clinker was high in C_3A or C_4AF . Calcium sulfoaluminate was not readily observed even when the C_3A was as high as 12 percent and the SO_3 was 1.8 percent. The hydration of C_2S was difficult to detect, probably because of its slowness to hydrate.

Calcium hydroxide crystallized around hydrating clinker particles and tended to fill pores and voids. It seldom crystallized in channels. In all cases there was a considerable increase in crystalline $Ca(OH)_2$ between 7 and 28 days.

Channels of various widths down to $\frac{1}{2}$ micron, the limit of resolution of the microscope, were observed. They were not many in number and were always tortuous. They led in devious ways from voids and larger pores to hydrating

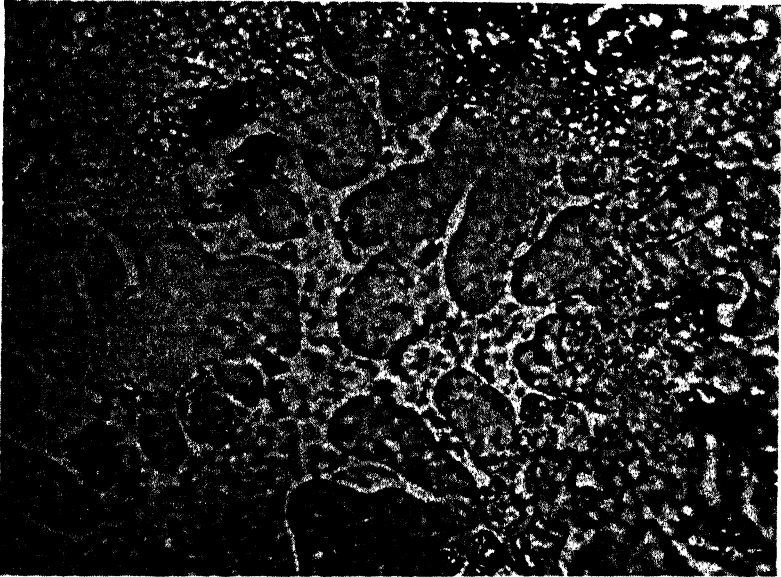

Figure 209. Photomicrograph of a thin section showing a gel exuding or fingering out from the groundmass gel into a large void. $\times 900$. (Ward)

grains. Sometimes they could be observed starting and ending in the gel. This probably is because the observations were made in one plane and such channels may actually lead from a void in one plane to a clinker particle in another. Whether or not these channels are adventitious, that is, caused by turbulence in settling or bleeding, was not determined.

As the pastes aged, a clear gel appeared to exude from the general groundmass, or to precipitate, into larger voids and tended to fill channels. Such behavior is illustrated in Figure 209, where the new gel has "fingered" into a large void. The new gel does not show the irregular structural detail seen in the original groundmass gel. Apparently complete equilibrium throughout the groundmass is difficult to attain.

Although a few grains were observed which were encased in an envelope of hydrated material, the frequent occurrence of shattered and broken grains, and

the extrusion of the gel into pores and voids, led Ward to conclude that the various single phases reacted independently and that, at a favorable concentration, a general precipitation of the gel occurred. This was further borne out by the optical similarity of the gel, wherever produced.

Although estimates were not attempted of the rates of the reaction, the photomicrographs shown in Figures 210 and 211 from a thin section of a cement paste, at 3 days and 90 days respectively, reveal very clearly the progress of the hydration in that period. In these photographs, the dark grains are the unhydrated material, embedded in a groundmass gel, shown in white.



Figure 210. Photomicrograph of a cement paste hydrated for 3 days. Note the large number of unhydrated and partially hydrated particles. $\times 450$. (*Ward*)

The technique used by Brownmiller (7) for following the hydration of cement pastes consisted in polishing sections of the hardened paste by hand on a chamois with tin oxide. By this means the friable paste was preserved intact. Neat cement pastes with 40 percent mixing water were used, these being sealed in glass vials for 24 hours and thereafter differently treated. Immediately after removing the specimens from storage for examination, a flat surface was ground on them with the finest grade of corundum. That face was stained with several applications of patent-blue dye in alcohol. The dye was absorbed by the hydrated compounds but not by the unhydrated grains, and was used primarily to obtain good contrast for photographic purposes. After staining, the specimens were allowed to dry for several hours at 35° to check hydration, and then the stained surface polished on a chamois. Specimens so prepared could be kept in a desiccator for long periods with no apparent change in structure. An etching of the surface for 3 seconds in a solution containing 1 drop of concentrated HCl in 10 ml of alcohol served to

bring out details of the unhydrated cement, especially the outlines of the C_3S and C_2S crystals.

Some of the results obtained in this study are shown in the accompanying photomicrographs. The general progress of the hydration is shown by reference to Figures 212 and 213. Figure 212 represents a paste of high-early-strength cement after 1 day of hydration as above described. The unhydrated cement grains are shown in white against a background of hydrated material shown in black. Figure 213 shows the same cement after 7 days of hydration. The decreased amount of unhydrated material is strikingly apparent. This cement contained 66 percent C_3S , 4 percent C_2S and 14 percent C_3A by calculation from the oxide

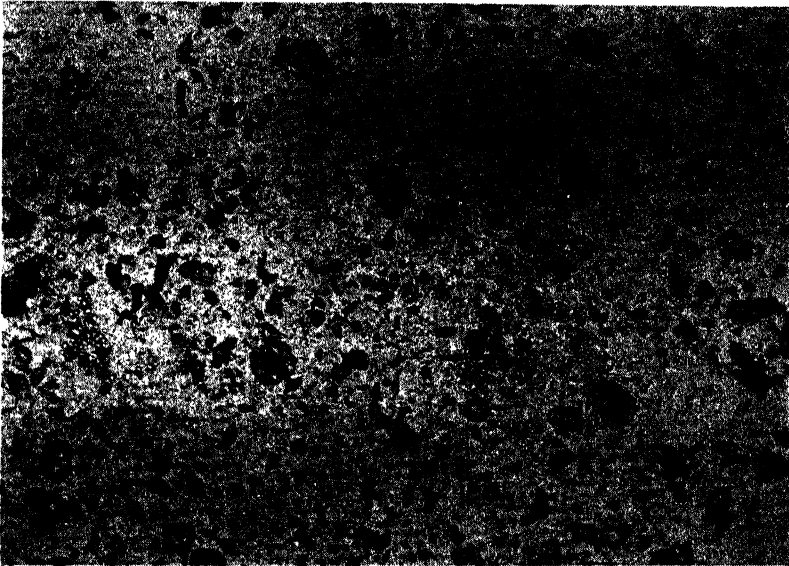

Figure 211. *Photomicrograph of the same paste as shown in Figure 210, hydrated for 90 days. Note the large increase in groundmass gel and the decrease in unhydrated particles. Many grains show shattering and a few are enveloped. $\times 450$. (Ward)*

analysis, and the surface area was 2580 sq cm per gram. About 2 percent was coarser than 60 microns. The hydration had proceeded into the individual grains at the rate of about 20 microns during the first 7 days. At 1 day the amount of unhydrated material was about 33 percent; at 3 days, this had been reduced to about 5 percent; and at 7 days, to about 1 percent.

Figure 214 shows the presence of unhydrated grains of C_3S and C_2S in a cement hydrated for 28 days. The white areas in this figure are unhydrated interstitial material, shown protruding at certain regions. Grains are shown also of C_3S crystals which have been hydrated. Such figures reveal that no single constituent of the cement is entirely and selectively decomposed. There was no evidence observed of channelling of the water into the grains to hydrate the more reactive C_3S , but hydration seemed to proceed by the gradual reduction in the size of the particle as a function of the surface exposed to the water. Some of the interstitial

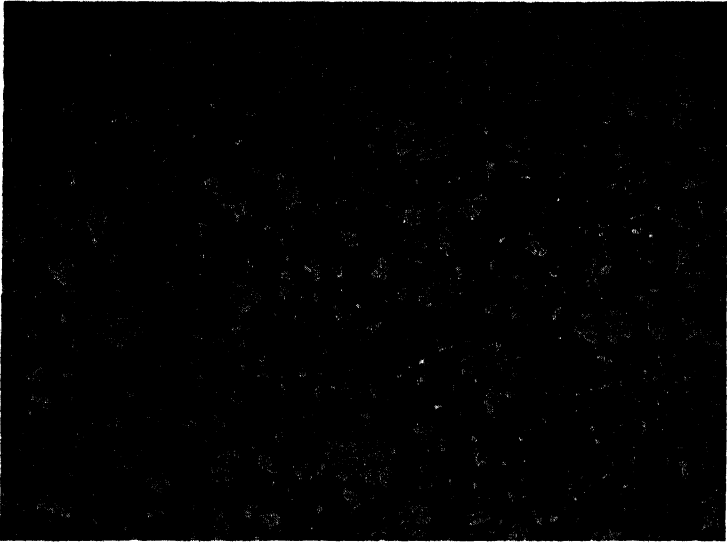

Figure 212. Photomicrograph of a neat cement paste after 1 day of hydration. The white grains are unhydrated cement particles in a groundmass of hydrated material which appears black in the figure. $\times 220$. (Brownmiller)



Figure 213. The same paste as shown in Figure 212, hydrated 7 days. The advance in the hydration is shown by the greatly diminished amount of white unhydrated grains. $\times 220$. (Brownmiller)

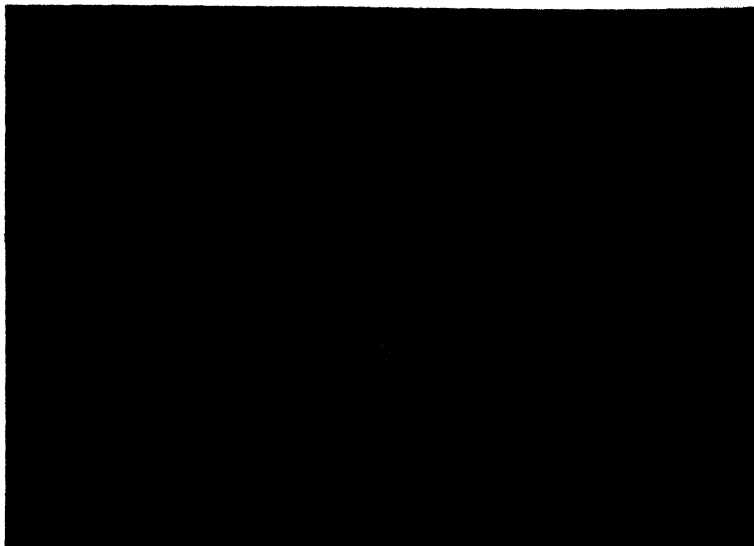

Figure 214. A cement paste hydrated 28 days, showing unhydrated C_2S crystals, partially hydrated C_2S crystals, and unhydrated interstitial material. $\times 900$. (Brownmiller)



Figure 215. A cement paste hydrated 28 days, etched to show $Ca(OH)_2$ crystals, which appear as dark flecks. $\times 220$. (Brownmiller)



Figure 216. Section from the same paste as shown in Figure 215 at 28 days, taken from the top layer to show the difference in structure in the laitance. $\times 220$. (Brownmiller)

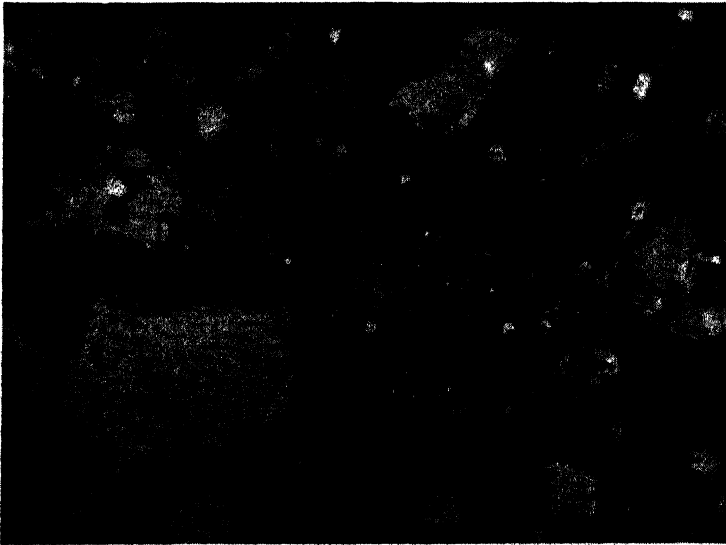

Figure 217. A cement paste hydrated 7 days, etched to show structural details of the grey hydrated material. $\times 900$. (Brownmiller)

material seems to hydrate more slowly than the crystalline grains. Unhydrated grains of MgO were observed frequently.

The general structure of the paste after 28 days hydration is shown in Figure 215, of a cement computed to contain 40 percent C_2S , 31 percent C_3S , 6 percent C_4A and 13 percent C_4AF . The section was etched with water at 15° for 1 second to bring out especially the $Ca(OH)_2$, which appears here as black particles. The white areas are unhydrated material, and the grey areas are hydrated compounds. It is seen that a considerable quantity of $Ca(OH)_2$ has been liberated, estimated in this case at about 10–15 percent.

A similar section, Figure 216 taken from the upper (laitance) region of the cylinder indicates a marked difference in structure in that region.

The general structural characteristics of the hydrated material is shown to good advantage in Figure 217, where it is seen that the hydrated gel is not merged into a homogeneous phase, but itself possesses an intricate structure.

Electron Micrographs of Cement Compounds

The hydration of tricalcium aluminate and tricalcium silicate has been followed by Eitel and his co-workers (12) (29) by means of the electron microscope. Katz and his associates (31) have reported the hydration products of portland cement as observed by this means, and a few unpublished electron micrographs have been made available to the author by McMurdie (21).

The method used by Eitel was to shake air-dried C_3S in water for 2 hours. After this treatment nodules and $Ca(OH)_2$ crystallites in the shape of hemispheres, about 0.2 to 1.0 micron in size, were observed with the electron microscope. Magnifications of 31,000 were used. When the C_3S was shaken for the same length of time in a mixture of isobutyl alcohol with 18 percent water, the hemispheres were again observed, but smaller, being from 0.1 to 0.2 micron in size, together with disks 0.07 to 0.1 micron in diameter. In addition to these, nodules identified as crystalline calcium hydrosilicate were visible.

The C_4A was shaken with water at room temperature for 16 hours. The electron microscope then revealed, at a magnification of 31,000, hexagonal crystals identified as C_3AH_{12} , having a maximum length of 1.3 microns, a width of 0.9 micron, and a thickness of 0.05 to 0.1 micron. In the isobutyl alcohol-water mixture, the hexahydrate, C_3AH_6 , was identified. The crystals looked spherical but were supposedly icositetrahedrons 0.06 to 0.13 micron in length. Besides these crystals, others were observed having the same shape and dimensions as the crystals of C_3AH_{12} noted in the pure water. No amorphous colloidal material was observed in any of the preparations.

In the studies by Katz, 0.5 to 0.75 g of the finely powdered material was mixed with about 10 ml of freshly-boiled distilled water and allowed to stand without agitation for various periods. The specimen for test was a droplet of the supernatant liquid, placed on a collodion film. The sample was taken up on a No. 200 stainless steel screen, and the water allowed to evaporate by standing in a closed dish for a few minutes. Thus the images revealed in the electron microscope may have been either suspended material or crystals which separated from the solution during the evaporation of the water. Micrographs were made, at 2250 to 20,000

magnifications, of several of the cement compounds and of commercial cements, hydrated as above indicated for various periods of time.

The gypsum was found to form monoclinic-type crystals in all cases. Calcium hydroxide revealed spheres as the principal form, as illustrated in the electron micrograph of Figure 218, but also was observed as a fibrous or needle-like structure. Calcium carbonate formed rhombic slabs as shown in Figure 219. Dicalcium silicate was believed to hydrate first to rhombic slabs which adhered to form accordion-shaped aggregates. Later, amorphous spherulites were formed. Tricalcium silicate showed the same products as dicalcium silicate, together with

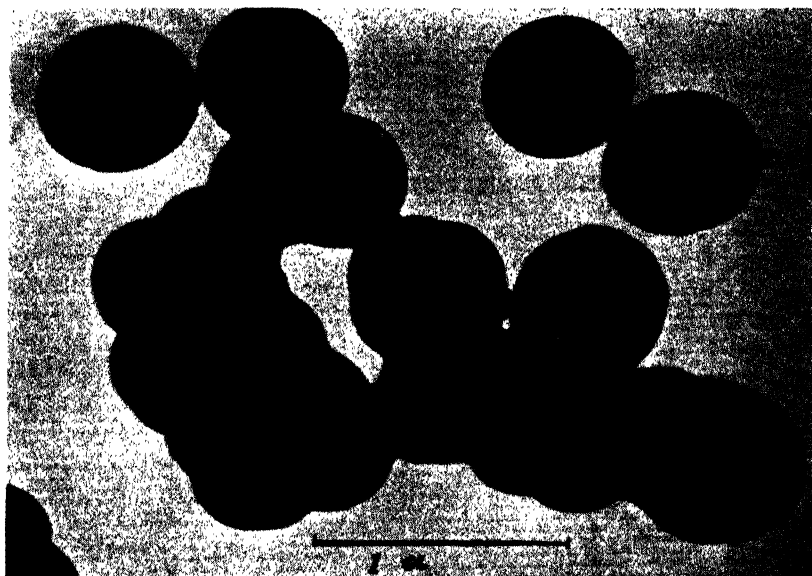

Figure 218. Electron micrograph of calcium hydroxide obtained by hydrating calcium oxide 2 days. $\times 33,000$. (Katz *et al*)

crystals of $\text{Ca}(\text{OH})_2$. Tricalcium aluminate revealed rhombic slabs, thin hexagonal plates, and spherulites. Needles and splines, sometimes observed, were tentatively attributed to calcium sulfoaluminate due to sulfate contamination. Tetracalcium aluminoferrite was found to decompose after several hours to form the same products as C_2A , plus a background of calcium ferrite and possibly $\text{Ca}(\text{OH})_2$.

Electron micrographs made by McMurdie (21) of the cement hydration compounds showed no evidence of the rhombic slabs observed in nearly all the preparations by Katz and his associates. The probability is suggested that the rhombic crystals, noted in the preparations of C_2S , C_3S , C_1A and C_4AF by Katz, are actually crystals of CaCO_3 , which were formed by the carbonation of $\text{Ca}(\text{OH})_2$. In Figure 220 is shown an electron micrograph by McMurdie of C_2A after hydrating in water for 24 hours. Following this period the product was separated from the liquid by centrifugation, resuspended in ethyl alcohol and mounted on a collodion film. Only hexagonal plates of hydrated calcium aluminate are observed.

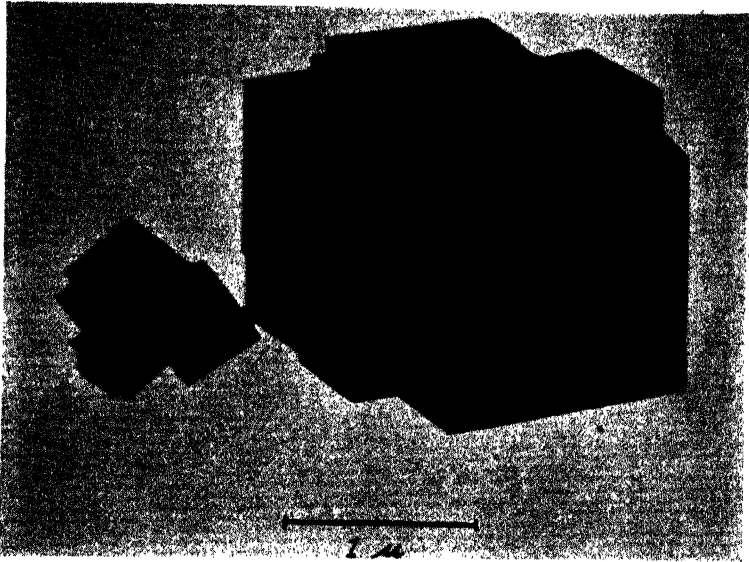

Figure 219. Electron micrograph of calcium carbonate obtained by hydrating calcium oxide 4 days in a solution saturated with carbon dioxide. $\times 27,000$. (*Katz et al*)

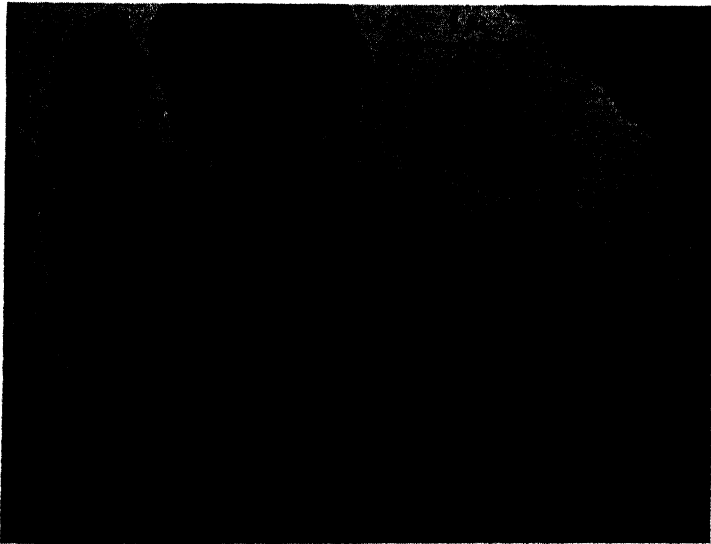

Figure 220. Electron micrograph of C_1A after hydrating in water for 24 hours. Shows plates of hexagonal calcium aluminate hydrate. $\times 20,000$. (*McMurdie*)

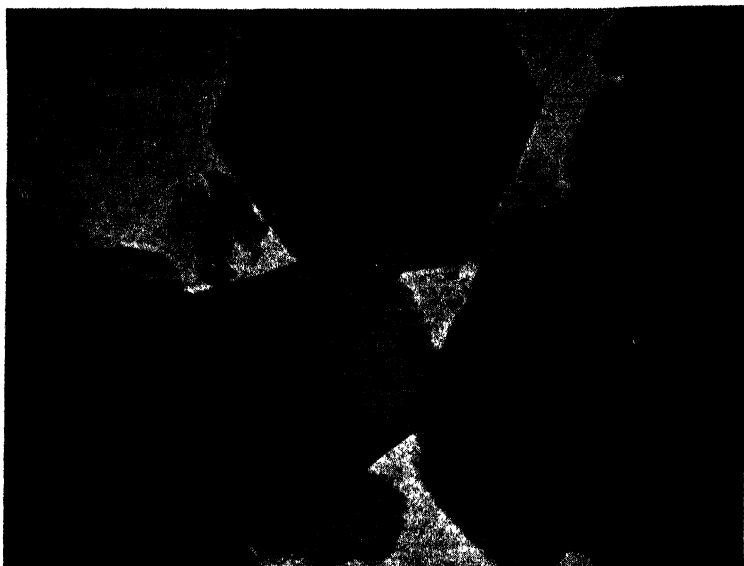

Figure 221. Electron micrograph of C_4AF after hydrating in water for 3 hours. Shows plates of hexagonal calcium aluminate hydrate. $\times 23,000$. (*McMurdie*)

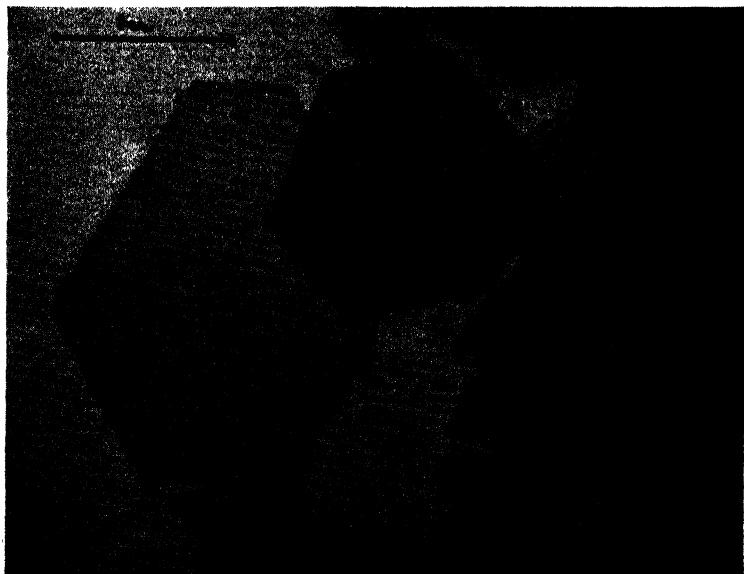

Figure 222. Electron micrograph of C_3NA_2 after hydrating in water for 24 hours. Shows plates of hexagonal calcium aluminate hydrate. $\times 24,000$. (*McMurdie*)

Similar preparations of C_4AF (hydrated 3 hours) and of C_3NA_3 (hydrated 24 hours) are shown in Figures 221 and 222. In both of these preparations only the same hexagonal plates were observed. Contrary to the findings of Eitel, McMurdie observed in the hydration products of the calcium silicates and of commercial cements globules of gel, as indicated in Figure 223. The fringe, however, shows a most interesting structure and the possibility cannot be ignored that this may indicate a crystalline character.

When gypsum was present with the C_2A or the C_4AF , heavy splines of the high-sulfate form of calcium sulfoaluminate were always noted. In Figure 224

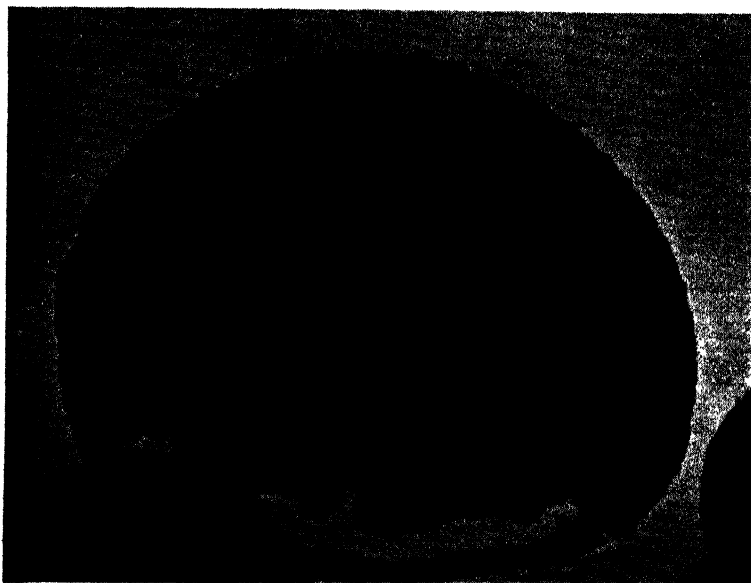

Figure 223. Electron micrograph from a part of the field of a commercial portland cement after hydrating in water for 5 hours. Shows a gel structure dried and shrunk in the vacuum of the microscope. $\times 20,000$. (McMurdie)

is shown an electron micrograph by Katz of C_2A with $CaSO_4$ after hydration for 10 days. Hexagonal plates of hydrated calcium aluminate are shown together with the $C_2A \cdot 3CaSO_4 \cdot 31H_2O$ and other unidentified material.

Commercial cements showed all the forms observed with the pure compounds, except gypsum and hexagonal plates of calcium aluminate hydrate. Such an electron micrograph by Katz is shown in Figure 225.

The work done up to this time in the application of the electron microscope to cement research must be considered as quite tentative. Final conclusions cannot yet be given in the case of any constituent because of the difficulties of adapting the electron technique to this material. But the work presented constitutes a necessary pioneer exploration of the field, and holds forth a promise of important results to be attained by systematic study.

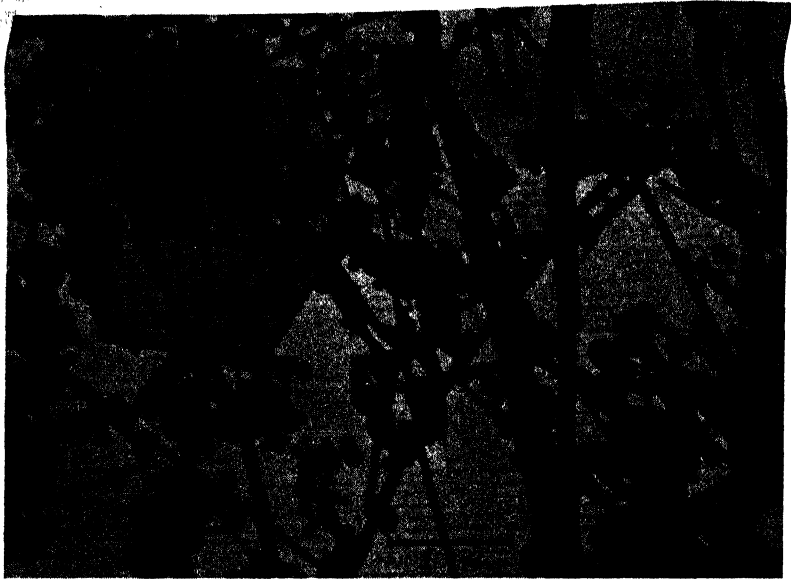

Figure 224. Electron micrograph of C_3A (4 parts) and $CaSO_4$ (1 part) hydrated 10 days. $\times 16,000$. (Katz *et al*)

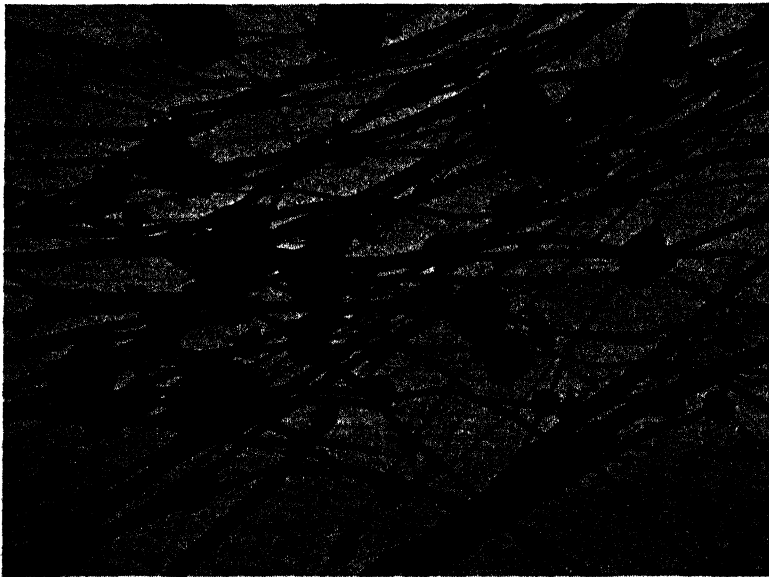

Figure 225. Electron micrograph of a commercial portland cement hydrated 18 days. $\times 9800$. (Katz *et al*)

Physical Characteristics of Hydrated Pastes

Gel Structure. According to Giertz-Hedstrom (15), the formation of the amorphous hydrated calcium silicate, to which the formula C_2SH_4 is given by Forsen (13) and often referred to as the "cement glue," may take place in different ways. The newly formed hydrate may form an envelope, growing from within by action of water that has penetrated the surrounding film; the dissolved silicates may pass through the envelope and precipitate as the outer layer; or a colloidal solution may be precipitated throughout the mass after a condition of supersaturation is reached, and within this structure further reactions of hydration may continue.

The cement glue, or gel, appears under the microscope as an amorphous colloid; Bogue and Lerch (4) found that, even after 2 years of contact with water, the X-ray diffraction patterns failed to give evidence of any crystal structure. Kuhl (19), however, found that crystallization appeared to have taken place after 20 years. Brandenberger (5) was unable to find any clear indication, by X-ray studies, of a crystalline development in the hydrosilicate gel. As indicated above, the electron micrographs of Eitel and of Katz revealed, on the other hand, no non-crystalline material in any of the hydration products. These latter results cannot, however, be taken as conclusive, for the conditions of the studies may not have been adequate to determine this point. The electron micrographs of McMurdie are inconclusive but suggest the possibility of crystalline development.

During the process of hydration, the volume of the solid phase increases, that of the liquid water decreases, but the volume of the system cement plus water suffers a contraction (23) (24). In the early stages of the reactions, before a stiffening of the paste takes place, there may occur a selective sedimentation or settling of the larger or heavier grains or aggregates of concretes, mortars or pastes, leaving a layer of fine water-rich material, known as *laitance* at the surface and along the under surfaces of aggregates. This condition, known as *bleeding*, *weeping* or *sweating*, has been examined by the fundamental laws of sedimentation by Powers (25) and by Steinour (32).

Various agents have been applied with the purpose of controlling the physical characteristics of the pastes, especially the dispersion and the air entrainment. Powers (26) has presented arguments, based on a development of colloid principles, that dispersion would be undesirable in cement pastes because it would increase the rate and amount of sedimentation and promote particle-size segregation; it would destroy the plasticity of the pastes and give them the properties of a fluid; and it would have no beneficial effect on rate of hydration, because even when the particles are flocculated the whole surface is normally exposed to the action of the water. The use of agents, as Vinsol resin, for entraining air in the pastes has been found useful for improving the workability of the concrete grout and for improving the durability of concrete structures, especially when exposed to cycles of freezing and thawing, and to salts employed for ice removal (34).

The reaction velocities of the process of setting, the summation of which is the hydration of the cement; have been measured by many means, several of which have been discussed. These include changes in electrical conductivity, heat evolution, specific gravity, water fixation, and microscope observations of optical

properties. In addition to the above, important information on the structure of the hydrated paste may be obtained by a study of the water contents of pastes in equilibrium with water vapor at a number of pressures or temperatures. Such experiments have been carried out by many investigators, including Jesser (17),

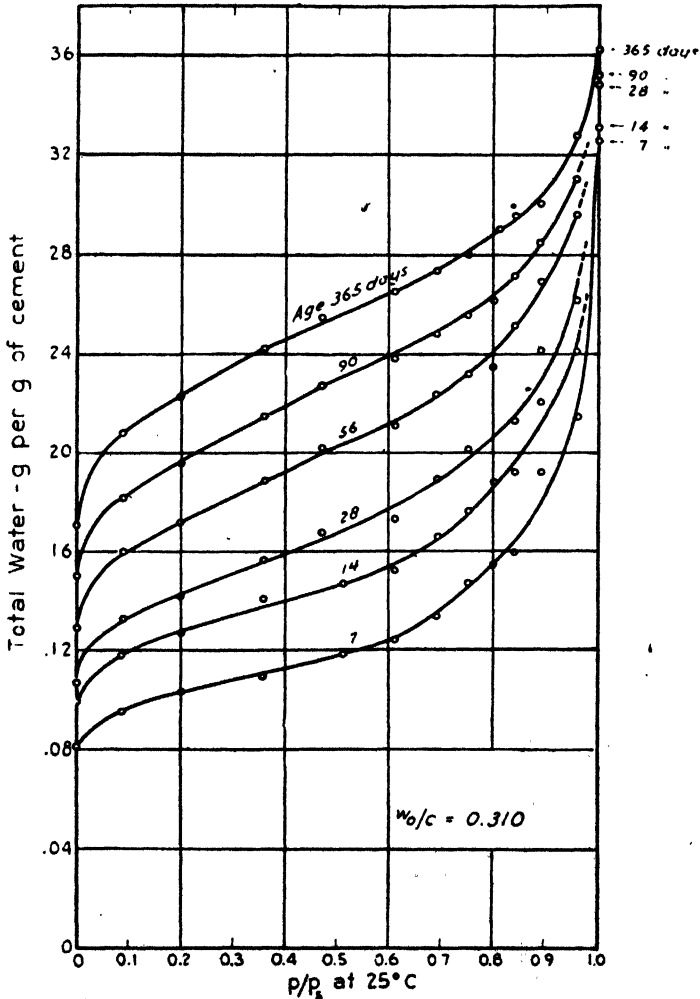

Figure 226. Adsorption isotherms of a cement paste at various ages at 25°. (Powers and Brownyard)

Gessner (14), Giertz-Hedstrom (16), Berchem (2) and Powers and Brownyard (27).

Adsorption Studies. The experiments by Powers and Brownyard made use of two types of specimens. In one, crushed samples of mortar or neat cement pastes, after specified periods of curing in water at 21°, were graded between the

35- and 100-mesh sieves. Portions of about 15 g were then placed in vacuum desiccators over anhydrous magnesium perchlorate and exhausted to a constant weight. The water lost during this drying procedure is designated as *evaporable water*, and that retained, as *non-evaporable water*. Another type of specimen consisted of thin slabs of neat cement paste, about 0.3 mm thick, made by sawing slices from a cylinder of the hardened paste and grinding down.

The precise measurements of the equilibrium water content of variously cured specimens at various vapor pressures and constant temperature were made in especially designed equipment of two types. In one the specimens are suspended, on helical springs made of quartz, in an atmosphere of pure water vapor at variously controlled pressures at 25°. The changes in weight of the sample were observed by measuring the changes in length of the quartz spring by means of a cathetometer. By the other procedure, the crushed specimens were placed in flasks over which was passed a mixture of air and water vapor of the desired water content. This water-vapor content was obtained by passing purified air through sulfuric acid of the required concentration, and the vapor contents were varied by varying the acid concentration. The action was continued at a given vapor content until the weight of the flasks containing the samples remained constant. The results obtained by the two methods gave results which were quite comparable.

A typical family of water-adsorption curves is shown in Figure 226, where each curve represents a cement paste which was cured to a different age, as designated. The total water content of the pastes after attainment of equilibrium, in grams per gram of cement, is plotted against the relative vapor pressure, p/p_s , where p is the existing water-vapor pressure and p_s is the water-vapor pressure of pure water at the temperature used, *e.g.*, 25°.

The adsorption curves obtained were examined and interpreted by Powers and Brownyard in accordance with a capillary-condensation theory, based upon the energy available at a solid surface and the energy available at the surface of a liquid. For the former, the equations of Brunauer, Emmett and Teller (8), known as the multimolecular-adsorption theory, were employed, with modifications by Pickett. For the latter, the equations of Lord Kelvin for the relationship between surface curvature and vapor pressure were used. By this theory, the shape of an adsorption curve depends on the range of sizes of the pores in the material, and the total capacity of each pore size.

Since, according to the theory, the surface area of the adsorbent should be equal to the product of the number of adsorbed molecules in the first layer and the area covered by a single molecule, the equation is written

$$A = a_1 \frac{V_m N}{M}$$

where

A = the surface area of the adsorbent, cm^2/g ,

a_1 = surface area covered by a single molecule,

N = number of molecules in a gram molecule, $= 6.06 \times 10^{23}$,

M = molecular weight of adsorbed gas, and

V_m = quantity of adsorbed gas required to give a layer 1 molecule deep.

The values for all factors other than V_m were known from other work, and V_m was

calculated by use of the equations above discussed from the adsorption data. Thus the surface area of the whole solid phase could be calculated, against water as the adsorbent, as equal to $(35.7 \times 10^6)V_m$, expressed as cm^2/g .

Since V_m is proportional to the non-evaporable water, W_n , the specific surface of the cement alone could be computed by the equation

$$\frac{A}{C} = 35.7 \times 10^6 k \frac{W_n}{C}$$

where C = the weight of cement. The specific surface of the dry paste would then be:

$$\frac{A}{C + W_n} = \frac{35.7 \times 10^6 k W_n}{C + W_n}$$

By these equations, the specific surface of the normally cured pastes was found to be in the order of 2.1 to 2.5 million cm^2/g of original cement. The specific surface of a steam-cured paste, however, was computed to be of a much lower order, 0.07 million cm^2/g , which suggests that all but about 5 percent of the colloidal material was converted to a microcrystalline state by the high-temperature steam curing.

From a relationship between the volume of the pores and the area of the pore walls, the mean diameter of the pores was calculated to be from 20 to 40 Angstroms. From the specific surface of the solid phase, the order of magnitude of the units making up the solid phase is estimated to be about 140 A in diameter.

It cannot, of course, be assumed that a cement paste is made up of spheres of hydrated material inclosing spherical pores. But the above values, calculated from an application of theories on capillary forces to adsorption data, indicate the character of structure which may obtain in the hydrated pastes.

References

1. Bates, P. H., and Klein, A. A., *Tech. Paper NBS*, 78 (1917).
2. Berchem, H., *Dissertation*, Zurich, 1936.
3. Bessey, G. E., *Symposium*, 185.
4. Bogue, R. H., and Lerch, W., *Ind. Eng. Chem.*, **26**, 837 (1934); PCAF Paper 27.
5. Brandenberger, E., *Schweizer Archiv.*, **45**, (1937).
6. Brown, L. S., and Carlson, R. W., *Proc. Am. Soc. Testing Materials*, **36**, 332 (1936).
7. Brownmiller, L. T., *J. Am. Concrete Inst.*, **14**, 193 (1943).
8. Brunaure, S., Emmett, P. H. and Teller, E., *J. Am. Chem. Soc.*, **60**, 309 (1938); Brunaure, S., Deming, L. S., Deming, W. E. and Teller, E., *ibid.*, **62**, 1723 (1940).
9. Bussem, W., *Symposium*, 163.
10. Eiger, A., *Symposium*, 390.
11. Eiger, A., *Rev. materiaux const. trav. pub.*, **33**, 141 (1937).
12. Eitel, W., *Z. angew. Chem.*, **54**, 185 (1941).
13. Forsen, L., *Symposium*, 298; 370.
14. Gessner, H., *Kolloid Z.*, **46**, 207 (1928); **47**, 65, 160 (1929).
15. Giertz-Hedstrom, S., *Symposium*, 505.
16. Giertz-Hedstrom, S., *Zement*, **20**, 672; 734; 801 (1931).
17. Jesser, L., *Zement*, **23**, 514; 677; 691 (1934); **25**, 518; 537; 899 (1936).
18. Kuhl, H., *Zement*, **13**, 362 (1924).
19. Kuhl, H., "Cement Chemistry in Theory and Practice," translated by J. W. Christelow, p. 34, London, Concrete Publications, Ltd., 1931.

20. Le Chatelier, H., *Compt. rend.*, **94**, 13 (1882).
21. McMurdie, H. F., Unpublished data.
22. Michaelis, W., *Chem. Ztg.*, **18**, 982 (1893).
23. Neville, H. A., and Jones, H. C., "Colloid Symposium, Monograph," **6**, 309 (1928).
24. Powers, T. C., *Ind. Eng. Chem.*, **28**, 790 (1935).
25. Powers, T. C., *PCA Bull.*, **2** (1939).
26. Powers, T. C., *J. Am. Concrete Inst.*, **17**, 117 (1945).
27. Powers, T. C., and Brownyard, T. L., *J. Am. Concrete Inst.*, **18**, 101; 249 (1946); subsequent issues scheduled for publication to April, 1947.
28. Pulfrich, H., and Linck, G., *Kolloid Z.*, **34**, 117 (1924).
29. Radczewski, O. E., Muller, H. O., and Eitel, W., *Naturwiss.*, **27**, 807; 837 (1939).
30. Rodt, V., *Chem. Ztg.*, **42**, 174 (1918).
31. Sliepeevich, C. M., Gildart, L., and Katz, D. M., *Ind. Eng. Chem.*, **35**, 1178 (1943).
32. Steinour, H. H., *Ind. Eng. Chem.*, **36**, 618; 840; 901 (1944); *PCA Bull.*, **3** (1944).
33. Tavaschi, B., *Zement*, **30**, 43 (1941).
34. U.S. Army Engineers, Interim Report, 1942; A. A. Anderson, *Proc. Assoc. Highway Officials, No. Atlantic States*, **17**, 67 (1941).
35. Ward, G., *Res. Reports, PCAF*, April, 1944.

CHAPTER 27

The Setting of Cement Pastes

When water is mixed with portland cement, the chemical reactions which follow bring about a change in the structure of the paste by which the fluid mass becomes rigid and hard. The terms *initial set* and *final set* are expressions which have been given arbitrary and empirical values indicative of the progress of such reactions (1), but the term *setting* has reference to the change from a fluid to a rigid state. The early theories of the setting process have been given in an earlier chapter.*

The setting process has been found to be closely associated with temperature changes in the paste, the time of initial set corresponding closely with the time at which rapid temperature rises occur, and the final set occurring at the time when the temperature reaches a maximum (11). It has also been found that a sharp drop in the electrical conductivity occurs at the time of the final set (25).

A number of theories have been proposed to explain the nature of the setting process and the effects brought about by the addition of retarding or accelerating agents. The theories currently held include the selective hydration of the cement compounds, the formation of crystalline hydration products, the development of films around the cement grains, and mutual coagulation of components of the paste. Special conditions produce the state of false set. For the control of set, essential in the utilization of cement, research has shown that optimum amounts of a retarding agent should be used, and methods have been developed for establishing those amounts. A consideration of the reactions with the aid of the principles of phase equilibria reveals the bases for a rational interpretation of the effects of SO_2 . All of these aspects of the setting process are discussed below.

Theories of the Setting Process

Selective Hydration. The change in the electrical conductivity of the paste as a means for studying the setting process was investigated by Shimizu (25). His apparatus consisted of a glass conductivity cell, a water thermostat for maintaining constant temperature, and a Kohlrausch alternating-current bridge for measuring the current. The conductivity cell was a glass tube 2 cm in diameter by 25 cm in length. An inner tube, enclosing the lead-wires attached to the two platinum electrodes, was inserted into the freshly prepared cement paste which was placed in the bottom of the conductivity cell. Measurements were started immediately and continued at necessary intervals for as long a period as desired. In these experiments, normal and high-early-strength cements gave pastes which showed a rapid rise in conductivity for a brief period of about 30 minutes, followed by a period of 3 to 4 hours (the lesser time at the higher temperatures)

* See pages 367-370.

when the conductivity decreased slightly with time. At the end of this period, identified with the final set, a sharp reduction in conductivity occurred over a half hour period and thereafter it decreased with diminishing rate for several days.

The thermal changes occurring in cement pastes during the setting process were studied by Bogue and Lerch (6) in 1933 by the use of equipment measuring the rate of heat liberation. The method consisted in noting the temperature changes in 200-g specimens of cement and water placed in small tin cans within thermos bottles which were installed in a constant-temperature cabinet at 20°. Thermocouples inserted in the pastes were connected with a potentiometer-recorder whereon the temperatures were recorded automatically over a period of 48 hours.

From the results of this study a number of principles governing the set of cements were postulated. It was suggested that the cause of the initial set of portland cement may be the formation either of hydrated C_2A or of hydrated C_3S . The time required for initial set appeared to be governed by the time necessary for the one or the other of those hydrates to appear. When no retarder was present, or when the content of C_3A was high, the C_2A went into solution very rapidly and C_2A hydrate formed very quickly. This formation might be of sufficient magnitude to produce rigidity of the paste, in which case the paste is said to have a *flash set*, which is accompanied by a marked rise in temperature. In this case the precipitating calcium aluminate hydrate established the structure of the paste. But if the C_2A content were low, or if a retarder were present which functioned to reduce the solubility of the C_3A or to delay the precipitation of the calcium aluminate hydrate, then the more slowly reactive C_3S would be given time to go into solution and precipitate as the calcium silicate hydrate. In that case, the latter hydrate would establish the set and the structure of the paste. The time of set would be normal and high temperatures would not be produced.

The presence of calcium sulfate was found to bring about a reaction with the C_3A and $Ca(OH)_2$ in solution to form the very difficultly soluble calcium sulfoaluminate and, in doing so, to reduce the concentration of the C_3A in solution below the point where calcium aluminate hydrate could separate out. This process would continue until either the $CaSO_4$ or the C_3A was exhausted, and in this period the C_3S hydrated as in the absence of C_3A . When the $CaSO_4$ was depleted, the remaining C_3A could hydrate, but would be precipitated within the structure established by the C_3S . Increases in fineness of the cement and in temperature accelerated the rates of the reactions, but the influence of temperature was found to be specific for each compound, and thus to have different effects with cements of different compositions.

Thus it was suggested that a normal retarded set is due to the hydration of the C_3S , requiring a number of hours to proceed to the point of attaining rigidity in the usual mixes of concrete or mortar. But the very rapid reaction of C_2A with water may bring about a flash set if it is not retarded by some agent, as $CaSO_4$, which will suppress its normal hydration.

Crystallization of Hydration Products. Other factors than the ultimate chemical composition have, however, been found to affect profoundly the character of the hydration processes and consequently the rate of set and hardening of cement pastes. Cements of almost identical chemical composition and surface

area have shown pronounced differences in physical properties. Those various effects have been shown to be related closely to the thermal treatment of the clinkers which, in turn, determines the phase composition of the clinkers, as has already been shown. Slow cooling will allow the alumina and iron compounds to crystallize from the melt, but rapid cooling will cause the liquid to solidify to a greater or lesser extent as glass. That the crystallized compounds and the glass have different hydration characteristics has been shown by many investigators.

The early reactions of hydration which take place in slowly and quickly cooled clinkers were studied by Lerch (19) by the microscopical examination of

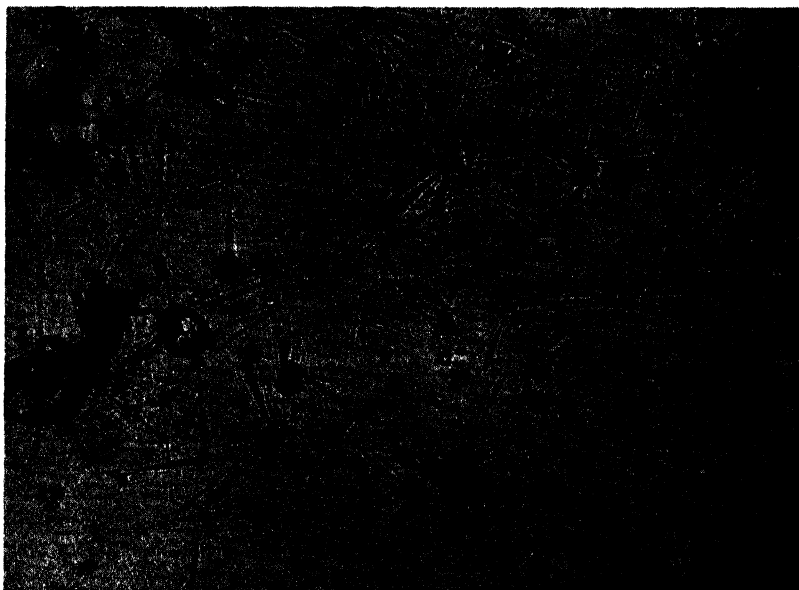

Figure 227. A cement, prepared from a slowly-cooled clinker, after hydration in water for 30 minutes. An abundant growth of calcium sulfoaluminate and hydrated calcium aluminate is shown. $\times 300$. (Lerch)

fluid cement pastes and the observation of their characteristics. The clinkers studied were commercial clinkers, portions of which had been reheated to clinkering temperature and one part of the charge cooled slowly, and another part cooled quickly. Specially prepared laboratory clinkers were also employed. The clinkers were mixed with gypsum to give cements containing 1.8 percent SO_3 , and ground in a laboratory mill to a uniform surface area of about 1700 ± 50 sq cm per gram. A small quantity of the cement was placed on a microscope slide with a drop of water, and covered with a cover-glass, which was sealed with paraffin to prevent evaporation. The course of the hydration was then followed by observations under the microscope.

By this means it was noted that there were some fundamental differences in the nature of the initial reactions of hydration with the different cements. In some cases an abundant growth of needle-like crystals appeared in from 1 to 5

minutes; in other cases no needle-like crystals were observed for more than 2 hours, although at 24 hours such crystals were always present. These crystals were found to consist of calcium sulfoaluminate and a hydrated calcium aluminate. An amorphous hydration product formed in all cases, within a few minutes, as a film on the surface of the cement grains.

The principal factor determining the appearance of the above crystalline phases appeared to be the glass content, or rather the presence or amount of crystalline C_3A in the clinker, which was established by the cooling rate of the clinker. This is illustrated in Figures 227 and 228. In Figure 227 is shown a

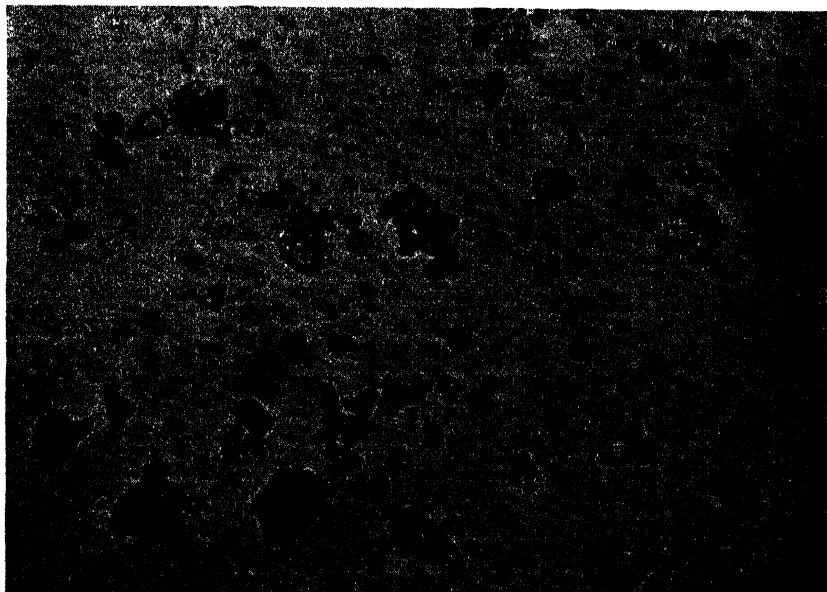

Figure 228. A cement, prepared from the same clinker as that shown in Figure 227, except that the clinker was cooled quickly, after hydration in water for 30 minutes. No crystallization products are found, but a film of dark amorphous material surrounds the cement grains. $\times 300$. (Lerch)

photomicrograph of a cement, prepared from a slowly-cooled clinker, after hydration in water for 30 minutes. An abundant growth of the needle-like crystals appear, extending out from the clinker grains. A similar preparation, made from the same clinker which had been reheated and quickly cooled, is shown in Figure 228. In this case no needle-like crystals are observed, although the amorphous material formed around the clinker grains is noted.

From a study of some 75 clinkers, it was observed that the early appearance of the crystalline products occurred much more frequently, and in more abundant amounts, in the cements prepared from the slowly-cooled clinkers having a low glass content than in those prepared from the quickly cooled clinkers having a high glass content. But in some cements of low potential C_3A content, a slow cooling of the clinker did not give rise to the early formation of the crystalline

hydration products, and in some cements of high potential C_3A content a rapid cooling of the clinker did not suffice to prevent the formation of such crystalline products.

The above results point to a relationship between the crystalline C_3A content of the clinkers and the rapid formation of crystalline hydration products. In most clinkers, it seems that the rapid cooling will reduce the C_3A below a critical value above which crystallization products appear quickly when water is added. But where the C_3A is very high, such a cooling may not sufficiently reduce the C_3A to prevent rapid crystal formation. Likewise, in cements of very low potential C_3A content, there still may be insufficient C_3A in the clinker, even on slow cooling, to produce the rapid reaction.

There was also observed a very consistent relationship between the relative amounts of the crystalline hydration products and the plasticity of the pastes, as also the amounts of water required to produce a paste of normal consistency. The slowly cooled clinkers gave cements which stiffened unduly and required excessive amounts of water.

Likewise, the water-retaining capacity was affected, the rapid formation of crystalline hydration products tending to cause the paste to increase its water-retaining capacity or, in terms of cement technology, to bleed less. It is known that the specific surface of the cement is an important factor in determining the bleeding or water-retaining capacity of the paste, but the additional surface produced by the crystalline hydration products is new surface not taken into consideration in the determination of specific surface of the cement. In the absence of such crystal formation, the compactness of the particles would be more complete and a larger quantity of water would be forced to the surface. And since the strength is a function of the density and compaction of the mass, it would be expected that the development of a more porous structure, as caused by the formation of the crystalline hydration products, would result in lower strengths. This was borne out by tests on the compressive strength of these cements, the strengths obtained with the cements prepared from the quickly-cooled clinkers, of high glass content, showing in general the higher values.

All of these results show that the properties of a cement are seriously affected by the early formation of crystalline hydration products in the paste, and that such formation is in turn determined in large measure by the composition of the cement and the relative amounts of C_3A or glass in the clinker. When the solution of alumina is relatively rapid and that of lime relatively slow, it is probable that the solution becomes supersaturated with respect to the calcium aluminates very quickly. It is known* from the work of Wells (28) already described, that hydrated calcium aluminates will separate quickly from such a solution and, in the presence of gypsum, the calcium sulfoaluminate will also crystallize. But where lime enters the solution rapidly, the high concentration of $Ca(OH)_2$ in the solution depresses the solubility of alumina and greatly retards the crystallization of these products.

It appears, therefore, that the glass of cements enters into solution relatively slowly as compared with crystalline C_3A . Hence the lime concentration may become high, in the glassy cements, before sufficient alumina has entered the

* See pages 401-404.

solution to result in crystallization. It would appear, also, that, if additional lime were introduced into the high- C_2A , low-glass cements, a similar condition might prevail, and the early separation of the crystalline hydration products be avoided. Such was found to be the case, for the tempering of the high- C_2A , low-glass, cements with saturated lime water effectively prevented the early crystal formation. In such cases, all of the effects of these crystals, as above discussed, were counteracted.

Film Formation. An interesting theory of retardation of set was developed by Roller (23) in 1934. According to this investigator, the direct hydration of C_2A proceeds with the formation of $C_2A.aq$. But in the presence of high concentrations of $Ca(OH)_2$, the tetracalcium aluminate hydrate will form and deposit as a film upon the grains of C_2A . The formation of this film then slows down the normally rapid hydration to $C_2A.aq$ and so retards the set. Thus $Ca(OH)_2$, according to Roller, is the primary retarder of the set in portland cements, and any agent which will bring about the formation of $Ca(OH)_2$ in the paste acts as a retarder by virtue of that reaction.

Thus gypsum will react with alkali hydroxides in the cement with the formation of $Ca(OH)_2$,

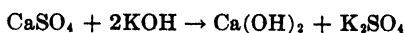

and by virtue of that reaction $CaSO_4$ acts as a retarding agent. Calcium sulfoaluminate may be formed in small amounts but, according to Roller, will be prevented from forming by the presence of an excess of $Ca(OH)_2$. When the latter condition obtains, as is usual in portland cement pastes, $C_4A.aq$ will be produced and the sulfoaluminate will be present only in negligible amounts. This condition is expressed by the reversible reaction:



A deficiency in $Ca(OH)_2$, permitting the formation of the sulfoaluminate, will bring about a quick set.

Since C_2S hydrolyzes rapidly, with the formation of $Ca(OH)_2$, C_2S acts as a retarder of set. Likewise, according to Roller, all soluble lime salts may function in this manner. Alkali compounds react with $Ca(OH)_2$ and so remove it from solution. For that reason they accelerate the set.

The retardation of set caused by subjecting the cement to steam has been reported by a number of investigators. In 1894 Geyer (12) suggested the addition of water to the mills as a means for retarding the set of a quick-setting clinker, and nine years later the introduction of steam for that purpose was patented by Bamber (2), and again in 1909 by Edison (8). The subject has been further discussed by Gadd (10) and Ware (27). An attempt to explain this action was made by Roller (24) in 1936.

It was emphasized by Roller that the exposure of clinker to moist air functioned to retard the set, and this action again was attributed to the formation of $Ca(OH)_2$. In this case the C_2S was believed to be activated by the water vapor in such a way that the hydrolysis of the compound or subsequent treatment with water was greatly accelerated. The absorption of too much water vapor, however, brought about a condition of overseasoning, due to the activation of the

C_2A , as well as the C_2S , which was deleterious in that it resulted in an increased water requirement for normal consistency and probably decreased strengths, but did not accelerate the set.

When the seasoning was accompanied by the absorption of CO_2 in excess of the water vapor, an acceleration of set resulted. This was attributed to a reaction of the CO_2 , "with potential calcium hydroxide in the tricalcium silicate-water vapor complex," resulting in a deactivation of the C_2S with respect to hydrolysis. A reversion in set was brought about in some clinkers by either CO_2 or abstraction of water through heating, but retarded set could again be attained by exposure to moist air.

A somewhat different interpretation of experimental results has been presented by Forsen (9). The normal set of cement, as conceived by this distinguished Swedish chemist, results from the solution of the calcium silicates, and their reprecipitation as C_2SH_4 . The rate of this action, however, is variously influenced by other materials entering into the solution.

Soluble calcium salts decrease the OH ion concentration and thus accelerate the solution of the calcium silicates. Also, they increase the Ca ion concentration, causing a more rapid precipitation of C_2SH_4 . In this way such salts accelerate the hydration of the silicates. Dissolved aluminates, however, retard the formation of C_2SH_4 by precipitating a film of insoluble material around the grains of the silicates. Under normal setting, such films are deposited and the velocity of hydration of the silicates is retarded. These films may consist, according to Forsen, of either the tetracalcium aluminate hydrate or calcium sulfoaluminate.

Any agent which will give rise to the precipitation of such compounds acts as a retarder. The most prominent ones are calcium salts in the presence of lime in such quantity that instantaneous precipitation of the aluminates will take place. Some calcium salts, as $CaCl_2$, however, may so reduce the OH -ion concentration of a solution, even though saturated with lime, that the aluminates enter into solution without being precipitated. In such cases, no retardation of set occurs. When gypsum is present, the insoluble calcium sulfoaluminate is formed on the silicate grains, and retardation is effected. Exposure of cement to moist air may bring about retardation of set by causing a film of hydrated compounds to enclose the silicate grains. In the absence of some retarding agent, quick setting occurs due to the rapid solution of the aluminates and silicates, and reprecipitation as hydrates. The low strengths obtained with such pastes is attributed by Forsen to the coagulation of aluminum silicate which prevents the formation of C_2SH_4 .

The quick set of clinkers which do not contain alkalies can be retarded by lime alone because tetracalcium aluminate hydrate is instantaneously precipitated from saturated or supersaturated lime solutions. Cements high in C_2S are thus self-retarding, even though they are high in aluminates, says Forsen, since the C_2S gives rise very rapidly to an excess of $Ca(OH)_2$ through hydrolysis. The quick set of clinkers containing alkalies cannot be remedied by lime alone, because of the low solubility of lime in alkali solutions, but gypsum will neutralise the alkali and form $Ca(OH)_2$, which will then precipitate the aluminates as a protective film around the cement grains and retard the set.

Hedin (14) confirmed the work of earlier investigators that the iron-contain-

ing phases of clinker, crystalline or amorphous, have a very low rate of solubility. For this reason they exercise little or no influence upon the early reactions of setting. But gradually these phases enrich the solution and eventually the iron is precipitated as a gel which forms a protective film around the clinker grains. This film retards the continued hydration of the cement compounds, and so may delay the appearance of final set considerably, though not affecting the initial set. The addition of lime or gypsum offsets the film formation either by further delaying the hydration of the iron phases or by the formation of crystalline hydration products. Similar film formation was shown to occur when C_2S was shaken with an aluminate solution, or when a CAS glass was shaken with water.

An extensive study of set at the Building Research Station (26) brought out the serious retardation which may be caused by low temperatures on the setting and hardening of cements. Damage thus brought about upon concrete structures, it was pointed out, may be irreparable, especially if the temperatures have been so low as to freeze the fresh concrete.

Mutual Coagulation. Hedin (14) agrees with earlier investigators that there first occurs, when water is added to cement, a solution of the anhydrous compounds, followed by a precipitation of the less-soluble hydration products. Both the solubility of the anhydrous compounds, and the character of the hydrated compounds, are affected profoundly by the concentrations of other ions in the solution. Thus the concentration of the calcium ions in the solution affects to an important degree the solubility of both the silicate and the aluminate anhydrous compounds, whereas basicity of the solution affects only the latter. Through a systematic control of these factors, one may control in turn the whole process of set, together with the many properties which are dependent upon the character of the set.

By means of solubility studies, Hedin showed that calcium salts in general, including gypsum, accelerate the solution of the calcium silicates but retard the solution of the calcium aluminates. The pH is lowered by the presence of calcium salts and may be reduced so greatly, as in a lime-calcium chloride solution, that precipitation of the hydrated calcium aluminate is prevented entirely, and in its place $Al(OH)_3$ is formed.

On the basis of the lime concentration and the presence of ions in the solution, Hedin explains the apparently inconsistent results of various investigators. Where the solution is supersaturated with $Ca(OH)_2$, the hydrated silicate may have the composition C_2SH_2 , whereas in solutions only saturated with $Ca(OH)_2$, the product will be $C_2S_2H_2$. Intermediate compositions are formed at intermediate concentrations.

The development of quick set, according to Forsen (9), is due to the mutual coagulation of the silicic acid and aluminum hydroxide. The precipitated gel encloses the unhydrated grains, and subsequent development of strength and cementing quality are unsatisfactory. But if lime can by any means be brought rapidly into the solution, this coagulation is prevented by the prior formation of insoluble crystalline C_4A hydrate. This allows the silicate to hydrate unaffected by the aluminate. If gypsum were present, instead of lime, a similar effect would be obtained due to the prior formation of the insoluble calcium sulfoaluminate. Furthermore, the hydration of the silicate was found to be more rapid in saturated

lime-gypsum solution than in saturated lime solution as shown in Figure 183 (see page 390).

The reason why the silicate is not coagulated by the aluminate solution, in spite of the formation of the above insoluble compounds, was made the subject of a special investigation by Hedin (14). In these experiments he shook together various concentrations of sodium aluminate, sodium sulfate and sodium silicate solutions. The alkali compounds were used in order to avoid the complications which would result from secondary reactions of the lime. It was found that, in the presence of sodium sulfate, the silicate coagulation took place at least as rapidly as the precipitation of $\text{Al}(\text{OH})_3$. Hence, it seemed that the diminished aluminate content of normal cement solutions, caused by precipitation of $\text{Al}(\text{OH})_3$, could not be responsible for the absence of the silicate coagulation. The explanation appeared to Hedin to lie in a reduction in the activity of the aluminate ions in solutions containing sulfates.

The action of sugar, humic acid, boric acid, etc. on the cements brings about a quick set, even in the presence of calcium sulfate or lime. These materials produce salts with lime which are very slightly dissociated. Thus the calcium ion concentration is strongly depressed and remains inadequate to prevent the rapid coagulation of the aluminates and silicates.

Many investigators have shown that a considerable portion of the alkalis in cement go into solution very quickly when water is added. Since $\text{Ca}(\text{OH})_2$ is much less soluble in alkali hydroxide solutions than in water (13), the calcium ion concentration cannot become high enough to prevent coagulation of the aluminates and silicates, even though their concentration is also low. But the addition of a calcium salt may produce the necessary calcium ions to prevent the coagulation which causes quick set.

False Set. An abnormal type of set which occasionally takes place is known as *false set*, *gum set* or *hesitating set*. This is a condition characterized by the development of rigidity in the paste in a very few minutes, but without the evolution of appreciable heat such as always accompanies flash set. But when this stiffened paste is remixed without further additions of water, it resumes its plasticity and may then be placed in the usual manner without loss in strength.

The causes for this condition of false set have been variously explained. It had been observed that high temperatures in the grinding mills often give rise to this effect and, since it was known that gypsum loses water under those conditions, the usual explanation was that the anhydrite so produced had, because of its lower rate of solution, lost its power to retard the setting process (3), (7) and (5). But if this were the case, the paste would be flash setting rather than false setting, because the set would have been caused by the rapid hydration of the C_2A . Blank (4) has listed a number of factors which appear to influence the development of false set, but he noted inconsistencies in the explanations offered, which led him to conclude that no one theory would cover the question.

In a study of this condition by Bogue and Lerch (6), it was observed that the hemihydrate of calcium sulfate, plaster of Paris, is capable of inducing a condition of rigidity in cement pastes by itself hydrating to gypsum. Because of its more rapid rate of solution than the other forms of calcium sulfate, the hemihydrate may enter solution more rapidly than the tricalcium aluminate and, by its own

hydration, bring about such a rigidity in the cement paste as to be designated as a false set. In manufacturing operations, the hemihydrate may be produced in hot mills by the partial dehydration of the gypsum.

Another cause of false set was found to be associated with the presence of alkalies in the cement (6). Alkali carbonates may react with $\text{Ca}(\text{OH})_2$, produced by the rapid hydrolysis of the C_3S , to precipitate CaCO_3 , and this carbonate may be adequate to bring about the rigidity of a set. Such carbonation of the alkalies in cement may occur during storage in a humid atmosphere.

The Control of Set

The Effect of Gypsum. In order better to understand and appraise the effect of gypsum in the control of the set and other properties of the cement, Lerch (21) has made use of the conduction calorimeter* for determining the rate of hydration as measured by the rate of heat liberation from the pastes for periods of about 72 hours after mixing. The variations which were studied included principally the composition and fineness of the cements, together with gypsum addition, and the effects were noted on rate of hydration and various physical properties of the pastes.

Some of the typical results are shown in the diagrams of Figures 229 and 230, which indicate the rate of heat liberation from two cements of high and low C_3A content, respectively, in the presence of various amounts of gypsum. Two or three cycles of increasing heat liberation are found for all cements. The first cycle, indicated by a broken curve, represents the heat liberated immediately upon mixing with water. When flash set occurs, the paste becomes stiff and unworkable at this point. A second cycle normally begins in 4 to 6 hours, as shown by the solid curves, and this is indicative of the stage of the initial set. A third cycle sometimes follows within a few hours.

Lerch explains these cycles of heat liberation on the basis of the reactions which have been observed to occur in lime-aluminate solutions. The first sharp heat liberation is the result of the initial rapid solution of anhydrous aluminates and, in some cases (flash set), the rapid crystallization of hydrated calcium aluminates. Meanwhile the lime and gypsum are going into solution and in a few minutes normally reach such a concentration that the first reactions are depressed through a sharp decrease in the solubility of the alumina in such solutions. This period is indicated by the descending portion of the broken curves.

After the solution has become saturated with lime, the aluminates continue to dissolve slowly and react with gypsum to form calcium sulfoaluminate, and the silicates dissolve and form hydrated calcium silicates. These constitute the reactions of hydration in the retarded state, which gradually increase, with heat liberation, to the time of initial set. After this period a slowing down occurs due in part to the disappearance of the smallest grains and the deposition of hydration products around the remaining unhydrated material. At some stage, the gypsum may become depleted and the SO_3 concentration in the solution decreases. At this point, the solubility of the aluminates again increases and a rapid reaction will occur if sufficient unhydrated aluminates are still available. The third cycle of rapid hydration and heat liberation occurs with this reaction.

* See pages 444-445.

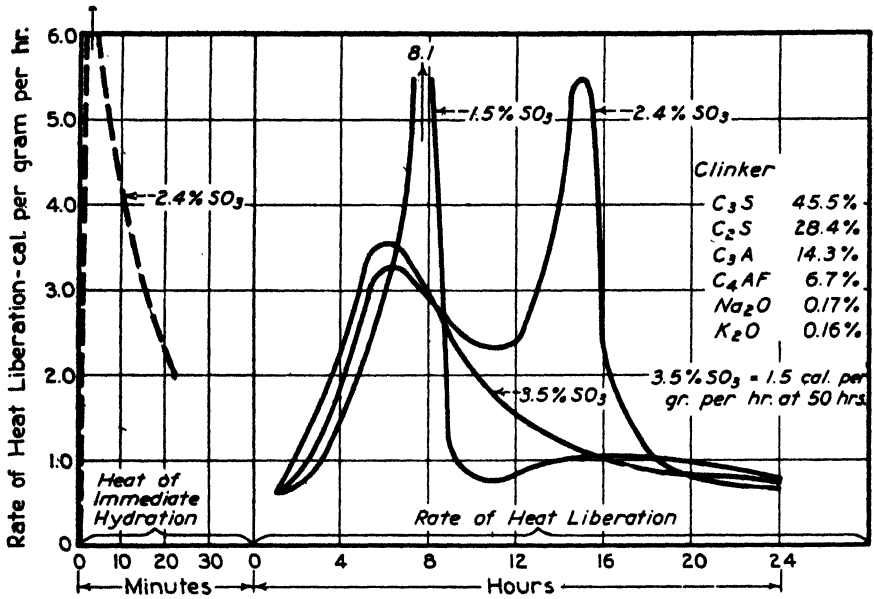

Figure 229. Rate of hydration of cements of high C_3A content, with SO_3 varied. (Lerch)

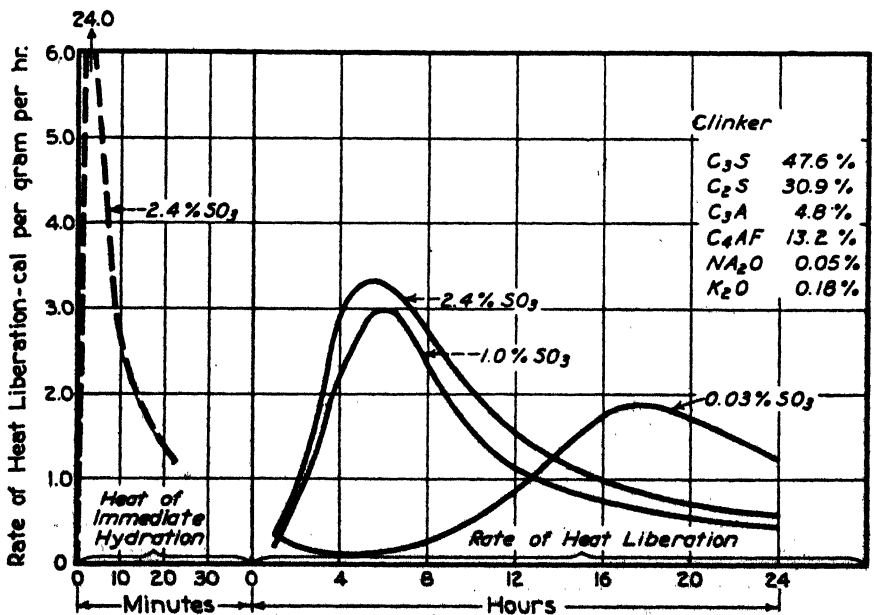

Figure 280. Rate of hydration of cements of low C_3A content, with SO_3 varied. (Lerch)

Thus the time at which the rapid hydration cycles occur will depend upon the composition and fineness of the cement, and the amount of gypsum present. That this is the case is indicated by the curves which show the appearance of the cycles at different time periods and in different degrees of intensity for cements of different composition and for different SO_2 contents. Analysis of the extracted liquids from cement pastes at various periods confirmed this conclusion.

It has been observed that, in the absence of gypsum, cements low in C_2A and alkalis do not exhibit a flash set, and that the addition of gypsum accelerates the set, as shown by the curves in Figure 230. This condition is explained by Lerch as due to the hydration of the C_4AF . The low concentration of C_2A and formation of amorphous hydrated calcium ferrite by the C_4AF would account for the absence of flash set when gypsum is not present whereas, in the presence of gypsum, a crystalline calcium sulfoferrite is formed. Such a crystalline product, replacing the dense amorphous material formed in the absence of gypsum, would allow a more rapid reaction, as is found to occur.

It was observed further that aluminate phases containing alkalis react with water more rapidly than do similar phases which are free of alkali or of lower alkali content. Thus cements of higher alkali content were found to require larger additions of gypsum for proper retardation than similar cements of lower alkali content. Increasing the specific surface of the cements increases the quantity of aluminate phases available for immediate reaction with water and thereby increases the quantity of gypsum required for proper retardation for cements of moderately high or high C_2A contents. No difference in the rate of hydration was found by using plaster of Paris in place of gypsum.

From the above investigation it appears that each cement has a gypsum requirement for optimum retardation which is characteristic of its composition and fineness. Tests on strength, expansion in water and contraction in air all indicated that the best results are obtained when this optimum amount of gypsum is present. This optimum quantity is defined by Lerch as the minimum amount of gypsum which will give a heat-liberation curve which shows two cycles of ascending and descending rates, and which shows no appreciable change with larger additions of gypsum. Excess of gypsum above this amount may, however, produce unfavorable results on the cement properties.

A convenient test for the maximum SO_2 content was devised which was based on the concentration of SO_2 in neat pastes at 24 hours. If the pastes retain gypsum, the SO_2 concentration of the extracts will approach that of saturated gypsum which is 1.2 g per liter. If the gypsum has been depleted, the SO_2 concentration will approach that of calcium sulfoaluminate, which is about 0.05 g per liter. According to the theory underlying the test, the maximum amount of gypsum permissible in the cement should be such that no or very little unreacted gypsum shall remain in the specimen of paste at 24 hours, and hence the SO_2 in the extract should be of the lower order of magnitude. Gypsum in excess of that amount would be available for reaction, in the hardened paste, with aluminates to form calcium sulfoaluminate which might result in undue expansions.

The conclusions of Lerch were confirmed by Whittaker and Wessels (29) who made use of a similar type of calorimeter. These investigators found that the cements examined by them required larger amounts of gypsum than were allowed

by standard specifications, varying between 3 and 4 percent SO_3 , to retard properly the rates of hydration. Such increased additions were found to have little effect upon the time of set of the pastes, but improvements were observed by a reduced autoclave expansion and increased tensile and compressive strengths, especially at early ages. Expansions of specimens in water were not appreciably altered except when an excessive amount of gypsum was present. With increased gypsum content there was noted an increased tendency for false set or premature stiffening of the paste, especially when the grinding temperature was high. For this reason, Whittaker and Wessels recommend that grinding temperatures be kept below 80° when the larger amounts of gypsum are used.

In commenting upon the paper of Lerch, Kalousek (16) advances arguments in favor of the hypothesis of the formation of a slightly permeable hydrous film on the surface of the cement grains as the explanation of the reactions of setting. The Al_2O_3 content of saturated or nearly saturated lime solutions of hydrated calcium aluminates (0.0004 to 0.004 g per liter), he points out, is of an order not greatly higher than that of the Al_2O_3 content of saturated or nearly saturated lime-gypsum solutions of calcium sulfoaluminate (0.0002 g per liter). Kalousek also notes that the almost instantaneous saturation of cement pastes with $\text{Ca}(\text{OH})_2$ and gypsum does not support the claim of a slow approach to saturation which was employed to explain the heat of immediate hydration. Thus he feels that calcium sulfo-aluminate rather than calcium aluminate hydrate is probably precipitated at once upon the addition of water. The manner in which a film deposition of the sulfoaluminate acts to retard the hydration of the anhydrous alumina phase is not known, but Kalousek offers evidence that suggests a relationship with the composition of the aqueous phase.

The Effects of Other Materials. In a study of the effects of calcium chloride on the hydration of the cement compounds, Rapp (22) found that CaCl_2 increased somewhat the heat contributed at the end of 24 hours by the C_2S and C_4AF , but decreased the heat contributed by the C_3A . No consistent effect was observed on the heat contributed by the C_2S . When added to cement pastes, CaCl_2 increased the rate of heat liberation in all cases. The strengths contributed by the C_2S and C_3S were increased, but that contributed by C_3A was decreased, by the CaCl_2 . The set was accelerated markedly in all cases.

Lerch (20) also found that CaCl_2 , added to the mixing water of neat pastes of commercial cements, accelerated the hydration, as indicated by the heat liberation in a conduction calorimeter. This effect is illustrated in Figure 231, where the rate of heat liberation from a low-heat cement is shown with 0, 0.5, 1.0 and 2.0 percent additions of CaCl_2 , expressed as percent by weight of the cement. With other cements the curves may be quite different, but the order of the effects is not changed. The principal effect is seen to be an increase in the heat liberated during the first few hours and a shifting of the peak of maximum heat liberation to an earlier age. Such an effect would be observed in practice by an earlier set and an increased strength at early ages.

When this effect was compared with the influence of temperature, Lerch found that, in general, the effect of adding 2 percent of CaCl_2 was equivalent to an increase of about 11°C in the temperature at which the hydration is carried out.

Kalousek, Jumper and Tregoning (18) noted that CaCl_2 differed in its action

from CaSO_4 by bringing about in the pastes an increase in the alkalis dissolved. This in turn was believed to accelerate the precipitation of calcium sulfoaluminate (trisulfate), probably accompanied by precipitation of the chloraluminat, which lowered the concentration of CaO and greatly diminished the concentration of SO_3 in the solution.

The action of sodium chloride was found by Lerch to be similar to that of calcium chloride but of much less intensity. Acceleration of the reactions of hydration was indicated by the heat curves, but the extent of the effect was much less. The acceleration continued for a period of 24 hours but at 3 days the heats of

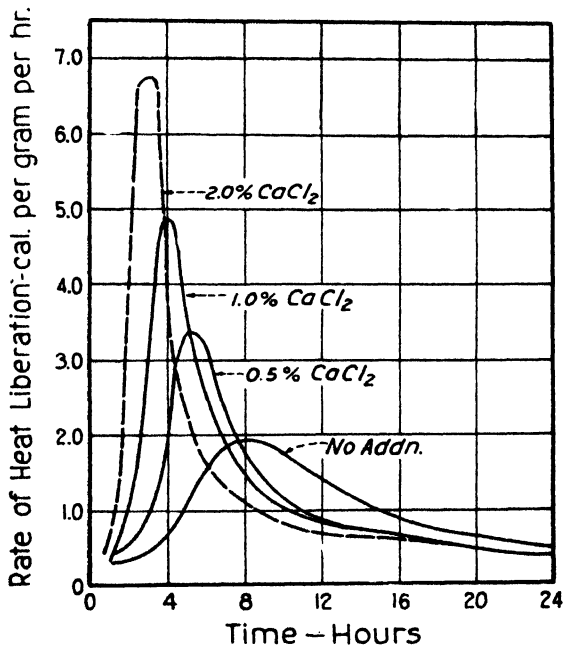

Figure 231. The effect of CaCl_2 upon the rate of hydration at 23° . Clinker composition: C_3S 37; C_2S 52; C_1A 2.4; C_4AF 5.7; MgO 1.8; gypsum added to give 1.9 percent. (Lerch)

hydration were sometimes depressed. It was suggested that this depression in heat of hydration by NaCl might explain the reduction in strengths which have been observed at 28 days in the presence of this salt.

Whereas increasing amounts of gypsum had been found to retard the hydration of cement pastes, as indicated by the heat liberation at early ages, Lerch found that additions of K_2SO_4 or Na_2SO_4 accelerated the hydration. This occurred not only when a deficiency of CaSO_4 was present for normal setting, but also in the presence of such an amount of gypsum that the set proceeded in a satisfactory manner.

This is of especial significance in explaining the influence of alkalis that are present in commercial cements. It has already been indicated that a part of the

alkali of clinker is present as the sulfate, and Kalousek *et al.* (17) showed that a considerable portion of these sulfates was dissolved during the first few minutes of the action of water on the cements. The subsequent reversible reaction of the alkali sulfates with $\text{Ca}(\text{OH})_2$ was shown by Roller (23) to follow the pattern

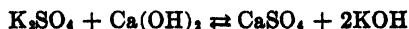

From the above, it would appear that the action of alkali hydroxides would be to interact with the gypsum to produce alkali sulfates, and that the effects of the presence of alkali hydroxides in the cement would then be similar to the effects of the alkali sulfates. This was confirmed by Lerch who found that alkali hydroxides accelerated the early hydration of the cements.

The effects of Na_2CO_3 were also found to be similar to those produced by the alkali sulfates and hydroxides. The action would be first to precipitate CaCO_3 according to the equation:

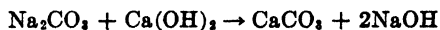

The resulting hydroxide would then act as if it were added as such. In addition, the $\text{Ca}(\text{OH})_2$ would be removed from solution and the gypsum would be attacked to form Na_2SO_4 . The result would be a marked acceleration of hydration and set.

Phase Equilibria in the Presence of CaSO_4

In order to explain the reactions which determine the set of cements, Jones (15) has plotted the equilibria* in the system $\text{CaO}-\text{Al}_2\text{O}_3-\text{CaSO}_4-\text{H}_2\text{O}$ at 25° , as reproduced in Figure 232. The line *MR* represents the lower boundary curve, and *WS* the upper limit, of the solid solution surface, $x\text{CaO} \cdot y\text{Al}_2\text{O}_3 \cdot z\text{CaSO}_4 \cdot \text{aq}$. The line *EF* shows the boundary curve for gypsum-trisulfate, and *FG* the boundary curve for lime-trisulfate. The dashed lines indicate the extensions which may take place in the location of the curves *EF* and *FG* due to the presence of a more soluble form of calcium sulfate than gypsum (as $\text{CaSO}_4 \cdot \frac{1}{2}\text{H}_2\text{O}$) or of lime than precipitated $\text{Ca}(\text{OH})_2$ (as burned lime). Thus the invariant point *F* may be shifted to *F'* by the use of a more soluble form of calcium sulfate, or to *F''* by the use of a more soluble form of $\text{Ca}(\text{OH})_2$, or to *F'''* by the use of both of those more soluble forms. In such cases, the salt concentrations will be much higher than in the normal condition at *F*.

When a cement is mixed with water (assuming the presence of only the components under consideration), the invariant point *F* (or one of the *F* primes) will be approached rapidly as lime and gypsum and calcium aluminate go into solution. At this point $\text{C}_2\text{A} \cdot 3\text{CaSO}_4 \cdot 32\text{H}_2\text{O}$ appears and the three phases exist together in equilibrium with the liquid. This condition will remain until no more gypsum is left in the solid phase, due to the continued formation of the solid sulfoaluminate. The equilibrium will then move along the boundary curve lime-trisulfate towards *G*, the invariant point for C_2AH_3 -lime-trisulfate. The C_2AH_3 would then be formed under conditions of stable equilibrium and the solution concentration show no further change. It is likely, however, that this compound will not appear, in which case the equilibrium would proceed to the metastable invariant point *M*

* The reader is referred to pages 427-432 for a fuller discussion of the system.

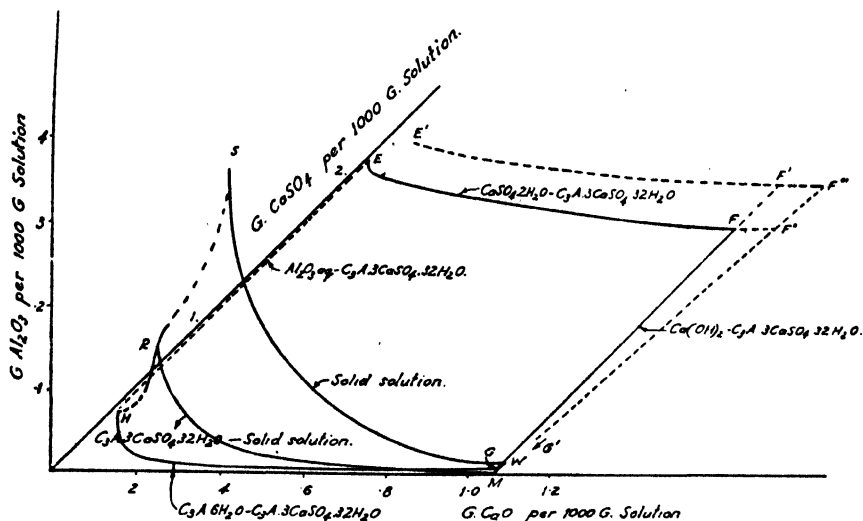

Figure 232. Equilibria in the system $\text{CaO-Al}_2\text{O}_3\text{-CaSO}_4\text{-H}_2\text{O}$ at 25° . (Jones)

where a third solid phase would appear consisting of a solid solution of $\text{CaO} \cdot \text{Al}_2\text{O}_3 \cdot \text{SO}_3$ and H_2O of high CaO and low SO_3 content.

In the presence of alkalis, the same sequence of equilibria would apply up to the invariant point G , and Jones thinks it probable that solid-solution equilibria similar to those found in the quaternary system would then obtain.

References

1. Am. Soc. Testing Materials, *Standards on Cement*, 1946, p. 127-130.
2. Bamber, H. K., U.S. Patent 743,218 (1903); *Trans. Concrete Inst.*, **1**, 106 (1909).
3. Berger, E. E., *Rock Products*, Dec. 1928.
4. Blank, A. J., *Concrete CMS*, Feb. 1935, p. 43.
5. Bogg, F. R., *Cement and Cement Mfg.*, **2**, 255 (1929).
6. Bogue, R. H., and Lerch, W., *Res. Reports PCAF*, Sept. 1933.
7. Brandenburg, H. R., *Cement and Cement Mfg.*, **2**, 96 (1929).
8. Edison, T. A., U.S. Patents 941,630 and 944,481 (1909).
9. Forsen, L., *Zement*, **19**, 1130 (1930); **24**, 5 (1935); *Symposium*, 298.
10. Gadd, W. L., Brit. Portland Cement Research Assoc., Pamphlet 1 (1922).
11. Gary, M., *Concrete Constr. Eng.*, **1**, 350; 431 (1907).
12. Geyer, H., *Tonind. Ztg.*, **18**, 280 (1894).
13. Hansen, W. C., and Pressler, E. E., *Ind. Eng. Chem.*, **39** (1947), in press.
14. Hedin, R., *Proc. Swedish Cement Concrete Res. Inst.*, **3** (1945).
15. Jones, F. E., *J. Phys. Chem.*, **49**, 344 (1945).
16. Kalousek, G. L., *Proc. Am. Soc. Testing Materials*, **46** (1946), in press.
17. Kalousek, G. L., Jumper, C. H., and Tregoning, J. J., *Rock Products*, Apr. 1941.
18. Kalousek, G. L., Jumper, C. H., and Tregoning, J. J., *J. Res. NBS*, **30**, 215 (1943); RP 1530.
19. Lerch, W., *Res. Reports, PCAF*, Sept. 1939.
20. Lerch, W., *Res. Reports, PCA*, Apr. 1944.
21. Lerch, W., *Proc. Am. Soc. Testing Materials*, **46** (1946), in press.

22. Rapp, P., *Proc. Highway Res. Brd.*, **14** (1934).
23. Roller, P. S., *Ind. Eng. Chem.*, **26**, 669; 1077 (1934).
24. Roller, P. S., *Ind. Eng. Chem.*, **28**, 362 (1936).
25. Shimizu, Y., *Concrete CMS*, May, 1928, p. 111; May, 1929, p. 109.
26. Thomas, W. N., and Davey, N., *Bldg. Res. Sta. Sp. Rept.*, **13** (1929).
27. Ware, J., *Ind. Eng. Chem.*, **5**, 369 (1913).
28. Wells, L. S., *J. Res. NBS*, **1**, 951 (1928); RP 34.
29. Whittaker, A. G., and Wessels, V. E., *Rock Products*, Aug. 1945, p. 95.

CHAPTER 28

The Hardening of Cement Pastes

The reactions of hydrolysis and hydration of the cement compounds, particularly in an excess of water, and the products of the reactions when a condition of equilibrium has been reached have already been discussed. And there also have been considered the particular aspects of these reactions which bring about the condition of set. It remains to look into the further progress of these reactions in the set cement by virtue of which the paste acquires the characteristics necessary for the development of strength and durability in concrete structures.

The Hydrolysis and Hydration of Cement Pastes

During the processes of setting and hardening, several forces compete for the available water: the physical forces of adsorption and capillarity, and the chemical forces of hydrolysis and hydration. Furthermore, the reaction products of one compound with water may greatly influence the nature or rate of the reactions of the other compounds with water, or the reaction products may themselves interact with other compounds in the system. It is therefore necessary to examine the behavior of the cement compounds, individually and collectively, when gauged with water in proportions similar to that used with cements in concrete, and to note the effects upon the properties of the cement pastes.

Such a study was made by Bogue and Lerch (7) in 1934. The cement compounds were mixed separately with water in an amount necessary to give a plastic paste, and the latter placed in a glass vial. If the amount of water used was less than 50 percent by weight, the additional quantity necessary to bring the total water to 50 percent was added on top of the paste and the vials sealed and stored at room temperature until tested. The reactions were investigated by chemical methods to determine the rate of hydration and hydrolysis, and the composition of the end products; by microscopical examinations to determine the progress of the reactions and to identify the reaction products; by X-ray examinations to assist further in the identification of the products; and by physical tests to determine the cementing properties of the various compositions.

The extent of hydrolysis of the calcium silicates was determined by measuring the amount of $\text{Ca}(\text{OH})_2$ produced at any given period. The $\text{Ca}(\text{OH})_2$ was converted to the oxide by heating at about 530° for an hour, and the CaO determined by the ammonium acetate method. By this means it was found that, under the conditions of the experiments, the C_3S had become hydrolyzed to the extent of 15 percent in 1 day, 23 percent in 7 days and 26 percent in 6 months. Beyond this period, no further hydrolysis was observed up to 2 years. Microscopic examination of the paste at 1 month showed only a few grains of the original material, and at 3 months none of the anhydrous silicate could be found. The products were very fine crystals of $\text{Ca}(\text{OH})_2$ embedded in an amorphous calcium silicate.

The β - C_2S , however, was only 0.9 percent hydrolyzed at the end of a year, and an abundance of unaltered material was found after 2 years. Only traces of $Ca(OH)_2$ were found in the calcium silicate gel.

These data show that the calcium silicates do not hydrolyze in pastes to the extent found in suspensions of the powders in an excess of water. For the conversion of C_2S to C_3S_2 , 36.5 percent of CaO would be released, and the percentage hydrolysis would be 50. For the conversion of C_2S to C_2S , 24.3 percent of CaO would be released, and the percentage hydrolysis would be 33.3. The values obtained show only 19.3 percent CaO released at 6 months to 2 years, which is

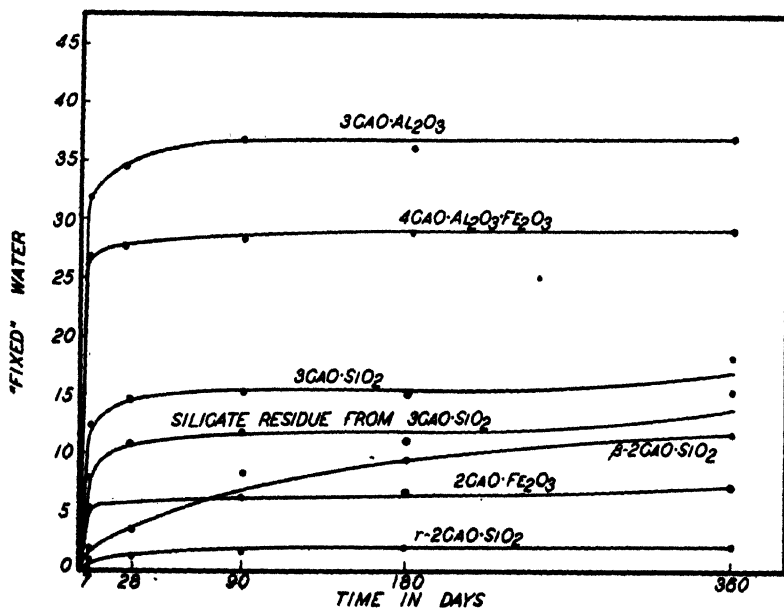

Figure 233. "Fixed" water in combination with pure cement compounds. (Bogue and Lerch)

equivalent to 26.4 percent hydrolysis. Thus the C_2S was hydrolyzed, in the pastes, to a composition somewhat more basic than C_2S hydrate, an amount only 53 percent of its equilibrium value for C_2S_2 hydrate. The β - C_2S was hydrolyzed to only 3.7 percent of its equilibrium value in 2 years.

By examining completely hydrated cement pastes by the calorimetric and lime-extraction methods, Bessey (3) observed the correlation between the assumed compound composition and the results of his free- CaO values. The best correlation was obtained by the assumption of the presence of the compounds $C_2S_2.aq$, $C_2A.aq$, $C_4A.aq$, $C_2F.aq$, and $C_2A.3CaSO_4.aq$. He considers his results as strong evidence that the silicate hydrate is in the form of $C_2S_2.aq$ rather than of $C_2S.aq$. The $C_2S.aq$ was found to be stable only in saturated lime solution at normal temperatures, but the depression of the solubility of lime by other

components in the solution, as alkalis, may render the compound unstable and lead to the formation of the less basic compound $C_3S_2H_2$.

The extent of hydration was determined by Bogue and Lerch (7) by noting the loss in weight obtained upon heating to 1000° a sample of the hydrated material which previously had been pulverized and dried at 105° to constant weight. This is referred to as *fixed water*. On subtracting from this the water of hydrolysis (combined as calcium hydroxide), the water of hydration was obtained. The results are shown in Figure 233.

The C_3S was found to take up over 8 percent of water in 1 day and 19 percent at the end of a year. By deducting from these values the water combined in the $Ca(OH)_2$ formed on hydrolysis, there remained 6 percent water of hydration of the silicate residue at 1 day and 16 percent at a year. The β - C_2S hydrated very slowly, combining with less than 1 percent water in 1 day and 12 percent in a year; γ - C_2S was only slightly hydrated in a year. No evidence was found, by microscopic or X-ray examinations of the hydrated silicate, that any hydrated crystalline calcium silicate was formed up to 2 years. The introduction of gypsum slightly accelerated the hydration of the silicates.

The C_3A reacted vigorously, either by itself or with 10 percent of added lime, but when 15 percent gypsum was added there was little rise in temperature. The amount of water combined with the C_3A at 1 day was about 30 percent, which increased to 35 percent at 1 month and 38 percent at 2 years. The hydrate consisted of fluffy aggregates of very fine crystalline grains of poor definition. These aggregates were isotropic having a refractive index of 1.605 ± 0.003 . In the presence of gypsum, the same products were observed. No gypsum nor calcium sulfoaluminate were found by microscopic or X-ray means, but this is explained by the known submicroscopic form which may be taken by the latter compound. Solubility studies indicated the presence of calcium sulfoaluminate.

The compound C_4AF hydrated rapidly, taking up about 25 percent of water in 1 day and 29 percent in a year. The hydrated product consisted of a crystalline phase having a refractive index of 1.640 ± 0.005 . The X-ray diffraction pattern was identical with that of the hydrated C_3A , and the raised index was attributed to amorphous iron-containing material adhering to the surface of the crystals. An amorphous phase produced in the course of the hydration was not identified but was believed to be a hydrated monocalcium ferrite. An addition of gypsum resulted in a decrease in fixed water for a month, beyond which time there was a slight increase.

Compressive strengths were obtained on the cylinders of pastes at various ages, the results of which are shown in Figure 234. Tricalcium silicate hardened rapidly and gave high strengths at early ages, increasing slowly after 28 days. The β - C_2S had very low strength at 7 days but after a month the strength increased steadily, the two silicates having strengths of the same order at a year. The γ - C_2S remained soft and weak at all ages up to 2 years. The addition of gypsum had little effect on the strength of the silicates. The compressive strengths of the calcium aluminates were low but were improved by the addition of gypsum.

The introduction of 15 percent of C_3A to C_3S was found to raise the strengths of the C_3S up to 3 days but to reduce the strengths markedly at later ages. The reasons for this action became apparent in the course of the study and confirm

the deductions made in the previous chapter. A visual inspection of the set pastes containing the C_3A showed a rather open and porous structure in contrast to the more dense structure of the pure C_3S paste. In a mixture of the two compounds, water causes first the hydration of the aluminate, for this reaction is much more rapid than the hydration of the C_3S . This gives increased early strengths. The formation of the relatively open structure, due to the crystallization of C_3A hydrate, in the absence of a retarding material, may be expected to separate the grains of the silicate and prevent the close contacts which are necessary for maxi-

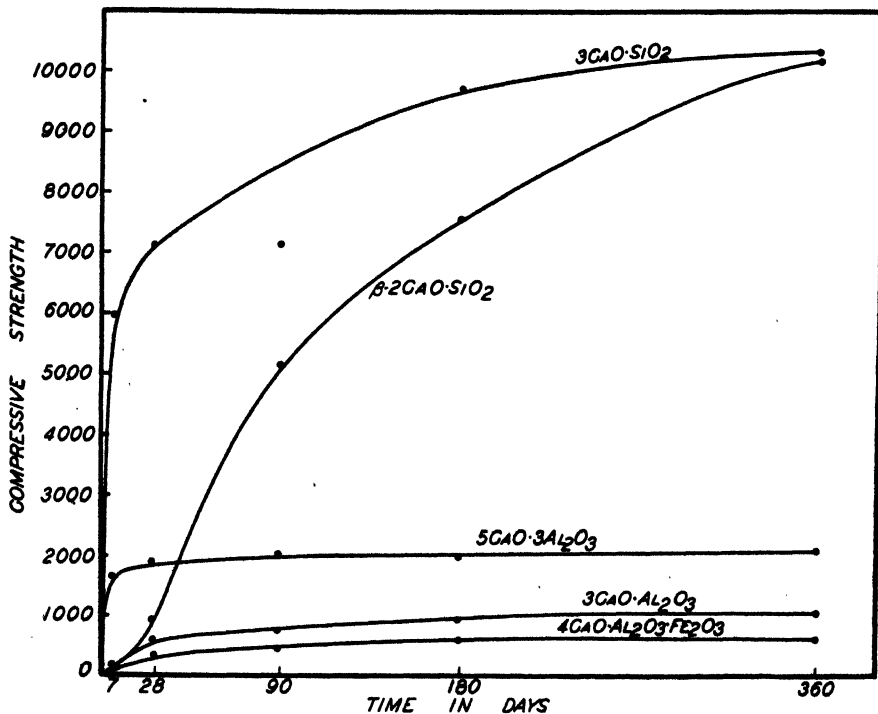

Figure 234. Comparison of compressive strengths of cement compounds. (Boque and Lerch)

imum adhesion and cohesion per unit of area. The effects are indicated by reduced strengths after the C_3S has begun to hydrate.

Curves of much the same character, relating the strengths of mortars to the period of hydration, were obtained by Woods, Starke and Steinour (38). It was brought out by these investigators, as of special interest, that the favorable influence of increasing concentrations of C_3S in the cement, which appears at early ages, becomes less with time and practically disappears at 6 months. This condition is illustrated by the curves of Figure 235 where the compressive strengths of mortars are plotted against the C_3S content of the clinkers at ages of 3, 7, 28, 90 and 180 days.

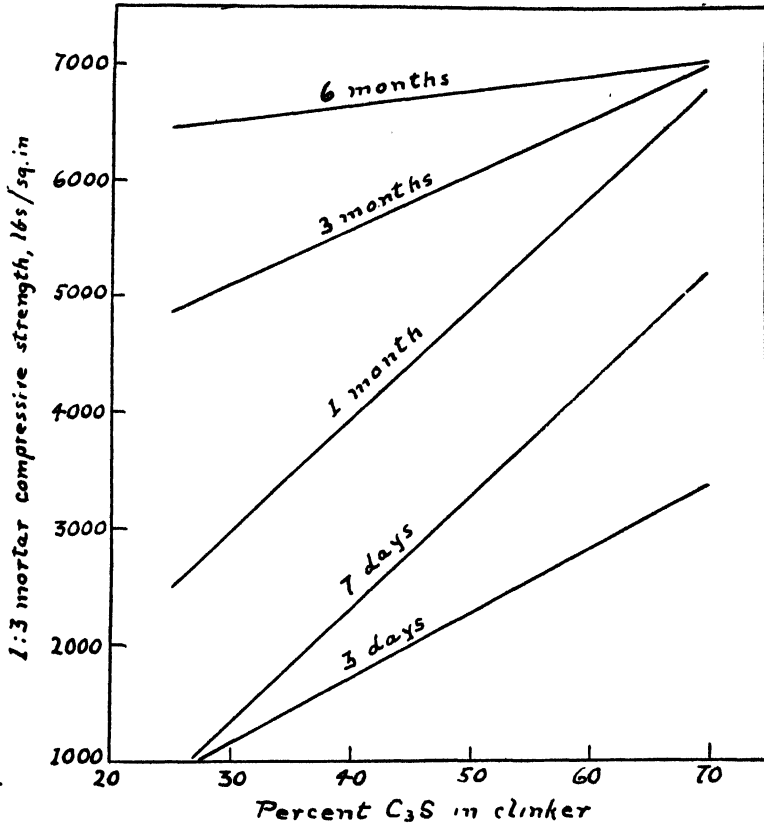

Figure 235. Curves showing at various ages the predominating influence of C_3S on mortar strength and its decreasing effect with age. (Woods, Steinour and Starke)

Hydration Measured by Depth of Hydrated Layer

The rate of hydration of cement clinker in water was examined by Anderegg and Hubbell (1) by a microscopic examination and estimation of the hydrated areas occurring after various periods of interaction with water. Carefully sized fractions of clinker, ranging between 15 and 35 microns, were obtained by elutriation in dried air. These were gauged with water under a variety of conditions and for various time periods. The partially hydrated material was then dried rapidly, ground in an agate mortar until a high degree of uniformity of size was obtained, and the powder examined on a microscope slide in an oil whose index of refraction was 1.67, a value between that of the unhydrated cement minerals and that of the products of hydration. The number of particles lying above and below the index of the liquid was then counted. Corrections were made for calcite in the original clinker and for the change in specific gravity due to the hydration. The depth of penetration of the hydration reaction was then calculated by multiplying the cube of the mean dimension by the percentage of unhydrated material and

extracting the cube root. This gives the mean dimension of the core, and the depth is one half the difference between it and the original mean dimension.

It was found that storage in water at 21° resulted in the hydration of a layer of a "typical" portland cement clinker (15 to 30 microns in diameter, and in the presence of 0.8 percent SO₃ as plaster of Paris) to an average depth of 0.5 micron in 24 hours, 1.7 microns in 7 days, 3.5 microns in 28 days and 5 microns in 90 days. In the absence of calcium sulfate, the penetration was somewhat greater. A temperature of 0° slowed down the initial reaction and one of 38° increased it at early periods, but no appreciable difference could be detected at 28 and 90 days at either temperature from similar hydrating cement stored at 21°. The values given indicate that this cement was 24 percent hydrated in 1 day, 42 percent at 7 days, 51 percent at 28 days and 60 percent at 90 days. In 9 to 12 months, the hydration had reached 95 to 98 percent completion.

A separate study on the hydration rate of the pure cement compounds showed that grains of C₃A 25 microns in diameter were about 75 percent hydrated in 3 hours. C₂S required about 7 days to reach a similar degree of hydration, and β-C₂S about 5.5 months for the same degree of hydration.

These conclusions in general confirm those of Schlupfer (28) who found that a coat of gel envelopes the grains of unhydrated cement, resulting in a slowing down of the reaction due to the increased difficulty of the water in penetrating the layer of gel.

The Soundness of Pastes

The *soundness* of a cement is the term employed to indicate freedom from or degree of volume change, warping or crack-formation of a cement paste as determined by standard tests involving the boiling or steaming of neat pats of the paste for stated periods at stated ages. A relationship is assumed between the soundness of a cement as noted by this test, and the ability of the cement in concrete structures to remain firm and sound.

It has been generally believed that the hydration of uncombined CaO or MgO in the cement is the chief cause for the condition of unsoundness (18), (29), (10), (2), but a number of other views have been held. Thus Erdahl (12) concludes that the dicalcium silicate formed as a result of underburning is the prime cause, and Kuhl (15) considers that a cracking in the boiling test may be caused by an increased crystallization of the hydrating material due to the high temperature. Against the free-CaO hypothesis he advances the argument that neither added CaO, nor the Ca(OH)₂ formed on hydrolysis of the C₂S, brings about that condition.

A study made by Lerch (19) demonstrated that none of the pure compounds: C₃S, β-C₂S, C₃A, C₂A, C₄AF or C₂F, nor mixtures of these compounds, gave any evidence of unsoundness in the standard steam test. Nor did a wide variety of laboratory cements, which contained these compounds in varying amounts, show unsoundness so long as the cements contained little or no free CaO. The introduction of MgO and alkalis also failed to produce unsoundness by this test although, as brought out later, an autoclave steaming at higher temperatures revealed an unsoundness due to MgO. But laboratory and commercial cements containing

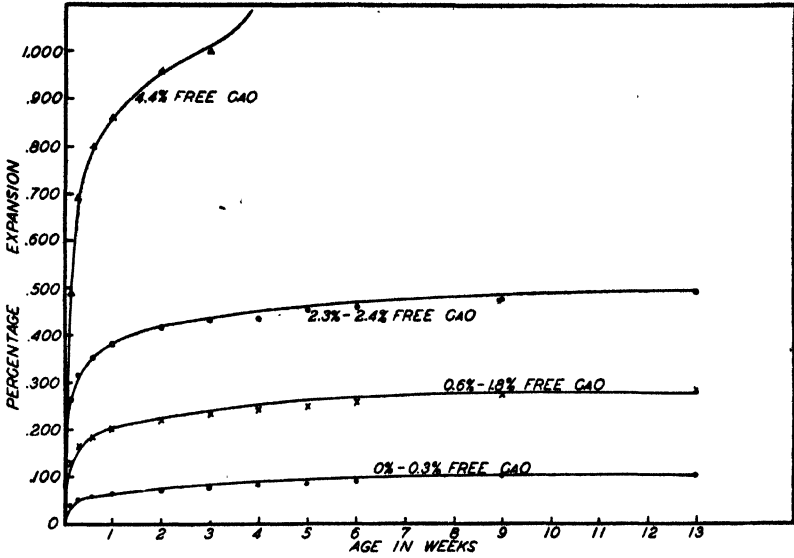

Figure 236. Effect of free CaO on length changes of neat cement bars stored in water. (Bogue, Lerch and Taylor)

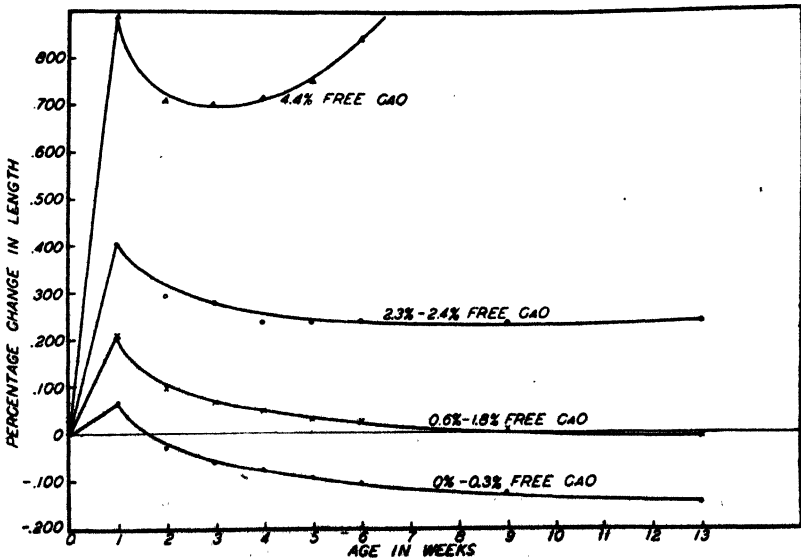

Figure 237. Effect of free CaO on length changes of neat cement bars stored in air after curing in water for 7 days. (Bogue, Lerch and Taylor)

appreciable amounts of free CaO were likely to be unsound in the boiling or low-temperature steaming test.

In experiments (8) where free CaO was caused to increase in the clinkers from 0 to 4.4 percent, the expansions of neat pastes stored in water increased in accordance with the percentage of free CaO, as shown by the curves of Figure 236. In general a large part of the expansion due to the free CaO was attained in the first few days and little further change ensued. In the cement containing 4.4 percent free CaO, however, expansion continued and the specimens disintegrated in 6 weeks. When these specimens were placed in air after 7 days in water, the resulting contractions were nearly independent of any effect of free CaO, as shown by the curves in Figure 237. In the case of the 4.4 percent free CaO cement, however, the specimens contracted normally for about 2 weeks after placing in air, but after that period they began to expand and disintegrated in about 6 weeks.

The reason why CaO added to a cement does not produce unsoundness was found to be due to the rapid interaction with water prior to set, whereas in clinker the grains of free CaO are intercrystallized with the other compounds and but partially exposed to the water during the first few hours after gauging. This protective action of enclosing material is overcome during the boiling test by the accelerated rate of the hydration, and the pressures exerted by the hydrating CaO cause the unsoundness.

The failure of the $\text{Ca}(\text{OH})_2$ resulting from hydrolysis to produce unsoundness is due to the fact that this $\text{Ca}(\text{OH})_2$ is precipitated from solution and hence will occur in the voids of the paste. The laws of solution indicate that, if crystallization from solution sets up an increased pressure at any point, the solubility of the crystallized phase in this region of increased pressure becomes greater. This would result in diffusion of that phase to regions of lower concentration. Thus the $\text{Ca}(\text{OH})_2$ crystals formed through hydrolysis of the silicates would not be expected to produce abnormal expansion. But in the hydration of free CaO a new phase, $\text{Ca}(\text{OH})_2$, is formed without passing through the solution state and, since this new phase occupies a greater volume than the original CaO, an expansive force results. Brown (9) refers to the latter type of crystallization as an "unaccommodative" action, in contrast to the crystallization from solution which he designates as an "accommodative" action.

The actual amount of free CaO necessary to cause unsoundness will depend, as pointed out by Bates (2), on the ratio of the expansive forces to the cohesive forces in the paste, that is, on the relation of the disruptive force to the tensile strength. Since C_2S increases early strength, the amount of CaO necessary to cause cracking will be greater as the C_2S content of the cement increases. Also, in finely ground cements, a greater amount of free CaO is exposed to the action of the water during gauging than in coarsely ground cements; and since the CaO thus exposed may hydrate prior to set, a larger amount is necessary to produce cracking in the fine cements.

The relative effects of free CaO and MgO in producing expansions during the water-storage of neat specimens (5) is illustrated in Figure 238. The expansions are plotted against time of two groups of cement pastes, one group containing 1 percent MgO and the other group 7 percent MgO. Each curve represents a cement of a different free CaO content. It is seen that, with increasing free CaO,

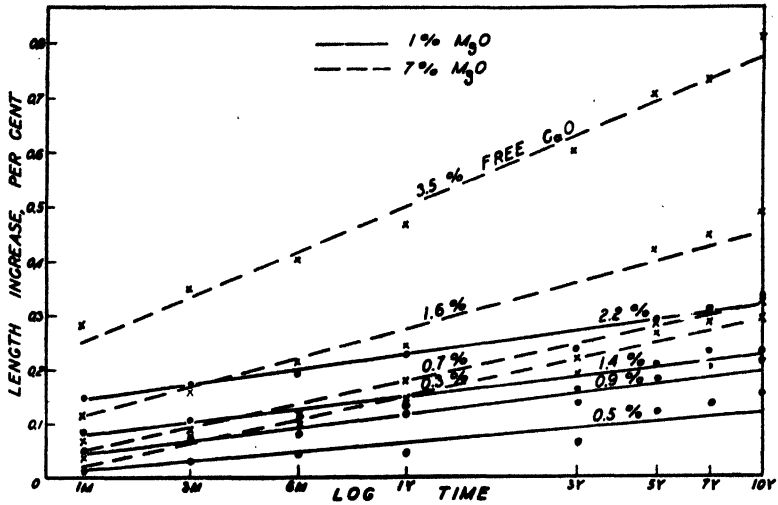

Figure 238. Effect of free CaO on the expansion in water of neat bars having MgO contents of 1 and 7 percent. (Bogue and Lerch)

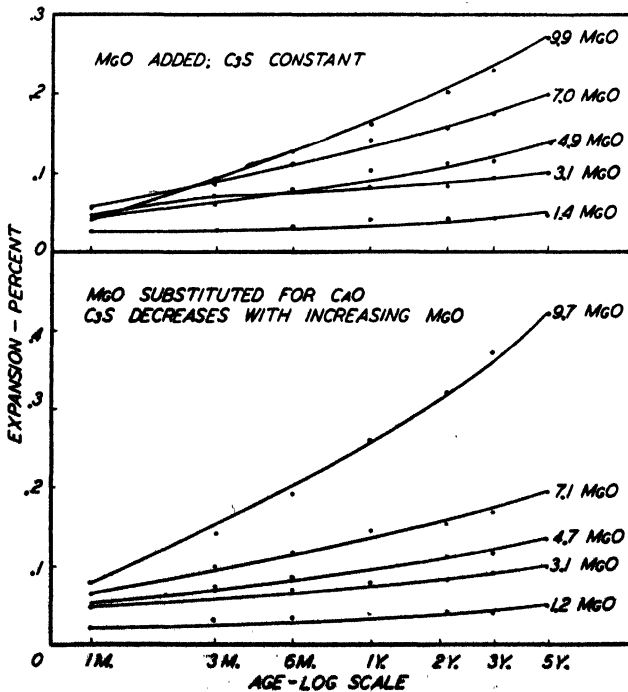

Figure 239. Expansion of neat cement bars stored in water, as a function of MgO. (Bogue and Lerch)

the expansions at all ages become greater. But, as the MgO increases from 1 to 7 percent, the expansions not only are greater but the rate of increase in expansion with age is also greater. In Figure 239 are shown curves indicating the expansions of cements containing increasing percentages of MgO, from 1.2 to 9.9 percent (6). The same tendency to increase in length at rates which become greater with age is shown.

The Effects of Composition

A comprehensive study of the effects of the compound composition of cements upon the properties of mortars and concretes was made by Gonnerman (14) upon a group of 121 laboratory cements covering 72 different compositions.

Tricalcium silicate was found to be chiefly responsible for strength at early ages, and continued to be effective in increasing strength at later ages also. The C_2S contributed little to strength up to 28 days but was largely responsible for the increase in strength beyond that period. Tricalcium aluminate contributed to strength to an important degree up to 28 days but thereafter its effect diminished and became negligible at a year. The role of the C_4AF was not clearly indicated but probably has little effect at any age.

The specific contribution of each of the four major constituents to the strength at various ages was computed by the method of least squares, and the results indicate that an additive effect of the compounds may be assumed at all ages. Writing the equation for strength as

$$\text{Strength} = aC_3S + bC_2S + cC_1A + dC_4AF,$$

the coefficients for 3 by 6 inch concrete cylinders, 1:3.4:3.6 mix by weight, were found to be

Coefficients	28 days	1 year
<i>a</i>	41.4 ± 2.23	54.8 ± 2.68
<i>b</i>	7.6 ± 2.07	42.4 ± 2.49
<i>c</i>	123.4 ± 6.25	100.4 ± 7.49
<i>d</i>	37.8 ± 7.12	53.5 ± 8.54

When MgO was substituted for CaO in the raw mix to the extent of some 10 percent, the strengths were reduced sharply with the percentage substitution. It will now be apparent that such substitution will result in a pronounced decrease in the C_3S of the clinker, with increases in C_2S and MgO. The reduction in strengths is accounted for by these changes in composition. The direct addition of MgO had an effect on strength only proportional to the diluting effect of the amount added.

Expansions in water and contractions in air were found to be virtually independent of the relative proportions of C_3S , C_2S and C_4AF , but variations in the proportions of C_1A had an appreciable influence. The expansion in water and the contraction in air both tended to become larger with increasing concentrations of C_1A in the cements. When an equation was set up, as above for strength, the coefficients representing the contribution of each compound to the total contraction of 1:3.6 mortar bars cured 7 days moist and tested at 1 year were as follows:

<i>a</i> (for C ₃ S)	0.00079 ± 0.000036
<i>b</i> (for C ₂ S)	0.00077 ± 0.000033
<i>c</i> (for C ₃ A)	0.00234 ± 0.000100
<i>d</i> (for C ₄ AF)	0.00049 ± 0.000144

Cements containing MgO showed increasing expansions in water which were proportional to the MgO content, regardless of whether the MgO was substituted for CaO or added to the raw mix. This subject will receive further treatment below.

Of the four major compounds, C₃A appeared to be the only one which reduced the resistance of mortar and concrete to attack in solutions of magnesium sulfate or sodium sulfate; this compound had a marked detrimental influence. The rate of disintegration varied somewhat with the type of specimen and the nature of the solution, the more rapid attack occurring on the lean mortar cubes. But the lean 1:4.25 cubes made with cements of low C₃A content showed much better resistance than the richer 1:2.75 cubes made with cements high in C₃A.

The resistance of concrete to freezing and thawing was found to be improved as the percentages of the two calcium silicates increased in the cements. On the other hand, increases in the C₃A content and to a less extent in the C₄AF content, lowered the resistance of the concrete in these tests.

The relationship between the strength developed by a cement and the extent of hydration has been studied by a number of investigators. Eiger (11) suggested that the strength developed is proportional to the amount of hydrated material produced, and Werner and Giertz-Hedstrom (34) suggested that the strength is proportional to the square of the amount of hydrated material produced. The hydrated material was defined as the sum of the volumes of the original cement and the non-evaporable water. This concept was confirmed by Freyssinet (13) who regarded strength as proportional to the volume of the hydrated cement divided by the sum of the volumes of the hydrated cement and the uncombined water. Freyssinet also introduced the concept that strength is proportional to the area of the interstitial surface per unit volume of paste.

Lea and Jones (16) determined the rate of hydration by measurements of the water retained in the set cement at 110° and lost on subsequent heating at 550° and 950°. In their final procedure they recommended that the corrected loss at 550° of a neat cement gauged with 32.5 percent water be used as a measure of the degree of hydration. The amount of water combined with the cement, as determined by the difference in loss at 110° and at 550°, was found to increase somewhat with the amount of water used to gauge the cement, and to approach a maximum value.

From a study of ten commercial cements differing widely in properties and composition, there was a fair correlation between the compressive strengths and the extent of the hydration. Their values are expressed in Figure 240 where the compressive strengths of 4-inch cubes of 1:2:4 concrete, of water:cement ratio 0.60, are plotted against the corrected losses at 550° obtained on neat cement of water:cement ratios 0.325, 0.245 and 0.22, at corresponding ages. These curves do not conform strictly to either the direct or the square relationship previously reported but, since they are concave to the strength axis, the strength was found to increase at a rate which is more than directly proportional to the degree of

hydration. The upper portions of the curves were, however, approximately linear.

Powers and Brownyard (27) have called attention to the futility of attempting to evaluate the strength of concrete or mortar as a function of only one independent variable, since several independent variables are involved. Through a study of cement pastes, however, they have derived an equation relating the compressive strength with the gel-space ratio. This constitutes a confirmation of the hypothesis of Freyssinet.

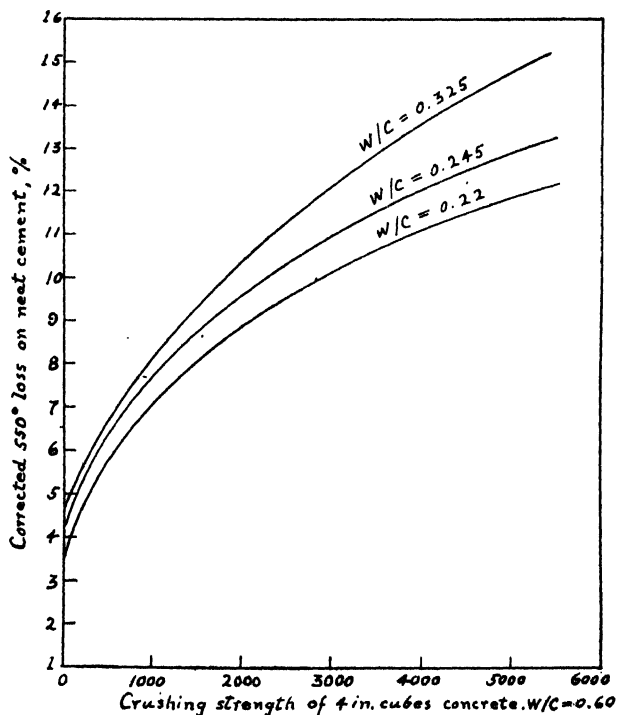

Figure 240. Relation between crushing strength and loss at 550° for different water:cement ratios of the neat cement. (Lea and Jones)

On the basis of adsorption studies,* the increase in the bulk volume of a paste upon hydration was found by Powers and Brownyard to be about $0.846(w_n + 4V_m)$. The term w_n is the non-evaporable water and, since this has become a part of the solid phase, it represents the increase in the absolute volume. The term V_m is considered to be proportional to the colloidal (gel) material in the paste. More specifically, it represents the water required for a complete condensed layer on the solid, one molecule deep. This value is proportional to the surface area, and since practically all surface is that of colloids the above relationship is implied. The factor $4V_m$ was found to be the weight of water required to fill all of the voids

* See pages 468-470.

in the gel. The factor 0.846 is the mean specific volume of the two classes of water, the evaporable and the non-evaporable.

Thus the solid-space ratio is indicated by the equation

$$\frac{\text{Increase in solid phase}}{\text{Original space available}} = \frac{0.846(w_n + 4V_m)}{w_o} \quad (1)$$

where w_o is the original space available, that is, the original water content of the paste. Since V_m/w_n was found to be a constant,

$$X' = 0.846 \frac{V_m}{w_o} \left(\frac{1 + 4k}{k} \right) \quad (2)$$

where X' = ratio of increase in solid phase to original water content.

The compressive strength, f_c , was found to be related to the solid-space ratio, in accordance with the equation

$$f_c = mX' + B \quad (3)$$

where m is the slope of the empirical line and B its intercept on f_c . Then, if M' is taken to represent the equation

$$M' = 0.846 \left(\frac{1 + 4k}{k} \right) m, \quad (4)$$

$$f_c = M' \frac{V_m}{w_o} + B \quad (5)$$

Powers and Brownyard evaluated the constants M' and B by plotting observed values of f_c against V_m/w_o for four cements, as shown in Figure 241. From these data, the straight line as drawn represents the relationship

$$f_c = 120,000 \frac{V_m}{w_o} - 3600 \quad (6)$$

Thus increase in strength was shown to be directly proportional to the increase in V_m/w_o regardless of age, original water-cement ratio, or identity of cement. On the basis of these experiments, Powers and Brownyard discard the hypothesis that strength is a function of the ratio of increase in solid phase to available space, in favor of the assumption that it is a function of the ratio of the volume of the gel to the space available. This ratio, which they call the gel-space ratio, X , is then written

$$X = \beta \frac{V_m}{w_o} \quad (7)$$

where β represents the proportionality between V_m and the total volume of the gel. By letting $M = m\beta$, equation 5 is rewritten

$$f_c = M \frac{V_m}{w_o} + B \quad (8)$$

and equation 6 is now defined as the relationship between strength and the gel-space ratio.

The values as given in equation 6 were found to apply with cements of normal gypsum content and low C_3A (below 7 or 8 percent) cured continuously wet at

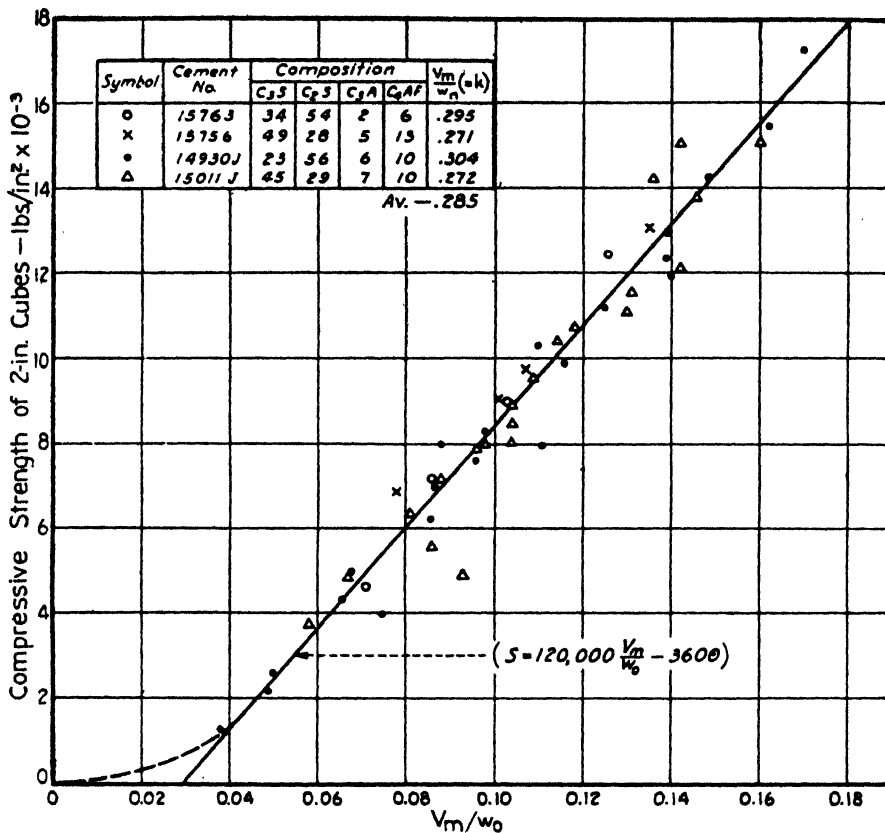

Figure 241. Relationship between compressive strength and V_m/w_0 for cements low in C_2A . (Powers and Browniard)

about 23°. But with cements of higher C_2A content the strengths were below those of the equation. In some of these latter cases, increases in the gypsum content produced conformity with the equation.

The Effects of Cooling Rate

As soon as it became possible to compute the composition and amounts of liquid formed under given conditions in the clinker (17), and a method had been developed for determining the glass content (20), a considerable interest developed in correlating the effects of the glass content with the properties of the cement. In a paper by Lerch and Taylor (21), the effects of various heat treatments of the clinker, giving rise to different degrees of crystallization of the compounds, were examined with reference to the grindability of the clinker, the time of set, the strength and the volume constancy of the resulting cements.

Since it has now been made clear that the quickly-cooled clinkers contain reduced quantities of crystalline C_2A , it would be a probable deduction that those

qualities which are characteristic of the hydration of that compound should be markedly modified in the quickly-cooled, high-glass clinkers. This could not be accepted *a priori*, however, because the glass itself might hydrate with the same result. Experiment was needed to establish the quantitative relationship, which was provided in the investigations of Lerch and Taylor.

A high- C_2A cement was expected to give a flash set, and the cements of high C_2A content, cooled slowly, gave such a set. But when the same clinkers were cooled quickly, reducing the crystalline C_2A to low values, there was in no case any evidence of flash set. The latter cements produced satisfactory plastic pastes which developed good strength at 1, 3 and 7 days. But the cements prepared from the slowly cooled clinkers produced a harsh paste which lacked the plastic characteristics, and the strengths obtained were low.

Of perhaps greater significance were the effects produced by the heat treatment on the volume constancy of the pastes in water storage. It was from these observations that the role of magnesia in producing delayed expansion of concrete structures became understood, and its control provided. Well-burned cements containing the compounds C_2S , C_3S , C_2A and C_4AF with low MgO (less than 1 percent) all showed low or moderate expansions when autoclaved in steam for 24 hours or more at 177°, regardless of the rate of cooling of the clinker. As the MgO content was increased from 3 to 5 or more percent, however, larger expansions were obtained upon steaming, and in this case marked differences were observed depending upon the heat treatment of the clinkers. The cements prepared from the quickly cooled clinkers (of 3 to 5 percent MgO) continued to give low or moderate expansions, but those prepared from the slowly cooled clinkers gave very large expansions upon steaming.

It was observed, further, that when the only variable consisted in a change in the $C_2A:C_4AF$ ratio, the expansions increased somewhat with the increasing C_2A content.

In explanation of the results obtained with varying MgO content, it was pointed out that MgO dissolves in the clinker liquid to the extent of about 5 percent (20). In the quickly cooled clinkers the liquid is frozen to a glass and microscopic examinations failed to reveal the presence of periclase (free MgO) or, if present at all, it occurred in a few fine crystals. In the slowly cooled clinkers the liquid crystallizes and microscopic examination revealed the presence of periclase in fairly large grains. The amounts so observed corresponded with the total MgO in the clinker, which further corroborated the finding that MgO does not enter into compound formation in portland cement clinker. The observations on steam treatment led to the conclusion that magnesia dissolved in glass does not contribute to excessive expansion, whereas magnesia as periclase is responsible for the excessive expansion observed with the low-glass, high-MgO cements.

These results, obtained with an accelerated hydration brought about by an autoclave treatment, were correlated with the expansions of specimens of neat pastes stored in water at room temperature over a period of 10 years (4). These experiments, illustrated by the diagram in Figure 242, showed that the cements of the higher MgO content attained the larger length increases at 1 to 10 years, which confirms the results of White (35) who found that the excessive expansions in water due to MgO may occur at late ages, from 4 to 8 years. Even after 5 years

of storage in water, an autoclave treatment produced large expansions with those cements containing 5 percent MgO , but no expansion with those containing less than 3 percent MgO . This indicates that even after 5 years in water, the MgO in these cements has not been completely hydrated.

The examination showed that there was a close correlation between the expansions in the accelerated autoclave test and those in the long-time water storage. The cements which showed the largest expansion when cured in water for 5 years also showed the largest expansion when autoclaved after 1 day in the molds. This suggested that the autoclave treatment may constitute a valuable

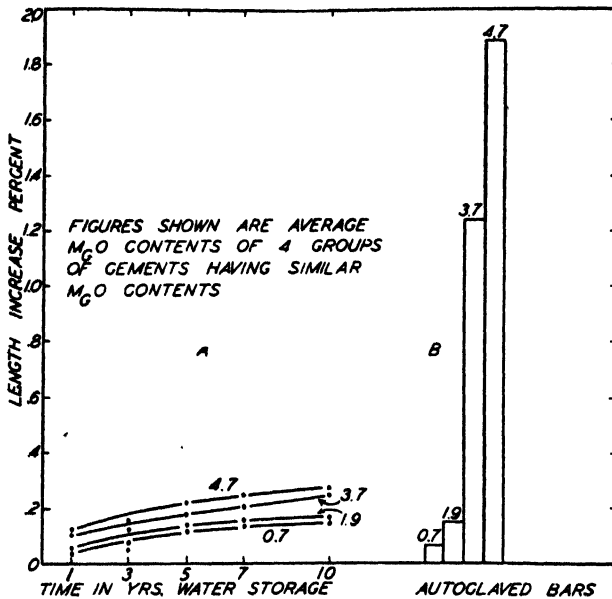

Figure 242. Effect of MgO on expansion of neat bars of commercial cements, A, stored in water and B, autoclaved 24 hours at 177° , stored in water for 7 days, and reautoclaved 48 hours. (Bogue and Lerch)

accelerated test to indicate the probable long-time expansion which may result, on water exposure, due to the presence of magnesia.

A similar study by Parker (25) indicated, in the high-glass cements, the same benefits of freedom from setting troubles and of improved early strengths. The heats of hydration of these cements were higher than those prepared from the slowly cooled clinkers, and some evidence was obtained that the drying shrinkage of the high-glass cements is lower than that of the low-glass cements. The quickly cooled high-glass cements also were found to have a considerably higher resistance to attack by sulfate solutions than those of lower glass content. This latter subject will be further treated in the following chapter.

The Effects of Steam Treatment on Strength

In 1912 Wig (36) reported the effects of curing mortars in steam under pressure. He found that an accelerated hardening occurred by steaming at 80 pounds

per square inch, but that the compressive strengths increased with the pressure and time of steaming. A short steaming might be deleterious to strengths, but a longer period sometimes gave strengths at 2 days which were double those obtained by normal curing for 6 months. An optimum temperature of steaming was found by Wig and Davis (37) of about 185°, but this optimum varied with the cement and duration of the steaming process.

Miller (24), however, found no important increases in strength from a 12-24 hour curing in water vapor or steam at temperatures between 39° and 177°, as compared with normal moist-curing for 28 days. Woodworth (39) found greatly improved strengths by steam curing.

Thorvaldson and his associates (31), (32), (33) found first a decrease on steaming, followed by an increase in the strengths. The initial loss was ascribed to the changes in the C_2A , and the subsequent increases in strength to the changes resulting in the silicates. An optimum temperature was found of about 175°. Very variable results were obtained on steaming by Pearson and Brickett (26), but in general a treatment at 170° for 18 hours gave strengths in excess of the normal 28 day values. The advantage of steaming was less with rich mixes than with lean mixes, and less with limestone or dolomite aggregates than with siliceous aggregates. Thorvaldson (30) explained these varying results on two assumptions. Low strengths would result from conversion of a gelatinous C_2A hydrate, or the hexagonal C_3A hydrate, to the crystalline C_2AH_6 , as also from the rapid hydration of C_4AF to C_2AH_6 and CFH . High strengths would result from the interaction between free $Ca(OH)_2$ and the siliceous aggregates, and from the hydration of C_2S and unhydrated C_3S to form crystalline hydrates. A later loss in strength might be due to the slow hydrolysis of the C_4AF and possible secondary changes in the calcium hydrosilicates.

Meyers (23) showed that the steam treatment of neat cement pastes for 24 hours at 96° reduces their thermal coefficients of expansion. The cements highest in calculated C_3S had their thermal coefficient lowered to the greatest extent, whereas cements of low C_3S and containing larger proportions of the less basic compounds were less affected.

Menzel (22) confirmed the earlier findings that, by curing in high-pressure steam, concrete could be obtained within 1 or 2 days after moulding having substantially higher strength and lower volume change than concrete cured moist for 28 days or more at normal temperatures. Excellent resistance to freezing and thawing, and to the action of solutions of Na_2SO_4 and $MgSO_4$ was also obtained. These experiments indicated that, during exposure to high-pressure steam, the somewhat soluble $Ca(OH)_2$ resulting from the hydration of the cement reacts with finely divided silica in the mix to form a fairly insoluble compound which not only contributes to the permanent strength and denseness of the hardening paste, but practically eliminates leaching and efflorescence. The steam-cured concrete was usually of substantially lighter color and considerably dryer than moist-cured concrete at the end of the curing period.

The recommended procedure provided that steaming could be begun 4 hours after moulding, and should be continued for 8 to 48 hours (depending on the size of the specimen) in saturated steam at 177° (120 lbs. per square inch). A period of 5 hours for raising the temperature, and a similar period for lowering the tem-

perature should be allowed. This procedure gave compressive strengths of the products which were slightly lower than those obtained on specimens cured 5 days in the moist room followed by 55 days in air at 21°. The shrinkage of the steam-cured concrete on drying to a condition of equilibrium with air in a heated building was shown to be at least 50 percent less than that of moist-cured concrete. The bond resistance was lowered. An advantage was obtained by the use of fine silica in steam-cured concrete in optimum percentages of 30 to 40 percent, regardless of the type of aggregate used.

The effects of steam treatment on the resistance to salt action will be discussed in the following chapter.

References

1. Anderegg, F. O. and Hubbell, D. S., *Proc. Am. Soc. Testing Materials*, **29**, 554 (1929), **30**, 572 (1930).
2. Bates, P. H., *Concrete CMS*, **15**, 35 (1919).
3. Bessey, G. E., *Symposium*, 285, 377.
4. Bogue, R. H., and Lerch, W., *PCAF Res. Reports* (Jan. 1944).
5. Bogue, R. H., and Lerch, W., *PCAF Res. Reports*, (July 1945).
6. Bogue, R. H., and Lerch, W., *PCAF Res. Reports* (Oct. 1936).
7. Bogue, R. H., and Lerch, W., *Ind. Eng. Chem.*, **26**, 837 (1934); PCAF Paper 27.
8. Bogue, R. H., Lerch, W., and Taylor, W. C., *Ind. Eng. Chem.*, **26**, 1049 (1934); PCAF Paper 28.
9. Brown, L. S., *PCA Res. Reports* (May, 1937).
10. Campbell, E. D., and White, A. H., *J. Am. Chem. Soc.*, **28**, 1273 (1906).
11. Eiger, A., *Tonind. Ztg.*, **56**, 532; 558 (1932).
12. Erdahl, B. F., *Concrete CMS*, **14**, 27 (1918); **15**, 56 (1919), **16**, 43 (1920).
13. Freyssinet, E., *Science et Industrie*, Jan. 1933, p. 3.
14. Gonnerman, H. F., *Proc. Am. Soc. Testing Materials*, **34**, 244 (1934).
15. Kuhl, H., *Zement*, **14**, 457 (1925).
16. Lea, F. M., and Jones, F. E., *J. Soc. Chem. Ind.*, **54**, 63T (1935).
17. Lea, F. M., and Parker, T. W., *Phil. Trans. Royal Soc.*, **234**, No. 731 (1934).
18. Le Chatelier, H., *Bull. Soc. encour. ind. nat.*, Nov. 1898.
19. Lerch, W., *Concrete CMS*, **35**, 109, 115 (1929); PCAF Paper 20.
20. Lerch, W., and Brownmiller, L. T., *J. Res. NBS*, **18**, 609 (1937); RP 997, PCAF Paper 32.
21. Lerch, W., and Taylor, W. C., *Concrete CMS*, **45**, 199, 217 (1937); PCAF Paper 33.
22. Menzel, C., *J. Am. Concrete Inst.*, **31**, 125 (1934); **32**, 51 (1935); **32**, 621 (1936).
23. Meyers, S. L., *Rock Products*, Jan. 1935, p. 28.
24. Miller, D. G., *Proc. Am. Soc. Testing Materials*, **30**, 636 (1930); *J. Am. Concrete Inst.*, **4**, 101 (1932).
25. Parker, T. W., *J. Soc. Chem. Ind.*, **58**, 203 (1939).
26. Pearson, J. C., and Brickett, E. M., *J. Am. Concrete Inst.*, **3**, 537 (1932).
27. Powers, T. C., and Brownyard, T. L., *J. Am. Concrete Inst.*, **18**, 101; 249 (1946), and subsequent issues to April, 1947.
28. Schlapfer, P., *Symposium*, 270.
29. Taylor, W. D., *Proc. Am. Soc. Testing Materials*, **3**, 374 (1903).
30. Thorvaldson, T., *J. Am. Concrete Inst.*, **4**, 102 (1932); *Symposium*, 246.
31. Thorvaldson, T., and Shelton, G. R., *Can. J. Res.*, **1**, 148 (1929).
32. Thorvaldson, T., and Vigfusson, V. A., *Eng. J.*, **11**, 174 (1928).
33. Thorvaldson, T., Vigfusson, V. A., and Wolochow, D., *Can. J. Res.*, **1**, 359 (1929).

34. Werner, D., and Giertz-Hedstrom, S., *Zement*, **17**, 1002; 1038; 1070; (1928); **20**, 1000 (1931).
35. White, A. H., *Proc. Am. Soc. Testing Materials*, **28**, 398 (1928); **42**, 727 (1942).
36. Wig, R. J., *Tech. Paper NBS*, **5**, (1912).
37. Wig, R. J., and Davis, H. A., *Tech. Paper NBS*, 47 (1915).
38. Woods, H., Starke, H. R., and Steinour, H. H., *Eng. News Record*, Oct. 13, 1932.
39. Woodworth, P. M., *J. Am. Concrete Inst.*, **26**, 504 (1930).

CHAPTER 29

External Reactions of Hydrated Pastes

When concrete is made, there may be present in the mixing water, or in the aggregates, materials which can interact with the cement compounds and affect the qualities of the paste or the durability of the structure. The effects of salts which are likely to be present in the mixing water have already been discussed in connection with the reactions of setting. A reaction which may occur by reaction of alkalis in the cement with opaline silica in the aggregates is discussed below, as the alkali-aggregate reaction.

Again, concrete structures may be exposed to soil waters rich in aggressive salts. The action of such salt solutions upon concrete structures has been of such a serious nature that extensive study has been given to the problem and much information obtained. The results of these studies are given below.

It has long been common practice for various materials to be added to the concrete mix, or the clinker, to obtain particular advantages in the paste or the concrete. These materials have appeared on the market under a great many proprietary trade names. A number have gained acceptance in the trade; many have been found to be of indifferent worth and have disappeared. Such materials, usually recommended for use in small quantities, have been proposed for a wide variety of purposes. These include the control of the period of plasticity of the paste; improvement in the workability, or water-tightness, or density, or structure of the paste; the incorporation of air into the paste; a control over the rate of hydration, heat liberation or hardening; improvements in durability, etc.

Some of the essential constituents of admixtures have been discussed at their appropriate places in the preceding chapters. As to the others, it is believed that they do not require a special treatment. Many papers have been presented covering the effects of certain admixtures on cement properties (32)(18), their classification (26), their evaluation (27), their influence on the solutions in the paste (21), and their special uses (16). However, comparatively little has been published in most cases, on the chemical nature or reactions involved in their use.

Another type of admixture is the material, known generally as *pozzolana*, which is sometimes employed in relatively large proportion with cement, for the purpose of improving the durability of concrete under particular conditions. Included under this class name are such materials as trass, volcanic tuff, diatomaceous earth, burnt shale and slag. Although some of these have been used for centuries, the nature of their action is still rather incompletely understood. A summary of some modern studies on these materials is included in the discussion given below.

Reactions with Sulfate Solutions

In previous chapters the reactions of the cement compounds with water and with solutions formed in the pastes during the normal processes of setting and

hardening have been discussed. Such solutions include especially those resulting from the presence of calcium hydroxide and calcium sulfate.

Concrete structures are often subjected to exposures in contact with various salt solutions, gases or organic liquids, some of which give rise to reactions which produce corrosion or disintegration. It is beyond the scope of the present work to enter into a discussion of the durability of concrete structures under such exposures, but it is pertinent to the subject to examine the interaction of the hydrated cement pastes with certain salts to which concrete structures are often exposed.

The Nature of Sulfate Corrosion. The susceptibility of structural concrete to attack by sulfate-bearing waters has been known at least since the experiments of Smeaton (39) in 1756 by which he determined, among the cementitious materials then available, the composition best suited for the building of the Eddystone Lighthouse in England. Vicat (52) devoted extensive research to the problem in 1812, and a large-scale series of investigations was conducted, by the immersion of specimens in the harbor of La Rochelle, from 1856 to 1875 (8). Reports have been made by Le Chatelier of work begun in 1887 (25), by Feret in 1890 (11) and by Michaelis in 1891 (30). Tests by the Scandanavian Association of Portland Cement Manufacturers started in 1896 have been reported by Poulsen (34).

Since the turn of the century, the literature bearing on the sulfate resistance of cements has been extensive and contributions have been made by many Scientists in many countries. An excellent bibliography of some 700 references was published by the U.S. Department of Agriculture in 1925 (51). An excellent summary with extensive references has also been given by Pagon (33). Studies of the causes underlying the corrosion of concrete were begun by Bates at the National Bureau of Standards in 1912 (2), by the Institute of Civil Engineers of England in 1916 (36) by Thorvaldson in Saskatchewan in 1919 (43), and by Miller at the University of Minnesota in the same year (31). Examination of the reactions of the hydrated cement compounds with salt solutions was initiated by the Portland Cement Association Fellowship in 1925 (5) and by the Swedish Cement and Concrete Institute in 1937 (15).

It was observed by Shelton (38) that, when sodium sulfate of various concentrations (0.5 percent to saturated) was added to tricalcium silicate (5 ml of solution added to 0.08 g of the cement compound), gypsum formed rapidly, together with an amorphous gel. The same action occurred with the dicalcium silicate, but the action was much slower. When the Na_2SO_4 solution was added to the tricalcium aluminate, crystals of calcium sulfoaluminate began to form very quickly, and hydrated calcium aluminate appeared shortly after.

Solutions of magnesium sulfate shaken with the silicates produced a milky precipitate of magnesium hydroxide together with crystals of gypsum. With C_2A , the MgSO_4 solutions produced sulfoaluminate crystals, gypsum and amorphous material which was thought to be mainly an aluminate.

In a first attempt to correlate this information with the observed effects of sulfate solutions on cement mortars, Thorvaldson and his students (46) devised the plan of measuring the length change of mortar bars during a period of immersion in the sulfate solutions. They noted that mortars made from pure C_2S or

C_2S did not disintegrate in the Na_2SO_4 solution, but that they expanded and finally disintegrated in the $MgSO_4$ solution (0.15M concentration). But when C_3A was added to the C_2S or C_3S , a rapid disintegration took place in both solutions, a condition often met with commercial cements. Exposure of properly made concrete specimens in sea water, however, was found by Bates, Phillips and Wig (2) not to result in decomposition.

Very much the same conclusions were obtained by Miller and Manson (31) in their extensive studies in which 106 commercial cements were investigated, both by the storage of concrete cylinders in a natural sulfate-bearing lake, and by the storage of similar cylinders and mortar briquets in $MgSO_4$ and Na_2SO_4 solutions in the laboratory. An important feature of the results obtained was the marked influence of composition of the cements upon their resistance to the sulfate solutions. Under identical conditions, concrete made of some cements lasted ten times as long as concrete made from other cements. It did not appear that alkalis, free CaO , MgO or other minor constituents materially affected the resistance, nor did the fineness of the cements. The predominating factor in determining resistance appeared to be the content of tricalcium aluminate and, when a limit was fixed of 5.5 percent C_3A as calculated from the original composition,* all cements within that limit were of high resistance.

The Effect of Steam Curing. Thorvaldson and Vigfusson (45) found in 1928 that, whereas a curing of the mortars in water vapor at 50° reduces their resistance to sulfate action, curing in water vapor or steam above 75° increases their resistance, and the more so as the temperature is raised (up to 150°). This conclusion was confirmed by Miller and Manson (31) who found that a curing in steam at temperatures from 100° to 177° increased resistance to sulfate attack almost to the point of immunity. At temperatures below 100° no benefit was found by these investigators except in connection with the use of certain admixtures.

The improved resistance of cements due to steam curing was first explained by Thorvaldson and Shelton (44) as due to the formation of a new crystalline substance. This was not identified but was described as consisting of orthorhombic crystals with parallel extinction, indices $\alpha = 1.614 \pm 0.002$, $\beta = 1.620 \pm 0.002$ and $\gamma = 1.633 \pm 0.002$, positive elongation, positive character, optic angle $2V = 68^\circ$.

In a later paper (48) the action of steam is discussed at some length. The compounds observed on steaming C_2S , C_3S and C_3A were C_2SH_2 , C_3SH , CH and C_2AH_3 . The hydrated silicates were slowly attacked by $MgSO_4$, and, where $Ca(OH)_2$ was present, the attack was somewhat more rapid. In Na_2SO_4 solution, the silicates showed very little evidence of attack in 9 years.

The theory was advanced that the tendency of a cement to expand is closely associated with its ability to form hydrated C_4A , in contrast to the aluminates of lower basicity. And the factor controlling this ability was said to be the capacity of the silicate base to liberate $Ca(OH)_2$. Thus when the cement is high in C_2S , a large amount of $Ca(OH)_2$ is formed and C_4AH_7 may be produced. This suggested that the removal of free CaO may be an important factor in increasing the sulfate resistance upon steaming of mortars containing quartz sand.

Another factor is concerned with the effect of the steaming on the aluminate.

* See pages 184-185.

In experiments where the hydrate C_2AH_6 had been introduced to a mixture in place of C_2A , the unsteamed mortar of that preparation showed a resistance in the $MgSO_4$ solution vastly superior to that of the C_2A preparation, and equal to the resistance obtained on steaming the latter. In Na_2SO_4 solution, the steamed C_2A preparation was superior to the unsteamed one made with C_2AH_6 , which indicated that the removal of $Ca(OH)_2$ by the steaming had an important effect with this solution. It had earlier been shown (47) that the resistance of cement mortars containing 15 percent silica gel was increased in Na_2SO_4 solutions, and

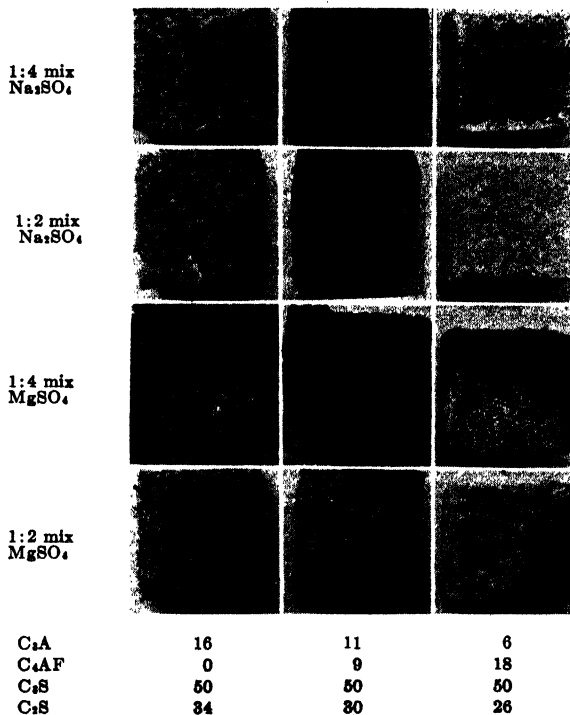

Figure 243. Mortar cubes with decreasing C_2A content. Al_2O_3 and C_3S are constant. After immersion in sulfate solutions for 6 months. (Bogue, Lerch and Taylor)

to a less extent in $MgSO_4$ solutions. This also was attributed to the removal of $Ca(OH)_2$.

The Specific Effects of the Cement Compounds. Thorvaldson and Vigfusson (45) found that the resistance of cement specimens increased greatly by changing the composition in such a way that C_4AF would be substituted for C_2A in the cement (48). This was confirmed by Fleming (12) who found that cements manufactured to contain 3 to 8 percent C_2A and 12 to 13 percent C_4AF expanded very little in Na_2SO_4 solutions whereas those containing 12.5 percent C_2A and 6 to 8 percent C_4AF expanded and disintegrated rapidly in the same solution. In $MgSO_4$ solutions, the comparative resistance of the former cements was more than 6 to 1 as compared with the latter products.

Merriman (29) found that the sulfate resistance of a group of 32 cements studied by the American Society for Testing Materials (35) varied in accordance with their computed C_3A content. After 2 months exposure to 10 percent Na_2SO_4 , the cements having a C_3A content of 6 to 9 percent were rated as good, those of 10 to 12 percent C_3A fair to bad, and those having 13 to 14 percent C_3A as very bad. Likewise, Carlson and Bates (10) found in a study of 132 cements, excellent resistance to Na_2SO_4 solutions with those containing 4 to 7 percent C_3A , but decreasing resistance with increasing C_3A in the cements. The same results were obtained by Hughes (17) on 18 brands of cement.

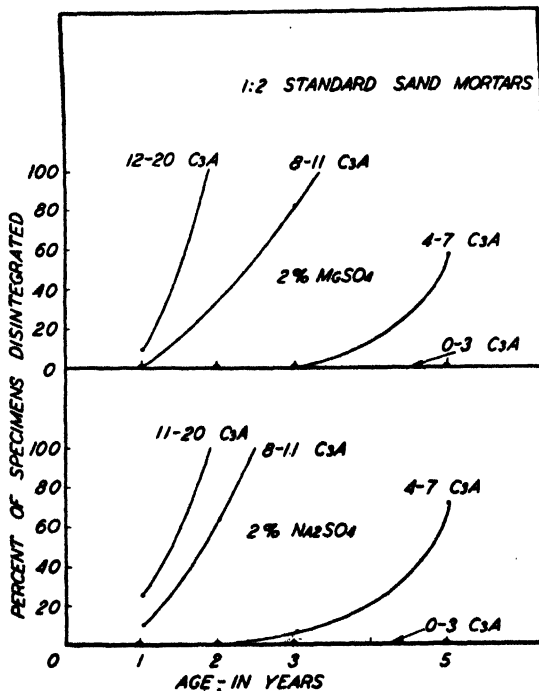

Figure 244. Percentages of specimens disintegrated in sulfate solutions as a function of the potential C_3A content. (Bogue and Lerch)

A number of the variables of composition as affecting the resistance to sulfate were examined by Bogue, Lerch and Taylor in 1934 (5). Many of the results obtained by earlier investigators on the effects of varying composition were confirmed.

One group of cubes after 6 months' storage in 2-percent sulfate solutions is shown in Figure 243. These cements were prepared in the laboratory from pure materials, and made up with Ottawa sand in the proportion of 1:2 and 1:4 with water added to give a paste of normal consistency. The compositions shown in the figure had a constant C_3S content. The Al_2O_3 was also constant but the C_3A was caused to decrease by increasing additions of Fe_2O_3 , which gave increasing percentages of C_4AF . The rich mixes were found to maintain a better condition

than the lean mixes, but in both cases the increasing C_2A produced advanced disintegration at 6 months. Moreover, the specimens of lowest C_2A content in the leanest mix were in much better condition at 6 months than the specimens of higher C_2A content prepared from the rich mix, which indicates that a reduction in the C_2A of the cement may be more effective in improving resistance to sulfate action than changes in the design of the mortar.

The results obtained on one series of cements of various C_2A contents (4) are shown in Figure 244. The data here are plotted as the percentage of the speci-

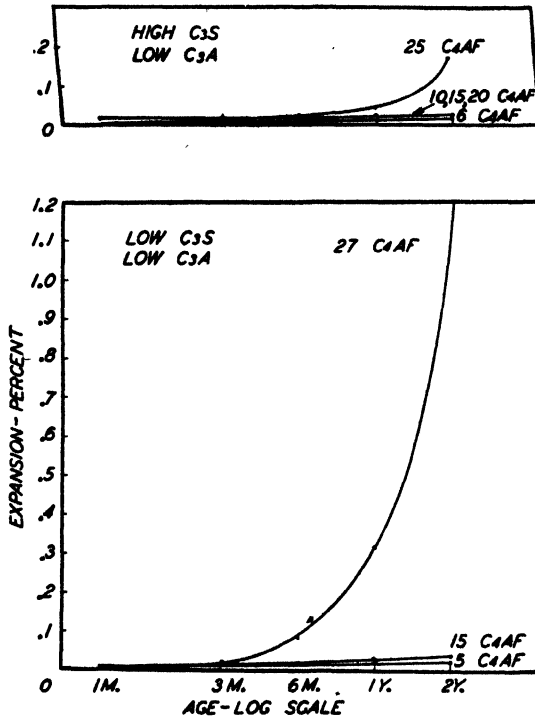

Figure 245. Expansion of 1:2 mortar bars in 2 percent Na_2SO_4 as a function of C_4AF . (Bogue and Lerch)

mens, arranged in four groups of different C_2A content, that disintegrated in the two sulfate solutions at various ages. It is seen that no disintegration had occurred in any of the 0 to 3 percent C_2A cements at 5 years in either solution, whereas all of the specimens containing 11 to 20 percent C_2A had disintegrated in less than 2 years in both solutions.

The effect of C_4AF , caused to vary with C_2S , while the C_2A and C_3S were held constant (4), is shown in Figure 245. It is shown that up to 15 or 20 percent C_4AF , no appreciable effect is observed, but at C_4AF concentrations of 25–27 percent, high expansions occur in Na_2SO_4 solution in 1 or 2 years. The action is more rapid in $MgSO_4$ solution.

When the C_3S percentage of the cements was increased from 25 to 70 percent at the expense of the C_2S , all other constituents being held constant, results were obtained on exposure to sulfate solutions which differed from those reported by Thorvaldson. Whereas the latter had found the resistance to be reduced with increasing $C_3S:C_2S$ ratio, Bogue, Lerch and Taylor (5) found the reverse to be the case under the conditions of their study. This effect was pronounced, however, only with cements of relatively high C_2A content. When the C_2A was low the cements were all resistant to sulfate action regardless of the $C_3S:C_2S$ ratio. This effect is illustrated by the cement cubes shown in Figure 246.

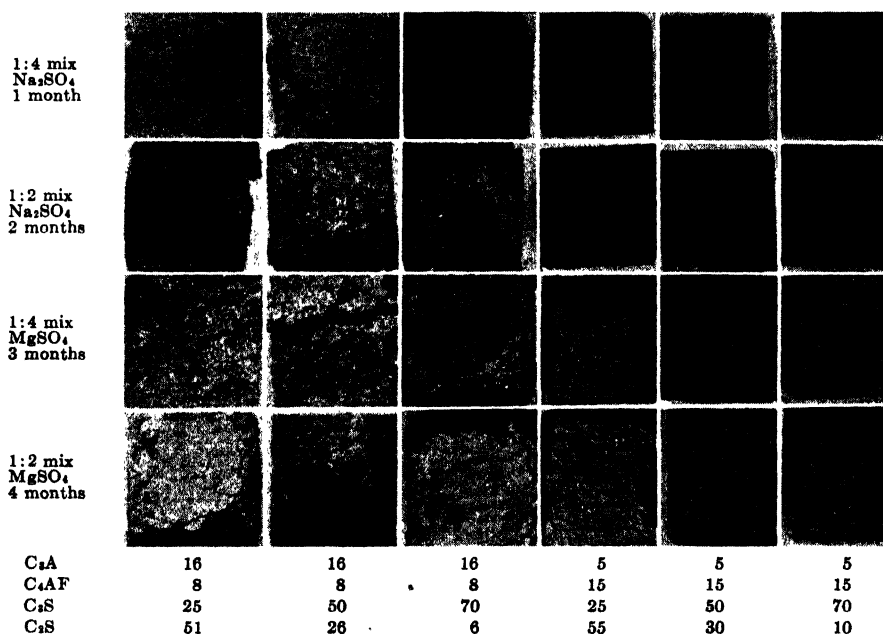

Figure 246. Mortar cubes with changing ratio $C_3S:C_2S$, in two groups of high and low C_2A contents, respectively. After immersion in sulfate solutions for different periods. (Bogue, Lerch and Taylor)

A reasonable explanation for the more pronounced disintegration of the high C_2A cements when the C_3S is low than when the C_3S is high, may be found in the denser paste structure and higher early strength of the high C_3S cements. Thus a structure may be developed at early ages strong enough to resist the expansive forces due to the formation of calcium sulfoaluminate crystals, and the greater density of the paste gives it a greater tightness against penetration by the salt solution. The beneficial effect of the increased C_3S thus appears to be due to a physical effect on structure and watertightness rather than to a greater resistance of the C_3S to attack by the sulfate solutions. Indeed, the findings of Thorvaldson indicating the more ready attack of C_2S than of C_3S are not contradicted but, under the conditions of the tests just described, the beneficial physical effects have

predominated over the unfavorable chemical effects to give a longer life to the specimen.

When MgO was introduced into the composition of the clinkers in amounts up to about 10 percent, little effect was observed on the expansions in sulfate solutions during the first month. After 3 months, however, the cements containing more than 5 percent MgO showed excessive expansions which were proportional to the MgO content.

The Alkali-Aggregate Reaction

In the course of investigations of concrete structures in California, Stanton (40) reported in 1940 that he had observed excessive expansions of certain structures, whereas other structures made with concrete containing the same cement but different aggregates had remained in good condition. By all of the usual tests for soundness, both of the aggregates used were equally satisfactory. On the other hand, other concrete structures were observed which, with the above poor aggregate but a different cement, had remained in excellent condition. This discovery led to the hypothesis that some constituent in certain cements reacted under given conditions with some constituent in certain aggregates, and that this reaction gave rise to the excessive expansions observed. Since the active agents of the cement and the aggregate must both be present in the concrete in order for the interaction to take place, the presence of the active agent in the cement would cause no damage unless the aggregate were reactive to it, and the presence of the active agent in the aggregate would cause no damage unless the cement were reactive to it.

Although normal curing did not reveal the existence of any expansive action by the use of the combinations which were destructive in the field, a test was discovered which indicated the reaction satisfactorily. It was found that when specimen bars, after 1 day moist curing, are placed in sealed containers containing a small amount of free water (not in contact with the bars), the reaction takes place and may be indicated by measurements of length increase of the bars over a period of several months.*

It was quickly indicated by these tests that the agent in the cements responsible for the action was the alkali, either Na_2O or K_2O . When different cements were used in connection with the reactive aggregate, the expansions which developed in the test were found to be proportional to the alkali content of the cement. But when used in connection with a non-reactive aggregate, the expansions were low irrespective of the alkali content.

A study of the aggregates revealed that the reactive aggregates contained up to 15 percent of shale and chert, and that when the sand of such aggregate was used expansions occurred with all cements containing more than about 0.6 percent alkali. The aggregates which were non-reactive with the high-alkali cements were practically free of shale or chert. The lime and magnesia contents of the deleterious shales and cherts were found to be relatively high, and Stanton refers to this rock as a "siliceous magnesian limestone." The principal reaction

* As this goes to press, a more rigid test procedure is proposed by R. F. Blanks and H. S. Meissner, *J. Am. Concrete Inst.*, 17, 517 (1946).

of this material with the alkali, as suggested by Stanton, was

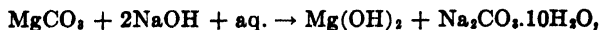

resulting in a calculated volume increase of 239 percent.

The findings of Stanton were confirmed in general by Hansen and Taylor (14) who found, furthermore, that the abnormal expansions observed with the Monterey shales and siliceous magnesian limestones of California were not obtained with cherts and flints from various other sources, nor with magnesite or limestone.

A part, at least, of the expansions could be offset, it was found, by incorporating the finely pulverized active materials into the paste. This benefit was thought to be due either to a reaction of the active ingredients during the mixing period, thereby avoiding a later reaction; or to an effect on increasing the shrinkage of the cement, thus offsetting expansions which might occur; or to a more uniform dispersion of the reaction products through the paste so as to prevent excessive expansion.

In the course of an examination of cracks which were observed in Parker Dam, Meissner (28) noted that clear, viscous beads of sodium silicate slowly exuded from cores taken from the troubled areas. This gel material appeared to fill many of the air-void spaces in the concrete, and on exposure to air it hardened. The gel was found to be associated particularly with a tuff aggregate containing numerous cavities and solidified veins of chalcedony, opal and quartz, and with a hard, igneous andesitic rock. The surfaces often showed zones of alteration and softening.

Meissner concluded that the alteration of the rocks referred to was caused by an interaction of some of their siliceous constituents with the alkali in the cements which usually was high. This belief was confirmed by laboratory investigations with the Parker Dam aggregates.

The existence of an alkali-aggregate reaction in other structures was reported by Kammer and Carlson (22), by Tremper (50), and others (41). Carlson (9) found that by elevating the temperature of the mortar during curing to 43° or to 65°, the reactions above described were accelerated, and furthermore that all aggregates containing silica produced some expansion in excess of that obtained by the use of aggregates free of silica. There was, however, no assurance that the expansions obtained at the elevated temperatures reflected a condition which would ever obtain at normal temperatures.

The mechanism by which the alkali-aggregate reaction produces expansion in concrete was studied by Hansen (13). The hypothesis developed was based on the reaction of alkali hydroxides with opaline silica in the aggregate, producing alkali silicates which, because of the semipermeable nature of the hardened cement paste, give rise to osmotic pressures.

The alkali hydroxides are believed to react with the opaline silica to form an alkali silicate, which may be represented by the equation



According to Hansen's hypothesis, the silicate ions of these alkali silicates associate into complexions which are not capable of diffusing through the hardened

paste. The paste then acts as a semipermeable membrane, permitting the passage of water and of the ions and molecules of the alkali hydroxides, but not permitting the passage of the complex alkali silicate. These are the requirements, it is pointed out, for an osmotic-pressure cell. The alkali silicate formed on the surface of an aggregate particle would tend to draw solution from the cement paste, and form a pocket of liquid within the specimen which would exert hydrostatic pressure against the confining paste. From this confined volume, the reaction product could not emerge; and since it occupies greater volume than the original silica, the hydrostatic pressure developed would tend to disrupt the structure of the paste.

This conclusion was confirmed by a number of experiments, and the action of a cement paste functioning as a semipermeable membrane toward sodium silicate was established directly. That $\text{Ca}(\text{OH})_2$ does not act in the same manner as NaOH or KOH , in producing osmotic forces of considerable magnitude, is indicated by the high degree of insolubility of the calcium silicates. For this reason, the formation of calcium silicate by interaction of $\text{Ca}(\text{OH})_2$ with SiO_2 would not tend to draw more solution to the particle, but might even seal the particle from subsequent attack.

Further tests by Hansen indicated that, with some feldspars and alkali-bearing rocks, a reaction with $\text{Ca}(\text{OH})_2$ might release alkali hydroxides which would then be available for reaction upon opaline silica in the aggregate. The extractions obtained from such rocks were much lower for potash, however, than for soda.

Kalousek (19) points out that the reaction product of Na_2O , CaO , SiO_2 and H_2O is a soda-lime-silicate gel, and that this gel, filling the pores of the cement paste, is probably the essential material constituting the semipermeable membrane.

The Action of Pozzolanas

Perhaps the most ancient material that was added to hydraulic cements by the Romans for the purpose of improving quality was a loosely consolidated rock of volcanic origin, consisting of various fragments of pumice, obsidian, feldspars, pyroxines, quartz, etc. The name *pozzolana* was first applied exclusively to this material, but the term has come to be extended to include not only natural volcanic tuffs and trass, but diatomaceous earths and other highly siliceous rocks such as French gaize, and also artificial products like burnt clays and shales and by-product hydrated silicas. Blast-furnace slags are sometimes included in this category. Lea (24) defines pozzolanas as "siliceous materials which, though not cementitious in themselves, contain constituents which at ordinary temperatures will combine with lime in the presence of water to form compounds which have a low solubility and possess cementing properties."

In Europe these materials have been used extensively. In the United States they have not gained a great deal of prominence. The chief purpose in their use has been the belief, rather widely confirmed, that concretes made with them possess a greater resistance to attack by sea water, and by soil waters either very pure or rich in sulfates or other corrosive constituents. Their beneficial action

is held to lie in their combination with $\text{Ca}(\text{OH})_2$; with the formation of insoluble and inert compounds, some of which may be cementitious, and so add to the qualities of the normal cement which impart strength and durability.

In a recent examination of 12 commercial portland-pozzolana cements, Kalousek and Jumper (20) failed to find any consistent improvement in the strengths of specimens due to the pozzolana, but a better resistance to 10 percent Na_2SO_4 solution was observed at early ages. No improvement was found in volume constancy upon wetting and drying, and unfavorable results were reported on heats of hydration and resistance to cycles of freezing, thawing and drying, as compared with standard portland cements.

A study of the effects of various forms of silica on the properties of cement pastes was made by Bogue and Lerch (4) in 1934. Through determinations of the silica rendered soluble by interaction with hydrated lime, it was found that precipitated silica and diatomaceous earth were actively reactive with the lime through periods of 28 days to at least 1 year, but that ground flint was almost unreactive. These active forms of silica were then introduced into cement mortars by substitution for a part of the sand. The total amount of finely divided siliceous material was constant throughout, and was equal to 30 percent of the weight of the cement. The active forms of silica were introduced in quantities of 0 to 30 percent, and the unreactive ground flint was introduced in quantities necessary to maintain the amount of the added fine materials constant. Thus the clinker content of each mixture was constant.

The amounts of water required for normal consistency increased with increasing amounts of the active silica. Perhaps for this reason the early strengths of 1:4 mortar cubes were reduced, with increasing additions of active silica; at late ages the effects were less pronounced. The expansions of neat $1 \times 1 \times 6''$ bars in water were reduced by additions of 1 to 10 percent active silica, but were increased by larger additions. Contractions in air became greater with the higher additions of silica.

In solutions of 2 percent Na_2SO_4 and MgSO_4 , the resistance of 1:2 mortar bars was found to be dependent upon the composition of the cements. Where the potential C_2A content was high (11 to 16 percent), the specimens generally disintegrated rapidly, regardless of additions of active silica. Where the potential C_2A content was low (2 to 3 percent), the specimens remained satisfactory at all ages tested (except that in MgSO_4 solution the bars continued to expand), and the added silica was without effect. But in the cements of intermediate C_2A content, the rate of attack in the sulfate solutions was diminished by certain additions of the active silica. It is probable that larger specimens, whose rate of disintegration would be slower, also would be benefited by the silica even if made of cements containing larger amounts of C_2A . The results point rather clearly to the conclusion that, although practical immunity from sulfate attack may be obtained by the use of cements low in C_2A content, the addition of active silica serves only to retard the attack of sulfate solutions on cements of higher C_2A content.

The explanation advanced by Bogue and Lerch to account for this action was based upon the reduction in $\text{Ca}(\text{OH})_2$ concentration as a result of the interaction of the active silica with the lime in the cement paste. Since calcium sulfo-

aluminate forms most readily in concentrated solutions of $\text{Ca}(\text{OH})_2$;^{*} and since the disintegration of cements in sulfate solutions is due chiefly to the formation of that salt, the presence of active silica will retard the formation of the sulfoaluminate and thus delay the disintegration of the structure. The important contributions of Lafuma (23), Steopoe (42), Sestini and Santarelli (37) and others upon the chemistry of pozzolanic action have been summarized by Lea (24).

According to Lafuma (23), expansion results when an insoluble compound in the set cement reacts with a substance in solution, whereas no expansion will occur if the cement compound first passes into solution and then precipitates out as a new insoluble compound. In the former case the crystals which are formed about the insoluble compound exert a thrust causing a disruptive stress, but in the latter case the new compounds are accommodated in the voids, and stresses do not occur. Brown (6) has referred to these two types of reactions as non accommodative and accommodative reactions, respectively. Thus the reaction of pozzolana with lime reduces the $\text{Ca}(\text{OH})_2$ concentration and provides the conditions by which sulfoaluminate may be formed in the voids.

Steopoe (42) suggested that the action between the pozzolana and lime produces hydrated calcium silicates and aluminates which are later decomposed by salt solutions, in which process lime is removed, leaving silica and alumina gels. By this theory, the improved resistance is attributed to the substitution of inert gels in the cement paste for unstable lime compounds. This hypothesis appeared to account for the observations reported by Sestini (37) and others that pozzolana concretes, immersed in sea water for very long periods, have remained in sound condition, although they have lost considerable quantities of lime. Lea (24), however, points out that much of Steopoe's theory is based upon experiments involving a distinction between soluble and insoluble silica, as the measure of the reactions involved. The method used for this determination (solution in cold HCl , $d = 1.12$) is believed by Lea to be empirical and probably inadequate.

The most satisfactory means for evaluating the effect of pozzolanas is probably some method for measuring the amount of lime with which they combine under some accelerated condition of test. In accordance with this idea, Lea found that the sulfate resistance, and the increase in strength at long ages, of portland-pozzolana cements can be assessed by short-period strength tests under accelerated conditions of curing. He proposes that the difference in tensile strength of platic mortars cured under the two conditions:

- (1) 1 day in moist air at 18° ,
6 days in water at 18° ,
- (2) 1 day in moist air at 18° ,
4 days in water at 18° ,
46 hours in water at 50° ,
2 hours in water at 18° ,

is a good index of the above two properties.

A further test of value is the amount of free $\text{Ca}(\text{OH})_2$ remaining in the set cements following the accelerated test. Bessey (3) considers that the best method

^{*} See page 419.

for measuring this material is by the lime-extraction process (1). This method consists of shaking, for 24 hours, a weighed portion of the sample with a half-saturated $\text{Ca}(\text{OH})_2$ solution, in such proportion that the final lime concentration lies between 0.8 and 1.0 g CaO per liter. After allowing it to settle, the increase in lime concentration of the solution is determined. The values obtained represent the lime that is not in combination with alumina, ferric oxide or silica, when in contact with lime solutions slightly below saturation.

The chemistry of pozzolanas is still not solved, and extensive systematic investigation with the tools of modern physical chemistry is required. In this connection Bussem (7) has found that a hydrated calcium aluminosilicate of the composition C_2ASH_2 is formed by the action of lime solutions on burnt kaolin. If the alumina of the pozzolanas forms this compound, and if this compound is more resistant to sulfate attack than the C_2AH_2 or other hydrated calcium aluminates, then the improved sulfate resistance of the pozzolana cements would be explained. And only when the chemical action is completely understood will it be possible to design a "pozzolan" of ideal composition for any particular purpose.

References

1. Bakewell, B., and Bessey, G. E., *Bldg. Res. Report*, **17**, (1931).
2. Bates, P. H., Phillips, A. J., and Wig, R. J., *Tech. Paper NBS*, **12** (1912).
3. Bessey, G. E., *Symposium*, 484.
4. Bogue, R. H., and Lerch, W., *Res. Reports, PCAF*, July, 1934; Jan., 1944; Oct., 1936.
5. Bogue, R. H., Lerch, W., and Taylor, W. C., *Ind. Eng. Chem.*, **26**, 1049 (1934); PCAF Paper 28.
6. Brown, L. S., *Res. Reports, PCA*.
7. Bussem, W., *Symposium*, 497.
8. Candlot, E., "The Influence of Sea Water on Mortars," translated by Carter and Giesler, *Eng. Record*, **36**, 557 (1897).
9. Carlson, R. W., *J. Am. Concrete Inst.*, **40**, 205 (1944).
10. Carlson, E. T., and Bates, P. H., *Eng. News Record*, **107**, 130 (1931).
11. Feret, R., *Ann. Ponts Chaussees*, **1**, 375 (1890).
12. Fleming, A. G., *Eng. J.*, **16**, 215; 260 (1933).
13. Hansen, W. C., *J. Am. Concrete Inst.*, **40**, 213 (1944).
14. Hansen, W. C., and Taylor, T. G., *Res. Reports, PCA*, Dec. 1940.
15. Hedin, R., *Proc. Swedish Cement Concrete Inst.*, **3** (1945).
16. Hornibrook, F. B., *J. Am. Concrete Inst.*, **41**, 13 (1944).
17. Hughes, C. A., *Proc. Am. Soc. Testing Materials*, **33**, 511 (1933).
18. Jumper, C. H., and Kalousek, G. L., *Rock Products*, Apr. p. 54; May, p. 28; June, p. 58; July, p. 64 (1942).
19. Kalousek, G. L., *J. Am. Concrete Inst.*, **40**, 288 (1944).
20. Kalousek, G. L., and Jumper, C. H., *J. Am. Concrete Inst.*, **40**, 145 (1943).
21. Kalousek, G. L., Jumper, C. H., and Tregoning, J. J., *J. Res. NBS*, **30**, 215 (1943); RP 1530.
22. Kammer, H. A., and Carlson, R. W., *J. Am. Concrete Inst.*, **37**, 665 (1941).
23. Lafuma, H., *Rev. materiaux constr. trav. pub.*, **243**, 441 (1929); **244**, 4 (1930).
24. Lea, F. M., *Symposium*, 460.
25. Le Chatelier, H., *Ann. Mines*, Series 8 (2), Pt. II.
26. McMillan, F. R., and Powers, T. C., *J. Am. Concrete Inst.*, **34**, 129 (1938).

27. McMillan, F. R., and Powers, T. C., *J. Am. Concrete Inst.*, **30**, 325 (1934).
28. Meissner, H. S., *J. Am. Concrete Inst.*, **37**, 549 (1941).
29. Merriman, T., *Eng. News Record*, **104**, 62 (1930).
30. Michaelis, W., *Inst. Civil Eng.*, **107**, 370 (1891).
31. Miller, D. G., and Manson, P. W., U.S. Dept. Agric. *Bull.*, 358 (1933); *Proc. Am. Soc. Testing Materials*, **40**, 988 (1940).
32. Newman, E. S., Blaine, R. L., Jumper, C. H., and Kalousek, G. L., *J. Res. NBS*, **30**, 281 (1943); RP 1533.
33. Pagon, W. W., *J. Baltimore Eng. Club*, **5**, Nos. 2, 3, 4, 6, 7, 8, 9 (1915-16).
34. Poulsen, A., 13th Internat. Congr. Navigation, London.
35. *Proc. Am. Soc. Testing Materials*, **28**, (1), 233 (1928).
36. Purser, J., and Grose, H. J., 8th Intern. Rept., Inst. Civil Eng., (1928).
37. Sestini, Q., and Santarelli, L., *Ann. chim. app.*, **26**, 167; 193; 202; 533 (1936); **27**, 105 (1937).
38. Shelton, G. R., *Ind. Eng. Chem.*, **17**, 589; 1267 (1925); **18**, 854 (1926).
39. Smeaton, J., "Narrative of the Building of the Eddystone Light House," 1791.
40. Stanton, T. E., *Proc. Am. Soc. Civil Eng.*, **66**, 1781 (1940).
41. Stanton, T. E., Porter, O. J., Meder, L. C., and Nicol, A., *J. Am. Concrete Inst.*, **38**, 209 (1942).
42. Steopoe, A., *Tonind. Ztg.*, **52**, 1609 (1928); **58**, 592 (1934); **59**, 765 (1935); **60**, 487; 503; 944 (1936); *Zement*, **24**, 795 (1935); **26**, 169; 643 (1937).
43. Thorvaldson, T., Harris, R. H. and Wolochow, D., *Ind. Eng. Chem.*, **17**, 467 (1925).
44. Thorvaldson, T., and Shelton, G. R., *Can. J. Res.*, **1**, 148 (1929).
45. Thorvaldson, T., and Vigfusson, V. A., *Eng. J.*, March, 1928.
46. Thorvaldson, T., Vigfusson, V. A., and Larmour, R. K., *Trans. Royal Soc. Canada*, **21**, 295 (1927).
47. Thorvaldson, T., Vigfusson, V. A. and Wolochow, D., *Can. J. Res.*, **1**, 358 (1929).
48. Thorvaldson, T., and Wolochow, D., *J. Am. Concrete Inst.*, **34**, 241 (1938).
49. Thorvaldson, T., Wolochow, D., and Vigfusson, V. A., *Can. J. Res.*, **6**, 485 (1932).
50. Tremper, B., *J. Am. Concrete Inst.*, **37**, 673 (1941).
51. U.S. Dept. Agric. *Bull.* 1343 (1925).
52. Vicat, J. L., "Brards Sodium Sulfate Test," translated by J. T. Smith, 1835.

CHAPTER 30

Tests for Cement Quality

Tests for the quality of portland cement are of several kinds. The standard specifications* of the American Society for Testing Materials, of the Federal Specification Board, of various state and government agencies, require tests of various character. These vary slightly among the different agencies, and are changed from time to time. For the most part, they involve physical requirements, such as strength, setting time, etc., and need not be further considered. Chemical requirements are for the most part limitations on oxide or calculated compounds and need no elaboration.

Other tests for quality are sometimes made or required, such as the heat of hydration limitation on cements of the low-heat or moderate-heat types. The measurement of these values has been discussed in a previous chapter.† Tests for durability are sometimes required, and these are of various character. The freezing and thawing cycle or the wetting and drying cycle applied to mortar or concrete prisms are often made. A special cycle applied for studying the alkali-aggregate reaction has been referred to.‡ The use of an autoclave test for indicating unsoundness due to magnesia has been discussed.§ An autoclave test applied to clinkers has been introduced into specifications of the New York State Highway Department, but has not received extensive study so cannot be discussed.

There remain the rather extensive tests which have been proposed for indicating the resistance of cements to sulfate action, and the durability tests proposed by Paul and Merriman which are referred to as the water test or floc test, the disintegration index, and the sugar-solubility test. These are described below.

Methods for Predicting Sulfate Resistance

The methods that have been commonly used for the prediction of the sulfate resistance of cements may conveniently be grouped into six classifications as follows:

- | | |
|------------------------|----------------------------------|
| (1) Visual observation | (4) Elastic modulus |
| (2) Strength change | (5) Calculation from composition |
| (3) Length change | (6) Chemical action |

These will be separately discussed below.

Visual Observation. Most of the early methods for noting the aggressive action of natural waters on concrete consisted of observations made upon speci-

* See pages 22-23.

† See pages 79-85; 442-445.

‡ See page 515.

§ See page 503.

mens or structures immersed in natural water or in a solution which contained one or more of the salts believed to be responsible for the disintegrative effects. Thus the specimens placed in the harbor of La Rochelle in 1856 consisted of blocks of concrete. These were observed, with numerous additions, over a 40-year period (7). Large concrete beams were partially submerged in the harbor at Boston in 1909 (1) and examined periodically for the effects of sea water, of wetting and drying and of freezing.

An early investigation by Bates, Phillips and Wig (2) made use of hollow concrete cylinders within which were placed various solutions. The rate of attack was observed by noting the amount and character of the damage over a period of many months.

A test devised by Miller in 1922 (20)(22) employed standard 1:3 mortar briquets. These were broken after a curing period of 20 hours in the moist closet and 6 days in water. One of the broken briquet halves was then stored in 1 percent $MgSO_4$ solution and the other half in 1 percent Na_2SO_4 solution, and their condition observed from time to time.

A new procedure employing a different type of specimen was suggested by Merriman in 1933 (17) and has survived as the *Merriman Slab Test*. The test is performed as follows:

Neat slabs are prepared, $2 \times 4 \times \frac{1}{2}$ inch, cured 1 day in the molds and 2 days in water, then suspended in 10 percent Na_2SO_4 solution. Sulfate concentration is maintained constant by daily additions of H_2SO_4 to neutrality. Specification requires freedom from cracking or warping for 28 days.

The Merriman slab test was investigated by Taylor (30) through the examination of a series of cements, consisting of 32 laboratory-prepared cements of widely varying composition.

In general, the rate of disintegration was proportional to the C_2A content of the cements but, with high C_2A cement, the reaction products resulting from a high C_4AF content were found to delay evidence of sulfate action. This may be due partly to a protective coating of hydration products of the C_4AF on the C_2A grains and partly to the type of disintegration occurring in the slabs made with high C_4AF cements. In the latter case, the slabs softened and then disintegrated rapidly, sometimes to a sludge. Thus in this test it seems that disintegration may be under way long before evidence of it is observed. Miller (21) reports only fair agreement between the resistance of cement to sulfate attack (determined by length changes of bars in sulfate solutions) and the results of the slab test. He is left with the impression however that the slab test "is not severe enough to be entirely satisfactory as an acceptance test."

Strength Change. Among the early employment of the strength changes of cement pastes stored in sulfate solutions, as a means for measuring sulfate resistance, may be mentioned the interesting tests by Burke and Pinckney begun in 1909 (5). Neat briquets were made, cured in the damp closet for 24 hours, and stored in earthen jars containing a strong solution of sodium sulfate.

The course of attack of specimens in sea water was reported by Bates, Phillips and Wig in 1913 (2) by measurements of compressive and tensile strengths at intervals up to 2 or more years. Concrete cylinders of several mixes were cured

in the damp room for various periods; then duplicate groups immersed in sea water and in fresh water and triplicate specimens broken under compression at stated ages from 4 to 182 weeks. Briquets were made both of neat cement and of 1:3 mortar and, after 1 day in moist air, duplicate groups were immersed in sea water and in fresh water and tested at periods from 4 weeks to 2 years. The values of individual tests are recorded which provide an unusual opportunity for making an analysis of the significance of individual tests and of averages.

The percentage spread in the compressive strength of cylinders between the lowest and the highest value obtained in each triplicate group has been calculated (3). It is found that the low value in each group of specimens stored in sea water is less than the high value by amounts varying from 1 to 52 percent but averaging 15 percent for the 42 sets of specimens listed. When the results of the companion specimens (24 sets) stored in fresh water are similarly compared, the low value is found to be less than the high value by amounts varying from 1 to 45 percent, the average being 13 percent.

The order of spread between the high and low values in sea water storage (15 percent) is shown to be similar to that obtained by fresh water storage (13 percent). Neither is wholly satisfactory from the standpoint of reproducibility but the point which may be made is that, under the conditions of fabrication and storage employed, the reproducibility of results is as good in sea water as in fresh water. This may be due to the condition, concluded by the authors, that properly made concrete, totally immersed, is not subjected to decomposition by the chemical action of sea water.

The data reported on five briquets of each sample (the number recovered for test at 2 years was often less than five) were treated similarly to those for the concrete cylinders. Only the samples without admixtures were included in the analysis. In 33 sets of samples which were stored in sea water, the low value is less than the high value by amounts varying from 9 to 93 percent giving an average of 52 percent. But in 45 sets stored in fresh water, the low value is less than the high value by amounts varying from 1 to 36 percent giving an average of 18 percent. Here, it seems, the comparison reveals that the order of reproducibility for fresh water storage (18 percent) is not maintained upon storage in sea water (52 percent) and that the consequent reliability of any individual result may be subject to serious question.

The explanation for the pronounced unreliability of individual values obtained with the specimens stored in sea water may perhaps be found in the fact that the neat briquets, unlike the concrete cylinders, were in many cases seriously attacked by the sea water. Under such conditions it appears that reproducibility is markedly impaired: one specimen may remain firm when its duplicate has been badly damaged, and slight unknown differences incurred during making, handling or storage may affect greatly the rate of attack by the solution.

Small concrete cylinders, 2 inches in diameter by 4 inches long, were chiefly employed by Miller and Manson (22) in early studies at the Agricultural Experiment Station at St. Paul. The cylinders were cured for 24 hours in a moist closet at room temperature and then separate cylinders stored in distilled water and solutions (0.25 to 15 percent) of Na_2SO_4 and MgSO_4 . Cylinders were stored also in the alkali water of Medicine Lake, South Dakota. The salt concentration here

increased from 2.3 percent in 1924 to 7.4 percent in 1931. The resistance of the cylinders stored in Medicine Lake was measured by strength ratios at 1 and 5 years based on strengths at similar ages of cylinders stored in tap water in the laboratory (23).

Unfortunately for the purposes of this analysis, the strength values reported are averages usually of values obtained on five cylinders. It is not therefore possible here, nor with most similar reports in the literature, to examine the order of reproducibility of individual results. From extensive observations however it may be assumed that, in general, the character of variation among individual results is fairly indicated by the analysis of data given for the values of Bates, *et al.*

Mortar briquets were employed by Thorvaldson, Larmour and Vigfusson (34) upon which tensile strengths were obtained. These were made up in accordance with standard specifications, using 1:3 and 1:5 mixes with standard Ottawa sand. They were stored in the damp closet for 28 days and then in solutions of Na_2SO_4 and MgSO_4 of different concentrations. The authors found that the values for the tensile strength of the individual briquets were somewhat erratic, especially during the latter part of the exposure to the sulfate solution, an occasional briquet losing strength much more quickly or slowly than the average. This again confirms the observations of Bates and his associates that wide discrepancies may appear when the action has become rapid and destructive.

Length Change. The length-change method of determining sulfate resistance was adopted by Thorvaldson and his associates (33) in 1922 as a means for noting quantitatively the rate of attack of various aggressive waters on specimens of cement. Recalling that mortar and concrete specimens made from portland cement expand during disintegration in sulfate waters, they made a study of the expansion with a view to using it as a measure, on the one hand, of the disintegrating action of sulfate solutions and, on the other hand, of the resistance of various samples of cement to sulfate action.

The specimens used were 1:3 mortar bars, $\frac{3}{8}$ by $\frac{3}{8}$ by $7\frac{1}{2}$ inches, stored in the damp closet for 28 days. Tensile strengths were determined on corresponding specimens of mortar briquets. The bars were finished with a thin layer of neat cement on each end to give a suitable surface for the accurate measurement of length. The specimens were stored in wide-mouthed stoppered glass jars in sodium sulfate and magnesium sulfate solutions of various concentrations.

Many variables were examined. The rate of attack was retarded by use of a longer curing period in the damp closet, by increasing the number of bars stored in a given volume of solution, by increasing the cement content of the mix, by decreasing the concentration of the solutions, and by lowering the temperature of the solutions. It is emphasized that comparisons of the expansion of mortar bars in sulfate solutions are not permissible when the ratio of amount of mortar to volume of solution varies.

On comparing the results of the two methods of test, the authors find that there is a very marked relation (after the initial period of increase in strength) between the tensile strength curve for mortar briquets and the expansion curve of mortar bars of the same mix exposed to sulfate solutions. These curves are reproduced in Figure 247. A careful examination of the curves however elicits a caution in their interpretation, and the authors state that, while it would be

possible to predict the value for the tensile strength of a mortar specimen from its expansion, it is evident that the two curves have marked differences apart from the early increase in strength. The expansion is very gradual during the early stages and later the rate increases to an almost constant value, while the loss in strength, after the sixth day, is at first very rapid and later slows down materially. The expansion curve is what one would expect from consideration of the tensile strength curve, say the authors, if one assumes that the expansive

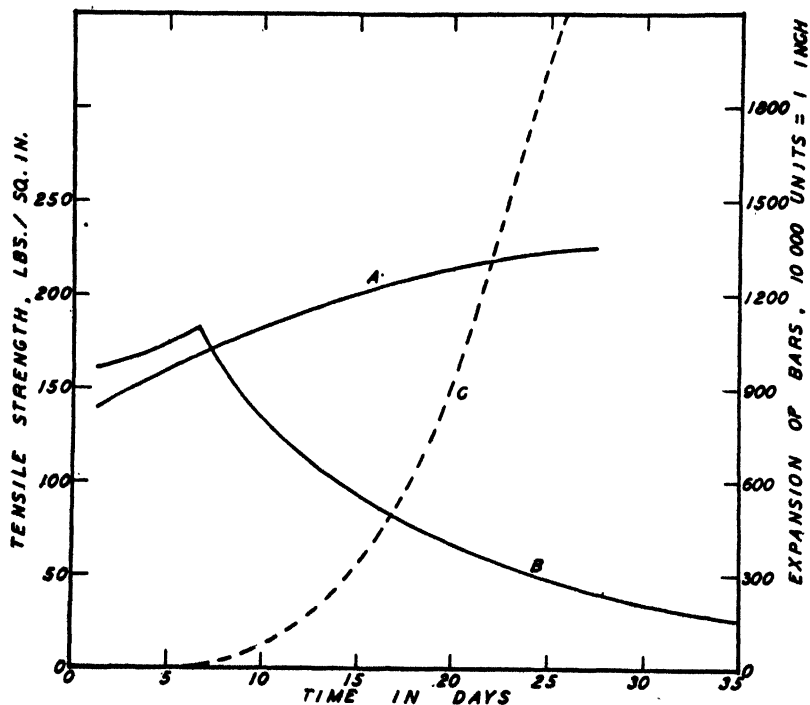

Figure 247. Comparison of expansion of 1:3 mortar bars, and tensile strength of mortar briquets in $0.15M$ Na_2SO_4 . A, Tensile strength of briquets in water; B, Tensile strength of briquets in Na_2SO_4 ; C, Expansion of bars in Na_2SO_4 . (Thorvaldson)

force is constant, or nearly so, while the cohesive force, of which tensile strength is a measure, decreases rapidly at first and then more and more slowly.

Thorvaldson and his associates conclude that, since expansion is one of the principal factors causing failure, it is admissible to use the expansion method as an independent method for determining sulfate action. They point out however that the large variations in strength often obtained on briquets stored in water, seems to be magnified when the specimens are exposed to disintegrating solutions.

Length change measurements were inaugurated independently by Miller (20) also in 1922. The specimens used in this study were 2×4 inch concrete cylinders. In each end of the cylinders a 1-inch brass screw was set in neat cement. Changes in "volume" were determined by measurements between screw heads.

Companion specimens were made without the inserts for compressive strength tests.

It was noted that an increase in strength of the solution had a large accelerating effect on the rate of attack up to a concentration of about 1 percent, but beyond that value the increase in rate of attack was slight.

As a result of the correlations made possible by the two methods of test, the author reported that an increase in length of 0.01 inch in a 2×4 inch cylinder ordinarily indicates a 50 to 70 percent strength loss. This figure was given in a later paper by Miller and Manson (22) more specifically as about 66 percent. The authors add that this relation was found to hold consistently with the different brands of portland cement in mixtures leaner than 1:2, and to vary only moderately with water-cement ratios between 0.44 and 0.73. However, for a mix of 1:1 and for neat cement, an increase of 0.01 inch in the cylinders was found to indicate a loss in strength considerably greater than the loss for the leaner mixes. Because of the consistency of the above relationship in 1:3 mixes, the practice was adopted of rating relative resistance of the test cylinders on the basis of the time required to increase in length by 0.01 inch, and of considering the usefulness or life of all such cylinders to have ended when that increase in length had occurred.

More recently (1943), Miller (21) has reported the results of a cooperative study on sulfate resistance carried on under the auspices of Committee C-1, American Society for Testing Materials. Various methods of test were used but the most uniform results were obtained with 1:5 bars stored in solutions of sodium and magnesium sulfate of 0.15M concentration (equivalent to 2.1 percent Na_2SO_4 and 1.8 percent MgSO_4). Concerning this test, Miller states that the bars leaner than 1:5 were found to give so many erratic results that "it was evident that frequently the test became rather one of uniformity of workmanship in making the bars than of the conditions to which the bars were exposed." Even 1:5 bars gave decidedly erratic results when exposed to any of the magnesium sulfate solutions with molarity greater than 0.15M. In magnesium sulfate solutions of 0.15 molarity it sometimes happened that individual 1:5 bars went completely out of line indicating that the margin between good and poor workmanship in making the bars was just about as narrow as practicable for an acceptance test. The weakness of the test, he says, is the difficulty encountered in consistently making lean mortar bars of satisfactory uniformity.

Study on sulfate resistance was initiated at the laboratory of the Portland Cement Association Fellowship (4) in 1926, the materials first examined including some of the cement compounds and synthetic cements prepared from chemicals of C.P. quality. Since the above investigation was initiated, many similar studies have been made in this and other laboratories. The detail of procedure has been varied by the employment of specimens of different sizes, the use of different mixes and consistencies, the use of various types of reference points and means of storage and measurement. In principle however this method has come to be regarded as more or less the standard procedure to which all other methods are referred in the determination of the sulfate resistance of cements.

In studies by the PCAF, the data obtained with length measurements of mortar bars have been analyzed (3), and some of the conclusions are given below.

It is noted frequently in the prisms that the edges and corners of the bars are the first parts of the specimen to be attacked. The length measurement between reference points is actually a measurement only of the length of an inner core. This core, being in the center, is the last part of the specimen to be attacked and hence the last to undergo the changes induced by that attack. Hence it is not surprising that the length increase of this core may in some cases be slight, long after the more exposed parts have shown a severe corrosion. Such a condition gives rise to recorded values which are not at all indicative of the extent of the action that has taken place.

On the other hand, some types of action are very uniform throughout the specimen, giving rise to a uniform expansion without scaling. In such cases the edges may retain their sharpness although the expansion has increased greatly in all directions. Such specimens are doubtless correctly rated by their length increase but such values cannot well be correlated with values obtained on other specimens which are affected by the attack in the manner described above.

When a specimen is subjected to chemical forces resulting in dimensional changes, it is obvious that the reference points, whatever they are, will not be similarly attacked. Hence there will be stresses set up between the specimen and the inserted material which often will result in a loosening or distortion of the reference point.

Any specimen molded by the usual methods will possess characteristics which vary in each of the three dimensions. This causes unequal attack on each pair of surfaces. Also it appears to be practically impossible to fabricate specimens so that the characteristics of any one are consistently identical with those of any other. This is revealed by the localized areas of attack often observed and by dissimilar behavior of duplicate bars.

During storage of cement specimens in solutions of the sulfates, the hydroxyl-ion concentration of the solution increases and the sulfate ion concentration decreases due to interaction with components of the cement. Thus the character of the solution changes progressively with time and it has been shown (34)(22) that the behavior of specimens in a solution several weeks old may be markedly different from their behavior in fresh solution. This feature makes it difficult to correlate results obtained in one period with those obtained in some other period.

Likewise, the temperature of storage may have a pronounced effect on the rate of attack, particularly at early ages. Hence specimens prepared in one season or at one condition of the laboratory may behave quite differently from similar specimens prepared in another season or condition. A constant-temperature storage would be necessary to eliminate this difficulty.

It has been found that the length changes through a given prolonged time-period cannot be construed as necessarily indicative of the anticipated life of the specimens stored in sulfate solutions. A failure to recognize this condition has often led to a misunderstanding in the interpretation of data obtained by this method and may account for numerous cases of apparently anomalous behavior of cements under examination. On the other hand, waiting until the age of disintegration would require time periods which would so delay the results of the test as to make the method untenable.

Again, an average of two dissimilar values seems not to be justified because

of unequal rates of attack caused by factors unrelated to the resistance of the cement as distinguished from that of the mortar specimen. Since the purpose of the test is to classify the cements, and not the specimens, a doubt of the validity of the test is raised except the "specimen error" can be equalized.

Finally, the question is encountered as to what is the ultimate criterion upon the basis of which sulfate resistance may be defined. Cements from Miller's studies may be used to illustrate the inconsistency between different criteria:

No.	Concrete 2" × 4" cylinders percentage of normal strength after 5 yrs. in Medicine Lake (Miller, 23)	Mortar bars, 1:5 cured 3 days, then immersed in 10% Na ₂ SO ₄ . Weeks to disintegrate (Gause, 10)
	%	Wks.
438	0	25
516	70	13

From the results of the tests by Gause (10) on 1:5 mortar bars, cement No. 438 appears to be much more resistant to sulfate action than cement No. 516, but the reverse is emphatically indicated by the tests of Miller on concrete cylinders immersed in Medicine Lake.

From this analysis it must therefore be concluded that various factors and conditions employed in the method of length-change measurement for sulfate resistance impose uncertainties in measurement and difficulties in interpretation. In addition, the method requires several weeks or months for its satisfactory completion. It appears that a development of methods which could successfully overcome any of the difficulties enumerated would be of interest to the industry.

Elastic Modulus. A dynamic method of measuring the modulus of elasticity of a concrete or mortar specimen was described by Powers (28) in 1938. This method consists in a determination of the natural frequency of vibration of the specimen and was found to give a true elastic modulus, not complicated by plastic flow, and fully as reliable as values obtained by static loading methods. The frequency was first determined by finding the bar, in a set of tuned steel bars, which had the pitch nearest to that of the specimen. Later a sonometer was made which could be tuned to unison with the test specimen and the error of measurement became very small.

Hornibrook (11) developed an apparatus for determining the fundamental flexural frequency of a specimen vibrating as a free bar, making use of a tuned-circuit audio oscillator and a cathode-ray oscillograph. With this apparatus he made measurements (12) of the elastic modulus of a number of mortar bars and compared the results with the linear expansions and flexural strengths following storage in sulfate solutions for periods up to 14 weeks.

The specimens used were 1:5 mortar bars, 2 × 2 × 10 inches, variously cured and stored in 10 percent solutions of sodium sulfate and magnesium sulfate. One set was held continuously in the solutions; another set was subjected to a cycle consisting of 18 hours in the sulfate solution followed by 18 to 20 hours of drying in an oven at 95° to 110°.

Some of the data from this study are reproduced in Figure 248. The study

indicates that, in specimens having low expansions in sulfate solutions (Cement A), the elastic modulus increases rapidly to a high value and remains high. On the other hand, in specimens having high expansions (Cement B), the modulus of elasticity at first increases rapidly but after a few weeks drops to low values. The moduli values were erratic in specimens subjected to the cycle of sulfate exposure and drying.

It was found that specimens which had withstood 9 weeks or more of continuous immersion or 14 cycles of repeated immersion in sulfate solutions without

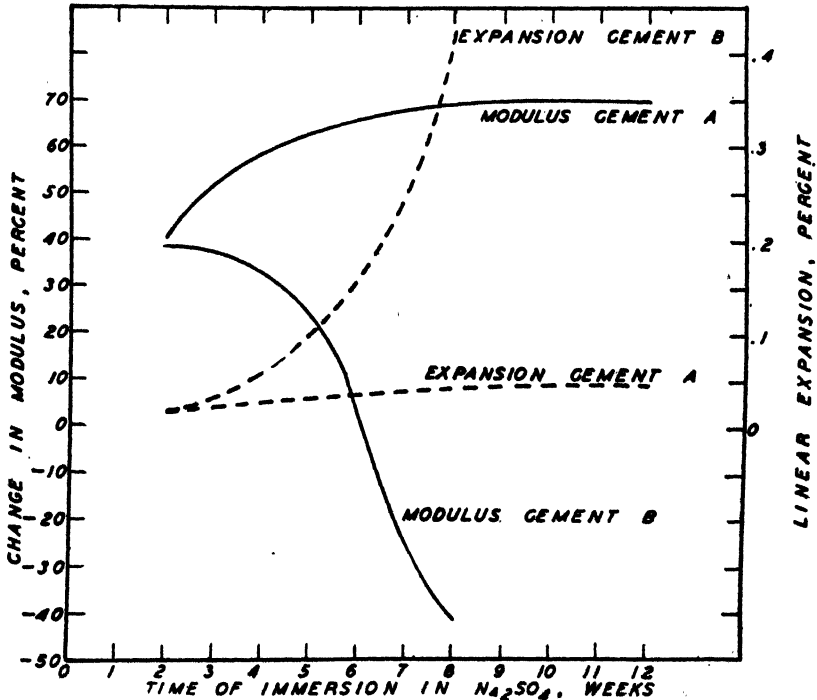

Figure 248. Comparison of change in modulus of elasticity with length increase during storage of $2 \times 2 \times 10$ inch 1:5 mortar bars in 10 percent Na_2SO_4 solution for 12 weeks. (Hornibrook)

expanding as much as 0.2 percent also had a modulus of elasticity greater than $2\frac{1}{2}$ million psi (pounds per square inch). The specimens which had expanded 0.2 percent or more during the sulfate exposure had a modulus of elasticity less than $2\frac{1}{2}$ million psi. Accordingly, Hornibrook believes that a criterion of the relative resistance of mortar bars to the aggressive action of sulfate solutions might be the length of time of exposure to cause the modulus of elasticity to decrease to a given level (which was $2\frac{1}{2}$ million psi in his study). The criterion might also be the relative values of modulus of elasticity of specimens which had expanded by a given amount, as 0.2 percent. It was furthermore noted that a modulus of rupture of about 200 psi separated the specimens into the two groups just mentioned. All specimens having elastic modulus below $2\frac{1}{2}$ million psi and expansions

above 0.2 percent were found to have a modulus of rupture below 200 psi. All other specimens had a modulus of rupture above that value.

Methods of Calculation. It was argued that, since sulfate resistance may be primarily determined by the C_2A content, and since the potential C_2A can be computed, a limiting calculated potential C_2A content could properly be employed for specification purposes to delimit cements which would be considered satisfactory with respect to their resistance to sulfate action.

The propriety of such an expedient has been variously debated but was advocated by Miller and Manson (23). Commenting on their data, they say,

Judged by results of the tests as applied to 106 commercial cements, a specified upper limit of 5.5 percent tricalcium aluminate would come as near to securing cements of high resistance to attack by magnesium and sodium sulfate as reasonably could be expected and, at the same time, would eliminate all cements of low resistance. It appears sound, therefore, to rely chiefly on this chemical approach for the selection of a cement to be exposed to the action of these sulfates, until a short-time laboratory test may be devised that is of proven greater reliability.

Thus a limiting calculated value of 5 percent C_2A has been adopted for sulfate-resistant cements by both the American Society for Testing Materials and the Federal Specifications Board, as calculated by the formula:

$$3CaO \cdot Al_2O_3 = 2.65Al_2O_3 - 1.69Fe_2O_3.$$

Other factors of composition have been examined and some influence observed. Thus C_4AF has been shown to be susceptible to the attack of sulfate solutions (3) but expansions of a high order have not resulted from this cause alone except with very high C_4AF values, provided the cements were otherwise of a resistant composition. Also it has been noted (4) that the resistance of cements to sulfate action may be somewhat improved by increases in the ratio of C_3S to C_2S .

It will be recalled that the conditions justifying the use of calculated values for predicting sulfate resistance assume, (a) that the phases as computed are substantially those which are actually present and, (b) that the control of C_2A suffices to determine the sulfate susceptibility of the cement. Both of these criteria are only partially realized. The computations do not generally take into consideration the undercooled liquid or glass and it has been found that the glass is usually less reactive with sulfate solutions than is crystalline C_2A . The resistivity of the glass moreover is a function of its composition. Likewise, the effects of certain minor components are not yet known.

Methods Based on Chemical Action. *The Formation of Calcium Sulfoaluminate.* The interaction of an aqueous solution of calcium aluminate with calcium sulfate was shown by Candlot (8) in 1890 to produce a calcium sulfoaluminate. Two years later Michaelis (19) ascribed the disintegration of cements in sulfate waters to the formation of that compound.

A considerable amount of study was given this reaction by numerous investigators, different formulas were assigned to the high-sulfate compound discovered by Candlot, and a low-sulfate compound was discovered. * Difficulties in observing

* See page 419.

these compounds in concrete however prevented a direct solution of the problem. The controversy raged particularly about the possible action of the compound in bringing about disintegration of concrete in sea water. Michaelis believed this to be probable, and was supported by such authorities as Le Chatelier and Meyer but others, as Candlot, Kuhl and Passow, considered that the compound was decomposed by sea water (25). Rebuffat (29) assumed that the salt forms but is immediately decomposed by the sea water.

The subject was investigated at length by Nitzsche (25) who devised a method referred to by him as a *pure culture* method for determining the *degree of aggressiveness* of sulfate waters. The procedure involved the examination of precipitates occurring in flasks after a few days of contact of the sulfate water with given quantities of pure calcium hydroxide and calcium aluminate. The character of the crystal formation indicated the aggressiveness of the solution, or that part of its aggressiveness which could be ascribed to the action of calcium sulfoaluminate formation. In some solutions crystals formed abundantly, in others they formed but slightly or not at all. Sea water was in the latter group.

This test, designed chiefly as a means for discriminating between various aggressive waters, was recognized as a test which could be employed with equal validity as a means for differentiating between cements of different degrees of resistivity to attack by sulfate water.

A Sulfate Susceptibility Test. In most of the methods heretofore proposed for the differentiation of cements on the basis of resistivity to sulfate attack, the specimens have consisted of prisms or cylinders of hardened mortar or concrete. When such specimens are stored in sulfate solutions, the rate of attack is a function not alone of the cement used but also of the physical characteristics of the specimen. So long as all of those characteristics are identical, the measured effect may properly be interpreted as a measure of the sulfate resistivity of the cement. But it has been noted that such variations as normally occur in the attempted production of identical specimens are of sufficient magnitude to give rise, not infrequently, to wide discrepancies in behavior.

This leads to the suggestion that a better basis might be found for differentiating the cements by the use of the cements alone, quite apart from any fabricated specimen, and developing a test based on the reactivity of the cement with the sulfate.

It has been pointed out that a major cause of the disintegrative attack of sulfate solutions on portland cement lies in the reaction between the alumina-containing phases and the sulfate to form calcium sulfoaluminate. This double salt is highly insoluble (0.001 g SO_3 per 100 ml in saturated lime water (14) (6)). It seems that the sulfate susceptibility of a cement might therefore be indicated by obtaining a measure of the amount of calcium sulfoaluminate formed as a result of the interaction between SO_3 and the reactive alumina-containing phases in the cement.

It may be postulated that:

(1) When a cement is shaken with lime-water the SO_3 contained in the cement will go into solution to the extent of the solubility of the sulfate in the lime-water provided sufficient time is provided.

(2) The SO_3 will combine with the alumina and calcium hydroxide, precipitating calcium sulfoaluminate, in proportion to the amount of aluminate that has entered the solution.

(3) The filtered solution will then contain SO_3 in an amount equal to the difference between the original content of soluble SO_3 and the amount precipitated.

(4) A measurement of the SO_3 content of the filtered solution will thus reveal the amount of calcium sulfoaluminate precipitated, and hence the susceptibility of the cement to attack by sulfate solutions.

A detail of test procedure has been suggested by Taylor (32) as follows:

About 30 g of standard Ottawa sand, or some similar sand, is placed in a dry 100-ml graduated cylinder so designed that it can be fitted with a stopper. (A blank determination should be made with each lot of sand that is employed.) A 3.000-g sample of cement is weighed and placed in the cylinder containing the sand. One hundred ml of saturated limewater is measured in a 100-ml pipette and added rapidly to the cylinder by inverting the pipette. A clean rubber stopper is inserted and the mixture is shaken vigorously at once by hand. The cylinder then is fastened to a rack* that is caused to rotate for 6 hours at a rate of 60 rpm from the time of the addition of the limewater. Just before the end of the 6-hour reaction period, preparations are made for the filtration. A 9-cm No. 42 filter paper, or a comparable paper, is inserted in a Buchner funnel and moistened with distilled water. The water added to the flask in this operation is removed, about 10 drops of 1 : 1 HCl and a few drops of methyl red or methyl orange indicator are added, the funnel replaced, suction applied, and the contents of the cylinder poured into the funnel. The cylinder is washed with 50–60 ml of distilled water at room temperature and the washings poured onto the funnel. This step is repeated once. A foam sometimes adheres to the sides of the funnel and when this occurs the sides are washed down with a minimum of water from a wash-bottle.

The filtrate is transferred to a 600-ml beaker. The filter flask is twice washed with 50–60 ml of distilled water and the washings added to the filtrate. The volume now should be made up to about 350 ml. Five ml of concentrated HCl is added. The filtrate, which at this stage should be definitely acidic, is heated to boiling and 10 ml of hot 10 percent BaCl_2 solution added slowly from a pipette. The beaker is covered with a watch glass and set on a steam-bath to remain overnight. The volume of the solution containing the BaSO_4 precipitate is increased to its original volume the following morning by the addition of the proper amount of distilled water. After an additional $\frac{1}{2}$ hour or more on the steam-bath, filtration is made using a No. 24 filter paper. A policeman is used to remove any BaSO_4 adhering to the walls of the beaker and stirring rod. The filter paper and precipitate are washed with hot distilled water until no Cl ions are detected in the washings by the addition of AgNO_3 solution. The paper containing the precipitate is dried, then placed in a weighed crucible. The paper, with free access of air, is slowly charred without flame. The final ignition to constant weight is conducted in a muffle furnace maintained between 800° and 900° .

* The rack should be so designed that no cylinder is more than 6 inches from the hub.

After the amount of SO_2 remaining in the solution is determined from the weight of the BaSO_4 , that value is subtracted from the amount that was present in the 3.000-g sample of cement. This difference is the quantity of SO_2 that reacted to form calcium sulfoaluminate during the period of the test. This is calculated as the percentage of the SO_2 originally present in the cement and is designated as the *sulfate reaction value*. These values are reported to the nearest whole number.

Correlations of the sulfate reaction values, obtained by the application of the above sulfate susceptibility test, were made with the performances of specimens of a large number of commercial cements as reported by Miller and Manson (23). From these correlations it was tentatively concluded that:

(1) Cements having sulfate reaction values of 50 or less have potential sulfate reactivities that are insufficient to affect materially concretes and mortars made with these cements.

(2) Cements having sulfate reaction values of 65 or more have potential sulfate reactivities that are sufficient to damage seriously concretes and mortars made with these cements, regardless of the otherwise excellent qualities that may be possessed by the cement or by the mortars and concretes.

(3) Potential sulfate reactivities of cements to the extent of those indicated by sulfate reaction values of slightly over 50 to about 65 are serious threats to the soundness of concretes and mortars. Whether or not a structure will be damaged extensively by forces of this magnitude appears to be dependent upon other qualities of the cement and the structure.

The sulfate-susceptibility test has not been confirmed by other investigators, but it is claimed by its author to be both rapid and reliable. Results are available in a day and the test was found to be superior to other methods in distinguishing the definitely good from the definitely poor sulfate-resistant cements.

The Water Test for Durability

The amount of floc which will be formed after several days in a water suspension of a cement was suggested by Paul (27) in 1936 as a measure of the durable qualities of the cement. Paul refers to the test as the *water test*, and it has been known also as the *floc test*. It is carried out as follows:

A 1 g portion of cement is shaken briefly in a glass tube with 100 ml of water, and the tube allowed to remain undisturbed on its side for 7 days. The floc which forms is decanted from the settled cement, filtered, ignited and weighed. Very low or zero floc formation is said to indicate a "durable cement."

In a study of the test made by Committee C-1, American Society for Testing Materials (35), the effects on the test resulting from varying the composition of the clinker, the burning temperature, the rate of cooling and the fineness of grinding were examined. The results indicate that floc develops in the test only in those cements having a potential C_2A content of about 10 percent or more. Variations in the potential content of the calcium silicates, calcium aluminoferrite, magnesia and free lime have little effect on floc formation.

The floc was found to consist essentially of calcium sulfoaluminate, which is formed only when C_2A and CaSO_4 are both present. Some of the floc is formed

within and held by the cement paste, and some is formed in the supernatant liquid as a result of the combination of such amounts of C_2A and $CaSO_4$ as have passed into the solution. Only that portion formed in the supernatant liquid is separable (31). Cements prepared from rapidly cooled clinkers developed less floc than those prepared from corresponding slowly cooled clinkers, indicating that crystalline C_2A is more reactive than are its components in the form of glass. Increased surface area also increased floc formation.

The results of the above tests, in which several laboratories collaborated, indicate that in general the reproducibility of the results is poor and that small differences in the operative technique change greatly the amounts of floc recovered. In a later report concerning the test, Miller (21) questions the adequacy of the method for indicating the sulfate resistivity of the cements, but thinks that it might be improved with modifications.

The Disintegration Index

Studies on the solubility of cements in sugar solutions were first reported by Merriman in 1924 (15), and developed into a "test for durability" in 1930 (16). The comparisons actually made were between the values obtained by the lime-sugar test and observational values on the condition of neat briquets stored in 10 percent solutions of sodium sulfate. It appears that the author used the latter indication as the equivalent of the "cement durability" and as a measure of the degree of permanence "under outdoor exposure."

The test was carried out as follows:

A 7.5-g sample of cement is shaken for 2 hours in 100 ml of a 15 percent sugar solution to which has been added an amount of $Ca(OH)_2$ such that 25 ml of the solution requires 5 ml of $N/2$ HCl for neutralization. At the end of the shaking period the solution is filtered and one 25 ml portion titrated with $N/2$ HCl using phenolphthalein as an indicator and another 25 ml portion similarly titrated using methyl orange as an indicator. The difference between the above two titration values was called the *disintegration index* and was believed to indicate the "durability" of the cement.

The addition of the lime to the sugar solution was believed to be necessary in order that the sugar solution could attack the cements at once "from the same plane." It was said to be "analogous to that of a key unlocking a door." That is, "the causticity of a lime-sugar solution acts to unlock the combinations of a cement and thus to render it more soluble. The more completely a cement has been manufactured and the more closely its combinations have been perfected the less of it will be dissolved by a lime-sugar solution."

The cements employed in the test were the 32 cements which had been reported by Committee C-1 of the American Society for Testing Materials in 1928. Neat briquets stored in 10 percent Na_2SO_4 solution were rated visually at 2 and 5 month periods and these ratings compared with the *disintegration index*. Merriman wrote that the concordance between the results of the sulfate test and the difference between the solubilities is so striking as to leave practically no room for doubt as to the value of this indication as a measure of cement durability.

The particular significance of *disintegration index* or differences in solubility, as measured by titrations using the above mentioned two indicators, was said to lie in the fact that the methyl orange titration reveals the total quantity of lime, silica, ferric oxide and alumina whereas the phenolphthalein titration reveals only the quantity of lime in the solution. Thus the difference between the two values was considered to be a measure of the silica, the iron and the alumina which the sugar-lime solution has taken up from the cement. It was consequently argued that a cement which gives up a relatively large amount of those oxides to the solution is less thoroughly formed and its constituents less completely combined than is the case with a cement which gives up only a small quantity of those oxides to the solution. The test therefore was said to be a criterion of the completeness with which a cement has been manufactured.

The test as given above was never adopted into extensive use but it served as the basis for a greatly revised *Sugar-Solubility Test* for cement durability as described below.

The Sugar-Solubility Test

The *sugar-solubility test* was developed by Merriman (18) in 1938. It was claimed that this test indicates the quality of concrete which, properly fabricated, will result from the use of a given cement, first, by providing information on the thoroughness of the burning of the clinker, and second, by indicating whether hydration has occurred subsequent to burning, either by the addition of water to the clinker or by an unprotected condition of the clinker prior to grinding. He believed that underburning might produce a "loose combination" of the cement components, not indicated by the free lime test, and that the presence of such material, or of the hydrated lime formed by the addition of water, would cause an immediate reaction, during the mixing of the concrete, resulting in the formation of weakly bonded, chalky materials. The sugar-solubility test, he believed, would reveal the presence of such loose combination.

The specification for the test (24) is given below in abbreviated form:

The sugar solubility of the cement shall not be greater than 8.0 to the phenolphthalein end point, nor greater than 10.0 to the final clear point. These values shall be determined as follows: A sample of about 100 g of the cement is passed through the 200 mesh screen and put into a glass bottle closed with a rubber stopper. From this bottle 15 g are then weighed out and placed into a Nessler tube containing 100 ml of a 15 percent solution of cane sugar in distilled water. The tube and its contents are then quickly shaken by hand and placed on a wheel revolving about 60 times per minute. At the end of about 1 hour and 50 minutes the mixture is poured into a filter paper and funnel and allowed to filter for 10 minutes when the beaker containing the filtrate is removed. Twenty-five ml of the filtrate is now titrated with $N/2$ HCl in the presence of phenolphthalein and the number of ml of acid to the end point is the first measure of the sugar solubility. The titration is then continued until the solution is crystal clear and nothing remains in suspension. The total number of ml of acid from the beginning of the titration to this final clear point is the second measure of the sugar solubility.

In a study of the significance of the test made by Taylor and Bogue (33), it was noted that, of 134 commercial cements examined, only a third of them passed the test. Of these, the free CaO in no case exceeded 0.9 percent, and the potential C_3A was usually under 10 percent. On the other hand, about two thirds of the cements which failed in the test had free CaO values above 0.9 percent and the C_3A contents were often high.

An examination was made (33) of data obtained by Flint and Bates (9) on the composition of extracts obtained in the Merriman test on 23 cements and clinkers.

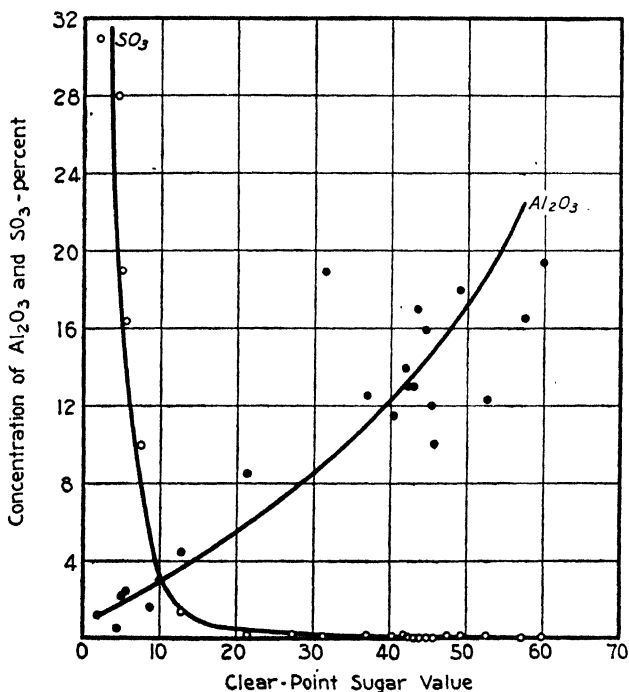

Figure 249. The concentrations of Al_2O_3 and SO_3 in extracted solids of cements and clinkers, plotted against the clear-point sugar-solubility values. (From data by Flint and Bates)

This analysis showed that, as the sugar-solubility values increased with these cements, the solids which were dissolved in the extracts increased rapidly, but the SO_3 content of the extracts diminished to very low values with all cements having low sugar-solubility values.

The relationship between the Al_2O_3 and SO_3 in the extracts, plotted against the sugar-solubility values, is shown in Figure 249. It will be seen that in the cements of low sugar-solubility value (below 10), the SO_3 content is relatively very high and the Al_2O_3 content very low. But beyond a sugar-solubility value of 10, the SO_3 practically disappears from the solution and the Al_2O_3 content increases markedly.

This remarkably clear relationship between the SO_3 and Al_2O_3 concentrations

in the sugar solution indicates that in cements of low sugar-solubility the gypsum goes into solution rapidly, reaching high values. Such cements have a low C_2A content and a low free-CaO content. An increase in the C_2A of the clinker will increase the amount of Al_2O_3 entering the solution, and the solubility appears to be greatly increased by the presence of free CaO. Hence as C_2A or free CaO increase in the clinker, the conditions are obtained by which calcium sulfoaluminate is precipitated from the solution, and the SO_3 is reduced to near the vanishing point. Such treatments of the cement as finer grinding or longer shaking time with the sugar solution also advance the solution of the components and give rise more quickly to the condition where the sulfoaluminate is precipitated. And as the Al_2O_3 in the solution increases during this process, the sugar-solution value increases.

This relationship was further emphasized by Lerch (13) who suggests that the results obtained in the test upon cements of high C_2A content, or of high free CaO content, will depend upon the SO_3 content of the cement. Where the SO_3 content is low, the gypsum becomes depleted during the 2-hour shaking and the titration values are high, but if more gypsum is added to the cement the gypsum may not become depleted and the titration values will be relatively low.

Most commercial cements contain various amounts of C_4AF and a glassy phase, and it was shown (33) that free CaO renders these phases more soluble in the sugar-solution. Hence the principal criterion in the test is the free CaO. For this reason, no cements having in excess of 1.0 percent of free CaO will pass the test. But when the free CaO content is low, the magnitude of the titration value will be a function of the potential C_2A content. Thus it was shown that, in general, the maximum free CaO content allowable in the test for cements containing 0 to 6 percent potential C_2A is 0.9 percent; for cements containing 7 to 11 percent potential C_2A , 0.7 percent; and for cements containing 12 to 14 percent potential C_2A , 0.4 percent.

Since the lime dissolved in the sugar solution accelerates the reaction of the gypsum, Lerch concludes that the test does not necessarily have any particular significance in predicting the quality of the cement.

The reactions of the calcium aluminates, C_2A and C_3A , with sugar solutions have been studied by Niven (26). This investigator reported that C_2A , in concentrations up to 2.28 g per 100 ml of 15 percent sugar solution, goes completely into solution prior to the initiation of secondary reactions (about 2 minutes). Calcium hydroxide is liberated at once, which combines with dissolved sugar to form sucrates. Reactions occurring in the solutions containing in excess of 0.229 g C_2A per 100 ml produce metastable extracts which precipitate colloidal hydrated alumina together with tricalcium sucrate. The high reactivity of the C_2A with sugar solution is considered to be due to the high OH-ion concentration in the extracts. Evidence obtained by pH measurements and optical rotation of the extracts indicates that the sugar in solution not only combines with $Ca(OH)_2$ but precipitates from solution as insoluble tricalcium sucrate.

References

1. Aberthaw Construction Co. Tests, 1920.
2. Bates, P. H., Phillips, A. J. and Wig, R. J., *Tech. Paper NBS 12* (1913).

3. Bogue, R. H., *Res. Reports, PCAF*, Dec., 1940; July, 1943.
4. Bogue, R. H., Lerch, W., and Taylor, W. C., *Ind. Eng. Chem.*, **26**, 1049 (1934); PCAF Paper 28.
5. Burke, E., and Pinckney, R. M., *Montana Agric. Col. Exp. Sta. Bull.* **81** (1910).
6. Cameron, F. K., and Bell, J. M., *U.S. Bur. Soils Bull.* **33** (1906).
7. Candlot, E., "The Influence of Sea Water on Mortars," translated by Carter and Giesler, *Eng. Rec.*, **36**, 557 (1897).
8. Candlot, E., *Bul. soc. encour. ind. natl.*, 682 (1890).
9. Flint, E. P., and Bates, P. H., *Rock Products*, Oct. 1940, p. 46.
10. Gause, G. R., *Am. Soc. Testing Materials, Bull.*, Oct., 1941.
11. Hornibrook, F. B., *Am. Soc. Testing Materials Bull.*, Dec., 1939.
12. Hornibrook, F. B., *Am. Soc. Testing Materials Bull.*, Dec., 1941.
13. Lerch, W., *Res. Reports, PCAF*, Feb., 1945.
14. Lerch, W., Ashton, F. W., and Bogue, R. H., *J. Res. NBS.*, **2**, 715 (1929); RP 54; PCAF Paper 19.
15. Merriman, T., *Eng. News Record*, **93**, 669 (1924).
16. Merriman, T., *Eng. News Record*, **104**, 62 (1930).
17. Merriman, T., Fort Peck Dam Specifications, 1933.
18. Merriman, T., *Rock Products*, Jan., 1938, March, 1938; *J. Boston Soc. Civil Eng.*, **26** (1) (1938).
19. Michaelis, W., *Tonind. Zig.*, **16**, 105 (1892).
20. Miller, D. G., Univ. Minnesota, *Paper* 625 (1926).
21. Miller, D. G., *Am. Soc. Testing Materials Rept.*, Com. C-1, 1943.
22. Miller, D. G., and Manson, P. W., *U.S. Dept. Agric. Tech. Bull.* **358** (1933).
23. Miller, D. G., and Manson, P. W., *Proc. Am. Soc. Testing Materials*, **40**, 988 (1940).
24. New York Board of Water Supply, 1937-40.
25. Nitzsche, H., *Z. angew. Chem.*, **32**, 195 (1919).
26. Niven, W. W., Dissertation, Montana State College, 1946.
27. Paul, I., *Proc. Assoc. Highway Officials*, 1936.
28. Powers, T. C., *Proc. Am. Soc. Testing Materials*, **38**, 460 (1938).
29. Rebuffat, O., *Rend. Acad. Sci. (Napoli)*, **11**, 280 (1896).
30. Taylor, W. C., *Res. Reports, PCAF*, 1934-35.
31. Taylor, W. C., *Res. Reports, PCAF*, Feb., June, 1937.
32. Taylor, W. C., *Res. Reports, PCAF*, Sept., 1943.
33. Taylor, W. C., and Bogue, R. H., *Res. Reports, PCAF*, Feb., 1944.
34. Thornvaldson, T., Larmour, R. K., and Vigfusson, V. A., *Eng. J.*, April, 1927.
35. Wolochow, D., *Am. Soc. Testing Materials Rept.* Com. C-1 (1937).

APPENDIX 1

X-Ray Diffraction Patterns of Clinker Components and Compounds*

CaO (7)	SiO ₂ (7)	α-Al ₂ O ₃ (7)	β-Al ₂ O ₃ (6)	γ-Al ₂ O ₃ (6)	MgO (6)	Fe ₂ O ₃ (6)
2.77 s	3.32 ss	3.49 m	2.82 s	2.86 m	2.43 w	2.69 ss
2.40 ss	2.45 w	2.56 s	2.69 ss	2.75 m	2.01 m	2.51 ss
1.700 ss	2.28 w	2.38 m	2.52 s	2.57 ww	1.483 ss	2.20 m
1.450 s	2.12 w	2.09 s	2.42 s	2.45 s	1.266 ss	1.837 ss
1.388 s	1.975 w	1.740 s	2.37 m	2.33 m	1.243 m	1.690 ss
1.201 m	1.815 s	1.603 ss	2.25 s	2.25 m	1.212 s	1.593 m
1.101 m	1.665 w	1.510 w	2.14 s	2.03 s	1.049 m	1.482 s
1.074 s	1.540 m	1.402 m	2.03 s	1.908 w	.963 w	1.448 s
.979 s	1.452 ww	1.374 s	1.936 s	1.800 w	.939 s	1.344 ww
.923 m	1.415 ww	1.234 s	1.834 m	1.624 ww	.856 s	1.307 m
.848 w	1.378 s	1.191 ww	1.743 w	1.541 m	.806 w	1.255 m
.811 m	1.286 w	1.149 ww	1.653 m	1.486 w	.741 m	1.224 w
.799 m	1.255 w	1.122 ww	1.594 s	1.447 w	.698 m	1.186 m
.757 m	1.228 w	1.100 w	1.569 s	1.388 s	.662 m	1.161 m
.723 m	1.199 w	1.078 w	1.484 m		.631 m	1.136 m
.693 ww	1.183 w	1.042 m	1.415 s		.580 m	1.101 m
.672 w	1.154 w	.995 m	1.393 ss		.559 m	1.052 m
.666 w	1.081 w	.933 ww	1.344 s			1.037 ww
.641 w	1.044 ww	.904 w	1.241 m			.987 w
.625 w	1.016 ww	.854 w	1.208 w			.960 m
.582 w	.991 ww	.843 ww	1.170 ww			.952 m
.565 w	.961 ww	.828 w	1.153 ww			.944 w
.553 w	.916 ww	.806 ww	1.132 ww			.907 w
.549 ww	.896 ww	.796 w	1.050 w			.876 m
.535 ww	.815 ww	.761 ww	1.019 w			.853 w
.525 ww	.791 ww	.719 ww	.992 w			.844 m
.522 ww		.686 ww	.967 w			.838 m
.510 ww		.662 ww				.805 w
		.637 ww				.760 m
		.630 ww				
		.616 ww				
		.600 ww				
		.578 ww				
		.564 ww				

C ₂ S (2)	α-C ₂ S (4)	β-C ₂ S (2)	γ-C ₂ S (5)	C ₂ A (3)	C ₂ A ₁ (3)	KC ₂ S ₁₂ (8)
3.02 s	2.81 ss	3.80 w	4.31 w	4.07 m	3.77 m	2.75 ssb
2.940 w	2.70 ss	3.37 w	3.80 w	3.32 w	3.18 m	2.63 w
2.770 ss	2.218 m	3.03 wb	3.35 w	3.03 w	2.98 s	2.29 w
2.730 ss	1.945 s	2.870 w	3.00 s	2.83 w	2.67 ss	2.240 w
2.600 s	1.749 w	2.780 ss	2.88 w	2.77 w	2.55 m	2.185 m
2.435 ww	1.579 m	2.730 ss	2.74 ss	2.69 ss	2.44 s	2.043 m
2.320 m	1.559 m	2.610 s	2.61 w	2.57 ww	2.34 m	1.969 s

* Line intensities are indicated as follows: ss = very strong, s = strong, m = medium, w = weak, ww = very weak, b = broad.

Continued

C ₂ S (2)	α -C ₂ S (4)	β -C ₂ S (2)	γ -C ₂ S (5)	C ₂ A (3)	C ₂ A ₃ (3)	KC ₁₂ S ₁₂ (8)
2.178 s	1.470 m	2.540 w	2.52 w	2.46 ww	2.180 s	1.805 w
1.975 m	1.350 m	2.440 m	2.45 w	2.400 w	2.055 w	1.789 w
1.932 m	1.217 w	2.400 m	2.33 w	2.375 w	1.943 s	1.717 w
1.825 w	1.164 w	2.278 m	2.19 w	2.270 w	1.906 w	1.632 ww
1.762 s		2.182 s	2.04 w	2.200 m	1.846 w	1.593 m
1.627 s		2.080 w	1.970 w	2.135 ww	1.800 ww	1.484 ww
1.542 mb		2.040 w	1.905 s	2.085 w	1.764 w	1.417 ww
1.487 s		2.020 w	1.800 m	2.033 w	1.728 m	1.370 wb
1.458 w		1.980 m	1.752 m	1.981 w	1.694 w	
1.390 ww		1.895 mb	1.690 w	1.947 w	1.660 s	
1.198 w		1.800 m	1.630 m	1.905 s	1.629 m	
1.162 wb		1.755 w	1.523 w	1.821 w	1.599 s	
1.132 wb		1.700 wb	1.490 w	1.785 ww	1.544 w	
1.090 wb		1.632 w	1.472 w	1.731 m	1.520 m	
1.020 ww		1.610 w	1.440 w	1.693 ww	1.493 w	
		1.575 ww	1.405 w	1.669 ww	1.472 m	
		1.548 ww	1.355 w	1.640 w	1.390 s	
		1.528 w	1.255 w	1.611 w	1.353 ww	
		1.482 w	1.235 w	1.554 ss	1.336 w	
		1.447 ww	1.160 w	1.512 ww	1.305 m	
		1.415 w	1.135 m	1.486 w	1.290 ww	
		1.393 ww	1.095 w	1.449 w	1.274 w	
		1.370 w	1.013 w	1.426 ww	1.260 w	
			.960 w	1.404 w	1.234 w	
			.895 w	1.360 w	1.207 w	
			.830 w	1.354 s	1.187 ww	
				1.315 ww	1.171 w	
				1.262 ww	1.140 ww	
				1.231 w	1.110 m	
				1.204 s	1.091 w	
				1.165 w	1.084 w	
				1.155 ww	1.066 w	
				1.099 w	1.057 w	
				1.053 ww	1.048 ww	
				1.034 ww	1.031 w	
				1.017 s	1.017 w	
				.998 ww	.989 ww	
				.966 ww	.968 ww	
				.897 m	.927 w	
				.850 ww	.916 ww	
				.811 ww	.900 ww	
				.777 ww	.890 w	
				.746 ww	.857 ww	
				.726 ww	.846 ww	
				.694 ww		
				.652 ww		
				.620 ww		

MA (6)	MF (6)	C ₂ F (6)	C ₄ AF (6)	KA (1)	NA (3)	NC ₂ A ₂ (3)
2.84 s	2.95 m	2.69 ss	2.77 s	3.07 ww	2.94 s	3.37 w
2.43 ss	2.52 ss	2.07 w	2.63 ss	2.72 ss	2.68 s	3.03 w
2.02 ss	2.17 m	1.940 ss	2.54 ww	2.59 w	2.60 ss	2.68 ss
1.644 m	1.706 m	1.840 s	2.43 ww	2.48 w	2.55 ss	2.60 w
1.551 ss	1.606 s	1.740 w	2.19 m	2.395 w	2.38 w	2.53 w
1.423 ss	1.476 ss	1.655 w	2.15 m	2.315 m	2.22 ww	2.41 w
1.362 w	1.322 w	1.585 s	2.03 s	2.215 w	2.145 w	2.37 w
1.274 w	1.274 w	1.558 m	1.921 ss	2.000 w	1.983 ww	2.20 s
1.231 m	1.116 w	1.523 m	1.853 m	1.918 m	1.950 m	2.10 w
1.166 m	1.089 m	1.475 w	1.808 s	1.567 s	1.869 m	2.03 w
1.131 w	1.044 w	1.330 m	1.728 m	1.488 ww	1.805 w	1.915 s
1.079 m	.965 w	1.170 m	1.572 s	1.348 m	1.762 m	1.888 s
1.050 s	.876 w	1.140 w	1.532 s	1.214 s	1.599 s	1.840 ww
1.008 w	.853 w	1.087 w	1.492 m	1.109 w	1.523 w	1.797 ww
.949 w	.806 w	1.010 w	1.448 m	1.025 m	1.497 s	1.746 w
.930 m		.973 w	1.415 m	.906 w	1.471 w	1.692 wb
.901 m		.945 ww	1.385 m	.860 m	1.458 s	1.628 w
.844 m		.894 ww	1.357 m	.820 w	1.415 m	1.558 ss
.822 s		.871 ww	1.339 m	.754 w	1.362 s	1.492 w
.780 m			1.317 s		1.302 w	1.347 m
.712 w			1.207 s		1.283 w	1.235 w
.647 w			1.154 m		1.176 ww	1.210 m
.636 w			1.130 m		1.119 m	1.103 w
.615 w			1.098 m		1.065 ww	1.101 w
			1.074 m		1.048 m	1.055 w
			1.039 ww		1.028 ww	1.019 mb
			1.002 s		1.010 w	.899 w
			.981 ww		.980 ww	
			.966 w		.975 ww	
					.955 w	
					.918 ww	
					.910 ww	
					.880 ww	
					.805 ww	
					.782 ww	
					.762 ww	

References

1. Brownmiller, L. T., *Am. J. Sci.*, **26**, 260 (1935); PCAF Paper 30.
2. Brownmiller, L. T. and Bogue, R. H., *Am. J. Sci.*, **20**, 241 (1930); PCAF Paper 24.
3. Brownmiller, L. T. and Bogue, R. H., *Am. J. Sci.*, **23**, 501 (1932); PCAF Paper 25.
4. Greene, K. T., *J. Res. NBS.*, **32**, 1 (1944); RP 1570; PCAF Paper 45.
5. Hansen, W. C., *J. Am. Ceramic Soc.*, **11**, 68 (1928); PCAF Paper 12.
6. Hansen, W. C. and Brownmiller, L. T., *Am. J. Sci.*, **15**, 225 (1928); PCAF Paper 14.
7. Harrington, E. A., *Am. J. Sci.*, **13**, 467 (1927); PCAF Paper 8.
7. McMurdie, H. F., in paper by Taylor, W. C., *J. Res. NBS.*, **27**, 317 (1941); RP 14 21; PCAF Paper 40.

APPENDIX 2

X-Ray Diffraction Patterns of Cement Hydration Products

Ca(OH) ₂ (5)	CSH (7)	Afwillite C ₃ S ₂ H ₃ (7)	C ₂ S ₂ H ₂ (7)	Hillebrandite C ₂ SH (7)
3.11 m	6.13 ww	6.5 s	4.30 m	12.6 s
2.62 ss	4.52 w	5.06 m	3.68 w	4.77 m
1.930 s	4.24 w	4.68 w	3.45 w	4.05 ww
1.795 ss	3.80 ww	4.18 w	3.39 ww	3.52 ww
1.685 m	3.58 w	3.76 ww	3.22 m	3.34 m
1.555 w	3.21 m	3.17 ss	3.10 ss	3.01 m
1.480 m	3.01 ss	3.05 ww	2.98 w	2.92 ss
1.455 m	2.78 m	2.85 ss	2.94 ww	2.83 ww
1.312 m	2.50 m	2.74 s	2.86 w	2.75 ww
1.175 ww	2.23 s	2.66 w	2.73 w	2.68 ww
1.144 m	2.116 ww	2.59 w	2.64 w	2.62 ww
1.128 w	2.013 w	2.44 ww	2.58 w	2.45 ww
1.601 m	1.893 s	2.36 m	2.253 s	2.373 m
1.038 w	1.868 ww	2.83 ww	2.066 s	2.247 m
1.013 w	1.808 ww	2.275 ww	2.034 w	2.056 w
.954 w	1.772 m	2.159 m	1.987 ww	1.963 m
.898 w	1.632 ww	2.065 ww	1.943 m	1.928 w
.883 ww	1.601 w	2.026 w	1.897 ww	1.864 m
.861 ww		1.988 w	1.833 w	1.812 m
.848 ww		1.955 m	1.792 w	1.747 w
.814 ww		1.924 w	1.756 w	
.790 ww		1.868 w	1.699 s	
.760 ww		1.808 m		
.739 ww		1.782 m		
.711 ww		1.735 ww		
.684 ww		1.705 w		
.670 ww		1.679 w		
.654 ww		1.629 w		
.618 ww		1.606 m		
.595 ww		1.596 m		
.582 ww		1.564 w		

C_2SH_7 (7) Preparation (B), $n = 1.60$	C_2SH_7 (7) Preparation (C), $n = 1.64$	$C_{10}S_4H_6$ (7) Preparation (A)	$C_6S_3H_2$ (7) Preparation (D)	C_2SH_4 (8)
4.83 w	4.22 w	5.33 ww	6.64 w	3.02 ss
4.26 m	3.82 ww	4.18 s	4.63 w	2.77 w
3.55 w	3.04 ss	3.91 w	4.24 w	2.46 w
3.38 w	2.84 m	3.53 m	3.79 w	2.29 w
3.28 w	2.70 s	3.27 s	3.39 ww	2.09 m
3.05 s	2.47 m	3.05 ww	3.30 ww	1.92 w
2.93 ss	3.35 w	2.89 m	3.23 ww	1.87 w
2.42 ww	1.897 s	2.80 m	3.06 s	1.82 w
2.40 w	1.850 w	2.72 w	2.96 m	1.65 w
2.24 w	1.799 m	2.66 w	2.85 s	1.58 w
2.07 w	1.732 w	2.59 w	2.81 ss	1.52 w
1.963 m	1.656 m	2.51 ww	2.71 s	
1.875 m	1.540 w	2.41 s	2.607 m	
1.819 m	1.264 m	2.32 ww	2.535 s	
1.637 w	1.170 w	2.24 w	2.455 w	
	1.156 w	2.15 w	2.404 ww	
		2.05 wb	2.349 ww	
		1.98 ww	2.275 s	
		1.950 w	2.22 m	
		1.915 m	2.169 w	
		1.833 w	2.140 m	
		1.780 s	1.987 m	
		1.730 m	1.951 ww	
		1.706 m	1.928 ww	
		1.649 s	1.901 ww	
			1.738 w	
			1.708 m	
			1.670 w	
			1.634 m	
			1.421 w	
			1.460 w	
			1.270 m	

C_3SH_2 (7)	AH (6)	Gibbsite $\gamma\text{-AH}_2$ (1)	Bayerite $\alpha\text{-AH}_2$ (4)	Isometric C_3AH_6 (9)
8.8 m	6.0 ss	4.83 ss	4.82 ss	5.13 s
3.32 m	3.14 ss	4.35 ss	4.37 s	4.45 s
3.03 m	2.81 ww	3.24 m	3.20 s	3.36 s
2.91 ss	2.34 ss	3.30 m	2.68 ww	3.14 s
2.83 m	1.978 w	3.20 m	2.46 m	2.814 ss
2.47 w	1.850 ss	3.12 w	2.37 w	2.68 ww
2.17 ww	1.765 w	2.84 ww	2.23 ss	2.57 w
2.088 m	1.655 m	2.73 ww	2.08 ww	2.47 m
2.026 ww	1.523 m	2.66 ww	1.99 ww	2.30 ss
1.996 w	1.445 s	2.46 s	1.73 s	2.04 ss
1.879 s	1.382 m	2.43 ww	1.65 ww	1.99 ww
1.769 s	1.307 s	2.39 s	1.61 ww	1.815 w
1.696 m	1.210 w	2.34 ww	1.565 w	1.742
1.667 ww	1.175 w	2.29 w	1.46 m	1.710 w
1.632 w	1.156 w	2.25 m	1.395 w	1.679 s
1.573 m	1.131 w	2.16 m	1.340 m	1.595 m
1.506 w	1.110 ww	2.08 ww	1.285 ww	1.572 m
1.438 w	1.050 ww	2.04 s	1.265 ww	1.484 w
1.366 w	1.018 ww	1.99 s		1.407 s
		1.96 ww		1.372 m
		1.91 m		1.342 m
		1.80 s		1.298 w
		1.745 s		1.283 w
		1.680 s		1.244 w
		1.650 w		1.199 m
		1.630 ww		1.167 m
		1.590 w		1.148 m
		1.570 w		1.120 m
		1.555 ww		1.086 w
		1.530 ww		1.048 w
		1.505 ww		1.020 m
		1.485 ww		
		1.455 s		
		1.445 m		
		1.410 m		
		1.398 m		
		1.377 w		
		1.360 w		
		1.327 w		
		1.313 m		
		1.295 ww		
		1.270 ww		
		1.262 ww		
		1.250 ww		

Isometric C_2FH_6 (2)	Hexagonal C_2AH_6 (9)	C_2AH_6 (10)	C_2AH_{10} (10)	Ettringite $C_2A_3CaSO_4 \cdot 31H_2O$ (8)
5.20 m	2.86 s	10.6 ss	8.2 ss	9.3 s
4.54 s	2.70 w	5.3 s	4.1 m	7.23 w
3.40 w	2.47 ss	3.55 m	3.9 m	5.66 m
3.19 s	2.31 w	2.87 s	2.9 m	5.02 w
2.85 s	2.14 w	2.69 w	2.73 w	4.68 w
2.72 ww	1.970 ww	2.54 w	2.64 ww	4.26 ww
2.60 m	1.865 m	2.48 m	2.55 ww	3.92 m
2.50 ww	1.655 ss	2.11 w	2.45 m	3.03 m
2.326 m	1.622 ww	1.955 w	2.37 w	2.81 m
2.069 m	1.532 ww	1.835 w	2.31 ww	2.57 m
1.988 w	1.430 m	1.667 m	2.24 m	2.226 m
1.881 ww	1.370 w	1.591 w	2.06 w	2.155 w
1.801 ww	1.080 m	1.443 m	2.000 w	1.967 ww
1.766 m			1.951 ww	1.850 w
1.728 w			1.766 w	1.673 w
1.702 ss			1.670 m	1.586 ww
1.615 ww			1.637 w	1.547 w
1.590 w			1.554 ww	1.515 ww
1.500 w			1.500 ww	
1.425 m			1.475 ww	
1.391 ww			1.400 w	

References

1. Bessey, G. E., in paper by Jones, F. E., *J. Phys. Chem.*, **48**, 318 (1944).
2. Flint, E. P., McMurdie, H. F. and Wells, L. S., *J. Res. NBS.*, **26**, 13 (1941); RP 1355.
3. Forsen, L., *Symposium*, 390.
4. Frick, R., *Z. anorg. Chem.*, **175**, 249 (1928); **179**, 287 (1929); in paper by Jones, F. E., *J. Phys. Chem.*, **48**, 318 (1944).
5. Harrington, E. A., *Am. J. Sci.*, **13**, 467 (1927); PCAF Paper 8.
6. Mather, D. T. and Thorvaldson, T., *Can. J. Res.*, **15**, 331 (1937).
7. McMurdie, H. F. and Flint, E. P., *J. Res. NBS.*, **31**, 225 (1943); RP 1560.
8. McMurdie, H. F., Unpublished data.
9. Thornvaldson, T., Grace, N. S. and Vigfusson, V. A., *Can. J. Res.*, **1**, 201 (1929).
10. Wells, L. S., Clarke, W. F. and McMurdie, H. F., *J. Res. NBS.*, **30**, 367 (1943); RP 1539.

APPENDIX 3

Equations for Calculating Phase Composition of Clinker

(L. A. Dahl, *PCA Res. Bull.*, 1, 1939. See pages 200-203)

The equations for calculating the phase composition of clinker are given below. The symbols A, B, C, and D represent potential percentages of C_2S , C_3S , C_4A , and C_4AF , respectively, in any mixture under consideration in the system $CaO-Al_2O_3-Fe_2O_3-SiO_2$. L is liquid, G is glass. Where $MgO(M)$ is to be considered, the estimated percentage of glass containing MgO is not G, but may be designated P. Then if M is greater than 0.06P, $G = 0.94P$, and free $MgO = M - 0.06P$. If M is less than 0.06P, $G = P - M$, and free $MgO = 0$.

TABLE A. *Potential composition, equilibrium crystallization*

(1) System $C_2S-C_3S-C_4A-C_4AF$

$$C_2S = 4.0710CaO - 7.6024SiO_2 - 1.4297Fe_2O_3 - 6.7187Al_2O_3$$

$$C_3S = 8.6024SiO_2 + 1.0785Fe_2O_3 + 5.0683Al_2O_3 - 3.0710CaO \text{ which is the same as } 2.8675SiO_2 - 0.7544C_2S$$

$$C_4A = 2.6504Al_2O_3 - 1.6920Fe_2O_3$$

$$C_4AF = 3.0432Fe_2O_3$$

(2) System $CaO-C_2S-C_3A-C_4AF$

$$CaO = CaO - 2.8012SiO_2 - 0.3512Fe_2O_3 - 1.6504Al_2O_3$$

$$C_2S = 3.8012SiO_2$$

$$C_3A = 2.6504Al_2O_3 - 1.6920Fe_2O_3$$

$$C_4AF = 3.0432Fe_2O_3$$

(3) System $C_2S-C_3A-C_4A-C_4AF$

$$C_2S = 2.8675SiO_2$$

$$C_3A = 3.6133CaO - 6.7478SiO_2 - 3.3130Al_2O_3 - 2.9610Fe_2O_3$$

$$C_4A = 4.8803SiO_2 + 4.3130Al_2O_3 + 0.9178Fe_2O_3 - 2.6133CaO$$

$$C_4AF = 3.0432Fe_2O_3$$

TABLE B. *Classification key*

System $C_2S-C_3S-C_4A-C_4AF$

	Type
C/D exceeds 0.64	
B/D exceeds 0.32	
C/D exceeds 3.33	
B/D exceeds 2.40	
B/C exceeds 0.72	A-1
B/C less than 0.72	A-2
B/D less than 2.40	A-2
C/D less than 3.33	
B exceeds 0.77C - 0.17D	A-1
B less than 0.77C - 0.17D	A-2
B/D between 0.28 and 0.32	C-2
B/D less than 0.28	C-4
C/D less than 0.64	
B/C exceeds 0.50	B
B/C between 0.43 and 0.50	C-1
B/C less than 0.43	C-3

TABLE C. Equations for calculating phase composition during the process of fusion, and the products of complete independent crystallization

Type	Series	At equilibrium	Independent crystallization	Approx. temp.
Liquid at T_2 (1338°)				
A-1	1	$C_2S = A - 0.03D$ $C_2S = B - 0.32D$		
A-2		$C_2A = C - 0.64D$ Liquid = 1.99D		
B	2	$C_2S = A - 0.04C$ $C_2S = B - 0.50C$ $C_4AF = D - 1.56C$ Liquid = 3.10C		
C-1	3	$C_2S = A - 0.08B$		
C-2		$C_2A = C - 1.99B$		
C-3		$C_4AF = D - 3.11B$		
C-4		Liquid = 6.18B		
Liquid arriving at T_1 from line T_1T_2 . (1341°C.)				
C-3	4	$C_2S = A - 0.27B$		
C-4		$C_2A = C - 2.33B$ $C_4AF = D - 3.63B$ Liquid = 7.23B		
Liquid leaving T_1 on line T_1X . (1341°C.)				
C-3	5	$CaO = 0.14C - 0.33B$ $C_2S = A + 1.33B - 0.68C$ $C_4AF = D - 1.56C$ Liquid = 3.10C	$CaO = 0.14C - 0.33B$ $C_2S = A + 1.33B - 0.57C$ $C_2S = 0.43C$ $C_2A = C$ $C_4AF = D$	
Liquid leaving T_1 on line T_1D . (1341°C.)				
C-4	6	$CaO = 0.09D - 0.33B$ $C_2S = A + 1.33B - 0.44D$ $C_2A = C - 0.64D$ Liquid = 1.99D	$CaO = 0.09D - 0.33B$ $C_2S = A + 1.33B - 0.37D$ $C_2S = 0.28D$ $C_2A = C$ $C_4AF = D$	
Liquid leaving T_2E to follow C_2S - C_2S surface				
A-1	7	$C_2S = A + 0.65C - 0.44D$ $C_2S = B + 0.17D - 0.77C$ Liquid = 1.12C + 1.27D		$1436 - \frac{195D}{L}$

TABLE C. (Continued)

Type	Series	At equilibrium	Independent crystallisation	Approx. temp.	
Liquid leaving T_1E to follow C_2S-C_3S surface. (Continued)					
A-1	C/D 0.68 to 3.33	8	$C_2S = A + 0.65C$ $- 0.44D$ $C_2S = B + 0.17D$ $- 0.77C$ Liquid = 1.12C $+ 1.27D$	$C_2S = A + 0.65C$ $- 0.45D$ $C_2S = B + 0.34D$ $- 0.49C$ $C_3A = 0.42C - 0.40D$ $C_3A_2 = 0.42C - 0.29D$ $C_4AF = D$	1436 - $\frac{195D}{L}$
		A-1	More than 3.33	9	$C_2S = A + 0.58C$ $- 0.19D$ $C_2S = B - 0.72C$ Liquid = 1.14C $+ 1.19D$
Liquid leaving T_2E to follow C_3S-C_3A surface					
A-2	B/D 0.32 to 0.35	10	$C_3S = A + 0.85B$ $- 0.30D$ $C_3A = C - 1.30B$ $- 0.23D$ Liquid = 1.45B $+ 1.53D$		1436 - $\frac{195D}{L}$
		A-2	0.35 to 2.40	11	$C_3S = A + 0.85B$ $- 0.30D$ $C_3A = C - 1.30B$ $- 0.23D$ Liquid = 1.45B $+ 1.53D$
A-2	More than 2.40			12	$C_3S = A + 0.80B$ $- 0.19D$ $C_3A = C - 1.39B$ $- 0.01D$ Liquid = 1.59B $+ 1.20D$
		Liquid leaving T_2W to follow C_3S-C_3S surface			
B	C/D 0.0 to 0.10	13	$C_2S = A + 0.11C$ $- 0.30D$ $C_2S = B + 0.01D$ $- 0.12C$ Liquid = 1.01C + 1.29D	$CaO = 0.004D - 0.04C$ $C_2S = A + 0.16C$ $- 0.016D$ $C_2S = B + 0.012D$ $- 0.12C$ $C_3A = C$ $C_4AF = D$	1320 + $\frac{36D}{L}$

TABLE C. (Continued)

Type	Series	At equilibrium	Independent crystallization	Approx. temp.	
Liquid leaving T_1W to follow C_2S-C_3S surface (Continued)					
B	C/D 0.10 to 0.34	14	$C_2S = A + 0.33C$ $- 0.32D$ $C_3S = B - 0.40C$ $+ 0.04D$ Liquid = 1.07C $+ 1.28D$		$1320 + \frac{36D}{L}$
	0.34 to 0.64	15	$C_2S = A + 0.60C$ $- 0.41D$ $C_3S = B + 0.15D$ $- 0.74C$ Liquid = 1.14C $+ 1.26D$		$1320 + \frac{36D}{L}$
Liquid on 1400° isotherm, C_2S-C_3S surface*					
B	C/D 0.0 to 0.26	16	$C_2S = A + 0.15C$ $- 0.42D$ $C_3S = B + 0.05D$ $- 0.19C$ Liquid = 1.04C $+ 1.37D$	$CaO = 0.016D - 0.06C$ $C_2S = 0.25C - 0.065D$ $C_3S = 0.049D - 0.19C$ $C_2A = C$ $C_4AF = D$	
	0.26 to 0.64	17	$C_2S = A + 0.62C$ $- 0.54D$ $C_3S = B + 0.20D$ $- 0.76C$ Liquid = 1.14C $+ 1.34D$		
A-1	0.64 to 0.86	18	$C_2S = A + 0.66C$ $- 0.57D$ $C_3S = B + 0.21D$ $- 0.77C$ Liquid = 1.11C $+ 1.36D$		
A-1	0.86 to 3.33	19	$C_2S = A + 0.66C$ $- 0.57D$ $C_3S = B + 0.21D$ $- 0.77C$ Liquid = 1.11C $+ 1.36D$	$C_2S = A + 0.66C$ $- 0.57D$ $C_3S = B + 0.43D$ $- 0.50C$ $C_2A = 0.41C + 0.51D$ $C_3A_2 = 0.43C - 0.37D$ $C_4AF = D$	

* The percentage of C_2S should be calculated first. If a negative value is obtained, the liquid has passed from the C_2S-C_3S surface at a temperature below 1400°.

TABLE C. (Continued)

Type	Series	At equilibrium	Independent crystallisation	Approx. temp.	
Liquid on 1400° isotherm, C ₃ S-C ₂ S surface* (Continued)					
A-I	C/D 3.33 to 4.71	20	$C_3S = A + 0.67C$ $- 0.62D$ $C_2S = B + 0.22D$ $- 0.77C$ Liquid = 1.10C $+ 1.40D$	$C_3S = A + 0.67C$ $- 0.62D$ $C_2S = B + 0.47D$ $- 0.51C$ $C_3A = 0.40C + 0.55D$ $C_3A_2 = 0.44C - 0.40D$ $C_4AF = D$	
Liquid on 1450° isotherm C ₃ S-C ₂ S surface†					
B	C/D 0.0 to 0.16	21	$C_3S = A + 0.48C$ $- 0.54D$ $C_2S = B - 0.64C$ $+ 0.11D$ Liquid = 1.16C $+ 1.43D$	$C_3O = -0.21C$ $+ 0.03D$ $C_3S = A + 0.85C$ $- 0.14D$ $C_2S = B - 0.64C$ $+ 0.11D$ $C_3A = C$ $C_4AF = D$	
B	C/D 0.16 to 0.64	22	$C_3S = A + 0.48C$ $- 0.54D$ $C_2S = B - 0.64C$ $+ 0.11D$ Liquid = 1.16C $+ 1.43D$		
A-I	C/D 0.64 to 1.03	23	$C_3S = A + 0.60C$ $- 0.61D$ $C_2S = B - 0.72C$ $+ 0.16D$ Liquid = 1.12C $+ 1.45D$		
A-I	C/D 1.03 to 3.33	24	$C_3S = A + 0.60C$ $- 0.61D$ $C_2S = B - 0.72C$ $+ 0.16D$ Liquid = 1.12C $+ 1.45D$	$C_3S = A + 0.60C$ $- 0.61D$ $C_2S = B - 0.45C$ $+ 0.46D$ $C_3A = +0.47C$ $+ 0.54D$ $C_3A_2 = +0.38C$ $- 0.39D$ $C_4AF = D$	

* The percentage of C₂S should be calculated first. If a negative value is obtained, the liquid has passed from the C₃S-C₂S surface at a temperature below 1400°.

† The percentage of C₃S at equilibrium should be calculated first. If a negative value is obtained, the liquid has passed from the C₃S-C₂S surface at a temperature below 1450°.

TABLE C. (Continued)

Type	Series	At equilibrium	Independent crystallisation	Approx. temp.
Liquid on 1450° isotherm, C ₂ S-C ₂ S surface* (Continued)				
A-1	C/D 3.33 to 12.50	25 C ₂ S = A + 0.64C - 0.73D C ₂ S = B - 0.75C + 0.24D Liquid = 1.11C + 1.49D	C ₂ S = A + 0.64C - 0.73D C ₂ S = B - 0.48C + 0.55D C ₂ A = +0.43C + 0.65D C ₂ A ₂ = +0.41C - 0.47D C ₄ AF = D	
Liquid leaving C ₂ S-C ₂ A surface to follow T ₁ D				
A-2 C-2	B/D 0.28 to 0.37	26 C ₂ S = A + 0.79B - 0.29D C ₂ A = C - 1.66B - 0.18D Liquid = 1.87B + 1.47D		1416 - $\frac{149D}{L}$
A-2 C-2	0.37 to 1.88	27 C ₂ S = A + 0.79B - 0.29D C ₂ A = C - 1.66B - 0.18D Liquid = 1.87B + 1.47D	C ₂ S = A + 0.79B - 0.29D C ₂ S = 0.40B + 0.22D C ₂ A = C + 0.26D - 0.70B C ₂ A ₂ = 0.51B - 0.19D C ₄ AF = D	1462 - $\frac{248D}{L}$
A-2 C-2	More than 1.88	28 C ₂ S = A + 0.72B - 0.17D C ₂ A = C + 0.14D - 1.83B Liquid = 2.11B + 1.03D	C ₂ S = A + 0.72B - 0.17D C ₂ S = 0.46B + 0.13D C ₂ A = C + 0.15D - 0.64B C ₂ A ₂ = 0.46B - 0.11D C ₄ AF = D	1470 - $\frac{290D}{L}$
Liquid leaving C ₂ S-C ₄ AF surface to follow T ₁ X				
C-1	B/C 0.0 to 0.43	29 C ₂ S = A + 2.69B - 1.27C C ₄ AF = D + 6.23B - 4.23C Liquid = 6.50C - 7.92B		1347 - $\frac{18C}{L}$

* The percentage of C₂S at equilibrium should be calculated first. If a negative value is obtained, the liquid has passed from the C₂S-C₂S surface at a temperature below 1450.

TABLE C. (Continued)

Type	Series	At equilibrium	Independent crystallisation	Approx. temp.	
Liquid leaving T_1D or T_1X to follow $CaO-C_2S$ surface					
C-1 } C-3 } C-4 }	C/D 0.24 to 0.64	30	$CaO = 0.22C - 0.33B$ $- 0.05D$ $C_2S = A + 1.33B$ $- 0.34C - 0.22D$ Liquid = 1.12C $+ 1.27D$	$CaO = 0.22C - 0.33B$ $- 0.05D$ $C_2S = A + 1.33B$ $+ 0.21D - 0.90C$ $C_2S = 0.68C - 0.16D$ $C_1A = C$ $C_4AF = D$	$1328 + \frac{25D}{L}$
	A-2 } C-2 } C-4 } 0.64 to 0.80	31	$CaO = 0.19C - 0.33B$ $- 0.04D$ $C_2S = A + 1.33B$ $- 0.32C - 0.23D$ Liquid = 1.13C $+ 1.27D$	$CaO = 0.20C - 0.33B$ $- 0.04D$ $C_2S = A + 1.33B$ $+ 0.15D - 0.80C$ $C_2S = 0.60C - 0.11D$ $C_1A = C$ $C_4AF = D$	$1416 - \frac{149D}{L}$
	A-2 } C-2 } C-4 } 0.80 to 3.33	32	$CaO = 0.19C - 0.33B$ $- 0.04D$ $C_2S = A + 1.33B$ $- 0.32C - 0.23D$ Liquid = 1.13C $+ 1.27D$	$CaO = 0.19C - 0.33B$ $- 0.04D$ $C_2S = A + 1.33B$ $- 0.32C - 0.23D$ $C_2S = 0.24C + 0.17D$ $C_1A = 0.58C + 0.34D$ $C_2A_2 = 0.31C - 0.24D$ $C_4AF = D$	$1462 - \frac{248D}{L}$
A-2 } C-2 } C-4 } More than 3.33	33	$CaO = 0.18C + 0.02D$ $- 0.33B$ $C_2S = A + 1.33B$ $- 0.33C - 0.21D$ Liquid = 1.15C $+ 1.19D$	$CaO = 0.18C + 0.02D$ $- 0.33B$ $C_2S = A + 1.33B$ $- 0.33C - 0.21D$ $C_2S = 0.25C + 0.16D$ $C_1A = 0.65C + 0.10D$ $C_2A_2 = 0.25C - 0.07D$ $C_4AF = D$	$1470 - \frac{290D}{L}$	

TABLE D. Equations for calculating phase composition of clinker with an estimated glass content. Normal crystallization

Type A-1 (C_4AF the disappearing phase)

Series

Group 1. Crystallization at T_2 Equations to be applied when glass content is less than the quantity of liquid present when C_4AF disappears, as indicated in Groups 2 to 5.

$$C_2S = A - 0.014G$$

$$C_2S = B - 0.162G$$

$$C_1A = C - 0.322G$$

$$C_4AF = D - 0.502G$$

34

TABLE D. (Continued)

Group 2. C/D between 0.64 and 3.33

Series

(a) G less than 1.99D

Use equations in Group 1

(b) G between 1.99D and (1.12C + 1.27D)

$$C_1S = A - 1.19D + 0.58G$$

$$C_2S = B + 1.05D - 0.69G$$

$$C_1A = C + 1.14D - 0.89G$$

35

(c) G between (1.12C + 1.27D) and (1.11C + 1.37D)

$$C_1S = A + \frac{17.06C + 10.15D - 10.82G}{8.10 - C/D} - \frac{0.16C - 0.07G}{D/C - 0.12}$$

$$C_2S = B + \frac{0.05G + 0.04C}{D/C - 0.12} - \frac{9.96C + 2.05D - 2.72G}{8.10 - C/D}$$

36

(d) G between (1.11C + 1.37D) and (1.13C + 1.46D)

$$C_1S = A + \frac{10.25C + 0.43D - 2.46G}{C/D + 5.13} - \frac{0.67G - 0.87C}{D/C + 0.19}$$

$$C_2S = B + \frac{0.48G - 0.68C}{D/C + 0.19} - \frac{4.12C + 2.67G - 4.70D}{C/D + 5.13}$$

37

Group 3. C/D between 3.33 and 4.71

(a) G less than 1.99D

Use equations in Group 1

(b) G between 1.99D and 5.00D

$$C_1S = A - 1.19D + 0.58G$$

$$C_2S = B + 1.05D - 0.69G$$

$$C_1A = C + 1.14D - 0.89G$$

38

(c) G between 5.00D and (1.14C + 1.19D)

$$C_1S = A - 0.80D + 0.50G$$

$$C_2S = B + 0.76D - 0.63G$$

$$C_1A = C + 1.04D - 0.87G$$

39

(d) G between (1.14C + 1.19D) and (1.10C + 1.40D)

$$C_1S = A + \frac{10.62C + 9.85D - 9.00G}{4.49 - C/D} - \frac{0.65C - 0.46G}{D/C - 0.22}$$

$$C_2S = B + \frac{0.43C - 0.24G}{D/C - 0.22} - \frac{7.13C + 5.36D - 4.51G}{4.49 - C/D}$$

40

(e) G between (1.10C + 1.40D) and (1.11C + 1.49D)

$$C_1S = A + \frac{0.61C - 0.43G}{D/C + 0.20} + \frac{13.02C + 6.14D - 6.59G}{C/D + 5.02}$$

$$C_2S = B - \frac{0.41C - 0.23G}{D/C + 0.20} - \frac{7.00C + 1.12D - 1.57G}{C/D + 5.02}$$

41

Group 4. C/D between 4.71 and 12.50

(a) G less than (1.14C + 1.19D)

Use equations in Group 3 appropriate for the estimated value of G.

(b) G between (1.14C + 1.19D) and (1.11C + 1.49D)

$$C_1S = A + \frac{25.34C + 20.36D - 18.79G}{10.47 - C/D} - \frac{0.28C - 0.19G}{D/C - 0.10}$$

$$C_2S = B + \frac{0.18C - 0.09G}{D/C - 0.10} - \frac{15.87C + 9.89D - 8.32G}{10.47 - C/D}$$

42

TABLE D. (Continued)

	Series
Group 5. C/D greater than 12.50	
(a) G less than 5.00D	
Use equations in Group 3 appropriate for the estimated value of G.	
(b) G between 5.00D and (1.14C + 1.19D)	
Use equations in Series 39.	

TABLE E. Equations for calculating phase compositions of clinker with an estimated glass content. Normal crystallization

	Series
Type B (C ₁ A the disappearing phase)	
Group 6. Crystallization at T ₂	
Equations to be applied when glass content is less than the quantity of liquid present when C ₁ A disappears, as indicated in groups 7 to 10	
C ₂ S = A - 0.014G	43
C ₂ S = B - 0.162G	
C ₃ A = C - 0.322G	
C ₄ AF = D - 0.502G	
Group 7. C/D less than 0.10	
(a) G less than 3.10C	
Use equations in Group 6.	
(b) G between 3.10C and 4.88C	
C ₁ S = A + 0.98C - 0.23G	44
C ₂ S = B - 0.88C + 0.01G	
C ₄ AF = D + 0.90C - 0.78G	
(c) G between 4.88C and 13.91C	
C ₁ S = A + 0.60C - 0.25G	45
C ₂ S = B - 0.43C + 0.03G	
C ₄ AF = D + 0.83C - 0.78G	
(d) G between 13.91C and (1.01C + 1.29D)	
C ₁ S = A + 0.34C - 0.23G	46
C ₂ S = B - 0.13C + 0.01G	
C ₄ AF = D + 0.79C - 0.78G	
(e) G between (1.01C + 1.29D) and (1.04C + 1.37D)	
C ₁ S = A + $\frac{0.43G - 0.40C}{D/C + 0.36} - \frac{4.09G - 2.59C - 4.43D}{C/D + 2.81}$	47
C ₂ S = B + $\frac{1.28G + 1.22C - 1.62D}{C/D + 2.81} - \frac{0.79G - 0.76C}{D/C + 0.36}$	
(f) G between (1.04C + 1.37D) and (1.16C + 1.43D)	
C ₁ S = A + $\frac{5.14G - 5.10C}{D/C + 1.78} - \frac{1.04G + 3.21C - 1.19D}{C/D + 0.56}$	48
C ₂ S = B + $\frac{0.48G + 4.77C - 0.63D}{C/D + 0.56} - \frac{6.92G - 6.88C}{D/C + 1.78}$	
Group 8 C/D between 0.10 and 0.26	
(a) G less than 4.88C	
Use equations in Group 7 appropriate for the estimated value of G	
(b) G between 4.88C and (1.07C + 1.28D)	
Use equations in series 45.	

TABLE E. (Continued)

	Series
(c) G between (1.07C + 1.28D) and (1.04C + 1.37D)	
$C_2S = A + \frac{13.65C + 3.43D - 3.46G}{3.13 - C/D} - \frac{2.14G - 2.19C}{D/C - 0.32}$	49
$C_2S = B + \frac{2.46G - 2.51C}{D/C - 0.32} - \frac{11.52C + 0.30D - 0.33G}{3.13 - C/D}$	
(d) G between (1.04C + 1.37D) and (1.16C + 1.43D)	
$C_2S = A + \frac{5.14G - 5.10C}{D/C + 1.78} - \frac{1.04G + 3.21C - 1.19D}{C/D + 0.56}$	50
$C_2S = B + \frac{0.48G + 4.77C - 0.63D}{C/D + 0.56} - \frac{6.92G - 6.88C}{D/C + 1.78}$	
Group 9. C/D between 0.26 and 0.34	
(a) G less than 4.88C	
Use equations in Group 7 appropriate for the estimated value of G.	
(b) G between 4.88C and (1.07C + 1.28D)	
Use equations in series 45	
(c) G between (1.07C + 1.28D) and (1.14C + 1.34D)	
$C_2S = A + \frac{4.74G - 4.69C}{D/C + 1.18} - \frac{3.09G + 1.91C - 3.68D}{C/D + 0.85}$	51
$C_2S = B + \frac{2.24G + 3.76C - 2.83D}{C/D + 0.85} - \frac{5.92G - 5.87C}{D/C + 1.18}$	
(d) G between (1.14C + 1.34D) and (1.50C + 1.45D)	
$C_2S = A + \frac{0.14G + 12.48C - 2.96D}{C/D + 5.10} - \frac{1.47G - 1.80C}{D/C + 0.20}$	52
$C_2S = B + \frac{1.27G - 1.60C}{D/C + 0.20} - \frac{5.24G + 6.38C - 8.06D}{C/D + 5.10}$	
Group 10. C/D between 0.34 and 0.64	
(a) G less than 3.10C	
Use equations in Group 6.	
(b) G between 3.10C and (1.14C + 1.26D)	
Use equations in series 44.	
(c) G between (1.14C + 1.26D) and (1.14C + 1.34D)	
$C_2S = A + \frac{1.80G - 2.00C}{10D/C + 0.10} - \frac{1.60G - 2.22C - 1.58D}{C/100D + 1.05}$	53
$C_2S = B + \frac{0.55G - 1.16C - 0.53D}{C/100D + 1.05} - \frac{1.90G - 2.10C}{10D/C + 0.10}$	
(d) G between (1.14C + 1.34D) and (1.50C + 1.45D)	
Use equations in Series 52.	

TABLE F. Equations for calculating phase composition of clinker with an estimated glass content. Partial independent crystallization

	Series
Type A-1. (C_4AF the phase disappearing at T_2)	
Group 11. Independent crystallization from 1338°	
G less than 1.99D. Glass on RT_1 .	
$C_2S = A - 0.027D$	54
$C_2S = B + 0.020D - 0.172G$	
$C_2A = C + 0.013D - 0.329G$	
$C_4AF = 0.994D - 0.499G$	

TABLE F. (Continued)

	Series
Group 12. Independent crystallization from 1400°. C/D between 0.86 and 3.33	
(a) G less than (0.79C - 0.68D). Glass at R.	
$C_2S = A + 0.66C - 0.57D$	55
$C_2S = B - 0.46C + 0.43D - 0.16G$	
$C_2A = 0.41C + 0.51D$	
$C_2A_2 = 0.42C - 0.37D - 0.54G$	
$C_4AF = D - 0.30G$	
(b) G between (0.79C - 0.68D) and (0.31C + 1.73D). Glass on RT_2 .	
$C_2S = A + 0.66C - 0.57D$	56
$C_2S = B - 0.49C + 0.42D - 0.17G$	
$C_2A = 0.67C + 0.28D - 0.33G$	
$C_4AF = 0.16C + 0.87D - 0.50G$	
(c) G between (0.31C + 1.73D) and (1.08C + 1.34D). Glass on C_2S - C_2A surface.	
$C_2S = A + 0.66C - 0.57D$	57
$C_2S = B - 0.46C + 0.58D - 0.26G$	
$C_2A = 0.80C + 0.99D - 0.74G$	
(d) G between (1.08C + 1.34D) and (1.11C + 1.37D). Glass in C_2S primary phase volume.	
$C_2S = A + 0.66C - 0.57D$	58
$C_2S = B + 0.34C + 1.57D - G$	
Group 13. Independent Crystallization from 1400°. C/D between 3.33 and 4.39.	
(a) G less than (0.80C - 0.73D). Glass at R.	
$C_2S = A + 0.67C - 0.62D$	59
$C_2S = B - 0.51C + 0.47D - 0.16G$	
$C_2A = 0.40C + 0.55D$	
$C_2A_2 = 0.44C - 0.40D - 0.54G$	
$C_4AF = D - 0.30G$	
(b) G between (0.80C - 0.73D) and (0.32C + 1.71D). Glass on RT_2 .	
$C_2S = A + 0.67C - 0.62D$	60
$C_2S = B - 0.50C + 0.46D - 0.17G$	
$C_2A = 0.67C + 0.31D - 0.33G$	
$C_4AF = 0.16C + 0.85D - 0.50G$	
(c) G between (0.32C + 1.71D) and (1.08C + 1.36D). Glass on C_2S - C_2A surface.	
$C_2S = A + 0.67C - 0.62D$	61
$C_2S = B - 0.47C + 0.61D - 0.26G$	
$C_2A = 0.80C + 1.01D - 0.74G$	
(d) G between (1.08C + 1.36D) and (1.10C + 1.40D). Glass in C_2S primary phase volume.	
$C_2S = A + 0.67C - 0.62D$	62
$C_2S = B + 0.33C + 1.62D - G$	
Group 14. Independent crystallization from 1450°. C/D between 1.05 and 3.33.	
(a) G less than (0.71C - 0.73D). Glass at R.	
$C_2S = A + 0.60C - 0.61D$	63
$C_2S = B - 0.45C + 0.46D - 0.16G$	
$C_2A = 0.47C + 0.54D$	
$C_2A_2 = 0.38C - 0.39D - 0.54G$	
$C_4AF = D - 0.30G$	

TABLE E. (Continued)

	Series
(b) G between (0.71C - 0.73D) and (0.28C + 1.71D). Glass on RT_2 .	
$C_2S = A + 0.60C - 0.61D$	64
$C_2S = B - 0.44C + 0.45D - 0.17G$	
$C_2A = 0.70C + 0.31D - 0.33G$	
$C_4AF = 0.14C + 0.85D - 0.50G$	
(c) G between (0.28C + 1.71D) and (1.11C + 1.36D). Glass on C_2S - C_2A surface.	
$C_2S = A + 0.60C - 0.61D$	65
$C_2S = B - 0.42C + 0.61D - 0.26G$	
$C_2A = 0.82C + 1.00D - 0.74G$	
(d) G between (1.11C + 1.36D) and (1.13C + 1.46D). Glass in C_2S primary phase volume.	
$C_2S = A + 0.60C - 0.61D$	66
$C_2S = B + 0.40C + 1.61D - G$	
Group 15. Independent Crystallization from 1450°. C/D between 3.33 and 5.57	
(a) G less than (0.75C - 0.87D). Glass at R .	
$C_2S = A + 0.64C - 0.74D$	67
$C_2S = B - 0.48C + 0.56D - 0.16G$	
$C_2A = 0.43C + 0.65D$	
$C_2A_2 = 0.41C - 0.47D - 0.54G$	
$C_4AF = D - 0.30G$	
(b) G between (0.75C - 0.87D) and (0.30C + 1.66D). Glass on RT_2 .	
$C_2S = A + 0.64C - 0.74D$	68
$C_2S = B - 0.47C + 0.54D - 0.17G$	
$C_2A = 0.68C + 0.37D - 0.33G$	
$C_4AF = 0.15C + 0.83D - 0.50G$	
(c) G between (0.30C + 1.66D) and (1.09C + 1.36D). Glass on C_2S - C_2A surface.	
$C_2S = A + 0.64C - 0.74D$	69
$C_2S = B - 0.44C + 0.69D - 0.26G$	
$C_2A = 0.80C + 1.05D - 0.74G$	
(d) G between (1.09C + 1.36D) and (1.11C + 1.49D). Glass in C_2S primary phase volume.	
$C_2S = A + 0.64C - 0.74D$	70
$C_2S = B + 0.36C + 1.74D - G$	

Author Index

- Abrams, D. A., 42
 Adam, W., 43
 Adams, L. H., 239
 Akiyama, K., 90, 105, 106
 Albert, H., 418, 432
 Alberti, L., 5, 18
 Alkamade, von, 220, 256, 322
 Ambron, H., 369, 376
 Anderegg, F. O., 493, 506
 Anderson, A. A., 471
 Anderson, O., 141, 146, 247, 264, 266, 272
 Asch, D., 57, 58, 60
 Asch, W., 57, 58, 60
 Ashton, F. W., 63, 85, 113, 146, 240, 264, 419-423, 432, 539
 Aspdin, J., 9, 10, 18, 21
 Assarsson, G., 403, 405, 411, 412, 415, 427, 432
- Bakewell, B., 520
 Bamber, H. K., 477, 487
 Baneroft, W. D., 227, 264
 Barnes, R. B., 85
 Barth, T. F. W., 141, 146
 Bateman, J. H., 377
 Bates, G. N., 397, 398
 Bates, P. H., 112, 146, 160, 166, 247, 248, 252, 264, 374, 376, 383, 398, 401, 415, 446, 470, 496, 506, 509, 510, 512, 520, 523, 525, 537-539
- Baykoff, M., 365, 376
 Bayliss, J. R., 391, 392, 398
 Bechtold, I. C., 81, 85
 Bell, J. M., 539
 Benson, H. H., 376
 Berchem, H., 468, 470
 Berger, E. E., 375, 376, 487
 Bergmann, 7
 Bessey, G. E., 73, 74, 85, 385, 389, 393, 397, 398, 410, 412, 415, 432, 470, 490, 506, 519, 520, 547
 Blaine, R. L., 521
 Blaise, H. H., 42
 Blank, A. J., 90, 105, 158, 166, 480, 487
 Blanks, R. F., 105, 515
 Blount, B., 107
 Blum, W., 415
 Bogg, F. R., 487
 Bogue, R. H., 32, 70, 72, 75, 85, 86, 104, 106, 111, 113, 115, 141, 146, 152, 158, 161, 162, 166, 167, 185, 203, 241, 247, 264, 283, 286-292, 295, 299, 302, 323, 334, 336-341, 342-347, 351-353, 366, 399-400, 414, 415, 419-424, 432, 435, 438-440, 445, 467, 470, 473, 480, 487, 489-492, 495-497, 506, 511-514, 518, 520, 537, 539, 543
 Bowen, N. L., 118, 146, 231, 239, 253, 254, 264, 266, 272, 275-277, 281, 318, 323, 333-335, 337, 341, 347
 Brady, L. J., 141, 146
 Bragg, W. H., 85
- Bragg, W. L., 85, 142, 143, 146
 Brandenberger, E. B., 140, 141, 143, 145, 146, 467, 470
 Brandenburg, H. R., 73, 85, 487
 Breareale, J. F., 432
 Bredig, M. A., 120, 140, 144-146, 246, 264
 Breerwood, C. H., 35, 42
 Brickett, E. M., 505, 506
 Brill, R., 146
 Brown, L. S., 85, 129, 130, 132, 138-140, 146, 252, 264, 271, 295, 315, 332, 333, 446, 470, 496, 506, 519, 520
 Brown, W. G., 86, 445, 454
 Brownmiller, L. T., 62, 70, 80, 83, 85, 86, 115, 129, 131, 141-144, 146, 183, 201, 241, 242, 247, 264, 270, 272, 286-292, 299, 302, 318, 320, 321, 333, 334, 336-341, 347, 446, 456-461, 470, 506, 543
 Brownyard, T. L., 468-471, 500-502, 506
 Brunauer, S., 469-470
 Bryant, N. L., 42
 Bukowski, R., 73, 86
 Bunting, E. N., 238, 239, 241, 264, 280, 281
 Burchartz, H., 375, 376
 Burdick, M. D., 120, 146, 248, 264, 275, 281, 284, 286
 Burke, E., 523, 539
 Burton, C. J., 85
 Burton, E. F., 85
 Bussen, W., 141, 146, 251, 264, 389, 390, 398, 425, 432, 470, 520
- Cameron, F. K., 432, 539
 Campbell, E. D., 55, 56, 60, 287, 299, 506
 Candlot, E., 367, 371, 372, 376, 417, 419, 432, 520, 531, 532, 539
 Carlson, E. T., 111, 146, 160, 166, 264, 512, 520
 Carlson, R. W., 442-446, 454, 470, 516, 520
 Cartiaux, J., 376
 Caruso, E., 424, 433
 Caulfield, T. H., 281
 Chall, P., 445
 Chandler, W. R., 85, 103-106
 Chatonney, 44, 61
 Chaudron, G., 299
 Cirilli, V., 424, 433
 Clark, G. L., 85
 Clarke, F. W., 59, 60, 546
 Clarke, W. F., 147, 408-412, 416
 Cloes, C., 364, 376
 Cobb, J. W., 51, 52, 60
 Coghlan, R. R., 96, 100, 105
 Colony, R. J., 323, 376
 Cooper, W., 99, 106
 Coppet, 354, 376
 Cour Grandmaison, J. Le, 109, 146
 Cummins, A. B., 392, 398

- Dahl, L. A., 159, 166, 175-179, 182, 186-203,
 210-218, 227, 548
 D'Ans, J., 432
 Dautrebande, J., 375, 376
 Davey, N., 439, 445, 487
 Davey, W. F., 140, 141, 146, 147
 Davis, A. C., 7, 11, 19
 Davis, H. A., 505, 506
 Davis, H. M., 118, 126, 147
 Davis, W. A., 363, 364, 376
 Day, A. L., 238, 239, 264
 Deming, L. S., 470
 Deming, W. E., 470
 Desch, C. H., 117, 364, 376, 410, 415
 Descotels, 8
 Deval, 418, 419, 432
 Dittler, E., 96, 106
 Donnan, F. G., 366, 376
 Dormann, O., 96, 100, 106
 Duches, J. L., 173, 183
 Dumesnil, P., 26
 Dyckerhoff, W., 101, 102, 104, 106, 112, 113, 120,
 146, 158, 167

 Eckel, E. C., 174, 183
 Edison, T. A., 13, 477, 487
 Eiger, A., 141, 400, 415, 424, 425, 432, 446, 470,
 499, 506
 Eitel, W., 70, 86, 111, 141, 146, 160, 167, 251, 264,
 446, 461, 467, 470, 471
 Elber, M., 42
 Ellis, E. T., 29, 42
 Emley, W., 72, 85
 Emmett, P. H., 469, 470
 Endell, K., 97, 106
 Engelhart, G. K., 42
 Erdahl, B. F., 373, 376, 494, 506
 Erdmenger, 167
 Ernst, E. S., 90, 106
 Ernst, W. A., 90, 106
 Eubank, W. R., 346, 347
 Ewell, R. H., 96, 106

 Feret, R., 367, 376, 509, 520
 Ferguson, J. B., 267, 268, 272
 Feichtinger, 44
 Ferrari, F., 375, 376
 Finch, G. L., 71, 85
 Finley, A., 227
 Fisk, H. G., 43
 Fleming, A. G., 511, 520
 Flint, E. P., 85, 120, 146, 160, 167, 179, 183, 264,
 286, 285-289, 295, 296, 298, 400, 415, 425-427,
 432, 537, 539, 547
 Forbrich, L. E., 78, 86, 442-445
 Ford, C. L., 79, 85
 Ford, W. E., 432
 Forest, J., 432
 Forestier, H., 209
 Forson, L., 106, 174, 183, 380, 382, 389, 390, 398,
 405, 416, 432, 446, 467, 470, 478, 479, 487, 547
 Fox, E. N., 439, 445
 Fraas, F., 43
 Franke, B., 76, 85, 296, 398
 Franke, F. B., 37, 43

 Fremy, E., 45, 60
 Freyssinet, E., 499, 506
 Frick, R., 547
 Friedel, G., 423, 432
 Frost, J., 9
 Fuchs, J. N., 44, 61

 Gadd, W. L., 477, 487
 Gary, M., 487
 Gause, G. R., 529, 539
 Geiler, R. F., 238, 239
 Gessner, H., 468, 470
 Geyer, H., 477, 487
 Gibbs, J. W., 207, 227
 Gierts-Hedstrom, S., 467, 468, 470, 499, 506
 Gilbert, W., 106
 Gildart, L., 86, 471
 Gille, F., 113, 115, 117, 146, 174, 183
 Gillson, J. L., 120, 146
 Glasenapp, M. von, 363, 376
 Goldschmidt, V. M., 142, 146
 Gonnerman, H. F., 498, 506
 Goelich, K., 375, 376
 Gottfried, C., 141
 Gottlieb, S., 158, 167
 Grace, N. S., 251, 264, 406, 413, 416, 546
 Grant, J., 44, 61
 Greene, K. T., 111, 120, 141, 144, 146, 237, 239,
 247, 342-347, 543
 Greig, J. W., 239, 253, 254, 264, 267, 272, 281, 286
 Grimm, R., 373, 376
 Gronow, H. E. von, 99, 106, 107
 Grose, H. J., 521
 Guttman, A., 113, 115, 117, 146, 174, 183

 Haddon, C. L., 365, 376
 Hagg, G., 388, 398
 Hall, F. P., 281
 Hall, W. T., 86
 Hansen, W. C., 43, 85, 104, 106, 113, 117, 120,
 146, 152, 154-158, 167, 231, 242, 247, 248, 252,
 264, 269, 272, 283, 286-292, 299, 302, 333, 487,
 516, 517, 520, 543
 Harmon, R. W., 388, 398
 Harrington, E. A., 85, 113, 140, 146, 339, 543, 547
 Harris, G. M., 415
 Harris, R. H., 398, 521
 Hart, F., 50, 61
 Hashimoto, T., 90, 106
 Hatschek, E., 364, 376
 Hay, R., 281
 Hedlin, R., 380-382, 389, 390, 398, 405, 415, 424,
 432, 478-480, 487, 520
 Hedvall, J. A., 148, 167
 Hein, H., 432
 Heibig, A. B., 96, 106
 Heldt, 45, 61
 Hels, A. W., 77, 78, 81, 85
 Hendrickx, J., 99-101, 106, 172, 173, 188
 Hermann, C., 140, 146
 Heyrovsky, J., 73, 85, 413
 Higgins, B., 7, 19
 Hill, A. E., 227
 Hillier, J., 86
 Hoffmann, E., 149, 167

- Hoffmann, H., 400, 415
 Holdcroft, A. D., 95, 106
 Holland, A. S., 161, 167
 Hopkins, H. G., 85
 Hornibrook, F. B., 520, 529, 530, 539
 Hostetter, J. C., 281
 Hubbell, D. S., 493, 506
 Hughes, C. A., 512, 520
 Hutton, S. E., 158, 167
- Inaley, H., 63-67, 83-85, 96-106, 108, 110, 118,
 120, 132, 133, 146, 167, 179, 183, 269-272, 281,
 292, 299, 340, 404
- Jacques, W., 106
 Jander, W., 102, 106, 116, 149, 167, 396, 398
 Janecke, E., 97, 106, 111, 113, 115, 116, 146
 Jesser, L., 96, 97, 106, 468, 470
 Johannson, O. K., 82, 85, 99, 106, 247, 264
 John, J. T., 9, 19
 Johnson, I. C., 10, 11, 19, 21
 Johnston, J., 88, 106
 Jones, F. E., 417, 424, 425, 427-432, 486, 487,
 499, 506, 547
 Jones, H. C., 471
 Jordis, E., 52, 61
 Jumper, C. H., 332, 333, 484, 487, 517, 520, 521
 Justin-Mueller, 362
- Kalousek, G. L., 332, 333, 426, 429, 431, 432, 484,
 486, 487, 517, 518, 520, 521
 Kammer, H. A., 516, 520
 Kampf, L., 85
 Kanolt, C. W., 240, 241, 264
 Kanter, E. H., 52, 61
 Kats, D. M., 70, 86, 446, 461-463, 465-467, 471
 Keavil, N. B., 248, 264, 393, 394, 397, 398
 Keisermann, S., 369, 376
 Kelvin, Lord, 469
 Keyes, W. F., 144, 147
 Klein, A. A., 112, 146, 160, 166, 247, 248, 252,
 264, 268, 272, 370, 373, 374, 377, 383, 398, 401,
 403, 407, 413, 415, 418, 432, 446, 470
 Klinkenberg, 418, 432
 Knapp, 45
 Kohl, W. H., 85
 Kolthoff, I. M., 78, 85
 Kosaki, Y., 161, 167
 Koyanagi, K., 43, 158, 167, 251, 264
 Kraeck, F. C., 231, 237, 239, 318, 323, 333-337,
 347
 Kuhl, H., 43, 90, 102, 106, 112, 147, 174, 183,
 361, 369, 374, 375, 377, 400, 415, 418, 423, 432,
 446, 467, 470, 494, 506, 532
- Lacey, W. N., 30, 31, 106
 Lafuma, H., 406, 404, 416, 418, 419, 433, 432, 519,
 533
- Lagerquist, K., 140, 141, 147, 264
 Landrin, M., 45, 61, 352, 377
 Larmour, H. M., 79, 86, 93, 103, 106
 Larmour, R. K., 521, 525, 539
 Larsen, E. S., 62, 85, 278, 281
 Lavoisier, A. L., 352, 377
 Lea, F. M., 4, 80, 99, 106, 111, 117, 147, 175, 183,
 194-200, 203, 246, 264, 300-310, 317, 410, 415,
 499, 506, 517, 519, 520
 Le Chatelier, H., 45-48, 61, 87, 95, 100, 106,
 169-171, 183, 287, 299, 352-358, 365-367, 373,
 377, 382, 389, 391, 398, 404, 415, 419, 432, 446,
 471, 506, 509, 520, 532
 Leduc, E., 19, 59, 61, 147, 368, 377
 Lee, C. S., 85
 Lee, H. C., 141, 146, 247, 264
 Lerch, W., 72, 79, 80, 82, 83, 86, 103, 104, 106,
 128, 136, 138, 147, 183, 272, 381-383, 388,
 398-400, 414, 415, 419-424, 432, 435, 438-445,
 467, 470, 473-475, 480-487, 489-492, 494-497,
 502-504, 506, 511-514, 518, 520, 538, 539
 Lesley, R. W., 11, 19, 371, 377
 Lingane, J. L., 78, 85
 Linck, G., 361, 377, 385, 398, 403, 407, 416, 446,
 471
 Loring, A. D., 143, 147
 Lucas, A., 19
 Ludgate, T. G., 90, 106
 Lunge, 171
 Lykken, L., 86
- MacIntire, W. H., 392, 398, 418, 424, 433
 Mack, J. L., 61
 MacPhearson, D. R., 73, 86
 Malgrain, H., 370, 377
 Mallard, 46
 Malquori, G., 424, 438
 Manson, P. W., 510, 521, 524, 527, 531, 534,
 539
 Marignac, 354, 377
 Martin, E., 58, 59, 61
 Martin, G., 38, 43, 99, 106, 288, 286
 Mather, D. T., 413, 414, 416, 547
 Matignon, C., 336, 347
 McCaffery, R. S., 203
 McMaster, E. L., 106
 McMillan, F. R., 520, 521
 McMurdie, H. F., 63, 85, 110, 116, 120, 132, 133,
 141, 144, 146, 147, 264, 269-272, 292-295, 299,
 395, 398, 415, 416, 432, 461-465, 467, 471, 543,
 547
 McVay, T. N., 360, 377
 Meade, R. K., 6, 91, 106, 377
 Meder, L. C., 521
 Meissner, H. S., 515, 516, 521
 Mellor, J. W., 95, 106
 Mensel, C., 505, 506
 Merriman, T., 512, 521-523, 535-537, 539
 Merwin, H. E., 56, 62, 85, 230, 239, 241, 264-268,
 272-274, 281-283, 286, 287, 289, 299
 Meyer, A., 50, 61, 368, 373, 377, 532
 Meyers, S. L., 73, 86, 147, 264, 441, 445, 505, 506
 Michaels, W., 11, 50, 51, 54, 55, 61, 171, 388-361,
 372, 377, 389, 417, 419, 433, 446, 471, 509, 521,
 531, 532, 539
 Miller, D. G., 505, 506, 509, 610, 521, 523, 524,
 526, 527, 529, 531, 534, 535, 539
 Miller, L. B., 71, 86, 392, 398
 Month, E., 90, 106

- Morey, G. W., 226, 231, 236, 237, 239, 318, 323,
 333, 334, 335, 341, 347
 Morgan, R., 71, 86
 Morgan, W. R., 237, 239
 Morreau, G. de, 7, 19
 Morris, S. B., 84, 86
 Morton, C., 86
 Morton, G. A., 86
 Mosebach, R., 410, 416
 Motz, H., 86
 Muller, H. O., 86, 471
 Mylius, C. R. W., 412, 416, 433
- Nacken, R., 97, 98, 100, 106, 125, 385, 398, 410,
 416
 Nagai, S., 161, 167, 394, 398
 Naske, C., 106
 Neville, H. A., 471
 Neville, J., 363, 377
 Newberry, S. B., 106, 153, 167, 169-172, 183, 382,
 398
 Newberry, W. B., 88, 106, 153, 167, 169-172, 183
 Newhall, C. A., 376
 Newman, E. S., 85, 120, 124, 146, 147, 183, 245,
 257, 521
 Nicol, A., 521
 Niggli, P., 393, 398
 Ning Kang Tang, 86
 Nitssche, H., 377, 419, 433, 532, 539
 Niven, W. W., 538, 539
 Nordberg, B., 43
 Norman, J. E., 38, 43
 Nurse, R. W., 86
- Oesterle, G. E., 203
 Osborn, E. F., 257, 267, 268, 272
- Pagon, W. W., 509, 521
 Parker, J., 8, 19
 Parker, T. W., 66, 80, 86, 105, 106, 111, 138, 147,
 175, 183, 194-200, 203, 246, 264, 300-310, 317,
 504, 506
 Passow, 532
 Paul, I., 522, 534, 539
 Peaker, C. R., 86, 445
 Pearson, J. C., 505, 506
 Pettenkoffer, 44
 Phillips, A. J., 268, 272, 362, 373, 374, 377, 401,
 403, 407, 413, 415, 418, 432, 510, 520, 523, 538
 Pinkett, G., 469
 Pierce, S. C., 79, 86
 Pike, R. D., 43
 Pincney, R. M., 523, 539
 Fliny, 5, 19
 Poirson, 418, 423, 433
 Polack, W. G., 416
 Pompec, D. J., 86
 Pool, A. J., 43
 Porter, O. J., 521
 Pospjak, E., 118, 141, 143, 239, 275, 276, 281, 286
 Poulsen, A., 509, 521
- Powers, T. C., 467-471, 500-502, 506, 520, 521,
 529, 539
 Pressler, E. E., 487
 Pulfrich, H., 361, 377, 385, 398, 403, 407, 416,
 446, 471
 Purser, J., 521
- Quarrel, A. G., 85
- Radzewski, O. E., 86, 471
 Radeff, K., 369, 377, 400, 416, 418
 Ralston, O. C., 38, 43
 Ramberg, G. E., 86
 Rankin, G. A., 88, 106, 111, 117, 118, 120, 125,
 147, 150, 167, 171, 239-241, 243, 245, 246, 248,
 250-254, 257, 264-267, 272, 299, 301, 343, 363,
 364, 377, 382, 398
 Rapp, P., 484, 487
 Rathke, H., 73, 86
 Read, E. J., 369, 377
 Reaser, W. E., 43
 Rebuffat, O., 50, 61, 367, 377, 418, 419, 433, 532,
 539
 Reibling, W. C., 373, 377
 Reid, D. A. G., 43
 Reusch, H. J., 280, 281
 Reyes, J. D., 377
 Richards, J. W., 94, 100, 106
 Richardson, C., 52-54, 61, 106, 368, 377
 Rivot, 44, 61
 Roberts, H. S., 230, 236, 237, 239, 273, 274, 281,
 287, 299
 Robinson, A. W., 43
 Rockwood, N. C., 43
 Rodt, V., 446, 471
 Roeser, W. F., 237, 239
 Rohland, P., 50, 61, 360, 368, 372, 373, 377
 Roller, P. S., 477, 486, 487
 Rondelet, J., 5, 19
 Rooseboom, H. W. B., 53, 226
 Rordam, S., 73, 86
 Rosenhain, W., 365, 377
 Roth, W. A., 445
- Santarelli, L., 519, 521
 Sasa, S., 86
 Satoh, S., 96, 106
 Saylor, D., 11
 Schaffer, H. A., 43
 Schairer, J. F., 118, 146, 275-278, 281, 337, 347
 Schapiro, L., 203
 Schindler, D., 373, 377
 Schindler, K., 73, 86
 Schlapfer, M., 398, 399
 Schlapfer, P., 73, 86, 401, 416, 494, 506
 Schneider, W. G., 251, 264, 415
 Schott, O., 170, 360, 377, 418, 433
 Schreiner, O., 432
 Schwachheim, O., 103, 106
 Schweite, H. E., 86, 99, 100, 107, 110, 147

- Scribner, B. F., 78, 85
 Searle, A. B., 60
 Sehnoutka, J., 416
 Sestini, V., 519, 521
 Shaw, W. M., 392, 398, 418, 424, 433
 Shelton, G. R., 383, 394, 398, 399, 416, 418, 419, 433, 506, 509, 510, 521
 Shepherd, E. S., 111, 147, 238, 239, 264, 299
 Shikata, M., 85
 Shimizu, Y., 472, 487
 Short, M. N., 86
 Schroder, H., 43
 Siedentopf, H., 63, 86
 Slade, R. E., 416
 Shlepceovich, C. M., 86, 471
 Smeaton, J., 6, 7, 19, 20, 21, 509, 521
 Smith, M. M., 382, 398
 Smith, N., 71, 86
 Smolensky, S., 280, 281
 Snow, R. B., 281
 Soper, E. C., 95, 100, 107
 Sosman, R. B., 56, 239, 264, 281-283, 286, 289, 299
 Spanjer, O., 50, 61
 Spohn, E., 174, 183
 Stanger, W. H., 107
 Stanton, T. E., 107, 515, 516, 521
 Starke, H. R., 436-438, 441, 442, 445, 492, 493, 506
 Steele, F. A., 140, 147
 Steinour, H. H., 436-438, 441, 442, 445, 467, 471, 492, 493, 506
 Stenzel, R. W., 84, 86
 Steopoe, A., 519, 521
 Stern, 63, 86
 Stratling, W., 393
 Sundius, N., 120, 147, 246, 264
 Swayze, M. A., 239, 271, 272, 282, 283, 286, 288, 295-299, 310-317
 Swenson, J. A., 85, 120, 146, 179, 183

 Tavasci, B., 63, 65, 86, 117, 120, 147, 283, 286, 295, 299, 446, 471
 Taylor, K., 83, 86
 Taylor, T. G., 516, 520
 Taylor, W. C., 63, 75, 85, 86, 103, 104, 106, 132-137, 147, 158, 161, 162, 166, 322-333, 340, 495, 496, 502, 503, 506, 511-514, 520, 523, 533, 534, 537, 539, 543
 Taylor, W. D., 506
 Teller, E., 469, 470
 Thomas, W. N., 487
 Thompson, G. P., 71, 86
 Thorvaldson, T., 82, 83, 85, 86, 99, 106, 167, 247, 248, 251, 264, 383, 384, 393-398, 406, 407, 410, 413-416, 435, 436, 445, 505, 506, 509-512, 514, 521, 525, 526, 539, 547
 Thuring, H., 377, 400, 415
 Tilley, C. E., 240, 245, 264
 Tippmann, F., 375, 377
 Tornebohm, A. E., 48-50, 61
 Traube, J., 362, 377
 Travers, A., 412, 416
 Treadwell, F. P., 86
 Tregoning, J. J., 332, 338, 484, 487, 520
 Trempner, B., 376, 516, 521
 Trillat, J. J., 86
 Tschernobasoff, D., 95, 100, 107
 Tschirky, L., 43
 Tyler, H. F., 43

 Ulbrich, 423, 432
 Ulrich, F., 242, 264

 Vance, A. W., 86
 Vicat, L. J., 8, 9, 19, 171, 352, 377, 509, 521
 Vigfusson, V. A., 384, 397, 398, 413, 416, 506, 510, 511, 521, 535, 539, 546
 Vitalis, 8
 Vitruvius, P., 3, 5, 19

 Wahlstrom, E. E., 86
 Wallmark, S., 140, 147, 264
 Wang, T., 400, 415
 Ward, G. W., 66, 86, 127, 130, 135-137, 147, 180-183, 315, 317, 446-457, 471
 Ware, J., 477, 487
 Warren, B. E., 143, 147
 Warren, E. C., 120, 146
 Wartenberg, H. V., 280, 281
 Washburn, E. W., 280, 281
 Weaver, J. R., 86
 Wells, L. S., 83, 86, 120, 124, 146, 147, 160, 167, 245, 257, 264, 286, 385-389, 398, 401-404, 407-412, 414-416, 423-427, 432, 433, 476, 487, 547
 Wentworth, C. K., 86
 Wensel, H. T., 237, 239
 Werner, D., 499, 506
 Wessels, V. E., 483, 484, 487
 West, C. D., 63, 86
 Westgren, A., 140, 147, 251, 264
 Wetzel, E., 86
 Weyer, I., 116, 147
 Weyer, J., 246, 247, 249, 264
 White, A. H., 55, 56, 60, 71, 86, 284, 286, 361, 362, 377, 503, 506
 White, C., 11
 White, J., 281
 Whittaker, A. G., 483, 484, 487
 Wig, R. J., 504-506, 510, 520, 523, 538
 Willard, H. H., 86
 Williams, H. W., 337, 347
 Williams, J. C., 43
 Williams, W. B., 90, 105
 Wilman, H., 85
 Wilson, R., 240, 264
 Winchell, A. N., 86
 Wolochow, D., 398, 416, 506, 521, 539
 Wologdine, 107
 Woods, H., 90-93, 106, 107, 332, 333, 436-438, 441, 442, 445, 492, 493, 506
 Woodworth, P. M., 505, 506
 Wormser, S., 50, 61
 Wright, F. E., 56, 111, 117, 118, 120, 125, 147, 239-241, 243, 245, 246, 250-254, 257, 264, 299, 301, 348
 Wuhrer, J., 116, 167
 Wyckoff, R. W. G., 69, 86, 141, 147

 Zachariassen, W. H., 143, 147
 Zeis, E. G., 264
 Zimmerman, L., 375, 377
 Zulkowsky, K., 45, 50, 61, 367, 377
 Zurfos, S., 118, 126, 147
 ZurStrassen, H., 110, 147
 Zworykin, V. K., 86

Subject Index

- Adhesion, 355-357
Adsorption, 391-393, 468-470, 500
Air-entrainment, 467
Alite, 48, 50, 53, 55, 56, 111-117, 372
Alkali
 effect on setting process, 372, 373, 485, 486
 phase studies, 318-347
 removal from raw mix, 91-94
 sulfoaluminate systems, 431, 432
 volatilisation, 91-94
Alkali-aggregate reaction, 515-517
Alumina
 optical properties, 241
Alumina-containing systems
 Binary
 Al_2O_3 - Fe_2O_3 , 287
 Al_2O_3 - SiO_2 , 253
 CaO - Al_2O_3 , 249-253
 C_2S - KA , 327
 C_2S - KA , 326-327
 C_4AF - MgO , 292-293
 K_2O - Al_2O_3 , 330-331
 MgO - Al_2O_3 , 265-266
 Na_2O - Al_2O_3 , 336
 TiO_2 - Al_2O_3 , 279-280
 Ternary
 CaO - Al_2O_3 - H_2O , 410-413
 CaO - Al_2O_3 - SiO_2 , 235-264
 CaO - MgO - Al_2O_3 , 267
 CaO - CA - C_4AF , 293-295
 CaO - C_2A - CF , 287-292
 CaO - C_2A - C_2F , 295-299
 CaO - C_4AF - $(Na_2O + 3Al_2O_3)$, 346-347
 C_2S - C_2S - KA , 327
 C_2S - MgO - C_2A , 268-269
 FeO - Al_2O_3 - SiO_2 , 278
 K_2O - CaO - Al_2O_3 , 321-323
 KA - C_4AF - C_2F , 322-323
 $KC_{12}S_{12}$ - CaO - C_2A , 329-330
 Na_2O - CaO - Al_2O_3 , 337-341
 Quaternary
 CaO - Al_2O_3 - Fe_2O_3 - H_2O , 399-416
 CaO - Al_2O_3 - H_2O - $CaSO_4$, 427-432
 CaO - FeO - Al_2O_3 - SiO_2 , 278
 CaO - MgO - C_2S - C_2A , 269-272
 CaO - C_2S - C_2A - C_4AF , 300-309
 CaO - C_2S - C_2A - C_2F , 310-312
 C_2S - C_2S - KA - Fe_2O_3 , 327-329
 Na_2O - CaO - Al_2O_3 - SiO_2 , 342-346
 Quinary
 CaO - C_2S - C_2A - C_2F - MgO , 312-315
Anhydrite, soluble, 25
Annealing method, 229
Argillaceous rock, 8
Autoclave expansion test, 104, 105, 508
Beilby effect, 366
Belite, 48, 55, 117
Binary systems, 210-214
Bleeding, 41, 467, 476
Boundary curve, 216
Burnability, 149-166
Burning process, 87-91
By-products, 42
Calcium aluminates
 action with $Ca(OH)_2$, 404-406
 complex salts, 417-433
 di- and tetra-hydrates, 408-410
 electron micrographs, 461-466
 "five-three" compound, 251
 hydration, 401-415
 hydrolysis, 399-340
 microscopic structure, 448-451
 optical properties, 251-252
 preparation, 252-253
 tri-hydrates, 406-408
Calcium carbonate
 electron micrograph, 463
 vapor pressure, 88
Calcium chloroaluminates, 423, 424
Calcium chloride, 484-485
Calcium hydroxide
 electron micrograph, 462
 in cement, 74, 75
 in set cement, 73, 74
 pH, 382
Calcium oxide
 appearance, 126-128
 determination, 71-75
 protected phase, 126, 129
Calcium oxide-containing systems
 Binary
 CaO - Al_2O_3 , 249-252
 CaO - Fe_2O_3 , 282
 CaO - MgO , 265
 CaO - SiO_2 , 242-249
 C_2S - KA , 326-327
 C_2S - KA , 327
 C_2S - KCS , 324-326
 C_4AF - MgO , 292-293
 K_2O - CaO , 318
 $KC_{12}S_{12}$ - $CaSO_4$, 330-332
 $KC_{12}S_{12}$ - MgO , 330
 Na_2O - CaO , 334
 Ternary
 CaO - Al_2O_3 - H_2O , 410-413
 CaO - Al_2O_3 - SiO_2 , 235-264
 CaO - CA - C_4AF , 293-295
 CaO - C_2A - C_2F , 295-299
 CaO - C_2A - CF , 287-292
 CaO - C_2S - CF , 283-284
 CaO - C_2S - C_2F , 284-286
 CaO - FeO - SiO_2 , 276-277
 CaO - MgO - Al_2O_3 , 267
Basic slag, hydration, 367
Basest process, 42

Calcium oxide-containing systems (cont.)

- Ternary**
 $\text{CaO-MgO-C}_2\text{A}$, 268-269
 CaO-MgO-SiO_2 , 267-268
 $\text{CaO-SiO}_2\text{-H}_2\text{O}$, 278-298
 $\text{CaO-C}_2\text{AF-(Na}_2\text{O} + 3\text{Al}_2\text{O}_3)$, 346-347
 $\text{CaO-TiO}_2\text{-SiO}_2$, 281
 $\text{C}_2\text{S-C}_2\text{S-KA}$, 327
 $\text{K}_2\text{O-CaO-Al}_2\text{O}_3$, 321-322
 $\text{K}_2\text{O-CaO-SiO}_2$, 323-324
 $\text{KA-C}_2\text{AF-C}_2\text{F}$, 322-323
 $\text{KC}_{12}\text{Si}_{12}\text{-CaO-C}_2\text{A}$, 329-330
 $\text{Na}_2\text{O-CaO-Al}_2\text{O}_3$, 337-341
 $\text{Na}_2\text{O-CaO-SiO}_2$, 341-342
- Quaternary**
 $\text{CaO-Al}_2\text{O}_3\text{-H}_2\text{O-CaSO}_4$, 427-432
 $\text{CaO-Al}_2\text{O}_3\text{-Fe}_2\text{O}_3\text{-H}_2\text{O}$, 399-416
 $\text{CaO-C}_2\text{S-C}_2\text{A}_2\text{-C}_2\text{F}$, 310-312
 $\text{CaO-C}_2\text{S-C}_2\text{A}_2\text{-C}_2\text{AF}$, 300-309
 $\text{CaO-FeO-Al}_2\text{O}_3\text{-SiO}_2$, 278
 $\text{CaO-MgO-C}_2\text{S-C}_2\text{A}$, 269-272
 $\text{C}_2\text{S-C}_2\text{S-KA-Fe}_2\text{O}_3$, 327-329
 $\text{Na}_2\text{O-CaO-Al}_2\text{O}_3\text{-SiO}_2$, 342-346
- Quinary**
 $\text{CaO-C}_2\text{S-C}_2\text{A}_2\text{-C}_2\text{F-MgO}$, 312-315
- Calcium silicates**
adsorption, 391-393
chemical reactions, 391-393
electron micrographs, 461-466
hydration, 378-398
 in steam, 393-398
hydrolysis, 380-393
 constants, 386-388
ionization constants, 385-388
microscopic structure, 446-448
optical properties, 245-247
preparation, 247-249
solid solutions, 391-393
- Calcium sulfate**
action with water, 252-254
equilibrium with $\text{KC}_{12}\text{Si}_{12}$, 330-332
in clinker, 302-303
phase equilibria, 427-432, 486-487
retarder, 371-375, 473
various forms, 480-481
- Calcium sulfoaluminate**
formation in setting cement, 372-375
test for sulfate resistance, 531-532
solid-solution series, 426-427
- Calcium sulfiferites**, 424-425
- Calculation of phase composition**, 184-208
- Calorimeters**, 79-81, 437, 438, 443-445
- Calite**, 48, 53, 55, 56
- Cementation index**, 174
- Cement glue**, 467
- Cement, Portland**
 linker, 40-42
 color, 39
 composition, 25
 constitution, 44-61
 definition, 20-21
 field, 262-264
 industry, 11-18
 invention, 5-11
 kilns, 13
 manufacture, 27-43
 name, 7
 production, 12-18
 research laboratories, 16
 specifications, 21-23
 storage, 21-25
 testing, 42
 types, 21-25
- Cements**
 aluminous, 24-25
 ancient, 3-5
 bauxitland, 24
 British, 9
 classification, 20-26
 composition, 25
 eisen, 24-25
 ers, 24
 Ferrari, 24-25
 foudu, 24
 Frost's, 9
 gaize, 24-25
 grappier, 21
 history, 3-19
 hoehofen, 24-25
 hydraulic, 20
 iron-ore, 24
 Keene's, 25
 Kuhl, 24
 laitier, 22, 24
 lime-slag, 22
 metallurgique, 24-25
 natural, 8, 11, 21, 25, 29
 oil-well, 22
 Parian, 25
 pozzolana, 20, 24-25, 517
 quick-set, 22
 rock, 11, 28-29
 Roman, 8
 Rosendale, 21
 Santorin, 20
 silikat, 24
 slag, 24
 sorel, 25
 sur-sulfate, 22
 terras, 20, 25
 trass, 20, 24, 25
 white, 22, 25
- Chemical control**, 176-179
 methods of test, 71-76
- Classification of systems**, 188-192
 crystallization areas, 192-194
- Clay**, 6, 7, 9, 26
- Clinker formation**, 94-102
- Cohesion**, 355-357
- Colloid theory of hardening**, 358-366
- Combination of compounds**, 148-167
- Complex salts**, 417-433
- Composition**
 calculation, 184-200
 comparison of methods, 179-182
 Dahl's method, 217-219
 design and control, 168-183
 equations, 548-559
- Compound formation**
 stable at melting point, 219-220
 unstable at melting point, 220-221
- Concrete**, 378
- Condensed system**, 208
- Congruent melting point**, 212
- Constituents**, 108-147
- Constitution**
 early studies, 44-61
 formulas, 51, 54, 57-60
- Containers for charges**, 232-235
- Cooling**
 effect of rate, 502-504
 process, 40, 103-105
- Course of crystallization**
 in binary systems, 210-214
 in system $\text{CaO-Al}_2\text{O}_3\text{-Fe}_2\text{O}_3$, 315-316
 $\text{CaO-Al}_2\text{O}_3\text{-SiO}_2$, 256-262, 307-308

Course of crystallization in system (cont.)

- CaO-C₂S-NA, 344-346
- CaO-MgO-Al₂O₃-Fe₂O₃-SiO₂, 316-317
- CaO-SiO₂, 243-245
- Na₂O-CaO-Al₂O₃, 340-341
- in ternary systems, 216-227
- Crystal structure, 140-146
- Crystallization, 224-227
- theory of hardening, 352-366

Delayed expansion, 104-105, 503-504

Dicalcium silicate

- α - β inversion, 117-118, 124-125
- α -C₂S solid solution, 118-125
- β - γ inversion, 125-126
- microscopic structure, 120, 448
- optical properties, 245-246
- preparation, 247-248
- solubility in α -C₂S, 125

Disintegration index, 535, 536

Dispersion, 467

Durability

- disintegration index, 535-536
- sugar-solubility test, 536-538
- water test, 534-535

Dusting, 104, 125, 245, 247

Eddystone lighthouse, 6

Electric muffle, 232

Electron diffraction, 70, 71

Electron microscopy, 70, 71

micrographs, 461-466

Equations for calculating composition, 200-203, 548-559

Equilibrium

- calculations, 184-188
- metastable, 207
- true, 207

Etching technique

- clinker, 65-68
- pastes, 456

Eutectic point, 212, 229

False set, 424, 480-481

Felite, 48, 55

Ferric oxide, 282

Ferric oxide-containing systems

Binary

- Al₂O₃-Fe₂O₃, 287
- CaO-Fe₂O₃, 282
- C₂AF-MgO, 292-293
- MgO-Fe₂O₃, 287

Ternary

- CaO-CA-C₂AF, 293-295
- CaO-C₂A-C₂F, 295-299
- CaO-C₂A-CF, 287-292
- CaO-C₂S-CF, 283-284
- CaO-C₂S-C₂F, 284-286
- CaO-C₂AF-(Na₂O + 3Al₂O₃), 346-347
- KA-C₂AF-C₂F, 322-323
- Na₂O-Fe₂O₃-SiO₂, 337

Ferric oxide-containing systems (cont.)

Quaternary

- CaO-C₂S-C₂A-C₂AF, 300-309
- CaO-C₂S-C₂A-C₂F, 310-312
- C₂S-C₂S-KA-Fe₂O₃, 327-329

Quinary

- CaO-C₂S-C₂A-C₂F-MgO, 312-315

Ferrous oxide-containing systems

- CaO-FeO-SiO₂, 276-277
- CaO-FeO-Al₂O₃-SiO₂, 278
- Fe₂O₄-Fe₂O₃, 273-275
- FeO-Al₂O₃-SiO₂, 278
- MgO-FeO-SiO₂, 277-278
- SiO₂-FeO, 275-276

Final set, 472

Fineness, 41

Flash set, 104, 373, 473

Floc test, 534

Fluxing action, 160-166

Freundlich adsorption isotherm, 391

Furnace equipment, 232-236

Furnaces

- iridium, 238
- iridium button, 338
- platinum strip, 236-238
- quenching, 235-236
- resistance, 238

Gel

- formed on hydration, 454
- structure, 467-470

Glass

- appearance, 136
- chemical determination, 80-85
- effect in cement, 105
- on hydration, 476
- heat of hydration, 441-442
- microscopic determination, 66
- rate of solution, 476
- reactivity, 535
- solubility of MgO, 128
- x-ray investigation, 142-143

Grappiers, 46

Gypsum, 3, 24, 41

bonding action, 352-366

control of set, 481-484

retarder, 371-375

Hardening

- depth of hydration, 493-494
- early studies, 355
- effect of composition, 498-502
- cooling rate, 502-504
- steam treatment, 504-506
- hydrolysis and hydration, 499-493
- investigations, 489-507
- soundness, 494-498

Heat

- of formation, 94-102
- of hydration, 434-445
- comparison of methods, 442-445
- complete hydration, 434-436
- correlation with strength, 442
- effects of composition, 436-441
- glass, 441-442
- of reaction with CaCl₂, 484
- of solution, 79-85

- Heating curve method, 154-158, 230
 Heat treatment, 87-107
 Heterogeneous equilibrium, 379
 Hexite-pentite theory, 57
 High-temperature phase research principles, 207-227
 technique, 228-239
 Hot test, 189
 Hydration
 by electrical conductivity, 472-473
 cement pastes, 489-493
 colloid hypothesis, 358-359
 crystallisation theory, 352-358
 depth, 493-494
 discussion of theories, 359-366
 early theories, 351-377
 heat, 434-445
 in set, 472-473
 of calcium aluminates, 399-416
 in steam, 413-415
 of silicates, 380-398
 in steam, 393-398
 iron compounds in steam, 413-415
 principles, 378-380
 products, 473-477
 reactions, 367-376
 Hydraulic index, 171
 Hydraulite, 45, 50, 367
 Hydrogarnet solid solution series, 425, 426
 Hydrolysis
 aluminum silicates, 399-400
 calcium aluminates, 399-400
 calcium silicates, 380-393
 cement pastes, 489-493
 constants, 386-388
 iron compounds, 400-401
 principles, 378-380
- Independent crystallization, 194-200, 214
 Index
 determination, 63
 media, 62-68
 Initial set, 472
 Interstitial material, 110, 128-140
 amorphous, 136
 light, 136-140
 prismatic, 129-136
 rectangular, 129
 Invariant point, 210
 Ionisation constant
 derivation, 379, 385-388
 of calcium silicates, 385-388
 Iron compounds, 400, 401
 Iron oxide
 containers for high-temperature work, 230
- Jancskite, 112, 115
- Kaolin, 95, 96
- Laitance, 460-461, 467
 Lime
 artificial, 9
 deficiency, 176-178
- Lime (count.)
 factor, 172
 fat, 20
 hydraulic, 6, 8, 20-21
 lean, 20
 non-hydraulic, 20
 optical properties, 240-241
 quality, 7
 requirement, 176-178
 saturation, 174, 178
 Limestone
 composition, 7
 quality, 6, 7, 20
 Liquid formation
 amount, 158-160
 temperature, 152-158
 Liquidus curve, 212
 Lithia-containing systems
 Li₂O-SiO₂, 334-336
 NS-LS-SiO₂, 337
- Magnesia
 appearance, 126-128
 delayed expansion, 104-105, 503-504
 determination, 75-76
 in solid solution, 110
 solubility in liquid, 105, 128
 Magnesia-containing systems
 CaO-MgO, 265
 CaO-MgO-Al₂O₃, 267
 CaO-MgO-SiO₂, 267-268
 CaO-MgO-C₂S-C₃A₂, 269-272
 CaO-C₂S-C₃A₂-C₄F-MgO, 312-315
 C₂S-MgO-C₃A₂, 268-269
 C₄AF-MgO, 292-293
 KC₂S₁₂-MgO, 330
 MgO-Al₂O₃, 265-266
 MgO-Fe₂O₃, 287
 MgO-FeO-SiO₂, 277-278
 MgO-SiO₂, 266
 Manufacture, 27-43
 burning, 38-40
 control, 176-179
 dry process, 32-35
 flotation, 35-38
 kiln feed, 31
 operations, 27
 proportioning, 29-31, 168-176
 raw materials, 28-29
 wet process, 32
 Mass law, 379
 Merriman
 disintegration index, 535-536
 slab test, 523
 sugar-solubility test, 536-538
 Microscope
 early studies, 47-50
 structure of clinker, 108-110
 cement compounds, 108-110
 pastes, 446-461
 technique, 62-67, 446, 456
 Mineralizers, 160, 161
 Mortar, 378
- Nest cement, 378
 Non-equilibrium cooling, 192-200
 Normal crystallisation, 201

- Over-burning, 166
- Partial independent crystallization, 202, 208
- Particle size effect, 149-152
- Pastes
 electron micrographs, 461-466
 external reactions, 508-521
 hydrolysis and hydration, 489-493
 microscopic structure, 446-448, 454-461
 physical characteristics, 467-470
 properties affected by glass, 476
 soundness, 494-498
- Petrographic technique, 62-68
- Peritectic point, 212
- Phase rule, 207-210
 derivation, 208-210
 usefulness, 207-208
- Plaster of Paris
 bonding action, 352-366
 definition, 24
 retarding action, 371-375
- Polarographic analysis, 78, 79
- Polished sections, 63-65
- Polycomponent systems, 215-227
- Potash
 effect on combination of CaO, 327-329
 effect on set, 373
- Potash-containing systems
 C_2S-KA , 327
 C_2S-KA , 326-327
 C_2S-C_2S-KA , 327
 $C_2S-C_2S-KA-Fe_2O_3$, 327-329
 C_2S-KCS , 324-326
 $K_2O-Al_2O_3$, 320-321
 K_2O-CaO , 318
 $K_2O-CaO-Al_2O_3$, 321-322
 $K_2O-CaO-SiO_2$, 323-324
 K_2O-SiO_2 , 318-320
 $KA-C_2AF-C_2F$, 322-323
 $KC_{21}Si_{12}-CaO-C_2A_2$, 329-330
 $KC_{21}Si_{12}-CaSO_4$, 330-332
 $KC_{21}Si_{12}-MgO$, 330
 $KS-NS-SiO_2$, 336
- Potash recovery, 91
- Powder mounts, 62, 63
- Possolanas
 action, 517-520
 nature, 3
- Primary phase, 215
- Proportioning formulas, 168-176
- Protected phases, 315, 316
- Pseudo-system, 221
- Pumicite, 26
- Quality tests, 522-539
- Quenching furnace, 335, 236
 method, 229
- Quick set
 by organic materials, 480
 solubility relations, 406
- Reaction in solid state, 145, 149
 rate, 88-91
- Retardation of set, 478
- Retarder
 anhydrite, 478
 calcium chloride, 371-372, 375
 calcium sulfate, 371-375
 definition, 41
 nature, 478
 organic materials, 375
- Santorin earth, 3, 26
- Saturation, 161-166
- Sedimentation laws, 467-470
- Separation of phases, 49 55
- Septaria nodules, 8
- Set
 alkali action, 372-373
 control
 effect of gypsum, 481-484
 effect of other materials, 484-486
 crystallization of hydration products, 473-477
 definition, 41
 early studies, 367-376
 effect of potash, 373
 electrolytic effects, 373-375
 film formation, 477-479
 mutual coagulation, 479-480
 phase identification, 369-370
 rate, 371
 retardation, 371-376
 selective hydration, 472-473
 solubility studies, 371-372
 theories, 472-481
- Shale, 5, 26
- Silica, optical properties, 241
- Silica-containing systems
 Binary
 $Al_2O_3-SiO_2$, 253
 $CaO-SiO_2$, 242-249
 C_2S-KA , 326-327
 C_2S-KA , 327
 C_2S-KCS , 324-326
 K_2O-SiO_2 , 318-320
 $KC_{21}Si_{12}-MgO$, 330
 $KC_{21}Si_{12}-CaSO_4$, 330-332
 Li_2O-SiO_2 , 334-336
 SiO_2-FeO , 275-276
 TiO_2-SiO_2 , 279
- Ternary
 $CaO-Al_2O_3-SiO_2$, 253-264
 $CaO-C_2S-C_2F$, 283-284
 $CaO-C_2S-C_2F$, 284-286
 $CaO-FeO-SiO_2$, 276-277
 $CaO-MgO-SiO_2$, 267-268
 $CaO-TiO_2-SiO_2$, 281
 $CaO-SiO_2-H_2O$, 378-398
 C_2S-C_2S-KA , 327
 $C_2S-MgO-C_2A_2$, 268-269
 $FeO-Al_2O_3-SiO_2$, 278
 $K_2O-CaO-SiO_2$, 323-324
 $KC_{21}Si_{12}-CaO-C_2A_2$, 329-330
 $KS-NS-SiO_2$, 336
 $MgO-FeO-SiO_2$, 277-278
 $Na_2O-CaO-SiO_2$, 341-342
 $NS-Fe_2O_3-SiO_2$, 337
 $NS-LS-SiO_2$, 337
- Quaternary
 $CaO-C_2S-C_2A_2-C_2AF$, 300-309
 $CaO-C_2S-C_2A_2-C_2F$, 310-312
 $CaO-FeO-Al_2O_3-SiO_2$, 278
 $CaO-MgO-C_2S-C_2A_2$, 268-272
 $C_2S-C_2S-KA-Fe_2O_3$, 327-329
 $Na_2O-CaO-Al_2O_3-SiO_2$, 334-336

Silica containing systems (cont.)

Quinary

CaO-C₂S-C₃A₂-C₂F-MgO, 312-325

Slag, 5, 26

Soda-containing systems

CaO-C₂A-F-(Na₂O + 3Al₂O₃), 346-347KS-NS-SiO₂, 336Na₂O-Al₂O₃, 336Na₂O-CaO, 334Na₂O-CaO-Al₂O₃, 337-341Na₂O-CaO-Al₂O₃-SiO₂, 341-342Na₂O-CaO-SiO₂, 341-342Na₂O-TiO₂, 380-381NS-Fe₂O₃-SiO₂, 337NS-LS-SiO₂, 337

Solid phase reactions, 148, 149

Solid solution

 α -C₂S, 118-125 β -C₂S, 126

binary, 312

hydrogarnet series, 425-426

hypotheses, 52-56

in C₂S, 108, 113-114

in setting process, 368

of hydrated silicates, 391-393

of MgO in C₂A-F, 110

sulfoaluminate series, 426-427

ternary, 224-227

Solidus curve, 212

Solubility product, 379-380

Soundness, 30, 31, 169, 494-498

Spectrographic analysis, 77, 78

Steam

curing, 405

effect on strength, 504-506

effect on sulfate action, 510-511

hydration of aluminates, 413-415

iron compounds, 413-415

silicates, 393-398

hydrogarnet series, 425-426

Strength

derivation from gel-space ratio, 500-502

effect of composition, 499-500

effect of cooling rate, 502-504

effect of steam treatment, 504-506

Structure

crystal, 140-146

electron micrographs, 461-466

gel, 467-470

hydrated pastes, 446-471

microscopic, 446-461

Sugar-solubility test, 536-538

Sulfate reactions, 508-515

effect of composition, 511-515

effect of steam treatment, 510-511

nature, 509-510

Sulfate resistance

effect of composition, 511-515

effect of cooling rate, 504

effect of steam treatment, 426, 431, 510-511

hydrogarnets, 425-426

methods of tests, 522-534

calcium sulfoaluminate formation, 531-532

elastic modulus, 529-531

length change, 525-529

methods of calculation, 531

methods of chemical action, 531-534

strength change, 523-525

sulfate susceptibility test, 532-534

visual observation, 522-523

sulfoaluminate effect, 419, 431

Sulfate susceptibility test, 532-534

Surface area, effect on burnability, 149-152

Technique of phase research, 228-239

Temperature control, 236-238

Tests for quality, 522-539

Tetracalcium aluminoferrite

electron micrograph, 464

hydration, 400-401, 413-415

light interstitial material, 136-140

microscopic structure, 450

optical properties, 268

Thermal reactions, 94-102

Thermocouples, 236

Thin sections, 62, 63

Titania

forms and properties, 278-279

systems

CaO-TiO₂-SiO₂, 281Na₂O-TiO₂, 280TiO₂-Al₂O₃, 279-280TiO₂-SiO₂, 279

Trass, 5, 6, 26

Tricalcium aluminate

dissociation, 156

electron micrograph, 463, 466

hydration, 401-408

microscopic structure, 448-449

optical properties, 251-252

preparation, 252-253, 406

Tricalcium silicate

alite problem, 111-117

hydration and hydrolysis, 380-391

microscopic structure, 447

optical properties, 246-247

preparation, 248-249

stability, 111

Tufts, 5, 6

Vinsol resin, 467

Voids, 357

Water-containing systems

CaO-Al₂O₃-H₂O, 410-413CaO-Al₂O₃-Fe₂O₃-H₂O, 399-416CaO-Al₂O₃-CaSO₄-H₂O, 427-432CaO-SiO₂-H₂O, 378-398

Water test, 534-535

X-ray diffraction

clinker compounds, 541-543

crystal structure, 140-146

hydration products, 544-547

methods, 65-70

oxides, 541

pattern, 116

