

Birla Central Library

PILANI (Rajasthan)

Class No ...3..7..0...

Book No L...3..5..M... V 2

Accession No ...7..2..2..1.

**MACMILLAN'S
TEACHING IN PRACTICE
FOR SENIORS**

VOLUME TWO

MACMILLAN'S TEACHING IN PRACTICE FOR SENIORS/

AN ENCYCLOPAEDIA OF MODERN METHODS
OF TEACHING IN THE SENIOR SCHOOL
WRITTEN BY RECOGNISED AUTHORITIES
IN EDUCATION AND

EDITED BY

E. J. S. LAY

Editor of Macmillan's *Teaching in Practice in the Junior School*,
Teaching in Practice for Infant Schools, etc.

*In Eight Volumes, with a Portfolio
of 150 Class Pictures*

VOLUME TWO



MACMILLAN AND CO., LIMITED
ST. MARTIN'S STREET, LONDON

1938

COPYRIGHT

CONTENTS OF VOLUME II

BIOLOGY IN THE SENIOR SCHOOL

	PAGE		PAGE
SYLLABUS	6	SECOND YEAR'S COURSE	69
FIRST YEAR'S COURSE	9	THIRD YEAR'S COURSE	118

SCIENCE TEACHING IN THE SENIOR SCHOOL

	PAGE		PAGE
SYLLABUS	197	THE BICYCLE	216
HEATING	205	THE EYE	248

DOMESTIC SCIENCE

	PAGE		PAGE
SYLLABUS	281	SECOND YEAR'S COURSE	305
FIRST YEAR'S COURSE	284	THIRD YEAR'S COURSE	331

HEALTH EDUCATION IN THE SENIOR SCHOOL

	PAGE		PAGE
INTRODUCTION	355	SECOND YEAR'S COURSE	379
SYLLABUS	362	THIRD YEAR'S COURSE	396
FIRST YEAR'S COURSE	363	LESSONS IN DETAIL	410

FIRST AID

	PAGE		PAGE
APPLICATION OF BANDAGES	442	CESSATION OF BREATHING	464
BLEEDING	449	BURNS AND SCALDS	468
WOUNDS, BRUISES AND STINGS	452	ELECTRIC SHOCKS	470
FRACTURES, SPRAINS, ETC.	454	REMOVAL OF FOREIGN BODIES	472
POISONING	460	GAS DETECTION	473
INSENSIBILITY	462	SUGGESTIONS FOR LESSONS	475

HOME NURSING

	PAGE		PAGE
INTRODUCTION	481	COMMON NURSING TREATMENTS	507
BASIC PRINCIPLES	481	NURSING OF CHILDREN	512

A TELEPHONE PROJECT

This article, which begins on page 515, deals with a school co-operative activity which provides opportunities for the correlation of branches of school work such as science, mathematics, history and geography.

PRINCIPAL CONTENTS OF THE EIGHT VOLUMES

VOLUME I

The Teaching of English Literature and Composition; Some Notable Authors; The Teaching of Poetry illustrated by some forty poems by modern poets; Some Notable Poets; Speech Education; Senior School Drama; Speeches for Notable Occasions; Some Notable Orators.

VOLUME II

Biology; Science Teaching; Domestic Science; Health Education; First Aid; Home Nursing; A Telephone Project.

VOLUME III

Art and Craft.—The Teaching of Book Crafts; Sketching Out of Doors; The Making of Presents in Needlework; The Teaching of Woodwork.

VOLUME IV

Art and Craft (continued).—Gardening for the School and Home; A Three Years' Course of Needlework; The Mothercraft Course of Needlework; Handicraft in Science; Repairs in the Home; The Foundations of Drawing.

VOLUME V

Art and Craft (continued).—The Teaching of Drawing; Beauty in the Home; Decorative Metalwork; Engineering Metalwork; Picture Making with a Camera; Weaving.

VOLUME VI

The Teaching of Music; The Story of Music; Some Famous Musicians; A Three Years' Course of Geography; Holidays in Europe.

VOLUME VII

The Teaching of British History; The History of British Costume; Ancient History and Helps to Bible Teaching; Common Law for the Home and School; The Teaching of Civics; Notes on the History of Ancient Greece, Ancient Rome, China, Japan and India.

VOLUME VIII

Time-tables; The Teaching of Mathematics; The Treatment of the Backward Child; The Leavers' Class and Vocational Guidance; Getting a First Job; The House and Team System; The School Camp and London Journey; The Care of Pets.

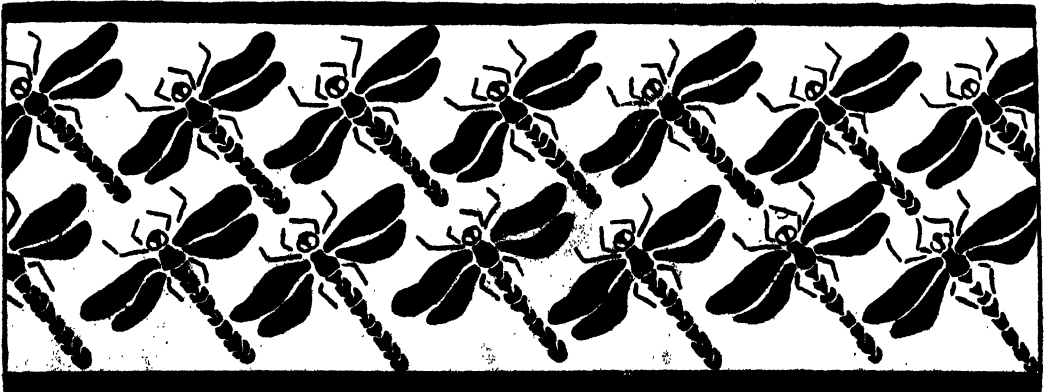

BIOLOGY IN THE SENIOR SCHOOL

In this Series of Articles the Term Lesson Unit is used to indicate that several Periods of Study are covered by the one Title.



PLATE I.
SMALL BRITISH MAMMALS
 (Class Picture No. 27 in the Portfolio.)
 For the description of this Plate see page 66.

INTRODUCTION TO THE THREE YEARS' COURSE

IT is true that the whole of a child's school education should prepare him for life, but the three years spent in the senior school differ from the earlier years in that consciousness of this purpose is dawning in the child's mind. He is beginning to live beyond the school boundaries and limits, and his happiness and interest in school life depend to some extent upon how far the school can assure him that what he is doing, and learning, will later find an application in living. The child hardly knows to what he looks forward. In many cases no doubt there is merely a vague and feeble hope of earning his living in some employment of a not too exacting nature, and the idea of freedom and money to enjoy trivial pleasures and assert his individuality in commonplace ways.

It is surely the most important function of the senior school to encourage a better, more intelligent and more definite outlook than this. The child in these three years should gain some clear ideas of the interests and possibilities, and also responsibilities, of life. Biology has much to contribute in this preparation for living, for by considering to what extent man and other creatures must submit themselves to the discipline imposed by natural laws or principles, and by noting the relationship between cause and effect, we realise the need of self-discipline and self-control, and we see that a healthy, vigorous life must be in harmony with natural tendency. We find out, too, along what lines and to what extent man can guide and control his destiny.

Naturally, only the beginnings of such lines of thought can be inculcated before the age of fourteen; in fact we can hope to accomplish very little, and we do not wish to force upon the child ideas which are

beyond his years. But if his mind is awakened, there is always the hope that development will continue further; it is, at any rate, his main chance, since at that age formal education will stop.

With this object, then, of contributing something valuable to the preparation for life, we should think out our aims in more detail—and frame our syllabus.

In the first place, we should try to help children to realise that in all living things certain physical functions are normal and necessary; therefore, in human society, conditions should provide for them. A healthy mental outlook, both of the individual and society, depends on a healthy physical and social basis. All members of a state should, ideally, be actively aware of what this basis is; that is, should not only possess theoretical knowledge but should exert themselves, individually or by encouraging state action, to bring about suitable conditions.

What is this "biological basis" for social and mental well-being? In other words, what does man, as an animal, need? Every living creature exists by taking in food. Nearly all animals have to seek their food actively, hence the value of movement. Movement carries with it structural peculiarities of many kinds, and the history of the development of this power is a very large part of the story of evolution. As a result of obtaining and assimilating sufficient food, together with sufficient oxygen, energy is set free for work—and work is the movement of mass from one place to another, so that these activities seem to complete a circle, or perhaps a spiral. Work includes, of course, all movements within the body; e.g., circulation of blood, passage of food. Any excess of digested food not needed for

immediate use to supply energy is stored and allows growth to take place, that is, increase in size. Growth is invariably accompanied, in all creatures whose bodies consist of more than one cell, by development—that is, by an unfolding or change of form—until the final, mature condition is arrived at.

When no further development of the individual is possible, energy is still accruing. This finds its outlet in reproduction. In nearly all plants and animals this takes place by means of fertilised eggs; though in some of the lower animals, and in many plants, other means of reproduction may also be found. Asexual reproduction means the formation of a new individual from a single cell, or group of cells, not from the union of two cells.

From a consideration of the various manifestations of the "urge" to reproduction, we may branch off in two directions; (1) to the development of family and group life, and (2) to the important questions bound up with inheritance.

Both animals and plants low down in the scale produce very large numbers of reproductive cells, which are usually broadcast and left to their fate. As evolution has proceeded, it has been accompanied by limitation of the number of offspring produced, together with greater provision for their welfare. The fundamental distinction between male and female comes from the fact that the egg carries food for the young—hence it must be larger than the male cell, and has tended in consequence to lose its mobility. The differentiation seems to have extended gradually to the whole physiology of the female, which tends to be conservative of energy, since the young have to be provided for.

Many different devices have been adopted for the care of the young. Amongst the highest insects and the highest mammals these have become extremely well developed. In bees and ants the elaborately organised community is the result of the attempt to provide both food and shelter, or safety,

during a long childhood. Amongst birds and mammals food and shelter have also been provided. Birds have developed the large yolky egg which enables the young to be incubated in the nest for a long time, followed by the protected nestling period. In mammals, retention within the mother's body has served the same purpose even more effectually, the nest, lair or den, or, alternatively, the collective protection of the herd, providing a safe shelter both before birth and during childhood; while in man, the home has grown up round the children and the community round the home. It would, perhaps, be as well at the present day if this biological fact were more widely realised; it appears to be of fundamental importance to the continuance of modern society, as it was to its growth and development. It need hardly be stated that the importance of a long period of childhood lies in the possibility of education, for it is a long plastic period during which the child should be adaptable to varied surroundings. Incidentally, one cannot too strongly emphasise the biological importance of adaptability, perhaps the one characteristic in which man has, so far, proved himself superior to all other creatures, and the one to which he certainly owes his survival in the struggle for existence.

It is a commonplace that "like begets like." This is what is meant by heredity. It is equally well established, and is the basis of Darwin's theory of evolution, that variations from type are common occurrences, so that no two members of a family are absolutely identical, even "identical twins." It was Darwin's argument, supported by evidence collected for over twenty years, that a process of natural selection operated upon such variations, if they were in any way useful, or vitally useful; for creatures which varied in a useful direction would have a greater chance of life and therefore a greater chance of producing offspring. Any offspring which varied in the same direction would, in their turn,

tend to survive until in due course a new race, a species, would be evolved, having the new features as fixed characters. This theory was explained in Darwin's book *The Origin of Species*, published in 1859.

One of the chief criticisms of Darwin's theory was that small variations could have no survival value; there was no reason to suppose they would be cumulative and they would tend to merge again into the typical form with cross-breeding. Recent work on heredity, however, stimulated by the important experimental work of Gregor Mendel—published but neglected in 1865-6, but re-discovered at a crucial moment in 1900—shows that new characteristics do not disappear again, or become modified, but survive in a certain proportion of offspring. Further, such new characteristics are generally marked and definite, not small and cumulative as Darwin thought likely. It may be that both types occur, and it has even been suggested by some modern biologists that all variations do not follow the same rules of inheritance.

From the practical point of view, the important fact which bears on man's affairs is that characteristics are very strongly and permanently inherited, that "what's bred in the bone," or rather, in the egg and sperm cells, comes out in each individual, and that we cannot alter inheritance by altering the conditions of life, or environment.

Therefore, if human society is to use the knowledge gained from a study of biology, there must be an organised and conscious control both of the conditions of life, to encourage desirable breeding, and of the human stock itself, to discourage those who might ultimately become a danger to the race.

There are many other interesting biological principles—or generalisations from observed facts—which have a bearing on human life because they relate to all life. Some of these will be indicated as occasion arises, but the teacher of biology should certainly keep in mind the functions and processes just summarised, in selecting

material and determining upon methods of treatment, if he wishes his teaching to contribute something to the life interests of his pupil.

Two other points should be given prominence before proceeding to plan a scheme. The first is that the study of biology may be an effective means of giving children some acquaintance with "scientific method." By this we mean that children should have an opportunity of making careful, precise observations and records, and then drawing conclusions from their own data. Such conclusions should then be linked up, by the teacher, with other information and reasoning which may not be within the children's own reach, so that eventually, some understanding of the principles just outlined may result. Wherever possible, teaching should be based on the children's own observations; it should start there, but not end there!

The remaining aspect is the leisure value of an interest in biology. It is hardly necessary to enlarge upon this. The love and reverence for nature is very deeply implanted; it needs only opportunity to grow and spread. It is an important part of the work of the biology teacher to see that the opportunity occurs. We see many manifestations of this delight, sometimes curious ones, as, for instance, in the case of the crowds of fishermen who pour out of London on gloomy winter Sundays to fish the rather depressing reaches of the river Lee, and sit wrapped for hours in solitary contemplation.

The encouragement of such love of nature will come largely from the teacher's own attitude rather than from any formal teaching. The formation of a Natural History Club gives opportunity both for group expeditions and individual efforts. Reading of short papers on first-hand work carried out, display and explanation of collections, gathering of wild flowers, especially keeping named exhibits of fresh flowers in a prominent place in the school, school nature festivals (harvest or May day), all

help to encourage the naturalist, and many boys and girls who do not come into prominence in other activities will gain an outlet and a means of self-expression in this way.

No apology is made for this long introduction because it is felt that many people are not clear as to the importance of biology in education but regard it as a modern craze or fashion, so it is hoped that due thought will be given to this preamble before the schemes suggested are accepted.

These schemes are not intended to be followed rigidly but as suggestions for a

general outline, which may be modified as the needs of various schools, surroundings and types of children make desirable.

Some familiarity with common plants and animals and their life histories, some simple experimental work on the growth of plants and perhaps on the sensitivity of garden animals (earthworms, snails, caterpillars), some acquaintance with communities such as those of a hedge or a pond, are assumed as a result of nature study in the junior school. If the teacher finds they are lacking, it will be necessary to take steps to supply such a background.

SYLLABUS OF THE COURSE

THE following are suggestions for a three-year syllabus in biology based on the foregoing considerations. Throughout all three years it is desirable that the naturalist outlook be encouraged through field work.

1. The recognition of as many common plants and animals as can be obtained; e.g., trees by leaves, buds, flowers, bark and general form; flowering plants, including common grasses, by leaf, flower and fruit; birds by habits (including characteristics of flight and song) and appearance; non-flowering plants, such as toadstools and mosses; butterflies, moths and other insects, including galls made by insects; seaweeds, shells, rock and shore-dwelling animals in seaside schools.

2. Simple ecological studies; e.g., wood, moor or other available locality, weeds of particular fields, colonisation of waste ground or old wall, community in a garden.

It is obvious that the basis of all biology must be familiarity with living things in the field.

Broad treatment is also important throughout the course. Classroom study of needs of plants, for instance, should be linked up with horticultural and agricul-

tural conditions; e.g., hoeing, to keep soil cool and evenly moist; rotation of crops, to supply different ingredients to different plants; distribution of grasslands, crops such as wheat, oats, millet, trees. Means of coping with fungoid and insect pests.

In rural districts especially, the biology can be linked up with the common occupations and interests of the neighbourhood.

FIRST YEAR—11 TO 12 YEARS OF AGE

Study of the whole life, as far as possible in their natural environment, of several animals, with special stress on food, feeding and movement; e.g., rabbit, newt, frog, dragonfly, water boatman, gnat. Skulls of dog and rabbit for teeth and jaws.

Study of stages in life of a plant from several examples; e.g., broad bean, horse chestnut, oak, sycamore, marrow.

Growth and development in plants and animals. Seasonal rhythm. Preparations for winter.

The soil as the partial source of plant food. The water current. Wood. Trees.

Garden work: preparation of seed beds and sowing of seeds, recognition of common

vegetable and flower seeds and seedlings, and seedlings of common annual and perennial weeds. Hoeing and raking.

Recognition of animals met with in garden as they occur; e.g., birds, inhabitants of soil, injurious or otherwise.

A garden notebook might be kept in addition to the ordinary nature notebook.

SECOND YEAR—12 TO 13 YEARS OF AGE

Further study of food and feeding. What happens inside the body. Digestion, blood circulation, respiration, excretion.

Modes and apparatus for breathing compared; e.g., fish, frog, mammal, various aquatic invertebrates.

Dissected frog to show organs connected with these functions. External jaws of different kinds; e.g., crab or prawn, several insects. Teeth of snail, shown by micro-projector.

Classification of animals, with special reference to feeding in vertebrates.

Respiration in plants.

Further study of growth and development. Animal: chicken. Plants: wheat, maize, onion.

Need of specific substances from soil for plant growth. Water cultures.

THIRD YEAR—13 TO 14 YEARS OF AGE

Plants and animals with special relation to man.

1. How they affect man's life.

The food of plants: photosynthesis.

The oxygen cycle.

The nitrogen cycle.

Soil.

Fungi and bacteria. Injurious insects. Birds.

Pollination and seed formation in plants—an important source of food for man.

(Incidentally here, use of a flora.)

2. How they help to explain the physical aspects of man's life.

Recapitulation of functions of living things.

If possible, dissection of rabbit or rat to show organs, since these are more nearly related to man than are organs of frog.

Ideas of evolution and heredity.

Family and group life.

Insect communities. Nesting of birds.

Habits of mammals. Adaptability.

Special adaptations to environment;

Man has specialised in adaptability, or versatility.

Distribution of plants and animals in time and space.

The geological record.

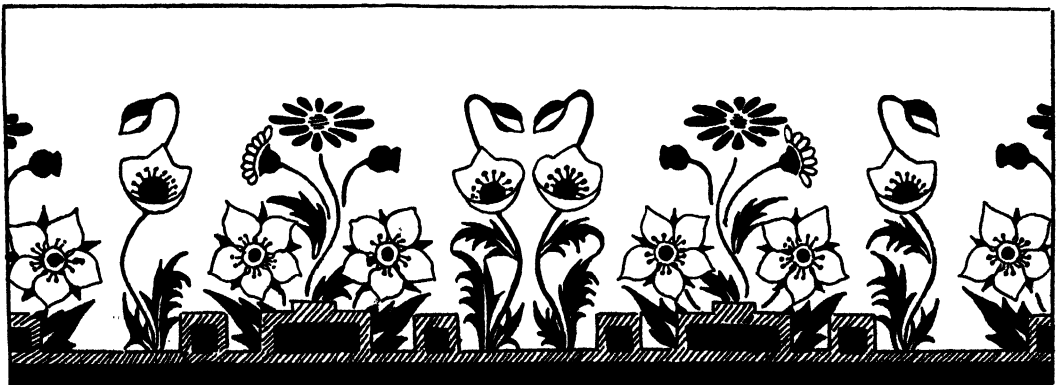

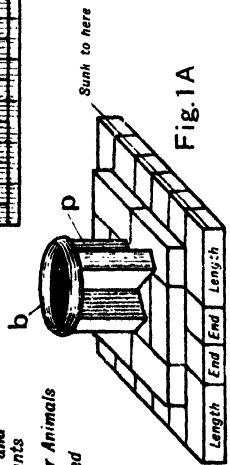
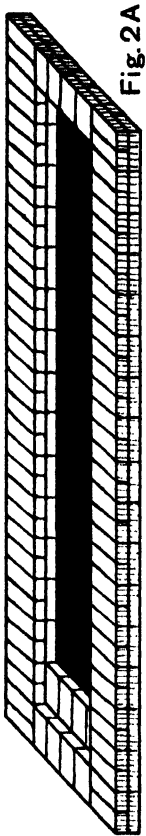
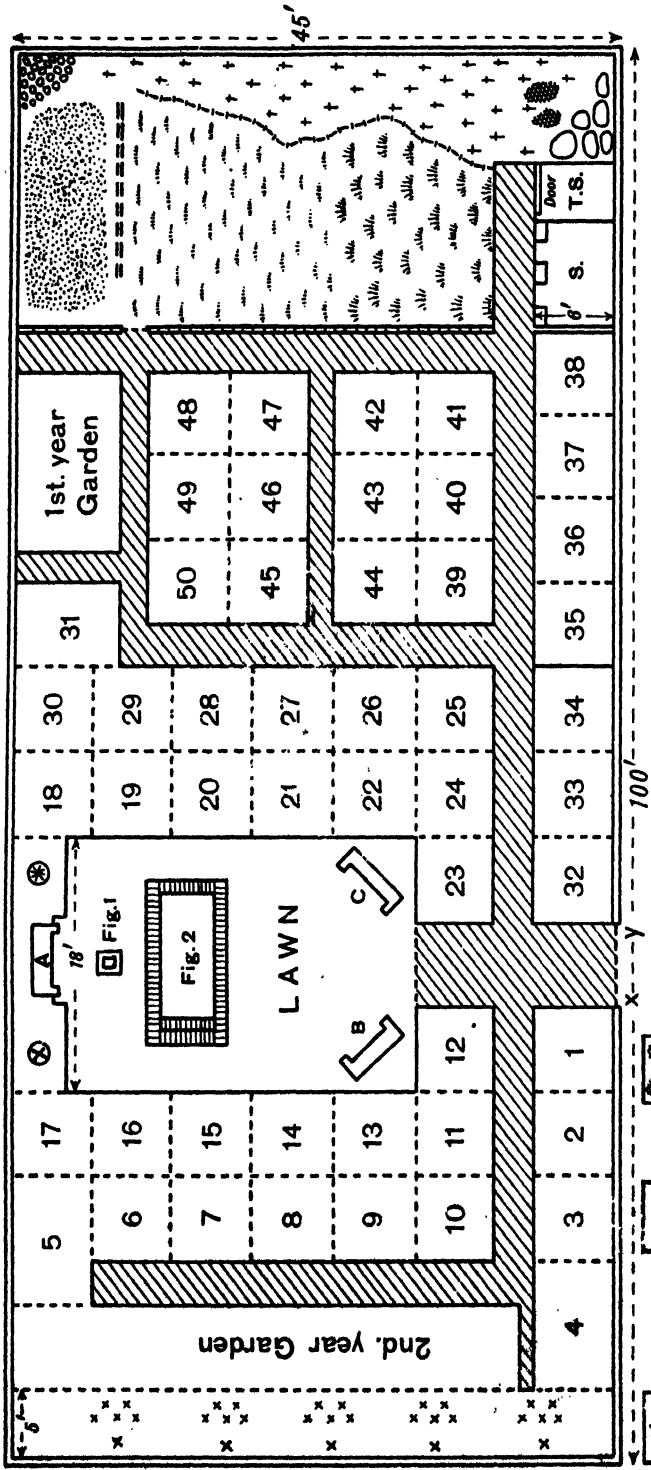

PLAN OF A SCHOOL GARDEN

FIRST YEAR'S COURSE

AUTUMN TERM

GARDEN WORK

THIS will be the basis of the term's practical work, supplying material to be examined in the classroom, where drawings and notes will be made, as well as giving information which will prepare the children for formal lessons on the preparations made by plants and animals for the winter.

1. Clear all beds allotted to this class and dig them over, keeping a special look-out for inhabitants of the soil.

2. Keep any such animals alive for a few days in tumblers of damp soil, covered with glass plates. Keep any eggs and cocoons found for further developments. Make drawings and notes of habits.

3. Identify the weeds found. Make a pressed collection. Watch the stages in seed development from flowers. Note the dying down of perennials. Dig up underground or surface-creeping stems. Examine their winter buds. Note their depth, length of stems, brittleness or toughness, and any other points that might help in survival.

Examples.—Couch grass, bindweed, colts-foot, creeping buttercup, cinquefoil.

If there is no school garden, enlist the children's interest in collecting such material in their own gardens or allotments or on waste ground, getting them to note the habits and environment.

Suggest that the children should try to note in the course of the winter what food is available for birds, where they can be seen and, if possible, what they actually do eat. Encourage the children to start nature notebooks, and inquire at regular intervals whether they have anything to communicate on this point. Keep a look-out for information in the "nature notes" of newspapers,

collect cuttings and encourage the children to do the same.

Arrange that a bird table shall be set up, and let the children keep it supplied as part of their practical work.

The children need training in selecting what they will draw and in making careful, detailed sketches which really bring out the points they regard as important and wish to illustrate. No drawing or notes should be made without a definite object. This descriptive, observational work must be given adequate time, and will provide material for several lesson periods.

LESSON UNIT I—PREPARATION MADE BY ANIMALS FOR THE WINTER

Introduction.—Refer to the children's autumn nature studies in the junior school and to the conditions they have been investigating in the garden or other places. State the subject for consideration: the behaviour of animals in preparing for the winter.

Make a blackboard list of the data offered by the class; e.g.:—Behaviour of animals in autumn.

1. Birds are not so numerous, and scarcely any sing. (Note if any are heard. Specify which have disappeared.) Finches and sparrows flocking in separate sexes in fields, where they can get grain. Starlings, lapwings flocking.

2. In harvest fields, young rabbits are very plentiful—this year's litters. (They seem to have left their parents for all seem about the same age. As the corn is cut, they tend to run to the middle of the field and at the last are trapped, and easily shot.)



1



2



3



4



5

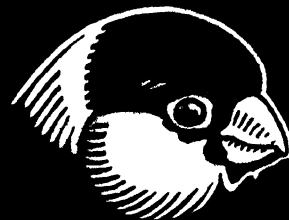

6

PLATE II .

SOFT-BILLED INSECT FEEDERS

2. HEDGE SPARROW.

3. WHITETHROAT.

HARD-BILLED GRAIN FEEDERS

5. YELLOW-HAMMER.

6. BULLFINCH.

3. Spiders are very abundant. Flies also are still numerous in warm autumn days.

(Note the effect of frosts, and the date of the last appearance of spiders and flies.) Cocoons of spiders can be found.

4. Hover flies, bees, some butterflies (tortoiseshell, red admiral) are still seen on bright, warm days over herbaceous borders (Figs. 1, 2 and 3). (Note the large number of pollen-producing flowers which they seem to like; e.g., Michaelmas daisies.)



FIG. 1. HOVER FLY



FIG. 2. SMALL TORTOISESHELL BUTTERFLY

- a. Reddish orange ground.
- b. Blackish brown.
- c. Yellow.
- d. Blue crescentic spots.

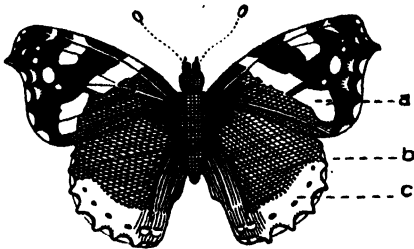

FIG. 3. RED ADMIRAL BUTTERFLY

- a. Scarlet.
 - b. Brown.
 - c. Scarlet.
- The rest is black and white.

5. In soil, certain animals are as numerous as ever; e.g., earthworms. Cocoons and some caterpillars are found resting there. (Note which ones.) Cockchafer larvae and cocoons may be found. (These have a long immature period in the soil—over three years.) Ground beetles, which prey on worms and grubs (or larvae). (Figs. 4, 5 and 6.)

Development.—Consider the points collected and note that two principal factors seem to influence the behaviour observed:

1. Diminution of food supply.
2. Lowered temperature, especially where it is so low that frost occurs.

1. Food supply.—Birds gradually exhaust the supply of seeds, both grain and weeds.

As the temperature becomes progressively lower, insects die or disappear into sheltered

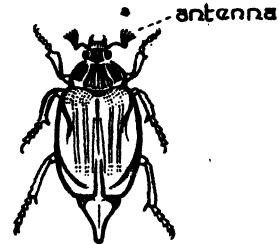

FIG. 4. COCKCHAFER

Top left: Larva.
Top right: Cocoon.



FIG. 5. GROUND BEETLE



FIG. 6. TIGER BEETLE

(Popular names should be used where possible.)

positions underground; snails hibernate in hidden spots. Even earthworms burrow deeper and deeper into the soil as it grows colder, especially if at the same time the weather, and therefore the soil, is dry. Other soil inhabitants do the same. They are not, however, exposed to the cold winds as are animals dwelling above the soil. Most of the animals living in soil can stand a fairly low temperature so long as their surroundings are moist.

Birds and many mammals (or furry animals) can stand cold better than most of

the lower creatures, provided they can obtain enough food. It is chiefly lack of food that makes it necessary for birds to migrate. Note that it is chiefly those which feed on insects that migrate—the flycatcher, the various warblers, the swallow and martin—though a few of these, e.g., the robin, blue tit and great tit, remain for the winter. These birds search the bark of trees most persistently and patiently for insects hidden in the crevices, whether adults, larvae or eggs, and little escapes them. Incidentally, note what a great service is thus performed unknowingly for man, in destroying pests which might do serious damage in the next year.

Suggest that the children shall note what other animals can be found during the winter, and anything that can be found out about their food.

Rabbits come out to feed in the evening; squirrels may occasionally be seen; the fox, the otter and the badger, though the last two are becoming rare, roam about; the water vole appears from time to time. Probably all these animals exist on short commons during the winter and they are usually in poor condition by the spring.

Many animals, whether they hibernate or remain active, store a certain amount of food in the form of fat, which is gradually used up during the winter. Probably most of the mammals have some fat reserve; the frog has special fat bodies in the region of the kidneys; snails have extra fat.

2. Lowered temperature.—Birds are able to keep warm except in extremely cold weather, because their feathers are non-conducting. They hold a considerable amount of air, and this can be increased in very cold weather. Thus, when sometimes one is inclined to think a bird in cold weather is very plump and well fed, it is really puffing out its feathers so that they hold as much air as possible to keep out the cold, and it may actually be near starvation point.

Hibernation does not merely mean winter sleep, but that great changes have taken

place in the whole working of the body. Every process is slowed down. The dormouse is a good example of a mammal which hibernates. Enclosed in its winter nest, tightly curled up to keep in as much warmth as possible, it is practically in a state of coma; if it wakes, it is very likely to die of exposure to the cold, since it is only in the hibernating state that its body is adequately prepared to resist it. When it eventually awakes in the spring, it is a mere ghost of the fat little creature of the autumn.

Breathing is almost at a standstill during hibernation. It is difficult to believe that it is going on at all when one realises that frogs will bury themselves in the mud at the bottom of a pond, or may be packed tightly into a drain in hundreds.

The blood of frogs, newts and invertebrate animals changes temperature with the external air or water. This in itself tends to sluggishness of disposition during the cold weather.

The higher animals—birds and mammals—have elaborate arrangements for keeping the blood always at a constant temperature. The minute arteries, or arterioles, near the surface of the body, contract in cold weather and so prevent loss of heat. The covering of fur or feathers also prevents the escape of heat. Thus the deep-lying vital organs are kept at a constant temperature. Any "chill" to these organs might entail serious consequences.

Incidentally, one of the dangers of taking alcohol before going out into the cold is that it paralyses the small nerves controlling the blood circulation at the surface, and so causes the arterioles to be relaxed, allowing heat to escape. At the same time it gives a false sense of security and well-being, since the escaping heat gives the sensation of skin warmth, which is attained by the loss of heat from the deeper parts of the body.

Note.—These lessons might run concurrently with lessons on convection, conduction and radiation of heat in the periods devoted to general elementary science. In any case the two should be linked together.

LESSON UNIT II—PREPARATION MADE BY PLANTS FOR THEIR INDIVIDUAL SURVIVAL OVER THE WINTER

Introduction.—The children will have noticed during their preliminary work in the garden the dying down of plants, sometimes completely, sometimes only of the aerial parts, while permanent roots and stems survive underground. They will also have noticed that the woody plants—shrubs and trees—retain their aerial parts also, most of them losing their leaves, though the evergreens retain them.

Development.—The preparations a plant makes in the autumn for the winter and following spring are important because they affect both the individual plant and the race.

1. Seeds.—If the individual plant dies completely, it does not do so without making some provision for carrying on the race, or species. It does not die until it has scattered its seeds. Annual plants do this in the course of one summer, while ephemeral plants are those which produce several generations in one season; e.g., chickweed. Biennials take two seasons to produce their seed. True biennials then die; e.g., cabbage.

2. Buds.—In addition to seeds, perennial plants produce what are called winter buds; that is, buds which cease all activity throughout the winter, but continue their growth and development in the following spring. Examples should be shown, Fig. 7.

All growth of stems and leaves takes place from buds. A bud is composed of a portion of a stem—the growing point—together with a number of small outgrowths—the developing leaves. The winter buds of trees and shrubs become the summer buds by losing their protective scales, for however many leaves unfold, there is still a bud, with a growing point, at the tip of the stem.

As the summer advances, growth at the tip becomes slower, the leaves develop more slowly and by July have usually stopped

altogether. The summer bud then becomes the protected winter bud, for the leaves on the outside of it are incomplete, being either leaf bases; e.g., horse chestnut, sycamore, or outgrowths of leaf bases (stipules); e.g., beech, lime, folded round it. (Plate III.)

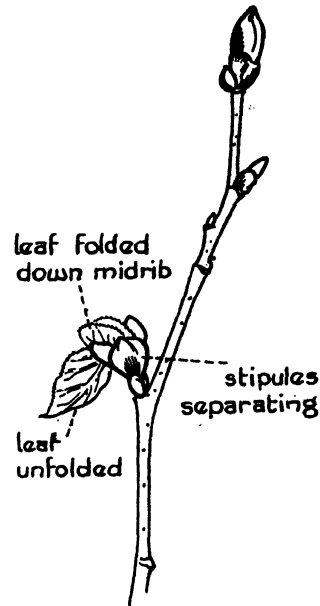

FIG. 7. LIME BUDS UNFOLDING

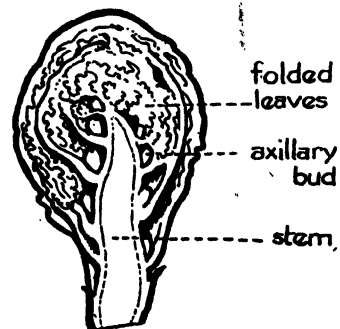

FIG. 8. BRUSSELS SPROUT TO SHOW TYPICAL BUD STRUCTURE

While growth is active, small buds are also formed immediately above the point where each leaf joins the stem—in the axil of the leaf. These are therefore called axillary, or lateral, buds, Fig. 8. Note this

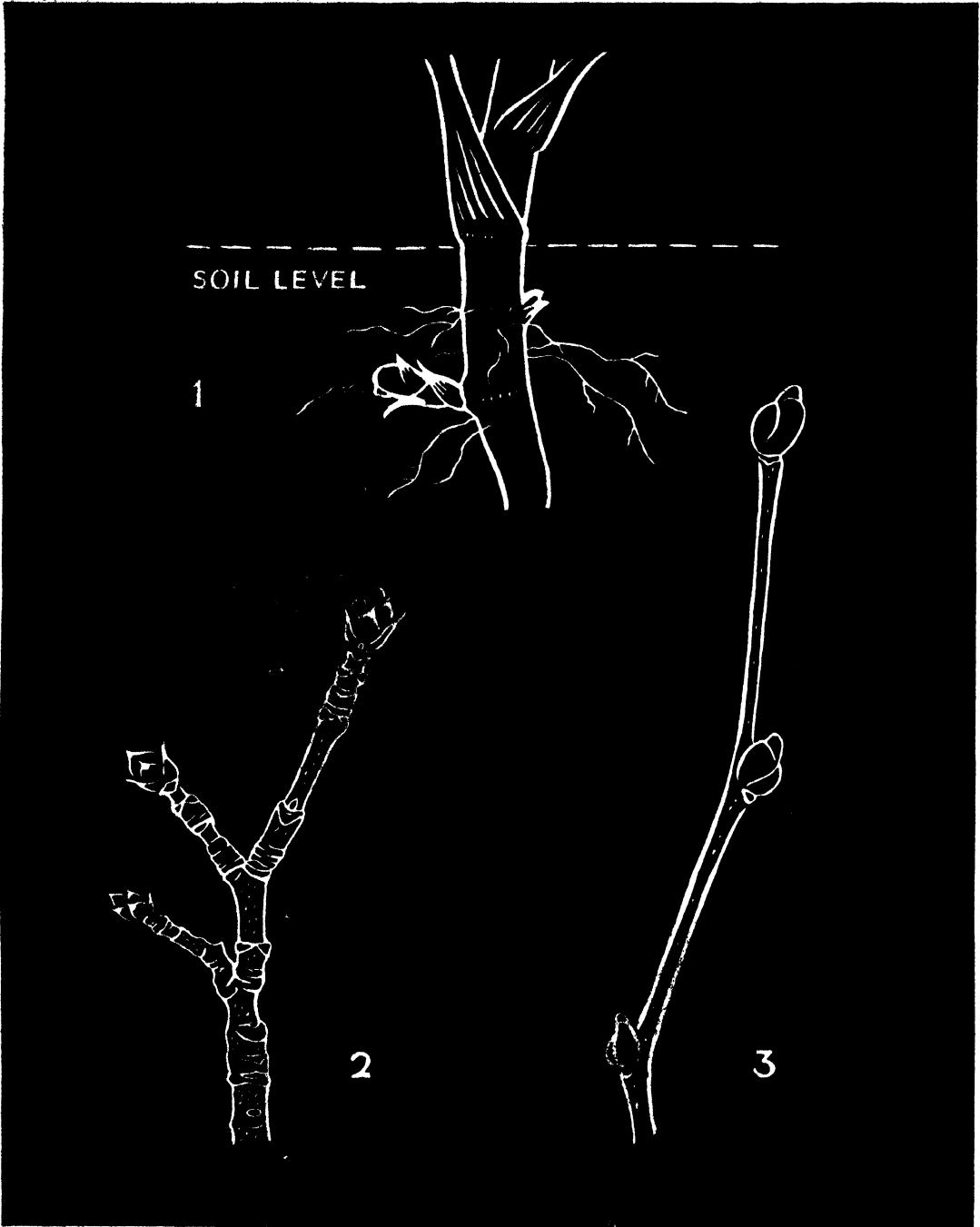

PLATE III.

Buds

1. UNDERGROUND BUD OF COLTSFOOT. 2. WINTER BUDS OF SYCAMORE.
 3. WINTER BUDS OF LIME.

in the twigs examined, finding leaf scars with buds above them.

After the leaves have finished growing, both the axillary and apical, or terminal, buds swell to their full size, then the outer scales become hard enough to resist the cold winds, frost and rain of the winter.

In the case of underground buds the protection is of the same kind, though the scales may be less hard and with less marked individual characters. In many cases a good deal of growth takes place under the ground before the bud makes its way above the ground and opens out into foliage leaves; e.g., in couch grass, bindweed, willowherb, evening primrose, coltsfoot. In other cases the bud will grow into an upright stem and force its way above the ground close to the parent crown; e.g., chrysanthemum, delphinium, dandelion, daisy. Leaves unfolding below ground are usually leaf bases only (scales). Examine some of these underground growths from each group.

In all these cases the plant has made provision for continuing individual growth but, in the case of underground buds being formed, it is also increasing the area occupied. This is especially obvious where long underground stems are found; e.g., couch grass, willowherb. Moreover, these buds are of the same kind whether they are dormant, sustaining life through the winter, or active during the summer. There is a less marked dormant period than in trees or shrubs, for it will often be found on digging down that the buds are growing late in the autumn or very early in the spring.

3. Vegetative propagation.—In some cases in course of time the withering of the intermediate stem leads to the separation of new plants from the old—e.g., nettle, coltsfoot—so that this method of growth serves in the first instance to preserve the individual plant, later to increase the number, that is, preserve the race, by vegetative propagation. It is, of course, a property very widely made use of by gardeners. It is also one of the best means of race preservation for weeds, since

any buds left in the ground when weeding produce new plants to flaunt their vitality in spite of them; e.g., couch grass, bindweed.

Note.—This and the following lesson unit might be given fairly early in the term, since they serve to direct observation and encourage thought about the problems of plants. They should be illustrated by living material for the children to handle, and by diagrams. The children should also have an opportunity of digging up growing weeds to realise the importance and effectiveness of the underground buds. More detailed examination of the winter buds of trees, recognition of common trees in winter, and an account of the importance of leaf fall, if wished, would follow.

LESSON UNIT III—PREPARATION MADE BY PLANTS FOR RACE SURVIVAL

Introduction.—While a great many animals produce their offspring in the spring or early summer months—e.g., sheep, deer, birds, most insects—it is characteristic of flowering plants to produce their seed in the autumn. Exceptions to this are the ephemerals, which produce several generations, and a few—e.g., red dead nettle—which flower and seed continuously through the summer.

This is associated with another peculiarity of the majority of flowering plants, the fact that the seed, which contains the young plant or embryo, does not open immediately and allow the young plant to develop, but passes through a prolonged resting period, in many cases coinciding with the winter.

We are therefore in the habit of connecting the autumn with seed and fruit production, the spring with germinating or sprouting of young plants.

In some countries these periods are not so marked. In tropical countries growth takes place after the rainy season, and even deserts have a quick, ephemeral flora which springs up after a period of rain. But in the temperate zones a seasonal rhythm is well marked.

Development.—There are three main questions to keep in mind in studying seeds.

1. How is the young plant protected?
2. How is it provided with food for its early life?
3. How is it dispersed; that is, how is a suitable home found for it?

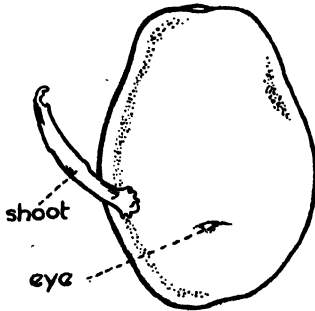

FIG. 9. POTATO TUBER WITH OPENING BUD.

We should also note in passing that there are other ways of producing new plants besides seeds. The most important are: (a) by special buds (bulbs) or specialised stems bearing buds (potato tubers, lesser celandine bulbils); (b) by spores, small units of living matter (protoplasm) usually with a protective wall (toadstools, moulds, mosses, ferns, seaweeds); Figs. 9, 10, 11 and 12.

1. Protection of embryo plant.—Provide each child with an ash fruit (Fig. 13) which has been soaked in water overnight. Let him slit this carefully with a needle down the middle, and after noticing how the seed lies in its pericarp, or fruit wall (the wall of the ripened ovary) which in this case gives protection, split the seed carefully along the edge with a sharp penknife. This exposes the whole small plant or embryo. It is

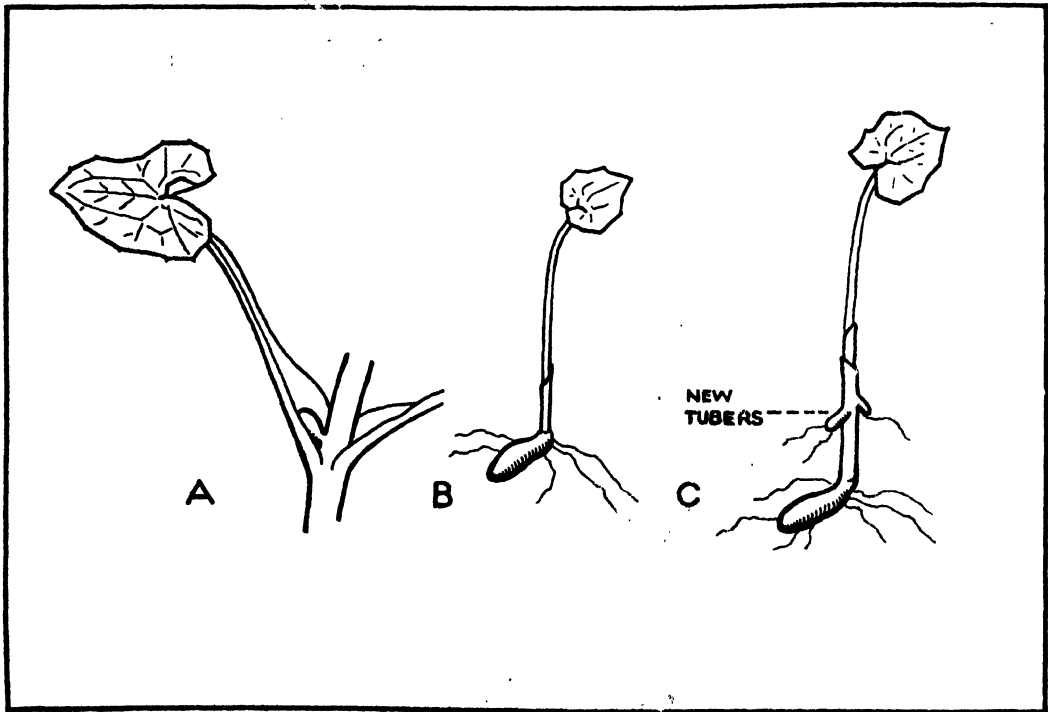

FIG. 10. LESSER CELANDINE
 A. Formation of bulbil in axil of leaf.
 B. Bulbil producing young plant.
 C. Later stage with tubers growing.

about $\frac{1}{2}$ in. long, quite white, and consists of a pair of narrow, thin leaves and a slightly thicker root. Note that the embryo lies embedded in a white substance called endo-

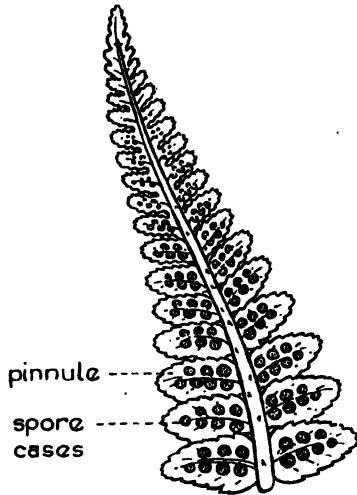

FIG. 11. UNDER SURFACE OF PINNA OF MALE FERN TO SHOW SPORE CASES

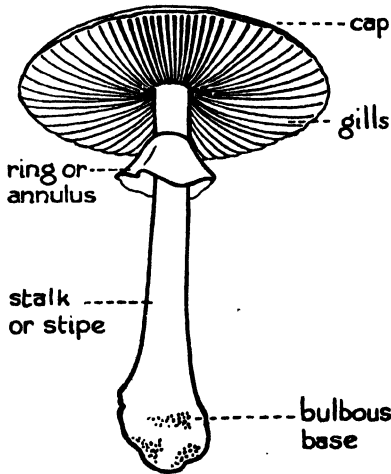

FIG. 12. TOADSTOOL

sperm, which serves as food. Note that the endosperm is quite hard and will therefore protect the embryo against any rough contact. It is covered on the outside by a thin brown testa.

Now compare this with some natural and soaked broad beans, Fig. 14. The pericarp is the pod. Show it if available; in any case refer to it. The seeds escape and settle in the soil, therefore the pericarp offers them no protection. The testa, however, is very hard, as can be felt. When the beans have been soaked, as they would be by the water in the soil, the testa

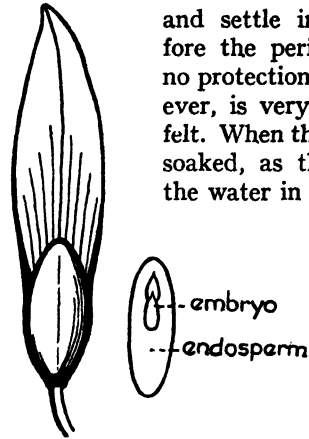

FIG. 13. ASH FRUIT AND A VERTICAL SECTION OF THE SEED

is still resistant and protective, being thick and tough. (Fig. 14.)

Let the children remove the testa by splitting down the edge, avoiding the black scar. On examining it inside they will find a neat little pocket into which the root, or radicle, fits. Opening out the bean itself, it will be found to separate into two halves, to one of which the root and bent stem, or plumule, remain attached. Note that while

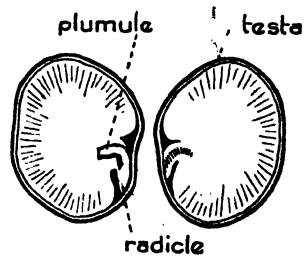

FIG. 14. BROAD BEAN, OPENED OUT

the root is protected by the pocket, the stem lies between the two white lobes, the cotyledons or first leaves, which thus protect it also. These lobes are large and thick because they have absorbed all the food from the endosperm, but they correspond to the narrow white leaves seen in the ash.

We see, therefore, that in each case the embryo consists of a root, stem and pair of leaves. It is protected either by endosperm or by the nature of the leaves themselves, and by the testa. It may also retain the pericarp as a further protection until it germinates, as in all the indehiscent fruits, and in any case will be enclosed in the pericarp until the seed is mature.

Details will differ, but these are the main protective measures for seeds. Any other examples available may be examined and these points determined.

2. Provision of food.—The question of food for the young plant may be left for more detailed consideration later.

3. Dispersal of seeds.—The children are sure to know something of this from their work in the junior school. It should only be necessary, therefore, to refer to the chief methods of dispersal, which will be found in any elementary botany textbook.

Tables might, however, be made of the fruits found, under the headings *wind dispersal, dispersal by animals, dispersal by explosion or propulsion, dispersal by censer action* (swinging in the wind; e.g., campion, poppy). It should also be noted with examples found that many light, small seeds are very effectively dispersed without any special mechanism; e.g., poppy, plantain, and also that many indehiscent fruits (acorn) or dehiscent fruits (horse chestnut) with no special means do seem to find suitable places in which to grow.

LESSON UNIT IV—FOOD OF EMBRYO PLANTS

Introduction.—Soaked seeds of several different kinds should be examined. Find the embryo in each case and note whether the cotyledons have already absorbed the food, or whether the embryo lies embedded in endosperm. Note also the size of the seeds and amount of food stored. Has this

any relation to the time taken to germinate after soaking? Try it.

Development.—Why should a young plant need food? In order to grow. A large part of the substance of a plant is water, but there is a certain amount of solid substance. We can find out how much by heating a plant until all the water has been given off.

Experiment.—Let different children weigh a woody twig, a small herbaceous plant; e.g., groundsel, lettuce; a carrot, some fruit such as plum or apple, a horse chestnut seed. Then set these to dry in an oven with a temperature of 110° to 120°. A biscuit tin over a very low Bunsen flame, with an asbestos mat between, would do. Let the class record all the first weights and, when the experiment is completed, re-weigh and calculate percentage of water in each substance.

If carbon dioxide has been prepared in the general science class, heat some of the tissue still further over a Bunsen burner in a small dish or tin lid, and test for the gas by holding a drop of lime water on a glass rod over it.

Explain that a good deal more of the substance will turn to gases if further heated until at last a small amount of ash remains. This consists of mineral substances taken out of the soil. Show that if water is shaken up with soil and allowed to stand, then filtered, and evaporated to dryness in a white enamel cup over a very low flame, a powdery stain will be left which shows that soil water contains some substance dissolved in it.

State that plants not only obtain substances from the soil which build up their bodies, but their leaves take something from air also. No further explanation should be given here; it will come later.

Now when a young plant, still inside the seed coat, begins to grow, its root grows first and begins to feed upon the water in the soil. As yet, however, its leaves have not emerged, and therefore cannot do their work. It is in helping the plant through

this early stage that the food in the seed, whether in the endosperm or already absorbed into the cotyledons, is useful. It is found to consist chiefly of starch. This can be proved.

Show the iodine test for starch with ordinary laundry starch and note the deep colour—blue-violet if a little thin paste is made in water and tested, black in the mass.

Now test a variety of seeds by cutting soaked seeds across and smearing the surface with iodine with a glass rod or paint brush. It may need to stand for a little while in some cases before it will penetrate. The violet stain indicates the presence of starch, and also shows how it is distributed. It is the commonest substance found as a food reserve in seeds.

Starch is also one of the foods on which human beings rely to a great extent, as it is useful for providing energy. Test flour, rice and any other cereals that can be

obtained; in fact, any common foods, and see which contain starch.

Although the cotyledons serve for food storage, they are true leaves. In many cases they serve as ordinary foliage leaves as well. Illustrate this by growing some mustard, which will germinate in a few days. Keep the point in mind also in connection with seeds to be grown in the following spring; e.g., marrow.

Notice what a large number of common weeds and other wild plants germinate in this way. Frequently these can be found germinating freely in the autumn, and in sheltered places almost throughout the winter; e.g., shepherd's purse, goosegrass, dead nettle.

Let the class make sketches to show the areas containing starch in various seeds, and also draw any seedlings which can be found in the garden with epigeal cotyledons; that is, cotyledons above ground.



WINTER-SPRING TERM

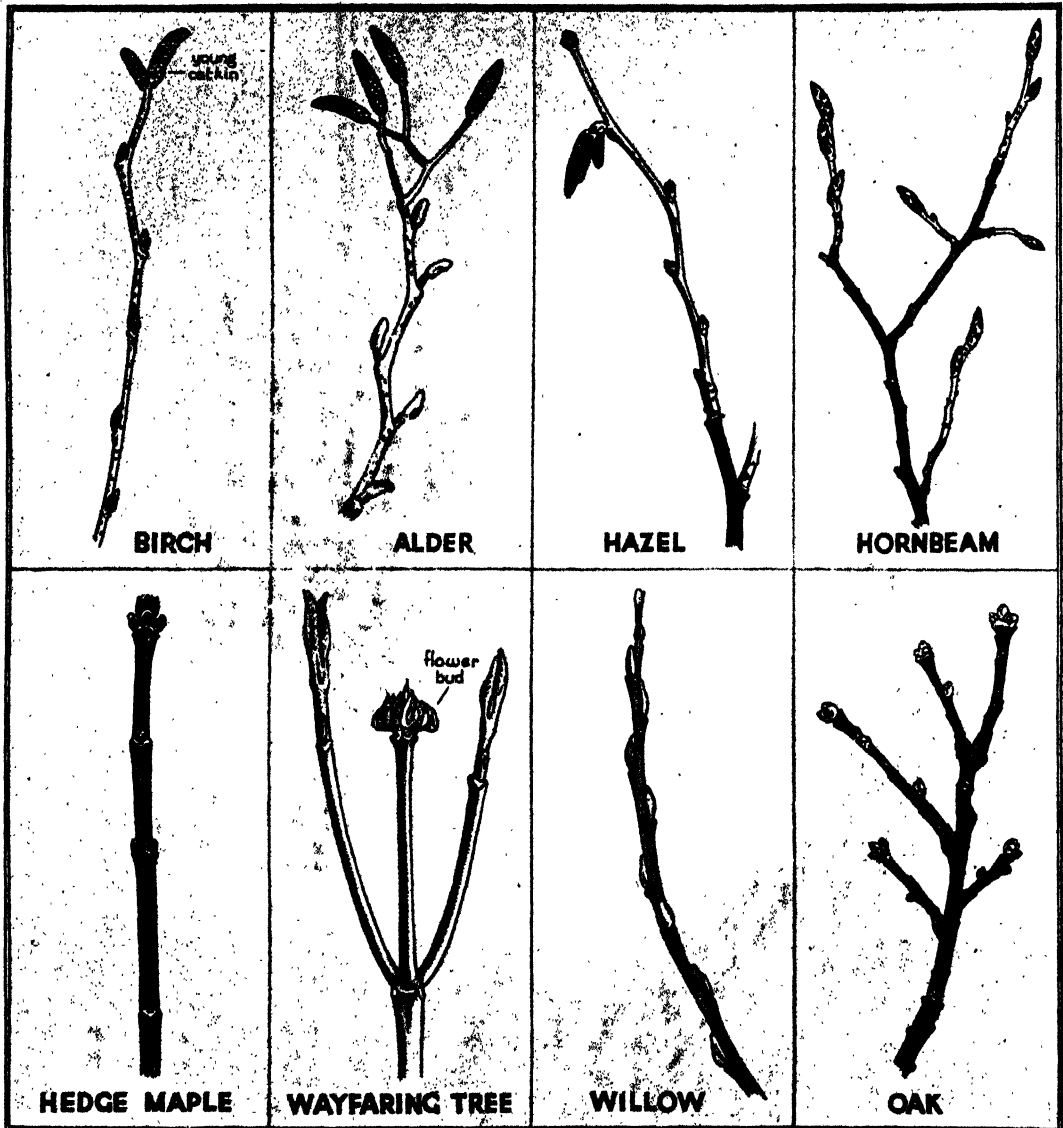

PLATE IV.

SOME WINTER TWIGS SHOWING BUDS

(Class Picture No. 20 in the Portfolio.)

WORK FOR WINTER MONTHS

IT was suggested that, in connection with their study of buds in the autumn term, the children should learn to recognise some of the common trees by their winter buds (Plate IV), and also notice how the trees prepared for the winter by protecting the buds and, in most cases, dropping their leaves. The study of the conduction of water led to an examination of wood, and several of the experiments suggested can best be carried out with leafy twigs, so that an interest in trees will be sustained throughout the year—a good instance of a continuous interest through different aspects.

It would, therefore, be convenient to take a little time in January or February, when living material is scarce, to consider the importance of trees in relation to other forms of life.

As a practical accompaniment, so that the living tree is not lost sight of, the unfolding buds of horse chestnut may be studied, while flower buds of elm, hazel (a shrub usually), and alder will give an opportunity of noting the characteristics of wind pollination. Willow, in contrast to these, gives the earliest supply of pollen and honey to bees and other insects. All these will readily open indoors.

The seedlings of oak, horse chestnut and sycamore, from seeds planted in the autumn, should also be watched.

Winter twigs.—Although each has its own definite formation, to the unfamiliar it is often a difficult matter to distinguish the various buds of the common trees, especially before spring causes the protective cases to burst. The catkins of the delicate, twiggy birch, the stiff hazel of the hedgerow and the alder by the waterside provide clues in these cases. In the woods, the thin, closely-tucked spikes of the hornbeam and the knobby ends of the oak are unmistakable. Along the hedges the reddish clusters of the maple are quite common, and here and there, standing aloof, the three-armed tips of the branches of the wayfaring tree with

the fat flower bud in the centre may be met occasionally. Lastly, the numerous tight points of the water-loving willow seem almost ready to burst into the soft downiness of their spring jackets, Plate IV.

LESSON UNIT I—TREES: DISTRIBUTION AND ECONOMIC IMPORTANCE

Introduction.—The children might first of all be given a simplified street map, if in a town, in which to note the distribution of trees in their own neighbourhood. Symbols or letters would denote each kind. Alternatively, they might make a tree map of an adjacent park.

Development.—From these, two points would emerge; first, that all these trees have been planted; secondly, that certain trees have evidently been found more suitable for the purpose than others. Thus, a park may have many well-grown specimen trees, but in the streets there will be less variety and certain well-tried kinds, such as lime, plane or sycamore, will be used extensively.

This raises two questions:—Are various conditions required for various trees? What conditions are needed by trees?

1. Conditions influencing distribution of trees.—Here a vegetation map of the world, shown in most school atlases, might be consulted and the distribution of trees noted, Plate V. For instance, if Philip's *Modern School Atlas* is used, the key shows that coniferous forest, broad-leaved (i.e., deciduous) forest and meadow, evergreen trees and shrubs, and tropical forest occupy broad, well-marked areas.

Make two blackboard tables of these forest lands and their distribution. Then add, by consulting other maps in the atlas, the outstanding features of position, temperature and rainfall. It may well be that winds are important, too, but the effect is not so easy to indicate or estimate. The tables might be arranged somewhat as follows:

TREES IN NORTHERN HEMISPHERE

	<i>Latitudes.</i>	<i>Continents.</i>	<i>Rainfall.</i>	<i>Extremes of Temp.</i>
Coniferous.	Mainly 45°-75° with strips in mountainous districts as far south as 10°.	N. America. N. Europe. Asia.	All seasons. Summer about 10-20 in.	32° or less in winter. 64° in summer.
Deciduous.	South of the conifers. Chiefly temperate zone (60°-30°) but reaching nearly to equator in S. China.	Very little in Africa.	All seasons. Up to 40 in. but may be only 10-20 in.	Southern limit about 48° in winter. 64°-80° in summer.
Evergreen.	35°-45°. 28°-38°.	Round Mediterranean. N. of Gulf of Mexico.	Greater in winter. Up to 80 in.	
Tropical.	To about 28°.	S. America and into N. America. Africa. S. Asia.	80 in. and over.	80°.

TREES IN SOUTHERN HEMISPHERE

	<i>Latitudes.</i>	<i>Continents.</i>	<i>Rainfall.</i>	<i>Extremes of Temp.</i>
Coniferous.	None.			
Deciduous.	Temperate zone. 22°-55°.	A little in E. Australia and S. Andes.	40-80 in	48°-80°.
Evergreen.	30°-40°.	S. Australia.	Greatest in their winter. 5-40 in. range.	

When the two tables are compared we notice the following facts:—

(a) Coniferous trees are the most northerly, extending into the coldest regions, just into the arctic circle.

There is only snow-covered land in the corresponding region of the antarctic, so there are no conifers. It is interesting to note that the conifers are represented in the arctic circle by dwarf pines. Further, any

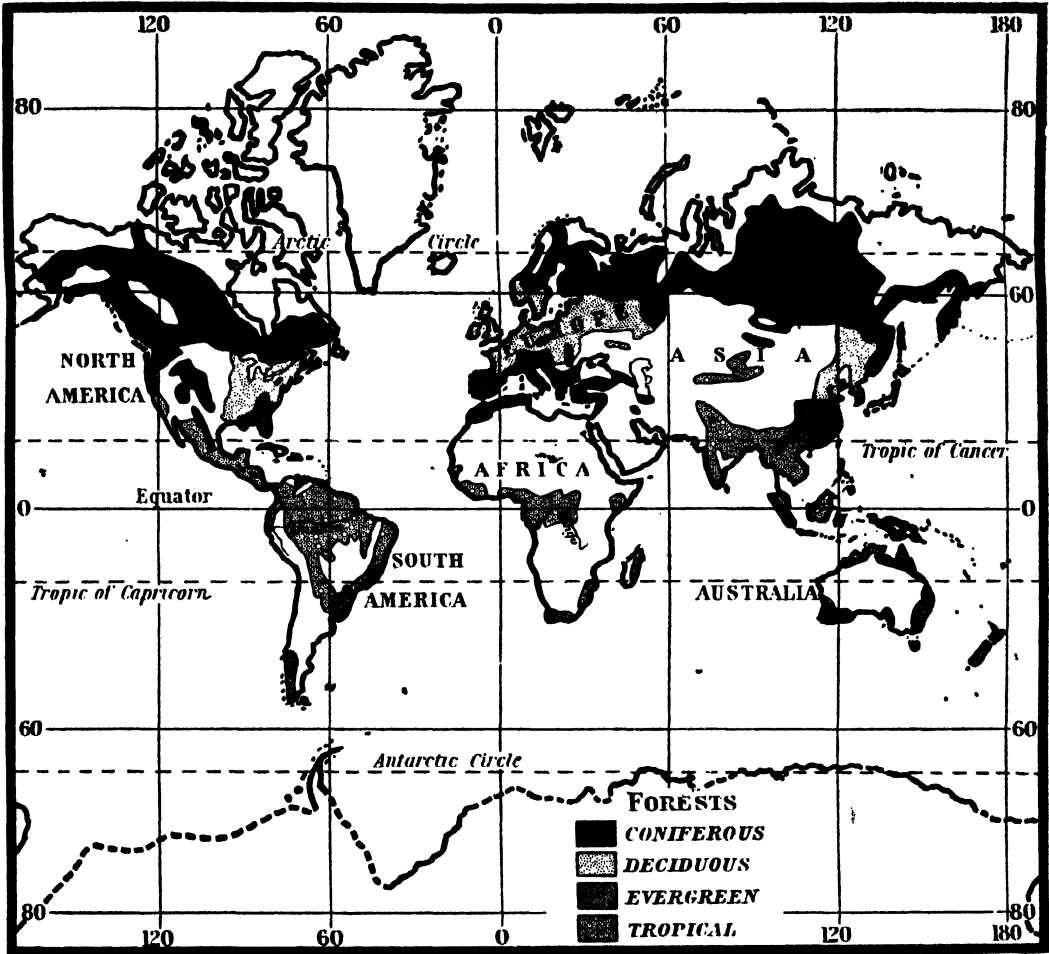

PLATE V.
 WORLD DISTRIBUTION OF TREES
 (Class Picture No. 15 in the Portfolio.)

deciduous trees found—willow, birch—are also dwarf forms. Such trees can survive the cutting winds of the winter only if they are beneath the snow; hence they grow only to a height that the snow covers; any buds above this are nipped by the wind. The trees are therefore flat, as if sheared off.

(b) On the whole, the conifers grow in

regions of less rainfall than the deciduous trees. Probably their narrow, tough leaves give off less water and so the roots do not need to take in so much.

(c) The deciduous trees are the typical trees of the temperate region. They share the land with the grasses—prairies, steppes, meadowland—and it is chiefly a difference

in water supply which determines whether trees will succeed in the struggle for existence.

Notice the effect this has had on the life of man. If trees grow, man will take to hunting and woodcutting. He will export skins and wood. This is true whether the woods are coniferous or deciduous. If grasses are established, the land becomes the haunt of wild horses and cattle, and man the hunter, who first hunts these animals, gives place to man the cattle breeder and horse breeder, and later, the grower of corn. So that the destiny of the races of man has been linked up with the destiny of trees or grassland.

Cattle may, by grazing, gradually increase the grasslands and cause the trees to disappear, since they destroy the trees by tearing off bark and branches, and, by eating the young seedlings, prevent new ones from growing. Rabbits may, in England, have the same effect.

In another way, trees in masses influence the life of man, for the water drawn up through their roots passes at last out of their leaves, the great mass of vapour condenses and forms clouds, and in due time these descend again as rain. It is, therefore, of great importance not to cut down trees recklessly without giving thought to the effect this may have on the climate. It is said that the rocky island of St. Helena was made barren by the cutting down of its trees.

(d) Notice the tremendous rainfall associated with the tropical forests, whereas the tropical lands with little rainfall are desert. The process works in a circle, for the rain pours down and the massive trees soak it up rapidly, passing it on again. The cooler night causes condensation, clouds form and the rain falls again. Hence heavy storms at frequent intervals are characteristic of tropical forests. If possible, read some first-hand description of tropical rain forest from books of travel or good novels; e.g., W. H. Hudson's *Green Mansions*.

One other point is of interest in connection with the world distribution of trees, and that

is their vertical distribution, Plate VI. Just as we find tropical trees in the hottest and wettest lands, then deciduous trees in temperate climates and conifers in the north temperate zone, so we find in climbing a mountain that, in passing from the warm, damp valley to the cold, windswept and well-drained summit, we pass from a region of broad-leaved trees with tender leaves, to the small-leaved conifers, and finally beyond the trees to grass and, last of all, bare rock covered only with dry lichens as in the arctic circle. It is possible in a tropical region to climb up a mountain, such as Kilimanjaro in British East Africa, not 4° N. of the equator, from tropical forest right through all these zones of vegetation and emerge in a region of perpetual snow.

2. Soil conditions.—We now know something of the conditions which influence the distribution of trees—rainfall, winds, temperature, and because of this, height or latitude. But there is another factor which may determine what trees will naturally grow in particular places, and that is the character of the soil.

Broadly speaking, we may divide soils into sandy, chalky and clay soils, with the acid peat soils found in marshy districts. An examination of the trees in our own country will show us that there is a definite relation between the soil and the native trees found.

If oak and ash trees are the commonest trees in the school neighbourhood, it will probably be found that the soil is based on clay. If oak and birch trees or pine trees are abundant, then most likely there is sandy heath. Beech trees love the chalk country. Willows and alder flourish in damp, waterlogged soil—it probably contains a good deal of clay. Sweet chestnut trees are said to be "lime-shy," because they cannot bear lime or chalk in the soil; neither can rhododendron shrubs.

The various trees tend to be associated with particular kinds of undergrowth; thus primroses and bluebells are found in beech

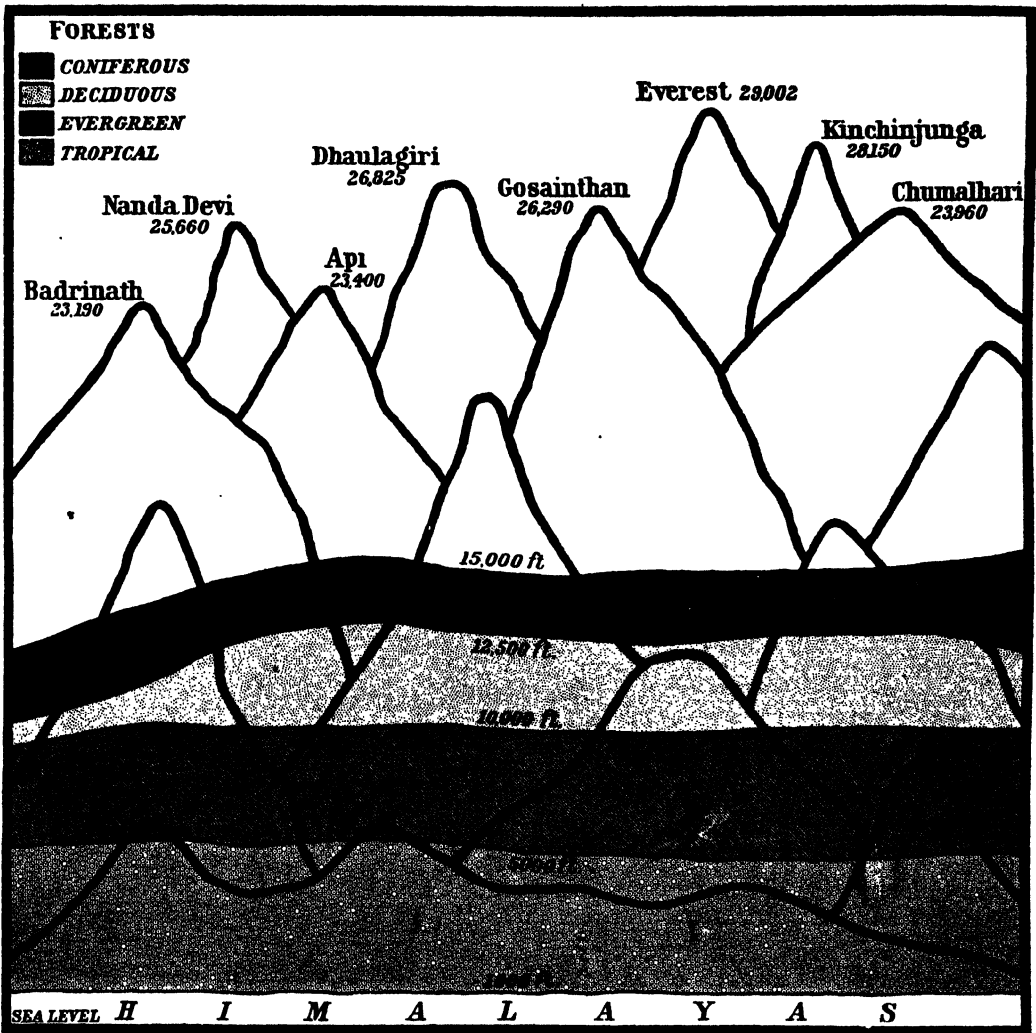

PLATE VI.
 VERTICAL DISTRIBUTION OF TREES ON A MOUNTAIN
 (Class Picture No. 16 in the Portfolio.)

woods, bluebells and bracken in oak woods. Some trees cast such a deep shade that nothing can grow under them in the summer; for instance, both beech and pine woods are dark and have little undergrowth.

It would be interesting to follow up this lesson by trying to make a complete list of all native trees which can be found in

the neighbourhood, if the school is in the country, and by consulting the geological drift maps to see what kind of soil underlies them.

Attention might also be drawn to the use made of trees in binding sand dunes or swamps, and thus reclaiming land; e.g., the pine forests of the Landes, in France.

LESSON UNIT II—SOIL

This also gives suitable work for the winter months when little living material is available.

Introduction.—It has been found that plants grow better in soil than in sand or water. The next thing to do is to find out something about the properties of soil which make it suitable for plant growth or otherwise. As was mentioned in the previous lesson, agriculturalists speak of soils by different names: such names as heavy loam, sandy, clayey, or chalky soil, indicate their contents. They also speak of the surface soil and the subsoil. What do these names mean? What kind of soil is in the neighbourhood of the school?

Development—1. Surface soil and subsoil.—If we dig in any soil, we find a layer at the top, perhaps 8 in. to 1 ft. in depth, which is darker than the soil further down. It can be shown that it is the humus which makes the surface soil look dark.

Dig up samples of surface soil and subsoil from the school garden, if possible. After examining their general appearance, take samples of each for rough analysis by the sedimentation method.

Using equal quantities, pour a little water on to each sample in a beaker, stir and allow to settle. At the surface of the water containing surface soil, an accumulation of irregular particles of humus will be floating, whereas the water containing subsoil will have little or none.

Pour off the water and examine some of the humus with a lens. Broken bits of roots, stems and leaves can usually be identified.

Again pour water on the two samples, shake up or stir, and allow to settle. The water will be clouded for some time while a sediment is settling at the bottom, the coarsest and heaviest material forming the lowest layer, with finer layers above, until eventually the finest powder forms the top layer and the water is clear.

The finest substance is clay, the coarsest substances sand and gravel. They can be further separated, if desired, by repeated washings, the liquor being poured off and kept. When all clay has been washed out, only sand and gravel remain. When the sand is decanted by being swirled round in water and poured off, the gravel is left behind.

A more accurate method of separation is the dry method, using the standard sieves. The finest allows only clay to pass, the coarsest retains gravel. It is usual to use three of these sieves. The graduations are accepted for classifying all soils. The classification is, however, according to size of particles only, and does not really distinguish substances. For instance, large particles of chalk would count as gravel, very fine chalk as silt or clay, while there must be in any soil exceedingly fine, abraded grains of sand mixed with the clay by either method.

Loam indicates a soil with a good deal of humus mixed with the sand and gravel, but there are heavy loams (or clayey loams) and light loams (or sandy loams).

The physical characteristics of soil exert some influence on the growth of plants, chiefly because they affect the water and air content. It is important that the roots shall be able to obtain air as well as water. Sandy soil has large air spaces, clay is more finely packed. The air space and the water-holding capacity will, of course, be the same.

The drainage of soil also depends on the constituents of the soil, as every gardener knows. A light, sandy soil drains quickly, whereas clay soils hold water. Evaporation is also more rapid from the soils that have large air spaces. The addition of humus or stable manure helps the soil to retain moisture.

2. Capillary attraction.—Another feature of importance is the capacity to raise water from a lower level. This again depends upon the size of the air spaces, since these act as

capillary tubes, raising the water by the attraction exerted by their walls.

Capillary attraction can be demonstrated by taking a beaker or tumbler of water and some glass tubing of different thicknesses. The narrowest should be prepared by drawing out in the Bunsen flame a length of about 10 in., as finely as possible. Take a piece of $\frac{1}{4}$ in. thin-walled tubing, heat it in the top of the blue flame till quite soft, then remove and pull firmly till the required length and thinness is obtained. Cut this thin piece off by drawing a file sharply across at each end of it.

Fill the tumbler till it is on the point of overflowing, and notice the convex surface of the water above the level of the rim. Now pour some out. The surface is no longer convex, but very slightly concave, because it is being pulled upwards at the edge by the wall of the vessel.

Dip the series of narrow tubes into the tumbler. Coloured water may be used to make this clearer. Notice the surfaces. They are not only more hollow than the broad surface of the water in the tumbler, but are actually drawn up slightly above its level. The narrower the tube, the higher is the level of liquid in it; that is, the greater is the pull or force exerted by the walls. In the narrowest tube the water may be 2 in. to 3 in. higher than that in the tumbler.

In the same way the spaces between the soil particles act as exceedingly fine tubes, therefore they also may exert great attraction. This is known as capillary attraction. *Capilla*—a hair.

To demonstrate this, take three pieces of glass tubing of $\frac{1}{2}$ in. diameter, and 2 ft. to 3 ft. long. Plug one end lightly with cotton wool, and fill tightly with (1) ordinary garden soil—a medium loam perhaps; (2) clay, finely powdered so that it will shake down; (3) sand. All these should previously be air-dried by spreading in shallow trays for some days. Dip the three tubes in a small bowl of water and clamp them in position, using a retort stand. Mark the position reached at once by the water.

Watch and mark every minute, for about a quarter of an hour, then at regular intervals as often as possible in the next few days.

The level in the sand will rise rapidly at first, but will soon become stationary. In the clay, water will rise slowly at first but will continue rising for several days, and will probably eventually reach about 2 ft.

The rise in garden soil will be intermediate both in speed and ultimate height.

In clay soil, rain which drains some distance down may therefore, in due course, find its way upwards again through the capillary attraction of the small tubes formed by the soil particles, and so become available for the roots of plants.

Note.—In order to carry out this experiment satisfactorily, in filling the tubes, very little clay, etc., must be shaken in at once, and it must be packed closely. If this is not carefully carried out, cracks appear when the water has risen a little way, breaking the column across and so interrupting the rise of water and spoiling the result. The cotton wool must not be tight enough to interfere with the rise of water, but is merely to prevent the soil from falling out at the bottom.

3. Air capacity of sand and clay.—To show the air capacity of sand and clay, take equal quantities of sand and clay in two graduated measuring cylinders and pour water in until it just reaches the surface, noting the quantity of water used. This is not a very accurate method, but serves for comparison if the surface of sand and clay look equally wet.

A better method, which also compares drainage capacity, is to take equal quantities of sand and clay, by volume, and place them in funnels lightly plugged with cotton wool. Pour equal quantities of water through the funnels into measuring cylinders and read the measurement as soon as the drip ceases. The difference between the quantity of water poured in, and the quantity which comes through, shows the volume of air space in

the sand and clay. The clay will be found to hold its contents longer, while water runs through the sand quickly. Cover the funnels after the water has been poured in, to prevent any loss by evaporation which might slightly affect the result.

For further experiments on the properties of soils, consult Dr. E. S. Russell's *Lessons on Soil*.

4. Source of food for plants.—Although the subject of the chemical composition of soil is beyond children's understanding, it might here be mentioned that the soil actually provides the plants with food, dissolved in the soil water. The source of this food is twofold.

First of all, the decaying vegetable matter, called humus, supplies food. Before humus can be dissolved in water in a suitable form for plants, it is acted upon by tiny living creatures—really exceedingly small plants—living in the soil. These useful little creatures are closely related to the "germs" which cause disease. Like them they are called bacteria. They work away amongst the humus in order to obtain food for themselves, and in so doing they change it into a form which the roots of plants can use.

If some clover roots are dug up, it will be seen that they have small blisterlike growths called nodules attached to them. These nodules are caused by a special kind of soil bacteria, which live inside them and help to provide food for the clover plants as well as for themselves. They work so hard that after clover, peas or beans have been in the soil, the soil is made much richer for the crop that follows.

The second source of food is quite different. The clay, sand and chalk which form the soil have been worn away from rocks, which contain many kinds of mineral substances such as common salt and Epsom salts. Some of these mineral salts are necessary for the growth of both plants and animals. Plants obtain them dissolved in the soil water, and animals obtain them by eating vegetables and fruits.

LESSON UNIT III—HOW PLANTS OBTAIN FOOD FROM THE SOIL: THE WATER CURRENT

Introduction.—Everyone knows that both seedlings and older plants require water and die without it, and that the water is absorbed by the roots from soil. Why do they need it?

Development—1. Why plants need water.—

(a) In the first place, a plant deprived of water soon becomes limp and droops, or, in the case of a woody plant, shrivels and becomes brittle, while its leaves wilt. Even a tough evergreen twig of holly shows signs of shrinkage and the leaves curl if left for a few days out of water, though in winter, if placed in water, the leaves drop off. Therefore, water is needed to fill the tissues of a plant and keep them turgid.

(b) The plant dies without water, because water is necessary to the living substance, or protoplasm.

(c) It may be that there are substances necessary to the plant, dissolved in soil water. This can be investigated by taking four well-grown seedlings of equal size—e.g., lupins or broad beans—and growing one in tap water, one in distilled or rain water, one in sand and one in soil, both kept well watered with distilled or rain water.

At first little difference may be noticed, as the seedlings may still be making use of the store of food in their cotyledons, but later the differences will be marked.

Does the plant in soil grow best? If so, there would seem to be something present in soil which is not present in the other three cases.

Remember this result: it will be followed up later. For the present, we will inquire into the way in which roots take up water and where it goes.

2. The taking in of water by roots.—

Examine carefully the roots of the plants used in the preceding experiment.

You will probably find a much more extensive system of branching in the two

grown in sand and soil than in those grown in water. Compare also the roots of hyacinths grown in water with those grown in a bowl. You will also find that just above the tip of the roots, extending for some distance, there is a fringe of delicate white root hairs, which are not found in the plants grown in water. Now it would seem that it is less difficult for the plant actually having its roots submerged in water to obtain water, therefore it appears that the branching and the root hairs assist the plants in soil to obtain it.

This suggests two questions:

(a) Would plants in drier soil produce more root hairs?

(b) If the root hairs are removed, what happens?

Set up experiments to find the answers to these questions. The results would show that the absorptive part of a root is just above the tip, the region of the root hairs, and that the drier the soil, the more roots hairs are produced. For convenience in seeing this, grow plants in glass jars lined with blotting paper, pushing the seeds between the paper and the glass. The jars can be filled with sand or sawdust, to which measured quantities of water are supplied at fixed intervals.

The next question is:—Where does the water go after entering the plant?

By placing seedlings in diluted red ink, it will be seen in a few hours that the coloured water has passed up the roots into the stem and leaves. Cut the stem across; red dots will show that the ink has been confined to particular channels, the veins.

This may be emphasised by repeating the experiment with a stick of celery, in which the veins are very clearly marked. Some of the veins may be stripped away, when they will be found to be tough, supple fibres.

Many stems, when cut across and examined with a hand lens, show the veins.

3. Transpiration.—Now if water is constantly taken in by the roots and passed up the stem of a plant, though some of it is

used for growth, yet a good deal more must enter than the plant could possibly contain. What becomes of it?

This may easily be seen by placing a well-watered pot plant or a spray of leaves in water, under a bell jar. Cover the surface of the pot or jar with tinfoil or cardboard to prevent evaporation from the surface. In a few hours drops of water form on the sides of the bell jar. These must have come from the leaves. No water can be seen escaping, however, since it passes out as vapour. This process is called transpiration.

A control experiment should be set up, in which the same things are used, with the plant left out. No water appears on the bell jar in this case.

4. The conductive cylinder.—In young plants, isolated veins are sufficient to carry the supply of water up from the roots, but as plants grow in thickness more tubes are needed for this purpose. The need is met by new tissue forming between the original strands and, later, there is still greater growth both towards the centre and towards the outer surface, until eventually a firm, compact conductive cylinder is formed. This serves the double purpose of providing for conduction and for mechanical support, for the greater part of the tubes and fibres which compose it have their walls strongly thickened with wood. (The outer part of the conductive cylinder, called the bast, is concerned with carrying sap *down* the stem and distributing dissolved food material made by the leaves. For the time being this need not be mentioned, till something has been learnt of the work of the leaves. Separating the two tissues, wood and bast, is an actively growing layer from which both are formed.)

If a woody stem, such as a twig of lime or lilac in full leaf, is placed in red ink and then cut across, a continuous red ring will mark the position of the water-conducting wood. This, however, must be left till the summer.

If branches of some trees can be obtained, they may be sawn across and the cut surface

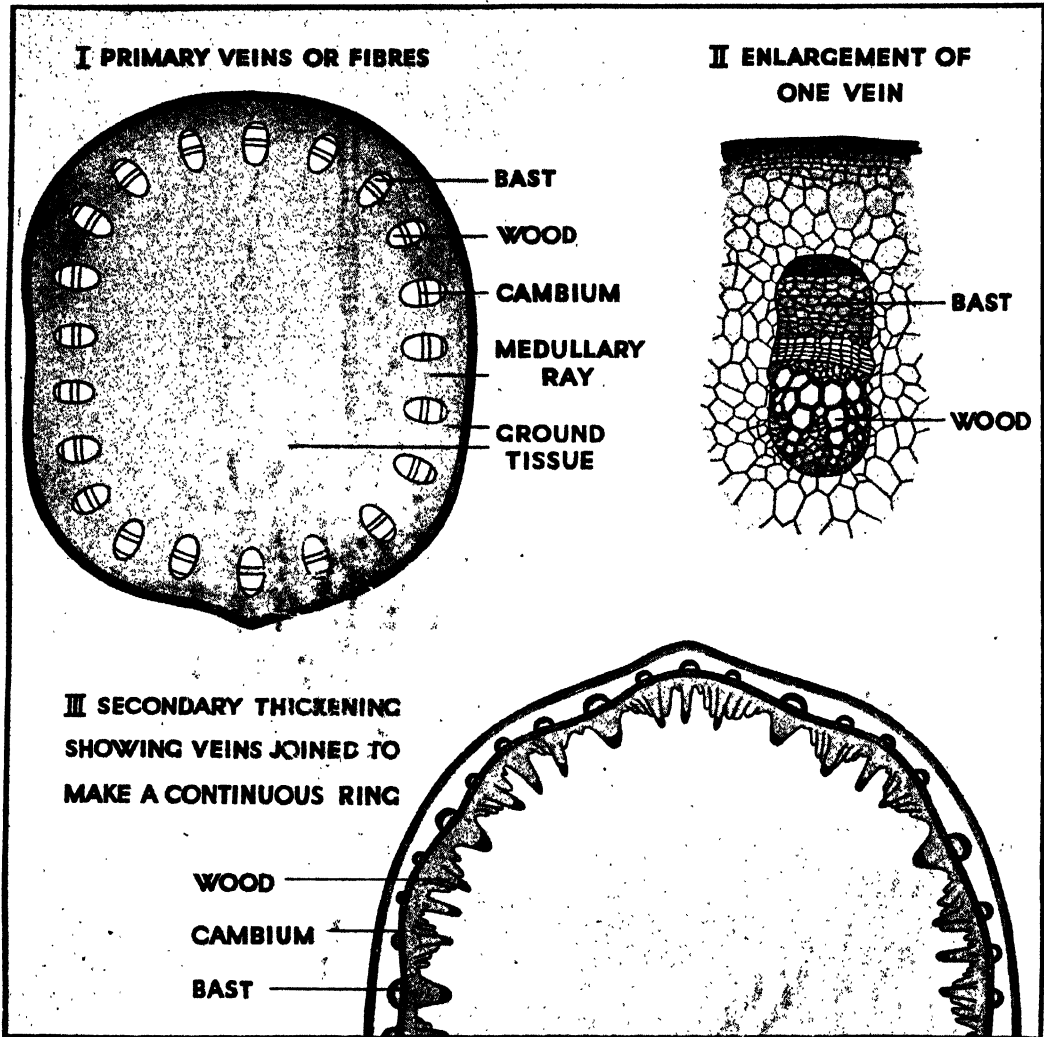

PLATE VII.

DIAGRAMS SHOWING ARRANGEMENT OF VEINS IN A DICOTYLEDONOUS STEM—
CROSS SECTION

(Class Picture No. 21 in the Portfolio.)

sandpapered and then lightly polished with linseed oil. It will then be possible to distinguish the characteristics of a mature woody stem, Plate VIII.

On the outside is a layer of bark, quite thin in a young branch, growing thicker each year.

Just underneath this there may still be

a narrow band representing the soft ground tissue or cortex which in a seedling, such as broad bean, makes up the greater part of the stem. A thin, whitish line is the outer part of the conductive cylinder, the bast. This tends to get crushed against the bark by the pressure of the vigorously growing wood, so that only its innermost part is in use.

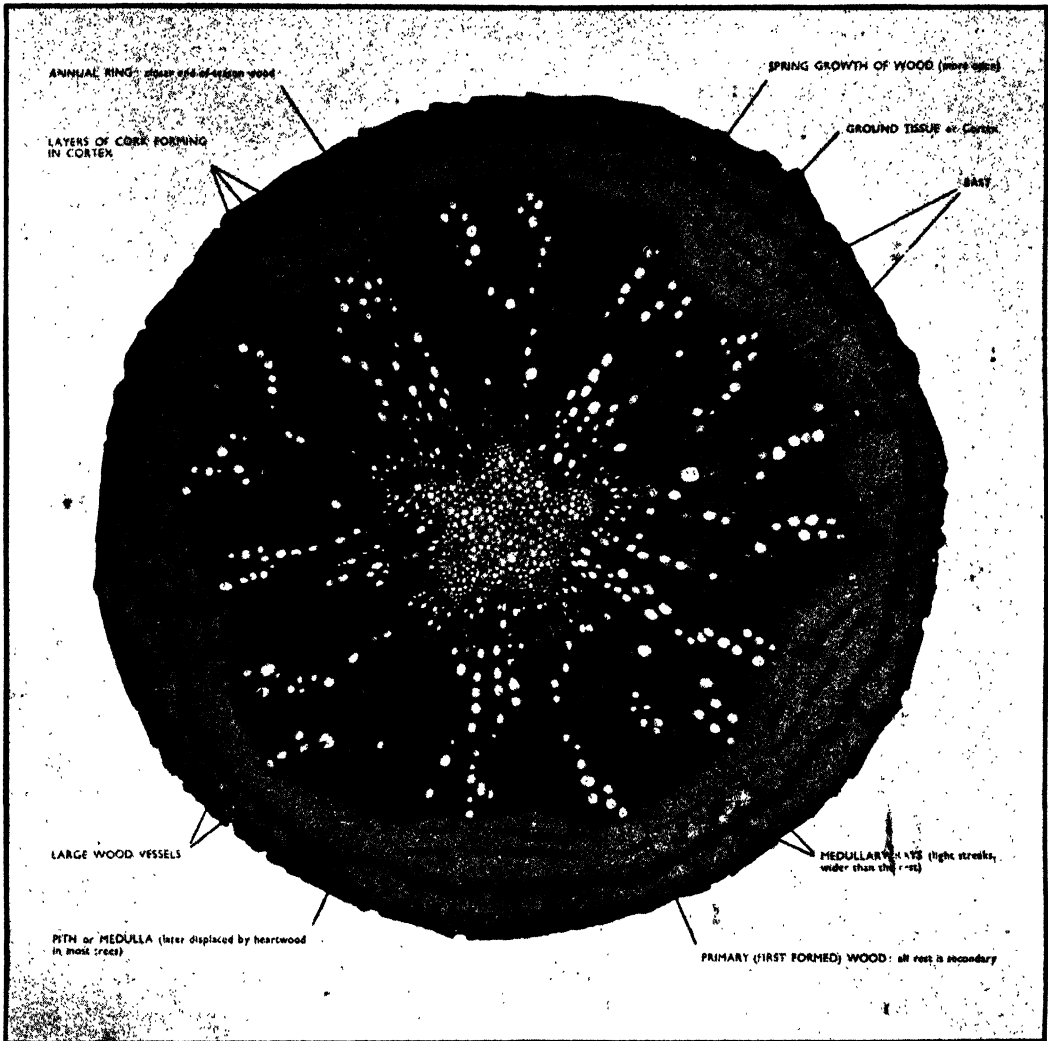

PLATE VIII.

CROSS SECTION OF BRANCH OF OAK IN THIRD SEASON
(Class Picture No. 22 in the Portfolio.)

The greater part of the cylinder, consists of wood. The older wood, pushed towards the centre, is no longer of use in conducting water, but becomes very hard and often contains substances, such as tannin in oak, which preserve it. This is called heart wood and is usually darker in colour than the active or sap wood.

Medullary rays.—Fine lines radiate through the wood from the centre to the bark. These make it possible for liquids to pass horizontally, and thus food can reach all parts and keep the plant alive. (They are called medullary rays.) Their work is very important.

One also notices light and dark alternating circles throughout the whole of the wood.



PLATE IX.

SECTION OF PART OF A LEAF

(Class Picture No. 23 in the Portfolio.)

This appearance is due to the fact that growth is quicker, and therefore the wood is more open, and lighter looking, in the spring and early summer than in the late summer. The closer growth causes the appearance of dark lines terminating each year's growth. Hence we speak of the annual rings.

Veins.—The veins are continued through roots, stems and leaves, so that water can pass through the whole plant. When it reaches the leaves, it passes into air spaces and escapes as vapour through pores which lie chiefly on the under surface.

In order to see the veins in a stem clearly, boil a piece of celery gently until it is quite

soft. The softer tissue can then be brushed away and the stringy veins will remain.

To see the network of veins in leaves search amongst heaps of decaying leaves for skeleton leaves, or prepare some box leaves by boiling gently in an enamel cup of rain water until the soft tissues can be brushed away. A "nut" of potash may be added to hasten the process.

Pores.—To see the pores, or stomata, on the surface of leaves, take some box leaves

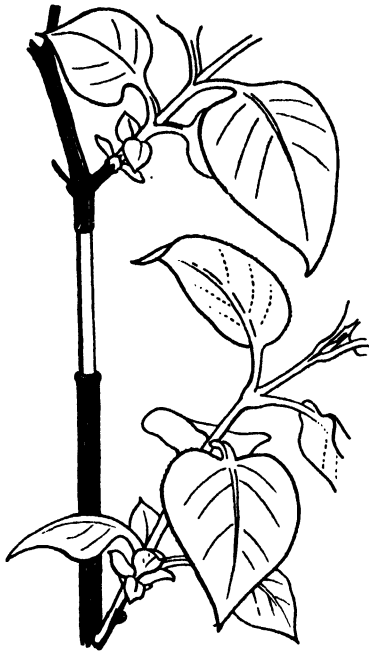

FIG. 15. LILAC TWIG, WITH A BAND OF OUTER TISSUE REMOVED TO EXPOSE THE WOOD

and boil as before with a piece of potash the size of a hazel nut in a cup of water. Cut off the edge of a leaf with sharp pointed scissors. It is then possible to separate the upper or lower skin, or epidermis, of the leaf from the middle part. If the lower epidermis is placed on a glass slide and examined with a hand lens, the pores or stomata can be seen quite easily, Plate IX.

Note.—The experimental work indicated here should be followed up in the summer by revising the subject matter and setting up

the following experiment on the conduction of water. Take a leafy twig; e.g., lime or lilac, and cut away a band 1 in. long of the soft outer tissue, exposing the woody centre, Fig. 15. Place this in water for a day or two. It will be found that the leaves above the cut are still alive, showing that water has risen to them through the central part, or wood. This does not, however, prove that the outer parts do not conduct water upwards. It is very difficult to remove the woody cylinder and leave only the bast, which would be necessary to prove this.

Some trees develop comparatively little wood and retain a soft, pithy centre for a long time. Elder is an example. Its branches are easily snapped.

LESSON UNIT IV—FOOD OF YOUNG ANIMALE

Introduction.—We have seen that it is very important for young plants to have a concentrated supply of food to start them on their way, and that many of those with a small supply quickly send up their cotyledons to do the work of foliage leaves and make food for them.

In the same way it is important for young animals to have an ample supply of food during the time of most active growth and development. By growth we mean increase in size; by development we mean the changes which transform an egg into a mature animal or plant; that is, the formation of the various organs and tissues.

Development.—Animals, like plants, may provide their offspring with very little food, in which case the eggs hatch quickly and the young are capable of looking after themselves at once. Compare seedlings with epigeal cotyledons. Many insects, e.g., gnats, have almost yolkless eggs.

Fishes have a fair supply of yolk, and after the young are hatched, though they swim about and are beginning to feed themselves, they still carry the yolk sac, protruding

from the underside of the body, until the yolk is completely absorbed, Fig. 16.

Snails and slugs have a moderate supply of yolk. The pond snail, *limnoea*, takes about a month to hatch, the common black slug about sixty days, and during this time they are developing, so that when they hatch they are complete, though minute, snails or slugs.

The earthworm egg has little yolk but a number of eggs are laid together in one capsule, or protective case, of yellowish parchmentlike substance, and as soon as they hatch the worms inside the capsule begin to feed on one another, until only one at last emerges. This is a clear case of "struggle for existence" and "survival of the fittest," Darwin's phrases, operating at a very early stage in their lives.



FIG. 16. -
FISH WITH YOLK SAC

Birds' and reptiles' eggs are supplied with a large quantity of yolk compared with most other animals. There is, however, a great range in the size of birds' eggs, and again we find that those with a small yolk tend to hatch comparatively early. In this case, the young are usually helpless, while those with a large yolk are retained longer in the egg and are more mature when hatched. This is not, however, an invariable rule. Most of the ground-feeding or water-feeding birds nest on the ground, or amongst reeds, and their young can walk or swim and dive as soon as hatched; e.g., the common fowl and duck, partridge, moorhen.

If birds are hatched at an early stage, this entails that the parents shall feed them until they can find their own food, as well as keeping them clean and safe, so that we see that the family life of birds is linked with the necessity for feeding the young. The same thing is, of course, true for mammals. Where the young are helpless and need

to be fed, the family, and the care of the parents, are necessary to their survival.

In mammals, the egg has practically no yolk, but a new solution of the problem of feeding the young has been found. Fertilised eggs are kept inside the body of the mother in a sac, the uterus, and after the egg has started growing it becomes attached to the wall of the sac, through which blood vessels pass into the embryo animal, bringing food and oxygen to it. This is the most certain way that is known of ensuring a steady, regular and sufficient supply of food, while at the same time the developing animal, or embryo, is carried about in safety.

After birth the young animal is fed by the mother by means of milk, made by the milk glands or mammary glands which give the name of mammals to the group. Kittens, puppies, lambs, calves and human babies are all fed in this way.

PRACTICAL WORK

This work is for demonstration to the class.

1. Place a hen's egg in an enamel dish of water, and carefully chip round it, lengthwise, with fine pointed scissors. Half the shell can then be lifted off to expose the yolk and white, or albumen. On the uppermost side a white spot will be seen. This is the "germ," consisting of protoplasm. It is this alone that gives rise to the chick. The yolk, enclosed with the "germ" in a thin membrane, is the food supply. Yolk and "germ" are suspended in the albumen, in which they float, by a twisted rope of albumen attached as the egg is passing slowly, with a spiral movement, down the oviduct or egg passage. Lower down, the shell is added in the same way. The albumen serves as a water bath to protect the embryo from shock, violent contact or undue pressure. It swings as a boat at its moorings, only it is moored at both ends, Plate X. The albumen is not a food supply, except just at the end of incubation. Compare it with the jelly surrounding a frog's eggs or

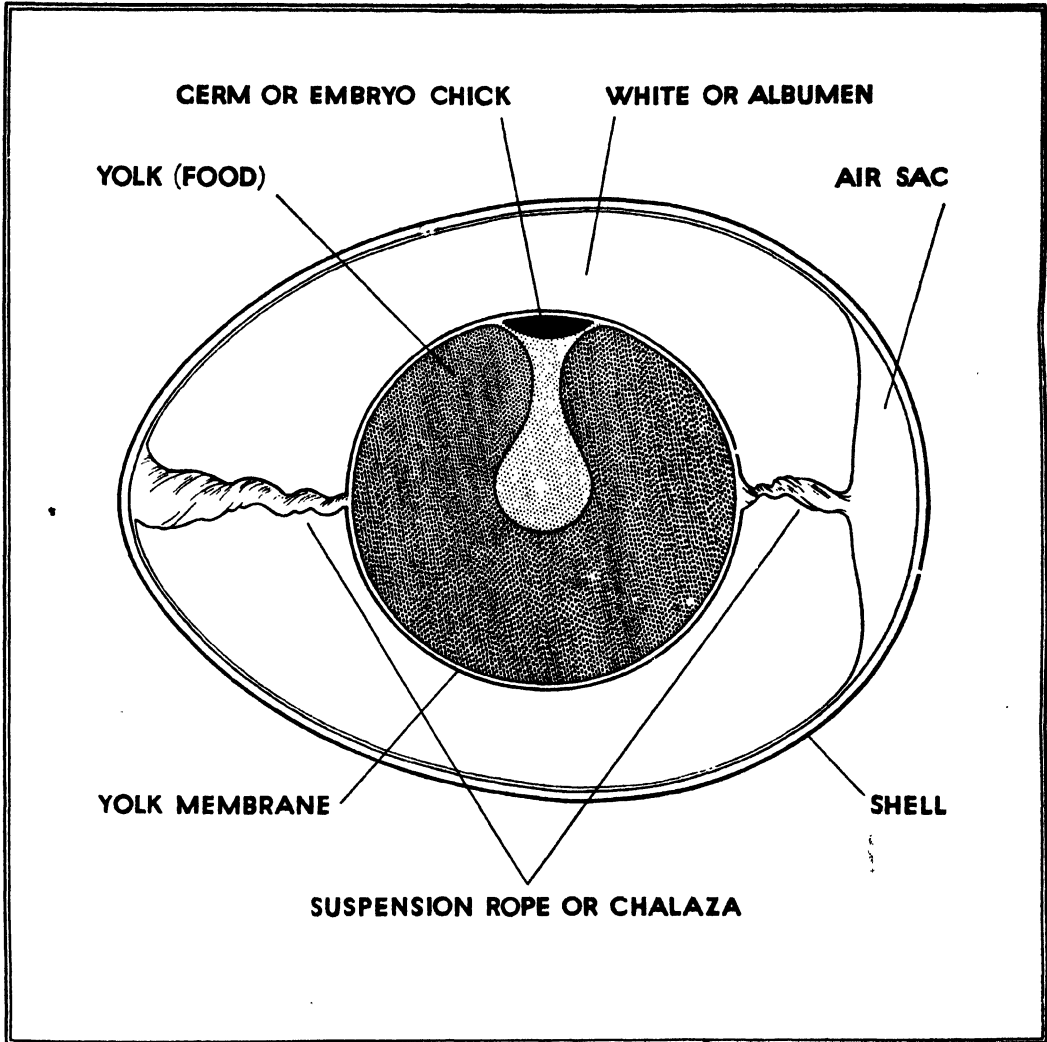

PLATE X.

DIAGRAM OF HEN'S EGG

(Class Picture No. 5 in the Portfolio.)

a water snail's eggs, serving the same purpose.

Let the children draw and label the parts of the egg.

2. Obtain eggs of slugs and snails and capsules of earthworms, and keep on moist

soil in covered saucers; the development can then easily be watched. If an earthworm's capsule is broken open, several small worms can usually be observed with a good hand lens. They can usually be found in damp earth or heaps of decaying leaves from March onwards, but the slugs'

and snails' eggs will not be found till about June. Slugs' eggs are opaque, snails' eggs transparent globules about $\frac{1}{8}$ in. in diameter.

3. Collect and keep any eggs that may be found in the garden, if possible until they hatch; e.g., millipedes, earwigs. Examine with a lens. Make notes on what is observed. All the examples named have direct development; that is, the offspring only differs from the parent in size, colour and degree of development. Many insects, however, have a larval stage which differs profoundly from the parent in structure and habits.

If it is not possible to obtain all this material at the time of the lesson, the need should be borne in mind and material supplemented later.

Another method of keeping such material under observation is to fill a straight-sided lamp glass with finely sifted soil, well damped, and place this in a saucer of water, covering the top with a glass plate which should be removed frequently to admit air.

LESSON UNIT V—ANIMALS WHICH FEED ON VEGETABLE FOOD

Introduction.—We know that ultimately all animals depend upon plants for food, whether they themselves eat plants or not. Food chains may be arranged, showing that this is so; e.g.:

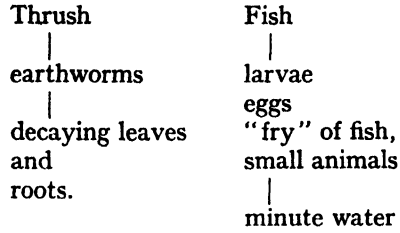
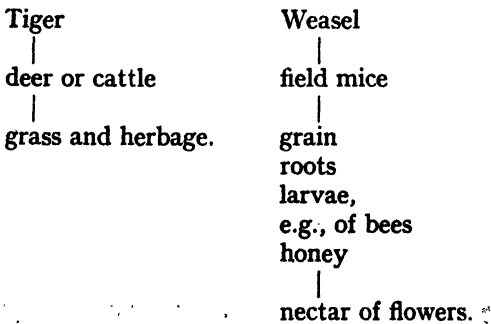

Vegetable tissues are more difficult, on the whole, to digest than animal tissues, because of the tough cell walls of cellulose. Cotton wool is an example of pure cellulose. Therefore, we find that special arrangements are needed in order to digest it. We will take the rabbit as an example amongst the higher animals of a vegetable feeder, or herbivorous animal.

Development—1. Characteristics of the rabbit.—The rabbit is a mammal belonging to the family of rodents; that is, animals which gnaw their food. Many members of this group will feed largely upon young bark and the wood of young trees. though they eat green herbs, grain and seeds as well. The rat, mouse, squirrel and beaver are all rodents.

Watch a tame rabbit feeding. Give it lettuce, a little stale bread, a carrot or a piece of apple, and notice how it takes it. First of all it sniffs at the food and, having decided that it is desirable, the soft lips grasp it, the cleft upper lip helping it to grip. The food is then bitten off by nibbling movements. If a piece of carrot which the rabbit has been biting is examined, the tooth marks show how it has been scraped away, not bitten off in large pieces. If an old tree trunk or branch is placed in a rabbit's enclosure, it will occupy many hours exercising its teeth on it and keeping them sharp.

2. Formation of skull and teeth.—Now examine the skull of a rabbit, Plate XI. A skull can easily be prepared by gently boiling, then scraping away the flesh and cleaning with a stiff brush and a small soft paint brush. It can be shown to the class and afterwards examined individually, enlarged

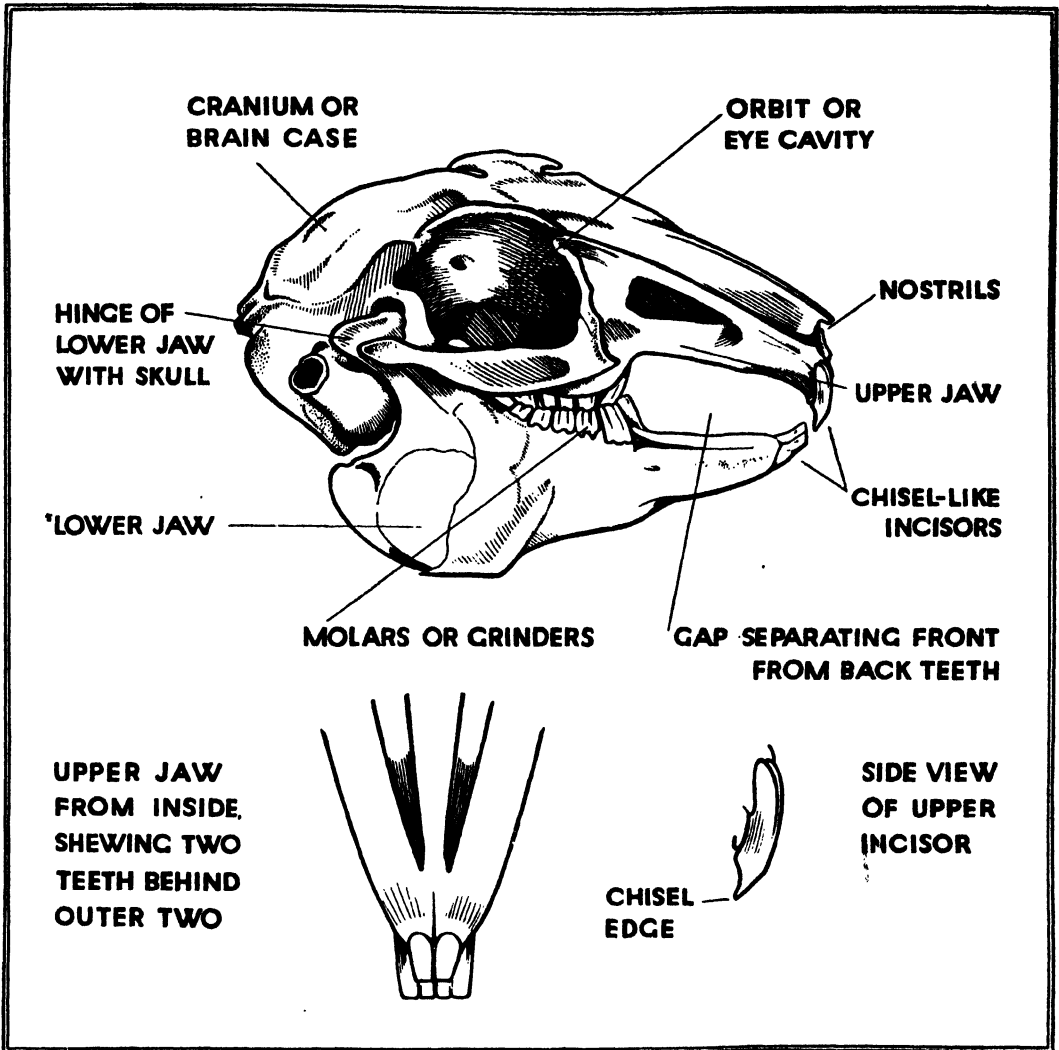

PLATE XI.

RABBIT'S SKULL AND VIEW OF UPPER JAW

(Class Picture No. 6 in the Portfolio.)

sketches on the blackboard bringing out the chief points to be observed. The lower jaw is hinged far back, below and behind the eye socket, to an arch of bone attached to the skull. The skull proper, or cranium, is the bony case which encloses the brain. It has free movement, up and down, upon the rigidly fixed upper jaw.

At the front of each jaw is a pair of straight-edged, sharp teeth for biting or gnawing. These are the incisors. A smaller pair of incisors lies behind those in the upper jaw. This is peculiar to the rabbit. The incisors meet one another. Biting keeps them sharp. The enamel covering the front of the teeth is thicker than the rest and is

worn away less rapidly; the teeth are therefore worn to a chisel edge; that is, bevelled on the inner surface of the edge. The value of this for cutting wood and hard substances can be seen.

A gap separates the incisors from the cheek teeth. This seems to help the lips and tongue in drawing food into the mouth. It is characteristic of all herbivorous mammals and can easily be noticed in the horse.

The cheek teeth grind and break up the food; they are therefore called grinders or molars. They have a grooved edge and a rectangular, grooved biting surface, and as they lie close together this results in a series of ridges which work upon one another to grind up the food. There are six in each upper jaw and five in each lower jaw. The teeth grow continuously from the roots, so that as they are worn away the loss is made up for. Occasionally a rabbit has a tooth broken and then the opposite tooth goes on growing and has been known to grow into the jaw so that the mouth was closed and the animal died of starvation.

The useful chisel edge to the incisors and broad grinding surface to the molar teeth are found in all herbivorous animals, though they are quite unrelated. The crown of the molars in a horse is worn down so that a pattern of curved ridges of enamel forms the hard grinding surface, with the softer substance, dentine, which forms the inside of teeth, filling the hollows.

3. Digestion.—The work of digestion is carried on by special tissues called glands, whose secretions are poured into the food canal. We have seen that milk is produced by glands. The first of these digestive juices is called saliva, which is poured out by the salivary glands in the mouth cavity. These glands lie under the skin which lines the cavity, the mucous membrane, and open into the cavity by narrow tubes or ducts. Saliva changes starch to sugar.

In vegetable feeders the lower part of the food canal, the intestine, is extraordinarily long; the sac or tube called the

appendix, which in man is useless and often troublesome, is in rabbits and sheep actively associated with the digestion of cellulose. Probably the length of intestine is necessary because a great bulk of food has to be absorbed through its walls in order to extract sufficient nourishment, for vegetable food consists largely of water, whereas seeds, eggs and flesh of all kinds are more concentrated and less need be eaten.

If a well-grown tadpole is examined the long intestine showing through the skin can be seen on the underside, coiled like a watch spring. It is longer in proportion at this stage, when the tadpole feeds chiefly on plants, than in the adult frog.

PRACTICAL WORK

1. Examine and draw the skull of a rabbit to show the incisors, the molars, and the gap which separates them. Look at the chisel edge of the incisors and draw the surface of a molar to show the ridged crown.

2. Using a lens, draw a tadpole from the underside to show the long coiled intestine.

3. Take a small piece of unsweetened biscuit, or a little arrowroot or cornflour, and chew it very slowly. After a time it will become sweet, showing that saliva is changing it to sugar.

4. Make a little starch paste in a test tube, divide it into two parts and test one with iodine. Mix saliva thoroughly with the other, and leave it to stand for some hours in a warm place (for the mouth cavity is warm) or heat it very gently. Test this also with iodine. Starch is no longer present, but the whole substance has become liquid. Other digestive juices perform a similar action, dissolving other food substances. We have previously seen how many foods contain starch, so the action of saliva is important.

LESSON UNIT VI—FLESH FEEDERS

Introduction.—There is a great difference in temperament and social habits between the animals which feed on plants and those which feed on other animals which they have to capture. Herbivorous animals are on the whole timid, gentle creatures which prefer, in the case of danger, to hid or fly from it, though there are exceptions in the case of mothers with young—cows, bison, deer—and males, especially in the breeding season—deer, bulls. Many of them live peaceably together in colonies or herds—rabbits, deer, cattle, wild horses—though on the other hand there are many living either solitarily or in pairs—squirrels. Carnivorous animals are by nature more ferocious,* bolder, less easily frightened away, though cunning and cautious, not showing themselves or running into danger unnecessarily. Few of them hunt in packs; wolves are one of the exceptions.

Development—1. Characteristics of mammals.—The need for hunting develops certain qualities in the hunter. Carnivorous animals are intelligent, generally more so than herbivores. They learn all the features of the country they live in and the ways of the creatures they victimise. In most cases, they are capable of very quiet, stealthy movement, and can stalk their victims. Their movements are also very quick, and nearly all can leap or spring upon their victims with great force.

Many are nocturnal in habit. So, in some cases, are the animals upon which they prey. In any case, many animals in the wild state frequent water holes either late in the evening or early in the morning, and this gives the carnivores their chance.

Both hunters and hunted have very keen senses. Their sight, hearing and sense of smell are acute, either for detecting the prey or escaping the hunter. Well-developed external ears are perhaps more marked in the hunted, such as rabbits, deer, cattle and horses.

Incidentally, it may be mentioned here that primitive and savage men were, and are, amongst the most skilful of hunters, and that a good deal of man's intelligence owes its development to the primitive need to outwit or circumvent the animals he hunted.

2. Formation of skull and teeth.—Physically, the most marked difference between the carnivorous and the herbivorous animals is the difference in the formation of skull and teeth. There is need for very strong jaws which can grip and hold as a vice, and teeth that can tear flesh and grind or crunch bones. If you try to take something from your own dog in fun you can test this grip. The jaws are clenched, by the contraction of very strong muscles, and the pointed teeth fit between one another and dig into the substance.

On examining the skull of a dog (Plate XII) notice the breadth and strength of the lower jaw, the small incisors—six in each jaw—but well-developed molars—six above and seven below at each side—and between the molars and incisors at each side, the large, conical, pointed canine tooth which is most useful both for holding and tearing flesh. The molars are strong and broad, each provided with three or four pointed prongs or cusps. It is usual to distinguish between molars and premolars. Premolars occupy the position of similar teeth belonging to the first, or milk dentition; molars are further back in the jaw and are developed only in the second or permanent dentition. For the purpose of these lessons, however, the distinction is unnecessary and they have all been called molars.

The two most important types of carnivore are represented by the cat and the dog. Wolves, foxes and jackals are of the dog tribe; lions, tigers, leopards and panthers are great cats. The cats are more subtle in their methods of hunting and attacking than the dogs. Cats use their claws as well as their teeth in attacking their prey and, indeed, these are very formidable weapons,

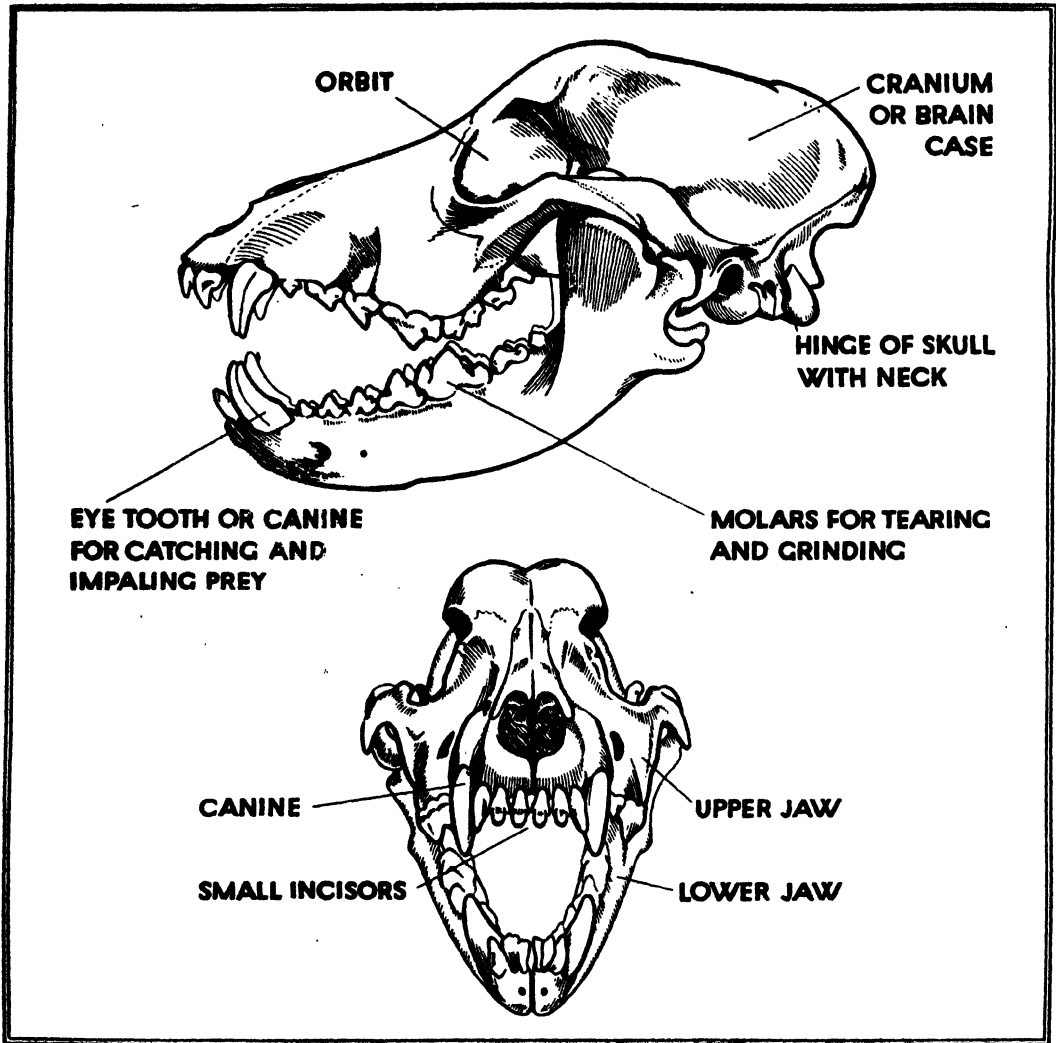

PLATE XII.

DOG'S SKULL—SIDE AND FRONT

(Class Picture No. 7 in the Portfolio.)

kept sharp by being retracted into a sheath when not in use. Since the teeth are not quite so important as a dog's in retaining a grip of the live prey, we find that a cat's jaws are shorter, its teeth smaller in proportion and fewer in number—four molars at each side in the upper jaw, three in the lower.

3. Characteristics of other carnivores.—

If we turn from the mammals to carnivorous animals in some of the other groups, we shall find rather similar characteristics, though the actual structures are different. Birds of prey, like the owls and hawks (Fig. 17), have very strong, sharply curved beaks and claws, both used in hunting, the claws to

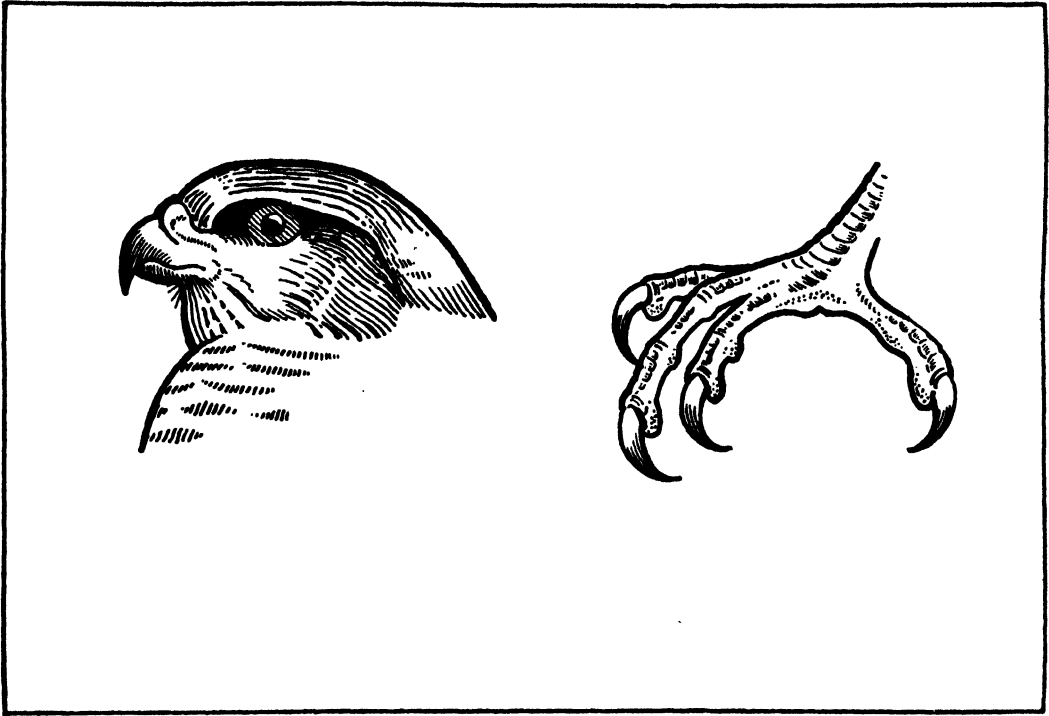

FIG. 17. HAWK
 Left: Side view of Hawk's head.
 Right: Foot of Hawk.

seize the victim and the strong scimitarlike beak to deal a death blow, probably a stab through the brain.

Amongst insects, we can find parallel cases in the stabbing beak of many of the water bugs—water boatman (Figs. 18 and 19), water scorpion—formed by modification of external jaws, hinged outside the mouth, and in the piercing mandibles, or jaws, of water beetles and their larvae (Fig. 20)

which seize upon some worm, tadpole or small fish as a pair of pincers, piercing into the flesh. In the spiders, to turn to another group still, we find the same kind of apparatus—jaws in the form of a pair of sharp pincers which pierce and then suck the blood.

In many of these creatures, too, we find exceedingly alert senses, though the animal's awareness is often masked by an appearance of sluggish inertia till the victim is within reach and the sudden, instantaneous movement of capture is made.

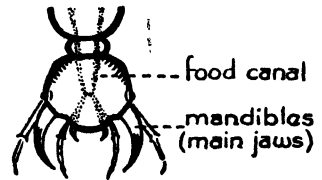

FIG. 20. HEAD OF LARVA OF GREAT WATER BEETLE.



FIG. 18. WATER BOATMAN

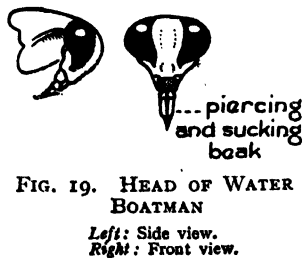

FIG. 19. HEAD OF WATER BOATMAN

Left: Side view.
 Right: Front view.

PRACTICAL WORK

1. Examine and draw the skull and teeth of cat or dog.
2. Examine, if possible, a stuffed owl or hawk and note the character of its claws and beak.
3. In the summer term, examine and draw the jaws of any carnivorous insects, and of a spider, using a good lens. Note also in the live animals in the summer any habits connected with their feeding such as lurking, "freezing" or becoming perfectly still, and resemblances to their surroundings. Make feeding one of the main points of inquiry in connection with pond study.
4. Get the children to watch their own animals—dogs, cats, rabbits—and make notes on their feeding habits and signs of intelligence and thought in regard to food.

LESSON UNIT VII--MOVEMENT

Introduction.—When we think of the differences between animals and plants, the first thing, perhaps, that occurs to us is that animals eat, by which we mean that they take in food through a mouth, and the second is that they move about from one place to another. Though it is not true in every instance, yet this distinction does seem to be a fundamental one and the two characteristics are related, for the movement of animals is undoubtedly closely associated with either finding food or escaping from an enemy which is itself seeking to devour.

Development—1. Gliding and contraction.
—The smallest and simplest animals are not provided with legs by which to move about. The life substance of both plants and animals is a jellylike, colourless substance called protoplasm. Amongst very simple animals the best known is a creature found creeping over mud at the bottom of stagnant pools and ditches, where it feeds

on even smaller creatures in the decaying plant matter. It is called amoeba, and when full grown is a mere speck, too small to be seen. It obtains food by flowing round a small particle and sending out two projections to surround it, Fig. 21. It digests this food by pouring upon it a juice made (secreted) by the protoplasm (just as the

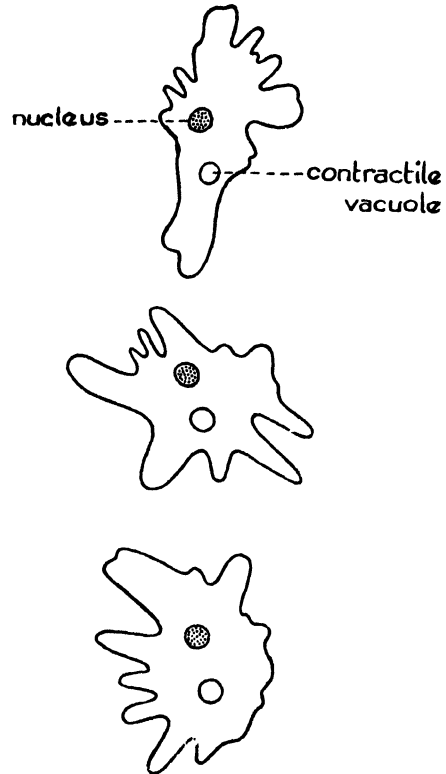

FIG. 21. AMOEBIA SHOWING VARIOUS POSITIONS ASSUMED

Note the projections or pseudopodia in the second and third diagrams.

salivary glands secrete saliva which digests starch). The digested food is then absorbed into the protoplasm. It is because solid food is actually eaten in this way that amoeba is regarded as an animal. If anything remains undigested it is left behind as the animal glides on. This is an example not only of the simplest type of movement, but also of the simplest method of digestion.

This animal is just a tiny mass of protoplasm. If possible, show amoeba and other primitive animals in water by means of a microprojector.

Another characteristic of all protoplasm is its power of contraction. This is also used in bringing about movement. The body of amoeba can shrink to a very small size and then expand again.

2. Muscles.—In higher animals, the power to contract is greatly increased in certain parts of the tissue of the body, which we call muscles. When a muscle contracts it becomes thicker and shorter. If you bend your arm and watch the biceps muscle which forms the front of the upper part of it, you can see it thicken and feel that it grows harder as it contracts.

Let the children watch an earthworm moving along on a piece of paper. It can be seen that contraction of muscles is taking place. In this case, two sets of muscles compose the body wall, some passing lengthwise and others passing round the body. If some of the long muscles are contracted, that part of the body becomes thicker. If the circular muscles are contracted while at the same time the long ones relax, the body becomes thinner. On the underside of the body the earthworm has a series of short, curved bristles (Fig. 22) embedded firmly in the skin. These are arranged in

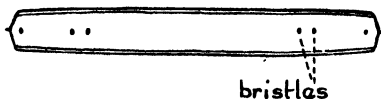

FIG. 22. ONE SEGMENT OF THE UNDERSIDE OF THE EARTHWORM

four double rows. By digging the bristles on this part of the body into the ground and contracting the long muscles just behind them, the earthworm can drag that part of the body along.

As this process is repeated throughout the whole length, the whole body is pulled forwards. If an earthworm is trying to burrow into hard soil, the front end will be

drawn back by contracting the long muscles and then by contractions just behind it, pressed against the earth with considerable force. This movement will be repeated until a small hole has been drilled, into which the front end, made as thin as possible, will pass, and this will be deepened until eventually the whole body can be drawn in. Though the bristles are too small to see, they can be heard scratching against the paper.

Here we see movement due to muscular efforts of the body, together with a grip on the ground enabling the body to be drawn along. Muscular movements without this grip would not result in progression.

3. Limbs.—The next stage in improving movement is the development of the limbs. At first these seem to have been developed in connection with swimming, for we find sea worms (Fig. 23) swimming by means of bunches of bristles used as oars, and these are supported on small paired projections on either side of the body. Amongst the Crustacea—

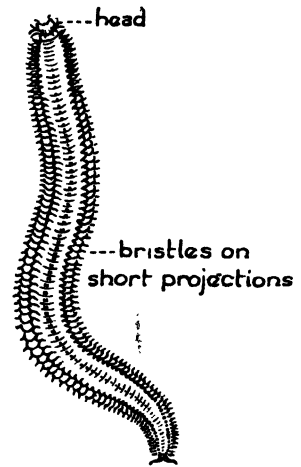

FIG. 23. NEREIS, A SEA WORM

crabs, prawns (Fig. 24), lobsters—these projections have become jointed limbs ending in claws and enclosed in a hard "shell" or exoskeleton; that is, external skeleton. Some of them may still be used for swimming, others have become walking legs. (Examine in shrimps or prawns from a fish dealer.)

In the fishes, too, the lowest of the animals which possess an internal skeleton and backbone (vertebrates), the limbs are swimming organs which we call fins. There are

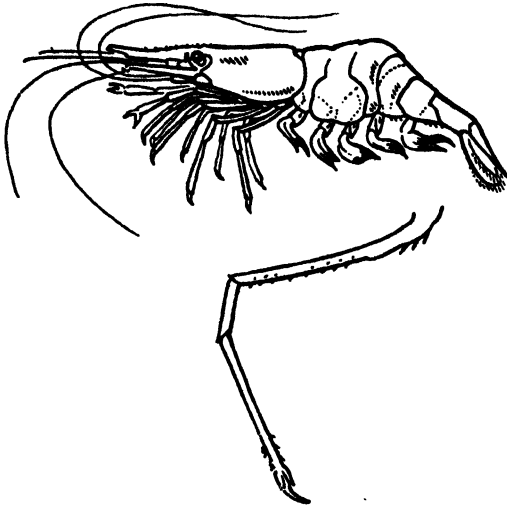

FIG. 24. PRAWN WITH JOINTED LIMB

two pairs of these fins, besides several unpaired ones, consisting of thin skin supported by bony rays. Certain fishes, for instance the Queensland salmon of Australia (Plate XIII), have taken to supporting themselves on the paired fins when the water in the rivers dries up, and waddling about on them in the mud. This has suggested that the legs of the land-dwelling vertebrates arose from the paired limbs of fishes. If the limbs of the higher animals are studied, it will be seen that their structure has a very definite relation to the way in which they are used and that this in its turn is closely related to the way the animal obtains its food. A few instances will illustrate this.

Examine the mounted skeleton of a dog or rabbit. If possible, have a live animal present; notice how its limbs are formed and compare them with the skeleton. If a living animal is not available, let the children compare the limbs with their own.

There is a great similarity of plan between the limbs of frogs, reptiles (such as a lizard) and many of the mammals; e.g., dog, rabbit, man.

Consider first the front limb. It consists of three main parts—upper arm, forearm

and hand, or front foot. It is shorter, slighter and straighter than the hind limb, for it does not take so great a part in bearing the weight of the body, nor so great a part in movement. A dog going at speed uses its hind legs and back muscles much more than its front legs; a rabbit springs by sharply bending and then straightening its hind legs, landing with them bent again. It gets a "take-off" from the spring board of its long feet, and lands on their whole length when it comes to rest again.

Dog and rabbit use their front feet for scratching in the ground, a squirrel or mouse for holding things. We use our hands for grasping. Therefore the front feet or hands need to be movable both at the wrist and between the shorter joints. Ours are much more movable than a dog's, of course.

Look at the bones of the front leg in the skeleton available, to see how this mobility is brought about. The whole limb is fitted into a shallow socket by the rounded end of the upper arm bone, allowing very free movement. It forms what is known as a ball-and-socket joint. Compare this with the hip joint. It is again a ball and socket, but the socket is a deep cup which grips the head of the bone firmly to prevent it from slipping out. This corresponds with the greater strength of the hind leg and the more severe strain to which it is subjected. In the living animal bands of tough material, called ligaments, fix the bones together.

The forearm has two bones. One is slightly longer, and projects a little at the elbow, beyond the hinge or joint which it makes with the upper arm bone.

The wrist consists of several small bones, firmly wedged together. They give very free movement in ourselves, but in the dog or rabbit they cannot be rotated, only moved in one direction. This makes the leg more rigid (for taking weight) than our arm.

The hand consists of four or five bones, to which the fingers are joined. These bones are bound together by the flesh of the hand (muscles and ligaments).

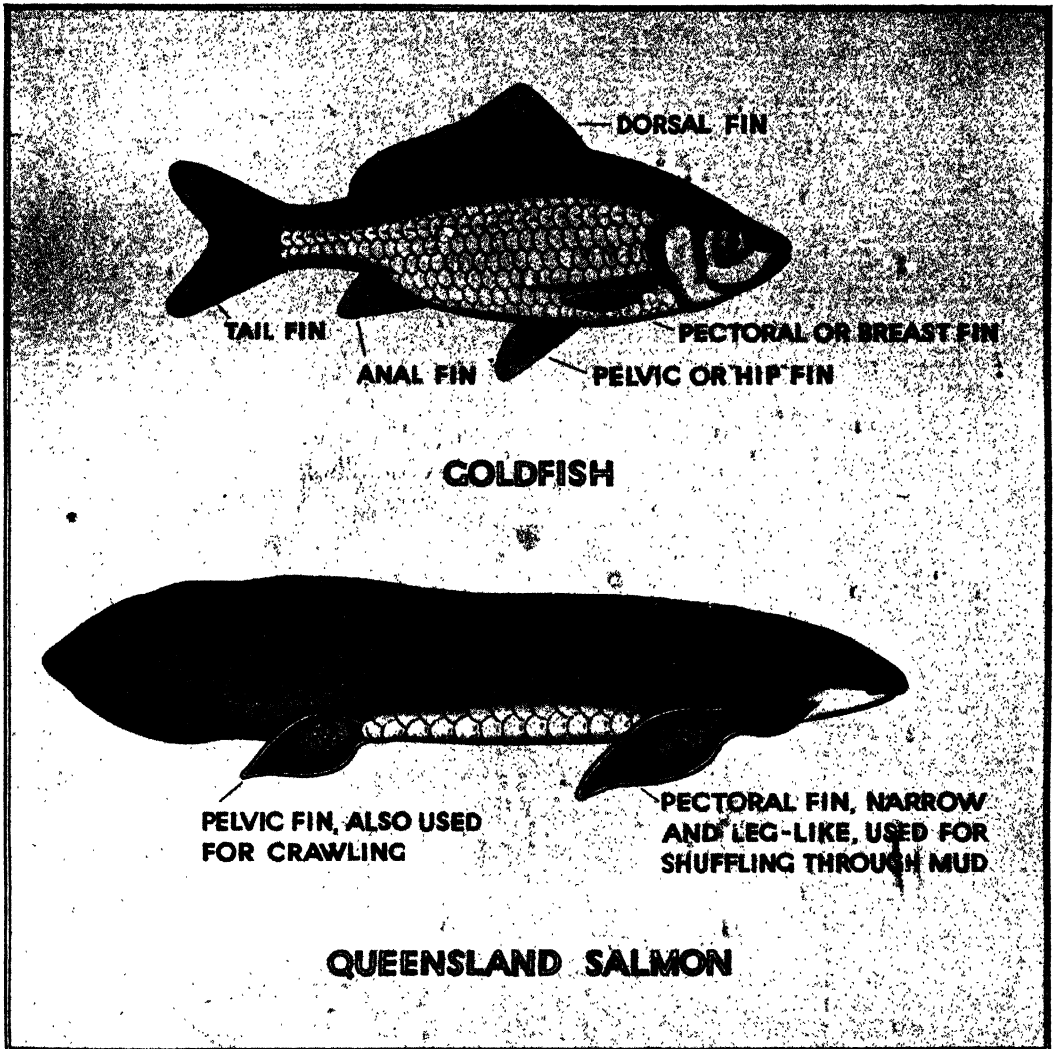

PLATE XIII.

GOLDFISH AND QUEENSLAND SALMON

(Class Picture No. 34 in the Portfolio.)

Each finger has three joints. If the first finger, or thumb in ourselves, is present, it has only two joints. Ours are freely movable.

The hind leg has the same plan as the front, but every part is stronger. There are fewer ankle bones than wrist bones, and less play at the ankle. This is important, as the

hind leg must be fairly rigid if it is to take the heavy weight of the body. At the same time there must be free forward movement at the joints.

Framework.—It is obvious that the limbs of these animals would be of very little use unless there were some strong supporting framework upon which they could work.

We have already mentioned the ball-and-socket joints which hold the limbs to this framework. If we look again at the skeleton and compare it with the live animal, we shall see that the trunk is supported by a curved chain of small bones, fitting closely together. Spines projecting backwards and sideways from these chain bones, or vertebrae, support the muscles which make up the back and sides of the trunk. These make it possible either to hold it rigid, by contracting them, or to turn and leap, for we have already noticed that trunk as well as limbs take part in movement.

In the region of the front limbs, several plates of bone, firmly bound together, make a strong girdle, which takes the weight of the limbs and gives them a firm base against which they can work.

This girdle (breast or pectoral girdle) consists of two large triangular bones at the back (shoulder blades), the breastbone in front, and in man and other climbing animals an extra pair of bars called the collar bones, strengthening the girdle in front to take the weight of his body when he swings on his arms from a branch or rope.

The socket for the head of the arm bone is at the narrow end of the shoulder blade.

A second strong girdle, the hip or pelvic girdle, is also joined to the trunk bones to support the legs and take the weight of the body. In the sides of it are the deep sockets for the leg bones. The chain bones in this region are broadened out and joined together to give still greater firmness.

In the front part of the body a number of slender, curved bones, the ribs, also join with the chain bones. Some of these are joined to the breastbone. They form a protective cage for the heart and lungs, as well as making the body more rigid.

Cats, dogs, rabbits and the insect-feeding mammals—e.g., the mole, shrew, hedgehog—have limbs of the type just described. These animals walk upon the toes, which spread

out a good deal. The frog has similar limbs, with four toes on the front foot, but the hind foot and leg are specially lengthened for leaping, and the hip girdle is also lengthened in a curious way.

Now newts and lizards hold their bodies close to the ground, whereas the higher animals hold the body well above the ground in most cases—it is supported, not merely dragged along. This is due partly to the much greater development of the shoulder and hip girdles, and partly to changes in the legs themselves. The majority of mammals walk upon their toes. The foot and leg bones have been lengthened, and some of them have disappeared, or become fused together, to give greater rigidity, and therefore both support the body better and give greater speed.

The rabbit has progressed in this direction. It supports itself on its front toes and hind foot when resting, but the long hind foot is always ready to be used as a spring board. A sudden bend of the knee joint, and a spring from the foot send it leaping away at the slightest alarm. The front feet just take the weight between the springs.

The horse is a good example of rigidity and fleetness going together. Each long foot consists of only one toe, and one hand or foot bone with a pair of splint bones, representing hand or foot bones which have disappeared, Plate XIV. Fossil ancestors of the horse have been found in which both three, four and five well-developed toes were present. It seems that the earliest ancestors of the horse dwelt on marshy ground where a splaying foot would be useful in preventing it from sinking into the soft, wet soil, but as thousands of years passed and the land became drier, animals arose in which the five toes gave place to the smaller number, the toes became thicker, and the whole leg and foot more column-like and rigid. The ostrich is an example of a bird in which the toes have been reduced to one, again in connection with the power of swift running over firm ground.

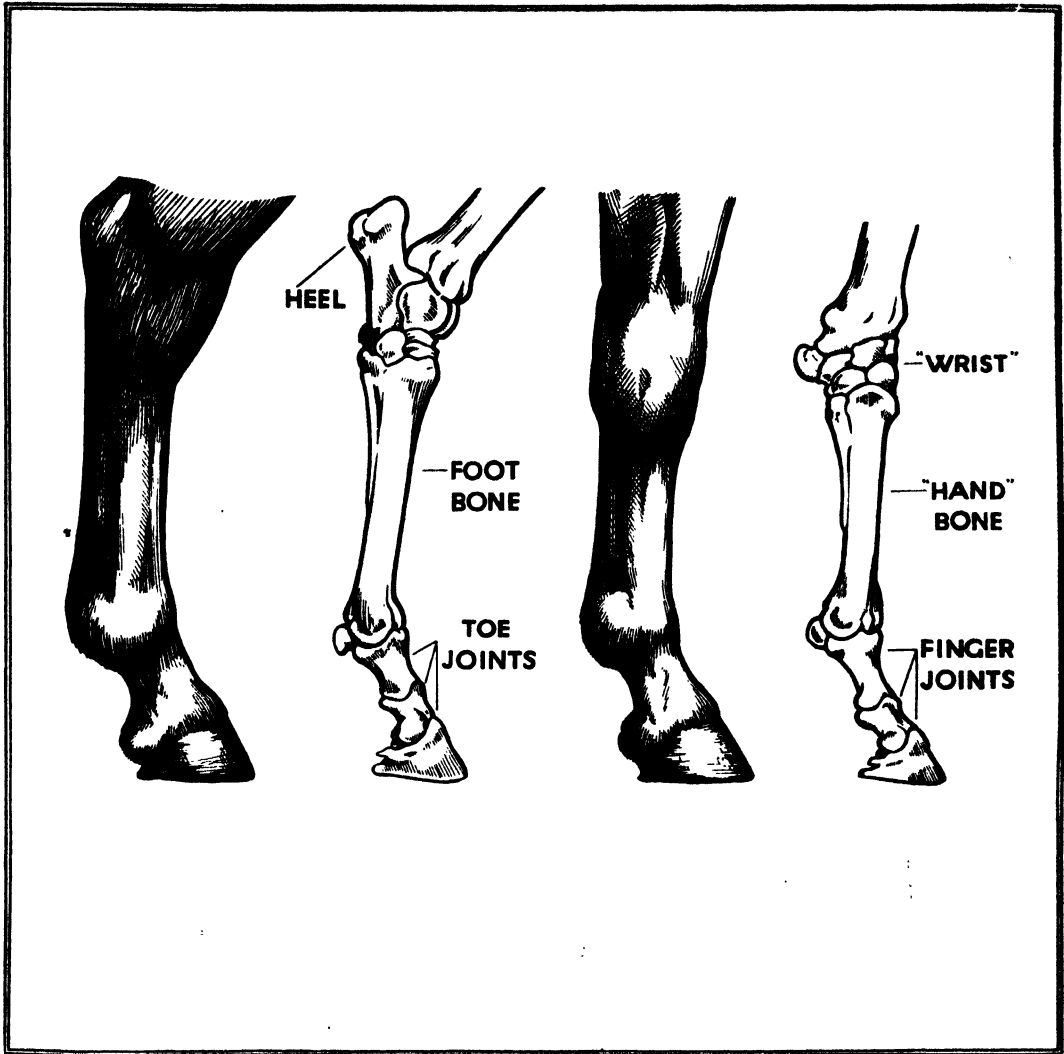

PLATE XIV.

HIND AND FRONT FEET OF HORSE TO SHOW LENGTHENING OF FOOT AND "HAND" BONES

(Class Picture No. 9 in the Portfolio.)

PRACTICAL WORK

This practical work should be interspersed with the foregoing.

1. If possible, show to the class a living amoeba by means of a microprojector, noting the points explained. Note also the granular appearance of the protoplasm,

except for a clear layer round the edge where it thins out. Small solid particles of food, each surrounded by a small space, filled with digestive juice, the food vacuole, will probably be seen.

2. Watch the movements of an earthworm and note the contraction of muscles and the

extreme suppleness, helped by segmentation of body.

3. Examine the skeleton of a rabbit. Notice the arched backbone, or vertebral column, made of a number of separate vertebrae, giving suppleness and free movement. A mounted skeleton is best for this.

Examine the bones of the front and hind legs, and notice how they are attached to the pectoral (breast) and pelvic (hip) girdles. Identify from diagrams. Notice especially the spines of the vertebrae and flattened surfaces of other bones to which large and important muscles are attached.

4. Examine the limbs and watch the movements of any other animals available, especially some of the lower animals with jointed legs, such as a water beetle, a ground beetle, a centipede. Dead prawns might

also be examined. Note that joints, both of body and legs, give flexibility.

Note that in some forms muscular efforts of the whole body are chiefly instrumental in causing movement (newt swimming, water beetle larva, demoiselle dragonfly larva swimming, fish swimming rapidly); in other cases the limbs are chiefly used, working on the rigidly held body (fish moving slowly, crab, beetle), while in some cases both come into play (a dog or rabbit, especially at full speed). Note the strong sideways action of the tail pressing against the water in fishes and newts. The insect larvae and newts will not be available till the next term, but goldfish could be watched.

5. Show a prepared slide of voluntary muscle. The body and tapering ends can be seen. Voluntary muscle appears to be striped with dark and light bands. The microprojector will show this.



SUMMER TERM

WORK OF THE TERM

MOST of the biological principles which it is desired to bring before the class in the first year have now been introduced, so that the main work of the summer term will be amplifying or continuing studies already begun.

The chief new work on animals will be a study of their life histories. While this is going on, there will be further opportunities for noting their activities in connection with food and movement.

New work on plants will also be concerned chiefly with life histories, especially, if possible, as observed under natural conditions in the garden. Quick-growing annuals, including common weeds, offer the best opportunity for this, as they will produce seed during the summer term if sown just before or just after the Easter holidays. Where there are facilities, such as a small greenhouse or frame, or a built-out window case in the science room, some of the seedlings might be started indoors, then planted out in properly prepared beds.

The children should be given clear instruction, followed by taking notes, on the preparation of seed beds and the need for watering and protecting seeds and young plants, arising out of their indoor observations in the previous terms. The value of raking and hoeing should be related to what they have learnt by experiment with soils. They should then be given opportunities of practising these operations.

Studies of trees may be continued informally and incidentally by noticing the unfolding of leaves and flowers, the falling of the leaf scales, the persistence of buds, continuing growth through the summer, and the early cessation of growth and beginning of preparations for the winter.

LIFE HISTORIES OF POND ANIMALS

The study of this subject should be spread over the summer term. The animals should be kept under observation in suitable aquaria. The reasons for all procedure should be made quite clear to the children. Straight-sided enamel bowls and pie dishes are useful. No great depth of water is needed but the surface should be extensive so that the water is well exposed to air; green pond weeds, tied in small bunches to stones, should be rooted in a sandy bed, so as to provide oxygen. Everything should be kept scrupulously clean; no remnants of food should be allowed to remain in the water. A small net and a long pair of wooden forceps, which may both be easily made, are useful for securing scraps or dead animals, and bits of soft muslin may be kept for wiping the sides of the bowl to remove microscopic water plants which tend to settle there. In a healthy tank the water should not need frequent changing, but a little should be added to make up for evaporation. It is best to keep tanks covered when not under observation, to keep out dust. Butter muslin or fine net serves the purpose and can be held in place over the rim of the vessel by elastic run through a hem.

The children's attention should be drawn to the following points, to prepare them for the course before formal lessons on life in ponds are begun.

We have noticed that the autumn is the time when plants prepare for offspring—seeds, bulbs, and offsets are ready before the long winter rest sets in, but they, as well as the parent plants, take a rest before continuing their growth which has, of course, begun inside the seed or bud.

Animals are different from plants in this respect and in a great many cases produce

their young in the spring or early summer. If we think of life on a farm, chickens, ducklings and other young birds are hatched, lambs are born, while in trees and hedges the wild birds are breeding.

In the ponds, too, there is a great outburst of new life among the animals. Frogs spawn amongst the earliest—in March—gnats will be seen on the wing together with many kinds of midges, as soon as there is warm sunshine, and will drop their eggs into the water. Later, many different kinds of insect lay their eggs in the pond.

Newts are rather later than frogs in laying their eggs, so that if you wish to study their life history throughout one season it is best, if possible, to induce them to breed in your own aquarium or, better still, in a small enclosed pond or pool on the school premises.

Ask the children to look for newts and bring them to the classroom.

A pair should be obtained early in April, and provided with suitable pondweed on which the eggs can be laid. A good plan is to arrange a zinc, or perforated zinc, tray resting on one side of the tank, and plant small plants of watercress, bitter cress or other small marsh plants so that they are kept moist and some of their lower leaves are under water. Newts will make use, too, of starwort and Canadian pondweed, which can be rooted in the sand at the bottom.

The swimming, feeding and breeding habits of the newts may then be watched and recorded by notes and sketches.

LESSON UNIT I—NEWTS

Two kinds of newt are usually found in the spring in ponds where they have come to breed—the common or smooth newt and the crested or warty newt. The common newt is both smaller and paler than the crested newt. The male in both cases appears larger than the female, because of the prominent crest along the back (better developed in the crested newt) but the female has actually the larger body, which

at this time of year is much distended with eggs.

If newts are kept in aquaria, they need a plentiful and varied supply of food. Very small earthworms, blowfly larvae or gentles, mealworms (the larvae of a beetle) and finely shredded raw meat should form the staple diet; it may be supplemented by dried fish food which can be bought from fishing tackle dealers and naturalists' shops. The aquarium needs to be kept very closely covered or the newts invariably escape, especially as they must have some kind of platform above the water, since they do not spend all their time under water.

1. Feeding and movement.—The children should have the opportunity of feeding the newts, in order to watch both their feeding habits and their movements. If a small piece of raw meat, snipped off with scissors, is dropped gently into the water, the newts seem to be unaware of it for a few moments, then they suddenly become alert and with powerful body strokes shoot through the water towards it, swimming like fishes. This suggests that it is rather by the sense of smell than by sight that they find their food. On the other hand, if a live worm is dropped wriggling into the water near them, the movement quickly catches their attention, so that evidently both sight and smell come into play in perceiving food. The children might be asked to think of ways in which the use made of sight and smell might be tested. For instance, if fresh meat juice instead of solid meat were used, there would be nothing to see, so that the sense of sight could be ruled out, and it might be possible to obtain some mechanically moving device, to eliminate smell, or to flash coloured lights to see how far sight is depended on.

A newt, like a frog, has minute teeth on the palate but they merely help it, by their roughness, to obtain a grip of its food, not to bite or chew. Consequently, however large the food is it must be swallowed whole. This may be gradual. A worm may be gripped by the head end and gradually

gulped down, by swallowing movements, helped (again as in the frog) by downward pressure of the eyeballs, which lie in open sockets; i.e., with no bony floor. Frequently two newts will attack one worm from either end and go on swallowing till they meet in the middle, when one is forced to disgorge unless the worm breaks in two.

Under natural conditions, newts dive and swim under water in search of food for a

nails. In neither has the slimy skin any horny outgrowths such as scales, or hair, which are of a similar nature to nails.

The long, slender body has no projections which might impede swimming. There are no ears to be seen, though a small plate on each side of the head shows their position. Both body and tail are strongly muscular, like those of fishes.

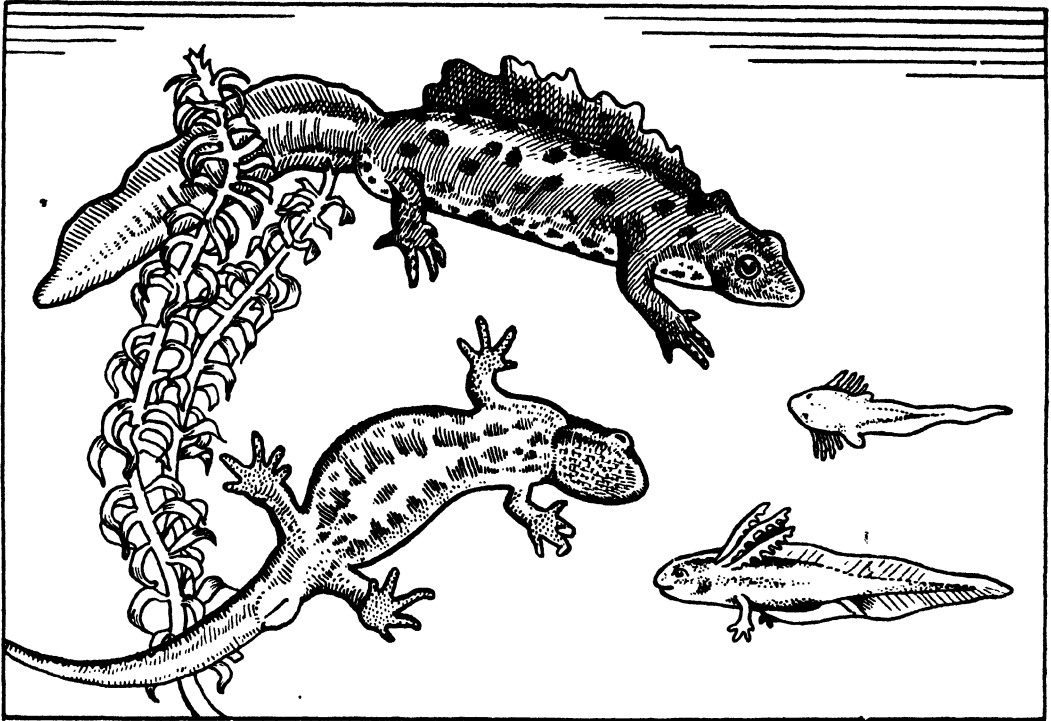

FIG. 25. CRESTED NEWTS, MALE AND FEMALE (UNDERSIDE). NEWT LARVA: UPPER, WITH GILL; LOWER, WITH FRONT LEGS DEVELOPED

considerable part of their time, coming up at intervals to breathe, when a small bubble of used air escapes from the nostrils or mouth at the surface of the water. When not swimming vigorously, paddling movements of the legs are made and the legs seem also to take part in balancing and perhaps directing movement. Unlike the frog, there are no special developments of the feet for swimming. The toes are short and have no

2. Larvae.—Newts and frogs belong to the class of Amphibia, that is, vertebrate animals which spend the early stages of their life in water but the later stages on land. The animal in the early stage has a different structure from the adult stage, hence it is known as a larva (compare with many insects). It is, in fact, a much simpler animal, representing a stage passed through by its ancestors thousands of years ago,

when the whole life was lived in water. The larvae of frogs and newts in most respects closely resemble fishes. In particular, they breathe like fishes, for they take up oxygen which is dissolved in the water. Newts are marked at the breeding season by their bright colours and iridescent, healthy-looking skin. If the conditions are carefully attended to and the pair well fed, eggs will probably be laid in the aquarium.

Each egg is pressed on to a leaf by the female, under the water, and usually the leaf is then carefully folded over the egg, so that it is hidden. It is a small, transparent object, perhaps $\frac{1}{10}$ in. in diameter.

After a few days, the envelope is broken open and a minute, transparent fishlike larva emerges. It is flattened from side to side, very pale in colour, and provided with tiny tufts at the side of the neck which serve for breathing and are called gills, for

they are able to extract oxygen from the water. There is always a little oxygen dissolved in fresh water.

It would be difficult to detect what the little creature finds to eat—probably microscopic animals and plants in the water. The best way to ensure that it does have enough nourishment is to pour small quantities of pond water into the aquarium, as this will contain organisms which can be used as food. It is a good plan, when collecting, to obtain a concentrated supply of such food on the spot by pouring water into a wide-necked corked bottle by means of a funnel, letting it escape again by means of a short glass tube over which fine muslin has been tied, to keep back any organisms which might escape, Fig. 26.

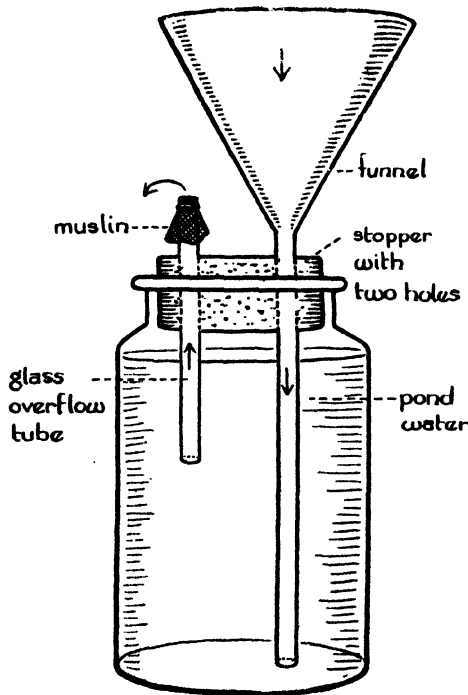

FIG. 26. APPARATUS FOR OBTAINING A CONCENTRATED SUPPLY OF FOOD FOR THE AQUARIUM

3. Development of the newt.—If the newt larvae are sufficiently fed, they will grow steadily and become rather less frail and transparent, while scattered specks of pigment gradually give a yellowish and brownish-grey colour to the body. It can then be seen that there is a head and trunk, with a transparent, unbroken fin (as in a frog tadpole) lying along the dorso-ventral ridge, but the head end is not swollen and rounded as in the frog, nor is it so darkly coloured.

The front legs are the first to appear, and are so fragile that they increase its fishlike appearance by resembling fins until one looks at them with a lens, when the toes can be distinguished, at first three, then a fourth.

When they are several weeks old, they begin to take rather larger kinds of food, and will appreciate such things as water fleas brought from the ponds, which generally swarm with them in the summer especially if the weather is warm.

Presently the tufted gills disappear, for the young newt has been growing lungs, which gradually take the place of gills. At last, late in the summer, the hind legs appear, and the body and head become more cylindrical and opaque, while the fin disappears, leaving just a slight ridge along the

tail for a while, Fig. 25. Then the baby newt leaves the pond and finds a resting place in a ditch or hollow where it can be protected by decaying vegetation and fallen leaves. Here it remains dormant for the winter.

It might be possible, in a suitable vivarium, to keep the young newts through the winter but, as the adults do, they make every attempt to escape and can slip through a very small crevice. Consequently, it is not easy to watch the whole life history and it has to be patched together from what one sees of many individuals.

The parents get dull-looking and listless in captivity, and should not be kept very long after the eggs are laid. In any case they must be removed from their young, or there will be cannibalism.

4. Other points of interest.—Newts, frogs and toads are not only of interest because of the details of their lives but because they have remained at the lowest point of terrestrial life, at least amongst vertebrate animals. They throw light, by their life history, on the emergence of animal life from water to land. They show how fishlike animals may have become land dwellers, especially by their transition from gills to lungs and from fins to legs for movement, and yet they show limitations which make it impossible for them to range on land, except where coolness, shade and moisture guard their delicate, unprotected skin from being dried and shrivelled. For the moist, slimy skin helps in breathing. Consequently they are all dwellers in marsh and pond. They are, of course, limited also by the fact that they must not wander so far from water that they cannot return to it in due season to lay their eggs. These are some of the difficulties which the races of "higher animals" had to face in their colonisation of the land, long ago in what is known as the mesozoic (middle-animals) or secondary geological period, when some of the reptiles, birds and mammals had come into being.

Further, they are "cold-blooded," which means, not that the blood is cold, but that

it changes with the surrounding temperature instead of being maintained at one level, as it is in ourselves. This again is a drawback, for it means that the animal is necessarily sluggish in cold weather and winter sleep or hibernation shortens its active life.

It is interesting to notice the behaviour of newts on land. They run quite rapidly, with a slightly wriggling movement, and their soft, moist "hands" and feet seem able to act as suckers in clinging to upright surfaces, even the smooth sides of a glass tank. Consequently they climb almost as quickly as they run on the flat ground. They are alert, and stop dead when alarmed, then run on again—two very primitive responses to alarm. Notice the delicate nostrils and the gulping movements as they swallow air into the lungs, sitting at rest on a stone. They seem to become a little tame in captivity and soon begin to come for food.

Note.—The teacher would naturally use his discretion in presenting the foregoing ideas according to the intelligence of his class, but an "A" class with good general knowledge would grasp the references to the evolution of the races of animals.

If it is decided to make these references, the following explanation may be helpful.

We know that the earth we live on has not always been just as it is now, but that in the very early days of living things it consisted chiefly of great oceans. In these lived only fishes and some of the lower animals related to crabs, jellyfish, cuttlefish and octopuses, cockles, sponges. Then gradually the bottom of the ocean was raised up, forming land—just the tops of sea mountains. At first this was very swampy. Plants grew on it, but not like our present-day ones; they were more like giant ferns and horsetails. (Show horsetails and ferns, or pictures.)

Some of the fishlike creatures began to crawl out on to the land and breathe the air. They must have been very like giant newts. It is thought that they must have

had a life history like newts and frogs, too, living as tadpoles, with gills, to begin with, and then coming out of the water, having developed lungs. Later as the land became drier, reptiles, birds and mammals came into existence. We have good reason to believe that the reptiles developed from some of the newtlike creatures, and that they in their turn, thousands of years later, gave rise to birds and mammals. All this took millions of years. New kinds of plants were also growing up, and insects were also taking to the land and to the air.

We know all this from what we call fossils, that is, from the bones of animals and hard parts of plants which were preserved in mud and at last, by the pressure of a great weight of earth collecting over them, changed to stone.

LESSON UNIT II—THE FROG

As the tadpoles of frogs have no doubt been watched in the infant and junior schools, it will be sufficient here to obtain the spawn once more and note the changes in development and the length of time taken for each stage.

The spawn can usually be obtained in March, by the shallow margin of ponds or in ditches.

The writer found difficulty in getting frogs to breed in captivity but, if the attempt is made, a pair of frogs ready to spawn should be obtained and comfortably housed in a cool, airy vivarium, where they can be undisturbed. The floor may be covered with short turf, kept moist by regular sprinkling with water. A shallow enamel or earthenware pan of water should be provided. If the frogs are ready to breed they will probably not feed for several days, but mealworms and small earthworms should be provided.

1. Spawning.—The frogs will sit in the shallow water for hours, even several days, the male with his forelegs clasped round the

female, the thickened thumb pads pressing against her body, an action which is supposed to help the passage of the eggs. Egg laying is a very slow process; several batches may be laid, with long pauses between. As the eggs slip into the water, the male exudes a fluid containing the sperms, or male cells, which penetrate and fertilise them. This external fertilisation is called spawning.

The eggs are black on the upper pole, white on the lower; the white part is the yolk or food substance, the black part will develop into the embryo, feeding on the yolk.

Each egg is enclosed in a gelatinous envelope, the whole mass adhering together. This swells up in the water, spacing the eggs, protecting them from collision, and buoying them up so that they are exposed to light and air—all important points in development. It is not food.

2. Development of the tadpole.—(Plate XV.)

The eggs at once begin to develop. Before hatching the embryo, larva or tadpole has head, trunk and tail marked out, and three pairs of external gills, small tufts of delicate skin, projecting from its neck. When it hatches, at the end of a fortnight, it breathes oxygen from the water through these gills, just as the newt does.

On the underside of the head is a sucker, by which the young tadpole attaches itself to weeds, where it waits for its mouth to open. Hundreds of these tadpoles, not more than $\frac{1}{4}$ in. long, may be seen crowded together.

In three or four days the round mouth appears, fringed by horny jaws and thick lips, capable of rasping away the vegetation on which the creature feeds. At the same time, four pairs of slits appear on the sides of the neck, piercing through the food canal. These are provided with delicate tassels of skin and are the new set of breathing organs, or gills, which replace the first-formed tufts. By about the end of the fourth week they become covered over by a fold of skin, leaving a little spout open

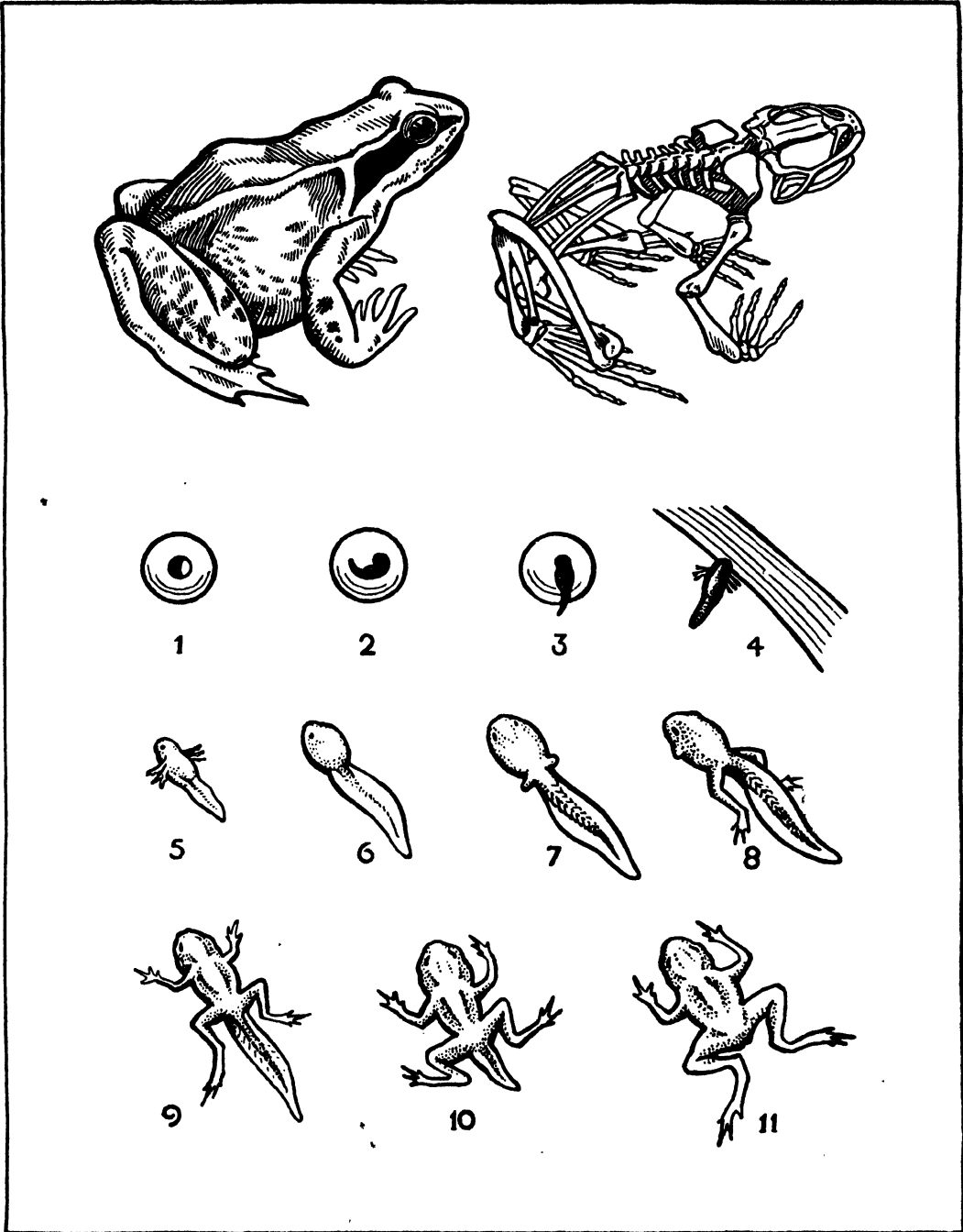

PLATE XV.

FROG AND TADPOLE

Above: Side view of Frog, and Skeleton.
Below: 1-11. Stages in the Life history of the Tadpole.

on the left side. The tadpole swallows water, which flows out through the gill slits and escapes by the spout. As it flows over the gills, they take out oxygen. The first-formed gills gradually disappear.

As the tadpole grows, it can be seen that the body wall on the underside is thin, and through it can be distinguished the long food canal coiled like a watch spring to pack it into the small space. All vegetarian animals need to have a long food canal because it is necessary to eat so much.

The tadpole, however, is not a strict vegetarian, but soon begins to show a taste for bits of raw meat, and even for its brothers. It thrives on a mixed diet and grows more rapidly than on pond weeds alone. In a shallow pond tadpoles may often be watched rooting like pigs in the mud and sand of the bottom, apparently digging out tasty morsels.

The head and body are by this time oval and swollen, the tail is a powerful muscular swimming organ, with a delicate fin like that of the young newt, but not bony like a fish's fins.

By about the eighth week the hind legs can be seen, at first mere stumps; then toes and joints appear. At about the same time it will be noticed that the tadpole is beginning to come to the top of the water from time to time and take in gulps of air. Its lungs are growing and beginning to be used, and as they are used so they will grow all the better. But for some time the gills are also in use, so that the tadpole is breathing both as a water animal and a land animal. Gradually the gills are used less and less until at last they shrivel and disappear altogether. The tadpole is nearly ready for life on land.

But an interesting point arises here. It cannot complete the necessary changes and become a frog unless it can leave the water. So it must be provided with a landing stage. At last it can struggle out. By this time the front legs have formed, but they cannot be seen because of the surrounding fold of skin. The left one struggles out through the "spout."

3. Final change.—By about the eleventh week, all being well, it is ready for the final change, or metamorphosis. It ceases to feed, it casts its skin and frees its legs. The body shrinks and changes to the shape of a frog. The tail is absorbed. The gills are absorbed. The lips and jaws give place to the wide, thin mouth of a frog. The tongue becomes much larger, for it is soon to be used for catching food. It is attached at the front to the lips, but free behind, so that it can be shot forward to catch unwary flies, which now become its main food. The eyes become large, bright and prominent. The peculiar high arched bone of the hip region, concerned with jumping, takes form. These changes occupy some days and the marvellous transition from a water to a land animal takes place before our eyes, a sight so familiar that its interest is apt to be lost; but the frog has recapitulated, in a few short weeks, the history of its race as they struggled from water to land, probably for a million years. The development of the individual shows the evolution of the race.

As in the case of the newts, frogs and toads are still bound to the water by the necessity of returning to lay their eggs, and they dare not risk any but a moist situation for fear their skin should dry up and cause suffocation, for they, too, breathe partly through the skin. Moreover, neither amphibia nor their eggs can survive salt water so they have never reached distant oceanic islands. The reptiles are the first vertebrates to lay hard-shelled eggs which can withstand adverse conditions.

4. Movement and feeding.—Frogs differ in a remarkable way from newts in their methods of movement and feeding.

Both swimming and movement on land—leaping—are helped by the peculiarly developed hind legs. A much elongated hoop of bone forms the hip girdle, which is not unlike a small catapult in shape. To this the hind legs are attached. They are very long, especially the feet, which are pressed firmly against the ground as the animal

springs forward. In the sitting position they are much bent, but as it leaps the legs are straightened (compare with the leaping of a rabbit already noticed, and of a kangaroo). The toes are webbed, so that a broad surface is provided for pressing against the water in swimming. The movements in swimming can readily be watched if the animal is placed in a large zinc bath.

If mealworms or small earthworms are introduced into the vivarium, the method of feeding can be watched. The frog sits perfectly still, with a blank expression, but as one watches a shade of interest and concentration seems to come into its eyes. A few seconds may pass. Then there is a sudden movement, so rapid that it is almost impossible to say what has happened, except that the worm is no longer there. But if the performance is watched several times one becomes quicker in following, and then a sudden movement of the tongue—just a flick out and in—can be seen. It is said that the tongue is provided with a sticky or slimy secretion that holds the victim. It may curl round it slightly. At any rate, the tongue is a very sure weapon, the aim precise. Sometimes the frog jumps or rears itself up, but usually it seems to wait until the unwary victim is within certain range.

5. Hibernation.—Frogs, as other amphibia, hibernate, and they have the peculiarity, like snails, of crowding together in dense masses. They will bury themselves in the mud at the bottom of ponds, and they have frequently been recorded packed tightly together in drain pipes, from ponds or fields, either in silt or under running water which would both, it is suggested, give them protection from frost.

Before hibernation, frogs have stored a considerable amount of fat, which constitutes a food reserve. This is practically exhausted when winter is over. All the bodily functions are at a low ebb and apparently very little, if any, breathing goes on, so that the fact that they have practically no air supply does not seem to matter.

6. Change of colour.—One other point which children would investigate with pleasure is the possibility of change of colour. If frogs are set up in surroundings which are differently illuminated, their chameleonlike ability to adapt their colour to their surroundings—a valuable protective device—may be shown.

Several wooden boxes should be procured and the top and bottom replaced, one with perforated zinc, the other with wire netting or glass, to serve as front and back. By means of screens of coloured (green, blue, brown, grey) and light and dark paper, strong and weak lighting, stones and moss, a variety of different environments can easily be arranged, and frogs of approximately the same colouring placed in them; that is, equally light or dark in colour. In a few hours marked changes will take place, some of the frogs becoming light, others dark, with green, brown and yellow predominating, according to the background.

This is due to the varying effect of the light on the nerve supply of pigment cells in the skin. These cells are branched. The colour can either be sent along the branches or withdrawn to the centre of the cell, and according to its distribution the appearance of the whole skin will alter. Its protective value will be realised. It is interesting to notice whether the frogs seem to perceive light, or seem to show any preference by trying to change from one environment to another, if given the opportunity.

LESSON UNIT III—WATER INSECTS

Insects suggested:—Mayfly, dragonfly, water boatman, bloodworm, gnat.

Before beginning the study of insects living in water, it is desirable to consider the conditions prevailing in their community. Although there has already been some awakening of interest in the life of a pond, through the study of frogs and newts, the early season of the year at which this can be begun, as well as the exciting nature of

both these animals in children's eyes, make it probable that they have been watched for their own sake and with little reference to the companions who share their life or the common conditions.

If possible, therefore, start this section of the work by making a visit to a pond and surveying it as completely as possible in the time and circumstances. Notice first of all the isolation of the pond. It seems at first sight completely cut off from the surrounding land, a world in itself. Yet there are certain points in common. Both receive sun, rain and winds. Both are influenced by changes in temperature. The pond, in addition, owes its existence to drainage from the land, either immediately or because it has its source in a spring bubbling up from below and supplying it with water drained through the soil somewhere else, Fig. 27.

These points might be explained to the children so that they are ready to look out for them before the first visit is made. It may also be pointed out that the vegetation of the land is always encroaching on the water, roots penetrating and making meshes which entangle soil and so tending to change a pond, first to swamp and then to dry land. Signs of this condition may be looked for.

1. Pond life.—On first visiting the pond, its size should be measured, either by rope, chain or pacing, its aspect noticed, any shelter from sun or wind, the prevailing winds, and the vegetation surrounding it. Then water plants should be noticed, both as a source of food and shelter for the inhabitants. Then let the children watch for living things before disturbing the water in the effort to collect.

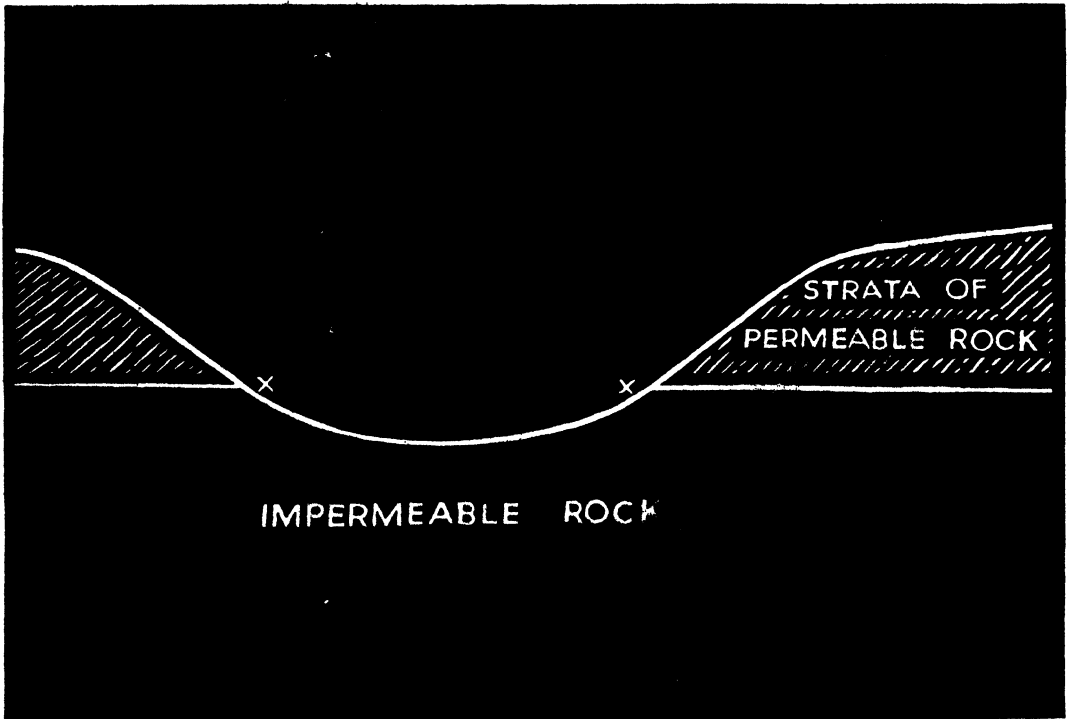

FIG. 27. HOW A SPRING MAY GIVE RISE TO A POND

X. Spring level: water percolates to the level of impermeable rock. Where this meets the surface, a spring forms.

It is desirable, indeed, to disturb the pond as little as possible. Nets should be used with long, gentle sweeps, not with an excited dash. A net with a stout galvanised iron rim and a diameter of 8 in. or more is satisfactory, mounted on a strong stick—a broom handle will serve. This may be drawn firmly but smoothly against weeds, and jerked to dislodge small creatures resting on them, but weeds and mud should not be dragged up more than can possibly be helped. In many cases it is possible to locate the animals by watching, and draw the net gently under them before giving the upward jerk which ensures the capture. Water beetles and water boatmen can usually be caught in this way; dragonfly larvae and beetle larvae are more likely to be amongst reeds and firmly rooted weeds; mayfly larvae and bloodworms on or near the surface of the mud at the bottom. Usually the bloodworms are protected by small tubes of the mud but, if the water is disturbed, they rise and swim about. Gnat larvae and pupae are chiefly found near the surface in fairly open water. Bloodworms and gnat larvae are frequently in stagnant water, ditches or puddles or rain tubs.

The catch should be taken home, with a little mud and weed. The best way to keep the creatures alive, though not the most decorative way of housing them, is simply to place them in shallow bowls and saucers and keep them constantly supplied with fresh pond water containing plenty of small organisms for food. Most of these animals can best be watched in this way, using a hand lens to follow their movements through the water, so that a plentiful supply of such vessels for children to use is necessary. If large dragonfly larvae should be included in the catch, they should be separately housed or they will destroy all the rest. They might be carefully displayed, as described for newts, so that their movements, breathing and feeding may be readily watched. Water boatmen also take heavy toll of the other creatures if left amongst them.

2. Movement.—Each of the insects chosen has its own distinctive method of swimming, so that an interesting extension is possible of the ideas already gained about the movement of animals. With the exception of the water boatman, all the insects chosen are in the larval stage, the adult winged insect being aerial.

The bloodworm (the larva of one of the midges, about the size of a gnat, known as the harlequin fly) and the gnat are wormlike in appearance, having no legs. They move by violent jerks of the whole body. The gnat larva doubles its body and straightens

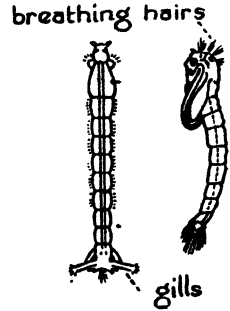

FIG. 28. BLOODWORM
Left: Larva.
Right: Pupa.



FIG. 29. HARLEQUIN FLY, PARENT OF THE BLOODWORM

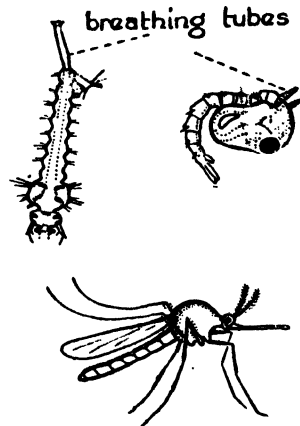

FIG. 30. GNAT
Top left: Larva.
Top right: Pupa.

it again, so jerking forward. Both are peculiar in being followed by an active, instead of a passive, pupa, which also jerks itself through the water, Figs. 28, 29 and 30.

The bloodworm doubles its body into a figure eight, straightens it, and doubles in the same way but in the opposite direction. This causes very jerky progression.

Larvae.—Two kinds of larvae are found, a blood red one and a pale greenish one which is almost colourless. The red form lives in the mud and comes to the upper layers of water only if it is disturbed. It makes itself a tube of slime from its body and mud, where it spends most of its time. It lives by picking small organisms out of the water and mud. The pale form is more active and frequents the surface water. The red colouring matter (haemoglobin, as in the blood of mammals) apparently renders it easier to obtain oxygen (haemoglobin has a chemical affinity for it).

The gnat larva and pupa, and the blood-worm pupa, come to the surface to breathe.

The mayfly larva is sluggish in habit, crawling about at the bottom or on stems to which it clings with its three pairs of long, slender, jointed legs. If it is disturbed, however, it shoots through the water by a sudden swish of the hinder part of its long body, the abdomen. The body is arched and then straightened. It is difficult to see exactly what happens. Probably the three long projections, called cerci or styles, on the last joint help in movement, though they are also thought to help in breathing, Fig. 31.

There are many different kinds of dragonfly. The larvae most commonly found are the slim little green demoiselles, which change to bright, iridescent blue "flies." The adults are frequently seen poised over ponds or darting with smooth, horizontal movements from reed to reed, where they rest. The body is held very stiffly and the

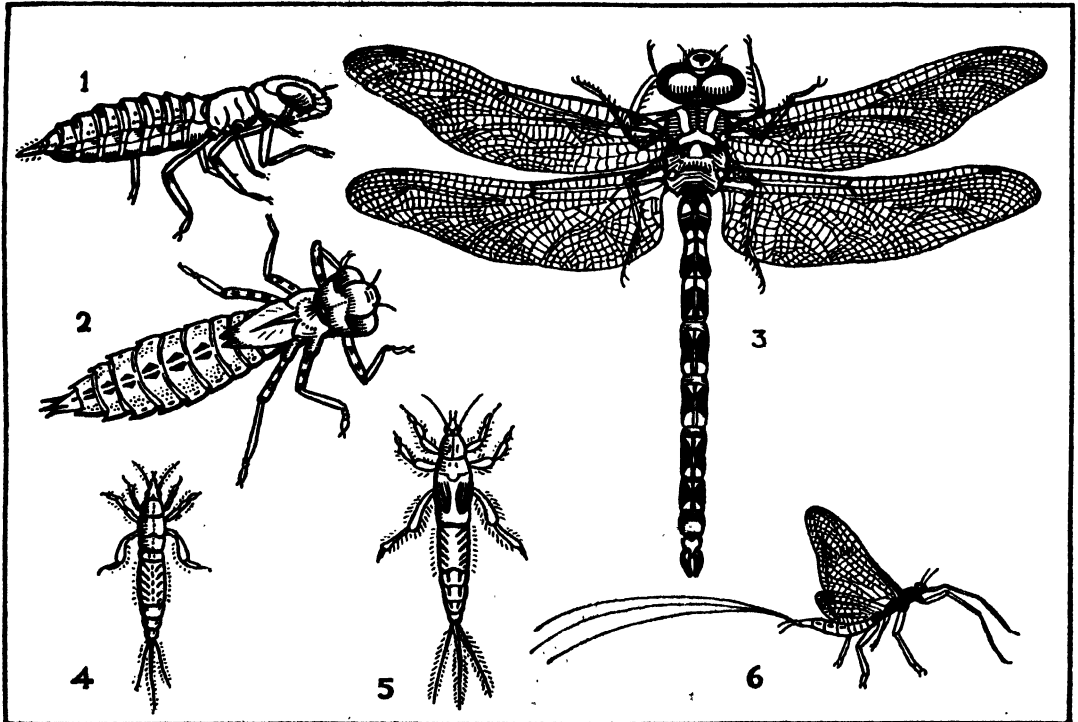

FIG. 31. LIFE HISTORIES OF DRAGONFLY (*AESCHNA*) AND MAYFLY

1. Larva. 2. Nymph. 3. Adult. 4. Larva (enlarged). 5. Nymph (enlarged). 6. Adult.

wings are so delicate that it is often difficult to see them until closely watched.

The larvae may be found of all sizes up to about 1 in. or $1\frac{1}{4}$ in. They are at first transparent and wingless, as are the mayfly larvae, but gradually become more opaque, developing two pairs of wings which, however, do not unfold but remain in a sheath till the adult stage. After the wings have begun to form, the larva is known as a nymph, in both insects, Fig. 31.

The larvae dart about by means of side-wards movements of the abdomen, or crawl over plants by using their thin legs. They spend much of their time lurking amongst weeds and stalking their prey, and usually swim only when alarmed.

Another kind of dragonfly has a short, thick body, and the larva is correspondingly squat-bodied, covered with coarse bristles which entangle particles of mud and sand and so help to conceal it. This, too, lurks and stalks its prey, only crawling slowly and never swimming.

Yet another form, the long bodied form represented by the familiar "horse-stinger" (which, however, does not sting) has a large larva, about $2\frac{1}{2}$ in. long when full-grown. This is quite a formidable-looking creature, with prominent eyes and large ferocious-looking jaws forming what is known as a "mask" which lies folded under the head when not in use. The mask is jointed, so that when an unwary victim comes within reach it can be shot out, while at the same moment the jaws open and close on the food, Fig. 32. All dragonfly larvae feed in this way. If they are kept in an aquarium with smaller animals, such as mayfly, gnat and bloodworm larvae, tadpoles or small fish, they will soon devastate it and leave nothing alive. The same applies to beetles, beetle larvae and leeches.

The water boatman is interesting in its movements, which are quite unlike any of those described, and more like those of beetles, for it rows itself through the water by means of long, oar-shaped legs; the third pair are modified for this purpose, being

provided with bristles which form a broad blade. It feeds on other animals, living or dead, which it spears with its long, sharp beak. This beak is formed by the interlocking of a pair of jaws, hollowed out to serve both as a weapon and a feeding tube, Fig. 19.

The swimming movements of all the animals considered may be summarised by saying that they use the body itself for swimming, contracting it sharply and straightening it, or they swim by rowing themselves through the water. Most other animals which come under observation will fall into one of these two categories.

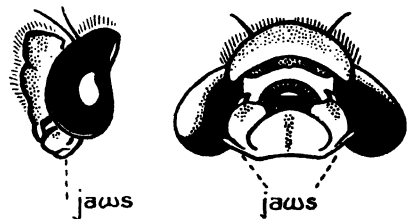

FIG. 32. JAWS OF ADULT DRAGONFLY

Left: Side view.
Right: Front view.

3. Feeding.—All the insects described are carnivorous, but there are insects—e.g., some of the beetles and caddisworms—which feed chiefly on vegetable food.

It will be seen that the method of movement is very closely connected with the manner of feeding. Animals which feed on exceedingly minute animals usually find them at the surface of the mud or inside it, so that they are characteristically crawling or gliding unless disturbed, when they may become more energetic. Carnivorous insects, on the whole, hide in ambush but can usually pursue rapidly if necessary, or can dart out suddenly.

The method of feeding is closely connected with modifications of the jaws to fit them for it, as indicated in the dragonfly larva and water boatman. The dragonfly tears its food to pieces, the water boatman sucks the blood or juices. In all cases, the jaws of

insects are external, hinged on either side of the mouth and folding over it when not in use. They are not jaws in the sense of bony supports for the mouth, but are weapons and instruments for feeding.

LESSON UNIT IV—LIFE HISTORIES OF PLANTS

Plants suggested:—Oak, sycamore, horse chestnut, marrow, broad bean, goosegrass, shepherd's purse.

As most of the plants will be familiar, and all structural details can be realised by watching their development, it will be sufficient to indicate a few important points to look out for.

1. Spiral growth.—Development suggests a spiral ascent, and the actual unfolding of buds is, in fact, a spiral movement, the elongation of a stem marking its spiral shape by leaving behind opening leaves at fixed intervals. This can be brought out clearly by winding a thread of cotton round a growing stem so that it passes just above each leaf in turn. The elongation of the lower internodes—distances between one leaf-origin and the next—makes the turns of the spiral further apart than near the bud, where they are still short. Thus the idea that the growth of a plant is due to the elongation of a main axis, already present in it, setting free the leaves so that they can unfold, is grasped.

2. Roots.—Before any external appearance can be seen, there is a struggle for escape inside the seed coat. The taking in of water through the whole seed coat causes the embryo plant—cotyledons+radicle+plumule, if formed—to swell and press against the surrounding wall until eventually the radicle breaks through at a weak spot—the micropyle or “small hole” which has served already for the absorption of water and, still earlier, for the entrance of the pollen tube which brought about pollination. The root, or radicle, now seeks to establish

itself, and must do so successfully before it is advisable for any upward growth to take place. It may produce lateral branches which serve as guys or stays. It is also establishing a water current which can feed the growing plant. In some cases, roots contract and pull the seed downwards, or, as the awn in grasses such as barley, a projection on the fruit coat may penetrate the ground, contract and so help to fix the seed. Note the force exerted in clinging to stones

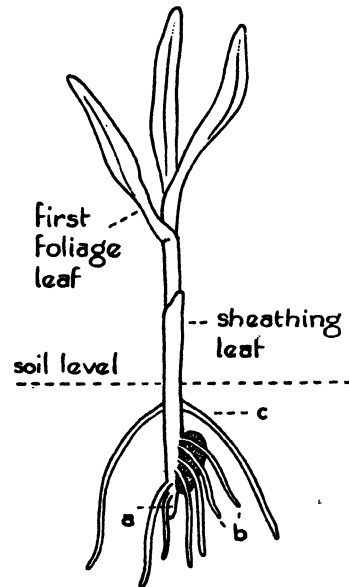

FIG. 33. MAIZE SEEDLING—FIRST ROOT SYSTEM AND LEAF SERIES

a. Primary roots.
b. Adventitious roots.
c. Thicker roots.

and earth, which can be realised when efforts are made to uproot even young plants.

An interesting point in the establishment of many grasses is the serial development of roots. A short radicle or primary root is followed by the growth of adventitious roots from the region where radicle and plumule join. These are succeeded by a ring of thicker roots, very like tent ropes, at the first node of the stem, when this has developed; and later, the second or even the third

node may give rise to yet other rings of roots. This is beautifully shown in maize, which grows so tall that it would topple over but for this steadying device, Figs. 33 and 34.

In woody perennial plants, the roots eventually grow woody and form a perman-

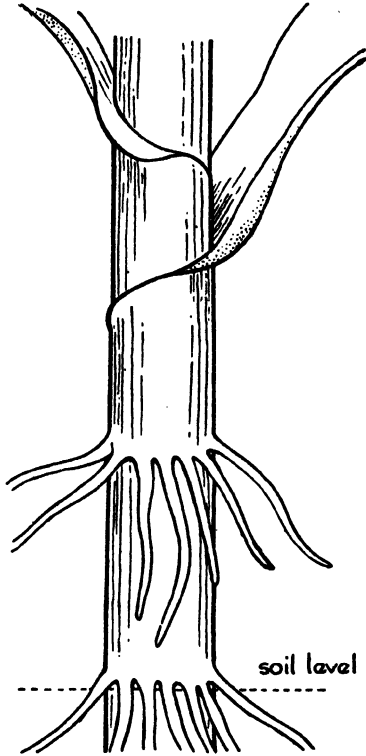

FIG. 34. RINGS OF ROOTS ON MAIZE STEM

Note at soil level the roots from the first node, serving as stays to support the tall stem. Above these are the roots from the second node.

ent strong support. In trees, the roots may occupy an area in the soil wider than the crown of the tree, as well as penetrating deeply. Their origin from the base of the trunk may often be seen above the soil; e.g., beech.

3. The plumule.—Emergence of the aerial parts of the embryo follows the firm establishing of roots. In some plants the plumule

now emerges, in others the cotyledons, when the plant is said to be epigeal.

In oak, horse chestnut, and broad bean (Fig. 35), the plumule emerges first, the cotyledons remaining enclosed in the seed coat below the soil (hypogeal). Considerable force

has to be exerted to extricate the plumule. This is often aided by the growth of the cotyledonary stalks, which separate

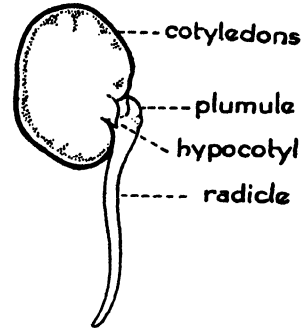

FIG. 35. BROAD BEAN SEEDLING WITH PLUMULE EMERGING

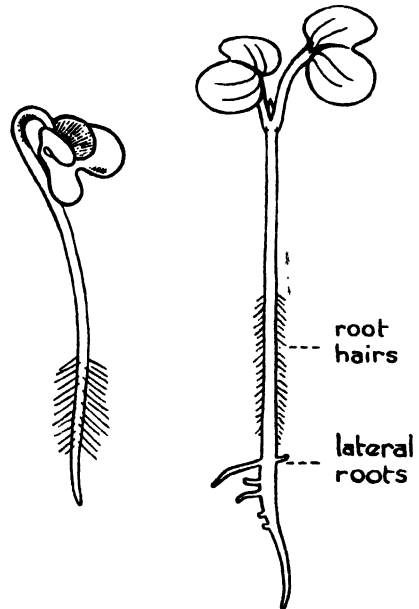

FIG. 36. MUSTARD SEEDLING
Note the cotyledons and plumule

the cotyledons from the main axis and cause the plumule to be drawn out. In the horse chestnut, these stalks are long and pressed closely together so that they would

be mistaken for part of the root, but eventually they separate, revealing the plumule lying snugly protected between them, quite outside the cotyledons. The value of this will be clear if an attempt is made to separate the cotyledons for, unlike most seeds in which they separate easily, they are tightly pressed together and interlocked by means of their indented edges.

The plumule of the oak is also protected by the cotyledonary stalks until it has been

withdrawn from the seed coat, when it pierces its way out between them.

The minute size of the plumule at this early stage is striking when compared with the advanced development of other parts.

In epigeal seedlings—marrow, goosegrass, shepherd's purse, sycamore—the cotyledons are withdrawn from the seed coat, grow above the ground through elongation of the hypocotyl, then unfold and turn green, and begin to serve as foliage leaves. Probably

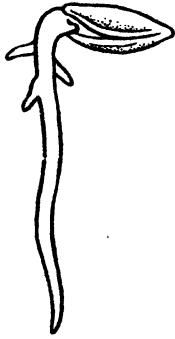

FIG. 37. MARROW SEEDLING, SHOWING THE TESTA, PEG, LATERAL ROOT AND RADICLE

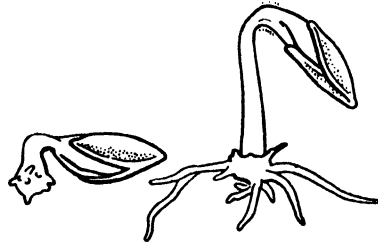

FIG. 38. MARROW SEEDLINGS AT SURFACE OF SOIL, WITH COTYLEDONS READY TO EMERGE

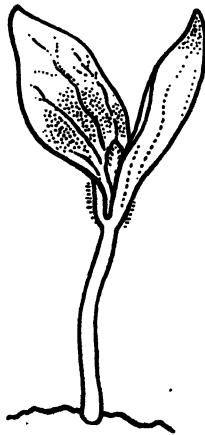

FIG. 39. MARROW SEEDLING WITH COTYLEDONS EXPANDING

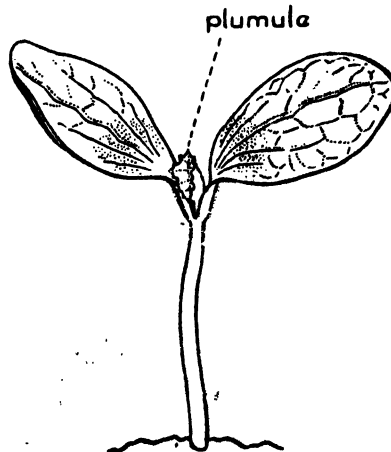

FIG. 40. MARROW SEEDLING WITH COTYLEDON FULLY EXPANDED

their emergence is helped by their bent position, and they obtain some purchase in forcing their way through the soil as they straighten out.

The bent position in an emerging plumule probably makes additional force available in the same way.

In the marrow (Figs. 37 to 40), a little peg appears on the radicle just as its junction with the hypocotyl. This fits into the split seed coat and holds it down in the soil while the cotyledons are dragged out. It does not invariably develop, however, in seedlings grown in pots or in blotting paper.

4. Leaves.—The succession of leaves should also be noticed, both the spiral growth and the differences in development. Frequently the first formed leaves are of a simpler type than the later ones. They are of interest because they are thought to represent a more primitive stage in the

race history. In the broad bean, for instance, the first-formed leaves are merely leaf bases with small winged outgrowths called stipules. The next leaves have well-developed blades, separated from the base by a stalk, while later leaves establish the typical pattern of the plant, a compound leaf with two pairs of broad oval leaflets.

5. Study of normal development of a plant.—If possible, follow the further development of all plants by growing them from seed in the garden, so that any abnormalities due to growth indoors may be counter-balanced by observing normal growth. Follow the life history through to seed production and, if possible, set some of the seeds produced.

Sketches and accurate measurements of growth should accompany these studies, and should emphasise the points here stressed, Figs. 41 and 42.

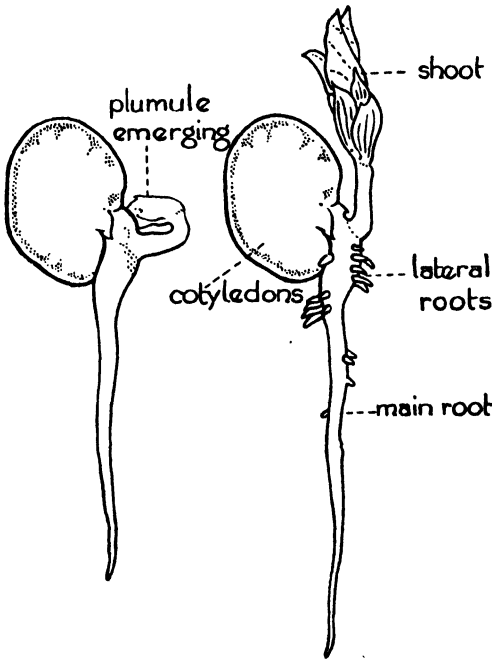

FIG. 41. BROAD BEAN—DEVELOPMENT OF SEEDLING

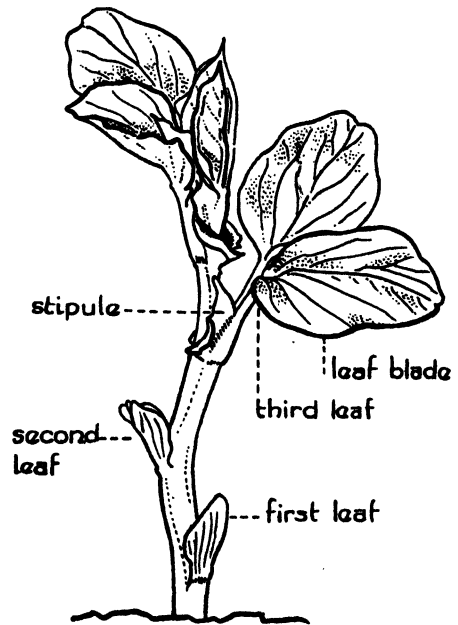

FIG. 42. BROAD BEAN: SUCCESSION OF LEAVES

SMALL BRITISH MAMMALS

CLASS PICTURE No. 27

THE British wild mammals (Plate I) form a complementary part of the natural society of the country, taking their toll of other wild creatures and thus helping to keep a balance. The carnivorous and insectivorous forms, together with birds, control mice and insects which tend to become so numerous as to rank as pests if their natural enemies are destroyed by farmers and gamekeepers. Probably even the rodents—rats, mice, squirrels—play some part in keeping down weeds by devouring quantities of seeds, though there is no doubt they injure crops. Consequently, indiscriminate killing of any and every little wild mammal or “beastie” is to be deprecated, both because of the economic results of their wholesale destruction, and because of the charm and interest of the little creatures which all offer some attractive studies in ways of life. In many cases damage is attributed to birds and beasts of which they are quite guiltless, and a real knowledge of their ways would prevent this, but tradition and ignorant superstition block the path to knowledge and tolerance.

1. WEASEL.—Male 10 in., female $8\frac{1}{2}$ in. from nose to tip of tail. Slender body, short legs. Rippling, snake-like movement. Small rounded flat head and short snout—like stoat and otter. Short tail, light reddish-brown, short fur. Habitually uses the runs of field mice, and feeds chiefly on mice. Contrary to popular opinion, it does very little harm though it may take an occasional partridge or chicken, but amply compensates for the theft by killing hundreds of mice and young rats in hay ricks and farm premises.

2. STOAT.—Male 17 in., female only $13\frac{1}{2}$ in. For a long time thought to be

different species the difference in size being so marked, the female being very little larger than a male weasel (10 in.) but always distinguishable by the black tip of the tail, common to both male and female stoat. Long sinuous body and short ears. Rich yellowish-brown, with conspicuous cream under parts. Hunt chiefly rabbits, but will take mice, rats and young birds. Hunt in family parties and once on the scent (like weasels) never leave it till the quarry is caught. Bite at the back of the neck and feed chiefly on head and shoulders; badgers, hedgehogs, rats, beetles and other scavengers finishing it, unless food is scarce, when the stoat will return. On the whole a friend of the farmer in keeping down rabbits and helping to keep the “balance of nature”—as Miss Frances Pitt points out in *British Animal Life*.

3. WATER VOLE or WATER RAT.— $12\frac{1}{2}$ in. The voles are sometimes called short-tailed mice, but differ from mice in having a rounded broad head and blunter nose, longer hair and smaller eyes. The water vole is the largest of them, having a body about 8 in. long, the size of a rat, and a tail about $4\frac{1}{2}$ in. long. Dark greyish-brown, sleek coat. Live in burrows in the banks of streams, where they have two or three litters in a year. Swim and dive well, but not better than true rats. Feed on leaves, reeds, branches of trees dipping into or near water, water weeds, grass.

4. WOOD MOUSE or LONG-TAILED FIELD MOUSE.—A true mouse, and probably the commonest mouse. Larger than the house mouse; about 7 in. from nose to tip of tail. Legs and tail are longer. Fur light yellowish-brown, not so grey or drab as the house mouse. These are the mice which dig up and eat our young peas, nibbling

the seed and leaving the shoot behind, with a little hollow where each seedling was growing, and later, running up sticks to eat the peas in the pod. They will often take possession of birds' old nests or the nests of dormice, to which they will take hips and other berries. They make winter stores of nuts and berries in underground homes. (See Hans Andersen's story of *Thumbeline* for a sympathetic account of their winter ways.) Found in banks, hedges and fields, especially cornfields in the autumn; also in ricks, and will enter houses. Preyed upon by owls and weasels especially.

Not to be confused with the yellow-necked mouse, or de Winton's mouse, a distinct and larger variety, also quite common. Both are great climbers, and both will make their homes in houses and greenhouses as readily as in their natural surroundings.

5. DORMOUSE.—Length about 6 in. from tip of nose to tip of tail. Rounded head; bright yellowish-buff hair with white underparts; short ears, long whiskers, big dark eyes; plump body, bushy tail.

Excellent climber. Winter nest well hidden, summer nest about size of a cricket ball in bushes 2–3 ft. from ground, especially in hazel, but also in brambles and honeysuckle. Frequently made of strips of bark lined with a few hazel leaves. Sleeps in day time and roams at night. Hibernates October–April. Lives largely on insects.

6. SHREW.—The common shrew is about the same size as a house mouse, but has a shorter tail. Though many are killed by cats and other animals, few will eat them. Make run-ways in grass and coarse undergrowth and keep to these routes, shrieking shrilly as they scold or fight with one another. Useful because they catch enormous numbers of slugs, caterpillars and other grubs, as well as spiders, beetles and worms. Thick, close fur like plush, of a dark grey-brown colour; young, light brown. Long, pointed snout and very small, sunken eyes. Unpleasant odour probably disliked by

preying animals, though owls will eat them. Digest food so rapidly that they must be constantly feeding, and it is said that they frequently die of hunger if without food for two or three hours. Exceedingly active and fierce. Many of them die after a year—possibly this is normal span of life.

7. HARVEST MOUSE.—Length of body 2–2½ in.; to tip of tail about 5 in. Local and not very common, but its habit of weaving together corn stalks and suspending its nest between them is well-known. First described by White of Selborne.

Greyish-brown, with reddish hind quarters. Often found in corn, oat and bean stacks; probably carted at harvest. *Food*: largely insects, but eats seeds as well. Usually runs *upwards* to escape. Needs water.

8. HEDGEHOG.—Length about 9 in. Known by sharp-pointed head and long spines or bristles. Contracts into a ball when alarmed. Often nests in brushwood or wood piles. Litter of four to six cream-coloured and soft-spined young; easily alarmed, when whole brood will be rapidly removed. *Food*: insects, slugs, carrion; e.g., dead rabbits left by stoats. Hence *very useful* in gardens.

9. MOLE.—Length about 6–8 in. Thick, close, short fur is greyish to nearly black. Snout sharply pointed, eyes very small, no external ears. Broad front paws for digging. Lives underground, but is known to feed at the surface at times. *Food*: earthworms, slugs, beetles and various insects. Male makes elaborate galleries and domed central sleeping chamber, but excavations made by females are less elaborate. The sexes do not live together and the animals are solitary. They are thought to need plenty of water, and they certainly require much food—more than their own weight daily, it is said.

10. BADGER.—Length 3 ft. Clumsy, heavy body, short legs. Long, rough grey fur, black legs and under parts, head white

with two broad black stripes covering small eyes and short ears. Head carried low. A night prowler, living chiefly on insects and grubs, for which it digs. Will kill young rabbits, digging a straight shaft down to their nursery, which it detects by smell. Does much less harm than is popularly supposed, is quite inoffensive unless attacked, when it will fight and bite hard. Excavates its "sett" or "earth" in rocky woodland, not far from water. Two entrances. Often black and white hairs mixed with bedding thrown out will reveal it.

11. OTTER.—Length about 3 ft. 4 in. from tip of nose to tip of tail. Carnivorous and solitary, except during mating season. Mother alone rears young, usually making a nest under roots of tree or other sheltered hollow near water. Although the adults are expert swimmers and divers, able to swim for long distances under water and twist and turn to catch fish, the young have to be taught all these activities. Feed largely on fish, but will eat any live creatures they

can catch—frogs, snails, eggs and young birds. The head is rounded, with short ears sunk in fur; body long and slim, like a large weasel, with short legs and broad, flat, pointed tail. Five toes. Unfortunately, for it is a most interesting creature, becoming rare through being unmercifully hunted.

12. HARE.—Length 25 in. Legs and ears longer than in rabbit, colour lighter and more sandy, white underneath. 5 in. longer than rabbit.

Lives in open country, pasture fields or furrows of cultivated fields, especially on gravel or chalk. No nest or lair, but cowers low on ground in slightly hollowed "form." Extremely keen sight, smell and hearing. Colouring affords good protection, while light underside counteracts ground shadow.

The young, (two, three or four) much further developed than young rabbits, being covered with hair, with open eyes. Separate after a few days, though they may still feed together when the doe has left them, which is after about one month.



SECOND YEAR'S COURSE

AUTUMN TERM

LESSON UNIT I—FOOD, MOVEMENT AND FORM

Introduction.—It was shown in the previous year's work that food is an animal's greatest need and that the power of movement is largely bound up with the need to obtain food. Both the legs and jaws of many animals take part in the capture of food. It was noticed that some water insects use their powerful jaws, like pincers, to grasp the prey; e.g., water beetle and dragonfly larva.

We are now going to see how the development of both head and jaws has been connected with the need for obtaining food.

Development—1. Hydra.—Have the microprojector ready for use so that the objects can be shown at appropriate points in the lesson. (See Appendix I on use of microprojector.) Remind the children that last year they were shown one of the simplest known animals—amoeba—and were able to see it move about. Ask how it moved. Show it again if desired. Note that its shape is indefinite, and that it can move equally well in any direction. This, however, has one disadvantage. It changes its direction so easily in response to conditions in the water—e.g., the slightest contact with any other object, or changes in the amount of light—that it is unlikely to make much progress in any one direction. Most animals need to be able to follow

their victims, hence it is important for them to be able to move straight and swiftly in one direction. For this a long slim body is an advantage. Let the children think of all the fast-moving animals they can remember, and note that they have this characteristic.

There are amongst the lower animals many cases in which the body is not long, but more or less round. This is usually characteristic of sedentary animals—animals which remain in one place, sometimes attached. A good example is the small animal called hydra (Fig. 43), which is

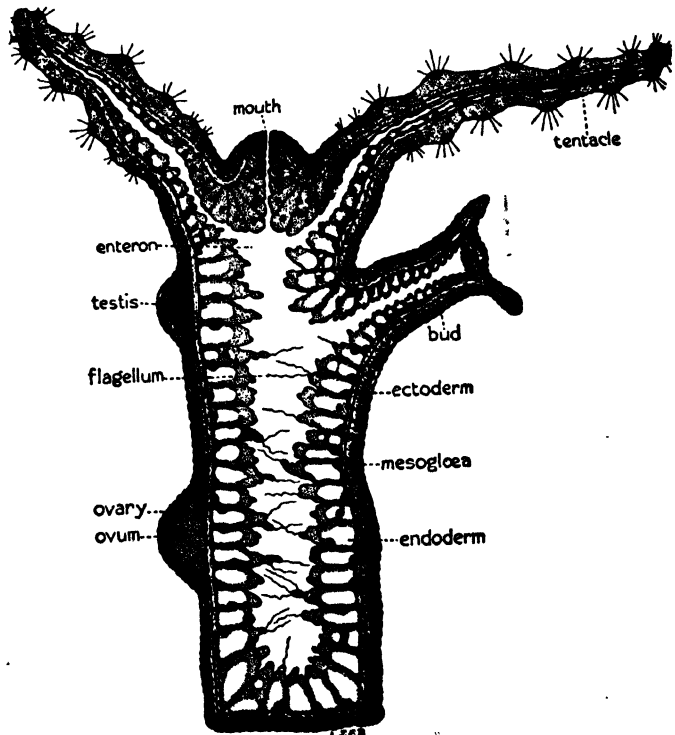

FIG. 43. VERTICAL SECTION OF HYDRA

found in many ponds and ditches attached to duckweed or other pond weeds, not far below the surface. (Show on microprojector.) There are two forms of this, a brown form and a green one. When contracted they are barely visible, but when fully expanded they may extend to about $\frac{1}{2}$ in. The body is a slender tube attached by its base to a weed. At the free end a ring of six to eight fine feelers or tentacles encircles the mouth, which is raised on a little cone. Although there is a mouth, there is no true head, and the mouth is merely an opening into an internal sac in which food is digested. The tentacles, and indeed the whole surface of the body, bear minute poison darts which can be shot out as soon as the animal is touched, and these paralyse the water fleas and minute shrimp-like creatures on which hydra lives. They are then pushed through the mouth by the tentacles into the body cavity, where they are digested.

If the living hydra is displayed in a glass cell by means of the microprojector, it is possible to watch the rapid muscular contraction and slow expansion (relaxation) of the body and tentacles, and to see the cone upon which the mouth is situated and the

lighter colour which indicates that the body is a hollow tube, Fig. 44.

If a few small water fleas are placed in the water, it might be possible to see the hydra feed, but this is a matter of chance.

Let the class see the actual size by holding the cell against the lighted screen.

It is possible for hydra to change its position by bending down and adhering to a support with its tentacles, then raising the base and bringing it close to the mouth end. By a series of such looping movements, like those of a looper caterpillar, it gradually moves along; or it may turn a somersault by bringing the base right over in front of the tentacles, Fig. 45. Show this by diagrams on the blackboard.

2. Flatworms.—If hydra had to follow its prey, this would be an inconvenient method. It is much better for an animal to follow its head. Such a method of procedure has been adopted by a very lowly group of animals, not much higher in the scale than hydra, called the flatworms, Fig. 46. Some of these are marine, others are found in ponds and ditches or damp places. A small black form, about $\frac{1}{2}$ in. long when fully

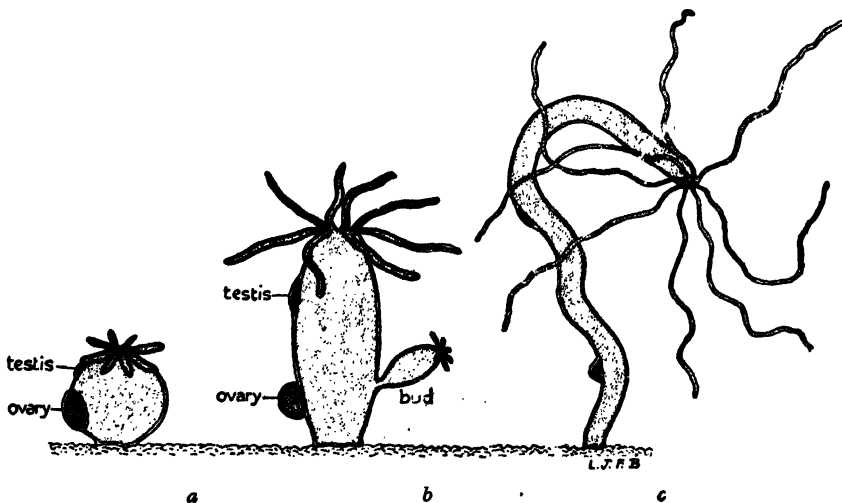

FIG. 44. HYDRA

a. Contracted. b. Half expanded. c. Fully expanded.

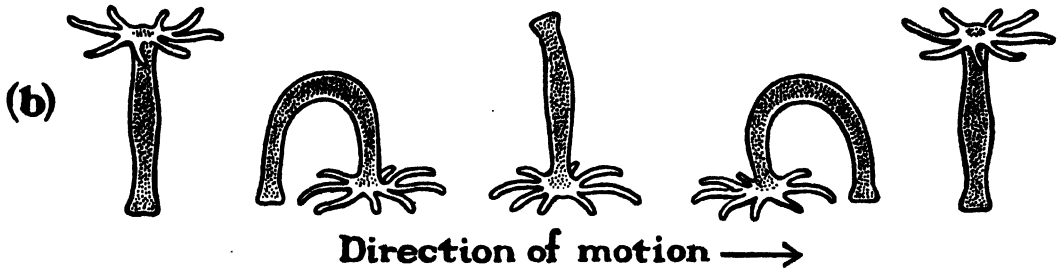
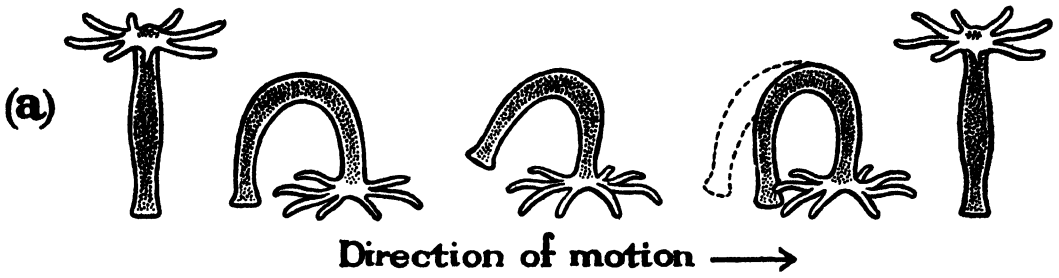

FIG. 45. MOVEMENT OF HYDRA

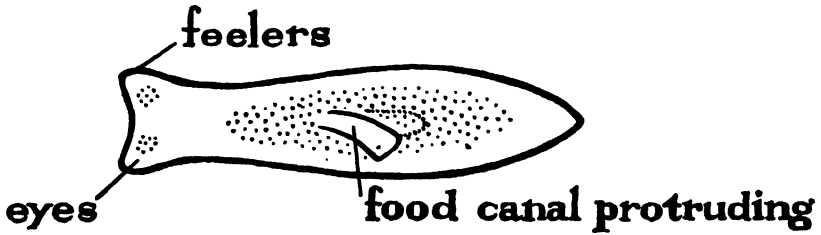
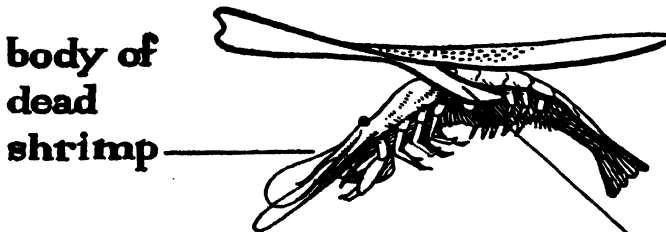
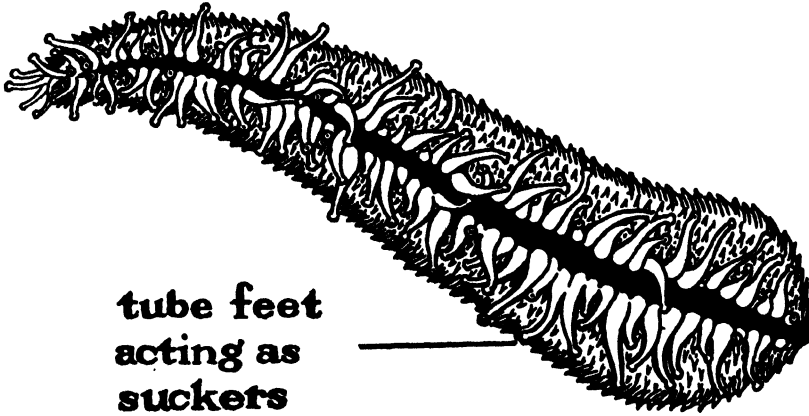

Diagram shewing gliding movement



Food canal evaginated as animal feeds

FIG. 46. FLATWORM



**tube feet
acting as
suckers**

FIG. 47. STARFISH--UNDERSIDE OF ARM

grown, usually turns up in any "catch" from a pond and should be watched in the aquarium. It has a smooth, gliding movement. It can suspend itself on the surface film and glide over weeds. It will be found feeding on dead larvae of insects or other dead creatures, and if it is then raised gently by means of a thin blade or fine brush it will be seen to be firmly attached to its food by means of a narrow white tube protruding from its mouth, which is in the middle of the under surface. Here, then, is a curious condition, for head and mouth are not together. At the anterior end of the body there is a pair of short, blunt tentacles, and the microscope would show a very

primitive brain, and scattered pigment spots or eyespots which are sensitive to light, so that this region must be regarded as a simple head. It seems as if this group of worms is experimenting to find the best relationship for mouth and head, for in some cases the mouth is at the posterior end of the body and in others at the head or anterior end, a position which has been adopted by all the higher animals as most convenient. In higher animals, the chief sense organs—eyes, ears, organ of smell—are also concentrated in this region, round about the mouth. This draws our attention to the importance of sense organs in relation to catching food.

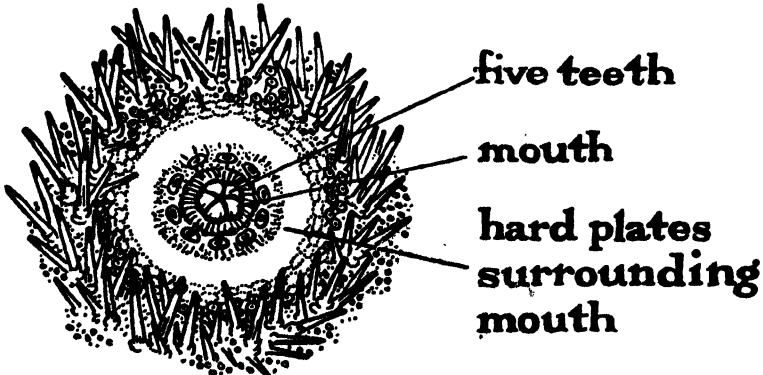

five teeth

mouth

**hard plates
surrounding
mouth**

FIG. 48. CENTRAL PART OF UNDERSIDE OF SEA URCHIN

3. The starfish and sea urchin.—As a contrast to the animals which have developed a long body and a head, the children might be shown dried specimens of a sea urchin and a starfish, which have retained the more primitive circular form. As their food consists chiefly of shellfish, which are not in the habit of moving quickly, a haphazard gait is just as likely to bring them in contact with it as a more direct and rapid one.

Both starfish and sea urchin move by using numerous small projections called tube feet which act as suckers, Fig. 47. These are situated in five radial grooves, and are part of a water-pumping system which enables them to move or adhere to the surface on which the animal is crawling. By attaching its arms, containing the tube feet, to a mussel or oyster, the starfish can exert such force that it can pull the valves apart, when it pushes its stomach into the opening and sucks up the contents for, like the flatworms, it can evert the food tube. In the sea urchin a very strong arrangement of jaws encloses the mouth just inside the shell, enabling it to crush its food, Figs. 48 and 49.

PRACTICAL WORK

1. Make sketches of hydra while watching it thrown on the screen by the microprojector.

2. Watch and make sketches of a flatworm. Put minute scraps of raw meat in the water and try to watch it feed.

3. Draw a starfish and sea urchin from museum specimens, to show the central position of the mouth, and circular shape. Note that there is no head, or front end.

LESSON UNIT II—FEEDING UTENSILS: EXTERNAL JAWS

Introduction.—In the last lesson we considered the importance of an elongated shape, the power to move in one direction, and the importance of a head, with mouth and sense organs at the front of the body. We also referred to the importance of jaws. Jaws have a twofold function. They may help in capture and in mastication.

Development.—In the lower animals, or invertebrates, if jaws are present they are

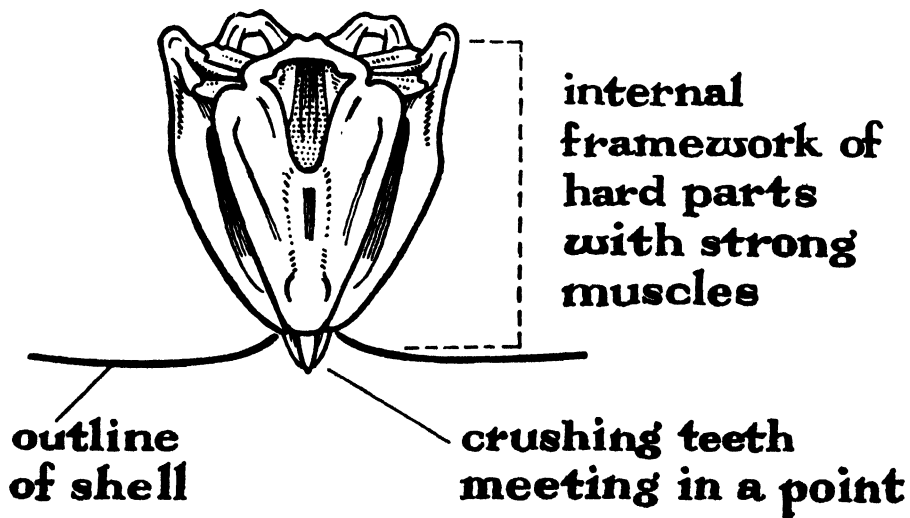

FIG. 49. "ARISTOTLE'S LANTERN"—JAWS OF SEA URCHIN

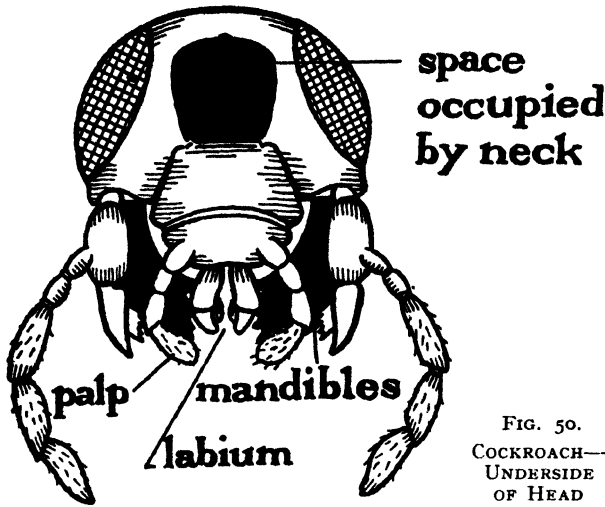

FIG. 50.
COCKROACH—
UNDERSIDE
OF HEAD

the crabs, lobsters and spiders. The jaws consist of blades, which work sideways on hinges, rather like scissors. There may be quite a complex system of blades and, in addition, there are usually outer branches called palps, which are capable of testing the food by touch and possibly by taste.

1. **The cockroach.**—Show by means of the microprojector a slide of the mouth parts of the cockroach, Figs. 50 and 51. It will be seen that there are three pairs of jaws. First to be seen, on either side below the cheeks, is a pair of strong, slightly curved

usually external to the mouth; the sea urchin is an apparent exception. It has been seen that in insects they are hinged at the sides of the mouth. This is true also of

blades, with a toothed edge. These are called mandibles.

Projecting slightly beyond them is the second pair, called maxillae, each consisting

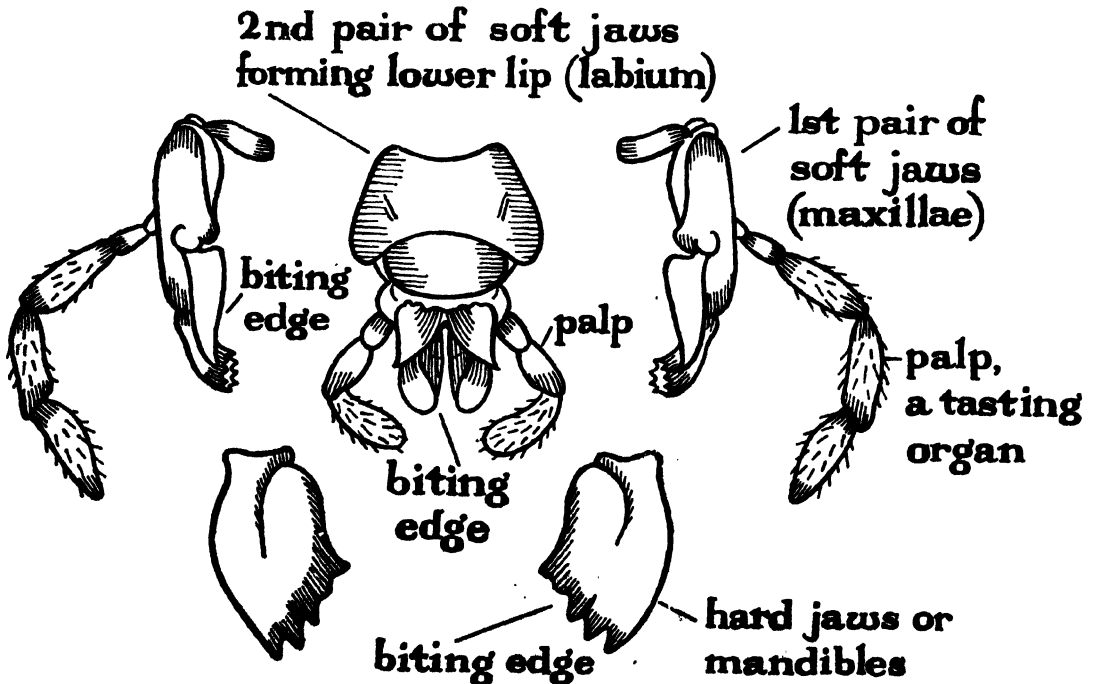

FIG. 51. JAWS OF COCKROACH

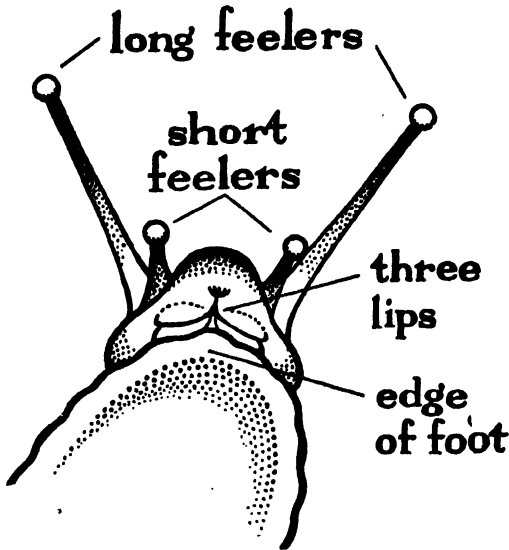

FIG. 52. SNAIL—UNDERSIDE OF HEAD

of a blade and an outer palp of several joints.

Meeting the middle line is the third pair, of the same type as the maxillae but fused together at the base to form a plate or lower lip. The whole organ is called the labium. The method of mastication by tearing and chewing food and passing it from jaw to jaw is wasteful; probably a good many crumbs are dropped, and the labium seems to serve as a plate to catch them and so prevent some of this waste. It can be seen that an internal system of mastication such as we find in the mammals, with the food enclosed in a mouth cavity during the process, would be more economical.

Overhanging the whole system of jaws is an extension of the headplates, called the labrum or upper lip.

If it is possible to obtain some cockroaches and enclose them in a glass bowl, with some bread crumbs, the method of using the jaws may readily be watched, together with the exploratory movements of the feelers. If they are then killed by being dropped into boiling water or by a few drops of chloroform on a small pad of cotton wool,

the jaws may be examined with a lens and the above points determined. For use with the microprojector it is best to separate the jaws, using botany needles and fine-pointed scissors. They may be placed on a microscope slide, without using any mounting medium, covered with a cover slip and ringed with gold size, or mounted in Farrant's medium. (See Appendix III.)

2. The garden snail.—Another invertebrate which is provided with a jaw is the garden snail. The mouth lies immediately below the head, in front of the foot. The mouth is surrounded by three lips, which open to disclose a horny arch or jaw above, and the so-called tongue, which is really a muscular pad bearing a ribbonlike band of teeth. This pad can be projected; the fine graterlike teeth rub away the surface of soft green leaves. The substance is scooped up into the mouth as the rasping organ or radula moves back again, and swallowed. It is said that the teeth number about 15,000. Part of the radula can be shown as a slide, Figs. 52 and 53.

The octopus and cuttlefish.—In the distantly related octopus and its relations the cuttlefishes, a pair of powerful jaws is found

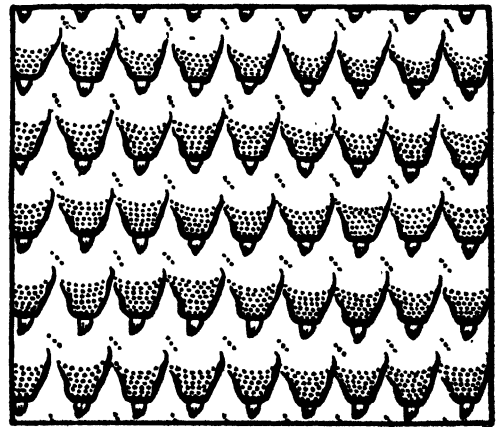

FIG. 53. SNAIL—PORTION OF RADULA, SHOWING ROWS OF MINUTE TEETH HIGHLY MAGNIFIED

(Fig. 54), rather like the beak of a parrot, and these together with the long, powerful tentacles often provided with horny suckers, make them a terror of the seas. The common sepia, a small cuttlefish with ten arms, not eight as in the octopus, is often thrown up on our beaches or thrown out of fishing nets when the fish are sorted, so that it is sometimes possible to obtain these quaint creatures and examine them.

PRACTICAL WORK

Make labelled sketches of the jaws of a cockroach. Watch living cockroaches enclosed in a glass vessel searching for food and feeding.

Note at the same time the typical characteristics of an insect, as follows:

1. Horny outer covering or skeleton of jointed plates. Note how these are arranged.

2. Body divided into three regions:

(a) Head, bent downwards on thin neck, bearing one pair of feelers or antennae, eyes, three pairs of jaws.

(b) Chest or thorax, bearing three pairs of long, jointed legs on the ventral side, and two pairs of wings on the dorsal side on the second and third segments. Note the membranous wings.

(c) Trunk or abdomen, bearing no append-

ages except on the last segment a pair of jointed styles or cerci.

There are actually ten abdominal segments; but several are telescoped at the posterior end, as is often the case with insects. The typical arrangement is head plus thirteen segments. Cockroaches are amongst the more primitive insects. In the higher orders a good deal of change and fusion of parts has taken place, especially of mouth parts, concealing the original plan.

3. Watch a garden snail feeding. Place it on a glass plate and look at the jaws with a lens. Watch a pond snail feeding on the side of a glass aquarium and look for the radula with a lens.

LESSON UNIT III—CLASSIFICATION OF ANIMALS

Introduction.—Much time has been given to a consideration of food and feeding, because of their vital importance to all animals and because feeding and movement have largely influenced the forms which animals have assumed—the shape of the body; position of mouth, head and sense organs; character of the jaws and teeth; character of the limbs. Since the classification of animals is based upon similarities and divergences of form,

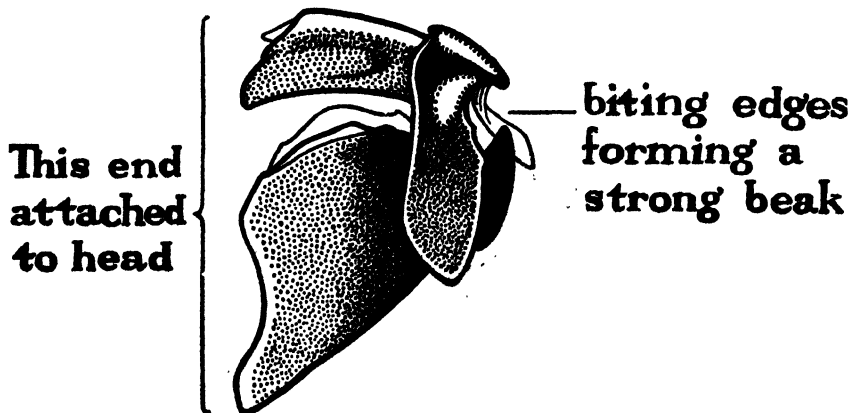

FIG. 54. JAWS OF OCTOPUS

indicating near or very distant kinship, this seems a suitable place to consider how animals are classified. Only the more important groups have been included here.

Development—1. Method of classification.

—We divide the world of living creatures into the plant and animal kingdoms. Each individual animal or plant belongs to a species, or kind, of which the members are so similar that, as one zoologist says, "To know one is to know all." For instance, all domestic cats are of one species. Only individual differences distinguish them.

Species are grouped or gathered together into genera, another word meaning kinds, which have a great many features in common but at the same time more marked differences that distinguish one species from another. For instance, the domestic cat belongs to the same genus, *Felis*, as the lion, tiger, panther and leopard. The round skull, short, strong jaws, sharp cusped and pointed teeth, soft fur, retractile claws, sinuous body, as well as habits generally, characterise all these animals.

The native British red squirrel, and the Canadian or American grey squirrel, are examples of different species of the same genus. These show marked differences from the rat, hare and rabbit, beaver, guinea pig, yet the nature of their teeth, with a chisel edge for gnawing wood and vegetable substances (see illustrations on page 37) together with various characteristics of limbs, skull and internal organs, show that all these animals are related. This relationship is expressed by gathering them together into the same order, the rodents (*Rodens*—gnawing). The rodents belong to the larger group, or class, of the mammals.

The mammals are animals which suckle their young on milk. Further, the young are developed for some time, varying widely in different orders, inside the body of the mother. The body is covered with fur. In most cases, well-developed teeth are found, specially differentiated, that is, of different kinds, in connection with the different kinds

of food used. Thus, mammals feeding on vegetable food have chisel-like front teeth or incisors, and broad, flat, ridged cheek teeth or molars. This result is achieved in different ways, so that, apart from size, there would be no difficulty in distinguishing the teeth of rabbits, horses, sheep and the more primitive kangaroos, for although their teeth have these characteristics in common, they are quite unrelated and the patterns are different. It is said that "fingers were made before forks," but teeth and claws were made before fingers, and the diversity of these natural tools is linked with the diversity of food.

In explaining these points to a class, pictures are useful but the teacher should make every effort to secure actual skulls so that they can be demonstrated and sketches can be made. Refer back to work done in first year, lesson units IV, V and VI of the second term. A visit to a local museum is desirable. There should be no difficulty in obtaining skulls of a cat and rabbit, some insect-feeding mammal such as a mole or shrew, and one can often pick up the jaw bone of a sheep or readily obtain a head from a butcher. Heads of birds showing different kinds of beak in connection with different feeding habits might also be shown for comparison. For the preparation of skulls see Appendix II.

2. Main groups of animals.—Having explained and illustrated the method of classification of animals, the teacher might now show the children a tabulated arrangement of the main groups of animals. They will be interested in seeing the position of the animals they already know and finding out on what grounds they are so placed. In subsequent work, any new animals mentioned or studied should be referred to their place in the scheme. There is no need to attempt to learn this table by heart, but constant reference to it in later lessons will soon make it familiar. The characteristics of each group are briefly indicated in the accompanying tables. It

THE ANIMAL KINGDOM

(Three phyla have been left out.)

<i>Phylum I.</i>	<i>Phylum II.</i>	<i>Phylum III.</i>	<i>Phylum IV.</i>	<i>Phylum V.</i>	<i>Phylum VI.</i>
Protozoa or non-cellular animals. Ex: amoeba.	Sponges.	Coelenterates or sac-like animals. Ex: hydra; sea anemone; coral; jellyfish.	Flatworms. Includes many parasites such as tape-worms.	Echinoderms (=spiny-skins). Ex: starfish; sea urchin.	Annulates or ringed worms (body divided into segments). Ex: earthworm; many sea worms; leeches.

Phylum VII.

Arthropods (=jointed-feet).

Four main classes:

Class I. Crustacea

(=hard skin).

Ex: crab, shrimp, woodlouse.

Class II. Myriapods

(=myriad feet)

Ex: centipedes; millipedes.

Class III. Insects

(head, thorax, abdomen, 3 pairs legs, usually winged).

Ex: cockroach.

Class IV. Arachnids.

Ex: spiders.

Phylum IX.

Molluscs (=soft bodied).

Commonly called shellfish.

Ex: cockle; snail; cuttlefish.

Phylum X.

Chordates.

Animals in which the principal nerve or central nervous system is dorsal in position. In nearly all it is enclosed in a cartilaginous (gristly) or bony skeleton (vertebrae). These belong to the sub-phylum vertebrates.

THE ANIMAL KINGDOM

Sub-phylum Vertebrates

(Several classes of primitive chordates have been left out.)

Class Pisces or Fishes.

Live in water and breathe by gills.

Swim by means of paired fins, which are supposed to be the forerunners of legs, and unpaired fins. Lay eggs.

Ex: herring; shark.

Class Amphibia.

Early life passed as a larval stage, swimming in water by using a tail fin and breathing by gills.

Adult life breathing atmospheric air by lungs, and moving by means of legs. Lay eggs.

In a few forms (salamander) these are retained in the body of the mother through larval stage. This takes place where they are far from water, in high mountains.

Ex: newt, frog, toad.

Class Reptiles.

Breathe atmospheric air by lungs. Lay eggs. Scaly skin. Creep on ground by short legs, or without legs. Many orders including many important extinct forms. Were at the height of prosperity in mesozoic period.

Ex: snake; lizard; tortoise; crocodile.

Class Birds.

Breathe atmospheric air by lungs.

Lay eggs. Fly. Front limbs converted to wings, covered by feathers, but scaly legs. No teeth. Horny beak.

Class Mammals.

Young developed in body of mother, and suckled with milk.

Furry or hairy covering. Ex: cat.

THE ANIMAL KINGDOM

Class Mammals

Orders (some left out).

1. *Cetacea.*

Mammals which have gone back to live under the sea, but come up to breathe, using lungs.

Front limbs converted into fins (cf. flippers of seal, which is half-way back to the same kind of life). Back legs lost. No hair. Large tail fin for swimming, but not like that of a fish in structure.

Ex: whale; porpoise.

4. *Carnivores (=flesh-eaters).*

Sharp, pointed, cusped teeth for tearing flesh. Strong claws.

Each of following examples represent a different family: lion; dog; bear; weasel; otter; seal; walrus.

9. *Primates.*

Nearly all adapted to tree life. Opposable thumb allows grip, and well developed collar bone helps to take weight when hanging from a tree. Teeth and food canal suited to a mixed diet. Brain well developed. Nails flat. Gregarious habit.

Ex: monkeys; man.

2. *Ungulates (=hoofed).*

Single hoof—horse.

Cloven hoof—cow, sheep. Herds of animals in open spaces or in mountainous regions. Swift-footed, long-legged.

Incisors chisel-like, molars ridged and flat.

3. *Rodents (=gnawing).*

Chisel-like front teeth and broad, ridged molars. Small animals.

Ex: mouse; rat; squirrel; rabbit.

5. *Insectivores (=insect-eaters).*

Small animals with fine needlelike teeth of a simple type (cf. sharp fine beaks of insect-eating birds such as tits).

Ex: mole; shrew.

6. *Bats.*

Like insectivora but able to fly. Front paws have elongated bones with membrane stretched between.

is suggested that the teacher should make enlargements of them for class use.

**LESSON UNIT IV—DIGESTION OF FOOD:
DISSECTION OF EARTHWORM AND
FROG**

PRACTICAL WORK

Revise teeth of dog and rabbit, and draw any additional teeth (or skulls) available, either in the classroom or museum, labelling them to point out essential features.

Introduction.—In order to move and perform its various activities, an animal uses up its supply of energy, which the body has to provide. We know that a petrol engine obtains energy, which moves a car

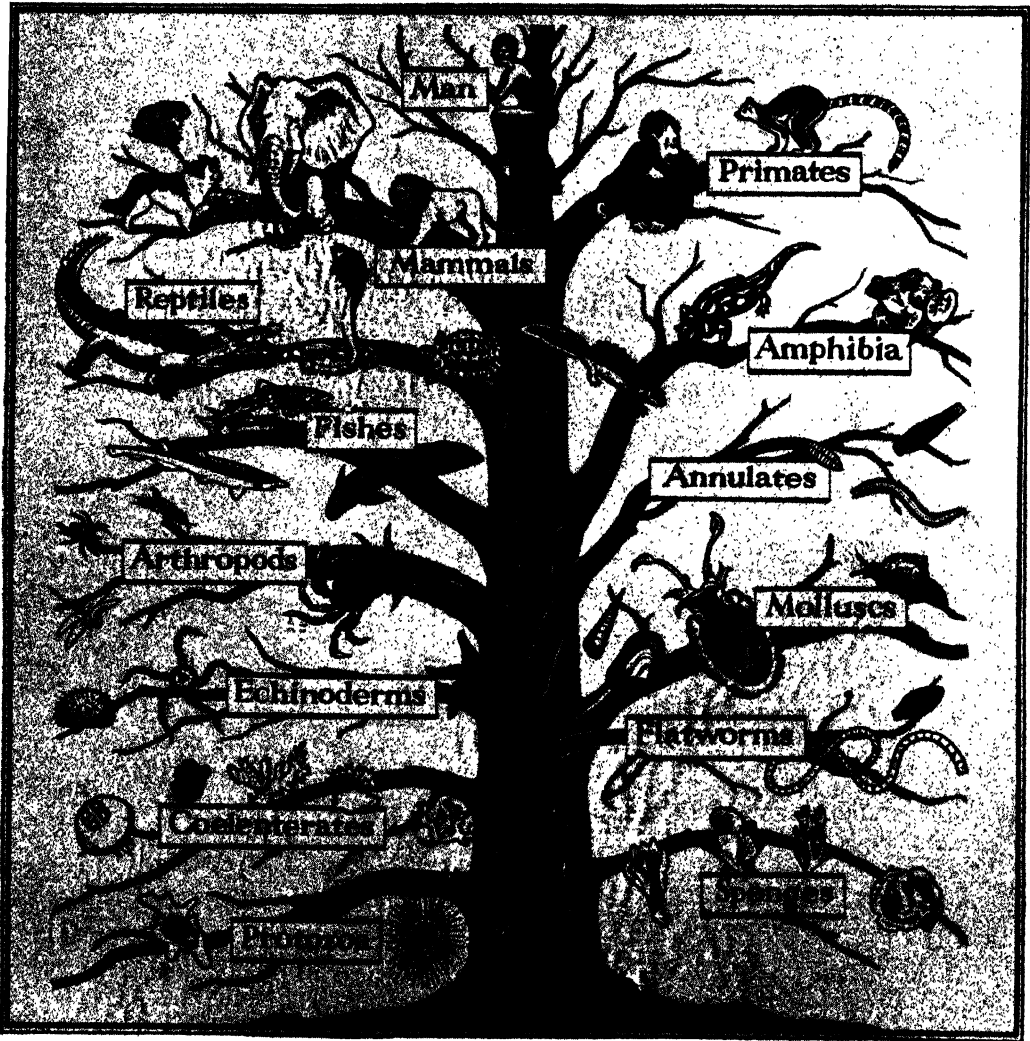

PLATE XVI. TREE OF ANIMAL LIFE
(Class Picture No. 88 in the Portfolio.)

or an aeroplane, from its fuel, the petrol; while a boy moving on a bicycle has to supply the energy himself from his own muscles. His body performs work to release energy, which then propels the bicycle.

Just as petrol is split up when energy is released, so the actual tissues of which our bodies are made—muscles, bones, blood—are split up, and used up or worn away, to give us the energy we need. The tissues are holding it in reserve, or storing it.

Our tissues were originally built up—or grew—as a result of the food we took. As these tissues are worn away new substance must be formed. This also we obtain from our food. It follows, then, that food is the source of our energy. But before our food can be built up into body tissues, it must be able to reach the site of these tissues. This cannot happen while the food is in a solid form. Hence it is necessary that the food shall be broken up, dissolved, and then absorbed into the body, so that it may ultimately reach its proper destination. These processes of breaking up, dissolving and absorption together make up digestion.

Development—1. The lowest animals.—In the lowest known animal, amoeba, the substance of the body sends out processes which surround the food. It is enclosed in a space into which a digestive juice pours from the surrounding substance. This juice dissolves the food and it is then absorbed directly. In hydra, the food enters a hollow tube or body cavity. The lining of this tube makes a digestive juice which acts upon the food, breaks it up and dissolves it, so that it can be absorbed into the wall of the cavity.

2. The earthworm.—In the higher animals, however, with larger and more complicated bodies, there is always a special, separate tube in which digestion takes place. This runs from one end of the body to the other, opens by the mouth in front and the anus at the hind end, and is called the food canal or alimentary canal.

This can be seen in its simplest form in the earthworm. So that all the class may have an opportunity of seeing them, several specimens should be prepared by the teacher in the following way:

Kill some large earthworms by placing them in methylated spirit. Place each worm in a small dissecting dish dorsal side uppermost, extending it gently so as not to tear it, and with a pair of fine dissecting scissors make a cut lengthwise along the middle line. Begin in the wide region just behind the anterior end, cutting carefully forwards to the anterior end and backwards till part of the intestine is exposed—about half the length of the worm. Keep the scissor points nearly horizontal so as not to cut too deeply into the tissues.

Pin out the flaps with fine pins, sloping them with the heads outwards, as flat as possible. The alimentary canal has now been exposed. Fig. 55 shows the main parts. A blackboard diagram will help the class to distinguish them.

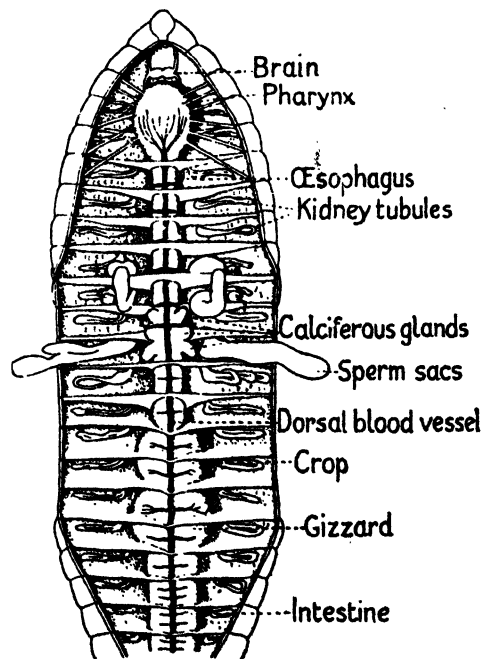

FIG. 55. DISSECTED EARTHWORM

Let one boy or girl in each group insert a seeker into the mouth of the worm. It will be seen that it passes into a strong-walled chamber extending to about the sixth segment. This is called the pharynx. Its aperture is quite small, as may be seen later, when sketches have been made, by cutting it open. It seems to be used chiefly in helping the worm to draw food into the mouth, for both mouth and pharynx can exert a strong suction, sufficient to remove leaves, leaf stalks, small stones and other objects, and drag them into the burrow. As a considerable amount of soil is swallowed and food extracted from it, this power of suction is important and compensates for the absence of jaws.

Note that the seeker has passed through this into a thin-walled tube behind it, the oesophagus. Through this the food passes and enters another thin-walled, wide sac, the crop, where it is apparently stored for a time before entering the gizzard. This is a strong-walled chamber with a hard, horny lining, and serves as a mill in which food is ground up. Verify this by feeling its hard wall and, later, slit it open and examine it. It reaches to about the twentieth segment. Compare with the crop and gizzard of a bird, which serve the same purpose.

The gizzard narrows down a little, then flattens out into the thin-walled intestine, dark in colour and overlaid by a yellow substance known as the yellow cells, but concerned not with digestion but excretion.

Certain whitish substances in the region of the oesophagus are called the calciferous glands; they manufacture a limy substance which is poured into the oesophagus, and it is thought that this neutralises the acidity due to the large quantities of decaying plant material in the soil eaten.

If the intestine is slit open, or broken as it often is by accident, it will be found that the contents are finely ground and soft. Much of this consists of finely divided soil, which passes out at the anus and is left as a coiled casting at the opening of the burrow.

It seems probable that digestive juices pour into the intestine and that, after being dissolved, the food is absorbed here; that is, it passes through the thin wall. Note in this connection that a long blood vessel and many small ones lie in the region of the food canal. As will be explained in more detail later, it is the blood which carries the dissolved food to the tissues which need it.

Note also that in the region of the oesophagus, five pairs of swollen blood vessels, perhaps having the form of bead-like chains, may be seen. These are called the hearts, and by their pulsating movements drive the blood forward and downward and so keep it circulating.

While the earthworm is being examined, note also various whitish bodies lying below and round the oesophagus. These are the reproductive bodies, producing eggs and sperms, or male cells, which by their union form offspring. Each earthworm combines both male and female, but does not fertilise its own eggs. Cross fertilisation takes place as in many flowers.

Before leaving the earthworm, press aside the food canal and note with a lens a double nerve cord lying in a slight groove beneath it. In each segment notice small swellings or ganglia on this cord. It is interesting to realise that such a lowly creature has a well-developed system of nerves. It has also a minute brain, or rather larger pair of ganglia, but these are difficult to find. Note also how the body is divided into segments by thin plates of skin, which help to fix the food canal in position.

3. The frog.—From an examination of the means of digestion in the earthworm, pass on in the next period to that of the frog, which is one of the Amphibia and, therefore, of the lower vertebrates (see classification).

Any animals required for demonstration should be killed and prepared beforehand. The animal is chloroformed in an airtight vessel—a box or tin with a very tight-fitting lid. It can be dissected under water in a pie dish. It is pinned down through the

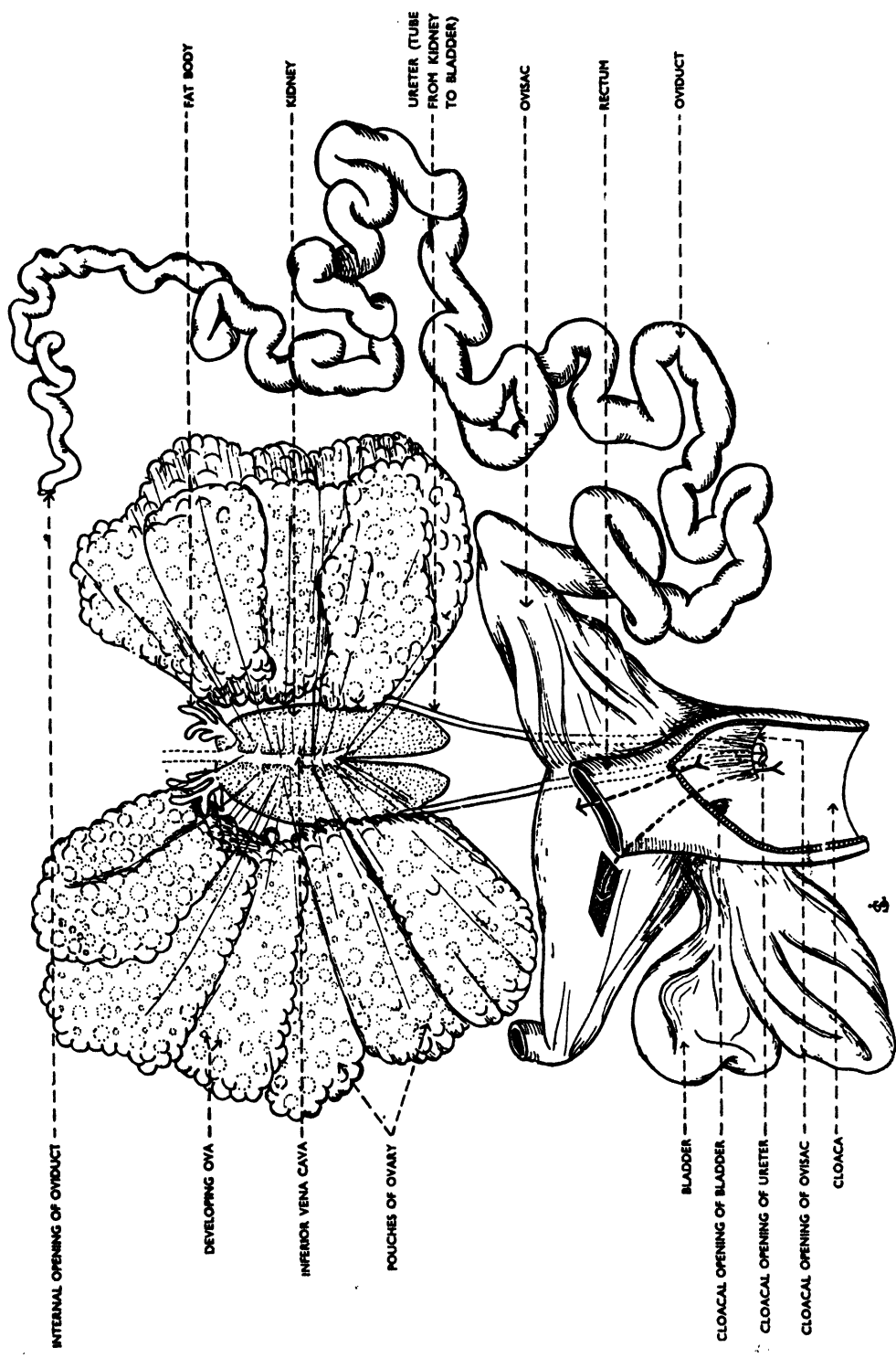

PLATE XVII. REPRODUCTIVE SYSTEM OF FEMALE FROG

The right oviduct is removed, left partly uncoiled and spread laterally. Cloaca is opened ventrally to show apertures of bladder, ovisac and ureter (tube from kidney), for which it forms a common exit with the food canal.

extremities and a slit is made through the skin and body wall on the ventral surface. The flaps are turned back and pinned down.

It is sufficient to open the body cavity and show the main organs without attempting any dissection. The delicate membranes enclosing heart and lungs will need to be cut away very carefully to expose these organs. The alimentary system is the most important part for children to see, but their attention may be drawn at the same time to the position of heart, lungs, kidneys, bladder, reproductive organs. These may be identified from the accompanying diagrams, Figs. 56, 57 and 58, and Plate XVII.

The heart lies well forward in the middle line, with its apex pointing backwards. It is dark red in colour and cannot be clearly seen till the enveloping membrane (pericardium) is cut away.

The lungs are narrow pinkish sacs lying rather deeply embedded on either side of the heart, and slightly obscured by the anterior edges of the liver which spreads across the whole cavity and consists of several dark red lobes. To see the lungs clearly insert a blow pipe or glass tube drawn to a narrow aperture into the throat, and inflate them by blowing.

A greenish ball pressed against the liver on the right side of the body—left as the

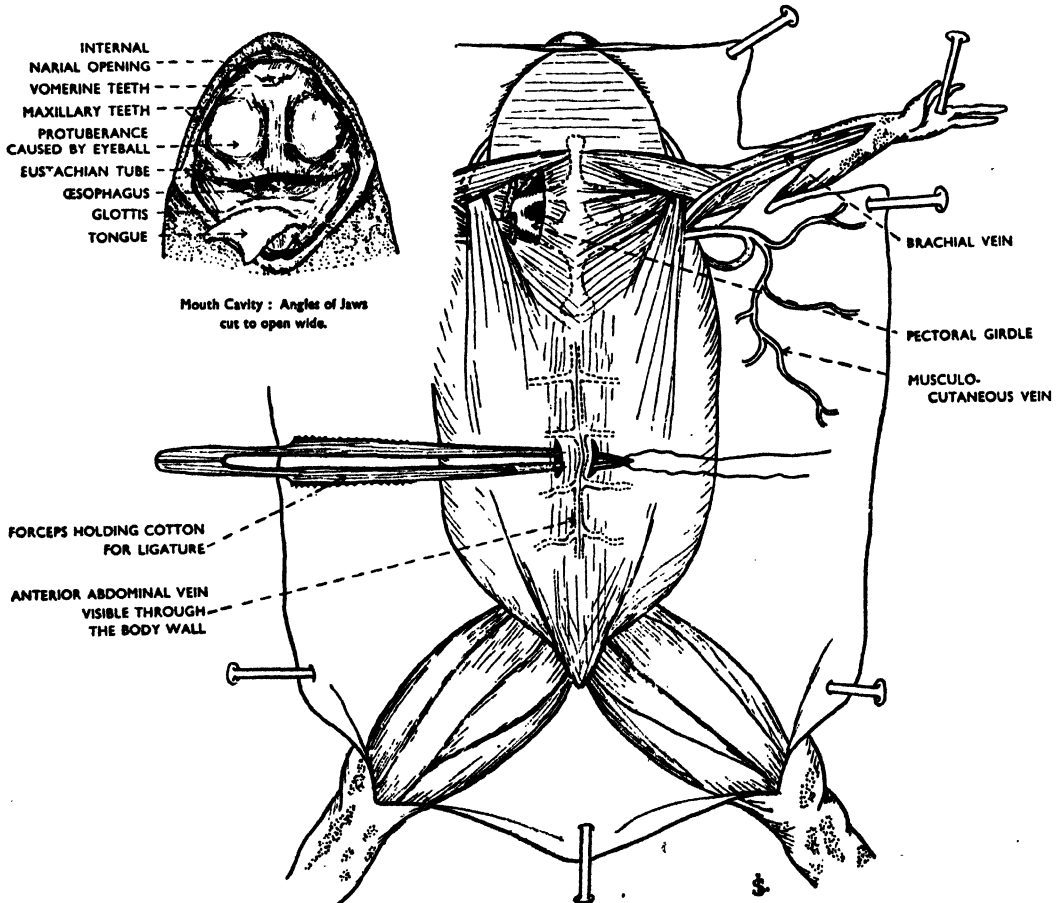

FIG. 56. DISSECTION OF FROG—FIRST STAGE, SHOWING HOW TO LIGATURE ABDOMINAL VEIN

observer looks at it—is the gall bladder, which manufactures bile. Further back in the folds of the intestine may be seen a small dark red ball; this is the spleen.

Close to the vent is a thin-walled sac, fastened down in the middle and having two lobes. This is the bladder, opening into the cloaca.

In order to see the kidneys, move aside the whole of the intestine. In the middle line, attached to the back wall, are two long, dark red organs. These are the kidneys and closely connected with them, in the male, are two oval organs, the reproductive bodies. In the female, especially just before the breeding season, the whole abdominal space is crowded with the black and white eggs, lying in the ovaries, while twining between them are the white, shiny-looking, convoluted tubes (oviducts) by which they will escape.

Just below the kidneys the backbone comes to an end, and passing outwards from it can be seen a number of conspicuous white nerves, spreading out from the spinal cord to the hinder part of the body. Blood vessels may also be noticed in the region of the intestine, stomach and kidneys, showing how well supplied with blood the body is. Note also the large vessels spreading from under the arms to the skin. This is important because the frog breathes by means of its skin as well as by lungs.

4. Dissecting a frog.—In dissecting a frog, one precaution must be taken, owing to the presence of a vein which runs in the middle line of the abdomen. After cutting through the skin this can be seen. Instead of cutting through the body wall exactly in the middle line, cut slightly to one side so as to avoid this. Make a slit about $\frac{1}{4}$ in. long, then a corresponding slit on the other side of the vein. Take a piece of thread and with fine

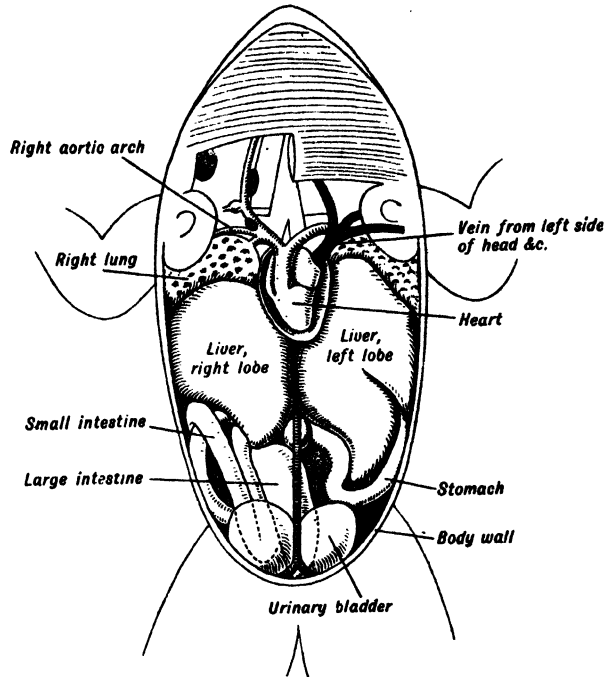

FIG. 57. DISSECTION OF FROG—SECOND STAGE, SIMPLIFIED TO SHOW MAIN ORGANS

forceps slip it under the vein and tie it tightly round, Fig. 56. An inch away from this, tie another thread. This is called a ligature and prevents the blood from flowing when the vein is cut. Now cut through the vein between the two ligatures. Next continue one of the cuts alongside the vein, avoiding cutting through it again. Strong scissors will be needed for cutting through the breast-bone and great care must be taken not to cut deeply, as the heart and important blood vessels lie just beneath it. A middle piece of the bone may be removed to facilitate spreading out the flaps of the body wall and pinning them down.

5. Differences between the frog and earth-worm.—If it is desired to keep for several days an animal which has been opened, it can be kept in 4 per cent formalin, or formaldehyde. The strength usually sold is 40 per cent. This can be diluted with distilled water—9 parts water to 1 part formalin.

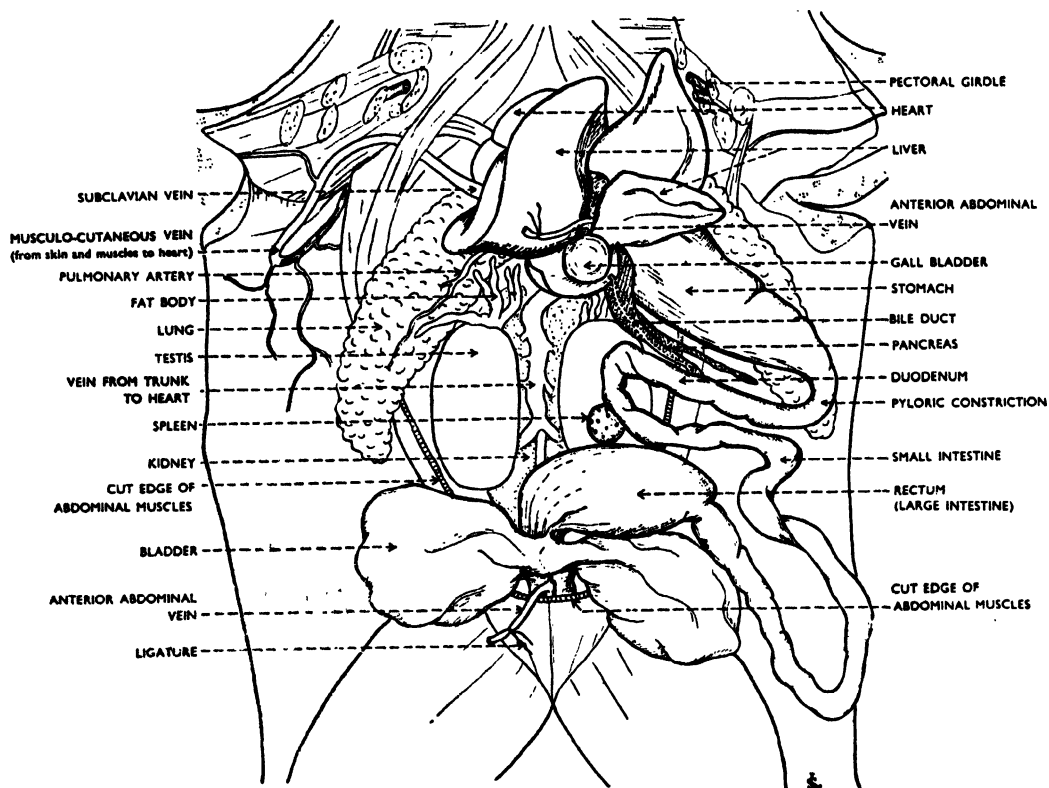

FIG. 58. DISSECTION OF FROG—SECOND STAGE:
BODY WALL CUT THROUGH AND PINNED BACK TO EXPOSE ORGANS

The chief advance we shall find on the earthworm is that a special organ called the stomach has been developed. This corresponds in some respects to the gizzard of the earthworm, but has this additional characteristic, that food is churned up with the slightly acid gastric juice and so partially dissolved as well as broken up.

The next difference is that the first loop of the intestine, bent against the stomach, also receives juices from organs which lie outside it, called the liver and pancreas, so that here the processes of dissolving or digesting the food are continued. These digestive juices are the bile and the pancreatic juice.

Below this loop, called the duodenum, lies the coiled tube known as the small intestine, concerned, as in the earthworm, with

absorption of the now liquified food through its wall. This is much longer than in the earthworm, and therefore there is a greater area of absorption, but coiling enables it to be packed into a small space. If a tadpole is examined, the intestine can be seen through the thin abdominal wall, coiled like a watch spring. It is proportionately much longer than in the adult frog, a fact connected with the vegetarian diet of the tadpole, for it is necessary to eat much greater bulk of the less concentrated vegetable food to obtain sufficient nourishment.

The intestine widens out into a short tube, called the large intestine because of its greater width. In the higher animals this part is chiefly active in absorbing water, and the residue which cannot be absorbed then passes out, by the anus, as a solid

mass. In the frog, the intestine opens into a common passage, the cloaca, which receives the openings from the bladder, kidneys and reproductive organs as well.

In both the earthworm and the frog, waves of muscular movement pass down the whole length of the alimentary canal, and these contractions slowly force the food along. Effective digestion of food is known in the higher animals to be dependent to some extent on the healthy condition, or "tone," maintained by the nerve supply of these muscles, for if this movement (peristalsis) is inadequate the food tends to become stagnant.

6. Summary.—The following are the main processes of digestion in earthworm and frog:

1. Food passes through the mouth cavity and pharynx into the oesophagus. No digestion takes place here. In mammals, however—e.g., rabbit and ourselves—some of the starch is digested by saliva.

2. In the earthworm, food enters the crop and then passes to the gizzard, where it is broken up. If acid, it is neutralised by the product of calciferous glands. In the frog, it enters the stomach where it is churned up with gastric juice from the walls of the stomach.

3. In the earthworm, it now passes into the intestine, where it is liquified and absorbed through walls. The intestine is a straight tube.

In the frog, the first loop of the intestine (duodenum) receives the bile and pancreatic juice, and further digestion proceeds until the food is completely liquified. It is absorbed by the small intestine, a coiled tube (to give extra length).

4. Undigested residue passes out by the anus. In the frog, the large intestine or rectum passes into the common tube (cloaca) into which open the bladder, kidneys and reproductive organs.

PRACTICAL WORK

1. Examine and draw the alimentary canal in a dissected earthworm. Show also the hearts and calciferous glands, and septa (a septum=a division) dividing the segments.

2. Examine a frog and draw the alimentary canal. Look for the heart, lungs, kidneys, bladder.

3. Open the pharynx, crop, gizzard and intestine of the earthworm. Note the thick walls of the pharynx and gizzard and the finely divided soil in the intestine. Look for earthworms' castings in the garden and compare.

4. Mark off a piece of soil in the garden containing earthworms' burrows. Sweep it clear of leaves and stones, then place leaves, small twigs, small stones, and small triangles of paper on the soil and note whether any of them are pulled into burrows. Mark their first and last positions on a diagram and measure how far they have been pulled. This shows the strong power of suction possessed by the mouth and pharynx.

5. Keep some frogs in a comfortable vivarium, with fresh turf and a shallow bowl of water. Feed on mealworms (grubs of the click beetle, obtainable from naturalist's shops), blowfly "maggots" or "gentles" (from fish tackle dealers, or easily bred by leaving a small piece of meat in a plant pot out of doors), and flies if obtainable. Watch the frog eating. Note how it catches its food and that it bolts or swallows it whole, having no teeth for mastication but only small needlelike teeth which help it to grasp its victim. If a large creature is swallowed, note how the eyes are drawn down to press into the mouth and help in swallowing.

Constant movements of the throat can also be seen. The frog has to swallow air for breathing.

WINTER—SPRING TERM

BREATHING : VERTEBRATES

THIS section may be best studied from fishes and man, with some reference to the breathing of birds (including breathing of a chick in the egg), tadpoles and frogs. As living animals will be needed, it will be convenient at the same time to notice their habits and structural characteristics, while concentrating attention especially on methods of breathing.

LESSON UNIT I—BREATHING IN FISHES, TADPOLES AND FROGS

Introduction.—Obtain some goldfish and tadpoles. Keep the goldfish in glass tanks, zinc baths or enamel bowls having straight sides and a large surface. If possible, aerate by means of running water for an hour or two daily, and keep growing water weeds and clean sand in them. The water need only drop into the tank to carry air with it.

Draw attention to the regular opening and shutting of the mouth, while the sickle-

shaped plates at the sides of the head rise and fall. What does this suggest?

Development—1. Necessity for breathing.

—State that, besides eating and drinking, all animals have to breathe. We breathe air, which we draw down into our lungs, and we open our windows to let in fresh air. Now it is not the whole of the air that we breathe, but a substance called oxygen contained in it. Air is a gas, or rather a mixture of gases, and just as we cannot see the coal gas which we burn for cooking, so we cannot see the gases which make up air. We cannot feel, taste or touch air, but we can feel the effect of it when it rushes past us as wind. We can smell coal gas, but we cannot smell air.

The gas oxygen which is contained in air is necessary to all living things, and nearly all of them extract it from air. Fresh, running water contains a certain amount of air, and therefore of oxygen, dissolved in it.

When a fish opens and shuts its mouth, and the plates at the sides of the head, it gulps in water, but instead of being swallowed,

the water passes out through slits in the throat, which are covered by plates of hardened skin called gill plates or opercula (singular=operculum), Fig. 59.

It will be seen that for an instant the fish's mouth and the opercula are closed at the same time, and thus the mouth cavity, full of water, is completely closed. The pressure of the water inside is then sufficiently great to force it through the slits.

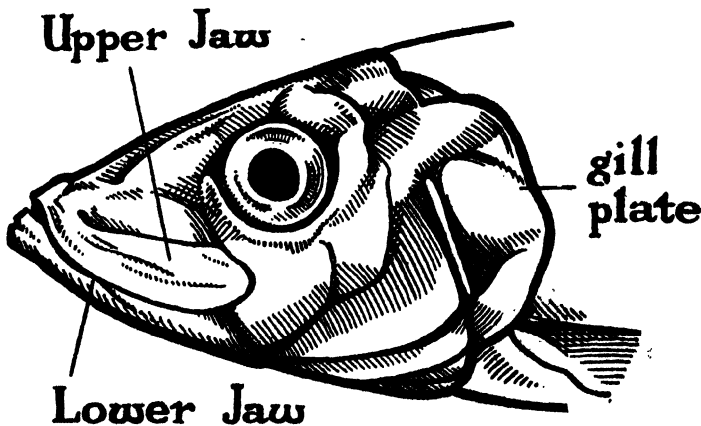

FIG. 59. HERRING—SIDE VIEW OF HEAD

2. The mouth of a fish.—In order to understand what takes place inside the mouth, obtain enough herrings for the children to share them. Cut away the operculum from one side of the head, Fig. 60. It will then be seen that a number of bright red fringes occupy the cavity. They are made of delicate, soft skin, filled with blood contained in hairlike blood vessels. Now red blood has the power of being able to take up oxygen. As the water is forced through the slits between these fringes, which are called gills, the blood in them takes up the dissolved oxygen and then

3. Air content of water.—In order to show that water really does contain dissolved air, or at least some gas, a hard glass boiling tube 2 in. in diameter should be fitted with a rubber stopper with one hole, in which a glass tube is tightly fixed and the whole apparatus filled with water. This may be held by means of a test tube holder, or clamped on to a retort stand. The free end of the tube should pass into a test tube filled with water, inverted in water as shown in Fig. 61. If the boiling tube is heated, the air in the water will be driven along the tube and will collect at the top of the test tube.

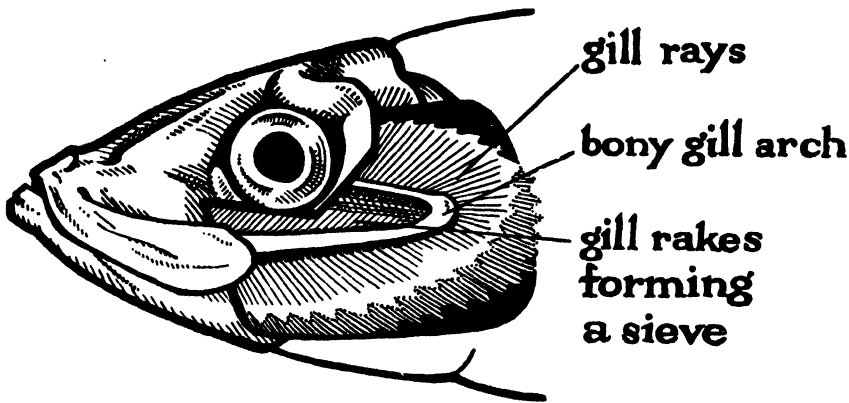

FIG. 60. HERRING—SIDE VIEW OF HEAD, WITH GILL PLATE CUT AWAY

flows through the body, carrying the oxygen wherever it is needed. It has been found that the blood flowing through the gills also gives up what for the moment we may call bad air, which has been collected as it flowed through the body before reaching the gills.

It will be noticed that the gill fringes or rays are on the outer side of a thin bony arch, while on the inner side there are stiff spikes, called rakes. These act as a sieve to prevent food from escaping between the gill slits, so that only water runs out. If goldfish are fed on small live worms it will often be seen that they manage to wriggle out by the gill plate, or operculum, in spite of the presence of rakes.

Note.—The bent tube used should have a rubber connection in the middle. This can be disconnected as soon as heating is stopped. Hold the test tube in the right hand with its mouth still under water while the tube is disconnected and slipped out; then press the ball of the right thumb over the opening and lift the test tube out, still inverted, to show the class that a small quantity of gas has collected. State that chemists have proved this to be air.

4. Breathing of tadpoles and frogs.—Fishes, then, are able to breathe under water; they extract oxygen from the air dissolved in it. In watching tadpoles, both in the previous year and this term, it will have been

noticed that for about two months they live entirely under water and never come to the surface, so evidently they too must breathe under water. This would apply also to any water creatures which the children have kept, if they are never seen to come to the surface; e.g., the little red bloodworms.

If we look at tadpoles shortly after they are hatched, we notice little tufts of skin on either side of the head. These are also gills and, though not quite like those of a fish, they too are able to take up oxygen from water.

Later gill slits break through the throat region, and the tadpole breathes like a fish, by gulping in water which passes out over the gill slits, so that oxygen is extracted. Instead of having two opercular plates like a fish, a tadpole has one operculum which grows as a fold of skin back over the gill slits and is closed except for a spout which can be seen projecting slightly on the left side.

As the tadpole approaches the time when it will change into a frog, as the children will have noticed in the previous year, it begins to come to the surface to swallow air. It is changing its way of breathing. Gradually it gives up using its gills, and they shrivel away. It is now filling with air two sacs inside its body. These are called lungs.

If a frog is watched, a constant pulsating movement of the throat may be noticed. The frog is drawing air through its nostrils and swallowing it. The air passes into the lungs. It is found that frogs also use their skin for breathing. This is why the skin of a frog must always be kept moist: it could not breathe through a dry skin. Note that this is true for many creatures living in damp places. Earthworms breathe through the skin and snails take air into the large first coil of the shell, and both need a moist atmosphere for breathing.

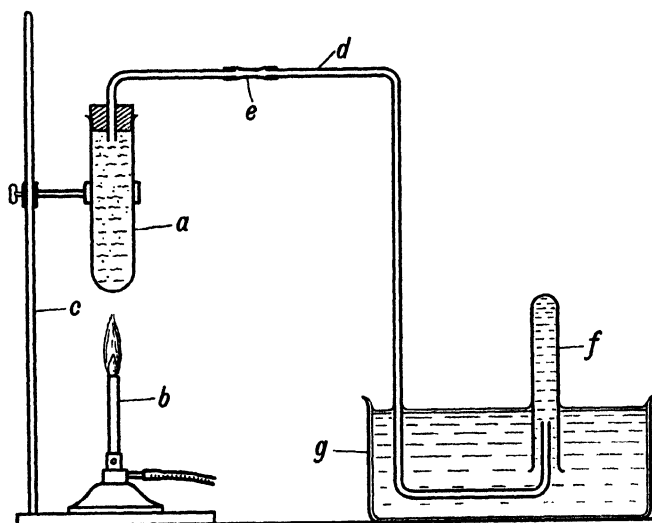

FIG. 61. APPARATUS FOR SHOWING THAT WATER CONTAINS OXYGEN

a. Boiling tube. b. Bunsen burner. c. Retort stand. d. Bent glass tube. e. Rubber tubing connection. f. Test tube filled with water. g. Glass trough of water.

Remind the children that when they looked at the inside of a frog, a large blood vessel was noticed spreading over the inside of the skin at each side of the body. Here again, the blood is concerned with carrying oxygen, and just as the gills, which are the breathing organs of a fish, contain red blood, so must the skin, by means of which the frog breathes. Note also that the earthworm, which may go deep down in the earth, and the bloodworm (if it has been seen), which lives in the mud at the bottom of ponds, ditches and water butts, where there is not much oxygen, have red blood to help them in breathing.

Experiment.—It can easily be proved that tadpoles need air in the water by placing them in boiled water, from which, as has been shown, all air has been driven out. They can live only a very short time.

PRACTICAL WORK

1. In addition to watching goldfish and making notes on the movements connected with breathing, let the children draw the head to show the operculum. Note that at

the free edge there is a very thin membrane, which adheres closely and so is effective in closing the opening.

2. Let the children sketch the head of a herring with the operculum removed, to show the position of the gills. They can see the rays, rakes and gill arch. Then let them cut out a complete gill and examine it more closely. Note the hinges which enable the bones of the arch to move—necessary in opening the mouth—and the copious supply of blood and delicacy of the rays.

3. Draw tadpoles at different stages to show the first (external) gills, and later, the opercular gills, and the stage when the gill pouch (operculum) has completely surrounded them, and the spout can be seen.

4. Watch for the older tadpoles beginning to come to the surface to breathe. Watch newts, too, if they are available. A small bubble of gas escapes at the surface just before the gulp of fresh air is taken.

diaphragm. Above this lie the heart and lungs, and they, with the oesophagus (leading to the stomach), the windpipe and the bases of the important blood vessels, fill the cavity completely, Fig. 62. The lungs are

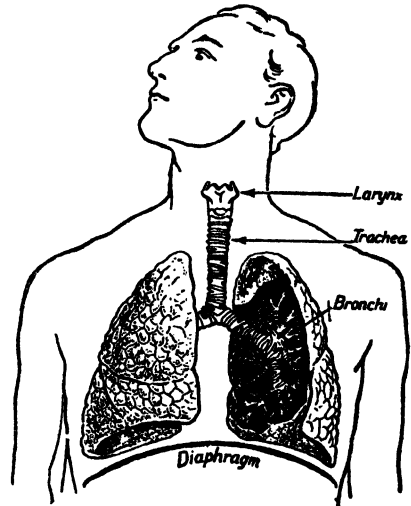

FIG. 62. POSITION OF LUNGS AND DIAPHRAGM IN MAN

LESSON UNIT II—BREATHING IN MAN: USE OF OXYGEN TO THE BODY

Introduction.—We have noted that fresh air is necessary to animals because of the oxygen in it, and that fishes, tadpoles and frogs, as well as the lower animals such as earthworms and snails, have some means of taking oxygen out of the air and absorbing it into their bodies—usually into the blood. Further, the children have been told that air is taken into a pair of sacs called lungs in the frog, and they have seen the lungs in the dissected frog.

Development—1. How mammals breathe.
—In the case of the frog, air is gulped down and the lungs become inflated, just as they did in the dead frog when the teacher inflated them with a blow pipe. Now in the mammals, which include man, there is a special means of filling the lungs. The body cavity is divided into a lower part, the abdomen, and an upper part, the chest or thorax, by a sheet of muscle called the

enclosed in a skin or membrane, the pleura, which adheres closely to the chest wall and to the lungs. The diaphragm is slightly dome-shaped; that is, it bulges upwards into the chest cavity. When it contracts, as all muscle can do, it is flattened out and thus the chest cavity is enlarged. The lungs, since they adhere to the wall, enlarge with the chest, and air rushes in to fill the extra space. This is called inspiration.

As the muscular diaphragm relaxes again it resumes its normal position and the thoracic cavity becomes smaller. The lungs are pressed upon by its wall and their cavities too are reduced, and in this way air is forced out. This is called expiration.

The ribs support the thoracic cavity, and as the diaphragm contracts the ribs are at the same time both slightly raised and moved outwards, enlarging the chest cavity still further. This movement can be both watched and felt in a dog lying on its side. During deep breathing, these movements

can be increased and the lungs more completely filled with air. It is also possible to force out more air in expiration by contracting the abdomen.

Let the children breathe deeply and feel these movements of ribs and abdomen as they make a deep inspiration and then a forced expiration.

The inside of a lung is rather like a sponge, made up of number of tiny spaces, surrounded by thin walls which contain numerous small blood vessels. (Remind the class of the pinkish colour of a frog's lungs, due to the blood.) All the small spaces give a very large surface of skin for absorbing oxygen.

It is important that the lungs shall be well protected and kept moist, hence their deeply hidden position in the bony cage of the ribs, backbone and breastbone is valuable. The air reaches them through the nose, by means of a tube (the windpipe), which starts behind the nose (the pharynx) and passes down the neck in front of the alimentary canal. In the region of the collar bone in man it divides into two main branches to enter each lung, and these branches divide again and again until every little space (alveolus) of the lungs can be reached by the air current as it is drawn in. The blood in the walls of the alveoli then takes up oxygen, as in the gills of fishes, and carries it to all parts. At the same time an unwanted gas is passed out.

Since it might be possible to pass food into the windpipe instead of down its proper path, a lid is closed over the entrance to the windpipe when swallowing takes place.

As air passes through the nose it is warmed, cleansed and moistened.

2. Model to show how lungs work.—Make a model to show how lungs work (Fig. 63), using either a sheet of thin but strong india-rubber—it must be very supple—or a piece of sheep's bladder which has been soaked in water to keep it pliable. If bladder is used it must first of all be scraped and wiped as clean as possible. Rubber is perhaps more

convenient. Pinch up a small piece in the centre and tie a thread to it.

Now take a bell jar with a rim at the lower edge, to represent the thoracic cavity, and tie the sheet of rubber or bladder securely over this rim, to represent a diaphragm. The thread should hang down.

Take a rubber stopper which will fit the neck of the jar, with one or two holes through it, and fit a glass tube tightly into the hole or holes. To the lower edge of each tube attach a toy balloon, which must fit very tightly. Press the stopper firmly into the neck of the bell jar. The balloons represent lungs.

If the thread is now pulled downwards, as if the diaphragm were being contracted, it enlarges the cavity inside the jar. As the cavity is closed, but the balloons are in connection with the outer air, air will be sucked into them and they will expand quite appreciably. This is quite a satisfactory demonstration of the principle involved in filling the lungs.

3. Use of oxygen to the body.—We have now to consider why oxygen is necessary to the body, and therefore why we must breathe.

We have already said that food is built up into the substance of the body, and that whenever we move or perform work (which means moving a mass—ourselves or part of ourselves, or anything else) we use up some of that substance to provide the energy. We compared this with what happens in a petrol engine, for when it works the petrol is ignited to provide energy. Most people know that for this to take place air must be mixed with the petrol. It is the oxygen in the air which is really needed. An electric spark "fires" the petrol in the presence of oxygen, and turns it to gas, which escapes through a valve and in so doing drives a piston. The energy set free drives the piston, which in turn, since it is attached to the shaft or axle of a wheel, turns the wheel.

In a comparable way, in the presence of oxygen our muscles set free energy which drives the arm or leg and so moves it. Just

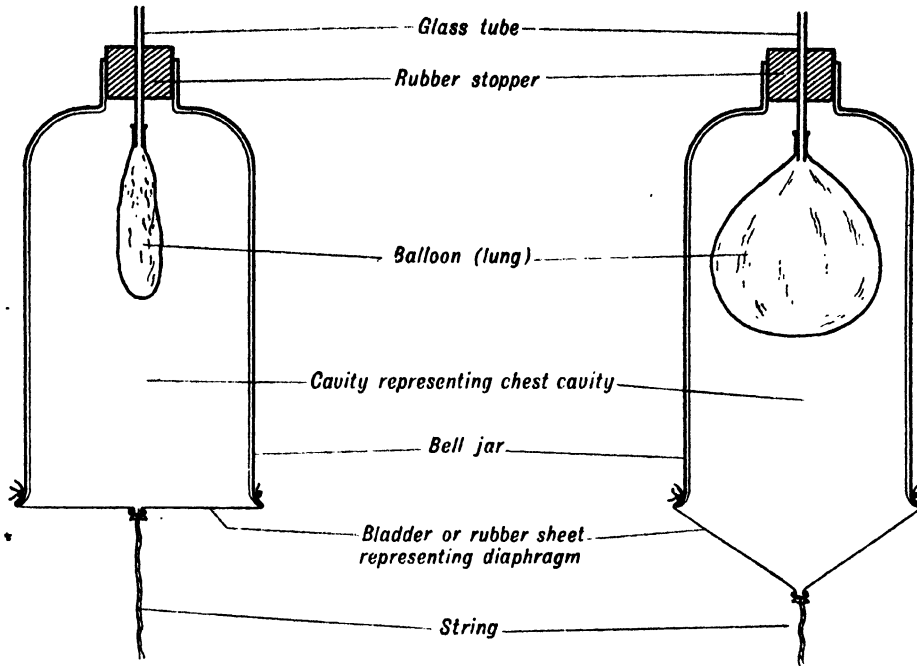

FIG. 63. MODEL TO SHOW HOW LUNGS WORK

as any kind of fuel, a coal or wood fire, oil, coal gas, or petrol can be ignited if oxygen is present, so our tissues are slowly burnt away and as they burn they give up energy—kinetic or movement energy, and heat. They do not, of course, give light, merely because they are not burning sufficiently fiercely.

We now see the importance of the oxygen we breathe in enabling us to move and work. It is also needed by the brain for mental processes.

LESSON UNIT III—DEVELOPMENT OF A CHICK

This might either be taken in the second year, in connection with the functions by which life is maintained, or in the third year, in connection with the study of birds. In either case it could be dealt with only very briefly, from the point of view of the need for the same functions during embryonic

life. Great detail of structure would be out of place and have little meaning.

Introduction.—Consider what will be the needs of all very young animals, and then see how they are provided for in the development of a chick from the egg.

Safety from attack, air, food, warmth and a certain amount of moisture are needed, as well as safety from shock, concussion and pressure.

The habit of birds of placing their eggs in a secluded or inaccessible nest makes for safety; the hard shell is a protection against pressure and undue evaporation of water; the mother's habit of sitting on the eggs (incubation) keeps them at an even temperature equal to her body heat, and as she frequently turns them the warmth is evenly distributed. The shape of the eggs, broad at one end and pointed at the other, prevents them from rolling and so falling out of the nest, as well as filling the whole space with no gaps between.

In order to understand how feeding and breathing proceed, it is necessary to open and examine an egg, and also to see several stages—at least two—in the development of the chick. A newly laid egg, one that has been incubated for three or four days, and one that is about half-way through its development, should be obtained.

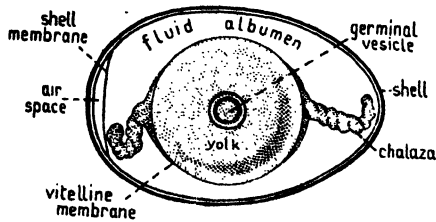

FIG. 64. EGG OF FOWL WITH SHELL REMOVED

Development—1. Early stages and feeding.

—Stand a new laid egg in a small dish, deep enough to support it slightly. With a pair of fine dissecting scissors snip off half the shell from end to end, Fig. 64. The egg can be passed round for the class to look at, and the following points should be noted:

The large round yolk is the true egg. It is enclosed in a very thin membrane, easily broken when an egg shell is opened. On the upper surface is an opaque white spot. This is the part which will develop into the chick, the germ or blastoderm. It has already begun to develop before the egg is laid, and consists of a plate of cells, but exposure to cool air stops development, which proceeds again only when the hen begins to sit on the eggs. This is important, as in fowls and many other birds it takes several days to lay the whole clutch and it would be very awkward if there were both young birds and eggs in the nest at the same time. Yolk and blastoderm together constitute the egg.

This is suspended by a twisted rope of "white" or albumen to the ends of the shell, and swings freely in a water bath of albumen, a provision for keeping the egg from being injured by pressure or shock. Quite late in development the albumen is absorbed, but

the yolk is the main food of the chick, which absorbs it from the very first, through the underside of the blastoderm. The whole is enclosed by the hard, protective shell, composed of lime secreted by the wall of the egg passage or oviduct. Both this and the albumen are laid on as the egg descends with a slow, spinning motion.

When incubation starts, development of the blastoderm at once continues. The germ spreads over the yolk, forming a thin, flat plate, while in the middle a thickened ridge rises up, having its sides folded downwards and head and tail end tucked under, to form the body of the embryo. By the second day there is a well-marked brain, the spinal cord and vertebrae are marked out, and the heart can be seen beating. Spreading out over the yolk to the edge of the blastoderm fine red blood vessels can be seen, connected with the heart. The yolk is being actively absorbed into these vessels and carried to the body. The underside of the animal, still spread out flat over the yolk, is later closed to make the alimentary canal, which is connected through an opening with the yolk almost until the young bird is ready to hatch. Compare this with what was described in the young fish, where the yolk sac hangs down from the underside.

In order to show this stage, with the heart beating, the brain and the blood vessels developing, it will be necessary to transfer the three or four days' old egg straight from an incubator or nest to water of the same temperature, which must be taken at the time. It is convenient to use a small enamel pie dish and to place this over a very low Bunsen burner, with an asbestos mat or sand bath between and a thermometer to make sure that the temperature is constant. If the egg is wrapped in warmed flannel and transferred quickly, the chick will live for an hour or two. Having placed the egg in position, carefully chip off the upper half of the shell and let the children examine the embryo. It is well worth while to take this trouble for the interest of seeing the living chick with its beating heart.

2. Breathing and develop-

ment.—In addition to feeding, the chick must breathe and get rid of waste material. The egg shell is porous, and though it is lined with a very delicate skin it allows air to enter. A special membrane or sac, called the allantois, grows out from the hinder region of the chick and, spreading out, not only surrounds the embryo but also forms a complete lining to the shell. This sac is the breathing organ, for it is able to absorb oxygen through the shell and transfer it to the embryo. It is thus a very important feature. It is also concerned with the removal of waste matter, which is said to accumulate in its cavity.

At a somewhat earlier stage another out-growth forms a sac close round the embryo, which becomes filled with liquid and so takes the place of the albumen as a water cushion. This is called the amnion. If a three-day chick is examined (Fig. 65), these sacs can just be seen beginning to grow, looking like small bubbles. In the half-grown chick these membranes can be seen completely enclosing it.

The details of development need not be entered into. When the body of the embryo is quite distinct, it leans over and lies on its side, while head and tail ends curve down until they meet, and in this coiled position the chick grows until it entirely fills the shell. Meanwhile, limbs grow, the wings at first resembling arms with fingers, but soon one

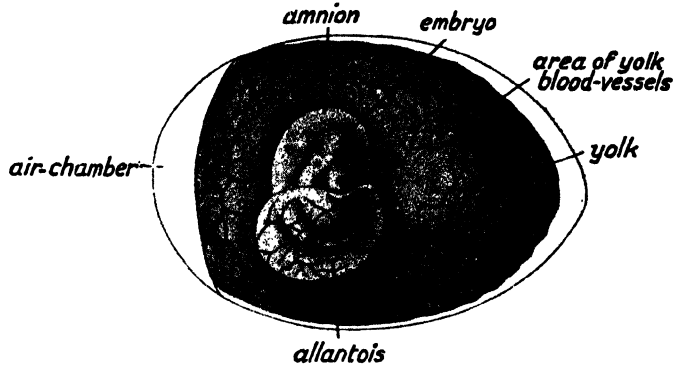

FIG. 65. CHICK THREE DAYS OLD

finger grows longer than the rest to form the bone which will support feathers, and fusion takes place so that eventually there is only one distinct digit. Beak, eyes, feathers are formed—the down feathers of the chick. Some birds are, of course, hatched naked, but those which must run about and peck food at once usually have nestling down.

By the twenty-first day the chick is ready to emerge. A curious little knob on the end of its beak is used to break through the shell, after which it struggles and quickly frees itself from the remainder. Before emerging it takes a deep breath of air from a small space lying between the membranes and the shell, at the blunt end of the egg, and this seems to give it strength to make its way out.

Before the children look at the demonstration specimens, it would be a good plan to explain these points, making large blackboard diagrams from the drawings accompanying this description.



SUMMER TERM

LESSON UNIT I—CRAYFISH, WITH SPECIAL REFERENCE TO BREATHING

THESE animals, which live in fresh water, can be obtained from dealers in naturalists' requirements. In order to keep them alive it is desirable to have running water or constant aëration. They may be kept in a zinc bath over a sink, with the tap dripping slightly, or a rubber tube may be connected with the tap, with a pinchcock attached so that it can be

regulated to a very slow flow. Two or more tanks may receive water from one tap by inserting a three-way glass tube in the end of the rubber tubing, and fastening other rubber tubes to its arms, Fig. 66. An alternative method of aëration (Fig. 67) is to introduce bubbles of air by means of a slow-dropping trickle of water, as shown in the diagram. Water dropping from the narrow outlet of the upper tube into the similar end of the lower tube draws in an air bubble through the hole in the glass jacket.



Fig. 3. PINCHCOCK

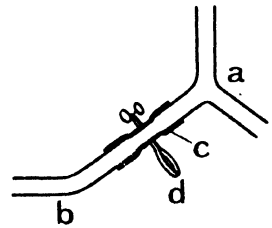

Fig. 2.

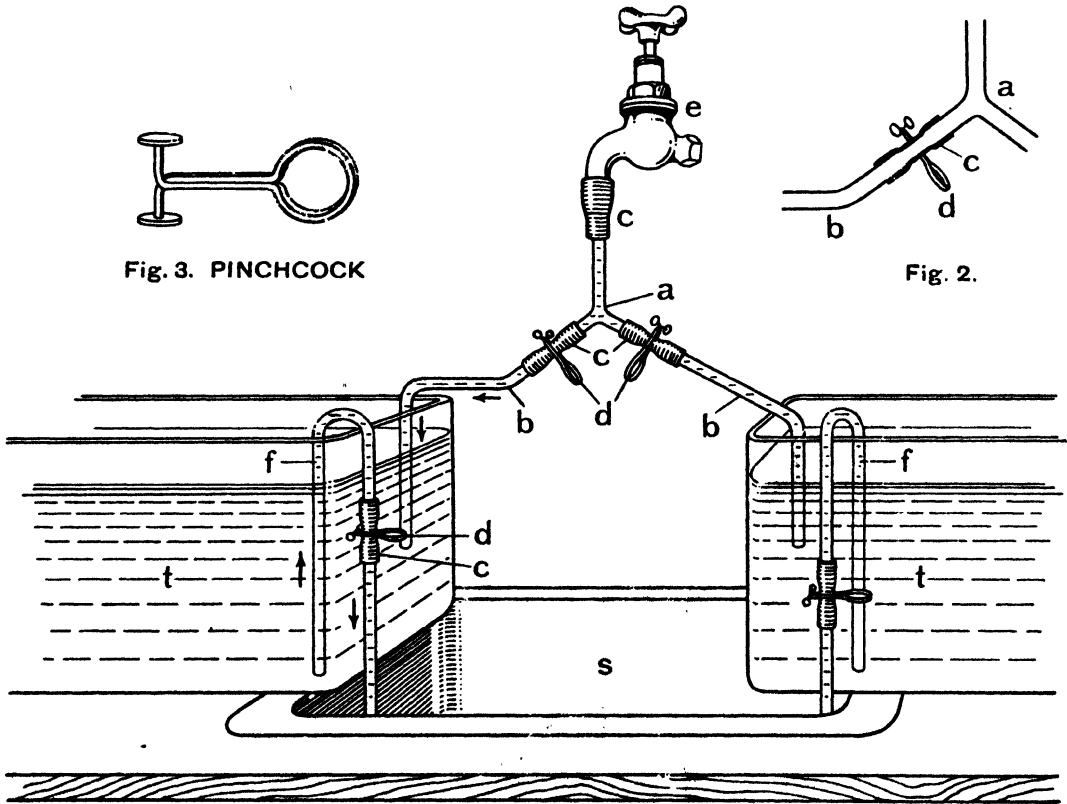

Fig. 1.

FIG. 66. ARRANGEMENT OF PIPES FOR SUPPLYING AND EMPTYING TWO TANKS FROM A SUPPLY TAP
a. Three-way tube. *b.* Arms of tube. *c.* Rubber tubing joint. *d.* Pinchcock. *e.* Tap.
f. Siphon tube. *s.* Sink. *t.* Tank

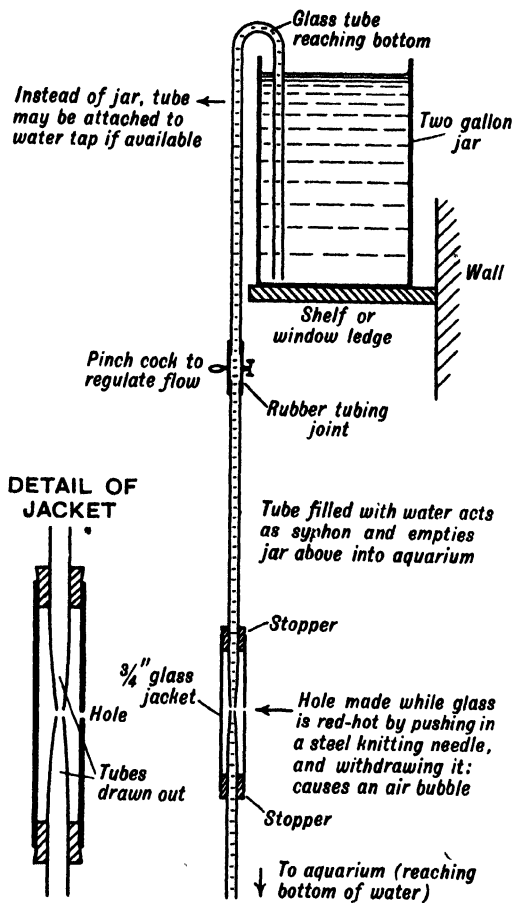

FIG. 67. ALTERNATIVE METHOD OF AERATION

Thus a chain of air bubbles is kept moving down the lower tube. The flow is regulated by the pinchcock on the rubber connection. A bed of clean sand and some rooted pondweed should be provided, and the tank shaded. The animals may be fed on small pieces of raw meat or fish, tadpoles, and pond snails, which they tear out of the shells with their large claws.

Crayfish offer a good example of the Crustacea, large enough for both structure and habits to be easily noticed. Special interest is attached to their method of breathing, as they use gills which are entirely different in origin and position from those

of fishes and yet, like all gills, they are folded membranes thin enough to absorb oxygen dissolved in the water.

Introduction.—Crayfish (Fig. 68) are found in slow rivers and streams, spending most of their time in holes in the banks or under ledges, lying on the bed of the stream and seizing small animals passing by or brought by the current. Their dark colour makes them difficult to see in the shadows in which they live. Though they can live for some time out of water, they are essentially water dwellers and must breathe under water.

They belong to the invertebrates, Phylum Arthropods, Class Crustacea, so they have the characteristic features of jointed body and limbs, horny skin—in this case further hardened with lime—and limbs, or appendages, on every joint.

There is a general structural resemblance to insects in the jointed body divided into distinct regions, but whereas in insects a distinct head, thorax and abdomen can be seen, in the crayfish the head and thorax are united and covered by a large shield or carapace on the dorsal surface, made from the fused plates and hardened by lime. The carapace extends downwards, enclosing a large space on each side which serves to contain the breathing organs.

The abdomen consists of seven joints, all except the last bearing appendages.

Development.—As it will hardly be possible for a whole class to see the crayfish at once, it will be well to give the children some points to look for and then to let them examine the specimens available in small groups or individually, making notes and sketches, while the rest of the children are occupied with other things. Pond mussels, described in the next lesson unit, can be obtained and examined conveniently by other groups working at the same time and interchanged, while at the beginning of the summer term it is usually possible to obtain other members of the Crustacea living in fresh water; e.g., the fresh water shrimp (*Gammarus*), the

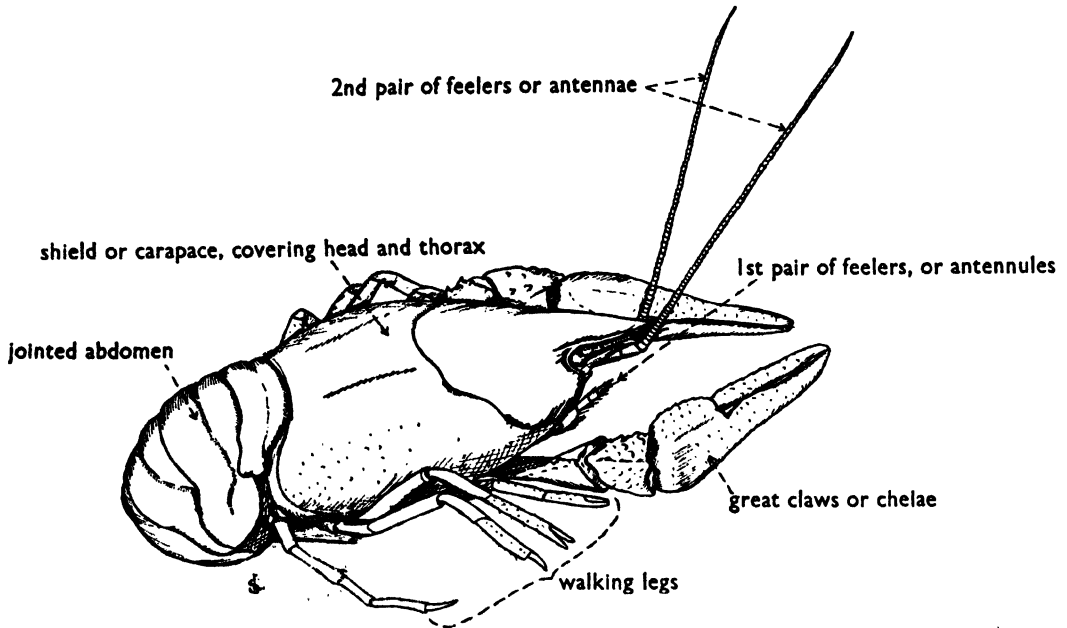

FIG. 68. CRAYFISH

water slater (*Asellus*), the water flea (*Daphnia*), which can be watched with a lens. It is exceptional for crustacea to live as land animals, breathing atmospherically, but the common woodlice are an example of this habit and might be studied. Dead prawns or shrimps from a fishmonger are also convenient to examine in order to understand the structure of crustacea. It is a good plan for each pupil to examine one carefully, removing all the appendages and mounting them, then showing by sketches their typical features.

The main points to notice in the habits of the crayfish are as follows:

1. Feeding.—All sorts of living and dead animals found in the water are seized by the pincers of the large strong claws, torn into pieces, then passed forward to the small appendages—half jaw, half foot in structure, having a cutting inner edge, and thence to the jaws, which shred the food into fine bits. All these jaw feet and jaws are

superimposed, as in the cockroach, and surround the mouth.

2. Movement.—Slow crawling is performed by the four pairs of thoracic legs behind the claws, while the abdomen is supported by five pairs of small swimmerets, which beat the water rapidly like a double row of minute oars rowing a flat boat. Each swimmeret is forked. These are much larger in prawns and shrimps, in proportion, and are their means of swimming.

Rapid movement is due to a sudden, violent doubling of the abdomen, which ends in a broad, flat tail-fan. This presses suddenly against the water, and the effect is to jerk the body forcibly backwards. Watching an enemy closely, the animal can by this movement enter its hole "in reverse" and so take shelter. The tail-fan consists of the last segment, or telson, together with a pair of broad, flat appendages belonging to the segment in front—the sixth abdominal.

Most of the larger crustacea fight fiercely, and frequently tear off one another's limbs. In this connection there is an interesting structural point, though it cannot be seen. Each joint is almost closed by a thin plate continuous except for a small hole through which blood can pass. If part of the limb is torn off, the exposed opening is closed and therefore no bleeding takes place (compare again the condition in a tree, when leaf fall occurs). In time a new joint grows to replace whatever has been lost.

Note that there are far more appendages than in insects, which have only three thoracic pairs of legs and none on the abdomen.

3. Breathing.—It is not possible to see the actual movements taking place in breathing, but if a little pure powdered carmine is squirted into the water under the edge of the thorax by means of a small tube, in a few moments two thin red streams will be seen to emerge near the front border, just under the head. This is due to the action of two little scoops or spoons attached to the third pair of jaws. They lie inside the two breathing chambers under the carapace, and bale out water in a regular, continuous movement.

This causes water to pass forward through the chamber, bathing rows of featherlike gills attached to the wall of the thorax and to the top of the legs, and thus enables them to extract dissolved oxygen from a constantly fresh supply.

4. Senses.—Nothing can actually be observed except that the long jointed antennae and short antennules move as if they were sensitive to touch, while if a little stale, strong-smelling fish is dropped near them they exhibit tremors of awareness and excitement. It has been ascertained, however, that both the organs of smell and hearing are situated in the antennules. The eyes are prominent, on short stalks, and elaborate in structure, having many small lenses so that the image thrown on to them

is built up like a mosaic. It is thought that the image is dimmer and less sharp than in ourselves.

5. Growth and reproduction.—The eggs of crayfish are contained in brood pouches under the abdomen, attached to the bases of the swimmerets of the mother, and are popularly known as the "coral" in crabs and lobsters. They are about the size of lead shot and contain red yolk. The abdomen of the female is much broader than that in the male. As in the majority of animals, before the eggs can develop they must be fertilised by the sperm, or reproductive cells of the male. These are placed amongst the eggs by the male as soon as they are deposited. After this, the eggs remain in the brood pouch until they are fully developed, though minute, when they are set free in the water.

As in the case of all arthropods, growth is limited by the hard skin. This difficulty is solved by periodically shedding the skin, several times in the first two years, later only twice a year. The new skin underneath is soft and capable of being stretched, and at this time growth can take place. Most crustacea hide in some secluded crevice while this process of shedding the skin, called ecdysis, takes place. This, of course, is similar to the habit of insects. An interesting feature is that with the hard skin the animal also sheds a considerable amount of waste matter which has been deposited in it, much as trees deposit waste matter in the heart wood. The crayfish has, however, a pair of "kidneys" situated in the head and opening at the base of the second antennae. This is the so-called "green gland" which is always removed in dressing a crab for table.

PRACTICAL WORK

1. Watch the animal moving and feeding, and note the response made by antennae and antennules to touch and to the presence of food. Carry out the experiment with carmine. Try to get the animal to "swim"

backwards by beating the water in front of it or blowing with bellows or a bicycle pump. Make notes and sketches illustrating these points in its behaviour.

2. Examine a dead prawn and sketch the main types of appendages, comparing them with those of a crayfish. If opportunity occurs in the summer holidays, watch prawns or shrimps in sea-shore pools or shallow sea. Note the way in which the long antennae are used. Examine dead shore crabs and watch living ones also.

3. The teacher might obtain a crab or lobster from a fishmonger, and mount a complete series of appendages (Fig. 69) which, if carefully dried, will keep indefinitely. These should be carefully labelled for reference and kept in the school museum. Without expecting the class to learn by rote the numbers and character of the appendages on each segment, it may be pointed out that the three smallest pairs of mouth appendages

correspond to those of insects, while the jaw feet are typical of crustacea.

The gills might also be examined while fresh. If a thoracic leg is carefully pulled out, the gill comes with it. It is soft but firm and compact, cream in colour, with lateral branches on a main axis.

LESSON UNIT II—POND MUSSELS

These may be obtained from a dealer. A list of dealers who supply biological materials is given in Appendix V.

Introduction.—Pond mussels are found in similar situations to crayfish. They bury themselves in mud at the bottom of streams, but in an aquarium may be given sand. They usually take up an oblique position with the front end downwards—there is no head—and the hind end projecting.

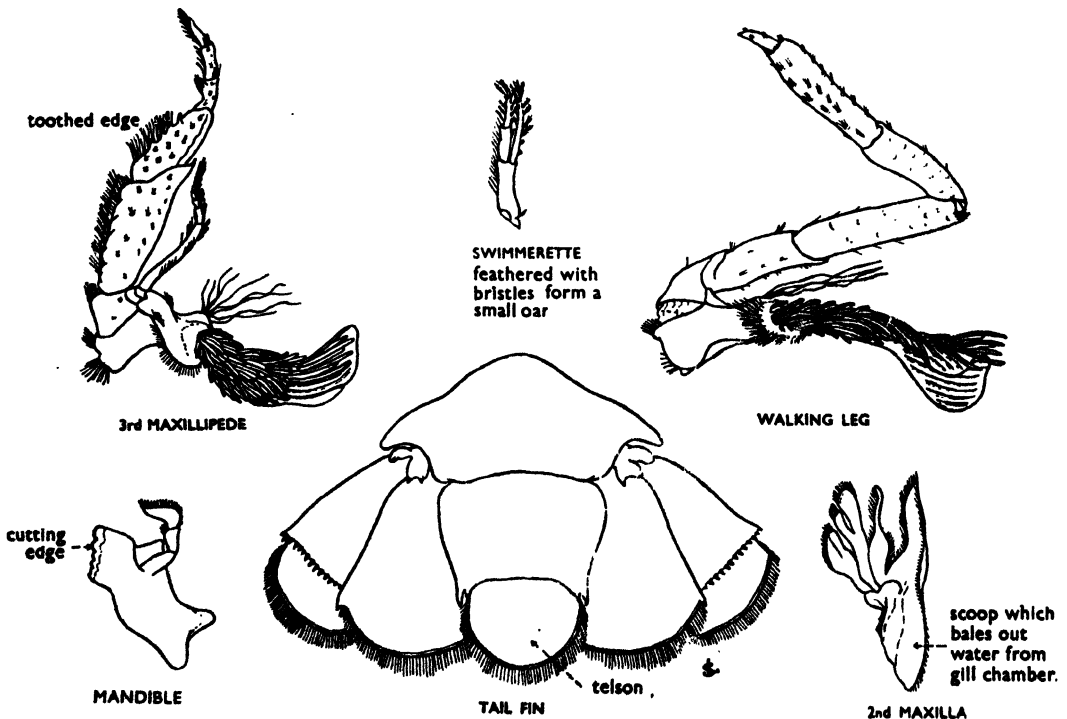

FIG. 69. APPENDAGES OF CRAYFISH

The swan mussel is the commonest British form. It belongs to the phylum of molluscs, to which also belong the snails and the shell-less cuttlefish and octopuses. In the whole of this group the soft body is wrapped in a fold of skin, called the mantle. When, as in most cases, a shell is present, the mantle forms a lining and lies close to the shell. In the snails it forms the breathing membrane which lines the air chamber. The shell gland, which makes the shell, lies in the mantle.

Development—1. External appearance.—

As in the previous lessons, it is best to let the children in small groups examine living pond mussels, suggesting points they shall look for. Having noticed the position of the mussel, look closely at the exposed end. On the upper margin the mantle may be seen protruding, forming two shallow funnels slightly fringed at the edge. This is due to the two lobes lining the shell being joined together along their edges except just in this position. Now take a little finely powdered carmine in a small glass tube, with a bulb attached, and squirt it close to the two openings. It will be seen to be drawn into the lower, wider tube, and a few seconds later a red stream will emerge from the upper one, showing that there is some circulation of water through them. The lower tube is called the inhalent and the upper tube the exhalent.

Actually, it is found, the water which enters the inhalent passes between the two lobes of the mantle, bathing all the lower part of the body and carrying with it both microscopic organisms, which serve as food, and oxygen which can be utilised in breathing.

2. Shell and mantle.—Gently draw the mussel out of the sand and placing it in clear water examine the shell. It may be 5 in. or 6 in. long if full grown, rounded in front, gradually widening to beyond the middle, and then narrowing to a blunt end, to which the lower edge slopes upwards like the keel of a boat. As the valves of the

shell are flattened from side to side, the whole appearance is rather boatshaped. Along the upper edge, the two valves of the shell are hinged together and held by a tough connecting ligament.

As soon as the animal is touched, the shell valves snap together and are kept tightly closed by two muscles extending between them, one at each end, but when the animal is embedded in the sand it is held in position by a thick, muscular projection at the anterior end, called the foot and corresponding to the foot of a snail, Plate XVIII, Fig. 1. With this it can dig itself in.

Nothing more can be seen without opening the shell, so at least one should be opened and passed round, and afterwards there should be an opportunity of identifying the main parts and sketching them. A class diagram would be useful here.

To open the shell, the teacher should first insert something to keep the valves, which are normally slightly separated, from closing. The wooden wedges used for rattling windows are useful. Then insert a sharp penknife carefully between the one valve (Plate XVIII, Fig. 2) and the mantle until it meets with the resistance of the anterior muscle, and cut through this. Then cut through the posterior muscle, when the valve can be lifted up and pressed back. If care has been used, the uninjured mantle is now exposed, soft and of a delicate flesh colour, Plate XVIII, Fig. 3.

Examine the valve first. The outside is striated by lines which show how the shell has grown, by uneven layers, from a point called the umbo at the anterior end; but the inside is perfectly smooth except for the marks of attachment of muscles and mantle, as it is covered with a smooth deposit of pearl. The outside is horny, and the middle layer consists of lime. The horny layer protects the lime from the dissolving action of water containing carbon dioxide.

Some kinds of fresh-water mussel produce valuable pearls. These are due to a secretion formed when some irritating object, such as a particle of sand, finds its way in and

presses on the soft body. The smooth pearly secretion is a means of protecting the animal by enclosing the foreign body.

3. Breathing and gills.—Now draw back the mantle lobe, Plate XVIII, Fig. 4. This reveals the main organs. The blunt triangular foot projects at the front end, between large, rounded flaps which occupy almost the entire space. These are the gills, by which breathing is carried on. As mentioned before, water is drawn in by the inhalent, and as it circulates round the body, whipped along by delicate threads which cover the gills, it passes over and between the gills, which can then extract oxygen and give up at the same time an accumulation of the waste gas carbon dioxide, which in all animals results from the activities carried on in the body.

If the gills are examined with a lens, it can be seen that they consist of a complicated crisscross arrangement of bars, so that they appear furrowed and spongy. They can be lifted with a seeker or blunt skewer to see their arrangement, two on either side of the foot. It is interesting to notice again, in an animal quite unrelated to those previously studied, the nature of the apparatus for breathing under water—delicate skin, folded to give a very large surface, so that water, and therefore oxygen, can penetrate as completely as possible.

4. Feeding.—Just in front of the gills lies the mouth, which can be found with a seeker, lying between soft, fleshy upper and lower lips—probably capable of tasting and to some extent selecting food. As microscopic organisms are brought in by the current of water, they can be drawn into the mouth and then digested. By separating the gills and passing the seeker onwards through the mouth, the visceral mass, consisting of stomach and a large digestive gland, may be found. The rest of the food canal consists of an intestine which is difficult to follow as it takes a course through the heart and into the foot to open to the exterior.

Not only does the circulatory current carry food, oxygen and waste carbon dioxide, but other waste substances from the body are washed away by it through the exhalent.

5. Comparison with hydra.—It is interesting to compare the life and structure of the pond mussel with that of the tiny hydra already studied. Both live a sedentary life, attaching themselves to one spot and moving only rarely and very slowly to another. Both are dependent on their food and oxygen being brought to them in a current of water—in fact, they “stand and wait.” Neither has a head, jaw or eyes—only necessary when an animal moves in search of its prey—though it is possible that in the pond mussel these organs have been lost. The only active part the mussel takes in obtaining food is the entirely automatic beating of the minute threads or cilia, which keep the current moving, and the same device is used in hydra, though this has tentacles as well. In both, waste matter is also carried away by the circulatory current of water. The difference is that in the much more primitive hydra the current is inside the body, whereas in the pond mussel it is outside, though inside the shell and mantle fold.

So we see that this curiously inert animal has solved some of its problems in the same way as the sedentary hydra, but has produced elaborate breathing organs of a type resembling in a general way those of the Crustacea and fishes, groups which are widely different in all other respects, though they have in common the problem of how to breathe under water.

6. Reproduction.—Although it is unlikely that the young forms will be seen, the life history is so interesting that it is worth mentioning. Here again, comparison with the methods employed by the crayfish is interesting. In the pond mussel, the eggs are desposited in the outer gills, which therefore serve as brood pouches, protected by the shell. Males and females exist, and the

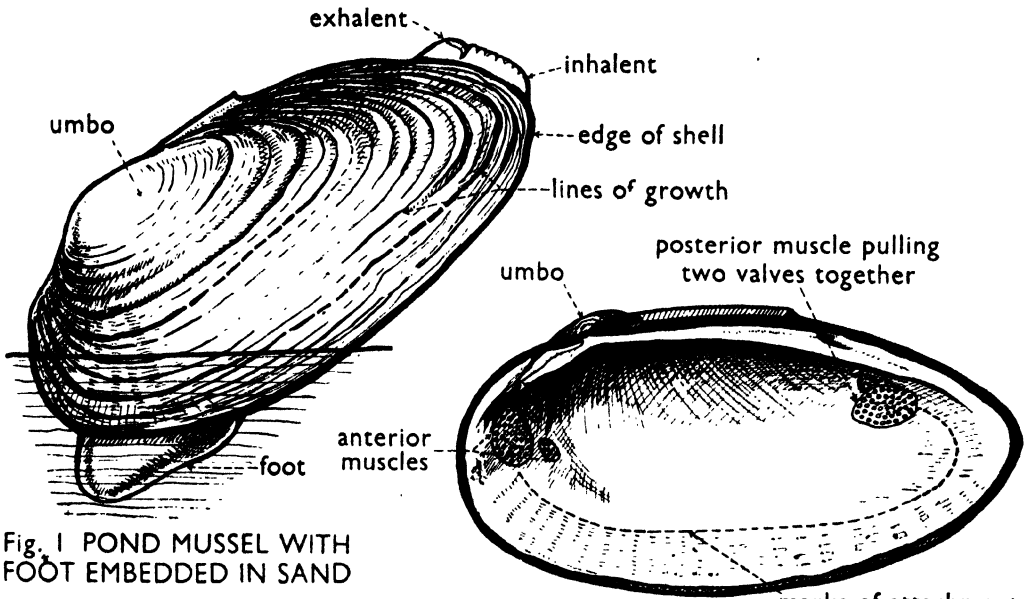

Fig. 1 POND MUSSEL WITH FOOT EMBEDDED IN SAND

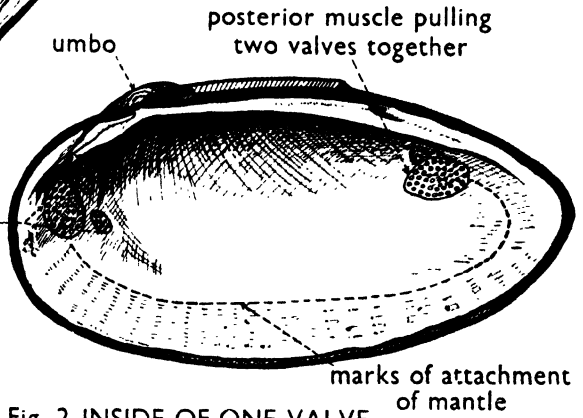

Fig. 2 INSIDE OF ONE VALVE

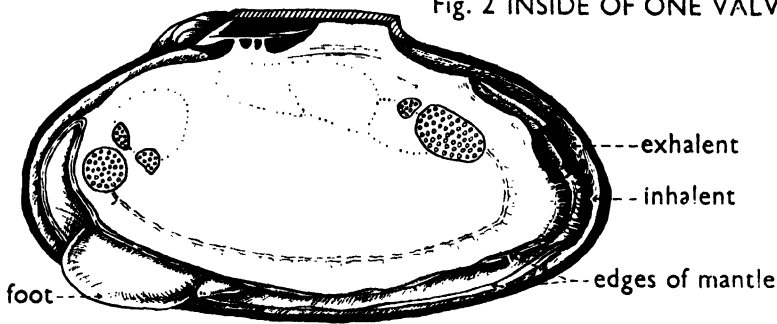

Fig. 3 ONE VALVE REMOVED TO SHOW MANTLE

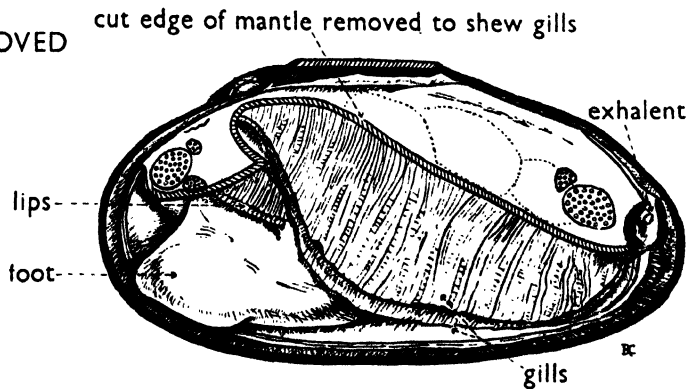

Fig. 4 POND MUSSEL WITH MANTLE REMOVED

sperms are carried into the shell of the female by the water entering the inhalent, whence they reach the eggs. Development takes place and the outer gills become swollen masses, producing a food substance for the embryos. Having spent the winter in this way, the embryos are discharged into the water early in the spring. They are true larvae, for they are quite unlike their parents, having a minute triangular bivalve shell with a small incurved tooth on each apex. A strong muscle unites and can close the two valves. From it hangs a long sticky thread, the byssus. They float in the water, and here begins the peculiar part of their lives. Having fed so far on the gill substance of the mother, they are still not ready to feed themselves, and if they come near to a fish—minnow or stickleback perhaps—they show great excitement, clapping their shells together. The byssus, which is more or less coiled, extends, and if it touches a fish, sticks to it. Now the shells may touch the skin of the fish, when they at once grip it with the two hooks on the shell and fix themselves firmly. Probably the fish bears many of these larvae. A protective blister forms round each, due to the slight irritation they cause to the skin, and enclosed in this each larva lives and is carried about, absorbing food from the juices surrounding it. This is an instance of temporary parasitism, for after about three months they drop away. During this time a shell of the true mussel type forms inside the larval shell, which thus remains perched on top of it for some time. Eventually, when the new shell is well formed though small, the larval shell drops off. Each year new layers are added to the edge of the shell, thus making lines of growth. Pond mussels may live for twelve to fourteen years.

7. Care of the pond mussels.—In addition to seeing that the conditions of the aquarium are suitable, it is important to provide sufficient food. As this consists of microscopic pond organisms, and the animals are voracious, it is no easy matter, but the

mussels may be kept for weeks or months if a co-operative effort to obtain sufficient food is made. Many small organisms can be bred by keeping pond water and weeds in tanks, but it is a good plan to procure bunches of fresh weeds—Canadian pondweed, starwort, duckweed or other rather thickly-growing plants—and wash and shake them well in a bowl of pond water, which will then be found to contain quantities of microscopic creatures which can be transferred as required to the aquarium; or the weed may be immersed in the aquarium, shaken, and then removed.

LESSON UNIT III—FUNCTION OF BLOOD, AND CIRCULATION

It is desirable to give only a very brief account of blood and blood systems, as detail could not be understood.

Introduction.—We have now seen that all animals require food and oxygen; food to build up tissues and so provide a store of energy, oxygen to attack the tissues and release the energy for work.

Development—1. Blood.—In the saclike body of hydra, it is easy for both food and oxygen to reach all parts of the body, but as the bodies of animals become larger and more complicated this is more difficult. We find that in the higher animals a system of spaces or tubes has been established, containing liquid which is able to transfer both oxygen and food to the tissues, and so meet this difficulty. The liquid is pumped all over the body by means of the heart, but all hearts are not necessarily like the human heart. We saw that in the earthworm there were five pairs; in insects and crustacea the heart is a tube extending along the back, just under the skin, nearly the whole length of the body, while in the molluscs (pond mussels) we noted the peculiarity that the intestine passes through the middle of the heart which again is a long tube.

Blood may be colourless (pond mussel); red, or slightly blue (crustacea). If there is colouring matter, it may be diffused, as in the earthworm, or collected in small bodies called corpuscles, as in amphibia, reptiles, birds and mammals.

In man the red corpuscles are minute discs, racing along the veins and arteries on their rims like tiny coins. They carry oxygen, while the liquid in which they are suspended, called the plasma, carries dissolved food and also the waste gas carbon dioxide.

There is another liquid circulating in the body, called lymph, which also carries dissolved food. The lymph channels or lymph ducts open at certain places into the blood vessels, so they are remotely connected with the blood system. In frogs there are four lymph hearts lying in front of the shoulders and thighs, which pump the lymph through its channels.

In both blood and lymph there are irregularly shaped white cells, called white corpuscles. They are capable of movement and resemble amoebae, though they are smaller. They are, however, an actual part of the blood, not little foreign animals. Reference will be made to their work later, in connection with bacteria.

In order to see blood corpuscles in the active state, wrap a live tadpole in damp blotting paper and place it on a microscope slide. Place a drop of water on the tail and over this a cover glass. A small elastic band slipped over the body where it joins the tail will keep the animal securely in position. Place the slide under a low power of the microscope and focus till the blood vessels of the tail can be clearly seen. The oval corpuscles will be seen coursing along the vessels, slipping round bends and apparently chasing one another along. There is no difficulty in seeing this.

2. Heart and blood vessels.—In order to see what the pumping heart is like, it is best to get a sheep's heart, Figs. 70 and 71.

The heart is a large muscular organ consisting of four chambers, the auricles at the broad end, lying slightly behind the much larger, stronger-walled ventricles, which reach to the apex. If the heart is placed with the broad end uppermost and the auricles behind, you are looking at it in its natural position in the body, but left and right sides are reversed, so that the left is opposite to the observer's right. The apex points slightly to the left. Waves of contraction pass from the broad end to the apex, squeezing the

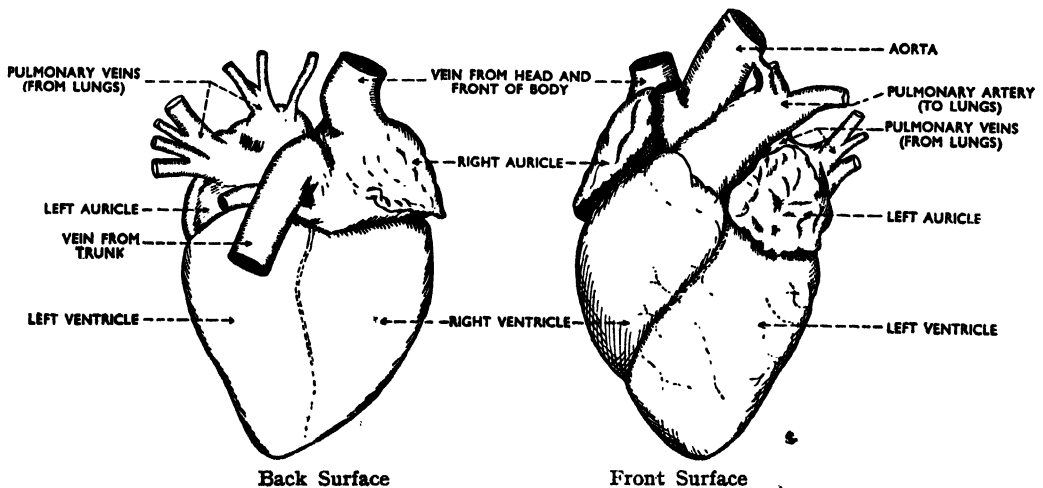

FIG. 70. HEART OF SHEEP

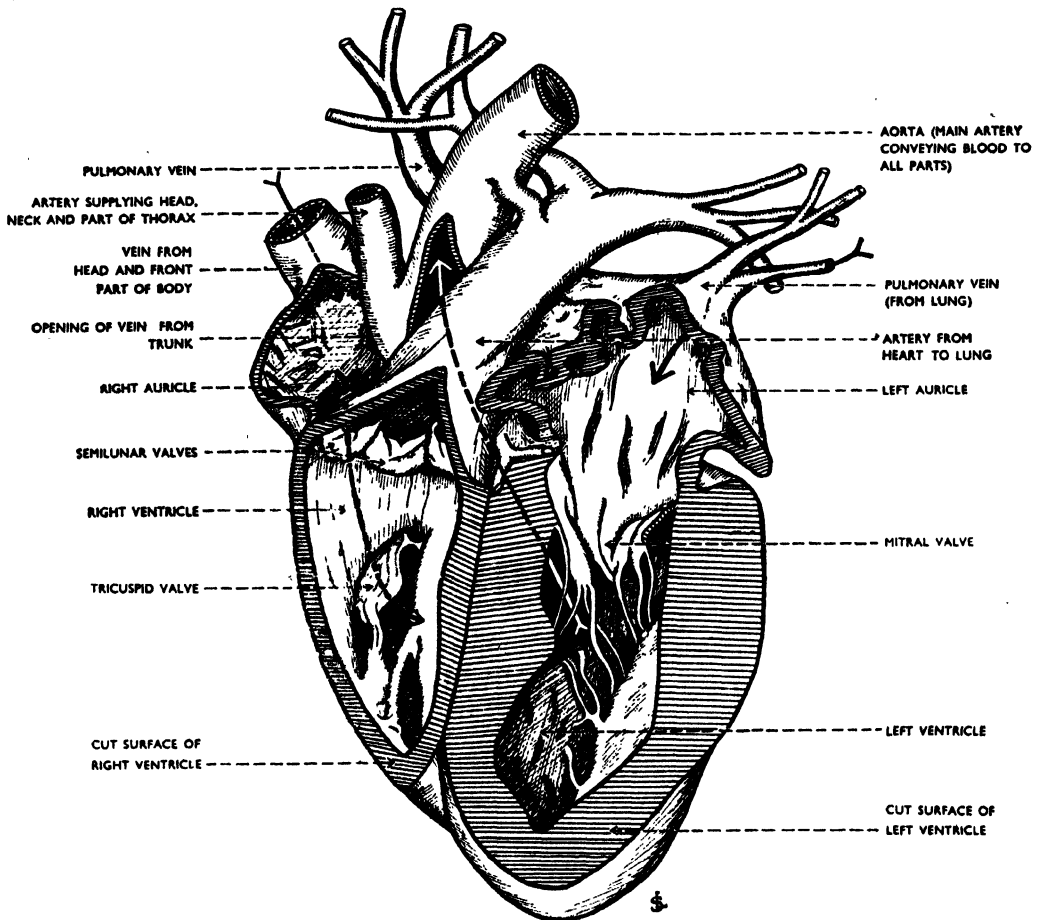

FIG. 71. SHEEP'S HEART, FROM VENTRAL SURFACE

The ventral walls of both auricles and ventricles have been removed to show the cavities within. The pulmonary arch has been cut open.

blood through the auricles into the ventricles, and thence out.

Having identified the four chambers, look for the strong white walls of the arteries, which leave the ventricles at their front border. The artery leaving the left ventricle is the aorta. This carries purified blood to the body, dividing into a number of important vessels, some of which go forwards to the head and neck, and others backwards to the trunk, viscera and legs. They divide into smaller and smaller branches, until at last

they are as fine as hairs. These vessels, in the skin and extremities, are called capillaries.

The arteries carry blood containing oxygen, for it has come to the left ventricle, through the left auricle, straight from the lungs, where all the carbon dioxide it contained was discharged and oxygen taken in. In this way all parts of the body receive oxygen. The blood is also carrying food.

Having given up food and oxygen, the blood flows into other capillaries, which are gathered together to form the veins, and

so flows again to the heart. Here it enters the right auricle and, passing downwards as the muscular wall of the heart contracts, it enters the right ventricle and thence is forced into the pulmonary artery which takes it to the lungs.

Identify the aorta and the pulmonary artery leaving the left and right ventricles respectively and the large veins entering the auricles at the back. The veins are thin-walled and collapse when empty.

LESSON UNIT IV—EXCRETION

Introduction.—We have now considered almost all the important functions or activities of living animals which enable them to grow and reproduce. We have seen that energy is required for all activities, especially for movement which enables animals to obtain food, and that this is set free by oxygen from the tissues where it is stored. Growth is due to there being an excess of energy over what is required for daily needs, so that the tissues store it; that is, food is built up into tissues which are not all used up again for energy. When the animal has reached a certain size and condition of maturity, it uses up its surplus energy by producing offspring. The same is true of plants.

Development—1. Animals.—Now in the process of setting free energy, certain substances are produced which cannot be used, but if they remain in the body they would interfere with its activity—in other words, act as poisons. We call these substances waste products. Even if they could be stored they would make the animal unduly bulky and so tend to interfere with movement.

However, most animals have some means of ejecting such waste substances. The lowly amoeba has what is called a contractile or pulsating vacuole, noticed when it was examined, which collects waste liquid and, bursting like a bubble, throws it out into

the water. Earthworms have a series of coiled tubes opening to the exterior by small pores on the sides of each segment. The green gland in the head of the crayfish has been referred to, and the allantois of the developing chick, while in hydra the water swirling round inside the body cavity washes out all waste matter.

This waste matter is chiefly of two kinds, the gas carbon dioxide and a substance called urea, usually passing out as a liquid but in birds it is a solid white excrement. There are slight quantities of other substances.

The whole process of ridding the body of waste is called excretion. The carbon dioxide is taken up by the blood, as previously mentioned, and carried to the lungs, where it is exhaled during expiration. In earthworms and to some extent in frogs, it escapes by the skin, which acts as a breathing organ. We see, then, that breathing is not concerned entirely with obtaining oxygen but also with getting rid of this waste gas.

In all the vertebrates, urea is excreted by the kidneys. These are a pair of organs (seen in the frog) consisting of complicated tubes and blood vessels, Fig. 72. The poisonous substance collected by the blood passes into these tubes, and is eventually carried by a pair of long channels or ducts to the bladder. Here it is stored for some time and expelled at intervals. There may be a separate opening, as in mammals, or there may be a common vestibule or cloaca, which receives the opening of the food canal and reproductive organs as well, as in the frog.

In some animals—e.g., man—the skin also takes part in excretion, through perspiration.

An efficient system of getting rid of these poisonous substances is absolutely essential to healthy life.

2. Plants.—With plants it is different. Since a tree, for instance, remains always in one place, additional bulk is unimportant so long as the injurious waste substances are removed from circulation. Trees, there-

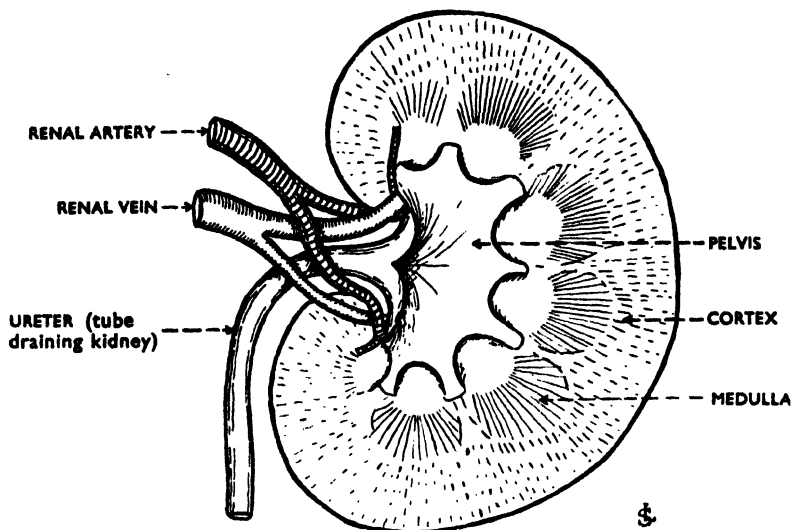

FIG. 72. SHEEP'S KIDNEY CUT LONGITUDINALLY TO SHOW GENERAL FEATURES

fore, store their waste products instead of removing them entirely, though they too get rid of carbon dioxide, which they breathe out. The dark heart wood found in most trees is discoloured by the accumulation of solid waste matter which fills the cavities of the wood. This accounts for the hardness of heart wood.

The waste products of plants frequently serve to protect them from the attack of bacteria, moulds and burrowing insects such as beetle, moth and sawfly larvae, for they are bitter to taste. Notice that trees without heart wood are much more frequently attacked; e.g., willow (goat moth).

Sometimes the waste products are stored in the leaves, making them unpleasant to taste, or they may form hard crystals which make the foliage hard to touch with the tongue. In this way the plant may be protected against grazing animals.

It is not practicable to give children much actual work to do in connection with excretion. They may be shown a blackboard diagram of the excretory system of the frog and reminded of the position of the organs as they saw them in a dissection.

Sheep's kidneys may be cut through (Fig. 72) so that the main substance, made of narrow tubes, can be seen, and the conical parts, the pyramids, into which these drain to be carried away by the duct or ureter.

LESSON UNIT V—CHIEF ACTIVITIES IN THE LIVES OF PLANTS: FOOD

Introduction.—It is commonly accepted that plants are living things. Probably if the children are asked why, they will say that plants grow. They may even suggest that, as animals do, they produce offspring, since plants produce seeds from which new plants grow. If they are asked whether plants feel, feed and breathe, as animals do, they may be very doubtful.

Development—1. Feeling.—If by feeling we imply consciousness of surroundings and knowledge of what is happening to them, then we have no reason to think that plants have feeling; at any rate, they do not show any signs that we can recognise. If, however, we mean that they are aware, though

unconsciously, of external conditions and capable of responding to them, there is no doubt that they are both sensitive and irritable. As an illustration, experiments may be set up which will readily show their response to light and the presence of water, and that these have a directive effect.

A simple way of investigating the directive effect of light is to place some seedlings in a dark box which excludes light except through a narrow slit in one side.

To see the directive effect of watering, wheat or maize seeds which have begun to germinate may be set in a box on the surface of soil which is only slightly damp. Plug the bottom of a small porous plant pot securely with a new cork and press it into the soil at one side of the box, some distance away from the seeds; then fill this with water. Note the direction in which the roots grow, Fig. 73.

A second method is to plant some seeds in a sieve or on muslin or net, placed over a jar of water. When they have grown through towards the water, remove the water and substitute a wet sponge or pad of cotton wool on top of the seeds. Note the direction of growth of the roots.

This section of the work can be extended to cover all the chief responses of plants to external stimuli if desired; e.g., the response of roots and stems to gravity, and of all organs to light.

2. Feeding.—With regard to feeding, it is at once obvious that plants do not take in food by means of mouths, as do animals. This is the most notable distinction between plants and animals. Yet we know that plants take in water. (This was shown in the first year, and is common knowledge.) Is pure water enough?

We usually think of plants as growing in soil, though seaweeds and some pond plants grow in water, without having roots.

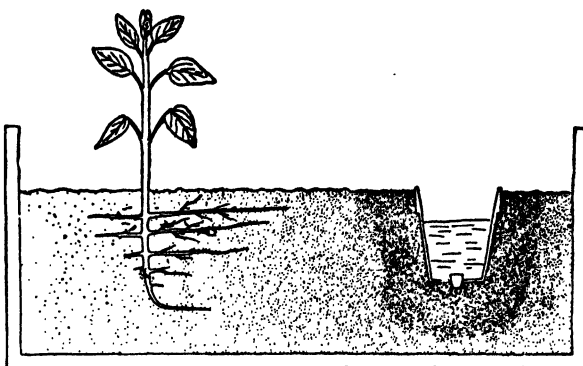

FIG. 73. TO SHOW DIRECTIVE EFFECT OF WATER

The roots can be seen growing through the soil towards the water, which is contained in a porous plant pot.

Seaweeds have holdfasts, but these do not absorb anything. Is there anything in the soil which helps plants to grow? It is easy to find the answer to this question by setting some seeds—onion, mustard, wheat—on flannel or net over rain water or in sawdust or sand kept moist, and others in ordinary garden soil, and comparing the results. If the plants in soil are better grown and healthier after a time, then it looks as if there may be something in the soil which serves as food.

3. Experiments on the content of soil water.—Shake up a little soil with water, filter it and evaporate the water to dryness in an evaporating basin. A light powder is left in the basin, which can be rubbed off with the fingers. Do the same with tap and rain water for comparison. Evidently there was something in the soil which was soluble in water. It is possible that this might serve as liquid food for plants, for it is impossible for the roots to take in solids.

As a matter of fact, it has been proved that plants do take in, through their roots, certain substances dissolved in soil water. These come from two sources. There are mineral substances which have been dissolved out of the rocks, or the soil particles which are rock debris, as the water percolated through them, and there are decaying plant

and animal substances, or organic remains, called humus in the case of plants. Chemists have been able to determine what these substances are, and it has been found that plants select those they need.

4. Elements required by plants.—Most of the substances which enter into the composition of the bodies of plants or animals, which we call organic substances, are of a complex nature. When these substances decay, they are attacked by oxygen and reduced to much simpler forms, though most of them are still what we call compounds. Chemists have found out that compound substances can be split up into simpler forms, until a stage is arrived at when no further splitting is possible unless the substance itself is dispersed as energy. Substances in their simplest form are called elements. They may occur in nature, for instance, oxygen and sulphur are elements; but it is much more usual for them to occur as compounds, which have to be split up by great heat or other treatment, in order to isolate the element. Most metals occur in a compound form; for instance, iron oxide or iron sulphide, combined with oxygen or sulphur. All pure metals are elements.

The substances which plants obtain from soil are compounds, but they have been analysed to discover what elements they contain. It has been found that the following elements must be present in the food of healthy plants:—carbon, hydrogen, oxygen, nitrogen, sulphur, phosphorus, iron, calcium (the basis of lime and chalk), potassium, magnesium.

The means of obtaining carbon will be dealt with in the third year's course, as this is a special process. Hydrogen and oxygen are the substances which are combined in water, and the remaining substances are obtained from soil. Tap water will contain a certain amount since it is derived from rivers and lakes, and the water has poured down through and over rocks and soil; hence in comparing the growth of plants in soil and water, either filtered rain water or distilled

water must be used. Rain water has been "distilled" by the sun, which causes water to evaporate, in a pure form, and it collects as clouds, eventually resuming the liquid form again as rain.

It is advisable to make up a solution containing all the substances which have been found necessary for plants, and to grow some plants in this, and others in rain water for comparison. Do not grow only one plant in each as this is not conclusive; besides, accidents may happen.

Here are two recipes for water culture solutions, each containing all the necessary elements:

(a) Distilled water	1200 c.c.
Potassium nitrate	.5 grammes
Ferrous phosphate	.5 "
Calcium sulphate	.5 "
Magnesium carbonate	.25 "
(b) Distilled water	50 c.c.
Potassium phosphate	1 gramme
Potassium nitrate	1 "
Calcium nitrate	4 "
Magnesium sulphate	1 "

A nail placed in the water will provide a trace of iron, which is all that is required. Make up 2 or 3 c.c. to 1000 c.c. with distilled water.

Note the small quantity of each salt used. This point is important in connection with the use of artificial fertilisers which, as anyone who gardens will notice, are chiefly composed of the salts used in these culture solutions.

It would be interesting to use artificial manures in the school garden and at the same time to make a culture solution containing each and note its effect on plants grown in water, or in sand which is watered with the solution. Different strengths might be used. Strong solutions act as poisons.

To carry out experiments with culture solutions, either use sand or place plants in wide, straight jars, supported by a split cork through which the stem passes, packed with a little asbestos to hold it in place.



[Reproduced by courtesy of Rothamsted Experimental Station

FIG. 74. BROAD BEAN

a. Complete. *b.* No sodium. *c.* No sulphur. *d.* No magnesium. *e.* No phosphorus—note stunted condition. *f.* No iron—the photograph does not show that the plant lacks colour. *g.* No calcium—scarcely any growth. *h.* No potassium. *i.* No nitrogen (nitrate).

It is interesting to make up, in addition to the "standard solution," solutions in which each salt in turn is left out, and to notice the effect of the omission on growth. It will be noticed that plants grown without potassium are dwarfed in every respect; without nitrogen they are spindly, frail, and small though not perhaps dwarfed; while without calcium (or lime) they may be fairly sturdy-looking, but stunted in height. The effect of omissions will be very marked on the production of seed. (Fig. 74.)

Gardeners recognise what has been called the "golden tripod" of manures—potash (or potassium nitrate), phosphates and sulphates—without which their crops cannot flourish. Lime is also essential.

PRACTICAL WORK

In addition to the laboratory or classroom experiments described, it would be valuable

to carry out all the experiments possible in the garden.

1. The effect of animal manures, stable manure and humus or leaf mould. Besides supplying food, these have certain mechanical properties that make soil more workable, especially by helping to retain water, by giving off heat in the early stages of decay (hot beds) and by keeping the soil cool when well decayed.

2. The effect of artificial manures on leaf development, root and stem growth, seed and fruit production, and hence the need for discrimination according to the result required; for instance, leaf crops, such as cabbage and lettuce, require more potash; fruits and seeds, such as beans, require more phosphate. If wheat, maize, onions, cabbages and dwarf kidney beans are used for experiment, there is an opportunity of extending the study of life histories, which should be continued every year. There should be a

plot for each plant, subdivided for treatment with various fertilisers, including the natural or animal and plant manures, side by side with those mentioned above. Note that calcium phosphate, calcium nitrate and calcium sulphate also provide lime, which is essential to nearly all plants. Certain plants which do not tolerate it are said to be "lime-shy;" e.g., heaths, rhododendrons, sweet chestnut.

LESSON UNIT VI—RESPIRATION OR BREATHING IN PLANTS

Introduction.—It is not possible to see movements accompanying the breathing of plants, but it is possible to prove that they remove oxygen from air and that carbon dioxide passes into it, and these are the changes which take place in air when animals breathe.

As some attention has been given to the mechanism of breathing in animals but so far the taking up of oxygen and giving up of carbon dioxide have been assumed without any proof being offered, this is a good opportunity for seeing something of the properties of the gases, oxygen and carbon

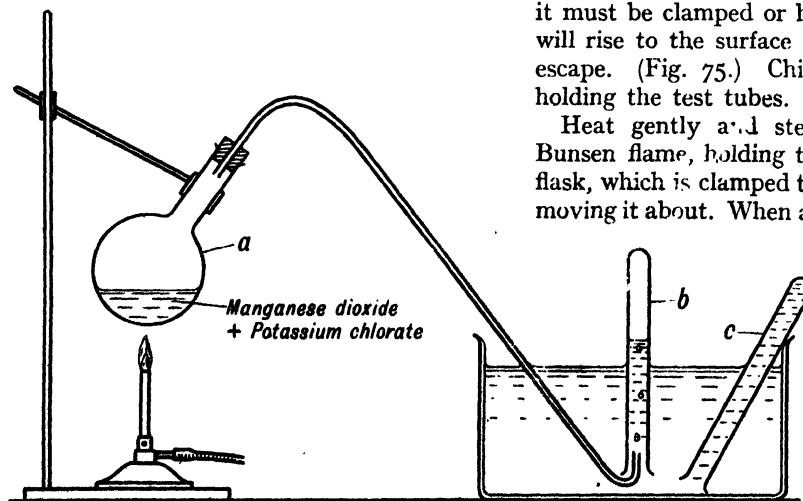

FIG. 75. PREPARATION OF OXYGEN

a. Round-bottomed flask. b. Space filling with oxygen. c. Test tube filled with water.

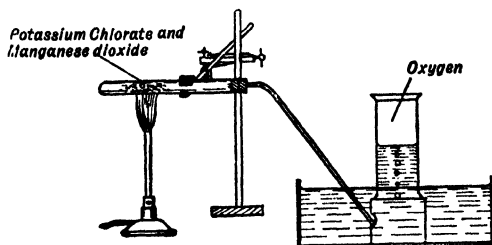

FIG. 76. PREPARATION OF OXYGEN USING HARD GLASS TEST TUBE

dioxide, and also showing that in the case of both animals and plants the atmosphere is affected by their breathing.

Development—1. Preparation of oxygen.—

The gas oxygen (chemical symbol O) can be obtained by heating a mixture of manganese dioxide and potassium chlorate in a perfectly dry, round-bottomed flask—not one that is flattened at the base. The flask is provided with a rubber stopper and bent glass tube, and the gas may be driven off and collected in test tubes over water. A number of test tubes may be filled with water and inverted in a trough of water ready for use. One is slipped over the end of the glass tube, and off again when full still under water, but when filled with oxygen it must be clamped or held in position or it will rise to the surface and the oxygen will escape. (Fig. 75.) Children may help by holding the test tubes.

Heat gently and steadily with a small Bunsen flame, holding the burner under the flask, which is clamped to a retort stand, and moving it about. When a sufficient number of

test tubes have been filled, loosen the stopper before taking away the flame, otherwise the cold water in the trough will rush in as the flask contracts and, meeting the hot glass, will break it.

There will be some crackling and sparks as the oxygen mixture is heated. These should not be too violent or explosion might result, hence the need for gentle heating. The salt used must be of the best quality. It is best for the teacher to carry out this experiment as a class demonstration.

2. Properties of oxygen.—Having filled several test tubes take each out in turn, slipping the ball of the thumb under the mouth to prevent the oxygen from escaping. Still keeping the tube inverted, insert a lighted match into one. The match will burn more brightly.

Take a lighted chip or wooden spill, blow it out, and immediately place it in another test tube. It will begin to glow brightly and may burst into flame again. These tests both show that oxygen facilitates burning.

Place these two test tubes in a rack as soon as used, pour a little clear lime water into each, and shake. It will turn milky. Note this result for future reference.

Pass round the other tubes of oxygen (inverted) to let children smell. It has neither taste, smell nor colour.

Hold a burning match in a test tube of air. It burns for a moment, not so brightly as in oxygen, then goes out.

It is found that oxygen is the only gas in which burning, or combustion, can take place. Things burn in air because about one-fifth of the atmospheric air is oxygen; the rest is chiefly the gas nitrogen, with a little carbon dioxide.

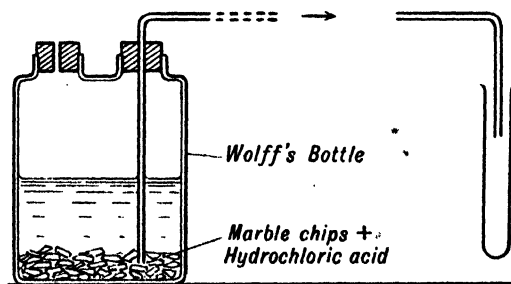

FIG. 77. PREPARATION OF CARBON DIOXIDE

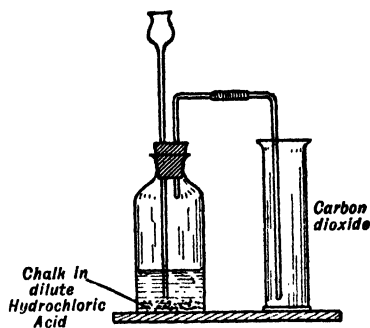

FIG. 78. PREPARATION OF CARBON DIOXIDE

3. Preparation of carbon dioxide.—The gas carbon dioxide—symbol CO_2 , which shows that it is composed of one atom carbon to two atoms oxygen—can be prepared from chips of marble by the addition of acid. Concentrated hydrochloric acid may be used, a little water being added to the marble first. No heat is needed. As CO_2 is heavier than air, it need not be collected over water, but can be collected straight into tubes or gas jars under the end of a bent tube leading from the flask in which it is prepared. These can be placed in a rack and covered with greased plates. Use either a Wolff's bottle (Fig. 77) (which has two necks) or a flask with a two-holed stopper (Fig. 78), into one of which a funnel is fitted so that the acid can be poured in. Effervescence takes place rapidly and the gas is given off. This is also a test for the amount of lime in soil. It is the same gas that escapes when a soda water siphon or "fizzy" drink of any kind is opened.

4. Properties of carbon dioxide.—Use the same tests as for oxygen. It will be found that a light immediately goes out and a glowing chip is not revived. Now test a fresh tube or jar by pouring clear lime water into it and shaking it up. The lime water at once turns milky. This is the characteristic test for CO_2 . Recall the fact that when a glowing chip or burning match was held in oxygen, it burned till the oxygen was used up, and that when lime water was

poured in this turned milky. This shows that CO_2 was present after burning. The carbon of the wood united with the oxygen to produce it. Children can help with all these tests.

Now let various children blow steadily into tubes of lime water through a straw or a glass tube. When they do this, they are breathing the contents of their lungs into the lime water, which turns milky, showing that CO_2 is passing in. If a tame mouse is shut up in a closed bell jar for some time and then lime water is poured into the bell jar, the same thing will happen; or if a lighted taper is inserted, it will go out.

5. To show that oxygen is removed from air which has been breathed.—Set up a bell jar in a trough of water. Take a rubber stopper which fits tightly and has one opening, in which a glass tube is inserted tightly. Suspend inside the bell jar by means of a fine wire a small test tube or open dish containing potash, which even more than lime water has the property of absorbing CO_2 . The wire may be slipped inside the neck of the bell jar and held in place by the stopper.

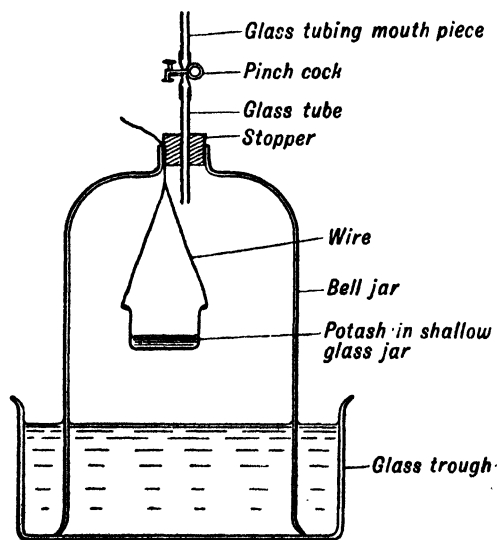

FIG. 79. TO SHOW THAT OXYGEN IS REMOVED FROM AIR WHICH HAS BEEN BREATHED

To the glass tube attach a piece of rubber tubing and a pinchcock, with a short glass mouthpiece above, Fig. 79. Mark the level of water in the bell jar with a strip of gummed paper. When all is ready, let one of the children breathe into the mouthpiece. As he does so, the water in the glass trough can be seen to rise as he inspires and to fall as he expires. Let him repeat this several times (with the object of exhausting all the oxygen in the bell jar), then close the rubber tubing completely with the pinchcock.

Now mark the level of the water in the bell jar with another narrow strip of gummed paper, labelling it 2, and leave till the next lesson. When it is looked at again, the water will have risen. When the water has quite stopped rising, mark the latest level 3.

What has happened? The carbon dioxide breathed out has been absorbed by the reagent used and, since the level of water is higher than the original level, something must have been taken out of the air in the trough. Light a taper, take out the stopper and very quickly insert the taper into the bell jar. It goes out. As CO_2 has been absorbed, this must be due, not to the presence of CO_2 , but to the absence of oxygen. This means that the oxygen must have been drawn out during inspiration.

6. Respiration in plants.—Now if we can show that plants also take oxygen out of the air and give up CO_2 , we shall have reason to think that they too breathe. There is, however, a curious process going on in plants in daylight which masks the effect of breathing. It is therefore necessary to carry out this experiment in the dark by placing the plants in a dark box, cupboard or room. This may be checked by carrying out the following experiments both in the light and in darkness. The experiment is similar to the last one, in which oxygen was withdrawn and CO_2 breathed into a bell jar, but the plants are enclosed in jars and the gas content of the jars is tested after several hours.

A very simple experiment may be set up. Line several jars with damp blotting paper and fill them respectively with flower heads (dandelions, daisies); leaf buds just beginning to open; germinating wheat at the stage when the shoot can be seen; and germinating seeds (wheat, peas, or mustard). Fill one also with dead material as a control; e.g., germinating peas which have been boiled for a few minutes to kill them. Stopper the jars closely and leave. A similar set may be left in sunlight, as suggested in the last paragraph. After a few hours, test with lime water some of the jars which have been in the dark; the lime water will turn milky, showing the presence of CO_2 . Test with a lighted taper those which were kept dark; the taper will go out. This may be due to absence of oxygen, but we know from previous experiments that it may also be due to the presence of CO_2 . At any rate there can be no oxygen present. Check by holding a lighted taper in a jar of air. Does it burn longer? To prove conclusively that all oxygen has been absorbed, we must arrange to have the CO_2 absorbed as well and then hold a lighted taper in the jar. This may be done by repeating the experiment, using one jar only this time and placing among the flowers or seeds a small piece of potash, which we have already noted will absorb CO_2 . If solid potash is used (potassium nitrate) manipulate it with wooden forceps, not with the fingers, as it burns badly. Place it in a small crucible or small jar, Fig. 80.

The jars used are lined with damp blotting paper in order to keep the material fresh during these experiments.

An amusing experiment is to invert a test tube filled with mercury in a small basin of mercury, clamping it into position, and then fill the tube with germinating peas. This is done by slipping each pea under the test tube mouth with the fingers. As the pea is so much lighter than mercury, it shoots to the top. Continue until the tube is quite full. Leave this for several days. It will be found that the test tube fills with

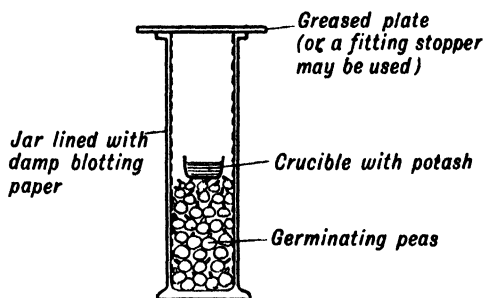

FIG. 80. TO PROVE RESPIRATION IN PLANTS

a gas, whose pressure gradually depresses the mercury until eventually it has been entirely displaced. If this is tested with lime water, it is found to turn it milky, showing that the gas is CO_2 . It can have come only from the peas, which are therefore assumed to be breathing. In this case the peculiar point is that no oxygen is present; it is thought that germinating seeds obtain it in some way by the breaking down of their own tissues.

LESSON UNIT VII—LIFE HISTORIES OF WHEAT, MAIZE AND ONION

Introduction.—The method is the same as for plants dealt with in the first year's course. These plants may be used for experiments suggested.

The special characteristic of all is that they have seeds with only one seed leaf or cotyledon (monocotyledons). As amongst dicotyledonous plants, they may be either hypogeal, retaining the cotyledon below the ground, or epigeal, carrying the cotyledon above ground by growth of the hypocotyl, to serve as the first foliage leaf. Wheat and maize are hypogeal, onion—also bluebell and scilla, which would be equally good for study—epigeal.

Development — 1. Wheat and maize.—Wheat and maize, except for minor differences, have the same type of growth and structure. Both might be grown for

comparison. A maize seed (Fig. 81) consists of a mass of yellow endosperm and an embryo, which is pressed into one side of it. The embryo is a white shield-shaped mass, consisting of one cotyledon lying against the endosperm, and a plumule and

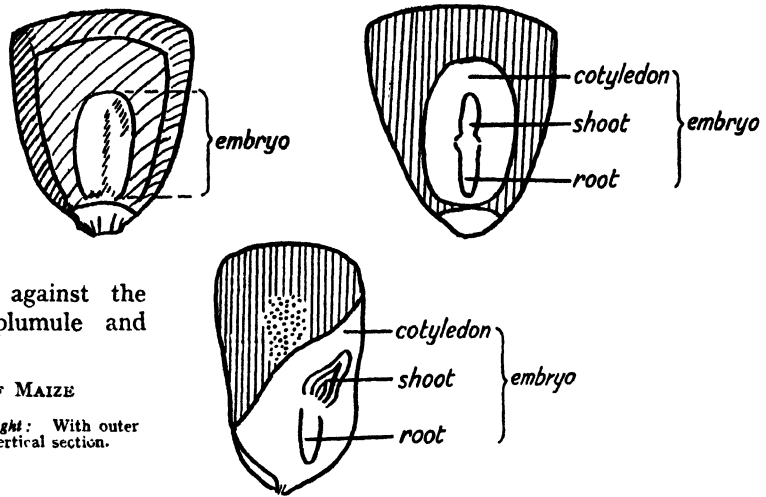

FIG. 81. SEEDS OF MAIZE

Top left: Surface view. Top right: With outer coat removed. Centre: Vertical section.

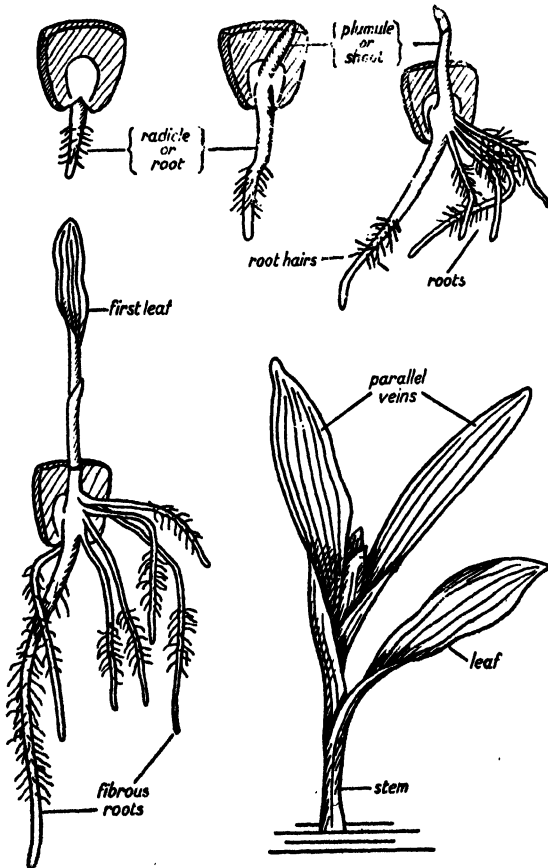

FIG. 82. DEVELOPMENT OF MAIZE

radicle enclosed by the cotyledons. The two edges of the cotyledon meet on the surface of the seed, and they must be separated with a needle or penknife, after removing the outer skin—combined seed coat and fruit wall—to expose the plumule and radicle.

When growth begins (Fig. 82) the radicle emerges and enters the soil. It grows only for a very little way, then stops short, while other roots grow from the region of the hypocotyl, and base of the stem, to take its place. These are called fibrous or adventitious roots. Meanwhile the plumule is beginning to elongate and push its way out of the seed coat. It ends in a tubular leaf which is thick and hard and is able to push its way through the soil without being injured. When it has emerged into the air the foliage leaves enclosed inside it appear one by one and unroll.

As the roots grow, fine root hairs for absorbing water appear just above the tips.

Early growth takes place at the expense of the endosperm. The cotyledon—called the scutellum, which means a shield—is able to digest and absorb this food through its skin, or epithelium, which separates them.

A later stage in the growth has been noted in the first year's course (Summer Term, lesson unit IV), the growth of rings of roots from the stem to support the sturdy plant.

The flowers are of two kinds, in separate inflorescences; staminate spikes with long stamens at the top and pistillate tassels with long stigmas in the axils of large sheathing leaves below. These give place to the cobs after fertilisation. They should be grown in the garden up to the flowering stage.

2. The onion and other bulbs.—The onion has a long tubular cotyledon which grows above ground, carrying the testa up with it. The stages in its emergence should be watched, Fig. 83. It turns green and serves

as the first foliage leaf. It encloses the true foliage leaves which emerge later. These are called radical leaves because no stem axis is found, but they all arise from ground level. They are parallel veined, as in maize and almost all monocotyledons.

Scillas can usually be found producing seed and seedlings if they are grown in the rock garden. Note how the heavy fruits (capsules) are pressed into the soil by the bending of their stalks, so that the seeds are set round about the parent plants. Young bluebells should be examined in the woods, but not uprooted. If the seeds are collected they can readily be grown, and growth of bulbs, which takes about two and a half years to complete, may be watched.

elongation of hypocotyl and cotyledon carries up the testa, which is ultimately shed

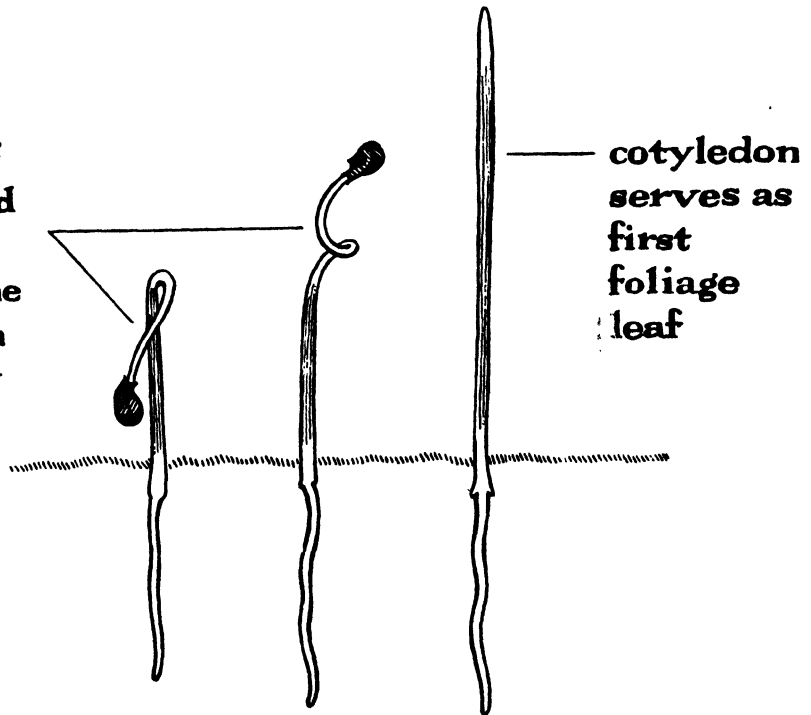

FIG. 83. ONION SEEDLINGS

THIRD YEAR'S COURSE

INTRODUCTION

THE main theme for this year is the lives of plants and animals as they affect the life of man. This falls into two main parts: (1) the direct influence of other creatures upon man, and (2) the part played by biology in helping man to understand his own life as regards the functions of his own body, and the environment in which he lives. It is important as far as possible to carry out the study of these subjects through practical work and therefore to some extent the work will still be seasonal. This makes it impossible to finish with one aspect before beginning the other, and from time to time we shall change from one aspect to the other, keeping the two interests going side by side. The work in the third year will be more theoretical than hitherto, and it will not always be possible to

illustrate every subject by means of actual material.

It is desirable that some time shall still be given to extending the children's knowledge of living creatures through recognition of new forms, making collections, and studying new life histories. No notes have been given on this as the method should now be familiar, and any living plants and animals which are available will provide subjects of interest. The children should particularly be encouraged to make individual studies throughout this year, applying the methods they have learnt; that is, inquiry by observation and experiment and careful recording by sketches and notes. Where no practical work, or very little, is indicated in connection with the lessons, the teacher can make opportunities for this kind of work to proceed. This would apply particularly to the spring and summer terms.

AUTUMN TERM

LESSON UNIT I—THE FOOD OF PLANTS: PHOTOSYNTHESIS

Introduction. — By the beginning of September there are definite signs that the period of active life is drawing to a close. The harvests are gathered, berries are ripening in the hedges, and trees and shrubs are just beginning here and there to change colour. This change indicates a new phase, which suggests the questions: What is the work of leaves which necessitates their being green throughout the summer? Why can it stop (in most cases) apparently, in the winter, when leaves are evidently not needed? What are the changes taking place?

Development—1. The colour in leaves.—Heat some leaves in methylated spirit, placed in a beaker inside a larger beaker or saucepan of water. The leaves will lose their green colour and become almost white, while the spirit will change to clear green.

The green substance which has passed out of the leaves is called chlorophyll, and is present as small granules. (These can be seen in the drawing of a section of a leaf shown in Class Picture No. 23 and reproduced in Plate IX.) Chlorophyll breaks down into red and yellow substances, which give autumn leaves their colour.

2. The work of chlorophyll.—We could find out whether chlorophyll is necessary to

the growth of plants if we could get rid of it from some plants and see how they grow without it. This has in fact already been done in another connection, for when seedlings were grown in the dark they were colourless. This may be repeated. Two points emerge: (1) that sunlight is necessary for the formation of chlorophyll, and (2) that plants which have none are starved looking, thin and weak, with small leaves though they may be tall. This suggests that chlorophyll is in some way connected with feeding the plant.

One of the commonest foods found stored in plants is starch. We have already shown by the iodine test that it is present in many seeds. It also forms the chief bulk of potato tubers, from which new plants can be grown. Shall we see if it is present in leaves?

We shall use the iodine test again, but it is desirable to bleach the leaves first by boiling in methylated spirit inside a beaker of water as before. Place the bleached leaves in a saucer and pour iodine on them. They turn deep blue, showing that starch is present.

Children are always interested in making patterns on leaves by cutting out stencils in thick paper or tinfoil and pinning them on to the leaves of growing trees in the sunlight. After a few hours the leaves are picked, bleached and tested with iodine, when the part covered remains as a white pattern on the dark blue exposed part, Fig. 84.

Now keep some leaves for several days in the dark, then test with iodine. There is no reaction. This suggests that there is some connection between starch and chlorophyll, for neither is formed in leaves without sunlight. In fact, sunlight and chlorophyll are responsible for starch being formed in leaves.

3. Where does starch come from?—This cannot readily be shown but it has been proved that plants with chlorophyll are able to take carbon dioxide from the air, and combine it with water taken in by the roots to make starch and sugar. Sugar then

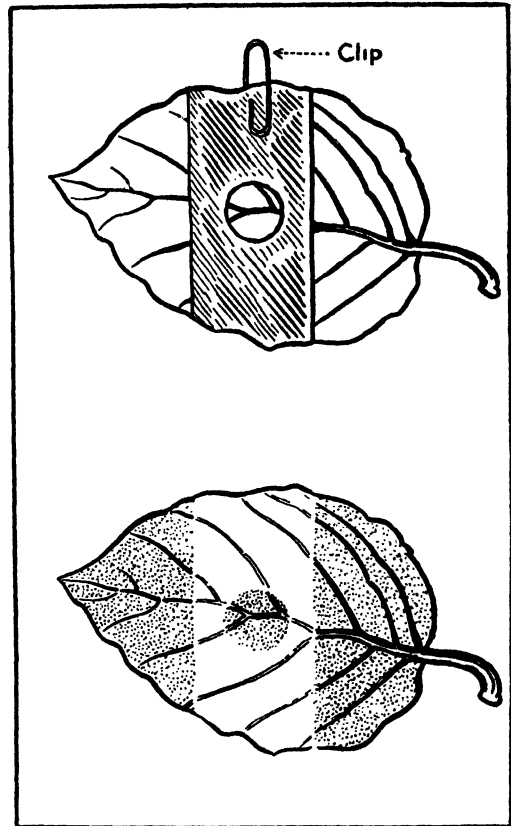

FIG. 84. LEAF SHOWING ABSENCE OF STARCH IN PART THAT HAS BEEN COVERED. WHEN TESTED BY IODINE THIS PART REMAINS UNSTAINED

combines with nitrates (which have already been shown to be necessary) to build up new plant tissues. Thus the element carbon is introduced in the form of carbon dioxide. This is a process which no human chemist has yet been able to perform, but it is exceedingly important to humanity for it is through plants alone that we are able to obtain starch and sugar which are valuable sources of energy.

The whole process in plants is called photosynthesis, which means "putting together by light." The sun's energy enables the plant to carry out this work.

4. Giving off of oxygen.—Another consequence of this activity can be shown. Place

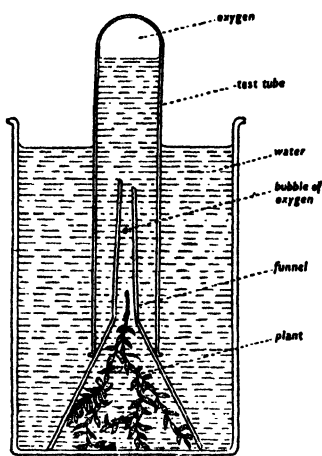

FIG. 85. CANADIAN PONDWEED KEPT IN STRONG SUNLIGHT

some water plant such as Canadian pondweed or starwort in a large beaker of water in sunlight, preferably out of doors. Over the plant place an inverted funnel with the stem filed short, and over this slip a test tube filled with water (Fig. 85), placing the ball of the thumb over the opening of the tube, and then sliding it into position with the mouth under water, and clamping it to a retort stand. If a large glass trough is used instead of a beaker the test tube can be filled by laying it under the water, which should be deep enough to come some distance above the funnel.

After an hour or two small bubbles will appear all over the leaves and stem. Some of these detach themselves and presently thin streams of bubbles will be seen ascending the test tube and collecting at the top. If there are several sunny days the test tube may fill with gas. In twelve hours or so enough may be collected to test it. If a thin chip is lighted, blown out and then inserted while still glowing into the gas, it will glow

more brightly or even re-ignite. This proves that the gas is oxygen. To remove the test tube for this purpose, slip the ball of the thumb under the opening again, quickly turn the tube right side up, then remove the thumb and insert the chip.

Repeat the experiment using boiled water, distilled water, and in darkness—or carry out all four experiments at the same time. No gas is formed. This shows that oxygen forms only in sunlight, and since boiled water and distilled water contain no CO_2 , its absence explains the absence of oxygen, for no starch formation can take place. Oxygen is given out into the air by green plants as a result of photosynthesis. We call it a by-product. This is important, because it means that actively-working green plants are both increasing the supply of oxygen in the atmosphere, which other creatures can breathe, and decreasing the CO_2 , which is poisonous if present in too large quantities. Plants are, of course, also breathing out CO_2 but in daylight this is neutralised by the O given out

5. Summary.—To sum up, we find then that an important source of the food of plants is the CO_2 of the air, which is provided either by the breathing of plants or animals, or by decaying substances. Green leaves carry out the important work of taking in

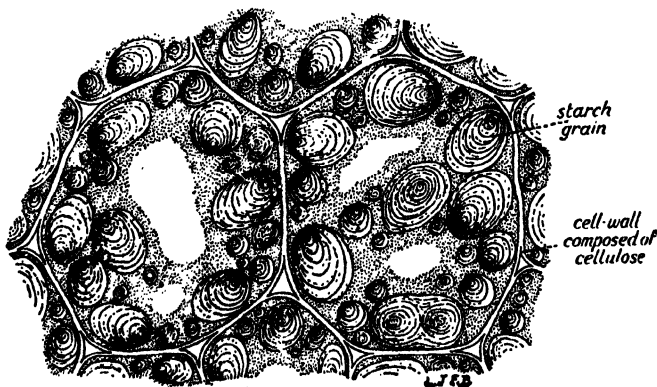

FIG. 86. MAGNIFIED STARCH GRAINS IN CELLS OF A POTATO TUBER



PLATE XIX. POLLINATION OF FLOWERS

(Class Picture No. 24 in the Portfolio.)
For the description of this Plate see page 128.

this gas, and combining it with water to make starch. It is the chlorophyll in the leaves which can do this. The energy for the manufacture is derived from sunlight. Oxygen is given out as a by-product of the process photosynthesis.

Thus we see that leaves have three duties to perform. They breathe, they give out water vapour, and they manufacture starch.

Before they fall in the autumn the food they contain is drained back into the tree, which passes into a quiescent or dormant stage during which it needs scarcely any food. The food is stored so that it is available for the great burst of activity in the spring, for at first the opening buds will not be able to carry on photosynthesis and so the tree must depend on its reserve supply.

LESSON UNIT II—POLLINATION AND SEED FORMATION

Introduction.—In the junior school there will have been lessons on the part played by insects in pollinating flowers, and on the function of the flower in the life of the plant. It will, however, be necessary to revise these ideas and to make sure that the children know the parts of a flower and the purpose they serve. Snapdragons (*antirrhinum*s) are convenient flowers to use in the autumn for this purpose. A large blackboard diagram of a vertical section should be used (Fig. 87), and a flower, which may be cut vertically into halves, provided for each child.



FIG. 87. VERTICAL SECTION OF FLOWER OF *ANTIRRHINUM*, SHOWING TWO STAMENS AND PISTIL

Development—1. Function and essential parts of flower.—The following points should be enumerated, verified from the specimens available and illustrated by diagrams:

(a) *Flowers are formed usually when plants are mature.*—As a result of taking in food from the soil and carrying on photosynthesis, the plant has been able to grow vigorously and develop all its parts. Some plants flower very early, others late. Most of those which flower early have some special means of forcing growth; e.g., tubers of lesser celandine, underground stem of wood anemone, bulbs. The flower is an expression of the fact that the life of the plant has reached its zenith. It has superabundant energy, or stores of food, which it cannot use for itself at least during that season, and it puts its energy into the formation of offspring to continue the race. The same thing is true of animals, though the organs of reproduction are internal and are not produced as an outgrowth at a particular time.

(b) *The function of the flower is to produce seed.*—For this two parts are essential: (1) pollen, which is borne by stamens, and (2) ovules which, when pollen has been conveyed to them, will grow into seeds. The ovules are contained in the ovary, but the name of the whole organ, of which the ovary is a part, is the pistil. It is situated in the centre of the flower, and consists of one or more chambers or compartments, called carpels. These carpels may be free from one another—buttercup (Fig. 88), wild clematis, wood avens—or joined together in various ways, and according to varieties in this arrangement different types of fruits may be formed.

The simplest type is the pod or legume (pea), which consists of one leaflike carpel folded edge to edge and joined by its edges to which the ovules are attached, so that they are enclosed, Fig. 89. The place of attachment of ovules is called the placenta. In the snapdragon two carpels closed in this way have fused together, forming a thick column or rod as the placenta, where they unite, Fig. 90. Cut specimens across and

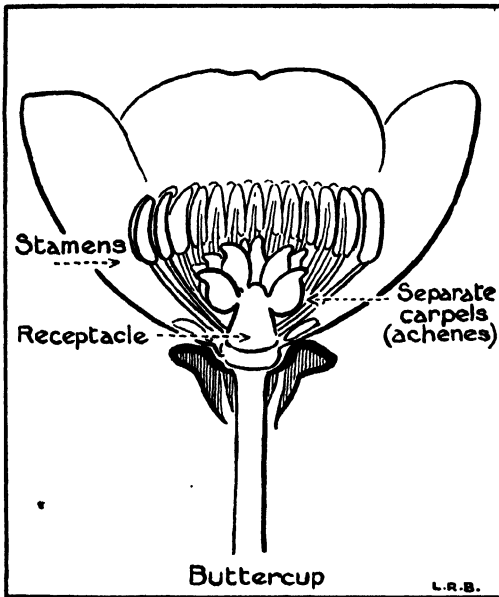

FIG. 88. VERTICAL SECTION OF FLOWER OF BUTTERCUP, SHOWING FREE CARPELS FORMING PISTIL

note that this arrangement gives a large area for ovules. In the violet, three carpels have united edge to edge, instead of each closing round its own ovules, Fig. 90. This process may be illustrated by making oval paper shapes, and pinning them together.

(c) *Pollination and fertilisation.*—Embedded in each ovule is a minute mass of



pea (legume)
FIG. 89. CONTENTS OF PEA POD

protoplasm, the egg cell, corresponding to the egg of an animal, while inside each pollen grain a corresponding male cell is formed. These two cells have to be brought together for the inception of a new generation. This union is fertilisation, the essential process. Pollination is merely the act of bringing pollen to the pistil.

In most cases, the pistil consists of the ovary formed of one or more carpels, a specially sensitive tip of the carpels capable of receiving pollen—the stigma, and if the flower is deep or narrow, an elongation of the carpels into a stalk, called the style, which bears the stigma to the necessary level for receiving pollen.

When a pollen grain is deposited on a stigma of the same kind of flower, it sends out a tube, which grows at the expense of the stigma and style, inside their substance, down into the ovary. Here it is guided to one of the ovules, which it penetrates. The male reproductive cell passes down this tube into the ovule, finds the egg cell, and unites with it. A second small mass of

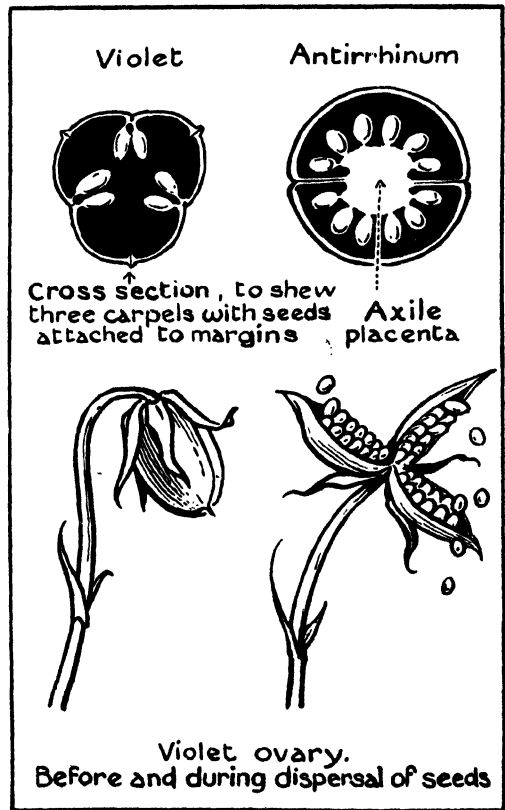

FIG. 90. OVARIES OF VIOLET AND ANTIRRHINUM

protoplasm passes into the ovule at the same time, and fuses with another similar mass, Fig. 91. The result of the first union is the production of an embryo plant, while the second gives rise to the endosperm. Remind the children of the grain of maize or wheat already studied.

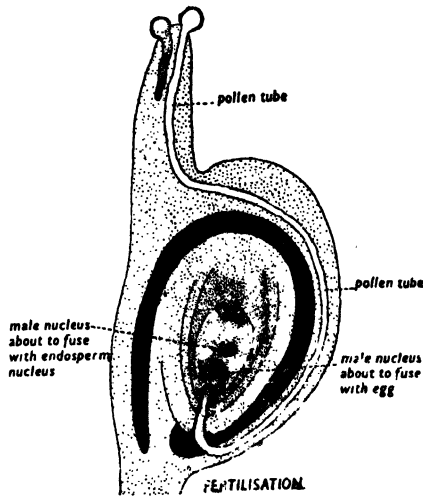

FIG. 91. VERTICAL SECTION OF AN OVARY SHOWING HOW FERTILISATION TAKES PLACE

For the teacher's information, although for simplicity reference has been made to male and female cells, in the flowering plants these cells are represented by nuclei—the controlling element in cells—only, for the protoplasm round them is not separated off from the surrounding substance of the ovule. In essence they are cells, corresponding to the complete cells of animals and lower plants. This is too difficult to explain to children.

2. Accessory parts.—In addition to the essential parts of a flower, there may be accessory parts which either protect the pistil and stamens, or help to bring about pollination by attracting insects. It will be noticed that in wind-pollinated flowers accessory parts are very slightly developed and are chiefly concerned with protecting the young reproductive parts. Petals are

usually the main attractive organ—colour, scent, and striking shape or arrangement the means of attraction. Yet they are only signals indicating to insects that there is something worth coming for—nectar, a sweet fluid produced by glands called nectaries (Fig. 92), or abundant pollen which will serve as food. Incidentally, in carrying away nectar or pollen, the visitors may touch the sensitive stigma with the same kind of pollen brought from another flower. This is the service required by the plant, for although the male and female organs are usually present in one flower (hermaphrodite), more vigorous and numerous seeds are produced when cross-pollination is

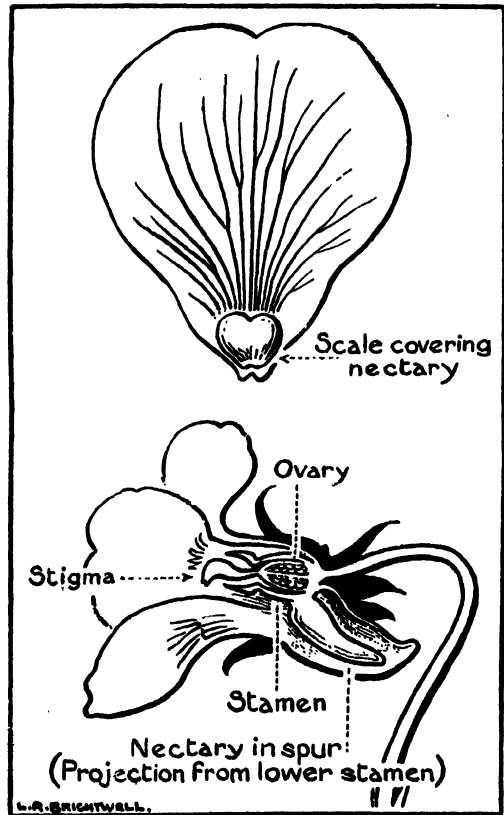

FIG. 92. POSITION OF NECTARY

Top: Petal of buttercup.
Bottom: Vertical section of violet.

effected than when self-pollination takes place.

3. Results of fertilisation.—The changes which follow the act of fertilisation are not confined to the production of a seed—embryo and endosperm—for all parts of the flower are influenced. Usually the sepals and petals wither, the stamens, stigma and style drop off, but occasionally some of these parts remain and in a modified form assist in the dispersal of fruit. For instance, in St. John's wort the calyx (outer cup, or sepals) persists as a scaly brown cup enclosing the fruit, while in the dandelion and thistle (Fig. 93), in which it is reduced to a ring of hairs, this ring develops after fertilisation

into the parachute (pappus) which bears the fruit away. In wood avens (Fig. 93) the style persists, becomes woody, and produces a hook at the end which enables the fruit to cling to the coat of some animal.

Changes take place in the ovary wall or pericarp. It may become hard and woody (acorn) and eventually split to let out the seeds (horse chestnut). This gives us the distinction of indehiscent and dehiscent dry fruits; or it may become succulent (plum). Whatever the change, it is usually, again, connected with dispersal.

PRACTICAL WORK

1. Encourage the children to search for flowers and fruits in as great variety as possible during the autumn, and not only to collect and identify them, but to examine the flowers to find the essential and accessory parts—not overlooking the nectaries, which often are overlooked though to insects they are the prime meaning of flowers. Try to follow the changes which take place after pollination, and to see what parts of the flower are represented in the fruit. This is extremely important if one is to realise that every detail has some significance in making sure of offspring.

2. Examine examples of as many of the plants mentioned as possible. Cut across ripening ovaries of plants to see how the carpels are joined and where the seeds are attached. If seeds are attached to a central column or axis, this is called axile placentation (campion). If the walls have broken down, leaving just the axis, this is free central (pimpernel), while attachment to the sides of the ovary is called parietal (violet, poppy).

3. Collections should be made, not haphazard, but to illustrate different conditions. It will be useful to keep boxes of dried fruits in the school museum for reference, as it is not always possible to collect fresh material of every type needed. The class should make carefully labelled sketches of selected fruits. Any inarticulation textbook

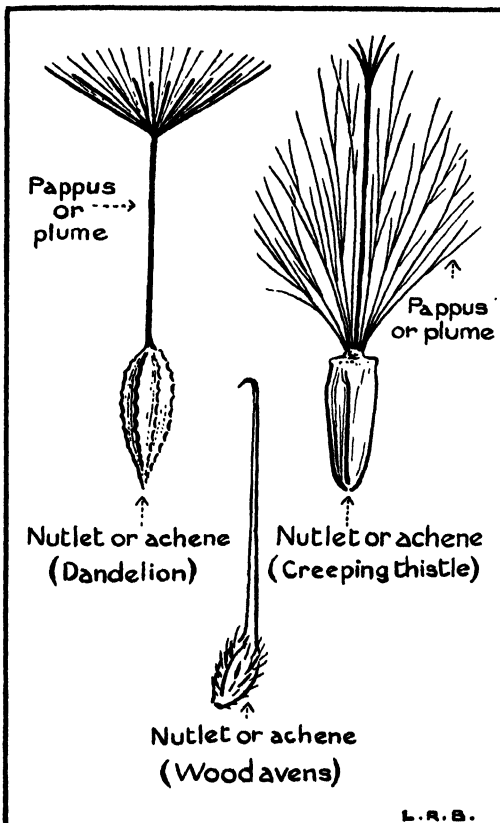

FIG. 93. THREE FRUITS SHOWING MODIFIED PERSISTENT PARTS OF FLOWER

of botany gives details of structure and classification.

4. In addition to noticing changes in structure, look out for changes in the behaviour during the flowering and fruiting period. In the early autumn one can still find plenty of flowers. It is impossible here to give many details, but, as examples, the garden nasturtium brings only one stamen into a position to be touched by visiting insects at a time (Fig. 94); the hollyhock changes the position of stamens after pollen has been shed; the little ivy-leaved toadflax bends the fruit stalk so that the developing fruit is turned away from the light, and so gets pushed into a crevice in the wall, where the seeds may lodge and root. In all these cases again, slight details, easily overlooked by an observer, may be of great importance in securing descendants for the plant.

NOTES ON FLOWER STUDY FOR THE SUMMER TERM

Interest in flower study may be increased if some account is given to the children of the way in which the facts of pollination were discovered.

Introduction.—The majority of flowers contain both stamens and pistil in one blossom, but although self-pollination may be possible, it has been discovered that cross-pollination, that is, pollination by pollen from another flower, increases the vigour of the stock.

Development—1. Darwin and Sprengel.—This discovery was made by Darwin but he was led to it by reading a book written by a German pastor, a great flower lover and observer, towards the end of the eighteenth century. His name was Sprengel. It was not until Darwin proclaimed it that the value of Sprengel's book was recognised, after his death.

2. Sprengel's observations.—It was Sprengel who first observed that the shapes, colours

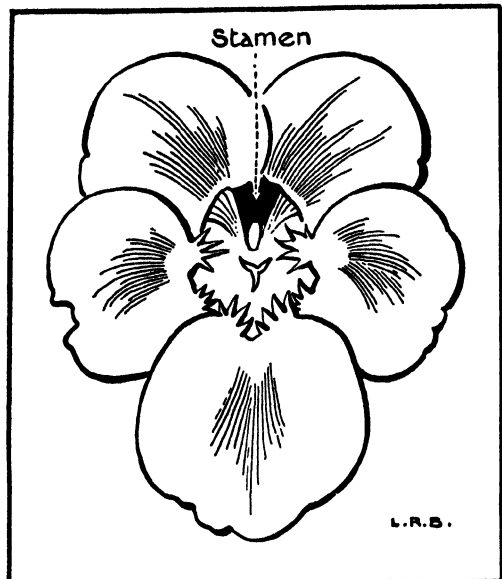

FIG. 94. FRONT VIEW OF GARDEN NASTURTIUM SHOWING ONE STAMEN IN POSITION FOR POLLINATION

and markings of flowers have significance in attracting insects, by directing them to the nectar. His attention was first drawn to the clear blue salver and yellow ring of the forget-me-not, and he saw that the yellow ring served as a honey guide; later, he noticed lines and markings serving in the same way on many other flowers. At first he did not realise that the insects performed any service in return for the meal of nectar provided, but later on he found that insects actually effected cross-pollination. It was Darwin who discovered that this had a definite value in improving both the stock and the fertility of plants. The work of Sprengel and Darwin was later followed by many other botanists, and many of the details of insect and wind pollination came to be understood.

PRACTICAL WORK

When any new flower is found, children should be encouraged to try to answer the following questions, both by examining

and watching the flowers, and by looking up the points in reference books:

1. Is the flower cross-pollinated or self-pollinated usually?

2. Is it pollinated by insects or wind?

3. If by wind, what are the special features which help to bring about pollination? (Usually dry, light, plentiful pollen; long slender filaments; tufted, protruding stigmas; slender flower stalks so that the staminate flowers at any rate swing in the wind; flowers either produced before leaves unfold, or swinging clear—sycamore—or held above—grasses. Negative characters: absence of nectar; absence or diminution of accessory flower parts; e.g., petals especially.)

4. If insect-pollinated, does the flower offer nectar or pollen as the chief attraction, or both?

5. How does the flower advertise its wares? Is each flower conspicuous, or does it rely on mass effect, and if so, how is it attained? (Different types of inflorescence.) Does the shape help? Smell? Colour?

6. How does the flower help its insect visitor or ensure that pollination will be effected? (Alighting board or stage, as in dead nettle; or protections to cling to, as in violet and gorse; guiding lines and hairs to block all but the proper entrance, as in violet. Devices such as concentration of stamens and stigma so that insect must touch them, as in dead nettle.)

7. Are there any devices for securing cross, not self-pollination? (Readiness of stamens and stigma at different times. Separation in different flowers. Two forms, with long and short styles and stamens, as in cowslip.)

8. Does the flower exercise any selective powers? (Bee flowers, narrowed down and barricaded so that only insects with a particular length of tongue can reach the nectar; e.g., wild thyme and white clover can be reached only by hive bees. Similarly, there are butterfly and moth flowers—long tubes, usually with a circular shape, whereas the bee flowers, including bumble bee flowers like snapdragon, are frequently bilateral in shape. The two forms are

referred to as being radially symmetrical—primrose—and bilaterally symmetrical—dead nettle or snapdragon. Note also that certain insects seem to show colour preferences—butterflies like pink, moths like pale colours which, of course, are white and therefore conspicuous at dusk, bees like blue and yellow.)

9. Has the flower any particular habits associated with those of the insects that may pollinate it? (Time of year and of day when it opens. Note that the nectar flow takes place usually on warm, still, sunny days and may be confined to certain hours, when particular insects fly. Some flowers have sleep movements, as they are called; that is, they close in cold, damp or sunless weather; e.g., daisies, crocuses; others close at a definite time each day; e.g., John-go-to-bed-at-noon, morning glory or convolvulus. Some flowers move into a different position after pollination, thus showing insects that it is no use wasting time on them; e.g., lesser celandine, ivy-leaved toadflax, dandelion, clover. In some cases, the stamens change colour—hawthorn—and position; e.g., as previously noticed, in garden nasturtium only one stamen at a time is ready to give up its pollen and the filament moves so as to bring it to the middle of the entrance.)

The attempt to answer these questions will provide ample opportunities for practical work, limited only by the variety of flowers available and by the time the teacher feels may profitably be set aside for it. Systematic outdoor observational work, with a notebook for jottings on the spot, may be followed up by indoor sketches to illustrate the various structures concerned and the way they work. The teacher will probably find it desirable to select certain questions and provide material from which the answers may be discovered, so that all the children cover a certain minimum. The children may then go further in the directions which most interest them, not necessarily covering identical ground. This subject, so wide and varied, would lend itself admirably to short "lecturette," illustrated by large diagrams

made by the individual lecturers, and by their own collections of examples. These little talks should be based chiefly on what the children are able to see and find out by watching, though there is opportunity also for learning to use reference books. For this purpose Lord Avebury's *British Insects in Relation to Wild Flowers* and J. H. Lovell's *The Flower and the Bee* are both valuable.

Notes on Class Picture No. 24, *Pollination of Flowers*:

1. POPPY.—Cup-shaped, offers pollen but no nectar to all insects, relying on chance of large numbers transferring some pollen to same kind of flower.

2. CRAB APPLE.—Cup open to all. Attracts by colour aided by clustered arrangement. Nectar—in disc round base of style—and pollen.

3. MEADOW VETCHLING.—Crowded inflorescence conspicuous. Free petals, held by united sepals, form a tube, broadening into standard, and wings at side, enclosing boat-shaped keel formed by union of two front petals. Stamens form a tube, making nectar at base difficult to reach. Pollen falls into keel. Insect drags down wings and keel, brushlike style projects and sweeps out pollen which dusts chest of insect. A bee flower, as are most irregular or bilaterally symmetrical flowers.

4. COW PARSLEY.—Minute white flowers crowded into a flat inflorescence—umbel. Outermost petals larger, increasing attractive effect. Nectar open to all, on flat disc at base of styles. Masses of flowers bloom in May with striking effect. Stamens ripen before pistils, ensuring cross-pollination. Visited chiefly by flies.

5. TOADFLAX.—Flower a tube. Like meadow vetchling, but more advanced in having petals united, making nectar at base of tube more difficult of access. Closed at throat by a pouch in the front petal, which is also produced into a spur. Inflorescence a conspicuous raceme, flowers sulphur-yellow with orange spots attracting attention. A bee flower.

6. FIGWORT.—Of same family as toad-flax—Scrophulariaceae—but unusual in having terminal flowers opening before lower. Pollinated by wasps, said to begin with the upper flowers and travel down. Since the pistils ripen before the stamens, this would ensure that pollen—from lower flowers—was carried to other plants. Dull purplish crimson, and greenish yellow.

7. FORGET-ME-NOT.—Conspicuous yellow rings on blue ground act as honey guides, the classical example first studied by Sprengel, discoverer of cross-pollination. A little nectar is secreted on disc at base of short tube, but if not visited by bees pollinates itself by growth of corolla bringing stamens into contact with pistil.

8. MEADOW CRANESBILL.—Large regular blue flowers with two rings of five stamens, nectaries alternating with outer ring. Stamens open first, bending outwards after shedding pollen.

9. ARCHANGEL.—Rings of yellow flowers conspicuous, as is shape of flowers. Tube of united petals spreads to form a hood and lip. Hood protects stamens and forked stigma till ripe, when they grow beyond it, stigma downwards. Insect alights on lip and is guided by orange lines on it. Seeks nectar at base of tube, brushing head and back against stamens and stigma. A bee flower.

10. RED CAMPION.—Regular (cyclic or radially symmetrical) flowers. Long tube of free petals widens into salver-shape held by calyx of united sepals. Small projections form a corona which partially blocks throat—as in forget-me-not. Nectaries at base of tube. A butterfly flower, but white campions pollinated by moths. Separate P. and S. flowers.

11. COWSLIP.—Cyclic flowers with long tube of united petals. Orange spots on yellow cup probably honey guides. Umbel conspicuous. Flowers of two types: *pin-eyed* with long style, *thrum-eyed* with anthers in this position and short style. Throat widened in thrum-eyed type to accommodate the cluster of anthers. Cross-pollination ensured since the shorter organs touch the

tongue and the longer ones the head or base of the tongue of the visitor. Long-tongued insects only can reach the nectar.

12. HONEY-SUCKLE.—Sweet scent at night and pale colour attract hawk moths, the only insects with sufficiently long tongues to reach the nectar. Irregular, conspicuous flower; umbel also easily visible.

13. LIME.—Strong sweet scent indicates presence of nectar, which is copious. Open flowers allow any insects to take it, bees especially. Not conspicuous, sheltered by leaves.

14. RYE GRASS.—Like all grasses, wind-pollinated. Stamens swing on long, slender stalks, feathery stigmas catch and hold dry, light pollen. Inflorescence held clear of surroundings foliage so that wind reaches it.

15. ALDER CATKINS.—Wind-pollinated. Compare with grass. Dry, light pollen scattered in clouds. Petals minute, reduced not conspicuous; no scent. Flowers before leaves, exposed to wind. Stigmas project from conelike pistillate inflorescences.

16. RIBWORT PLANTAIN.—Wind-pollinated. Open situations like grasses; flowers held above leaves. Inflorescence a spike, pistils ripening first, circlet of anthers held well away by long stalks. Corolla reduced, but some plantains are still pollinated by insects and others in a transitional state. Their nearest relations having insect pollination are the Scrophulariaceae.

LESSON UNIT III—FUNGI

To arouse their interest, the children might be asked to collect examples of fungi in late October and early November. The school garden, lawns, paths, vegetable patches and manure heaps, fallen trees and piles of faggots, as well as woods, heaths, downs and pastures, are all likely to yield their own types. The group is an important one economically, because it includes many serious pests of trees and crops, though the majority of these are minute and not spectacular. The various "blights" and mildews belong to this group.

The study of the subject would fall into three parts; (1) identification of as many forms as can be found, making sketches and trying to find all stages in their life history, and noting as much as possible about their occurrence and habits; (2) growing moulds in the classroom or laboratory, and observing their growth; (3) a short lecture to give information on the economic importance of the group, including some account of the disease-causing forms. This could, if preferred, be put off to later in the year. In that case it could be taken as part of a short course on the economic importance of plants and animals, which would include birds, insects and bacteria.

Introduction.—Display and name as many varieties of attractive or curious fungi as can be collected, so that they can be easily passed round or held up, if large enough, for the class to see. Say where they were found. For instance, a selection of the following:—Toadstools—ink caps, verdigris toadstool, sulphur tuft, honey-coloured toadstool; puff-balls; polypores (with minute pores leading into tubes on the under surface—the name means many pores); stump flap (which is small and thin), the large "brackets" which are seen on tree trunks, the bright sulphur-yellow boletus which looks like a toadstool till you look underneath and see the pores; coral spot on twigs; candlesnuff, also on twigs. See Class Picture No. 26 and notes on it for identification of common types.

Development—1. How organic food is obtained.—Draw attention to a characteristic of all these plants, the absence of chlorophyll. From their recent work on photosynthesis, the children will realise that this implies a special food problem—the plants cannot obtain carbon from the air and manufacture starch.

In consequence, they all obtain their "organic" food; i.e., food containing carbon, and incidentally nitrogen (for without CO₂ to make starch, they cannot carry out the process of building up tissues with nitrates),

by feeding upon plant or animal tissues. If they feed on living animals or plants, we call them parasites, while if on dead tissues, they are called saprophytes.

The structures which have been collected are not the main part of the plant but correspond to the fruits of flowering plants. To find the vegetative part, we should have to cut into the tissues upon which they were growing. One can, however, see something of this by examining dead leaves among which toadstools have been found growing. A plentiful supply of such leaves should be provided for the class to examine; beech leaves are perhaps the best for the purpose.

On looking at a mass of beech leaves which have lain for some time on a wood floor, it will frequently be found that they stick together in clumps. On separating them, one can see that they are closely interwoven with white threads, making a thick mat, often following the pattern of the veins. These threads penetrate the whole substance of the leaves. They are the fungus plants. They are called *hyphae* (sing. *hypha*) and the network or web formed is called a mycelium. These threads are capable of sucking in and digesting the food they need from the plant or animal on which they are living.

A "brick" of mushroom "spawn" is really a mass of mycelium holding together dung, roots, soil, and decaying grass or fibre. If a piece of mushroom spawn is broken into small pieces and handed round, the children can see, especially with the help of a hand lens, the delicate white threads penetrating the substance.

2. Fruit bodies.—The mycelium can go on living for years in many cases. From time to time it produces the fruit bodies which are familiar to us. In the case of toadstools, a number of hyphae collect together and form a small knob, which then swells up and becomes distinguishable into a head and stalk. The whole structure may be covered by a sheath or universal veil, which breaks as the cap expands, sometimes

leaving a collar, the volva, round the base, or a few scales on the cap (the white scales on the scarlet fly agaric are an example).

A delicate skin binds the edge of the cap to the stalk, the secondary veil. This also is broken as the cap spreads out and sometimes it leaves a marked ring on the stalk, Fig. 95.

3. Spores.—When the cap has expanded, the purpose of the toadstool becomes clear. The under surface of the cap is thrown into radiating folds, called gills, covered with a delicate skin. This skin bears thousands of minute masses of protoplasm—or cells—each capable of germinating under suitable conditions and producing a new plant. They

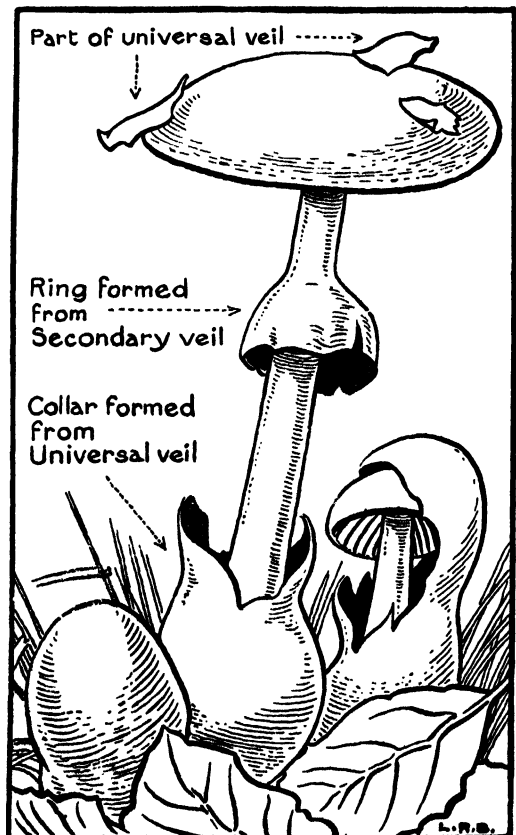

FIG. 95. A PALE YELLOW TOADSTOOL—THE DEATH CAP OR DESTROYING ANGEL (*AMANITA PHALLOIDES*)

are called spores, Fig. 96. Amongst the non-flowering plants they are the chief means of reproduction and are found in many kinds of plants, including seaweeds, mosses and ferns and horsetails as well as fungi.

In order to see the spores, cut off the caps of some toadstools and place them spore side downwards, some on dark and some on light paper. After a few hours the spores will be thrown down, forming the pattern of the gills on the paper in a fine powder, "spore prints." Spores may be white, red or pink, brown or black.

Spores are usually carried away by wind but may be carried by animals such as slugs, mice, beetles, flies and perhaps squirrels. Their dispersal is haphazard and undoubtedly many are lost; consequently great numbers are needed. The various forms taken by the fructifications are devices for producing very large numbers of spores in a small space. The classification of fungi is based upon these devices and upon microscopic details connected with them. Thus the toadstools (and mushrooms) bearing their spores exposed on gills belong to the large group of agarics; the brackets, stump flap and boletus have the spores protected by narrow parallel tubes penetrating the cap. They are called polypores. The candlesnuff and coral spot have a different system altogether, for their spores, instead of projecting, are enclosed in flasklike cells which can be seen only with a microscope, lying immediately below the surface skin. These are collected together into elaborate organs, but the detail is too difficult for children.

Puffballs contain their spores in a network which forms the inside of the ball. When this eventually breaks open, the slightest knock will cause them to emerge like a cloud of smoke, giving the fungi their name.

Practical work.—Let the children draw several types of fungi, indicating their spores and bringing out these points clearly in the

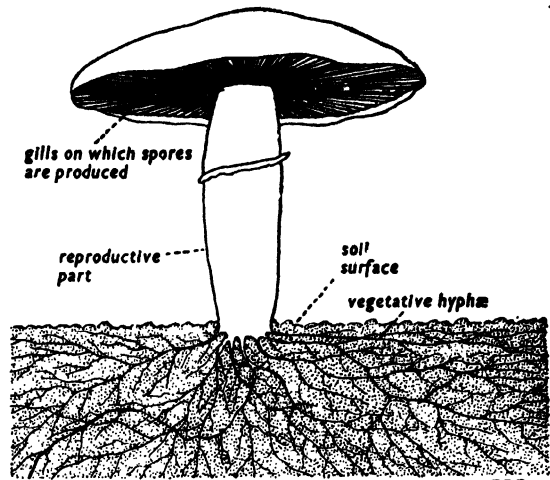

FIG. 96. MUSHROOM

sketches. Note at the same time when and where they grow.

If possible, let them examine some spores under the microscope by shaking them on to a dry slide. The clear, colourless protoplasm and coloured protective wall can be seen. Also make as many spore prints as possible.

4. Moulds and mildews.—The majority of toadstools are saprophytic, though a few (e.g., the honey-coloured toadstool, which is injurious to living as well as dead trees) are both saprophytic and parasitic. Amongst the lower fungi we find a great many which are injurious to living plants and animals, especially to plants. If a search is made amongst the plants of shepherd's purse growing as weeds in the garden, one frequently comes across a white fluffy mould protruding from cracks in the stem. If this can be procured the children should examine it.

If so-called "ants' eggs" have been used for feeding goldfish, and these are left in the water, they frequently become infected by a mould, appearing again as white tufts. These are the spore-bearing parts—the mycelium, which cannot be seen, has grown into the tissues and, in feeding upon them, has destroyed them.

If a few "ants' eggs" are left in stagnant water it is usually possible to secure this mould. Both of these are parasitic, but the second can be saprophytic as well. It spreads to goldfish, beetles and other creatures in aquaria. A saprophytic mould can be grown on damp bread covered with a jam jar and kept in a warm place. It is a good plan to stand a saucer containing the bread in a shallow dish of water, which will keep the air in the jar moist. After two or three days the bread will probably be covered with a fine white fluff, and a day or two later with small black dots like pinheads. This is called the pin mould (*mucor*). The black dots are hollow balls, containing spores. They burst and the spores shoot out, alighting on the glass and on the saucer all round the mould. If a little of the ripe mould is placed under a microscope, on a dry slide, the tiny spore cases can be plainly seen.

Other moulds of different colours, will probably make their appearance on the bread. If the jam jar is removed, it will be found that the bread has a peculiar smell—sour, musty, acrid, possibly slightly alcoholic, showing that chemical changes have taken place in its composition. If it is broken it is found to have changed colour and texture, while the mycelium of the mould has penetrated throughout. Other moulds may readily be grown on cut lemon ("green mould" usually); on home-made jam kept moist and warm, and on cheese. These illustrate the great variety of saprophytic moulds, while the change of smell and colour indicate that the mould is affecting the tissues on which it lives—they are fermenting, in fact. The spores of these moulds seem to be present in dusty air, and on all exposed surfaces—window ledges, tables, floors. The slightest disturbance will set them floating about, to settle again and, if they are on suitable materials, grow.

5. Economic importance of fungi.—Following the practical work described, the study may be concluded by giving the children

some idea of the importance of fungi in the life of man.

The agarics, polypores and "higher fungi" generally are of comparatively little importance. Here and there we find an instance of injury, like the damage to wood by the honey-coloured toadstool, or the more serious "dry rot" caused by a large, spongy fungus which spreads through floors and woodwork of houses, where the floors are not properly ventilated. On the whole, the chief importance of the fungi is that they help to start the processes of decay which eventually reduce plant and animal tissues to the condition when green plants can use them as food. Although a few can be eaten, their value as food is not important.

Amongst the lower fungi of the type found on shepherd's purse, there are, however, many which cause serious plant diseases. One of the most dreaded is the potato blight. The spores of this fungus are carried in England by south-west winds and, dropping on the fields in rainy weather, immediately break up into a number of peculiar spores, called zoospores (i.e., animal-like) because they are capable of swimming actively in the damp soil, or in rain or dew on leaves. These zoospores germinate, each forming a short hypha which penetrates a leaf (often by a stoma) and soon branches and forms a mycelium in the leaf. Eventually the whole plant becomes rotten. Then the mycelium sends branches to the under surface of the leaves, where they form a delicate, glistening film of threads. From these threads minute spores are budded off. Where once the pest occurs it is exceedingly difficult to get rid of, for wind-borne spores, zoospores, and broken bits of mycelium, rotting tubers and rotting leaves all tend to spread and perpetuate it. It is checked by spraying with Bordeaux mixture (copper sulphate and lime) and by treating the soil with gas lime.

This illustrates the type of activity of the lower fungi. Their small size makes them difficult to detect except by the results of their activities, when the damage is already

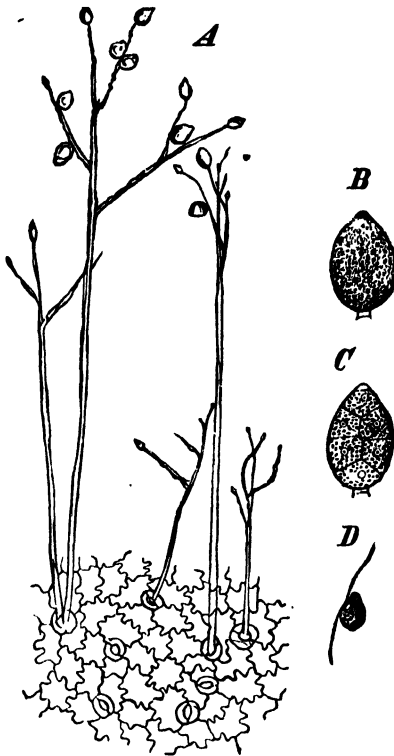

FIG. 97. LIFE HISTORY OF POTATO BLIGHT

- A. Branches growing through pores of leaf surface, to scatter spores.
 B, C. Spores, called conidia.
 D. Free-swimming spore or zoospore.

well under way. Other fungi cause mildew on rose and vine leaves, "rust" and "smut" on cereals, "damping off" of seedlings which are over-watered and not given sufficient air.

Comparatively few fungi attack living animals, but one well-known example is the cause of ringworm in man.

LESSON UNIT IV—SOIL

Introduction.—It has already been said that plants obtain both water and a certain amount of their food from the soil. Since all animals ultimately depend on plants for food, it follows that if men are to grow crops for their own and their animals' use, they must have some knowledge of the character-

istics and properties of soil. The characteristics which may affect the growth of plants may be either chemical, physical or biological.

Development—1. Chemical composition of soil.—Chemical composition refers to the actual substances of which soil is made. The soil particles will have a particular composition according to the rocks from which they are derived, for it was mentioned in a former lesson that soil is formed by the weathering of rocks. Amongst others may be mentioned limestone, chalk, granite, silica, felspar. From the point of view of the plant's needs, these are chiefly important according to whether they are soluble in water or dilute acids, and contain substances of any value as food when dissolved.

In addition to rock particles, there are finely divided plant and animal remains. The plant remains eventually assume the form of a soft, dark brown substance, capable of holding a good deal of water. This is called humus. For many years it was considered that this was the form in which plants made use of soil substance as food, but it is now known that much more breaking down must take place, producing simpler substances which are absorbed. This is where the biology of the soil begins to be important, for it has been found that tiny living plants called bacteria inhabit the soil, and in the course of their life activities break down humus and render it both simpler and soluble, so that the roots of plants can at last absorb it. Further reference will be made to this later in connection with bacteria.

Recall the experiments made with the growth of plants in culture solutions, and the effect of adding different artificial manures in the garden. In making these experiments, chemical substances which are normally present in soil were used to show what part they played in helping plant growth. One of the most important is nitrate, which may be present combined with various elements, calcium, sodium or

potassium being the commonest. Nitrates are derived largely from animal remains and excreta, but an important source is again connected with the activities of bacteria. So valuable are nitrate supplies that wherever considerable deposits are found they are highly prized commercially. Chili saltpetre and various deposits of bird droppings in great quantity, called guano, are the most important. Plants are always exhausting the supplies in the soil and so cultivators must constantly find fresh supplies.

Plants of the bean, clover and lupin family (Leguminosae) have long been known to enrich the soil with nitrates, but it is only since the discovery of bacteria that it has been realised that this too is due to their activity. Certain bacteria live in the roots of these plants, forming what are called nodules, which are little swellings. Examine some clover or bean roots to see these. It has been found that they can take nitrogen out of the air and change it into nitrates for their own use—a feat as marvellous as that of the green plants taking in CO_2 and manufacturing starch. These bacteria make far more nitrate than they need, and the surplus is partly used by the plant on which they are living, partly left in the soil, which is thus enriched.

It will be seen that in discussing the chemical properties of soil it is not possible to separate them from biological factors, since both bacteria and animals contribute to the nitrate supply. One other chemical substance which is important to plants should be mentioned, and that is lime or chalk—calcium carbonate. It not only keeps the soil from becoming too acid or “sour” but it also seems to help plants to make use of other substances which they need. It is said to “unlock” other substances, a word which covers complicated chemical changes in which the lime plays a part, resulting in making insoluble substances soluble and therefore available. It further helps to make heavy clay soils workable, that is, makes them easier for the roots of plants to penetrate.

2. Physical properties of soil.—Certain physical properties of soil are also important to plants—the coarseness of particles, the amount of humus in relation to other substances, coldness, and wetness—that is, capacity for holding water, capacity for drainage and for soaking up water from below. These properties will depend very largely upon the chemical nature. The teacher who wishes to do much work on soil in connection with gardening should get Sir John Russell’s little book, *Lessons on Soil*, and should also consult his larger works and those of Hall, and the publications of the Rothamsted Experimental Station of which Sir E. J. Russell is director.

Let the children carry out the experiments described at the end of this section. On completion, the results obtained should be summarised and discussed, and conclusions drawn from them, which will be somewhat as follows:

Soils may have a preponderance of clay, chalk or sand. Sandy soils with a fair proportion of humus are called light loams; clay soils made less adhesive by humus are heavy loams. Most soils contain all three constituents, together with humus. Subsoil contains little or no humus.

When equal quantities of water are poured upon pure clay, chalk and sand, so that the water can drain through, the sand will drain more quickly than the other two and will allow more water to percolate through. The clay will hold the water longest and allow less to drain through.

Consequently, clay soils are likely to hold water, and to be wet and therefore cold; chalky and sandy soils will be dry, and therefore inclined in the summer to be very hot, but at other times to be warm enough for roots of plants to live and work actively. Clay soils are apt to be very cold and water-logged in winter.

When the soil is saturated with water there are no air spaces. The space available for holding air and water must be the same. Roots need air for breathing and cannot

live long in either hard and compressed, or waterlogged soil.

The application of this fact to gardening will show why it is necessary to hoe and fork the soil frequently. It assists drainage while at the same time distributing the moisture evenly, and preventing evaporation by protecting the soil below the surface from dry air and rain.

It will be noticed that when a small brick of clay is made it expands when wet but shrinks and at the same time tends to crack as it dries. Applying this to clay soils, the caking and cracking of the clay are both objectionable to the roots of plants.

A property of importance to roots is the ability of soil to raise water which has drained to lower levels, probably to a water table. This is due to the force known as capillarity. The word *capilla* means a hair. The walls of very fine, hairlike tubes cause liquid to adhere to them with sufficient force to draw it up. The finer the tube, the higher the water is drawn, Fig. 98. This enables roots to use supplies of water which would otherwise have drained away beyond recall. Deep-rooting plants, such as trees, and plants which are generally

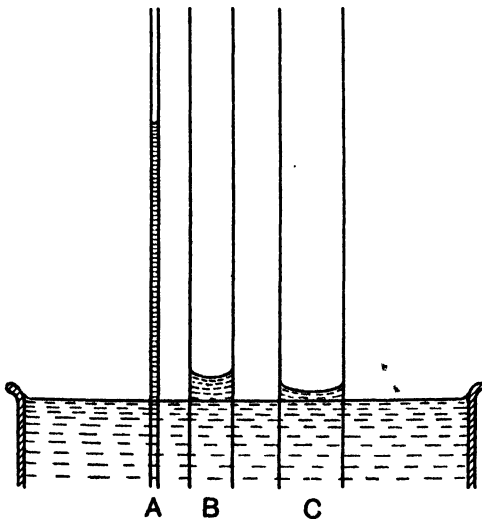

FIG. 98. TO SHOW CAPILLARY ATTRACTION
A. Capillary tube. B, C. Wider tubes.

found on clay soils, such as wild parsnip, have long tap roots which do "tap" these underground supplies, whereas plants with short roots, such as most cereals, must depend on surface supplies and therefore need a plentiful, regular rainfall in their early growing stage. Differences in rainfall (both quantity and time of occurrence) will, under natural conditions, determine whether grass (prairie, steppe) or woodland vegetation will be established.

Let the class examine and sketch some plants with tap roots and some with adventitious roots, noticing the shape, distribution of roots, and area covered, Fig. 99. Adventitious roots are frequently characteristic of plants with creeping surface stems, which root at intervals and so cover a large space with numbers of short tufts, capable of extracting water from a large surface area; e.g., white clover, creeping buttercup, cinquefoil, violet.

3. Biology of soil.—Apart from the presence of bacteria, whose work in the soil is of such great importance to crops, there are many other inhabitants of soil. Some of these, for instance the protozoa, are invisible. These include certain very primitive and minute animals, amoebae and still smaller related forms. Some of them are important from our point of view because they feed upon bacteria. Counts have shown that the numbers of bacteria and these small protozoa fluctuate in a definite relationship. If there are many protozoa, the bacteria diminish; then apparently for a while the protozoa have not enough to eat, and their numbers decrease until the bacteria have recovered again.

Amongst animals large enough to be seen are earthworms; beetles and their larvae; the larvae of many flies feeding upon dung or humus; wolf spiders which prey upon all these; centipedes feeding on worms and grubs; millipedes feeding on plant remains and roots of living plants; and a multitude of insects—such as, for instance, the onion fly—hatching from eggs laid in soil but



FIG. 99. DIFFERENT TYPES OF ROOT—PARSNIP, COUCH GRASS, CREEPING BUTTERCUP AND A TREE

finding their way to plants which they infest, causing disease. Many beetles hunt and kill insects, worms, slugs and snails, while the much larger mole does the same. In the winter, in addition, countless small creatures hibernate in soil though their active life is spent elsewhere. This brief summary is enough to show that, from the point of view of plant life, and therefore in connection with agriculture, the biology of the soil cannot be ignored.

PRACTICAL WORK

1. Experiments on the lime content of soils.
2. Experiments to find out some of the physical properties which affect plant and animal life in it.

Samples of air-dried soil from a well-cultivated garden will be required and if possible from other situations where

it is poorer in humus. Sand, clay and chalk.

Refer again to the importance of the soil to many plants and animals, and ask what conditions it provides. It will probably be suggested that the soil gives water to plants, shelter, food and the necessary dampness to earth-worms and many ground-dwelling insect larvae, centipedes, millipedes, woodlice and so on. It also affords means of keeping plants upright. Suggest trying to find out of what substance soil is composed, and which of its physical characteristics might be important to living things.

(a) *To find out of what soil is composed.*—Remind the children that a great deal of leaf mould is added to the soil each year as leaves fall and decay (aided, as we know, by fungi and bacteria). The dying down of herbaceous plants also adds great quantities. Ask them to try to think of some way of isolating the plant remains so that they can

compare the amount present in equal quantities of soils taken from different situations.

Tell the class that it has been found that humus is lighter than the other substances in soil, and that this has suggested a means of separating it out. Take a little fairly rich garden soil, and shake it up in a tumbler of water; then watch it settle. At first the water will be very muddy, presently only cloudy, with a fine suspended sediment. Pass it round, holding it very steadily so as not to shake it. It will be noticed that most of the soil is at the bottom, and that it is settling with the coarsest underneath and finer soil forming an upper layer. Very fine soil is still floating in the water, and on the surface are irregular soft masses of decaying plant tissues, together with recognisable scraps of less decayed leaves, roots and stems. The formless, soft brown substance is humus.

The surface may be skimmed and the scum dried. Let the children, in groups, repeat this with various soils and compare results.

Note.—It is not necessary that all the children should perform every experiment. It is quite a good plan to divide them into groups, giving each group a certain section to carry out; then let one member of each group demonstrate what has been done, explaining and illustrating the method of procedure, and stating what result was obtained and conclusion drawn. Blackboard summaries might be made and copied by the rest. The following scheme for recording experiments is clear:

Aim—To see whether there is any humus and plant fibre in a certain soil.

What we did.

Result—or what happened.

Conclusion—or what we deduce from the experiment.

Note that the aim of an experiment should be stated as an *inquiry*, not to *show* or *prove* that a particular result will be obtained. The children should not be told what result to expect from their experiments. This applies generally.

Ask what other substances besides humus the children think may be present. What makes the bulk of the soil? This is the next inquiry. Let the children try to think of some way of separating what is left. Perhaps some of them will remember that there was some fine substance held in the water for a long time. Here is the clue. Let us wash and wash the soil and keep all the fine substance we can pour off. How can we collect and examine it? In time perhaps that would sink to the bottom and could be collected. But a quicker way would be to drive off the water by heating it and leave the substance behind. Old saucepans or any kind of metal vessels that will resist heat can be used for this; tin cans will serve if they can be made perfectly clean. In the laboratory a porcelain dish over a sand bath would be used. If possible allocate this experiment to be carried out by a second group. Failing any appliances, the teacher will have to conduct these experiments while the children look on; but it is much better if the children can take part. Any small oil stove can be used if a gas ring is not available. This experiment takes time and the vessel will have to be left heating till the water has evaporated. As an alternative method shallow vessels can be used and left in the sun for evaporation.

The same method will be applied to the first sediment. It will be repeatedly washed and the liquid evaporated (either over heat or spread out in the sun) until a graded series of dried samples is obtained. These will be found to consist of fine gravels, coarse sand and fine sand. The finest substance will probably be clay. If so, it is a very smooth, non-gritty powder which sticks to the finger. If moistened again and allowed to dry it will crack. It will also be found to shrink into a smaller space as it dries. To test this, fill any small vessel to the brim with wet clay and see what happens as it dries.

We conclude, therefore, that soil consists of humus, clay, sand and gravel.

(b) *To find out how much water the garden soil holds.*—The children know that a

garden needs rain or artificial watering, and that both plants and animals need the water. Ask how we could find out how much water soil will hold. By discussion the following points should be brought out:

- (i) That the soil must be dried or we shall not know whether it already contains some water.
- (ii) That if we pour water on, we must know how much.
- (iii) That if the soil is in a vessel, so that the vessel holds the water, it is not possible to say when the soil is exactly full.

The third point will probably cause some perplexity. The soil can be air-dried and the water to be poured on measured; but how shall we know that the soil is full? The teacher will probably have to point to a solution. If a funnel is used, the water can pass right through, and we can measure both what goes in and what goes through. It will also be necessary to know how much soil is being used. This can be measured either by weight or volume. The simplest way, if only makeshift apparatus is available, is to graduate a straight-sided glass vessel of measured capacity, marking the volumes on the outside with strips of paper, and then use this for all measurements. The bottom of the funnel should be lightly plugged with cotton wool. It will be seen that the water comes through with a rush at first, then much more slowly, and finally only an occasional drop. If we wait too long there will be evaporation. So we see that the time element comes in also, and we have to notice how long we leave the water on the soil before measuring what has come through.

The same method can be applied to powdered clay, chalk and sand. Note here how important time is, for water runs through sand very quickly, and through clay and chalk more slowly, though the porous chalk rock, which has not been powdered, drains rapidly.

(c) *To find out how much air soil will hold.*
—Discuss the need for air in soil. Animals

most certainly need it to breathe. The children do not yet know whether the roots of plants need it, but they may have heard of soil being waterlogged, and that it is left roughly dug in the winter, or hoed in the summer, to let air get into it. With a little thought they will see that they have already measured the air space, for it must be the same as the water-holding capacity.

(d) *To see what happens when there is water down below the soil.*—It has probably been noticed in very dry weather that many of the plants look quite strong and vigorous, and do not seem to need watering, while others wilt easily. If possible dig up a plant of each kind and show the difference in the length of roots. The deep-rooted plants must be able to reach down to water somewhere. Some of the rain drains away underground and at last reaches springs or rivers, but some of it remains deep in the soil and keeps it damp. Show what a little way you need to dig in the garden in dry weather to come to damp soil. Now suggest that we might see what happens when we place dry soil so that there is water touching it underneath.

A lamp glass may be filled with soil and stood in shallow water. The soil should be tightly packed. Gradually the water will be seen to rise in the soil. An investigator who carried out this simple experiment fitted a piece of blotting paper on to the top of the soil; the paper became wet when the water reached it and so gave additional evidence. She also tied a piece of filter paper over the bottom to prevent the soil from coming out into the water.

This property of soils is one common to all narrow tubes, for it is to the walls of the narrow tubes formed by adjacent soil particles that water adheres and so is drawn up. The walls exert force, called the force of capillarity.

If it is desired to compare the capillarity of the different soil substances—clay, chalk and sand—glass tubes about 2 ft. long and $\frac{1}{4}$ in. in diameter should be carefully packed with these substances, so that there are

no spaces, and lightly plugged with cotton wool at the bottom, then clamped upright in basins of water. As the water rises, the level may be marked, Fig. 100. It will be found that the water rises quickly in the sand to begin with but soon stops, whereas in clay the rise is slow but continues for many days to a greater final height. At first the rise will need to be marked at very short intervals.

3. The biology of soil offers a good opportunity for individual studies during the winter months. Digging in the garden is the best way of finding out what inhabitants there are in the soil. Watch the habits of animals disturbed, collect specimens to examine in the classroom, making small

vivaria to contain damp soil—tumblers with fitting caps are useful, but air must occasionally be admitted. Some of the animals remain active, others hibernate, some caterpillars and chrysalises and snails enter the ground only to hibernate, living above the surface at other times. It is possible to keep these, and the larvae of beetles, and so work out the life histories. Some beetles feed on vegetable matter but others are voracious flesh feeders, and appropriate food will need to be supplied. Those that feed on slugs and grubs are, of course, allies of plants, while those feeding on roots and leaves are enemies. Notes should be made on these points as they are observed.

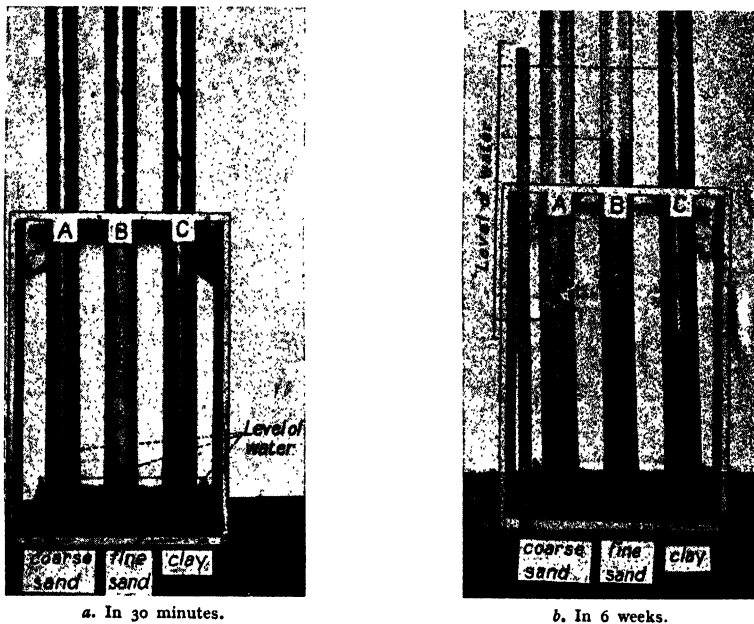

FIG. 100. TO SHOW RISE OF WATER IN TUBES PACKED WITH CLAY AND SAND

WINTER—SPRING TERM

LESSON UNIT I—THE OXYGEN AND NITROGEN CYCLES: BACTERIA

Introduction.—Recall to the class that in considering the functions, or activities, by which living creatures carry on their lives, we have found that both plants and animals must feed and breathe. All require that their food shall contain nitrogen in the form of nitrates, for these are essential for building up tissues. The children will know from their hygiene lessons that the three chief food substances required by animals are carbohydrates, fats and proteins. Proteins differ in composition from carbohydrates and fats in that they contain nitrogen. Carbohydrates and fats are useful for providing energy rapidly, while proteins are built up into tissues—bone and muscle—which are also available for energy, but not so rapidly. In order to set free energy oxygen is required, and this is obtained by breathing.

Consequently, the necessity of obtaining both oxygen and nitrogen presents both plants and animals with two of their great problems, and in the solution of these problems they depend upon one another. The chemical changes which take place, in the course of which animals and plants are able to supply their needs, are sometimes referred to as the oxygen cycle and the nitrogen cycle.

Development—1. The oxygen cycle.—Both plants and animals take up oxygen from the air in breathing. In the case of animals and plants living in water they obtain it in solution in the water. We have already noticed that the animals in water sometimes have difficulty in obtaining a sufficient supply. Now during the process of photosynthesis carried on by plants during the daylight, oxygen is given out. Consequently the supply of oxygen, depleted by both

plants and animals during the day and night in breathing, is renewed again by plants during the daytime. At the same time we must recall that plants are taking CO_2 out of the air in the daytime in order to obtain their supply of carbon to build up carbohydrates. In this way, in serving their own ends, they perform a double service to animals, for they both supply oxygen and remove the injurious CO_2 which would be poisonous in large quantities. This is the oxygen—carbon dioxide cycle.

It may be expressed in the following way as a blackboard diagram:

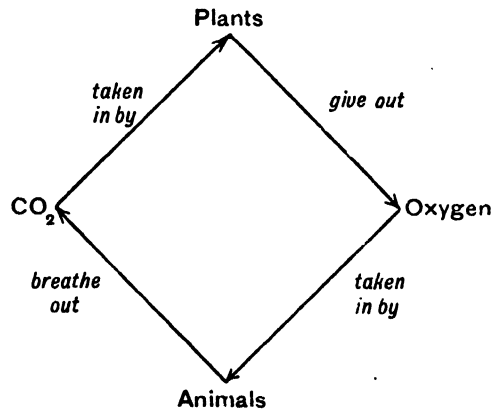

2. The nitrogen cycle.—Both plants and animals need nitrogen, but since animals are more energetic than plants (that is, are more active, and so use more energy) they need proportionately more.

Nitrogen exists in the atmosphere as a gas, in the proportion of $\frac{1}{4}$ to $\frac{1}{5}$ of oxygen. It is called an inert gas; its properties are mainly negative and it will not support life; its presence in the air, however, causes life to go on more gently and slowly than it would in an atmosphere consisting of oxygen, in other words we should "burn out" much more rapidly without it. Animals and plants, however, cannot use nitrogen in

this form. During thunderstorms the electric currents (lightning) passing through the atmosphere and the falling rain convert a small proportion of nitrogen into nitric acid, which is washed down into the soil and may in due course combine with other substances to form nitrates, the form which plants require, but this minute supply would do nothing appreciable to meet the demands of living creatures.

Fortunately for the rest of the world, there exist in the soil millions of microscopic, invisible bacteria, which also, being alive, need nitrates, and as we noted in the lessons on soil they are capable of supplying themselves from the free nitrogen gas of the atmosphere. Some of these bacteria live freely in the soil, others in the root nodules of leguminous plants. In both cases, they manufacture far more nitrates (or as we say, fix more nitrogen) than they can possibly use. The surplus is available for plants in a soluble form which the roots can absorb.

The second great source of nitrate supplies is the store locked up in the dead bodies of plants and, much more, of animals and in the excretions of animals. This store, no longer needed by the creatures themselves, would if returned to the soil help to enrich it and so to feed plants, and in fact plants are largely dependent upon these animal supplies. But they have no means of obtaining it for themselves. Animals can obtain their nitrates (in the form of proteins) by feeding upon flesh, but herbivorous animals must obtain it from plants and the plants must obtain it from the soil.

To understand the links in the chain, we must follow what happens to dead plants and animals. When they fall to the ground they are at once attacked by countless bacteria (and to some extent fungi) which begin to feed upon them. This starts certain chemical changes, which we call fermentation and decay. The bacteria use some of the substance, and in so doing break up the mass into simpler things. More bacteria take up the work, one kind after another,

each kind supplying themselves with the energy they need, and at last the mass of decaying substance is turned largely into the simple, soluble nitrates which the plants require. This is what is happening in every manure heap, sewage farm, refuse dump and heap of dead leaves, or in the fallen bodies of birds and other animals. It may be helped in its first stages by other animals—the grubs of flies, burying beetles, rats and carrion birds. In hot countries there is no doubt these animals do a great service in hastening decay, for in a few hours nothing will remain of a putrid mass but clean, dry bones.

It is worth while trying to understand something of this nitrogen cycle, whereby plants obtain nitrates from dead bodies, and living animals by feeding upon plants, and also realising the part played by bacteria, for it is literally on this activity that our life is based. Without the unconscious help of plants, including bacteria, and animals, man could not exist. We may represent the processes by the following diagram:

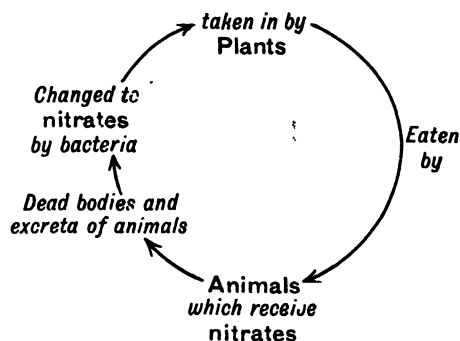

Bacteria are so extremely minute that it requires some practice to detect them, even with a high-powered microscope. It is therefore impossible to show them to a class of children, but it is possible to show their presence in soil by their effect. We have stated that they cause fermentation of "organic" substances; that is, substances which form part of the bodies of animals or plants. Such fermentation during decomposition or decay is usually accompanied by

a strong smell. Many of these smells are familiar—the smell of sour milk, of “high” meat, of bad eggs. Where animal proteins are being decomposed they are usually accompanied by very “bad” smells, and the process is called putrefaction.

Now if we take a little of several animal substances, such as meat or chicken broth and milk, and boil them, we kill any existing bacteria and so sterilise the fluids. If they are boiled in flasks or test tubes lightly plugged with cotton wool, the plug is sterilised at the same time and, since no more bacteria can enter, no decomposition takes place and the broth and milk remain fresh and sweet.

At the same time, prepare a duplicate set of test tubes or flasks with similar contents. With forceps which have been dipped into boiling water, remove the plugs and drop into each a little garden soil; then replace the plugs. Leave the two sets of test tubes for several days. Then remove the plugs and *smell* the contents. The broth and milk which had soil dropped into them will, by their strong smell, show that putrefaction has taken place, while those from which the plug was not removed will be without smell.

Note.—If the sterilisation was not absolutely carefully carried out there may be a slight smell, due to the entrance of some bacteria from the air, but even so the difference will be quite marked.

Since the only difference between the two sets of material is that one has had soil added, the inference is that bacteria have been introduced with the soil.

Note, however, that we have not proved this, but merely illustrated the effect of the activities of soil bacteria.

We owe our knowledge of the activities of bacteria largely to Louis Pasteur. Although he did not actually discover soil bacteria, his work on bacteria in sewage pointed the way to scientists who were working on soil, and it was he who discovered how to sterilise fluids by boiling and keeping them corked, so preventing further infection.

This leads to a few words on infectious diseases. Though this will probably be dealt with in hygiene lessons rather than in biology, the children should realise that the activities of bacteria are very wide and that in the course of living their own lives various kinds of bacteria may be either beneficial or neutral in their effects; that is, having no effect one way or another, but that a comparatively small number have taken up their abode in or on the bodies of man and animals, and in so doing, some—by no means all—cause disease, for, as animals do, they form waste products and it is usually these waste products that are poisonous, just as an animal would be poisoned by its own waste products if they were retained in its body instead of excreted.

It is difficult to give any impression of the nature of bacteria unless they can be shown, but the children may be told that they are exceedingly minute, moving bodies, spherical or rodlike or spiral in shape, sometimes attached together in chains, Fig. 101. They

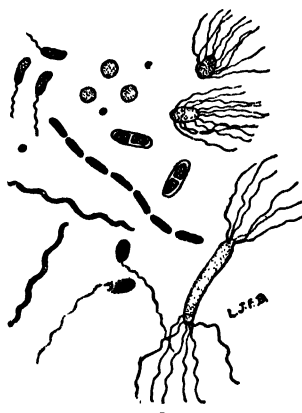

FIG. 101. SOME FORMS OF BACTERIA

are colourless bits of protoplasm, and they are regarded as plants because they can take in only liquid food. The round ones may be about $\frac{1}{1000}$ millimetre in diameter while the rod-shaped ones may be as much as $\frac{1}{100}$ millimetre long, but it is difficult to imagine what these measurements mean.

They are very, very much smaller than the tiniest amoeba. A speck of dust might carry hundreds of them.

LESSON UNIT II—BIRDS, AND THEIR IMPORTANCE TO MAN

This subject will fall into two parts, a theoretical and practical section studied in the classroom, and out-door study undertaken by the children, with the object of learning to recognise common birds and observing the habits and characteristics to which attention has been drawn by the teacher.

Understanding of the part played by birds in relation to other living creatures, and especially their relation to man, should be based on observation to have reality. It is suggested, therefore, that an introductory lesson drawing attention to the general characteristics of birds should be given, followed by practical work, which would consist of attempts to recognise and observe common birds, and an examination of stuffed birds, skeletons and feathers, in order to understand the bearing of structure upon flight. The following points should be made clear and discussed in the introductory lesson:

1. BIRD STUDY

Birds, through their power of flight, have attained control of a much wider field than most other animals. This power of flight

is the clue to the special characteristics, both in habits and structure, which distinguish birds from other vertebrate animals. It has made accessible great varieties of food, and enabled the birds to search a wide area rapidly in the quest of it. It has enabled them to choose safe, hidden nesting places, not easily reached by their enemies. It has led to the habit of migration, so that birds can leave their native locality when shortage of food and hard climatic conditions set in, spend the winter in a milder climate where the worms and insects which are their chief food supply are not driven into hiding or killed by cold, and return, probably to their racial home, for the breeding season.

Migration is not peculiar to birds, but it is a much more widely spread and systematic habit amongst them than amongst any other animals. Besides the migrants which seek a new country in the winter, there are others whose migration is limited to a narrower range. They move inland from the sea-coast (gulls, many waterfowl), from northern to southern counties, or from woods, coppices and hedgerows to the open fields, as, for instance, do the chaffinches. It is characteristic of many of the smaller birds to flock together in one sex during the winter, males in one flock and females in the other, and in some cases the flocks contain birds of different kinds (house sparrows and chaffinches, or starlings, rooks and jackdaws). They search the ploughed lands particularly for food.



In the spring, urged by the reproductive instinct, the flocks separate, return to their breeding haunts, and each male seeks out a territory and stakes a claim which he defends against all comers. Here he and his mate will be able to obtain food and build a nest. Even from foreign shores it is generally noticed that the males arrive first. Authoritative observers of bird life are agreed that the meaning of a bird's song is first of all a challenge to other birds to dispute its territory, and later an announcement to the females in the vicinity that there is a settled home and maintenance assured to the selected mate. No doubt it has other emotional significance as well, and is the expression of the bird's exuberant well-being and desire for a mate.

The variety of sites and materials chosen for nests is very great. Usually birds make a selection from material near at hand, though sometimes they bring back straw, wool, twigs or feathers from a distance. The weaving and moulding of the nest is accomplished by beak and feet, according to an ancestral pattern ingrained in the bird's mental heredity. To some extent it is thought that imitation comes into play, as it has been found that there is a tendency for young males to mate with older females who have already had nest-building experience. It will often be noticed that the hen bird decides the actual position of the nest. The writer has seen a pair of house martins dispute the exact spot under the eaves, and the hen settle the matter by firmly dabbing the first spot of mud on the wall. The male accepted the position and together they laid the foundations.

The nests of birds which build in trees and hedges usually consist of an outer shell of fine interwoven twigs. Such material is sometimes reinforced by mud, as in the case of the thrush, perhaps packed in the spaces with bits of moss, lichens and leaves which may help to disguise it. The nest is then lined with softer materials, such as fine hay, hair, feathers, wool and thistledown, which serve as a bed for the eggs to lie on and

help to retain the heat of both eggs and nestlings.

The young birds need constant feeding. A pair of blue tits are recorded to have worked from 2.30 a.m. to 8.30 p.m. and averaged twenty-six visits an hour. Swallows are said to feed their young once in three minutes. (Morris, *British Birds*.) It has been suggested that one advantage of a northern breeding place is the longer working day it allows for feeding the young. Soft, easily digested, concentrated food is usually provided at first, either caterpillars, fat grubs and worms, or partially digested grain. Pigeons have a special curdlake secretion known as "pigeon's milk."

Although birds are equipped with highly specialised instincts beautifully adapted to their needs, yet there seems to be some room in their lives for education, or learning by experience. This is one of the advantages of their sheltered home life. Those whose nests are not on the ground are hatched at a sufficiently immature stage to be able to profit by intensive individual methods of education. Young birds are both encouraged and taught by their parents. In flight they are shown what to do, a little at a time, urged to try their wings, and sometimes even pushed off a safe ledge into space. They seem to be guided in their choice of food. A hen with chickens can be seen to encourage them to peck at the food she has found for them.

Children are always interested in birds because of their bright, attractive ways, their song, their familiar presence in garden, hedge and field, or on ponds, and the mystery and excitement of finding their nests. It is therefore with these familiar aspects that the study should begin, leading later to some consideration of the characteristics of birds as a group. Begin by noticing the points by which the commonest birds (the sparrows and starling) are recognised, then try to define the distinctive features of other birds, especially the character which strikes you first. Notice (1) peculiarities of movement, (2) colours displayed in flight

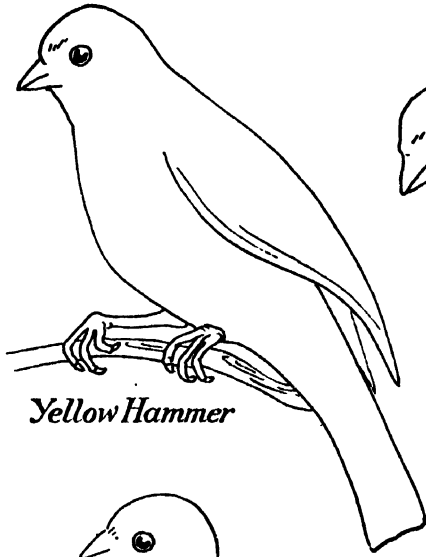

Yellow Hammer

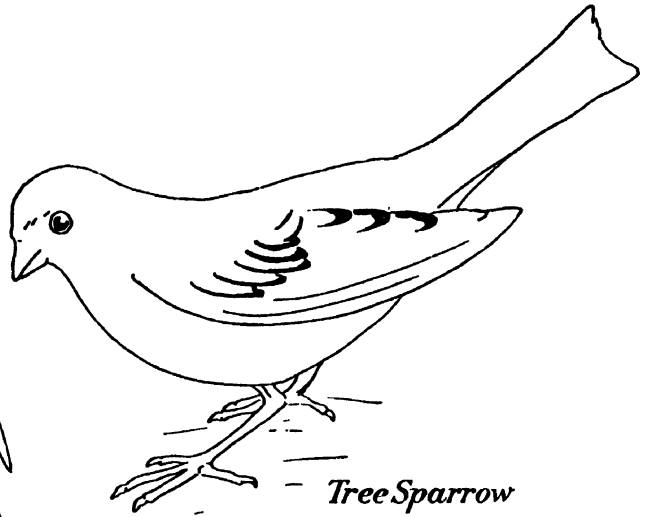

Tree Sparrow

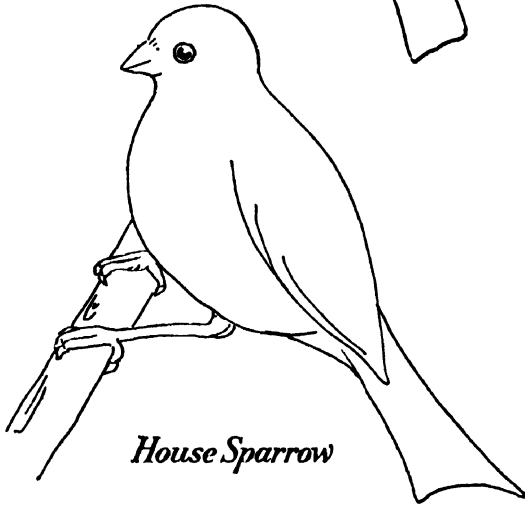

House Sparrow



Chaffinch

which give the bird a different appearance from that you know when it is at rest; e.g., the white bars in the wings of a chaffinch, the brick-red back of a yellow-hammer, the pale fawn feather at each edge of the tail in a lark.

2. RESIDENT WINTER BIRDS— HARD-BILLED

Introduction.—A good plan, suggested by Mr. W. P. Westell in his *Bird Studies*, is to give to the children on a postcard an outline of some common bird such as a house sparrow, and let them fill in the colouring as exactly as possible from observation during the week. (Mr. Westell suggests a pigeon.) They may be asked what they know of its colour, and then set out to verify their own impressions. Many will say it is a little brown bird. Ask how they would distinguish it from a robin, a linnet, or any other small, brown birds that are common in the neighbourhood. Ask what other birds they know and how they would recognise them. Get an account of some distinguishing feature of each, and then suggest that the children shall try to observe other details during the week.

Referring to the house sparrow again, ask if the cock is like the hen in colour, and whether young birds can be distinguished among the others. Give them two postcards with outlines, one for the colours of the cock and one for those of the hen. Suggest that they shall look for the colouring of head and neck, breast, wings, back and tail.

Find out what the children can tell you about the habits of sparrows and any other common birds. With the children's help make a short list of birds that can be seen in the neighbourhood, and then give the children a set of questions to guide them in deciding how they can be recognised.

Questions.

1. Where do you see the bird most?
(Hedges? fields? woods? gardens?)

2. Does it come out into the open, or keep in shelter?
3. Is it tame or shy?
4. Do you see it on the ground?
5. Does it hop, walk or run?
6. Is there anything by which you can recognise its flight?
7. When does it get up and go to bed?
8. Has it any striking colour?
9. Does it sing, or has it any call notes?
10. What does it feed on, and how?

If the questions are read through, and related to the list of birds just compiled, many children will have answers to suggest, and if these are discussed the class can be asked to confirm the statements by further watching, and to be prepared to give their answers in a later lesson. Perhaps a fortnight might be allowed, and in the meantime the possibility of setting up a bird table, bird bath, or other means of attracting birds, could be considered, and the apparatus could then be assembled and set up.

Collecting of observations made.—The children's notes on the colours of birds might be looked through before the actual lesson, so that the teacher would know how far they had been accurately noted and how far they needed correction or more detailed attention.

Aim of lesson.—To obtain accurate descriptions of the appearance and habits of specified winter resident birds; e.g., house sparrow, chaffinch, yellow-hammer.

Material.—The teacher should have, if possible, coloured pictures of the birds under discussion. A very good series of coloured postcards can be obtained from the Natural History Museum, South Kensington, for 2d. each. If stuffed specimens are available, their legitimate use is to help in recognition, and to give an opportunity of close observation when the living bird has already been watched. It is desirable to have a good reference book, to which teacher and

children can turn for information on any doubtful point. The sooner the scientific habit is acquired, the sooner the children will attain confidence and serious interest. Dr. Sanders' *Oxford Book of British Birds* is an excellent book at a moderate price.

1. Refer to the colour notes sent in (bird diagrams) and make any comments they require. Build up, with the children, the colouring of the house sparrow. (The same diagram enlarged for the blackboard would be useful, or a tabulated summary could be made.) Then refer to the sheet of questions and let the children offer information.

Amongst other points, the following would emerge:—the house sparrow chatters or chirps loudly and continuously in the early morning and at dusk, that is when it gets up and when it goes to bed. It should be noted that the time varies with the time of year. It also chirps excitedly if it is alarmed or angry. It hops on both feet at once. Short flights from a roof to the ground are direct and straight, but in flying horizontally it rises and falls in short jerks or curves, spreading its wings and then shutting them forcibly as it sinks on the curve. This is characteristic of all the finches, of which the sparrow is one. The yellow-hammer has a similar flight, but more sinuous and less jerky. Compare this with the straight, strong flight of the starling and blackbird, or the sweeping curves of the swallows, house martins and swifts (which cannot be seen in the autumn as they have left us). The house sparrow will eat almost anything—crumbs, bits of fat, grain, and in the spring our newly-set peas and grass seed. Notice its short, strong beak, very broad at the base, which enables it to crack seeds. Notice, too, how wary it is when feeding, although it is so tame. Its head moves from side to side, it never stays long in one spot on the ground, and it seems to see every movement and hear every sound. The male has a black bib; the female and immature birds have not. The young birds are lighter coloured.

2. Using these details as a basis, compare the house sparrow with each of the other birds under observation. (Notes on some common birds are appended, as different selections may be made.) Probably only about three birds can be dealt with in one period. If it is possible to enlarge the list, leave further discussion and any attempt to generalise till a later lesson. If the list is a short one, it may be possible to proceed further in this lesson.

NOTES ON COMMON PERMANENT RESIDENTS—HARD-BILLED

HOUSE SPARROW

Appearance—*The male*.—Length 6 to 6½ in. Plump body and short tail. Rounded head, short broad beak. Four toes ending in claws, one turned backwards, as in most birds. Head dark slate-grey, neck chestnut, breast grey, with a black patch over chin and throat. Back, tail and wings mingled light, dark and reddish-brown, the tail being the most deeply coloured. Some of the streaks nearly black. Across the wings is an oblique whitish or pale fawn bar edged with black, very clear in flight. (This distinguishes it from both male and female tree sparrows, which have *two* such wing bars, and a chestnut head. They both have a black bib, which is more extensive round the eyes than in the house sparrow.)

The female.—Smaller, 5½ to 6 in. Paler colouring, less red. No black patch on throat.

Young birds.—Like females, but paler, and plumage often not so smooth. Attain adult plumage after autumn moult. All have duller appearance in winter, owing to dusky fawn and grey tips of new feathers.

Habits.—Lives on roofs of houses, in streets and gardens. Bold, cunning, alert, not easily daunted. Very pugnacious. *Food*: omnivorous, chiefly seeds and grain, but kills many flies and butterflies on the wing, and collects enormous numbers of caterpillars

and wireworms to feed its young, that is nearly all the summer. A calculation was made from observations of one pair, that they killed over 3,000 caterpillars and wireworms in a week. The general impression that sparrows are wholly injurious is incorrect, though they do take a large toll of grain and young seedlings. They destroy crocuses and other flowers, probably in search of minute insects inside them, but possibly wantonly, as they seem to choose the yellow and brightest-coloured flowers. Fond of bathing and dust baths.

No song, but monotonous, loud chirping, often incessant for long periods morning and evening, and if excited. They hop on the ground on both feet, or give little leaps. Flight undulating, except for short distances, or when rising or flying down to the ground. They start their flight with several quick jumps, with wings spread and feathers separate.

Breeding.—Three, sometimes four broods in a year. Nest under eaves, in chimneys and spouts, or in old or stolen nests of other birds. Eggs, five or six, greyish-white, with dusky brown streaks and spots. Vary in size, about $\frac{3}{4}$ in. to nearly 1 in. Nest loosely and untidily made of straw, hay, wool, feathers, sometimes twigs. Cup-shaped and variable, about 6 in. across, sometimes much more. Both parents attend young until fledged, then the father looks after them while the mother prepares for the next brood. All the broods remain in the neighbourhood of the nest. While the mother is sitting, the father and any young which have left the nest, roost somewhere near.

CHAFFINCH

Appearance—*The male.*—Length, 6 to $6\frac{1}{2}$ in. or more. Often slightly larger than house sparrow. Distinguished by slate-blue head and rosy-pink breast, becoming soft dove-grey farther back. In flight, white wing bar and two white marginal tail feathers are conspicuous. Forehead black.

Back chestnut, merging into olive. Dark wings and tail (olive, brown and lead colour), with a yellowish bar in the wings as well as the white markings already mentioned. The bird is very shapely and handsome, and the bright spring colouring appears exotic amongst our birds. It is often mistaken for the bullfinch by casual observers, but is very much commoner. Its colour, though bright, has not the deep rose-crimson of the breast, nor the glossy blue-black of tail and wings of the bullfinch, which is seen in secluded woodlands and gardens rather than in the open and populous places frequented by the chaffinch.

The female.—Slightly smaller, paler in colouring. Head greyish-olive, not blue, breast pale fawn or greyish-fawn, with just a tinge of red. Two wing bars as in male, but less conspicuous.

Young birds.—As female, till after autumn moult. All duller in the winter.

Habits.—Seen about hedges and trees, in the open stubble and ploughed fields in the autumn and early winter; later in the winter they go to the stackyards in search of grain (wheat and oats particularly). They are a great help in clearing the soil of the tiny seeds of all kinds of weeds, on which they feed largely. They feed on the edges of the cornfields when the corn is ripe and have been seen to shell each grain before swallowing it. They will destroy early crops of onions, radishes and other vegetables, and flowers such as polyanthus. On the other hand, besides the seeds of weeds, they destroy leaf-rolling caterpillars which infest fruit trees, and many other species, when feeding their young. They are very watchful, and utter a quick alarm note. In the winter the flocks are generally either male or female, and they are probably to some extent migratory, passing from northern to southern counties. It is possible that those which are seen in the north during the winter have come from other northern countries. (Linnaeus observed that flocks of females left Sweden.) They are amongst the earliest

birds to sing, beginning early in February, and have a cheerful short phrase, ending in a quick run—"pick, pick, pick, pick, little de-ar." In the spring they have the habit of singing from one place, and very persistently, often fairly high up in a tree, but not like the thrush, which stands clear on the highest twig that will support it. The young males begin to sing at about the beginning of August, singing an incomplete song at first. They move like sparrows, with short, quick hops, and their flight is similar.

Breeding.—Two broods are hatched, one about the middle of May, the second by the end of July. The nest, completed about the end of April, is usually in small trees, such as fruit trees; sometimes in tall hedges. It is placed 6 to 12 ft. from the ground, sometimes higher. It is a neat, compact cup, wedged in a fork of branches. Fine materials are used, chosen from what is available in the neighbourhood, so that they vary to some extent. The outside is of grasses, small stalks and roots, tightly interwoven with wool, spiders' webs, or other fine fibres. The upper edge is very neatly woven, the opening being $1\frac{1}{2}$ to $1\frac{1}{4}$ in. across. It is lined with hair, with a few feathers added sometimes. A very characteristic feature, which makes it easy to identify but not to detect, is the outer covering of bits of lichen and moss, taken from the tree in which it is built and therefore disguising it very completely. It has been found by different observers to take from six days to three weeks to construct, then the female sits for eleven or twelve days, and after the young birds are hatched the male helps to feed them. During the brooding time he guards the nest and will try to beguile intruders to follow him away from it by cries and flutterings. Both behave in this way when the young are hatched. There are four or five eggs, rounded oval, about $\frac{1}{8}$ in. long, dull bluish-green, clouded with dull red, slightly streaked and spotted, rather variable. When the young leave the nest they follow the parents and are fed for some days, and by

the time they are fledged have begun to feed on grain.

YELLOW-HAMMER (YELLOW BUNTING, YAFFLE)

Appearance — *The male.*—Length, 7 in. Bright yellow head, neck and throat lightly streaked with olive or reddish-brown, and a little dusky black on the head. The amount of yellow variable, more extensive and paler in older birds. Back bright reddish-brown, deepening to orange-brown near tail. Wings deep reddish-brown, olive and dusky, with grey and yellow underneath. Brightest in the spring. The rusty red of the back very conspicuous in flight, which is undulating but strong, and with longer, shallower curves than in sparrows and chaffinches.

The female.—Slightly smaller. Colour much less conspicuous, and duller. Very little yellow, confined to forehead and breast, and obscured by dark streaks and dull olive colouring. General impression dusky brown-olive, with dark streaks and lighter back and tail. The reddish colour is seen on the back.

Young birds. — Dull yellowish-brown, streaked with dark brown, and yellowish-grey streaks beneath. Assume yellow head after autumn moult.

Habits.—Very characteristic of hedges in open cultivated country, and of gorse and broom on sandy commons. Almost strictly grain feeders. Flock in the winter in families, parents remaining together, but associating with birds of other kinds. Song a series of short, rapid notes with a long drawn out final note, familiarly given as, "A little bit of bread and no ch-ee-ee-se." Beginning as early as February they sing perched on the top of the hedge, with the tail bent downwards. They are often to be seen sitting very still for a long time in this position when not singing.

Breeding.—Nest usually (though not invariably) low down in the hedge or on the

ground at the foot, sheltered by a bush or clump of grass. Moss, roots, small twigs, hair, are used. It is compact and well-made, but not nearly so neat and strong as that of the chaffinch. Note that nests on the ground or firmly supported are not so strongly and firmly made. Eggs three to five, pale purplish-white with thin irregular zigzag streaks and blotches of dark reddish-brown, as if a child had scribbled over it with a fine pen (sometimes called the scribbling lark or scribbling bird). Length $\frac{5}{8}$ in. The male feeds the female carefully during incubation, and takes his turn in sitting upon the eggs. The young begin to fly in the middle of June.

3. RESIDENT WINTER BIRDS— SOFT-BILLED

Introduction.—A week or so before the lesson, after observations on sparrows, chaffinches and yellow-hammers have been discussed, give the children a list of other birds to look out specially. These might include such birds as the song thrush, blackbird, starling and redbreast, and (if they are known to frequent the neighbourhood) mistle thrush, blue tit and great tit. Suggest that similar observations to those already made shall be carried on. Similar notes and other records might be made.

1. The class lesson would proceed on the same lines as the last, the teacher filling out the children's observations after discussion has taken place, and giving further information which they can later try to verify.

As thrushes, blackbirds or starlings have been watched, they will probably have been seen pulling worms out of the ground and eating them. The thrush may have been seen breaking snail shells by hammering them on a stone. A particular stone may be used frequently, so that the ground round it is littered with broken shells. Notice the difference in shape between the beaks of these birds and those of the house sparrow, chaffinch or yellow-hammer. They are long, slender and sharply pointed. The blue tit and great tit also have a thin, sharp beak with which they dig out insects or the contents of buds. The two types are distinguished as the *Soft-billed* and *Hard-billed*, those which feed chiefly on soft food (insects, worms, snails and fruit), and those which feed on grain, hard seeds and nuts. The bird's sharp, narrow beak can stab or impale its victims, or pick them up like fine pincers; the broad, strong beak can be used as a pair of nutcrackers. (The notes on birds that follow will help the teacher to indicate further points for study.)

2. A bird chart might be kept throughout the winter, and the children would then notice when newcomers begin to arrive, when pairing begins, what birds begin to sing, how many can be heard singing in the same spot at the same time each day (the territory), and they would note the change to brighter plumage. If two or three old nests can be collected and examined, the children can find out something of the structure and characteristics of some common



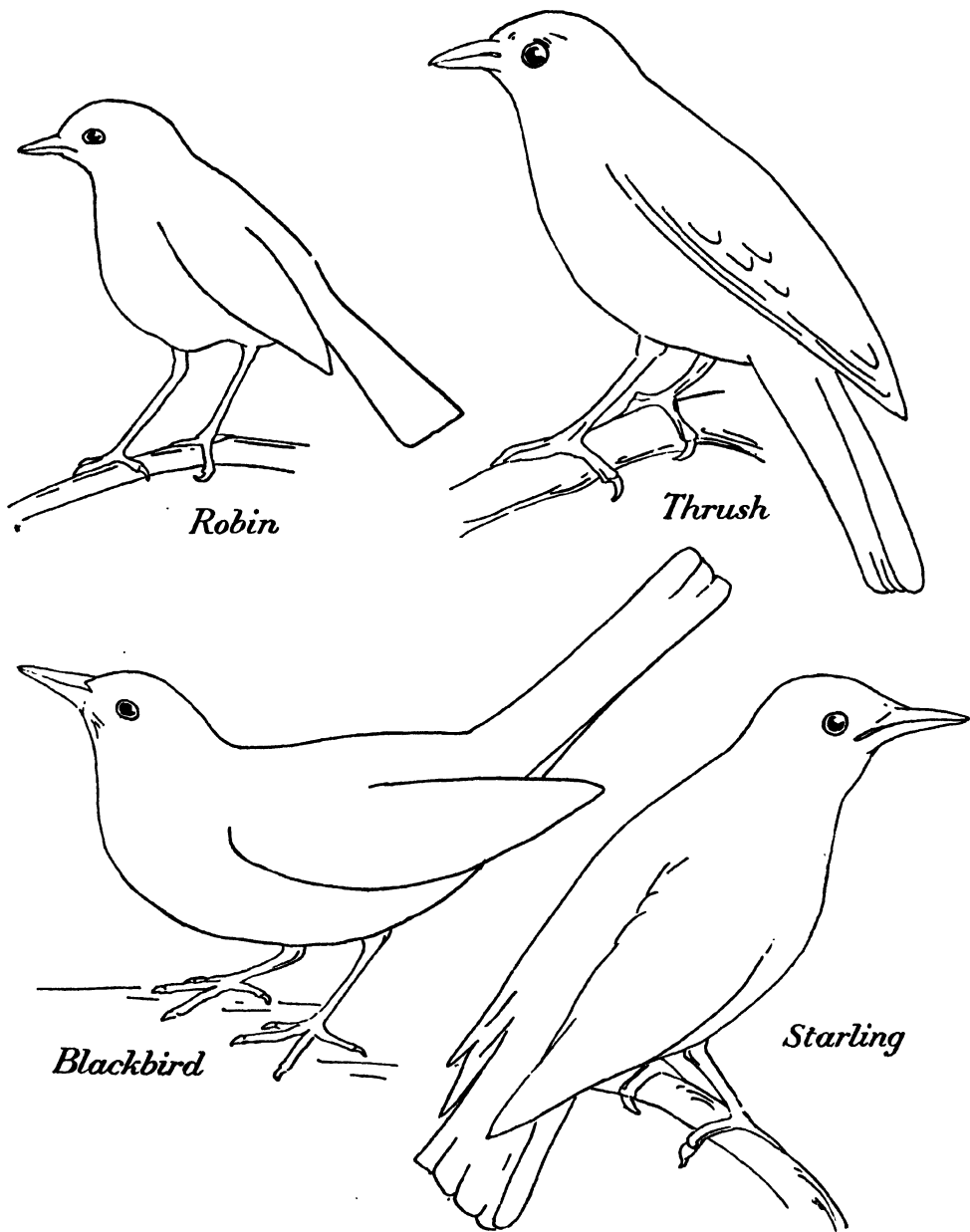

Robin

Thrush

Blackbird

Starling

PLATE XXI

COMMON PERMANENT RESIDENTS—SOFT-BILLED

(For actual size see text.)

ones. They may be told where to look and how to look for nests, and above all to approach quietly so as not to frighten the birds, and *never* to touch them, as the parents can smell if a nest and eggs have been handled, and they will often desert the nest even if the young ones are hatched.

With regard to egg collecting, unless the teacher has reason to think that the children are taking eggs, it is probably best to deal with it indirectly by enlisting the children's sympathy and friendliness towards birds. The more children are interested in watching birds, the less they are likely to wish to interfere with them, but the collector's instinct is strong and the question is sure to arise some time. It calls for reasonable treatment and discussion. A ban on collecting can only do harm, as it will lead to secret raids, and any attempt to penalise a child by rousing public opinion against him may lead to a feeling of resentment, since there are many grown-up collectors who claim to be naturalists and pride themselves openly on their hauls.

The songs of birds can be gradually learnt only by patient and solitary listeners. However, the teacher can do something to help children by telling them where certain birds are to be heard, by incidentally calling attention to the songs of common birds whenever they can be heard about the school, by suggesting that children who are interested shall try to imitate some of the songs with the help of bird whistles, and perhaps by encouraging some of them to give a "concert." There is probably no need to refer teachers to the interesting broadcasts on bird song (notably those of Professor Garstang), which have been given from time to time, with imitations and gramophone records.

NOTES ON COMMON PERMANENT RESIDENTS—SOFT-BILLED

SONG THRUSH

Appearance.—*Male* and *female* alike. Length $8\frac{1}{2}$ in. Nut-brown or olive-brown,

pale fawn to white breast spotted with dark brown, many of the spots forming long streaks, whereas in the mistle thrush they are short, nearly round, or arrow-head shaped.

Young birds.—Yellowish, upper parts flecked with buff.

Habits.—Though many are winter residents, especially in towns, there is no doubt that a great many migrate, either farther south for the winter or to other breeding places. They sing almost the whole year round, and can often be heard singing joyously in January or February when there is a warm, bright spell. Their rich, varied song, with its repetitions of short phrases and notes, needs no description. They will often sing from the top of a high tree.

Food.—Worms and slugs, and snails which they break open by hammering them on stones. Fruit occasionally. They will patter all over a lawn, and the earthworms rise in response to the vibration as they do to rain, and so are caught unawares and snapped up before they have time to hook themselves into their burrows. They have a preference for cultivated fields and gardens, probably because worms are nearer the surface and frequently turned up by the plough or fork.

Breeding.—The nesting places chosen are variable, though most frequently in a bush or tree. The fairly compact nest of grass and fine twigs is lined with mud, kneaded into a hard cup and bound together by bits of straw, dung, or decaying wood. Eggs, four or five, blue with black spots, about 1 in. long. Nest building begins very early. The first eggs are usually laid in March, and two or three broods are reared in the summer.

MISTLE THRUSH

Appearance.—This bird is larger than the song thrush, greyer, with more distinct,

roundish spots on a lighter breast, and white underparts which show distinctly in flight. Length, 11 in.

Young birds.—Yellowish on upper parts, with pale buff spots. Note that in many birds the young have spots more generally distributed than in the parents, and may have spots when the parents have none; e.g., young robbins.

Habits.—It feeds especially on berries, and is said to derive its name from its love of mistletoe berries, though it also feeds on worms and snails. It is common in wilder country, especially in hilly country. It is said to have ousted the song thrush in localities where they have come into competition. It is a vigorous, pugnacious bird, called the "stormcock" from its habit of singing through stormy weather. Like the redwing and fieldfare, many come to the south of England in the winter, returning farther north to breed.

Breeding.—They breed even earlier than the song thrushes. Mr. T. A. Coward records instances of the birds being interrupted by falls of snow filling the nest, and going on again when the snow had melted. Eggs larger than those of the song thrush, about $1\frac{1}{4}$ in. White, suffused with green or brown, and spotted with dark purplish-grey or brown. Usually two broods.

BLACKBIRD

Appearance—*The male.*—Length, 10 in. Glossy black plumage, occasionally blotched with white or nearly all white. Bright orange beak, long and daggerlike for impaling worms and soft insects, or acting as forceps in holding them.

The female.—Dark brown, with a paler breast streaked with black, suggesting a thrush, but darker. Beak also brown.

Young birds.—Lighter brown, with some streaks. The beaks of young males are dark until the second year, when the adult plumage is nearly complete.

Habits.—Found in hedgerows and bushes chiefly, and in garden shrubberies, coming out into the open to feed on worms but retiring on the least alarm. Flight straight and vigorous, rising rapidly from the ground and often flying low for some distance. Runs and hops on the ground, often flirting its long tail.

Food.—As the song thrush, to which it is nearly related.

Song.—Its beautiful, deep song contains rich, pure notes and low gurgles and chuckles, of somewhat the same character as that of the thrush, but lower, less varied, and without the many repetitions. It lasts for a shorter season. It has in addition a low-pitched, loud chatter or rattle when alarmed, angry or excited, very startling to hear unexpectedly, and a warning of danger to the whole neighbourhood.

Breeding.—Nests in bushes, trees or hedges. Nest made chiefly by the hen, of grass lined with mud and then grass again, thus differing from the thrush's nest. Eggs, four to six, about 1 in. long, pale greenish-white, finely dusted with dull red.

FIELDFARE

Another member of the thrush tribe, common in many parts of England in open fields, especially ploughed fields, in the winter months, when large flocks may be seen. They retreat farther north for the breeding season, usually about March. They are larger than the mistle thrush, and have a grey general colour, due to the slate-grey head and rump conspicuous in flight, together with the warm chestnut back. Seen standing at close quarters they are more thrushlike, with rich brown throat and pale underparts streaked with black, and in the winter head and rump also. The beak is dark brown in the winter. They are larger than thrushes, about 10 in. long. Food is similar to that of other thrushes. They work very system-

atically up a field, or roost all together in trees. They rise and fly together if approached, uttering loud, harsh alarm cries.

REDWING

This is another winter visitor of the thrush tribe, closely resembling the fieldfare in its habits, appearing and feeding in the same places, often with flocks of fieldfares. It is distinguished from the thrush by the tawny red colour of the underwing, and sides of the body, showing especially in flight, and by the long narrow streaks which take the place of spots.

STARLING

Appearance.—Length, $8\frac{1}{2}$ in. Colours different in summer and winter. *Male* and *female* alike, but female rather duller. Summer plumage, glossy, metallic purple, blue and green in sunshine, looking duller and blacker on a dull day. Beak lemon-yellow. In winter, pale tips to the feathers give it a spotted appearance, much lighter and with the metallic feathers hidden. These tips gradually wear away, and by January or February it is beginning to assume its dark, glossy raiment. Legs dull brown.

Habits.—Gregarious birds, collecting into large flocks as soon as the nesting season is over, going to a common roosting place at nights (like rooks, to which they are distantly related) and searching the fields and gardens by day. Many are permanent residents, but others are birds of passage, or summer or winter residents only.

Song.—Very wide range, rich whistling, chuckling and bubbling notes, but capable of imitating the songs of most other birds and any noise that attracts them.

Breeding.—They nest in holes almost anywhere—chimney pots, caves, haystacks, ruined walls—making a loose, untidy nest

of straw and feathers. Eggs, five to seven, about 1 in. long, pale blue, laid in April. A second brood is reared.

BLUE TITMOUSE, BLUE TIT OR TOMTIT

Appearance.—*Male* and *female* almost identical, but female slightly smaller and duller. Length, $4\frac{1}{2}$ in. Distinguished by deep blue head and white cheeks, with a black line passing across the eye and encircling the cheeks. Back yellowish-green. Sides of neck and breast yellow. Tail blue, with a white bar conspicuous in flight. A short, plump body, with slender, bluish-grey legs, and short, sharp beak used as fine pincers for picking minute insects out of crevices. Distinguished from the great tit at a glance by its size (it is more than an inch smaller) and blue head.

Young birds.—Much yellower.

Habits.—Lives chiefly amongst trees, picking out tiny insects from bark and leaves, small moths and flies flying about, or small caterpillars swinging from the branches on threads, aphides, and leaf-pests of all kinds. It destroys numerous buds in the spring, possibly in search of insects, though this is unproven. It is often seen swinging on the fragile twigs of birch or elm trees and fruit trees, and will hang upside down or in any position. Quick, jerky movements which explain the name of "titmouse." Takes short, rapid flights from tree to tree, with quickly-beating wings.

Song.—A rapidly repeated, tinkling note.

Breeding.—Selects a hole in a tree for its nest, and fills it up with moss to the required depth if it is too deep. Returns to the same hole year after year, and takes readily to a nesting box. Nest a mossy cup, lined with wool, hair or feathers, contains from seven to twelve eggs (possibly sometimes laid by more than one hen). These are about $\frac{1}{2}$ in. long, white with dull red spots. The

bird will make a hissing noise if anyone looks into the nest when she is sitting, and bite if a finger is inserted.

GREAT TIT

Appearance.—Length $5\frac{1}{2}$ in. Similar colouring to blue tit but much less blue, and with conspicuous black head, neck and bib. Back yellow to olive-green, passing into bluish-grey. Tail and wings blue-grey, with conspicuous white wing bar. Breast and underparts yellow. Much duller after the autumn moult, assuming bright spring colours as tips of feathers wear away. *Male and female alike.*

Young birds.—Duller.

Habits.—Remain with us all the year. Flock with other kinds during the winter, searching the trees, fallen leaves and mast for food. Come to the ground much more than the blue tits. Daring and pugnacious, using the sharp beak to attack birds as well as insects, and said sometimes to kill a smaller bird by driving its beak into the skull.

Food.—All kinds of small insects, especially larvae and leaf-burrowing insects such as spangle galls on leaves, and even the marble galls of the oak, which, Mr. Coward states, are often pecked to the central chamber to extract the larva inside. Nuts and seeds are also eaten. Both tits will eat hive bees as they emerge on the threshold in the spring.

Song.—Known as the “saw-sharpener,” the two quickly repeated up-and-down notes sound very much like a tool being sharpened on a stone, or a wire fence being tweaked by someone swinging it. Mr. Coward gives it as “pee-lar, pee-lar.” It goes on insistently for long periods, sometimes with another quickly-repeated final note or varied by pauses which make little phrases.

Breeding.—Similar to the blue tit, in holes in trees, with a large clutch of white

red-spotted eggs. These are larger than those of the blue tit, about $\frac{3}{4}$ in. long. It has the same habit of hissing and biting.

ROBIN OR REDBREAST

Appearance—*Male and female alike.* Length, $5\frac{3}{4}$ in. A neat, trim little bird, standing very upright on rather long legs. The scarlet breast is the adult's chief distinguishing feature, merging into light fawn and dove-grey, with a rim of blue-grey separating back from breast. Bright black eyes, slender pointed beak.

Young birds.—For some time speckled, with much the colouring of a thrush. Gradually lose the speckled appearance, becoming more like adult, attaining mature plumage after autumn moult.

Habits.—Found especially in cultivated places, hedges and gardens, and readily come to a bird table or hop round where digging is going on. Remain with us summer and winter, and are astonishingly friendly and tame.

Food.—Insects chiefly, and small worms, but soft berries (haws) and even seeds are eaten.

Song.—Begin to sing in the second year, at first an incomplete song, then the characteristic sweet, high and varied tune. They give also a series of quick notes at times like the opening and closing of scissors, and a variety of short alarm notes and call notes.

Breeding.—Build in ivy, old walls, bushes, or in any kind of receptacle that offers a hole (they have been recorded in old cans, discarded hats, pillar boxes). Eggs, four to six, about $\frac{3}{4}$ in. long, pale greenish-blue, finely speckled with dusky green or brown. The young clamour for food incessantly, and are constantly fed by both parents, who bring four or five caterpillars at once. Chiefly fed on soft larvae. Frequently two broods in the year.

4. STRUCTURE OF BIRDS

There seems no doubt that birds developed from some kind of lizardlike reptile, leaping and running amongst the trees of the mesozoic period, the time when great reptiles flourished on the earth. Further reference will be made to this in a later lesson. At that time dry land was emerging, and living creatures, which had always made their homes in the ocean, were, so far as we know, for the first time beginning to emerge from the water to explore and colonise the land. It was a region of swampy forests and jungle, probably with a hot, steamy atmosphere not unlike the great rain forests of the present day. Probably there were also barren uplands which could as yet hardly support life. Reptiles of many different kinds were abundant both in the sea and in the swampy lands, dragonlike carnivorous forms, flying dragons, and all sorts of smaller kinds. Probably amongst these smaller animals were the ancestors of both birds and mammals, neither of which had as yet made their appearance.

Towards the end of this period the first true birds seem to have appeared. They are represented in fossilised form in the rocks, and some of the earliest were divers rather like the present-day gannets, but they differed from any modern birds in having teeth.

The earliest bird appears in certain mesozoic limestone rocks of Bavaria, where two complete skeletons have been found. One of these is in the British Museum. This bird has been given the name *archæopteryx*, which means ancient bird or earliest bird, Fig. 102. This bird is regarded as a link between modern birds and reptiles, for it has the drawn-out beak of a bird, the skull is birdlike, it has wings, and in the rock are impressions of feathers. But the beak is provided with needlelike teeth like those of a lizard (Fig. 103), it has a long



FIG. 102. ARCHÆOPTERYX

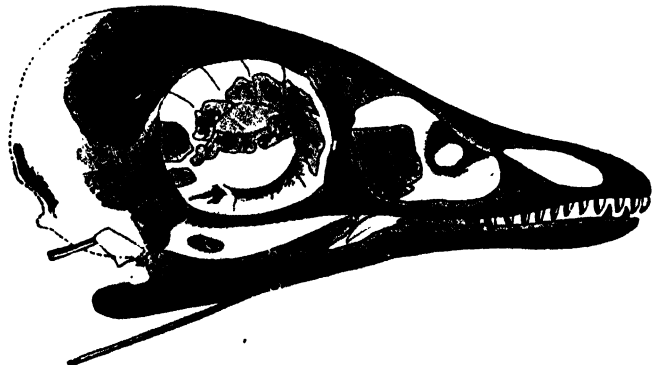

FIG. 103. SKULL OF ARCHÆOPTERYX (NOTE THE TEETH)

tail like a lizard (though feathered) and instead of the wing ending in a single pointed bone, bearing feathers, it has three distinct fingers, like claws.

Let the class examine the skeleton of a bird and a stuffed bird, in order to see what special adaptations of structure fit birds for flight. Pigeons are useful examples, Fig. 104.

A heavier-than-air flying machine has certain constructional points with which children will already be familiar. It is light in weight, the body part is rather small and not bulky and is pointed at both ends to offer as little resistance as possible to the wind. But resistance is offered by lateral planes, and it is the pressure beneath these which buoys up the machine. All these points find a parallel in the structure of a bird. The wings form the planes, and must combine a large surface and long cutting edge with lightness. Feathers are an ideal covering for lightness and, in addition, by clinging closely to wings and body they offer scarcely any resistance to the air, protect the body from cold winds and, being non-

conductors of heat, conserve the body heat.

Note the important difference between wings and the planes of an aeroplane. Wings provide the engine power as well as the surface for flight. The heart and the wing muscles are the energy-producers which carry out the wing-stroke. This accounts for the great development of breast muscles, for these *are* the wing muscles. The major muscles draw the wings down, while smaller ones are employed in raising them.

Now turn to the skeleton. Notice the wide breastbone, with its strong ridge or keel. It is this that supports the great flight muscles. The cage-like skeleton of the trunk encloses the vital organs and protects them against injury from the great air pressure to which they are subject during strong flight. Notice that the ribs are held firmly in position by means of small backward projections, which are held down by ligaments. At the same time their limited power of movement makes breathing somewhat difficult. We find, however, that the

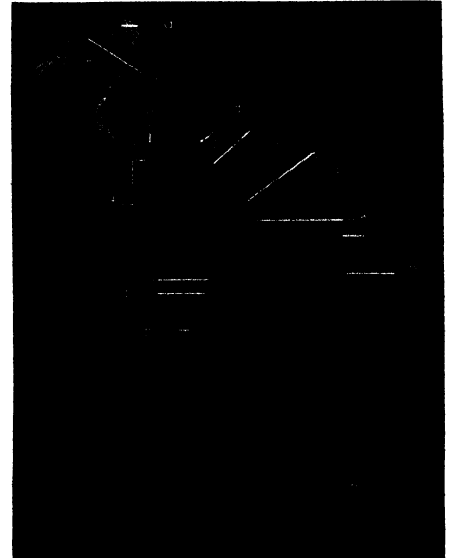
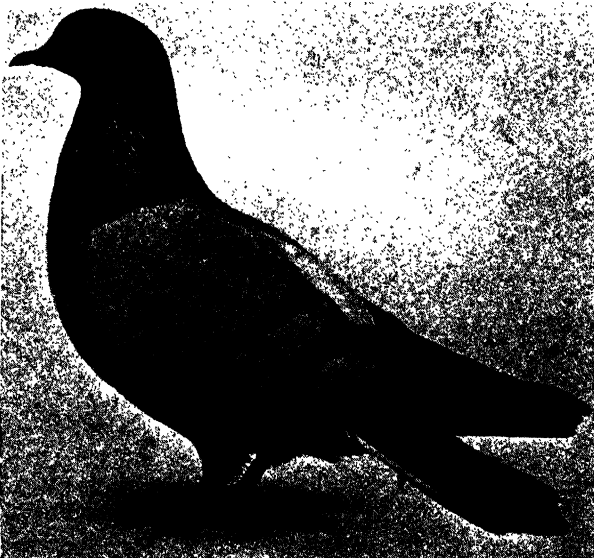

[Reproduced by courtesy of the British Museum (Natural History)]

FIG. 104. ROCK PIGEON AND SKELETON

a. Skull. b. Eye socket. c. Upper "arm" bone. d. Lower "arm" bone. e. "Wrist." f. "Hand" bones. g. Knee. h. Foot. j. Rib. k. Process which projects backwards from rib. l. Hip girdle. m. Keel of breastbone. n. Socket of leg bone.

lungs of birds are supplemented by air sacs which enable extra stores of air to be taken in; the action of emptying the lungs during expiration causes the fresh air in these sacs to be drawn through the lungs, so that there is said to be a double tide of fresh air during both phases of breathing.

A bird's bones are hollow, another means of keeping down weight.

Notice the peculiar wing bones, Fig. 105. There is no doubt that these have been formed by the fusion and reduction of the ordinary type of hand and finger bones; only two fingers are represented in addition to a small remnant called the bastard wing. The two fingers are fused together to make a rigid support for the wing feathers, for it is essential that the wing-planes shall be rigid.

Get the children to watch the flight of birds and try to analyse the strokes. It can be seen that it is the downward stroke which, by beating against the air, forces the bird along, while the upward movement merely brings the wing back into position for the next stroke. The downward stroke must be made with great force. As the great breast muscles contract and draw the wing down, the quill feathers form an impervious

membrane which will not allow any air to pass through, but as the upward stroke is made the feathers separate slightly, air passes between them and the resistance is decreased. It will be seen that if upward and downward strokes were equal in force they would neutralise one another.

It is probable, however, that the possibility of separating the feathers is also connected with the prevention of "stalling" or side-slipping, a danger to which aeroplanes are subject, and that the openings between them correspond to the slots in an aeroplane wing, in function.

The class should examine some feathers carefully and make sketches of them to see how their structure helps flight, Fig. 106.

The two main types are the large, strong wing and tail feathers concerned with flight (the tail feathers in steering and braking), usually called quills, and the covert or contour feathers which clothe the body. Many of the contour feathers are downy at the base, where they are overlapped by others, making a thick, warm covering. In addition there are small, fine and sparsely branched feathers called filoplumes, which may represent the primitive type of feather.

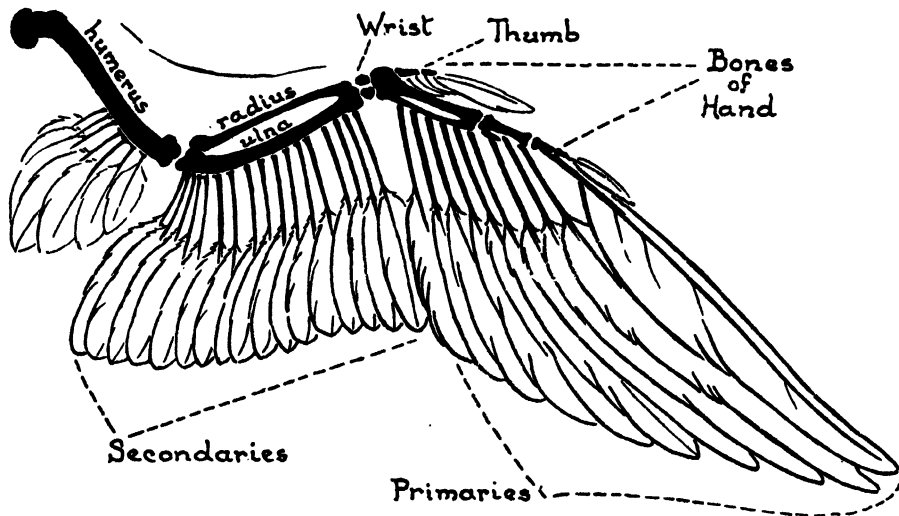

FIG. 105. WING OF A BIRD

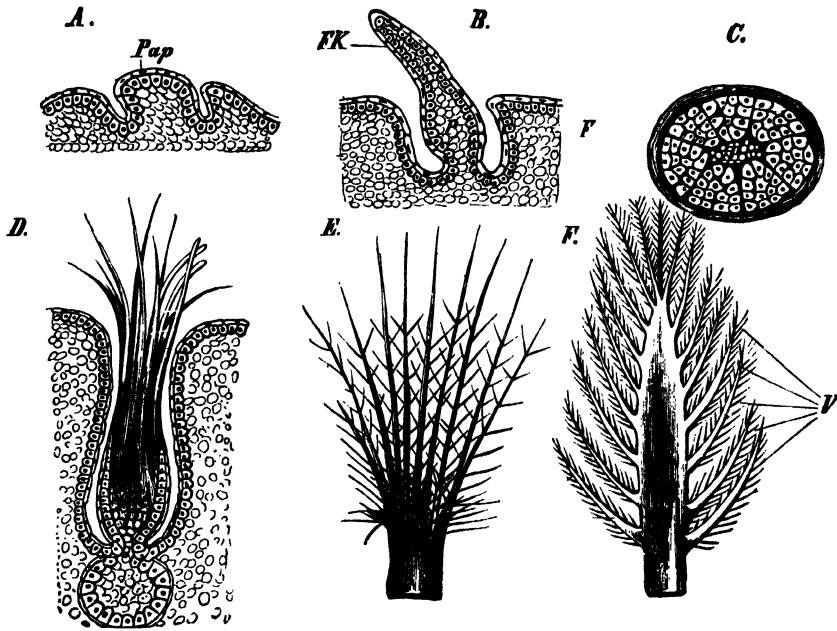

FIG. 106. GROWTH OF A FEATHER

A. Bud or papilla (Pap) which gives rise to the feather, surrounded by a shallow socket.
 B. Bud elongating, socket becoming deeper (FK. Feather; F. Socket or follicle).
 C. Cross section. D, E. Barbs forming. F. Shaft elongating (V. Barbules).

A typical feather consists of a lower part forming a stalk or quill, continuing into an upper part, the shaft, from which branches or barbs grow out laterally, forming the web or vane. The barbs are all held together by means of interlocking barbules (Fig. 107), which are lateral branches from the barbs. It is this interlocking which makes the web impervious to air. The mechanism is interesting. The barbules on the side furthest from the quill, called the distal barbules, are provided with small hooks, while those on the side nearest the quill, the proximal barbules, have a slight ridge or groove, into which hooks on the distal barbules of the adjacent barb fit.

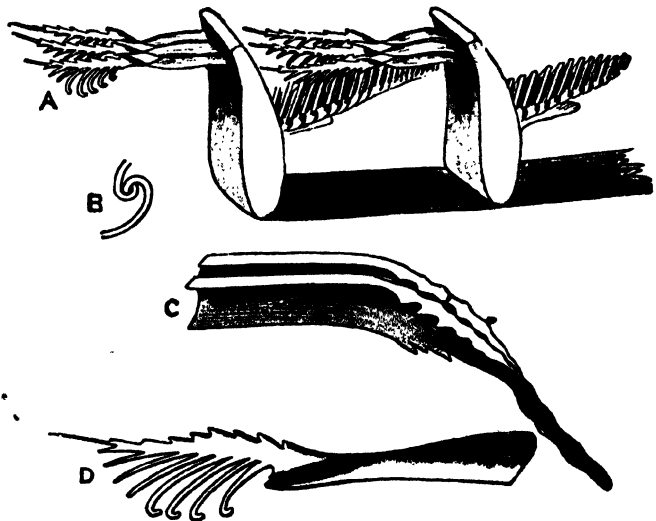

FIG. 107. BARBULES, SHOWING METHOD OF INTERLOCKING

A. Proximal and distal barbules interlocking (diagrammatic). B. Section showing interlocking of two barbules. C. Proximal barbule. D. Distal barbule.

The downy barbs found at the base of most covert feathers have no hooks on the barbules and so are quite free, giving them a fluffy appearance.

5. ECONOMIC IMPORTANCE OF BIRDS

Having made some study of birds for their own sake, because of the interest they provide, we may now turn to a consideration of the very important part they play in the life of man.

Apart from their value as food, indirectly they affect our lives very considerably, chiefly because so many of them feed upon insects, slugs and the seeds of weeds which otherwise would take a very heavy toll of our crops and forest trees.

There is considerable difference of opinion as to the merits of particular birds in this respect and it is not by any means easy to strike a balance between their good deeds and their misdeeds. The fruit grower sees thrushes, blackbirds and other birds marauding amongst his orchards or currant bushes, and it is difficult to persuade him, or the gardener who finds his young peas and beans eaten and sees that the culprits are certain birds, that at other times these same birds, by eating caterpillars and other grubs, are more than counterbalancing the harm they have done. The only scientific way of gaining information is by careful investigation of the feeding habits and examination of the contents of birds' crops. The National Society for the Protection of Birds is publishing a series of charts based on such observations, showing exactly on what food certain birds live, and the proportion of injurious insects or seeds of weeds. The Ministry of Agriculture and Fisheries has also instituted inquiries and published a series of advisory leaflets on different birds for the guidance of gardeners and farmers. (H.M. Stationery Office, 1s. 6d.)

Amongst birds which, in the popular phrase, "do more harm than good," the wood pigeon has undoubtedly a high place.

It is a greedy feeder; starting in the autumn with depredations in the wheat, oats, barley and rye fields and stacks, it goes on to attack the winter cabbages, swedes and potatoes if it has access to them, eats the buds off trees, the tops off turnips and makes holes in the roots; then in the spring it takes the young clover and sprouting grain and almost every crop in season. Certainly it takes weeds and their seeds as well, but on balance, from man's point of view, it has to be regarded as a criminal.

The house sparrow is also a serious pest because of its attacks on cultivated grain, especially just before the harvest, when the birds desert all their other haunts and flock to the fields. They also strip fruit bushes of their buds and pull up newly-sown peas. They may also cause damage by blocking drain pipes and gutters with their nests, and by driving away insect-feeding birds such as swallows and martins and taking their nesting sites.

On the credit side, sparrows feed their young on caterpillars and grubs, including the injurious leatherjackets, and do something towards keeping down such pests as cabbage butterflies; they also include many seeds of weeds in their diet.

Starlings are also birds which cause considerable loss to fruit growers and farmers. They not only visit orchards in great flocks, but fields of sprouting grain are attacked *en masse* and the young plants pulled up.

The case of the starlings and sparrows draws attention to a point of great importance in considering the relationship of birds to man's life, and that is that so long as the numbers are moderate the harm done is negligible, because the natural sources of food other than crops will provide the greater part of their food. But when for some reason their numbers increase unduly, as in the case of sparrows in Australia and starlings in the last twenty-five years in England, their feeding habits tend to alter and they concentrate on the easily accessible food provided by man. There seems no doubt that in the case of pigeons, starlings

and house sparrows, the numbers need to be regulated if farmers and gardeners are not to suffer serious loss.

On the other hand it is important to realise that it is dangerous to interfere with the bird life of a district indiscriminately or with insufficient knowledge. Attention has been drawn earlier in this course to the existence of food chains, the interdependence of series of plants and animals for food. If too many insect-feeding birds, such as starlings and rooks, are destroyed in the conviction that they are causing damage to crops, then other pests may make their appearance. After a very severe winter some years ago (1917-18) when birds were dying of starvation in the hedges, there followed plagues of caterpillars which stripped trees of their leaves. Oak trees in particular suffered in certain districts. Moreover, it is not always true that "seeing is believing." A farmer brought a dead rook to a certain biologist, saying, "You say these fellows don't eat potato roots but I shot this one in the act!" On the crop being opened, it was found to be full, not of potato, but of leatherjackets (crane fly larvae) which had been feeding on the roots.

Under natural conditions birds and beasts of prey check too great an increase of other creatures, including birds. Such creatures as kestrels and sparrow hawks, weasels, stoats and badgers, keep down all kinds of small life—mice and birds chiefly—which otherwise might multiply sufficiently to become pests to man. Gamekeepers are apt to regard all these creatures as absolute enemies but there is a useful side to their depredations.

The great majority of insect-feeding birds are to be regarded as friends, and encouraged. The planting of trees and shrubbery, especially evergreens, the placing of nesting boxes and any other encouragement to them to breed and inhabit a neighbourhood, all help to preserve the crops from insect raiders. So also most of the finches are on the whole helpful because of the numbers of weeds they destroy by eating the weeds.

The Ministry of Agriculture is careful to point out that the strictures on house sparrows do not apply to tree sparrows, which are not nearly so numerous, and of course not to hedge sparrows, which are not of the finch tribe in spite of their common name of sparrow, but are insect-feeders related to the robin.

Amongst friends we should reckon all the warblers—garden and willow warbler, white-throat and blackcap—the flycatchers, swifts, swallows, martins, and tits. See also notes on Class Pictures Nos. 31 and 32 in *Gardening for the School and Home*, Volume IV.

Needless to say, the help or injury done by birds is quite unconscious and unintentional. They are concerned merely with their own needs, and are not trying either to help or hinder man; neither can they be regarded as having been created for any such purposes.

PRACTICAL WORK

Keep notes, in diary or chart form, on the feeding habits of all the birds which can be watched. Try to map the occurrence of birds, where and when seen, numbers of nests in the district (without, however, disturbing or touching). If dead birds are found, boys might like to examine the crops and gizzards and so obtain definite information about their food. The contents should be washed out, then spread out, examined, and results tabulated, with date and whether bird is young or mature. Note that small stones and gravel are present, which help to grind the food small. Birds' food is almost completely digested, a fact which helps to account for their great energy. They use mainly highly concentrated foods—compare with the highly concentrated foods carried by airmen on long flights.

LESSON UNIT III—RECAPITULATION OF FUNCTIONS OF LIVING CREATURES

This subject is treated with special reference to mammals and man, and the dissection of a rabbit or rat.

Introduction.—Remind the children that in the course of their study of plants and animals certain common needs have been noticed. What do plants and animals need, and find in their environment, in order to live? Food, warmth, light, water, are essential. How is the food obtained by animals? What happens to food after it has been eaten? What is its use to the body?

Revise briefly the main features of digestion and absorption of food, of circulation of blood, and of breathing. These processes together constitute the means of obtaining and releasing energy.

Development—1. Animals' dependence on plants.—Remind the class that all animals depend eventually upon plants. From what has been said about photosynthesis it will have been realised that plants manufacture starch and sugar, which with nitrogen is then built up into proteins, and that other plants—bacteria—supply the nitrogen in an available form—nitrates from free nitrogen or complex organic (animal or plant) proteins.

One point we have not hitherto mentioned; for this highly complicated manufacture, energy is needed—for it is *work*. This energy is derived from the sun in the case of green plants. This is a very important fact. The sun has been pouring out a constant stream of energy—radiating energy—for millions of years, and green plants have been receiving it and storing it up in their tissues. When animals eat plants, this energy is obtained, stored and finally released again by their muscles. Consequently plants act as intermediaries between animals—including of course, man—and the sun. It is true that to some extent we can make *direct* use of the sun's rays, and need to do so. That is one of the more recent discoveries of bio-chemistry. But we are dependent upon plants for a considerable amount.

In another way man is largely dependent upon the energy stored in plants, and that is for his supply of external warmth, by fires, for the heat given out by coal or wood is the

sun's heat, stored by green plants as a result of photosynthesis, and released for our use when the plant tissues are burnt.

2. Mammals.—Animals which carry out their functions efficiently grow and in due time reproduce. Reproduction is an output of surplus energy. The animal grows to its full size and as it still goes on feeding yet, generally speaking, eats more than the bare minimum which will keep it alive and provide necessary energy, it has energy to spare. Thus reproduction is a form of further growth of the individual, only in this case new individuals separate from the parent.

Man belongs to the highest class of vertebrates, the mammals. (Possibly we call it the highest *because* we belong to it, for in many ways birds are equally if not more highly developed.) The mammals differ from the reptiles in several important respects which a study of such an animal as a rabbit will illustrate.

3. Rabbit.—Borrow a live rabbit and give the class an opportunity of watching it so that the following points can be seen:

1. *Soft covering of fur.*—Not so light in weight as feathers, yet still light, and, next to feathers, the warmest covering known. Hair, either smooth and silky or woolly, is characteristic of mammals and helps to keep the body temperature at a constant level, another characteristic which they share with birds but not with the lower vertebrates. This has an important effect upon their vitality; they do not become torpid in cold weather (with few exceptions) and so their active life is lengthened. Note that in the case of man, however, hair has been lost and he needs clothes in temperate climates to help his body to retain heat.

2. *Alert expression and well-developed eyes and external ears.*—Rabbits have a much more lively expression than reptiles (lizards, snakes); the external ears are a characteristic of mammals: they help to focus sound. Note too the soft lips and tongue (also mammalian features) and oblique nostrils.

3. *Well-developed skull and jaws.*—A skull should, if possible, be shown here and points noted in earlier lessons recalled; the orbit is closed by bone at the back, forming a cup supporting the eyeball, with a hole by which the optic nerve enters; the jaws are well developed and bear teeth of two kinds, chisel-like incisors and broad-crowned molars

for chewing vegetable food. Differentiation of teeth is again a mammalian character.

4. *Nature of the limbs.*—A skeleton would be useful here, Plate XXII. Note the arch of the back, the front legs well forward and hind legs well back, the long hind foot for springing. The bones of the foot are of the same pattern as in a lizard, except that the

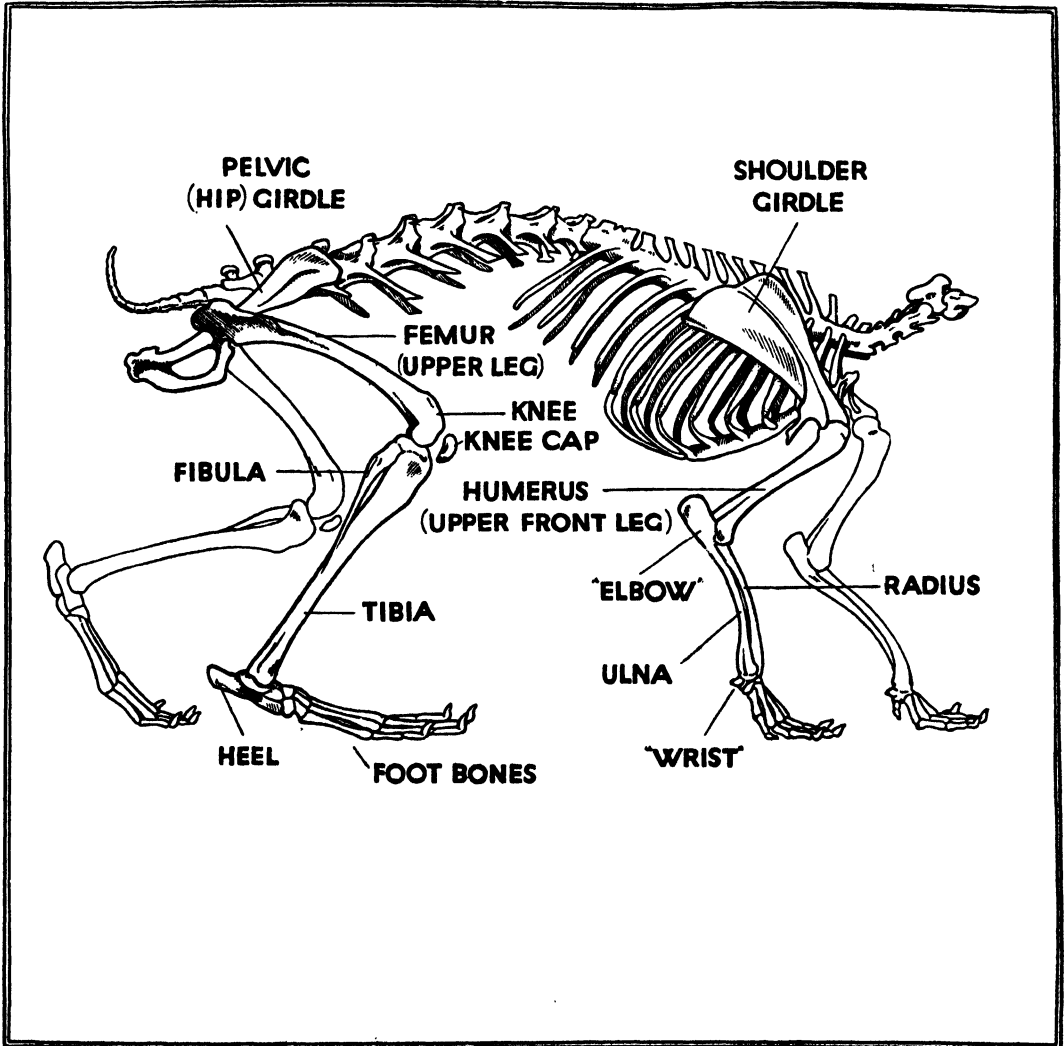

PLATE XXII

SKELETON OF RABBIT TO SHOW LIMBS

(Class Picture No. 8 in the Portfolio.)

hind foot of a rabbit has only four toes, whereas in the lizard both front and back have five. There are well developed claws. It is interesting to note that claws (or finger and toe nails), hair, fur, scales, feathers and teeth are all skin structures. It is in fact probable that feathers and teeth are developed from scales. Such skin structures are met with only in vertebrates; the amphibia are the only ones in which none of these outgrowths are found.

5. *Body*.—If the body is carefully felt, it will be found that the chest region, or thorax, is supported by a firm breastbone, part of the pectoral girdle which gives support to the front limbs. The ribs can also be felt; together with the breastbone they encase the vital organs of the thorax, the heart and lungs.

An important difference between mammals and the lower vertebrates should be recalled here—the diaphragm. If possible, this should be demonstrated in a dissected rabbit.

The hind part of the body, behind the diaphragm, is the abdomen. This feels quite soft, as there is no bony support on the underside, but the hip girdle or pelvic girdle of broad bones meeting in the front forms a support for the internal organs. In man, who is upright, the pelvic girdle forms a sort of basin, in which these organs rest.

6. *Female*.—If the rabbit observed is a mature female, on the underside of the body it will be possible to see several pairs of small projections, the nipples. Here again we have a specially mammalian character, for certain areas of skin develop milk glands, that is, special bodies capable of secreting or manufacturing milk on which the young are suckled. This is a highly concentrated food and, what is very important, free from bacteria since it is never exposed to air but passes straight from mother to offspring.

7. If possible the class should be shown a dissected female rabbit, about six months old, and the following organs should be pointed out:—(a) The organs already seen

in the frog; viz., alimentary canal (oesophagus, stomach, long intestine, exceedingly long and coiled, as this is a herbivorous animal); liver and pancreas; heart; lungs; kidneys, ovaries. (b) Organs which are not present in the frog; viz., diaphragm, uterus, often containing several developing embryos. Internal development of the young distinguishes the mammals.

Demonstrations will have to be given to small groups, while the rest of the class is occupied with notes, reading or sketching the live rabbit or parts of the skeleton. It is possible that some of the class may not wish to see the dissection; it is better not to force this upon them, but by this time most of them will take it as a matter of course. Fairly full notes are given so that the teacher may select what seems desirable but it is not necessary to show all that is mentioned below.

4. *Dissection of rabbit*.—The rabbit may be killed by chloroform or coal gas in a lethal chamber or by drowning. A shot rabbit is spoiled for dissection usually, and there are humanitarian objections to trapping.

Obtain a large drawing board or baking board and specially made steel pegs with wooden handles, or very strong pins, which are used to peg the rabbit to the board through the limbs. Lay it on its back and pin in position. If preferred, it may be skinned first (there is no need to remove the skin from the head) or the fur may be wet to prevent it from flying about.

Abdominal viscera.—Make a slit along the middle ventral line in the soft part of the abdomen with a strong pair of scissors. Cut outwards just behind the ribs from this incision, and pin out the flaps right and left. The abdominal cavity is now exposed and the following organs may be observed in their natural position without disarranging them, though they will have to be raised or pushed aside slightly.

1. *The liver*, a large dark red body at the anterior end. This extends further back on the left side than on the right. Pressed into

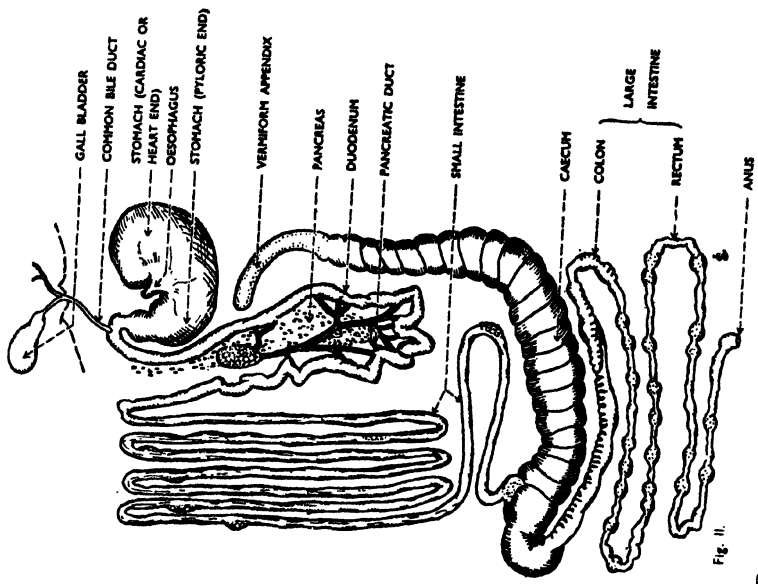

Fig. II.

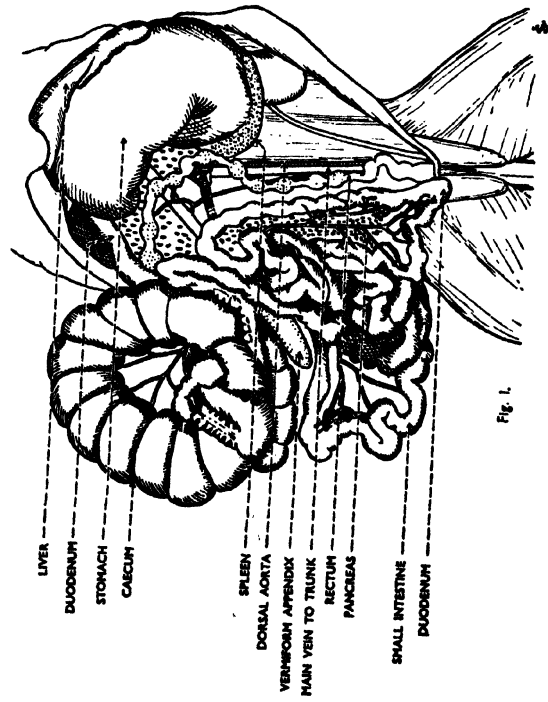

Fig. I.

THE DIGESTIVE SYSTEM OF THE RABBIT.

Fig. I ($\times \frac{1}{2}$). The abdominal region with the digestive system spread to the animal's right side.

Fig. II ($\times \frac{1}{2}$). The digestive system after dissection.

PLATE XXIII. INSIDE OF A RABBIT
Fig. II shows the digestive tube uncoiled.

its dorsal surface lies a greenish sac, the gall bladder.

2. *The stomach*, smooth, slightly shining, and bluish. Partly covered by the liver and just behind it. It can be seen by pushing the liver forwards and the intestine to the animal's left.

3. *The duodenum*, the U-shaped first loop of the intestine, into which open ducts of liver and pancreas. These ducts may be looked for later, if desired, by stretching the membrane which binds the loop and tracing from the organs to it. The pancreas is a pinkish fatlike substance lying in this membrane.

4. *The small intestine*, a dark, almost black tube. There are 8 ft. of this, bound together by a membrane called the mesentery. If desired, this may afterwards be removed and uncoiled on the dissecting board.

5. *The caecum*, at the junction of the small intestine with the large intestine or colon lying over almost all the other viscera and obscuring them. It is very wide, with a spiral constriction, and ends in the narrow, pale-coloured vermiform appendix—the appendix so famous in operations! The caecum serves, in vegetarian animals, to store partially digested food. The appendix in man is said to have lost all function and to be merely a relic of past usefulness.

6. *The colon or large intestine* runs obliquely across, between the folds of the caecum. This can best be seen by taking out the intestine. Its walls are thrown into regular sacs and it is rather flattened.

7. *The rectum* or last part of the large intestine, which opens to the exterior by the anus. Note that there is a separate opening for the alimentary canal, not a cloaca as in the frog. The rectum is white, and beaded with pellets of undigested food ready to be voided. As the whole intestine is coiled only small portions of each region are visible at once.

8. *The bladder* is a thin-walled median sac just in front of the union of the pelvic bones on the ventral surface. Only part of it can be seen without special dissection.

By turning the alimentary canal over to the animal's right side, the following organs may be seen:

9. *The spleen*, a long dark red body attached to the left end of the stomach, and lying behind it.

10. *The kidneys*, attached to the dorsal wall of the abdomen, behind the liver. (In front of each is a small round yellow body, the adrenal organ, one of the much talked-of glands whose secretions control the emotions.)

11. *The diaphragm*, forming a shallow dome separating the abdomen from the thorax. This can be seen by moving back the liver.

Thoracic viscera.—Cut across the thorax just in front of the diaphragm (Fig. 108), then cut through all ribs except the first on each side. The ventral wall may then be carefully removed in one triangular piece. Keep the points of the scissors nearly horizontal so as to avoid injuring structures below.

1. *The heart*, enclosed in a thin membrane, lies in the middle, with its apex directed backwards and slightly to the left.

2. *The lungs*, pink and spongy, fill the greater part of the cavity. As soon as air is let into the thorax by opening it the lungs collapse.

Note the convex surface of the diaphragm now looked at from the other surface. Note too the small size of the thoracic cavity.

Remove the thymus, a soft, pinkish mass, and membrane surrounding the heart. The greater part exposed consists of the ventricles. Note that in a mammal there are two ventricles, completely separated. The right ventricle, which is soft to touch, does not reach the apex. The left ventricle is larger, more muscular and therefore firmer, and includes the apex.

Remind the class that in a previous lesson on the circulation of blood it was noted that the aerated blood passes from the lungs through the left side of the heart, and is then pumped to the whole body. Hence it is important that the left ventricle shall

be very strong and large, for it has this work to do.

The auricles may now be identified; they are at the anterior end, lie largely behind and are concealed by the great blood vessels. Note the roots of these emerging from the anterior border of the ventricles. The arteries have thick, white walls, but the veins are thin-walled and collapse easily. Until William Harvey in the seventeenth century discovered how blood circulated, it was thought that the arteries were air tubes, because they are never found containing blood after the heart stopped beating, for it has been driven on into the veins.

Urinary system.—If the abdominal viscera are thrust to one side, the kidney of one side may be seen. These are paired organs, rounded on the outer side and slightly indented near to the middle line of the body. They are attached to the dorsal wall of the abdomen, lying in a bed of fat. From the inner border a thin white tube arises and passes backward to enter the bladder, lying

just in front of the anus. The bladder is continued backwards as a tube which opens to the surface in front of the anus. This tube, in the rabbit, also receives the opening from the reproductive system (Plate XXIII), but in higher mammals there is a separate opening.

Female reproductive system.—Without going into detail, it is interesting for the children to see the main features of the reproductive system of the female rabbit (Plate XXIV). The details of the male system are very complicated and require expert dissection. If wished, the children could be told that in the male the reproductive cells or sperms lie in a small sac outside the body, and that this has a narrow neck through which they pass back again into the base of the abdominal cavity, reaching the surface by a common tube from the bladder.

The female organs consist of a pair of ovaries, lying behind the level of the kidneys in the abdominal cavity, bound in place by

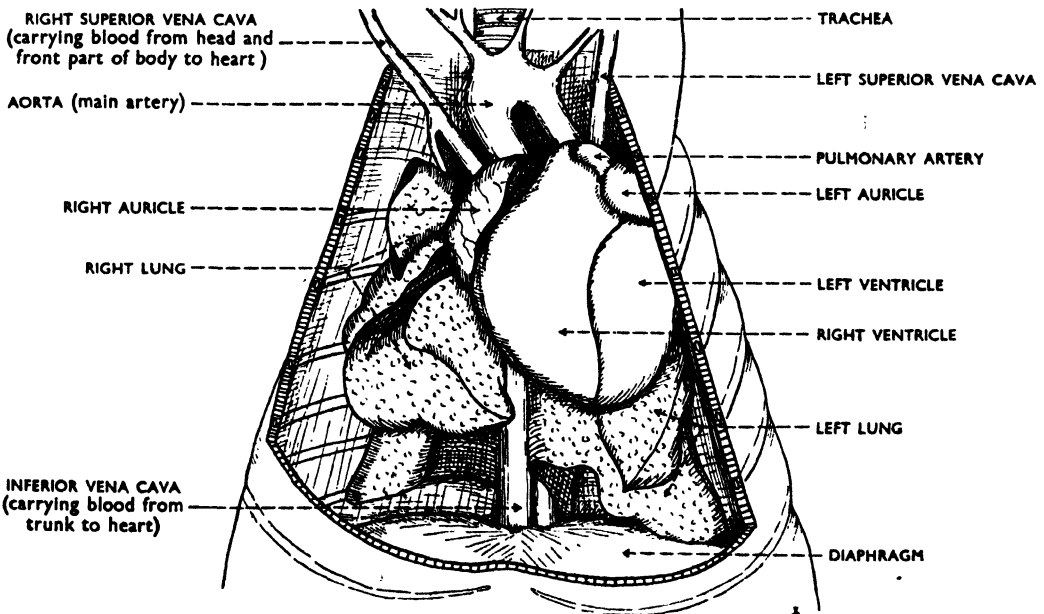

FIG. 108. THORAX OF RABBIT, OPENED TO SHOW DIAPHRAGM, HEART AND LUNGS IN SITU

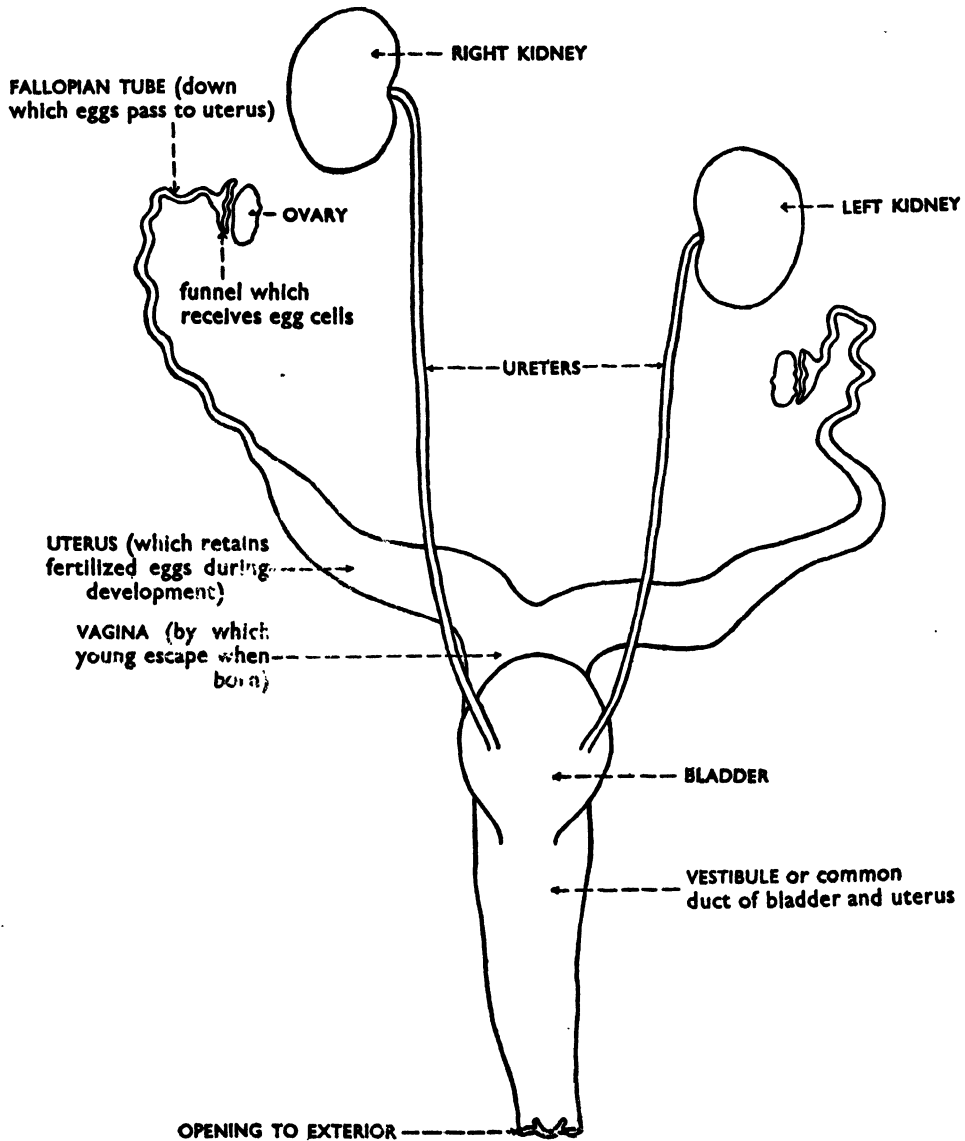

PLATE XXIV

URINARY AND REPRODUCTIVE SYSTEMS OF FEMALE RABBIT

the lining membrane and attached to the dorsal wall. They are pale yellow, and oval, about $\frac{1}{4}$ in. long. The minute eggs are discharged into the body cavity, and thence find their way into a pair of tubes with large funnels lying alongside the ovaries

and attached to the front end, so that the eggs easily drop into them. These narrow down, then widen to form the two sacs in which the young develop. In human beings there is only one of these sacs, formed by the two tubes becoming joined. It is called the

uterus. In the rabbit the two open into another wide tube which passes into the neck of the bladder and thence to the surface, but in human beings the uterus is continued as a tube which reaches the surface by a separate opening between the anus and the urinary opening.

It is quite probable that several developing young will be found in the two uteri. It is not possible to go into further details, but it may be explained that the advantage of this arrangement is that the young are protected during a very critical period of their lives, when they are helpless, and not only protected but fed, for part of the wall of the uterus is joined to membranes surrounding the developing embryo or foetus, and through it blood vessels pass. By means of this organ, called the placenta, the embryo receives food and oxygen, while waste substances pass away through it and are dealt with by the excretory system of the mother. It will be remembered that the developing chick was surrounded by membranes, one of which (the allantois) carried out breathing. The same membranes in a mammal take part in forming the placenta.

In preparing to show a dissected rabbit, it is useful to make large blackboard diagrams showing the thorax and abdomen separately, with their contents in the natural position, so as to indicate what to look for. A separate diagram of the whole alimentary canal to show its course and the shape of the organs is also useful. If the children are to examine the dissected rabbit themselves, it is necessary to provide them with a set of directions, which might be made from these notes.

It may be that the teacher will decide that only a very small number of children will profit by this part of the work, or that much less than is given here will suffice, but it is well worth while to undertake it for those who show genuine interest as there is no doubt that many children who do not ask questions are yet curious about the anatomy of their bodies, and the general

structure and arrangement of organs in the rabbit are, with minor differences, a close replica in miniature of that of man.

LESSON UNIT IV—FAMILY AND GROUP LIFE

Discussion of the development of the family as a means of protecting and looking after the young follows logically from the realisation that mammals have, by two special physical characteristics—retention of the young, which are fed from the blood of the mother, and milk production—concentrated on this problem. Mammals and birds, the warm-blooded vertebrates, have both specialised in the care of the young and it may be this characteristic as much as any that accounts for their success at the present time—success judged by numbers, variety of kinds adapted to many different conditions, and wide distribution.

Although only biological ideas are given in this and the two following lesson units, it will probably be found desirable for a teacher to link up the ideas presented here with the children's other interests and studies, especially those presented in connection with history, geography or civics. Many parallels may be drawn between the family and social life of animals and of man, and understanding of the origin of conditions found in man's society can often be helped by a study of the lower creatures. The teacher will be the best judge of how and when to present the material that follows. Here an attempt is made to found certain biological theories and generalisations upon the knowledge gained through the preceding studies.

Introduction.—We have said in a previous lesson that reproduction is the outcome of growth, and it is easy to understand that without reproduction all races of plants and animals would come to an end. If we go back to the lowest creatures we have studied—amoeba and the bacteria—it is found that when they reach a certain size they divide

into two, and so go on growing again. In this case, we cannot call one individual the parent and the other the offspring—both are the same age and size. But with larger creatures it has come about that only part of the body is set aside for reproduction—the rest lives as an individual, and dies. This is the penalty paid for higher development. The lowly amoeba is, except for accidents, immortal, since we cannot say the parent has died but the child lives—but it is immortal with a very limited kind of life. In a sense, we may say of the higher animals and plants that their reproductive cells—their eggs—are immortal, since as each develops, again part of it is set aside to produce a new generation.

Development.—All animals seem to be driven by two urges—the urge to eat and the urge to produce offspring—but amongst the lower animals, when once the offspring are produced, the parents show no further interest in them. There are certain exceptions it is true, yet it is characteristic of the lower invertebrates below the insects, and the lower vertebrates—fishes, amphibia and reptiles. Get the children to mention examples from amongst those which have been studied. *It is a general rule that the lower the type, the larger the number of offspring, and the more offspring, the more careless are the parents of their future.* A pair of herrings, for instance, produce many thousands of eggs each year; they are spawned and left to their fate, and since the number of herrings remains practically constant, it follows that of all these thousands, only two survive on an average.

1. Safeguards for the young.—It is interesting to notice in what ways animals have attempted to reduce the great risk of high mortality amongst their offspring, realising, of course, that until we reach man none of these ways has been consciously adopted or thought out. We can glance at only a few.

Crayfish and pond mussels, we have seen,

retain the young in brood pouches till they are fairly capable of looking after themselves. This is probably connected with the fact that they live in fresh water. If their larvae drifted down the rivers and out to sea, they would be killed by the salt water. Notice that it foreshadows the device used by mammals. Amongst skates and dogfish, a small number of eggs is produced and retained in the egg-passage, a very close parallel with mammals, while in one of the salamanders, a newt which lives high up in the Alps where no ponds or streams are available, the young are kept in the egg-passage until they have become fully developed, that is, right through the stage when they would be breathing under water. A close relation of this salamander, living in the Swiss valleys, passes through the ordinary life history of a newt.

When we consider birds and mammals, we find they have both achieved the same means for looking after their young after they are hatched or born—the family. There are many instances where the young are kept in a hidden nest or lair, and fed and cared for by one or both parents. As a general rule, the more helpless the young the more secluded and safeguarded is their home and the longer the parents care for them. Now, where the young have a great deal to learn in order to adapt them to a complicated and difficult life, the more helpless they are and the longer is their youth—not because helplessness is an asset but because they are more adaptable if immature, and more capable of learning, or more educable. Most birds and carnivorous, hunting animals have much to learn, hence a period of youth when they can learn with the experience of their parents to guide them is important. It will be seen that these principles apply equally to human young, and because they have so much to learn they need a long youth during which they can be educated. As life becomes more complicated, youth and education tend to lengthen. Here we have, then, the biological meaning of family life.

2. Herds and packs.—Now amongst mammals which are exposed to great danger from other animals there is a tendency to form larger groups than the family, or rather, in most cases, to form one large family under a leader, a patriarch or father, who is both strong, cunning and experienced—the *herd*. The example of wild cattle, buffalo or bison will make this clear. There is one old male or bull, with many wives, and young sons who will eventually dispute the leadership with him, drive him away or kill him, but not until they have the necessary qualities; or they will disperse and start new herds. In the herd, the young calf runs with its mother; the father has no special interest in it and the mother guards it; in fact, amongst most wild animals it is the rule that the mother guards her young. Since fleetness of foot is essential for safety, the young calf is soon able to run with the herd, for those which cannot are soon wiped out by enemies. Hence amongst animals which roam in herds the young must not be helpless, at least as far as running is concerned.

It is necessary for the safety of all the herd that all shall fear the same enemies, act quickly together in the same way and stick together. Whether they attack an enemy (for instance, a pack of wolves) with their horns or their hoofs, a crowd can be far more effective than an isolated member. Consequently herd instincts are strongly developed and an animal behaving as an individual is soon shown his error.

In human society such herd instincts still persist. Sometimes they are of value, sometimes they are obsolete survivals which hinder the development of a humane society. If we understand their origin and significance, it is possible to judge whether they are still of value, or whether we should try to modify or eliminate them. It is important to remember that *fear* is the ruling instinct of a herd, and the original cause of their remaining together—and equally important perhaps to realise that without fear animals would not escape from their enemies in the wild

condition. Yet fear in a civilised society is, in some aspects of life, a danger, not a valuable asset. The teacher may like to discuss here the advantages or dangers of fear in human society—a good subject for debate, perhaps.

Another kind of group differs from the herd in its motive. The *pack* is organised for aggression and attack, and has developed, besides speed, high skill and cunning in hunting, greater intelligence in some respects—though herds of wild creatures are much more intelligent than the domesticated varieties. Man's early organisation into societies—tribes—seems to have combined the two motives, to have had value for safety and for hunting, and to have shown some of the characteristics of both the herd and the pack. As civilisation progresses, it is important to understand how it began and what motives are still at work, it may be below the surface.

It is interesting to compare the social organisation of man with that of highly organised insects, such as ants or bees. It has been the fashion to admire them. "Go to the ant, thou sluggard, consider his ways and be wise." Kipling has a story of a beehive, in which he points a moral for man. The truth is that in insect communities the individual must be the complete slave of the society—the unthinking, blind, obedient, mechanical slave to a purpose of which he is unconscious. Moreover, there is no reason to think that these organisations can evolve any further. They are largely organisations for the care of offspring. Two questions arise. Is that a sufficient end in itself? Has the individual any value, as such, that is, as a personality, to his society? These also would be useful as subjects for a debating society to discuss.

LESSON UNIT V—EVOLUTION, ADAPTABILITY, HEREDITY

The theory that all existing species of plants and animals have become gradually

adapted to their mode of life and have evolved from very different, probably much simpler, ancestors by a process of natural selection, has not only become generally accepted by biologists but has been extended to explain the origin of human societies and processes of behaviour such as instincts and habits, both individual and collective.

It seems worth while, therefore, to try to give the children in senior schools a very simple account of this theory before they leave, though it will necessarily omit any difficulties, compromises and modifications which have been put forward in accepting it. It is, however, a very difficult subject for children and the teacher will have to select from the following notes such matter as may be considered possible to deal with.

Introduction.—People have always been interested in the many forms of life and puzzled as to how they came into being. From the earliest times two theories (or explanations) seem to have been discussed. We know at least that the ancient Greeks discussed them. One was the theory of *special creation*, which held that every kind of creature had been separately created and placed on the earth in the beginning of life, just as it is now. Although remains of animals and plants were recognised in the rocks as fossils or "petrified," this knowledge did not alter the belief for it was thought that these forms belonged to older, separate creations which had been wiped out by some overwhelming catastrophe, such as flood, fire or earthquake, and that after everything had settled down again they were replaced by a new creation, a complete break in the chain of life separating them.

The second theory was that existing forms of life had developed from preceding forms by a process of gradual change from time immemorial, and that this accounted for the relationships which, it seemed clear, existed between living groups—they were derived from common ancestors in the remote past. This was the theory of evolution. But although both theories were hotly

debated from time to time for at least two or three thousands years, nobody could explain how living things had come into existence and strangely enough nobody thought it necessary to provide any proof of either supposition.

Development.—Remind the children of the classification of animals already given, and tell them that plants also can be similarly classified. (Reference will be made to this in the summer term.) These classifications have been framed only during the last seventy to eighty years. They are the result of the work of biologists who accepted the theory of evolution set forth by Charles Darwin in 1859 in a famous book called *The Origin of Species*. He was the first man to take up the theory of evolution and suggest *how* the changes might have been brought about, and to *offer proof* in support of his views.

1. Early years of Darwin.—Charles Darwin was born at Shrewsbury in 1809, so his childhood belongs to the days when Wellington and Nelson were the heroes of England, and he was a little boy of six when the Battle of Trafalgar was fought. His mother died when he was eight, and he went first to a small day school and then to Shrewsbury School. He was an imaginative little boy, given to inventing marvellous stories of his doings, as many small children do, and he was also a great collector of eggs, beetles and other things, and a great dog lover. He was also very fond of fishing and later was a fine shot.

His interests were always largely those of a naturalist. He went to Edinburgh University for a little while with the intention of studying medicine (his father and grandfather were doctors) but he was horrified by the operations he saw, one on a child, and gave it up for, as he says, this was "long before the blessed days of chloroform."

He then went to Cambridge, with the idea of becoming a clergyman, but this intention died a natural death for, on leaving Cam-

bridge, he was offered the post of naturalist on a voyage of scientific discovery made by H.M.S. *Beagle* in 1831. Darwin was already on terms of friendship, although he was only just twenty-two years old, with some of the most eminent scientific men of his day, which shows that they must have thought him a young man of great promise; indeed, he was already a first-rate geologist and botanist, as well as having through his love of walking, riding, fishing and shooting a very extensive knowledge of animal life, especially of birds and insects.

It was, then, this keen, intelligent, highly trained young naturalist who set off on a voyage which occupied five years and touched all sorts of out of the way places—St. Helena and the Galapagos Islands and many parts of South America amongst them. (Galapagos means tortoises in Portuguese, for these equatorial Pacific islands, six hundred miles from the coast of South America, were inhabited by gigantic tortoises.) He examined, dissected and collected all the animals he possibly could. He wrote descriptions of all he saw in a carefully kept journal. In particular he made most important geological discoveries, and collected fossil bones of animals which had lived thousands of years before. *He was especially struck by the resemblance of these ancient forms to the present-day forms he found in South America and in the Galapagos Islands*—giant sloths and tortoises particularly. Certain South American thrushes, amongst living birds, were strikingly like some which he found living in isolation in oceanic islands.

(For a fascinating account of the journey, much of which the children could read and enjoy, see his own book, *The Voyage of H.M.S. Beagle*.)

2. Development of his theory.—When Darwin returned home, he found that his scientific friends were keenly interested in his journals and collections, and that he was already becoming famous. He planned several books on the scientific discoveries he

had made. He read and worked tremendously. The voyage had turned his thoughts to the puzzling questions, "Are all the different forms of life (that is, different species of plants and animals) on the globe descended from some one common ancestor, or from a very small number of ancestral forms? If so, how have all their diversities come about?" It was his experiences on the voyage of the *Beagle* which eventually gave him the answers and made him not only the most famous scientist of the nineteenth century but the most famous biologist of any century.

It has been said that genius is "an infinite capacity for taking pains;" Darwin was one of the most patient and painstaking men who ever lived. Although the theory, now known as "The Theory of Evolution by Natural Selection," was forming in his mind, and although he discussed it with one or two close friends, he never breathed a word publicly until he had amassed evidence of all kinds which eventually satisfied himself. It was not until twenty-two years later that he felt justified in making his conclusions public—and by that time he had ample proof, for Darwin differed from all previous men who had discussed such questions, in seeing that *without definite proof theories and discussions were valueless*.

3. Darwin's theory of evolution.—This is, briefly, the line of Darwin's argument. All animals and plants are subject to variations; no two, even in the same family, are ever alike; e.g., two kittens in a litter, two chickens in a brood. Suppose such variations had any value in the life of a particular creature, they might increase its chance of life. If its life were lengthened, then it would be likely to produce more offspring than others which had not this *favourable* variation. This he called the *survival of the fittest*. (Fit=fit for the particular conditions in which an animal or plant finds itself.)

Now Darwin emphasises that there is always *a struggle for existence*. Under natural conditions there is frequently not

enough food to go round. There are always birds of prey and flesh-eating beasts and reptiles looking for food. There are parasitic and blood-sucking insects. So that the phrase undoubtedly expresses a real condition.

In the struggle for existence a favourable variation might tell in favour of its possessor to such an extent that its life was saved. The less fit would die out, whether they were weaklings in general, or merely did not possess the new, favourable variation. This Darwin called *natural selection*, but he also adopted the alternative phrase coined by Herbert Spencer, "the survival of the fittest." He had been particularly struck by the part played by stock breeders as artificial selectors of the qualities—or variations—they wished to have handed on. He thought it possible that harsh conditions in nature, by wiping out the unfit, might play the part of natural selectors. In course of time the new variety would take the place of the less suitable form, and a new species would be established.

4. "The Origin of Species."—There is only space to give a few illustrations from Darwin's book *The Origin of Species* in which the theory was set forth.

(a) *From Chapter IV:*

"Take the case of a carnivorous quadruped, of which the number that can be supported in any country has long ago arrived at its full average. . . . It can succeed in increasing . . . only by its varying descendants seizing on places at present occupied by other animals: some of them, for instance, being enabled to feed on new kinds of prey, . . . some inhabiting new stations, climbing trees, frequenting water, and some perhaps becoming less carnivorous. The more diversified in habits and structure the descendants of our carnivorous animal became, the more places they would be able to occupy."

(b) *Summarised from Chapter VII:*

The pincers or chelae of crustacea show every stage from the simplest form, in which

the last segment merely shuts down on the broad end or side of the one below, so that an object can be gripped between the two, to the stage in the lobster in which there is a long, toothed projection from the lower segment which fits against the end one to make an elaborate and effective grasping organ and weapon. In between are stages showing that this inner, curved prong has developed gradually, first as a small projection, then a longer, slightly toothed point, against which the hinged joint works. In the more primitive forms the limb is still used as a walking leg, but in the lobster it is a tool and weapon only.

(c) *Summarised from Chapter VII:*

Darwin investigated the manner of climbing of twining plants, and was struck by the many gradations which exist from mere stem-climbers, through leaf-twiners (e.g., wild clematis) to elaborate tendrils which he felt sure were derived from leaves (e.g., vetches). At one point in the series an entirely new character (or variation) comes in, that is, sensitiveness to touch, by which "the foot-stalks of the leaves or flowers, or those modified and converted into tendrils, are excited to bend round and clasp the touching object." Each of these changes, and especially the last, is beneficial in a high degree to the plant, for each makes more certain that it will gain effective support. There would be a distinct advantage, therefore, if these were inherited, and so they would be acted upon by natural selection—they would be the "fittest" and so survive.

(d) *Summarised from Chapter VII:*

Whales of the type which produce whale bone or baleen obtain their food by straining sea water through fringed plates of this substance hanging down from the palate. This keeps back all sorts of minute creatures (such as sl.rimps) which are the sole food of these great creatures. Ducks obtain their food in a similar way, but the strainer is not so well-developed, being merely a

roughening or grooving of the inside of the beak. Amongst the whalebone whales of different species the plates vary in length from about 9 in. to 15 ft. in the Greenland whale. Another whale (not nearly related, but closer to the toothed whales) has neither true whalebone nor true teeth, but "the palate is roughened with small, unequal, hard points of horn." "There is nothing improbable in supposing that some early cetacean (whale) was provided with similar points of horn on the palate . . . which, like the knobs on the beak of a goose, aided it in seizing and tearing its food. If so . . . the points might have been converted through variation and natural selection into lamellae (plates) as well-developed as those of the Egyptian goose, in which case they would have been used both for seizing objects and sifting the water; then into lamellae like those of the domestic duck; and so onwards, until they became as well constructed as those of the shoveller, in which case they would have served exclusively as a sifting apparatus."

Note that in all these cases, *each stage* in development through further variation would be useful. Darwin was showing that even very slight variations might be valuable. At the present time, biologists are coming to the conclusion that it is probable that many variations—perhaps most—are distinct and often quite new; e.g., entirely new colours in flowers, large horns from hornless animals, well-marked hair from previously smooth forms; but Darwin thought that only slight variations probably occurred and that they gradually accumulated.

(e) *From Chapter VII:*

"With the giraffe, the continued preservation of some extinct high-reaching ruminant, which had the longest necks, legs, etc., and could browse a little above the average height, and the continued destruction of those which could not browse so high, would have sufficed for the production of this remarkable quadruped."

Note that in this case Darwin is, for once,

merely surmising, and does not support his case with evidence from relative forms as in all the others we have quoted, but he mentions it only casually in passing as an interesting possibility; it is not one of the cases to which he gives weight as evidence for his case. As it is, however, one of the most frequently alluded to in popular accounts of natural selection, it has been included here.

Practical work.—Collect and examine examples of variation amongst common plants and animals; e.g., banded snails from the hedgerows; and in the spring and summer, flowers and leaves—numbers of petals, different shapes of leaves such as hollyhock, sycamore, differences in markings of birds' eggs, occasional "sports;" e.g., blackbird with some white feathers. Make lists of those found.

From these examples we may pick out two points which Darwin has emphasised as being essential to his theory. The first is the importance of *adaptability*, which is the result of *variability*. Because members of a species arise with variations, some at least may vary in a direction which is valuable, and so survive and perpetuate their species—possibly in time a new species. The survivors live because they are *better adapted* to their surroundings. It is worth noting that man seems to have made adaptability itself his speciality. More than any other animal individual men can adapt themselves to new conditions in their environment. This is largely because they have developed two things, the power of using their hands and the power of thought. There is not space to follow this idea further here, but it is worth throwing out for discussion. Incidentally, the development of hand and brain have gone on side by side, and have influenced one another.

The second point is the importance of *heredity*. The whole theory depends on variations being inherited. In Darwin's day very little was known about the laws of

inheritance, but we know now that characteristics are passed on from parent to child in accordance with mathematical rules. If new variations occur, a certain proportion of offspring will inherit them, and they will reappear from generation to generation. This strengthens Darwin's theory considerably, for it means that the creature which survives because it possesses a new and favourable (or vitally valuable) character will with certainty pass on this character to some of its offspring, thus increasing *their* chance of life. We still know nothing of what causes variations to appear, though we are perhaps a little nearer to this knowledge than the biologists of Darwin's day.

Our present-day knowledge of the laws of heredity was made possible by the work of another famous man, whose name we have only just space to mention, Gregor Mendel, monk and abbot of Brn in Silesia. He worked out certain conclusions as a result of experiments on the cross breeding of peas. He was less fortunate than Darwin, for his contemporaries did not realise the importance of his work; though he published his results in 1866, the papers were overlooked and lost, and it was not until 1900, long after his death, embittered and disappointed, that they were re-discovered hidden away in a library, and their value was understood.

LESSON UNIT VI—THE GEOLOGICAL RECORD OF PAST LIFE

In case any teachers wish to omit the previous chapter, this chapter is complete in itself without reference to it, but where lessons on evolution have been given reference would naturally be made to them.

Introduction.—It has been suggested from time to time in this course of lessons that present-day plants and animals are descendants of much simpler forms which lived in the remote past; e.g., that in the development of broad bean seedlings the first, simple

leaves are like the leaves of their primitive ancestors, and that the limbs of the higher land animals probably developed from some such structures as those of the Queensland salmon (Class Picture No. 34, reproduced on page 45), which uses its fins to crawl in the river mud. Incidentally, this fish also shows how lungs may have arisen, for it fills its swim bladder with air when the river dries up, as some of the Australian rivers always do in the summer. Most fishes fill the swim bladder with gas to regulate the pressure inside the body as they rise or swim downwards, but the Queensland salmon have found a new use for it and if other ancient fishes, as is thought, did the same, this was an important step in adapting the body to breathe on land. It has also been stated that there has been gradual progress in the development of animals in the shape of the body, the head, limbs and internal organs.

This process of change is called evolution, that is, present-day animals and plants are believed to have evolved from earlier, simpler forms. There are three main types of evidence on which this belief is based. They are derived from (1) the comparative study of structure; (2) the study of life histories from the earliest stage of development, and (3) the study of what is called the geological record. Some attention has been given throughout all this three years' course to the first two, so we are going to wind up by explaining a little about the third.

Development—The Geological Record.

1. How the record has been made.—From very early times, certainly as far back as the ancient Greeks, men have found preserved in the rocks plant and animal forms which they recognised as being the remains of some earlier kind of life. Sometimes these remains took the form of impressions of such things as footprints or leaves, at other times hard skeletal parts and shells had been preserved through gradual replacement of the bone or shell by much harder substances, such as lime or sand. People used to describe such

forms as "petrified" or changed to stone, and they were called fossils.

Only the hard parts of plants and animals could persist long enough to be petrified or fossilised, for the soft parts would soon decay after death. The chance that even these would be preserved depended upon their falling into some place where they would be protected against the action of the oxygen in the air. Such conditions would be most likely to occur in the beds of rivers, lakes, glaciers and the sea, where water or ice would keep out air and the fine silt would bury the remains. Thus bones, shells and the trunks of trees are usually found in deposits that were at one time under water. Bogs too afford these conditions, and some of the more recent remains are found in such places, for instance the Irish bog oak and the ancient giant deer called the Irish elk; while the mammoth, an extinct giant elephant with long hair, is a well-known example of the action of ice in preserving animals. These have not had time to be fossilised, for their period of life immediately precedes our own.

2. Rock strata.—In course of time the weight of water, and the increasing layers of mud washed down, would compress the silt and form rock, so that the fossils became embedded in a rock matrix. We speak of the layers of rock formed at different periods as strata. Between the formation of one stratum and the next it is quite probable that many thousands of years may have elapsed. Rock strata are frequently referred to as geological strata. (*Geology*=knowledge of the earth.)

3. Geological epochs.—After careful and prolonged study, geologists have been able to say in what order most of the rocks forming the earth's crust were laid down, and approximately how long ago, though as Mr. H. G. Wells and Mr. Julian Huxley have pointed out in *The Outline of History*, they differ so much in their estimates that while some authorities consider that the most

ancient rocks were formed eighty million years ago, others think that it may be eight hundred million years ago and would multiply each number in the series of estimates up to the present time, by ten. Whatever may be the truth, and we shall probably never know, it is certain that life has developed very slowly, and that for more than half of the time the earth has been in existence, it bore no life at all.

The various rock strata are characterised by very different fossils, which can be arranged in an ascending order from the most primitive. Each long period of time—certainly millions of years—which was characterised by particular forms of life is called a geological epoch. Study the table on page 178 to see what were the main characteristics of each epoch.

Although geologists are not agreed as to the actual length of each epoch, they are in agreement as to the relative endurance of the periods. The late Professor A. A. Thompson and others have represented this relationship by means of a clock face, showing as a twelve-hour day the whole of geological time during which there has been life on the earth and indicating how many hours each epoch lasted. We have had a diagram and a picture—Plate XXV and Class Picture No. 1 reproduced in Plate XXVI—prepared to bring out these points. The best way to use these would be to make an enlarged blackboard copy of the diagram, while the picture is pinned up so that all the children can see it. They should be given an opportunity of studying it in detail individually later.

4. Chart and picture of prehistoric epochs.

Azoic.—Refer first to the diagrammatic chart. This represents the whole of the earth's existence as twelve hours. Notice that the earliest, or azoic, epoch, receives its name from the probability that it bore no animal life at all. Nor would there be plants. In the geological twelve-hour day, this condition went on until 3 o'clock, at which time *life probably dawned*.

ERA	Predominant animals	Predominant plants	NOTES	PERIODS (rock strata)
RECENT			So short in comparison that it should be represented by a mere line, or a few seconds out of an hour, possibly, on a clock face.	
CAINOZOIC	MAMMALS BIRDS INSECTS	Modern types.	Flora of Europe that of a much warmer climate—tropical and subtropical—until the Ice Age (Pleistocene). Mammals especially predominant.	Pleistocene Pliocene Miocene Eocene
MESOZOIC	REPTILES	Monocotyledons and Dicotyledons appear; e.g., Palms, Oaks.	<p>THE AGE OF THE GREAT REPTILES</p> <p>Dinosaurs, Fish-lizards, Sea Dragons, Flying Dragons. The earliest mammals and birds appear—birds resembling the Terns and Divers. Archæopteryx, the earliest known bird, which is a link with the reptiles, found in Jurassic rocks of Bavaria. The highest families of insects appeared—Hymenoptera (Wasp and Bee family) and Lepidoptera (Butterflies and Moths).</p>	Cretaceous Jurassic Triassic
LATER PALAEOZOIC	FISHES and AMPHIBIA	Tree ferns (and smaller ones). Giant Horse-tails, Giant Club Mosses.	<p>Great swamp forests of the Carboniferous, (including the Coal Measures) swarmed with fishes in the water and amphibia in the swamps (giant newts and smaller forms)—the first air-breathing vertebrates. Also air-breathing insects—Dragonflies, Cockroaches, Land Snails and Spiders.</p>	Permian Carboniferous
EARLY PALAEOZOIC	INVERTEBRATES and more primitive FISHES	Algae. Some with calcareous skeleton fossilised.	<p>Trilobites and Sea Scorpions (Euryptids) abundant and other ocean-dwelling invertebrates, such as Sea-lilies (Crinoids), Sponges and Radiolaria (one-celled animals with a minute silica shell). Fishes of Dogfish and Lung-fish type, especially in Devonian. Also armour-plated fishes of a class now almost extinct (Ganoids).</p>	Devonian Silurian Cambrian
PROTEROZOIC AZOIC or ARCHAIC	Probably Jellyfish and very primitive invertebrates		Proterozoic and Azoic lasted for longer than the rest of the eras put together, yet nothing is known of their life, if indeed any existed.	Laurentian

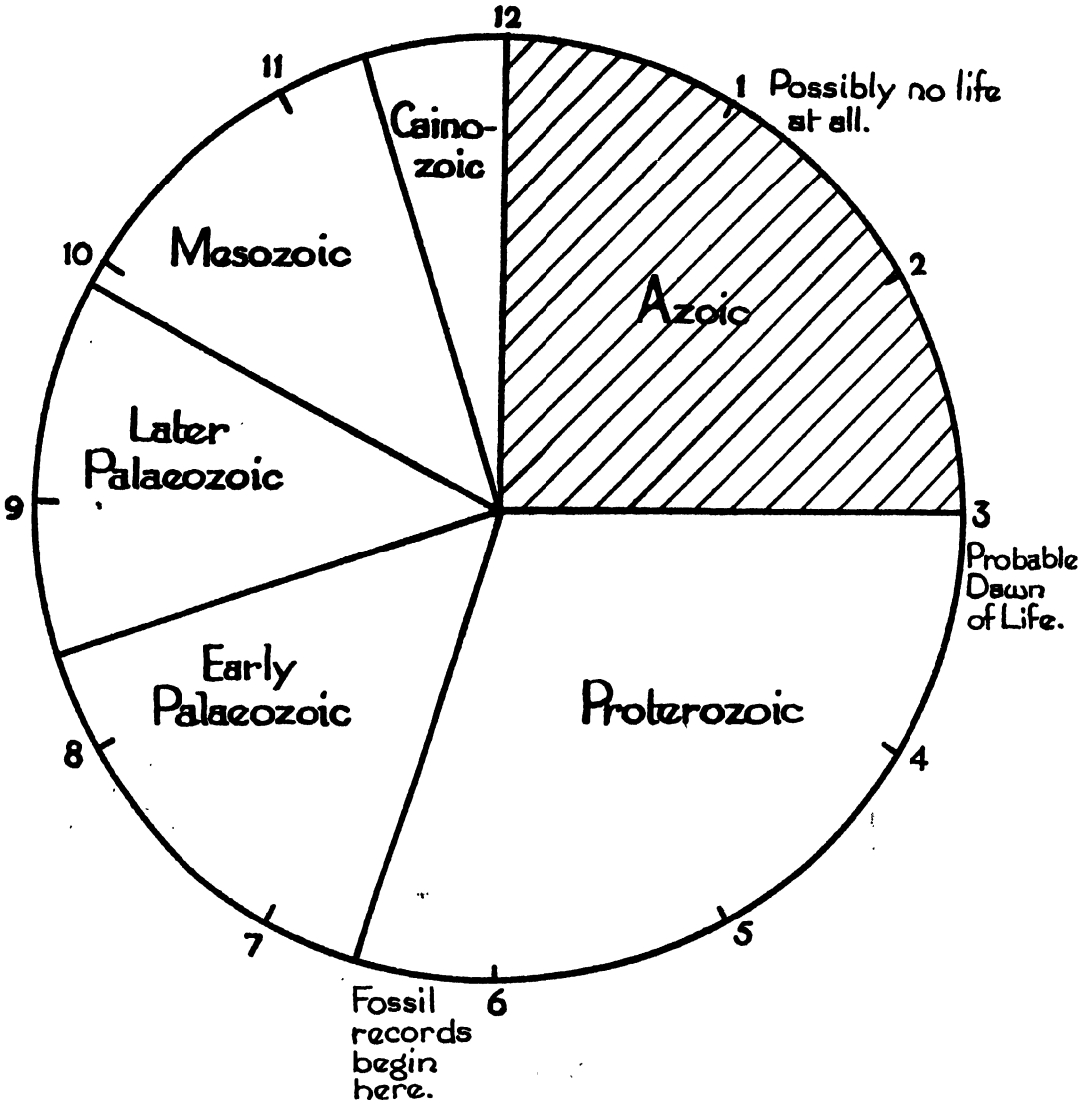

PLATE XXV. DIAGRAMMATIC CHART OF PREHISTORIC EPOCHS

Proterozoic.—It was followed by a long period of exceedingly simple forms, many possibly of the amoeba type. In all probability amoeba came into being during this time. Our picture of life on the earth begins here, so that 3 o'clock on the chart is zero hour on the picture. But for the moment we will follow the chart. The name protero-

zoic means primitive animals, or first animals. No doubt primitive plants also appeared.

Palaeozoic.—The fossil record begins at about 6.30, for the simpler forms of the first part of the period had no hard skeletons. This is called the early palaeozoic, meaning early ancient animals. Now we might turn



PLATE XXVI. CHART OF PREHISTORIC EPOCHS
 (Class Picture No. 1 in the Portfolio.)

to the Class Picture to see what they looked like. At the top are two jointed creatures looking a little like lobsters, and at the bottom some oval, jointed forms not unlike woodlice but with the body divided by deep grooves into three lobes, from which they

have been given the name trilobites. All these creatures are primitive arthropods. Probably their nearest present-day relations are the scorpions of sandy deserts, but these creatures all swam about in the palaeozoic ocean. They were accompanied by curious-looking fishes,

whose present-day descendants, the sturgeons which provide the much prized delicacy caviare, are found in certain Russian and Central European rivers. They are so rare in British waters that if one is caught it is a perquisite of the king, and is called royal sturgeon.

In the lower corners of the palaeozoic picture are groups of sea lilies. These are relatives of starfish and sea urchins, and still exist, but must be sought in muddy abysses of the ocean which are such undesirable residences that there is no competition, and so these "old stick-in-the-muds" are left in undisturbed possession, rooted in the slime. Notice that early palaeozoic animals are now either extinct or found in isolated localities.

We pass now to the later palaeozoic, and here we see invertebrates belonging to all the great present-day groups, which inhabit water—fishes resembling our modern fishes, and amphibians great and small, chiefly resembling newts, swimming about and clambering out of the water amongst the muddy swamps and roots of trees which are the first sign that land is emerging from the waste of waters. Notice that the trees are very different from our modern forms, but the one in the left-hand corner is a tree fern not unlike certain tropical species, while if you are familiar with the stagshorn mosses of high moorlands you will recognise the resemblance to these trees, of which they are diminutive descendants. The trees in the foreground on the right are reminiscent of the present-day field horsetail and marsh horsetail which are probably known. And last, we notice that winged insects have put in an appearance, as soon as they can find land to fly over and plants on which to alight.

Referring once again to our clock-picture, we shall see that the cainozoic is by far the shortest epoch. Roughly speaking, the palaeozoic lasted till 7.20, the mesozoic till 10.40, the cainozoic till about 12, and just before the stroke of 12, man crept out of his cave. But to follow his adventures to the

present time we should have to begin another day. How far he will go we have no means of knowing. Taking the most conservative estimate, the palaeozoic lasted twenty-two million years, the mesozoic ten million, the cainozoic four million. Notice that the more ancient periods are much longer. Of man's history on the earth we know only between 4,000–6,000 years, his first appearance was possible 20,000 years ago. Compare this with the thirty-six million years of life on the earth and you will consider that he is still newly-born.

Mesozoic.—The name of the next epoch means the middle animal period. We referred to it in the lesson on birds. It is especially the time when reptiles flourished, and so, though there were invertebrates, fishes and amphibia of many kinds, our picture shows mainly reptiles to emphasise their importance. By this time the earth's surface seems to have consisted of ocean, swampy jungle and bleak, barren highlands. The reptiles took advantage of all these conditions. Some inhabited the seas like seals and whales; some crawled about in the swamps like hippopotamuses and alligators—in fact crocodiles and alligators were amongst the reptiles which existed then. Some roamed over the dry land, browsing on the plants or preying upon one another, for some were herbivorous like cattle and deer, others were carnivorous and occupied the position now taken by lions, tigers, bears and wolves. Some of the smaller forms made their homes amongst the branches of trees, running and leaping as lizards do, while others developed wings on the same lines as the bats and flew. This is the first instance of vertebrates taking to flight.

At the end of the mesozoic the group of reptiles dwindled from its important position of dominating the earth. This seems to have been due partly to the fact that many forms were of gigantic size and unduly hampered by heavy armour-plating, spines and horns, as the dinosaur triceratops in the upper section, stegosaur with the crest of triangular spines, and long-necked diplodocus—80 ft.

<p>CAINOZOIC Age of Mammals and birds.</p>	
<p>MESOZOIC Age of Great Reptiles.</p>	
<p>PALAEOZOIC Age of Invertebrates, Fishes, Amphibia.</p>	
<p>PROTEROZOIC Very primitive, chiefly one-celled animals.</p>	
<p>ARCHAIC</p>	

PLATE XXVII. CHART OF GEOLOGICAL EPOCHS

from head to tail—show. *Diplodocus* shows too what small brains they had, another drawback. So the huge forms died out, leaving as representatives of the group comparatively small forms, with a few of moderate size, such as the alligators, boa constrictors and some turtles.

Although the great reptiles were most impressive, it is to some of the smaller ones that all the mammals and birds of the present day owe their existence, for there is no doubt that their ancestors are to be found amongst the insignificant lizardlike reptiles. Towards the end of the mesozoic the first birds had made their appearance. Near the centre of the picture can be seen the earliest bird of which we have any knowledge. As already stated in lessons on birds, it has been given the name of *archæopteryx*, which means ancient or earliest bird. We have noted previously that it had a long tail, feathered to the tip, claws on its wings and teeth in its beak, but was a true bird nevertheless. It was about the size of a pigeon. Only two specimens have been found, in limestone rocks in Bavaria.

Cainozoic.—The next epoch brings us to the animals and plants which immediately preceded ourselves on the earth, the cainozoic or period of new animals. Birds, mammals, every kind of flying insect, could be found in climate and country which showed many changes yet which resembled the varied climates of our present world, and amongst plants which did not greatly differ from those of the present day. For instance, birch woods and pine forests existed. The outstanding characteristic climatically towards the end of this epoch was the alternation of extreme cold with milder periods. Four times at least, snow and ice spread over the northern hemisphere. Great glaciers flowed over Europe and large parts of North America, then the snow and ice retreated and again advanced. This is known as the glacial epoch. These periods occupied thousands of years, and great changes in

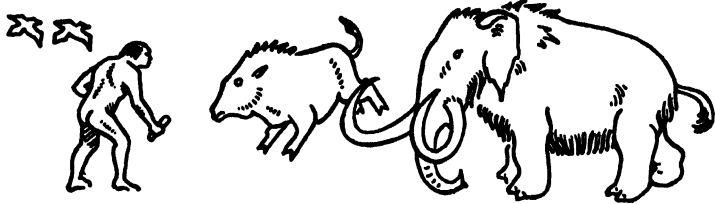
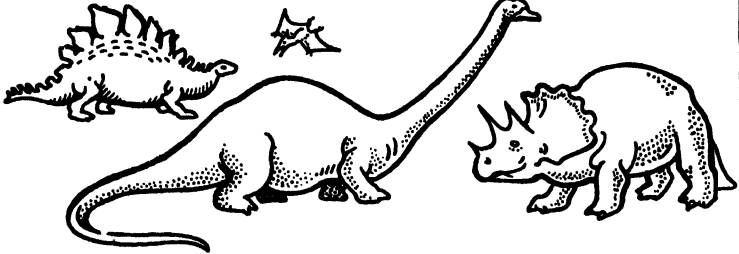
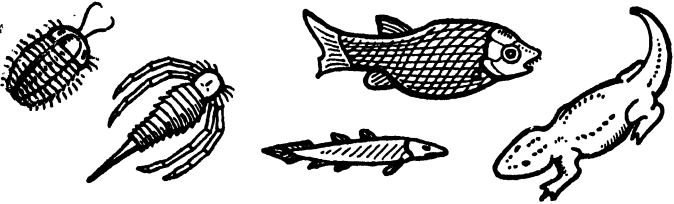
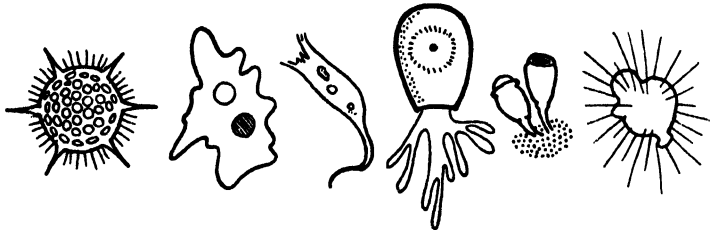
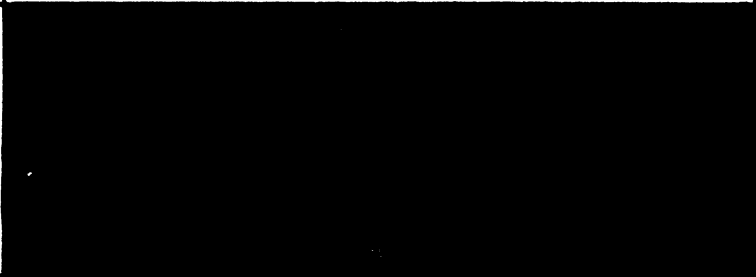
both the personnel and the distribution of plants and animals occurred, as they alternately retreated before the ice and advanced to occupy again the land from which it receded. The animals pictured to represent this period are the mammoth, Irish elk, sabre-toothed tiger, and a small wild ancestor of the present-day horses, while near the centre of the picture primitive man emerges from the dark cave in which he has made his home—man the hunter, pitting his brain against the speed and caution of the animals, beginning to use his hands not merely to throw sticks and stones on the chance of killing them but to fashion weapons and implements out of bone with which to make his aim more sure and deadly. With the dawn of man's life on the earth we must leave the story, which in later years was influenced more and more by his developing mind. Let us notice, however, that from his earliest appearance, from the evidence he has left behind, he was already trying to dominate his surroundings and modify them to suit his needs. The men who made the first stone weapons had the same spirit as the men who make and use all the most up-to-date modern machines and scientific discoveries.

One of the most amazing links with pre-historic times has lately been brought to light at Wrangel Island, in the Arctic Ocean, according to a report from the Soviet Academy of Science. This is the discovery of the carcass of a mammoth, the huge woolly elephant which has been extinct for thousands of years. The carcass is refrigerated in the Arctic ice and is perfectly preserved. Petrov, chief of the Wrangel Island station, states that the mammoth meat is still quite fresh. Apart from this surprising fact of meat having been perfectly preserved in the Arctic "meat safe" since the Stone Age, the discovery is of great scientific importance for the body of the mammoth is intact, even to the hair with which it is covered.

SUMMER TERM

LESSON UNIT—CLASSIFICATION OF PLANTS : USE OF A FLORA

IT is probable that a certain number of boys and girls, perhaps only a small number, are now sufficiently interested in the field side of biology to wish to continue it as a hobby when they leave school, and sometimes the example and interest of a teacher will give just the stimulus that is needed to rouse a lifelong interest. They cannot get very far alone unless they know how to use reference books, especially books that will enable them to identify plants, birds and insects. Since books of this type are rather difficult for young people to use without guidance, it is often useful to introduce them first to descriptive reference books. This type of book should be followed by a standard *Flora*, and the more scientific books on birds and insects. If the use of a flora is described here, it will serve to illustrate the method usually followed in books of this kind. The book usually introduced to schoolchildren is Watt's *School Flora*, which is reasonably priced, clear and simple to follow, though later the keen field botanist may want a more advanced and complete work.

It would be useful if the school possessed a set of such floras, sufficient to enable the children to use them in pairs. As these would be used year after year by different classes, the initial expense would cover the needs of a very large number of children. If, however, this is not feasible, small groups might be instructed in the use of the flora at a time.

A preliminary talk to the whole class would clear the ground. This would necessitate also a slight understanding of the principles of classification of plants.

Introduction.—It was said in a previous lesson that the modern classification of

plants and animals implies certain relationships within the groups. Thus, all animals grouped as mammals have fur and suckle their young, all birds have feathers and lay eggs with hard shells, all insects have a head, thorax and abdomen, six legs and, in nearly all cases, wings on the thorax. Within these bigger groups are smaller groups whose members are yet more closely related, and finally we recognise genera and species, the species being made up of individual members.

Development—1. Species and genera.—Just as we have the genus of cats, the species lion, tiger, wild cat, puma, panther, leopard, so we can recognise genera of plants, such as the buttercup, *ranunculus*, with a number of species, the common field buttercup, *Ranunculus acris*—bitter—the creeping buttercup, *R. repens*; the bulbous buttercup, *R. bulbosus*; the lesser celandine, *R. ficaria*; the water buttercup, *R. aquatilis*. Note that in each case two names are given, the genus being written first, with a capital letter, the species with a small letter. Note also that these scientific names are always in Latin. This is not a mere whim, or a desire to appear learned, but due to the necessity that scientists all over the world shall know that they are speaking of the same plant or animal, and so they have agreed on a system which they all understand. It would not suffice to translate popular names into different languages. For instance, the French call the garden nasturtium *capucin*, which means a monk's hood, but we call an entirely different flower monkshood. If, however, each has a fixed Latin name, we know exactly to what flower it belongs.

2. Natural orders.—To go back to classification, the species are grouped into genera, the genera into families called natural

orders—natural meaning according to their true relationship, for the theory that they are related and of common origin has been accepted. These are grouped again into still larger groups.

3. Beginning to use a flora—Flowering and flowerless plants.—Now, in trying to find out what a plant is, it must first of all be assigned to the most comprehensive group and then the inquirer works gradually down to the smaller groups. The first thing to do is to decide whether it is a flowerless plant—cryptogam—or a flowering plant—phanerogam—that is to say, whether it reproduces by spores or seeds.

4. Monocotyledons and dicotyledons.—Suppose the specimen to be flowering plant. The next point to decide is a question of the structure of the seed. Has it one or two cotyledons? If it has one, it is called a monocotyledon, if two, a dicotyledon.

It is extremely unlikely that the specimen will have both flowers and seeds, so that at first sight it seems impossible to go any further. However, there are certain other features which are always associated with these characteristics of the seeds. Plants belonging to the class Monocotyledon nearly always have parallel veins, and the number of parts of the flower are in threes. Take a daffodil as an example. It has a ring of three outer floral leaves; then a ring of three inner ones; a ring of three outer stamens and three inner ones; then an ovary of three chambers or carpels. It is also parallel-veined. Its leaves grow straight from the ground with no stalk. This is called radical, and is another feature of monocotyledons.

Plants belonging to the class Dicotyledon, on the other hand, usually have at last some of their leaves growing on a stem or axis above the ground, and they are net-veined. The parts are in fours or fives. A violet, for instance, has an outer cup (or calyx) of five sepals; then a ring of five petals, the corolla; then five stamens. The ovary alone has three parts or chambers. The leaves too

have the dicotyledonous characteristics; they are stalked and net-veined, and though they appear to grow straight from one point they are actually on a short, thick stalk creeping just under the surface.

5. Grouping together of natural orders.—Having decided that a plant is a flowering plant and, say, a dicotyledon, we try to discover its natural order. But we shall find it easier first of all to find the group of natural orders to which it belongs. Otherwise we should have to wade through the whole list. To save time, therefore, the natural orders are grouped together under three letters:

- A. Polypetalae: Flowers with both calyx and corolla, and petals not united. (*Poly*=many.)
- B. Gamopetalae: Petals united. (*Gamo*=joined or united, the same root as in monogamy, polygamy.)
- C. Apetalae: Without petals.

6. Sub-classes.—The Polypetalae are grouped into two sub-classes: (1) Thalamiflorae (from *thalamus*, a cushion) have the stamens growing—inserted—on the flattened top of the flower stalk, which forms a cushion or receptacle; (2) Calyciflorae have the stamens inserted on the turned-up edge of the receptacle, which thus forms a tube and brings the stamens up round the ovary or above it.

In the Thalamiflorae, therefore, the parts of the flower are inserted below the pistil, as in the poppy, and the parts are said to be hypogynous (from *hypo*=below, and the Greek word *gynoecium*=pistil).

In the Calyciflorae, the parts of the flower are perigynous or epigynous (from *peri*=around and *epi*=above or upon).

The Gamopetalae have only one sub-class, Corolliflorae, and the Apetalae are subdivided into two.

For further convenience, a system of symbols is used to group the natural orders according to certain characters they may

have in common, so that it is not necessary to read through the characteristics of all the sub-classes to find the natural order.

Having found the group, it is necessary only to read through the brief synopsis of the natural orders and to eliminate those with which our specimen does not agree. This determines the natural order and, on turning to the index, the page can be found. All this information is given at the beginning of the book.

7. Artificial key.—In most floras there is also an artificial key, from which the natural order may be determined by eliminating one of a pair of characteristics, the remaining member having a number attached on the right-hand side, which must be looked for again, lower down, on the left. This takes the inquirer from point to point, is easy to follow, and useful. It has the disadvantage that it can be followed again and again without any guiding principle emerging, and so no knowledge is gained either of the method of classification or of the facts on which it is based.

In order to avoid a purely mechanical exercise, the teacher should point out how the points noted—such as union of petals into a tube, position of stamens, nature of styles—help to serve the flower's purpose of pollination. For illustrative details see notes on Class Picture No. 24 on Pollination of Flowers at the end of Lesson Unit II of last term.

A glossary at the end of the flora explains all botanical terms, so that it is quite simple to use and no one who reads the introduction carefully and who turns to the glossary for unknown terms can be unsuccessful with a little practice; there seems to be a general impression that a flora is something obscure and needing special initiation, which makes many people diffident about using it, but this has no foundation in fact.

For notes on flower study to accompany the study of classification, refer back to chapter on Pollination and seed formation, Lesson Unit II in last term's work.

LABORATORY TECHNIQUE

APPENDIX I

The use of a microprojector.—The senior school teacher who wishes to give his pupils some knowledge of the detailed structure of plants and animals, for which microscopes are usually required, will find the instrument known as a microprojector of great use, Plate XXVIII. It is strongly recommended as necessary equipment by H.M. Inspectors of the Board of Education.

This is a microscope placed horizontally upon a stand, and illuminated by a strong lamp shining direct upon the principal lens, or objective. If a microscope slide is then placed upon the stage of the microscope, it is between the lamp and the objective, and an image is thrown which, instead of being focussed on the retina of the observer, as with an ordinary microscope, can be focussed upon a silver screen placed some distance away.

In order to secure exact alignment of the lamp, the object, and the centre of the objective, all these parts are firmly screwed in a sliding groove on a horizontal metal bar, clamped to a strong foot. By means of various adjustments the relative position of the three parts can be regulated so as to obtain a clear image.

For examining preserved material this is all that is required, but it is often convenient to examine small living organisms. For this purpose small tanks and glass cells are provided, which can be inserted in the position of the object. As the great heat from the lamp would injure living creatures, a cooling trough is used, between the lamp and the cell.

For examining amoeba, hydra and other living organisms, and for such things as the legs and jaws of insects and spiders, small whole insects, plant sections, this is of great value. Children of senior school age are rather young to learn to handle microscopes and a great deal of time would have to be given to the supervision before they

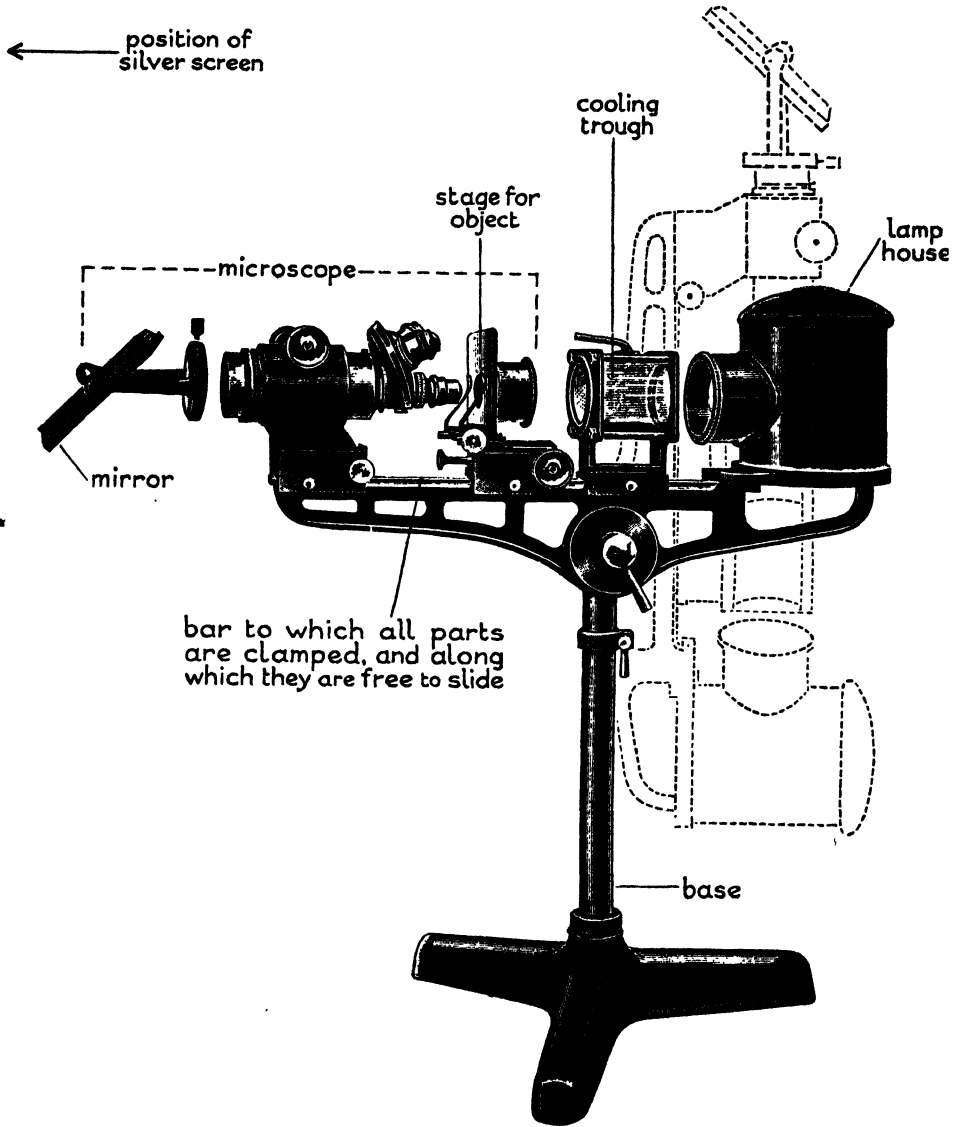

[Reproduced by courtesy of Messrs. Flatters & Garnett, Ltd.]

PLATE XXVIII. MICROPROJECTOR

would learn to see anything, to realise what was there or to handle the instrument with sufficient care. By means of the microprojector, which costs little more than one good microscope, a class of twenty to thirty children can see and hear explanations at

once. In the writer's experience the instrument usually gives good definition at a distance of about 10-12 ft. from the screen, with an image which can be clearly seen 15-20 ft. away. It is not possible to make sketches from this as the room must be in

darkness, but an adjustable mirror enables one to direct the image vertically upon a sheet of white paper on a table, when as many children as the table will accommodate—perhaps eight—can sketch in the light thrown by the lamp.

Optical instrument makers have placed several reliable microprojectors on the market; the one illustrated has been found very satisfactory.¹ It is possible for a skilled amateur craftsman to adapt an ordinary microscope for the purpose by making a horizontal board and clamping microscope and lamp to it. Two difficulties are exact alignment and ensuring that the heat from the lamp is not so great as to injure the material (by cooking it) or melt the mounting reagent, which is usually a balsam or gelatinous substance.

The lenses used with a microprojector have a much lower magnifying power than those generally used with the microscope, but for school purposes high magnification is unnecessary.

APPENDIX II

Preparation of bones, including skulls, as museum specimens.—Skin and as much flesh as possible should be scraped away, then the object should be simmered slowly till all flesh falls away easily. The bones can then be brushed and picked clean and carefully air-dried. A little powdered alum scattered in inaccessible parts will help to dry and sterilise any small remaining particles of tissue. While drying, the bones should be frequently dipped in water, then left in sunlight. This helps to bleach them.

The bones will be whiter if instead of boiling they are left to macerate in rain water for several weeks, followed by very thorough washing. A few drops of potash in the water will quicken the process of softening the flesh. As much as possible should be scraped off beforehand in any case. This method may also be used for preparing skeleton leaves.

¹ From Messrs. Flatters & Garnett,

APPENDIX III

The preparation of objects for the microscope.—*Required:* Glass microscope slides, 3 in. by 1 in.; thin, round cover glasses, $\frac{3}{4}$ in.; 2 in. watch glasses in which processes described are carried out; small camel hair brush and 2 needles mounted in wooden handles (botanical needles) for lifting the objects being prepared.

1. Temporary mounting.—Reagents; glass rod. If objects are required only for immediate examination under the microscope, they can be mounted in water or dilute glycerine. Place a very small drop of fluid by means of a glass rod on the slide. Place the object in it with a brush or needle. Now with thumb and forefinger take a clean cover glass by its edges (not touching the surface) and, holding it with its centre over the object, lower it very carefully till it touches the liquid, which is thus spread under the cover glass without either displacing the object or letting the fluid run beyond the edge of the glass. It is essential that no liquid shall touch the objective of the microscope.

Keep an old silk or fine linen handkerchief for wiping the lenses of the microscope and for drying cover glasses, or blot the cover glass dry on blotting paper.

2. Permanent mounting.

(a) *Canada balsam.*—If a permanent mount is required, and this is always necessary for the microprojector, three processes are usually necessary. The object must be dried completely, cleared so that it is transparent, and then rendered air-tight and immovable.

Drying.—If the mounting substance is to be Canada balsam, the object is dried by being passed through different strengths of alcohol to extract all water from the tissues, ten to twenty minutes in each. This gradual process is necessary because sudden extraction, by its effect on the tension of the tissues, would cause shrinkage or tearing. Where skeletal or horny objects are to be

mounted, they can be dried by direct immersion in pure spirit.

The usual strengths are 30 per cent meth. spirit—50 per cent—70 per cent—90 per cent—100 per cent or absolute alcohol. Ethyl alcohol is in general use, but if this cannot be obtained duty free iso-propyl alcohol (technical) is equally good and should be requisitioned instead as there is no duty upon it.

Clearing.—The object is taken from absolute alcohol to cedar wood oil or clove oil (less expensive). It will sink to the bottom of the watch glass when clear. As a final precaution it is washed in a drop of xylol. This may be done on a slide. All processes may be carried out on slides provided the material is never allowed to dry, but this is less likely to happen in watch glasses, which should be covered with others.

Mounting.—Canada balsam is a kind of gum, dissolved in xylol or some other volatile solvent. It takes several hours to dry and harden completely, so that the slides should be kept where they will not be touched, preferably in a warm place, till the next day. Mount as with water, and be very careful to see that the balsam does not extend beyond the edge of the cover glass. It tends to spread out a little more as it dries.

(b) *Glycerine jelly.*—Another mounting substance convenient to use is glycerine jelly. This is particularly good for soft plant tissues, such as growing points, or young leaves.

Drying and clearing are accomplished in one process, by soaking the object in dilute glycerine (10 per cent). If the tissues are very delicate, several strengths are used (as with alcohol) to accustom the object by degrees to differences in tension. The object is left soaking in 2 per cent glycerine exposed to the air. The water in this gradually evaporates, so increasing the strength.

Mounting.—The jelly is melted by immersing the bottle in warm water, and used in the same way as balsam, that is, a drop is deposited on the object with a glass rod,

after it has been arranged on the slide with brush or needles, and surplus dilute glycerine blotted off. A cover glass is then lowered gently into position.

Farrant's medium for mounting is good, as objects can be transferred straight from water. It is used cold. To prepare, dissolve 100 cc. gum arabic in 100 cc. cold distilled water. Add 50 cc. best French glycerine. Strain through clean flannel, and keep in a stoppered bottle with a piece of camphor. When used it soon hardens at the edge of the cover glass, so needs no ringing.

Ringing.—For further security the cover slip may be sealed by a ring of gold size. This is supplied ready for use by all microscopic supply dealers. It is carefully brushed round the edge of the cover slip. Sometimes dry mounts are prepared of skeletal or horny substances, such as the jaws of insects, scales of butterflies' wings, spores of fungi, minute shells. These are merely placed on a slide, covered with a glass slip, and ringed. In most cases, however, the other methods described are preferable.

Staining.—The teacher who prepares slides for the microprojector might in some cases desire to colour the object in order to show its points more clearly. For general staining, borax carmine, safranin or haematoxylin are useful. Staining is really dying on a very small scale, and the tissues of the object pick up the dyes in varying degree and so help the observer to distinguish the parts more readily.

Slow staining with weak stains is usually the best method for bulk staining. The time will vary from two or three minutes to two hours, according to substance and bulk as well as strength of stain. With glycerine, water soluble stains are used, but if alcohols are used for drying, then stains dissolved in 70 per cent alcohol should be used. They can be obtained ready prepared or in solid (powdered) form, in which case instructions for preparation should be asked for. The solutions made in the laboratory should be filtered before use. The stain is used when the object has been in 70 per cent alcohol.

It is then washed with acid alcohol and returned to 70 per cent and dehydration is then completed.

Staining may be accomplished with coloured glycerine jelly. The stain is dissolved in the jelly, the object mounted in it, and the stain gradually permeates it.

To prepare coloured glycerine jelly obtain water-soluble solid safranin. Melt the jelly in a bottle inside a water bath, over a Bunsen flame. Then add a small quantity of the stain, stirring carefully with a glass rod until it is dissolved, and the jelly has a distinct but not deep colour.

To prepare acid alcohol for washing out superfluous stain, shake up 2 cc. hydrochloric acid in 98 cc. methylated spirit (70 per cent strength, the usual form in which it is sold commercially).

APPENDIX IV

Equipment.—The following is a list of the minimum satisfactory equipment.

A well-lighted room, with solid yet preferably movable benches and chairs, to allow for elasticity in arrangement of groups and for free movement—so that children can pass from one bench to another to see different experiments, material or happenings.

A fixed wall bench for gas taps and sinks for children's use.

A demonstration bench—not necessarily very large, but with two gas taps and a sink—or a sink within easy reach at the wall.

Broad, low shelves for illustrative material and working experiments to be left, and *children's exhibits*.

Cupboards for apparatus, with a few drawers for small apparatus.

A preparation room, and if possible a small heated greenhouse-vivarium where plants and animals can be kept under experimental conditions—all one unit. Preferably opening into experimental garden.

Bookshelves for reference books.

Display cases for museum specimens which may be kept in cupboards when not actually in use.

Apparatus.

For general use.—An ample supply of shallow dishes and vessels for experiments and for observation—not necessarily laboratory glass; e.g., white saucers, enamel or aluminium cups, and saucepans for heating; a few bone and wooden spoons; enamel dishes and bowls of various sizes. Gauze or fine net. Small rubber bands. Glass troughs and accumulator tanks. Hand lenses (double), enough for whole class. Plenty of jam jars and potted meat jars. Bottles.

For demonstration purposes and occasional use by class.—Ordinary laboratory apparatus; e.g., beakers, flasks, glass-tubing up to $\frac{1}{2}$ in. thick, rubber stoppers, wide-mouthed flasks, bell jars, boiling tubes and test tubes. Tripod stands and retort stands. Test tube holders.

Microprojector for showing microscopic preparations to groups of children.

Dissecting boards—drawing boards will do—and dissecting dishes, usually enamel pie dishes fitted with boards of soft wood, to take pins, weighted with sheet lead.

Dissecting pins.

Set of dissecting instruments for the teacher's use, including two pairs of fine-pointed dissecting scissors, two scalpels, one pair fine forceps, one pair strong forceps, and if the rabbit is to be dissected, bone forceps, one seeker.

Dissecting needles mounted in wooden handles for whole class.

For numbers, type and quality it will be best to consult a firm of laboratory apparatus makers, stating the type of work for which apparatus, including instruments, is required.

APPENDIX V—SUPPLY OF BIOLOGICAL MATERIALS

1. *The Biological Supply Agency, Rhyd-yfelin, Aberystwyth.*

Living and preserved botanical and zoological material; micro-preparations. Catalogue on application.

2. *Mr. F. Ward, Taxidermist, Histon, Cambs.*

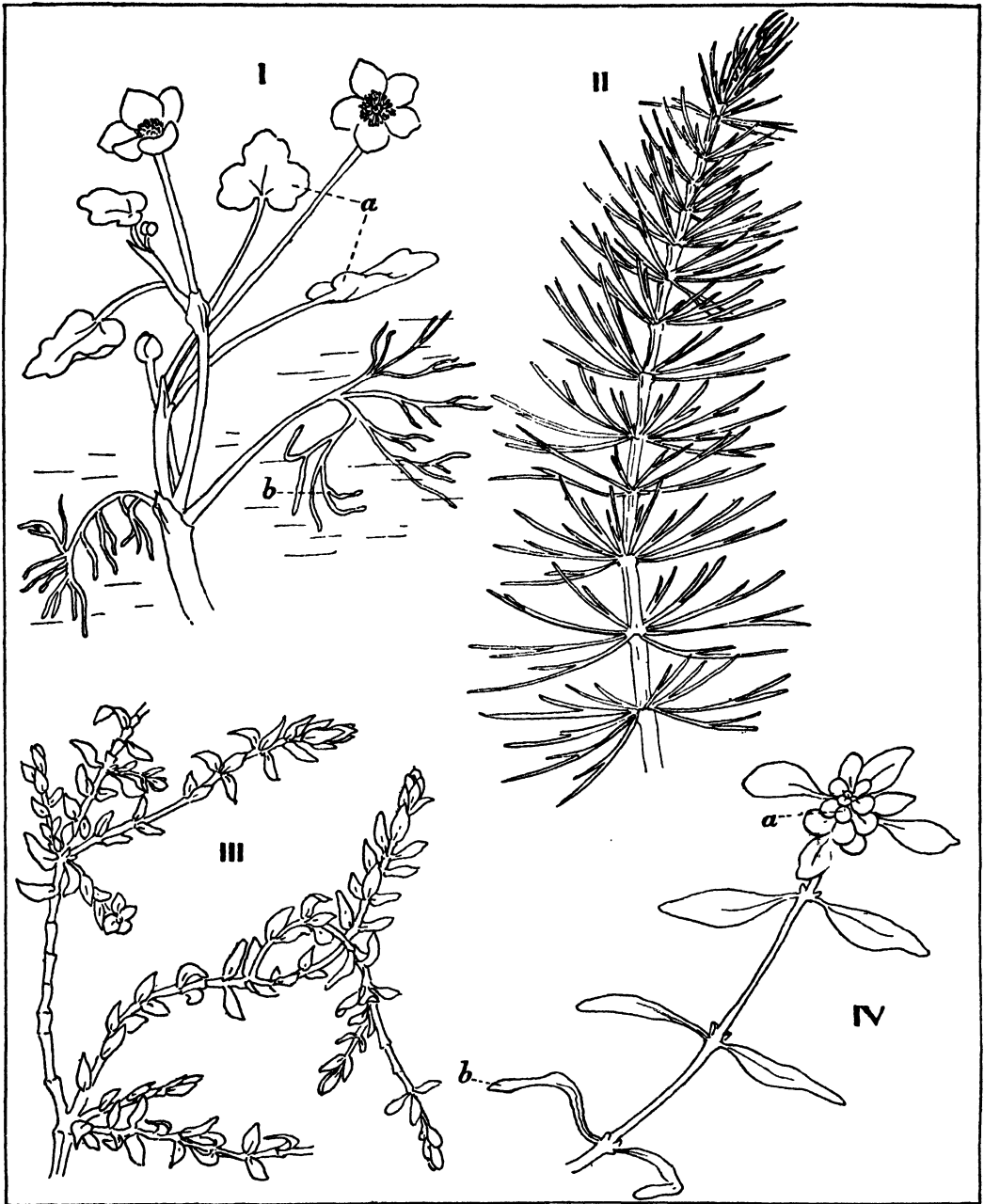

PLATE XXIX. PLANTS SUITABLE FOR THE AQUARIUM

- I. WATER CROWFOOT (*Ranunculus aquatilis*), natural size: *a*, floating leaves; *b*, submerged leaves.
 II. HORNWORT (*Ceratophyllum*),—branch, reduced size.
 III. CANADIAN WATERWEED (*Anacharis*), natural size. The plant is dark, stiff and glossy.
 IV. STARWORT (*Callitriche*), natural size: *a*, floating leaves; *b*, submerged leaves.

Specimens mounted for school museums.

3. Messrs. W. R. W. Williams, F.L.S., and Jan Van Houtte, Ltd., Old Sorting House, Lampmead Road, Lee, London, S.E.12.

Supply plants and bulbs for nature study and school gardens.

4. Messrs. L. Cura & Sons, Bath Court, Warner Street, Rosebery Avenue, London, E.C.1.

Aquaria, tropical and fancy fish, vivaria, reptiles and batrachians, hydra, foods, etc.

5. Messrs. Flatters & Garnett, Ltd., 309, Oxford Street, Manchester.

Collecting apparatus, specimens, aquaria, and every requisite for the teaching of biology. Microscope slides in all branches. Lantern slides from original photographs for sale or hire. Catalogues on application.

6. Messrs. Edward Gervard & Sons, 61, College Place, Camden Town London, N.W.1.

Nature study specimens—zoology, biology, and botany; also zoology models.

7. Mr. L. W. Newman, F.E.S., Bexley, Kent.

Breeder of British Lepidoptera.

8. Mr. L. Haig, Beam Brook, Newdigate, Surrey.

Aquaria, aquaria apparatus, fish, aquatic plants, insects, larvae and amphibia. Amoeba, hydra and other microscopical material. Living foods, daphnia, bloodworms, etc.

Inquiries for any kind of aquatic life invited.

Teachers of biology are strongly advised to join The School Nature Study Union (annual subscription, 4s.); Treasurer, Mr. A. J. Potts, 4, Ashridge Close, Kenton, Harrow.

School Nature Study, the official journal, is sent free to members in January, April, July and October and has useful articles and reviews of books.

Excursions dealing with all phases of nature study are arranged from April to October.

Leaflets—seventy in number—are published for the use and convenience of members, at practically cost price.

Exhibitions are arranged in alternate years.

Kate Harvey.

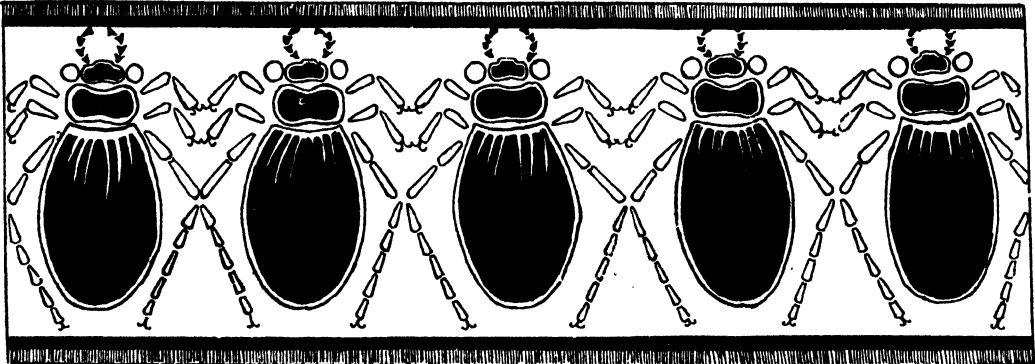

**SCIENCE TEACHING
IN THE
SENIOR SCHOOL**



SCIENCE IN THE SERVICE OF MAN

FOREWORD

THE traditional teaching of science has been ably treated in many standard books, and has figured in the education of most teachers. In preparing this article, therefore, it was felt that the best interests of readers would not be met by a brief résumé of conventional practice, as the details of this are widely known and are available in convenient form already. With the assistance of a few books, any teacher should be able to assemble a mass of teaching material, and with a little experience should encounter no serious problems when planning a teaching sequence. This being the case, the inclusion of schemes of work and complete teaching notes upon them appeared to be unnecessary in an article of this kind.

At the outset, it is well to emphasise that an attempt has been made here to present modern thought on science teaching, and to augment it by selected examples. In order to make the best possible use of the space available, most of the conventional work has been deliberately excluded from both discussion and examples. Sufficient

"pointers" have been included, however, to indicate where classical material finds its niche in the new teaching. The topics which are given practical treatment are themselves selected as illustrations, and through them it is shown how modern material can be worked into the classroom and how various methods of teaching may be practised. No topic is discussed exhaustively.

The senior school is young and its science teaching even younger. Education in all its branches is inevitably a matter for controversy and differing opinions. Universal acceptance of the suggestions which are put forward cannot therefore be expected, but if these stimulate the experienced and help the beginner they have served their purpose.

The official Board of Education Report upon which the article is based was published in 1932. Since that date, teachers have developed their technique. In reflecting that development, the article breaks away to some extent from its guide, but the break is held to be merely an extension and not a contradiction.

INTRODUCTION

THIS article is intended to be a series of suggestions which may help the senior school teacher to translate into practice the recommendations made by the Board of Education on the subject of science teaching in the senior school. The work to be considered arises out of a report published by the Board.¹ In this pamphlet, the conclusions reached by a panel of H.M. Inspectors are summarised, and a welcome emphasis is laid on the broad human

influences which direct the most effective work in the laboratories of the new schools. Every teacher of science should read this stimulating memorandum before attempting to plan the work to be done in his school.

The first question which arises in connection with school science is, quite naturally, the selection of subject matter. Now the extent to which the field of scientific knowledge may be utilised as a means of education in the senior school has not yet been

¹ Board of Education: Educational Pamphlet No. 89, "Memorandum on the Teaching of Science in Senior Schools."

determined. It is indeed doubtful if any precise limits will ever be applicable, for the everyday experience of scientific devices which a child has is constantly extending, and school practice is being modified to make use of new features of the child's environment. Thus subject matter which was entirely outside the scope of schools a few years ago is now being utilised. The ever-increasing applications of science, and the grip which science is gaining on the toys and literature favoured by the present-day child, demand an extensive curriculum which may effectively use everyday experience. Making a selection from the subject matter available and applying a scheme of organisation to it are necessary preliminaries to actual school work. Suggestions on how to prepare a science syllabus therefore find an appropriate place in the next chapter.

The importance of subject matter is not the only criterion which directs school activities. Although they live in an environment which is to a great extent the result of adult activity, the children of the senior schools are themselves immature. School work has therefore to be based on experiences which arise out of the application of children's immature powers in an environment designed primarily for the convenience of an adult. If effective use is to be made of these peculiar experiences, suitable methods of teaching have to be devised. The natural experiences of a child often need to be enriched by repetition or by the addition of new but correlated experiences before they can be effective media of education. Without adequate treatment, the original experience is often useless to the educator. Not infrequently, it is incomplete and misleading. The methods of teaching available in a school should have a great influence on the selection and arrangement of the subject matter to be used, and may determine the range of science teaching which is possible. School science and teaching methods find a natural place in the chapter following the discussion of subject matter.

No single scheme of work in science can find useful application in all schools, for circumstances differ so much. Moreover, at the present time, great differences of opinion exist in connection with the precise form which a science scheme should take. Practical details of a particular scheme can therefore only have a limited value and for that reason no attempt is made here to formulate a teaching syllabus. To treat the whole of the subject matter of science is quite impossible, so any useful description of science in senior schools must therefore be selective rather than comprehensive, and suggestive rather than dictatorial. The greater part of the article is concerned with the treatment to be afforded to a number of scientific topics in school, and in selecting these a principle of illustration has been applied. Topics which elucidate the points discussed in the earlier chapters have been included, and they have been based on varied subject matter which is likely to figure in the courses of work of many schools. In this way, it is hoped that a group of suggestions having a wide range of usefulness and an illustrative nature may have been made available to those teachers upon whom the work of developing the scientific side of senior school activities falls.

The problem of finance is undoubtedly one of the greatest stumbling blocks in the way of the science teacher. There are, however, ways and means of overcoming limitations in this direction. Secondhand and cheap stores can be used to relieve the strain, whilst much useful equipment is obtainable free in the form of waste household and industrial material. In order to make this article of the greatest possible service, these sources of supplies have been borne in mind and reasonable limits of expenditure have been set to direct the practical examples. Nevertheless, economy has not been allowed to involve sacrifice of efficiency, so that even the most favoured schools may profitably employ the information put forward here.

PLANNING A SCHOOL SCIENCE SYLLABUS

Selecting subject matter.—As the home, school, shop, office, factory, farm and amusement centre all rely on a large and constantly increasing number of scientific devices, applied science has an important bearing on the life of school children. The ubiquity of applied science ensures that some knowledge of the subject develops from practically every person's normal experience and that this is directly associated with everyday life. It is from such knowledge and experience that school science starts. Now the extent of this implicit knowledge may easily be over-estimated. Many children do learn a lot of science without assistance, but, as a rule, unaided experience gets little further than the correlation of simple causes and effects—petrol causes a motor car to move, electricity heats the laundry iron, and so on. When wisely chosen, school science is closely associated with real life and holds a vital interest for children, who find in it an illuminating extension of their ordinary experiences. It is now generally recognised that the most effective science teaching develops from the child's everyday contacts with scientific devices, and uses the principles of science primarily as a means to an end and not as an end in themselves.

The chief difficulties which arise when developing school subject matter from the phenomena of everyday life are the problems of what to include and what to omit, and how best to group the chosen material. The claims for consideration which may be put forward on behalf of many topics are very strong, and it is well to recognise at the outset that no syllabus can contain all the subject matter which can justifiably claim a place. To potential teaching material, criteria other than intrinsic merit must be applied, in order to bring the number of topics down.

Practical value.—In preparing a science syllabus, a good plan is first to gather together all possible subject matter, by applying a test of realism to topics arising out of a consideration of the environment. Preparation of a comprehensive list will be facilitated by reference to senior school text books. The teacher should satisfy himself that no subject is entered on this preliminary schedule without the recommendation of being directly associated with some aspect of real life, within the experience of the pupils. This test alone, rigidly applied, will eliminate completely or seriously weaken the claims of many subjects. To the teacher it may mean pangs of regret at the exclusion of some classical item, particularly as it may be felt that a topic, though divorced from practical life, has served most effectively in the secondary school as a means of education. But the teacher must be ruthless—the limited time available in the senior school does not permit exceptions to the rule. Sadly perhaps, but resolutely, the teacher must cut out the academic ingenuity of the classical syllabuses. It may be most interesting, for example, to determine a specific heat, and the method of mixtures with its attractive experimental paraphernalia may arouse admiration and enthusiasm, but these are not enough. All items in the list at this stage must have *practical value*.

Local bias.—The schedule resulting from the application of the recommendations made in the previous paragraph will be a patchy collection of disconnected jottings. Before attempting to sort the items out and arrive at a planned scheme, it is very convenient to apply further eliminating tests. Of these, the first is *local bias*. It is not suggested that this factor is the next in importance after *practical value*, but only that it is applied best at this stage in

the work. Every item in the schedule should be examined with the peculiar characteristics of the school and its neighbourhood in mind. The existence of important chemical works in the district, for instance, will suggest that certain topics, which under other circumstances would be considered of comparatively small significance, might be emphasised. Underlining, or the addition of some suitable sign on the schedule is therefore needed. Again, a school serving a district which lacks a supply of coal gas will not demand a syllabus in which this commodity receives much attention. The presence of some particular activity in the normal occupational routine of a great part of the district's adult population gives that activity a vitality which it would be wrong to ignore in school. The application of local bias increases the possibilities of school visits, a point well worth bearing in mind. The result of applying local bias to the syllabus schedule should be that certain topics are emphasised, others weakened and some eliminated. Nevertheless, as the factor applied is really an external one, the teacher may quite rightly choose for some reason finally to ignore or limit its influence.

The economic factor.—The schedule should now be surveyed with the *economic limitations* of the school in mind. So far as the senior school is concerned it is well to look upon science as a practical subject based on real things, and to design activities in a way which will emphasise this. Therefore if limitations of space or equipment prevent adequate practical treatment from being given to certain topics, then the advisability of omission or curtailment in these directions should be seriously considered. There are so many good subjects from which to choose, that it is possible to keep down the unillustrated lessons to a minimum. To many teachers who have to work under difficult conditions, this doctrine will no doubt be rather trying, but it is felt that the practical avenue of approach to science is so important that the economic circumstances of a school must be allowed to

influence the selection of subject matter. Fortunately, the most important and fundamental topics do not demand great stocks of expensive material and so by expending a modest allowance wisely, the requirements of these, at any rate, can be met. Thus the economic factor need not seriously disturb the balance of the syllabus.

Personal inclinations.—The days when teachers were looked upon as fountains of knowledge, pouring forth history, languages or mathematics at the word of command, are now happily over. The *personal inclination* of a teacher cannot be ignored. The most effective teaching of subject matter for which the educator himself has no enthusiasm is not to be expected. In preparing a school syllabus, therefore, some bias in favour of those topics for which the teacher has a special flair is perfectly sound policy. For this reason alone, ready made schemes of work in science for application in a group of schools can never be the means of achieving the greatest successes.

Finally, the children's capacity and interests must not be overlooked in the mass of notes which accumulates in the process of scheming. Everything in the science syllabus should be a source of vital interest to the pupils. Subject matter should be chosen and arranged so that there is plenty to see and do. Things which figure prominently in boys' periodicals need to be incorporated in the scheme of school work. Appliances in which boys and girls are interested but which they are not able to examine or handle in the ordinary course of events should find a place in the practical room.

Classification.—By applying the recommendations which have been made, a list of topics of a diverse but practical character will result. The remainder of this chapter is intended to show how the items may be sorted out. One particular form of syllabus structure has not yet attained a success which places it definitely in advance of others, and so several systems of classification

which may serve as frameworks for schemes are given in order that the reader may conveniently apply one which meets his requirements or may adapt the characteristics of several. The groups put forward have been utilised in school and many of them have been adopted as the basis for text books. They may therefore be used with some degree of confidence.

Topics.—So far as the senior school is concerned, the traditional groupings of heat, light, sound, magnetism, mechanics, etc., may be considered dead. Modifications of what is called the *topic* classification seem to be the most promising forms of organisation and these figure in most of the schemes now finding favour in the schools. In the topic system, a number of subjects of everyday importance are grouped under a major heading and are developed under the correlating influence of that designation. Two examples of these great co-ordinating topics are *Air* and *Water*, a pair which has found a place in the schemes of many schools. Other less popular topics are included in the groups which follow. Apart from this generally accepted principle of topic correlation, the forms of organisation applied in present day practice differ widely. Many kinds of topic find favour, the choice of which shows the influence of many external factors. In some schools, a topic is dealt with as an entity, its content forming the work of a term or so. In others, the topic is used as a means of linking together sections of work spread over the whole of the school course, so that a sensible reason for revision and recapitulation is provided. By including the following summaries here, it is hoped that the reader will be enabled easily to consider the relative merits of various schemes.

1. *A Chemical Classification.*—Although chemistry itself does not figure to any great extent in the senior school curriculum, a grouping planned on a chemical basis can be a useful feature of a science course. Such a grouping is not complete in itself, but needs to be combined with one which

represents other aspects of life. The following are useful topics of the chemical type:

1. Air.
2. Water.
3. Raw materials.
4. Living things.

2. *A Physical Classification.*—Some useful topics which arise in this general category are:

1. Heating.
2. Lighting.
3. Machines.
4. Power.

3. *A Biological Classification.*—The physical processes associated with the living organism, apart from matters of purely biological interest, can form a group of topics which may link together the two main branches of science. The following are topics of this kind:

1. Breathing.
2. Feeding.
3. Moving.
4. Sensing.

4. *A Domestic Classification.*—Courses for mixed classes or for girls alone may advantageously show a domestic influence. The fundamental needs of domestic life are great topics which split up into numerous smaller ones:

1. Food.
2. Clothing.
3. Shelter.

5. *An Industrial Classification.*—Excellent topics such as the following connect school work directly with practical life and industry:

1. The Road.
2. The Railway.
3. The Docks.
4. The Factory.
5. The Farm.

6. *An Ancient Classification.*—Good use can still be made of the *Elements* of the Greeks:

1. Earth.
2. Air.
3. Fire.
4. Water.

7. A "*Personal*" Classification.—This plan arising directly out of the personal requirements of the children, offers many useful features:

1. The air we breathe.
2. The water we drink.
3. The food we eat.
4. The clothes we wear.
5. The houses we live in.
6. The games we play.
7. The ways we travel.
8. Our means of communication.
9. Machines which help us.

Conclusion.—Each of the topics which have been listed embraces a wide range of subject matter, the details of which are to be found in the schedule whose preparation was described earlier in this chapter. As all the classifications have arisen directly out of real life, their application to syllabuses ensures contact with everyday things and gives character to the schemes of work. Wisely chosen to suit the particular requirements of the school, and liberally interpreted in order to incorporate comfortably the material entered on the schedule, a classification provides atmosphere and fosters continuity, but does not limit or hamper the actual work done. A classification determines the conditions under which a particular

item turns up in the school course, but it does not select the scientific material which is to be the fabric of the course. Thus, for example, the science of flotation will arise in many courses, but in one with a domestic basis the subject may be woven round a floating scrubbing brush or a ball tap, whilst in another it may be associated in the first place with the floating of an ocean liner. In the two examples, education recognises a fundamental difference of emphasis.

The organisation of schemes of work offers plenty of opportunities for development. Every teacher should aim at achieving a practical classification which suits his circumstances and which contains the proposed subject matter in a natural sort of way. Complete balance is not attainable at once, but it is possible gradually to build up a course of work which fits its circumstances by modifying the first preliminary scheme in the light of experience from time to time.

Provided that the interests and requirements of the children are kept definitely to the fore, it seems that an innumerable series of effective courses of work on the topic plan may be developed, each approaching the same scientific material from its own particular angle.

TEACHING METHOD

Introduction.—As in most branches of the curriculum, both class instruction and individual activity figure as accepted methods of teaching science in the senior school. An idea which had a good deal of support some time ago suggested that these two methods of instruction were rivals. This notion is now completely discounted, and the two are recognised as complementary to each other. The time allotted to each varies from school to school and from topic to topic, and even under similar conditions

teachers differ amongst themselves in their allocations. The distribution of time between the methods is not so fundamental a matter as might at first be supposed, and provided that neither is obviously neglected, good work may be done.

Demonstrations.—Class instruction in science has characteristics which differ from those shown by the pedagogical technique applied to some other subjects. Its outstanding feature is perhaps its domination

by the practical demonstration. In an effective course of senior school science, dozens of class experiments and practical illustrations will be shown. These demonstrations, which form the foundation of this method of instruction, are augmented by exposition which welds the class and individual activities into a whole.

Aims.—Experiments shown as demonstrations should enrich or extend a point which has been developed previously or should suggest the answer to a problem which has arisen. They may also be used as starting points for new inquiries. Through them, a standard of efficiency for class activities may be set or the practical possibilities of the materials used in scientific work may be shown, but these functions are incidental. The demonstration should not be looked upon as a kind of individual activity. In well organised work the demonstration has a sphere and a technique of its own and whilst the co-operation of one or two class members may be enlisted for the sake of speed or efficiency, it is not to be considered a special objective of the work.

Types.—The following types of senior school science demonstrations are recognisable:

1. Activities which show new phenomena, or old phenomena in new ways, thereby developing entirely new experiences.
2. Exhibitions of pieces of apparatus or mechanisms in such ways that certain problems arise and demand attention.
3. Experiments which provide answers or offer clues to problems which arose as results of earlier work.
4. Experiments which confirm or cast doubt on conclusions suggested by other work.
5. Repetitions or modifications of class experiments, performed to confirm doubtful ideas or to extend from a simple activity to a similar, but more complex one.

Exposition.—The peculiar value of the demonstration lies in its close association with exposition, and the chief function of

the combination is to render explicit the implicit knowledge and experience of the pupils. The exposition associated with a demonstration should not be a lecture, but should be a guide to the thoughts of the pupils. Long explanations are out of place when made to accompany the practical work. A teacher involved in long talks during a demonstration should ask himself first, whether his aim had been correctly formulated and second, whether the demonstration itself had been designed in the simplest possible form and operated in the most direct manner. Opportunities for more extended forms of exposition are likely to present themselves when the implications of a demonstration are being reviewed.

Illustration.—The work done by demonstrational methods needs to be augmented by further illustration, which should include the exhibition of pictures and diagrams, and the study of text books. The question and answer type of notes serves well to direct this study along the most appropriate channel. Text book work should be guided with great care as adolescent readers may easily be discouraged by attempting to read descriptions in which many scientific terms are used. Excessive technicality in the terminology used in some school books is a fault which is not uncommon. Books which go very slowly and which give plenty of illustrations should be chosen, and the parts to be studied should be defined precisely by the teacher. A child tends to look upon a series of associated phenomena as a group of items, each of which needs individual attention. Books which tend to present information in summarised form should be used, therefore, with discrimination, as classification and summarising with children can be carried out satisfactorily only when the individual characteristics of the various phenomena in a group have become thoroughly familiar. This familiarity is best attained by using the "Marvel of Science" type of book as library readers.

The lantern.—On the illustrative side of the work, much needs to be done. Theoretically, the use of the lantern and slides is admirable, but in practice an adequate collection of slides is not likely to be found in any school. This defect may be overcome in the future if local authorities choose to establish slide libraries and to co-operate in obtaining a really good range of specimens, but such a state of affairs does not seem to be a probable development of present policy. Except for those illustrations which may be prepared by the teacher himself or which may be borrowed from commercial firms, the lantern appears to have a limited value as a device for illustration. This is a pity, for of all forms of projector, the lantern stands out pre-eminently as the one most suitable for effective classroom work. Every science room should have a lantern, however, for its range of usefulness is not limited to mere picture showing. Incidentally, the instrument chosen should not be one which is incorporated with an episcopé in the form of an epidiascope, as these instruments are too heavy and not sufficiently adaptable for many practical purposes.

The episcopé.—As a really practical substitute for a lantern and a large selection of slides, the use of an episcopé is recommended. By means of such an instrument a diagram, photograph or drawing in full colour may be shown on a screen, the illustrations themselves being obtained from books, notes, catalogues, etc. In cases where strict economy must be practised, the instrument may be made in school, and an economical episcopé of adaptable design is described and illustrated later, page 271, so that readers who have had little experience of this type of appliance may conveniently supervise the construction of one in their own schools.

Films and visits.—Concerning illustrative work through films and school visits there is little to say. The general advantages and difficulties of this kind of work apply to science as to any other subject. Properly used, the film and the school visit have great

value in science teaching, but there is no special technique peculiar to scientific activities demanding comment here.

Individual work.—The practical work carried out by the pupils themselves has certain generally accepted characteristics, and others concerning which agreement has not been completely attained. It may be said without fear of contradiction that the work undertaken by the pupils will arise as a natural consequence from either a class demonstration, a discussion or a problem brought forward by a pupil. A piece of work should not be carried out simply because it is the next item on a list or because certain apparatus is conveniently to hand. There must always be a clearly conceived purpose in the minds of the pupils as they do their work and this can be created only by using a suitable introduction.

Instruction cards.—On the question of organisation, opinions differ greatly. Many teachers have found that the use of instruction cards has been a helpful device, although others, fearing the formality associated with the system, have preferred to adhere to the plan of giving oral instructions. In some schools, it is the practice to arrange that all the children shall work together at the same time on the same experiment, differing speeds of working being adjusted by periods of private study and reading. Criticism for this method of working has not been lacking, however. At the present stage, it appears that a combination of these systems will be the ideal arrangement for many schools, the form applied to a particular experiment or group of experiments depending on the nature of the work, the resources of the room, the ability of the children and the time available. With able children and well prepared cards, remarkable progress has been made in many schools. The system of using individual written instructions should not be discarded completely in any school without careful consideration. For the guidance of those who have had little or no experience of

the instruction card method in effective practice, an experiment which lends itself to this treatment is worked out in detail in the next chapter, page 214.

Constructional work.—Apart from experiments in the generally accepted meaning of the word, the pupils' individual work will include items of a constructional character. As handwork enters so prominently into these, some teachers of science hesitate to include many examples in their schemes, as they consider them to be time wasters. Lengthy they often are, and unless a generous allowance of time is available or a plan of correlation with the instruction in handwork is possible, many teachers may have to curtail their schemes in this direction. The Board of Education recommends this branch of the work as being specially suitable for inclusion in the sphere of the Scientific Society, an out-of-school organisation of great value to both teacher and pupils. It is quite certain that this form of practical work will develop as its possibilities come to be more completely understood, and in the examples given later special emphasis has been laid on it. Constructional work is the means by which valuable apparatus may be created, to the mutual benefit of the maker, the teacher and the school. As a rule, it will be found that whilst the less able children will do more constructional work than their fellows, the latter will be the providers of the devices of permanent value. Two types of constructional activity should be recognised, and a child should know when he is making an object whether it is intended to be a permanent addition to the school equipment or whether it is merely to have temporary value. Moreover, the standard of craftsmanship required for apparatus which will be dismantled after use should be determined only by the stipulation that the device shall work when finished. It is important to carry this idea to its logical conclusion, however, and to discard or dismantle these temporary pieces of work when they have served their immediate purpose. There is a very real temptation

for the teacher to preserve work which was intended to be only of temporary value, and such a practice if indulged to any great extent will destroy the atmosphere of neatness and efficiency which should characterise the permanent stock.

Constructional work in science is not easy to devise, to organise or to supervise. It is best introduced into the scheme gradually, a start being made at the top of the school with a class which has been reduced numerically by the passing out of one or two groups of children of leaving age. In order to relieve the attention of the teacher for application to the new branch of activity, a convenient plan is to run a card system and a course of constructional work together. If the cards are well prepared and the class is not unwieldy in size, the teacher will be at liberty to give special supervision to the apparatus which is being made and so to avoid waste of time and material. Raw material and a minimum stock of tools are essential. The tools should not be borrowed but should belong to the science department and should be kept on a rack near the craft bench or in the drawers and cupboards in it. Although much can be done on a table adapted for constructional work, it is very desirable to have a special bench in the practical room set apart and equipped for craft work. Such a bench, designed and constructed specifically for use in a practical science room is illustrated, page 204. Vices, both for wood and metal work, are fitted. A drop-down extension leaf is provided for use when large pieces of apparatus are being prepared or when several boys wish to use the bench simultaneously. As there is no tool trough, the bench is satisfactory as an auxiliary table. By making the small cupboard to open at the side instead of at the front, the one defect of the bench would be overcome. In its present form, the small cupboard door cannot be opened fully when the vice handle is set in a vertical position.

Unless there is a reasonable chance of success with constructional work, and this implies the presence of equipment and

space, the pupils should not undertake any ambitious activities of this description, for failures are most discouraging. In its memorandum, the Board of Education makes a number of useful recommendations concerning the tools and raw materials to be bought for use in the practical room. The list given can be reduced if circumstances demand it, as some of the items mentioned are used only when

a fairly extensive course of development is contemplated. At the end of this article, page 277, a modification of the Board's list is given, and every science teacher should aim at acquiring the bare minimum of tools there specified.

School-made apparatus is of such value that even in schools where adverse circumstances such as excessively large classes prevent real individual work from being practised, the teacher should endeavour to build up a select stock, using his own odd moments for the work. In actual practice, one or two enthusiasts will always be found amongst the pupils, who will be happy to do most of the work in their free time, thus reducing the teacher's lot to supervising, encouraging and suggesting. In circumstances such as these, the apparatus chosen for construction should lend itself to class demonstration.

Summary.—Summarising the characteristics of senior school science teaching which

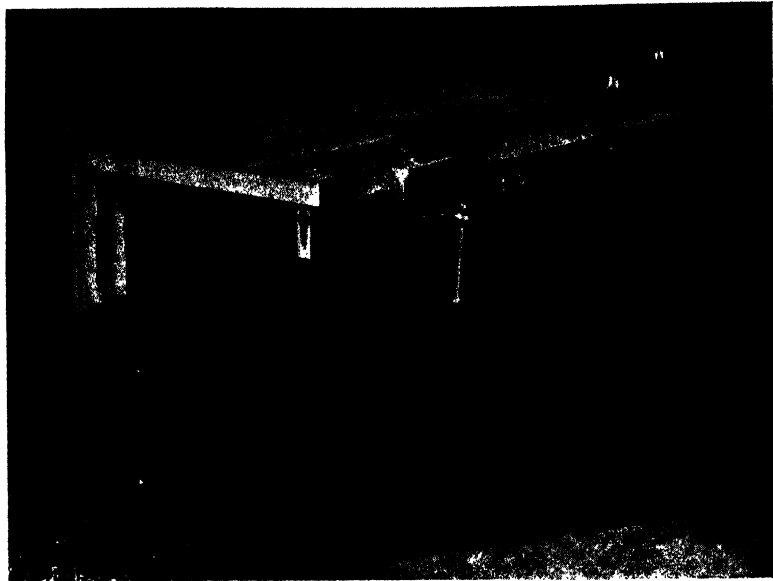

PRACTICAL ROOM CRAFT BENCH

have been outlined briefly here, it may be said that a discussion on some aspect of the pupils' everyday experience of applied science gives rise to a series of activities of the following types:

1. Practical demonstrations.
2. Visual illustrations.
3. Individual or group investigations.
4. Practical constructions.

These activities are carried out for the following purposes:

1. To present opportunities for gaining new experience.
2. To revive or enrich old experience.
3. To test or clarify preconceived ideas.
4. To suggest new ideas or problems.

The teaching in its various forms makes extensive use of:

1. The scientific experiment.
2. Illustration by optical projection.
3. The working model and mechanism.
4. Handwork as an educational medium.

TOPIC I—HEATING

Introduction.—The topic *Heating*, though it utilises much of the material associated with the abstract subject *Heat*, differs from its predecessor particularly in the points which it emphasises. *Heating* implies that the effects and uses of heat are to receive special attention, but *Heat* attaches importance to the energy itself. The topic is a large one and divides quite naturally into a number of closely related sub-topics which in turn link on to other aspects of science. In school, the treatment afforded to a branch of the syllabus such as this, can be varied in a number of ways to suit local requirements. For instance, the chemical aspects of combustion may be omitted from this section, if necessary, without any incompleteness being felt. Combustion may then be incorporated with the biological study of breathing and a cross reference developed. Again, if it is felt that *Heating* is best used as a unit occupying one section of the course only, then links between the work on heating and on other topics (e.g., motor car radiators and steam engines), should be strengthened. Alternatively, the sub-topics may be used to divide the work into semi-independent parts to be distributed at intervals over the whole course. For the purpose of this chapter, examples of practical work have been selected to illustrate the following sub-divisions. Neither the list of sub-topics nor the examples claim in any way to exhaust the possibilities of *Heating*, but are intended to show some of its potentialities.

1. *The coal fire.*—Inquiries into this subject may deal with coal itself, the construction of household grates, the purpose of chimneys, the social problem of smoke, the question of combustion, the function of air and a host of other items.

2. *Matches.*—The history of matches and the modern methods of manufacture always interest boys. The topic can be used to extend the conception of combustion developed in the previous one. The subject of fireworks arises conveniently here if desired.

3. *The hot water system.*—Every child whose home is fitted with this apparatus knows what parts comprise it. With the aid of a working model and a few illustrative experiments to show the practical effect which heating has on the water in the boiler, a very valuable series of lessons may be built on this topic.

4. *The geyser.*—As an introduction to the practical use made of good conductors of heat in real life, this device can be very effective. The remarkably high temperature attained by the water issuing slowly from a small model always excites comment and focuses attention on the significance of heat conductors in other appliances of a similar kind. (Kettles, boilers, etc.) As a sequence, apparatus and material used to prevent passage of heat naturally call for some thought, and so the work can lead on very easily to the next sub-topic.

5. *The vacuum flask.*—This subject does not always prove successful in school as many children tend to ignore the vacuum. The experiment on this subject suggested in the examples does help to avoid this unfortunate error and is specially recommended if this sub-topic is to be attempted.

The details of actual teaching material which occupy the rest of this chapter are classified under the five preceding sub-topic headings. The information is offered in a way which should prove a really practical guide to those whose experience of the laboratory arts is very limited.

The coal fire.—To develop a topic by starting with a complex but common phenomenon and moving on to the basic principles is recognised as praiseworthy practice, but the realisation of the scheme is not always easy to achieve. The complex phenomenon which forms the beginning of the process is often linked with a wealth of unimportant detail which masks the essential qualities. By using a well-designed teaching model which has been stripped of the unnecessary side issues, attention may be directed to the features which have special significance. Moreover, through a model, experience of objects which are not actually present in the room may be revived. Teaching based on the coal fire grate can be facilitated by means of the following model.

Model fireplace.—The device to be described serves primarily to show the influence of dampers, "draw tins" and adjustable ventilators on an open fire, but its action can be utilised in connection with discussions on the purpose of air in combustion and on the effect of chimneys. The apparatus itself, which is school-made and requires the use of only the humblest of raw materials and tools, consists of an open-fronted chamber having a candle holder at the bottom and a chimney at the top. The application of a shutter to various parts of the instrument influences the burning of the candle and suggests certain scientific facts. The chief fault of the device is perhaps its smallness, but as the observation to be made whilst it is actually working consists simply of noting the state of the candle flame, no practical inconvenience is caused. In any case, the apparatus can be duplicated without difficulty so that a set of specimens can easily be acquired for class use.

The model is built of tinplate and brass tube. New material is quite unnecessary, and the particular model illustrated was made from an old tin and a length of tubular curtain rail. Convenient dimensions for the components are given in the diagram, but these are not critical, Fig. 1. The central

portion of the model consists of a square prism of tinplate, open at both top and bottom. One edge of the prism has a soldered joint and one face has two windows cut in it. These represent openings in the fireplace, one being above, and the other on a level with, or below, the fire itself, Fig. 1A. Provided that care be taken not to

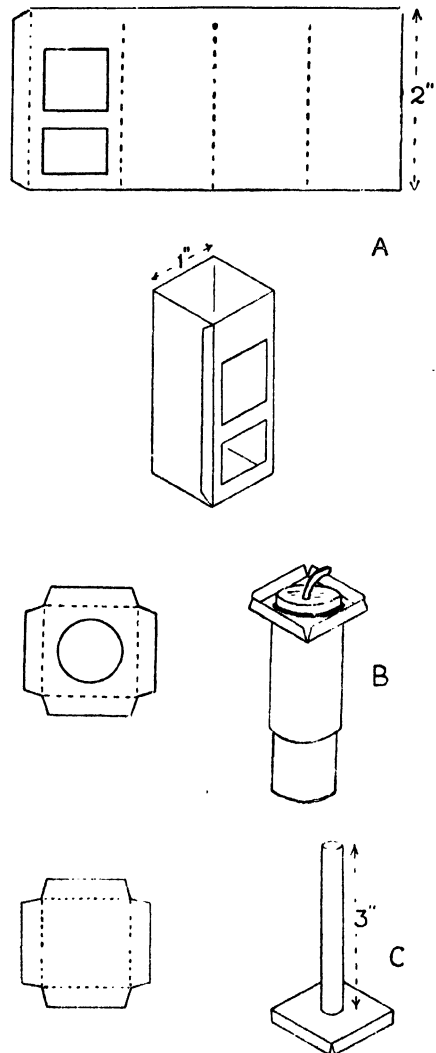

FIG. 1. COMPONENTS OF MODEL FIREPLACE
(Dotted lines indicate bends in the tinplate.)

use the model for prolonged periods, straight-forward soft soldering will serve quite well for the joint. The windows can be cut with a small cold chisel.

A slip-on lid for the base of the prism has a candle-holding tube of tinsplate soldered to it, Fig. 1B. The tube can be cut from a flat piece of material and then shaped by bending round a wooden stick whose diameter compares with that of the candle to be used. The top lid carries a narrow tube which is to act as chimney, and is constructed in the same way as the base, Fig. 1C. The complete apparatus in its assembled form is shown in the photograph, page 210.

To operate the model, a candle is fitted in the lower tube with its burning end just above the level of the base. The main features of the household grate are thus reproduced, the candle serving as fire, the upper tube as chimney and the two windows as open sections at the front of the grate. When the apparatus is in the condition described, the candle burns in a normal manner. The following modifications and observations can now be made:—

1. Close the top of the chimney and note the decrease in the flame. Compare this with the action of the fire damper.

2. Cover the lower opening on the front of the apparatus and observe the decrease in brilliance and the excessive smoking which result. Compare with the action of the ventilator fitted in front of the ashbox on many grates. The cover used for this experiment should be transparent and fire-proof, requirements met very satisfactorily by mica. Many sheets of this valuable material can be obtained from dismantled condensers taken out of obsolete wireless sets.

3. Cover both front openings and the flame is extinguished, as its air supply is practically cut off.

4. Cover the upper opening only and the candle flares up into the chimney. Compare this with the popular method of "drawing the fire up."

The hot air balloon.—The following interesting little experiment which demonstrates the upward movement of hot air has not had the publicity which it deserves. As it has a direct bearing on the action of the apparatus just described, it is included here. A piece of ordinary *thin* tissue paper about six inches square is bent into an open-ended cylinder and fixed with a folded or very lightly pasted joint. It is then stood upright on the bench and the top edge is ignited at two or three points. The ash which remains when the paper has burnt out envelops a quantity of hot air, whose lifting power is usually sufficient to carry it to the ceiling like a miniature balloon.

Matches.—The materials and methods used in commercial match construction are chosen to meet the following general requirements:—

1. The match must contain a quantity of combustible material.

2. It must have a self-contained oxygen supply.

3. It must be convenient and safe in use.

4. It must be capable of easy ignition.

5. It must be non-poisonous.

By undertaking the preparation of a specimen match or two, pupils may be helped to realise the significance of these points. Manufacturers vary in their choice of materials, but for school purposes the recommendations made in the following paragraph are convenient and give satisfactory results, and may therefore be used with confidence.

Sugar matches.—Prior to the introduction of friction matches early in the nineteenth century, the sugar match enjoyed some popularity, although judged by modern standards it is an inconvenient and dangerous device. As a means of ignition, the match utilises the heat produced by the chemical action of sulphuric acid on sugar.

The form taken by the match in school is very simple. A small quantity of powdered sugar is carefully mixed with a similar amount of potassium chlorate and then

made into a thick paste by the addition of a few drops of ordinary liquid gum. The mixture is then moulded on the ends of short sticks which have previously been soaked in paraffin. When the match heads are dry, they may be ignited by dipping momentarily in concentrated sulphuric acid.

The influence of each item in the composition of the matches may be developed by a short series of demonstrational experiments. The action of the potassium chlorate is shown by burning a small quantity of powdered sugar alone on a tin lid. The slowness of the burning process will be observed. A mixture of sugar and potassium chlorate is now used. The mixture flares up in quite a startling way, due to the oxygen available in the chlorate. Clearly, the presence of potassium chlorate facilitates burning. The action of the sulphuric acid may be shown by putting a few drops on a lump of sugar. The heating effect makes itself evident in the bubbling, blackened mass which results.

If the matches are made with normal care, their efficiency will not be questioned by the pupils, for the chemical action involved is a reliable one which does not demand precision in the proportions of the substances used. The defects of these sugar matches are very evident to anybody who handles them, and the pupils' own experience will serve to show why they were superseded by the friction type. A demonstration of the rotting action of concentrated sulphuric acid on a piece of rag will bring out very clearly the danger associated with this chemical, and will also encourage the pupils to show to it the respect which it deserves.

Although the work just described is easy and safe when properly conducted, a word of warning is necessary at this stage, particularly for those teachers whose practical experience of handling chemicals is limited. First of all, potassium chlorate should never be rubbed or ground with any combustible material, as there is danger of explosion. Alone, it may be ground in a clean mortar

quite safely, but it is preferable to specify *powdered* when ordering for stock, and thus avoid the need for grinding. When potassium chlorate is to be mixed with any substance, the two should be put on a paper and the mixing effected by folding or otherwise manipulating the sheet. Concentrated sulphuric acid must not be handled in any way by children. Pupils who have made sugar matches should be allowed to dip them in a small dish of acid on the teacher's bench, and a sheet of old card should be provided to catch any acid droppings and to take the spent match sticks. A teacher without previous experience of concentrated acids should either obtain some practical tuition or at least read on the subject in a standard work on practical chemistry.

Safety matches.—Work on the sugar match shows that matches consist of a means of ignition, an oxygen supplier and some combustible material, and thus it illustrates clearly the essential principles which govern match action. Owing to the dangerous character of the reactions involved, the inclusion of further experimental study of matches in school cannot be considered. Fortunately, the loss is not serious educationally, although some of the more advanced experiments are very interesting.

Explosives.—The reasons for limiting experimental work on such topics as matches are indicated in a recent memorandum¹ in which the Board of Education points out the dangers of carrying the experimental study of combustion too far. The Board reports that, as a result of preparing a mixture of red phosphorus, antimony sulphide and potassium chlorate in connection with the study of matches and explosives, an unexpected explosion occurred in a school during a science lesson and caused serious injury to the teacher in charge. The memorandum proceeds to point out the extremely dangerous character of potassium chlorate when mixed with either sulphur or red phosphorus and to emphasise the illegality of preparing such mixtures. It also

¹ Board of Education: Administrative Memorandum No. 167.

deprecates strongly the making of gun-powder for experimental purposes and draws attention to the law regulating the manufacture of fireworks. Further, it indicates the possible dangers of chemistry sets and articles about fireworks in children's magazines.

In connection with neither matches nor fireworks should explosive mixtures be prepared, but the experiments should be limited to the classes of work exemplified in the preceding paragraphs on sugar matches and the following ones on fireworks.

Fireworks.—As fireworks are closely connected with matches, it is easy to extend from one subject to the other. As a rule, fireworks are composed of three classes of chemicals:—

1. Combustible substances.
2. Oxygen suppliers.
3. Colour-producing chemicals.

The following two activities, which illustrate the types of experiment which may be included under the present heading, are interesting to boys and are easy to carry out in school. The first demonstrates the oxygen-supplying property of potassium nitrate, and the second the pyrotechnical interest of certain chemicals.

Paper which has been soaked in a concentrated aqueous solution of potassium nitrate and then been allowed to dry, will smoulder rapidly if a spark be applied to it. The *blue tips* on commercial fireworks consist of paper which has been treated in this way. Pupils can make the necessary solution and can prepare such tips for themselves. The solution may also be used to make a simple indoor firework. A drawing or word is sketched on a piece of tracing paper, using a wooden splinter as pen and the potassium nitrate solution as ink. The design adopted must be simple, the solution concentrated and the system of lines continuous. Plenty of liquid should be used. When the paper is thoroughly dry, a piece of smouldering string is applied to a point on the sketch. From this point the whole design burns

itself out, due to the oxygen provided by the potassium nitrate.

The *flame tests* of the analytical chemist can be simplified and used in the senior school in connection with fireworks. The colour-producing chemical is introduced into the bunsen flame by means of a looped piece of iron wire. Convenient substances to test are:—

SUBSTANCE	FLAME
Common salt	Yellow
Copper sulphate	Bluish green
Potassium nitrate	Lilac
Barium nitrate	Green
Strontium nitrate	Crimson

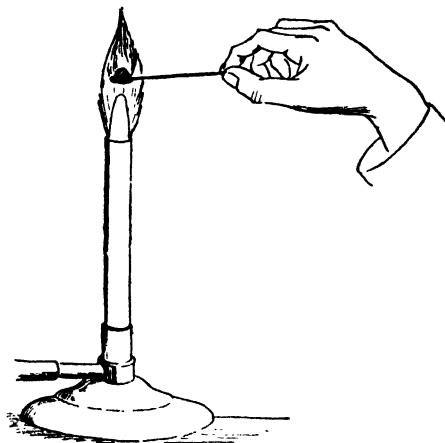

FIG. 2. TESTING FOR COLOUR EFFECTS IN THE BUNSEN FLAME

The hot water system.—Many teachers base their lessons on the hot water system on a simple apparatus intended to show convection in liquids. From the point of view of the child, a rather more complex model which has a real boiler, cylinder, tap and tank is more convincing. The full diagram of a complete hot water installation

(Fig. 3), though perhaps of value to old or particularly capable pupils, carries too much detail to be of great service as a teaching illustration in an elementary course. It is certainly very unsatisfactory as a means of introducing the subject of hot water systems, although it may be utilised at a later stage to show the connection between an actual household apparatus and the simple models around which most of the teaching is centred.

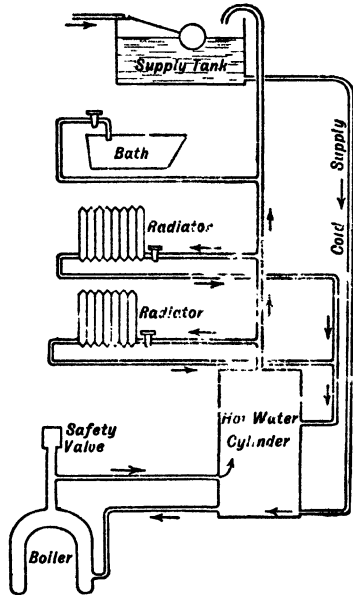
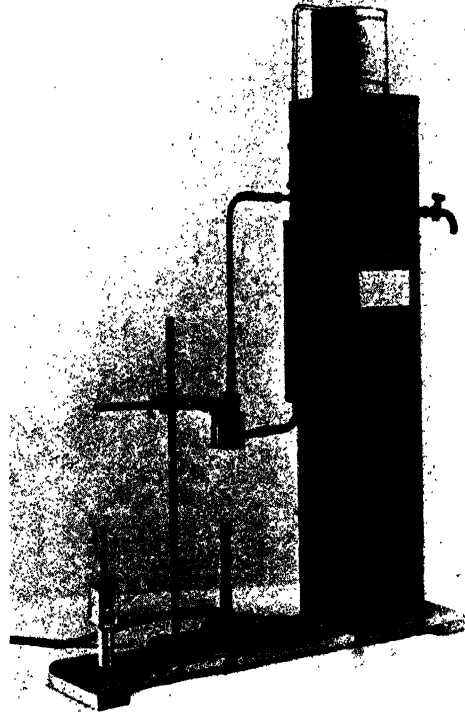

FIG. 3. COMMERCIAL TYPE OF HOT WATER SYSTEM, FITTED WITH PIPES WHICH PROVIDE A SECONDARY CIRCULATION THROUGH RADIATORS

In the model hot water system illustrated here simplicity has been achieved by omitting all hot water taps except one, by eliminating both the automatic supply tap in the cistern and the secondary circulatory system, and by utilising a primary circulation of the simplest kind. The form of the actual apparatus is most easily visualised with the aid of the photograph, but the diagram (Fig. 4) shows the pipes and connections more clearly. Apparatus of this kind may be made in either metal or



SIMPLE MODEL FIREPLACE (On left)
SIMPLE MODEL HOT WATER SYSTEM (On right)

a combination of glass and metal. In the model illustrated, a boiler made from a length of copper exhaust pipe taken from an old motor cycle is used. The pipe is two inches high and two inches in diameter, and is fitted with sheet copper ends. Ordinary soft solder holds the end plates in position. The inlet and outlet pipes are of brass tubing cut from an old gas bracket and are connected by means of glass tube and rubber joints to the cylinder. A long piece of exhaust pipe, fitted with two-holed stoppers, forms the cylinder. A good alternative cylinder is a lamp glass. The hot water tap is an old gas fitting and the cold water cistern is made from an ordinary tin. After filling the system with cold water, heat is applied to the boiler by means of a bunsen burner. Hot water from the boiler

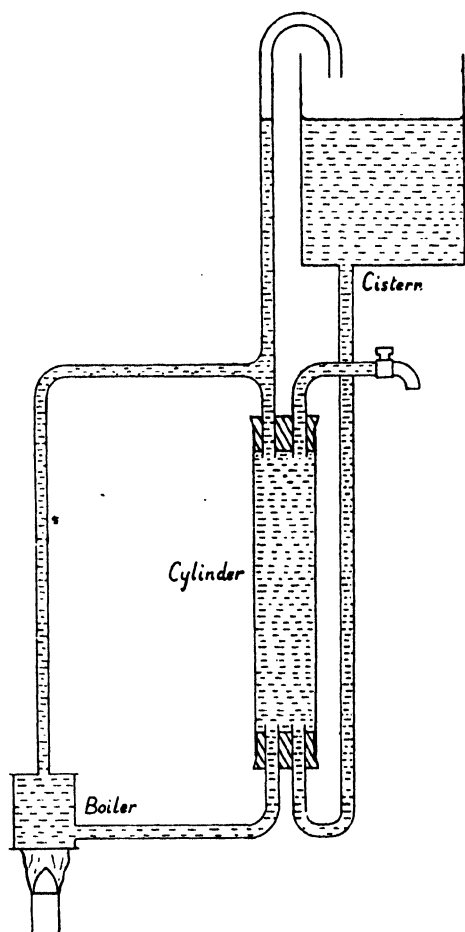

FIG. 4. ARRANGEMENT OF MODEL HOT WATER SYSTEM

passes up the outlet pipe to the upper part of the cylinder, where it accumulates ready for being drawn off through the tap.

In certain commercial forms of hot water system, the cold water cistern and the hot water storage cylinder are built as a unit in order to eliminate some of the lengthy connecting pipes associated with the usual design of apparatus. The storage tank unit has a double partition which divides off the hot and cold compartments. The photograph, page 213, shows the appliance worked out as a school model, and the diagram (Fig. 5)

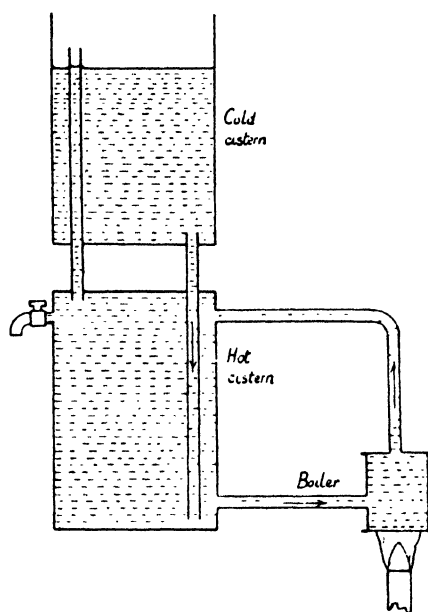

FIG. 5. ANOTHER ARRANGEMENT OF MODEL HOT WATER SYSTEM

gives constructional details. Two similar cans represent the storage unit, the bottom of one and the lid of the other forming the double partition. A gas tap soldered directly into the wall of the lower tank is used to draw off the hot water. A boiler similar to that already described completes the apparatus.

Experimental work.—The usual experiments on convection in liquids should be associated with this work on hot water systems. The following two are particularly useful.

By floating hot water on top of cold, the difference in density may be directly and clearly demonstrated. To do this, a beaker half full of cold water is stood on the bench and a small piece of wood is floated on the surface. To facilitate the successful addition of the hot layer, a small funnel is used as a guide, Fig. 6. The water which is to be added should be very hot and should be coloured by means of a few crystals of potassium permanganate in order to make

it contrast with the liquid already in the beaker. By pouring gently it is possible to

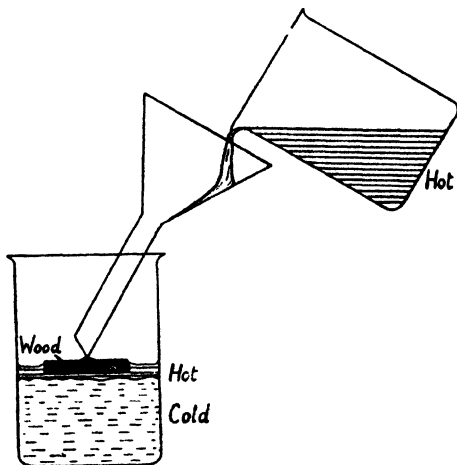

FIG. 6. FLOATING HOT WATER ON COLD

avoid mixing, as the piece of wood in the beaker diverts the hot stream and helps it to form a clearly defined stratum above the original liquid.

The circulation of water under the influence of convection currents may be shown very simply by means of the following school-made apparatus. Two glass tubes, worked into the shapes shown in the diagram (Fig. 7A), are connected by two short rubber joints to form a circuit. After filling the apparatus with water, a few crystals of

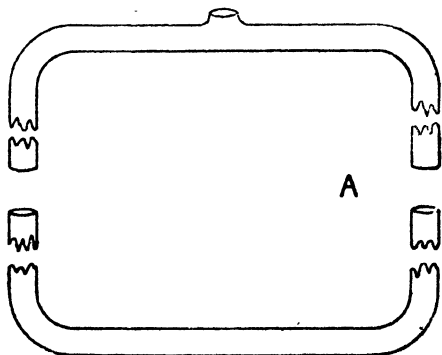

FIG. 7A. TUBES FOR CONVECTION APPARATUS

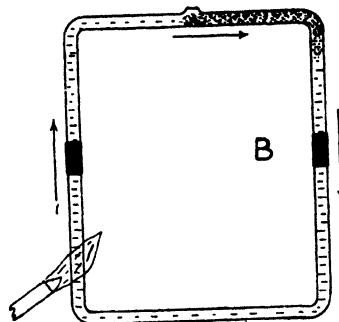

FIG. 7B. ACTION OF CONVECTION APPARATUS

potassium permanganate are added at the neck. On heating a point on the tube (Fig. 7B), a circulation is set up. This is shown very clearly by the movement of the purple colouring. To guide those teachers whose experience of glass blowing is very limited, the process of forming a neck on the upper tube of the apparatus is illustrated diagrammatically, Fig. 8. A start is made with a straight piece of tube, Fig. 8a. Using both hands to support the tube, a point near one end is heated strongly in a bunsen flame until the glass softens. Even heating of the tube is assured by slow rotation. When the glass is soft, the tube is pulled out slightly, Fig. 8b. Heat applied to the constriction causes collapse at this point so that the main tube is sealed off, Fig. 8c. The short end piece is waste. A point about half way along the tube is now heated strongly with a small blowpipe flame, the heat being concentrated on as small an area as possible. When the tube begins to collapse inwards at the heated point (Fig. 8d), the operator removes the tube from the flame and blows gently with the mouth into the tube end. A small pimple should thus be produced, Fig. 8e. By repeated heatings applied to the pimple head, alternated by gentle blowing, the pimple may be built up (Fig. 8f and 8g), and finally burst, thereby forming a neck, Fig. 8h. At this stage, the sealed end is cut off and the rest of the tube bent to the required shape in the usual way.

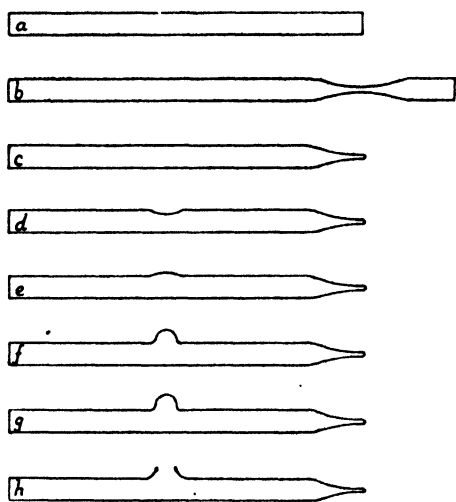

FIG. 8. STAGES IN BLOWING A NECK ON A GLASS TUBE

The geyser.—A very simple model of this appliance can be made by plugging the ends of a metal tube with stoppers which carry

glass tubes. Such a model is operated by connecting one tube to the tap and heating the metal with a bunsen burner, Fig. 9.

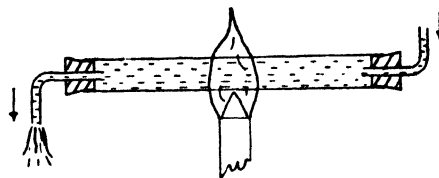
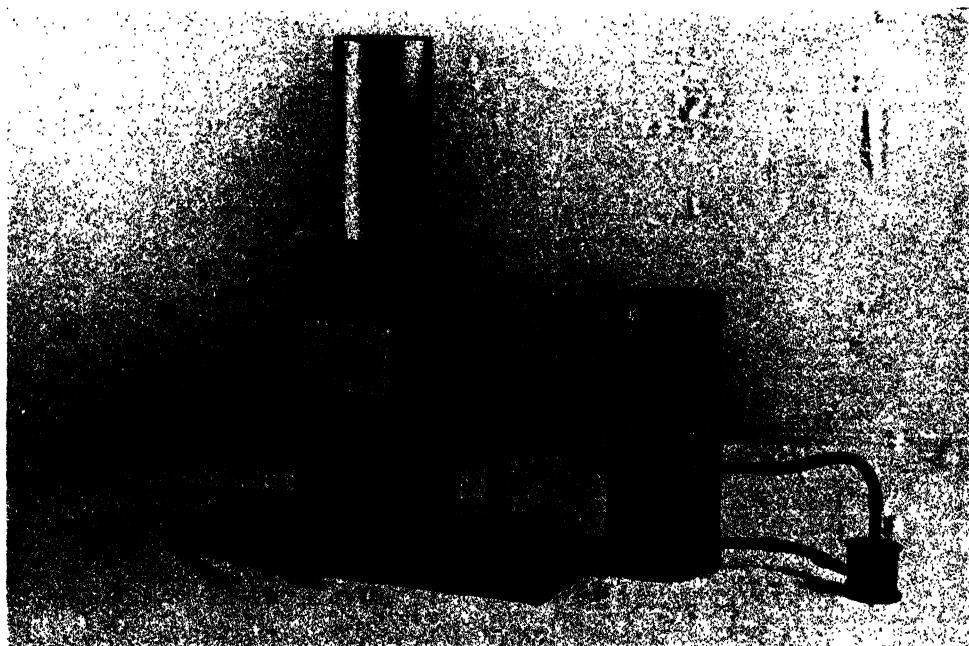

FIG. 9. SIMPLE MODEL HOT WATER GEYSER

A model, fitted with a spiral heater, gives a more convincing performance than one of the straight tube variety. In the illustration below, the apparatus is shown as a self-contained appliance, with no external water connections. The heater for this model is prepared by coiling copper tube round a stick. The tube should have a diameter of about a quarter of an inch. By taking care it is possible to avoid undue flattening of the tube without resorting to the artifice



SPIRAL TYPE MODEL GEYSER (On left)
 MODEL HOT WATER SYSTEM WITH COMBINED HOT AND COLD STORAGE TANKS (On right)

of packing. The coil, when completed, should have a diameter which permits a bunsen flame to play on the whole of the inside surface of the coil at once. Straight lengths of tube at each end of the heater connect to the remainder of the apparatus. The coil shown in the illustration was made from the petrol pipe of an old motor car. A small gas tap at the upper end of the heater controls the flow through the apparatus and a tin attached to the lower end serves as cold water reservoir. A wooden stand of simple design holds the various components of the model in their correct positions. To operate the geyser, the tap is turned on and a bunsen flame is then arranged within the heater coil. It is convenient to have the spiral with its axis in a vertical position, Fig. 10.

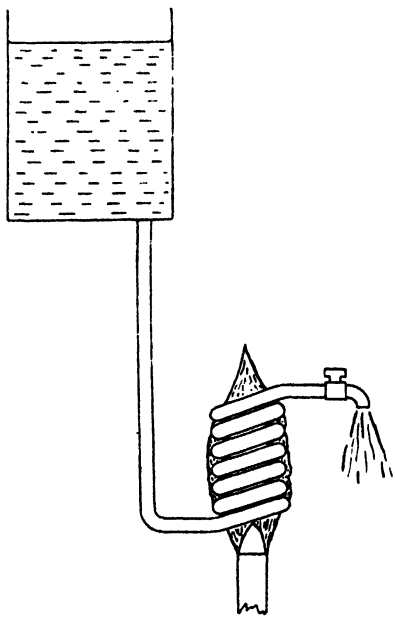

FIG. 10. MODEL HOT WATER GEYSER WITH SPIRAL HEATER

The vacuum flask.—An impressive experiment which illustrates the influence of the vacuum on the efficiency of the flask can be carried out with the aid of three suitably prepared specimens. The cheap vacuum

flasks now available are quite satisfactory for the present purpose. As it is not practicable to have many sets of these flasks in the school, and as the investigation is not one which lends itself to demonstrational methods, an instruction card on the experiment may advantageously be used to direct the work of a small group of boys. The following paragraphs not only suggest how an instruction card may be planned for this particular experiment, but also how the card system may be used to encourage initiative through suggestions for further work. A card which gives instructions only and which leaves no scope for individual effort is open to serious criticism.

Purpose of experiment.—To show that a vacuum flask keeps liquids warm only when its walls contain a vacuum.

Apparatus required.—Three vacuum flasks, mounted in stands; three one-holed cork stoppers to suit; three similar thermometers; a watch or clock; bunsen burner, tripod, pan, etc.

Notes on apparatus.—No. 1 flask is a good one, and No. 2 is exactly like it except that the *pip* has been cut off. No. 1 flask therefore has a vacuum between its two glass walls, whilst No. 2 has a space filled with air. No. 3 has had most of the outer glass wall taken away, so that you may see the inner wall and so that you may find out if the outer wall makes any difference to the working of the flask. The flasks are very delicate—handle them with care.

Practical work to be done.—The three flasks are to be filled with hot water, and the rate at which each cools is to be observed with the aid of a thermometer. The difference made by the vacuum and the outer glass wall will be shown by the thermometers in the three flasks.

Notes on method.—Obtain a panful of hot water from the kitchen or the domestic room. Bring the water to boiling point over a bunsen and then allow it to cool for a minute or two to avoid risk of cracking the flasks.

Fill the flasks to a level just below the neck. (Make all three alike.) Put the stoppers and thermometers into position. The thermometer stem above the 80° F. mark should project above the stopper in each case.

Make a note of the time and also the three thermometer readings. Read the thermometers once every ten or every fifteen minutes.

During the experiment, feel at the out-sides of the flasks. Which appears to be permitting most heat to escape?

Results.—Tabulate your observations in your notebook in four columns as follows:—

Time	Temperature Flask No. 1	Temperature Flask No. 2	Temperature Flask No. 3
------	-------------------------------	-------------------------------	-------------------------------

Explain the experiment in a few sentences with the aid of a diagram. State clearly what your results and observations have shown. How long did you spend on the experiment? How many degrees did the temperature lower in each flask during that time? Did the vacuum retain the heat particularly well? Did the outer wall of the flask make much difference?

Further work.—1. Look up details of the life of Sir James Dewar, the inventor of the vacuum flask. Be sure to notice for what special purpose Sir James used vacuum flasks. Put a short paragraph in your notebook under the heading *Sir James Dewar*.

2. Make a diagram showing the various parts of a vacuum flask.

3. From the reference books, find out:

(a) Why vacuum flask walls are silvered.

(b) Why there is a *pip* on the flask bottom.

4. Check what you find out about the effect of silvering by means of the following experiment:—

Boil some water in a shiny tin. Carefully lift the can on to a piece of cardboard on

the bench, stand a thermometer in the water and notice how long it takes for the water to cool from 180° F. to 120° F. (Use a watch or clock for timing.) Repeat the experiment, using the same amount of water in a dull black tin.

Enter your results in your notebook. What does the experiment suggest to you?

5. Try to make a *pip* from a piece of glass tube. Heat the middle of a short length of tube in the bunsen burner. Hold both ends of the tube and keep turning it as it is being heated. When the glass softens, take it out of the flame and pull gently. Try to seal off the two halves of the tube neatly in the bunsen. Under the heading *Making a Pip* draw three diagrams to show the piece of tube as it was at first, its appearance when it had been drawn and then the pips after they had been sealed off in the bunsen.

6. Make a list of common appliances which are polished in order to avoid rapid cooling.

Note.—The experiment just described gives convincing results, as the following set of observations illustrates:—

Time	Flask No. 1 (Un- damaged)	Flask No. 2 (No vacuum)	Flask No. 3 (No outer wall)
10.45 a.m.	167° F.	157° F.	163° F.
11.0 a.m.	165° F.	149° F.	153° F.
11.15 a.m.	164° F.	138° F.	140° F.
11.30 a.m.	163° F.	131° F.	132° F.
11.45 a.m.	162° F.	126° F.	126° F.
12.0 noon	161° F.	120° F.	119° F.
1.30 p.m.	155° F.	98° F.	93° F.
2.30 p.m.	150° F.	84° F.	80° F.
4.30 p.m.	140° F.	65° F.	65° F.

The instructions given in the card are adequate for boys who are accustomed to individual practical work and who have fair ability. (The experiment is not suitable for slow children or those of low intelligence.) If the work is to be successful, the necessary

apparatus should be boxed ready for use. Book references should be given in connection with the *Further Work*. There is no need to prolong the period of observation to the extent indicated in the specimen set of results. The last three entries in the table above are only given in order to show the experimental possibilities taken to their limit.

The three flasks required for the experiment need to be prepared carefully. The metal cases should have large pieces cut down the sides, so that the interior portions may be seen without having to dismantle the appliances. Cases prepared in this way can still serve as holders for the glass parts during the experimental work, Fig. IIA. The vacuum of flask No. 2 may be destroyed by nipping off the pip with a pair of pliers. With the same tool and method, much patience and a modicum of good luck, the lower part of the outer glass wall of flask No. 3 may be broken away successfully. It is neither necessary nor advisable to attempt to remove the whole of the outer wall, Fig. IIB. If they can be spared, three thermometers should be set permanently in the flask stoppers. Heavy loss through breakages is likely if boys attempt to manipulate thermometers.

The making of a pip, suggested in *Further Work No. 5*, is an example of a type of work which it is easy to overlook. Most text books pass over the pip as an unimportant trifle, but a boy is almost certain to ask about it when the flask is first shown to him. As the

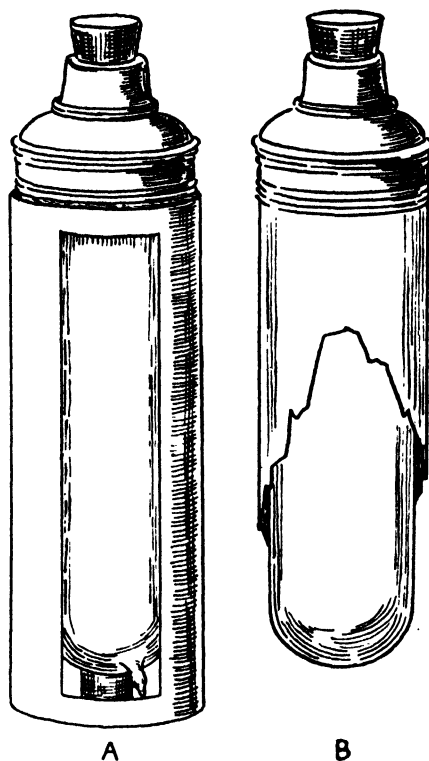

FIG. 11. A. VACUUM FLASK, WITH CUT-AWAY CASE
B. FLASK INTERIOR, WITH OUTER WALL PARTIALLY REMOVED

pip arouses curiosity, it is good practice to include a little investigation on the subject. Short lengths of glass tube relegated to the scrap box may have a final period of service in this connection.

TOPIC II—THE BICYCLE

Introduction.—The design of a syllabus, and the choice of topics which is made when compiling it, both influence the distribution of certain items of subject matter very considerably, as these lend themselves readily to several different treatments. Thus, when dealing with the bicycle, it is quite fitting

to include work on compressed air and lamps, but if the syllabus is one which accepts these subjects more suitably in another connection, then they may not figure in the present one. For example, if *Lighting* or a topic closely allied to it appears as a major feature of the course, then it is

idle to make more than a passing reference to cycle lamps when dealing with the bicycle. Nevertheless, in a scheme which permits it, many "floating" items can be fitted into places which appear rather strange at first, but which prove very satisfactory in practice. "Some aspects of lighting," incorporated in the topic *The Bicycle*, is an example of one of these unusual but effective arrangements. The following headings interpret the main topic liberally in order to suggest the range which it may cover in favourable circumstances.

1. *How does a bicycle save energy?*—A number of factors contribute to the efficiency of the bicycle as a means of transport. By comparing cycling with walking, in the light of ordinary experience, it is possible to conclude what these factors are and to judge their relative importance.

2. *Why is high speed possible on a bicycle?*—After the first consideration of *ease*, speed is the next natural advantage of cycling. In this connection, the bicycle is treated as a machine which, by working at a mechanical disadvantage, produces speed at the expense of power.

3. *Why are inflated tyres used on a bicycle?*—The elasticity of air, developed from the pneumatic tyre, is a very interesting topic of wide application. Bicycle tyres, pumps and valves all deserve attention in connection with it, and they may be used to open up the wider subject of compressed air and its everyday applications.

4. *How do bicycle lamps work?*—In almost the simplest form, bicycle lamps show the application in practice of the principles of oil, gas, battery and dynamo lighting. In fact, in its scope cycle lighting is unique, for no other practical system of lighting applies all the four energy sources mentioned. As the possibilities of this sub-topic are almost endless, its limits in a particular scheme are determined by the time available in the course.

The character of the four sub-topics listed is different from that shown in the previous chapter, for in the present case the sub-topics

form a series of problems. A course built up on such a group of problem topics has much to recommend it.

How does a bicycle save energy?—Summarised in conventional terms, the work in this sub-topic is concerned with the forces of friction and gravity, and the functions of the wheel, the bearing and the inclined plane. In school there is a danger of letting these generalised ideas take the lead, so that the interest in bicycles which started the inquiry is lost. This should not occur. The topic is the bicycle, and this must dominate throughout.

Walking and cycling.—If a class is to realise how a bicycle enables a person to travel under his own power with a less expenditure of energy than when walking, some clear thinking and sound exposition will be needed. The problem can be the basis of a useful and most interesting piece of school work, but it is one which requires a carefully prepared presentation. In an inquiry of this sort, the first thing to do is to put the subject to the class in problem form:—Why is it possible to travel more easily when cycling than when walking? A number of suggestions which give possible solutions will be supplied by the members of the class when they have grasped the precise significance of the question. Favourite replies include the following, in various guises:—

1. When cycling, a person is sitting down.
2. A bicycle has wheels.
3. Pedalling is easier than walking.
4. The wind can help more when a person is cycling.
5. A bicycle goes by itself downhill.
6. A bicycle moves easily without much pushing.

By surveying the answers supplied, the class can be helped to compare the possible solutions and to put on one side those which partially solve the problem. Although acknowledging the importance of other factors, the boys will quickly realise that

the wheels of the bicycle mark off the two forms of locomotion from each other by what appears to be a fundamental difference. In order to compare cycling and walking accurately, it is necessary to examine both, and to find out what happens during each process. That the bicycle *rolls* along on steadily rotating wheels is obvious. How does walking compare with rolling?

Walking and rolling.—A well known platitude, of a very misleading character, states that the wheel is the one mechanism not found in nature. In a narrow sense, this may be true, but the system of locomotion which the wheel is designed to utilise, namely rolling, is common enough in nature, although the mechanisms which use it differ in structure from the wheel. The following analysis is intended to show that walking, like cycling, is really a process of rolling.

The diagram shows a man walking behind a farm cart which rolls along on large wheels, Fig. 12. The working parts of the person

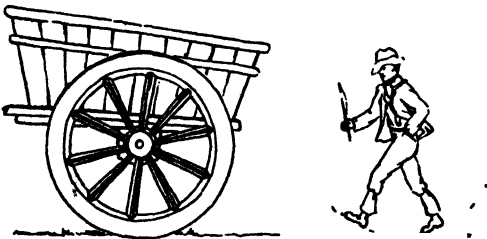

FIG. 12. DIAGRAM TO ILLUSTRATE THE SIMILARITY BETWEEN WALKING AND ROLLING ON A WHEEL

are two legs and two feet which swing round the hips as centre, the feet describing an arc of a circle whose radius equals the length of the leg. The remaining portions of the body move forward at a fairly regular speed without taking an active part in the process of propulsion. Their weight forms a balanced load on the hips. In the case of the farm cart (referring to one wheel only for the sake of simplicity), the working parts are a rim and a series of spokes which rotate steadily round the axle shaft. The main

mass of the cart, like that of the person walking, constitutes a load on the rotation centre and moves forward at a regular speed. A similarity between the two cases illustrated thus reveals itself. Both the man walking and the wheeled vehicle consist of a main mass which has a constant forward speed, and a *driving portion* which consists of parts having a circular motion. Another similarity may be seen by ignoring those parts of the wheel which at a particular moment are taking no part in the process of propulsion, for under such conditions the wheel resolves itself into a small portion of rim in contact with the ground, supported by one or two spokes. A comparison now reveals a distinct similarity between the functions of legs and spokes, and the feet and the rim. Both legs and spokes support the main mass of the object and also link the stationary portion of the mechanism which is pushing on the ground with the part which is steadily moving forward. Both feet and the rim are curved so that they may apply a steady push on the ground, which the forward movement of the whole will not interrupt.

The design of man is such that a complete set of *spokes* and a continuous circular *rim* are unnecessary, as each of the two *spokes* provided retraces its path after a cycle of service and so brings its section of *rim* into the working position again before its fellow has quite finished its course. This swing back to the starting position eliminates the long period of idleness characteristic of the spokes of an artificial wheel, Fig. 13B. A wheel can be considered to be a set of legs and feet, particularly if the rim is sectioned between the spokes. In nature, the legs have a reciprocating movement, which in the wheel is replaced by continuous rotation, Fig. 13A.

As the fundamental principle of rolling is adopted both in walking and in wheel action, it follows that the ease of cycling must be due to other factors. The order in which these are dealt with in class will depend to a great extent on the way in

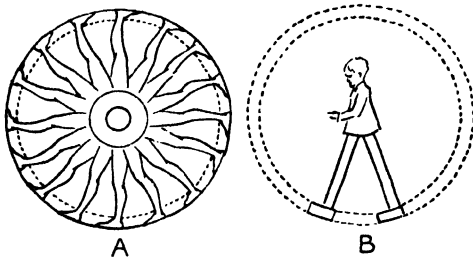

FIG. 13. A. A WHEEL OF LEGS AND FEET
B. WALKING ON SPOKES AND RIM

which they are suggested, and the sequence given here will not necessarily be adopted in practice. A class which is fully satisfied by the analysis given above will suggest points about cycling which have no connection with the wheels. In cases where the feeling that the secret lies in the wheels still persists, the differences between leg and wheel action will be developed further. Ultimately, both approaches lead to the conclusion that the virtue of the bicycle lies in the fact that through its action the cyclist travels a long distance for every leg movement.

Cycling and sitting.—A fact which differentiates sharply between walking and cycling is that a rider sits. This sitting removes the dead weight of the body from the cyclist's legs and applies it directly to the road through the bicycle frame and wheels. The walker has no such relief and therefore becomes fatigued partly as a result of a burden which is entirely lacking when cycling. The following illustrations show how important the transference of dead weight can be:—

1. A person who stands motionless quickly tires, owing to the constant strain on the supporting muscles of the legs.
2. If a person rides a bicycle without sitting on the saddle, he very soon shows signs of fatigue.
3. Holding a weight is very tiring, although the task is one which an inanimate object such as a table can do equally as well as a person.

4. A person can move a heavier load than he can carry if he lets the ground take the weight directly and then applies a push or pull.

Leg balance.—Pedalling offers a feature which is lacking in walking, namely, a state of balance between the two legs. The leg moving downwards balances the other which is rising, and so little is demanded of the rider apart from the effort actually used in propelling the machine. A lift with balance weights and movable roadways of the Tower Bridge type make use of the same kind of balance. The lifting of the legs which is involved in walking is a tax on the strength of the pedestrian concerned, and makes no contribution to progress.

Gravity.—The influence of gravity in cycling is a mixed blessing. On down gradients, with the aid of a free wheel clutch, cycling is gloriously easy, but uphill it is often an ignominious failure. In any ride which starts and finishes at the same spot, the helpful and the hindering effects of gradient cancel each other out apparently. A practical cyclist will not agree with this, for he knows from experience that a long, gentle down gradient is of greater assistance than a short, steep one, and that a short, stiff rise is a less serious obstacle than a long, steady climb. On level ground, of course, the effect of gravity may be discounted completely.

Gravity and the inclined plane have special importance to the cyclist and their effects should be studied. The experiments available for this work are conventional in character and utilise traditional apparatus, but they should be presented in a way which casts further light on the action of the bicycle. For instance, the relation between the gradient of an inclined plane and the force needed to pull a loaded trolley up it will be investigated because that inquiry represents in a convenient form the fundamental one (so far as the class is concerned) of correlating the slope of a hill and the effort to be made by a cyclist riding up it. Trolleys represent bicycles, weights repre-

sent riders, inclined planes represent hills, tensions in cords represent forces on bicycle rear wheels, and so on.

Free wheeling.—Arising out of either the subject of rolling or of gravity is the obvious advantage which a bicycle offers in its power to *free wheel*. The capacity to make an impulse effective over a variable road distance is totally lacking in walking, although it is evident in most wheeled machines; e.g., handcars, perambulators, shunted railway trucks. Consequently, although a pedestrian has remarkable control over his movements, and can twist, turn or stop with the greatest of ease, he cannot appreciably decrease the number of impulses which he has to employ in covering a certain distance.

The design of a rolling mechanism determines its capacity to free wheel. A human being who walks does not free wheel at all, although, on a favourable gradient, gravity may cause involuntary running which might be considered a rudimentary form of free wheeling. A farm cart, with its heavy, clumsy wheels, shows but little disposition to free wheel. A bicycle, on the other hand, moves freely along under the impulse of a light touch. The reasons for these differences are not difficult to comprehend.

The legs and feet which form the driving mechanism of a creature which is walking are heavy, and in the case of human beings they form quite a large part of the total weight. Now these heavy parts perform a series of backward and forward swings in addition to moving steadily with the rest of the body. These reciprocating movements characteristic of walking are kept up only through the expenditure of energy derived from the muscles which operate the legs. The wheels of a farm cart are heavy and can be set in motion only by applying a force to them, but once started they show a tendency to continue. There is, therefore, no energy lost in frequent stopping of the moving parts and little in restarting in a new direction. It is in this respect that the wheel has an advantage over walking. The comparatively simple movement of a wheel

can be set up by a steady force acting upon the rim. A push exerted by a person or a gravitational pull may therefore cause rotation of a road wheel, but walking cannot take place solely as the result of the application of such simple driving influences.

The bicycle is designed to make the best possible use of the natural advantages enjoyed by the wheel. The rotating parts are very light in weight so that little effort is needed in order to start or increase their motion. (There is opportunity for using illustrative experiments on inertia in connection with this point.) Reciprocating movements are reduced to the minimum, and the whole machine is accurately made in order to attain free running. The elimination of *friction* is an important factor in bicycle design. The use of a free wheel clutch enables a bicycle to move under the influence of forces applied by the rider through the medium of the pedalling equipment or alternatively under the influence of an external force, especially gravity.

Friction and ball bearings.—The subject of friction can be illustrated by experiments of the conventional types, but the work on the ball bearing should be closely associated with the bicycle itself. The following investigation, which illustrates the efficiency of ball bearings in contrast to plain, is carried out with the aid of cycle parts. The front wheel of a discarded bicycle is stripped of its tyre and tube, and is then fitted into its place in a front fork whose stem is strapped to the bench, Fig. 14. A peg, consisting of

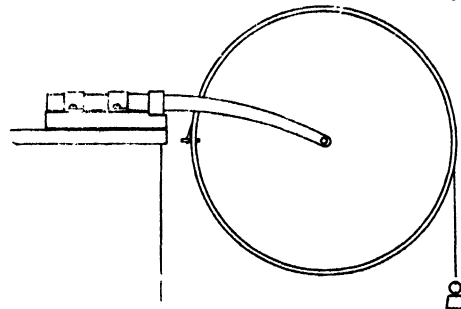

FIG. 14. ARRANGEMENT OF APPARATUS DESIGNED TO COMPARE THE EFFICIENCY OF BALL AND PLAIN BEARINGS

either a smooth metal bolt or more simply a short length of pencil, is fitted in the valve hole in the rim. On to it is slipped a loose loop made at the end of a piece of string. This string, after passing round the wheel rim, supports a weight. The diagram shows the starting position of the apparatus. A point on the wheel is whitened with chalk to facilitate the counting of revolutions and then the weight is released. The number of revolutions which result from the impulse given by the weight is noted. By adopting the peg and string arrangement, the wheel moves freely under the influence of a definite impulse. The apparatus does not disturb the wheel as the string and weight fall clear of the mechanism after approximately half a revolution. When the number of turns per impulse has been determined, the wheel is removed from the fork and its bearings and spindle are replaced by a well lubricated plain shaft which makes a good fit in the hub shell. The wheel is refitted in the fork by means of nuts and washers on the plain shaft. The string and weight are put into position again, and a count of revolutions per impulse is made as before. The plain bearing absorbs more energy than the original fitting did, and so the wheel makes a smaller number of revolutions before coming to rest. The following are results which have been obtained by the method described:—

Driving weight used:	8 ounces
With ball bearing spindle:	1st trial: 17 revolutions 2nd trial: 19 ,, 3rd trial: 19 ,,
With plain spindle:	1st trial: 9 revolutions 2nd trial: 10 ,, 3rd trial: 10 ,,

The cyclist's long strides.—The most important factor in the economy of the bicycle

has not yet been discussed. The human legs are capable of exerting with comfort forces much greater than those required in ordinary walking, but they are not adapted for high speed. When they are relieved of their normal burden of weight, the legs are able to exert great pressure without being strained. Therefore, in making the best possible use of the legs as a means of locomotion, the bicycle takes upon itself the function of weight-supporting which normally devolves on the legs and then offers an economical system for applying the pressure which can be exerted by the feet. When walking, a single movement of the leg propels the body a distance of two or three feet. When cycling, a single leg stroke which is comparable with a stride drives the machine and rider a much greater distance than this. Hence the suggestion that the bicycle is a machine which lengthens the stride.

The importance of the push applied by the cyclist on each pedal, and the increased distance travelled per leg stroke, need to be illustrated fully in teaching. Modified systems of walking, such as skating, roller skating and stilt walking, show the value of lengthened strides and by developing from these to the use of rather more complex machines, a good series of examples can be worked out.

The hobby horse.—The basic reason for the bicycle's effectiveness can be taught most satisfactorily by considering a simpler, but similar machine. The modern bicycle is a complicated mechanism which has gradually evolved during the past 120 years from a very primitive invention, the *hobby horse*, Fig. 15. Following the discussion of skating and stilt walking, this historic machine or its directly descended modern counterpart, the scooter, should be brought to the notice of the class. These two machines make good teaching illustrations because they present the essential quality of the bicycle without any of the modern refinements. Every child knows how a scooter is propelled, and he will easily realise that

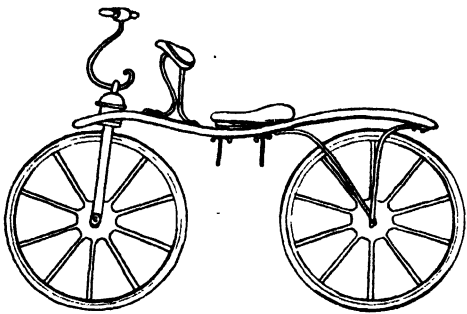

FIG. 15. THE HOBBY HORSE, FORFRUNNER OF THE MODERN BICYCLE

the hobby horse operates in a similar way, although as the rider of the latter machine is seated, he is able to use both legs for propulsion. The weight of the hobby horse rider is supported by the saddle and stomach rest fitted on the wooden cross beam, Fig. 15. In skating, scooting and hobby horse riding the legs have a striding action, and a great distance is travelled for each leg movement. During each stride, a definite push is applied with the foot and this propels the machine.

The "Penny Farthing" bicycle.—Although the principle of pushing with the feet is retained in this later machine, the work is made more convenient by the fitting of pedals, Fig. 16. In order to attain a large

movement of the machine for every leg stroke, the driving wheel has to be very big. Mechanically, the design is sound enough, although its stability and convenience leave much to be desired. The modern bicycle is the penny farthing machine with a modified form of pedalling arrangement, wheels of equal diameter, lower build, and rear wheel drive. None of these changes is fundamental and the modern machine, like the penny farthing, uses foot pressure on a pair of pedals to propel the bicycle, and moves a long distance for every pedal stroke.

Why is high speed possible on a bicycle?—Like other simple machines, the bicycle acquires speed at the expense of power. In working out this principle, this sub-topic extends the scope of its predecessor to include the mechanical features of a modern bicycle.

The three speed gear.—As speed is the subject of the problem, the three speed gear makes a good starting point. Most boys know the value of a variable gear on a bicycle and they know the circumstances which demand the use of the various ratios. By finding out exactly what effect a gear change has, it is possible to decide why a bicycle offers high speed transport. The preliminary information which the boys have to offer on the subject of three speed gears should be gathered together and tabulated as follows:—

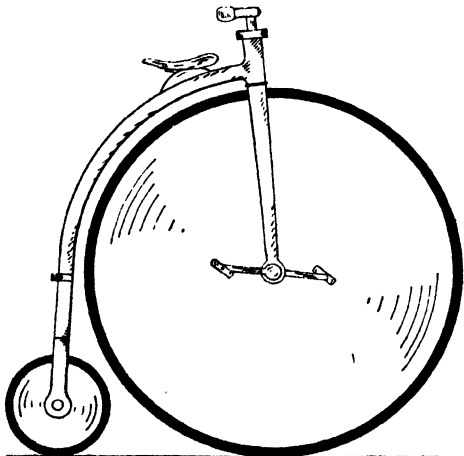

FIG. 16. THE PENNY FARTHING BICYCLE

Gear	Road speed	Pedalling	When used
Low	Slow	Easy, but fast	Uphill, or against a wind
Normal	Medium	Medium	On the level or on slight hills
High	Fast	Hard, but slow	Downhill, or with a following wind

Verification of these general conclusions may then form the subject of experimental work. Firstly, the connection between pedalling speeds and road speeds is investigated by measuring the distance travelled

by the bicycle per revolution of the pedals. A measurement is made for each position of the gear change lever. The quantitative results thus obtained bear out the qualitative conclusion previously derived from everyday experience. In high gear, a bicycle travels farther per revolution of the pedals than in the lower gears. High road speed has thus been acquired without increasing pedalling speed. Has anything been sacrificed in order to attain this advantage?

When the measurements for the purpose of the previous paragraph are being made, care must be taken to avoid slip. After setting one pedal crank in a vertical position, the contact point of the front wheel is marked with chalk on the ground. Under the influence of pressure applied with the hand on the pedal, the machine is driven forward until the crank is again in a vertical position. Another chalk mark is now made. Provided that no free wheeling has occurred, the distance between the chalk marks corresponds with one revolution. The following are typical experimental results:—

Gear used	Distance travelled by pedal	Distance travelled along the road
Low	1 revolution, or 3 feet 8 inches	14 feet
Normal	Ditto	19 feet
High	Ditto	25 feet

If the necessary machines can be borrowed, the distances travelled per revolution of the pedals by the following classes of bicycle should be measured. The results obtained should then be compared with what everyday experience suggests.

1. A lady's bicycle. (These are geared low.)
2. A child's cycle. (Geared very low.)
3. A carrier bicycle. (Geared, low.)
4. A tandem. (Geared high.)

The second big effect of changing gear is next investigated. A bicycle is fixed firmly

on the bench with its back wheel clear of the surface. To the rearmost point of the back tyre and rim a weight is attached by means of cord. This weight represents the force applied to the road surface by means of which the machine and rider are pushed along. After setting the pedals in a horizontal position, a spring balance is hooked on to the front pedal spindle and held so that it balances the weight which is pulling against it on the rear wheel, Fig. 17. The force

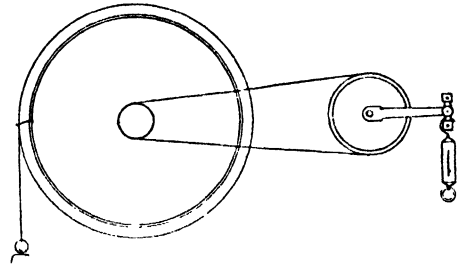

FIG. 17. COMPARING THE FORCE APPLIED ON THE PEDAL WITH ITS RESULTANT AT THE REAR WHEEL RIM

necessary to balance the weight is read on the balance scale. The machine is then set in another gear and the observation repeated. Results obtained in this way are as follows:—

Gear used	Weight on rim	Force applied through spring balance
Low	1 lb.	3 $\frac{3}{4}$ lb.
Normal	1 lb.	5 $\frac{1}{8}$ lb.
High	1 lb.	7 lb.

From the two investigations described it is easy to see that for a comfortable, steady speed of pedalling, a high gear produces a faster road speed than a low gear, but it requires a greater pressure on the pedals. By comparing the tables of results, a general conclusion may be reached: Speed can be attained at the expense of power, or power can be increased at the expense of speed. Now even in low gear, power is lost and speed is gained (3 $\frac{3}{4}$ lb. are reduced to 1 lb., and

one revolution gives a road distance of 14 ft.). Can a person riding a bicycle apply a bigger force than is necessary to propel the machine? If he can, then by sacrificing force he may attain speed. The observations already described suggest that a sacrifice of power does take place in every gear of the bicycle. The suggestion may be confirmed by direct observation.

On most ordinary roads, only a very small force is needed in order to propel a bicycle and rider. This force can be measured very roughly by towing a cyclist with a cord to which a spring balance is attached. That a rider is able to apply a much greater force than this on the pedals may be shown by actual measurement. To make the observation, a rider sits in a normal position on a machine which has its rear wheel jacked up. One pedal is attached to the bicycle cross bar through a spring balance and cord, Fig. 18. The force applied by the foot is read directly on the balance scale.

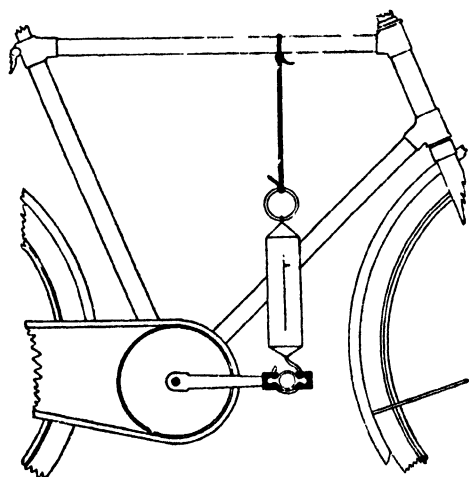

FIG. 18. EXPERIMENTAL ARRANGEMENT USED FOR MEASURING THE FORCE APPLIED BY A CYCLIST ON THE PEDALS

Mechanical advantage.—The principle which relates loss in power with gain in speed needs now to be given richness and wide significance by references to other kinds of machines. Many of the common appliances

used in everyday life should therefore be discussed and compared with the bicycle. In each case, gain or loss in speed should be given special thought and each device should be classified with, or separate from, the bicycle according to whether the change in speed is positive or negative. The machines considered should include both simple and complex examples, the only point looked for being a gain in force or in speed. If desired, the machines may be further classified into lever, inclined plane and screw groups, although at this stage such an extended classification tends to cloud the issue. In any case, mathematical treatment of the machines is quite out of place.

When adequate series have been discussed, the term *Mechanical Advantage* can be applied to those machines which increase the force applied to them. The other series is linked to the term *Mechanical Disadvantage* or *Speed Advantage*. The project embraced by these series of machines is a very wide one. Without attempting to exhaust its possibilities the following lists are given. These should prove helpful and may suggest fruitful lines along which development may take place:-

<i>Machines giving Mechanical Advantage</i>	<i>Machines giving Speed Advantage</i>
<p><i>Wedges:</i> Teeth; needles; knife blades; ship bows.</p> <p><i>Screws:</i> Car jack; engineer's vice; propellers; nuts and bolts.</p> <p><i>Geared mechanisms:</i> Gear boxes; clothes wringer.</p>	<p><i>Clockwork mechanisms:</i> Toys; clocks and watches; gramophones.</p> <p><i>Levers:</i> "Try your strength" machines; typewriter keys; human forearm.</p> <p><i>Geared mechanisms:</i> Lathes; emery wheels; egg beaters</p>

Mechanical advantage of a bicycle.—An effective way of concluding the inquiry is to make observations on the two simple machines which together form the bicycle,

and from these to determine the mechanical advantage of the whole appliance. Although the necessary measurements may be made with the aid of a complete machine, it is preferable to adapt an old bicycle for the work. The apparatus suggested is shown in the photograph below. Set out as illustrated, the device is ready for observations to be made on a complete machine,

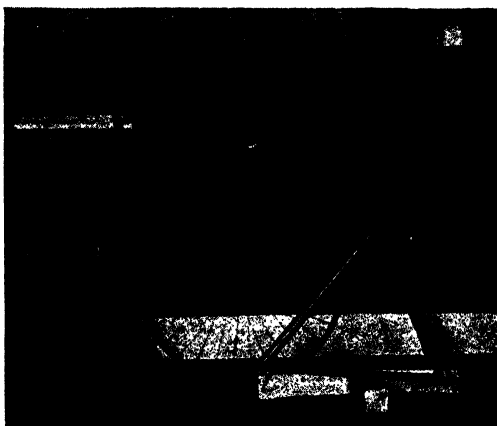

AN OLD BICYCLE ADAPTED FOR EXPERIMENTAL PURPOSES

but by removing the driving chain the rear wheel unit and the driving mechanism become independent as each has its own support.

To determine the mechanical advantage of the crank and gear wheel unit, the driving chain is hung over the sprocket teeth and to one side of it a weight is tied. This is balanced by a force applied to the pedal through a spring balance, Fig. 19. Different loads are tied to the chain and the corresponding efforts measured on the balance. The numerical value of the mechanical advantage is found by dividing the weight on the chain by the force indicated on the balance.

A similar arrangement to that described is adopted for the rear wheel and sprocket unit. A weight is tied to the rim of the road wheel and the spring balance is hooked

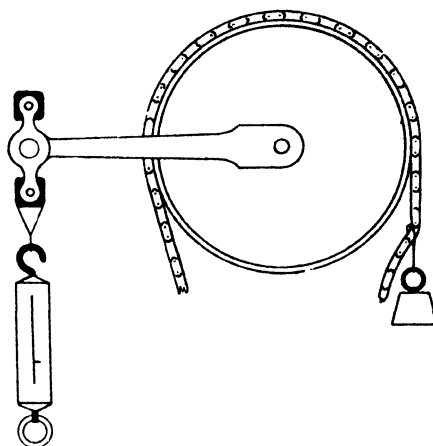

FIG. 19. HOW TO ARRANGE THE CRANK AND GEAR WHEEL UNIT

in the driving chain which hangs over the small sprocket, Fig. 20. The mechanical advantage, which in this case is less than unity, is worked out by dividing the load on the wheel rim by the effort applied to the sprocket chain.

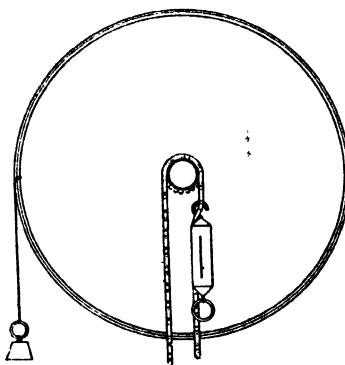

FIG. 20. HOW TO ARRANGE THE REAR WHEEL AND SPROCKET UNIT

The mechanical advantage of the complete bicycle can be determined by direct observation and then compared with the product of the two already found. For this last part of the experiment, the two units are coupled by means of the driving chain, and a weight tied to the wheel rim is supported by a force applied through the spring balance on the

pedal spindle, Fig. 17. Several different weights are used. The load on the wheel rim, divided by the effort applied on the pedal, gives the value of the mechanical advantage for the whole machine. The following results show the experimental possibilities of the work described:

1. *Using crank and gear wheel unit.*

On gear wheel (Load)	On pedal spindle (Effort)	Mechanical advantage
4 lb.	2½ lb.	$\frac{4}{2\frac{1}{2}} = \frac{16}{9} = 1.8$
8 lb.	4½ lb.	$\frac{8}{4\frac{1}{2}} = \frac{16}{9} = 1.8$
10 lb.	5½ lb.	$\frac{10}{5\frac{1}{2}} = \frac{20}{11} = 1.8$

2. *Using rear wheel and sprocket unit.*

On wheel rim (Load)	On sprocket chain (Effort)	Mechanical advantage
½ lb.	4½ lb.	$\frac{1}{4\frac{1}{2}} = \frac{1}{9} = .11$
¾ lb.	6¾ lb.	$\frac{1}{6\frac{3}{4}} = \frac{1}{9} = .11$
1 lb.	9 lb.	$\frac{1}{9} = .11$

3. *Using complete bicycle.*

On wheel rim (Load)	On pedal spindle (Effort)	Mechanical advantage
½ lb.	2½ lb.	$\frac{1}{2\frac{1}{2}} = \frac{1}{5} = .20$
1 lb.	4¾ lb.	$\frac{1}{4\frac{3}{4}} = \frac{4}{19} = .21$
2 lb.	9½ lb.	$\frac{2}{9\frac{1}{2}} = \frac{4}{19} = .21$

4. *Theoretically.*

Mechanical advantage of whole machine = mechanical advantage of first × mechanical advantage of second
 = 1.8 × .11
 = .20

Summary.—The following summarises the factors which contribute to the speed and economy of the modern bicycle.

1. Use of mechanical rotating wheels of light weight.
2. Complete cessation of effort on favourable gradients.
3. Application of main weight directly to the road through the saddle, frame and wheels.
4. Balance of legs due to the design of the pedalling mechanism.
5. Slow speed of legs, and consequent low loss due to internal friction, etc.
6. Use of definite push applied by each foot.
7. Use of a driving mechanism which gives a speed advantage.
8. Use of a variable gear to adjust the mechanical disadvantage at which the cyclist works to suit road conditions.

Why are inflated tyres used on a bicycle?—

Many children are not familiar with all the parts which together form a modern pneumatic tyre, and for that reason it is recommended that this sub-topic be started by examining an inflated tyre. In the course of the demonstration the tyre should be deflated, dismantled, inspected, reassembled and inflated again. Attention may be drawn to important features of the structure by a few well directed questions asked during the demonstration. The manipulation involved in the work has great value if carried out in a workmanlike manner for it encourages respect for what is undoubtedly a remarkably effective appliance. Incidental hints on tyre management and repairs are not out of place here and such lend realism to the school work. Particularly is it worth while showing the correct way of removing and replacing an outer cover. During the first stage of removal and during the last stage of replacement, the wired edge of the cover should be pressed into the central well of the rim at a point diametrically opposite to the part which is to surmount the rim

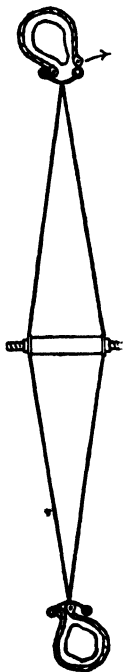

FIG. 21.
POSITION OF
WIRED EDGES
DURING TYRE
REMOVAL AND
REPLACEMENT

edge, Fig. 21. By doing this, the wire at the point under manipulation may be slackened enough to permit its fairly easy passage over the wheel rim.

This demonstration should not take a long time, because many boys think they know all about tyres and they therefore need to indulge in some practical self-expression at an early stage in the work or else need to meet some difficulties. A series of questions requiring short written answers is a useful teaching device in circumstances such as these, for it can help to concentrate much everyday experience on to the work in hand. The following examples are suitable for inclusion here:—

1. Tyres are used on all road vehicles. What is their chief purpose?
2. Besides inflated tyres, what other kinds do you know?
3. What are the advantages of rubber tyres?
4. What great weakness has the inflated tyre?
5. Why are there two steel wires in an outer cover?

The range of application of the inflated tyre is extending, as this type shows marked superiority over its rivals. The work already discussed shows that its virtue lies in the air which it contains. The primary object of the work on this sub-topic therefore resolves itself into an investigation of the function of air in tyres and the working of those important accessories, the valve and pump.

The air in the tyre.—By observing a collision which takes place under suitable conditions, it is possible to conclude what

happens to the air in a tyre when its wheel strikes an obstruction. The experimental requirements of the following demonstration are quite simple, but the results obtainable are convincing.

The tyre on a bicycle wheel is inflated to its normal working pressure and then chalked liberally on the surface. By standing the chalked part on a board, the contact area which the tyre normally makes on a flat surface is marked. The chalky patch obtained in this way is small. The wheel is now dropped in a vertical plane from a height of a foot or eighteen inches on to the board. It is caught in the hand on the rebound. The chalk mark made this time, when compared with the first, shows a great increase in the surface of contact and suggests that the air in the tyre suffered compression during the impact. As the tyre regains its normal appearance almost immediately after the shock, it follows that the air within it is springy and quickly returns to its normal condition after distortion. By repeating the observations with lower inflation pressures, dropping the wheel from the same height each time, the greater yield and decreased bounce of a soft tyre may be demonstrated, Fig. 22.

The experiment shows clearly what happens to a tyre on the road. When the side of a pot-hole or a raised stone is struck, the air

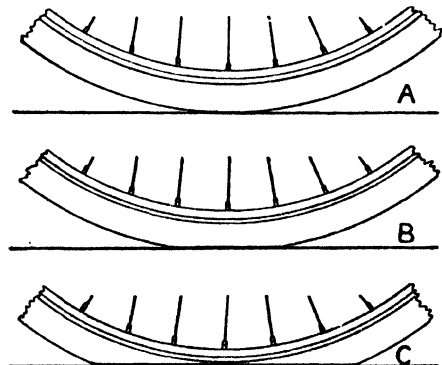

FIG. 22.
A. NORMAL TYRE CONTACT
B. HARD TYRE AT MAXIMUM COMPRESSION
C. SOFT TYRE AT MAXIMUM COMPRESSION

within the tyre is compressed to an extent depending on the inflation pressure. Almost immediately, the air is free to regain its normal volume, but the rebound normally associated with this reaction is damped by the weight of the bicycle and rider. Tyre pressures are chosen to suit the load to be carried and the roughness of the surface which is to be traversed.

Elasticity.—At this stage, the term *elasticity*, applied to air and other substances which yield momentarily and then, under suitable conditions, regain their normal shape, may be introduced. Its significance may be enriched by collecting together illustrative examples of elasticity used in everyday life; e.g., rubber buffers on carpet sweepers, doors, etc., rollers on clothes wringers and typewriters, air in cushions, footballs, etc. The range of application of the term may then be widened by illustrating the elasticity of steel. Using a steel ball bearing, the rebound from both wood and glass surfaces is observed. To avoid fracture, the bearing chosen for the experiment must be small and the glass block thick. The bearing should not be dropped from a great height. On the wooden block the rebound obtainable is small, but on glass it is great, the difference being due to the low elasticity of the wood. On the extremely hard and elastic surface of the glass block, the steel ball suffers compression just like a tennis ball on a stone floor. It therefore rebounds vigorously as it regains its original shape. As steel is a very hard substance its elasticity is shown only when it strikes a surface capable of resisting it. As a tyre, steel only proves satisfactory when used on a hard surface with very slight irregularities. Such a surface is used on the railway, and here the steel tyre holds a virtual monopoly.

In connection with the elasticity of air, the potato pop gun should certainly be mentioned. This interesting toy appears to have lost popularity in recent years and may therefore be entirely new to some children. The gun consists of a barrel and ram rod

which may conveniently be a piece of glass tube and glass rod respectively. The ends of the tube are blocked by pressing them in turn into a slice of potato. On forcing one plug smartly towards the other with the ram rod, the air compressed within the tube obtains the space necessary for expansion by ejecting the plug which is free to move. The passage of the missile is accompanied by the *pop* of expanding air, Fig. 23.

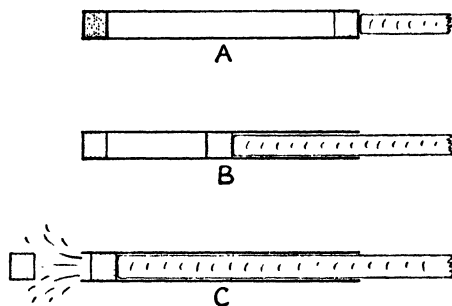

FIG. 23.

- A. LOADED POP GUN
B. AIR GUN UNDER COMPRESSION
C. END OF FIRING STROKE

Compressed air.—Other practical uses of compressed air and its elasticity can be mentioned with advantage. Chapters on pneumatic hammers, drills, locomotives, delivery tubes, etc., are to be found in many of the books on popular science which are now available, and these may be used to extend the class work. To demonstrate the use of compressed air, it is convenient to have a suitable container into which air can be pumped and from which it may be drawn to operate simple models. A bicycle tyre, slightly modified, can serve this purpose.

At a point diametrically opposite to the valve hole in the rim of a bicycle wheel, a second similar hole is drilled. A valve, obtained from a discarded tyre, is fitted in the inner tube at the place which corresponds with the new hole in the wheel rim. The cover and modified tube are then fitted on the rim, the two valves occupying the holes prepared for them. The additional valve is not a replica of the original one, for instead of a plug and screw cap it carries a length of rubber pressure tubing, wired securely

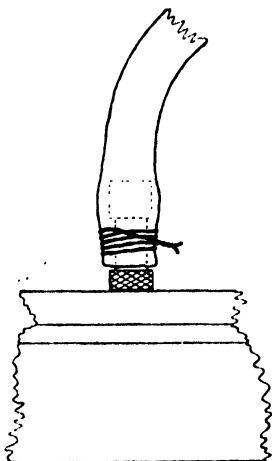

FIG. 24. HOW THE ADDITIONAL TYRE VALVE IS ASSEMBLED

in place on the body of the valve protruding through the rim, Fig. 24. The rubber tubing is fitted with a screw-down clip by means of which the passage of air from the tyre may be controlled. During inflation, the clip is tight and air is supplied in the usual way through the ordinary valve. When the tyre is hard, the rubber tubing is attached firmly to the apparatus which the compressed air is to operate, and the clip is opened. The following examples indicate some of the practical applications of the device:—

1. The quantity of air which has been pumped into the tyre may be measured directly by filling a jar with the surplus as it escapes from the pressure tubing. The air is allowed to displace water in the usual way, Fig. 25. An ordinary tyre holds

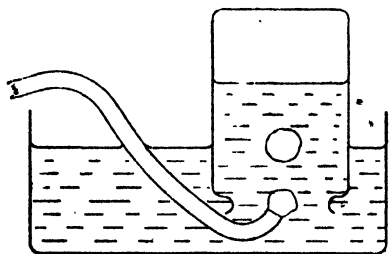

FIG. 25. MEASURING THE AIR IN A PNEUMATIC TYRE

sufficient to fill a large jam jar several times.

2. By means of air from the tyre unit, a reciprocating compressed air engine may be operated. The rubber supply pipe is coupled directly to the steam inlet of an ordinary toy steam engine, or, if more convenient, to a short length of metal tube screwed into the safety valve socket on the boiler. Using a small engine of reasonably good quality a run of many seconds duration follows the opening of the air inlet clip.

3. To illustrate the use of compressed air in cellulose surfacing, a simple spray is connected to the tyre pipe. An ordinary glass tube, drawn out to suitable diameters, is used in the construction of the spray itself, and water in a jar represents the cellulose, Fig. 26.

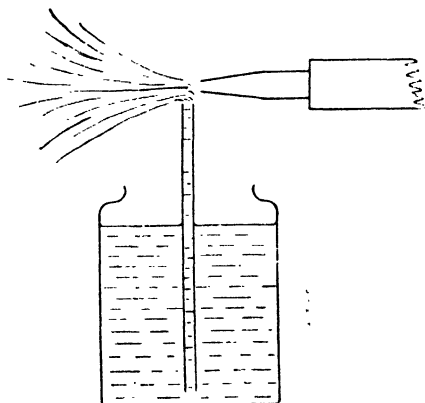

FIG. 26. MODEL OF COMPRESSED AIR SPRAY

4. A long straight glass tube in which an ordinary pencil can slide freely, used in conjunction with the compressed air from the tyre apparatus, can demonstrate the principle of the various pneumatic devices which work on the piston and cylinder system. If the compressed air is applied at full force to one end of the glass tube, the pencil shoots out at the other with remarkable speed. By manipulating the clip on the supply pipe, a steady, controlled movement may be obtained. With the tube set in a vertical position the pencil may be made to represent a lift.

The bicycle pump and tyre valve.—As the working parts of the pump and tyre valves of a bicycle are enclosed in opaque casings, it is impossible to watch the pump washer or valve tubing in action. As these two devices are by no means the simplest forms of valve, the addition of some practical illustration to verbal explanation and diagram work is very desirable. The working models to be described are intended to meet this need.

A piece of glass tube with one closed end and one side opening is prepared in the blowpipe in the usual way, Fig. 8. The side hole and closed end of the tube are covered by a loose-fitting tube of oiled silk or tissue paper which is held in position by thread wrapped round it near the open end of the glass, Fig. 27. The device thus

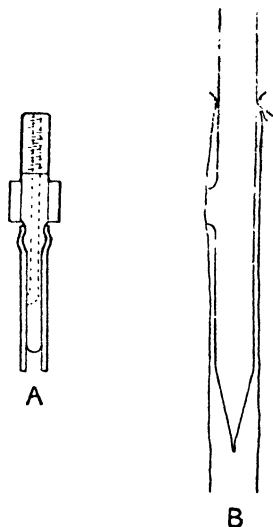

FIG. 27.

- A. BICYCLE TYRE VALVE
B. MODEL OF BICYCLE TYRE VALVE

prepared represents a tyre valve very adequately. Blow with the mouth at the open end of the model and air will pass freely, as the silk or paper tube lifts slightly under the influence of the pressure and therefore leaves the side opening clear. Suck at the tube and the pliable material drops on to the side hole and prevents the passage

of air. As the complete model may be six or eight inches long, and the side hole a quarter of an inch or more in diameter, the movements of the membrane are easily visible.

In the pump model, the barrel is represented by a length of glass tube which has a diameter of about one inch. The glass tube of the model valve is fitted in one end of this barrel by means of a one-holed stopper. The piston of the pump is a built-up unit clamped between a pair of nuts on the end of a piece of straight brass wire which acts as piston rod. The assembly consists of two odd washers and a piece of leather, Fig. 28.

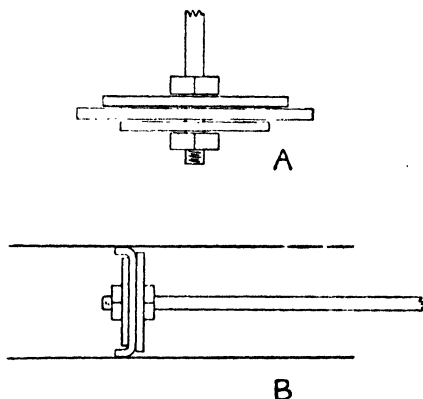

FIG. 28. MODEL TYRE PUMP
A. PISTON ASSEMBLY
B. PISTON IN BARREL

One washer should just have a comfortable clearance between its edge and the glass barrel, whilst the other should be rather smaller. The leather should be circular in shape and of a diameter rather greater than that of the barrel. After wetting, the piston is inserted in the tube. When a downward stroke of the piston is made, the leather washer is seen to press firmly against the tube wall, whilst the flexible material over the side hole in the glass valve rises visibly to allow egress of air. On the upward stroke, the membrane sinks into place over the valve exit and the leather washer collapses as air moves into the barrel round its periphery.

How do bicycle lamps work?—If tradition be allowed to exercise its customary influence, this topic will be treated on lines dictated by the historical development of artificial lighting. Oil lamps will be accepted as the only possible starting point, and the work will cover the well trodden path through gas and battery lamps to dynamo systems. Now it is not suggested that this scheme is bad or wrong, but rather that something more effective from the child's point of view is possible. After all, the sequence just outlined can claim no great virtue—its strength lies solely in the support given by history. Actually, the oil lamp is neither simpler to understand nor more fascinating to use than its successors. As its popularity is rapidly declining, a teacher will do well to consider carefully before starting the present sub-topic with the oil lamp. For the sake of completeness perhaps, discussions on cycle lighting should include references to both oil and gas lamps, but it is wise to subordinate the positions occupied by these in the inquiry. To the modern boy, cycle lamps suggest electricity. The teacher should accept the fact and turn it to good use.

The cycle dynamo lighting set.—From the point of view of science teaching, it would be difficult to imagine a more satisfactory basis than this apparatus for an elementary study of electric generators. Although stripped of every unessential detail, the bicycle dynamo retains its contact with real life, and is in every way a delightful little appliance. The form of treatment given in the practical room to the lighting equipment of a bicycle will depend on the previous electrical knowledge of the boys. If this is the first topic in which electrical problems have arisen, then the work will have to be planned to show fully the purpose served by each accessory, a start being made with the bulb, the switch or the connecting cables. On the other hand, if an earlier topic in the course has been used to develop ideas about conductors and insulators, heating effects, circuits, etc., then the boys will proceed immediately to examine the dynamo itself.

The dynamo.—As different makes of dynamo have characteristics peculiar to themselves, the following remarks may not be applicable universally, although they will serve as a general guide. Cycle dynamos generate alternating current. They have permanent field magnets and a simple slip ring pick-up arrangement. One end of the armature windings is earthed to the dynamo case through a brush which rubs on the shaft. The other end is connected to an insulated metal ring fixed on the shaft. A second brush, mounted in an insulated holder, bears on the ring. The external circuits are wired across the two brushes. To ensure mechanical efficiency, cycle dynamos are equipped with ball bearings.

When dismantling a dynamo of the kind described, the magnet poles *must* be bridged by a suitable piece of iron when the armature is removed from its normal position. Otherwise, loss of magnetisation results. Whilst the dynamo is being exhibited in class, the attention of the boys should be drawn to the following:—

1. The presence of a strong permanent magnet.
2. The shape of the magnet and the grouping of the poles round the armature.
3. The armature, consisting of an iron core on which several coils of thin wire are wound.
4. The small clearance between the poles and the core.
5. The ingenious arrangement of brushes by means of which constant contact with the ends of the revolving coils is possible.
6. The great pull which the magnet exerts on the armature core, and the consequent opposition which is felt when the armature is rotated by hand.

Out of the examination of the dynamo two points arise. First, the chief properties of magnets need to be studied, and second, the effect of a magnet on a moving coil requires illustration.

Magnetic fields.—For the present purpose, attraction and repulsion between poles, magnetic fields round poles and the use of soft iron pole pieces are important. Bar magnets, compass needles, the earth's magnetism and similar matters make little or no

Magnetic records of this kind are prepared quite easily. A sheet of ordinary tracing paper is soaked in hot, melted paraffin wax and then allowed to drain and set. This waxed sheet is supported in a horizontal position immediately over the magnet whose

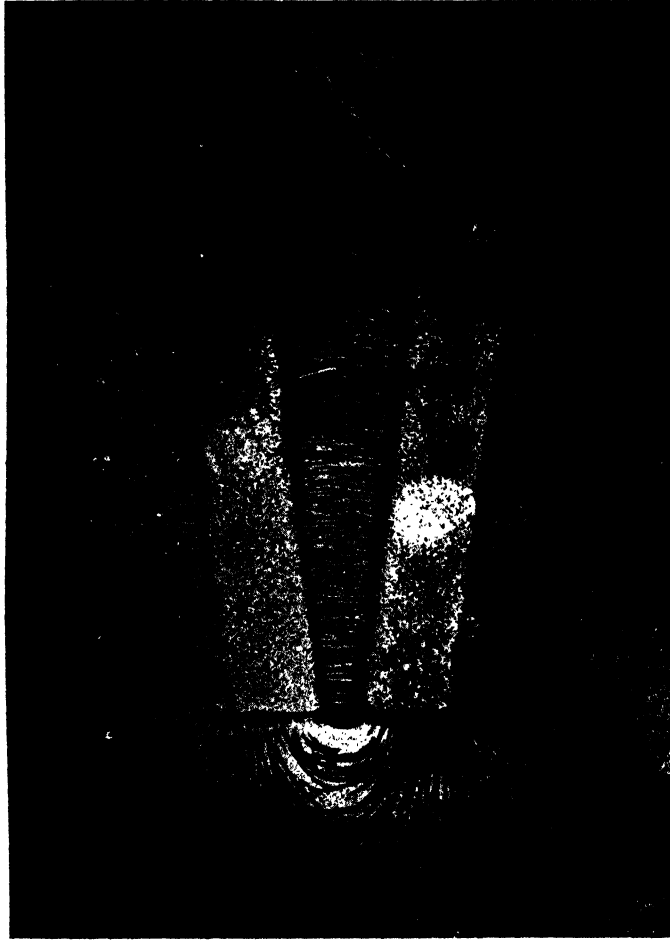

MAGNETIC MAP OF HORSE SHOE MAGNET

contribution to the subject under investigation and may safely be omitted. The important thing to make clear is the intense field which exists between the poles of a U magnet. The best kind of illustration to use in this connection is the iron filing map.

field is to be mapped. Fine iron filings are sprinkled thinly and evenly over the surface of the paper. By dropping the filings from a small tin whose lid is punctured with many fine holes, a good distribution may be obtained. The sprinkler should be

held a foot or more above the sheet so that the filings have opportunity to spread whilst falling. A gentle tap on the tracing paper helps the iron to set along the lines of force, but this tapping should not be overdone or clumps of filings will form near

Faraday's experiment.—An electric current is generated in a coil which moves near a magnet, or in a stationary coil near which a magnet moves. In a simple form, this statement summarises the results of part of Faraday's classical research of 1831. By

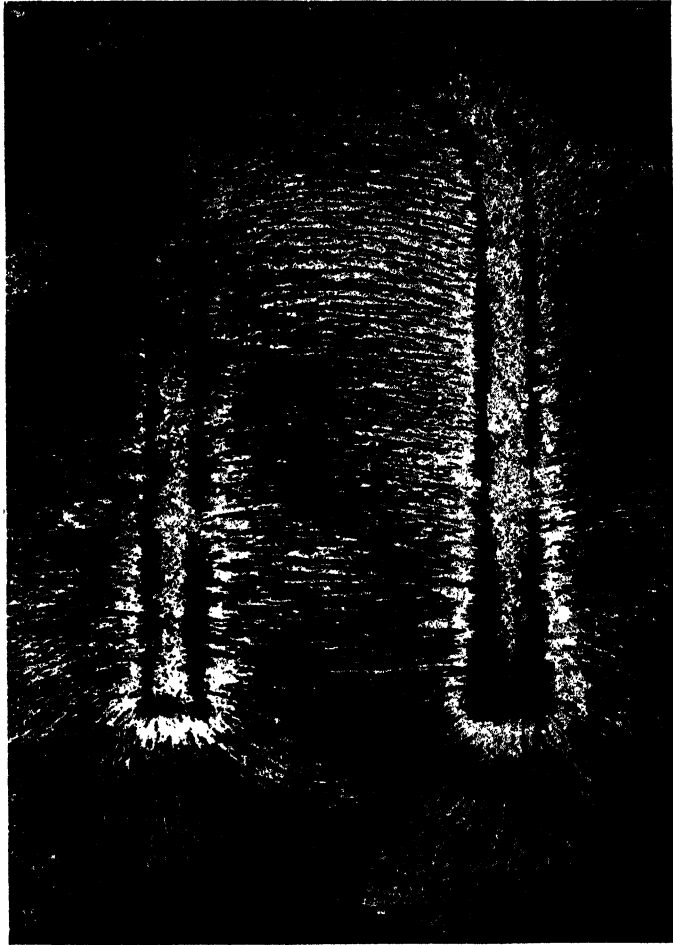

MAGNETIC MAP OF U MAGNET

the poles. When a clear map has been obtained, the filings are fixed in position by moving a bunsen flame quickly over the waxed surface. When the source of heat has been removed, the wax sets and grips the filings in their correct positions.

demonstrating an experiment adapted from the original investigation carried out by Faraday himself, it is possible to show the essential features of a cycle dynamo in an elementary fashion. The apparatus fitted up for the demonstration should be developed

from the dynamo itself. In the dynamo there is a magnet which constitutes an indispensable unit of the machine. In the experimental apparatus there must also be a magnet. The dynamo contains several coils of wire which,

filament lamp which shows the passage of electricity. Being much less powerful, the experimental circuit needs a more sensitive indicator which will be influenced definitely by the small current generated. By working

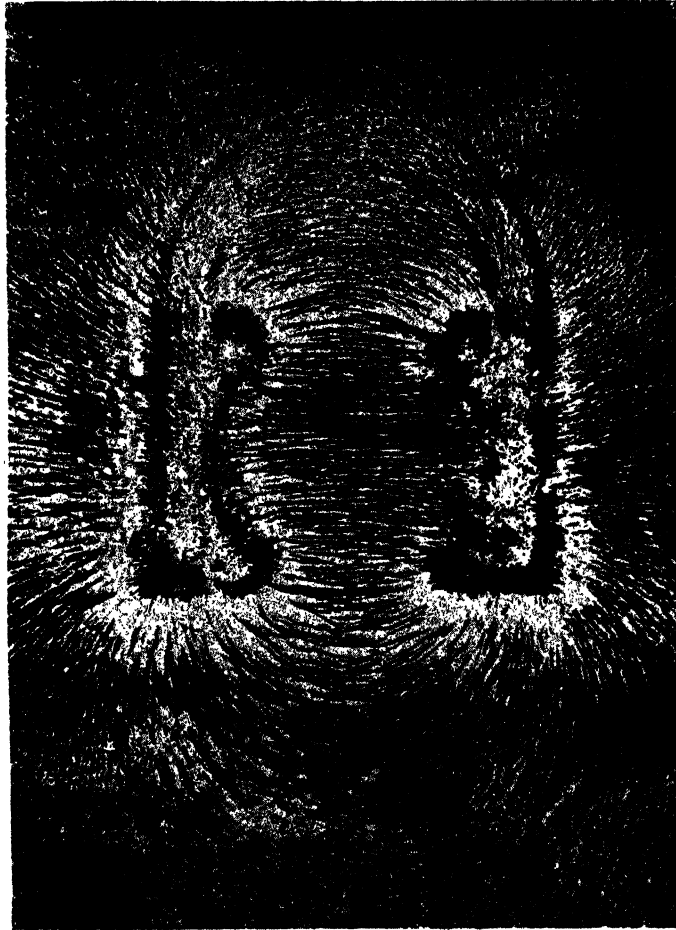

MAGNETIC MAP OF U MAGNET WITH SOFT IRON POLE PIECES

in the experiment, are represented by a single coil. Although the dynamo has a shaft, bearings and brush gear, these are in a sense refinements and so have no counterparts in the experimental apparatus. In the external circuit on the bicycle is a

out an analogy in steps such as these, the practical significance of Faraday's famous experiment may be presented effectively. The actual demonstration is very simple. An ordinary bar magnet is plunged into a coil and thereby gives rise to a deflection

on a galvanoscope which is connected across the coil. Pulling the magnet out of the coil causes a deflection in the opposite direction.

The coil required for the experiment is a very simple affair. About two hundred turns of wire of approximately 24 or 26 S.W.G. are wound on a cardboard or ebonite former which has an internal diameter to suit the bar magnet. The coil should be about two inches long and should have wooden end pieces which prevent the turns of wire from slipping and also hold the terminal strip at which the winding starts and finishes, Fig. 29.

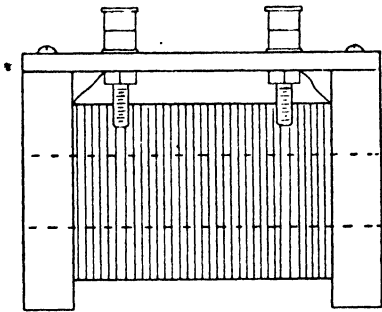

FIG. 29. ARRANGEMENT OF COIL FOR FARADAY'S EXPERIMENT

The galvanoscope consists of a fixed coil and a freely suspended magnet. By magnetising a gramophone needle in a solenoid, an excellent magnet for the instrument is produced. It is mounted in a small paper stirrup and suspended by an unspun silk thread from a brass screw fixed in the wooden case of the galvanoscope. The fixed coil, through which the current passes, is wound on a cardboard former. The central hole of this former should have an internal diameter slightly greater than the length of the magnetised needle so that the suspended system may swing without touching the coil unit. The end cheeks of the former should be about one and three quarter inches in diameter and not more than three quarters of an inch apart. The cardboard components are best fixed together by means of Chatterton's compound, a well-known insulating fixative obtainable through all scientific instrument dealers. The completed bobbin is filled with copper wire of about 26 S.W.G., and the ends of the winding are brought out to terminals on the instrument case. In assembling the complete apparatus, care must be taken to see that the silk fibre hangs clear of the coil bobbin and that the needle is free to turn within the



SIMPLE MIRROR GALVANOSCOPE, WITH SCALE AND LAMP BOX

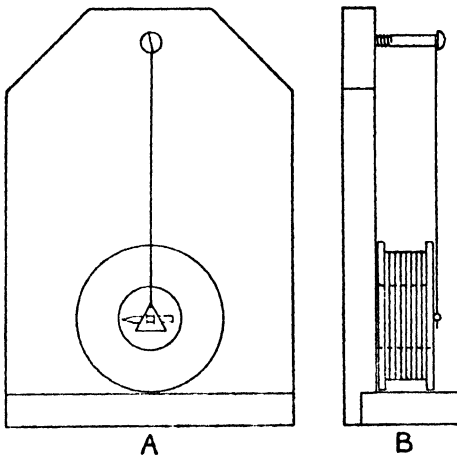

FIG. 30. CONSTRUCTIONAL DETAILS OF THE GALVANOSCOPE
A. FRONT VIEW
B. SIDE VIEW

coil end, Fig. 30. For purposes of demonstration, the galvanoscope may be used as a mirror instrument. A tiny slip of silvered glass from a broken powder compact mirror is fixed with Chatterton's compound to the suspended system. Mirror obtained from the source suggested is very thin and so its addition to the magnet unit increases the weight of the movement very little. A parallel ray of light from a simple lamp box is reflected by the suspended mirror on to an indicating scale made of tracing paper. The photograph, page 235, shows the components of this mirror instrument and the diagram (Fig. 31) illustrates the optical arrangement to be adopted.

Although Faraday's experiment suggests the alternating character of the current generated by a simple cycle dynamo, there is no reason for discussing this point fully with a class at this stage. A much more appropriate place for dealing with A.C. and D.C. is in connection with the mains supply of electric power. Such instruments as transformers make the difference between the two types of current have practical significance, whilst so far as

electric lighting is concerned they are equivalent.

Constructional work.—The magneto principle is adopted in the design of the most satisfactory school-made dynamos. Although machines of this kind are limited in output and electrically inefficient, they are simple to build and modest in their demands on raw material. Many commercial firms supply the necessary parts for constructing self-exciting machines, but these, excellent though they may be, do not offer the educational possibilities of less ambitious projects. No objection can be raised to the limited range of the constructional work imposed by the adoption of the magneto principle, as all cycle dynamos exemplify this. In the following paragraphs two kinds of dynamo for school constructional projects are described. Although they differ considerably from each other in design, they both belong to the magneto class as the field in each case is provided by a permanent magnet.

Simple dynamo.—In this machine, a permanent U field magnet and a straight armature are used. The raw materials required for its construction are quite cheap and easily obtainable. When made properly, the dynamo is able to light an ordinary

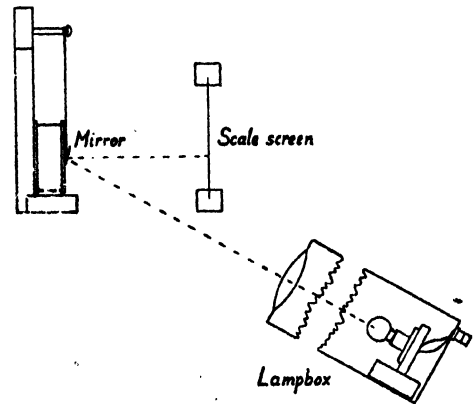

FIG. 31. OPTICAL ARRANGEMENT OF MIRROR GALVANOSCOPE

flashlamp bulb. The work splits up quite naturally into three sections:—

1. Mounting the field magnet and shaft bearings.
2. Making the armature.
3. Assembling.

A wooden block of sufficient size to support a U magnet from an old magneto is fixed rigidly to a suitable baseboard. On it the magnet is clamped by means of a cross piece and two wood screws. The magnet poles should project slightly beyond the edge of the supporting block, Fig. 33. On the end of the wooden block nearest to the magnet poles a metal bearing for the armature shaft is fitted. This strip is held in position by two wood screws, which are fixed so that the bearing hole is on a level with the pole centres, Fig. 32.

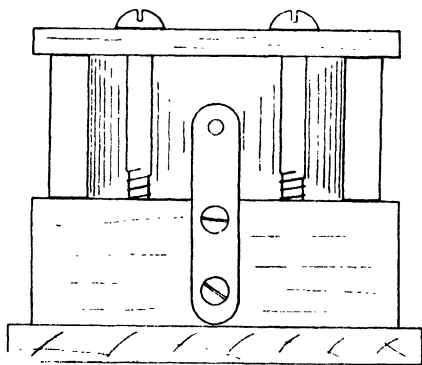

FIG. 32. BEARING STRIP ON MAGNET SUPPORTING BLOCK

A stout strip of iron, bent at right angles, forms the second bearing. This is screwed to the baseboard and is drilled for the armature shaft at a point on a level with the shaft hole in the other bearing strip.

For the armature core, a rectangular piece of iron of a size which will bridge the U magnet poles is prepared. If a supply of magnet iron is available, then this material should be used. Otherwise, a piece of scrap iron should be softened for the purpose. To do this, the iron is heated to redness amongst

the hot cinders of a domestic fire and then allowed to cool very slowly as the ashes burn themselves out during the night. After trimming the block to the required rectangular shape, clearance for the shaft is drilled at the middle point. In order to get the hole axis at right angles to the surface, the work should be done on a bench drill. At this stage, the parts which are to rotate may be assembled in their bearings in order to make sure that the drilling has been carried out properly. If everything is correct, the iron block is cleaned and then filed smooth, particularly at the ends where it is to approach the magnet poles. On each side of the shaft hole in this iron core, a strip of empire cloth or similar insulating material is wrapped. Two equal windings of 30 or 32 S.W.G. copper wire are then put on. Wire with enamel and a single cotton covering is best for the purpose, but D.C.C. will serve. As much wire as possible should be put on, care being taken during the winding to ensure that mechanical balance is preserved. The shaft fixing hole must not be masked, and the wire must be kept where it cannot foul the magnet poles when the finished machine is operated.

The iron core, with its windings, can be fixed in position on the shaft by means of solder, but boys find this a difficult job. A more convenient scheme is to fit a grub screw in the armature core at right angles to the shaft. A small flat filed on the shaft at the correct point helps the screw to gain a firm hold. The slip ring is the next part to be prepared. A very good specimen may be made by plugging a short length of brass tube with ebonite rod and then drilling to get a firm driving fit on the shaft. A simpler one is a cotton reel whose curved surface is covered with copper foil. If the hole in the reel is too big for the shaft, tin end plates may be pinned in position and drilled centrally. The copper foil is held in place by pins also. These pins should be cut short so that there is no risk of them making contact right through to the shaft

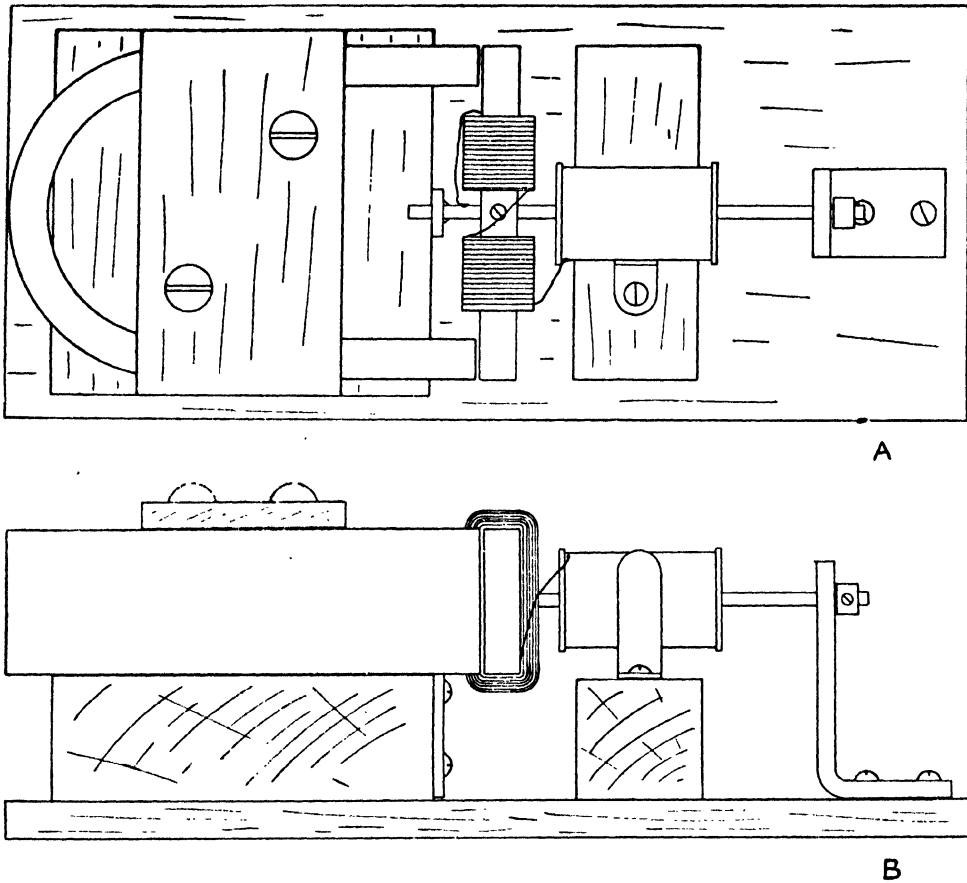

FIG. 33. SIMPLE SCHOOL-MADE MAGNETO DYNAMO

A. PLAN

B. SIDE VIEW

and thereby short-circuiting the slip ring. When the slip ring has been mounted firmly, one end of the winding is soldered to it. The other end is connected to the shaft. (The two sections of the winding are continuous, so there are only two free ends.) The completed armature is then put in its bearings and set so that the iron armature *just* clears the magnet poles as it rotates. A collar, fitted on the shaft at its free end, prevents the pull of the magnet from disturbing the setting of the armature. A brush of strip brass bears firmly on the slip ring. A flashlamp bulb is wired across this

brush and one bearing strip. A high speed of rotation is needed if the lamp is to light and this may be attained by driving a pulley on the dynamo shaft by a cord and hand driving wheel.

Magneto dynamo.—A much more impressive dynamo than the one just described can be made from an old magneto taken from a discarded car or motor cycle. So long as the magneto to be used is complete and not demagnetised, its condition matters very little. Burned-out windings, for instance, are no detriment. Complete dismantling and a good clean are the first stages in the



SIMPLE SCHOOL-MADE DYNAMO (*On left*)
COMPONENTS OF MAGNETO REBUILT AS DYNAMO (*On right*)

work. The distributor, if one is fitted, and the contact breaker are discarded, but the carbon brushes are carefully preserved. The wire on the armature is cut away with old scissors, after the brass end plates of the core have been removed. All the time that the armature is out of its tunnel a piece of iron should be in position across the magnet poles.

When the initial stages of the project are completed, the apparatus will be seen to consist of a U magnet fitted with pole pieces and mounted in a framework, and an H section armature core with slip ring and bearings. These parts are transformed into a dynamo by rewinding the armature and reassembling the rotating mechanism in the tunnel. The core is filled with 24 or 26 S.W.G. D.C.C. wire, wrapped on in even layers. During the winding process, varnish made by dissolving shellac in methylated spirits is applied to the layers of wire to make them damp-proof. A few inches of wire are left free at each end of the coil. The end pieces and slip ring are now bolted

into their original positions on the ends of the iron core, but the condenser which featured in the magneto is omitted. One of the free ends of the winding is soldered to the slip ring. In the magneto, a similar connection was made, and the same soldering point should be used in the modified instrument. There must be no solder in the track of the carbon brush on the ring. The second connection from the armature winding is made by soldering the remaining wire to the brass end piece of the core. The complete armature is then slipped into its original position in the magnet tunnel and the bearing plates are replaced. The *two* carbon brushes are inserted in their holders and bolted down so that they bear on the slip ring and brass end piece respectively. On to the shaft end is screwed a simple driving handle made from thick wire or built up from bolts and strip iron. Across the brushes is wired a flashlamp bulb. As the handle is turned, the lamp lights quite brilliantly, although it shows a definite flicker owing to the low speed of rotation. Details of the

construction are shown in the diagram (Fig. 34), and the components of a magneto which has been modified in the manner described are illustrated in the photograph, page 239.

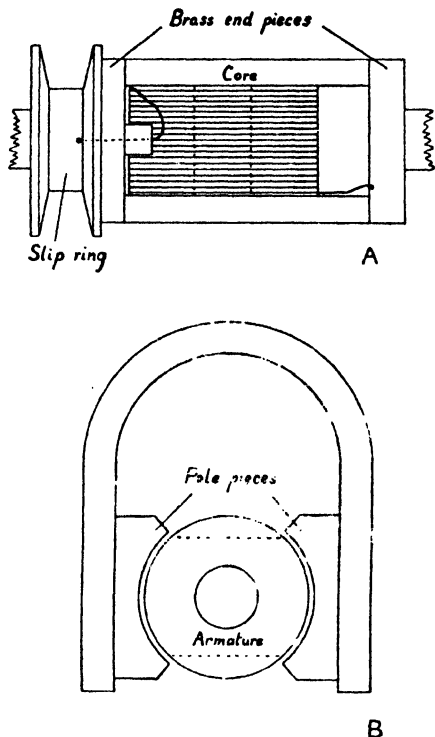

FIG. 34. THE MAGNETO DYNAMO
 A. DETAILS OF ARMATURE ASSEMBLY AND WIRING
 B. END VIEW, SHOWING MAGNET, POLE PIECES AND ARMATURE

Battery cycle lamps.—The subject matter in this section may be classified in three groups according to the portion of the device with which it is concerned. Investigations are to be made on batteries, bulbs, and controls. Presented in the way which is most likely to appeal to boys, these three groups of investigations arise out of the following practical problems:—

1. Why are cycle batteries discarded instead of being recharged? How can they be recharged?

2. In what ways do the various bulbs used in bicycle lamps differ from each other?
3. How does a dimming switch work?

Batteries.—In dealing with the first problem of the three, the best starting point is obviously a battery whose days of usefulness are over. Most boys know something about the internal structure of dry batteries, but few have ever compared an old dismantled specimen with a new one, as boyish human nature revolts at the idea of cutting open a cell which still gives a light. Nevertheless, actuated by a spirit of scientific research, the sacrifice should be made in order to find out why a battery fails. Several old cells, and one reasonably new one, should be cut and examined. Use causes the zinc case to disappear almost completely, whilst the white paste within it dries and forms hard lumps. The central sac units do not appear to deteriorate.

An attempt should next be made to revive a cell. To do this, the parts which are obviously useless are discarded and replaced by suitable substitutes. The use of ammonium chloride solution instead of paste, and a little zinc plate instead of the worn-out case is very satisfactory. Wet cells, assembled in small jars and incorporating these replacements, and some sac units from old batteries, are capable of lighting a flashlight bulb. Two or three should be joined in series, Fig. 35.

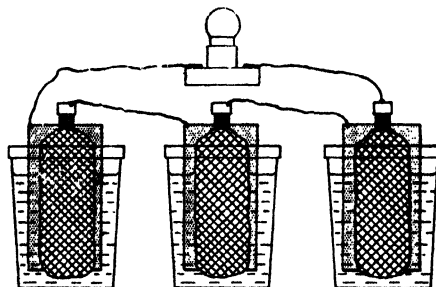

FIG. 35. REVIVED CELLS IN SERIES WITH A FLASHLAMP BULB

All old sacs do not give satisfactory results in the revived cells. The effect of use on the sacs does not show itself to the eye, but

these units suffer none the less in service. It may therefore be necessary to try several apparently good sacs before finding one which is effective. As the carbon rod in a cell is the only component fit for continued service, the reconstruction of dry batteries on a commercial scale is not practicable.

For containing the cells of the reconstructed batteries, jam sample jars are invaluable. Zinc for the negative elements may be purchased in sheets of thickness about 16 S.W.G., which may be cut to the required sizes by means of a hacksaw.

Volta's pioneer work and inventions should be discussed and illustrated whilst on the subject of batteries, in order to show primary cells in their simplest forms. The applications of dry batteries in everyday life should be listed. Leclanché and bichromate cells may be mentioned, but very little of the theory of these should be attempted in the senior school. The most that can be done in this direction is to work out the comparable components in the various types, and to indicate the function of the depolariser as an oxidising agent which keeps the positive element free from hydrogen bubbles. The comparison can be set out very conveniently in tabulated form, as shown below:—

Accumulators.—Before leaving the subject of batteries, something should be said about accumulators. Chemically, these are very complicated, but for the purpose now in mind it is only necessary to show the following points:—

1. The accumulator, like the primary cell, contains two plates and an electrolyte.

2. When discharged, the chemicals can be brought back to their original working condition by passing a current through the apparatus. No replacement of material is therefore necessary.

3. The constituents of an ordinary accumulator are:—

- (a) Plates of a composition which includes lead.
- (b) Electrolyte consisting of sulphuric acid solution.

A piece of apparatus which demonstrates the essential action of the accumulator can easily be constructed. Three strips of lead are fitted into two small jars, one strip forming a bridge across the jars, Fig. 36. The cells are wired in accordance with the diagram (Fig. 36B), and are then filled with ordinary accumulator acid. The two position switch is first put over on the charging contact so that a current from the external six volt accumulator passes through the two cells and charges them. When the switch is moved over to the alternative position, the bulb glows as the little accumulators discharge through it.

Cycle lamp bulbs.—In recent years, many different kinds of bulbs have been introduced to suit the various cycle lamps now on the market. The electrical characteristics of these cover quite a large range, and it is necessary to know something of the common

<i>Cell</i>	<i>Positive plate</i>	<i>Negative plate</i>	<i>Electrolyte</i>	<i>Depolariser</i>
Dry	Carbon	Zinc	Ammonium chloride paste	Black powder (Manganese dioxide)
Leclanché	Carbon	Zinc	Ammonium chloride solution	Black powder (Manganese dioxide)
Bichromate	Carbon	Zinc	Sulphuric acid solution	Potassium bichromate solution

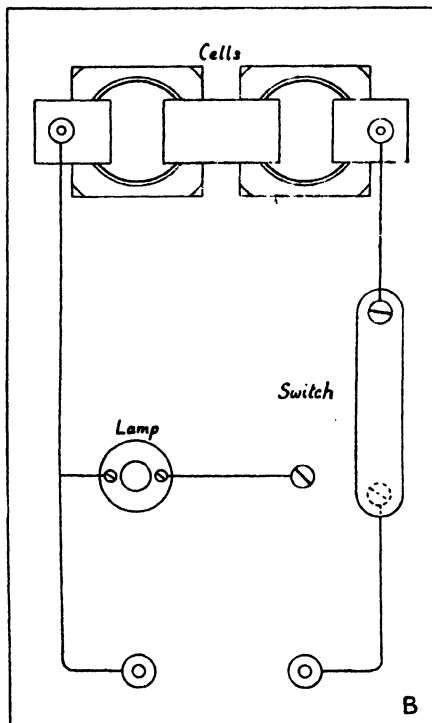
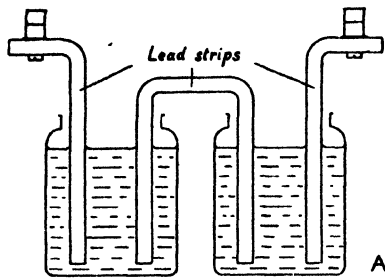

FIG. 36. ACCUMULATOR APPARATUS
 A. ARRANGEMENT OF LEAD STRIPS
 B. CIRCUIT

and a table of the following kind may be prepared as a starting point for the investigation:—

Kind of lamp	Volts	Amperes	Watts
Ordinary flash-lamp bulb	3.5	.3	
Two cell cycle lamp bulb	2.5	.3	
Motor car tail lamp bulb	6		6

If a sufficient number of lamps has been used in preparing the table, it will be possible to deduce certain points from the figures listed; e.g., voltage seems to have something to do with the number of cells in the battery; watts show a close correspondence with the brightness of the lamp. At this stage there is no need to worry about gaps in the table, as many of these can be filled in later when the technical terms are more completely understood.

It is now opportune to consider each electrical unit separately in detail. A start is made with the *volt*. Although open to criticism on technical grounds, the analogy of pressure and voltage is not without value, and its use in the senior school is quite

electrical units if these characteristics are to be understood. Material for study should therefore be collected by examining the markings on as many examples of low voltage bulbs as can be obtained. The names *volts*, *amperes* and *watts* may be introduced and used at this stage without explanation



MODEL ACCUMULATOR APPARATUS

justifiable. Volts and voltages are made into thoroughly familiar terms by collecting together as many examples as possible of common everyday voltages. By direct measurement, using suitable voltmeters, the voltages of all the batteries and transformers in the practical room are determined. Further inquiries may be stimulated by questions such as the following:—

1. What is the voltage of the mains supply? (It is marked on the electricity meter at home and at school.)
2. What voltage is supplied by a bicycle dynamo?
3. What is the voltage of a car battery?
4. What is the voltage of the overhead grid cables? (This is marked on poles near Street.)

Voltages can be a good subject for individual study under the guidance of an instruction card.

The significance of *amperes* in everyday life should next be developed. By means of ammeters the current flowing through common appliances is measured and tabulated to show that voltage and current are quite different from each other. The effect of increasing the voltage applied to a given circuit is demonstrated in order to show that there is a very real link between voltage and current. A four volt flashlamp bulb is wired in circuit with an ammeter of range 0 to 1 ampere, and the effect of one accumulator cell is compared with the effect of two, Fig. 37. It is particularly important to show that neither the voltage nor the current *alone* indicates the power which is being expended. The two following experiments are useful illustrations in this connection:—

1. The current taken by an ordinary 60 watt lamp operating on the mains is compared with that which passes through a 2.5 volt cycle lamp bulb connected to a single cell accumulator. The two observations may be made with the same ammeter, provided that one suitable for both A.C. and D.C. is available. There is risk of shock

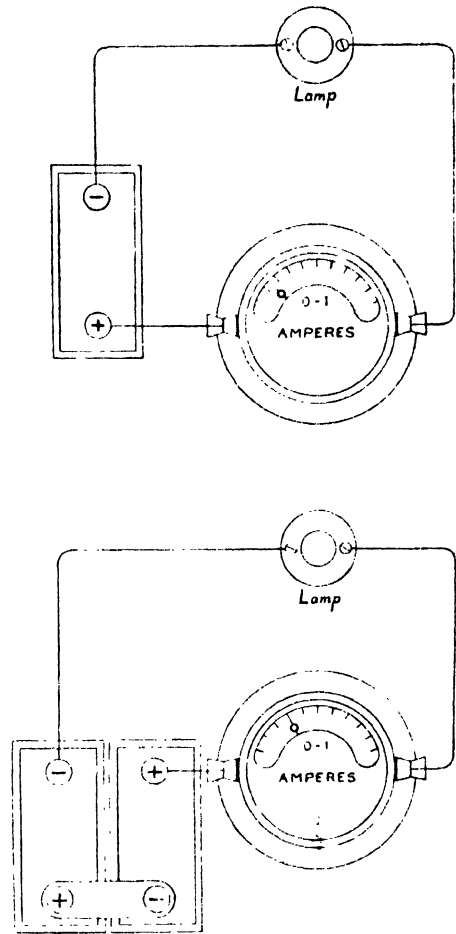

FIG. 37. EFFECT OF INCREASING THE VOLTAGE APPLIED TO A CIRCUIT

when circuits from the mains are wired with unshielded connections, and danger should be eliminated by keeping the pupils away from the demonstration bench when such are in action. With the two lamps suggested the current registered on the meter is approximately the same, although the first lamp is obviously of greater power than the second, Fig. 38.

2. That equal voltages do not imply equal powers may be shown by observations on

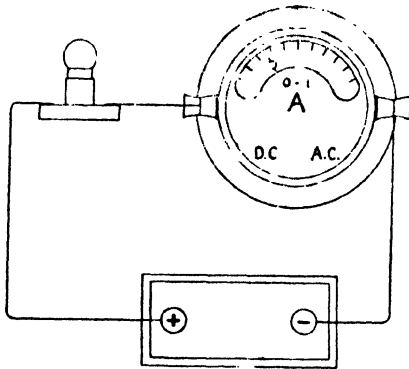
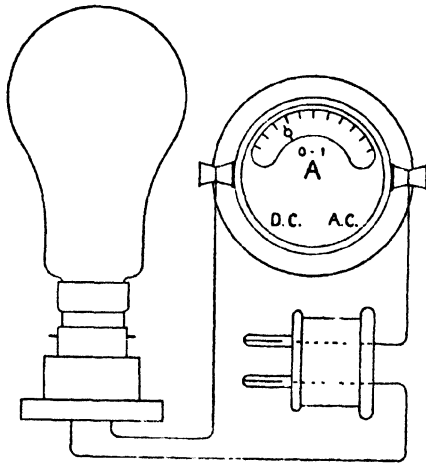

FIG. 38. COMPARING THE CURRENTS TAKEN BY A HIGH VOLTAGE AND A LOW VOLTAGE BULB

headlamp and sidelamp motor car bulbs. The voltages are measured directly across the bulb contacts and are found to be identical (Fig. 39), although the intensity of the light proves them to be of different powers.

After seeing experiments such as those described, intelligent boys realise that both voltage and current play their parts in determining power. The meaning of *watts* may now be explained. The wattage of an appliance is found by multiplying the voltage

applied to it by the current passing through it. Gaps left in the table on page 242, can now be filled in and the wattage marked on commercial lamps and other appliances can be checked. Although this work on electrical units can be extended to include kilowatt hours, such a development does not fit in very well with the sub-topic under consideration, and it is better to deal with it when making a more direct study of the mains supply of electricity.

The excursion into the realm of electrical measurements is completed by reviewing the set of cycle lamp bulbs which formed the starting point. In the light of experience, gained from the practical work and discussions, the markings on the bulbs become useful guides to the cyclist. The voltage marking enables him to choose a bulb which

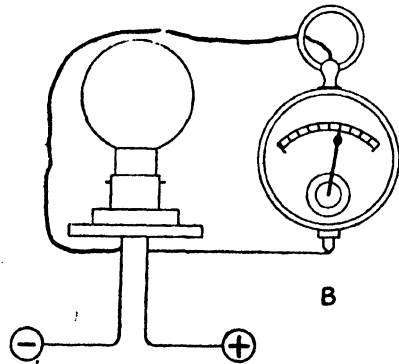
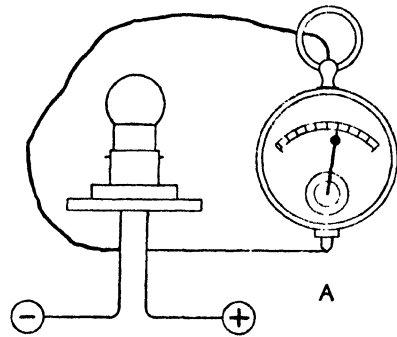

FIG. 39. VOLTAGE MEASUREMENTS ON BULBS
A. SIDELAMP B. HEADLAMP

will be effective with the particular battery or dynamo which he has available. The wattage, or the consumption in amperes combined with the voltage, is a guide to the power of light which may be expected and the demand which will be made on the supply.

Dimming switches.—On a bicycle, a dimming effect is usually obtained by putting a small auxiliary resistance into circuit by means of a two position switch, Fig. 40. In more elaborate lamps, bulbs

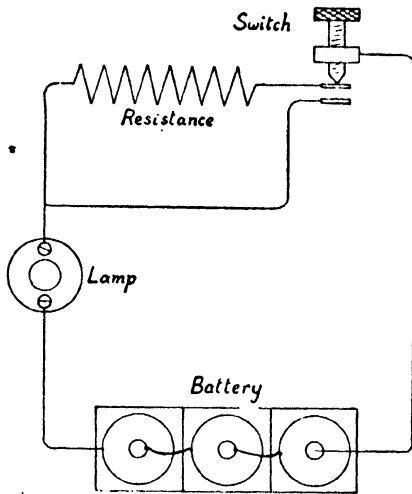

FIG. 40. CYCLE LAMP CIRCUIT, WITH DIMMING SWITCH

of different powers are sometimes fitted, and a change-over is made by a simple switch. On motor cars a dimming arrangement which has enjoyed some popularity consists of a switch which connects two bulbs either in series or in parallel across the battery. All these forms of light control can be investigated experimentally in the practical room.

The essential features of rheostat control, of which the simple cycle lamp dimmer is but a particular example, may be reproduced by means of a flashlamp bulb and holder, a battery, a few connecting wires and two or three yards of resistance wire

of a gauge not thicker than 30 S.W.G. Gradual dimming is effected by a contact peg which slides along the resistance wire, but sudden change is obtained by short circuiting the resistance, Fig. 41 A and B.

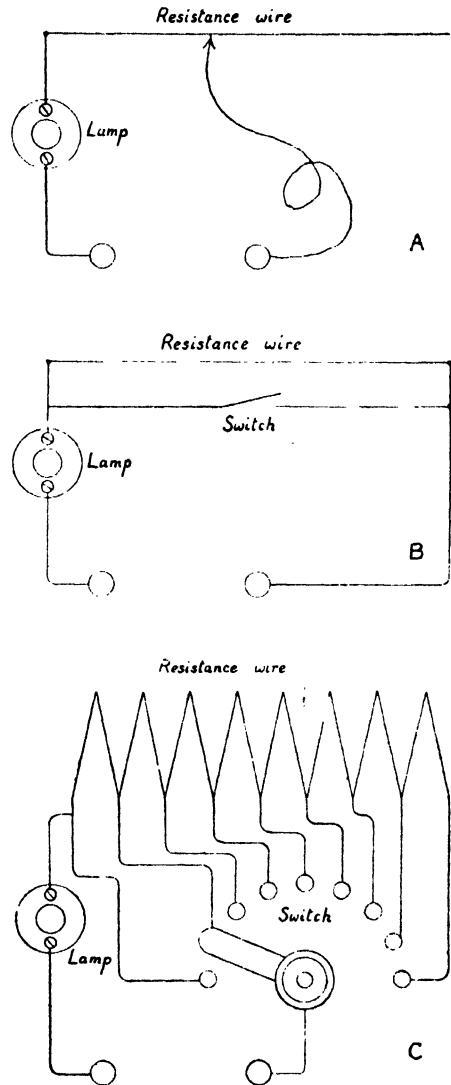
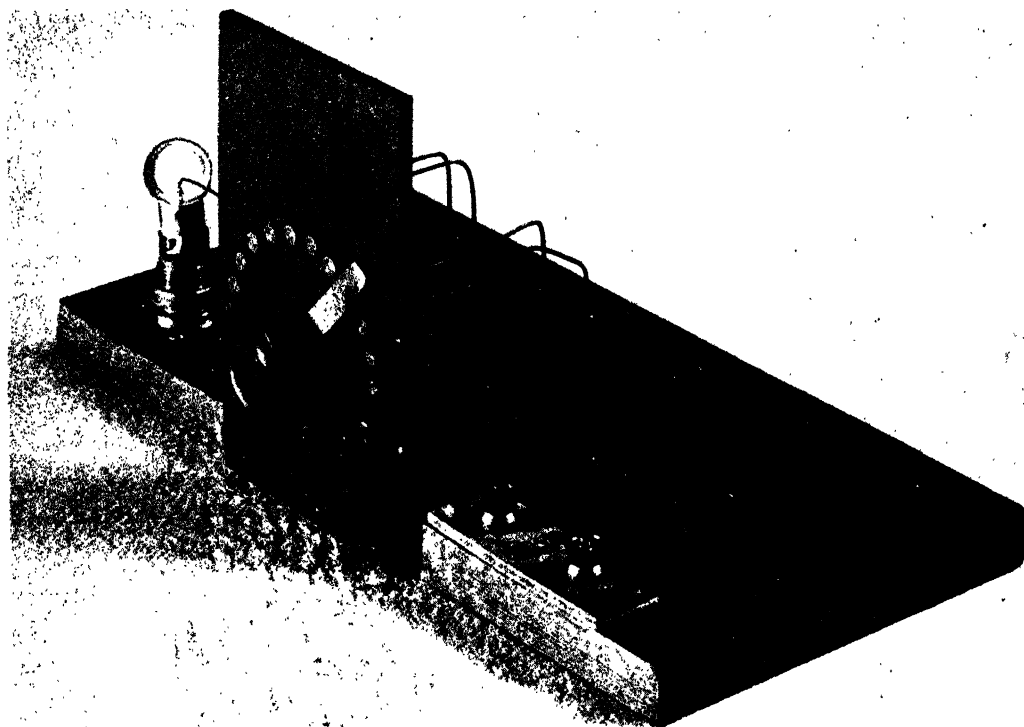

FIG. 41. A. CIRCUIT FOR SLIDING CONTROL DIMMER
 B. CIRCUIT FOR SWITCH DIMMER
 C. CIRCUIT INCORPORATING RHEOSTAT CONTROL



STUD SWITCH RHEOSTAT

A permanent resistance control, which combines the two simple principles, is illustrated above. In this apparatus, a length of resistance wire is switched in or out of the circuit by means of a multi-position stud switch which varies the brilliance of the lamp gradually, Fig. 41C.

Cycle lamps which use a system of alternative circuits for obtaining bright and dim lights can be illustrated by simple models. A switch, consisting of three screws and a strip of brass taken from an old battery, is able to control two circuits, Fig. 42A. A two way tumbler switch can be used instead of the screw and strip type if desired, Fig. 42B.

Other interesting lamp circuits are shown in the diagram, Fig. 43. These use two similar bulbs and give a dimming effect by

putting them in series instead of in parallel. In the first arrangement (Fig. 43A), one two way and one single way tumbler switch are used. The four settings of the switches give both lamps on full, both lamps on dimly, first lamp on and second off, first lamp off and second on. The second arrangement (Fig. 43B), uses a double ended stud switch with four positions, and gives both lamps on full, both dim, one on and one off, both off.

Oil and gas cycle lamps.—The teaching material connected with the treatment of these appliances in school is well-known and conventional, and much of it arises in other connections. For example, surface tension and capillarity play an important part in biological spheres and where possible it is wise to deal with these from this point of view. Unless the course provides for them

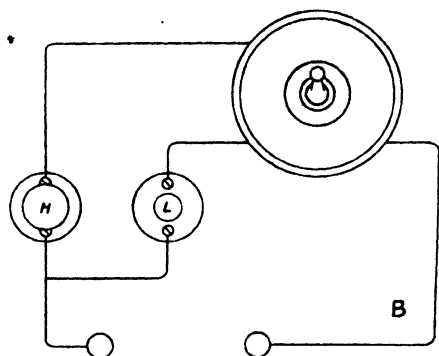
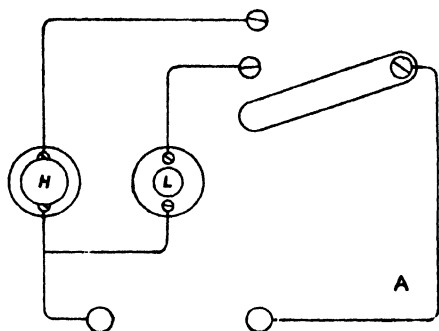

FIG. 42. A. HIGH AND LOW POWER LAMP CIRCUITS WITH SIMPLE CHANGE-OVER SWITCH
 B. ALTERNATIVE ARRANGEMENT WITH TWO WAY TUMBLER SWITCH

elsewhere, the teacher should consider the inclusion of some or all of the following items at the present stage:--

1. The design of oil and gas cycle lamps. Ventilation arrangements. Combustion of oil and acetylene. Products of combustion.
2. Luminosity. Burning in the form of flame. Incandescence.

3. Cycle lamp fuels. Preparation and properties of acetylene. Oil fuels. Volatility. Use of wick. Capillarity and surface tension.

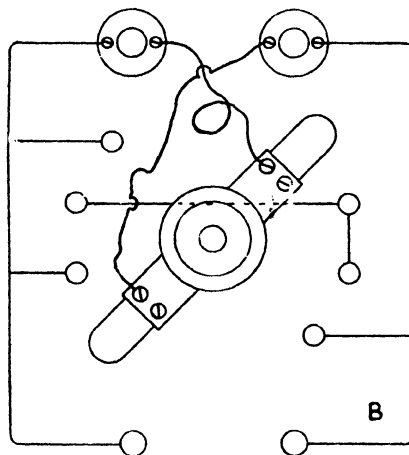
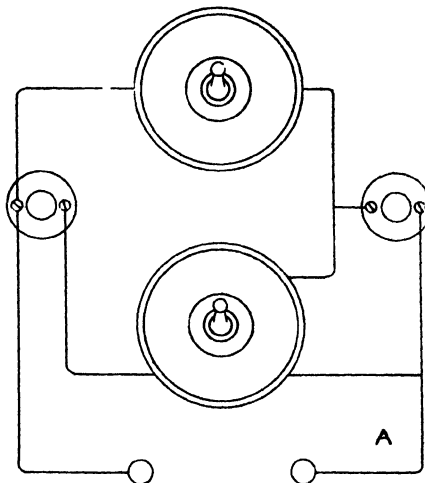

FIG. 43. A. SERIES PARALLEL CIRCUIT, USING TUMBLER SWITCHES
 B. SERIES PARALLEL CIRCUIT, USING DOUBLE ENDED ROTARY STUD SWITCH

TOPIC III—THE EYE

Introduction.—By selecting *The Eye* as a topic for discussion here, an opportunity to deal with optical work is presented, and as this subject does not figure at all in the two previous chapters, its inclusion widens the scope of the series of examples. The choice has also been influenced by the present-day tendency towards biological teaching. The eye, though fundamentally a biological topic, requires a treatment which is mainly physical, and so it forms a bridge between the two branches of science.

The nature of the eye determines very definitely the subject matter which the topic may reasonably embrace, but the details of presentation are left entirely to the teacher's judgment. Now the traditional method of presenting elementary optics will not do in the senior school. The pins and parallax methods, optical bench measurements, coefficient determinations and the like, to which optics has been wedded for so many years, are merely practical dodges for introducing mathematics. To the adolescent they give a totally wrong impression of the significance of things. Instead of a lens being an instrument which opens up new worlds of interest and delight to the human eye, it too often appears to boys who have been nurtured on traditional optics to be a wretched juggling trick with v , u and f . It is not suggested that there is anything wrong with mathematical physics. On the contrary, for this branch of knowledge every science teacher should have the greatest respect, but his regard for it must not cloud his judgment. After all, the pupils in the senior schools are very young, very inexperienced and, in many cases, of very limited mental power. Such children cannot hope to thrive on the cold beauty and stern precision of applied mathematics, even if their doses of this strong food are diluted or given with pedagogical jam!

A teacher will do well to forget completely the traditional teaching when he is organising his optical work, and to start with a free mind from first principles. In the present case, where the topic is *The Eye*, suitable sub-divisions have to be made. Approaching this task from a common sense point of view, four fairly obvious groupings for the subject matter present themselves:—

1. What the eye will do.
2. What the eye fails to do.
3. How the eye does its work.
4. How certain appliances help the eye.

Other headings can be devised, of course, and even within the general divisions given infinite variations are possible. The work may be biased by emphasising one or neglecting another. A closely linked development of the four will reveal the subject matter as a unit whose centre is the sensory organ, the eye. A specialised discussion under the second heading may link optics to radiation generally. The practical work which follows has been chosen to show how many branches of optical science may be used in the senior school. The examples are grouped in accordance with the four sub-topics listed above and are intended to suggest the kind of material which fits in each of them.

What the eye will do.—When dealing with a topic like the eye, it is a good plan at the outset to review briefly certain items of implicit knowledge. Everybody knows what the eye can do, and yet few could make a confident statement on the subject at a moment's notice. A class commencing to study the eye should therefore be helped to realise what are the chief characteristics of the work done by the visual organ. Guiding questions should be used to develop the following points:—

1. By means of the eye it is possible to recognise a great range of colour.

2. The size, shape and position of an object and its distance from the observer can be judged by sight.

3. The speed and direction of a moving object can be estimated.

The subject of colour is an interesting and important one, and as much of the pleasure of seeing is closely linked with it, there is every reason for giving special consideration to it in school. The second and third items mentioned above do not offer much scope for practical work and so they are not given further attention here.

Colour.—A simple study of colour makes a good start for a course of optical work, as through it many of the characteristics of light are revealed, and the knowledge thus acquired finds application later.

The colour which the eye recognises does not depend only on the object which is being examined, but also on the light which falls upon it. Children think that colour is an inherent property of an object like its hardness or shape and this impression needs to be corrected. Coloured pictures should be examined in coloured rays of light from the lantern. (Gelatine filters mounted as slides are the most convenient cheap means of obtaining different colours.) The strange effect of yellow light from a spoonful of salt in a bunsen flame is worth demonstrating. Using such an illuminant, familiar objects take on queer sickly hues. When the pupils are thoroughly acquainted with the effects of red, blue, yellow, etc., on the apparent colour of objects, they are able to realise that a red object looks red when red light falls upon it, but that other colours in the same circumstances lose their natural colour to a certain extent. Similarly green looks green in green light, and so on. That most common objects are not self luminous is very obvious, and so it follows that the colour of a thing is derived from the light which falls upon it and which is reflected into the observer's eye. If there

is no red light in the incident beam, then a red appearance cannot be expected. From this there follows very naturally the question: Why can there be so many colours visible when the light falling upon all the objects is sunlight of no apparent colour? Ought not everything to appear a white or grey? Here is a problem the solution of which involves the spectrum.

It is always worth while to decompose white light into a series of colours, but the Newton's disc method of building it up is not very convincing. A perfectly satisfactory spectrum can be produced by means of the lantern. A piece of card, the size of a lantern slide, has a slit cut in it. It is then put in position in the lantern and an image of the slit is focused on a screen. An ordinary glass dispersing prism is set in front of the lantern objective lens and the apparatus is readjusted so that the image is again on the screen. By interposing coloured filters in the path of the beam, portions of the spectrum may be absorbed.

To show the production of new colours by mixing, the shadow experiment is convenient. Three flashlamp or motor side-lamp bulbs are contained in a simple box. The bulbs are a few inches apart and each is opposite a window in the box front. These windows are covered with red, blue and green gelatine. A short distance away from the box is a screen on to which the shadows of a pencil or some similar object may be cast, Fig. 44. The lamps are controlled individually and the box contains partitions which isolate the three sources of light. Each lamp, if operated alone, produces a general colouring of the white screen and a black shadow. When two or three are working at the same time, a double or triple-coloured shadow is produced due to red-green, red-blue and green-blue combinations. When all the lamps are turned on, the screen illumination is more or less white. A pure white cannot be expected with ordinary quality filters.

Ideas about the composition of light which have been developed from the spectrum

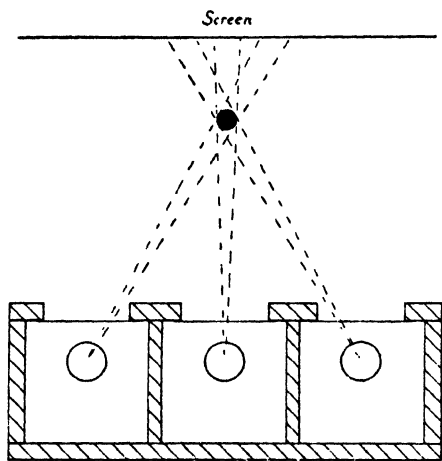

FIG. 44. PLAN OF COLOURED SHADOW APPARATUS

and shadow experiments can be verified and extended by further investigations. An arrangement of three projectors is useful for this purpose. A patch of coloured light from the lantern is projected on to a white screen, and two smaller patches from separate lamp boxes are superimposed upon it. These two are coloured red and green respectively. The blue filter is fitted in the lantern where a powerful lamp is available to penetrate it. A combination of two or three coloured discs may be built up by suitably directing the rays from the three projectors. Different combinations may be tried by simply changing the coloured gelatines. To get the best secondary colours it may be necessary to vary the intensity of illumination of one of the lamps. In the case of the colour provided by the lantern, this change may be made by moving the screen backwards or forwards. In the case of a lamp box, sliding the lamp nearer to the lens will increase the diameter of the disc of light on the screen and so diminish its intensity. The diameter of the disc provided by the lantern may be reduced to a size similar to the others by a card with a circular hole, which fits in the slide carrier. The three projectors, when fitted with red, green and blue filters, can give satisfactory

magenta, peacock blue and yellow secondaries and a fairly convincing white.

The optical arrangement of the experiment is illustrated diagrammatically, Fig. 45. The lamp boxes are of very simple form. A cheap convex lens is fixed in the front of a wooden box. At the focus, within the box, a motor car headlamp bulb is arranged so that a parallel beam is projected through the lens. Measurements for the appliance depend on the characteristics of the lens chosen, but when a reading glass of the type sold in the cheap stores is used, a box with a square section of side four inches and with a length of twelve or fourteen inches will be found satisfactory and convenient. Such a lamp box is illustrated on page 235.

An alternative method of doing the three colour experiment is available. A plate with three windows is fixed in front of the condenser of the lantern. The openings are symmetrically disposed so as to form an equilateral triangle. They are covered by pieces of red, green and blue gelatine. Opposite the filters, on a second similar plate, are three convex lenses which focus discs of coloured light on a screen. By adjusting the plate containing the lenses the discs may be made to approach each other

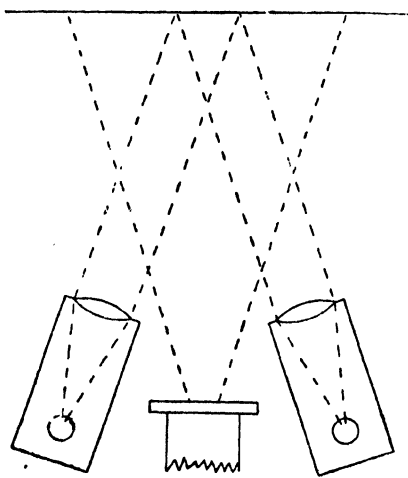
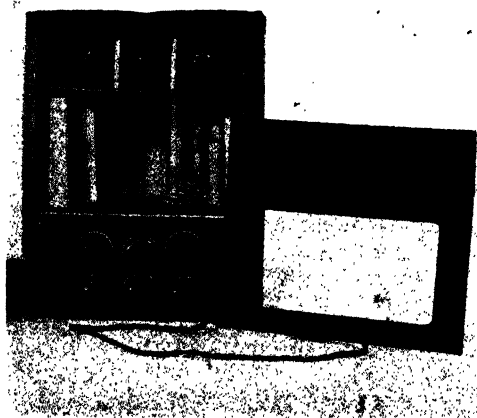

FIG. 45. PLAN OF THE THREE COLOUR PROJECTOR APPARATUS

and finally to overlap. The intensity of a colour may be varied by partially covering its filter.

Stage lighting.—Apart from the common phenomena of colour to which reference has already been made, the experiments on colour synthesis have other interesting applications which should certainly be recognised in school. The shop window, the stage, and the cinema all utilise systems of lighting which are based on the scientific ideas arising from colour investigations. The three pieces of apparatus now to be described serve to show how the practical subject of lighting effects may be represented in school.

The first model is a stage with lighting in three colours. It is contained in an old box which stands on end, the stage itself being a shelf which rests on supports about one third of the way up the box sides. This shelf extends only about three-quarters of the depth of the box, so that light from a set of lamps in the lowest section may be projected upwards behind it. Another set of lamps is housed near the front in the upper portion of the box, Fig. 46. In the model illustrated below, the lamps operate



MODEL STAGE, WITH FRONT REMOVED TO SHOW TOP SET OF LIGHTS

R—VOL. II-S

directly from the mains and each group contains three bulbs. A more effective mingling of the colours would undoubtedly be attained if a larger number of less powerful lamps were used, and the design offers scope for development in this direction. Each bulb is boxed in a separate compartment which has a tinted window, opening on to the stage, and each is controlled by a separate switch on the case front. Red, green and blue filters are used in both top and bottom lights. For convenience, the model illustrated has been fitted with a detachable front and sliding stage so that the whole of the interior is easily accessible. A white paper lining in the box reflects stray light on to the stage. For the sake of a realistic appearance, stage fixtures made from wooden blocks and broom handles have been grouped at each side and these reflect the light and give many pleasing gradations of colour. All the parts which are normally visible are painted in black, white or grey so that the colours are not disturbed by partial absorption. The distances separating the sources of light cause uneven distribution of the three colours over the surface of the stage, and so good mixing is not attained. Nevertheless, a great variety of effects may be obtained by choosing different combinations from the six switches. When directing the construction of a model such as this, it is important to remember the need for adequate ventilation of the lamp houses and effective insulation of the electrical fittings.

Rheostat control for lamps operating directly from the mains is not a practical proposition in the senior school, and the lights in the model stage have therefore to be turned on and off abruptly. A useful piece of apparatus which may supplement the stage model shows small scale lighting effects controlled by rheostat. A form which this may take is illustrated, page 252. The upper portion of an old wireless set cabinet is fitted with a white cardboard reflector which is curved to catch the light from a multi-partitioned lamp box fixed in the

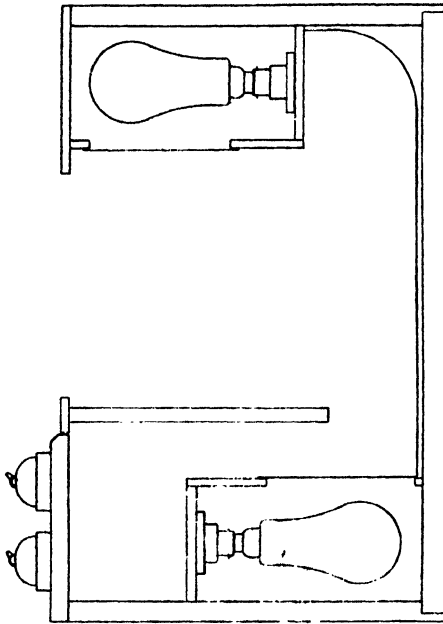
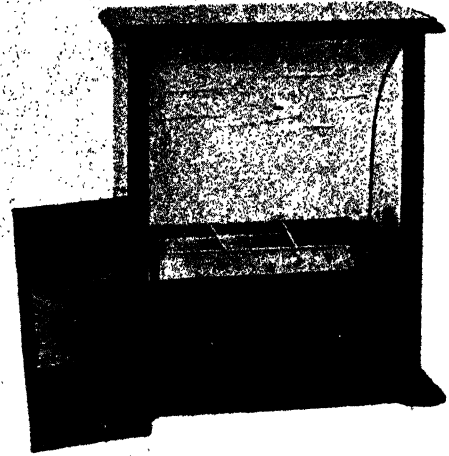

FIG. 46. ARRANGEMENT OF MODEL STAGE LIGHTING APPARATUS

lower part of the case. Three knobs on the cabinet front control small rheostats which are inside. The resistances themselves are portions of discarded wireless receiving sets. The lamp box contains six flashlamp bulbs in suitable holders, and these are wired in pairs, each pair being controlled by a rheostat. To avoid overheating the resistance elements, the lamps in each group are in series. Each bulb therefore gets a maximum of three volts from the six volt transformer which works the whole model, Fig. 47. Over the lamp box fits a double glass panel containing six gelatine filters, two of each primary colour. No two similar colours are adjacent. In the completely assembled apparatus, the presence of the lamp box is masked by a sloping front board which has been omitted from the photograph. The intensity of the three colours on the curved reflector may be controlled with great precision by means of the rheostats, and as each colour is shared by two sources of light, a good distribution is obtainable.



RHEOSTAT CONTROLLED COLOUR EFFECTS APPARATUS

The two models just described may be elaborated by adding extra lamps in different positions. Side lighting and spot lamps on the stage, for instance, would be particularly impressive additions. In schools where circumstances permit it, however, the natural extension of the work is to full scale activities. These may include the making of flood or spot lights for the school stage, a filter disc for the projector or a complete lighting system in colours for use in connection with dramatic work. To illustrate this kind

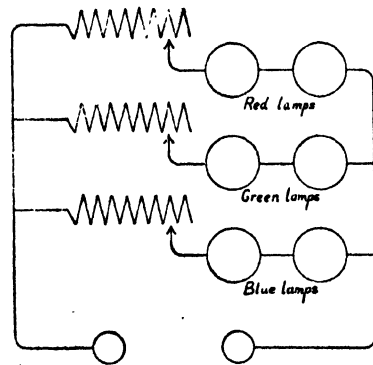

FIG. 47. CIRCUIT DIAGRAM FOR LAMPS AND RHEOSTATS

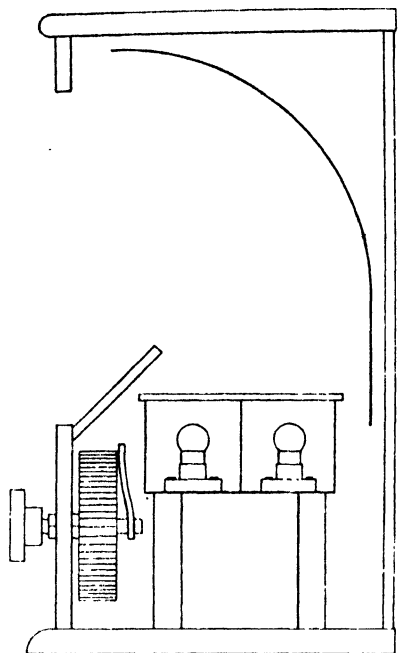

FIG. 48. ARRANGEMENT OF RHEOSTAT CONTROLLED COLOUR EFFECTS APPARATUS

of project, the accompanying photograph of some portions of a school-made stage lighting system has been included, page 254. The form taken by work of this description varies from school to school according to the conditions which govern the plans, and so full details of one particular project can serve little useful purpose. There are, however, a number of points of general interest about the apparatus illustrated which might be suggestive to teachers who propose to undertake similar activities. The following considerations guided the design:—

1. The apparatus had to be cheap.
2. It had to be safe, both in and out of use.
3. It had to be movable for ease of storage.
4. Its construction had not to involve much work beyond that which boys could undertake.
5. The preparation of the apparatus had to be shared by many boys.

In order to meet these requirements, the equipment is mounted on a number of separate baseboards, to which no permanent connections from the mains are made. The wiring is carried out in 3/029 cab cable and is enclosed in long hollow wooden cases to which individual sockets for the lamps are screwed. These cases are the full length of the stage and supply power to lamps along the top and bottom of the proscenium and to others at the sides. The lamps, with their large baking tin reflectors, are mounted on bases in groups of four, and on each set there fits a gelatine frame with four openings. The frames have iron wire supports across the openings to protect the filters. These filters are loose fits in the frames so that they may be changed or replaced easily. The lamps are controlled from a switch panel into which the flexible leads from the main distributing cases are plugged. The connection to the mains is made by means of a heavy three core flex from the switch panel to a wall socket of high rating.

What the eye fails to do.—The limitations of the eye always interest boys, and as they extend the previous sub-topic and also serve to introduce several points of great optical importance, they form a very useful subject for study. A number of them are referred to in the following paragraphs:—

1. The *blind spot* demonstration is well known. Two marks are made a few inches apart on a piece of paper and the attention of the right eye is fixed on the one at the left hand side. The other eye is closed. By varying the position of the paper, a point is found at which the second mark disappears.

2. Really clear vision is possible only over a limited field at any particular moment. For instance, when the attention of the eye is given to an object some distance away, it is impossible to read printing which is close at hand. When boys have realised this for themselves, they appreciate the fact that the eye is constantly adjusting itself to circumstances. Some children have difficulty in controlling their eyes and may

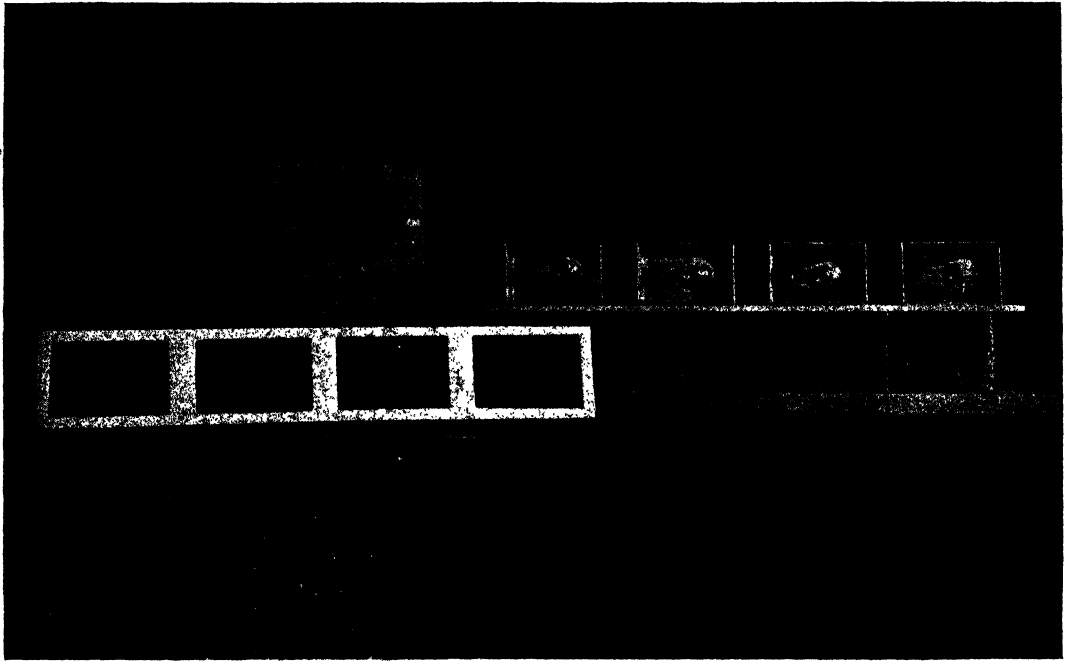

COMPONENTS OF SCHOOL-MADE STAGE LIGHTING SYSTEM

- A. SWITCHBOARD B. SET OF LAMPS AND REFLECTORS
C. GELATINE FILTERS IN WOODEN FRAME D. PLUG BOARD CONTAINING WIRING

have to be assisted in carrying out the observation. Lack of control may spoil the first demonstration also, as the eye may turn unconsciously from one mark to the other and give the impression that both are visible together.

3. That there is a minimum distance of distinct vision may be seen by actual trial. Printing held close to the eyes appears blurred and illegible.

4. An obvious but none the less important limitation of the eye is its range of movement. Only by moving the head or by using an auxiliary instrument is it possible to see to the sides or to the back.

5. A single eye is not efficient at judging distances. With a sweeping movement of the hand, guided by one eye only, it is difficult to knock over a matchbox which is stood up on the bench. The solidity of objects, which is apparent when viewed in the

ordinary way with two eyes, may be emphasised by demonstrating the stereoscope.

6. The eye gives false impressions at times owing to fatigue. If the attention be fixed for a minute on a bright green or violet design and then transferred to a white ceiling, the design is seen there, in a colour complementary to the original.

7. The presence of a disturbing element in the neighbourhood of an object which is being viewed, may give rise to a false impression. Judgment of size, shape, colour and direction are all liable to suffer when the environment is unfavourable. Many examples of these optical illusions have been published, and the group given is representative, Fig. 49.

8. An impression in the eye persists for a short time after the exciting influence has gone. So far as school is concerned, this limitation of the eye is decidedly the most

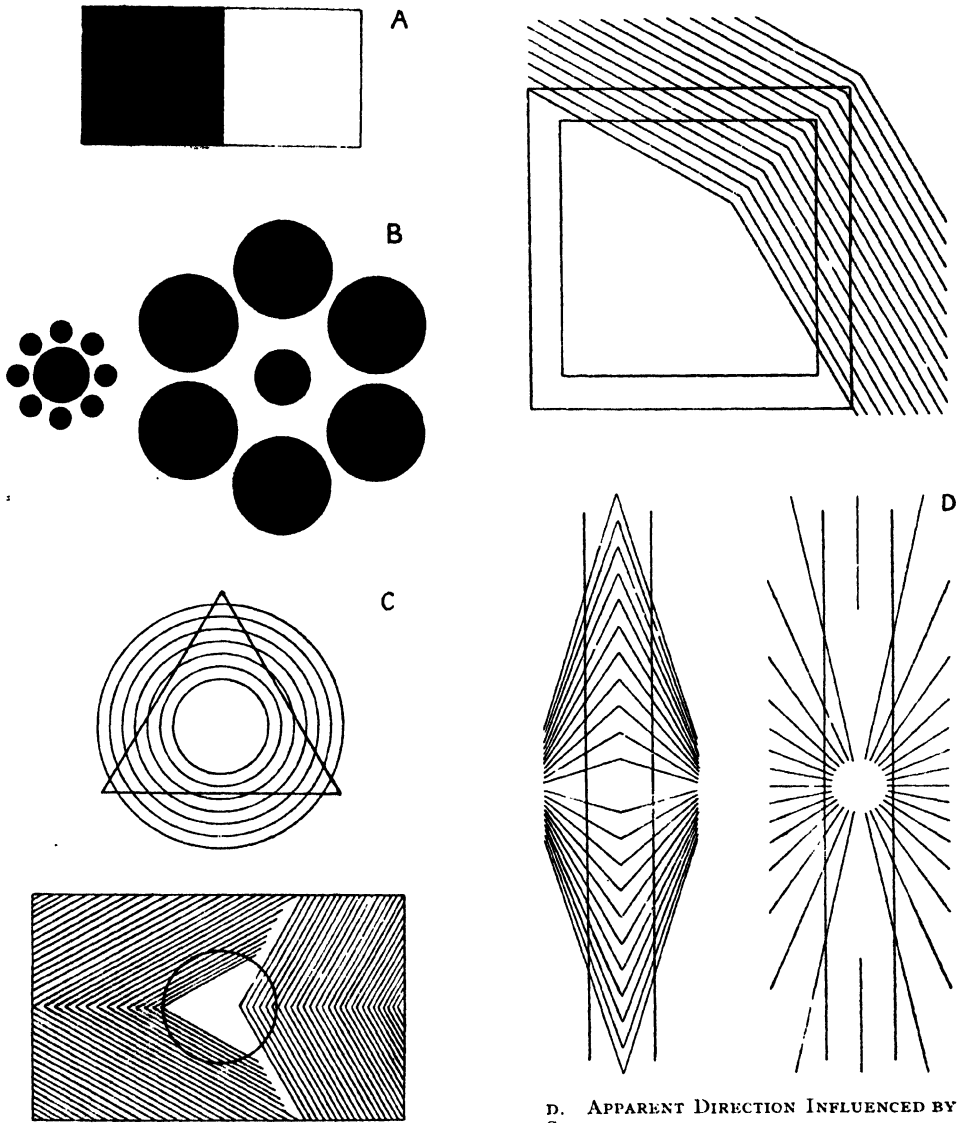

FIG. 49. OPTICAL ILLUSIONS

- A. APPARENT SIZE INFLUENCED BY COLOUR. The Black and White Squares are Equal Size.
- B. APPARENT SIZE INFLUENCED BY SURROUNDINGS. The Central Discs in the Two Groups are Equal in Size.
- C. APPARENT SHAPE INFLUENCED BY SURROUNDINGS. The Triangle, Square and Circle are not Actually Distorted.

D. APPARENT DIRECTION INFLUENCED BY SURROUNDINGS.

The Pairs of Heavy Lines are Parallel.

important one, as through the study of it the cinematograph may be understood.

The cinematograph.—The work arising in connection with this instrument may be divided into three sections:—

1. The cinematograph as an optical appliance.
2. The persistence of vision.
3. The mechanism of the cinematograph.

The optical system of the machine is identical with that of the lantern and it is best dealt with in connection with the latter instrument. The mechanical parts, however, are designed to make practical use of the phenomenon known as persistence of vision and the two should therefore be studied together. Using the scheme upon which this chapter is based, the simple phenomenon is studied and the practical application follows as a sequence, but with other forms of organisation the cinematograph may well serve as introduction, the persistence of vision then being brought in as explanation. In both cases, the same teaching material will be used, although the particular starting point and method adopted will affect the order in which the experiments are presented.

That an impression in the eye tends to lag may be shown by a number of observations on rotating bodies. A spark on the end of a string which is being whirled round gives the impression of a circle of light. Broken designs drawn on a spinning top appear complete. Eccentric circles, spirals, etc., on a rotating gramophone turntable seem to execute very strange gyrations. Stiff, bent wires spinning rapidly round a centre appear as symmetrical solid objects, Fig. 50.

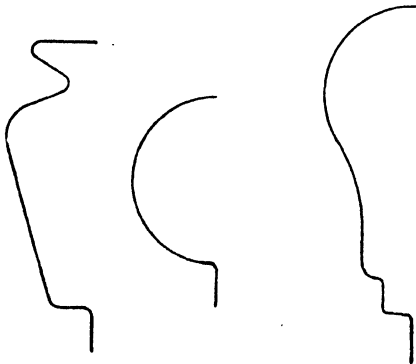

FIG. 50. SHAPED WIRES FOR SHOWING THE PERSISTENCE OF VISION

Rotating propellers and spoked wheels look like discs.

A very peculiar effect is noticeable when a fan-shaped black card is rotated on the shaft of an electric motor, Fig. 51. As the

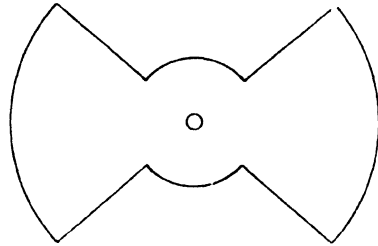

FIG. 51. FAN-SHAPED CARD FOR ROTATING SHADOW EXPERIMENT

speed of the motor increases, a point is reached when the shape of the card may be seen rotating rapidly in the opposite direction to the shaft. A further increase in speed reduces the rate of the shadow's movement until a point is reached when it remains stationary. Still higher speed causes the shadow to rotate slowly and then more quickly in the same sense as the motor shaft. Finally, the shadow disappears in a blur. If, instead of illuminating the card by means of a filament bulb, a neon lamp be used, then the desired effect is heightened considerably.

By using a light which flickers, it may be shown directly that the eye cannot detect rapid alternations of light and darkness. A convenient way of doing the experiment is to project a parallel ray of light from a lamp box through a rotating shutter on to a white screen. The usual type of lamp box can be used, page 235, and the fan-shaped card on the motor shaft described in the previous experiment will serve very well as a mechanical shutter. The speed is controlled by a switch or rheostat in the motor circuit, Fig. 52. When the shutter is running at low speed, the eye can detect that the screen is being illuminated intermittently. As the speed increases, the effect changes to a slow flicker and then to a more rapid one until

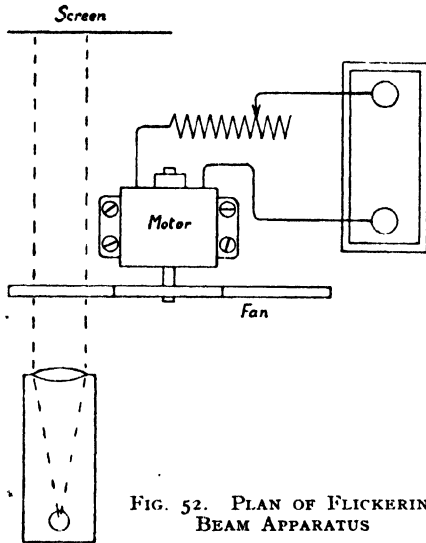

FIG. 52. PLAN OF FLICKERING BEAM APPARATUS

finally the disc of light on the screen appears to be perfectly steady. The experiment is valuable as it illustrates the action of the shutter in the cinematograph and shows how it is possible to mask the movement of a film in the machine. In conjunction with the experimental work, an examination of films and a projector should be undertaken so that cross references may be developed.

The next piece of apparatus presents two pictures which, under suitable conditions, appear to coalesce. This has an obvious bearing on the projection of films which consist of numerous separate pictures. A simple picture is drawn in two parts, one on each side of a piece of card. This is then fixed in a suitable holder and rotated rapidly. The images of the two parts are superimposed upon each other on the retina due to the high speed of rotation and the persistence of vision, and so the observer gets the impression of a complete picture. A holder for the picture card may be made by fixing a slotted block of metal with two clamping screws on to the end of a rod or thick wire, Fig. 53. The apparatus may then be turned either by rolling the rod between the palms of the hands or by a mechanically driven winder.

A natural extension of the thaumatrope principle leads to the *flicker*, a device which shows a series of pictures in rapid succession. The pictures should represent the stages in some simple movement, the difference between two consecutive ones being very small. The drawings are made in the top right hand corners of the margins of an old soft-backed magazine. It is important to ensure that all the units in the series occupy exactly similar positions in the margins. A pinhole through the whole magazine helps by acting as guide. A simple subject, such as the rotating of a spoked wheel, should be chosen for this experiment as the drawings necessitated by more complex ones require a great deal of

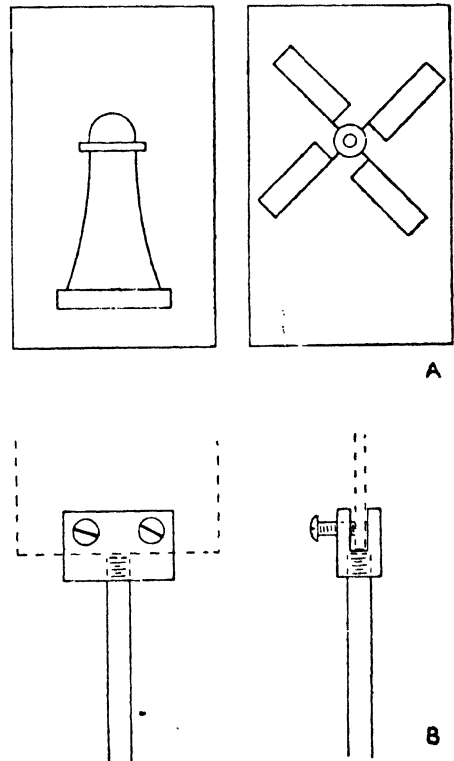

FIG. 53. THE THAUMATROPE
A. PICTURE CARD DRAWINGS
B. CARD HOLDER

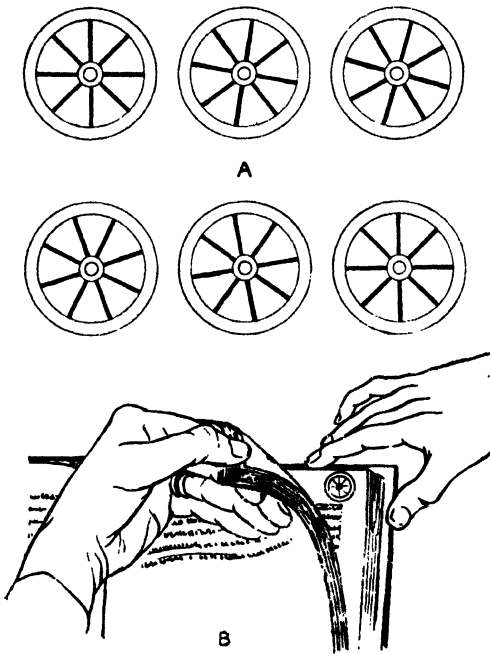

FIG. 54. THE FLICKER
A. CONSECUTIVE DRAWINGS
B. HOW TO WORK THE FLICKER

time for their execution and are very easily ruined by a little carelessness. By allowing the pages of the magazine to slip past the thumb in rapid succession, images of the series of pictures are superimposed upon each other on the retina and give the impression of steady movement, Fig. 54.

The last two pieces of apparatus to be described in this section are simple moving picture machines. Both devices are based on the same principle as the cinematograph but they differ in mechanical detail. In the first, a series of pictures mounted in a drum is used, whilst the second incorporates a picture disc. Unlike the cinematograph, these two are direct vision machines.

The chief part of the drum instrument is an open-ended cardboard cylinder fitted on a wooden base. Round the inside wall of the cylinder is pasted a series of pictures

of the usual kind, and above each of these a slot is cut. A diameter of ten or twelve inches is convenient, as this size permits the use of a fairly long series of drawings. For such a cylinder, a rectangular piece of cardboard five inches wide and about forty inches long will be needed. The length may be built up if necessary by gluing together two or three short lengths. Before being bent into its final shape, the card has the appearance shown, Fig. 55. The circular

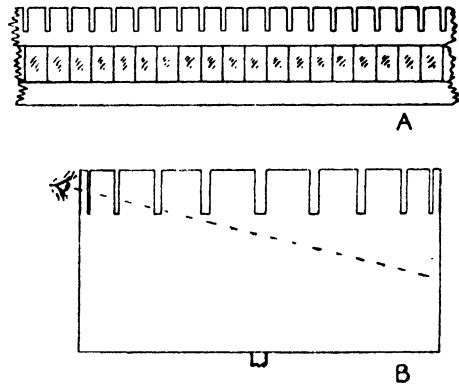

FIG. 55. THE WHEEL OF LIFE
A. ARRANGEMENT OF PICTURES AND SLOTS
ON CARDBOARD STRIP
B. HOW TO VIEW THE MOVING PICTURE

plywood base of the cylinder is held in position by pins which pierce the card and penetrate the base rim. The complete drum is mounted on the turntable of a gramophone, the central peg of which projects through a hole in the plywood disc. The pictures in the cylinder on the side remote from the observer are viewed through the slots in the cylinder wall as the turntable rotates, Fig. 55. A complete drum instrument is illustrated, page 261.

The disc type of apparatus is easier to construct than the drum and is quite as efficient. The appliance can be built with either a single or a double rotating disc system. With a single disc, a plane viewing mirror has to be used, but with a double arrangement, the pictures may be observed directly.

Both types are illustrated, page 261. The drawings, which show the stages of a simple movement in the usual way, are spaced evenly round a circle, Fig. 56. Near the edge of a disc of plywood whose diameter equals that of the drawing circle a series of radial slots is cut to correspond with the pictures, Fig. 57A. The sheet of pictures is fixed either to the slotted disc itself or to a similar plain one. If the slotted disc is used as a mount for the drawings, then the observer looks through the slots from the

side of the disc which is blank and sees the pictures by reflection from a stationary plane mirror fixed at a convenient distance, Fig. 57B. If, on the other hand, the pictures have a disc to themselves, then they are viewed directly, Fig. 57C.

The disc or discs are mounted on a shaft and this is supported in suitable bearings so that the discs are in a vertical plane. The side of the plywood nearest to the observer is blackened to prevent the reflection of stray light. The disc shaft is turned either by hand

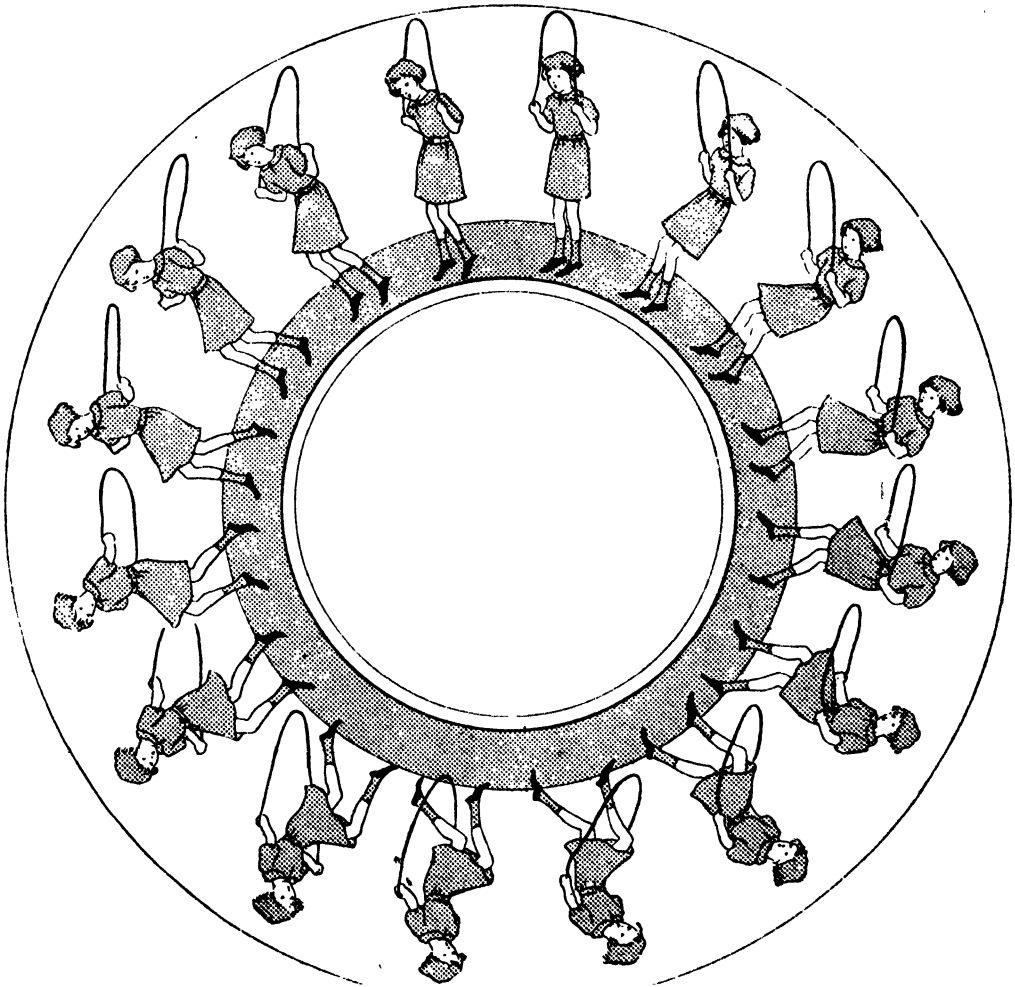

FIG. 56. SERIES OF DRAWINGS FOR THE SLOTTED DISC MOVING PICTURE APPARATUS
(CLASS PICTURE NO. 65 IN THE PORTFOLIO.)

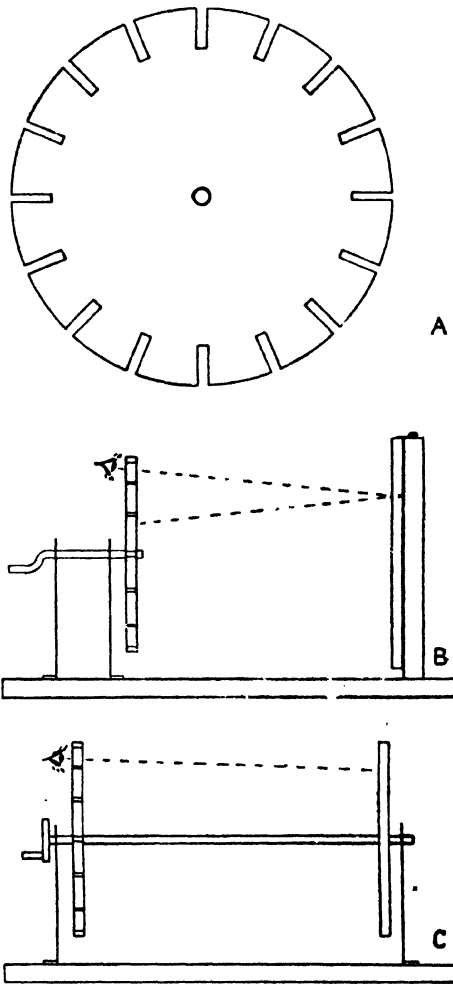

FIG. 57. THE DISC APPARATUS

- A. THE SLOTTED DISC
- B. ARRANGEMENT OF SINGLE DISC MODEL
- C. ARRANGEMENT OF DOUBLE DISC MODEL

or by mechanical means and the moving pictures are observed through the slots.

How the eye does its work.—This sub-topic necessitates a study of eye structure and is based on a demonstration in which a bullock's eye is dissected. Although it is easy to show the major features of the eye in the course of such a demonstration, the form of the

organ of vision when in normal condition is not evident from the dissection as the parts become displaced and distorted. It is necessary therefore to augment the observations actually made in class by further information given in diagram form, Fig. 58. As many children find difficulty in visualising a section accurately, such an illustration needs to be used with care. The diagram, the eyes of members of the class and the bullock's eye must be correlated if misunderstandings are to be avoided. A series of drawings showing different views of the eye is useful. Although these do not need to be detailed, they should be clear enough to link up the eye as the dissection and Fig. 58 reveal it, with the eye as it is usually seen, Fig. 59.

A model eye.—A simple working model of the eye can help boys to learn how the agent works. The appliance to be described is really a crude camera, but there is no reason for introducing it under that title. Its immediate purpose is to reveal what happens in the eye, and its structure is determined solely by that objective. That the model eye is really a camera is a fact which may safely be left to dawn on the boys as they use it. The apparatus is a simple modification of the eye, planned so as to be recognisably similar to its prototype and yet arranged in such a way that its internal action may be watched.

The essential features of an effective model can be determined by studying the diagrams already given. A case or box

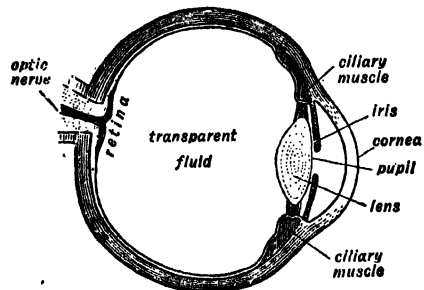
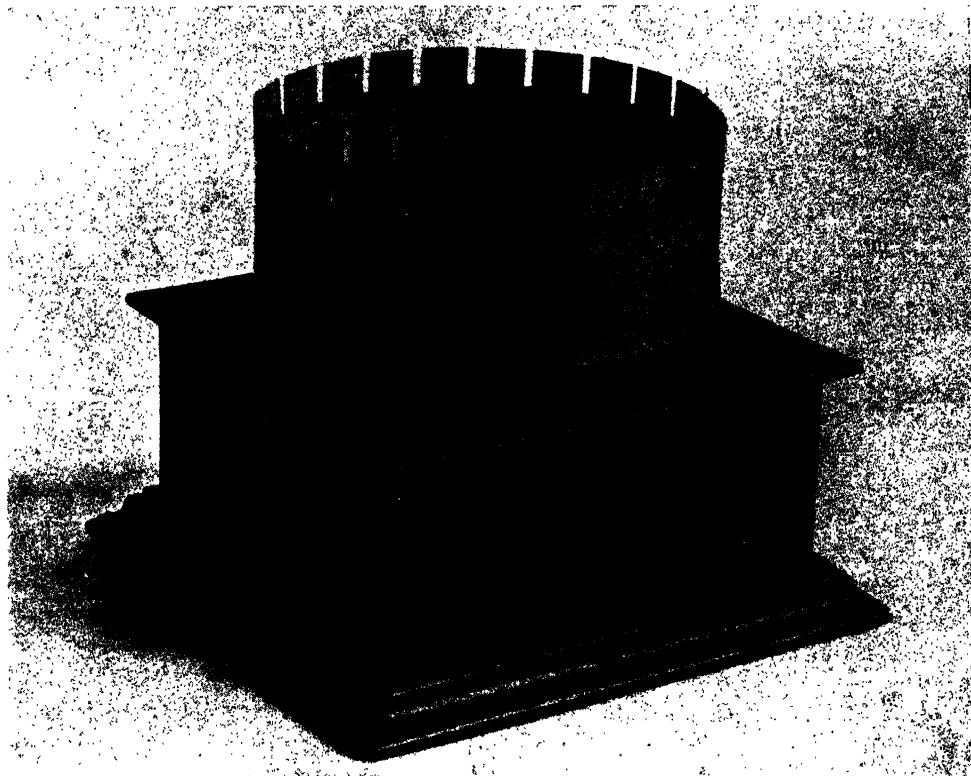
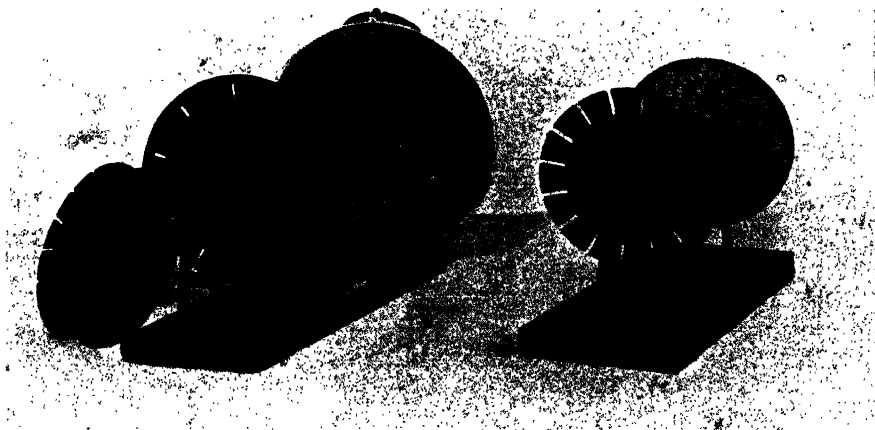

FIG. 58. HORIZONTAL SECTION THROUGH THE HUMAN EYE



THE WHEEL OF LIFE, A SIMPLE MOVING PICTURE APPARATUS



REFLECTING TYPE SLOTTED DISC APPARATUS (On left)
DIRECT VISION SLOTTED DISC APPARATUS (On right)

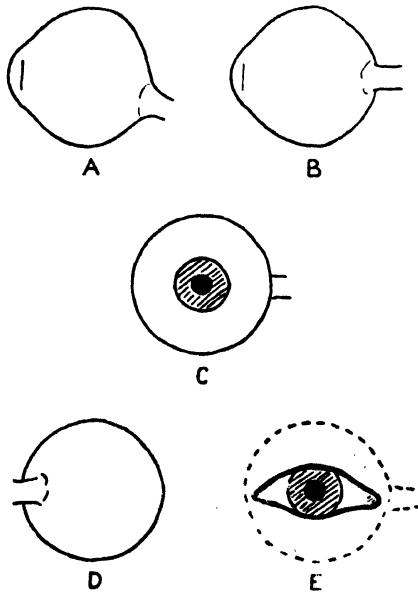

FIG. 59. SKETCHES OF THE RIGHT EYE, FROM DIFFERENT POINTS OF VIEW

- A. FROM ABOVE
- B. FROM THE LEFT SIDE
- C. FROM THE FRONT
- D. FROM BEHIND
- E. NORMAL VIEW, WITH HIDDEN PORTION DOTTED

represents the eyeball and a hole at one end serves as pupil. A slip of plain glass covering the hole acts as cornea, and a set of small cards in which holes of different sizes have been cut gives the effect of an adjustable iris. A short focus convex lens of glass takes the place of the crystalline lens, and a sheet of tracing paper fixed at the back of the box does duty for the retina, Fig. 60. A hole in the tracing paper indicates the spot at which the optic nerve leaves the eye, and as the image on the paper is incomplete at this point when the instrument is working, a reason for the blind spot phenomenon, page 253, is not difficult to find.

As the back of the instrument is made of tracing paper, it is not necessary to have observation windows in the box sides as the internal action may be judged by looking at this translucent screen. As it is undesirable

to have recourse to focusing adjustments at so early a stage as this in the study of optical instruments, the screen of the model eye is fixed at a distance from the lens which is rather more than the focal length, so that the images of all distant objects may be fairly well defined. When in use, the model shows that the eye lens produces an inverted image on the retina, that the iris controls the brightness of the image and that for objects at different distances from the eye, the images are not equally clear. These points lead on to the action of lenses, to optical instruments which are similar to the eye and to the two common methods of adjustment whereby well-defined images of objects at different distances are attainable. The remainder of this section is occupied by teaching material which may prove useful when dealing with these items.

The lens.—In addition to the usual illustrative experiments on refraction, it is very necessary when dealing with the lens to include some class and individual work which shows the effect of the instrument in a direct way. Two forms of convenient and effective apparatus have proved satisfactory, the first using an inclined surface to intercept the rays of light, and the second applying smoke for the same purpose.

For demonstration, a form of ray apparatus is used. Light from a suitable source is split up into a series of rays which pass through the lenses or blocks whose effects are being observed. By arranging a board at a small angle so that the rays glance on it along the whole of their course, the

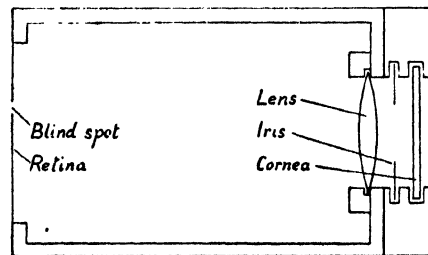

FIG. 60. ARRANGEMENT OF MODEL EYE

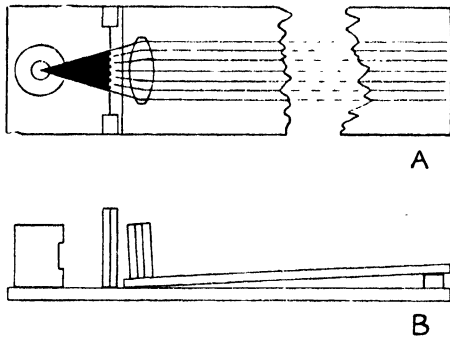

FIG. 61. ARRANGEMENT OF RAY APPARATUS
 A. PLAN, SHOWING A CONVEX LENS PRODUCING A PARALLEL BEAM
 B. SIDE ELEVATION

track of each is made visible. No complicated or expensive equipment is necessary. A motor car headlamp bulb with a straight filament is housed in a tin canister so that the source of light is practically a vertical line. The beam passes through a rectangular window cut in the side of the container and strikes a slit screen immediately in front of it. If the apparatus is intended only for intermittent use, ventilation holes in the canister are unnecessary, but the life of the bulb will be very short if such an ill-ventilated box be worked continuously and allowed to overheat. The purpose of the screen which stands in front of the lamp house is to split the wide, diverging beam from the window into a series of narrow rays. This component may be built up from strips of brass or tinplate, or it may be cut from a single sheet. A spacing of about one-eighth of an inch between slits is very satisfactory, the slits themselves being as narrow as possible. Using sharp snips, the cutting of the screen offers no great difficulty. Although equal spacings and slits give a good appearance to the apparatus, precision in this direction is not essential, and so the preparation of the screen is not a task beyond the ability of a boy.

The complete screen is rather taller than the lamp house with which it is used, and it is fitted with a simple base so that it can

stand with the slits vertical without additional support. A light coloured board which is to intercept the rays which pass through the slits is inclined at a small angle to the horizontal so that the whole of its length may be effective. The optical appliance, the action of which is being studied, is placed in the track of the rays at an appropriate point on the board. In cases where it is desirable to use a parallel beam, the rays from the slits are diverted by means of a cylindrical convex lens before they pass through the appliance under examination, Fig. 61.

The only real objection to this apparatus arises from the difficulty which a class experiences when trying to view the horizontal board. If the demonstration bench be a low one, this may not be serious, as a small class can stand round and see fairly well. With larger numbers it may be necessary to support the board in a vertical position by spring strips. A more convenient method of improving the visibility requires a large plane mirror to be arranged over the ray board at an angle of forty-five degrees, so that the class may view the demonstrations through it, Fig. 62.

The ray apparatus can be used for demonstrating many different optical pheno-

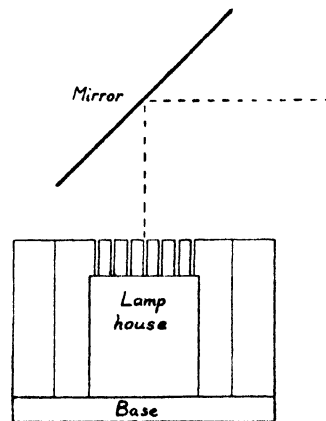

FIG. 62. VIEWING MIRROR ARRANGED ABOVE THE RAY APPARATUS

mena, but the lenses which are to be employed are of a special cylindrical form, Fig. 63. Two or three specimens of both convex and concave varieties should be purchased, and these should have differing optical characteristics. Plano-concave and plano-convex lenses may be included in the group with advantage, but the less common types need not be mentioned in the senior school, and samples of them should not be bought.

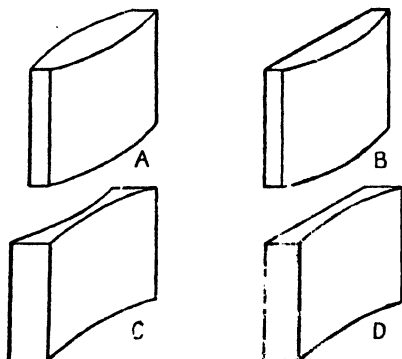

FIG. 63. CYLINDRICAL LENSES FOR USE WITH THE RAY APPARATUS

- A. BICONVEX
- B. PLANO-CONVEX
- C. BICONCAVE
- D. PLANO-CONCAVE

For demonstrations of reflection and refraction, using the ray apparatus, ordinary laboratory glass blocks, prisms and plane mirrors are satisfactory. If the path of the rays *within* a glass block is to be shown, then the base of the block must be enamelled, frosted or roughened. Rubbing with emery powder and turpentine on a glass slab will produce a useful result. The ray apparatus cannot claim to be the most impressive means of showing reflection and refraction phenomena, and it is not specially recommended for this purpose. As a demonstrant of lens action, however, the appliance is particularly valuable. It is indeed doubtful if any other form of apparatus of similar cost can offer a range of service to the senior school which could equal this in directness, quickness and adaptability. In a later section of this chapter, page 275, a

method of using the ray apparatus to demonstrate the action of spectacles is described. The accompanying diagram (Fig. 64) illustrates how the device is used to show the work done by simple lenses.

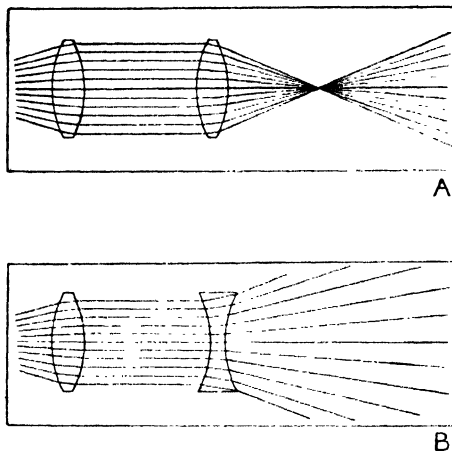

FIG. 64. RAY APPARATUS IN USE

- A. SHOWING THE EFFECT OF A CONVEX LENS ON A PARALLEL BEAM
- B. SHOWING THE EFFECT OF A CONCAVE LENS ON A PARALLEL BEAM

The smoke box is a useful means of familiarising the boys with lenses. In its simplest form, the apparatus consists of a plain wooden box with sliding glass front. In one end is a circular window through which a beam of light may be projected. A motor car headlamp bulb stands at the focus of a convex lens which is fitted in the smoke box window. The rays which



SIMPLE OPTICAL SMOKE BOX, WITH LENS HOLDER AND LAMP

traverse the box are parallel in consequence. A tin lid containing smouldering brown paper rests in one corner of the box, and the beam of light may therefore be seen through the glass front by reflection from the smoke particles, which rise from the tin lid.

A set of lenses, selected and numbered, is used in conjunction with the box. Each lens is examined and then supported in the path of the ray by means of a simple lens holder. The effect which it has on the ray is observed, Fig. 65.

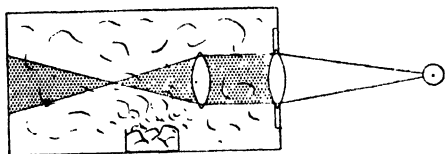

FIG. 65. ARRANGEMENT OF THE OPTICAL SMOKE BOX

The series of observations may be tabulated under headings such as the following:—

1. *Type of lens.* The shape of the lens is judged by direct observation. (Biconvex, plano-concave, etc.)

2. *Thickness.* This is estimated qualitatively in a very general way by comparison with a pair of standard lenses supplied with the others. Each lens is classified as *thick* or *thin*.

3. *Effect.* The change in the ray as it passes through the lens will indicate whether the specimen is to be termed *divergent* or *convergent*.

4. *Strength.* The influence of a lens on the ray may be large or small in extent, and so the instrument may be classed as *strong* or *weak*.

The results of the investigation suggest two generalisations which are of considerable practical importance. Firstly, thickness and strength appear to be related. Secondly, convex lenses seem to have a convergent effect whilst concave ones produce divergence.

The camera.—As this instrument is a modification of the eye, its study extends and enriches the work already suggested. The greater part of the time allotted to the camera will naturally be spent in considering it from the optical point of view, but a brief account of the wider subject, photography, should be given. This should be illustrated in a practical way by taking a photograph and going through the various processes necessary to obtain a finished print of the original object. The science of photography is too complex for senior school purposes, but the demonstration suggested may arouse an interest which will develop in later years when the maturing mind is better fitted to grasp the technicalities of the subject.

From the optical point of view, the new feature introduced by the camera is the process of focusing. In the first study of the eye this was omitted for the sake of simplicity. In the ordinary box camera, a change of focus is effected by placing an auxiliary lens into the optical system. This *portrait attachment*, as the extra lens is usually called, strengthens the normal lens and makes it suitable for close range working. There is a clear analogy between this and the accommodating power of the eye which should be carefully worked out. Focusing by strengthening or weakening the lens is the method adopted by nature—the lens muscles vary the thickness of the crystalline lens to suit the circumstances.

Cameras fitted with extensible bellows use the second method of focusing, and as this is the system adopted in most optical instruments, its action should be thoroughly familiar to the boys. Each boy should use both a real camera and a model so that he may be aware of the adjustment necessary when a change is made from viewing an object near at hand to viewing one at a distance. A long cardboard box with one open end can easily be adapted as a model camera. A convex lens is fitted in the middle of the closed end and a tracing paper screen, mounted on a simple wooden stand, is slid into the box through the open

end. Focusing is effected by moving the screen backwards or forwards, the influence of the movement being judged by watching the image through the open end of the box, Fig. 66. The inside of the model is

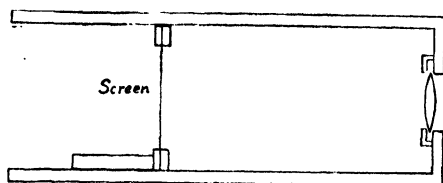

FIG. 66. MODEL CAMERA

painted black so that stray light cannot reflect and interfere with the clarity of the image. The range of usefulness of the device may be increased by making the lens detachable so that lenses of different focal lengths may be compared.

The *view finder* of the popular hand camera is worth consideration, and a model of it is very instructive. Three forms which this might take are indicated, Fig. 67. In the first, no focusing adjustment is possible, the instrument being set so that all distant objects are clearly seen on the screen. The second has a sliding lens and the third an adjustable screen. All three are similar in construction.

An optical system consisting of a short focus lens, a plane mirror and a tracing paper screen is housed in a simple wooden case of a size chosen to suit the lens. In the non-adjustable model the case is a plain rectangular one with a lens hole at the front, mirror supports set at the correct angle inside, and a small sheet of tracing paper on top. The distance from lens to screen via the mirror is a little more than the focal length of the lens. The best positions for the components should be found by trial. The second type of instrument is similar to the first, but it has a single stage telescopic lens tube of tinfoil fitted in the front hole. A broad elastic band round the joint in the sliding tube makes it lightproof. The third form of the apparatus has its screen on a framework separate from the main

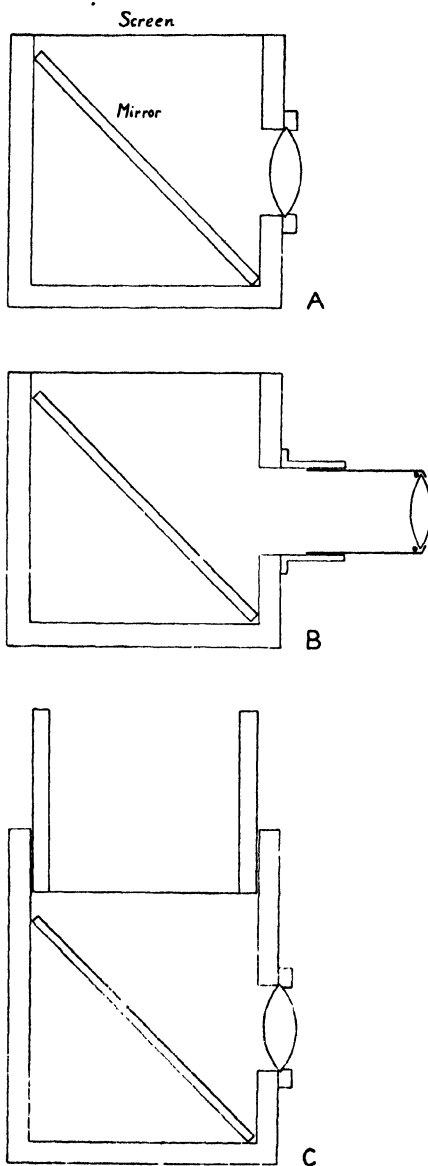

FIG. 67. A HAND CAMERA VIEW FINDER

- A. FIXED FOCUS TYPE
- B. WITH ADJUSTABLE LENS
- C. WITH ADJUSTABLE SCREEN

structure so that its distance from the mirror may be varied at will. In both adjustable models, the minimum optical



SIMPLE SCHOOL-MADE MODELS OF OPTICAL INSTRUMENTS

- CAMERA WITH SLIDING SCREEN (*On right*)
 LANTERN (*In centre*)
 VIEW FINDER WITH ADJUSTABLE SCREEN (*On left in foreground*)
 EPISCOPE (*On left*)
 ADJUSTABLE PINHOLE CAMERA (*In centre of foreground*)

distance between lens and screen is made a little less than the focal length.

The episcopo.—In all the lens instruments which have already been discussed, the image has been *smaller* than the object. The episcopo is a simple appliance which uses a convex lens to produce *large* images, and several other important instruments work on the same principle. It is instructive to compare the structure of the two types. The camera, for example, has a convex lens and a small *screen* mounted in a shallow box. The objects photographed are large and are a long way from the instrument. The episcopo on the other hand has a convex lens and a small *object* mounted in a shallow box. The image and screen are large and are at some distance from the lens, Fig. 68. If the boys have not had experience of an episcopo in action, the preliminary discussion may be based on the optical lantern or cinematograph, but an early opportunity for introducing the episcopo should be taken.

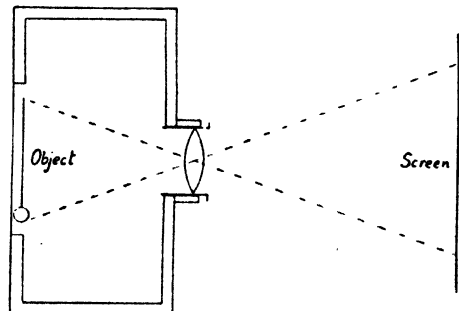
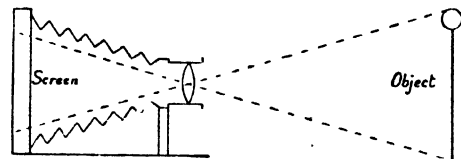

FIG. 68. DIAGRAM SHOWING THE ESSENTIAL DIFFERENCE BETWEEN THE CAMERA AND THE EPISCOPE

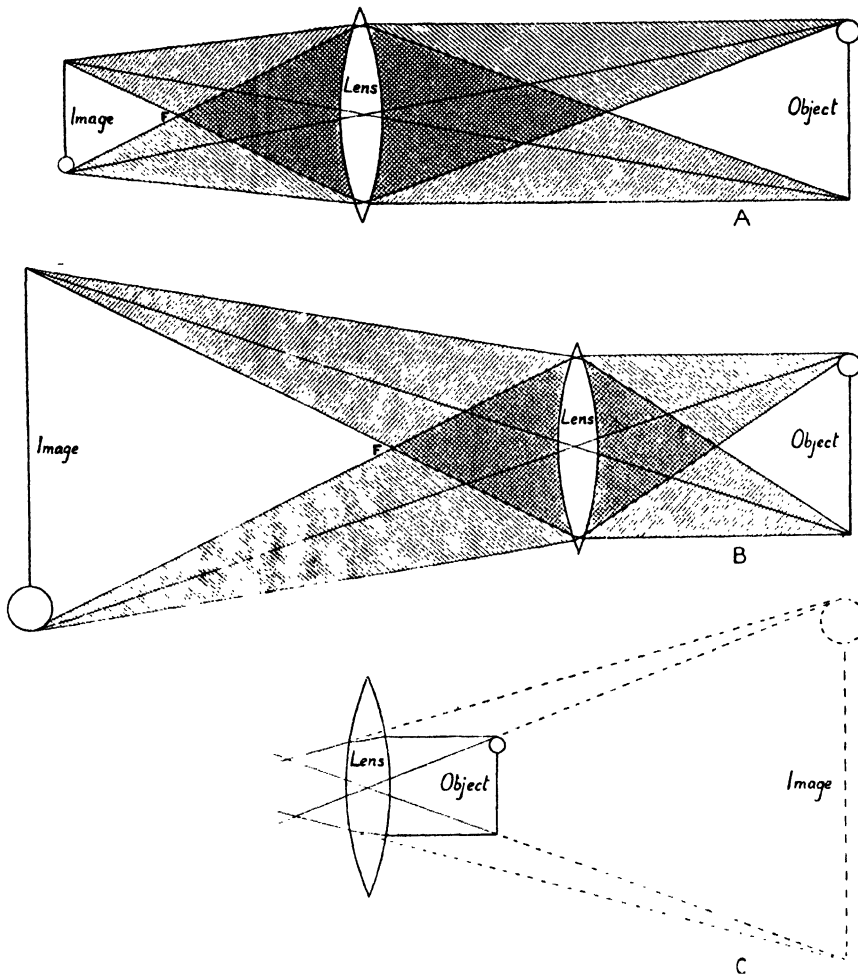

FIG. 69. IMAGES PRODUCED BY A CONVEX LENS

- A. REAL, INVERTED, DIMINISHED IMAGE (*Camera type*)
- B. REAL, INVERTED ENLARGED IMAGE (*Episcope type*)
- C. VIRTUAL, ERECT, ENLARGED IMAGE (*Reading glass type*)

The image-forming property of the convex lens should be investigated thoroughly, as it forms the basis of so many of the more common optical appliances. For the experiment the boys require an electric lamp, a sheet of white paper and a convex lens mounted in a cardboard screen. By selecting appropriate positions for the three units, diminished or enlarged images of the lamp

may be projected on the paper, Fig. 69. The boys should find and examine the image for many different positions of the lamp, and should associate each with either the camera or the episcope. Diminished images are the camera type and enlarged ones are the episcope type. At this stage there is no need to dwell on the enlarged, virtual images which are formed under

certain conditions, although the phenomenon will be noticed.

A working model episcopes which shows an image-forming convex lens put to practical use is illustrated, page 267. A wooden box with hinged top has a convex lens of short focal length fitted in a hole in the front. For this and other similar small scale optical models, folding pocket lenses can be employed. Round the lens hole on the inside of the box, several flashlamp bulbs are mounted, and these illuminate the object or picture which is fastened to a vertical board opposite to them. This object board is on a stand which is free to slide along the box base for focusing purposes, Fig. 70A. The image produced by the appliance is caught on an external screen. Direct projection from the instrument on to the screen gives an image which is reversed. This may be corrected by reflecting the rays through an angle of ninety degrees by means of a plane mirror, Fig. 70B. As the lamps recommended are of low power only, the images obtainable are but feebly illuminated. Nevertheless, in a darkened room the model serves its purpose very well, particularly when an object with bold contrasts is used. (A watch or simple pen and ink sketch makes an excellent object.)

The construction of a full-sized practical episcopes for school use is a project which presents itself at this stage. In making preparations for such a piece of work, two great difficulties have to be faced, the first being concerned with expense and the second with design. High grade materials for episcopes construction are very costly, as the ideal projector uses a well made wide aperture lens, heat resisting glass and a first class mirror. An instrument giving adequate ventilation is difficult to design, unless it is proposed to incorporate motor-driven cooling fans. The episcopes to be described is put forward as a reasonable compromise. By making use of material already to hand, the instrument avoids the need for serious expenditure. Its design is flexible so that a great range of refinements

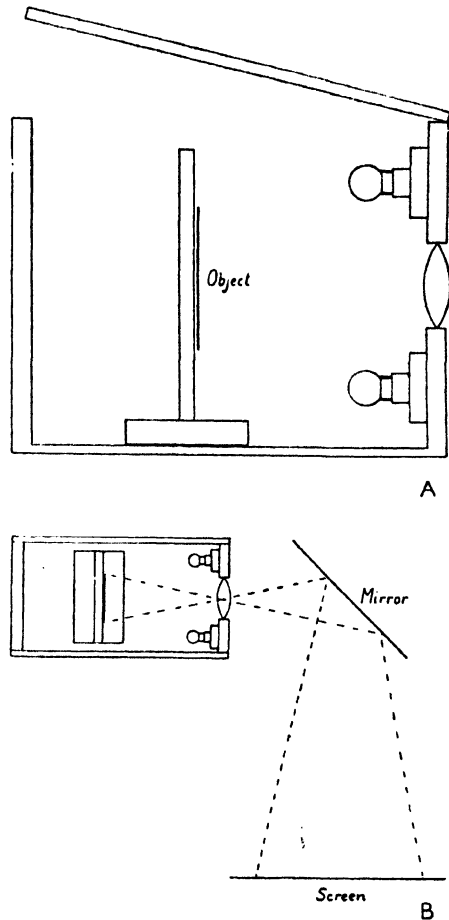

FIG. 70. A. SIMPLE MODEL EPISCOPES
 B. EPISCOPES PROJECTION, USING A REVERSING MIRROR

and modifications may be introduced if circumstances permit. Yet the actual work involved in its preparation is not difficult, and so boys can undertake the project with confidence.

The heart of every episcopes is its lens. Many promising instruments are ruined by false economy applied when purchasing this vital component. Cheap lenses will work in projectors, but the results obtainable are never satisfactory. The scheme recommended for the purpose of the instrument illustrated

is to use the lens of an optical lantern. As it is unlikely that both lantern and episcopes will be in use at the same time in school, one lens of the slip-in tubular variety will serve for both instruments without anybody suffering great inconvenience. Such an arrangement is, of course, not without its faults. The aperture of a lantern lens is not as large as one might desire for episcopic purposes, but its optical efficiency more than counterbalances this shortcoming.

The image produced by a good episcopic lens can be ruined by using a cheap mirror to reverse it. The best inexpensive way of rectifying an episcopic image is to project it through the screen. The instrument under consideration is intended to be used in this manner. To avoid loss of light by screen absorption, a thin translucent material should be used. Tracing paper, stretched tightly over a very large picture frame and glued in position, makes an excellent screen. The paper is available in very large sheets so there is no need to have a joint. To minimise the risk of damaging the fragile material, the frame should be suspended by cords from the ceiling so that the screen may be stored at a safe height or lowered to the correct working position without having to be touched by hand, Fig. 71.

The body of the episcopes is constructed to suit the lamp or lamps which are to be

used. Three useful shapes are shown, the first being intended for instruments which have two or four ordinary filament lamps, the second for those with a single projector lamp, and the third for others with twin projector lamps, Fig. 72. In cases where only the cheapest form is possible for economic reasons, the instrument may be

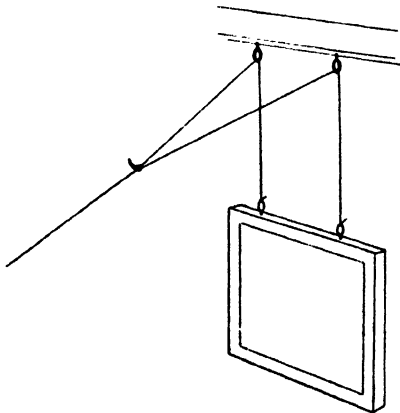

FIG. 71. EPISCOPIC SCREEN AND SUPPORTING CORDS

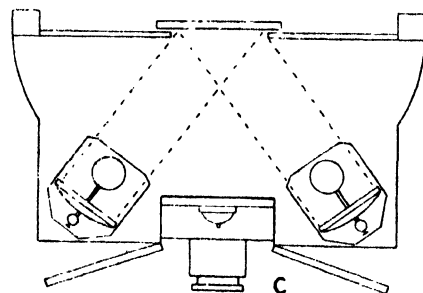
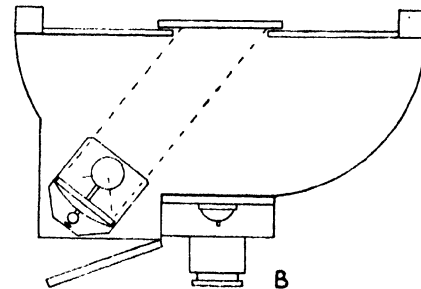
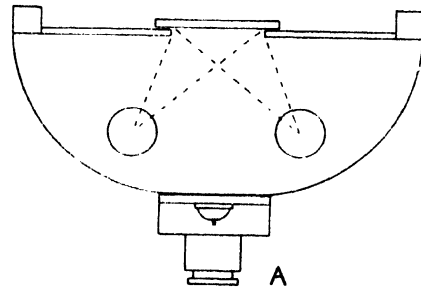
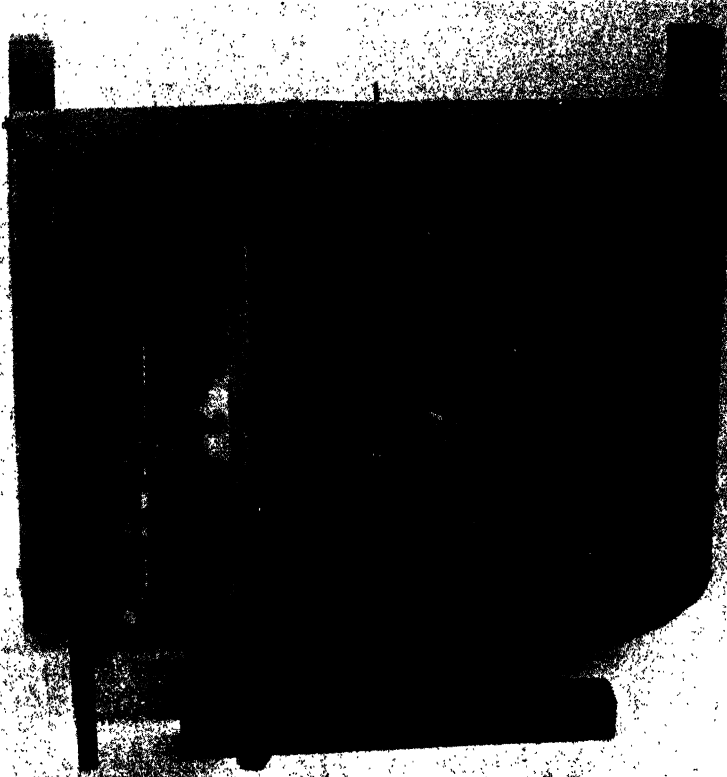

FIG. 72. A. PLAN OF EPISCOPIC FITTED WITH ORDINARY FILAMENT LAMPS
B. PLAN OF EPISCOPIC WITH SINGLE PROJECTOR LAMP
C. PLAN OF EPISCOPIC WITH TWIN PROJECTOR LAMPS



THE EPISCOPE

constructed with a view to modification at a later date. The photograph shows an episcopes which is fitted with a single projector lamp, but which in its original form contained four ordinary lamps and had no projecting lamp house.

The top and bottom of the episcopes are of half inch oak, cut to shape by means of a bow saw. The curved sides are of sheet iron, snipped from an old five gallon oil drum. The extensions which house the lamps and reflectors are of oak and these are made to suit the size of the lamps available. A lantern lamp, complete with tray and silvered reflector, is mounted in the extension of the instrument illustrated. By adopting this artifice, a single lamp serves a double purpose, and the episcopes is fitted up with a powerful lamp without

involving expense. Large ventilation holes are drilled in the top and bottom of both the main case and the extensions, and simple light baffles of tinplate are screwed on the inside over each hole, Fig. 73. So

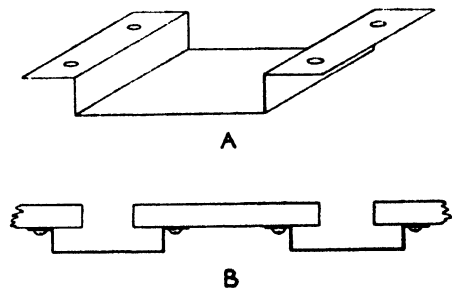

FIG. 73. A. TINPLATE LIGHT Baffle FOR EPISCOPE VENTILATORS
 B. DIAGRAM SHOWING Baffles IN POSITION

that the lower holes may be effective ventilators, the instrument is fixed on legs which hold the base a few inches above the bench. In spite of the numerous ventilators, the instrument tends to become very hot when in action, and it is wise to add chimneys made of tinplate to the top set of holes. Chimneys on the holes which are immediately over the lamps are particularly valuable. These additions are unsightly and they detract from the appearance of the apparatus, but the life of filament lamps is reduced considerably by overheating.

In the middle of the episcopes front is built a lens supporting structure. The lens itself slides smoothly in a jacket which is held firmly by means of brackets. For ordinary purposes, only a small range of focusing movement is necessary and the sliding device is quite sufficient, provided that the depth of the instrument case from front to back has been wisely chosen.¹ The lens panel of the episcopes is a suitable support for the lamp control switch.

Opposite the lens, in the wooden back of the episcopes, a hole about five inches square is cut. The wood round the hole is painted black to form a mask for the objects exhibited. The hole may be covered by a sheet of glass clipped to the back of the instrument, so that a picture can be held in the correct position for projection by merely pressing it against the glass. This scheme is not very satisfactory in practice, however, as the intense heat focused on to the picture area tends to crack the glass. A less convenient but more practicable arrangement is to have the glass plate fixed in a hinged frame which is subjected to heat only whilst a picture is actually being projected, Fig. 74. The glass, frame and picture can be held in position by a hinged board which is fastened by cord to the top of the instrument when

a particular picture has to be projected for a considerable length of time or when the operator needs to have his hands free during projection, Fig. 74.

Provided that the room is reasonably dark, the episcopes will project an image to fill a three foot screen, when using a 500 watt lantern lamp as illuminant. With ordinary filament lamps in the instrument the results obtainable are not nearly so impressive, as it is difficult to concentrate the light on the picture. Polished metal reflecting pieces behind the lamps do help of course, but they cannot produce an effect comparable with that of the concave reflector fitted to a lantern lamp. Two projector lamps with reflectors, each of 250 watts, form the ideal lighting system for the episcopes, for with them the problems of cooling are not so acute as with a single higher powered bulb.

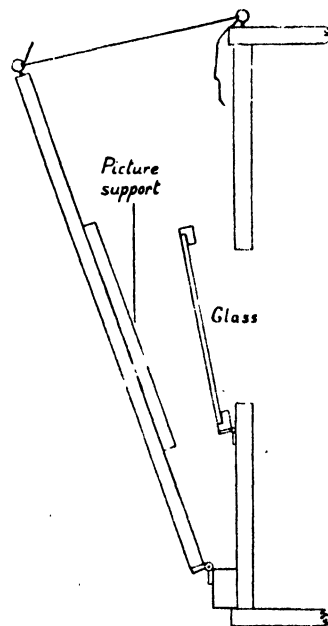

FIG. 74. ARRANGEMENT OF THE GLASS, FRAME AND PICTURE SUPPORTING DEVICE AT THE BACK OF THE EPISCOPES

¹ If an object is between twice and once the focal distance from a convex lens, the image is some distance from the lens, and is real and magnified.

Both in constructing and in using the instrument, the urgent need for cooling must constantly be borne in mind. The inside of the apparatus should be painted white to reflect light on to the picture and to prevent undue absorption of heat. The outside should be dark to serve as a good radiating surface. Short cooling periods, during which the lamps are turned off and the lamp house doors and picture square are opened, should be arranged as frequently as convenient when the instrument is being used in class. Valuable illustrations should not be subjected to the heat for long periods, as they may be scorched or may stick to the glass panel. The limitations of the episcopes seem very serious when gathered together in this way, but in practice the instrument is quite convenient, as the small group of illustrations connected with a particular lesson can be shown in a short time, during which troublesome excessive heat is not likely to be generated.

The optical lantern.—By arranging to study the optical lantern after the episcopes, special attention is directed to the condensing lens instead of the objective, as the function of the latter is obvious from the earlier work. Like the *burning glass*, the condenser of a lantern changes the direction of rays of light without being concerned with the formation of images. The object in an optical lantern is illuminated by transmitted light concentrated upon it by the condenser, but that in an episcopes depends on light which reflects from its surface. By examining the two instruments side by side the points of similarity and difference may be judged. A cinematograph added to the group and inspected with the others will show itself to be merely an adaptation of the lantern. Corresponding components in the three instruments should be compared.

The lantern can be modelled very easily. A motor car headlamp bulb, mounted on a suitable wooden stand, is placed inside a cardboard box so that its filament is on a level with the centre of a cheap convex lens

fixed in the box end. One end of the lamp house is left open, so that adjustments to the lamp may be made when necessary, Fig. 75. The lens need not be greater than

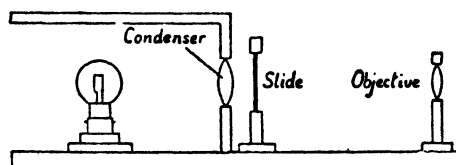

FIG. 75. MODEL OPTICAL LANTERN

a common reading glass in size, as no attempt to project a full-sized lantern slide is to be made. On the extended base of the lamp box stand the other components of the model. Near the lens is the slide support, and some distance away is the simple convex objective mounted in a suitable frame, photograph page 267. The best positions for the various movable parts of the model are determined by trial.

The size of the slide which may be projected depends on the aperture of the condensing lens in the box end. A standard lantern slide can be used if desired, but only a portion of it will be reproduced on the screen, unless a very large lens is being employed as condenser. More convenient transparencies can be made by mounting single frames of 35 mm. film between glass, or by drawing simple sketches on glass with slide makers' ink. Toy magic lantern slides are another excellent alternative.

An optical lantern for general school use can be constructed by boys, as such a project is particularly straightforward. A standard lamp, condenser and objective are purchased and a framework to support these is planned on conventional lines. The open stage type of instrument is easiest to make and most convenient in use. A long baseboard supports the whole of the apparatus, the lamp house assembly being fixed at one end, whilst the objective lens unit slides in grooves at the other, Fig. 76.

The lamp house consists of a framework

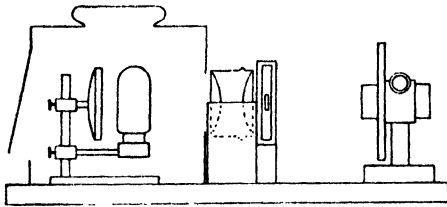

FIG. 76. ARRANGEMENT OF SIMPLE OPEN STAGE OPTICAL LANTERN

of strip steel to which sheet metal panels are bolted. Ventilation openings and a chimney are planned in the usual way. The condenser is supported in a large wooden block which stands immediately in front of the large circular window in the lamp house. The same block holds the wooden slide carrier. To prevent stray light from reaching the screen, a disc of plywood is fitted on the objective stand round the lens. Focusing is effected by sliding the front unit of the lantern in its grooves.

How certain appliances help the eye.—A great many instruments have been devised to help the eye, and hundreds of examples of these are in constant use. Most of them are very simple, but some use several optical principles to attain a comparatively complex result. Those devices which are commonly encountered in everyday life are for the most part of the first kind and may be classified in five groups:—

1. Appliances which utilise transparent material.
2. Reflectors.
3. Spectacles.
4. Instruments which form virtual images.
5. Devices using radiation other than ordinary light.

Transparency.—The value of this optical property can be shown by gathering together examples of its application in common appliances. Four lists may be made, showing transparent and translucent materials and also appliances which use these substances.

The following tables suggest promising lines of development:—

<i>Transparent Materials</i>	<i>Translucent Materials</i>
Glass	Frosted glass
Water	Tracing paper
Mica	Fog
Ice	Textile fabrics
<i>Transparent Appliances</i>	<i>Translucent Appliances</i>
Windows	Bathroom windows
Windscreens	Camera focusing screens
Glass ovenware	Pearl filament lamps
"Cellophane" wrappers	Curtains
<i>Reflectors which form images</i>	<i>Reflectors which merely redirect rays of light</i>
1. <i>Magnifiers and Reducers</i>	1. <i>Mirrors</i>
Shaving mirrors	Cycle rear reflectors
Powder compact mirrors	Lamp reflectors
Snapshot viewers (Fig. 77)	Heliographs
Motorists' mirrors	Galvanometer mirrors
2. <i>Plane mirrors</i>	2. <i>White surfaces</i>
Reflecting signs	Whitened kerbs
Looking glasses	Cycle mudguard flaps
Periscopes	Ceilings
Kaleidoscopes	Tennis and golf balls

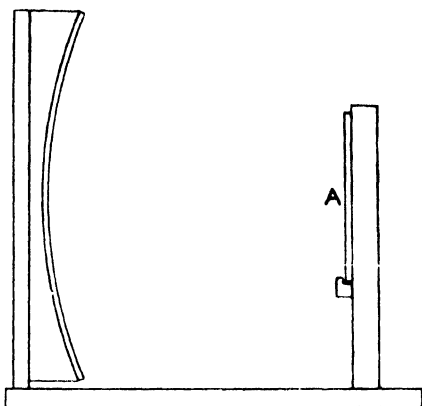

FIG. 77. SNAPSHOT VIEWER
(An enlarged virtual image of the small snapshot A is seen in the concave mirror)

eye defects and their correction give an opportunity for recapitulating and reviewing the subject matter of the whole section. Properly presented, this branch of the work encourages the pupils to have respect for

Spectacles.—By means of well-chosen lenses, the correction of long- and short-sight defects may be demonstrated directly on the ray board. To do this, a simple outline of the eye is drawn on the board and a cylindrical convex lens is put in position to represent the eye lens. In a normal eye, the lens focuses a beam on to the retina, Fig. 78A. Short-sighted and long-sighted eyes are represented by using a stronger and a weaker lens, or more conveniently by using the same lens as that in the normal eye but fitting it in a larger or smaller drawing, Fig. 78 B and C. The rays in a short-sighted eye focus at a point which falls short of the retina, and a correction is made by inserting a concave spectacle lens in front of the cornea, Fig. 79A. A long-sighted eye focuses at a point beyond the retina and is corrected by a convex spectacle lens, Fig. 79B. The spectacle lenses which are used are of course of the cylindrical type. The size of the drawings on the ray board has to be determined by trial, as it depends on the lenses which are to be used. Those lenses which represent spectacles should be of long focal length so that they do not deviate the rays very much when put in position.

Presented towards the end of the topic,

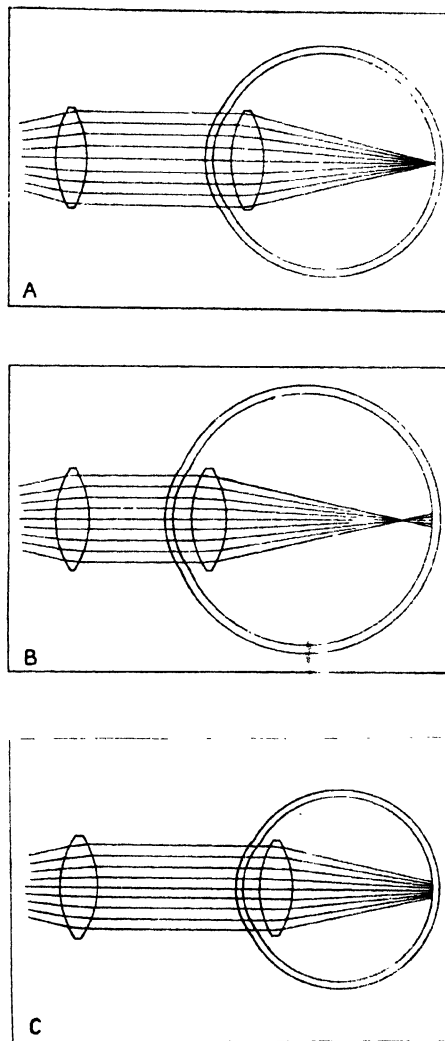

FIG. 78. EYE DEFECTS DEMONSTRATED ON THE RAY BOARD
A. A NORMAL EYE
B. A SHORT-SIGHTED EYE
C. A LONG-SIGHTED EYE

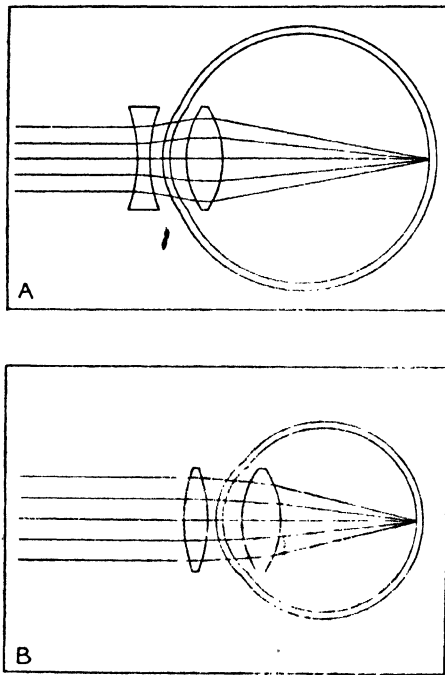

FIG. 79. A. A SHORT-SIGHTED EYE CORRECTED BY MEANS OF A CONCAVE LENS
B. A LONG-SIGHTED EYE CORRECTED BY MEANS OF A CONVEX LENS

the eyes as instruments of the highest quality, it discourages the practice, so common nowadays, of using cheap spectacles indiscriminately, and it fosters intelligent interest in the services rendered by oculists and opticians.

Instruments which form virtual images.—

This group includes reading glasses, binoculars, microscopes and telescopes. For the sake of completeness, these instruments should be mentioned, but it is not possible to give an adequate explanation of them in

the senior school. The geometrical methods of treatment essential to such explanations are not as satisfactory as they appear to be, as boys often have difficulty in visualising light in a mathematical way. Shaded blocks are more readily accepted as diagrammatic representations of the facts that are series of lines (Fig. 80), but the block system is not elastic enough for use with complex optical devices. It is recommended, therefore, that little be attempted in connection with the virtual image group of instruments beyond simple inspection and use.

Devices using radiation other than ordinary light.—The X and cathode rays have such important applications in penetrative photography and television that their existence cannot be ignored by the science teacher. These forms of radiation are, however, outside the sphere of the senior school, and this should be stated quite frankly in class. A little general discussion might be based on these modern features of science, and a few illustrations may be shown, but the subject should then be left. Such incompleteness is not without value, for it suggests that beyond the school course there are still many scientific worlds to conquer.

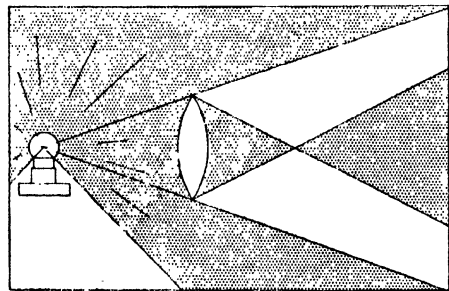

FIG. 80. SHADED BLOCK TYPE DIAGRAM, SHOWING THE EFFECT OF A CONVEX LENS

APPENDIX

THE following lists of useful tools have been compiled primarily to help those science teachers who, having little or no experience of handicraft, find difficulty in choosing the best items for their requisitions. The particular tools mentioned have been chosen to meet the requirements of a science teacher who has to work quite independently of a handicraft room or centre and who proposes to undertake constructional activities of the kind described in the preceding pages. The lists follow the lines laid down in the Board of Education's memorandum on senior school science teaching, but several omissions and additions have been made.

As many teachers in the older schools will be required to obtain their equipment through the normal channels without the aid of a special grant, the full range specified may be attained only as the result of many small purchases spread over a long period of time. Those more fortunate may enjoy the pleasure of acquiring a complete outfit at once, or may have a small allowance with which to make a start. In any case it is useful to have the items separated into two groups, the first of which embraces those tools which may be considered to be *essential*.

List A which follows contains these essential tools. As personal choice and opinion enter into this matter of selection, the list will not necessarily coincide with every teacher's judgment, but it will, at any rate, help the novice to avoid wasting time and money. Sufficient details are given to enable the reader to trace the tools in a toolmaker's or contractor's catalogue. List B gives other valuable items of equipment which are well worth their purchase money but which can hardly claim to be indispensable in the science room.

When extensive constructional projects are being carried out, certain tools are in

constant demand, and when circumstances permit it, the purchase of two specimens of each of these is worth while. The tools which are marked with an asterisk * in the lists may advantageously be duplicated, or modified forms of them may be bought.

List A

- 1 Hand saw, 22 in.
- 1 Tenon saw, iron back, 10 in.
- 1 Hacksaw frame, adjustable, pistol handle.
- 1 Fretsaw frame, 12 in.
 - 8 in. or 10 in. hacksaw blades, 24 teeth to the inch.
 - Ditto, 32 teeth to the inch.
 - Fretsaw blades, medium.
- 1 Iron smoothing plane, 2 in. blade.
- *1 Engineer's hammer, with handle, $\frac{1}{2}$ lb., cross pein.
- *1 Screwdriver, electrician's, narrow.
 - 1 Ditto, cabinet, 6 in. blade.
- *1 Ditto, ditto, 3 in. blade.
- *1 pair Tinman's snips, straight, 8 in.
 - 1 pair Scissors, 6 in.
- *1 Hand drill, capacity 0 to $\frac{1}{4}$ in.
- *1 set Drills, twist, $\frac{1}{16}$ in. to $\frac{1}{2}$ in. in 32nds.
- *1 pair Pliers, combination, 6 in.
 - 1 Brace, Joiner's, ratchet, 10 in.
 - 1 Auger bit for brace, $\frac{1}{2}$ in.
 - 1 Ditto $\frac{3}{8}$ in.
 - 1 Ditto, $\frac{1}{2}$ in.
 - 1 Centre bit for brace, 1 in.
 - 1 Small adjustable spanner.
 - 1 Try square, steel, 4 in.
 - 1 Centre punch, fine point.
 - 1 Wood chisel, $\frac{1}{2}$ in.
 - 1 Cold chisel, cross cut, $\frac{1}{4}$ in. by 4 in.
 - 1 Soldering bit, electric or 12 oz.
 - 1 set Files with handles, second cut, 6 in. Round, square, triangular, half round and flat.
 - 1 set Stocks and dies, sizes 4 B.A. and 6 B.A.

278 TEACHING IN PRACTICE FOR SENIORS

- 1 set Plug and taper taps, sizes 4 B.A. and 6 B.A., with wrench.
- 1 Twist gimlet, small.
- 1 pair Pincers.
- 1 Bradawl, small.
- 1 Oilstone, washita.

List B

- 1 Engineer's hammer, with handle, 1 lb., ball pein.
- 1 Steel rule, 12 in.
- 1 Knife.

- 1 Wood chisel, $\frac{3}{4}$ in.
- 1 Cold chisel, flat, $\frac{1}{2}$ in. by 6 in.
- 1 Soldering bit, 2 oz.
- 1 Scriber.
- 1 Mallet, joiner's, 4 in.
- 1 Centre bit for brace, $1\frac{1}{2}$ in.
- 1 set Stocks and dies, sizes 2 B.A., and Whitworth $\frac{1}{8}$ in., $\frac{3}{16}$ in., $\frac{1}{4}$ in., and $\frac{5}{8}$ in.
- 1 set Plug and taper taps, sizes 2 B.A., and Whitworth $\frac{1}{8}$ in., $\frac{3}{16}$ in., $\frac{1}{4}$ in., and $\frac{3}{8}$ in., with wrenches.



THE OLD OBSERVING-ROOM, GREENWICH

DOMESTIC SCIENCE



From the painting by F. Madox Brown.

[By courtesy of the Town Hall Committee of the Manchester Corporation.

DALTON COLLECTION: MARSH FIRE GAS

INTRODUCTION

IN working out this scheme the writer has had in mind two chief ideas— (1) the educational value of scientific training, and (2) the practical application of scientific knowledge. We live in a scientific age and the discoveries of scientists help towards a simpler and fuller life than was possible for our ancestors. Machinery does much for us that was previously done by hand workers and multiple production has done away with much individual work. The worker in any trade has not the satisfaction of making a complete article as he used to have. He spends his time in routine repetition of a simple operation and becomes expert in his little part of the whole; but his work calls for very little exercise of his intelligence. We cannot, and would not if we could, do away with machinery, but we must, in educating a child, remember that the education gained in the old days by skilful craft work is no longer possible to-day, but that we must so train our children that they are able to use their minds in every department of life, and they will be able to spend their leisure profitably as well as pleasantly.

All normal children are interested in the why and wherefore of things, and are naturally delighted with the wonder of life. A person is never really old so long as he can be interested in something new and it is important that teachers should aim at

helping their children to retain this wonder all through life. Science is knowledge, and all knowledge is an asset in helping one to a fulness of life. But it is not the mere knowledge of scientific facts which is valuable, but the ability to discover truths for oneself.

That is why all scientific training should be practical. The children should work out most of the experiments for themselves, and be helped to make their own conclusions from the experiments. The progress may seem slow at first, but the training of the mind is most valuable.

All the experiments suggested in this course can be made by the children, and it will be found that they will suggest other ways of proving the same things.

The scheme has been carefully worked out for children of senior school age. If a fourth year is possible, the girls can specialise in botany, for the children will then have sufficient knowledge of elementary science to help them to understand better their botanical work, and make it most enjoyable.

In a rural school this domestic science course will help the children to understand and take an interest in agricultural processes. The knowledge obtained will be remembered, and the children will not merely accept facts, but will want to investigate for themselves.

SYLLABUS

FIRST YEAR'S COURSE

1. General properties of three forms of matter.
2. Simple experiments to show effect of heat.

Change of condition:—

- (a) Solids become liquids.
- (b) Liquids become gases.
- (c) Some solids; e.g., iodine, burn directly into gas.

3. Use of a thermometer.

Experiments to find melting point and boiling point of various substances:—

- (a) Water.
- (b) Fat.
- (c) Alcohol.
- (d) Liquids compared.
- (e) Ice.

4. Expansion of solids.

Experiments with:—

- (a) Ball and ring.
- (b) Steel knitting needles.
- (c) Iron and copper compared.

5. Expansion of liquids and gases.

Experiments with:—

- (a) Water.
- (b) Spirits.
- (c) Air.
- (d) Comparison of gases.

6. Types of thermometers.**7. Use of the balance.****8. Metric weights and measures.****9. The principle of Archimedes.****10. Density of solids.**

- (a) Experiments with coins, glass, nails, etc.
- (b) Experiments with wax, cork.

11. Specific gravity of liquids.

- (a) Brine.
- (b) Milk.
- (c) Milk and water.
- (d) Olive oil.

12. Heat.

Experiments illustrating conduction, convection and radiation.

13. Air.

Experiments illustrating its physical and chemical properties:—

Weight, pressure, hot and cold air, water in the air, evaporation.

1. Water.

- (a) Its physical properties—air dissolved in water; expansion; contraction; evaporation and condensation; pressure exerted by water vapour.
- (b) Solubility of various substances in water.
- (c) Using a filter.
- (d) Hard and soft water.
- (e) Degrees of hardness—soap solution tests.
- (f) Removal of hardness—lime water and carbon dioxide.
- (g) Chemical constituents of water.
- (h) Hydrogen and its properties.
- (i) Impurities in water, inorganic and organic.
- (j) Importance of a good water supply.
- (k) Sources of water supplies.
- (l) Porosity of soils.
- (m) Wells and springs.

2. A flame.

- (a) Zones of luminosity and heat—candle and the Bunsen burner.
- (b) Incandescence.
- (c) Methods of heat—coal, gas, electricity.

3. Acids, alkalis and salts.

- (a) Tests with litmus.
- (b) Washing soda—its properties and uses.
- (c) Soap and its formation.

4. Air.

- (a) Its chemical constituents—oxygen, nitrogen, carbon dioxide.
- (b) Preparation of oxygen—tests to illustrate properties.
- (c) Carbon dioxide as an impurity in the air.
- (d) Ventilation and its importance.

SECOND YEAR'S COURSE

A series of experiments for children and for demonstration, illustrating:—

THIRD YEAR'S COURSE

A series of lessons supplemented by simple experiments relating to:—

1. Food.

- (a) Its necessity and effect on the various functions of the body.
- (b) Composition of foods—hydrogen, oxygen, carbon, nitrogen, mineral matter.
- (c) Starch—iodine tests.
- (d) Starch and its presence in various foods.
- (e) Sugar and its presence in various foods—Fehling's solution.
- (f) Nitrogenous foods.
- (g) Vitamins.
- (h) Fats.
- (i) Careful examination of milk, eggs and potatoes.
- (j) Combination of foods necessary for the well-being of the body.
- (k) Cooking—changes in food.
- (l) Principles of dietetics.

2. Food and its digestion.

- (a) Teeth and their care.
- (b) The salivary glands.
- (c) The stomach—gastric juices—osmosis.
- (d) The intestines and their juices.
- (e) Indigestion—some causes.

3. Food and its absorption by the body.

- (a) Fundamental needs.
- (b) Breathing—lungs, ribs, diaphragm.
- (c) The heart and its work.
- (d) The blood and circulatory system.

4. General principles of health.

- (a) Cleanliness—personal, home.
- (b) Exercise and rest.
- (c) Housing and conditions for health.

1 dozen specific gravity bottles, 1s. each.
Mahogany shelving for specific gravity bottles.

1 dozen tinned sand baths, 1s. 2d. each.
2 dozen beakers at 4s. a dozen.
2 dozen beakers at 6s. a dozen.
2 dozen beakers at 6s. 6d. a dozen.
10 test tube racks, 1s. 4d. each.
2 retort stands with rings, 4s. 6d. each.
1 dozen flatbottomed flasks at 3s. a dozen.
1 dozen flatbottomed flasks at 4s. a dozen.
1 dozen porcelain evaporating dishes, 5s. 9d. a dozen.
3 dozen small watch glasses.
1 dozen glass funnels, 4s. 6d. a dozen.
3 fitted flasks for demonstration, 1s. 9d. each.
3 fitted flasks for generating oxygen, 1s. each.
1 dozen measuring cylinders, 1s. 2d. each.

6 packets of filter paper, 3d. a packet.
2 dozen pieces of wire gauze, 1s. a dozen pieces.
3 glass tube cutters, 1s. each.
Set of measures—litre, half litre, quarter litre.

10 funnel stands, 2s. 6d. each.
Litmus paper:
(Red) 1 dozen books, 1s.
(Blue) 1 dozen books, 1s.
2 gross of test tubes 2 in. long, diameter $\frac{3}{8}$ in., 4s. 9d. a gross.
1 dozen test tube holders, 3s. 6d. a dozen.
1 large pneumatic trough tin, with movable shelf, for collecting gas, 6s. 6d.

2 lb. thermometer tubing, 2s. 3d. a lb.
2 lb. barometer tubing, 2s. 2d. a lb.
1 ball and ring to show expansion.
1 pyrometer.
1 double bar, 2 kinds of metal.
Starch paper.
Reagents—HCl H²SO⁴ HNO³ NH³.
Iron filings.
Manganese dioxide.
Copper filings.
Small pieces of marble.
Calcium carbonate.

APPARATUS

The following is a list of apparatus needed for a class of twenty children, working in pairs:—

- 5 balances, £1 9s. 6d. each.
- 1 dozen thermometers, 32°—240° F.
- Spring balances, 1s. 2d. each.
- Balance weights in boxes, 8s. 6d. each.

FIRST YEAR'S COURSE

LESSON 1

General properties of three forms of matter.—There are three states of matter—solids, liquids, gases. Solids have definite shape and keep that shape under ordinary conditions, wherever they are placed. Liquids take the shape of the vessel in which they are placed. Gases also take the shape of the vessel which contains them. They spread out and fill all the space available, but if not kept in closed vessels they pass out into the air of the room. Both liquids and gases can be poured from one vessel to another.

All substances are made up of tiny particles called atoms. In solids these particles are closely packed together. We say they attract each other, and this makes them cohere. In liquids and gases they are not so closely packed together, they move more freely and tend to spread apart, and so they flow. This flow is not equal in all liquids; water spreads very rapidly, oil and treacle flow more slowly. Liquids always have a level surface, and if liquid is poured into a bent or curved tube or vessel it will be the same level in both sides of the bend.

Experiment 1.—Turn on the gas in one part of the room. We soon notice a smell of gas in other parts of the room. Why is this? The gas has been allowed to escape from the pipe, and is spreading out into the room. We say it is diffusing into the room.

Experiment 2.—Invert a flask full of water on a beehive shelf in a trough full of water, so that the mouth of the flask is below the level of the water. Attach a piece of rubber tubing to a gas tap and let this tube lead under the water in the trough near the mouth of the flask. Turn on the gas.

Result.—Gas bubbles through the water into the flask, which becomes emptied of water, Fig. 1. What do you suppose is now

in the flask? How can you prove this? Smell the flask. It is now full of coal gas. The water will smell slightly of gas. We learn that coal gas is only very slightly soluble in water. Leave the flask. Smell it again in a few minutes. We cannot now smell gas. Where has it gone? It has diffused into the air of the room, is mixed with it and now occupies much more space than it did when first collected.

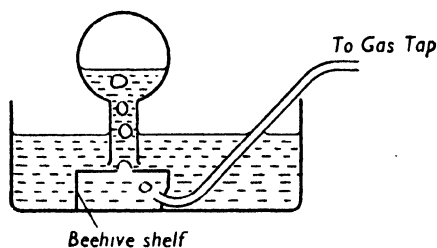

FIG. 1.
FILLING A FLASK WITH COAL GAS

Experiment 3.—Heat some lead pellets in an iron spoon over a Bunsen flame. What happens? The solid has become liquid and now flows about in the spoon. The pellets have lost their definite shape. Pour some of the molten lead in drops into water. What happens? We get a number of lead pellets again. The removal of heat has caused the liquid again to become solid.

Experiment 4.—Heat some butter, lard or other fat, in an evaporating dish. It also becomes liquid and can be poured like any other liquid. If we remember this we can make use of our knowledge to help us to remove grease spots from a dress or coat. Place the greasy part over a piece of blotting paper and then iron over the grease spot. The heat melts the grease, which is absorbed by the blotting paper.

Experiment 5.—Heat some water in a flask. After a time it boils and we see steam coming from the mouth of the flask. This passes into the air of the room and becomes invisible. In the same way steam passes into the air of a room from a kettle of boiling water. The heat has turned the water into its gaseous form. Have you ever noticed that, after a shower of rain if the sun shines strongly, little clouds of steam arise from the ground or flags? The flags dry. The water has disappeared. In this case, what was the source of the heat to bring about the change? Why do clothes dry more quickly on a hot sunny day than on a cold day?

Experiment 6.—Boil some water in a flask, and hold a cold spoon in the path of the steam. What happens? The spoon is covered with little drops of moisture, Fig. 2. The vapour has become cooled again and turned into liquid. We say it has condensed.

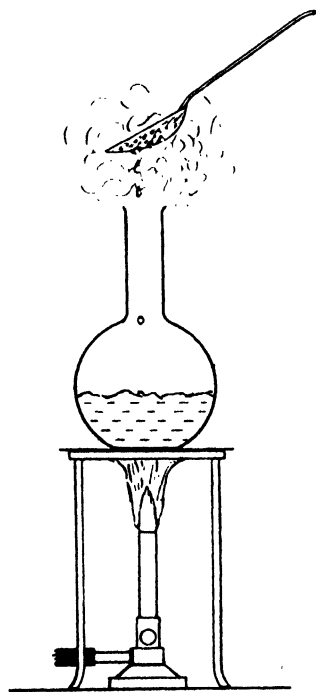

FIG. 2.
CONDENSING VAPOUR

Experiment 7.—Place a little ether or eau de cologne on your hand. Very soon it disappears. Where has it gone? What sensation had you on your hand? It felt cool. The heat from your hand was used to change the ether into a gas. You can now understand why, when you have a headache, eau de cologne on your head makes it feel cooler. If you wear damp clothes or shoes the heat from your body is used up to drive the moisture out of the clothes, and you feel cold. Why do you feel cooler when you wash in cold water on a hot day? Generally when solids are heated they turn first into liquids and then into the gaseous form. Sometimes a solid can pass directly from the solid to the gaseous state.

Experiment 8.—Heat a few iodine crystals in a glass tube. There is no change to a liquid form, but the iodine is quickly converted into a purple vapour, which in the cool upper part of the tube condenses again into the solid form on the sides of the tube, Fig. 3. Some substances which are liquid at ordinary temperatures become solid when very cold; e.g., water turns into ice.

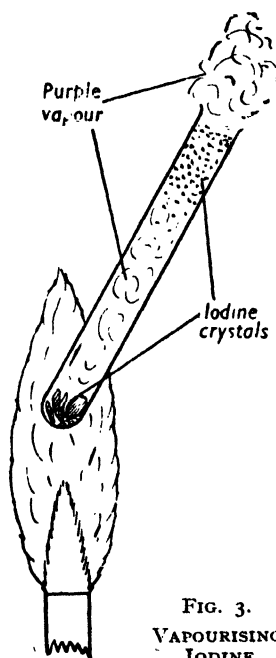

FIG. 3.
VAPOURISING
IODINE

Experiment 9.—Pound up some ice and salt. Fill a small test tube with water. Insert the test tube in the mixture and leave it, Fig. 4. In a short time the test tube is full of ice. It is possible with great cold to turn some gases into liquids; e.g., liquid air, liquid carbon dioxide.

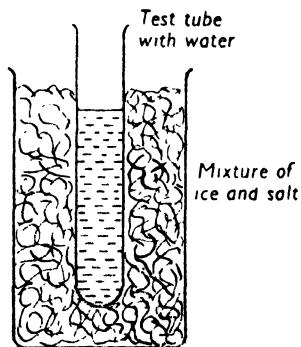

FIG. 4.
CHANGING WATER TO ICE

LESSON 2

Use of a thermometer.—To find the melting points and boiling points of various substances.

Experiment 1.—To find the boiling point of water. Fill a flask half full of water and place on a piece of wire gauze on a tripod stand over a Bunsen flame. Place a thermometer in the flask. What do you notice as the water gets hotter? The mercury gradually rises in the thermometer tube until, when the water boils, it remains steady at 212° , Fig. 5. No matter how long you continue to boil water the mercury does not rise above 212° . Continued heating does not make the water any hotter. The heat is gradually used in converting the water into steam. What is the temperature of steam coming from the boiling water?

Experiment 2.—Now remove the thermometer from the boiling water for a minute, then hold it in the steam coming out of the flask. Notice the position of the mercury in the thermometer tube. It is still at the 212°

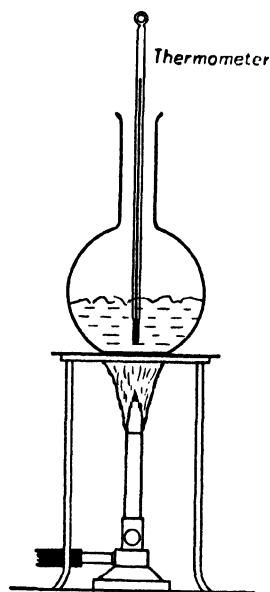

FIG. 5.
FINDING THE BOILING
POINT OF WATER

mark. Steam from boiling water is the same temperature as the boiling water. We call the extra heat which is used up in changing water to steam, the latent heat of water. When the steam changes back to water, the heat used to turn the water into steam is given up. This explains why a scald from steam is much more severe than a scald from boiling water. Steam is often used in pipes for heating rooms. As it changes into hot water in the pipes, it gives up this latent heat and as the temperature of the water falls it is continually giving out heat into the room. Sometimes in factories waste steam is led into cold water tanks, and gradually the water boils. This is used for making tea for the employees. Sometimes your mother cooks vegetables in a steamer, Fig. 6. In the pan there is hot water and perhaps potatoes. In the upper vessel there may be another vegetable. The water boils, turns into steam, passes up into the upper vessel over the vegetables, changes to water, gives up its latent heat and goes back into the

lower vessel. It is the latent heat of the steam which is used to cook the vegetables in the upper vessel. This is an economy in the use of a gas stove as two or three containers can hold different vegetables which can all be cooked with the heat from one burner.

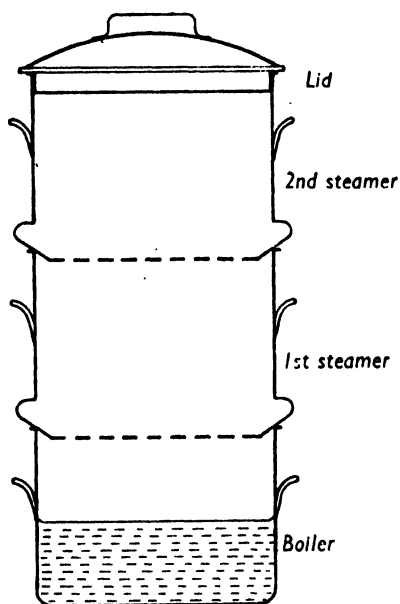

FIG. 6.
COOKING VEGETABLES

Experiment 3.—To find the melting point of butter or lard or any solid fat. Partly fill a beaker with water and place it on a piece of wire gauze on a tripod stand over a Bunsen flame. Coat the bulb of a thermometer with fat, place it in a test tube and place the tube in the beaker, Fig. 7. Note the temperature at which the fat begins to melt. You will see that once the fat has begun to melt there is no change in the temperature recorded by the thermometer. The extra heat is used up in changing the fat into the liquid state. The melting point of all fats is lower than the boiling point of water. Continue heating the melted fat until the water in the beaker boils.

The fat is still not boiling, therefore we know that boiling fat is hotter than boiling water.

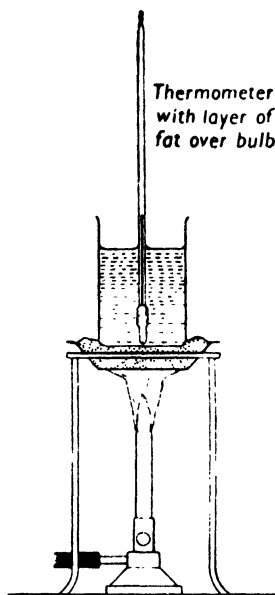

FIG. 7.
MELTING POINT OF FAT

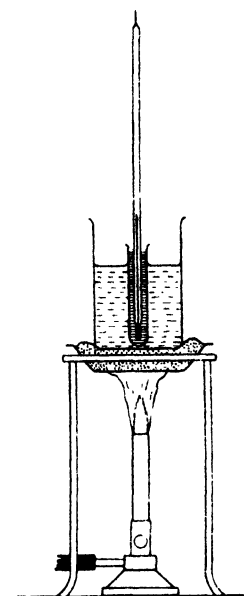

FIG. 8.
BOILING POINT OF ALCOHOL

Experiment 4.—To find the boiling point of alcohol. Place a little alcohol or methylated spirit tinged with red ink in a test tube. Place this in a beaker of water on a piece of wire gauze with a sand bath over it (as alcohol is highly inflammable) on a tripod stand, as in the previous experiment. Place a thermometer in the tube in the beaker, and heat, Fig. 8. Note that alcohol boils at a much lower temperature than water.

Experiment 5.—To show that various liquids expand at varying rates when heated to the same temperature. Take three small beakers. Half fill them with water. Take three test tubes. Half fill them with (1) coloured water, (2) alcohol coloured with red ink, (3) glycerine coloured with black ink. Place them on a sand bath on wire gauze over a Bunsen flame. Note the various heights to which liquids rise when heated

for the same time. There is no need to wait till any of them boil.

Experiment 6.—To find the freezing point of water. Make a freezing mixture of salt and broken up ice. Place a small test tube partly filled with water in the mixture, and place a thermometer in the test tube, Fig. 9. Note that the temperature gradually falls until the water freezes at 32° . Now you will be in a position to understand why for all ordinary purposes mercury is the best liquid we can use in a thermometer. The reasons are:—

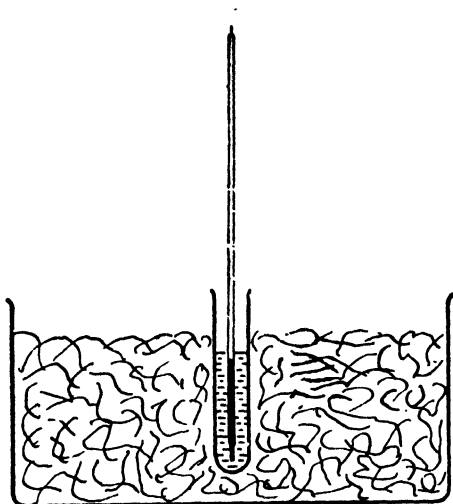

FIG. 9.

FINDING THE FREEZING POINT OF WATER

1. It is easily seen.
2. It does not smear the glass.
3. Its boiling point is high.
4. Its freezing point is very much lower than the freezing point of water.
5. It expands regularly.

LESSON 3

Expansion of solids.

Experiment 1.—For this the ball and ring apparatus is needed. The ball when cool is just able to go through the ring. Suspend

the ball over a Bunsen flame and heat strongly for five minutes. Now lower the ball to the ring. It no longer passes through the ring but rests on the top, Fig. 10. Why is this? Heat has made it expand. Leave the ball lying on the ring. After a short time it falls through the ring. It has cooled and returned to its original size.

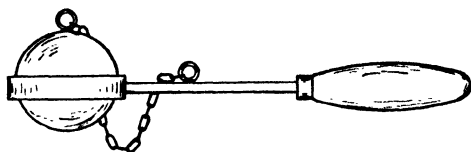

FIG. 10.

EXPANDED BALL RESTING IN RING

You sometimes have difficulty in removing a stopper from a bottle. Do not try to force it. Place the neck of the bottle in hot water for a few minutes. Then you will be able to remove the stopper easily. The neck of the bottle has expanded, and the stopper can easily come out. You can also remove a tight cork in the same way. This increase in size on heating is called expansion. In everyday life this has to be thought of. Have you ever noticed the join where two ends of a tram line or railway line meet? There is a short space between one portion of rail and the next. In hot weather the spaces are smaller because the rails have expanded. If they were placed exactly touching one another when they expanded they would make the line unlevel and trams would not be able to keep on the rails. A simple thing like this prevents serious tram and rail accidents. In building steel bridges allowance has to be made for this expansion. I expect you have noticed that some wheels have iron tyres. These are put on when red hot and then the wheel is plunged into cold water. This binds the wheel tightly as the tyre contracts when cooled. Iron staves on barrels are also put on in the same way, and for the same reason. Sometimes when you wash dishes you pour hot water on to certain parts of the dishes or glasses. The

heated part expands, the other part does not. This results in a crack. Put your dishes into the hot water, and you then have equal expansion of all parts and no cracking.

Experiment 2.—Take a steel knitting needle and fix one end firmly to a retort stand. The other end is free to move. It should rest at the other end on a long pin which passes through a thin piece of cardboard which acts as an indicator. The pin rests on a support so that it is quite level. The rod is heated in the middle by means of a large burner, Fig. 11. The indicator moves. The heat made the rod expand and that makes the pin roll round on its support. Take away the burner. The knitting needle cools down and the indicator moves back as the pin rolls in the opposite direction. This can be repeated with thin copper and brass rods.

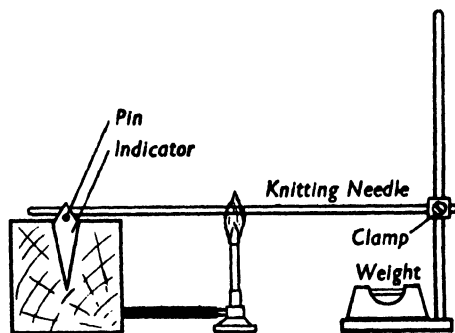

FIG. 11.
EXPANSION OF STEEL

General inference.—Metals expand when heated.

Experiment 3.—For this experiment we need a compound bar, that is, a bar made of iron on one side and brass or copper on the other, fastened together at each end. This bar can be fixed firmly at each end to a stand, Fig. 12A, and then heated in the middle. After a time the bar is no longer straight but is curved upwards, Fig. 12B. It is held in the flame so that the copper rod is uppermost. The copper bar curves away from the steel bar, and curves upwards.

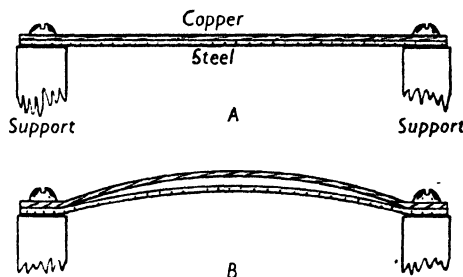

FIG. 12.

COMPARING EXPANSION OF IRON AND COPPER

General conclusions from this lesson.—

1. Heat expands solids.
2. They expand at different rates.

LESSON 4

Expansion of liquids and gases.

Experiment 1.—Fill a flask not quite full of water. Place in it a thermometer. Then place it on a sand tray on a tripod stand over a Bunsen flame. You will see the water gradually getting higher in the neck of the flask, Fig. 13, and very soon the water will

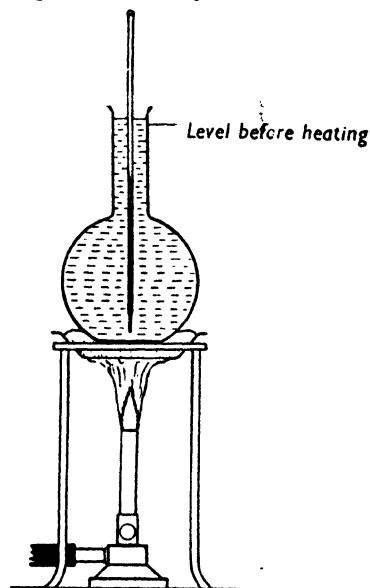

FIG. 13.
EXPANSION OF WATER

come over the sides of the flask. This happens as the water gets warm (shown by thermometer) but long before the water boils. Heat causes water to expand.

Experiment 2.—Take three small flasks of the same size. Fill one with water, another with turpentine and another with alcohol or methylated spirits. Fit each with a cork, bored with a hole to admit a piece of glass tubing. Push the corks into the bottles so that the liquid rises to the same level in each bottle. Mark this level with a piece of gum paper on the tube. Now place them all in a glass dish containing warm water. What happens? You will notice two things. The liquids rise in all the tubes, Fig. 14. They do not rise to the same height. The alcohol rises highest. The water rises least. We learn from this:—

1. That liquids expand when heated.
2. That some liquids expand more than others.

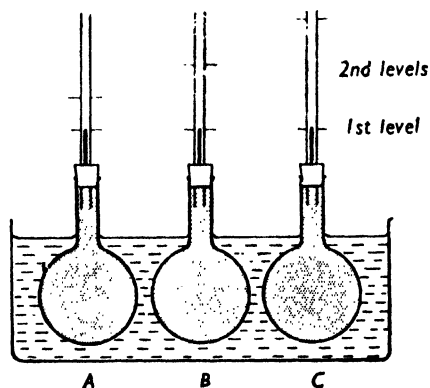

FIG. 14.
EXPANSION COMPARED OF WATER,
TURPENTINE AND ALCOHOL.

If, in addition, you place another flask fitted in the same way containing mercury, you will find that this expands less than some other liquids. When putting a kettle on the fire or a pan in which to boil liquids or cook vegetables, leave room for the expansion which takes place on heating the liquid. This will prevent boiling over, waste of material and resulting annoyance and extra work.

Experiment 3.—Take a small flask. Fit it with a cork bored so that a piece of glass tubing of very fine bore can pass through the cork and reach the bottom of the flask. Place in the flask a little coloured alcohol and insert the cork in the flask so that the tube dips into the alcohol. Place the flask in a vessel containing warm water. The alcohol rises up the tube, Fig. 15. The heated air in the flask has expanded and caused some of the alcohol to rise up the tube.

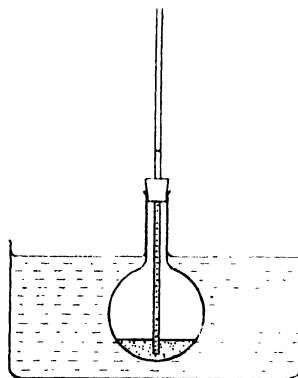

FIG. 15.
EXPANSION OF AIR

Experiment 4.—This experiment is for demonstration only. Fit up three flasks all exactly alike as in the previous experiment, and all containing the same amount of coloured alcohol. Let one of the flasks contain air, another coal gas, and the other carbon dioxide. Place all in the same vessel of warm water.

Result.—

1. Alcohol rises in each.
2. It rises to the same level in each,

Fig. 16.

All three gases have expanded when heated. All have expanded at the same rate.

General conclusions from these two sections:—

1. Solids expand when heated.
2. Liquids expand when heated.

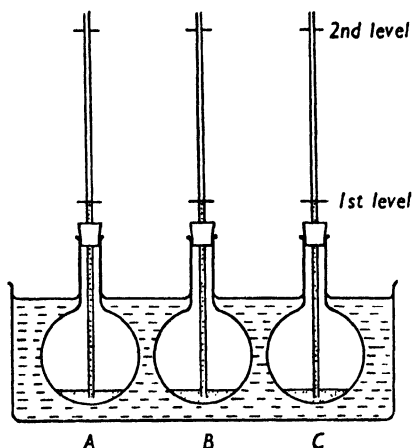

FIG 10.

COMPARISON OF EXPANSION OF AIR,
COAL GAS, AND CARBON DIOXIDE

3. Gases expand when heated.
4. Solids expand at different rates.
5. Liquids expand at different rates.
6. Gases expand at the same rate.

LESSON 5

Various kinds of thermometers.—The thermometer you have been using so far is called the Fahrenheit thermometer.

What is the boiling point of water indicated by this thermometer? What is the freezing point?

You are now going to use another kind of thermometer. It is called a Centigrade thermometer. Refer to the previous lesson when the temperature of boiling water was discovered. The children will be able to describe the apparatus used, and can repeat the experiment using the Centigrade thermometer. They will find by experiment that the boiling point of water on this thermometer is 100°.

Now you are to find the freezing point.

Repeat the experiment in the previous lesson, using a Centigrade thermometer.

The freezing point on this thermometer is 0°.

For everyday purposes we use the Fahrenheit thermometer, but for scientific purposes we use the Centigrade thermometer.

It will be useful to find out how to change from the Fahrenheit scale to the Centigrade scale, or from the Centigrade scale to the Fahrenheit scale.

How many spaces or degrees are there between boiling point and freezing point on the Fahrenheit scale? How many on the Centigrade scale?

180° Fahrenheit correspond with 100° Centigrade.

18° Fahrenheit correspond with 10° Centigrade.

9° Fahrenheit correspond with 5° Centigrade.

To change from Centigrade scale to Fahrenheit scale:—

∴ Find $\frac{9}{5}$ of the number on the Centigrade scale.

2. Add 32° to the answer.

This is the number of degrees on the Fahrenheit scale.

Example.—Change 35° Centigrade into Fahrenheit scale:—

$$\frac{9}{5} \text{ of } \frac{35}{1} = 63$$

$$63 + 32 = 95^\circ \text{ F.}$$

To change from Fahrenheit to Centigrade scale.

1. Take 32° from number on Fahrenheit scale.

2. Find $\frac{5}{9}$ of this number.

Example:—Change 131° Fahrenheit into Centigrade scale.

$$131 - 32 = 99$$

$$\frac{5}{9} \times \frac{99}{1} = 55^\circ$$

$$131^\circ \text{ Fahrenheit} = 55^\circ \text{ Centigrade.}$$

For further practice, allow the children to find the temperature of the air in the room and of tap water, and change from one to the other. If clinical thermometers are avail-

able, the children will enjoy taking each other's temperatures, and can calculate the change in another scale.

As a matter of interest, the children might be told that there is another kind of thermometer called from its inventor the Réaumur thermometer. In this, boiling point is 80° and freezing point 0° . It is used very little in this country.

LESSON 6

Use of the balance.—The weights used in this balance are those used in most other countries.

The unit of weight is 1 gram.

10 grams	= 1 Dekagram
100 "	= 1 Hectogram
1000 "	= 1 Kilogram
$\frac{1}{10}$ gram	= 1 decigram = .1 gram
$\frac{1}{100}$ "	= 1 centigram = .01 gram
$\frac{1}{1000}$ "	= 1 milligram = .001 gram

It is very easy to convert from one unit to another as it is always performed by multiplying or dividing by 10, 100 and 1000.

Whatever other tables are used, they are all built up in the same way, and consequently only the terms used for multiples, *Deka* (10), *Hecto* (100) and *Kilo* (1000), and for sub-multiples or parts, *Deci* (10), *Centi* (100) and *Milli* (1000) have to be remembered. These tables are used all over the Continent, and in some other countries as well.

Children must be taught to use the balance carefully. Nothing must be put in the pans when they are raised. Put the substance to be weighed in the left-hand pan of the balance. Then take the heaviest weight from the box. If that is too heavy, remove it and put on the next lighter one. If it is still too heavy repeat this, and continue, until when the balance is raised, both pans equally balance. Then add up the weights on balance beginning with whole grams first.

For example, suppose you have been weighing an object and at the end you have in the weight pan:—

- (a) 10 grams
- (b) 2 "
- (c) 1 gram
- (d) .5 gram
- (e) .01 gram
- (f) .002 gram

Whole grams:— $10 + 2 + 1$ grams = 13.

Fractions:— $.5 + .01 + .002$ = .512.

Total = 13.512 grams.

For practice let the children find the weight of:—

1. A halfpenny.
2. A penny.
3. A shilling.
4. A sixpenny piece.

LESSON 7

Measurement in metric scale.—The children are provided with rulers which are divided on one edge into inches and tenths and on the other edge into metric divisions.

Let the children discover for themselves that:—

10 centimetres	= 3.937 in.
$\therefore 100$ "	= 39.37 in.
i.e., 1 metre	= 39.37 in.

Find the length of 1 ft. in centimetres. It equals 30.5 cms.

Find the width of the bench, your book, and the length of the cupboard, in inches and centimetres.

Find the area of 1 page of your book, the base of your box of weights in inches and centimetres.

$$\text{Area} = L \times B.$$

$$\text{Volume} = L \times B \times H.$$

Find the volume of a box of weights in cubic inches and cubic centimetres.

Note.—100 c.c. are called 1 litre and this is used to measure all volumes.

10 litres	= 1 Dekalitre
100 "	= 1 Hectolitre
1000 "	= 1 Kilolitre
$\frac{1}{10}$ litre	= 1 decilitre
$\frac{1}{100}$ "	= 1 centilitre
$\frac{1}{1000}$ "	= 1 millilitre

Experiment.—To find the weight of 1 cubic centimetre of water. Take a flask capable of holding at least 50 c.c. of water. Counterpoise this on a balance with weights. Keep a record of these weights. Measure 10 c.c. of water. Put this into the flask again. Add further weights until the two sides equally balance.

Result.—Weight of flask water—weight of flask = weight of 10 c.c. of water.

Repeat this experiment adding:—

1. 20 c.c. of water
2. 30 " " "
3. 40 " " "
4. 50 " " "

From a comparison of these experiments you will be able to calculate the weight of 1 c.c. of water. If you have been accurate in weighing and measuring it should be 1 gram. The water used should be distilled water.

Note.—1 c.c. of water weighs 1 gram.

Now repeat these experiments, using tap water. You will find that 1 c.c. of tap water weighs more than 1 gram. Why? It is because tap water is not absolutely pure water, but contains some substances dissolved in it.

1000 c.c. of water weigh 1000 grams; i.e., a litre of water weighs 1 Kilogram.

LESSON 8

To find the volume of a solid which is insoluble in water, by its displacement of water.—Take a small beaker and fill it with water. Into the beaker carefully lower a solid object, a piece of marble, a small weight, or some nails. What happens? The water overflows, Fig. 17. Why? It is impossible for two things to be in the same place at the same time. The water has come out to make room for the objects which have been placed in it.

When you get into a bath, what happens to the level of the water? It rises. If you lie down in the water the level is still higher. Your body has pushed some of the water

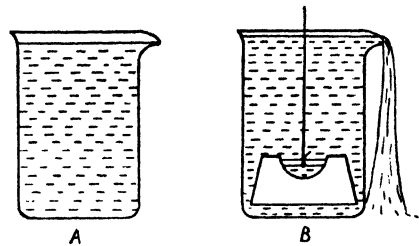

FIG. 17.
DISPLACEMENT OF WATER

upwards. It pushes up just as much water as corresponds with the volume of the part of it in the water.

Now try these experiments.

Take a cylinder graduated in cubic centimetres. Put into it 50 c.c. of water. Lower into the flask or cylinder a penny. Note height to which water rises in the cylinder. The difference between the first height and the second is the volume of water displaced by the penny, Fig. 18. This is the volume of the penny.

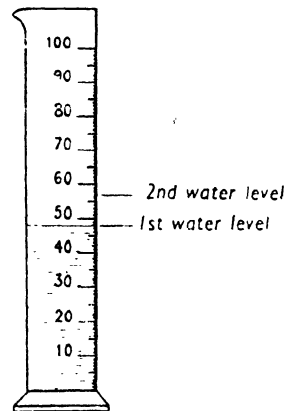

FIG. 18.
FINDING THE VOLUME
OF A PENNY.

Repeat this experiment using:—

1. A marble.
2. A metal cube.
3. Some nails.

Remember when putting water into a bath not to fill the bath.

Remember when preparing water for cooking vegetables to leave plenty of room for the vegetables, as well as room for the expansion of the water on heating.

LESSON 9

To find the density of a solid which is heavier than water.—When a solid is immersed in water it experiences an upward thrust from the liquid which is equal to the weight of the liquid which it displaces; and the volume of the solid is equal to the volume of the liquid which it displaces. We can make use of this principle to determine the density of a body which is insoluble in water.

Experiment 1.—Suspend a penny by means of a piece of cotton from one arm of an ordinary balance, and counterpoise with weights in the other pan.

Place a stool over the pan of the balance over which the penny hangs. Fill a beaker with water and place this on the stool so that the penny hangs into the water, Fig. 19. Notice the pan containing the weights. They no longer balance. What must you do to make them balance? Remove weights from

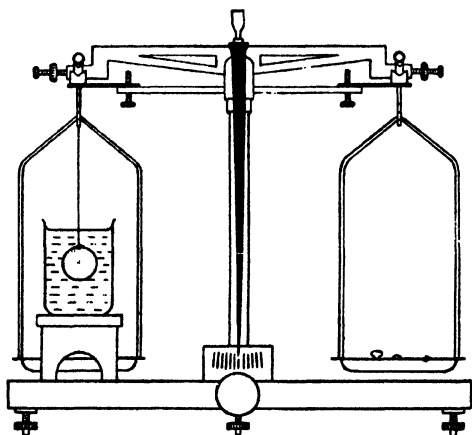

FIG. 19.
FINDING THE DENSITY OF A PENNY

the pan containing them. The penny weighs less in water than it does in air. The apparent loss; i.e., the difference between weight in air and weight in water, equals the weight of water displaced by the penny.

We can get a comparison between the weight of a substance and the weight of an equal volume of water. We call this its specific gravity. Suppose we call weight of penny W , and weight of penny in water W_1 , then weight of an equal volume of water $= W - W_1$. Specific gravity of penny $= \frac{W}{W - W_1}$ gives a comparison of the weight of the penny with the weight of the water.

Repeat this experiment using a shilling.

Repeat this experiment using a glass stopper.

Repeat this experiment using a small piece of steel.

Repeat this experiment using a nail.

From these experiments we get a comparison of the weights of various substances compared with the weight of an equal volume of water.

Experiment 2.—Many substances are lighter than water; e.g., cork or wax, and would float on the water. To make it sink, it must be fastened to a heavy body or sinker. Suppose we try to find the density of a piece of wax. Use the penny which was used in the previous experiment. Warm it so that the wax will stick to it. Weigh this as before in air.

Weight of penny + wax.

Weight of penny as in previous experiment.

Weight of wax alone $=$ Weight of penny + wax $-$ weight of penny.

Weigh wax and penny in water and calculate loss of weight of wax in water. As before,

weight of wax in air
weight of equal volume of water $=$ specific gravity.

LESSON 10

To find the relative density of a liquid.—To do this we have to compare the weight

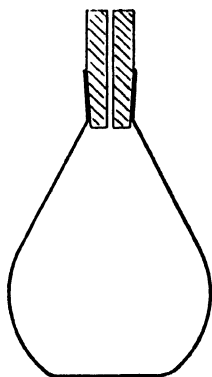

FIG. 20.
A SPECIFIC GRAVITY
BOTTLE

of the liquid with the weight of an equal volume of water. We generally do this by using a specific gravity bottle, Fig. 20. This is a small flask-shaped bottle fitted with a well fitting stopper. In the stopper is a threadlike hole. When the bottle is filled with liquid and the stopper inserted, a small portion of the liquid escapes through the very narrow hole. The bottle should be wiped quite dry after this has been done.

Experiment 1.—We use brine solution which has been made by dissolving 20 grams of salt in 200 c.c. of water. Take a specific gravity bottle and hold it near a flame in order to make quite sure it is dry inside and outside. Weigh the bottle empty. Now fill the bottle with ordinary water. Wipe off any water which escapes after inserting the stopper. Weigh the bottle full of water. The difference between these two weights equals the weight of the water.

$$\begin{array}{r} \text{Weight of flask + water} = W_1 \\ \text{'' '' '' alone} = W_2 \\ \hline \text{'' '' water alone} = W_1 - W_2 \end{array}$$

Now empty out the ordinary water, and fill the flask with salt water. Be sure the flask is dry outside. Weigh the flask full of salt water. Call this W_3 .

$$\begin{array}{r} \text{Weight of flask + salt water} = W_3 \\ \text{'' '' '' alone} = W_2 \\ \hline \text{'' '' salt water alone} = W_3 - W_2 \end{array}$$

The specific gravity can be found by dividing the weight of salt water by the weight of ordinary water. This is a number, not a weight. If you work carefully the relative density of the salt water of the strength you have examined should be 1.05.

If 1 c.c. of ordinary water weighs 1 gram, then 1 c.c. of this solution weighs 1.05 grams.

Experiment 2.—Find the specific gravity of milk. Proceed as in the previous experiment. A careful experiment will give you the result that the specific gravity of milk is 1.03. Which is heavier, 1 c.c. of water or 1 c.c. of milk?

Experiment 3.—Now take a mixture of milk and water, in equal parts, and repeat the last experiment. You will find that the mixture is heavier than water, but lighter than milk. Milk should be about 1.03. Suppose you suspect that the milk supplied to you has had water added to it, what could you do to help you to determine if this is so? Find its specific gravity and if it is less than 1.03, water has probably been added.

Experiment 4.—Empty your bottle and be sure it is dry inside and outside. Now fill it with olive oil. Weigh the bottle full of oil, and find the weight of the oil alone.

$$\frac{\text{Weight of oil}}{\text{Weight of water}} = \text{a fraction.}$$

Oil has a less density than water. Why does oil float on water?

Experiment 5.—For demonstration only. Make use of the specific gravity bottle to find the density of mercury. It will be found that mercury is about 13.5 times as heavy as water. It is the heaviest liquid known.

It is a useful exercise to find the density of water at various temperatures, and establish the fact that the higher temperature of water the less dense it is.

If there is time to allow for an extra lesson on this section, it will be useful to allow the children to find the densities of other common liquids; e.g., vinegar, glycerine, sugar solution, tea.

LESSON 11

Conduction of heat.

Experiment 1.—Hold a knitting needle in a Bunsen flame. The children in time will soon let the knitting needle fall. Why did you drop the needle? It became hot. Although it was not in contact with the flame the other end became hot. The heat

has travelled along the rod. We say that the metal has conducted the heat. You are all familiar with the fact that the handle of a poker which has been in the fire a little time becomes too hot for you to hold it. The handles of kettles and pans on the fire also become hot. The handle of a metal teapot filled with hot tea becomes too hot to hold.

Experiment 2.—To compare the conducting powers of metals. Clamp a thin tile to a retort stand. Take some pieces of wire about 12 ins. long, copper wire, steel wire, and silver wire. Place these so that at one end the ends of the wires are near together but not touching, and at the other end are spread out as in Fig. 21.

Heat by means of a Bunsen flame at end A for two or three minutes. Then run a match along each wire from end B towards A. The match used must not be a safety match. Notice at which point each match ignites. Mark each point. Repeat. The matches do not ignite at the same distance from A. The wire along which the match passes the shortest way will be the one which is the best conductor of heat.

The match will light first on the silver wire, next on the copper wire and last on

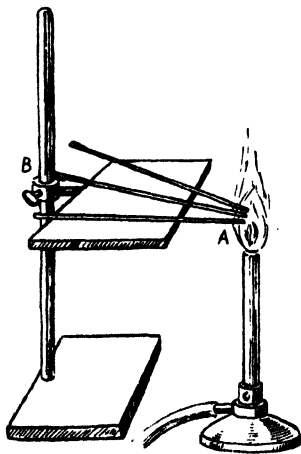

FIG. 21.
TESTING THE BEST CONDUCTOR
OF HEAT

the iron wire. Copper and silver are better conductors than iron.

Experiment 3.—Take three metal discs of about the same thickness, a penny, a shilling, and an iron disc. On each place a small piece of wax (same size on each). Place the discs on a sand bath over a tripod stand, over a Bunsen flame, and notice which piece of wax melts first, and which last, Fig. 22. The wax on the metal which is the best conductor will melt first. This is another way of learning the same thing as in the last experiment.

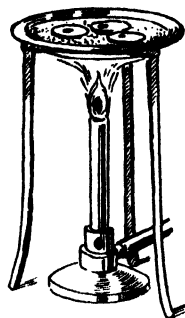

FIG. 22.
TESTING CONDUCTION
BY WAX

From these experiments we learn that metals conduct heat. Silver and copper and brass are better conductors of heat than iron. Which of these substances would be more economical of heat for use in cooking on a gas stove or fire? Copper costs more than iron, but lasts longer, and gets hot more quickly. In large factories where jam is made, boilers and pans are made sometimes of silver, and sometimes of copper. Why does a copper kettle and an aluminium kettle boil water more rapidly than an iron one?

Experiment 4.—Take a piece of slate, a piece of glass, and a piece of wood, a piece of china (a broken saucer will do) and a piece of thick cardboard (paper). On each place a piece of wax and place all on sand tray as in previous experiments, Fig. 23. Notice the rate at which the wax melts. In all these substances the time taken to melt the wax is longer than in

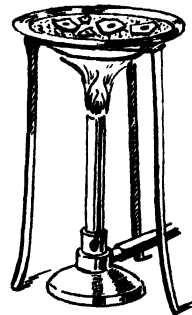

FIG. 23.
SHOWING BAD
CONDUCTORS

the case of any of the metal discs. These substances are bad conductors.

Experiment 5.—To show that metal is a better conductor of heat than air. Heat a thermometer in a beaker of water till it is 40° higher than the original reading. Hang the thermometer in the room and notice the time taken until the thermometer is at its original reading. You can do this by counting, or looking at your watch. Make a note of this. Now reheat the thermometer to the same temperature as in the previous experiment, and place the thermometer on a sheet of iron. Notice that it runs down much more quickly to its original temperature. If possible, repeat, using another sheet of metal. These experiments show that compared with metals, air is a bad conductor of heat.

You ought now to be able to understand why it is a good plan to have a wooden handle to a teapot, or to curling irons, why we use a wooden spoon for stirring jam or porridge and why cork and wood are useful as table mats. Can you explain why on a cold day iron railings feel colder than a wooden fence, and why the iron part of a spade feels colder than the wooden handle?

Experiment 6.—To compare the power of conduction of heat by wool and a metal. Take a penny and a piece of felt of the same thickness. Place a small piece of wax on each and heat on a sand tray over a Bunsen flame. You will see that the wax over the penny melts more quickly than that over the cloth. This shows that wool is a bad conductor of heat.

Why do we wear woollen clothing? Wool is a bad conductor of heat, and does not take away heat from the body. Wool which is used to keep us warm can also be used to keep ice cold. If ice is wrapped in a thick wool blanket the wool does not conduct heat from the outside to the ice, so the ice keeps longer as ice. Wool is also very porous. It contains air in these pores. This air is a bad conductor of heat, so the wool acts in two ways in keeping heat in the body and away from the ice. New wool is more porous than old, as however careful we are in wash-

ing there is sure to be some shrinking and the pores become smaller. That is, new wool contains more air than old wool. Why do people cover outside water pipes sometimes with felt in winter? Why are tiles and slates better roofing materials for houses than iron? Why do we cover tender plants in winter with straw? How does a loft in the roof of a house help to keep the house dry and warm? Houses with thatched roofs are kept cool in summer and warm in winter.

Clothing.—The best clothing for cold weather is in dark colours because they absorb most heat. The best clothing for hot weather is in light colours because they reflect or send back the heat. Woollen materials are bad conductors of heat, and are therefore best to wear in cold weather. In Summer a light coloured thin woollen dress is cooler than a dark cotton one. Fur and leather are bad conductors of heat and are therefore useful for keeping one warm in cold weather. Feathers are bad conductors of heat, so an eiderdown bedspread, though light, is very warm. All loosely woven materials are warmer than tightly woven ones, for they contain plenty of air, which is a bad conductor. All clothing should be loose in order that air may be present. Tight shoes and tight gloves cause cold hands and feet.

LESSON 12

Convection of heat.—At the moment of placing a vessel of water on the fire or over a gas flame to heat, all the water is at the same density. The part of the water nearest the flame begins to get hot. It then begins to expand and gets lighter than the rest. Because it is lighter it rises in the vessel. The heavier water sinks to take its place. This in turn becomes heated and rises, and the colder water again sinks. There is a continual rising of the heated water and a falling of the relatively cooler water to take its place. This circulation of the water is

due to differences in density, and the water carries with it the heat it has received from the flame. There is, therefore, actual conveyance of heat from one part of the water to another by actual movements of the particles of water. We say the heat is transferred by convection.

Experiment 1.—To show the presence of convection currents in water which is being heated. Take a flask and partly fill it with water. Scatter upon its surface some light particles of sawdust. Place the flask on a tripod stand and heat by means of a Bunsen flame. You will see the movements of the sawdust. It travels down the sides to the bottom of the flask; i.e., it goes down with the cooler water, then rises up the middle with the warmer water, and so on, Fig. 24.

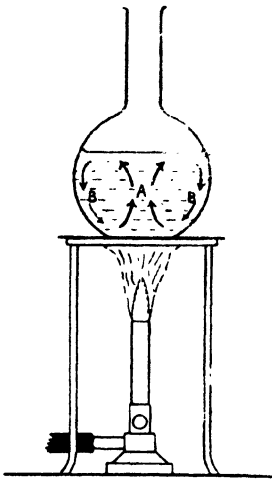

FIG. 24.
CONVECTION CURRENTS IN
HEATED WATER

Experiment 2.—A variation of this experiment can be shown by sprinkling a few grains of permanganate of potash crystals on the surface of the water. You will see a thin purple stream showing the path taken by the dissolved crystals. After a time the colouring matter becomes mixed with the water, which is now a uniform purple colour, and we can no longer detect the convection currents.

We make use of our knowledge of convection currents set up in heating water to warm large buildings such as schools, churches, factories, etc. Some private houses are also heated in the same way. There is a furnace in the basement connected with a boiler. Near the top of the boiler is a pipe called the up pipe, which goes upwards and sends branches to the various floors and rooms which are to be heated. The branch pipes are connected with radiators in the various rooms. After passing through the radiators, the water passes into the down pipes. These finally unite in one down pipe which enters the boiler at its lower part. Hot water is lighter than cold. The water in the boiler gets hot, rises into the main pipe, passes into the radiators, becomes cooler and flows down again to the bottom of the boiler. This is making use of a convection current for the distribution of heat, Fig. 25. This is a cheap and effective way

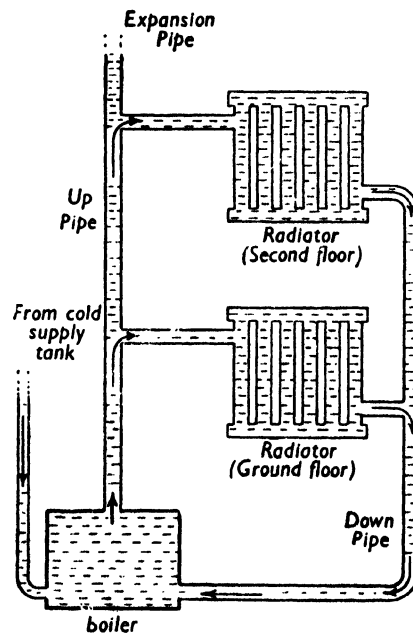

FIG. 25.
HEATING A BUILDING

of heating a building. Only one fire is needed to warm a large building. The cheapest kind of fuel can be used for heating. Labour is saved. Dirt is avoided. There is an even warmth in all parts of the room.

Air is also heated by convection currents. If you take a red hot poker from the fire into a cool atmosphere, you can see a shimmering which will show you the direction of the convection currents. These currents carry heat from a heated body to other parts of the room.

Experiment 3.—Place a lighted candle in a dish containing about 1 in. of water. Cover the lighted candle with a bell jar. The lighted candle goes out. It is not getting the air which it needs for combustion. Now cut a tongue of cardboard big enough to go down

half way into the bell jar. Relight the candle and place the bell jar over it. The candle will continue to burn, Fig. 26. The flame warms the air, which rises to the top of the jar. Cooler air goes down the other side. These convection currents set up in the jar keep the candle well supplied with air, and it continues to burn.

Radiation of heat.—When we stand in front of a fire we feel the heat from it. The air itself has not become hot, but the heat passes from the fire to us. In the same way we feel the heat of the sun's rays. We say the heat of the sun and the heat of the fire reach us by radiation.

If a thermometer is hung in a vessel from which air has been extracted, it can still receive heat from external objects. If you place a piece of black cloth, or dark coloured cloth so that it is exposed to the sun's rays, even on a frosty day this cloth becomes much warmer than the surrounding air. Heat can pass through the air without warming it as much as it does an object in the air. The drier the air the more rapidly does it allow passage of heat by radiation. Some substances do not allow the heat to pass through them but become rapidly heated. You have all felt how hot the wooden parts of a motor coach or bus become when exposed to the sun on a hot day.

We talk about rays of heat in the same way as we talk about rays of light. Substances which allow light to pass through them also allow radiant heat to pass through them.

In an eclipse of the sun, heat rays and light rays are cut off at the same time. Heat rays can be brought to a focus by a lens, as light rays can. Heat rays can pass through a lens on a bench to a piece of paper, and set fire to the paper. Long ago people discovered that it was possible by means of burning glasses to set fire to enemy war ships. Radiant heat can be reflected.

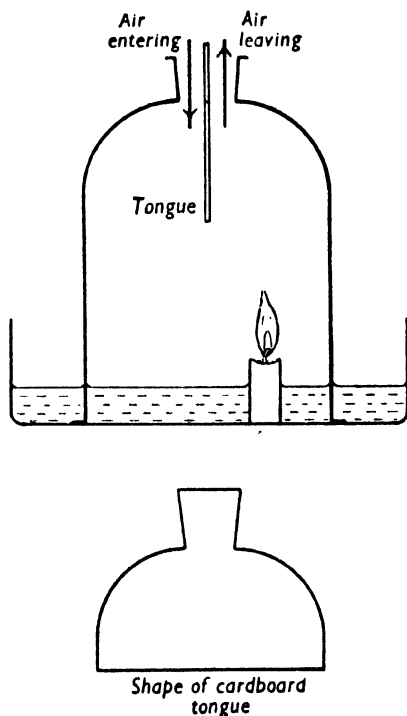

FIG. 26.
A CANDLE BURNING THROUGH
CONVECTION CURRENTS

Methods of heating.

- 1. Conduction—Used for boiling.
- 2. Convection—Hot water pipes.
- 3. Radiation—
 - (a) Coal fires; coke fires.
 - (b) Gas fires fitted with asbestos fuel, Fig. 27.

- (c) Electric fires, Fig. 28.
- (d) Radiation and reflection of heat. Gas and electric reflector stoves, Figs. 29 and 30. A heated surface has its heat intensified by reflection from a highly polished metal surface.

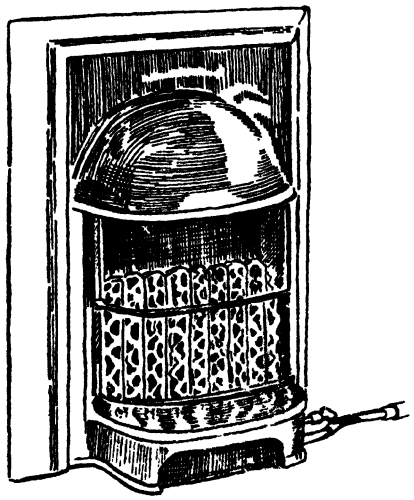

FIG. 27.
GAS FIRE

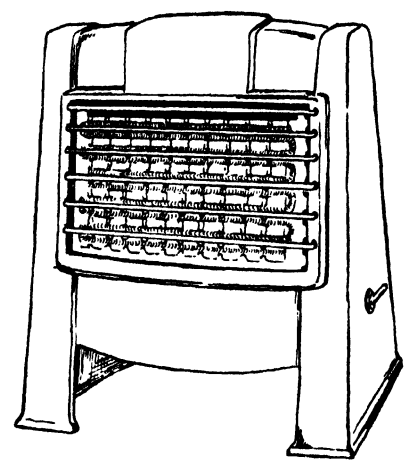

FIG. 28.
ELECTRIC FIRE

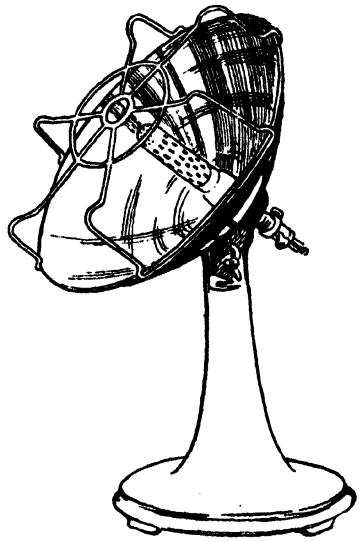

FIG. 29.
REFLECTING BOWL GAS FIRE

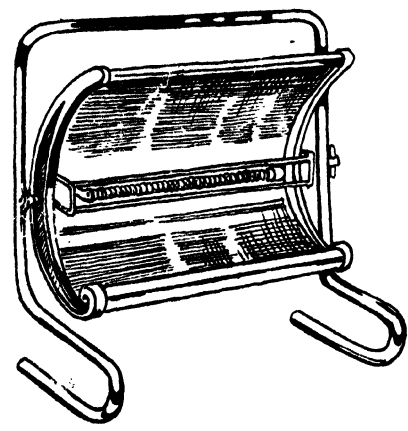

FIG. 30.
REFLECTOR ELECTRIC FIRE

LESSON 13

Physical properties of air.—Air, like every other substance, has weight. This can be shown by simple experiments.

Experiment 1.—Take a large round flask. Fit it with a perfectly fitting cork. Place through the cork a piece of glass tubing and over the glass tube place a small piece of rubber tubing which fits tightly, Fig. 31.



FIG. 31.
SHOWING THAT
AIR
HAS WEIGHT

Balance the flask, etc., and a small piece of wire on one pan of a balance. Draw air from the flask after inserting a small glass mouthpiece. Bend the rubber and fasten securely with the wire. Then remove the mouthpiece. Weigh again. You will have to remove weights from the pan until the two pans exactly balance once more. The loss in weight is equal to the weight of the air drawn from the flask.

Experiment 2.—Remove the flask from the balance and place it with its mouth under water. Untie the wire. You will see water rise up into the flask, Fig. 32. The volume

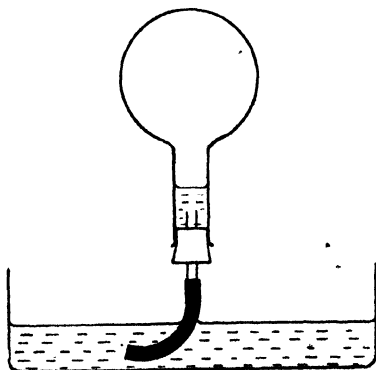

FIG. 32.
SHOWING HOW MUCH AIR WEIGHS

of the water which enters is equal in volume to the air which was removed in the first experiment. The loss of weight in the first experiment gives you the weight of the air withdrawn. Thus it is possible to find the weight of air and calculate the weight of a litre of air.

1 litre of air weighs roughly 1.3 grams.

Since a litre of water weighs 1000 grams, you can see how very light air is compared with water.

Experiment 3.—Another way to show that air has weight. Put a small quantity of water in a flask. Fit the flask with a good stopper which carries a short piece of glass tube to which is fixed a small length of rubber tube. Boil the water and allow plenty of steam to escape through the rubber tube. Remove the source of heat and then clip up the rubber tube, Fig. 33. Allow the apparatus to cool. The rubber tube collapses as the steam in the flask condenses to water. Weigh the whole piece of apparatus. Then open the clip. Air will be heard to rush in to take the place originally occupied by steam. Weigh again. The difference is due to the air which entered when the clip was opened.

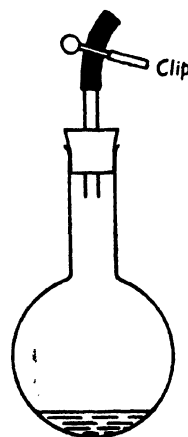

FIG. 33.
PROVING THAT AIR
HAS WEIGHT, 2ND
METHOD

Experiment 4.—Fill a tumbler full of water, so that you can see the curved top of the water. Now put a piece of paper or thin cardboard over the mouth of the tumbler and, still covering the paper with the hand, invert the tumbler so that it is upside down. Remove the hand from the paper. The paper remains covering the tumbler, and the water stays in, Fig. 34. This is because the air outside is pressing the paper upwards. If your tumbler was not absolutely full;

i.e., if there was air above the water, the paper would fall off, and the water come out.

You have all seen boys playing with a rubber sucker. This is a circular piece of rubber to which is attached a piece of string. The sucker is thrown on the ground, and the boy stamps on it to press out air from under it. Then you are asked to pull, and find that you cannot pull up the sucker unless you pull sideways to let air get under it. The pressure of air above the sucker keeps the sucker on the ground.

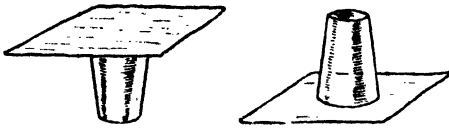

FIG. 34.

AIR KEEPING WATER IN TUMBLER

Experiment 5.—Take a glass funnel, and over it tie a thin piece of rubber. A piece from a toy balloon will do very well. From the stem end of the funnel suck out air from the funnel. The piece of rubber is drawn in at the centre, owing to the pressure of air from the outside, Fig. 35.

In bottling fruit, practical use is made of this knowledge. The fruit is placed in the

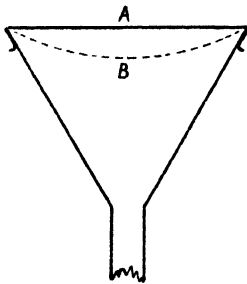

FIG. 35.

A. POSITION OF RUBBER AT FIRST
B. POSITION OF RUBBER WHEN AIR IS BEING SUCKED OUT OF THE FUNNEL
SHOWING AIR PRESSURE ON RUBBER

jars with water or syrup, and heated. This drives air out of the jar. Then the special covers fitted with rubber bands are placed on the jars. The fruit is sealed air-tight in the jar. To open the jar the cover has to be pierced or forced under one edge to admit air. Then it can easily be removed.

Experiment 6.—Hot air is lighter than cold air. Take a dry flask with a well fitting stopper. Weigh it, and leave the weights on the balance (Weight 1). Next heat the flask to drive out some of the air. While it is still hot insert the stopper and weigh again. You will see that to make it balance weights have to be removed from the pan (Weight 2). This shows that a volume of warm air is lighter than an equal volume of cooler air.

A famous scientist, Torricelli, was the first person to measure the pressure of the air. He performed the following experiment.

Experiment 7.—A glass tube about 33 in. long and closed at one end was filled with mercury. The open end was closed with the thumb, and the tube was inverted in a dish containing mercury. The mercury at once sank in the tube, until it reached a level of about 30 in., Fig. 36. There is a small space

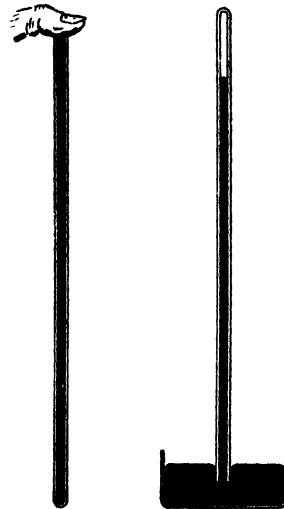

FIG. 36.

MAKING A BAROMETER

above the mercury. There is nothing in the tube but mercury and a small quantity of mercury vapour. The column of mercury in the tube is balanced by the column of air pressing on it. Torricelli thus made the first barometer or instrument for measuring the pressure of the air. When the pressure of the air is greater the column of mercury rises. When the pressure is less, the column of mercury falls.

If we tried to do this experiment using water instead of mercury we should need a much longer tube. Mercury is 13.6 times as dense as water, therefore a column of water to balance the atmospheric pressure would need to be $2\frac{1}{2} \times 13.6$ ft. high, about 34 ft.

As changes of weather are accompanied by changes of air pressure, it is possible to foretell weather changes by watching the rise and fall of a barometer. A high barometer indicates fine weather. A fall in the barometer indicates the approach of rainy weather.

LESSON 14

Air contains moisture.

Experiment 1.—Bring a tumbler containing cold water into a warm room. You will notice drops of moisture on the outside of the tumbler, Fig. 37. The cool surface of the

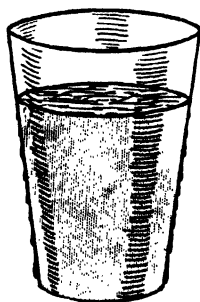

FIG. 37.
SHOWING MOISTURE
IN THE AIR

tumbler cools the air near it, and this cooling causes water in the air to condense on the outside of the glass. This can be seen in a

very striking way if a jug of water containing ice is brought into a warm room on a summer day.

Sometimes people wearing glasses will notice that on entering a very warm room the glasses are dimmed. The cool surface of the glass causes condensation of moisture out of the air.

Certain substances take water out of the air readily. Cobalt chloride paper indicates the presence of very small quantities of moisture in air.

Experiment 2.—Take a piece of blotting paper and dip it in cobalt chloride solution. This is pink in colour and colours the blotting paper pink. Dry this paper on a sand bath over a Bunsen flame. It becomes deep blue in colour. Remove the paper and leave it on the bench exposed to air in the room. It soon begins to go pink in colour, showing that there is moisture in the air of a room.

Catgut rapidly takes up water in wet weather. When dry it twists, and when moist untwists. I expect that you have all seen a little model house in which live a man and woman. It is so arranged that the man comes out when it is wet weather, and his wife comes out when it is fine, Fig. 38.

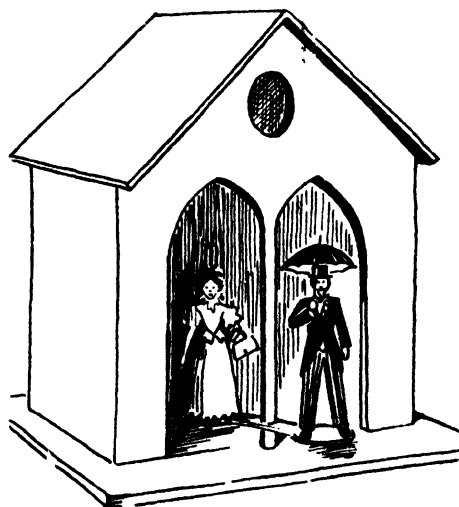

FIG. 38.
AN INTERESTING BAROMETER

A piece of catgut is used to do this. When dry it is twisted and the wife is sent out. When wet it untwists and the man is sent out

Experiment 3.—To find the effect of evaporation on the temperature of a thermometer. Take a thermometer and read the temperature. Then dip the thermometer in ether and hold the other end while the ether evaporates. The mercury falls in the thermometer; that is, its temperature is lowered. Evaporation causes a lowering of the temperature.

Experiment 4.—To find the loss of water by evaporation from different surfaces. Take a porcelain evaporating dish, a wide beaker, and a narrow mouthed flask. Put in each vessel an equal amount of water, say 50 c.c. Weigh each vessel and contents, and leave them exposed to the air of a room. Leave these for twenty-four hours. Weigh all the vessels again. You will notice that all will have lost weight, but not to the same extent; less has gone from the narrow necked flask, and most from the wide beaker. Evaporation of water into the air depends upon the amount of surface of water exposed to the air. Wherever there are large surfaces of water exposed to the air there will be rapid evaporation; i.e., from the surfaces of ponds, lakes and from the sea. The amount of evaporation also depends upon the dryness

of the air. On dry days there will be more evaporation than on wet days.

Experiment 5.—The substance calcium chloride absorbs water readily, and can be used for making an artificially dry atmosphere. Take two evaporating dishes and place in each the same amount of water. Weigh the dishes and water. Place one inside a balance case. Inside the case of another balance place the other dish, and also a dish containing calcium chloride to dry the air. Leave both for twenty-four hours and weigh again. Both will have lost weight due to evaporation of water, but the one in the artificially dried air will have lost most. On a dry day evaporation is most rapid.

Experiment 6.—Evaporation is increased by heat. Take two evaporating dishes as above, and place one in the warmest part of a room, near a radiator or fire, and the other in the coldest part. That near the heat loses water most rapidly.

Evaporation is increased by wind. Clothes dry better on a windy day than on a still day, because the air containing moisture evaporated from the clothes is constantly being taken away, and fresh air takes its place.

Air always contains some moisture, but this varies according to temperature and wind, and nearness to large surfaces of moisture.

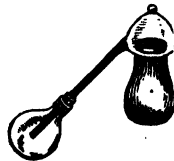

SECOND YEAR'S COURSE

LESSON 1

You have learned no doubt that water is a clear colourless liquid without taste or smell. At a temperature of 0° Centigrade it freezes and becomes ice, and at 100° Centigrade or 212° Fahrenheit it becomes converted into steam after it has boiled. It always contains a certain amount of air dissolved in it. On boiling water the air is driven out. This accounts for the flat taste of boiled water.

Experiment 1.—Place some water in a glass beaker and heat on a sand tray over a Bunsen flame. After a little time you will notice small bubbles on the bottom and sides of the flask. These rise to the surface and escape, Fig. 39. They are bubbles of air

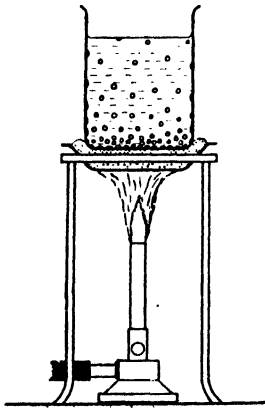

FIG. 39.
AIR DRAWN FROM WATER

which is dissolved in the water, and is expelled by heat. It is important to remember that water contains dissolved air. All things which live need air for breathing purposes and have various ways of obtaining it. In fishes water passes over the gills, which are full of very fine blood vessels. Air can

pass through the blood vessel walls and enter the blood in the gills. The blood then carries it to the places where it is needed. Water plants are able to use the small amount of air dissolved in water for breathing purposes also. Now the deeper we go down into the water the less is the amount of air dissolved in it, until in very deep water all life is impossible. Constant up and down movements in the water, caused by differences in temperature, cause water containing air to be carried in convection currents to lower regions in the water. Most substances when changing from the solid to the liquid state expand, and contract when solidifying. How does water behave in this respect?

Experiment 2.—Take a small flask and nearly fill it with ice broken up into small pieces. Add water to fill up the spaces between the ice. The smaller the pieces of ice, the less water you will need to add. Mark the level of the ice and water by cotton tied round the neck of the flask or by a piece of

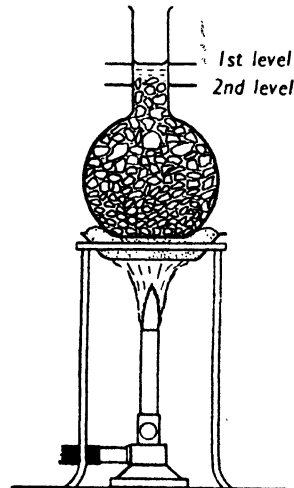

FIG. 40.
ICE CONTRACTING ON
MELTING

gummed paper. Then heat gently to melt the ice. This can be done by placing the flask on a sand tray over a Bunsen flame. You will see that the water level becomes lower as the ice melts, Fig. 40. From this we learn that unlike other solids, melting ice contracts when changing from the solid to the liquid state.

Experiment 3.—Take a small test tube and fill it with water. Cork it, and place it in a freezing mixture of salt and ice, Fig. 41.

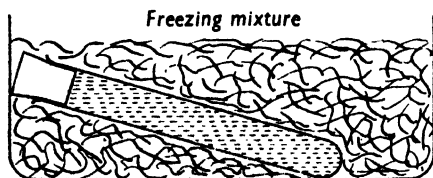

FIG 41.

EXPANSION OF WATER IN FREEZING

Leave it for about half an hour. By that time the water will have turned into ice which has expanded and broken the test tube. Water when changing into the solid ice expands, and the force of expansion has caused the glass to break. This experiment can be repeated in a striking way, by using a medicine bottle filled with water and fitted with a cork. The cork should be tied on with string. At the end of the experiment the bottle is cracked in several places, Fig. 42.

A scientist called Faraday did a remarkable experiment to show the force exerted when water is changed to ice. He took a cannon ball, filled it with water, and securely fastened it with a bung. Then he placed the cannon ball out of doors in some snow. After a time a loud report was heard. On examination, it was found that the force of the expansion of the ice had burst the cannon ball. This explains why, in very cold, frosty weather, we sometimes have burst pipes. Water in the pipes freezes, turns into ice, and the force exerted bursts the pipes. We do not discover the crack or burst until the thaw comes when the ice melts, and the melted water flows out through the cracks made.

You can see now why ice is able to float on water. About one-twelfth of the volume of ice floats above the water, and eleven-twelfths of its volume is below. In icebergs which are floating in the sea, about eleven times as much as you can see above water is below the water level. This peculiar behaviour of water is of great importance to us. If water contracted on freezing, ice when formed on the surface of a pond would sink to the bottom. If we had a long spell of cold weather it would be quite possible for lakes and ponds to be converted into blocks of solid ice. This would kill all the water animals and plants.



FIG. 42.

BOTTLE CRACKED
BY EXPANSION OF
ICE

Experiment 4.—To study more carefully the behaviour of water, we use Hope's Apparatus, Fig. 43. This consists of a large glass jar with two thermometers fitted through its side, one at the top, the other at the bottom. A trough is fixed round the middle of the jar. The jar is filled with cold water, taken preferably from a cold tap out of doors on a cold day. The trough is filled with a freezing mixture of ice and salt. We must watch the behaviour of the two ther-

ometers. At first the cooler layers of water sink and the temperature shown by the lower thermometer falls; the upper one is practically unaltered. When the temperature of the lower thermometer has fallen to 4°C., the temperature indicated by the lower thermometer remains stationary. The upper thermometer falls, until the temperature regis-

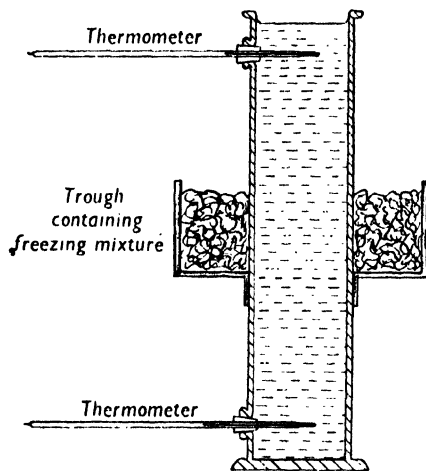

FIG. 43.
HOPE'S APPARATUS

tered by it is 0°, and a thin coating of ice forms on the surface of the water. This experiment shows that water has its greatest density at 4°C. Water at a temperature of 4°C. expands whether it is heated or cooled. Water when changing into steam expands into about 1700 times its original volume. Conversely it contracts when changed from steam into water. This can be shown by experiment.

Experiment 5.—Place some water in a flask and let it boil for ten minutes. Air is driven out of the flask, and the flask now contains water and water vapour only. Invert the flask quickly into a beaker containing cold coloured water. This condenses the steam in the flask, and cold water from the beaker rises in the flask, Fig. 44. The flask will be nearly filled with coloured water, and the water level in the beaker is lower.

Water vapour exerts pressure.

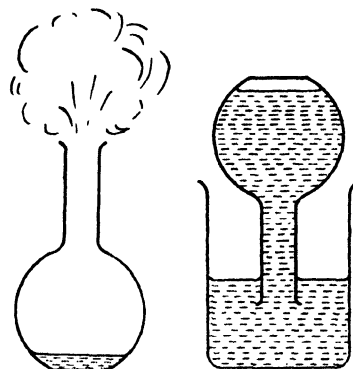

FIG. 44.
SHOWING CONTRACTION WHEN VAPOUR CHANGES TO WATER

Experiment 6.—Fill a barometer tube with mercury. Cover with the thumb, and invert the tube in a dish containing mercury. Fasten the tube upright by a clamp to a retort stand. Mark the level of the mercury with a strip of paper. Introduce by means of a pipette a drop of water under the open-

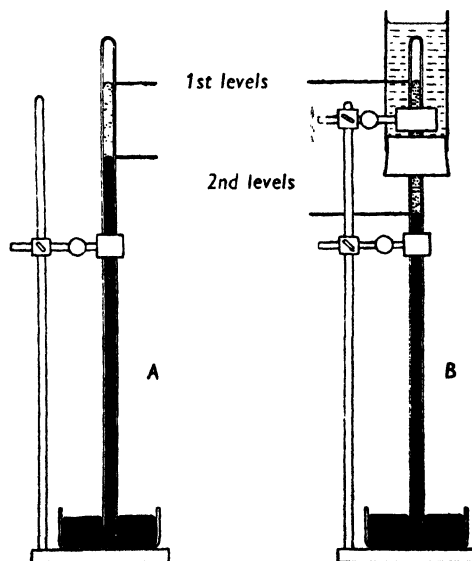

FIG. 45.
WATER VAPOUR EXERTS PRESSURE

ing of the barometer tube. The water, being lighter than the mercury, rises to the top of the mercury and quickly evaporates into the space above it. Repeat this until the drop no longer evaporates but remains as a drop on the surface of the mercury. The space has become saturated with water vapour. Notice the level of the mercury. It has now fallen in the tube, Fig. 45A. This is due to the pressure exerted by the water vapour on the column of mercury. Water vapour exerts pressure. The amount of water which can pass into vapour above the column of mercury is influenced by temperature. This can be shown by the following experiment. The upper part of the barometer tube is surrounded by a larger tube fitted with a rubber stopper through which the barometer tube can pass.

Experiment 7.—Invert the tube as in the previous experiment. Then pour water which has been heated to 35°C. into the surrounding upper tube. Introduce water as before into the mouth of the barometer tube. More drops of liquid pass above the mercury and turn into vapour before the space is saturated with water. The mercury column is still lower than it was in Experiment 6. More water vapour is above the column and the pressure exerted by it is greater, Fig. 45B.

LESSON 2

Solubility of substances in water.—Substances which disappear when put into a liquid are said to be soluble in that liquid. Salt and sugar disappear when put in water. They disappear more rapidly when the water is stirred. This is different from melting. Melting is caused by heat, and the state of the substance is changed, but does not disappear. How can you tell that salt and sugar are still in the water, when you can no longer see them?

Experiment 1.—To make a saturated solution of salt in water. Put 50 c.c. of water in a beaker (use tap water). Weigh 50 grams of common salt. Put a very small portion of

salt into the beaker of water and stir until it has disappeared. Keep on adding salt a little at a time until, on stirring, the salt no longer disappears. You have now made a saturated solution of salt in the water. Weigh the salt left. The salt which has disappeared has been dissolved, and you can thus find out how much has been dissolved. Find the temperature of the tap water and you will know how much salt was needed to make a saturated solution at that temperature.

Experiment 2.—Repeat experiment 1, using sugar instead of salt. Place a thermometer in the beaker, put the vessel on a sand bath and heat gently until the undissolved sugar has dissolved. Now add more sugar and stir, and continue this until the water is 20° hotter than the tap water. Then continue the experiment until the water boils. From these two experiments you learn:—

1. That water dissolves salt and sugar.
2. That heat increases the power of the water to form a saturated solution.

Experiment 3.—Leave the beaker containing the sugar solution to cool. What happens? Gradually you find an increased amount of sugar coming back out of the solution. When the temperature of the water reaches its first level, there will be a considerable amount of undissolved sugar in the beaker. Can you suggest anything we can do to get all the sugar back? Heat the water until a large proportion of it has been sent off in vapour. Then allow the rest of the water to evaporate slowly. When the water seems nearly to have disappeared, heat the beaker slowly on a sand bath and when the sugar is quite dry allow it to cool. Weigh the sugar in the beaker. That, together with the sugar you had left, should equal the amount of sugar you started with. You might get a more accurate result by weighing the beaker containing the restored dry sugar, then emptying the beaker and weighing it perfectly dry.

The children might be interested to show the solubility of Epsom salts in water at

different temperatures by means of a graph. This can be done by using squared paper. The temperatures can be indicated on the base line, and numbers placed at the side to show the amount of salt taken.

LESSON 3

Solubility of substances in water (continued).

Experiment 1.—Comparison of tap water with distilled water. Weigh two small evaporating dishes. Place in each 20 cubic centimetres of water, using in one case distilled water, and in the other water from the tap. Place the dishes on sand trays over a Bunsen burner, and heat, Fig. 46. Continue heating

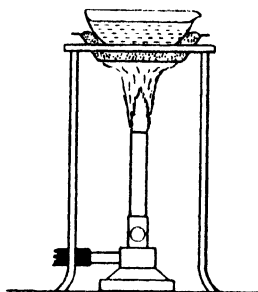

FIG. 46.
EVAPORATING WATER

until all the water has evaporated from the dishes. Then examine the dishes. In the case of distilled water you will find no deposit in the dish. In the case of tap water you will find a small deposit. On weighing again you will find that the evaporating dish which contained tap water has gained weight. From this you learn that distilled water contains nothing in solution, and that tap water contains dissolved matter. Repeat this experiment using water from a pond, a well, a river, and if possible from the sea. Water from all these sources contains substances dissolved in it.

Experiment 2.—To determine the effect of substances in solution on the boiling

point of water. Place in three similar beakers:—

1. Distilled water.
2. Strong salt solution.
3. Sugar solution.

Place each beaker on a sand tray and heat. In each beaker place a thermometer dipping into the liquid. Heat these on a sand bath over a Bunsen flame. Notice the time taken to bring the water to the boil, and the temperature registered by the thermometers when the liquids actually boil. You will see that the distilled water boils at a lower temperature than the water containing substances in solution. When cooking vegetables, it is best to bring the water to the boil first and add salt when the vegetables are nearly cooked. In stewing fruit it is also best to place a little cold water in the pan with the fruit, and allow the liquid to boil. When the fruit is soft then sugar can be added to sweeten.

Some substances are not soluble in water.

Experiment 3.—Weigh 5 grams of sand. Take a beaker containing water. Add the sand a little at a time to the water, and stir. The sand does not disappear in cold water. Heat the water, still stirring. The sand does not disappear. Continue heating until all the water has evaporated and the sand is quite dry. This can be left for a time on a sand tray over a Bunsen flame. Then weigh the beaker and sand. Empty out the dried sand and weigh the empty beaker. If you are careful you will find that the sand still weighs 5 grams.

Sand and other undissolved matter can be separated from water by means of filtering, that is, allowing the water to pass through something fine enough to keep back the sand.

Experiment 4.—Take some water which contains sand and fine soil so that it looks muddy. Line a filter funnel with filter paper. Stir up the water and pour it through the funnel into a beaker. The water which comes through is clear. The sand and mud

are left behind on the filter paper, Fig. 47. If the liquid is not perfectly clear the first time, pour it into another funnel which is fitted with a double filter paper, and allow it to fall into a beaker. The liquid will now be clear.

The filter paper does not remove substances dissolved in the water.

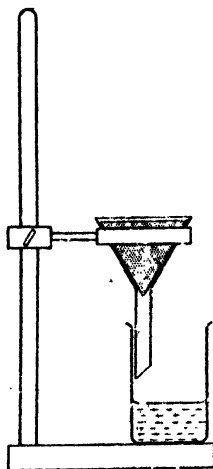

FIG. 47.
FILTERING A LIQUID

Experiment 5.—Take some water to which has been added salt and sand, and repeat the previous experiment. Taste the pure-looking water which comes through. It tastes salty. Filtering does not remove the dissolved material. It only removes suspended matter.

Experiment 6.—To remove dissolved matter from water. Fill a flask with salt solution. Fit the flask with a cork through which passes a piece of bent tubing which leads into the neck of another flask. The second flask can be dipped into a dish containing cold water to keep it cool. Place the first flask on a piece of wire gauze over a Bunsen flame. Heat. The water boils, is turned into vapour, which passes along the tube into the second flask. As this flask is kept cool, the vapour condenses and water collects in this

flask, Fig. 48. Continue until this second flask is full of water. Then put out the light. When the water in the second flask is cool enough, taste it. It now does not contain salt. That is left in the first flask.

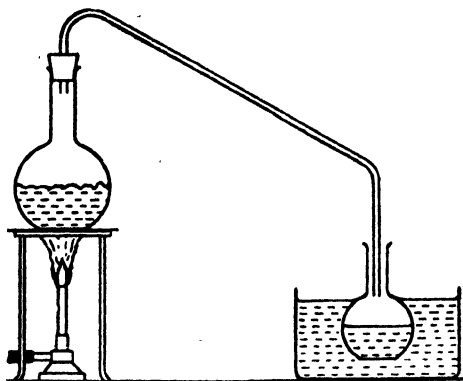

FIG. 48.
DISTILLATION APPARATUS

This process of converting water into steam and collecting and condensing the steam is called distillation. Distillation gives us absolutely pure water. The greater proportion of water used at sea for drinking purposes is obtained by distillation of water from the sea. It is possible on short voyages to get supplies of water, but only enough for a few days. On long voyages distillation is carried on all the time, and pure water for drinking and cooking purposes is obtained.

Experiment 7.—To obtain pure water from a mixture of water containing salt, sand, mud and red colouring matter. Filter as described in the previous experiment. Then distil the water coming through the filter paper. At the end of the experiment you will have (1) undissolved matter left on the filter paper; (2) dissolved matter (coloured) left in the heated flask; (3) pure water in the second flask. In addition it will add interest to this lesson if the children are allowed to distil a small quantity of cold tea and of beer.

LESSON 4

Hard and soft waters.—When we wash our hands we feel a difference when we use various kinds of water. When we use rain water the soap forms a lather easily with the water. When we use water which contains lime in solution it is difficult to obtain a lather. We notice this also when we try to wash in sea water. We say that water which forms a lather easily, is soft water, whilst water that only with difficulty forms a lather with soap, is called hard water. We also notice that with the hard water a scum which floats on the surface of the water is formed. Make solutions of common salt, Epsom salts, lime water and calcium sulphate, and we will use these for experiments to determine the relative hardness of water. To do this we must use soap solution. This can be prepared by shaking finely powdered soap in water until it is dissolved. Soap is more soluble in alcohol or methylated spirits and we can get a stronger soap solution by using this instead of water.

Experiment 1.—Take 50 c.c. of distilled water. Place it in a beaker. Add soap solution drop by drop with a glass stirring rod. Shake after each drop has been added until a lather is produced in the distilled water. Write down the number of drops added.

Experiment 2.—Take 50 c.c. of tap water. Continue as in the last experiment. Note down the number of drops added. More soap solution is needed to produce a lather.

Experiment 3.—Repeat the experiment, using lime water. Still more soap solution is needed to produce a lather, and a scum is produced on the water. Part of the solution is used up in forming the scum before the soap solution can form a lather. This requires more soap solution than is used in Experiments 1 and 2.

Experiments 4 and 5.—Repeat the former experiments, using water containing Epsom salts in solution, and water containing calcium sulphate in solution. These waters lather only slowly and need a large amount of soap solution before a lather is formed

at all. If possible, repeat with rain water. Distilled water is the softest of all waters, next to rain water. Waters containing salts of lime, magnesia and sulphates are all hard waters. Sand is insoluble in water, so water collected from sandstone districts is soft water. Water obtained from sources where it passes over limestone rocks and rocks containing sulphates can dissolve small amounts of these substances from the rocks, and so becomes hard.

LESSON 5**Removal of hardness from water.**

Experiment 1.—Take 50 c.c. of lime water used in the previous experiment. Boil it for ten minutes. You will see very shortly a whiteness produced in the water. That is, something in solution is deposited. Filter the water, and use the water which passes through the filter paper for the experiment. Take equal parts of this water and unboiled lime water. Add soap solution by drops to each until a lather is produced. Write down the number of drops needed to produce the lather. Boiled lime water uses less soap solution. Boiling has removed some of the hardness.

On passing through soil, water is able to take up carbon dioxide from the soil. Water containing carbon dioxide is able to dissolve some of the chalk from chalky rocks, and becomes hard. When you boil water containing lime in solution, the carbon dioxide is driven off, and the insoluble lime is deposited. In ordinary households where the water supplied contains chalk in solution, lime is deposited on the inside of pans and kettles when we boil water, and this forms the white scum or fur inside the vessels. This covering prevents the water from boiling so quickly and more heat has to be used. We have also seen that for washing purposes more soap is used. Thus hard water containing chalk is more extravagant in two ways than soft water for all domestic purposes. It also increases the amount of labour needed in washing clothes or floors.

Experiment 2—Take a beaker containing lime water and breathe into it through a glass tube, Fig. 49. The lime water turns milky. Carbon dioxide is the only gas which turns lime water milky. Now continue to breathe into the lime water. After a time the milkiness disappears. At first the milkiness is produced because calcium carbonate is produced. Calcium oxide + carbon dioxide produce calcium carbonate, which is insoluble in water. Later the excess of carbon dioxide is able to unite with the carbonate, and make a soluble compound with the lime.

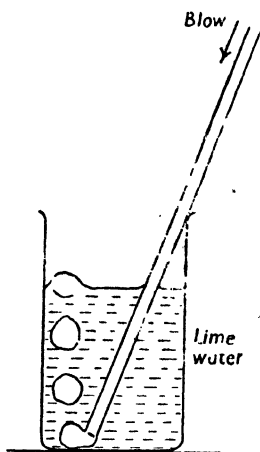

FIG. 49.
PASSING CARBON DIOXIDE
INTO LIME WATER

Experiment 3—Divide the clear liquid obtained from the last experiment into two portions. Heat one portion by boiling. Carbon dioxide is driven off and a deposit appears. This is repeating Experiment 1. To the second portion add pure lime water. Precipitation of lime takes place, because it combines with the excess of carbon dioxide to produce the insoluble carbonate of lime. This can be filtered, and the water tested with soap solution. It will be found to be softer. This method of softening water containing carbonate of lime in solution is employed on a large scale at water works.

Experiment 4—Now take some of the water containing Epsom salts in solution. Boil it for ten minutes. Compare the amount of soap solution needed to produce a lather with this boiled solution, and with some unboiled Epsom salt solution. The amount of soap solution needed is the same in both cases. We cannot soften this water by boiling. Hardness which is produced by carbonates in solution, and which disappears on boiling the water, is called *temporary hardness*. Hardness which is caused by sulphates in solution, and which does not disappear on boiling is called *permanent hardness*.

Experiment 5—Use of borax and soda to soften water for washing purposes. Take two samples of hard water, and divide each into two equal portions. As in the previous experiments to test for hardness, you will need soap solution. To half the first sample add borax. Now find the amount of soap solution needed to produce a lather in the untreated and treated portions. Less is needed after the borax is added. Repeat this using soda, and you will get a similar result. Soda and borax soften water. Water softened in this way cannot be used for drinking.

LESSON 6

You may know that air is a mixture of gases. In this mixture each gas retains its own characteristic properties.

In water we have something quite different. It is a substance in which we have two gases which are united chemically to produce something quite different from either of its constituents. One of them is the gas oxygen, the nature of which you examined in your lessons on air. The other is a gas called hydrogen and to-day you are going to see it made, and also some experiments to show you its properties.

Experiment 1—Preparation of hydrogen. Take a flask and a cork which exactly fits it. The cork must have two holes bored through it. In one hole fit a thistle funnel

to reach nearly to the bottom of the flask. In the other hole fit a piece of bent glass tubing, so that it just goes through the cork and the other end reaches a pneumatic trough. The pneumatic trough contains water and a beehive shelf. Fill three cylinders with water and cover with glass plates, Fig. 50B. Put some granulated zinc into the flask and cover it with water. Replace the cork. Pour a little dilute sulphuric acid through the funnel into the flask. After a few minutes place each of the jars in turn

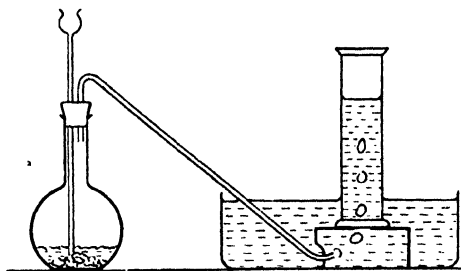

FIG. 50A.

APPARATUS FOR PREPARING HYDROGEN
(The flask contains granulated zinc and dilute sulphuric acid.)

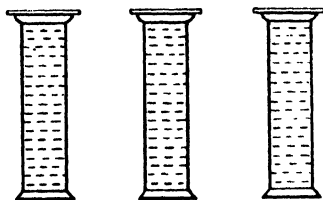

FIG. 50B.

GAS JARS, FILLED WITH WATER
AND COVERED WITH GLASS
PLATES, USED FOR COLLECTING
HYDROGEN

inverted over the beehive shelf and remove the glass plate. Bubbles pass through the water into the jar, and the water is sent downwards out of the jar, Fig. 50A. When quite empty of water replace the glass plate on the jar while it is still in the water, and place the jar on the bench upside down.

Fill the other jars in the same way. So far you can see that the gas produced is colourless, that it is lighter than water, and is insoluble in water.

Experiment 2.—Take one of the jars and remove the glass plate. Keep the jar still inverted and put a lighted taper near the mouth of the jar. You will hear a slight explosion and the gas near the mouth of the jar begins to burn. Hydrogen gas burns. When mixed with air it forms an explosive mixture.

Experiment 3.—Take another jar and plunge a lighted taper upwards into the jar. The hydrogen burns at the mouth of the jar but the taper is extinguished, Fig. 51. As the taper is drawn out of the jar it re-lights in the flame of the burning hydrogen. Plunge back into the jar. It is again extinguished. We thus learn that hydrogen, although it burns, does not support combustion.

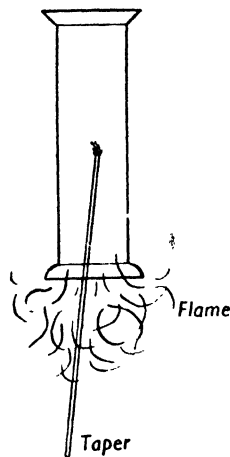

FIG. 51.

HYDROGEN BURNS, BUT
DOES NOT SUPPORT
COMBUSTION

Experiment 4.—Hydrogen is lighter than air. Hold a jar of air upside down. Remove the plate from the third jar of hydrogen and hold it in a slanting position. The hydrogen passes upwards into the air and

replaces it, Fig. 52. It is best to have a duster wrapped round the upper jar. Apply a lighted taper to the mouth of the upper jar. The gas burns.

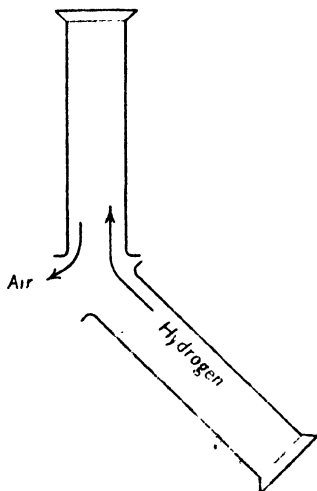

FIG. 52.

POURING HYDROGEN UPWARDS

Another experiment to show that hydrogen is lighter than air.—Counterpoise a large beaker on a balance. Place the beaker with its mouth just over the edge of the pan. Start the hydrogen apparatus working again by pouring a little more sulphuric acid down the thistle funnel. Place the mouth of the delivery tube under the beaker, and watch the balance. The pan containing the beaker will rise, Fig. 53. It is lighter than it was before. After about five minutes you will see that the beaker and the weights are again counterpoised. Hydrogen has escaped, and air again fills the beaker. Hydrogen has diffused into the air of the room.

Experiment 5.—After the hydrogen apparatus has been working two minutes apply a light to the delivery tube. Hold over the flame of burning hydrogen a large dry glass beaker. Notice the moisture deposited inside the beaker. Hydrogen when burning produces moisture.

Hydrogen and oxygen compared.—Both are clear, colourless gases without taste and

Tube from
hydrogen apparatus

FIG. 53.

HYDROGEN WEIGHS LESS THAN AIR.

smell. Oxygen does not burn. Hydrogen burns. Oxygen supports combustion. Hydrogen does not support combustion. Both are insoluble in water. Both are lighter than water. Hydrogen is lighter than air, therefore it is lighter than oxygen.

LESSON 7

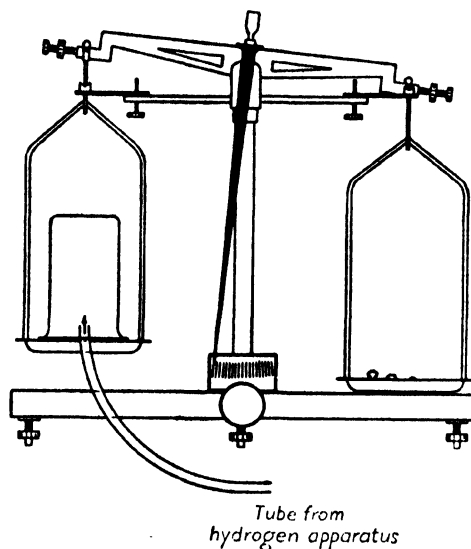
Some other impurities in water.—Water is sometimes called the universal solvent, because it is capable of dissolving small amounts of all matter found in the earth's crust. It is able to do this to a greater extent if it contains a small amount of acid in solution in the water.

Now, all water in passing through the soil is able to take up from it small amounts of carbonic acid gas. This is produced in the soil by the breathing of small plants and minute animals. One of the substances frequently dissolved by water containing carbonic acid gas is lead. Lead is a very dangerous poison. That is why large iron pipes and not lead pipes are used for conveying

water to houses and other buildings. The pipes coming into the houses are made of lead, because this substance is convenient for entering awkward passages and corners. Water should not be stored in leaden cisterns or in any cisterns in which lead is used at the joints. Neither should water for drinking purposes be used after it has stood for long in the pipes. During the day it is constantly being used and there is very little risk, but when filling a kettle in the morning after no water has been drawn for several hours, it is best to let the water run a little while before using it. Hard water has very little solvent action on lead, but soft water has a much greater action. Hot water has greater solvent action on lead than cold water, therefore it is risky to use water from a hot tap to fill a kettle for drinking purposes, or for any cooking purposes whatever.

Experiment 1.—To show the action of water upon lead. Take a beaker full of tap water if the water supply is soft, or of rain water, or of distilled water which has been well shaken up in a bottle containing air, to aerate the water. Take a small piece of lead and scrape it clean and place it in the beaker containing water. This should be kept for a few days. Take a similar piece of lead and leave it for the same time in hard water. Pass into each beaker some sulphuretted hydrogen gas, or sulphuretted hydrogen solution. In the beaker containing lead and soft water a brown or black colour will be produced, but not in the beaker containing hard water. The soft water has dissolved some of the lead, the hard water has not. This test is always used to indicate the presence of lead in water, and it shows even if there is only a very small amount of lead present.

Other kinds of impurities which are sometimes found in water are what we call organic impurities. These are small particles of decaying animal, plant or sewage matter. This kind of impurity is extremely dangerous, because it contains germs of disease which have been known to cause serious epidemics of disease. Germs

of cholera, typhoid fever and scarlet fever can be carried by contaminated water, also germs of diphtheria.

Experiment 2.—To test water for organic impurity. Place the suspected water in a beaker, and add to it a few grains of permanganate of potash. At first the solution is quite pink. If after a short time it turns brown it shows that organic matter is present. Compare tap water with water in which flowers have been kept for a week, or in which grass or straw has been kept.

General summary of the importance of a pure water supply.—Water is very largely used for drinking purposes and for cooking. Even if some people do not actually drink much water as water, it is still the basis of all our drinks—tea, coffee, cocoa and soups.

It is used for preparing vegetables and cooking them, and is used for making bread, pastry and puddings.

It is also used for personal cleanliness, for washing of clothes and houses, for baths, public baths and wash-houses, for cleaning streets and flushing drains.

Since it is used for so many purposes, our water supply has a very great importance in our healthiness, and it is essential that we have a constant and good supply for all purposes.

LESSON 8

Sources of water supply.—All the water comes in the first place from rain, which is condensed from water vapour in the clouds and falls upon the surface of the earth. The atmosphere always contains moisture but this varies according to the temperature. The warmer the air the more moisture it can hold until, of course, it becomes saturated. On a fine, warm summer day there is actually more moisture in the air than on a cool wet day.

When the air cools, the moisture is deposited as rain. Sometimes some of it is deposited as dew. The earth and plants on the earth have been warmed during the day,

and when darkness comes these begin to cool. The grass is cooler than the surrounding air, and the moisture in the air is deposited on them. This explains why dew falls on a summer evening and you see it on grass and other plants early in the morning. This formation of dew prevents plants from suffering unduly in dry weather.

Rain water as it falls is the purest of all natural waters, for it is practically distilled water. It is not very dependable for drinking purposes as its supply is not constant and if stored it is apt to become contaminated. Falling through the air it takes up smoke and dust, and in towns is very dirty. It should not, if it is to be used for drinking, be stored in wooden tubs, for wood decays and makes the water impure. It should be covered so that no living thing can enter it and cause it to be fouled. It is very soft and is very good to use for washing and cleaning purposes. In places where the usual water supply is hard, people often collect rain water for the above purposes. It can be freed from smuts and dust even in towns by allowing it to pass through muslin before entering the storage tub.

In the country it is very rarely used for drinking purposes as it is flat. This is because it does not contain sufficient air.

Other sources of water supply are rivers and ponds. Water from ponds is always dangerous to drink as it is liable to be contaminated by animals which visit the water for drinking purposes. Water from rivers may form a good source of water supply, but it must be collected from the early part of the river, before it has reached a large village or town. It is constantly in motion and is likely to be well aerated and is pleasant to taste. Unfortunately, a river at this stage is very small, and the amount of water in it very little. Do not be tempted to drink water from a river or stream when you are out for a walk, as it may have been contaminated and will then be dangerous. Some large towns as Paris and London do obtain a large supply of drinking water from the river, that is, from the River Seine and the

River Thames. This has to be treated by the water companies before it is delivered to the houses. It is first pumped into reservoirs and is treated in various ways. It is passed through various filter beds which remove suspended impurities and organic matter and is treated chemically to remove hardness.

Water for drinking purposes should not be stored in a tank or cistern, but should be drawn directly from the main water pipe. Water pipes supplying water for drinking purposes should be quite separate from those supplying water for flushing water closets or drainage purposes.

Water is sometimes supplied to towns from large mountain lakes. This is generally very pure and soft. Manchester receives most of its water from Lake Thirlmere in the Lake District, and Liverpool from a large lake, Lake Vyrnwy in North Wales.

One of the earliest known ways of obtaining water was from wells. When rain falls on the ground some evaporates, some finds its way to the nearest stream, and some of it passes through the soil. Some soils allow water to pass readily through them, others only allow it to go very slowly, and some not at all. Sandstone, sand and chalk allow water to pass through them rather quickly; clay, slate and granite do not allow the water to go through.

Experiment 1.—Take three funnels and line them with filter paper. Fill one with coarse sand, another with fine sand and another with powdered chalk. Leave a little space at the top of each funnel. Now fill three measuring glasses with water; put the same amount in each, say 100 c.c. The funnels should be placed on top of other graduated measuring glasses. At the same time line another with filter paper, and over the paper place a layer of moist clay. Place it over a jar. Pour equal amounts of water into each funnel. You will see that water passes more quickly through the coarse sand, less quickly through fine sand and chalk, but it does go through them. It does not go through the clay, Fig. 54.

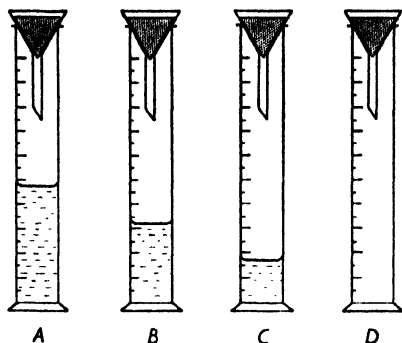

FIG. 54.
SHOWING POROSITY OF SOILS

- A. Coarse sand.
- B. Fine sand.
- C. Powdered chalk.
- D. Clay.

Experiment 2.—Now take some wet clay, and mix it well with coarse sand. Line a funnel with filter paper and place it over a graduated measuring jar. Then pour water on to the mixture. Water goes through, but more slowly and less in amount than when sand alone is used. If your soil is too dry in your garden a little clay dug into it will help to keep water in the soil. If your soil holds too much moisture it can be improved by digging well and mixing sand or chalk with the soil.

Formation of wells, Fig. 55.—As water goes through the earth it gradually dissolves some of the material over which it passes

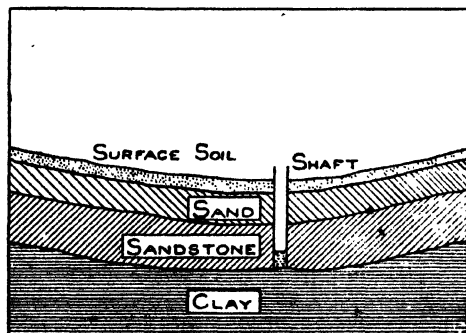

FIG. 55.
FORMATION OF A WELL

and becomes harder. It will go through the ground until it comes to slate or clay or granite, through which it cannot pass, and will collect on the surface of this impermeable layer. If a hole is bored through the earth to this layer, water will rise through the hole.

To make a well, a pit or shaft is dug to the impermeable layer, and water rises up it. The shaft is lined with some impermeable substance, and a well has been made. Sometimes the water does not rise actually to the surface, but has to be pumped part of the way. Well water is hard. The deeper the well the harder the water. If properly built it is free from organic impurities; it is also pleasant to drink, and is always cool. Shallow wells are not so safe; they are more liable to be contaminated.

Formation of springs, Fig. 56.—In some country districts water is obtained from springs which arise on a hillside. The rain water falls on the earth, sinks into the ground, and continues to fall until it reaches an impermeable layer. Then it flows along on the top of this impermeable layer until it finds an outlet in the hillside. This we call a spring.

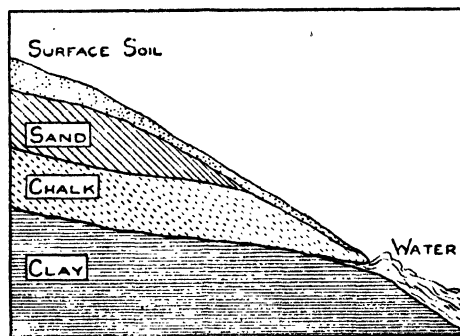

FIG. 56.
FORMATION OF A SPRING

At sea, use is made of distilled sea water. This is flat but it can be made pleasant to drink by allowing it to drip slowly through the air into a vessel beneath. In passing through the air it becomes aerated.

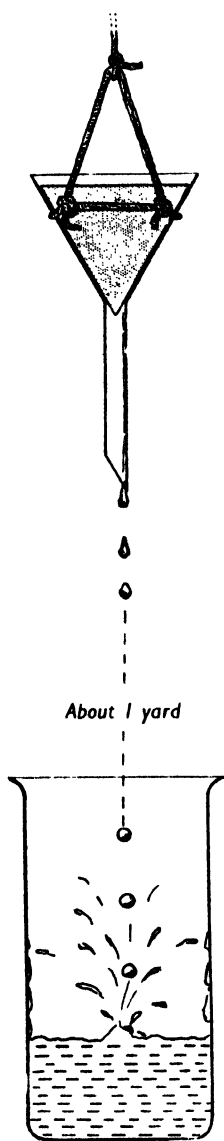

FIG. 57.

ARRANGEMENT OF
AERATION APPARATUS

A flame.—The inflammable material in a candle is the wax or tallow. These consist chiefly of carbon and hydrogen. Both these substances burn in air, and on burning, produce carbon dioxide and water. When a

Experiment 3.—To show how distilled water can be aerated. Take a funnel provided with a rim. Tie a piece of string round the rim. Tie another piece of string in two places on opposite sides of the rim, so that the funnel can be hung up. Line the funnel with filter paper. Hang this up so that it is about a yard away over the mouth of a beaker. Pour distilled water into the funnel and allow it to drip into the beaker, Fig. 57. The narrower the outlet from the funnel the more slowly will the water drip and collect in the vessel below. Now taste some of this water and compare it with some of the distilled water from which you took it. You will notice that it is not so flat, and more pleasant to taste. Each drop as it went through the air took with it some of the air. The water has become aerated.

candle is lit, the wax melts and is drawn up the candle wick. This material is converted into vapour and when hot enough burns, becomes luminous and forms what we call the flame.

Experiment 1.—Take a piece of strong white paper. With both hands hold the paper and depress or lower it through the flame to the level of the wick. Hold it there for about a second. Then withdraw it. You will see a ring of sooty matter on the paper, and within it a clean space, Fig. 58.

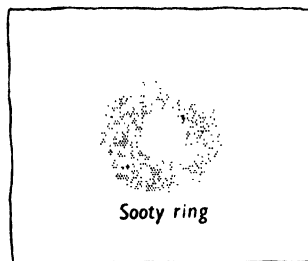

FIG. 58.

Experiment 2.—Now take a piece of tubing bent at each end, but in opposite directions, and hold it so that a short limb is in the centre of the flame. You will shortly see yellowish brown vapour pass along the tube and out at the end furthest from the centre of the flame. Let this continue for a little time. Then put a lighted taper at the end of the tube which is away from the flame. The vapour will also begin to burn, Fig. 59. These two experiments show you two things:—

1. That the actual dark part of the flame contains vapour but no burning or combustion takes place there.
2. The luminous zone surrounds this, and there combustion takes place. The light from the candle comes from this zone. It contains white hot carbon particles and the products of the incomplete burning of the vapours.

Now examine the flame again. You will see outside the luminous zone another non-

LESSON 9

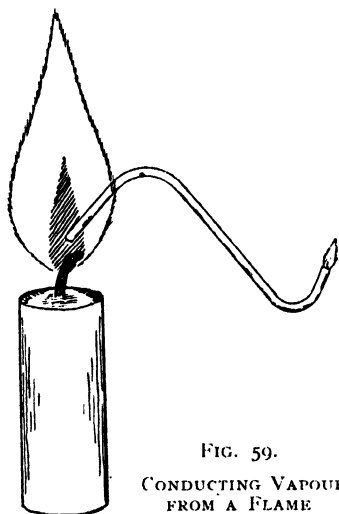

FIG. 59.
CONDUCTING VAPOUR
FROM A FLAME

luminous zone. Here the vapours are in closest contact with air, and there is complete combustion. There are no solid particles and you can hardly see the flame.

Experiment 3.—Now sprinkle a little finely powdered salt, table salt will do very well, on the flame. Immediately you will see the three zones in the flame easily, Fig. 60:

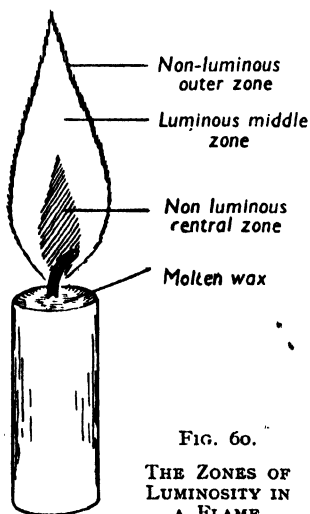

FIG. 60.
THE ZONES OF
LUMINOSITY IN
A FLAME

(1) The dark inner zone of no combustion.
(2) The middle zone of partial combustion.
(3) The outer zone of complete combustion. This is coloured yellow by the solid particles of salt in the flame. It is the sodium in the salt which causes the colour. The heat of the outer zone makes the solid salt particles hot and luminous.

Experiment 4.—Now repeat Experiment 1. You will see the clear inner ring, the ring of soot surrounding it and a scorched ring outside this, where, if you continue to hold the paper in the flame, it will begin to burn. The centre is the coolest part of the flame, the outside the hottest.

The kind of flame in a lamp and in an ordinary gas flame is similar to the flame of a candle. In the lamp the illuminant is oil already in the liquid form, and not so much heat is used in changing this into the form of vapour, whilst gas is already in the form of vapour.

Experiment 5.—Now examine your Bunsen burner. Turn on the gas and light it. The whole flame is dark and non-luminous. Partly close the holes admitting air at the bottom of the flame. What happens? The flame becomes partly luminous. Close the holes completely. The flame becomes more luminous still, and resembles the flame of a candle. By depressing a piece of white paper low down into this flame, you can see a ring of soot deposited as you did in the candle flame. The introduction of air through the holes at the bottom of the burner brings about complete combustion and causes greater heat in the flame. Now think of the flame in a gas oven, and in the burners on the top of the stove. The flame seen there resembles the flame of a Bunsen burner. If your stove is perfectly clean and the space where air enters the flame is quite open, then you have great heat, complete combustion of all the gas admitted and no carbon deposit on your cooking vessels. Which is most economical? There will also be no disagreeable fumes.

Experiment 6.—To show that the centre of the flame is coolest. Place a match across

the colourless flame near the middle of it. A longer splint can also be used. You will see that it begins to burn at the two outer layers, and that the middle part does not burn, Fig. 61. This shows that the middle of the flame is the coolest. It consists of unburnt vapour or gas.

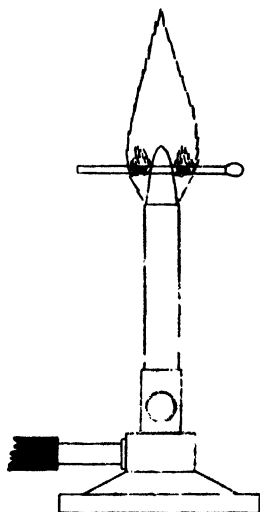

FIG. 61.
A MATCHSTICK BURNS IN THE
OUTER ZONE OF A BUNSEN
FLAME BUT NOT IN THE
CENTRAL PART

Experiment 7.—Draw a match very quickly through the flame until it is in the centre. The match does not take fire. Draw more slowly towards the outer part and notice where it ignites. This part is hotter than the middle.

Experiment 8.—Hold a piece of a wire gauze in the flame. Notice in the middle a dark portion and round it a red hot ring, Fig. 62. The inner portion is not hot enough to make the gauze red hot, the outer part is hotter.

LESSON 10

Incandescence.—You learned in the last lesson that solid particles in the flame of a candle or a gas flame make the flame lumin-

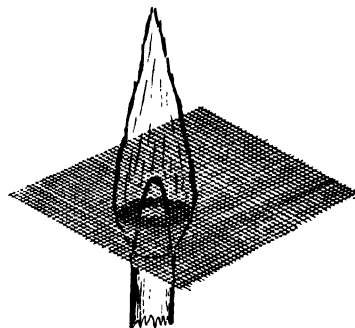

FIG. 62.
HOT AND COOL ZONES SHOWN IN
GAUZE

ous. You also saw that you could make the outer zone of flame in a candle luminous by introducing finely powdered salt. This kept the flame luminous until the salt was burnt.

Now in houses where gas is used for lighting purposes we use what is called incandescent light. The flame is surrounded by a mantle. This is made of fine material which is impregnated with a material which, when heated, becomes white hot but does not itself burn. This adds to the luminosity of the flame, and for an equal consumption of gas we get a better light than when using a plain burner without a mantle.

In an ordinary magic lantern the intense light needed to light the screen on which the pictures are shown is produced by means of the oxyhydrogen light. These burning gases play on the lime in the lantern, and make it white hot. As long as the lime is heated it is incandescent; when not heated it is not luminous. The lime does not burn away. A non-luminous flame is used and it is made luminous by the substance which is incandescent in it.

A gas fire.—The most satisfactory forms of gas fires are those which glow by incandescence. At the base of the stove is a row of Bunsen burners, and in front, a form of asbestos fuel. The non-luminous hot flames heat the asbestos, which becomes white hot, and while incandescent it continues to give

out intense heat. In some, small balls of asbestos are made incandescent. Some stoves are made to look like burning logs, or coal fires. In every case the fuel is non-combustible and glows by incandescence.

A gas fire has some advantages over the coal fire. It is much cleaner to use, and saves much labour in the home. It has not to be laid, and it does not make any dust. It can be turned off immediately it is no longer needed. If properly connected, it does not give off bad fumes into the air of a room. It can be easily regulated according to the amount of heat required at the time.

A gas stove for cooking purposes (Fig. 63) has many advantages. The temperature can

be regulated to the exact temperature desired for quick or slow cooking. This cannot be so easily done by means of a coal fire. The cooking utensils are kept clean more easily. The modern stoves are so constructed that the fumes produced in cooking are carried quickly away, so that there is less smell than when cooking in an ordinary fire oven.

Heating by means of hot water pipes supplied from a boiler heated by one fire only has been considered earlier in the course. This is an extremely economical and labour saving method of heating. It has the disadvantage of making the air rather dry. This difficulty can be overcome by having a bowl of water in the room, near the radiator. This water evaporates and keeps the air sufficiently moist. It has the disadvantage of not looking so cheerful or inviting as a coal fire or a gas fire, but it does warm the room more evenly than any other method.

In these days people are beginning to make greater use of electricity for lighting, cooking (Fig. 64) and warming purposes.

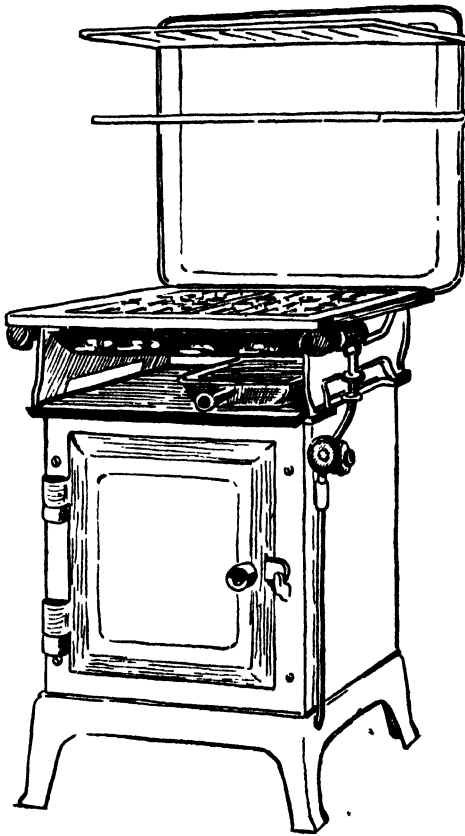

FIG. 63.
GAS COOKER

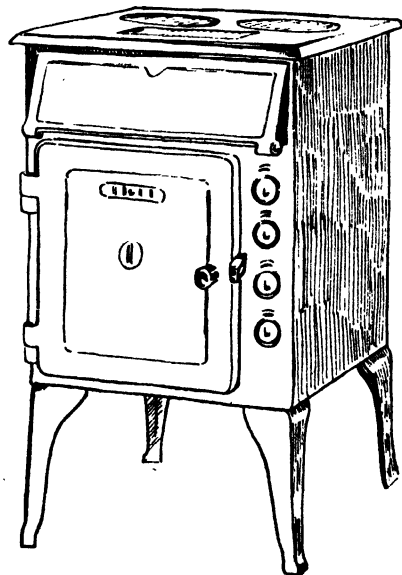

FIG. 64.
ELECTRIC COOKER

In one way heating and lighting by electricity are much better than any other way. There is no fuel used, that is, nothing is burning. As all burning results in the using up of oxygen and the giving out of carbon dioxide, electricity, which does not do this, is more healthy to use. The burning of an ordinary gas burner uses up more air than is needed for two people in a room and this means that in the evening, when most people are at home, the adequate ventilation of a room becomes more difficult. Electricity is the cleanest source of heat and light, no dust or soot is caused by its use, and consequently less labour is spent on cleaning, and upon renewals of wallpaper, etc. It is dearer to use, but the extra expense is compensated for in other ways.

LESSON 11

Acids and alkalis.—The action of acids on blue litmus paper.

Experiment 1.—Dip a clean glass rod into a bottle containing sulphuric acid and then place the rod on a piece of litmus paper. Wipe the rod dry after washing it under a tap. Repeat this, dipping the rod in turn into hydrochloric acid, nitric acid, acetic acid, lemon juice, rhubarb juice and vinegar. Note that in every case the blue litmus paper is turned pink. From these experiments we learn that all acids turn blue litmus pink. If you are ever in doubt whether a liquid is acid or not, place a little of it on blue litmus paper. You can make blue litmus paper at home by using vinegar in which red cabbage has been pickled. Take some red cabbage vinegar, add soda to it and stir until the liquid is not red but blue. Paper dipped in this liquid will be blue in colour, and it can be used to decide if a given liquid is an acid or not. Another property of acids with which you are all familiar is their sour taste. Think of vinegar, lemon juice, not quite ripe oranges, rhubarb juice, gooseberry juice.

Experiment 2.—Place a small piece of washing soda, which is sodium carbonate, in a porcelain dish, and drop on to it a small portion of each of the acids previously used. Effervescence takes place and a gas is liberated. The gas which is given off is carbon dioxide.

Experiment 3.—Place a little sulphuric acid on some scraps of granulated zinc in an evaporating dish. Effervescence takes place and a gas is given off. From your lesson on water you have learned that hydrogen is produced when an acid is poured on zinc.

Experiment 4.—Place a little acid in an evaporating dish. Add drop by drop sodium carbonate solution. This solution is obtained by dissolving washing soda in water. After each drop has been added this way, put a little on a piece of litmus paper. Put the rod under the tap every time, to wash off the solution. After a time the rod placed on the blue litmus paper does not turn the litmus paper red. You have now learned that acids:—

1. Have a sour taste.
2. Turn blue litmus red.
3. Cause effervescence with a carbonate.
4. Give off hydrogen gas when a metal is put in them.
5. Lose their acidity when sodium carbonate is added to them.

If you now taste the solution you will find it is no longer sour.

Alkalis.—The following substances are common alkalis:—caustic soda, ammonia solution, caustic potash, sodium carbonate, lime water. Pour a little of each of these substances into a glass beaker. Add water so that the solution is very weak. Stir well.

Experiment 1.—Dip a glass rod in each solution and taste the solution at the end of the rod. Do not drink it. In every case it has what we call a caustic taste.

Experiment 2.—Place a drop of each alkali on red litmus paper. The paper turns blue.

Experiment 3.—Put your finger into each alkali in turn, and rub your finger. Notice

the soapy feeling. Caustic soda and caustic potash are common alkaline substances. When these substances are exposed to air they become wet by taking up moisture from the air. We say they deliquesce. They dissolve readily in water and produce great heat.

Experiment 4.—Place a little caustic soda or caustic potash in a beaker containing water. Notice the increase in temperature. Such a solution might cause a severe burn. Lime is common alkali. It is produced when chalk is very strongly heated. To make lime for commercial purposes limestone is heated in a kiln. It is broken up into lime and carbon dioxide.

Experiment with lime (5).—Take a small piece of lime and place it on a filter paper. Drop water drop by drop on the lime. At first the water is absorbed and the lime gets hot and turns into a fine powder. After a time no more water is absorbed. At first the lime is called quick lime. Later it is slaked lime. Lime is used for making mortar with sand. A pit is dug in the ground. Lime is put into it and water poured on top of it. Until the lime has absorbed all the water it can, it is dangerous to go near a lime pit. A child falling in might be very severely burnt.

Experiment 6.—To see how much water quicklime is capable of absorbing. Weigh a porcelain dish. Place in it a piece of lime, and weigh again. You must do this quickly as it begins to take water out of the air. Record the weights. Then add water drop by drop until no more can be absorbed by the lime. As soon as there is free water in the dish, stop adding more of it. Drive off the excess water by heating the dish over a Bunsen flame. When cool, weigh again. You will find that it has gained weight. The gain is due to the water taken up by the lime. If you have worked carefully you will find that lime can absorb about one-third of its weight of water. Alkalis absorb carbon dioxide.

Experiment 7.—Collect in a glass tube over water some carbon dioxide gas, prepared by

the action of hydrochloric acid on marble. When the tube is full of carbon dioxide, break off about 1 in. of caustic soda and pass it under the water to the entrance of the tube containing carbon dioxide. An alkaline solution in the water is formed, and this rises up the test tube. It takes the place of the gas which it has absorbed. This can also be done with caustic potash. From this we learn that alkalis absorb carbonic acid gas.

Experiment 8.—Action of an acid on an alkali. Place some caustic soda solution in an evaporating dish. Add hydrochloric acid drop by drop until blue litmus paper is no longer blue, but faintly pink, that is until it is just acid. Heat the evaporating dish over a sand tray until all the liquid is driven off. You will see a white substance in the dish. Carefully dry the white substance and taste it. It tastes salty. You have made common salt. Dissolve some of this salt in water, and put in it some blue and pink litmus paper. The papers do not change in colour. Salt is neither an acid nor an alkali. The acid has neutralised the alkali and produced a salt. It is important to know that this happens, because if an alkali or an acid has been taken by mistake it can be neutralised. If a person has taken an acid poison an alkali can be taken to neutralise it; if an alkaline substance has been taken it can be neutralised by an acid. The combination forms a harmless salt.

LESSON 12

Soda, borax and soap.—Washing soda is an alkali. A solution of washing soda will turn red litmus paper blue. You have seen that an acid and an alkali can neutralise each other, resulting in the production of a neutral salt.

You are familiar with the fact that soda is useful in washing up. Dishes which have been used for cooking, or plates on which food has been placed, have a certain amount of grease on them. This cannot be removed

with cold water. If hot water is used, the grease is melted and with the hot water is poured down the drain from the sink. This in turn makes the sink greasy, and this grease has to be removed.

If soda is used, it unites with part of the grease to form soap. All grease consists of glycerine and a fatty acid. When butter or any other fat is kept too long it begins to decompose and splits partly into glycerine and the fatty acid. The unpleasant smell of rancid butter is due to the acid called butyric acid which it contains. Meat fat and all oils contain an acid constituent as well.

The soda used in washing up splits the fat into these two substances and unites with the acid portion to form soap. The soap is soluble in water and along with the other dirt present is removed from the dishes. Any other alkali would serve the same purpose, but washing soda is the cheapest to use and therefore the best for domestic purposes. Clothes which have been worn next to the body are soiled with perspiration and oily substances given off by certain glands in the skin. Soda used in washing them also combines with the acid substances found in them, forms soap which can be dissolved in the water and thus the dirt leaves the clothes.

Soda should not be used in washing woollens. It makes the wool hard and yellow. Neither should it be used in washing coloured materials. Water containing alkali in solution dissolves colours more rapidly than pure water. The soda used in washing white clothes tends to make them yellow. The clothes need careful rinsing in plenty of water, and blue is added to the last rinsing water to counteract the action of the soda and restore whiteness.

Examine some washing soda. Notice that it is made up of crystals. What happens to washing soda when you leave it exposed to the air?

Experiment 1.—Heat a small crystal of washing soda in a small tube. Note that water is given off in the form of steam,

Fig. 65. All crystals contain a certain amount of water, which is called water of crystallisation. On being heated, the water of crystallisation is driven off.

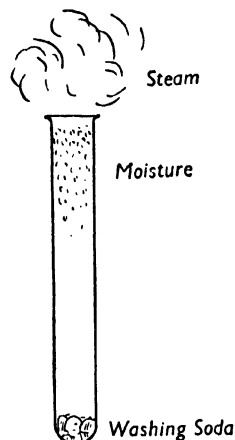

FIG. 65.

SHOWING WATER IN SODA

Experiment 2.—Place a small crystal of soda in a test tube, and pour on it a little dilute acid. Notice the effervescence and the giving off of a gas. When effervescence stops pour a little lime water in the tube and shake it. It goes milky. As carbon dioxide is the only gas which turns lime water milky, this gas must have been given off during effervescence.

Experiment 3.—Make a solution of washing soda. Take a small piece of greasy rag, rag on which an oil has been poured will do, put it in the soda solution and warm it for a few minutes. The grease has disappeared, Fig. 66. It has been used to make soap which has dissolved in the water.

Experiment 4.—On a piece of white calico place a piece of washing soda. Drop a little hot water on to the soda. Let it alone for a little while. Then dry the rag. You will notice a yellow tint where the soda was touching the calico, Fig. 67. Borax is also an alkaline substance.

Experiment 5.—Dissolve a little borax in water. Place a little red litmus paper in the

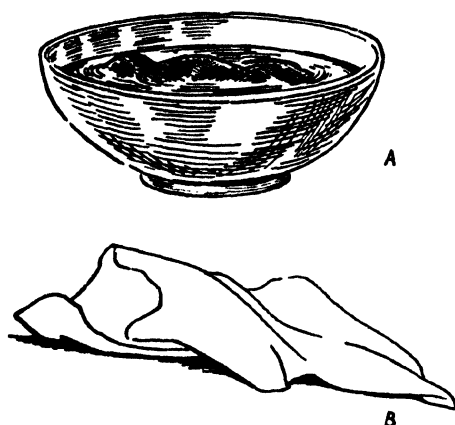

FIG. 66.

A. GREASY RAG IN HOT WASHING SOLUTION
B. RAG, CLEAN AFTER TREATMENT

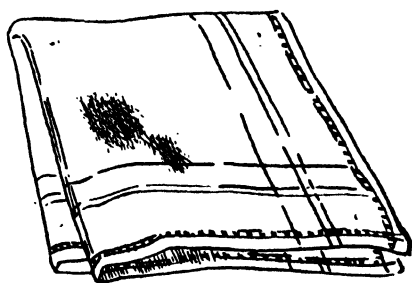

FIG. 67.

HANDKERCHIEF SHOWING WASHING SODA
MARKS

solution. The red litmus turns blue. Soap is formed by the union of an alkali with a fatty acid.

Experiment 6.—Boil some water in a beaker, and into it put some tallow or other fat. When the fat has melted add some caustic potash to the water. The fat disappears and the liquid has become slightly milky, Fig. 68.

Experiment 7.—Heat some water in a beaker, and then put into it some tallow. When the tallow has melted, put into the water a little caustic soda. The fat disappears, and the liquid now becomes milky.

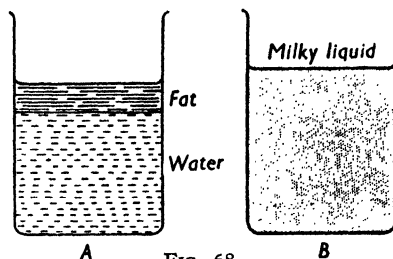

FIG. 68.

FAT AND CAUSTIC POTASH FORMING SOAP

Experiments 8 and 9.—Repeat the two previous experiments using olive oil to put in the water instead of tallow. You will obtain similar results.

Experiment 10.—Make a strong solution of caustic soda in a beaker, and in it place any oil or fat. Heat this on a sand bath. Soon you will see a white granular mass on the surface. Pour this off and allow it to cool. Underneath, the liquid left will contain the glycerine which was in combination with the acid in the fat. When the substance you poured off is cool, put a little on your hands, add water and rub. You will see that you have made soap. All soap is made by boiling fat with caustic soda or caustic potash. It is boiled in large tanks, the granular material is separated, heated again and then run off and allowed to set. Beef and mutton tallow and olive oil make the best hard soaps. Cheap oils, such as palm oil, coconut oil and cotton seed oil are also used for soap making. Hard soap is made by boiling the fat with caustic soda. Soft soap is made by boiling the fat with caustic potash. The cleansing power of soap is due to the alkali it contains. This alkali is liberated when the soap is added to water. Some soaps also contain free or uncombined alkali. This also helps in cleansing purposes. It is the alkali in the soap which is the cleansing factor. Why then do we trouble to use soap at all, and not use free alkali instead? Free alkali alone would have too strong an action on the skin and on materials to be washed. The use of soap ensures that not too much alkali is used.

LESSON 13

Air and its chemical properties.—Air is needed for burning to take place.

Experiment 1.—Take a candle and place it in a shallow dish containing a little water. Light the candle and place over it a wide-mouthed jar, Fig. 69. The candle burns for a little while, but soon goes out because it is in only a limited supply of air. The sides of the bottle become misty. Water has been formed during the candle's burning.

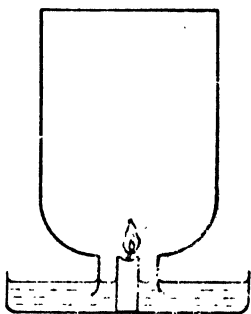

FIG. 69.
FLAME GOING OUT WITH-
OUT AIR

Experiment 2.—Quickly pour some lime water in the jar and shake it. The lime water turns milky. This is because the burning of the candle produces a gas which turns lime water milky. We call this gas carbon dioxide, or carbonic acid gas.

Experiment 3.—For demonstration only. Fill a large glass trough with water. On it float a dry crucible lid. Place a little phosphorus on the crucible lid. Use tongs to do this or the end of a knife, but do not touch it with the fingers. Cover the crucible lid containing the phosphorus with an unstoppered bell jar, Fig. 70A. Heat a piece of glass or metal rod, and pass it through the mouth of the bell jar and touch the phosphorus with it. Withdraw the rod and put in the stopper. The phosphorus burns and the jar is filled with dense white fumes. Leave the jar over the water till the fumes

have disappeared. The water during this time will rise up in the bell jar. Mark the level of the water inside the jar with a piece of gum paper, Fig. 70B. Estimate the amount of air left in the jar. About one-fifth has disappeared. About four-fifths are left.

Experiment 4.—Remove the stopper quickly and insert a lighted taper in the jar. The light goes out. The air in the jar does not allow burning to take place in it. We see that air contains at least two gases:—

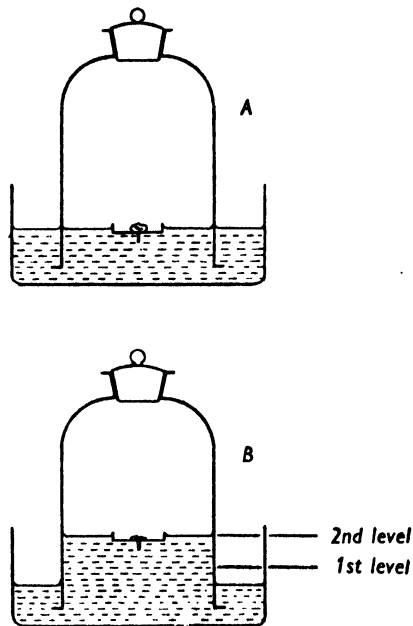

FIG. 70.
SHOWING RESULT WHEN PHOSPHORUS
IS BURNT

1. A gas which allows things to burn in it.
2. A gas which does not allow things to burn in it. About one-fifth of the air is the first gas. About four-fifths of the air are the second gas. Both gases are invisible. The first gas is called oxygen. The second gas is called nitrogen. Air consists of:—

1. Oxygen which supports combustion.
2. Nitrogen which does not support combustion.

Experiment 5.—Another experiment to show that air is needed for burning. Take two small crucibles or evaporating dishes. Place in each a small piece of charcoal, about the same size. Cover one with sand, and leave the other exposed. Place on a sand tray and heat strongly. The charcoal in the open dish gradually gets less, until at last there is left a small quantity of white ash. Turn out the contents of the other crucible. The charcoal is unaltered although it has been heated as long as the exposed charcoal. The first was exposed to air. The second was not. Air is needed for burning to take place.

Experiment 6.—To show the effect of breathing in air. Take a small flask fitted with a cork and a short piece of bent tubing. Place a little lime water in the test tube. Fit up a similar flask and leave it exposed to the air in the room. Breathe down the glass tubing into the first jar and notice bubbles going through the lime water. The lime water turns milky. The air we breathe out contains a lot of carbon dioxide. In the other flask after a few hours you can notice a slight cloudiness of the lime water. Air in the room contains a small amount of carbon dioxide, and air breathed out contains a large amount.

We have discovered now about air that it contains oxygen, nitrogen, and carbon dioxide, and always contains a certain amount of water vapour. All fires and all animals, gas and burning oil, all increase the amount of carbon dioxide in the air. You have probably learnt in your nature study lessons that green plants are able to take carbon dioxide out of the air, and use it for making starch. This work done by plants helps to keep the amount of carbon dioxide in the air very small, and keeps the air fit for breathing. There are fewer people and more plants in the country than in towns, and therefore the air contains less carbon dioxide. We say it is purer. The circulation of air or winds causes purer air to be brought to towns. You see the importance of having well-planned towns, with plenty of open spaces, grass and trees.

LESSON 14

Oxygen and its properties.

Experiment 1.—Take a small test tube, and in it place a little potassium chlorate. Hold the test tube with a holder and heat the lower part of it in a Bunsen flame. The potassium chlorate melts. After a little while hold a smouldering splinter of wood in the test tube. It immediately becomes brilliantly lighted. A gas is given off which supports combustion. This gas is oxygen.

Experiment 2.—For demonstration purposes. Fit a flask with a well-fitting cork and a delivery tube. Place a mixture of powdered potassium chlorate and black oxide of manganese in the flask, and support the flask on a retort stand, so that the delivery tube dips into a trough full of water under a beehive shelf. Fill a collecting jar with water, cover with a glass plate, and invert it over the beehive trough. Have

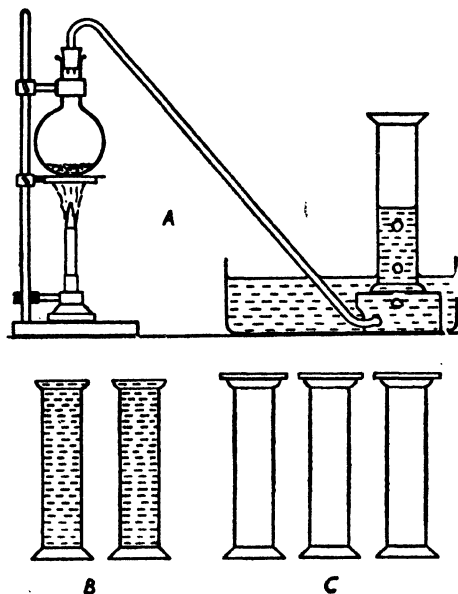

FIG. 71.

- A. APPARATUS FOR PREPARING OXYGEN. (The flask contains a mixture of potassium chlorate and manganese dioxide.)
 B. GAS JARS FULL OF WATER.
 C. GAS JARS, WITH GLASS PLATES, FULL OF OXYGEN.

ready four other jars filled with water and covered with glass plates. Place a lighted Bunsen burner under the flask. Notice bubbles of gas passing through the water into the jar, Fig. 71. When the jar is empty of water, replace it by another jar. First put a greased glass plate on the jar that is under water. Put the jar on one side for further experiments. Collect five jars in a similar manner. You will see that the gas is colourless and invisible. Remove the plate from one jar and smell the contents. The gas has no smell. Oxygen is a clear, invisible gas without smell. It must be lighter than water for it passes through it and gets to the top of the jars. It is insoluble, or only very slightly soluble in water.

Experiment 3.—Heat a piece of charcoal in a Bunsen flame until it glows. Then remove it from the flame. It ceases to glow. Heat in the flame again and, when glowing, plunge it into a jar of the oxygen collected. It now burns very brilliantly.

Experiment 4.—Place a small piece of phosphorus in a deflagrating spoon and plunge the spoon into a jar of oxygen. The phosphorus burns brilliantly in the oxygen and fills the jar with dense white fumes.

Experiment 5.—Heat a little sulphur in a deflagrating spoon and plunge it into a jar of oxygen. Notice the increased brilliancy of the flame.

Experiment 6.—Light the end of a piece of magnesium ribbon and plunge it into a jar of oxygen. Notice the brilliant flame.

These experiments show you that substances which burn in air burn more brilliantly in oxygen. They also show that oxygen does not itself burn.

Experiment 7.—Into the jar in which phosphorus and sulphur were burnt introduce a little water and a piece of blue litmus paper, and shake. The blue litmus paper turns red. Acids turn blue litmus paper red, so the gases produced when sulphur and phosphorus are burnt in air, are acid in nature.

From this series of experiments you have learned that oxygen is a clear colourless gas which does not burn, but supports combustion. It has no smell and is insoluble in water.

The gas which is left in the jar after a candle is burnt in air is nitrogen. It is a clear invisible gas, does not burn, and does not support combustion. Its use in the air is to dilute the oxygen.

LESSON 15

Ventilation.—You have already learned that air is a mixture of three gases, about one-fifth oxygen, nearly four-fifths nitrogen and a small amount of carbon dioxide, about .04 parts in 100.

You also know that oxygen is needed to support life, that nitrogen is inactive and dilutes the oxygen, and that carbon dioxide is a harmful gas. Every living thing breathes, and gives out carbon dioxide into the air, that is, they increase the impurity of the air. All fires which produce heat by burning fuel—either coal, coke, wood or oil—also use up oxygen and give out carbon dioxide. The only fires and lights which do not pollute the air are electric fires and electric lights. Not only do houses cause pollution of air, but also all factories and works where fuel is used also cause the air to be polluted.

Out of doors the ordinary movements of the air take away bad air and cause fresh air to be brought to us. It is necessary for us to have fresh air brought into our homes, that is we must have ventilation. Every time we open a door we allow fresh air to enter a room, but this is not sufficient to keep the air fresh and our rooms healthy. We must arrange for proper ventilation.

You have learned that air when warmed expands and rises.

Experiment 1.—Light a taper and hold this at the top of the door or window. What happens? The light of the flame is blown

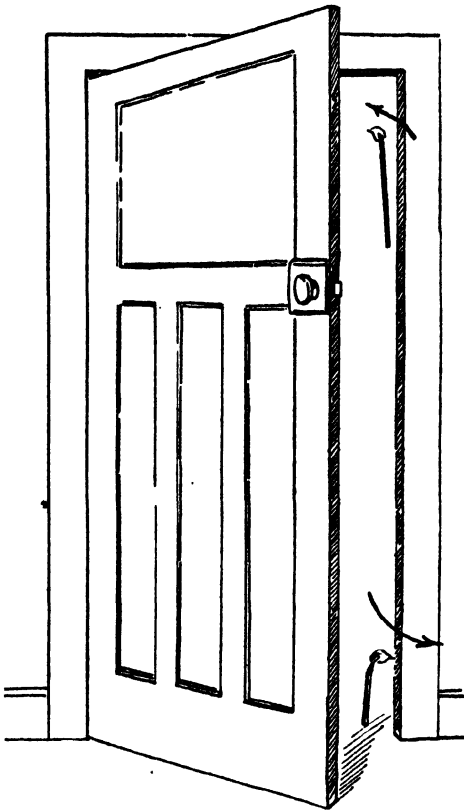

FIG. 72.

DIRECTION OF AIR CURRENTS

outwards, Fig. 72. That is, the warm air which has risen can pass out at the top of a door or window.

Experiment 2.—Light the taper again, and this time place it at the bottom of the door and window. This time the air blows the flame inwards, Fig. 72. Hold your hand in the current of air, and you will notice that it is cold. Cold air can enter at the bottom of the door or window. This cold air is also fresh air.

Whatever we do to ventilate a room, we must provide two things: (1) an inlet of fresh air; (2) an outlet for impure air. What do you do to ventilate your living room and bedroom at home? The window is opened at the top and at the bottom. Where does

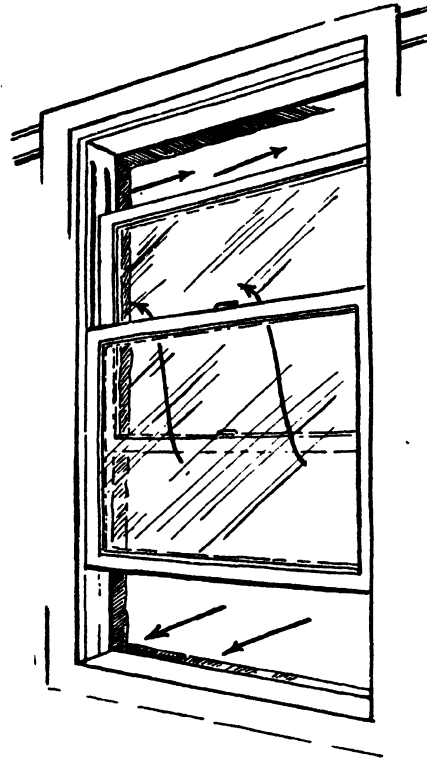

FIG. 73.

OPEN SASH WINDOWS, SHOWING AIR INLETS AND OUTLETS

fresh air enter? Where does impure air escape? (Figs. 73 and 74.)

It is most important that bedrooms should be ventilated. You spend more time in your bedroom than anywhere else and all the time you are breathing and making the air impure. The bedroom window should always be open a little both at the top and bottom. The drawn blind or curtain will prevent a direct draught upon the bed.

Even if people are ill in bed, the window must be open. If it is necessary to warm the room there can be a small fire, but fresh air must be freely admitted to the room.

An ordinary fire helps in the ventilation of a room. Warm air rises, passes into the chimney and fresh air enters to take its

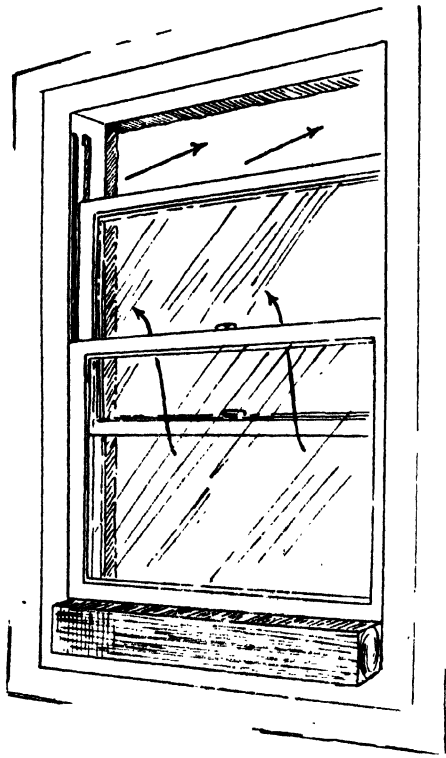

FIG. 74.
OPEN SASH WINDOWS, WITH LOWER INLET
BLOCKED BY PIECE OF WOOD TO ELIMINATE
DRAUGHT

place, Fig. 75. Sometimes in houses ventilators are fitted which communicate with the chimney and carry bad air away. If you do not ventilate a room properly, a chimney may become an inlet for fresh air, and you have smoke entering the room. One thing to do to stop a chimney smoking is to open the window and door and allow fresh air to enter by this means.

Perhaps in your class room you have inlet ventilators. These are about 5 ft. from the

ground, and the air coming in gets warmed by the air in the room and does not cause a draught.

Free circulation of air in a house also prevents damp. A well ventilated house is a dry house. In a damp house people are more liable to take cold. I expect you have all noticed a damp smell when you have returned home after a holiday and the house has been shut up for a week or more.

In large buildings special arrangements are often made for the ventilation. The incoming air is warmed to prevent draughts.

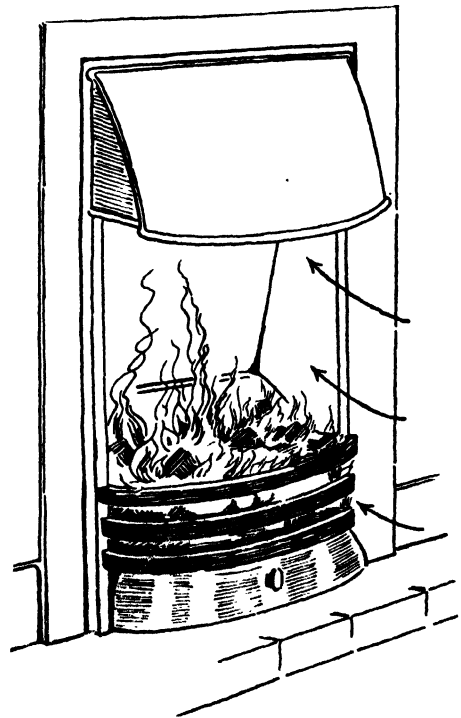

FIG. 75.
FIREPLACE, SHOWING DIRECTION OF AIR
CURRENTS

THIRD YEAR'S COURSE

LESSON 1

Food.—Food is absolutely necessary for the continuance of life. In that particular, all living things are alike. Plants and animals, if deprived of food, die. But the food of plants and animals is quite different. Plants are able, from chemical substances dissolved in soil water and carbon dioxide from the air, to build up complex substances which they use for growth. Animals cannot do this but have their food ready made for them by plants. All food of animals comes directly or indirectly from plants. Many animals are vegetable feeders, some feed on animals. These use as their food animals which have been fed on vegetable material. If there were no plants there could be no animals.

Food is useful for us in several ways. In the first place it is the material by means of which we grow. As we live and move we wear part of ourselves away, and all this waste has to be repaired by food we eat. To do any kind of work needs energy. Even when we are quite still, parts of our bodies are working, and energy is needed for this. The energy to do work comes from our food. Our body needs to be maintained at a constant temperature. This heat is produced by a process of slow combustion in our bodies. Substances taken in as food combine with oxygen which we take in in breathing, and heat is produced. Thus we see that food causes (1) growth; (2) repair of waste material; (3) production of energy; (4) production of heat.

Simple experiments.—To discover some of the substances found in food.

Experiment 1.—Cut a potato into small pieces. Weigh the potato. Make a note of its weight. Take one piece and heat it in a test tube. Notice what happens. At first

the sides of the tube are covered with vapour. After a time no more vapour is given off. Continue to heat the potato. It first turns brown, and later black. Put the blackened potato on white paper. It makes a black mark on the paper. It is charcoal. This is a form of carbon. Now continue to heat. The charcoal gradually burns away, and a small amount of ash is left. When cool, add a small amount of water to the ash. You have now learned that a potato contains water, carbon, a portion of which can be burned, and ash which cannot be burned. This is mineral matter. If you have done your experiment carefully you will also have noticed something else. When you heated it strongly, it gave off a pungent smell which resembled the smell of ammonia. Ammonia contains nitrogen, therefore, the potato contains hydrogen and oxygen in the water, carbon, nitrogen, and mineral matter.

Experiment 2.—Now take the rest of the potato and weigh it. Heat it in an evaporating dish over a sand bath until all the water has been driven off. You will need to weigh the potato at intervals of five minutes. When after two weighings you find the weight constant, you will know that all the water has been driven off. You will probably be very surprised at the amount of water the potato contained. The dried potato should weigh about one-fifth of the original weight. This shows that a potato contains about 80 per cent of water.

Now heat the potato more strongly until it is reduced to ash. The difference between the weight of the ash and that of the dried potato gives you the amount of material which can be burned. You will see that only a very small amount of the potato, about 1 per cent, is mineral matter.

All foods contain these substances but not in the same proportion.

Experiment 3.—To show that some foods which appear to be quite dry contain water. Heat in separate test tubes (1) a few grains of rice; (2) a little flour; (3) a dried pea; (4) a dried bean. Steam will appear on the sides of the test tube in every case. Continue heating. Each charrs, the charcoal material burns away and ash is left, and in every case during burning there is a smell of ammonia.

Thinking of foods which contain a large quantity of water. Onions, all green vegetables and juicy fruits contain a large proportion of water. Meat contains these substances too.

Experiment 4.—Heat a small quantity of meat in a test tube. Water is given off. It chars. The charred material burns, and a small quantity of ash is left.

LESSON 2

Starch and its presence in foods.

Experiment 1.—Take a small piece of laundry starch. With a glass stirring rod, place a drop of iodine solution on it.

Result.—A blue colour is produced. This is used as a test to discover the presence of starch, as iodine always turns blue when placed on starch.

Experiment 2.—Crush a little starch to powder, and place it in a test tube. Shake it up. The starch does not dissolve in cold water. If left for a time the starch powder settles at the bottom of the test tube.

Experiment 3.—To a little crushed starch add some cold water and boil. The starch partially dissolves in the boiling water and forms a sticky paste. It appears turbid, but a little more transparent than the original mixture. Boiling bursts the outer covering of the starch grains.

Experiment 4.—Put a very small quantity of powdered starch in water and add a little iodine solution to it—a drop is sufficient. It turns blue. Now heat the test tube. The blue colour disappears. Let it cool. The blue colour reappears. Starch is still present.

Experiment 5.—Place a little powdered starch in a test tube with water. Add a small quantity of hydrochloric acid. Put a little iodine solution (one drop) in this. The blue colour indicating starch is produced. Heat the test tube for a time. Then allow it to cool. If the blue colour returns, heat again. Then cool. Continue doing this until the blue colour does not reappear on cooling. Now taste the mixture. It tastes sweet. Boiling with the acid has changed starch into a kind of sugar called glucose.

Thus we see that starch can be changed into a form of sugar. Starch itself is insoluble, but sugar produced from it is soluble. Glucose obtained by boiling starch with weak sulphuric acid is largely used in the manufacture of jam and sweets and in making various kinds of confectionery. It is cheaper than ordinary sugar.

Experiment 6.—Place a little iodine solution with a stirring rod on a very small portion of flour. This produces a blue colour. Flour contains starch.

Experiment 7.—Heat a little flour in water and notice a similar change to that which took place on heating laundry starch.

These experiments can be repeated with small portions of ground rice, sago and tapioca. All contain starch.

Experiment 8.—Place a little iodine on a slice of carrot, a slice of turnip, a split pea, a butter bean, a slice of artichoke.

Experiment 9.—Take a small piece of cabbage leaf or any other leaf which you have kept in methylated spirit for a few days to remove the green colour. Place on it a little iodine. A blue colour is produced.

From all these experiments we learn that starch is a very common substance found in plants. It is also found in all parts of a plant—roots, stems and leaves. Some parts are large storehouses of starch, such as seeds, roots, bulbs, corms and some underground stems. The leaves make the starch, the other parts store it up. Starch is found in the plants as very small grains. In the same plant they are all the same shape, but in various plants they are various shapes; for

example, grains of wheat starch are round in shape, grains of potato starch are elliptical or oval, and grains of rice starch are angular and very small, Fig. 76.

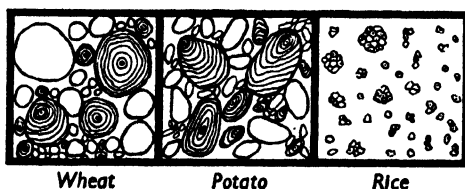

FIG. 76.
STARCH GRAINS

LESSON 3

Sugar and its presence in food.—Most of the sugar we use in daily life is obtained from the sugar cane and sugar beet, but it is present in very many other things. In America large quantities of sugar are obtained from the sugar maple. The sap of some palm trees contains sugar. The stalks of the Indian corn or maize plant also contain sugar. In a special kind of maize called sugar corn the cobs of corn are sweet owing to the presence of sugar. All sugars are sweet. This sweetness makes them a pleasant addition to other foods. It also is useful to help things to keep. Sugar in jam keeps the fruit wholesome for a long time. A little sugar is used in the preserving of ham.

To detect the presence of sugar, Fehling's solution is used. All sugars are soluble in water.

Experiment 1.—Take a little cane sugar and dissolve it in water. Add to this a little Fehling's solution, and boil. A brick red colour is produced. This indicates the presence of sugar.

Experiment 2.—Take a few raisins or currants and boil them in water. Pour off the liquid into another test tube after filtering to remove the colouring matter. Add a little Fehling's solution and heat again. A brick red colour is produced. Raisins and currants contain sugar.

Experiment 3.—To a little orange or lemon juice add Fehling's solution, and boil. A brick red colour is produced which is more pronounced in orange than in lemon juice. Oranges and lemons contain sugar. There is more sugar in oranges than in lemons.

Experiment 4.—Boil a small portion of apple in water, or a few gooseberries, and filter the liquid. Add Fehling's solution and boil. These also show the presence of sugar.

Experiment 5.—Take a small portion of honey. Dissolve it in hot water and test with Fehling's solution. The presence of sugar is shown.

Experiment 6.—Take a slice of beetroot and boil it in water. Filter the liquid. Add Fehling's solution and boil again. Repeat this with a slice of carrot.

We have thus discovered that many kinds of food contain sugar and you can think of many others.

Now we will repeat part of the last lesson. Take a little laundry starch and powder it. Add water, and boil it with weak sulphuric acid. When all trace of starch has gone (shown on the absence of colour change when iodine is added), place a little Fehling's solution in the tube, and boil. A brick red colour is produced. This experiment shows that starch can be converted into sugar.

Experiment 7.—Grind up finely a little starch. Add cold water to it. To this add a small quantity of malt extract. Leave it for half an hour in a warm place. Take a little of it and add iodine. No blue colour is produced. To the rest add Fehling's solution and boil. It turns brick red. Sugar is now present. Something in malt extract turns starch into sugar. This substance is a ferment called *diastase*. This is the reason why malt extract is given to people who cannot digest starch. It turns the starch taken in the food into sugar.

Many plants store starch in seeds. This is to be used by the seedling. Starch is insoluble, and cannot be carried to the growing parts of the young plant. But when a seed begins to germinate, there is always produced in it the starch digesting ferment,

diastase. Then the soluble sugar can be carried to the growing parts where it is needed.

Milk also contains sugar.

Experiment 8.—Add a little Fehling's solution to a small portion of milk, and boil. The presence of sugar is indicated. The particular form of sugar in milk, called *lactose*, is very easily digested. It is not so sweet as cane sugar. Milk sugar is separated from milk and is used for sweetening babies' foods.

Sugar contains a large amount of carbon.

Experiment 9.—Dissolve some sugar in hot water, so that the solution is saturated, that is, the water has dissolved as much sugar as it can contain. Now pour into the glass beaker containing it some concentrated sulphuric acid. Immediately the solution turns black and begins to froth up over the sides of the beaker. The acid has taken the water out of the sugar, and left the carbon behind. On being cooled, this can be washed with water and filtered. It will be found to consist of black grains of charcoal, Fig. 77.



FIG. 77.
CARBON FROM SUGAR

LESSON 4

Nitrogenous foods.—So far we have considered chiefly foods which contain either no nitrogen at all, or so little that it is practically non-existent. The function of non-nitrogenous foods, that is, of fats and oils, starches, sugars and gums, is twofold. They

are burned by a process of slow combustion in the body and this results in the production of heat, and they produce energy which makes us able to do work.

Fats and oils contain a greater amount of material which can be burned, hence these foods are specially valuable in cold weather for producing bodily heat. For cold northern countries inhabited by Eskimos the natives use a large amount of fat in their diet, and enjoy it. In warmer countries people do not eat so much fat, but require more sugar. Jams, because of the sugar they contain, are very valuable as heat and energy producers.

Foods which contain nitrogen are called proteids. These are absolutely essential for building up the body and for repairing waste. They are found in both animals and plants. These, like the non-nitrogenous foods, contain carbon, hydrogen, oxygen and in addition nitrogen.

Experiment 1.—Examine the white of egg. It is a thin, glassy liquid which dissolves in water. Shake a little up in water. Then add a little nitric acid and ammonia. A yellowish brown colour is produced. This is a test for the presence of proteid in food. It may sometimes be necessary to heat it. The proteid in the white of egg is called albumen. Its name means white.

Experiment 2.—Action of heat on albumen. Heat a little in a test tube. Water is given off as steam which can be seen on the inside of the tube. This shows that albumen contains hydrogen and oxygen which are the constituents of water. Continue heating. The albumen chars or burns, and has a smell of ammonia. Albumen contains carbon and nitrogen. Cooked albumen is insoluble in water. No food which is insoluble can enter into the blood, but has to be changed again by the body into some soluble substance before it can do so. Since raw egg is soluble, it can be more readily absorbed by the blood. We say that it is more easily digested.

Experiment 3.—Take a little meat juice—very weak bouillon or any meat extract will do. Add to it a little nitric acid and am-

monia, and heat. A yellowish brown colour is produced. This shows that meat juice contains a proteid material. When you begin to cook meat, you have probably noticed that a white substance is formed on the outside. Heat causes the albumen which is in the juice of meat to coagulate. The muscle of the meat also contains a nitrogenous food.

Milk.—You know that milk contains sugar, called lactose, and fat or butter. It contains other valuable food material as well. Add a little vinegar to milk and shake it. The milk begins to curdle. Separate some of the curdled part from the rest and do the following experiments with it.

Experiment 4.—Heat a little in a test tube. It chars, and gives off a smell of ammonia.

Experiment 5.—To a little of the curd add nitric acid and ammonia. A yellowish brown colour is produced. This shows the presence of proteid material.

The proteid material in milk is called casein. In the manufacture of cheese, milk is made to curdle by adding rennet to it. The solid floats in a clear liquid called whey. The whey is run off. The curds are pressed to remove all liquid, salt and other flavouring matter are added, and the new cheese is kept to ripen.

You see that cheese is a very concentrated form of food. It contains a large amount of nitrogenous material, and if made from unskimmed milk is also rich in fat. If extra cream is added it is still richer in fat.

So far we have considered foods which are produced from the animal world. One of them, milk, contains everything needed to feed the young animal and the human baby during their infancy. Eggs contain all that is needed to feed the young developing chick inside the egg. The germ of the young chick is only a very tiny speck inside the egg. All the rest, yolk and white, provides material to feed the embryo chick and produces flesh, blood, feathers and all else. Therefore, eggs are also concentrated food.

Nitrogenous foods are also obtained from the vegetable kingdom. The two which are most used are legumen, obtained from peas, beans and lentils, that is, from all seeds which have been contained in pods; and gluten, which is present in another common food, wheat flour. You have already seen that flour contains a great amount of starch, and in order to show gluten in flour we must get rid of the starch.

Experiment 6.—Tie a little flour loosely in a muslin bag. Hang it under the cold water tap, and let water trickle through it. This will wash out the starch. Continue to do this until the water which comes through is clear. All the starch will then have come away. Open the bag. Inside you will find a creamy coloured, sticky mass. This is gluten. This gluten helps to bind the flour together when making bread. People who suffer from diabetes eat gluten bread, from which the starch has been taken away.

Experiment 7.—To a little of this, in a test tube containing a little water, add nitric acid and ammonia, and boil. The yellowish brown colour showing the presence of proteid matter will soon appear. Test small portions of soaked beans, peas and lentils in the same way.

You will see that the commonest foods we use contain all that is necessary to support life, and to give us heat and energy to do our work. In a subsequent lesson we will consider how these can best be arranged so as to give us the best value for the food we take.

LESSON 5

Food (continued).—In addition to nitrogenous and non-nitrogenous food material, foods also contain vitamins. It is too difficult in ordinary school work to show the presence and nature of vitamins, but it is essential for every one to know how they can obtain them. The fat which is most common in use, the pleasantest to take and the most easily digested, is butter. This contains vitamins; butter substitutes do not.

For children at any rate butter, and not butter substitute, should be used. For adults who have finished growing it is not essential.

Fresh fruits and fresh vegetables also contain vitamins and are therefore very valuable as foods. Tomatoes and oranges are rich in vitamins.

Rice contains vitamins in the outer layers of the grain. Unfortunately, rice is often polished to make it look more attractive. To do this some of the outer layers of the grain are removed, and the vitamins with them. If pigeons are fed upon polished rice they suffer from a disease called beri-beri. They recover if given unpolished rice containing the vitamins needed.

Now in order to develop properly and keep healthy, a person must have proteid food material, non-nitrogenous food material and vitamins. It is not very easy to take a food which does not contain both nitrogenous and non-nitrogenous material. Some foods are rich in one kind, others in the other kind of food material.

Eggs contain a large proportion of proteid material, but they contain non-nitrogenous material as well. The white is the nitrogenous material albumen, and the yolk contains some nitrogenous material and a large amount of oil or non-nitrogenous food material.

Bread made from wheat flour contains some nitrogenous material and a large amount of starch. If a person tried to live on bread alone, he would need to take an excessive amount of starch to get the requisite amount of nitrogenous material. Much of the starch could not be used in the body and would merely be wasted. All meat contains a greater proportion of proteid food than of non-nitrogenous food. If one tried to live on meat alone, far too much proteid material would be taken in order to get the requisite amount of heat-giving material. Such a diet would be extravagant.

In a meal of bread and meat, or potatoes and meat, we take one food specially rich in proteid material, and another specially rich in non-nitrogenous or heat-giving

material. If in addition we take fresh green vegetables or a salad, we get a well balanced meal containing nitrogenous and non-nitrogenous food, and vitamins. This combination is more economical, for the body is able to make use of and digest the greater proportion of it, and has to get rid of less of it as waste. Consider the practice of cooking fat pork or bacon with rabbit. Rabbit contains very little fat itself and consequently very little heat-giving material. This deficiency is balanced by the extra fat of the pork. For the same reason we cook bacon with fowl, and serve forcemeat containing a large amount of fat. Fish, with the exception of salmon, herrings and sardines or other fish preserved in oil, are very deficient in fat. White sauce containing butter helps to make up for this defect, and if the fish is fried extra fat is obtained in that way. If chipped potatoes are eaten, extra fat is also taken. Common customs had made people arrange things like this long before they began to know that any useful purpose is served by doing so.

Cheese alone is a very bad meal. Bread and cheese is an example of a well balanced meal and, provided that one can digest cheese, is a very satisfactory one. We also make it our usual practice at dinner to have a meal in which there is a greater proportion of nitrogenous material than the amount we take at other meals. It is not necessary to take meat more than once a day. A well balanced diet can be obtained by taking meat once a day, and including also fish, eggs, milk, bread, cheese, butter, fresh vegetables and fruit.

LESSON 6

Cooking and digestion of food.—There are many reasons why food is cooked. In the first place cooked food is generally more palatable than raw food. Because it is more palatable it is eaten with greater pleasure. This makes it more beneficial. Food which is enjoyed is far better than food taken

reluctantly. During cooking, hard foods are made softer, certain changes which take place in it make it more easily digested, and it is only food which is easily digested which benefits us.

Whichever way we cook, we use heat to bring about the desired result. Sometimes we use dry heat as in roasting, baking and grilling; sometimes moist heat as in boiling and steaming. The method of cooking varies according to the material we have to cook. Naturally tender joints of meat are good roasted. The meat hardens on the outside, or rather the albumen is coagulated, forms a covering which keeps in the juices of the meat, and the inside is kept moist. Harder joints of meat, and rougher pieces, are not good roasted. They need prolonged cooking either by stewing or steaming. This prolonged cooking makes them tender, and they are just as valuable from a nutritive point of view as the more expensive joints.

In stewing joints, much of the nutriment from the joint passes into the water and makes very nourishing gravy. When cooked with vegetables the flavour is improved and a very nutritive meal results. Joints like brisket are excellent steamed. The extra heat used to change the water into steam, has a very beneficial result in making tender the toughest joints. If only a small quantity of water is used in the steamer, it will contain sufficient material dissolved from the joint to make it a very valuable basis for soups. If the brisket is pressed and eaten cold with salad, it forms an appetising and excellent meal. If vegetables are boiled in water, much of the valuable food material is lost in the water, which is thrown away by most people. If only a small amount of water is used, the water can be saved to add to the stock used in soup making.

If vegetables are steamed, less of the valuable material is extracted and the flavour is better. If vegetables have thin skins, they should be peeled as thinly as possible, otherwise there is waste of good food material. In potatoes, most of the nitrogenous or pro-

teid food material is found in the layers immediately under the skin, and if they are thickly peeled this is lost. It is better still to boil them in their skins, and skin them before taking them to the table.

Some of the vitamins in food are changed in cooking. That is why a good diet should always contain a certain amount of raw vegetable or salad, and raw ripe fruits. Cheap fruits like oranges and apples are very valuable. Raw orange juice and grape juice can be given to quite tiny babies. This ensures that they have the requisite amount of vitamins in their food. The most important thing to remember in cooking food is that the cooking makes it possible for digestion to take place more readily.

Most of our foods are insoluble. An insoluble substance cannot enter into the blood. Digestion is, broadly speaking, the changing of insoluble food substance into a soluble form. It can then pass ultimately into the blood stream and be used by the body for growth and other purposes. It is not the amount of food we take into our bodies which matters so much as the amount our bodies can digest and make use of.

Digestion actually begins in the mouth. There, two things happen. First the food is masticated or broken up into small pieces. This makes it possible for every particle of food to be mixed with the various juices which bring about digestion. Teeth are natural mills. They grind up the food into very small portions. A tooth is rather a complex structure, Fig. 78. The part we see in the mouth is the crown, the narrow part as it enters the gum is called the neck, and the part firmly fixed in the jaw is the fang. The part of a tooth you can see is covered with a very hard substance called enamel. This when once destroyed can never be renewed. Under this is the main substance of the tooth called dentine. This is rather like bone. In the middle of each tooth is a cavity filled with what we call tooth-pulp. This contains nerves and blood vessels. If the enamel is cracked or broken, germs in the mouth can enter the dentine, and cause

it to decay. This goes on until the tooth may be completely hollow.

Cracking very hard nuts may destroy the enamel. If teeth are decayed they are no use for the purpose for which they were intended and consequently cannot help to break up the food, and the person with bad teeth is very liable to suffer from indigestion.

Keeping the teeth and mouth clean can do much to prevent decay. Teeth should not be cleaned with any harsh substance which may cause the enamel to crack. In time the nerves may be exposed and you suffer from

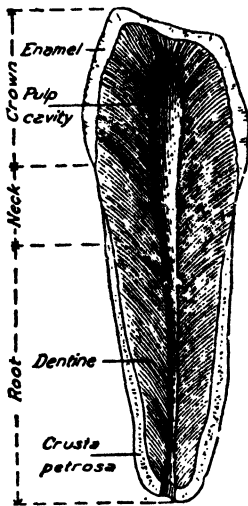

FIG. 78.

SECTION OF A TOOTH

toothache. This is a warning that something is wrong, and early attention can prevent further decay. The tooth can be filled and the crack covered so that no further decay can take place. Not only do bad teeth cause indigestion, but in decay they give off poisons into the mouth. These are swallowed and the person becomes unhealthy in other ways. Bad teeth are sometimes suspected of causing rheumatism.

Kinds of teeth.—The teeth in our mouth are not all alike. They differ in form and have different work to do. The teeth in the

front of the mouth are our biting teeth. These have a flat edge something like a chisel. When the edges of the teeth in the upper and lower jaw meet they can bite. People with prominent front teeth, with wide spaces between the upper and lower teeth, cannot bite very satisfactorily. Sometimes the lower teeth come outside the upper ones. In this case there is difficulty in biting. These defects in the early stages, that is while the teeth are still growing, can be remedied by dental treatment. Not only are defective teeth unpleasant to see, they are also dangerous to health, for any abnormality interferes with their work. At the side of these are the pointed teeth which are sometimes called eye teeth. These are useful for tearing. Such teeth are very well developed in dogs and cats and in all flesh eating animals which tear up their food. They are called canine teeth. At the sides of these are small grinding teeth called bicuspid teeth. These are useful for grinding up food into small portions. A baby when it has its full set of teeth has only these twenty teeth. Later, when about seven years old, some large teeth called molars appear. These are the big grinding teeth, and when the set is complete there are twelve of them.

Child's teeth.—8 incisors;
4 canine;
8 bicuspid.

Adult's teeth.—8 incisors;
4 canine;
8 bicuspid;
12 molars.

Between the ages of six and seven a child begins to lose its first, or temporary, teeth, and begins to get its second, or permanent, teeth.

There is also another process taking place in the mouth. The food is moistened with saliva. You have learned that starch can be changed into sugar outside the body. It can also be changed into sugar in the body. The saliva or spittle contains a ferment called ptyalin, similar to diastase found in malt,

which can convert starch into sugar. If you chew potatoes or bread, both of which contain large quantities of starch, for a long time, you will notice that they begin to turn sweet. That is because starch in them is being changed into sugar.

Saliva is made by certain glands in the mouth called salivary glands. They do not begin to make saliva until a child's teeth begin to appear, so a baby should not be given any starchy food until it has several teeth, as it cannot digest starch.

If soft food like potatoes and bread are bolted, they are not mixed with the saliva. You see, therefore, it is important to masticate all food thoroughly.

LESSON 7

Second part of digestion.—After the food has been thoroughly masticated and mixed with the saliva, it is swallowed and enters the gullet or food pipe. This leads from the back of the mouth to the stomach, Fig. 79.

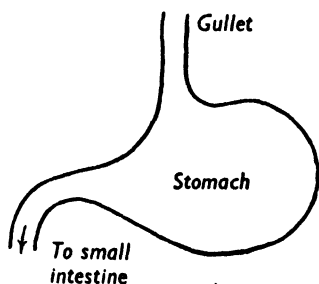

FIG. 79.

To reach the gullet it has to pass over the windpipe, which leads to the lungs. A little flap closes the windpipe and prevents food entering here, in the act of being swallowed. Food does not drop directly into the stomach. The walls of the gullet contain muscles, which contract and send the food downwards in easy stages.

The stomach is like a pear-shaped bag, with muscular walls. The outer wall is slimy to protect the structures underneath. Then

comes a coat containing many muscles. These are continually contracting and food is passed from one end to the other and back again. Then there is a coat containing a network of very fine blood vessels, and in the very inside a coat which has many small glands. The end of the stomach away from the gullet becomes narrow and leads on to the intestines. When food is being digested in the stomach, this narrow end becomes contracted and food cannot enter the intestines. As soon as food enters the stomach the glands in its walls begin to pour out a juice called gastric juice. This is slightly acid in character. By far the greater part of it is water, but it also contains an important substance called pepsin. This changes proteids or nitrogenous foods into soluble substances called peptones. You can see the action of pepsin outside the body. Pepsin tablets can be bought at the chemist's.

Experiment 1.—Take a little very finely shredded cooked lean meat. Put it in a beaker with water, a little dilute hydrochloric acid and a broken up pepsin tablet. Put it in a moderately warm place so that it is kept at the temperature of the body, 98° Fahrenheit. Examine it from time to time. After about two hours the pieces will gradually get small, and finally be dissolved.

Experiment 2.—Repeat this with a little cooked white of egg, or a small piece of cheese. The same thing happens in both these cases.

People who cannot digest proteids easily are often ordered to take pepsin tablets. Probably the stomach in such a case does not make enough gastric juice, and the added pepsin does some of its work. Pepsin will only act in the presence of a weak acid. The body is able to make a little hydrochloric acid. It obtains the chlorine it needs to do this from the salt which is taken in food. People who suffer from acidity should take less salt, as the body is making too much acid.

Something else happens in the stomach. Milk is curdled. If milk is drunk slowly, small portions of it are curdled at once. The

gastric juice can easily mix with it and act upon the proteid in milk. If milk is swallowed quickly it forms large clots or curds. It cannot then be easily acted upon by the gastric juice and it takes longer to digest.

The bodily heat, the constant movement, and the gastric juice are three aids to digestion in the stomach. After three to four hours in the stomach, digestion as far as this organ is concerned ends. At this time the food in the stomach consists of digested starches, digested nitrogenous food and undigested fats, starch which has escaped the action of the saliva, because it was not finely enough divided, and nitrogenous material which has escaped the action of the gastric juice. The digested starches and digested proteids are now in solution, and can readily pass through the walls of the stomach into the blood vessels in those walls. They are capable of passing through a thin membrane.

Experiment 3.—To show that substances in solution are capable of passing through a thin membrane. Take a thistle funnel and

on it tie a thin piece of parchment or pig's bladder. Pour down the tube into the funnel, water containing sugar in solution, coloured with a little red ink to make it visible. Fix the stem of the funnel by a clamp to a retort stand, so that it dips into a beaker nearly full of water,

Fig. 80. Mark the level of the water in the beaker, and the liquid in the funnel. Leave for a time and examine again. You will see (1) the water in the beaker is slightly red; (2) the solution in the funnel tube is higher than before.

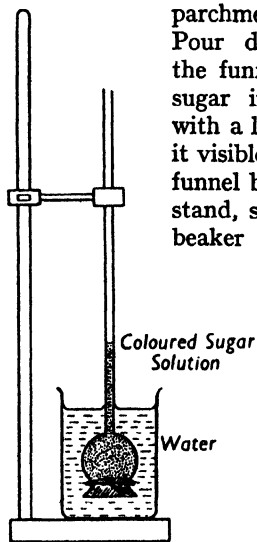

FIG. 80.
HOW TO SHOW
OSMOSIS

From this we learn that water from the beaker has gone into the funnel, and that something from the funnel has gone into the beaker. If you taste the water in the beaker it will taste sweet. By using Fehling's solution you can prove that sugar has gone through. Substances in solution can pass through a thin membrane. It is in this way, by what we call osmosis, that dissolved sugar and dissolved proteid can enter into the blood.

LESSON 8

Digestion in the intestines.—At this stage the food is ready to leave the stomach and enter the intestine. It consists of undigested fats, starch which has escaped the action of the saliva, and proteids which have escaped the action of the gastric juice. The only thing which has happened to the fats up to now is that the little proteid matter which enveloped the globules of fat has been dissolved.

As, in the stomach, heat, movement and a digestive juice assist in the digestion of the food, so in the intestine heat, movement and three digestive juices help digestion. The intestine consists of two distinct portions, the small intestine and the large intestine. It can be regarded as an extension of the stomach, as a long narrow tube—altogether this tube is about 30 ft. long. The first part is the longer. It is coiled and recoiled many times, then widens out into the large intestine which ascends as a straight tube outside the small intestine, up the right side, crosses over and descends down the left side, and passes out towards the surface of the body. The first part is concerned with digestion and absorption of the food, the last part with the elimination of waste material which cannot be digested, Fig. 81.

One of the digestive juices, the intestinal juice, is secreted by the intestines themselves. The others, bile and pancreatic juice, are made by organs outside the main digestive tract, but which communicate with it. Bile is secreted by the liver, which is the largest

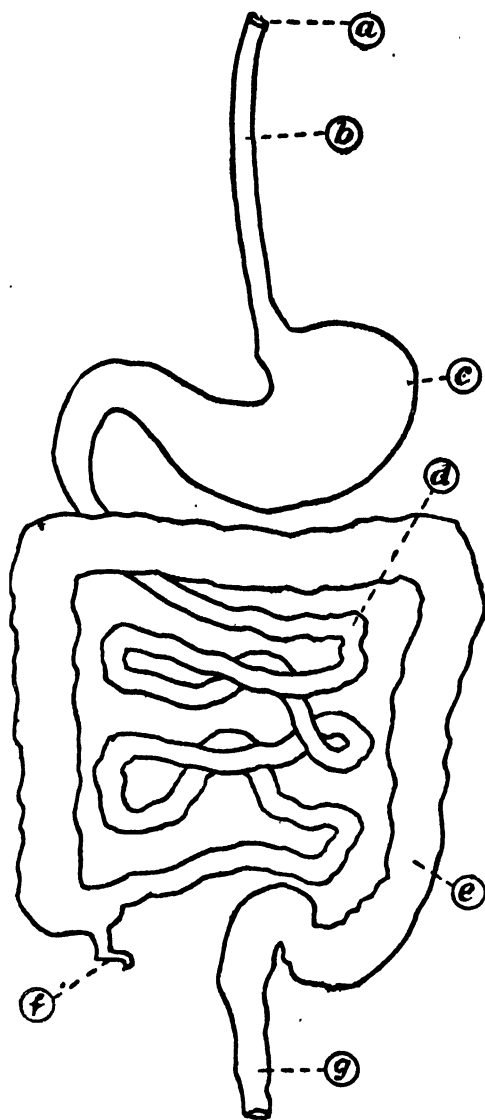

FIG. 81

THE DIGESTIVE SYSTEM

- | | |
|---------------------|---------------------|
| a. Mouth. | b. Gullet. |
| c. Stomach. | d. Small intestine. |
| e. Large intestine. | f. Appendix. |
| g. Rectum. | |

the small intestine, and pours its contents into the first part of the small intestine when food enters it. Pancreatic juice is made by the pancreas, and conveyed from the pancreas to the small intestine near to where bile is poured in. It is the bile which is concerned with the digestion of fat. Bile is strongly alkaline in nature, and, like any other alkali, it can unite with an acid. It unites with part of the fatty acid in the fats and makes a soap. This soap is useful as it stimulates the passage of waste matter along the intestine, and thus helps in the elimination of waste material. The rest of the fat is so finely broken up that it forms an emulsion, which is so fine that it can pass into small absorbing vessels called lacteals in the intestinal wall. They are called lacteals because the liquid they contain looks like milk.

The intestinal juice is capable of acting on all kinds of foods, as it (1) contains a starch digesting ferment; (2) contains a proteid digesting ferment; and (3) can emulsify fat. The pancreatic juice is also capable of digesting all kinds of food.

The intestine is covered with very similar coats to those of the stomach. The outer coat is slimy. The next is muscular. The next contains a good supply of nerves and blood vessels. The innermost contains glands which make the digestive juice, and the lacteals which absorb the digested food. When the food reaches the large intestine, digestion is completed. In the last part of the large intestine excessive water which was present in the digestive juices is gradually absorbed. If food is kept outside the body at the temperature of the human body, it soon begins to decompose. In the digestive tract there are bacteria which prevent decay. In the last part of the digestive tract there are bacteria which cause putrefaction of waste material. This helps to hasten the elimination of food.

gland in the body. It passes from the liver into the gall bladder, where it is stored till needed. This gall bladder communicates with

Sometimes people tell you in a very vague way that they suffer from indigestion. This may be from several causes and each kind of indigestion requires its own special treat-

ment. One person may suffer from lack of ability to digest starch. It is sometimes advisable to avoid starchy food for a time. In some cases this kind of indigestion is remedied by taking malt. Sometimes the stomach is not able to secrete enough gastric juice, or enough acid so that the gastric juice can begin to work. Pepsin aids digestion in the stomach, and the patient sometimes is given hydrochloric acid to ensure that there is the right amount of acid in the stomach.

Sometimes food like Benger's food is partially digested before it is taken into the body. In taking Benger's food, the specified time of waiting after the preparation before taking it must be adhered to.

Sometimes indigestion is caused by an excessive, and sometimes by a diminished, supply of bile. All this shows that in cases of indigestion, if continued for any length of time, it is advisable to obtain competent medical advice, so that the correct remedy can be taken. If a diet is faulty and not well balanced, it means that an extra strain is put upon the digestive organs to assimilate the food material and get rid of waste. Irregularity in meal times also causes indigestion. Roughly speaking, a meal is digested in about four to four and a half hours. There should be at least this interval between meals. It is better that it should be a little longer in order to let the digestive organs rest between meals. In the case of sickness it is better to have light meals, small in quantity and of foods which are easily digested.

LESSON 9

Maintenance of health.—There are certain fundamental requisites which must be obtained if we wish to keep our bodies healthy and fit. These include a good supply of fresh air; pure water used for drinking, for cooking and for purposes of cleanliness of the body, home and clothes; an adequate supply of good food; work; exercise and rest and recreation.

Air is needed for breathing purposes. The oxygen in the air enters into the blood finally and is used up in the tissues in the production of heat. Carbon dioxide is passed out of the body as waste material in the air we breathe out. In the section on air, you learned that carbon dioxide is given out during breathing and that it turns lime water milky. Now it is important to consider how the air gets into and out of the body and finally enters the blood. We take air into our bodies by way of the nose and mouth. When air enters the nose it goes through the nostrils into a narrow winding passage which leads to the back of the mouth. The nostrils are lined with hairs which keep dust from entering the fine nasal passages. Air is warmed also in going this way before it enters the body. It is important to attend to the regular cleaning of the nasal passages from a health point of view. The air then enters the windpipe and finally enters the lungs.

The lungs are situated in the upper part of the body or chest. The chest is separated from the abdomen or lower part of the body by a strong muscular wall called the diaphragm. In the chest are the heart and lungs, that is, the organs concerned with the circulation of the blood, and with breathing. In the abdomen are all the digestive organs and organs concerned with getting rid of waste matter. As the organs in the chest are so important for the continuation of life, they are well protected from possible injury. The chest is provided with a bony framework, Fig. 82. Down the back passes the spinal column or backbone. This is made of a number of small bones called vertebrae, which are jointed and capable of a certain amount of movement. The shoulder blades stretch from the vertebral column to the top of the arm and are connected with the collar bones. In front is the breast bone, which is also joined to the collar bones. To the vertebral column twelve pairs of ribs are attached. Ten pairs of these are directly joined to the breast bone and the other two are connected by gristle but not directly

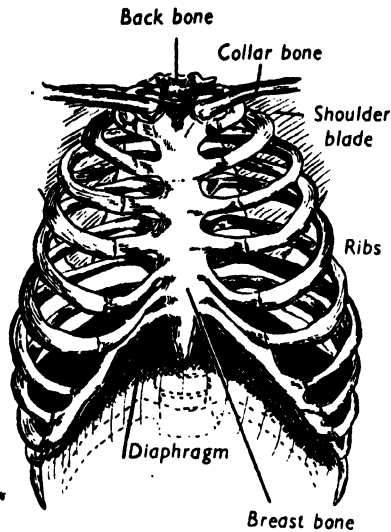

FIG. 82.

PROTECTIVE SYSTEM OF THE CHEST ORGANS

joined to the breast bone. These rings of bone look like the hoops of a barrel. Between the ribs in the chest wall are muscles. When the muscles contract the ribs are raised. This can make the chest bigger. The diaphragm is naturally curved upwards. When it contracts it goes lower down, and this also makes the chest cavity larger. We shall see the importance of this later.

The lungs.—The windpipe or trachea leads from the back of the mouth into the chest. It is $4\frac{1}{2}$ in. long, and divides into two branches. Each branch is called a *bronchus*, plural *bronchi*. One bronchus leads to each lung. It is important that these tubes should be kept open at all times, so that the passage of air into the lungs is not interrupted.

In the walls of the windpipe there are rings of gristle or cartilage which keep them open. The rings are not complete, as cartilage is absent where the windpipe touches the gullet. You will remember that the windpipe is in front of the gullet. The bronchi also contain plates of cartilage. In the substance of the lungs the bronchi break up

into smaller and smaller tubes called bronchial tubes. The finest bronchial tubes end in air chambers. The soft tissue in the lungs contains a very fine network of blood vessels. The lungs are covered with a very fine skin called the pleura. This has two folds, one fold attached to the lung itself and the other fastened to the chest wall. Because of this, when the chest wall moves, the pleura moves with it, so that the size of the lungs can be altered, Fig. 83.

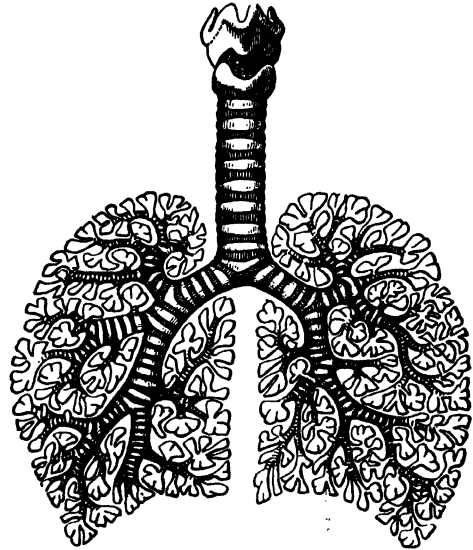

FIG. 83.

THE LUNGS ARE COMPOSED OF LITTLE POCKETS—OR SACS—INTO WHICH THE AIR RUSHES DURING INSPIRATION

To show how this acts, a simple model can be made. Take a bell jar and a piece of leather over the bottom opening. In the middle fasten another small ring of leather, to which is attached a piece of string. Through the stopper of the bell jar push a piece of glass tubing. Be sure this fits tightly. Vaseline can be placed at its junction with the hole in the stopper. On the end of the tube which will go inside the bell jar fasten securely a small toy balloon. It is now ready to be used. Hold the bell jar away from the table and by means of the string

pull the leather which covers the bottom. This makes the cavity inside the bell jar larger. Immediately you will see a change in the toy balloon. It begins to swell, Fig. 84.

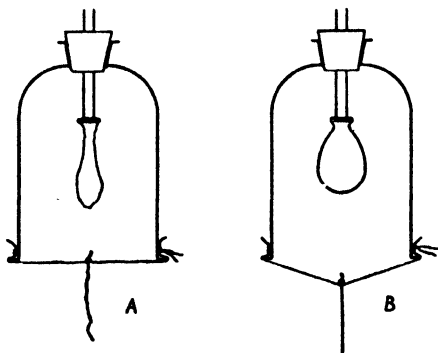

FIG. 84.

MODEL SHOWING LUNG ACTION

- A. Diaphragm raised—"lung" deflated.
 B. Diaphragm lowered—"lung" inflated.

The explanation is this. When you enlarge the cavity in the bell jar, you alter the air pressure in the bell jar. It is now less than the air pressure outside. Air tries to get in to make the pressure equal and it goes down the glass tube into the toy balloon. This may make you understand what happens when you breathe in. The chest cavity is enlarged in three ways. First the diaphragm moves downwards. This enlarges the chest from above downwards. The ribs are moved outwards and upwards. This enlarges the chest from side to side and from back to front. As the lungs are fastened by the pleura to the chest walls, they too expand. Air inside the chest is at a less pressure than air outside, so air passes down into the lungs to equalise the pressure. The greater the chest expansion, the greater will be the intake of air containing the oxygen we need.

Now when muscles have expanded, they recoil and return to their original size. They relax. The muscles in the chest wall relax and the muscle in the diaphragm relaxes. The diaphragm rises to its original position,

and the ribs fall. The chest capacity is lessened and air is expelled. This is how the ordinary taking in of air and the giving out of air take place. If there is any obstruction in the air passages, other muscles come into play. All the muscles in the abdomen contract in order to force the diaphragm upwards and expel the obstruction.

Where the change between the air takes place.—You will remember that the very finest bronchial tubes open out into small air chambers. These are surrounded by small air cells; and surrounding these are very fine blood vessels. Oxygen passes from the air cells into the fine blood vessels through the walls, and carbon dioxide passes from the blood vessels into the air cells, and can thus be expelled from the body. It is important to practise deep breathing in order to increase the amount of air taken into the lungs.

LESSON 10

The heart and its work.—The heart is a very important organ, Fig. 85. Its work is to send the blood containing food in solution and air to all parts of the body where it is needed. It also contains all the materials which the digestive organs need to manufacture the different juices needed for the digestion of food.

The heart is situated in the chest, between the two lungs. These, the heart and lungs, are the only organs in the chest. It is about the size of the closed fist, is roughly triangular in shape, and is so situated that the apex points downwards, forwards and to the left. It has strong muscular walls, and it is by the contraction of these walls that blood is pumped out all over the body. It has four divisions inside, two upper ones called auricles because they look like little ears, and two lower ones called ventricles. These look larger than the auricles, because they have thicker and stronger walls. The right and left sides are separated

by a thick wall called the septum. The right auricle communicates with the right ventricle and the left auricle communicates with the left ventricle, so that blood can pass from the auricles into the ventricles.

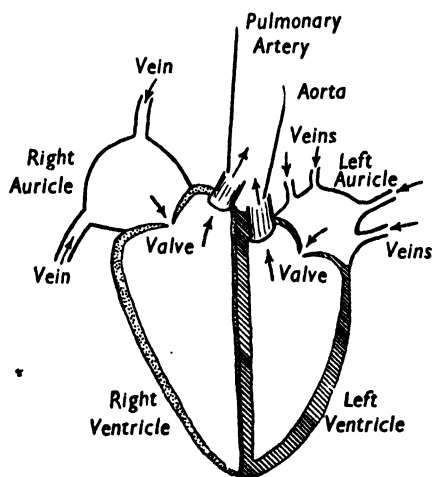

FIG. 85.

DIAGRAMMATIC SECTION OF THE HEART

Between the auricles and ventricles are little flaps of membrane which are called valves. They hang down into the ventricles and are fastened to the ventricle walls by little threads or tendons. Blood can flow from the auricles to the ventricles but not backwards, for when blood tries to return, it presses the flaps of the valves upwards and causes the openings to close. There are large blood vessels communicating with the heart. Those which take blood from the heart are called arteries and those which take blood to the heart are called veins. The right side of the heart contains impure blood and the left side, pure blood. Two large veins bring impure blood to the right auricle, and two bring pure blood from the lungs to the left auricle. An artery carries impure blood from the right ventricle to the lungs to be made pure, and the aorta, the largest artery in the body, leaves the left ventricle and carries pure blood all over the body.

Blood.—Blood is a liquid bright red in colour, and is slightly thicker than water.

If a small quantity, just a drop, is examined under a microscope, it will be seen to consist of a pale straw coloured fluid in which very numerous small bodies are floating. These are of two kinds, red corpuscles and white corpuscles, Fig. 86. There are very many more red corpuscles than white ones. The red corpuscles are shaped rather like draughts; they are round and have slightly concave upper and lower surfaces. Sometimes they are arranged in rows, piled up. The white corpuscles have a different shape. Each kind of corpuscle has its own definite work to do.

The red corpuscles are called oxygen carriers. In the air cells in the lungs they take up oxygen from the air, and give up carbon dioxide which they have taken up in their journey through the body. In the tissues they give up oxygen which is needed for slow combustion to keep up the body's heat, and take up carbon dioxide which has been made during slow combustion.

They contain a substance called haemoglobin, which is a compound of iron. It is this substance which takes up oxygen in the lungs, and is changed into oxyhaemoglobin, which is bright red in colour. It gives up its oxygen in the tissues and takes up the carbon dioxide and becomes dark purple in colour.

Sometimes in ill health the blood does not contain enough iron, and the person becomes anaemic. The red corpuscles then are not able to carry sufficient oxygen, and the tissues do not get the oxygen they need. Some soluble form of iron needs to be taken to give the needed iron to the blood.

The red corpuscles never leave the blood stream. The white corpuscles have quite another kind of work to do. They are capable of passing out of the blood stream. They do this when the body is attacked by germs. Germs cause diseases of various kinds, and the white corpuscles devour the germs. If we are healthy they are active enough to devour all germs, and so prevent illness.

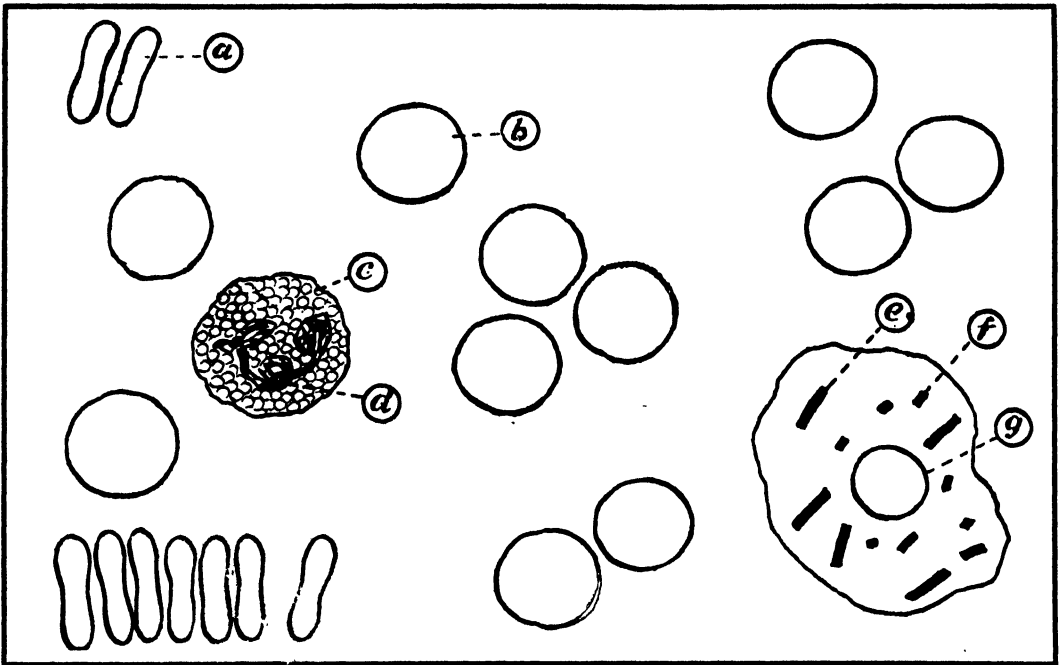

FIG. 86.

BLOOD CORPUSCLES

- a. Red corpuscles seen in profile.
- b. Red corpuscle seen flat.
- c. White corpuscle with granules.
- d. Nucleus.
- e. Healthy bacillus.
- f. Partly-digested bacillus.
- g. Nucleus.

When we are in a low state of health, the white corpuscles cannot devour the disease germs quickly enough, and then the germs multiply and the poisons they make in their growth cause disease.

Circulation of blood (Fig. 87).—The auricles of the heart begin to contract. Blood from the right auricle passes into the right ventricle. Blood from the left auricle passes into the left ventricle. When the ventricles are full of blood they begin to contract. Blood is prevented from returning to the auricles by the closure of the valves between the auricles and ventricles, and is forced from the right ventricle into the pulmonary artery, and from the left ventricle into the aorta.

We will consider the journey of blood from the left ventricle. This is pure blood, and is forced into the aorta by contraction of the ventricle. Shortly after leaving the heart the aorta divides into two branches, one branch carrying pure blood to the head, arms, and all the upper parts of the body. The other branch turns downwards and carries blood to the lower parts of the body and the legs.

Each of these divides and subdivides into many tiny branches. These finest branches are called capillaries. They are finer than the finest hairs. You can have little idea of the smallness of the corpuscles. They have to pass along the capillaries. In some cases the corpuscles go down the capillaries in single file. It is through these walls of

the finest capillaries that oxygen passes into the tissues and the carbon dioxide passes into the blood.

After passing through the tissues, these capillaries join and form larger and larger

vessels called veins. Finally these unite into two large veins, one carrying impure blood from the lower parts of the body, and the other impure blood from the upper parts of the body to the right auricle.

When the right auricle contracts, impure blood is forced into the right ventricle. When the right ventricle contracts impure blood is forced out of the heart into the pulmonary artery. This takes blood to the lungs, where it is made pure. It gives up its carbon dioxide in the air cells, and takes up oxygen. This purified blood is brought back to the right auricle of the heart by the pulmonary veins.

All arteries except the pulmonary artery carry pure blood.

All veins except the pulmonary veins carry impure blood.

It is in the capillaries in the tissues that blood becomes impure.

It is in the capillaries in the lungs that blood is made pure.

From this lesson and the previous one you see that the heart and lungs have both very important work to do for the body.

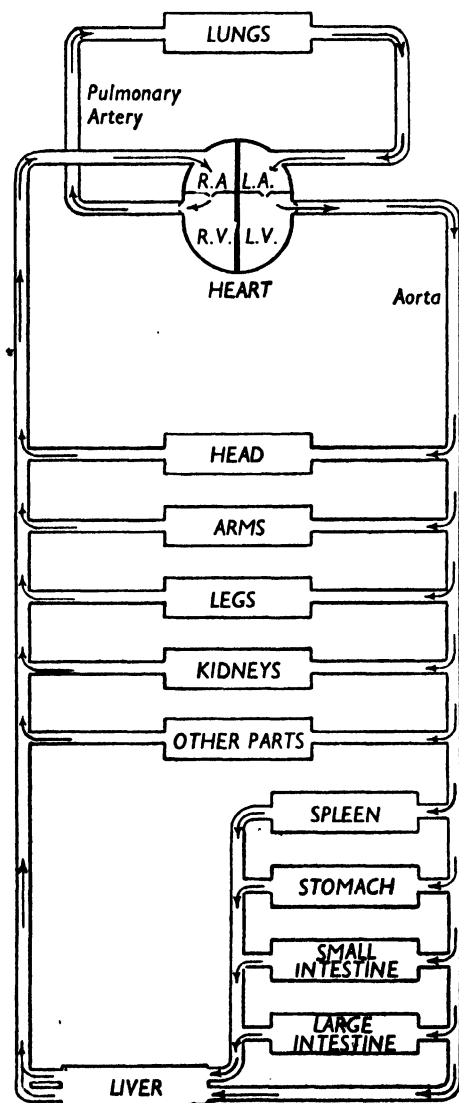

FIG. 87.

DIAGRAMMATIC REPRESENTATION OF THE CIRCULATION OF THE BLOOD

Z—VOL. II-S

LESSON 11

How the body gets rid of waste matter.—

You have seen how the body takes in all that it needs. Food and water are taken in by the mouth. Air is taken in by the lungs.

You also know that food finally enters the blood stream and is taken to various parts of the body, how it is used for growth and the production of energy, how the blood is made impure in the tissues, and then purified in the lungs. The carbon dioxide which is produced by slow combustion is got rid of when we breathe out. There are other waste materials as well.

One of the most important is uric acid. This is a poison made by the body, and if it accumulates it causes rheumatism and other illnesses.

This is got rid of by the skin in the perspiration which is given out, and by the

kidneys which separate it from the blood and finally pass it out from the body in the form of urine.

Undigested food material is passed out from the body by the large intestine.

Since the skin has such important work to do, it is as well that we should know something of its structure and how it works, then we can realise the necessity for taking care of it. Skin is the covering of the whole of the outside of the body and the lining of all our internal passages.

It is made up of two principal layers, the outer skin or epidermis, and the inner skin or dermis. Between these there is a layer containing colouring matter. This contains black colouring matter in negroes, brown in dark skinned races, yellow in the Chinese and Japanese, and pale in the case of white people. The outer skin is rather strong, and is full of small openings which are called pores. It is semi-transparent, and allows us to see the colouring beneath. It does not

contain either nerves or blood vessels. It is possible to prick the epidermis without shedding any blood, and without having any sensation of pain.

In the dermis, or true skin, there are many nerves and blood vessels. These are so close together that it is impossible to prick it anywhere without drawing blood and without a sensation of pain, Fig. 88. It is by means of these nerves in the skin that we get knowledge of objects by the sensation of touch. We get ideas of roughness and smoothness, that is of the texture of objects, some ideas of shape, and the weight of objects, by the pressure they exert on the skin. We also get sensations of heat or cold by contact of objects with our skin.

Some parts of the skin are more sensitive to touch, for example, the finger tips. Others are more sensitive to heat, such as the cheeks, the calves of the legs, the middle of the back, and the elbows. You know how people sometimes test the temperature of a baby's bath by putting an elbow into the water. If the water feels comfortably warm to the elbow, it will not be too warm for any part of the body. People sometimes test the heat of an iron by holding it a little way from the cheek.

Besides nerves and blood vessels, the skin also contains two kinds of glands, sweat glands and fat glands. The sweat glands look like long coiled-up tubes, and have one end connected with a pore in the skin. They are surrounded by very tiny capillaries. It is from the blood in these capillaries that the gland secretes perspiration or sweat. The sweat is composed of water containing uric acid in solution. This perspiration is always being secreted by the sweat glands and given off through the pores, but we cannot always see it. Usually it is quickly changed into vapour and passes off without being seen. Heat is needed to change it into vapour and

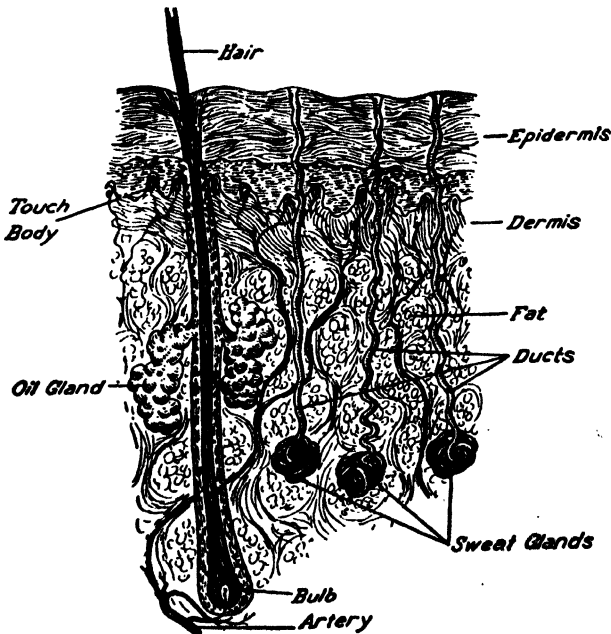

FIG. 88

SECTION THROUGH THE SKIN

this heat is obtained from the body. It is only when there is excessive perspiration that it remains on the skin for a time, and we see it as visible perspiration. If you taste a little of the visible perspiration it will taste salty. Our skin usually feels pleasantly moist and cool. In some illnesses or fevers, the skin is dry and feels hot. It is not secreting perspiration and giving it off. To reduce fevers, doctors generally give something which will induce perspiration, and when this happens the body's temperature is lowered as some of the heat is used up to convert the perspiration into vapour.

The oil glands are also constantly giving off oil, which keeps the skin smooth.

As perspiration and oil are given off they are mixed with dust on the skin surface and particles of dead skin. If these are allowed to stay on the skin they block up the pores and prevent the skin from acting properly. Poison which should be sent out of the body has to remain in the blood, and the person becomes unhealthy. Also if the skin is not acting properly, a person is more liable to suffer from changes in the outside temperature, and take cold more easily.

Cleanliness.—The best way to remove this perspiration is by the frequent use of soap and warm water. Hands and faces need very frequent washing, and the whole body should be washed daily. If a daily bath is taken the water should be pleasantly warm.

Sometimes baths are taken to encourage perspiration, as when one is suffering from a cold. In this case a hot bath is advisable, and sometimes a little mustard in the water is beneficial. Care must be taken not to expose oneself to a chill after such a bath. It is advisable to go to bed at once.

Cold baths are no use for cleansing purposes, but they act as a tonic for people who can stand them. A dip into cold water and brisk rubbing afterwards to promote circulation has for some people a very invigorating effect. If you try this, and do not get warm immediately afterwards, cold baths are not suitable for you.

The nails also need careful attention. All dirt contains germs of disease and unless nails are kept very clean disease germs are conveyed to food when it is being handled.

Not only is the personal cleanliness of one's own body important to health, but also there must be cleanliness of clothing and of the home.

All waste food material, if kept, begins to decay, and when there is this kind of decay

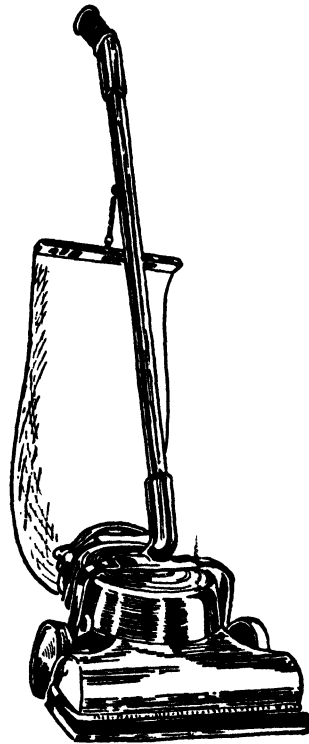

FIG. 89.

NON-ELECTRIC VACUUM CLEANER
The fan which drives the dust into the bag is operated through gears from the wheels of the machine.

there are always germs, so that refuse of any kind is a menace to health. It also attracts flies which have been proved carriers of disease by walking on uninfected food and conveying germs to it. It is essential that all such refuse should be burnt, then there is no risk. Food which has to be kept

for a day or two should be kept in a well ventilated safe, so that no flies can get to it. Milk should be covered by thin pieces of muslin to protect it from dust and flies.

Dust and other dirt should be removed daily, and the dust should be burned. If at all possible, it is best to remove dust from carpets, etc., by the use of a type of vacuum sweeper. This extracts the dust much more effectively than by trying to remove it with an ordinary brush. In using the latter, care must be taken that dust is not scattered about the room. If electricity is available, an electric vacuum cleaner is the best. They cost practically nothing to run. A seven-roomed house can be swept all through in a little over an hour, and if on power the cost is less than a halfpenny. No dust is left. It also removes dust from upholstered furniture. Walls can be swept frequently, and in a house kept clean by the use of electricity there is no need of a violent upheaval and discomfort for everybody at spring cleaning time.

An electric washer is also a great aid to cleanliness in the home. All kinds of domes-

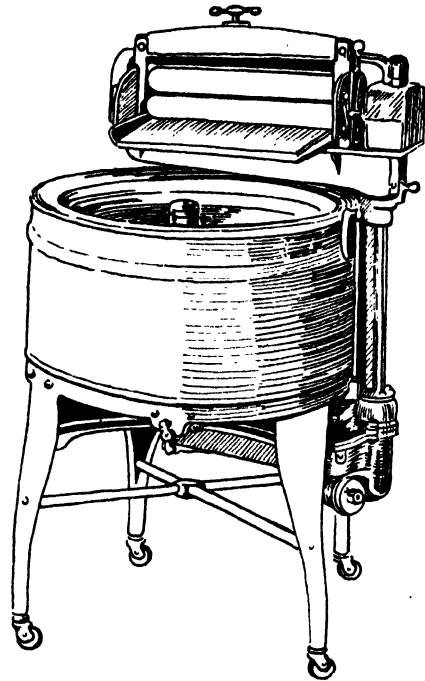

FIG. 91.
AN ELECTRIC WASHER

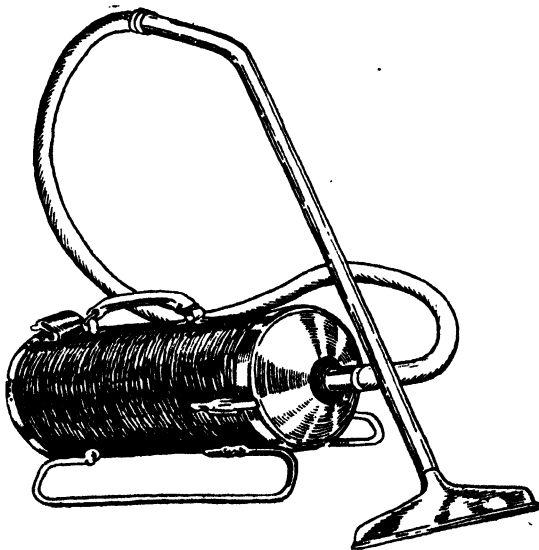

FIG. 90.
ONE TYPE OF ELECTRIC VACUUM CLEANER

tic washing can be done in this way far more quickly and effectively than by any other means. There is no need for rubbing or scrubbing of clothes, and there is therefore in the washing no wear and tear on the garments involved. It costs very little to run and is most economical in the use of washing material. The first cost is heavy but these washers can be bought through electricity companies by quarterly instalments. There is no need to send anything to a laundry—curtains, rugs, blankets can all be washed easily at home, and in the end there is an economy.

LESSON 12

Exercise and rest.—Adequate exercise and rest are important for the well being of the body.

Exercise is beneficial in various ways. In the first place it causes development of the body. If a limb for some reason or other has to be kept bandaged and still for any length of time, it is actually smaller than the free limb when the bandages are removed. It is also stiffer and not so easily moved.

One of the first things one notices when taking exercise is that we become warmer. Exercise increases the action of the heart and makes the blood circulate more rapidly. It also increases the rate at which we take in air. This means that more oxygen is taken in and carried by the blood to the tissues, and internal combustion takes place more rapidly. This natural production of heat is much better than sitting by the fire and getting warm externally. Since exercise results in taking in more air, it is important that the air taken in should be pure. Therefore it is best to take as much of our exercise as possible out of doors.

It is important that every part of the body should be exercised and that is why in schools graded exercises are taken. Walking is a very good form of exercise and helps to develop the body harmoniously. The influence of the mind on the body is also important. Exercise to be really beneficial must be pleasurable and that is why games involving running, skipping, jumping and ball throwing are important for children and young people. Many children enjoy games when they do not really enjoy just going for a walk. In the country, going for a walk may with advantage be connected with some nature study hobby. Then the interest and the pleasure involved give the most beneficial results from the taking of exercise.

Exercise also results in a better appetite, resulting in a desire for, and a greater enjoyment of food. As the blood has been circulating very freely, all the digestive organs are well supplied with the material they need to make the various digestive juices, therefore exercise has a good effect on digestion. Exercise also helps in the more rapid elimination of waste matter. It increases the action of the skin and kidneys.

Rest.—Every kind of work done by the body results after a time in fatigue. Then there must be rest for the body to recover, as undue fatigue is distressing.

Rest of tired muscles can be obtained by relaxing them; the greater the relaxation the quicker is the recovery from fatigue.

A person who has worked hard all day at muscular work can obtain relaxation by sitting still and reading a book. The book may be for pure recreation or it may be some study which will develop the mind. Some people enjoy a game of chess or other games of skill.

Every part of the body needs a rest. The heart has a slight pause after each beat. Sleep is the most perfect form of rest. All the muscles are relaxed, the heart beats more slowly and we breathe more slowly. Work by the digestive organs slows down. This is why it is important not to take a heavy meal just before going to bed. The brain also rests. The body should be perfectly comfortable in bed, and the bed clothes should be light but warm. The room should be dark and quiet. Fresh air should be freely admitted to the room. Under these conditions we get the most restful and healthy sleep. It is also during sleep that growth and the repair of waste material takes place. If one suffers from cold feet in bed it is best to have a hot water bottle, for cold feet prevent sleep.

As it is when we are asleep that growth takes place, it is important that children should have a relatively large amount of sleep. The smaller the child the more sleep it needs. A tiny infant sleeps the greater part of the day and night. As growth is most rapid in the early years of life, it follows that most sleep is needed then.

The quality of the sleep is also important. If people sleep restfully the actual hours of sleep need not be so long.

LESSON 13

Housing and health.—The situation of a house is important from a health point of

view. The ground on which a house is built should be well aerated. Clay soils have very poor aeration of soil and hold moisture. A damp foundation means a damp house, and a damp house is a cold, unhealthy house. Houses built on high ground are generally built on land which is better drained than low lying land. They are therefore more likely to be dry. In such a region there is also freer circulation of air which has a beneficial effect upon health.

Sun is another important factor in health, and it is wiser to choose a house which obtains the maximum amount of sunlight. In overcrowded districts, light and air and sun are blocked out, making such districts unhealthy to live in. There is also in such districts a shortage of trees, and very little grass. Since all plants help to purify the air, the deficiency of plants is a disadvantage. This is apart from the fact that such districts are depressing, and as mind influences the body, the health of the inhabitants is affected.

A house should have window space to allow of the admission of the maximum amount of light and air. Windows should be able to be opened. The house should be well built in order to protect the inmates from all kinds of weather, cold, damp and excessive heat.

It should have a constant and adequate supply of good water, and means of obtaining a constant supply of hot water. It often

happens that in houses which have been originally built for one family, and are now occupied by several families, the water supply is inadequate for the demands made upon it. The sanitary arrangements should be good, and there should be the means for everyone to have warm baths.

Accommodation for food storage should be good so that it can be kept without danger even in warm weather. Plenty of cupboards are needed, in order to keep the house tidy. It should be so planned that it can be kept clean and all the necessary amount of work done in it with the least possible expenditure of energy. Its means of obtaining artificial light should be good. It is better to have a small number of rooms of good size than more rooms which are smaller. The actual size of the house will depend upon the number of people who are to live in it, but there is no need to have small rooms in a small house. Larger rooms are more cheerful, easier to keep clean and more healthy.

A house should have a garden. This ensures a better air supply, and provides a safe place where children can play under the supervision of the parents. The children will learn to take an interest in the garden and watch things grow.

Attention to all the health suggestions mentioned in this course will help to build up healthy bodies with a good natural resistance to disease.

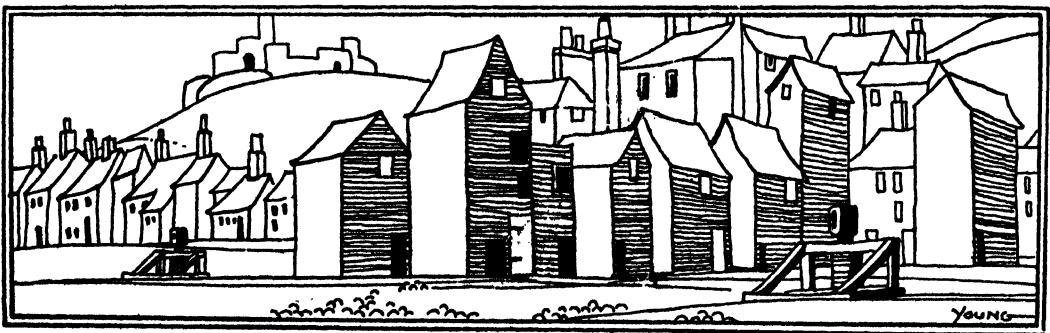

**HEALTH EDUCATION IN THE
SENIOR SCHOOL**

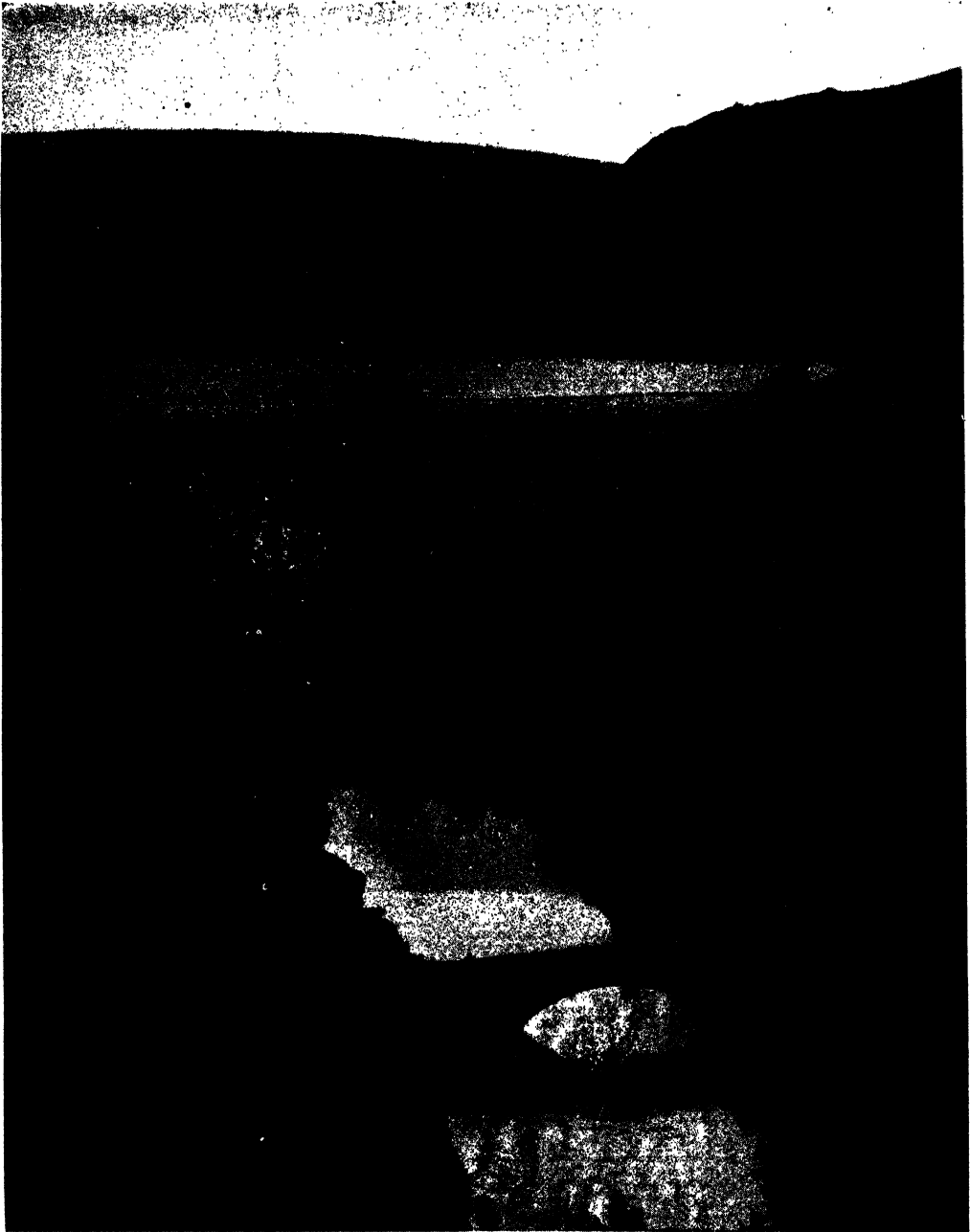

[Photo: E. N.A.]

THE ELAN VALLEY DAM, FROM WHICH BIRMINGHAM OBTAINS ITS WATER SUPPLY

INTRODUCTION

The aim of hygiene teaching in the senior school.—The teacher of hygiene in the senior school must keep one goal in view. The one clear purpose of all his work is to teach the child to value good health for himself and for others. The aim, therefore, of the health education periods is to help the child to understand his own body and the way in which it works normally. By this means the child will gain some knowledge of how to live at the maximum of fitness and so*of how to prevent ill health both in himself and in the people with whom he comes in contact. It is essential that the child should be led to realise the value of health to the community as well as to the individual.

Briefly, the aim of the health education course in the senior school is the prevention of disease; it is not concerned with the cure of illness, which is the doctor's work alone.

In practice, this means that the teaching will be definitely *positive* in outlook, stressing all the time what should be done, not what it is inadvisable to do. The teacher should say, "Go to bed early," instead of, "Do not sit up late;" "Brush your teeth up and down" rather than, "Do not brush your teeth from side to side."

The teacher of hygiene will stress, repeatedly, what should be done to keep fit, to raise the body's resistance, to preserve

community health. None of the teaching should be negative and of the frightening type that describes and stresses details of the fate that awaits those who neglect the suggestions of the teacher.

Just as excessive drinking, among adults, is now prevented or cured by the provision of and appeals to other interests, amusements and leisure pursuits, and is not combated by arousing fear through dwelling on the consequences, such as the drunkard's miserable home or the illnesses readily contracted; so, in school, the advantages of cleanliness, fresh air, good ventilation, sunlight, restful sleep are put forward, and allusions to the evil consequences of neglect of such conditions are, for the most part, avoided.

The teacher, knowing how suggestible children are, is always on his guard against arousing fears of ill health. He avoids, for example, lurid descriptions of symptoms of tuberculosis which might lead a child to think he has the disease, when he has not. Throughout it is a case of "Do this and help the community to be healthy," and not a case of "Do not do this or the community will not be healthy."

It is to be noted that throughout this section the teacher and pupil are spoken of as "he." This is purely a question of convenience, and in every case the matter is



[Reproduced by courtesy of the Dental Board of the United Kingdom.
The value of this poster is that it stresses "prevention" not "cure."



AN UP-TO-DATE CLASSROOM

[Reproduced by courtesy of the L.C.C.]

Children who have the use of such a classroom as this are likely to be discriminating in demanding and maintaining such an environment for themselves as adults.

just as important for, and applies as fully to, the woman teacher and the girl pupil as it does to the man teacher and to the boy.

Place in the curriculum.—Hygiene is sometimes treated as a sub-section of the biology scheme, and its treatment is sporadic. In some schools all the work is crowded together into one year or term of the science course, while in other schools the treatment is confined to occasional references to the similarity of some structure or function in man to that in the animal or machine which is being studied.

The closest correlation of hygiene with all branches of science is essential to ensure that the children shall not get an artificial or isolated view of the subject. At the same time, the importance of hygiene is such as

to make it essential, if it is to be treated adequately, that it should have regular weekly periods devoted to it throughout the whole of the senior school course. The importance of the subject to the future citizen as a guide to the regulation of his own life, earns for it a place in its own right, so that, by continuous, systematic work, the wide range of useful material may be accessible to the adolescent.

The senior schools are called on to give these adolescents, who will form a large percentage of the community, straightforward and unbiassed information about the working of their bodies, as this is the only reasonable information of this kind most of them will get for the rest of their lives. Such teaching is urgent to counteract and nullify appeals made by patent medicine

and food advertisements and by the superficial health articles in the daily and weekly papers.

Children from eleven upwards are encouraged by teachers of most subjects to read the newspapers. They cannot do this without meeting innumerable references to health and hygiene. While this reading serves to arouse interest in and attention to such matters, direct positive instruction and guidance by the teacher of hygiene is necessary to help the children to sift truths from falsehoods and helpful from harmful matter.

The teacher of hygiene.—Hygiene is best taught by a science specialist, but it needs to be someone with a biological outlook rather than a pure physicist. Other members of the staff, such as the teacher of physical training or a teacher largely responsible for training in civics, may have real contributions to make to the hygiene teaching. The teacher must have adequate and, above all, accurate knowledge, and at the same time a sincere conviction as to the value of the work.

Class organisation.—Hygiene is essentially a practical subject, and on all possible occasions the pupils should do experiments or the teacher should arrange demonstrations, so that the work does not become abstract. For this reason, hygiene should be one of the subjects where the teacher is responsible for a "half-class" at a time. Since the class is to be divided into two groups, it is preferable and natural in mixed schools to separate the class into a boys' division and a girls' division for hygiene periods. There should be no essential differences in the schemes for the boys' or the girls' groups, but the method of approach, the place of stress and the apportioning of the allotted time will obviously vary.

It is not advisable to combine parallel classes for teaching hygiene, putting, say, IA boys with IB boys, and IA girls with IB girls. Not only would the numbers in the

groups make practical work impossible, but the assumptions, illustrations and applications suited to the A class would prove too difficult for the B class.

Time allotted.—In allotting time to the subject on the time-table, it has been suggested that a weekly period is necessary. It must be remembered that both descriptive and experimental work are to be catered for, so that a short period of thirty to forty minutes will usually prove insufficient and uneconomical.

Periodically and as occasion offers, time will be needed for inspirational periods or visits to such places as clinics, institutions, exhibitions or dairies or water-works. In view of the crowded time-tables in senior schools, the usual hygiene periods would have to be forfeited on such occasions.

School scheme.—Once it is recognised that one purpose, namely, to teach the value of good health for the individual and the community, should govern all health teaching in the senior school, it becomes clear that the school scheme for hygiene must be a unified, graded one. Some hygiene syllabuses, like syllabuses in other branches of science, are not true schemes at all, but merely lists of isolated, disconnected topics. Such syllabuses lead to desultory, purposeless teaching and scrappy, undigested knowledge.

The hygiene scheme for the school must be framed as a whole. The work for one year, or one class, cannot be fixed without regard to the work of the other years. No scheme will prove satisfactory which does not take into account the fact that in this type of school formal education ends for the majority of the children at the age of fourteen or fifteen. Therefore the scheme adopted, simple though it be, must be complete in itself. Too often the scheme is constructed as though it were to form the basis of a series of more and more advanced schemes. It is as though foundations were dug for a skyscraper when the finished building could be only a bungalow.

A further important consideration must be kept in mind when framing the hygiene scheme. A subject which deals so directly with the life and the life interests of the children touches other parts of the curriculum at many points. The scheme must therefore take into account the work in other subjects.

It is obvious that there should be a natural correlation between the hygiene and the physical training, that is, between two branches of health education. There must also be a close agreement between the order of development of the hygiene scheme and that of the general science scheme. More detailed references are made to this later.

What is equally important, but not always so readily recognised, is that the social training in the hygiene course must be associated with the social and civic training given in other subjects. The child must realise that the citizen who studies the rates and taxes, bye-laws and regulations of his community is the same who is called upon to consider the health and well-being of that community.

Junior school basis for senior school work.—

The senior school is a primary school and as such must continue, add to, develop and modify the education given in the junior school. This is the case with regard to hygiene. The work of the senior school must take fully into account the work in the junior school.

For the most part the health teaching in the junior school is indirect and informal. The work of the teacher at that stage is, in the main, to develop the child's inborn nature in such a way as to fit him to live a full, useful, helpful life in a civilised community. For example, he turns the child's inborn desire for activity to useful ends when he sets him to scrub his hands, clean his teeth, brush his shoes. In the same way he directs the child's innate curiosity to matters of health and cleanliness. He enlists the child's native love of routine and repetition in the service of hygiene when he encourages

him, by regular daily practice, to form bodily habits necessary to healthy living.

The aim of all this indirect health teaching in the junior school is to create in the child assumptions of right living, so that he takes it as a matter of course that handkerchiefs should be used, that teeth should be cleaned regularly, that hands should be washed before meals or before doing a neat piece of work, and that rooms should be kept tidy and attractive without being lumbered up with superfluous decorations. These points will not have been dealt with in specific lessons, and it is only now in the senior school that, according to the Board of Education's recommendations, regular health education periods should be included on the time-table.

It is, therefore, the work of the senior school to put further meaning and purpose into the habitual health practices of the pupils, so that, for them, these practices may become not that which is expected of them but that which they do from choice. In short, the task is to ensure that health habits become health ideals.

Since the course of necessity, throughout the years, makes constant reference to the home, teachers should guard carefully against straining the family loyalties of children who come from particularly poor or unsatisfactory homes.

The child in the junior school knows that he is expected to have clean hands and nails, clean shoes, clean books and papers, just as he knows he must come to school at nine o'clock on five days of the week. To a large extent these details have all become a matter of habit. If he considers them at all he tends to view them as affairs settled by grown-ups and no real concern of his. The junior school child, though he has acquired many specific habits of cleanliness, has no general conception of cleanliness. Still less, though he has grown accustomed to many health practices, has he understanding of the wider and even more abstract term "health." It is important that in the senior school the adolescent should grow to realise the

significance of the familiar health practices; that he should recognise that the so-called laws of health are not arbitrary laws made by adults; that he should develop a right attitude of mind towards health.

Health education in the senior school is not merely a question of training the youth to think about matters of health, but rather one of training him to *feel* keenly about health and healthy living. These feelings should become so strong and so lasting that they determine not only the boy's line of thinking with regard to health, but that as dynamic forces they determine his actions.

Healthy life becomes one of his ideals. He grows to view it as something of value to

the individual and to the community. This attitude should become an enduring one and resemble his attitude towards his other ideals so that he views health as worthy of respect and reverence and is prepared to take his share in the work of sustaining and improving the health of the community.

He should reach the stage where he no longer continues health practices to win approval of others but to strengthen his own self-respect. In the words of the Board of Education, "No programme will be really successful unless it inspires him to adopt the right attitude of mind towards all these school activities which have as their common purpose the promotion of healthy living."

CONTENT OF THE COURSE

IN every subject the content of the course is determined not solely by reviewing the possible material that could be included, but largely by a consideration of the immediate interests and needs of the pupils. A brief consideration of the psychology of the adolescent proves fruitful in fixing both the content and method of treatment of the health education course for the senior school.

The pupils entering the senior school are steadily changing from the matter-of-fact boys and girls of the junior school. They are no longer satisfied to take the real world for granted; they begin to consider it in relation to themselves. They become absorbed in new interests. They experience anew an interest in self, including the physical self. This grows into an interest in self in relation to those around. It continues to develop into a growing interest in wider social problems.

These three related interests suggest a natural treatment of the health education material. They suggest that the work should be planned as follows:—

Year I (11 plus to 12 plus): Health Education and the Individual.

Year II (12 plus to 13 plus): Health Education and the Family and Immediate Surroundings.

Year III (13 plus to 14 plus): Health Education and the Race.

The young adolescent, boy or girl, is beginning to take a pride in personal appearance and fitness. The teacher should build on this, dealing, for example, with the social value of cleanliness. Youth is very suggestible, and so, though giving regular direct instruction, the teacher makes great use of indirect suggestion and, trusting to imitation, sets many desirable examples of behaviour and appearance.

The adolescent, when pondering upon himself in relation to those around him, is brought face to face with the problem of what he is going to be and to do, and how he is going to live. The teacher of hygiene seizes this opportunity to deal with health in relation to work and family life.

Again, when youth begins to interest himself in social problems, the teacher's natural opportunity occurs for dealing with social hygiene and public health.

If the teacher follows such a course, based on the present natural interests of his pupils, he can count on their whole-hearted co-operation. This co-operation is strengthened by the fact that these adolescents have a strong desire for independence in all directions, accompanied by a feeling of dependence and insecurity. They display a real eagerness to learn all that is necessary to attain the coveted independence, and can be quickly led to perceive that health knowledge is one of the necessities.

Spiral method.—Such a scheme enables the teacher to employ a spiral method of treatment. This means that the teacher does not take each topic of the syllabus in turn and treat it once and for all in its entirety. For instance, he does not deal with cleanliness or respiration in the first term of the first year and then never touch upon it again, except by way of mechanical revision work. A topic is introduced early in the course and treated from one particular aspect; somewhat later in the course the same topic again appears, this time in a different setting, and is then treated somewhat more fully from this new point of view. When the topic is referred to again, say towards the end of the course, the teacher, making use of the existing knowledge of the class, views the matter from still another angle and gives an even deeper and fuller treatment of it. In this way none of the information in the course is allowed to become dead knowledge, but is repeatedly being used in new connections so that the pupil's experience becomes richer and fuller.

It can be seen in dealing with health, first from the point of view of the individual, secondly from that of the family, and thirdly from that of the race, that the whole course is based on the spiral method, and that in consequence the various sections of the

syllabus profit by continual filling out and development according to this spiral method.

A plan of the kind indicated has the advantage of not being too rigid. A group of teachers may adopt the same framework, yet each of them would still have plenty of scope, in the actual division and sequence of lessons, to display his individual views and treatment.

In the section, *Lessons in Detail*, page 410, a series of lessons on food is worked out to show the spiral method of treating the various sections of the syllabus. The question of food is taken up in each of the three years and in each case treated from a different viewpoint.

Inspirational periods.—Successful teaching in any subject is measured not so much by what the children know of the subject as by their attitude towards it. A class may be able to name every bone in the body and yet feel revulsion, or may be able to enumerate the so-called laws of health and yet not value good health. The teaching in such cases could not be called successful. The teacher who has aroused in his class the desire to pursue the subject further because of awakening and increasing interest has accomplished far more, even though his pupils could not compete in a memory test on the facts.

For the most part a right emotional attitude towards a subject is created by suggestion and other indirect means. In addition to this, however, a more direct method has been found helpful—that of arranging periodic inspirational talks, or the more elaborate "celebrations" made popular by Dr. Hayward.

Health ideals depend upon appeal to the emotions and feelings. Study of the behaviour of crowds has shown that an emotional appeal is always more likely to be successful if made to a crowd than if made to an individual. An electioneering candidate does not rely solely upon house to house canvassing but organises large mass

meetings. The strong instinctive forces of imitation, suggestion and sympathy are at work in a crowd, and a teacher wisely makes use of these forces when he wishes to arouse a lasting respect and regard for healthy living.

On such an occasion the whole school is assembled, having been given some days beforehand the name of the pioneer of health work or the health topic to be celebrated.

These inspirational periods are particularly suitable for senior school children. Adolescence is a period of great emotional energy, and teachers are beginning to realise the significance of developing and training the emotional life of youth.

It should be noted that any such inspirational teaching in health education must be followed up promptly by activity so that the children may not become useless sentimentalists. All inspirational health teaching should issue in health practices. Thus posters, meant to be inspirational, which exhort the children to wash frequently or clean the teeth before meals, are useless if kept exhibited in a classroom until dusty themselves, and all the more so if the school is of a type in which the washing facilities are poor, so that practice cannot follow suggestion.

History.—All children find interest in the story of man's progress in the fight for health. For this reason it is rightly advocated that children should be given some knowledge of the historical background of health work. There is, however, a tendency to go to

extremes in this direction and to devote a series of hygiene periods to the detailed accounts of the lives of health pioneers. The history is divorced from the hygiene and, added to that, it is not kept in the background. Historical information is not subordinated to inspiration in such lessons.

Apart from the periodic inspirational periods for the assembled school, whole lessons should not be set aside for biographies, but the historical information should be woven into the general exposition whenever it is relevant. In this way the child forms his own judgment of our debt to the pioneer or scientist, and gradually grows to realise the extent to which our present health knowledge and facilities are due to the service of men and women of the past.

Visual Aids.—

Picture: selected from the wealth of those

available should be visual aids to learning. They should not be merely pleasing, like the upper poster on page 376, but they should be mentally stimulating and should actually assist the child by definite information about the topic in hand.

Regular training is necessary if children are to learn to extract the full benefit from a picture or diagram. If shown without comment from the teacher the photograph on page 405 will delight adolescent girls, but will not justify its place in the lesson. By a series of questions and comments however, such as—"Notice the baby's mouth. How is he breathing?"—the picture might form a good basis for a lesson on the conditions of healthy sleep.



MADAME CURIE

SYLLABUS AND SUGGESTIONS FOR A THREE YEARS' COURSE

BELOW are given suggestions for the work that should be covered during the three years. The syllabus will be seen to follow the spiral method indicated on page 360.

While it represents the complete scheme of work, all portions of it are not dealt with in the same way. Where the topic is straightforward it is inserted with few comments. Some sections of the scheme are treated at greater length. These are sections, such as that on *heat balance*, where it seemed helpful to indicate not only the content of the lessons but also the method of treatment. *Hormones* is another topic which is discussed in detail, as the subject matter is not obtainable in most school text books and is somewhat detailed in the more technical books.

In some instances the topic has been named in the following sections and its treatment has been demonstrated by an illustrative lesson in the section, *Lessons in Detail*, page 410.

While the scheme may suggest that much of the work takes the form of teacher's

exposition or class discussions, many of the topics can be equally well treated by methods involving less oral work, and at all stages, wherever possible, appropriate, simple experi-

ments should be demonstrated by the teacher or performed by the class.

For example, the teacher can often in preparing his lesson frame a series of "guiding questions." These the children study, individually or sometimes in small groups, and find answers to them with the aid of posters, pamphlets and simple text books. Lessons on teeth can most successfully be dealt with by this study method, if the teacher chooses carefully from the abundance of "literature," pictures and diagrams available on this subject.

The subject of cleanliness lends itself to treatment on project lines. The class will soon discover that the

subject is much too wide for one project, but that it naturally splits up into a series of smaller projects. Soap, for example, or dirt, provides an excellent minor project. Such projects suggest such a variety of activities

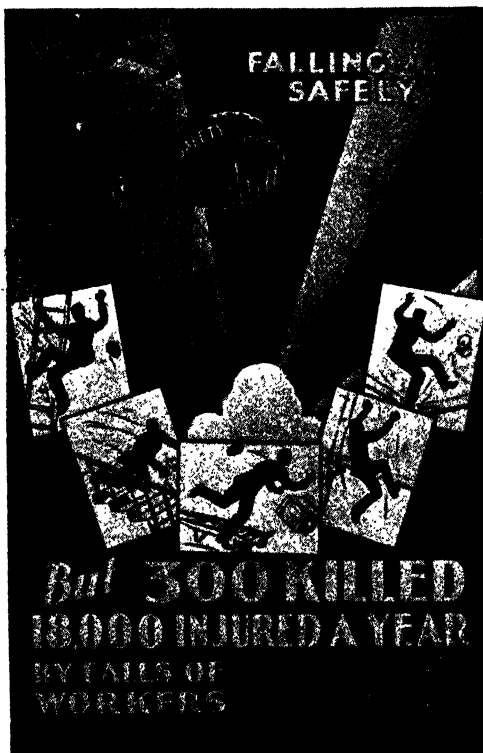

[Reproduced by courtesy of the National Safety First Association.]

Such posters as this interest older children because the subject matter is connected with that adult life in industry into which they will many of them enter shortly.

and pursuits that the interests of all members of the class are aroused and kept alive.

A teacher interested in Dalton Assignments could arrange the material suggested for a year's work into ten assignments. For example, in the third year, *The Provisions Made by the State for the Health of its Members* would form the topic of an assignment. The teacher would need to collect, and put at the disposal of the class, such things as sample Health Insurance cards, placards of different types of factory regulations, pamphlets supplied by local institutions, such as welfare centres, Health Week booklets, and town year books.

Each unit of the assignment would give a minimum of information, together with definite instructions as to what further information to collect and where to collect it. It would also ask for a definite piece of practical work, such as expressing data from a given book in graphical form, or reading a graph, or writing an appreciation of the work of some health institution or movement. As optional work, that is, work in addition to the minimum requirement of the assignment, the children might be asked to collect further literature or first hand information, or to make a poster that could be used by an institution.

FIRST YEAR'S COURSE FOR PUPILS AGED ELEVEN PLUS TO TWELVE PLUS

HEALTH EDUCATION AND THE INDIVIDUAL—THE BODY AND ITS NEEDS

The functions of plants and animals.—The attention of the class should be drawn to previous knowledge of plants and animals, and the children should be induced to supply information about how these live, move, eat, grow, reproduce. For example, they should state that plants move towards light, and that animals move towards food or away from danger, and, again, that both plants and animals need water.

The teacher should then make quite clear to the children that the purpose of the lessons that are to follow is to consider how far and in what ways man does these things. It is particularly advisable here that the class should know the aim of the year's course. Children of this age are interested in themselves, their make-up and their needs, and on hearing the purpose of the work will think, "Here lies the solution to many problems; here is something worthy of our attention and consideration."

The structure of plants and animals.—The teacher should deal with the structure of plants and animals as follows:—

All living things, plants and animals, are characterised by being made up of cells. The cells consist of a colourless, jelly-like substance, known as *protoplasm*, with, somewhere in the protoplasm, a differentiated part called the *nucleus*. There are many very small living things that consist only of one nucleus and the surrounding protoplasm. Such minute animals and plants are too small to be seen with the naked eye; they have to live in a liquid medium, as, for example, in a pond or in the sea water.

One well-known example of these minute organisms is the *amoeba*, which can roll itself along and engulfs food particles that drift to it for its food. When it is well fed and can grow, it divides itself into two halves, and each half becomes a new amoeba; but, when times are bad, or food is short, or the pond dries up, it can make a hard case round itself and wait in the mud for better times.

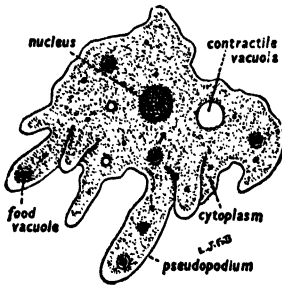

AMOEBA

The amoeba is only one example of the thousands of non-cellular animals which live in sea or fresh water or as internal parasites. The majority of these are so small that they can be seen only microscopically. This amoeba has been magnified at least 1,000 times.

entirely to be dealt with in the biology period. It is essential that the children should link up these ideas of the structure and function of lower animals with the ideas gained in hygiene regarding the structure and function of man.

What we mean by growth.—Man and all animals and plants with which we are familiar (e.g., cats, dogs, frogs, birds, fishes, trees, garden plants) are made up of not one but myriads of these so-called cells, each with its nucleus. Growth takes place in any of them—say, in a child, or in a bean seedling—because myriads of these cells have divided and are dividing and redividing continually.

If we want to have a bigger train or house or aeroplane or saucepan or cup instead of our smaller one, we must obtain an entirely new one, whereas a living plant or animal can itself *grow* from a small to a bigger size, within its own inherent limits. A kitten, for example, changes itself into a grown-up cat because it can eat food and change this food and build it into its own bodily structure, but a non-living thing, like a house, cannot increase or develop itself in this way. (Non-living things such as

The amount of work of this kind that is covered here will depend upon how much of the material the children have met in their biology course, and a consultation about syllabuses is advisable between the two teachers. In any case this work should not be left

crystals “grow,” but it is not necessary to raise such points at this stage. To omit mention of them is only to obey the maxim “Never teach exceptions at the same time as you teach the rule.”)

Movement in man.—This is the next topic for the teacher to take up. He states that one characteristic of living things is that they can *move*. How then does the human body move? It does not move as a heap of sand “moves,” particle by particle, but as a whole. Further, like a mechanical toy motor car that “works,” it moves because of something happening inside itself, and not like a “pretend” motor that really has to be pushed from outside.

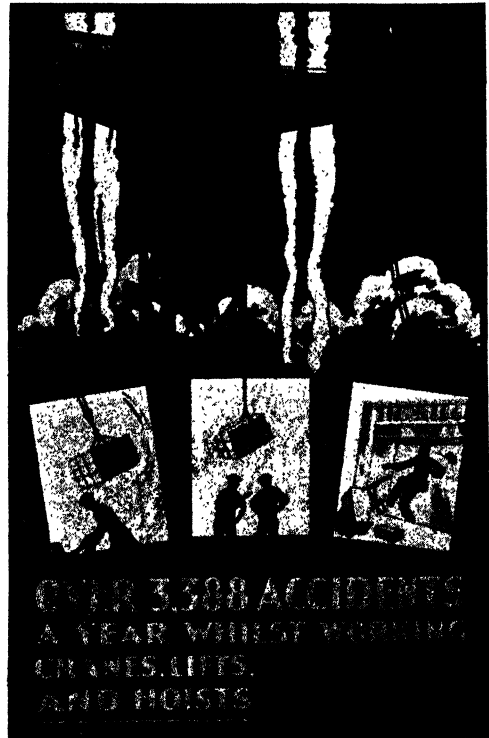

[Reproduced by courtesy of the National Safety First Association.]

The crane in this poster has a skeleton. The poster is also a further example of teaching about safety in industry.

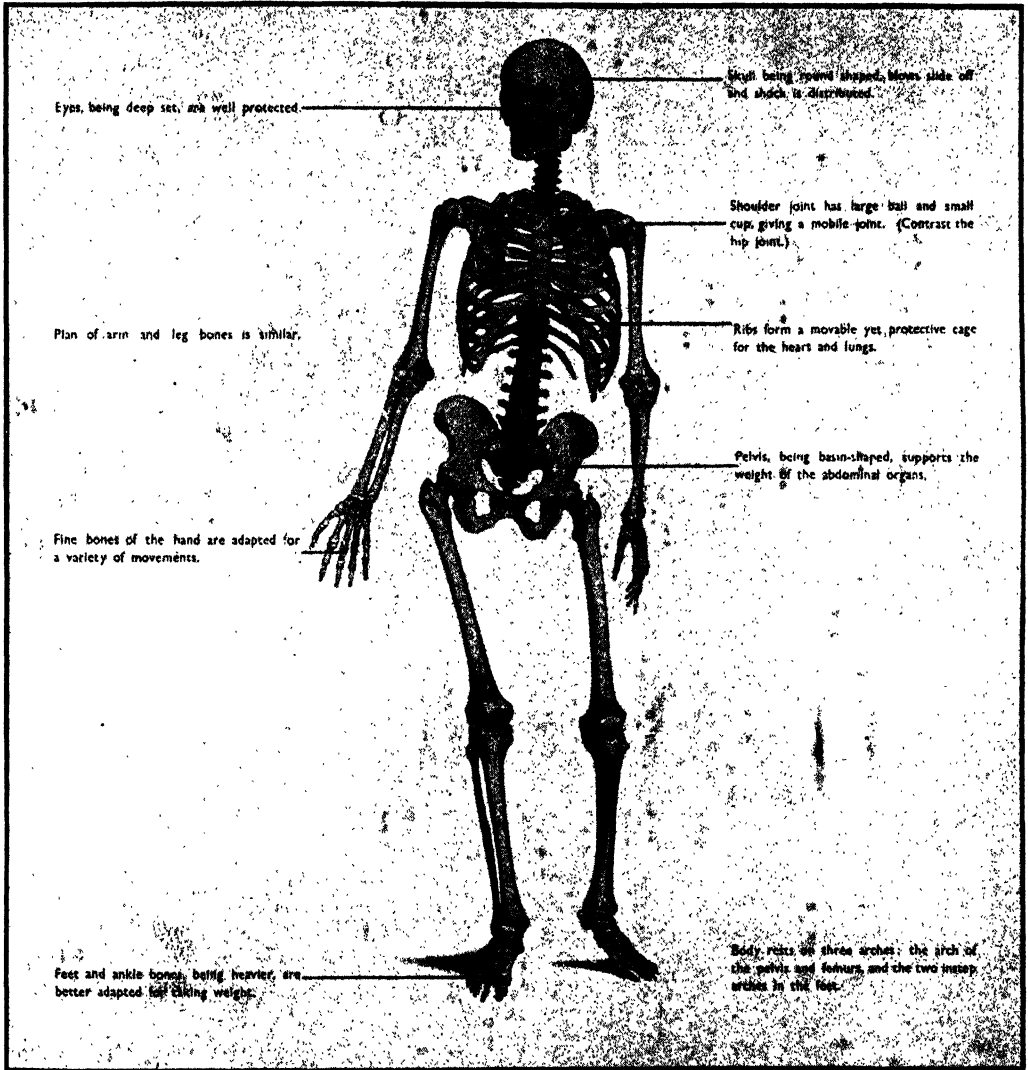

SKELETON OF MAN
 (Class Picture No. 10 in the Portfolio.)



HEAD OF AN EARTHWORM, SHOWING REPETITION OF SEGMENT-PLAN

[Photo: H. Bastin.]

A similar and related repetition can be recognised in man in the vertebrae and the ribs.

Man's framework or skeleton.—The teacher now tries to give the class an understanding of the various functions of the skeleton, as follows:—

You all know that a tall house or factory has an iron framework which can be seen while the building is being erected. The body has a somewhat similar framework, made of lime. It is called the *skeleton*. This skeleton serves a number of purposes; (1) it supports the body; (2) it protects the body; (3) it gives shape to the body; (4) it enables the body to move. Each of these uses is considered in turn. Examples are collected from the class of other analogous frameworks; e.g., frames of tents, kites, easels, windows, cranes. An attempt is made to decide how far each does work like the skeleton of the body.

The children should feel some of the bones of their own framework. For example, they can feel the bones in the fingers (how many?); in the palm (again, how many?); the jaw

(this helps to give shape to the face); and the skull (this is a mainly protective set of bones). The repetition of the ribs and the vertebrae shows that Man has evolved from far-back ancestors in which this repetition of segments occurred. The earthworm is one living example among many of such a body plan.

Joints and hinges.—This forms the next topic for discussion. The children could consider how a sledge or, say, a toy speed-boat moves. Each moves as one whole. They compare this movement with the way in which one part of an object moves relative to another part; for instance, this is possible in the case of the rudder of a boat, or the lid of a desk, or when the mouth is opened and closed, or when the first finger is bent and stretched by itself. The children try these last two examples and find that when the mouth is opened one bone moves on

another, and again when the finger is bent one bone moves on another.

The teacher then states that the place where bones move one on another is called a joint, and he compares joints with hinges in windows, doors, books, boxes, armour. The class and teacher then set to work to discover whether all the body joints work in the same way. The children try finger joints, top thumb joints and bottom thumb joint, and compare and contrast. They consider the knee joint and shoulder and hip joints. Hence they finally deduce differentiation between hinge joints and ball-and-socket joints. They find that the pivot joint at the elbow allows of useful turning over of the hand, as is experienced in turning a key or wringing clothes. (It is unnecessary to make much, at this stage, of immovable joints as in the upper jaw and cranium.)

A line of practical work which has proved popular in this connection is to give all the members of the class a hectographed paper manikin, on which they mark in the bones as they locate them and in this way consider the joints at the same time. (See fuller lesson notes, page 411.)

The composition of bones.—At this point the teacher should also discuss the make-up of bones; the fact that they are not solid throughout, but partly consist of spongy tissue with air spaces. This gives elasticity and lightness. In the hollow middle of "long bones," such as thigh or arm bones, is the

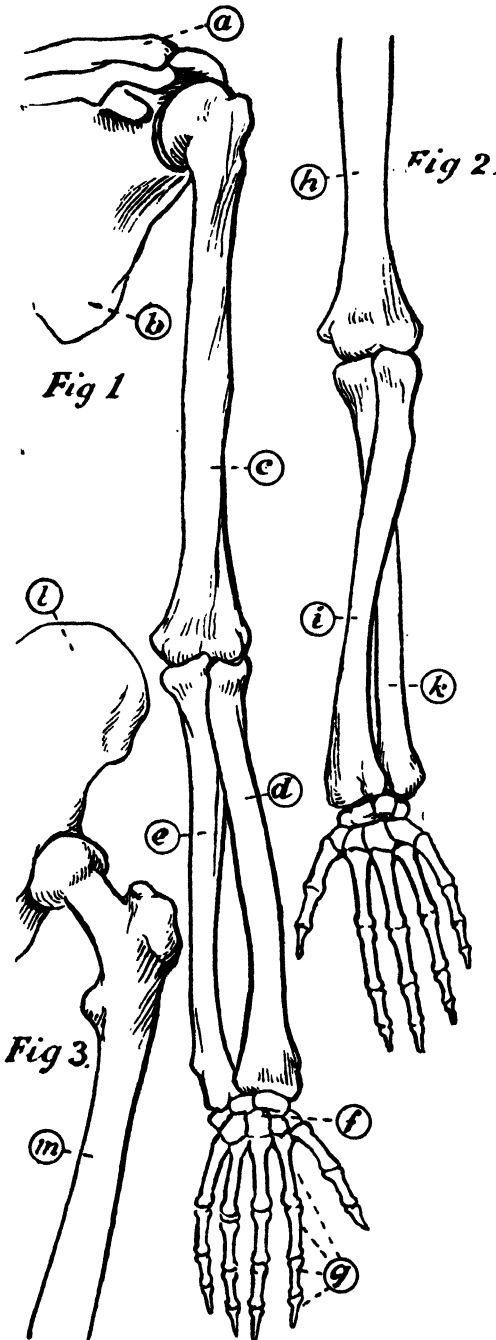

FIG. 1. SHOWS THE SHOULDER JOINT AND ARM, WITH THE BONES IN THEIR RELATIVE POSITIONS WHEN THE PALM IS TURNED DOWN.

a. Part of collar bone. b. Shoulder blade (scapula). c. Upper arm bone (humerus). d. Forearm bone (radius). e. Forearm bone (ulna). f. Wrist bones. g. Palm and finger bones.

FIG. 2. SHOWS THE ARM WITH THE BONES IN THEIR RELATIVE POSITIONS WHEN THE PALM IS TURNED UP. THE PUPIL SHOULD NOTICE THE DIFFERENT POSITIONS OF THE THUMB AND OF THE TWO BONES OF THE FOREARM IN FIGS. 1 AND 2, AND SHOULD BE ABLE TO FEEL THE LATTER IN HIS OWN ARM.

h. Humerus. i. Radius. k. Ulna.

FIG. 3. SHOWS THE HIP JOINT; THE THIGH BONE CORRESPONDS WITH THE UPPER ARM BONE IN THE ARM.

l. Hip bone (part of the pelvis). m. Thigh bone (femur).

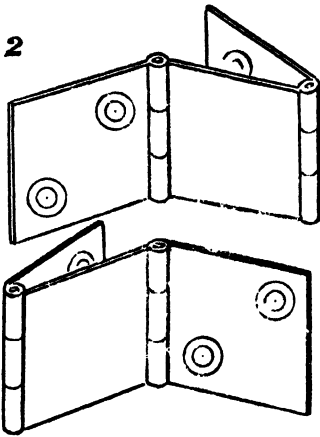
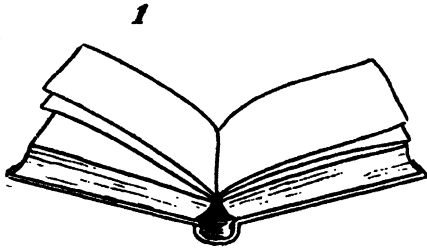

EVERYDAY HINGES

1. Book.
2. Screen hinge.

marrow, supposed to be associated with the manufacture of the red corpuscles of the blood. This is an example of the body's neat economical packing. In the first place, the "long bones" such as the thigh, shin and upper arm bones, are more resilient and elastic to withstand shocks, because they are hollow. In the second place, the body makes use of these hollow cavities running down the centre of the bones, and red blood corpuscles are manufactured there. Other examples of economical packing are seen in the inner surface of the lungs for if this were spread out it would cover over half a tennis court; in the convolutions of the brain; in the coiling into the abdomen of some twenty-five feet of intestine. The children

are not yet ready for these further examples, but they should be made to note them, as cases of this principle of economic packing, as they proceed through the course.

Muscles and their work.—The class must next consider how bones move on one another by means of muscles. The teacher shows that muscles always contract and pull the bones, to which the ends of the muscle are attached, nearer together.

The children can feel the biceps' tendon fixed into the front of the forearm, if the hand is turned palm upwards; and can feel the swelling and hardening of the muscle as it contracts to bend up the lower arm bone on to the upper arm bone. Thus

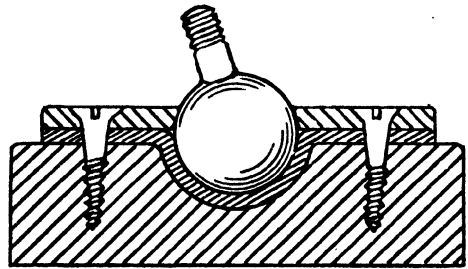

SECTION

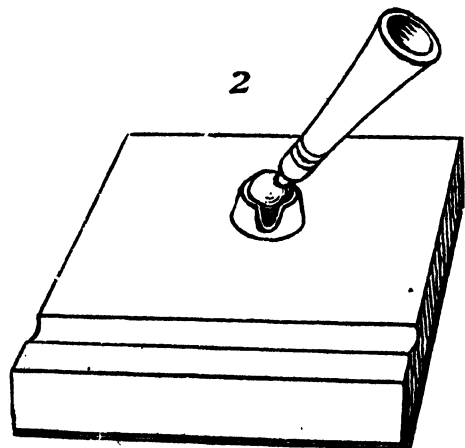

BALL-AND-SOCKET JOINTS

1. Cross section of ball-and-socket joint.
2. Penholder with ball-and-socket joint.

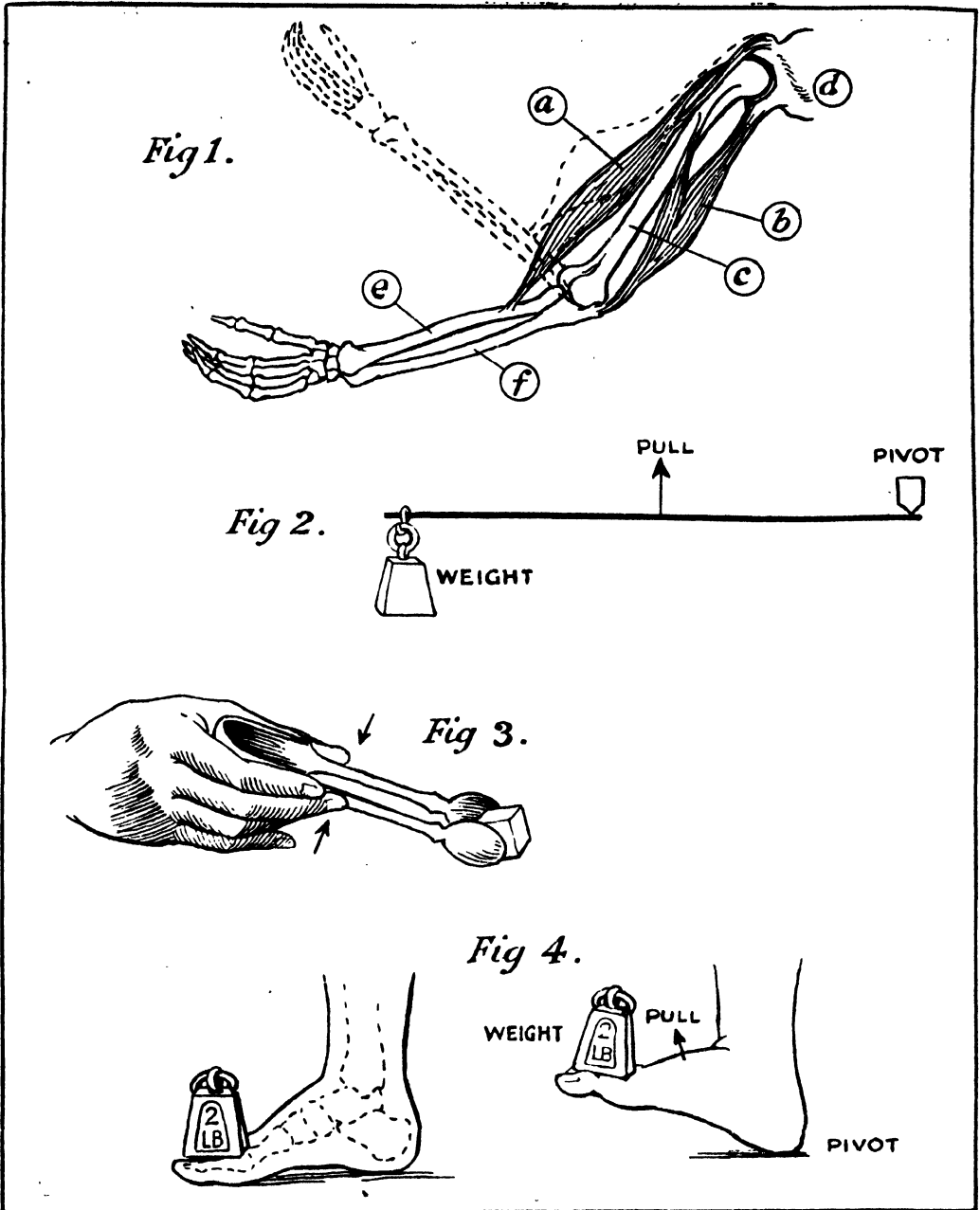

FIG. 1.

THE ACTION OF THE BICEPS MUSCLE IN BENDING THE FOREARM
 The effort is applied between the fulcrum and the weight as in using sugar tongs.

a. Biceps.
 d. Scapula.

b. Triceps.
 e. Radius.

c. Humerus.
 f. Ulna.

FIGS. 2, 3 AND 4.
 KINDS OF LEVERS

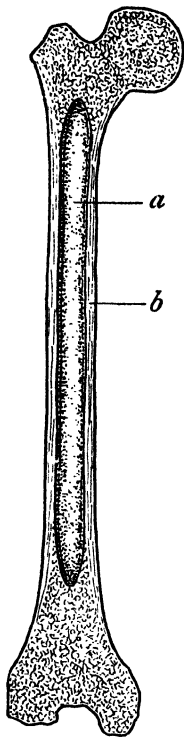

LONGITUDINAL
SECTION OF THE
FEMUR

a. Hollow, less dense
tissue inside.
b. Compact, solid
bone tissue outside.

the skeleton provides a rigid framework on which the muscles can produce movement, and the teacher should make clear that here the principles of the economical moving of weights by leverage applies.

Muscles and levers.—

The principle of levers is best approached by reference to the experience of the class. The question might be asked, "How would you overturn a heavy box?" The method finally decided upon would be pushing a stout rod under the box and lifting the end of the rod. Opening a box by using a chisel pushed under the lid could be compared, the children deciding in each case whether a short or a longer rod or chisel would work better. In this way the relations

between fulcrum, weight and effort, and the mechanical advantages in moving weights by leverage would be discussed. This will probably already have been dealt with more fully in science. There is no need to go into great detail or work out numerical illustrative examples in the hygiene course. The children want to be aware that such principles do exist and are applicable to muscle and bone movements.

Simple applications in the body will be shown: (1) An example of the first type of lever, such as a see-saw or a spade when thrust vertically into the ground to move earth is considered. Then it should be shown

that the head in nodding works like a see-saw. (2) Next should be discussed levers and leverage of the second type; for example, the way in which weights are moved by a wheelbarrow, or the way in which nuts are cracked with nutcrackers. In levers of this type the weight is between the effort and the fulcrum or fixed point. The raising of the body on the toes is an example in the body of the same kind of leverage. (3) The occurrence of examples of leverage of the third order, that in which the effort is applied between the fulcrum and the weight, should be shown to be frequent, the reason being that they allow of deft rather than strong movements. One example in everyday life is the picking up of a lump of sugar with the sugar-tongs. An example in the body is the bending of the forearm on to the upper arm by the biceps.

The teacher will probably find it best to leave the consideration of involuntary muscles until dealing with the heart or digestive system.

The needs of the body.—Having dealt with the structure of the body, the teacher and class now begin to consider some of the needs of the body such as oxygen, foods, cleanliness.

How the body eats.—The teacher links up the previous lessons on muscles with the lessons on food. To do this, he approaches the work as follows:—

For the muscles to contract, they must have *oxygen* and *energy-giving foods*. Consider how a fire must have a good draught of air and coal to make it burn. The oxygen for the muscles is like the good draught of air for the fire, and the energy-giving foods are like the coal. (The class must realise that food is needed for all other parts of the body, besides the muscles, but that it is convenient and clearer to deal with one type of food at a time.)

Air and oxygen.—The teacher's first task is to show that oxygen is obtained from the

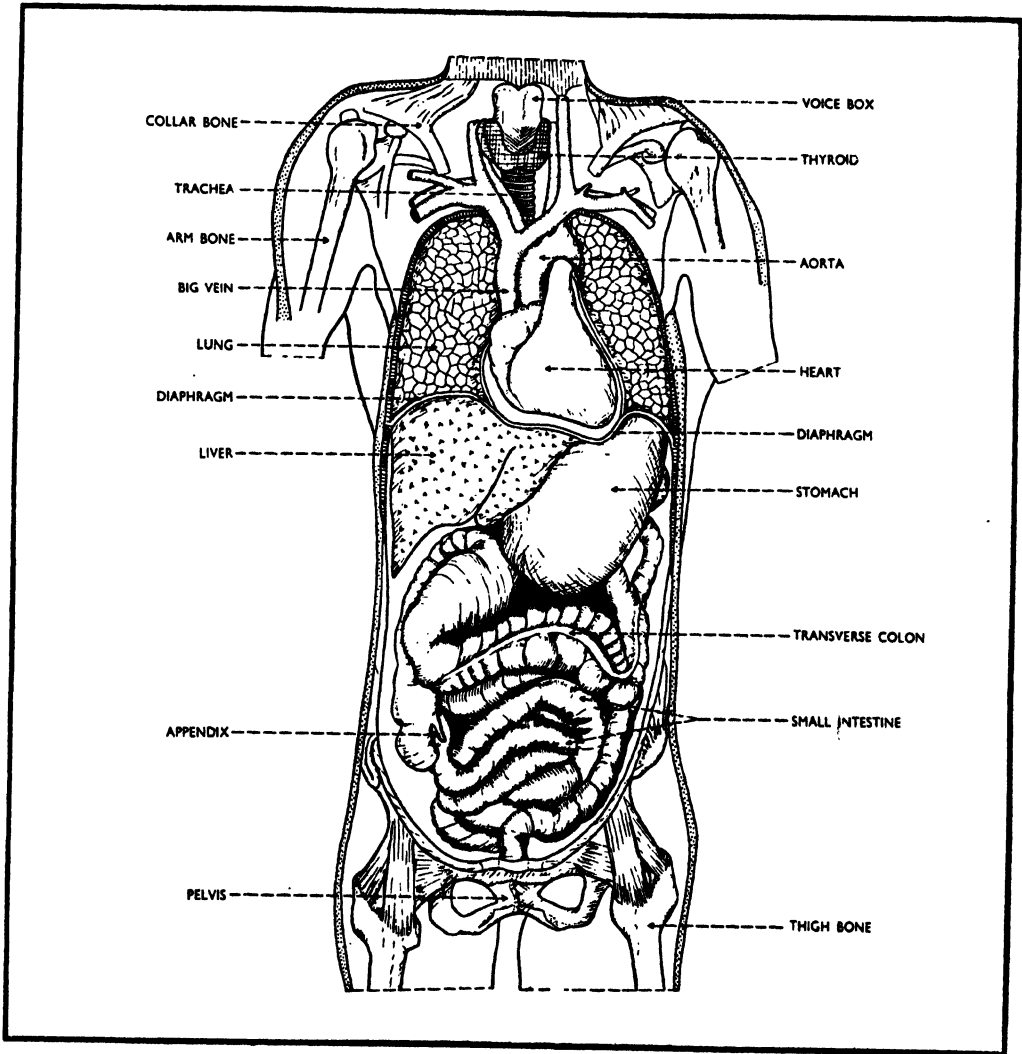

ORGANS OF THE BODY OF MAN
 (Class Picture No. 11 in the Portfolio.)

air. Routine experiments on the composition of air, such as burning a candle or allowing iron to rust in a glass jar with its base under water, will bring out the fact that one-fifth of air is the active part, supporting burning and also breathing, and four-fifths of any quantity of air is made up of inert gases. The active gas is the oxygen. This will probably be covered in greater detail in the science course.

The children are then asked how we know that air is all about us, since we cannot see it. Examples of the answers expected are wind effects, noises and movements, bubbles in water. Birds and aeroplanes could not lift themselves were there no air.

Oxygen and the lungs.—The next problem for the class is, "How does oxygen get to the muscles?" The teacher gets the children to realise that the next step is that the oxygen is taken into the *lungs* in breathing. He questions the class on how fishes breathe and makes use of any knowledge in this direction learnt in nature study or biology. He makes it plain that the way the lungs work is essentially the same as the way fishes breathe. At this point it is possible to show lungs from the butcher's and to inflate them. Before doing so, however, the feeling of the class in the matter should be tested. The teacher cannot risk the goodwill of his children so early in their hygiene course. If necessary the producing of actual lungs can be deferred until the question comes up

UPPER PART OF BODY

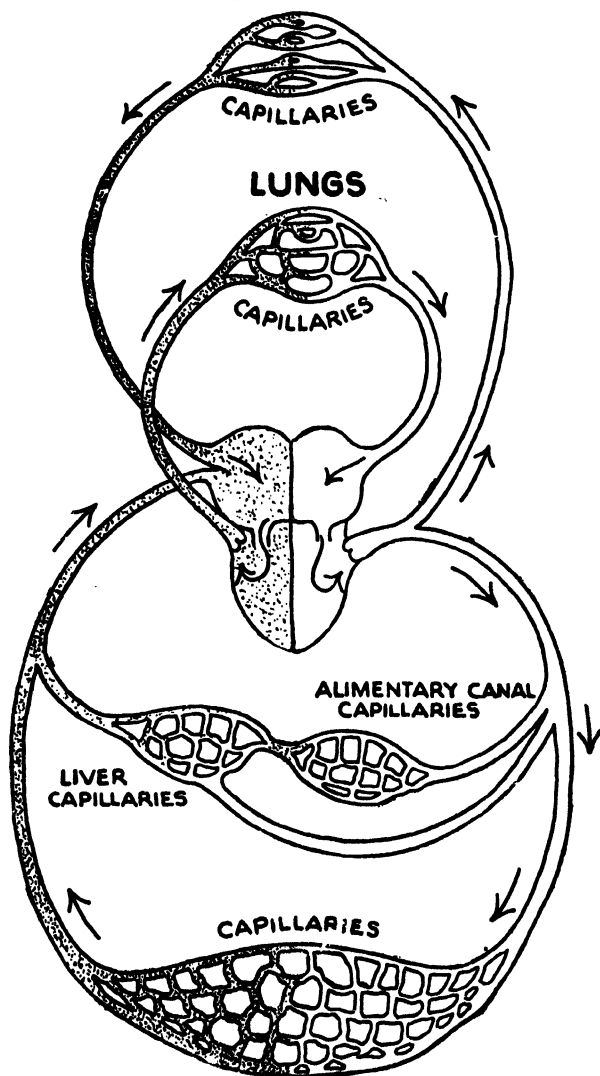

LOWER PART OF BODY

Reproduced from "An Outline for Boys and Girls and Their Parents" by permission of Messrs. Victor Gollancz.

GENERAL COURSE OF THE CIRCULATION OF THE BLOOD

again, as revision in the second year, in connection with ventilation.

The children are then asked a further question, "When are we specially aware of our breathing?" The answer expected is,

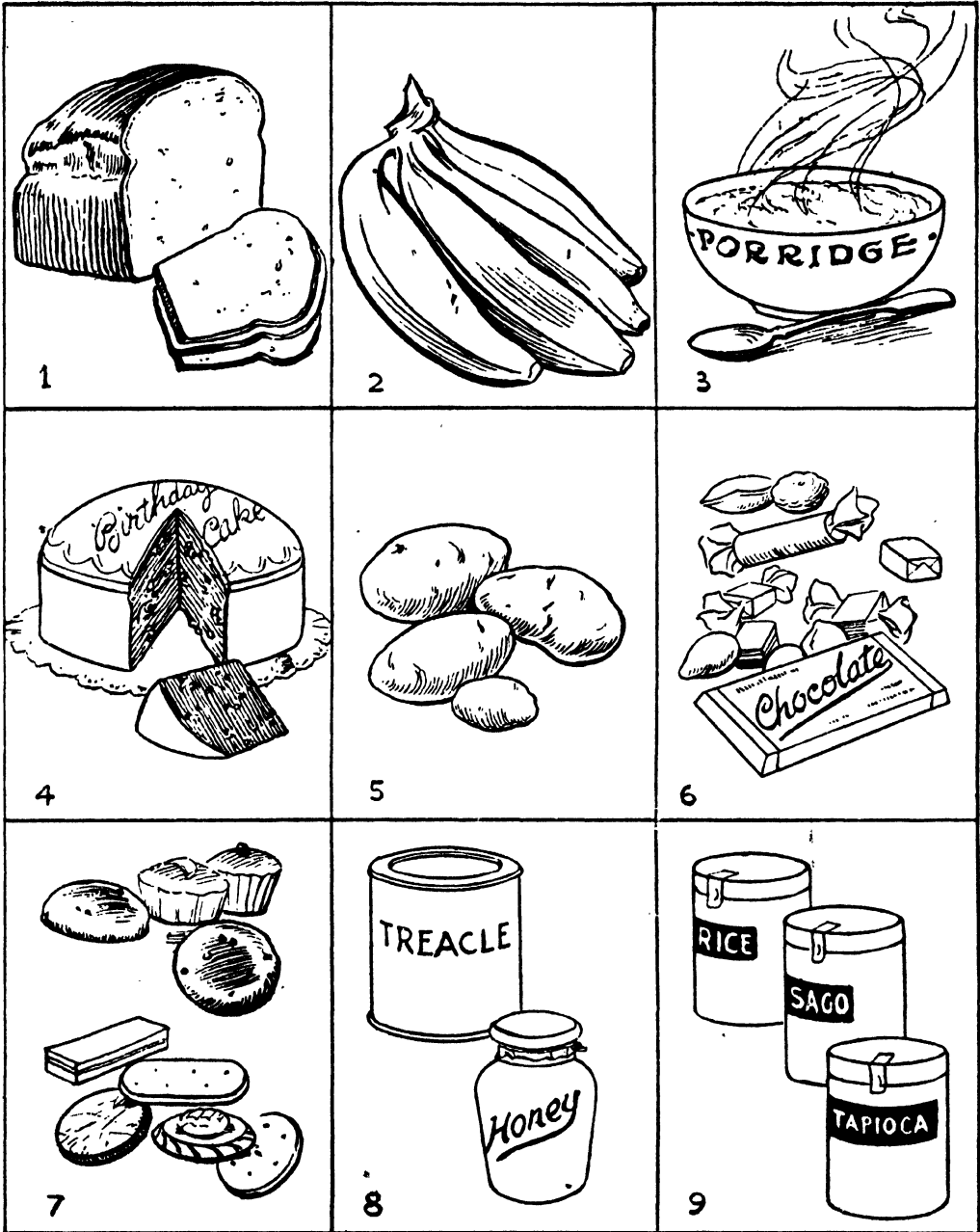

SUGAR AND STARCH FOODS

1. Bread. 2. Bananas. 3. Porridge. 4. Cake. 5. Potatoes. 6. Chocolate and Sweets.
7. Buns and Biscuits. 8. Treacle and Honey. 9. Rice, Sago and Tapioca.

"When we are out of breath." The teacher then explains the value of vigorous exercise, that it fills and empties the lungs fully. (Of course there is no mention of such things as "residual" or "complemental" air with these children.) He also touches upon the value of open-air life and open windows. The treatment will be amplified later in connection with clothing and ventilation.

Oxygen and the blood.—The next question to settle is, "Where does oxygen, from breathed air, go when it leaves the lungs?" The answer is that it is taken into the *blood* which conveys it round the body to the muscles. This introduces the lessons on the composition of the blood, the work of the heart, the circulatory system and the lymph system.

The children can find their own pulses in wrist and forehead palpating with fingers.

The work of the arteries, capillaries and veins should be considered. A vein can be found.

The work of the blood.—This can be summed up by the class as follows:—(1) Taking food and oxygen to the tissues in the blood; (2) removing waste carbon dioxide gas in solution, as well as other waste products; (3) distributing the heat made by muscle movement all over the body or flushing the skin to lose extra heat; (4) the making of digestive juices (of which more later) from the materials in the blood; (5) the clotting over of wounds and the destroying of disease germs which enter the blood and tissues, due to the presence of the amoeboid white corpuscles. The fact that blood is made up of colourless liquid serum in which float many red and fewer white corpuscles, needs to be specifically restated when the

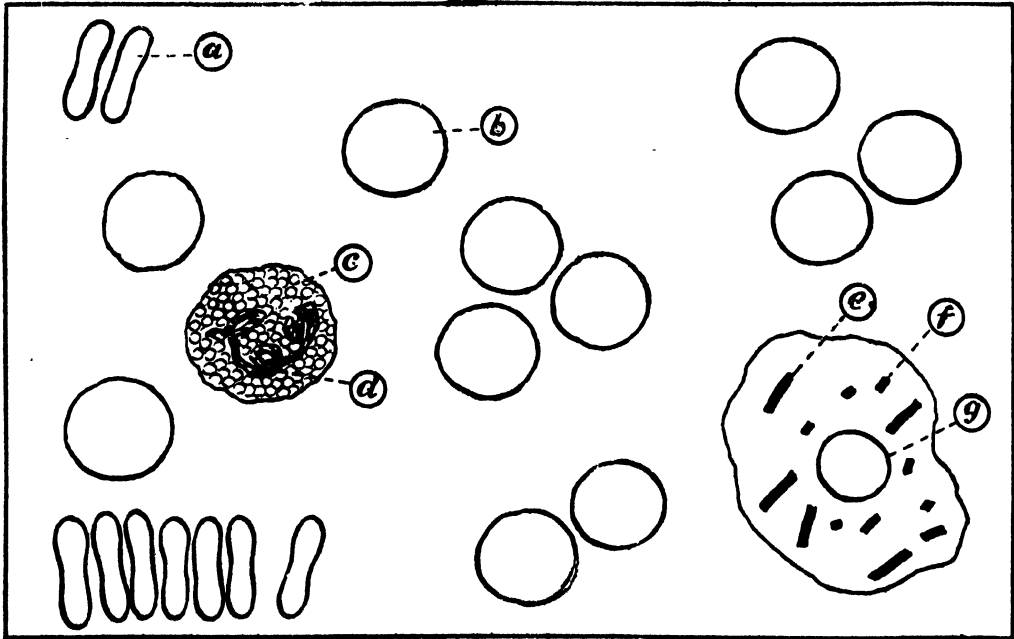

BLOOD CORPUSCLES

These blood corpuscles or cells are much magnified. Some five millions of the red corpuscles are present in a drop of blood the size of a pin's head.

a. Red corpuscles seen in profile. b. Red corpuscle seen flat. c. White corpuscle with granules. d. Nucleus. e. Healthy bacillus. f. Partly-digested bacillus. g. Nucleus.

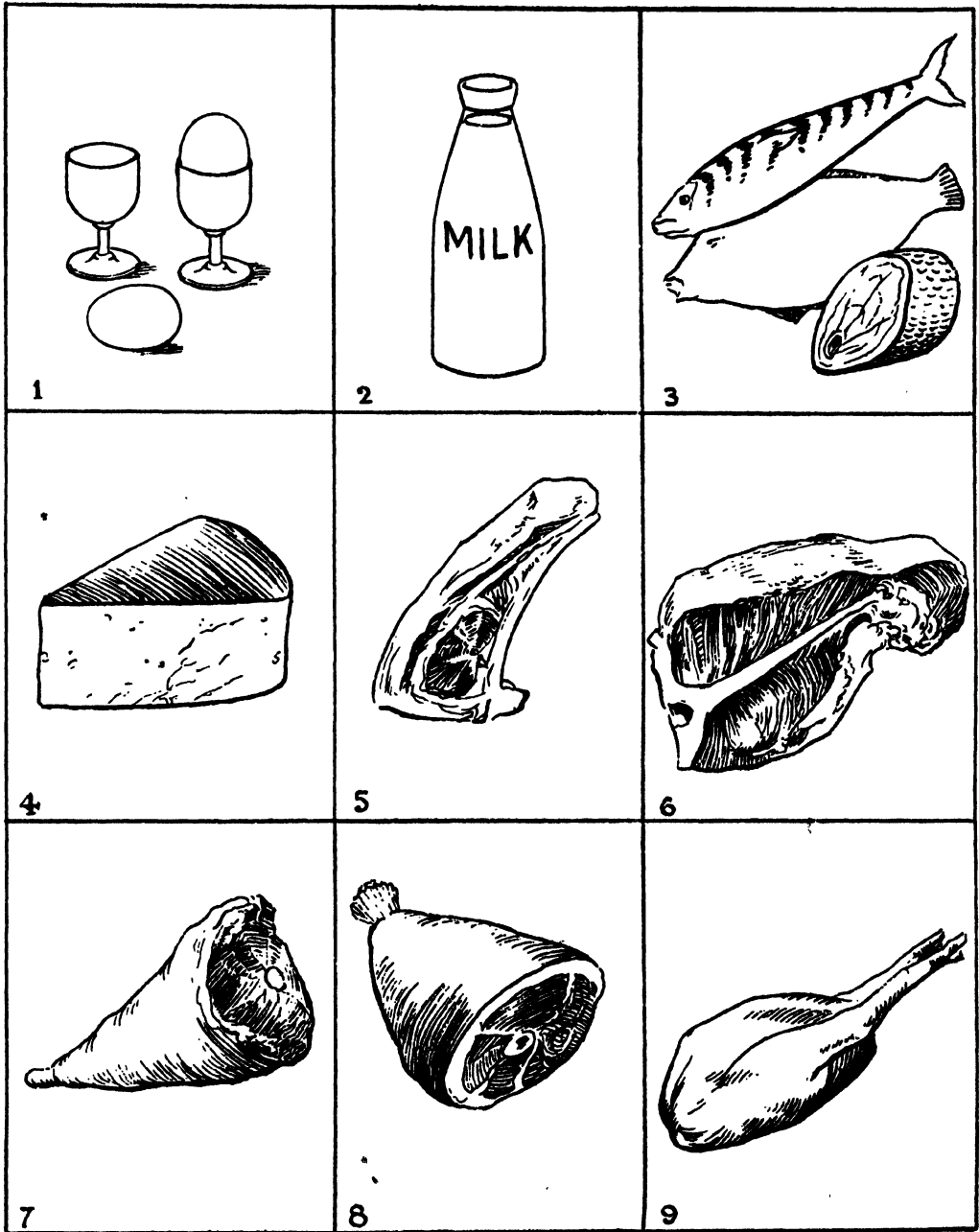

GOOD ANIMAL PROTEIN FOODS

1. Eggs. 2. Milk. 3. Fish. 4. Cheese. 5. Mutton. 6. Beef. 7. Veal. 8. Pork.
9. Poultry.

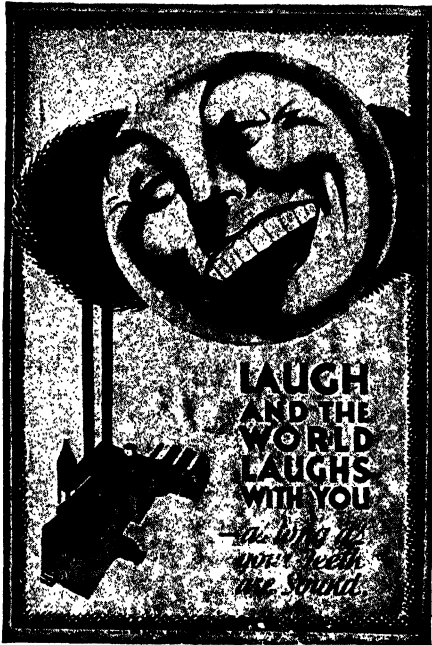

[Reproduced by courtesy of the Dental Board of the United Kingdom.]

This poster is more amusing than instructive, and is shown as a contrast to the one below.

functions of the blood are revised the work of the different constituents being restated.

Energy-giving foods and the muscles.—

Having considered how oxygen gets to the muscles, the children must next turn their attention to the question, "How do energy-giving foods get to the muscles?" The teacher uses the analogy of petrol which is burnt in the motor car engine and makes the car move until all the petrol is used up. He shows that coal under a boiler does similar work. He explains that energy is needed in the body in the same way to enable it to move, and that this energy is obtained from foods like sugar and bread and cake foods, called *starches*. The starches and sugars eaten are transformed in the process of digestion into *glucose*, a kind of sugar, which is then used up in the actual muscle cells

when movement takes place, and is the fuel for the movement. It is because glucose can be immediately absorbed by the body and used in the muscles that the use of glucose sweets is now advocated for quick energy-reviving. Honey is a natural form of food which contains glucose.

Other types of foods.—The teacher next discusses the fact that food is also wanted to make us grow bigger. (He compares the situation with wanting more bricks when a house is enlarged.) These kinds of food are also wanted for repairing tissues. Such foods are called *proteins*.

Other foodstuffs that the body must have—*fats, water, mineral foods, vitamins*—are discussed and the reasons are found. This should be dealt with briefly, but the examples should be lively. (Macfie's *The Body* in Benn's Sixpenny Series is useful here.)

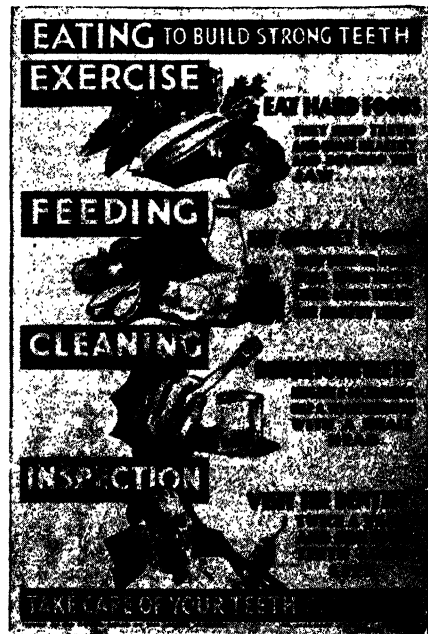

[Reproduced by courtesy of the Dental Board of the United Kingdom.]

This poster is useful because it supplies and sums up a number of facts about teeth care in a graphic and pleasing way.

Further reference will be made to food-stuffs, and the matter revised and amplified in each of the following years. (See section on *Lessons in Detail*, page 410.)

Food and the teeth.—The teacher draws attention to the part played by the teeth in eating. The children discuss the structure of teeth. They also consider the need for preservation of the teeth. The question is viewed from two angles. There is the physical reason for preservation, namely, that it makes for fitness; and there is the psychological reason, that is, that it makes us look nicer and more attractive. The teacher gives these positive reasons, but he does not give negative teaching by saying, "If you don't clean and care for your teeth—" That is, the teacher does not stress illness from carious teeth.

The teacher next deals with how to preserve the teeth, under the following headings:—

1. *Foods which help to preserve the teeth.*—He says that one reason why some foods are eaten is that they help to build up the teeth. Such foods are those containing *calcium* and *Vitamin D*. At this stage in the course this is explained mostly by examples, that is, by saying that milk, oranges, liver, fish liver oils, eggs, cheese, all help to preserve the teeth, and so does being out of doors in the sunlight. This work is amplified later in the course.

2. *Preserving the teeth by cleaning.*—Here the teacher and class discuss when, how, and why. This is to some extent revision of facts learnt in the junior school. The important point to stress is the cleaning of the teeth last thing at night, and *eating nothing afterwards*.

Bacteria.—The discussion of reasons for teeth cleaning makes a useful point for introducing a general understanding about bacteria. It should be emphasised that *bacteria* is the name given to a very small but prolific single cell form of vegetable life. Bacteria are a *class*, just as are school

children, or policemen or carters, and as there are different kinds of schoolchildren, or carters, so, similarly, there are different kinds of bacteria. There are two important shaped bacteria, the rod-shaped ones, called *bacilli*, and the round-shaped ones, called *cocci*. Bacteria are able to multiply by division very rapidly if there is plenty of food and moisture about. A division into two every twenty minutes, in favourable circumstances, has been observed. This means that the one would have become eight at the end of an hour; and if the food supply remained, at the end of about eight hours the one would have become, at this rate, some sixteen millions.

Not all bacteria are harmful. It is bacterial action that removes most organic refuse for us, a useful service actually. Bacteria are used in tanning; in making cheese, to "ripen" it; and in many other industries.

Bacteria reckoned harmful to man are those which, in living in him as their host, each give out a specific poison called *toxin*, which causes illness. Examples of these illnesses are measles, diphtheria, influenza, scarlet fever, the common cold. These will be considered later in the course.

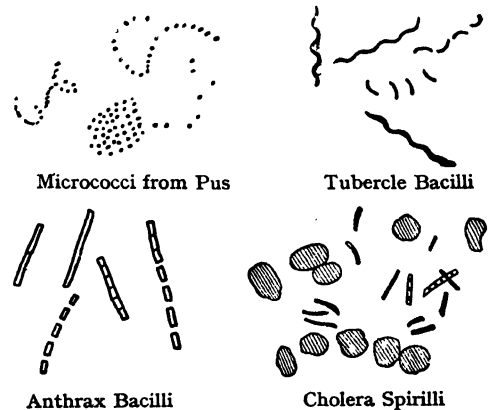

TYPES OF BACTERIA

Bacteria are so small that they can be seen only microscopically. Many do useful work, others do not affect man, while others again produce specific diseases. The characteristic smell of the sea shore or of damp earth after rain is partly due to bacterial action.

Teeth and bacteria.—One place where harmful bacteria find a ready supply of food in suitable conditions is the film of food left on the surface of teeth; and soft, pulpy foods such as biscuits, and sweet, fatty foods such as chocolate, are specially favourable. This is the reason for cleaning the teeth last thing at night, and eating nothing afterwards. In the day, since we are talking, we do not allow food round the teeth to become stagnant, but this happens during sleep. The bacteria, in taking in the food and in dividing, produce acid poisons which eat into the calcium or lime of the enamel, and through the small openings so made bacteria of decay can enter.

Cleanliness.—This should be the next section of the work. It arises naturally from the consideration of teeth cleaning. The teacher suggests the importance of cleanliness, not only for teeth, but for the body generally. The introduction of the "*Health and Cleanliness*" Text Book for Teachers, by Muir and Green, gives a realistic approach

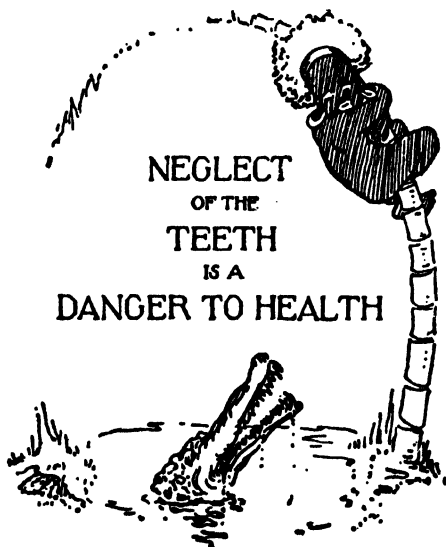

This head piece of a bookmark is reproduced by courtesy of the Bermondsey Borough Council. It is likely particularly to appeal to adolescent boys.

for this matter to children. The teacher can begin with skin structure. The functions of the skin can be supplied, to some extent, by the children. These are touch, proof against water, protection from harm, riddance of surplus moisture, and heat regulation. This last function should not be dealt with in any detail here. It is too difficult and should be dealt with in more detail in the second year.

Soap and dirt.—The children discuss the action of soap in removing dirt. They consider the differences between hard and soft water, and where each comes from. They are asked the question why some water makes a curd instead of lathering. This can be demonstrated by shaking up half a teaspoonful of soap solution with (1) soft water, and (2) hard water, and contrasting the amount of lather formed. The difference between hot and cold water in dissolving the soap and forming the lather can also be shown in this way, as a second experiment.

Hard soap can be made by adding a teaspoonful of "dripping" fat to boiling water with a quarter of an ounce of sodium hydroxide (NaOH). If, after stirring, salt is added, the soap will rise to the top. Soft soap can be made by using potassium hydroxide instead, but here no salting out is possible.

Actual teaching on cleanliness should be kept practical and specific—the importance of clean bodies and clothes, of clean nails and of regular nail cutting, of hair brushing, and of hand washing before meals, and, hence, of a spruce appearance. The psychological values of cleanliness attract at this age, and should be dealt with.

The children will have heard many of the facts about cleanliness before, but now they are learning the reasons for it, and this more grown-up view should be made to appeal to them.

Excretion.—It should be made plain to the class, towards the end of the year's work, that only some of the main functions

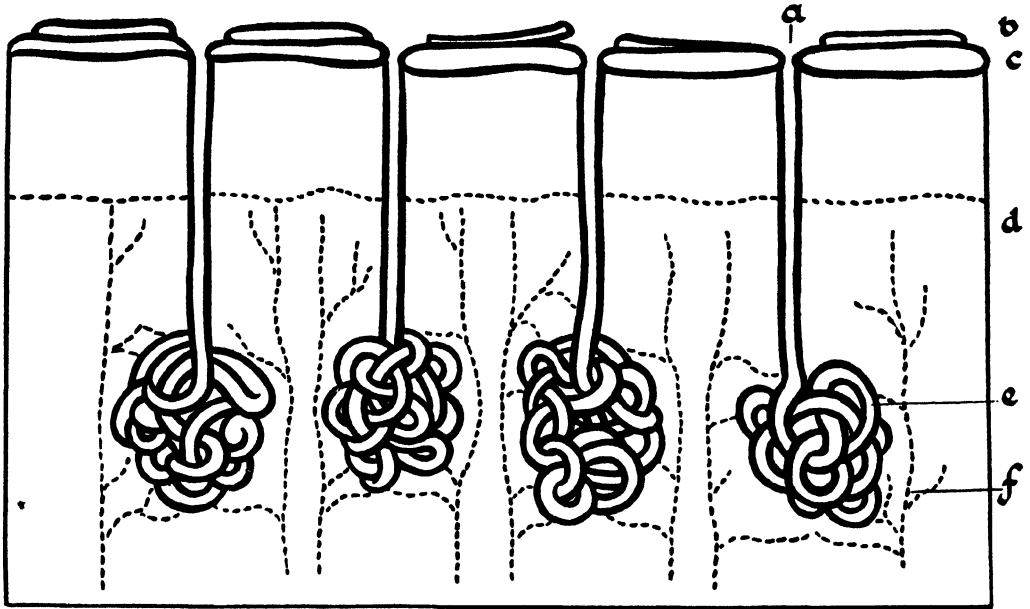

DIAGRAM OF A SECTION OF SKIN

a. Sweat Pore.
d. Inner Layer.

b. Flakes of Dead Skin.
e. Coiled Sweat Gland.

c. Outer Layer of Hard Skin.
f. Veins and Arteries.

and needs of the body have been dealt with. It is to be noted that excretion has not been stressed with first year pupils. It is not a function that needs stressing greatly for children, and is dealt with, as far as is necessary, in Years II and III, when the teacher will have got to know the class

thoroughly, and will have built up a satisfactory attitude towards body functions.

If the children, in enumerating the functions of animals, include reproduction, it is suggested that the teacher should treat the matter, with regard to man, briefly and in a natural manner.

SECOND YEAR'S COURSE FOR PUPILS AGED TWELVE PLUS TO THIRTEEN PLUS

HEALTH EDUCATION AND THE FAMILY—HOW THE FAMILY PRO- VIDES FOR BODILY NEEDS

AN attempt should be made, throughout the year, to keep in mind the family point of view, in treating such topics as (1) food, (2) clothing, (3) sleep and rest,

(4) clean conditions, (5) care of ears and eyes.

The family and food requirements.—The first lessons should deal with the *digestive system* and should teach how the body deals with different food stuffs (1) by breaking up the food and changing it from a solid to a

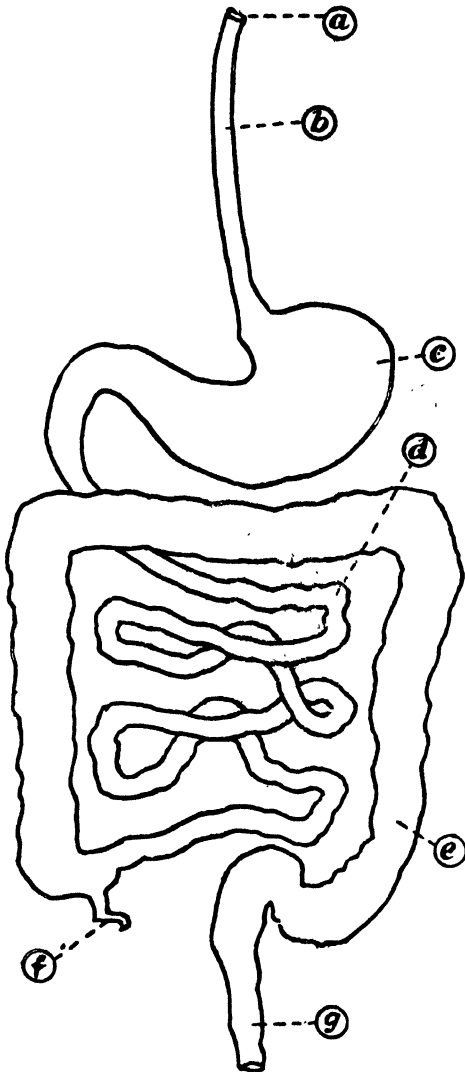

THE DIGESTIVE SYSTEM

- | | |
|---------------------|---------------------|
| a. Mouth. | b. Gullet. |
| c. Stomach. | d. Small intestine. |
| e. Large intestine. | f. Appendix. |
| g. Rectum. | |

liquid form by the teeth and stomach and first part of the small intestine; (2) by the assimilation of digested food material through the intestine wall into the blood and lymph streams; and (3) by the elimination of waste.

(These same processes in the rabbit will probably be dealt with in the biology course, when a rabbit will be dissected.)

This work allows for a revision and amplification of the first year work on foodstuffs, that is, the uses of the various types of food to the body, proteins, carbo-hydrates, etc.; the different foods in which these foodstuffs are found.

Vitamins.—These are now dealt with in more detail, that is, specifically. The facts to make clear may be summarised as: (1) *Vitamins*, unlike bulk foods, are *needed only in minute quantities*. A walnut-sized lump of Vitamin B would be sufficient to supply

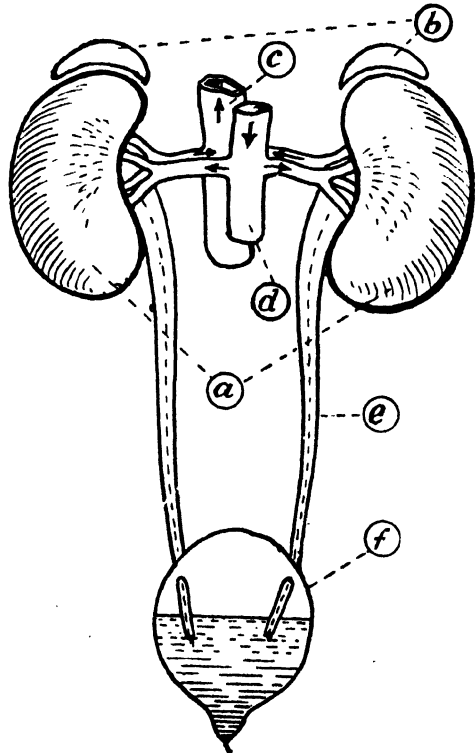

THE KIDNEYS

- | | |
|-------------|--------------------|
| a. Kidneys. | b. Adrenal glands. |
| c. Artery. | d. Vein. |
| e. Ureter. | f. Bladder. |

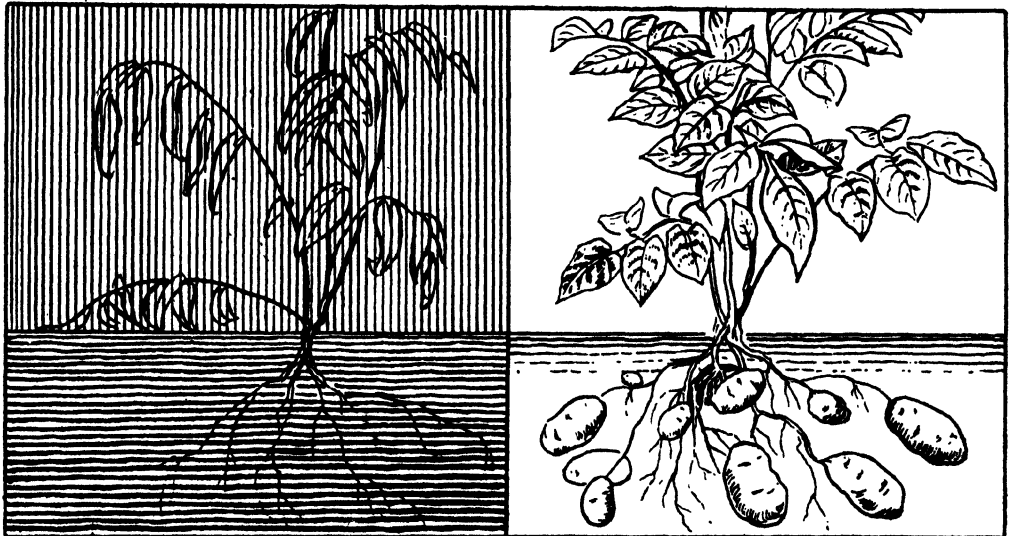
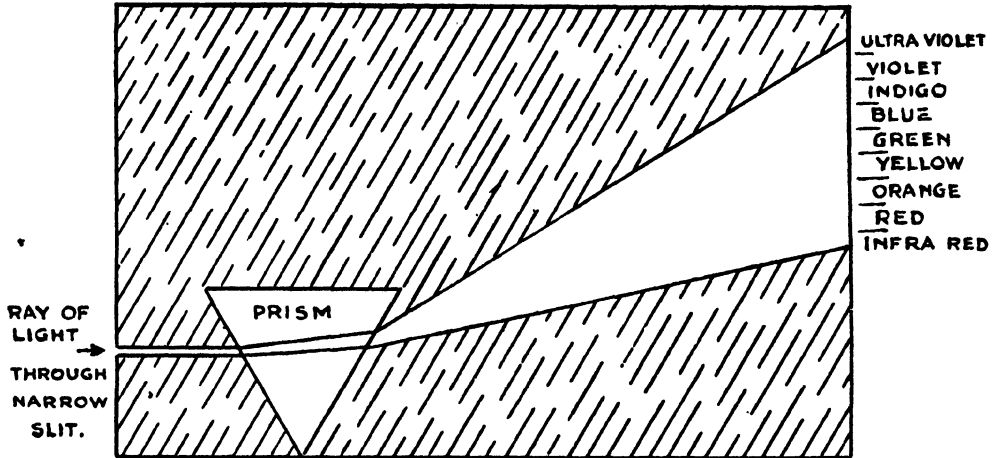
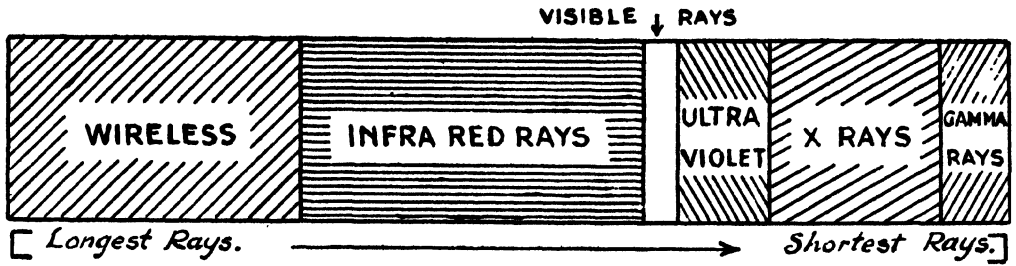

DIAGRAM OF SPECTRUM; DIAGRAM OF SPECTRUM AND PRISM; THE VALUE OF SUNLIGHT

a man for his whole life, if it could be obtained and distributed in very small quantities in some of his daily foods; (2) *vitamins* come primarily from vegetable material. Thus Vitamin A and Vitamin D are found in green leaves (not in yellow inner ones) and their presence in butter and milk is merely because the cows have eaten grass. Hence summer milk and its derivatives, and New Zealand cream and butter, are especially valuable as sources of supply.

Vitamin B₁ is associated with wheat germ and yeast products, and Vitamin B₂ with yeast products and lean meat and liver.

Vitamin C is found specially in acid fruits such as lemons, oranges, tomatoes and again in green vegetables.

Here the class will find the conception of "food chains" useful. For Vitamin A, for example, grass—cow—man; or, for Vitamin A and D in cod-liver and halibut-liver oil, green plankton—small crustacea—small fish—larger fish—cod or halibut—man

(3) The effect of *partial shortage* as well as complete shortage, because this is the more usual state of affairs in this country. (See detailed lesson on page 417.)

Vitamin D and sunlight.—This is the next topic for the teacher to take up. He explains that the relation of Vitamin D to sunlight is direct and exceptional, in that if there is *ergosterol* in the food fats (it occurs in mutton and beef fats), the unseen ultra-violet rays of the sun's light can change the ergosterol under the skin into Vitamin D. It should be stressed, however, that it is the *light rays*, not the dark heat rays at the red end of the spectrum, which do this. Hence early morning sun on the uncovered skin is the usual method of dosage, and too much sun's heat, as in sun-bathing, can be harmful. Lack of Vitamin D produces rickets, a deficiency disease rapidly disappearing in this country.

The following table on vitamins will be useful for class use:—

Chief Vitamins	Chief foods supplying them	Values
A and D	<i>A only:</i> Tomato; carrot; cabbage <i>D only:</i> Eggs <i>A and D:</i> Cod liver oil; halibut liver oil; milk; butter	Growth; hard teeth and bones
B ₁ and B ₂	Yeast extract; outer husks of wheat; oats; barley, rice; green vegetables, e.g., lettuce, cabbage; liver; egg; milk; lean meat (B ₂)	Absence of B ₁ causes beri-beri; absence of B ₂ causes pellagra
C	Acid fruits, e.g., pineapple, tomato, orange, lemon, grapefruit; cabbage	Raises body resistance and prevents infections

The Italian proverb, "Where the sun is seen, the doctor is unseen," makes a useful starting point round which a general lesson on the values of the sun can be planned. The values to be dealt with are as follows:—(1) The making of Vitamin D, as mentioned above; (2) the making of starch in green leaves, on the energy of which all life subsists, either directly or indirectly—directly in grass-eating animals such as the cow or the rabbit; indirectly in flesh-eating animals, such as the fox or man, who live on other vegetable-eating animals; (3) the warming and drying of the air; (4) the killing by its light of harmful bacteria, a value made use of when infected bedding is hung out in strong sunlight to disinfect it.

Diagrams on page 381.—The diagram of a spectrum shows the relation of visible light rays to other longer and shorter wavelengths.

The diagram of a spectrum and prism shows how a ray of white light which passes through a narrow slit can be split up by a glass prism into the component colours which

make it up. It is the *ultra violet* rays which, in falling on the bare skin, can change ergosterol stored superficially into Vitamin D. The heat of the sun's rays is associated with the other infra-red end of the spectrum. These rays can cause sunburn, and too prolonged exposure to them is definitely harmful.

The diagrams of a potato plant show the value of sunlight. That on the left has been grown in darkness. The growth is straggly; no starch has been made in the leaves and so none has been stored. The plant on the right has been grown in the light. The leaves have made starch, which is stored in the tubers.

The dietary needs of members of the family.—Now that the children have considered all the factors in a diet, they should be ready to deal with the dietary needs of different members of the family. They should consider the muscular and the sedentary worker, the children and the baby, and also why different foods, such as meat, eggs, beans, and oatmeal, are useful. This work, in the case of girls, should correlate with the cookery and housecraft course.

As practical work the children could make posters of grouped foods for a meal for a man digging all day, for a clerk, or for a schoolchild's sandwich lunch. Alternatively, they could make out a week's menus on the same plan.

Beverages.—The chief beverage to be considered is *milk*. The question of the daily school supply of milk should be considered by way of introduction. The children should supply the fact that there is fat in the cream of milk, and the teacher should add that there is also good protein, milk-sugar (not very sweet tasting), mineral salts, and Vitamins A, B, D and a certain amount of C. The teacher from this deduces from the class the place of milk in the diet of various members of the family.

The class should supply the names of different kinds of milk, and the reasons for its being served in bottles, or for its Pasteurisation. The teacher should discuss how milk can be kept clean in the cowshed and in transit to the customer. Pictures, films or slides are invaluable here. The teacher must, also emphasise the need for healthy cows. By way of practical, expressional activity the class could make up slogans and posters advocating milk. The most valuable activity of all would be to visit a farm where clean milk is

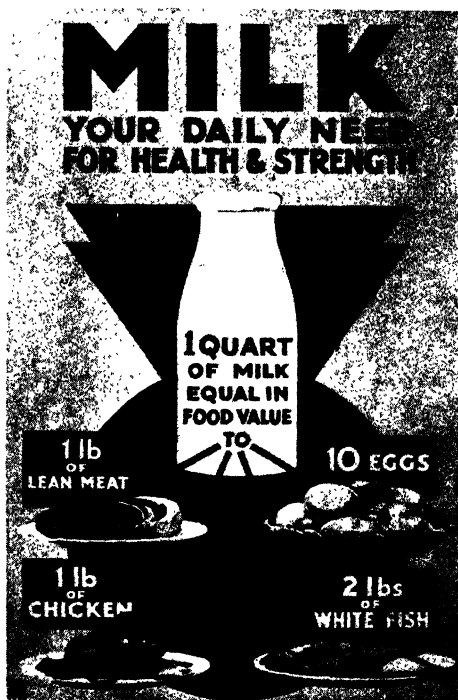

[Reproduced by courtesy of the National Milk Publicity Council]

The poster relates beverages to foods. Used at the beginning of a lesson it arouses curiosity; used towards the end of a lesson it enlivens revision.

produced, if it could be arranged.

Tea, coffee and cocoa should be dealt with briefly here. The teacher should consider, at great length, the importance of a clean water supply to the whole family.

Alcohol is not dealt with until the third year, when it is treated as part of the wider problem of temperance and restraint.

How the family provides for heat balance.—

This is the next section of the work with which the teacher should deal. Enough ground has now been covered with regard to fuel foods and blood circulation to allow of the question of heat balance being attacked by the class. The children should understand that the source of heat and energy is food (mainly the fuel foods, sugars and starches). They must know that this solid food is digested and synthesised into animal sugar glucose, which is taken round to the muscles by the blood. Here the sugar is burnt up, and movement of the muscle and the evolution of heat result. (Here the teacher should use the analogy of petrol burnt in the car engine, resulting in the car moving and the engine getting hot to the touch.)

Next the children should supply examples of conditions when one feels too hot (green-houses or laundry atmospheres), or too cold (dank cellar atmospheres). They realise that one does not feel one's best for work in either of these extreme conditions. The children should be able to find the average temperature of the classroom or of the air outside (a range from 50° to 60° Fahrenheit) and should know that the temperature of the body averages 98.4° Fahrenheit. From these two facts they should draw the conclusion that the body is always warmer than its surroundings and tends to lose heat to them constantly.

The question of bodies in general losing heat will probably have been dealt with already in the science course, and the amount of experiment and explanation given here should vary with this. In the same way the amount of time spent on considering the ways in which heat passes by conduction, convection and radiation will be governed by the science syllabus.

An immediate and practical illustration of making heat and at the same time wanting to get rid of some of it could be given by taking a "relief drill" in the classroom with the windows and door open.

Ventilation.—This should next be considered as one aspect of maintaining heat

balance. The class should learn that the body loses five-sixths of its heat from the skin, partly by making convection currents by heating the layer of air next to the skin, and partly by evaporation, that is by the drying-up of perspiration on the skin. The teacher should put a little scent or spirit on the hands of one or two of the children, asking them to report to the class what it feels like. They should state that it feels cold and that it evaporates very quickly. They should be made to realise that cold feeling is the result of the evaporation. As a further illustration, the teacher might refer to the spilling of hot water on a stocking, and how the patch soon feels cold because the water is drying up and cooling at the same time.

The teacher and class then consider how a crowd of people in a classroom, cinema, public meeting hall, or bus tend to heat the air in it, both because they heat the air with their bodies and because they breathe out hotter air than they take in. (The children could breathe on their hands and notice whether their hands feel warmer. The teacher might also remind them of the busman's habit of doing this in cold weather.)

The following conclusion should then be explicitly stated, namely, that one main reason for opening windows is in order that cool, stimulating air may be breathed in so that the body loses a certain amount of surplus heat, in order to be neither too hot nor too cold.

The teacher should then deal more fully with *moisture* and *movement* in the atmosphere. He asks what happens to the windows and other cold, shiny surfaces in a hot, stuffy, badly ventilated room, expecting the answer that moisture is condensed and runs down, because the air in the room is too moist. He inquires what is the best kind of day for drying clothes. This time the answer should be, "A day when the air is dry and there is a wind to carry away the moisture as it evaporates from the ground." He makes sure that the children realise that a bad day for drying clothes is

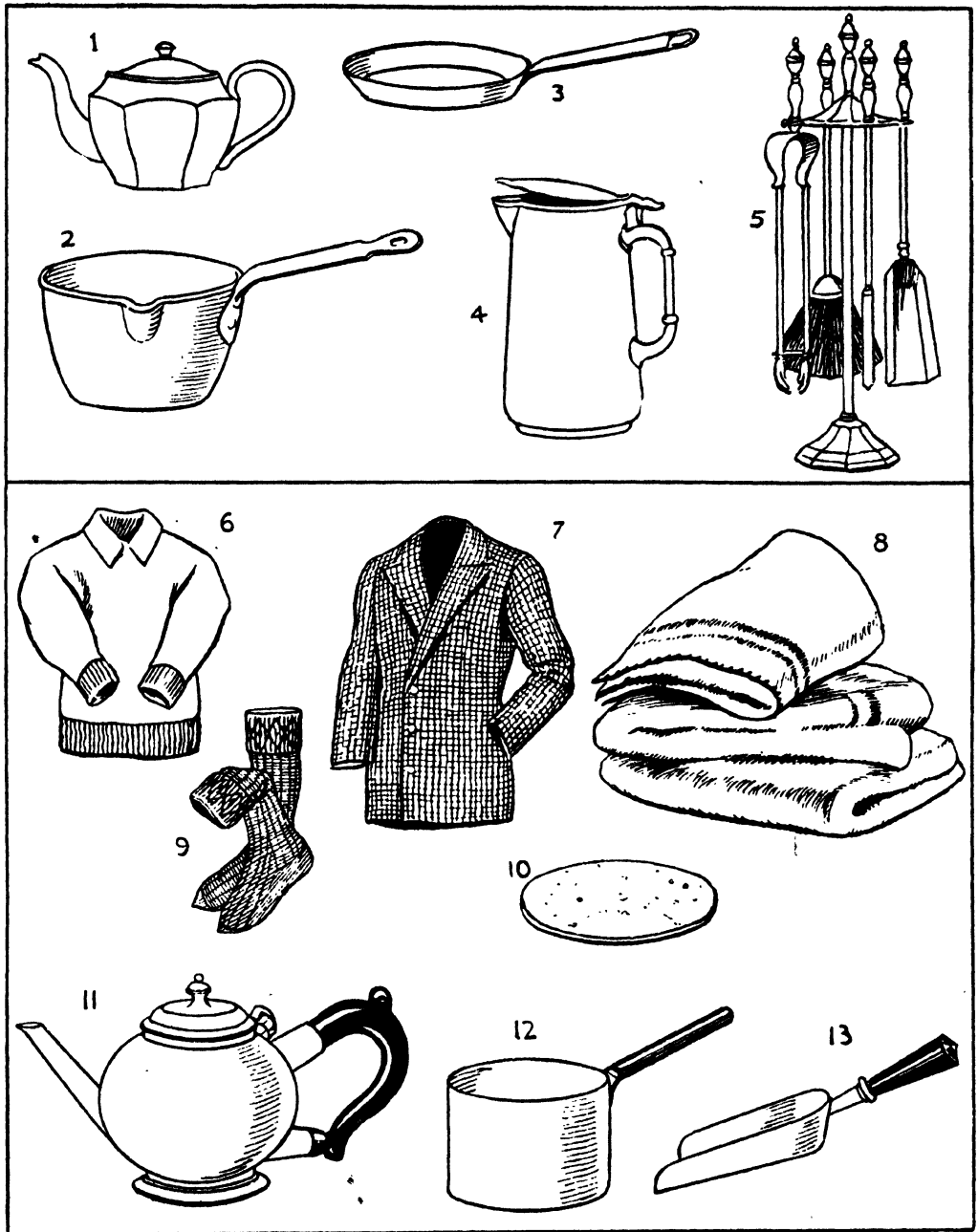

CONDUCTORS OF HEAT

GOOD CONDUCTORS: 1. Silver tea pot. 2. Aluminium saucepan. 3. Iron frying pan. 4. Metal hot water jug. 5. Brass fire irons.

BAD CONDUCTORS: 6. Woollen jersey. 7. Tweed jacket. 8. Blankets. 9. Socks. 10. Cork mat. 11. Tea pot (ebonite handle). 12. Saucepan (wooden handle). 13. Shovel (wooden handle).

one when the air is moist and dank and still, that is, when the moisture-laden air does not travel on so that less saturated air may take its place. The teacher then uses the above to make clear to the class that, in the same way, if the air in a crowded classroom is too moist and too still, (1) perspiration will not dry off the skin quickly, and (2) heated air will stay round the skin, and, everyone in the room will feel dull, listless and sleepy.

Flugge's experiments.—Flugge's experiments with a cabinet full of hot, moist, still air should be drawn on the board and the class should be asked to decide which man would feel fit and which sleepy. In the first experiment a man is entirely within the cabinet but for his head. In the second experiment a man sits outside the cabinet, but breathes, by means of a tube, the air of the cabinet. The children will probably state that it is the man in the second experiment who feels sleepy and unfit, whereas it is actually the man whose body is in the cabinet who is in this condition. The conclusion to be drawn from the experiments should be made explicit, namely, that hot, moist, still air on the skin is unhealthy.

The problem of clothing for the family.—The wearing of clothing is another way of regulating heat balance. In this country it is generally a matter of keeping heat in and the body warm, but clothing may be used to prevent the skin's being burnt by the heat of the sun.

In order to link the knowledge acquired in science with the problem of clothing, the class should feel a number of things near at hand, such as a cloth, desk-top, ink-pot, wall, window-pane. All the things in the room are at room temperature, about 60° Fahrenheit, while all the people in the room are much warmer, about 98·4° Fahrenheit. Yet some of the things feel colder than others. These are *good conductors of heat* because they have quickly taken heat from the hand put upon them. The class should consider tea-pot handles, and say which handle is the hotter to hold when there is hot tea in the pot—a metal or a china one. The metal is a better conductor of heat than is china, so the metal, in this case, feels the hotter, because it has drawn the heat from the very hot pot and contents.

The teacher's next task is to get the class to realise that the problem of clothing is largely one of conduction of heat, clothes sometimes serving to keep in the heat of the

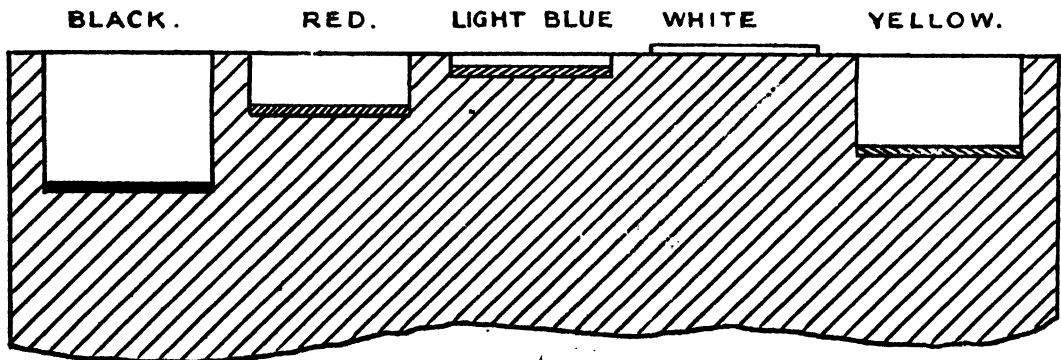

COLOURS ON SNOW
BENJAMIN FRANKLIN'S EXPERIMENT

Pieces of coloured cloth are placed upon snow and exposed to the sun. The black cloth absorbs most heat and sinks in most deeply, whereas white absorbs least heat and does not sink at all.

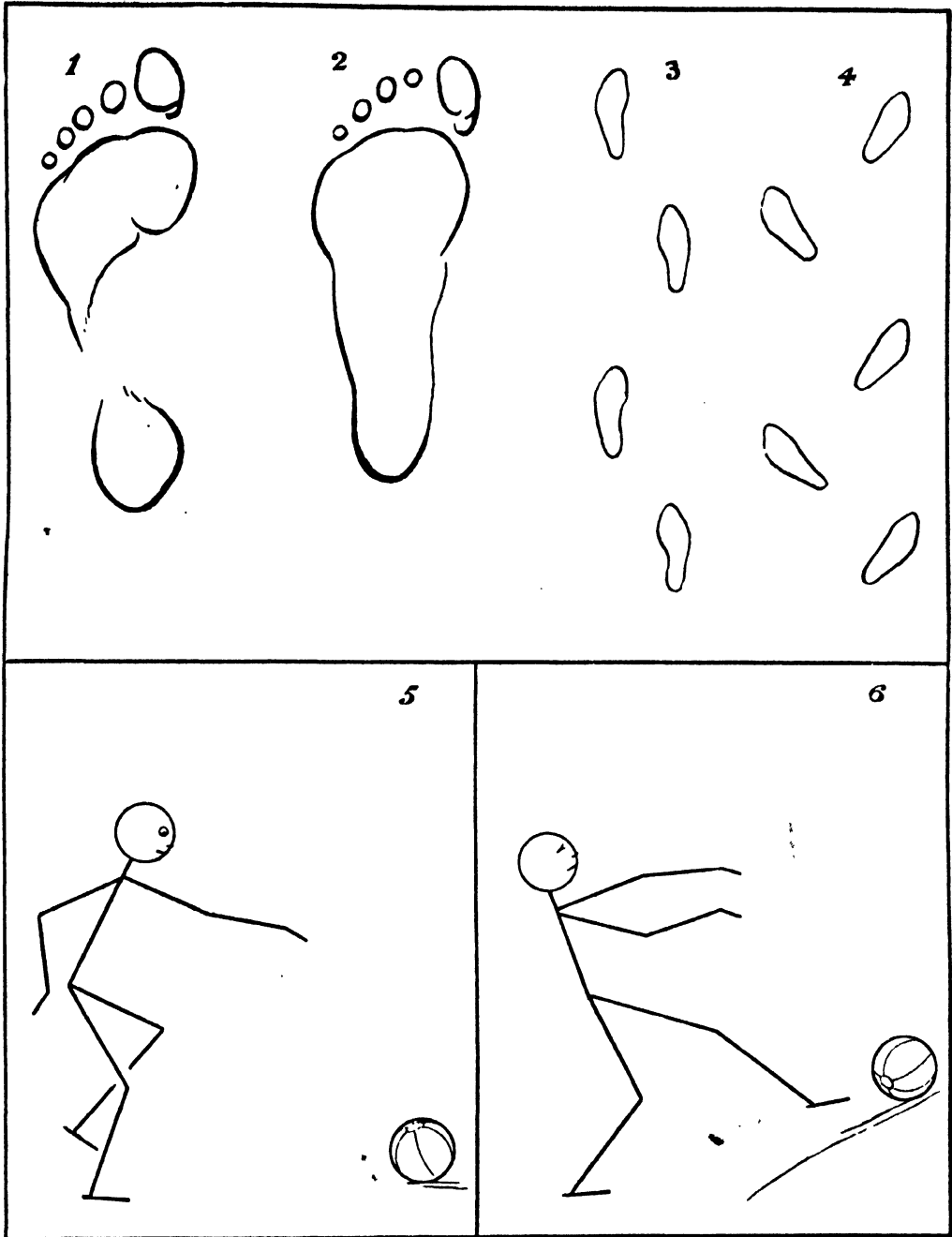

1. IMPRESSION OF THE SOLE OF A NORMAL FOOT. 2. IMPRESSION OF THE SOLE OF A FLAT FOOT.
 3. NORMAL-FOOTED WALK. 4. FLAT-FOOTED WALK. (This is uneconomical because the flat-footed person has to take more steps to cover a given distance than a normal-footed person.) 5 AND 6 SHOW AN EXAMPLE OF ONE VOLUNTARY ACTION. THE BOY SEES THE FOOTBALL AND DECIDES TO KICK IT.

body, and sometimes serving to keep out heat from the body. He gets the class to name materials used for clothing. He selects those which serve best to show the contrast between those which feel warm to the touch, such as wool, tweed, silk, and those which feel colder, like linen, calico, mackintosh. Using these examples, he deduces which kinds of material are wanted in cold and which in hotter weather, and why.

The children then consider the effect of colour in materials in the resisting of heat, reaching the conclusion that dark coloured materials are warmer in sunshine than are lighter coloured, because the dark ones absorb the heat rays of the sun, while the white and lighter coloured ones reflect the rays.

Cotton and woollen materials.—The relative powers of absorbing water of cotton and wool can be tested practically and inferences drawn. (See detailed lesson on page 420.) From this the children decide which materials are best for outside wear and which for wearing next to the skin. The teacher should tell the class that cellular cotton is now considered to be preferable to wool for wear next the skin, because, while it holds air in and thus is a bad conductor of heat, it dries up when damp from perspiration more quickly than wool, though not so quickly as to chill the body. Owing to these two properties of cellular cotton, the skin is kept warm and dry, rather than, as in the case of wool, warm and damp. This is a great advantage since such continual dampness is enervating and predisposing to rheumatism.

Clothing for the family.—The next topic to consider is the need of clothing of different kinds for the various members of the family according to their work and play. The reasons should be collected for the avoidance of tight clothing, such as tight hats, collars, belts, stockings and shoes, and garters and elastics round waist and thigh. Attention should be

drawn to the need for shoes to fit firmly round the heel and instep and to give plenty of room for the toes, short shoes producing bunions and badly fitting shoes, corns. The teacher should also stress the need for keeping shoes watertight. The importance of walking with the feet pointing straight forward and the avoidance of a flat-footed walk with feet turned out should be revised. Some mention should be made of avoiding chilblains by diet and also of avoiding ingrowing toe-nails by horizontal and concave cutting, instead of the convex cutting as used for finger-nails.

The need for removing all day-clothes on going to bed, and of not wearing too many night-clothes, should be stressed. Discussion of the importance of clean clothes and the regular changing of underclothes will lead to a further consideration of cleanliness in general.

Cleanliness.—The skin and kidneys should be briefly dealt with as excretory organs. There should be a discussion on the effects of uncleanness of skin and clothing on (1) social acceptance, (2) personal health, and (3) family and community health. The class should contribute as much of the material as possible and the teacher should add to this and sum up.

The value of sunlight on the skin and the values of swimming, camping and other outdoor activities could profitably be discussed here, as well as the damage to property and health caused by smoke, and how the family can help here. This will revise facts already learnt by fresh applications of them to practical family life.

WAYS IN WHICH MESSAGES ARE SENT ROUND THE BODY

This is the next main section of the work to be treated.

Messages conveyed by the nervous system are dealt with first. The brain, spinal cord, and nerv^s arrangement must be considered.

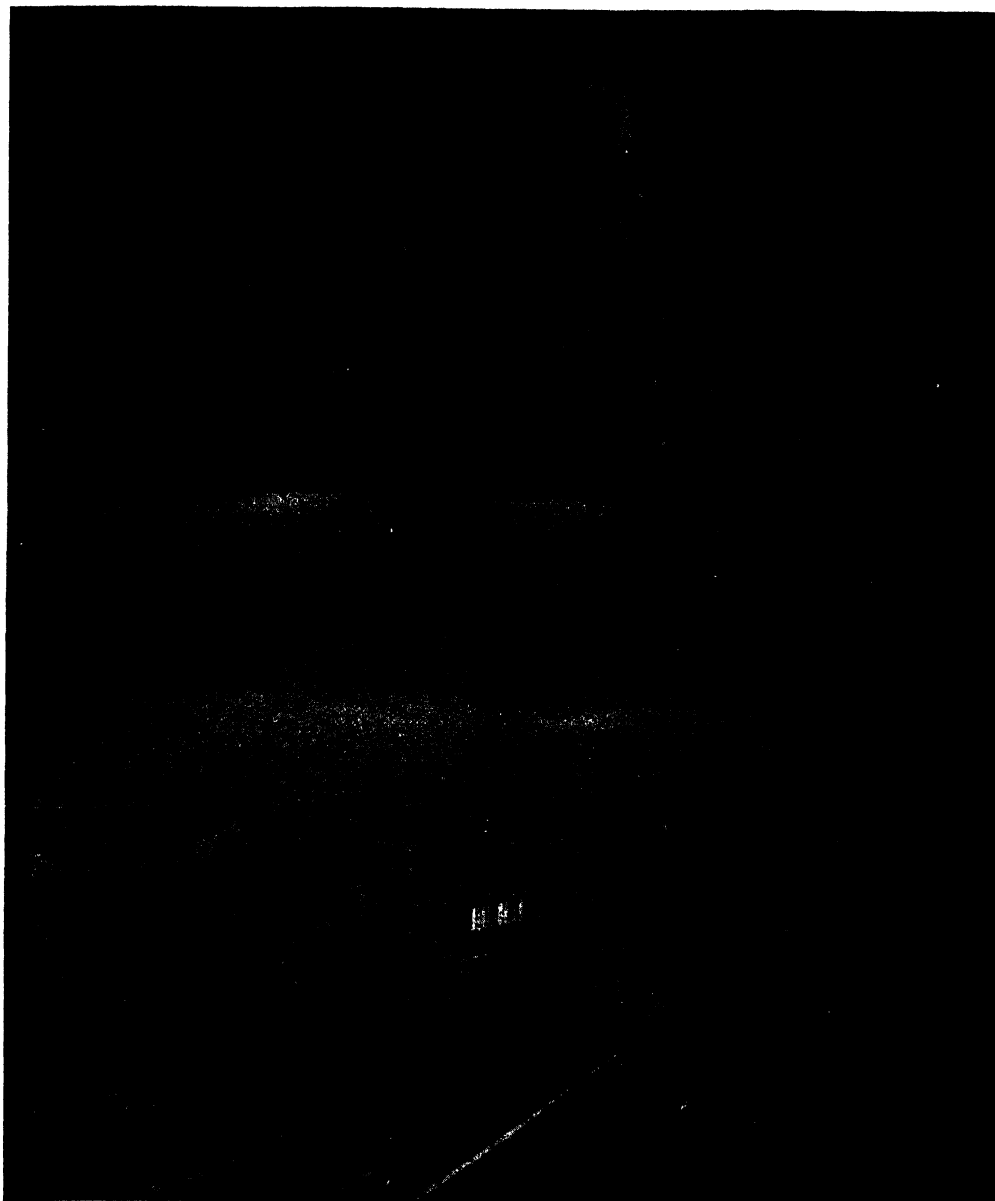

SMOKE OVER EDINBURGH

[Photo: Capt. A. G. Buckham.]

Smoke, such as this over a city, cuts off sunlight and the beneficial ultra violet rays. (See page 381.) It leaves deposits of carbon and chemicals on buildings and clothing. It prevents green vegetation from flourishing and it tends to make the climate less warm so that there is less wish to spend leisure time out of doors. Smoke also induces fog.

Sensory impressions followed by motor responses should be worked out from a number of practical examples, partly supplied

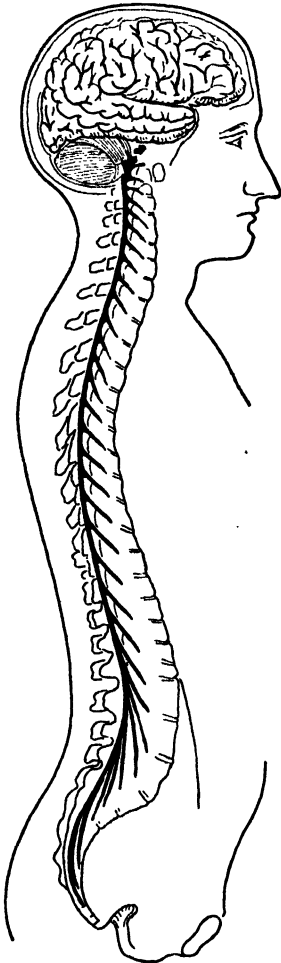

THE BRAIN AND SPINAL CORD

View of the brain and spinal cord from one side, showing the general arrangements of the parts and their position in the body. The spinal nerves have been cut short and are placed opposite their exits from the vertebral canal.

about to fall and stretches out to catch it, or, a woman recognises an acquaintance in the street and stops to wait for her,

or, a forward sees an opponent in the game bearing down upon him and passes the ball.

by the teacher, but mostly by the class, the teacher interpreting the events. It facilitates the work if the teacher deals with sensory responses first and if he postpones discussion of reflex responses, even if some are suggested by the class, until later.

Sensory impressions.

—The teacher should consider easy sense impressions in order, as follows:—(1) Hearing impressions; a person hears a tram and runs to catch it, or, a child hears the school bell and goes to his classroom; (2) impressions of smell; one smells roast beef and says, "It must be nearly dinner time;" (3) sight impressions; a boy sees a book

Voluntary actions.—The above examples are illustrations of voluntary, or willed actions (often termed volitional actions). The children need the opportunity of providing further examples. They should give the whole example of the sensory impression of its consequent voluntary action, say, "He saw a butterfly and chased it." They should then state which is the sensory impression—in this case, "He saw a butterfly"—and which is the voluntary action—chasing.

After a number of examples have been fully discussed the class should be clear how a willed action takes place. There is no need here to discuss the part that images (in the place of actual perceptions) play in the arousing of voluntary actions.

Involuntary actions.—The teacher should next deal with those types of actions which are automatic responses to a stimulus and are not thought out. These are of two types, (1) reflex actions and (2) actions due to the sympathetic nervous system.

1. *Reflex actions.*—This portion of the work should begin with the class experimenting individually with knee jerks. The knee is crossed and a sharp tap on the front of the lower leg, just below the knee cap, should produce an unexpected, involuntary jerking up of the lower leg at the knee. The teacher should point out that this is not a willed action. Sometimes it happens and sometimes it does not. With the help of a blackboard diagram, he explains that this is an example of a *spinal reflex arc of action*. The sharp touch sensation passes up the leg nerves to the spinal cord and from there the impulse or message comes back to the muscles of the front of the leg to contract and jerk the leg.

The class should contribute other examples of spinal reflexes, the teacher showing that

many of these are inborn and protective, as in springing away from a pin prick; dropping anything hot which has been picked up by mistake; turning the head at a noise behind, blinking at a bright light. Other inborn reflexes are sneezing, coughing, scratching when anything tickles.

The teacher then goes on to show how many of these involuntary actions are learnt, as in the reflex series of actions, in swimming, bicycling, driving a car, knitting, sewing, writing. The class should be asked to supply further examples.

cry. He has inhibited the reflex. At this point the class will be able to supply examples of inhibited reflexes such as coughing held back while a handkerchief is produced, or holding in a sneeze.

The teacher should make reference to social or "manners" inhibitions, such as holding back and not snatching food, or not saying the first thing one thinks in a new situation. Personal remarks and comments about clothes come under this head of actions to be inhibited.

Games make frequent calls upon individuals to inhibit action. Examples are not throwing

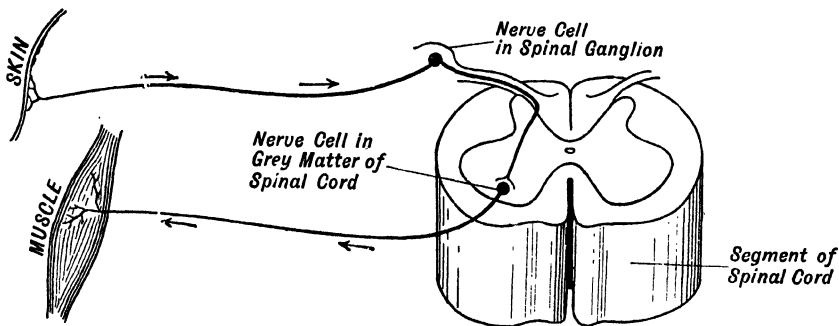

(Reproduced from J. Argyll Campbell's *Readable Physiology and Hygiene* by permission of Messrs. George Bell & Sons, Ltd.)

DIAGRAM OF FRONT ASPECT OF A SECTION OF THE SPINAL CORD SHOWING A REFLEX ARC

The arrows running parallel with the fibres indicate the path followed by the nervous impulses in reflex action. Note that the sensory, or afferent, nerve from the skin enters a spinal ganglion at the posterior aspect of the spinal cord, whereas the motor, or efferent, nerve to the muscle leaves the spinal cord at the anterior aspect.

Inhibited action.—The teacher explains that the process of growing up is partly one of learning fresh reflexes and partly one of preventing certain reflexes from happening. The learning of new reflexes has been discussed, so the teacher should now deal with the process of inhibiting or refraining from reflex action. He should argue somewhat as follows:—

A baby, when hurt or when it cannot immediately have what it wants, cries reflexly, and such a reaction is expected from the baby. As a child grows up he may, under similar circumstances, feel like crying, but he usually can and does manage not to

or hitting as hard as one can in hockey or netball, but just the right amount and to the right team.

2. *Actions due to the sympathetic nervous system.*—The teacher next explains that, besides the nerves that have already been discussed as being nerves by which we can control the action of our body, there is the sympathetic nervous system. This system of nerves is also connected up with the spinal cord and the brain, and keeps going our digestion, breathing, heart-beating, and many other processes in the body, day and night, without our being aware of their action at all, under ordinary circumstances.

The nervous system and three types of action.—The teacher and class then sum up, somewhat as follows. It is thus seen that man, through the working of his nervous system, is capable of three types of actions:

1. Voluntary actions when the action is entirely under the mental control of the individual, who has made a deliberate decision to act in this particular way.

2. Reflex actions which are actions only partially under the individual's control.

3. Actions due to the sympathetic nervous system; actions of which the individual, under normal conditions, is not aware, and which cannot be said to be under his control in any degree. (Breathing is to some extent an exception.)

Family care of the sight.—The teacher refers again to the way in which sensory impressions reach the body, by the eyes, ears, nose, palate, skin, muscles, and touch centres which include pressure, temperature and pain-spots. He should stress how important it is that these sense organs should be protected. This leads to the consideration of how the family safeguards and cares for the sight and hearing of its members. The teacher would probably deal with care of the eyes first.

The structure of the eye.—The teacher should begin by considering the structure of the eye. His best approach is to compare the eye to its copy, the camera. The teacher might also dissect a cow's eye, if he considers the feeling of the class could justify this, and if he himself is prepared

to undertake the demonstrations, group by group. (If, on such occasions, the teacher leaves it optional for the children to come to look, some children come immediately; and gradually, because curiosity or the crowd feeling is strong, the more timid ones venture. This situation is possibly more likely to occur in girls' classes.)

As a preliminary, the teacher should, with a convex magnifying glass (an ordinary reading glass), a candle and a sheet of white cardboard, show the class, in the dark for preference, how the glass held between the candle and the

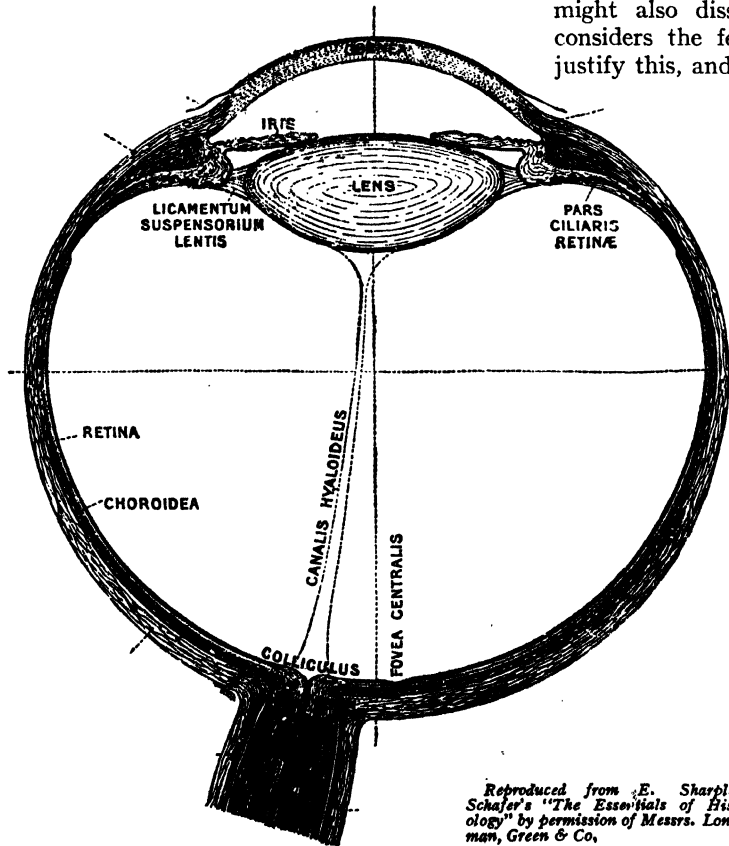

Reproduced from E. Sharpley Schaefer's "The Essentials of Histology" by permission of Messrs. Longman, Green & Co.

DIAGRAM OF A HORIZONTAL SECTION THROUGH THE RIGHT EYE OF A MAN

cardboard screen makes an inverted image of the candle on the cardboard. An electric light bulb in a table lamp sometimes pleases the children more than the candle. The teacher then explains that in the same way the lens of the eyeball makes an inverted image of things looked at, say the candle, on the *retina* (which is the name for the "eye" end of the optic nerve), and the brain and mind interpret what is

eye, when, as is said, we focus them on a particular point, we get this clear image. They should then be told that people with some kinds of defective vision get only the blurred image, and that glasses are then used to help the eyes to focus more sharply. The practical demonstration may, in a classroom, have to be done with a group of children at a time, but it is well worth while to arrange it.

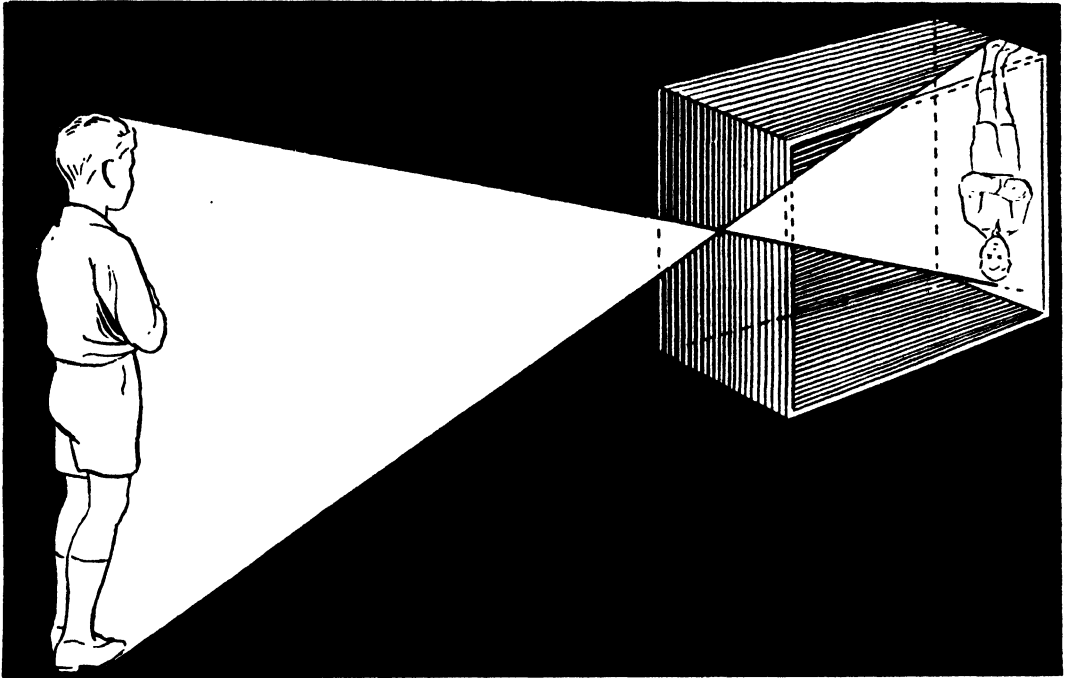

DIAGRAM SHOWING HOW INVERTED IMAGES ARE FORMED ON THE RETINA OF THE EYE

The diagram shows how a picture is formed upside-down on the film of a camera. In the same way, an even smaller inverted image, which is understood by the brain, is formed on the retina of the eye.

seen, recalling old associations or registering new ones.

The amount of time spent on this work will be governed by the amount done in the physics section of science.

The children will see that the candle's image can be made more sharp and clear cut, or less so, according to the relative position of the object and screen. In this way they will be prepared for the fact that in the

Other practical work that the class can do is (1) find the blind spot in the retina, by making a cross and a circle on a card and

+

○

looking at one with one eye closed. Hold the paper 18 in. from your eyes. Shut the right eye and look steadily at the circle with the left eye. As the page is moved gradually nearer to your eyes, the cross will vanish, to reappear when you move the page still

nearer. When the cross disappears, it is because it is then focused on to the blind spot. Try the experiment with the other eye and the cross as starting point.

(2) Find the reaction of the iris to light. Here the child looks for about half a minute at the light, and a second child checks up the size of his partner's pupil, which should be relatively small. The light is then turned off for about another half minute, and, immediately on putting it on again, the partner checks up the size of the pupil again. It should now be considerably bigger. This change in size is an example of an involuntary reflex action.

Protection of the eyes.—The class should next discuss what is the family responsibility with regard to eyesight. The care of the eyes should include the following points:—

1. There should be no attempt to do fine work or to read in a poor light.

2. It is advisable when reading to hold the print parallel to the eyes and not obliquely, as is so frequently done in reading in bed or when lying down.

3. If the eyes are strained it is most important to get early advice from a qualified doctor, an oculist, not from an optician, whose main interest is in selling the glasses.

4. It is important to wear glasses regularly if this has been prescribed, and also not to bend the frames of the glasses when cleaning the lenses. Glasses worn crooked are not doing the work they should do, and may even be making the sight more difficult.

5. It is more injurious to the eyesight to read, write or sew with the eyes nearer than twelve inches to the work. Against this should be noted the tonic effect of cool air on the eyes. (This may be outdoor air, or the air of a well ventilated room.)

It should be made quite clear to the class that to look at an object which is at a distance greater than twenty feet requires no *accommodation*, that is, requires no movement of the ciliary muscles which makes the lens thicker through from back to front. In consequence, looking at distant

objects, as when in the open air, definitely rests the eyes; whereas in reading and "close work" there has to be continual focusing of the eye on to the work.

(The aim of the above teaching has been to give the children instruction so that they may guard their own eyesight. Not only in the hygiene period, but at all times the teacher must actively prevent the child from straining his eyes. The child starts by being long sighted, and gradually becomes able to focus the eye on to near objects, in the same way that he gradually learns to make fine muscular movements, involved in speech and in writing. If the doing of fine work under straining conditions is pressed, for instance, fine sewing, or if there is inherited weakness of the eye tissues short sight may develop. Short sight rarely appears after twenty, and it is therefore important for the eye to be protected from strain during school years. The normal eye tends to become long sighted again during later life, owing to a loss of muscle elasticity.)

The family care of the hearing.—As in the case of instruction about the eye, the teacher's first task is to help the class to understand the construction and working of the ear.

The construction and working of the ear.—The teacher should proceed somewhat as follows:—

1. Explain the three parts of the ear.

2. Get about three members of the class each to tap a glass partly filled with water and to state what happens, that is, that the water in the glass moves.

3. State that what happens in the ear is something like what happens in the glass. There is a chain of happenings. The sound waves in the air shake the outer drum, the outer drum shakes the three connecting bones; these, in their turn, shake the inner drum and the inner drum causes the lymph inside the inner chamber to shake.

The inner drum is like the glass and the lymph is like the water. There is one great

difference, however, between the water glass and the inner ear. Into the lymph protrude the nerve endings of the auditory nerve. When the lymph is set in motion the nerve endings are stimulated and the message is conveyed to the brain and interpreted by the mind.

Any child with earache should be advised to go to the doctor without delay.

The family provision for rest and sleep.—The teacher should first deal with the question of *fatigue*. He should make clear that fatigue can be (1) physical, as from spells of muscular work, or (2) mental, which includes emotional fatigue such as from worry. Mental fatigue should be discussed at greater length in the third year. The teacher explains that whatever the fatigue is caused by we must have rest from the activity which has caused this fatigue. At times, this is provided by a change of activity, at other times, more complete rest, as in sleep, is necessary.

Conditions for useful sleep must be considered and these the class can partly supply. They include regular bedtime and sufficient length of sleep each night. For adolescents it should be emphasised that the body consolidates itself and probably does most of its growing during sleep, so that people who are still growing need plenty of sleep, starting early in the night.

The teacher should stress the importance of the family provisions of restful sleeping accommodation. It is important that people should sleep with the windows open (night air is in no way harmful), with light wool coverings. There should be few ornaments and hangings in a bedroom, and mats and furniture should be such as can be readily removed for cleaning. Much of this information should be obtained from the class as an application of work that has been learnt earlier in the course.

A fact which needs to be taught is that members of the family should respect the quiet needed for sleep by other members of the family, and a constant wireless turned on loudly should be considered in this connection.

A point that will interest the adolescent is that loss of sleep rapidly affects good looks and good temper; and so also will the fact

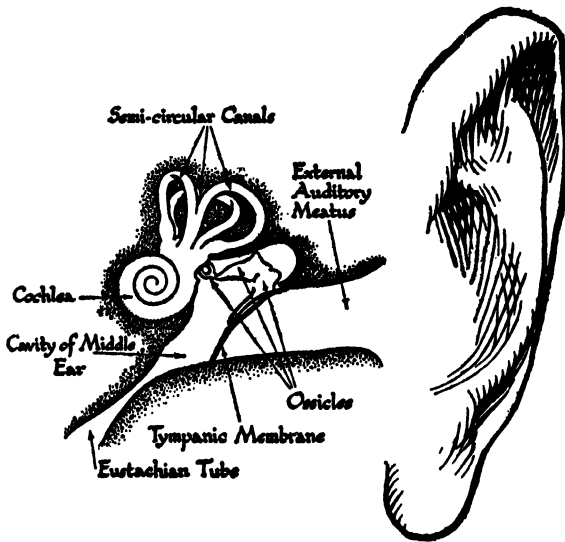

Reproduced from "The Body and Its Health" by W. Cullis and M. Bond by permission of Messrs. Ivor Nicholson & Watson, Ltd.

THE EAR

Care of the ear.—The teacher needs to explain the connection of the middle ear to the pharynx by the eustachian tube. This leads on to the care of the ear and the importance, in this connection, of clearing up such conditions as decayed teeth, sore throat, enlarged tonsils, because of the possibility of the middle ear becoming infected from them via the eustachian tube. This must not be done in a frightening fashion as though the condition would inevitably happen to everyone.

Too great stress cannot be laid on the importance of not poking things into the outer ear, because of the danger of damaging the outer drum.

that the effect of loss of sleep in any one night has been detected in the reactions of children up to three weeks later.

The family and the race.—If the question of the provision that the family makes for its own continuance is included here, it puts sex matters in their right setting, the family. Then infant welfare work and some

aspects of heredity, in the third year, provide opportunity for revision and extension of this teaching. In so far as it is the policy of the school to deal with sex teaching (apart from such teaching in connection with lower animals, dealt with in the biology course, by classroom methods, this is the place for it, treating it as a natural and essential family function.

THIRD YEAR'S COURSE FOR PUPILS AGED THIRTEEN PLUS TO FOURTEEN PLUS

HEALTH EDUCATION AND THE RACE —THE COMMUNITY'S PROVISION FOR BODILY NEEDS

AS far as possible, the year's work should be built up on a consideration of the institutions in the neighbourhood. Such topics will be dealt with as the school and the dental clinics; the local ambulance station or the mine's rescue station and First Aid; day nurseries and nursery schools in connection with infant welfare. There will also be a consideration of parks and their uses, of swimming baths and of playing fields, together with some discussion on sanitation, as well as on points connected with the Children's and Factory Acts.

To some extent such treatment will serve as a revision, from a new angle, of the work done in the first two years of the senior school course.

Health and the schools.—The introduction to the year's work might well take the form of a consideration of the provision made by the community for health in the schools. This should be treated from the point of view of (1) the *buildings* of the school. The amount dealt with in this section will depend upon the actual school building, and will vary

greatly from school to school and from area to area. There should be no negative teaching, and the school should not be considered as an example of what is undesirable; (2) *medical inspection*, including inspection of eyes. Up to this stage medical inspection has been regarded by the children merely as a routine matter. Now the children are old enough to consider why public provision of this kind is made. In the same way they should deal with school clinics, the natural outcome of medical inspections, as a national problem.

The treatment of this introductory work should be such as will make the class explicitly aware of how much the government, central and local, does for individuals and families. It therefore prepares the way for the important question, "*In what ways can these individuals and families serve the community in return, and help in the securing and maintaining of a healthy race?*" To try to answer this question will be the aim of the hygiene work for a large part of the year. It will be dealt with under several headings.

1. Keeping the "laws of health."—It should be made clear to the class that the first duty of the individual, and family, to

the State in this direction is to put into practice what they have learnt about sensible, healthy living. This will provide an opportunity for reconsidering health habits. In addition, it will enable the teacher to deal with the problem of *temperance*. Here the teacher should deal with temperance in its wide sense, meaning restraint in all directions; restraint with regard to food, smoking, late hours, dress, sunbathing, exercise, etc.

Alcohol.—The teaching about alcohol should be part of this general teaching on temperance. The points that the teacher needs to make clear are:—

(a) Alcohol is a narcotic poison, like ether and chloroform, and acts as they do. They block the synaptic junctions between nerve endings, and when anyone becomes more talkative and noisy, after a dose of alcohol, it is because he is less self-critical and less aware of what he is doing.

(b) Then, again, due to partial blocking of the synaptic junctions, a small dose of alcohol—say a wineglass of port, makes a person think he is more accurate at muscular co-ordinations, whereas he is really less accurate. It is for this reason that there is a preference for motor drivers who do not drink on duty, or do not drink at all.

(c) Alcohol is popularly supposed to “keep out the cold.” Actually, a dose of alcohol acts as a warm bath does on the skin; it causes the small blood vessels in the skin to dilate, so that there is more blood in the skin relatively and the skin feels warm and tends to perspire. This means that extra heat is being lost from the skin and the body is thus being cooled.

(d) Since the above are the effects when only a moderate amount of alcohol is drunk, drinking to excess is obviously bad for health, in the long run, and also for working capacity. While there is no actual harm in moderate drinking, even that is expensive, and most sensible people can find other more amusing ways of spending time and money than continual drinking. For instance young men drink less than they did, because they

prefer to spend their money on, say, keeping a motor bicycle rather than on drinking.

(e) Brewers in their advertisements try to make everyone feel that they ought to drink a good deal, but it must be remembered that brewers make a profit out of selling beer.

The teaching about alcohol should not be alarmist in character, attempting to frighten the listeners. The emphasis should rather be on training the children and awakening in them real interests that they will want to pursue in their leisure time, not mere love of amusement such as nightly cinemas. Such movements as the Scout and Guide Associations, the Playing Fields Association and the “Keep Fit” Movement, or any clubs or societies for people of similar interests supply this kind of emotional and intellectual satisfaction. It is a question of training in the right use of leisure, and to have given the senior school leaver something he or she definitely prefers to do to drinking is much better than any amount of teaching and precept not supported in this way.

2. Rendering First Aid.—It will be obvious that a second way in which an individual can serve the community, from time to time, is by rendering First Aid in time of accident. The children will realise that though such help is not constantly required, yet knowledge is necessary if one is to be



REEF KNOT.

GRANNY KNOT.

The reef knot is always used in First Aid work because it is the more secure.

ready for the emergency. This supplies a purpose for studying the subject.

First Aid teaching should be made as practical as possible. A number of the children may have done some of this work in connection with Scout or Guide work, and these children can be used as helpers or team leaders, judiciously.

While children of this age should not be pressed to take responsibility beyond their years, it should be realised that this will, in all probability, be the last opportunity some of them will have of getting an inkling into the scope and usefulness of First Aid work. At the same time, as in the case of mothercraft for senior girls, the First Aid teaching that is given at this stage may so arouse the interest of individuals that it makes some keen to attend voluntary classes later.

Further, in certain occupations a knowledge of First Aid is essential, and doing some in school appeals to some children as a thing which will help them in their future work.

Safety First.—The teacher needs to stress that, as far as accidents are concerned, it is better to avoid the accident and so the need for First Aid. Examples of such care can be collected—constructing street barriers and pedestrian crossings, the keeping of rules of the road, the obeying of the laws for guards round machinery, the locking up of poisons and the dispensing of them in

characteristic bottles; and in the same way, in school life, the training in controlled play, without pushing or snatching, in school games and physical training, or the having of supports for catching in vaults such as leap-frog.

Types of aid to be considered.—Another important point to be stressed is that First Aid is only a temporary measure while the doctor is being summoned.

The emergencies to be considered can be roughly summarised as (1) different kinds of unconsciousness; (2) fractures; (3) cuts, bruises and abrasions; (4) burns and scalds; (5) poisoning; (6) cases needing artificial respiration. In all cases treatment for shock, as well as for the specific injury, should be included.

The amount of practical work, such as treatment of fractures, will depend upon the available materials, but the more that can be included the better. The teacher should emphasise that an injured limb should be moved as little as possible, and should

demonstrate practically the importance of lifting and moving the patient, or the injured limb, with gentleness and smoothness when movement is necessary.

Pressure points for arteries should be found practically. There should be practice of artificial respiration, and for this purpose physical training mats can be utilised for the ground work (See page 400).



[Reproduced by courtesy of the National Safety First Association]

This kind of poster interests older children who are shortly going out into industry.

A small manual, such as Collie and Wightman's *Short Course in First Aid for Accidents*, published by Gill, is both useful and reliable from which to work.

Pressure points.—The two diagrams on page 400 show the points at which pressure should be applied to control bleeding from the arteries. Fig. 1 shows the position of the points in relation to the bones and Fig. 2 shows the arteries and numbered pressure points. In Fig. 2 where the artery is dotted, it shows that the artery is, in this part of its course, *behind* bones, when viewed from the front. All pressure points should be felt for with the finger tips, not with the thumb.

The arteries indicated by the different numbers are those of (1) neck; (2) angle of jaw; (3) temple; (4) back of head; (5) back of collar bone; (6) armpit; (7) upper arm; (8) elbow joint; (9) "thumb side" artery; (10) "little finger side" artery; (11) artery to thigh; (12) thigh; (13) artery behind knee; (14) fronts of ankle; (15) back of ankle artery.

For pressure points (7) and (12), a tourniquet is often used to control bleeding, while for pressure points (8) and (13) flexion of the elbow or knee over a firm pad is often used.

Arterial bleeding is so rapid that it is important that anyone who wants to be able to render First Aid should have practised finding and recognising the various pressure points, by the pulse beat that should be felt at each one. Practical activity is essential here (See article on First Aid).

3. Safeguarding ourselves and others from infectious diseases.—It will be clear to the class that a third way in which the individual can serve the community is by trying at all times to safeguard himself and those around him from infectious diseases. The teacher's work at this stage is to consider with the class how best this service may be rendered. He therefore discusses the prevention and home care of infectious diseases, at some length, from a community standpoint.

Bacteria.—The teacher revises the different kinds of bacteria. He speaks of their quick methods of multiplication when in good

conditions, that is, when in a wet, dark, warm environment with plenty of food available in solution. Secondly, he speaks of their ability to resist adverse conditions, such as too great heat or cold, too dry conditions or even a solution of poison such as carbolic acid, by making a hard, resistant spare case round themselves and waiting to emerge until better times.

Droplet infection.—The teacher should make clear that in considering the ways in which infections are carried, two media must be reckoned with, namely, a *wet medium*, and a *dry medium*. Bacteria, for example, are conveyed by droplet infection; that is a case of a wet medium. In a number of infections, of which the common cold, influenza, measles, scarlet fever and diphtheria are some examples, anyone who is sickening for or who has the disease, is breathing out droplets of moisture at each breath, breathes out, in them, the specific bacteria of the infection in question.

If a person sits near to someone thus infectious, so that the droplets breathed out by one are breathed in by the other for any length of time, it becomes increasingly likely that the second person will not be able to kill off the bacteria thus breathed in, and hence the infection will be caught.

If, on the other hand, there is a current of air moving past the individuals in these circumstances, the infected droplets are likely to be dispersed and a sufficient charge will not be breathed in to cause infection.

The body's resistance to bacteria.—This dispersal of the droplets by current of air gives one reason for open windows, namely, that there shall be a continual movement of air to blow away charges of bacteria if such be present. Another way in which a reasonably cool and fresh atmosphere helps in avoiding infection is that the body's resistance is thus made higher than if the surrounding air were hot, moist and stagnant.

The teacher then discusses other ways in which the body's resistance to harmful bacteria is raised, namely, (1) a well-balanced diet with plenty of fresh fruit, (2) a regular

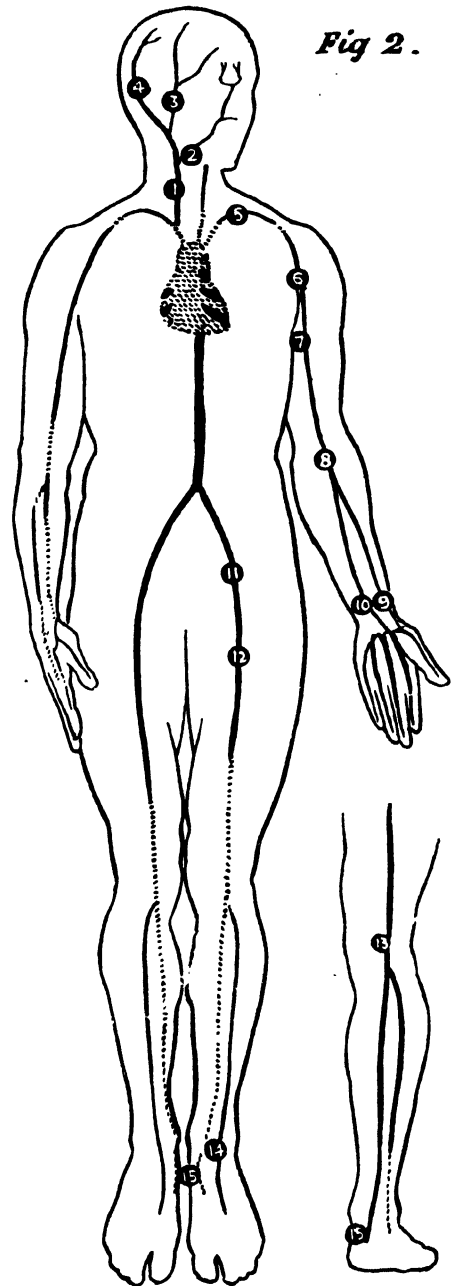
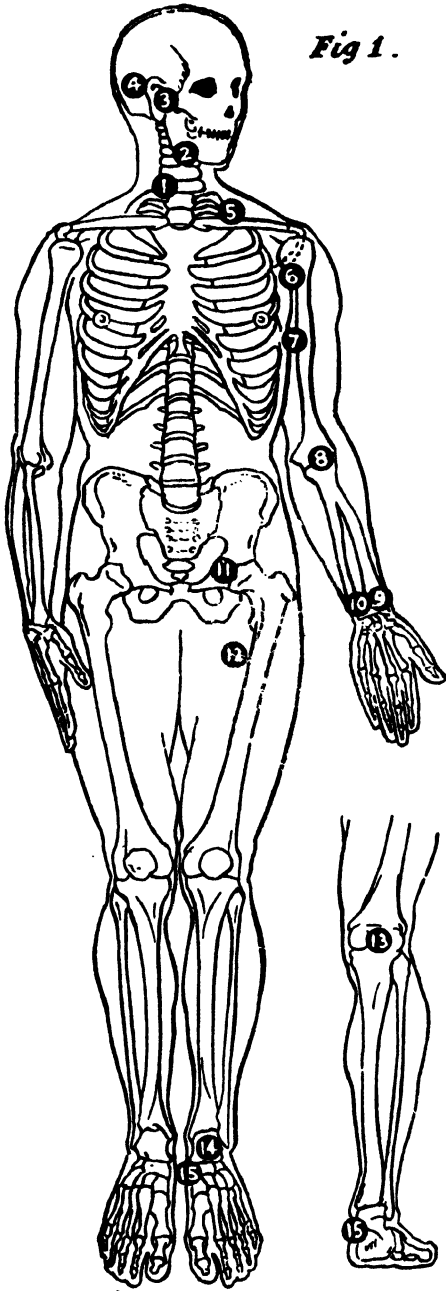

PRESSURE POINTS

life with plenty of sleep (with open windows for above reasons).

Water and milk as wet media for infection.—The teacher next proceeds to explain that, besides droplets, infection may be carried in a wet medium in water and in milk and on some foods. Here he stresses the importance of getting water for drinking from a deep rather than a shallow well.

He discusses how far the Government compels care with regard to the prevention of infection in this way. He speaks of how the Government enforces standards of cleanliness in this connection with the sale of food and drink. He explains, for instance, how milk can be infected by the workers in the cowsheds or dairy, or through washing utensils in infected water. He points out that milk is a nutrient fluid in which bacteria, harmless or harmful, lie and thrive. The class will be able to supply other ways in which milk is safeguarded, such as by Pasteurising it.

Dry spores of bacteria and infection.—The teacher discusses that the principal way in which infection is spread in the bacteria's dry endospore form is in *dust*. He says everyone must have seen dust particles floating in the air of a room at some time, when a shaft of sunlight lights them up, and, of course, all the air in that room is just as dusty as the small part lighted up and at each breath the occupants are breathing in charges of this dust into the lungs.

He explains that the dry hard-cased endospores are very light and can easily be carried round on these dust particles and in this way be breathed in. The dark corners of rooms, upholstery and heavy hangings and curtains that are not washable can all hold spores of bacteria, and if these are disturbed or shaken out, even a matter of years later, and are breathed in by someone susceptible, infection may occur. This is the reason why bedrooms particularly should have few curtains and hangings, and these should be washable. The rooms should also be free from unnecessary dust-collecting ornaments.

Spores of bacteria and sunlight.—It should be made plain that the one way in which these spores of bacteria can certainly be killed is by direct sunlight on the materials, out of doors (that is direct sunlight, not sunlight that has passed through glass). Attention is drawn to the fact that in some countries, Germany for instance, it is a common sight to see the family bedding hanging out through the open window in the sun.

Infection and cleanliness.—The teacher should carry still further the problem of infection and dirt. He argues that, since spores of *tuberculosis* and of many other infections are known to persist quiescent in dark and maybe dirty surroundings, it is clear that dust should be "kept down" and rooms kept clean in the home and at school. Vacuum cleaners, which remove the dust without raising it first, are particularly good because they remove the dust in such a way that people are not likely to breathe it in.

The class will see that here is a reason why the home care for cleanliness is important both for the family and for the community. The more people prefer clean homes, the more will they appreciate the same care in the streets, shops, cinemas, parks or seashore. The municipal services for the removing of rubbish from the home and for keeping the city clean, and for the supplying of good water, can be discussed, the class first providing the local facts and the teacher drawing the inferences and collating.

Infection and dirt.—The group can consider, from the above, what happens if rubbish from the family is left about and not cleared away. Some decays and flies settle on it, especially in hot weather. Decaying organic matter should always be removed and disintegrated by the action of relays of bacteria. (This should be commented upon as a case where bacteria are useful, not harmful.) If, however, this decaying material is not removed, and flies breed on it and then walk on food or food utensils, they are likely to carry harmful bacteria on their feet and infect the food and

food containers. This, for instance, causes summer diarrhoea among babies. The incidence of the complaint in hot summer weather has been much lessened since there have been more motor cars and consequently fewer stables with their horse manure from which flies used to carry infection.

The teacher should not fail to stress that, in order to avoid attracting flies, the family should do all that is possible to burn all organic refuse, to keep the dustbin lid tightly in place and to dispose regularly of its contents. The class will readily see that a family that is careless about this may be the cause of infected flies going to clean, careful families and causing illness there.

A further fact which the children need to know is that infections may also be spread by failure to burn infected dressings from wounds, and a family should be considered responsible for taking such precautions in the case of any wound with pus discharge. In the same way, it should be clear that utensils of patients, such as those of patients with tuberculosis, need to be sterilised after use and to be kept for the patients' use alone. Special care is needed on behalf of children, for they have not acquired, as do grown ups to some extent, the power of specific resistance to doses of infections.

Immunity from infections.—Different kinds of immunity from infections should be discussed next. The teacher should explain that some people, and some animals, are born immune from particular diseases. Sheep, for instance, are immune from tuberculosis, while cattle are not. Italian children in New York were found to have a congenital

immunity from diphtheria unshared by other races considered there.

The next point to deal with is the fact that most infections confer some immunity on the patient for varying lengths of time, for example, measles, scarlet fever, mumps, small-pox. The common cold, however, confers little immunity from further attack. This acquiring of immunity is made use of in the process of vaccination, in which a slight infection of regulated cow-pox is given to the patient; in the course of recovery, the patient makes in his blood the anti-toxin which confers immunity both from cow-pox and from small-pox, and this immunity lasts for some years.

If the children seem to be understanding with ease, the convenient semi-technical terms *toxin* and *anti-toxin* can be usefully introduced. It is explained that toxin is the general name for any poison produced in the body by bacteria, and an anti-toxin is the material, made in the blood of the patient, which neutralises the action of the toxin. Toxins, like poisons, are obviously

not all the same in effect. The toxin of measles, for instance, produces, as one effect, blotchy spots which occur first behind the ears; the toxin of german measles produces many pin-point spots over the body; that of scarlet fever produces red spots on the chest first; and the toxin of the common cold produces no rash at all.

Health pioneers and infections.—In the course of this work on infections, one period at least can usefully be given to the work of Pasteur, who discovered that the cause of many illnesses was specific bacteria. The bare facts of his life are to be found in



[Reproduced by courtesy of the Health and Cleanliness Council.]

All three injunctions are important. The third is often neglected.



LOUIS PASTEUR

Health Education (Board of Education) and can be supplemented from reference books. The teacher, keeping in mind the idea of service which should run through the work for the year, would do well to stress that Pasteur worked against difficulties and unpretentiously, but that the work he did has and is now benefiting people all over the world, including the group now remembering him. Such a treatment will prove worth while and give an ideal of conduct to the children.

The class should be asked to find out what Robert Koch, Peter Manson, Madame Curie, Lister and Humphrey Davy did for the community in the matter of making living safer from disease and therefore pleasanter. What they find out should form the basis of further periods of work. The men might be the subjects of "celebrations" whose purpose would be to inspire the adolescent to an emotional as well as an intellectual urge to serve the community in this matter of prevention of infections.

Tuberculosis.—In dealing with tuberculosis, the stress should be how to avoid getting the infection, and how this depends on com-

munity care and cleanliness and also on the individual's living a regular life as a means of setting up a resistance to the infection. The importance of open air in the daytime and open windows at night, of plenty of sleep and regular appetising food should be dealt with again. This time the class will produce most of the information.

While to give a great deal of specific information about the early symptoms is frightening and unnecessary, advice to consult a doctor if not feeling generally fit over a period of say, two or three weeks, is useful. The class should also be clear that advice about tuberculosis can be obtained free from the local tuberculosis doctor, and that here, as in all illnesses, prevention is better than cure.

The two kinds of tuberculosis, bovine and human, can be briefly reconsidered, thus connecting this work up with the earlier work on clean milk.

The treatment of the topic tuberculosis needs to be somewhat different from that



LORD (JOSEPH) LISTER



[Reproduced by courtesy of the Sunlight League

OPEN AIR TREATMENT OF TUBERCULOSIS

These children are having lessons while getting the benefit of mountain sunlight. Here the ultra violet rays are less cut off by clouds and smoke than nearer sea level in towns. (Contrast p. 389.)

accorded to other infectious diseases. The adolescents have chronologically passed the main age incidence of infectious diseases such as diphtheria, measles, mumps, chicken-pox and other more childish infectious diseases, and therefore consider their prevention in a more or less objective way, as a social duty, not as a personal safeguard. Tuberculosis of the lungs attacks, chiefly, those in the age range from fifteen to forty-five. To the adolescent therefore, the matter is a more personal one and likely to be more emotionally considered. The teacher's task is therefore to show that it is a natural thing for people to take precautions against tuberculosis, in order that they may enjoy to the full the years of life when they should be at their strongest, having passed the illnesses of children and not reached those of later life.

Emphasis is put on the available treatments for tuberculosis.

4. The employers' care for the health of their workers.—In this third year of the course, the school is dealing with pupils who are already beginning to turn their attention to ways and means of earning a livelihood. For this reason a fourth way in which individuals can serve the community might well be considered. This is the way in which employers of labour help the State by providing healthy conditions of work. Comparisons with school conditions will prove helpful here and also serve as revision of work done earlier in the year. It will be shown how there is an attempt to provide good physical conditions such as suitable ventilation, heating and illumination, and, in addition, good psychological conditions, with proper rest pauses and prevention of unnecessary fatigue and noise. With an "A" section some of the findings of the Industrial Health Research Board may be considered.



A TYPICAL HEALTHY BABY ASLEEP

[Photo: Studio Briggs.]

How the State co-operates with the individual and the family.—Having discussed these four ways in which the individual takes his share of responsibility for the health of the State, the teacher should, as a review of the work already covered, deal with the question of how the State co-operates with individuals and families in this.

He should mention the Ministry of Health and the local medical officer. The names of other health agencies should be collected from the class and discussed. In most cases these will include clinics, hospitals, and welfare centres; the use of National Health Insurance and Hospital Savings' services.

In a new area, the town planning might be briefly noticed from the health and sanitary point of view. The teacher should also discuss day nurseries, nursery schools, open-

air schools, and if possible arrange visits to them as well as to, say, the local water works or a model dairy.

Infant welfare.—The subject of infant welfare and its importance to the community should come in this part of the course. The subject for girls should be dealt with practically, as well as theoretically, in connection with the domestic science course. It should be stressed that infants, even when born healthy are delicate and easily upset. The class will then see that all the accepted family and community rules—for cleanliness; regularity, freshness and suitability of food; sunshine and fresh air; exercise and sleep—are of even greater importance to babies than they are to older people. The value of healthy, happy babies to the community should be dwelt upon.

HEALTH DEPENDS UPON NATURE AND NURTURE

The teacher should next draw attention to the two factors upon which health depends, namely, nature and nurture; to the fact that a person healthy at birth may fail to grow up healthily because of undesirable surroundings and conditions; and, on the other hand, that a weakling, however carefully nurtured does not stand the same chance of becoming a vigorous, healthy, useful member of the community as the baby who by nature is healthy in mind and body. He makes clear to the class that a community, or family, not only has to take heed to the healthy upbringing, or nurture, of its members, but also has to give thought to the conditions which determine the nature of these individuals.

The children will be quick to realise that the greater part of the health course, up to this point, has dealt with what the community, the individuals and, also, great pioneers have done and are doing to ensure right nurture. They will, therefore, probably be keen to consider what has been done and is being done with regard to the question of human nature and personality. It should here be pointed out that there are two great bands of workers in this field. There are all those who have worked on the problems of *heredity* and those who are doing research work on *glands and hormones*.

Heredity.—The amount of time given to the question of heredity will depend on what has been covered in the biology course about how characteristics are inherited. (See biology scheme.) In any case the start for this work should be from the simple non-human cases which are generally used, such as Mendel's tall and dwarf peas, or the colour in fowls.

However the work is done, whether in the biology time for the most part or in the hygiene time, the conclusion to be made clear, for health education, is as follows. Inherited characters, such as relative tallness,

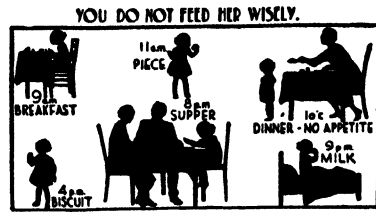

[Reproduced by courtesy of the Association of Maternity and Child Welfare Centres.]

WHY IS YOUR CHILD NAUGHTY?

The pictures show the interdependence of physical and mental health. Silhouettes always appeal to children.

colour of eyes, hair, musical ability, cannot be altered. Certain characters can, however, be given the chance to develop to the full by a good environment. This good environment includes (1) the optimum conditions for growing up and (2) the chances of finding out what one can do best and of getting training along that line.

Glands and hormones.—Research work with regard to glands and hormones is of later origin than such work on heredity. The topic is one which demands of the teacher much thought and tact. It is here placed at the end of the three year course as requiring a certain maturity of outlook for its understanding.

Endocrin or ductless glands.—The teacher introduces the topic by stating that the body has two ways of sending messages from one part of the organism to another, so that the different parts shall work together and so that the whole shall work in relation to its external environment. He asks the class to name one way the body sends messages. He expects the answer that messages are conveyed by the nervous system. He revises briefly sensations of hearing, sight and movement and the appropriate muscle and gland responses. This is work covered in the second year.

The teacher then states that there is another way in which the body sends messages, that is by means of hormones or chemical messengers, which are manufactured in endocrin or ductless glands, the secretion in each case passing directly from the gland tissue into the capillaries of the blood stream.

The very small quantities of hormone which are secreted into the blood stream are taken round in the circulation till the appropriate organ is reached and the stimulus is given. The teacher stresses that the hormone, of course, goes in the blood all over the body but produces an effect only on the parts susceptible to that particular hormone.

The teacher recalls how the secretion of the liver, kidneys, sweat glands, etc., accumulate in the gland and leave it by a duct. He then explains that the hormones do not make use of ducts but that they are secreted into the blood as it flows through the tissue of ductless glands.

The next point to develop is that there are two kinds of hormones, (1) those producing a temporary effect, and (2) those producing permanent and cumulative effects on the metabolism.

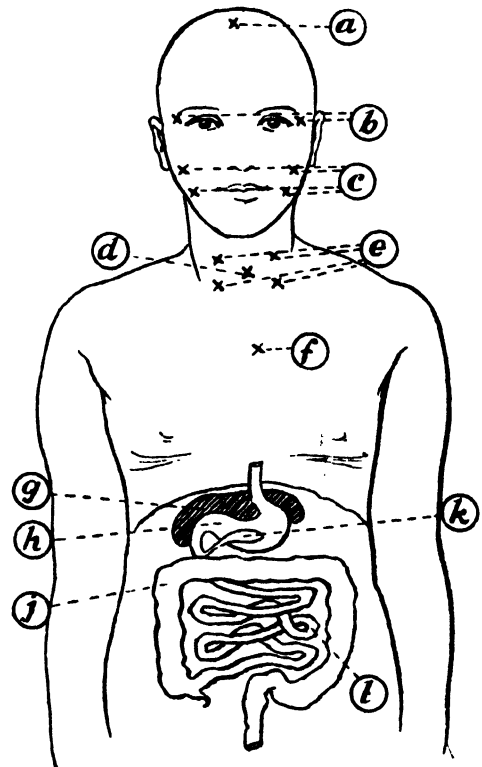

THE POSITION OF CERTAIN GLANDS

Glands which are ductless in function are in italics. The pancreas has both functions.

- | | |
|------------------------------|--------------------|
| a. <i>Pineal.</i> | b. Tear. |
| c. Salivary. | d. <i>Thyroid.</i> |
| e. <i>Para thyroids</i> (4). | f. <i>Thymus</i> |
| g. Liver. | h. Stomach. |
| j. Large intestine. | k. Pancreas. |
| i. Small intestine. | |

Hormones whose effects are temporary.—

1. *Secretin*.—This is the name given to the hormone given out at the lower pyloric end of the stomach when food is ready to, and about to, be passed from the stomach to the intestine. It circulates in the blood until its presence in it in the pancreatic tissue causes the pancreatic juice to be secreted and in this way digestion to be continued.

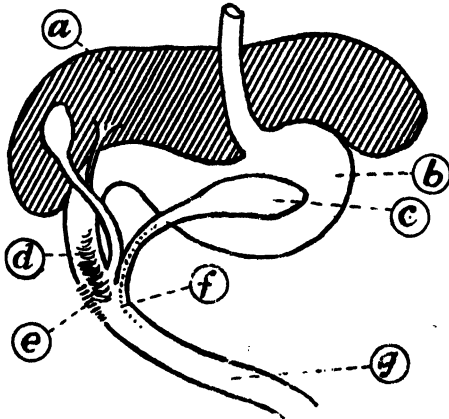

DIAGRAM OF SECRETIN

The dotted lines are to indicate that the secretin gets to the pancreas tissues via the blood stream and not via the intestine. When food passes the point marked *e* from the stomach, secretin is stimulated to pass into the blood stream and so to the pancreas.

- | | |
|--------------|----------------------|
| a. Liver. | b. Stomach. |
| c. Pancreas. | d. Food. |
| e. Secretin. | f. Pancreatic juice. |
| g. Duodenum. | |

2. *Insulin*.—The pancreas also manufactures in its tissue the hormone insulin. The presence of insulin in the blood regulates the amount of sugar there. Shortage of insulin leads to the disease *diabetes*. The disease is again alleviated by the injection of insulin. Insulin is, again, a hormone that helps to keep the metabolism constant, and so belongs also to the second class of hormones.

3. *Adrenalin*.—This is another example. It is given out by part of the supra-renal glands, which are situated just above the kidneys. If we need suddenly to make a supreme effort, either in attacking an enemy, or, more usually in civilised life, in rapid flight, such as dodging a fast car in the

highway, we perceive the danger and the supra-renal glands are stimulated to discharge, into the blood passing through the capillaries, extra adrenalin.

The effects are well seen in a cat frightened by a dog; the hair of the back stands erect, the hair of the tail stands out, the pupils of the eye are dilated and a generally fierce and belligerent appearance, calculated to frighten enemies from attacking, is the result.

X-ray photographs of such an animal show that digestion is stopped; extra *glycogen*, or animal starch, which is stored in the liver, is quickly turned into glucose, to be used for muscular contractions; the blood clots more readily and so guards against loss of blood if there is a wound, and the animal is able to make physical efforts, quite outside its range in what is rightly called "cold blood."

It should be pointed out that people who lose their tempers rapidly and on little provocation have specially actively working supra-renal glands.

Hormones whose effects are permanent and cumulative.—

1. *The Thyroid hormone*.—This is the hormone of the endocrin gland known by that name. The thyroid gland has a permanent and cumulative affect upon the metabolism so as to affect the growth of the organism. Children who are deficient in thyroid remain short and fat and do not grow up mentally. They can be cured by being given doses of sheep's thyroid gland, which takes the place of their own secretion. It is as though the thyroid, from this gland in front of the larynx, in the blood stimulated the body as a whole to grow normally and correctly.

2. *The pituitary hormone*.—In this case the gland is situated at the base of the brain. It controls a number of body processes from its different parts. One part gives out a hormone which stimulates the growth of bone tissue. If this part is upset, and secretes too much of the hormone into the blood, *giantism* results. This hormone's effect upon growth is also accumulative.

In some classes it may be advisable to limit the cases of hormones and endocrin glands to those given above. In classes where the question of puberty has been considered either in the hygiene or the biology course, the following additional glands may be dealt with.

3. *The thymus hormone.*—The thymus gland, in the chest under the breast bone, appears to tend to delay the onset of puberty, that is to delay "growing up."

4. *The pineal hormone.*—On the other hand the pineal gland, situated on the top of the cerebrum, appears to hurry on growth to adolescence. Thus the secretions of these two glands work against one another, and balance up their opposing effects.

5. *The hormones of the gonads.*—The tissues of the gonads give out hormones which stimulate the development of secondary sex characteristics, such as the horns in the male stag, the beard and breaking of the voice in man, and the development of the breasts in woman.

6. *The parathyroid hormones.*—The four parathyroid glands, which are smaller glands embedded in the tissue of the thyroid gland, but independent in function, control the intake and use of lime salts in the body. Lime, or calcium, is taken in in small quantities with such foods as milk, oranges, vegetables and meat, and is needed for building into the structures of the bones and teeth, and for the tone of the blood vessels.

Temperament and gland pattern.—Both temperament and build of body depend very largely upon the balance of endocrin gland secretions, and this is inherited. This point must be made very clear by the teacher. The endocrin gland balance decides whether people shall have, for example, a restless, active, energetic temperament, or a more placid, unworried one; whether

metabolism shall be quick and so the body thin, or whether metabolism shall be slower so that too much fat is readily stored. Races show inherited racial differences in endocrin gland pattern; some are consistently tall, others short; some are temperamentally more vivacious than others, some are more stolid and hardworking; and again some are more pioneering than others.

The teacher must now strongly stress the fact that while temperament is inborn, it is the part of intelligence to modify and control the emotional reactions. For example, anyone who cannot feel indignation, righteous or otherwise, on occasion, is not normal. Nevertheless, in life, as in boxing, the person who controls that temper is the more likely both to get his own way and to be respected.

Similarly some people have more difficulty in getting themselves to take initiative; to persevere with a piece of work begun; to do any work at all, than do others, and success often depends quite as much on this emotional control as on having a high intelligence quotient. The one, however, is likely to help the other, and environment (to a large extent provided by the family) and training help both.

This naturally leads the teacher on to the consideration of the meaning of mental health.

Mental and physical health.—The teacher should conclude his course by a consideration of the full meaning of health. He should discuss the meaning of mental health, taking examples in ordinary life. He should show the interdependence of physical and mental health upon one another. He should finish on the note that the aim of all health work is to aid in the promotion of physical, intellectual and emotional health for the individual as such and for the community as a whole. (See detailed lesson on page 433).

LESSONS IN DETAIL

INTRODUCTION

IN the following pages a number of lessons are worked out in greater detail in order to show more fully the method of treatment as well as the content.

The titles of the lessons are as follows:—

Year I:

Bones and Joints.

Food—Types of Foodstuffs.

Year II:

Food—Natural Foods and Vitamins.

Clothing—Relative Values of Materials.

Year III:

Charts and Graphs—Their Use for Showing the Results of Public Health Work.

Infections—The Fight Against Them.

The Value of a Healthy Outlook—The Relation of Mental Health to Physical Health.

Food—How to Discriminate when Buying Foods.

The work of the last year of school life is admittedly the most difficult for the teacher to organise, because it involves gathering together so many threads and making explicit so much which has been only tacitly assumed. It is on this account that the examples of types of lessons are more numerous for the third year than for the first and second years.

It will be noticed that there are three lessons on *food*. This, as stated earlier, is in order to give an example of lessons planned on a spiral method. It is to ensure that though food appears in the school syllabus for each year, the work in the second and third years shall not be *mechanical repetition* of the work of previous years. The lessons later in the course assume and revise the matter of previous lessons,

while approaching the main topic from a new, and more mature, point of view.

The introductory lesson on bones and joints has been chosen to show how an abstract treatment of the physiological and anatomical topics of hygiene might be avoided, and how the co-operation and natural interests of the class may be enlisted.

The lesson on clothing has been chosen to show one way in which the class may take an active part in the "health study" period by means of simple experimental work requiring no expensive apparatus or equipment. It should be noted that the experiments are inserted in a lesson to enable the children to draw conclusions which they understand. Experiments in which the apparatus or reagents are stranger to the children than the substances to be tested defeat their own ends. For example, to test for the presence of protein by means of caustic soda and copper sulphate solutions leads to parrotlike memory work and mental indigestion at the same time.

Statistics and charts have found a place in most of our everyday affairs, and have certainly "come to stay." The intelligent reading of the exploits of modern works in the field of health necessitates some acquaintance with the graphical records, and it is for this reason that the lesson on graphs is inserted. It is intended only as an introduction to the topic, and if treated early in the year the children may make profitable use of the knowledge in their investigations throughout the year.

The lesson on infections was partly chosen to indicate how the work of pioneers and discoverers could be incorporated *naturally* into the hygiene course. It is also intended to show how, by careful choice of examples, the teacher avoids alarmist teaching.

Though the importance of mental health

is becoming more and more recognised, many teachers show a reticence to discuss the topic with their classes. Undoubtedly the part played by the teacher in leading the children to a healthy outlook should be largely indirect, a matter of example, suggestion and encouragement, but "school-leavers," who have grown to realise that they must take responsibility for their own bodily health, are ready to accept like responsibility for their mental health, if the matter is made explicit to them.

The teacher should not give this kind of lesson, on mental health, early in the third year, because if he waits his class will probably give him a natural opening for such discussion. The teacher should then strike while the iron is hot, and set aside the more routine lesson he has prepared for a later period.

While "celebrations" of some of the pioneers of health, such as Davy, Lister, Pasteur, Ross, Koch, Starling, Florence Nightingale, Madame Curie, should find a place in the health course, a further series of inspirational periods might be devoted to Nature's great gifts to man. One period might be given to each of the following:—Sunlight, Fresh Air and Oxygen, Water. It should be noted that for the success of the "celebrations" detailed programmes are necessary for the children, so that they may feel they are taking an active share in the proceedings.

FIRST YEAR LESSON—I. BONES AND JOINTS

Aim of lesson.—To arouse the child's interest in the framework of his body.

The type of lesson.—The lesson aimed at is one in which there is informal class discussion (as opposed to a continued, unbroken narrative by the teacher) together with plenty of incidental experimental work.

Requirements.—These are blackboard sketches and fairly stout paper manikins, one for each member of the class. The manikin is hectographed and cut out, but blank, its size being 6 in. to 8 in. high. On this manikin the children "fill in" bones, on the back and front, as they locate and discuss them. Thus the collar bone will be put in on the front of the manikin and the shoulder blade and the spinal column on the back.

At this age the presence of a skeleton or of isolated bones would tend to destroy the idea of bones as a part of a living organism, capable of growth and modification. It might also arouse unnecessary emotional display from children not yet trained to respect the human body.

As with other nature study, museum specimens are not used as substitutes for the living form studied. Physiological wall-sheet diagrams, while not used for the actual class teaching, are useful to individuals afterwards for reference.

Facts to be taught.—Before actually preparing the first lesson, the teacher needs, here as always, to decide on the facts to be taught in the lesson series. In this series these may be summarised as:—

1. Examples of bones. (The teacher does not first give a definition of bones, nor state what bones are; he works from the child's incidental knowledge and interest first, and thus uses a psychological rather than a logical order.)
2. The work of the bones, and arising out of this.
3. The effect of bone structure, that is, the work and value of the skeleton as a whole.
4. The composition of bones and how it is maintained.

Starting the lesson.—The start of the lesson is particularly important here. The teacher must aim at catching the children's interest immediately, and he is likely to do this more readily if he begins from some-

thing they know and like; while trying to create a new interest he builds on one that is already strong. One principle can be applied in many ways, and there is obviously more than one way of arousing interest in this instance. The following is a suggestion of one way.

The lesson.—The teacher asks, "If you were going to make a kite, what part would you make first?" He expects the answer to be, "The frame," and adds that this is often called the skeleton. He continues by saying, "If you were putting up a tent or erecting a big building like a picture house, you would need frameworks, and these also can be called the skeletons of the tent or building."

He next asks the class to give examples of skeletons or frameworks. The kind of answers probably given would be the frame of a chicken; fish; umbrella; the foundation wires of "soft toys." He adds that crabs, lobsters, insects, snails and mussels have their "skeletons" outside, not inside. He tries to get from the class why this is a less useful plan for living and growing creatures.

The teacher says, "We have a frame or skeleton in the same way. See if you can feel part of your own framework or skeleton for yourself. Feel your head, arms, legs, fingers. Can you feel their frames?"

(The new word "skeleton" acts as a refrain through the lesson and is always linked up with the familiar and descriptive word "frame.")

It is convenient for the children to feel the hand. They are told to hold up the little finger; to feel and count the bones in it. How many bones are there in the third finger? in the second finger? in the first finger? By this time the children will, of their own accord, be finding out the difference of the thumb from the fingers, namely, that there are two bones, not three, to the hand junction.

Time is then allowed for the children to feel and discuss with their partners the bones of the palm. (Four can be felt, one

connecting with each finger and a separate one for the thumb.)

While the children are interested in exploring bones, the numbers in the arm and leg are considered. The jaw, the skull, etc., are also felt. As the children name bone structures, the teacher discusses briefly the reason for general shape; the roundness of the skull allows that blows glance off and the force of any blow is distributed; the eye socket is deep so that a blow tends to injure the tissues round the eye rather than the eye itself; the moveable cage of the ribs protects the heart and lungs; the legs are adapted for taking weight; the arms are less heavily made but are capable of being used for a wider range of actions than the legs and feet.

The teacher also mentions that some bones are too small or too deeply set to be felt readily. Thus he mentions the eight wrist bones and adds them to his board diagram (bones about the size of lumps of sugar). He does the same in the case of the seven ankle bones, one of which, the heel bone, can be felt protruding.

While the children compare the leg and arm the teacher puts "limb plan" diagrams on the board, and points out the close resemblance in structure, which is modified in so far as the work each does is different. All this will be revised and amplified from a fresh angle when dealing with joints.

At this point the teacher stresses *the unity of the skeleton* or framework, as against the bones considered separately.

He shows three individual meccano rods, which will not take much weight acting alone. When the three are bolted together, however, as shown on the diagram, they can support much greater weight relatively. The class can probably see this tie arrangement in the roof beams, in the classroom or the hall roof. The children can also be asked to supply examples of similar roof supports, bridges, etc., they have noticed.

This leads to the question of *joints* and would conclude the exposition of the first lesson period.

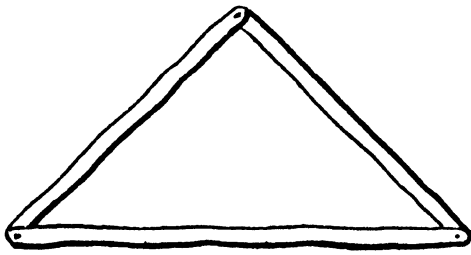

TIE TEAM

Towards the end of the period, the children, checking off on their own limbs, copy on their manikin the remainder of the blackboard "limb plan" diagrams, which have been produced step by step as the lesson proceeded.

To maintain interest the teacher suggests that the children find further examples of frameworks or skeletons. They might further consider the question, "What can you do with your hands that you cannot do with your feet, and vice versa?"

It is to be noticed that of the facts to be taught listed at the beginning, only the first three have been touched on in this first lesson period. (For the others see page 367.)

At this age strings of technical names such as ulna, radius, fibula, scapula are quite unsuitable and unnecessary. Such as facilitate work are introduced gradually, and not so as to make the material seem difficult and dull.

FIRST YEAR LESSON—II. FOOD

Aim of lesson.—To show that various types of food are necessary to health and what purposes each type of food serves. (The children know more about the actual food they eat and the shop it comes from than they do about their digestive systems,

and it is for this reason that the approach to food and digestion is made from this angle.)

The lesson.—The teacher begins his lesson by suggesting that the children consider what foods are bought from some of the shops in High Street.

In order to prevent diffuseness he suggests they consider Smith's, the butcher's, first.

(A scheme showing the different types of food is going to be built up as the lesson proceeds. The teacher actually begins it now. For the sake of convenience with

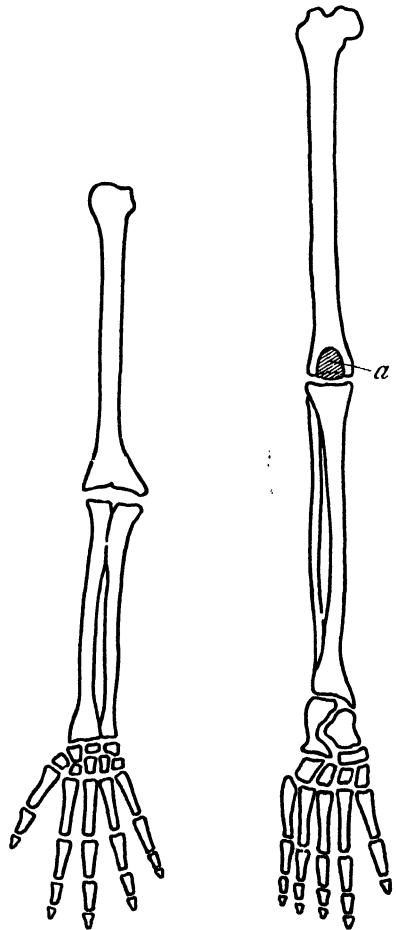

LIMB PLAN OF ARM AND LEG

a. Kneecap.

printing, only the completed table is shown below, but the places where the parts are to be inserted is indicated.)

The teacher does not spend time asking questions to which the answers are obvious such as, "What do we buy from the butcher's?" but he shows the class his line of procedure by saying, "Let us consider why we buy legs of mutton and joints of beef."

Here the teacher uses an analogy, somewhat as follows. If we want a car to go we need to keep it in repair by having, for instance, a spare wheel to put on when the one in use goes wrong, or by putting on spare nuts and bolts. (If the class consists entirely of girls, the sewing machine would make a better illustration than a car.) In the same way it is necessary to replace cell tissue of the body which wears away.

Just as we replace spare parts in the machine by similar parts, so we replace body tissue by similar tissue.

In every cell of the body is a substance known as *protein*. This same substance is found in other cells—in the cells of cows and sheep for instance, and so we eat the lean part of beef and mutton to supply more protein to the cells of the body.

In addition, our bodies not only need to be kept in a state of repair, but, so long as we are young, growth should take place. Protein is also necessary for this growth.

Let us put up on the board the first important fact we have learned about foods, and let us remember that from lean meat the body gets protein, the foodstuff which is in every cell of the body and which we all need both for growth and repair of tissues.

The teacher then suggests that the children think of purchases from Jones, the baker. (Enter on board.)

He returns to the analogy between the motor car and the body. The car needs petrol, that is, fuel, which is burnt up in order that energy may be produced to push the back wheels round and so move the car. In the same way the body needs fuel, that is foodstuffs that give heat and so energy to the body, to enable it to move. These

foodstuffs are called *carbohydrates*. (Call attention to carbo—carbon or charcoal—and burning.)

All kinds of starches and sugars are carbohydrates. Starch is made by plants in sunlight and one of the places where it is stored is in the grains of the wheat plant. Therefore, since bread is made from wheat, bread is a carbohydrate food. In the body the starch is changed into sugar before it can be used in the muscles as fuel.

Let us enter up on the board the second important fact that we have learnt about foods, and let us remember that from bread, biscuits and cakes the body gets starches and sugars, that is, carbohydrates, the foodstuff which serves as fuel and supplies energy to the body.

Let us next go to Brown's, the grocer's, and consider a third foodstuff that he can supply. This time let us go to the butter counter, and consider butter and lard.

The body needs to be kept warm, and the foodstuff that serves this purpose is *fat* in some form. Some of the fat gets stored under the skin and some is burnt up to produce heat.

We can now enter on the board a third important fact about foods and let us remember that from butter and lard the body gets fat, the foodstuff which serves to keep the body warm. The blackboard should now contain the following record:—

TABLE I

Name	Shop	Foodstuff	Use	Example
Smith	Butcher	Protein	Body-building and Repair	Lean meat
Jones	Baker	Carbohydrate (starches and sugars)	Fuel, giving energy	Bread, cakes
Brown	Grocer	Fat	Body-heating	Butter, lard

HEALTH EDUCATION IN SENIOR SCHOOL 415

By the time this work on food is finished the following line will have been added:—

Turner	Green-grocer	(a) Mineral salts (b) Vitamins	Body-regulating	Oranges, green vegetables
--------	--------------	-----------------------------------	-----------------	---------------------------

The next step in the lesson is for the teacher to discuss with the class other foods that contain the foodstuffs protein, carbohydrates, fat. He prepares another table

goes on to say that all of us, particularly growing boys and girls, need to have some good protein of animal origin in our food every day, so that it can be built into our bodies. The children state which foods on the board satisfy these conditions—lean meat, milk, etc.

The teacher then emphasises the fact that about the best and cheapest form of good protein is milk. He also gets the class to note that a fresh herring is as good as a similar amount of beef and usually much cheaper.

The children find a certain amount of pleasure in giving lists of things, so now they should be asked for foods in which sugars predominate. They will probably give jam, sweets, chocolate, honey, treacle, raisins. The teacher should enter them on the board.

In the same way, the list of starchy foods should be collected, say, flour, bread, biscuits, cakes, breakfast cereals, oatmeal and porridge, as well as potatoes and bananas.

The class can quickly decide from which shops we purchase carbohydrate foods.

This step should be repeated, collecting a list of the third class of foods, fatty foods. On the list should be butter, lard, cream of the milk, suet, cheese, yolk of egg. The teacher will probably have to give help with this list.

The board now shows the following:—



[Reproduced by courtesy of the National Milk Publicity Council.]

The class should analyse the chart, stating which foods contain protein, etc.

on the board (see Table II) and gradually fills it up.

He deals with protein first and explains that the best protein is from animal sources and in animal foods such as lean meat, lean bacon, poultry, fish, eggs, milk, cheese. (The class will be able to contribute some of these.) Protein can also be got from vegetable sources, such as peas and beans. The teacher enters these and asks from which shops protein foods can be bought. He

TABLE II

Foodstuff	Examples of foods in which the Foodstuff is found
Protein	(a) Lean meat, lean bacon, poultry, fish, eggs, milk, cheese (b) Peas, beans
Carbohydrate	(a) Jam, sweets, chocolate, honey, treacle, raisins (b) flour, bread, biscuits, cakes, breakfast cereals, oatmeal, porridge, potatoes, bananas
Fat	Butter, lard, cream of milk, suet, cheese, yolk of egg

As in the case of Table I, this table can be added to later in the lesson.

The teacher, referring to this second table asks, "Of which class of foodstuff is cheese an example?" There are of course two answers, protein and fat.

He repeats the question with, say, eggs and meat. By this time the class will have noticed that some foods consist of more than one kind of foodstuff and therefore serve the body in more than one way. The teacher takes herrings as a further example of this. They contain fat as well as protein, whereas white fish, like cod, contain no fat. He asks which is the better food. He further asks the class such questions as why a suet pudding is very acceptable on a cold day, the answer being because it is mostly fat and starch.

He points out that though we often eat fat indirectly, in the fat of meat and bacon, we also often eat it as part of a food, for example, the lard which has been used for frying the fish, or for putting in the cakes and pastry.

The teacher again, at this point, asks the class for the names of the three types of foodstuff already discussed. He then points out that we want all these foodstuffs in quantities, in bulk, as we say. The children, and again this serves as revision, can decide which kind of foodstuff we eat more of in bulk at, say, tea, dinner, and so on. The teacher points out that though we eat much more carbohydrate bulk than any other foodstuff, yet we must have foodstuffs of every kind for health.

As a preparation for dealing with foodstuffs which we do not need in bulk, he says that, for a moment, they are going to discuss wood, paper, and coal. He asks them to notice that wood is part of a plant, that paper which is made from wood is also of plant origin and so is coal.

He then asks, or demonstrates, what is left behind when a piece of wood, paper or coal is burnt and all the flame and heat has gone. The children eventually decide ash. He states that this ash is the mineral, unburn-

able part of the wood, paper or coal. He points out that just as plants have mineral matter in them, so we need and must have certain small amounts of mineral salts (as they are called) in our bodies, if we are to grow and to live satisfactorily.

The teacher continues by drawing attention to the fact that one place where we have clear evidence that we use the mineral lime or calcium is in our white, opaque teeth. This lime in our teeth has had to be taken from our food. Lime is also needed in our bones, to make them hard, and again it is needed in the general body metabolism.

There is a good deal of lime present in oranges, and in milk and in meat. Eggs contain some lime, which is provided for the needs of the embryo chick.

The body needs supplies of other minerals, also in minute quantities, for example iodine, iron in the blood, and other minerals present in the digestive juices. These minerals are obtained from fruits and vegetables. A short list of examples can usefully be collected.

The teacher next states that another important part of our diet is vitamins. These are obtainable in fresh, uncooked, greengrocer foods. They are present in very small quantities but are essential to life, because without them our food does not do us the good it ought to do. Milk, eggs, cod liver oil, all supply vitamins.

To revise the later section of the work, the class might consider the importance of purchasing foods from Mr. Turner, the greengrocer. His name, etc, should now be added to Table I (see page 415).

Dealing with various kinds of shops provides a good opportunity for the teacher to discuss the chemist's. He makes clear that we should not make regular use of the chemist's, for medicinal purposes, in the same way that we make purchases from, say the baker's. He explains that it is better to live healthily than to try to get health by a short cut, out of a bottle of medicine. (The teacher would here need to make clear that some things sold by the chemist are

foods rather than medicines, such as halibut liver oil, and therefore safe purchases.)

There is still one other important part of any diet that has not been mentioned, that is, water. It is not bought from a shop, but is so important that every home has to have its own supply. The class should consider briefly the ways in which water is used in the diet, (1) for drinking, (2) for cooking vegetables, (3) for boiling and steaming other foods. In addition, of course, it is contained in many foods.

The above represents the complete treatment of food during the first year. It is not intended that it should all be dealt with in one lesson period.

Many forms of expression work will suggest themselves with such a topic. Classes, for instance, find great pleasure, and profit, in drawing a kitchen table and arranging, say, body-building foods on one end and fuel foods on the other. They will also energetically produce slogans and posters. With regard to mineral salts they might be asked to explain one of the following, "It is said that the body has in it enough lime to whitewash a hencoop," or "There should be enough iron in the body to make five tin-tacks."

SECOND YEAR LESSON—I. FOOD

Aim of lesson.—To explain why we should eat fresh and natural foods.

The lesson.—The teacher opens the lesson by reminding the children of their discussion on the ways the sun affects food supplies. He sketches a diagram on the board showing a plant with the sun's rays on it, and asks the class to state what it is that the sun's energy, together with the green chlorophyll of the plant, makes. When the answer is given, the word STARCH is printed on the green leaf. The children then supply, say, three examples of starch stored in plants.

Likely answers are in potatoes, wheat, oats, nuts, peas, beans.

The teacher says that starch is an important food substance with which we are familiar. There are other important food substances which are not so well known, but which, like starch, are formed by the action of sunlight on the green parts of plants. They are called vitamins and are usually described as accessory food factors, because, though important, they are not found in bulk but in minute quantities. They are in fresh food and we get them by eating such foods. There are four chief vitamins, known as Vitamin A, Vitamin B, Vitamin C, Vitamin D. Though they are present only in very small quantities, shortage of them in our diet prevents us from being healthy in different ways.

The teacher discusses Vitamin A first. This is the Vitamin that makes us grow properly. One way in which we can get it is from such things as *green* lettuce leaves.

This can be expressed by what we call a "food chain":—

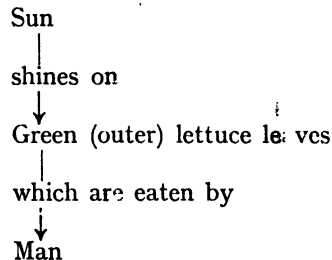

This food chain is built up in this way on the blackboard.

The teacher explains that the inner, yellow leaves may be tender and attractive, but that they have not had the sunlight on them to incite the manufacture of Vitamin A. At this point the teacher must mention that Vitamin A is also associated with the "orange" colour in carrots and tomatoes, and so these foods supply it to us; but he does not attempt to deal with the difficult question of the four pigments making up chlorophyll.

The teacher tells the class that closely associated with Vitamin A is Vitamin D which helps growth and makes bones and teeth hard and strong.

Vitamins A and D are found in milk. The chain that reminds us of this is:—

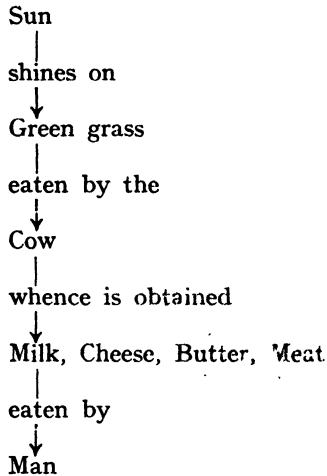

The teacher points out that the milk and butter, etc., supply the vitamins in sufficient quantity only if the cow has been fed on fresh grass, and so summer milk and butter

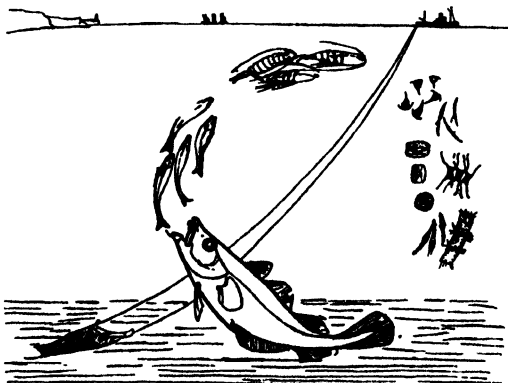

[Reproduced by courtesy of the B.B.C.]

HOW LIVING THINGS DEPEND ON ONE ANOTHER IN THE SEA

are better than winter produce. The teacher reminds the class that some cows stay in pens in the winter, and are given dry fodder, hay and clover.

The next point to be made clear is that Vitamins A and D can also be obtained from cod liver oil and from halibut liver oil, these oils being "expressed" from the livers of these fishes in which it is stored. The chain in this one is longer still:—

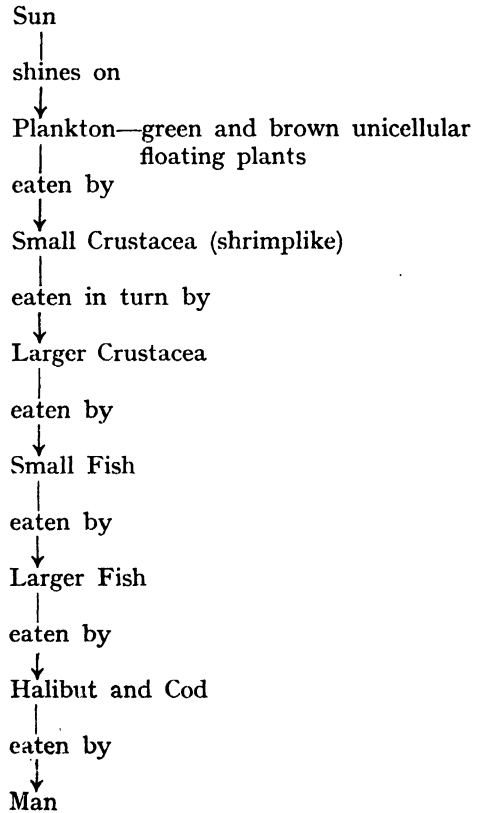

The teacher must take care to make clear that the vitamins are made at the plankton stage and transmitted through all the other stages to man. The teacher states that egg yolk and liver are also good sources of Vitamins A and D.

Since it has been discovered that rickets in children is due to shortage of Vitamin D, the disease has been prevented and is much less common nowadays.

The teacher's next point is to explain that children and grown-ups can make Vitamin D inside themselves if they have the sun's light falling directly on the bare skin. In eating ordinary fat, such as beef or mutton fat, we eat a certain amount of a stuff called *ergosterol*, and the sunlight turns any ergosterol that is stored just under the skin's surface into Vitamin D. At this point the children might be asked if they know the name of any open air school, and it might be shown that this making of Vitamin D was one reason why open air schools are good for children recovering from illnesses.

Vitamin C is next dealt with. This vitamin raises the body's resistance to illness and prevents us from getting spots and blemishes, or infections such as colds. The chains for Vitamin C are short. It is found in oranges, lemons, grapefruit, tomatoes, pineapple, and raw green vegetables, and cooking destroys it.

The teacher suggests that the children write down chains for Vitamin C and, say, oranges and watercress:—

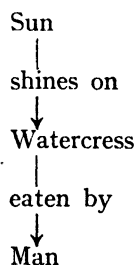
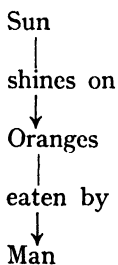

The teacher then asks which vitamin has not been considered. He explains that this vitamin, Vitamin B, is different from the others because it will withstand a certain amount of cooking, that is, it is not destroyed by being heated reasonably.

It is present in the *germ* of wheat and so is in brown bread. A chain for this is:—

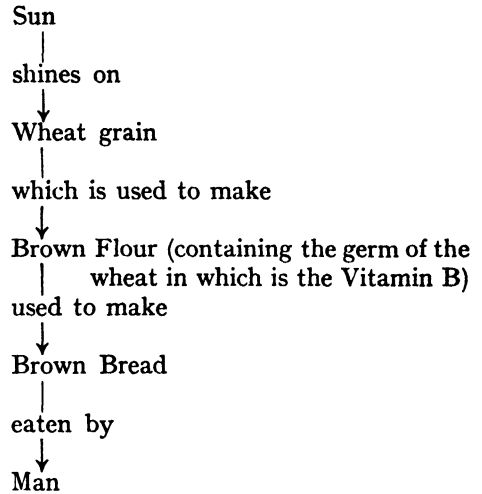

The teacher must stress the fact that white flour has had the bran, or outer husk containing the germ, and so the germ, milled out of it and in consequence it is much less valuable as a food.

Pigeons fed on polished rice which is much like white flour in that the husk and germ containing Vitamin B have been removed, get a form of beri-beri. They recover if fed on unmilled rice.

Malay prisoners fed on polished rice got beri-beri, but were cured by being given whole rice.

In this country we get only a partial shortage of Vitamin B in the diet, that is, we get some but not enough. We get digestive disturbances and loss of appetite for want of enough Vitamin B. Yeast extract, dried yeast and nuts are rich in this vitamin and are used to make up this shortage.

The teacher briefly states that there are other vitamins but that the above are the most important to us in this country.

A blackboard summary should be built up as the lesson proceeds, showing the vitamins in order, the chief foods in which they are present and what each does or prevents.

At this stage it is also convenient to consider briefly the allied foods that might be expected to, but do not, contain each

vitamin. For instance, Vitamins A and D though present in some animal fats are never present in vegetable oils (e.g., olive, almond, linseed) or in margarines made from them, nor are they present in lard, pork and bacon (unless the pigs have been reared out of doors and not in sties).

Again, Vitamin C is present in fresh fruits but not in dried fruits of any kind, such as prunes, figs, dates, currants (the teacher might ask the class, "What do these fruits supply however?") or in boiled milk, or in fruit or vegetables cooked a long time, or in jam or marmalade for the same reason. Tinned fruits because they are heated without air retain some Vitamin C, acid fruits the most.

Vitamin B has already come to notice as not being present in white flour, nor is it present in cakes or biscuits made from it, nor in cornflour, sago, treacle, or egg substitutes (which are mostly starch).

The class must realise that this does not mean that these foods which do not contain vitamins should never be eaten, but that the family should all eat some of the vitamin-giving foods regularly.

As an activity, the children can be asked to draw pictures of two articles of food supplying each of the Vitamins A, B, C, D, and show which food supplies which vitamins.

As a follow-up activity, they can usefully notice and bring to school anything they see in the papers about vitamins, before the next period. These contributions will have to be sorted out before use and those teaching anything relevant should be posted for general reading.

SECOND YEAR LESSON

II. MATERIALS FOR CLOTHING

This lesson has been chosen to show (1) a method of introducing experimental work into hygiene periods, and (2) to show what points should be emphasised in considering textures for clothing.

The purpose of the experiments is to give the children activity and to convince them by conclusions drawn from first-hand experience. The children should make *freehand* sketches of the apparatus and statements of the conclusions drawn, but it must be emphasised that there must not be lengthy note-taking and recording of the experiment, such as should be required only of adults. It is suggested that the conclusions drawn at each step should be put on the blackboard and from these it should be possible to get a final statement.

Aim of lesson.—To consider the relative values of materials for clothing.

Requirements.—Two large squares of each of the following materials:—flannel, calico, cellular cotton; several small squares of each of the same materials; several knobs of ice; glasses to hold water; six hot water bottles; stone ones are preferable, and small "stone ginger" bottles serve the purpose well. If nothing better can be produced ordinary medicine bottles will serve.

The lesson.—The class is told that the aim of the work is to compare and contrast the values of wool, cotton, and cellular cotton as materials for clothing. Attention is drawn to the fact that one thing we want clothing to do is to keep in body-heat in winter and so keep us warm, and to let out body-heat in summer and so keep us cool.

Experiment 1.—To find which material makes the best cover for a hot bottle, that is, which is the poorest conductor of heat.

Two hot water bottles are wrapped in flannel, two in calico, and two in cellular cotton.

(Throughout the lesson the actual activities are delegated whenever possible to members of the class. The teacher has to make constant comments, suggestions and queries as the activities proceed.)

Experiment 2.—To find which material makes the best cover when storing ice, that is, which is the poorest conductor.

EAT

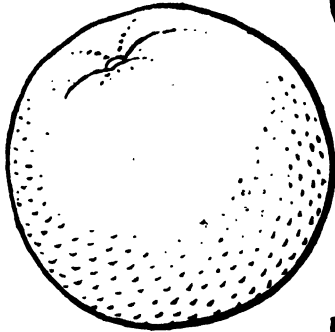

ORANGES

AND

PREVENT

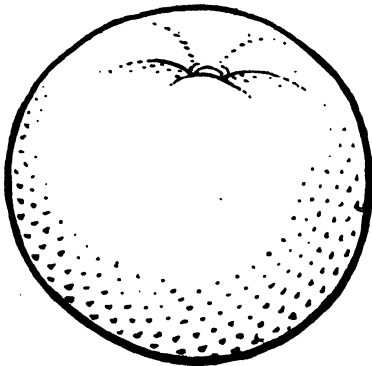

COLDS.

SAMPLE OF AN "ACTIVITY" POSTER

This is an example of the kind of activity that might arise out of a lesson, each child making up his own slogan and poster (See page 417).

Knobs of ice, as nearly as possible the same in shape and size, are wrapped up, two in flannel, two in calico, and two in cellular cotton.

In both experiments it is important that all the articles should be closely wrapped, so that air cannot circulate in and out. All the bottles should be placed in spots as similar as possible, and so should the pieces of ice, but these should be well away from the hot bottles. None of the objects should be in a draught.

The time of starting the experiment should be noted in each case. Brief notes should be made. Then the bottles and ice should be left until nearly the end of the lesson.

The teacher, having taken care in this way to set up first those experiments which need the longest time to show results, then proceeds with other experiments which take less time to finish.

Experiment 3.—To find which material is the most inflammable.

A piece of flannel and a piece of calico are each set alight. Two children holding the materials with crucible forceps allows of both pieces being lighted almost at once.

It is seen that the cotton lights up into flame and burns much more quickly than does the wool. The children sketch and record this briefly and should supply the conclusion that wool is safer material to wear, as far as the likelihood of catching fire is concerned. This conclusion is recorded on the blackboard.

Experiment 4.—To find which material absorbs water most quickly.

Pieces of cotton and of wool are dipped quickly in and out of two glasses of water, and it is observed that the cotton is soaked, whereas the wool can have the comparatively superficial drops of water shaken from it and is much less wet.

The children are then asked which material would be the better for wearing in a rain storm, and why. Then they are asked should top-coats be made of cotton or wool. They finally state the conclusion that wool absorbs water more slowly than does cotton, and this

is recorded. (Throughout, the flannel and the calico are used as typical examples of ordinary cotton and woollen materials.)

Experiment 5.—To find which material dries most quickly.

Fresh pieces of material are now put in water again, a piece of calico, a piece of cellular cotton and a piece of flannel. They are left for five minutes, until after the next experiment. A child records the time of putting them into the water. At the end of the time he takes them out, and hangs them in an agreed place, preferably in a draught by a window. The children record this.

Experiment 6.—To find, by feeling, which material is the poorest conductor of heat and which the best.

The children feel pieces of the various materials and record which feels warmest to the touch. They are reminded, by touching other objects in the room, some *feeling* hotter and some colder to them, that things that feel cold to the touch are conducting heat quickly from the hand, while those that feel warm take relatively little heat from one's hand. The objects which they touch are all at room temperature, about 60° Fahrenheit, while the hand is at about 98.4° Fahrenheit, that is, body temperature, the heat tending to pass from the warmer hand to the cooler object.

After a number of examples have been quickly revised, the class should be able to decide whether the wool or the cellular cotton or the calico feels the warmest and so which of them is conducting the least heat away, and so, technically, which is the poorest conductor of heat. (This experiment is mostly revision.) The children make a statement as to which, according to Experiment 6, is likely to be the best of the three materials for keeping us warm in cold weather. (At no point should the teacher state or imply that wool is the best of all materials for warmth, but only that it is the "warmest" of the three considered.)

Experiments 1 and 2 continued.—The children next investigate the progress of the

hot water bottles and the ice, wrapped up in the different materials.

A calico wrapper, a cellular cotton wrapper and a flannel wrapper should be removed, both in the case of a set of bottles and from a set of lumps of ice. With both experiments the three wrappers should be removed at the same time. The results should be carefully noted. Some difference should be apparent already; the results will be reinforced by the later records.

The hot water bottles wrapped in flannel and in cellular cotton are found to have kept hotter than those wrapped in calico. In the same way the knobs of ice wrapped in flannel and cellular cotton are larger (that is, less of the ice has melted, because less of the room warmth has reached it) than that wrapped in calico.

The children record these findings. They are asked which materials keep in heat better, and so which are better for wearing

in (1) cold, (2) hot weather, and why. The children decide for (1) wool, and (2) cellular cotton, and this is recorded on the blackboard.

The other set of three bottles, and also the other set of ice knobs, are kept in their covers longer, to establish a more marked difference. Certain children are made responsible for completing later in the morning the investigation and recording and reporting the results. (Of course the teacher unobtrusively supervises such work.)

Experiment 5 continued.—The children next consider the three pieces of material which were soaked and then hung up to dry. Different members of the class feel them. (There probably will not be time for all to do so, though this is desirable. It is an experiment the children can easily repeat for themselves if they show interest.) They then record which piece of material has dried most quickly and which least. The calico should be driest and the flannel still heavy

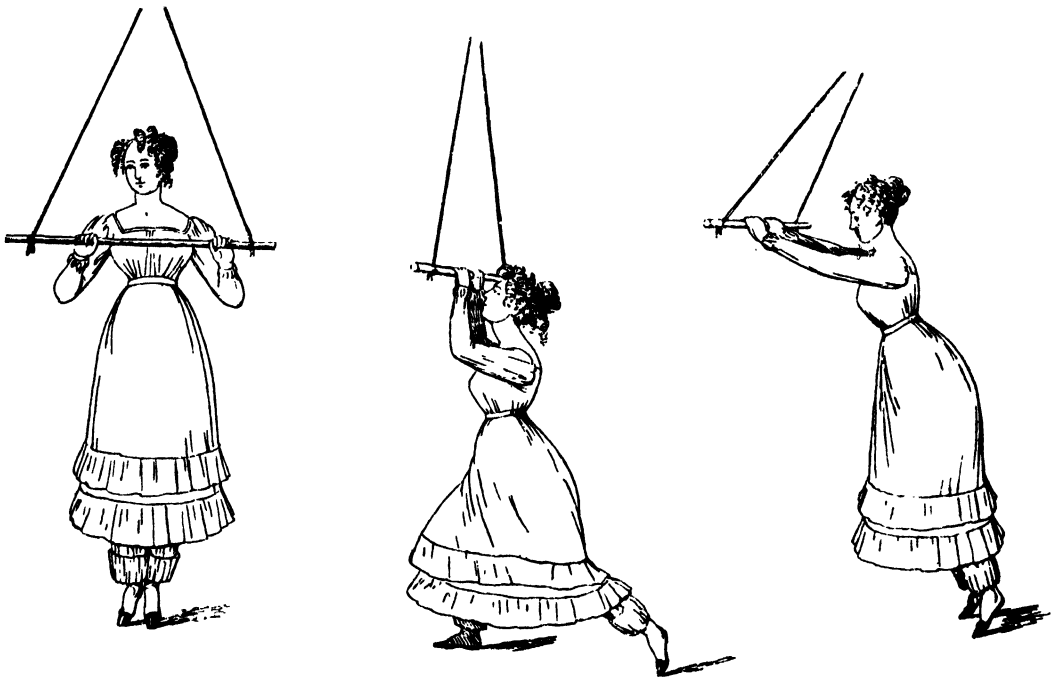

[Reproduced from Voarino's "Treatise on Calisthenic Exercises" (1827).]

Dr. Erasmus Darwin attributed the pale faces of young people in school to the oversedentary lives they led and urged a greater activity to promote health and growth. Compare the dress for physical activities in this picture with that in the picture overleaf.

with moisture, and the state of the cellular cotton should be intermediate. The result should be entered on the blackboard.

The teacher points out that wool once soaked dries slowly, and worn next the skin keeps the skin too moist; calico, on the other hand, dries too quickly and this chills the skin; hence cellular cotton is the best of the three next to the skin, because it dries after the skin has perspired quickly enough to keep the skin free from continual excess moisture, yet not so quickly as to make the

it cannot hold air in its texture to any extent, and so it is a good conductor of heat.

The conclusions that the teacher will eventually draw and record are:—

(1) In winter we need to wear wool rather than cotton for top garments, because it keeps heat in and does not readily get soaked in a rain storm.

(2) Cellular cotton material is best of the three materials all the year round, for wearing next the skin, because (a) it is a bad conductor of heat and keeps the body



[Reproduced from Board of Education Syllabus of Physical Training for Schools, 1933.]

A class of girls having free practice of agility activities. Contrast the dress with that in the picture on p. 423.

skin feel cold and clammy and so cause chills.

The teacher must also supply the information that the reason that wool and cellular cotton feel warm is that they hold air in the interstices of the material, and air is a bad conductor of heat. He compares the way in which animals with fur and with feathers hold the air they have heated round themselves and so keep warm. He also comments that, for similar reasons, fur-backed gloves are warmer than fur-lined gloves.

He draws attention to the fact that calico, on the other hand, is so closely woven that

at an even temperature, and (b) it absorbs moisture and dries more quickly than does wool and so keeps the skin healthily dry, rather than continually moist.

(3) In summer we need to wear cotton clothes that let us lose heat quickly and so keep us cool enough.

THIRD YEAR LESSON—I. CHARTS AND GRAPHS

The syllabus for the third year suggests that the child shall be led to consider health

problems from the point of view of the community. He is to gain some acquaintance with the various health agencies of the locality and of the State. Many of these agencies and bodies publish the results of their work and experiments in statistical and graphical form. It therefore seems advisable to train the child to read these records of clinics, hospitals, welfare centres and similar records of private workers.

Below is given an illustrative lesson on the reading of charts and graphs.

Aims of the lesson.—(1) To teach children to read simple charts and to make simple deductions from them; (2) to indicate to the children signs of interest and activity with regard to public health. (The lesson has been deliberately planned with this second aim in view, so that all the children will have a real interest in the lesson, not only those who have a *natural* liking for numbers and measures.)

The lesson.—The child of thirteen will not be entirely ignorant of column and line graphs. The value of the graph as a mode of expressing changes and the relations between quantities of all kinds is now clearly recognised, both in and out of school, and graphical work occupies a large place in the mathematical teaching and geographical teaching in school.

In connection with health education the child has probably met individual height and weight records in the junior school. The lesson might well begin with the consideration of one of these individual records, say the height record of a boy Smith from the age of seven to eleven. A simple column graph, like the one below will need to have been prepared on a blackboard sheet or on the actual blackboard.

The class will easily deal with this, and a number of the more competitive spirited children may decide to keep individual records to see who is growing at the greatest rate.

The main part of the lesson now begins by the teacher stating and recording on the board the following quotation, "England is not a milk-drinking or milk-using country." He then pins up the following diagram and asks the class to find out whether the chart confirms or contradicts the statement.

The children will see at a glance a certain amount of truth in the statement. The teacher, however, must carry this step of the lesson further and help them to obtain more definite information as to the milk

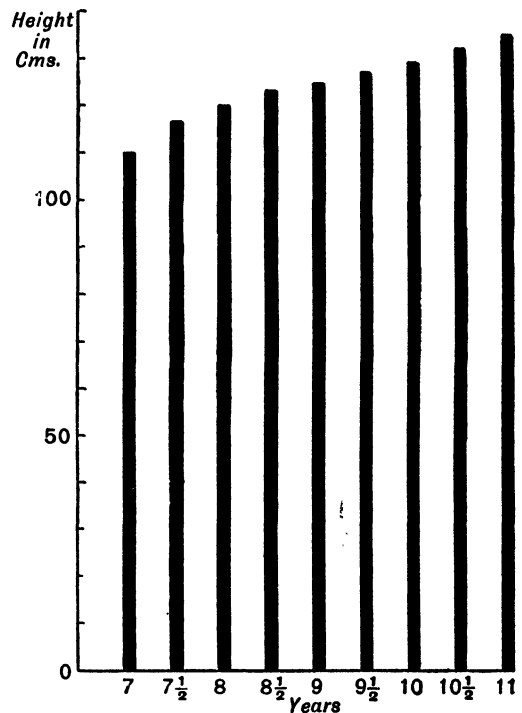

GRAPH I.

SMITH'S HEIGHT RECORD

Graph I shows the height record of a boy Smith (no actual boy in this case) during his years in the junior school. The usual custom of showing only the upper portion of the graph, (say, above the 100 cm. line here) has purposely not been followed in this graph. At a later stage the teacher might return and deal with the convenience of such a curtailing of data. A graph for the years 11-14, a "springing-up period," would have shown greater increases but would not satisfy the children unless actual height records were kept in their "11-14 year school."

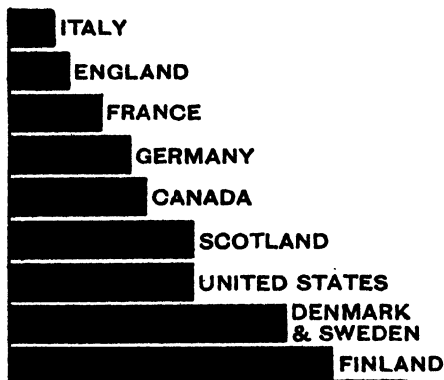

GRAPH 2.

DAILY CONSUMPTION OF MILK PER PERSON

From this the children verify the statement, "England is not a milk-drinking or milk-using country." It is also used to explain the phrase, "On an average." (From *Milk*, by W. C. Harvey and H. Hill.)

consumption in this country. This further information will consist of (1) comparison of amounts, such as that the column for England is only half as long as that for Germany, and only one-third as long as that for Canada; and (2) finding the actual amounts and meaning of these amounts. For this purpose the teacher should provide a cardboard rod marked out on the same scale as the graph. This should be applied to each column in turn. (At this stage such a gauge saves confusing the appearance of the graph by entering figures or scales. These will be entered as the children become more familiar with the general appearance of such graphs. In this way difficulties will be dealt with one at a time.)

When it has been discovered that *the daily consumption of milk per person for England is one-third of a pint*, the real meaning of this statement must be made clear. The final statement would be somewhat to this effect, "If the total amount of milk used in England in one day could be equally shared, every person would have one-third of a pint. The milk is not equally shared; some people have more than one-

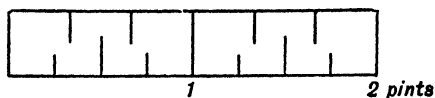

CARDBOARD ROD

A cardboard rod, marked off on the same scale as Graph 2, is applied to the columns in Graph 2 to find actual quantities of milk used. The gauge represents two units, and therefore measures "two pints." It is marked in thirds and quarters because the amounts were given in third-pints and quarter-pints.

third of a pint and some have less." To ensure real understanding of this idea of *average*, individuals should be asked to explain in similar terms the state of affairs in (1) U.S.A., (2) France, (3) Finland. The teacher might finally ask, "Is it true to say that every person in Germany drinks twice as much milk a day as every person in England?"

This question of equal sharing may seem laboured, but children often find real difficulty in the notion of "average." So many records are given in this form that children will need further practice in such work in later lessons.

In the next step the teacher briefly refers to the value of milk as a food. This is revision work. On the board the teacher has already written, "England is not a milk-drinking or milk-using country." Now below this, arising out of the revision work, he writes, "Milk is a valuable food."



[Reproduced by courtesy of the National Milk Publicity Council.]

Such a poster reassures the adolescent who fears being ridiculed for drinking milk.

He tells the class that a doctor named Corry Mann was aware of these two facts and, being keenly interested in the welfare of children and in public health, he set himself to find a way to convince the public that milk was a valuable food and that therefore it would be better if England became a milk-drinking and milk-using country.

He decided upon a way to do this. He made up his mind to experiment by providing a group of boys with extra milk daily.

He planned the experiment like this. He chose a school where the boys boarded, so that he would be able to fix exactly what food they should have. He divided the boys into two groups, A and B, and all the boys in group B were to have exactly the same food as the boys in group A, but they were to have *in addition one pint of milk each day*.

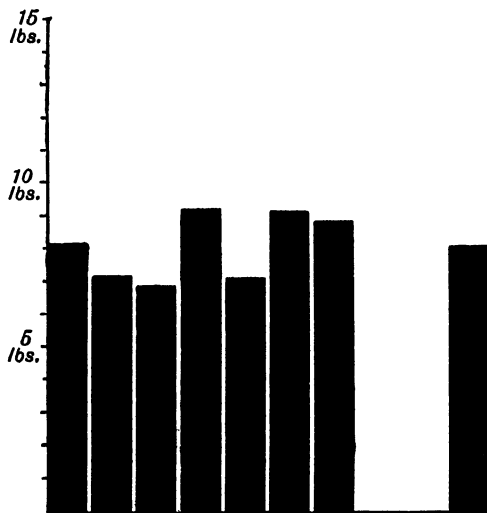

GRAPH 3.
CORRY MANN EXPERIMENT
GROUP A
INCREASE IN WEIGHT

Graph 3 shows the increase in weight of a sampling from Group A. The sampling consists of boys weighing 50-59 lb. at the beginning of the experiment. Average gain in two years is 8.0 lb. approximately. See last column of graph.

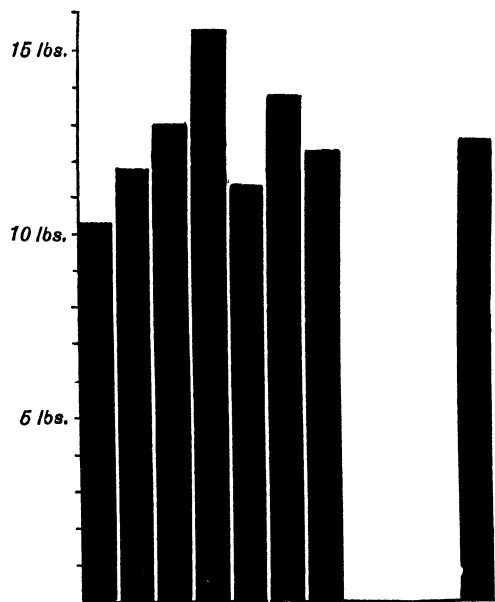

GRAPH 4.
CORRY MANN EXPERIMENT
GROUP B
INCREASE IN WEIGHT

Graph 4 shows the increase in weight of the corresponding sampling of boys from Group B (boys weighing 50-59 lb. at the beginning of the experiment). Average gain in two years is 12.5 lb. approximately. See last column of graph.

The teacher writes on the board:—

Group A. Daily diet.

Group B. Daily diet plus one pint of milk.

The experiment lasted for two years, and all the boys were weighed and measured regularly.

Here are two graphs, showing part of the results. Let us see what we can learn from the graphs. Each column represents the results for one boy.

The teacher has already prepared the graphs for the purpose. The children should read the titles and state what the graphs are meant to show. It is not necessary for them to find the exact increases in weight to an ounce.

They should draw a general conclusion from their observations. The teacher should draw attention to the "10 lb." line, and its significance. No boy (in the graph) in Group A increased in weight by as much as 10 lb.; and, no boy (in the graph) in Group B increased in weight by less than 10 lb.

At this point, the teacher should enter by the side of each graph the average increase in the group (see captions) so that the children may discuss averages further.

The teacher should not fail to tell the class that the graphs on the board are only representative parts of the complete records.

The teacher writes the general conclusion on the board as follows:—

Conclusion 1.—The boys in Group B gained in weight more than the boys in Group A.

The work should now be repeated with the "height" graphs, and general conclusion 2 should be entered on board.

Conclusion 2.—The boys in Group B gained in height more than the boys in Group A. The teacher tells the class that

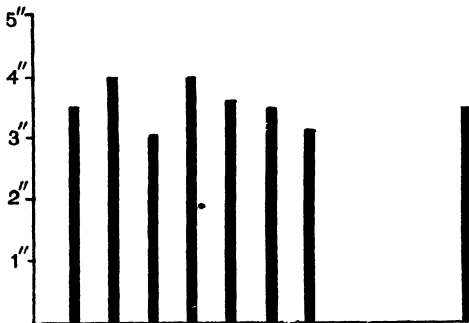

GRAPH 5.
CORRY MANN EXPERIMENT

GROUP A
INCREASE IN HEIGHT

Graph 5 shows the increase in height of boys from Group A. Average gain in height in two years is 3.45 in. All the graphs were drawn for the lesson from Corry Mann's Report, where the records are given in statistical form.

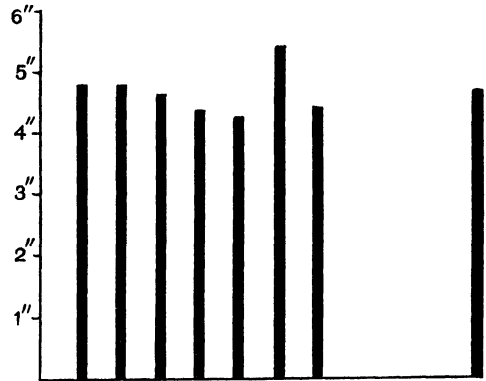

GRAPH 6.
CORRY MANN EXPERIMENT

GROUP B
INCREASE IN HEIGHT

Graph 6 shows the increase in height of boys from Group B. Average gain in height in two years is 4.64 in. Note that in all the four graphs the average gain means the average for the whole group, not for the few boys represented on the graph.

careful observation throughout the two years showed that the boys in Group B, that is, those with additional milk, improved also in general health and cheerfulness.

He also tells the class that Corry Mann finished his work by publishing a report, so that all might see the advantage of giving English boys and girls more milk.

Other people have since carried out similar experiments with very large numbers of children, with similar results. It is largely as a result of these experiments that school-children are now supplied with one-third of a pint of milk daily at a halfpenny a day.

These experiments, the teacher points out, are an excellent example of how men may serve the community and help to improve the health of the nation.

The next step in the lesson gives an example of a man's service for the health of others in another country.

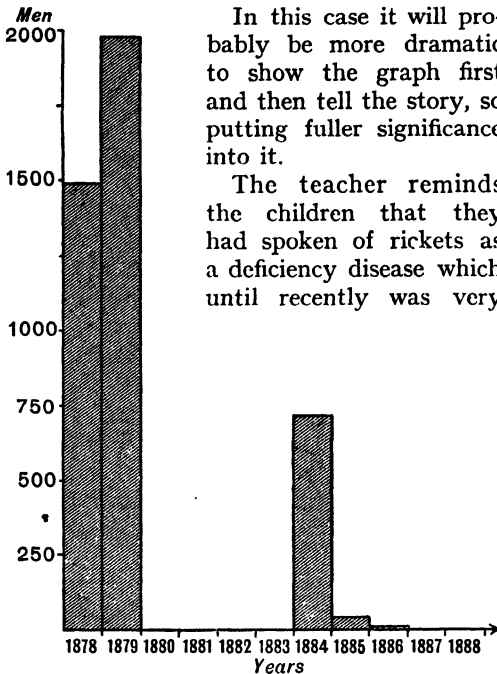

GRAPH 7.

THE CONQUEST OF BERI-BERI IN THE JAPANESE NAVY

This is a record of the number of cases of beri-beri in the Japanese Navy in certain years. It shows gaps in the record. This is the first graph in the lesson where the columns have been joined to adjacent ones. Note the purpose served by the arrow. (Graph made from statistics given in *Vitamins*, by Harris.)

common in the big cities of this country. He tells them that there is a widely spread deficiency disease known as beri-beri in some Eastern countries. He tells of its prevalence half a century ago in the Japanese navy. The children look at the graph again, read the title again, and note that in 1878 nearly fifteen hundred sailors had beri-beri, while in 1879 the number had increased to nearly two thousand. The teacher adds that about three out of every ten sailors in 1878 had the disease and in 1879 it was about four out of every ten (facts not to be found from this graph). The graph gives no record for the next four years. The

children look at the columns for 1884 and the following years. The great change was due to a Japanese doctor, named Takaki, who joined the navy in 1872 and determined he would find some cure for the disease.

He obtained permission to make changes in the diet of the sailors. Look at the graph, says the teacher, and find out how quickly he was successful. It was by experiment that he found the right kind of diet. It was not until many years later that it was realized that this new diet saved the sailors from beri-beri because it contained much more Vitamin B than the former diet.

The teacher asks the children how they know from the graph that Takaki was soon successful. He also asks what in the graph shows the conquest of beri-beri in the navy. What does the graph suggest would have happened had not Takaki altered the diet?

This step of the lesson should close by commenting upon this graph as a further record of the work of a man in the service of public health.

In order to give individual activity, the children can be set to work to read the following graph, and to write down all they can learn from it.

The graph is somewhat more difficult, and the work will need careful correction. The teacher should, however, allow the child uninterrupted time to do the exercise before correction takes place.

This last graph is in a sense "two graphs in one." The teacher could prepare for this idea by having Graph 8A, consisting of the columns showing percentage *before* treatment, and Graph 8B, consisting of the columns showing percentage *after* treatment. Graph 8A should be drawn on transparent paper and superimposed on Graph 8B to make the composite graph. Should the teacher, knowing the capacity of his class, think it advisable, Graph 8A might be kept separate from Graph 8B and compared with it.

This last graph was chosen to bring to the children's notice a further example of work which has been and is being done for

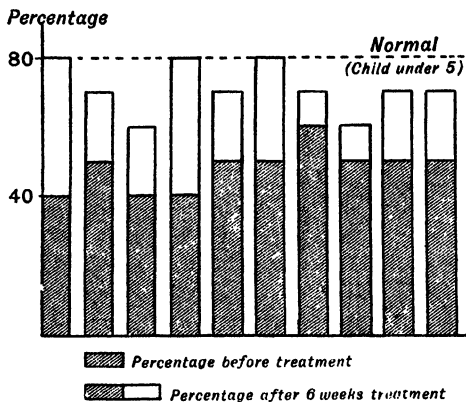

GRAPH 8.

HAEMOGLOBIN (BLOOD COLOURING MATTER) PERCENTAGE

Graph 8 shows the change in the amount of haemoglobin in the blood of children as the result of artificial light treatment. The amounts are expressed as percentages; this is the usual way of expressing amounts of haemoglobin.

The shorter columns represent the percentage at the beginning of the artificial light treatment. The longer columns give the percentage after six weeks' treatment.

Note the horizontal line that represents the normal percentage, 80, for children under 5 years. All the cases here are of children under 5 years.

(From *Artificial Light Treatment of Children*, by K. M. L. Gamgee.)

public health. Light treatment was chosen so that the children should not, by considering the other graphs in the lesson, think that men were searching for improvements in food and diet alone.

This lesson unit will occupy more than one lesson period and the interest of the children should be maintained between the periods by getting them to collect and bring other examples of graphical records and graphical evidence with regard to health matters. Many can be found and with *guidance* the children can learn much from them.

The graphs used in this first lesson have all been column graphs, but others should be displayed from time to time showing continuous linear and curved graphs. For example, senior school children show real

interest in the "growth curves" (preferably enlarged for the purpose), printed in the Board of Education's *The Primary School and Infant and Nursery Schools*.

This work should be done in the hygiene periods and not left to the mathematics periods. Here the graph is used as a tool for hygiene, whereas when taught in the mathematics class the situation is reversed and the hygiene material is used to illustrate the graphical technique. It will, however, be all to the good if the mathematics teacher can be persuaded to give *additional* examples in his graph work, following this lesson.

THIRD YEAR LESSON—II. EVERYBODY'S FIGHT AGAINST INFECTIONS

Aim of lesson.—To produce a health conscience against carelessness in spread of infections.

The lesson.—The teacher begins the lesson by pointing out that if anyone in the home or class has toothache it is unlikely that others will in consequence get toothache; whereas if someone has a "cold" there is some likelihood that other people will catch a cold too, and several people may, in turn, have a cold of the same type. The cold is said to be infectious, and we know that it is conveyed from person to person by the breathing in of bacteria, probably in a wet medium by droplet infection (see page 399), or in a dry endospore condition on dust particles. The class can supply examples of other infections such as measles, mumps, diphtheria.

The teacher next recounts the following:—

The Black Death in the Middle Ages has come down to us as an actual name, because it was a particularly bad example of such waves of infectious illnesses or epidemics.

These epidemics, as can be found from reading contemporary records, tended to occur after bad harvest seasons or times of civil unrest, when food was short in consequence and people's resistance to illness was

low. They also tended to occur when the shortage was one of fresh vitamin-supplying foods. (The epidemics of influenza that killed so many people in 1916 and 1918 during the Great War were undoubtedly due partly to the effects of food shortage on the general home population.)

The epidemics tended to be prolonged because people did not keep their bodies or their dwelling houses clean and because there was no efficient arrangement for the disposal of refuse, and this would breed flies and help to harbour infection. Suppose that everyone living in your street threw all his refuse into the road and it was left there to decay; you can imagine how unhealthy and smelly as well as unsightly the result would be. Yet this is what was done regularly.

You have all heard of the Great Plague of London which occurred when Charles II. was king. It is now known that that particular plague is carried by rat fleas, the fleas biting a patient with plague and later on biting a healthy person, injecting some of the infecting germs into the healthy person's blood, so that, if his resistance is low, the disease is contracted.

The class can suggest an obvious way to have stopped this plague, namely, to have kept down the rats. This seems obvious and sensible now that we know the cause of the plague, but the people at the time did not know the cause, and one of the ways in which they tried to deal with the plague was to kill off all the cats and dogs, the

very animals which would have been likely to keep the rats in check.

The teacher explains that another infectious disease, spread by fleas and associated with dirty conditions of living, is typhus, also called gaol fever because it is prevalent in gaols. At one time prisons and even hospitals were very dirty. In these dirty and dark prisons the prisoners were badly fed and clothed, and in consequence there are numerous recorded occasions when judges and other officials of the law courts,

in which the prisoners were tried, caught gaol fever from the prisoners and died from it wholesale.

The teacher next tells how John Howard (1726—1790), a Bedfordshire man, first took an interest in the improvement of prison conditions, and, after a long life spent in trying to convince people of the justice of his point of view, died of typhus himself when he was on a journey to Russia. He explains how gradually it came to be realised that to retain such foci or

centres of infection, as these prisons, was detrimental to the community as a whole, apart from the prisoners themselves.

The children are next shown that it was not, however, until Louis Pasteur (1822—1895), a French scientist, discovered that *specific* bacteria were the cause of certain infectious diseases that the way was opened for the wider application of these discoveries. Pasteur himself did much work on the disease rabies or hydrophobia, which resulted from the bite of a mad dog. He found the germ causing the disease and from this was



[Photo: British Museum.]

JOHN HOWARD

Portraits are an incentive to a class to search for information.

able to make an antidote, in the form of a vaccine, from the spinal cord of rabbits which had died from rabies. With this vaccine he was able to cure dogs which had rabies, and at last, in 1885, a boy who had been bitten by a mad dog was brought for treatment, and Pasteur unhesitatingly treated him with his "rabbit" vaccine. Then the boy got better without further trouble, but Pasteur must have been anxious until sufficient time—about six months—had passed for him to be sure that the disease would not occur. By 1899, twenty-three thousand people had been treated with a high percentage of success.

The children are asked to note that rabies is so rare in this country as to be nearly non-existent, and this for two reasons, (1) the care with which the disease among dogs was stamped out, by muzzling, and (2) the legal enforcement of six months' quarantine on any dog entering the country. Owing to this second enforcement any dog infected with rabies entering the country would develop the disease before leaving quarantine. This is another example of the value to the community at large of legal enactments.

The teacher continues to explain that when Pasteur, and the scientific workers who came after him, had once settled on the cause of the group of diseases we now speak of as "infectious," it became obvious that

methods could be taken to isolate patients who contracted these diseases, to prevent other people getting them.

It was also found possible to extend the antidote vaccine work, and an example of this, in the Great War, 1914—1918, was the inoculation of men against typhoid fever, also called enteric fever. This is a water-borne infection, and in the South African War, 1898—1901, more men died of typhoid fever than from the efforts of the enemy. In the 1914—1918 war, however, very few men contracted the disease, because even if they did drink infected water, they were able, because of inoculation, to resist the germs and remain uninfected. Similar inoculations were given against tetanus or lock-jaw, with great saving of life.

The teacher sums up to this effect. Pasteur's discoveries about the cause of infectious disease made these conditions *preventable*. His initial discovery has made possible the discoveries about bacteria and the control of them that

is still going on. The improved conditions under which we live have made life safer from illness while we live and given us all a probability of living longer. He has undoubtedly affected the lives of every one of us.

As a form of activity the children are asked to write down ways in which everyone can help to prevent the passing on of infections, and also ways in which the

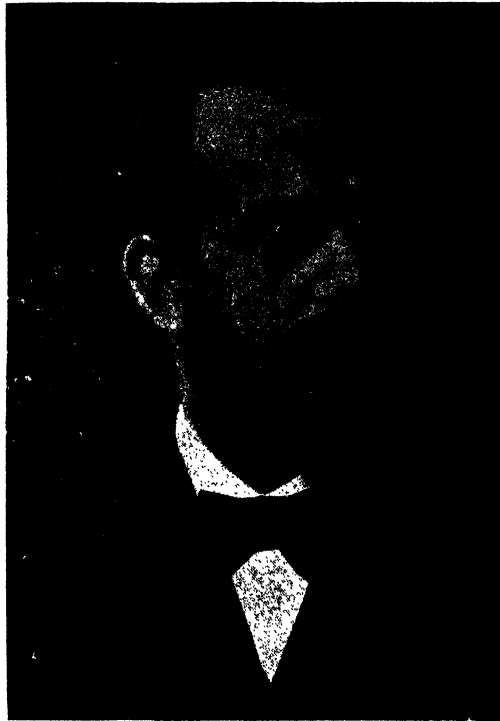

ROBERT KOCH

[Photo: Fischgitz.]

This portrait might be used to arouse out-of-school activity. Who was Koch? What do we all owe to him?

particular district authorities in the locality deal with this matter. This latter might usefully be made a matter of out-of-class activity, to be discussed with the teacher in a later period.

Out-of-school activity might also include the finding out of information about the work of Lister, Koch, Ross, Lind, Elizabeth Fry. It might take the form of making a poster emphasising the ways of keeping the body's resistance to disease high; illustrating such things as foods to eat, sleeping under good conditions, getting fresh air and sunlight, wearing the appropriate clothes for the activity in hand, and so on.

It is to be noted in the above lesson that examples of epidemics have been purposely taken from diseases now got rid of, rather than the disease still personally dangerous. This allows the class to grasp the principles without arousing fears for their own safety. The teacher should, however, be careful to leave a final impression that the help of *all* is still most important to the community; there should be no feeling that there is cause for self-congratulation and relaxation of effort with regard to infectious diseases.

THIRD YEAR LESSON—III. THE VALUE OF A HEALTHY OUTLOOK

Aim of lesson.—To help the class to understand the value of a healthy outlook.

The lesson.—Many of the ideas discussed in the lesson will have been assumed and taught indirectly throughout the three years. At this stage, however, they need to be made explicit.

Such a lesson cannot be approached until the teacher has the confidence and respect of his class.

Adolescence is a time of emotional development and emotional adjustment, and for this reason youth needs definite, positive guidance. Adolescence has been spoken of as a time of "oscillations," when mood succeeds mood, often in rapid succession.

The youth is now elated, now depressed; at one moment confident, at the next hesitating. He is introspective and tries to account for these fluctuations. The educator's task, at this stage, is to point the way to a healthy outlook.

The teacher must guard against any suggestion of mental defect in the sense of subnormal or low intelligence, and confine his work to the question of emotional stability. The whole topic must be dealt with in a matter-of-fact way, with no trace of sentimentality.

Hectographed or typed sheets like the following are distributed to the class:—

1. Mr. Smith interviewed candidate after candidate for the vacant job, but decided they were unsuitable. When Edward entered the room Mr. Smith thought, "Here is a fine, well-grown youth," but nevertheless, after talking to him for a time, he did not offer him the post. John was the next to be interviewed. Mr. Smith soon made up his mind. "Yes," he said to himself, "here is the boy for me. Not only is he strong, vigorous and active, but I like his frank, cheerful, unhesitating manner, and his readiness to tackle the unfamiliar parts of the job."

2. The sports were in full swing. The points for each House were slowly mounting up. It promised to be a close tussle. Jackson was aware of this. The contest of throwing the cricket ball had begun. What if he should fail? What would the boys think of him? He wished people were not watching him! Hesitatingly, as each of his three turns came round, he took his throw. They all fell short of Knight's, but then, thought he, Knight always was a cool customer and had all the luck.

After the class has had a short time in which to study them, the teacher discusses each incident in turn. His aim with the first paragraph is to obtain, from the class, the reason for John's success. He rounds off the discussion by stating explicitly that a man is judged not by his physique and appearance alone, but also by his behaviour.

The second "story" is used to reinforce the first. This time the children try to account for Jackson's failure. The teacher makes clear that Jackson had been thinking of his own reputation. Knight of the throw—perhaps of keeping his weight behind the ball, and of the angle of projection of the ball. Jackson, as the school knew, had the necessary skill, but he lacked something—confidence. Of the two Jackson would have been called the stronger, healthier boy; but Knight, the more determined, the more courageous, the more confident, won. It was Knight who proved a useful House member, and served the community.

The teacher now makes a generalisation from the discussion, to the effect that a sound, healthy mind is as necessary as a sound, healthy body. He introduces the terms physical health and mental health.

The teacher next tries to give a fuller and clearer impression of what is meant by mental health. He explains that when we speak of a healthy man or woman we should mean more than a person free from bodily ailments or weaknesses. We should mean an individual who is free from unnecessary fears, unfounded anxieties, excessive self-consciousness. We mean a person who is healthy in mind as well as in body. He can probably make the notion still clearer by saying, "Do you remember we said, when talking of bodily ill health, that disease meant not at ease? The same is true of mental ill health. It means the mind is never at ease. Jackson was not mentally healthy because his mind was not at ease. He was unnecessarily anxious and afraid."

The teacher, in order to break up the oral work, sets his children to do the following in their note books. "Name five necessities for bodily health." He suggests the number five to prevent the children from wandering too far from the most essential factors and then feeling aggrieved that their contributions are not taken up later in the lesson. He expects answers such as sleep and rest; food; exercise; fresh air and sunlight; cleanliness.

Having checked off the answers, he continues the lesson by saying, "In many ways a healthy, sound mind helps us to keep a healthy body, and *vice versa*. Let us take some of the needs of body that we have just written down, and see how far they are affected by our mental conditions."

The body needs sleep and rest.—If we allow ourselves to be troubled because we "came in fourth" in a race, because we did not get a certain Scout badge, because we were laughed at for being clumsy, we do not get restful sleep. If this continues, our bodily health suffers, and we become even less likely to remedy the troubles.

The body needs food.—We know the processes of digestion, and we know a little about the endocrine glands. If we are anxious about a swimming test, afraid about the consequences of a foolish prank or some unlucky accident, or jealous of some possession or success of another person, our gland secretions for the time being are not balanced. This lack of balance upsets our digestion, with the result, again, that bodily unfitness is added to mental unfitness. Notice still further that this indigestion, in its turn, makes further worry, fear or jealousy likely.

The body needs exercise.—The person who is hesitating and lacks self-confidence is afraid to try many forms of exercise which are excellent for bodily health, such as swimming, jumping, or boxing. In the same way some people, fearing ridicule, will not dance or play games like tennis.

People who are shy and unsociable miss many opportunities of exercise because they are not invited to go for rambles or picnics.

In each of these cases the body is denied the exercise it needs because the mind is not at ease.

The teacher, having worked out the above three cases of the relation between mental and bodily health, tries to get illustrations from the class with regard to the effect of mind on the other needs of the body—the body needs fresh air and sunlight, and the body needs to be kept clean. The

arguments for fresh air and sunlight are very similar to those for exercise.

In the case of cleanliness the teacher will, probably, have to give the first example, such as, if we are harassed or depressed we tend to lose our self-respect for the time being. We say, "Why should I bother; nobody cares whether I look clean or not; nobody will notice whether my hair is brushed or not."

(At the discretion of the teacher, the lesson may be broken here and continued in the next hygiene period. In such a case the teacher should include the work now called "optional" as a definite part of this second lesson.)

The next step in the lesson is to consider the effect of bodily ills on mental health. This should prove a fairly easy task. The children can be set to answer the following question in their note books:—Explain in what ways you think defective hearing, or short sight, or decayed teeth, may affect the mental health of a boy or girl.

This will need to be followed by brief discussion. The teacher can round off this step in the lesson by calling the attention of the class to the fact that when we are bodily tired out we lose our sense of proportion; we become, as we say, frightened at our own shadows. He discusses how the mountains of midnight shrink to mole hills next morning after a good night's sleep.

The next step is to make explicit the fact that a healthy individual is one who has adjusted himself to his environment. Firstly, the healthy person is one who faces reality, and, as we say, does not cry for the moon. He has learnt to realise that he cannot have everything his own way. He may be going to a picnic, but no action on his part will drive away the rain. In the same way, he may want to stay up late at night amusing himself and also be up early next morning for work or play, but he has to make a choice, realising that his bodily health will suffer for want of rest.

Secondly, the healthy person is one who fits himself to society. He has learnt that

he is a social creature, who lives to the full only in a community; and he has also learnt that community life brings responsibilities as well as privileges, gives opportunities and demands sacrifices.

The truly healthy person not only enjoys life himself, but in many indirect ways helps those around him to a more healthy life because the power of suggestion is strong in all of us. Think of the confident explorer or the fearless leader in a rescue party, how quickly their comrades throw off their doubts and fears and follow them. Again, think of the phrase, "He had an infectious laugh," and consider how the bright, cheerful, hopeful person passes on cheerfulness. On the other hand, think how the grumbler gathers other malcontents around him.

In short, the truly healthy person is the one who is at peace with himself and the rest of the world; the one who is not only no burden to the community, but a useful, helpful member.

The actual lesson concludes with some statement to the effect that we must do all we can to prevent mental ill health, just as we do to prevent bodily ill health.

Optional work.—As a piece of optional work the following may be given:—

Read this extract from the diary of Sandford Fleming, the daring leader of the Pathfinders who searched for a path for the Canadian Pacific Railway. Then say why you think Dave Leigh has been chosen here as an example of a healthy man.

"At Victoria I am to part with Dave Leigh, the last of the men who had been with us in the mountains. He joined us at Bow River, and had determined to see us to the end of our journey. From the day when we commenced with pack-horses to cross the range of mountains, Dave has stood by us and has gallantly helped in many a difficulty. He is a powerful Cheshire man, such as one would fancy a northern Englishman to be; honest, self-reliant, plain-spoken and staunch, with a peculiar

habit of calling a spade a spade. He has cooked for us in all circumstances, there is no other word for it, heroically. He did his share of the packing, and if there was a load a shade heavier it was caught up by Dave with some saying of his own, and off he trudged as if it were a plaything. He has done everything for us that a man could do with unfailing cheerfulness, and has followed our fortunes for many a mile. He has driven pack horses, paddled canoes, rowed boats, built rafts, stretched our tent, driven handcars, cooked our food. . . . He crosses the Straits of Georgia, and then at Victoria we have to say goodbye." (*The Story of the Canadian Pacific Railway*; Keith Morris.)

The type of answers expected are (1) those suggesting bodily health such as: powerful man; trudging off with heaviest loads; his many sided work; standing the hardships of the heroic journey; (2) those suggesting a healthy outlook: self-reliant; straight-forward; cheerful; he accepts reality; he fits in with his companions; he is of service to the others; he is healthy because he is at peace with himself and the rest of the world in spite of the difficult situation.

THIRD YEAR LESSON--IV. FOOD

Aim of lesson.—To teach discrimination in buying food, by showing the class how to apply the principles learnt in regard to food.

The lesson.—The children are asked some days beforehand to bring advertisements (pictures and slogans) about foods, and the teacher makes sure that he has any he particularly wants for the lesson. If possible the advertisements are all displayed, in groups, those for fruit together and so on. Such slogans as, "Eat more fruit," "Drink more milk," "Drink more beer," "Eat more bread," are some possible examples.

The teacher begins the lesson with the statement, "The hen and the cow do not

advertise." He discusses it briefly and goes on to show that there is, so to speak, publicity, these days, even on behalf of the hen and the cow. He discusses the Milk Marketing Board and the National Mark system, showing that they do something to point out the values of natural products such as milk and eggs.

The teacher states that when we come to spend our money there are roughly three classes of foods. He discusses each in turn as follows:—

1. *Natural foods.*—These include eggs, milk, lemons, fresh meat and fish, and oatmeal. You have not had to pay anyone to treat the natural product in any way. In addition, when you buy it in its natural state you do not have to pay extra as when buying it in a special packet under a special private trade mark or brand. Further, in such foods you are *sure* of getting the full vitamin content.

2. *Branded foodstuffs which are very fairly what they pretend to be.*—Here you have to pay for the "brand" mark (which you don't have to with an egg, for instance) and so such articles tend to be slightly dearer than the natural article. For example, the numerous breakfast food cereals are all carbohydrate at bottom, whatever treatment they have undergone, and they are no better foodstuff than the ordinary, unbranded oatmeal porridge which is cheaper.

3. *Foodstuffs sold under brands which are definitely not what they pretend to be.*—For example, lemonade powders are made in a chemical laboratory and have "never seen" a real lemon. It is only real lemons in lemonade which give both Vitamin C and salts such as calcium.

When a pot of jam is marked "Full fruit standard," it does not mean that it is all fruit and sugar, but that the minimum amount of, say, real strawberries that the Government requires in that size pot has been put in and the rest is made up with such cheaper things as coloured-up root vegetables.

Egg powders and custard powders, which

some people buy thinking they are made of eggs, can be tested with iodine and will be found to be mainly carbohydrate in the form of starch, highly coloured with yellow colouring matter. At this point the class should answer the questions, "What valuable foodstuffs would eggs supply which is lacking here? Are eggs or starch cheaper for the manufacturer to put in his food?"

The teacher points out that babies' and infants' patent foods can be tested in the same kind of way, and if they are found to contain starch such food would be definitely harmful to young children. One way in which infant welfare centres do good work is in supplying, at cost price, dried milk and other foods definitely good and suitable for young children.

The teacher then goes on to stress the need for thought when buying. The class will be quick at this stage to appreciate the following statement:—While branded foods may be, and many are, good, we should be careful about believing all that advertisements say about goods, for it is really a case of the manufacturer praising his wares in order to make money. What he says may be true, but it is likely to be somewhat over "glowing." We must therefore beware of being too suggestible.

The teacher next discusses with the class measures taken by the Government to safeguard the purchaser of unbranded foodstuffs. He makes clear to the class that unbranded foodstuffs have to conform to a certain standard of purity fixed and enforced by the Government. This service of supervision of foods is part of the protection we get as citizens for paying taxes. For example, milk may not be adulterated (as by adding water to it), and it must be produced under standard conditions of cleanliness. Butcher's meat is inspected before sale and diseased carcases may not be sold. Similarly, margarine must be marked as margarine, in letters not less than a set size.

This question of advertisements for foods leads naturally to the allied one of advertisements for patent medicines. The teacher

discusses this next and shows the class how advertisers play on our suggestibility. They do it by advertisements of patent medicine accompanied by pictures and descriptions of symptoms, meant to make the reader fearful and ready to think he has the illness even when he has not. He explains that doctors are less and less willing to encourage indiscriminate taking of bottles of medicine to promote health, and are more and more advocating the living of a healthy life. He says that Sir George Newman laid down six fundamentals for this healthy living, six things everyone must secure to be healthy and full of energy for whatever comes along. Enough sleep under the right conditions is one of these. Can the class write down some at least of the others.

It is decided that besides (1) sleep and rest, the other fundamentals for health are (2) good food, (3) fresh air and sunlight, (4) exercise, (5) warmth from clothing and from heating of buildings, (6) cleanliness of the individual and of the places he lives in. The teacher emphasises the fact that for none of these can we satisfactorily substitute a bottle of medicine.

The next point for the class to notice is that patent medicines are often expensive. The teacher says that an example of this which is often quoted is that a well known pill for constipation is sold at half-a-crown a box, the materials for which cost less than a halfpenny. He adds that instead of using such pills it is better for the body if we eat fresh foods and drink plenty of water. He points out that such remedies as cough cures and headache powders may stop the cough or the headache temporarily, but they do not treat the real cause. They may cause further harm because the patient may delay going to the doctor for the real treatment necessary to cure him.

The teacher should make a point of ending on a positive note, encouraging the children to be proud of being well rather than thinking they are interesting because they are ailing. People who feel fit and are happy and not always grumbling and

seeking sympathy are undoubtedly the kind of people with whom we prefer to live and work, so it behoves us all to try to be in this class ourselves. The best way to keep in this class is to secure the six fundamentals of healthy living, one of the most important of which is good, natural, fresh food.

CELEBRATIONS

Teachers will find it helpful occasionally to have a "celebration" dealing with either a famous pioneer of science, or with one of the necessities for healthy living. They might be used as an inspirational period for the assembled school. Detailed teaching would not be required, but each "celebration" should be followed up by one or more class lessons, care being taken that these "follow-on" lessons do not make direct reference to the "celebration," thus destroying its emotional appeal.

A "celebration" on WATER, for example, might be begun by the recitation of Russel Lowell's *The Fountain*, which would serve both as an introduction to the subject and also as a symbol denoting the source and beginning of things. The necessity of water for life would be pointed out, at the same time illustrating that it is possible to go without food for some considerable time since man can live on the fat stored in the body; but as he cannot store water in this way, he must have a constant supply of it. Reference to some famous reservoirs and dams should be made to show how man ensures a steady supply of water, and if possible illustrations of, say, the aqueducts of the Romans, the great dam at Assouan, the Pont du Gard, etc., might be projected

on a screen. *The Ancient Mariner*, by S. T. Coleridge contains many passages which are most suitable for recitation at a "celebration" on water; and from these passages deductions can be made concerning impure water, and water which is not fit to drink (salt water). Reference to filter beds could be made here, and if possible a picture of filter beds such as those at Kempton reservoir should be projected on the screen. Water as a cleanser must also be considered, for as a cleanser it is one of the greatest weapons with which to combat disease. *The Story of Chester* by James Williams contains a passage which will illustrate this point vividly.

Water is also essential to plants, and in time of drought, land must be irrigated in order that crops will not die, and thus cause famine and disease. Slides of various types of irrigation might be shown here.

The "celebration" might end with a further recitation or reading showing the absolute necessity of water for life and health, and then the teacher who is directing proceedings could briefly summarise the facts learnt, at the same time pointing out how thankful everyone should be for this great gift to man.

"Celebrations" dealing with famous pioneers of science should contain readings from biographies, or any literature concerning their lives, work and influence. It should be shown how these famous people revolutionised the scientific outlook of their time, and the debt we owe them for their courage and resource.

These "celebrations" will prove of great teaching value, especially if lantern slides can be shown. By appealing to the children's emotions, the necessary points will be enforced while at the same time the slight change from routine will prove encouraging.



FIRST AID

The Teaching of the Principles of First Aid can become a valuable activity for children in the Senior School.



CRAWLING RESCUE DRILL



MOVEMENT IN SMOKE

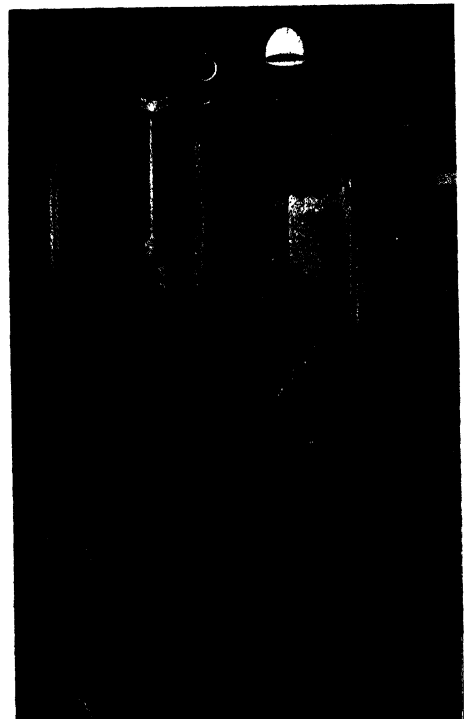

[These plates are reproduced by courtesy of the Controller of H.M. Stationery Office.]

DOOR DRILL

FIRE PRECAUTIONS IN SCHOOLS

INTRODUCTION

THERE are certain simple forms of 'first-aid' which every older boy and girl should be capable of rendering. It is, however, important not to expect or train children to take responsibilities in advance of their years; it is easy in rendering 'first aid' to do more harm than good."—From The Board of Education's *Handbook of Suggestions for Teachers* (1933).

In the 1937 edition of *The Handbook of Suggestions for Teachers*, the Board of Education draws attention to the changing conceptions of education. The school no longer resembles the cloisters of a monastery but approximates to the spacious airy workshop of a modern factory, where all are engaged in active pursuits. This spread of free activity has brought in its train the possibilities and likelihood of many more minor bodily accidents than occurred under the confined classroom conditions of the last century. In the school workshops, the craft-room, the laboratory and the cookery room are likely to occur mishaps which were undreamt of in the schoolroom where the only tools were pens and pencils. Many of these possible accidents, though slight, need prompt attention, and by the present day methods of active true-to-life auto-education, the children can be trained to render, or, at least, to assist in the necessary first aid. When it is remembered that in addition to numerous activities within the school walls, school life of to-day embraces excursions, expeditions and many forms of physical activities including field games and swimming, the adolescent's need for some knowledge and experience of first aid becomes even more apparent.

Teaching in this direction will be welcomed by the children themselves as having a bearing on their everyday life. They will no longer view it as something which may be of use in the remote future. First aid badges are much sought after among such organisations as the Boy Scouts and the Girl Guides, but it is desirable that there should be a course in the senior school in order that all children may have the opportunity of fitting themselves for this useful social service.

First aid should not be approached as a body of information to be acquired wholesale and memorised in a formal way. Like all the rest of the curriculum it "is to be thought of in terms of activity and experience rather than of knowledge to be acquired and facts to be stored." Many people know, for instance, the principle of applying a tourniquet, that a fractured limb is splinted, that an appropriate antidote is given for certain poisons. To know this much is a very different thing from actually knowing from practice how exactly to carry out the necessary operations. The teaching will be of value only in so far as it can be applied in the moment of emergency, without undue delay and yet with calmness and judgment.

Throughout the course, side by side with the training in first aid treatment, will be the consideration of prevention and safeguards to avoid accidents. This training in safety first, while dealing with road safety, will deal with safety in many other departments of life, such as safety in the use of tools, precautions against fire, risks when bathing, possibilities of poisoning and danger from unclean water and milk.

THE APPLICATION OF BANDAGES

SOME knowledge of bandaging should be included in any first aid course, however elementary, and it lends itself specially to being tried out practically. Bandaging which is learnt only theoretically will be of little use.

Bandages are applied for the following purposes:—

1. To support the injured part.
2. To keep dressings in place.
3. To fix splints.
4. To stop bleeding.
5. To protect wounds and keep them clean.

This and other similar lists of points, given here as summaries for the teacher's reference, should always, as far as possible, be elicited from the class by questioning. For example, in this instance it might be asked, when had the class seen bandages being used? For cuts and broken bones. What is the use of bandages for cuts? To keep the wound clean. To keep dressings on. And the use of bandages for broken bones? To keep the splints in place and to support the injured part. The items of a list should be discussed one by one, before the complete list appears on the board.

The kinds of bandages used are the triangular, the roller and the many-tailed bandage. The last kind need not be considered in school first aid.

The triangular bandage and its application.

—The triangular bandage is the easiest kind to use and a supply of such bandages for practical work can be cheaply obtained. The triangular bandage can be made by taking a 38 in. square of calico or linen, folding it diagonally and cutting along the fold.

General points about the use of triangular bandages can be summarised as follows:—

1. The bandage should be clean, and it should never be placed on the ground for folding purposes, or for any other reason.
2. In applying the bandage, the injured

part should be moved as little as possible, to avoid producing any further damage.

3. When the bandage is once fixed, there should be no attempt to adjust it further by pulling.

4. Knots should be tied firmly and arranged so that they do not rub or irritate (for example, in a fracture the knots should usually come on the splint).

5. In bandaging for a fracture, the bandage which secures the upper part of the fracture should be applied first.

The triangular bandage can be used either to make a sling or as a wide or a narrow bandage; see Fig. 1 for methods of folding to make the two bandages.

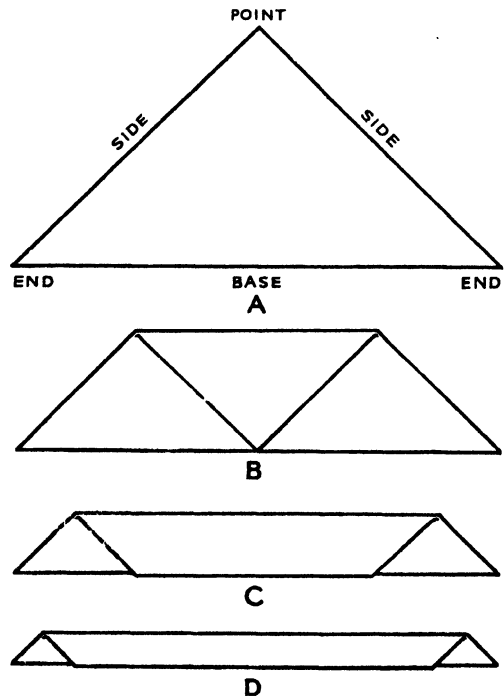

FIG. 1. THE TRIANGULAR BANDAGE

- A. The bandage when opened out.
- B. The bandage when folded once.
- C. A broad bandage.
- D. A narrow bandage.

All knots used in first aid should be reef knots and not the more generally used granny type. (See *Hygiene* section for details of how to make the reef knot.) The correct method of making the knot should be practised.

As a sling the triangular bandage can be adapted as:—1, the small arm sling; 2, the large arm sling and 3, the St. John's sling.

The small arm sling, as can be seen in Fig. 2, supports the forearm only. The bandage is folded "broad" and placed in position on the patient's chest, with the

uninjured side and is carried round the back of the neck as in the small sling. The forearm is placed gently across the chest over the middle of the bandage and the end hanging down is then carried up to the upper end and tied. The point of the bandage is brought forward over the elbow and pinned, using, as always in this work, a safety pin. See Fig. 2.

When the large arm sling is adapted to support the elbow, the bandage is placed with one end on the shoulder of the injured side, and the apex pointing in the opposite direction to the elbow. The forearm of the

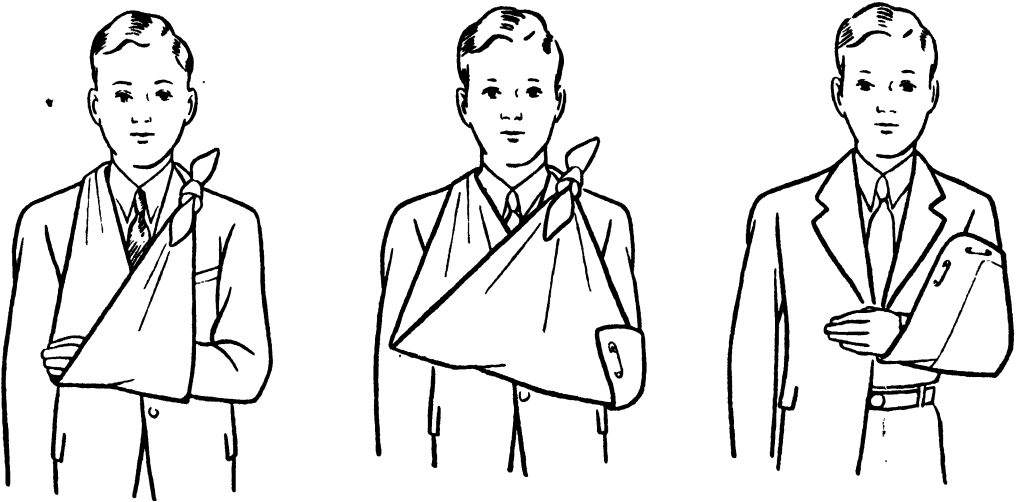

FIG. 2. THESE DIAGRAMS SHOW A SMALL ARM SLING AND A LARGE ARM SLING MADE FROM TRIANGULAR BANDAGES, AND ALSO HOW A COAT CAN BE PINNED UP TO ACT AS A SLING

upper end over the shoulder of the uninjured side. The end is carried round the neck at the back, so that it can be tied just above the clavicle of the injured side. The forearm is then bent up gently and the free lower end of the sling is brought up to tie just above the clavicle of the injured side.

The large arm sling can be applied to support the forearm or the elbow. The operator stands in front of the patient and places the bandage, unfolded flat on the chest, with the point beneath and well beyond the elbow of the injured side. The upper end goes over the shoulder of the

injured side is now gently flexed and placed across the front of the chest, with the fingers touching the opposite shoulder. The lower end of the bandage is now drawn over the elbow and across the chest to tie on the shoulder of the uninjured side. The apex of the bandage (Fig. 2) is now folded well over the forearm and pinned above on the injured side.

The St. John's sling is used for supporting fractures of the collar bone and the shoulder blade. The patient's forearm is flexed and placed across the chest so that the hand rests on the breast bone of the opposite side.

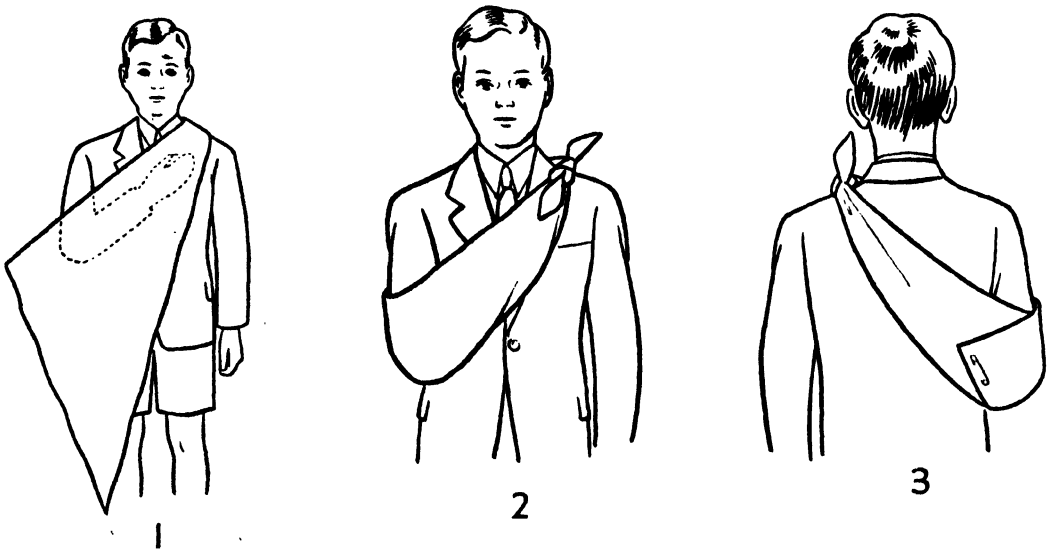

FIG. 3. THE ST. JOHN'S SLING

1. Before it has been adjusted. 2. As it appears, when adjusted, from the front. 3. As it appears, when adjusted, from the back.

An unfolded bandage is now placed so that one point lies over the shoulder of the uninjured side and the apex point lies well over the elbow. The lower free end of the bandage is now carried under the elbow (the elbow being carefully supported mean-

while) and across the back and the knot is tied on the uninjured side in the hollow of the collar bone. The apex is then pinned to the bandage as in Fig. 3.

The use of the triangular bandage for wounds must be preceded by the application of a clean sterile dressing, which is kept in place only by the bandage. The methods of applying the bandage can be readily followed from the illustrations, and it is suggested that, as far as time permits, the methods for bandaging more commonly injured parts, as of the hand, should be done practically in class; Figs. 4 and 5.

The triangular bandage is also used for putting up fractures and for arresting bleeding. This is dealt with in the particular sections concerned.

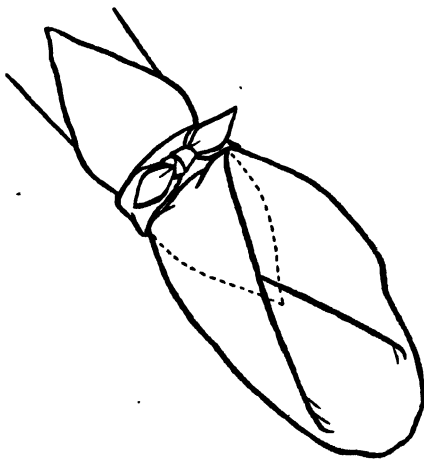

FIG. 4. THE TRIANGULAR BANDAGE USED AS AN OUTSIDE COVERING OVER STERILE WOUND DRESSINGS

The roller bandage and its application.—

The roller bandage is more generally useful for keeping on dressings or for supplying pressure over a wider area than is the triangular bandage, and it is more difficult for beginners and inexperienced operators to apply. Practice in applying the roller

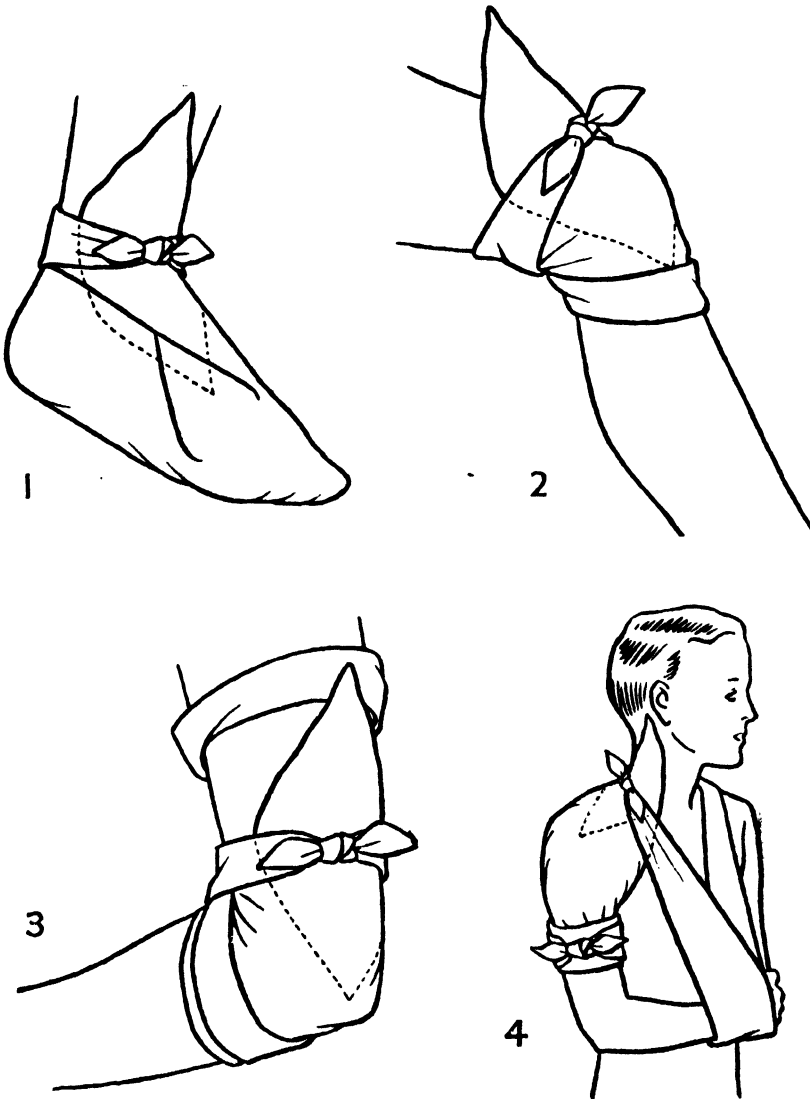

FIG. 5. THE TRIANGULAR BANDAGE

1. Applied to an injured foot.
2. Applied to an injured knee.

3. Applied to an injured elbow.
4. Applied to an injured shoulder.

bandage is essential, together with knowledge of the recognised principles of such work. While such bandages can be bought, satisfactory bandages for practice, as well as for use in emergencies can be made by tearing up old sheets into strips of appropri-

ate width, that is, from $\frac{1}{2}$ in. to 3 in. for general purposes.

In applying a roller bandage, the following points should be observed:—

1. The bandage must be tightly rolled up before starting.

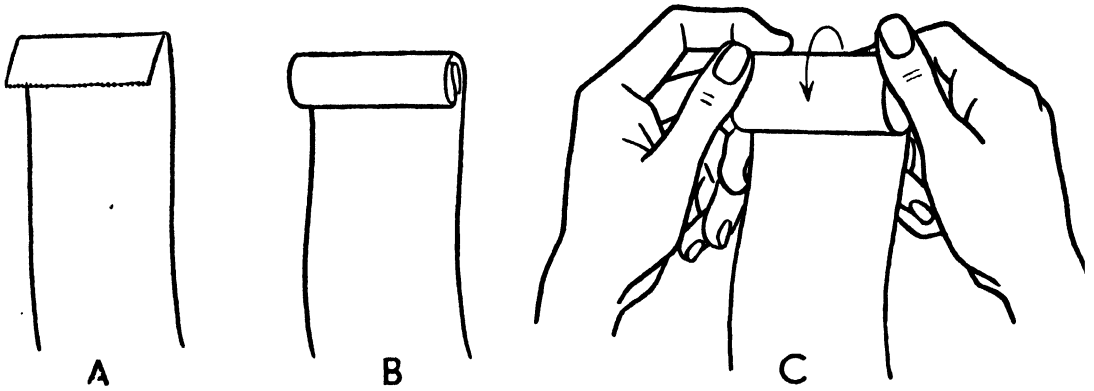

FIG. 6. ROLLING A BANDAGE

- A. Turn the end over. B. Fold it again tightly. C. Roll it towards you with the right hand, steadying it with the left.

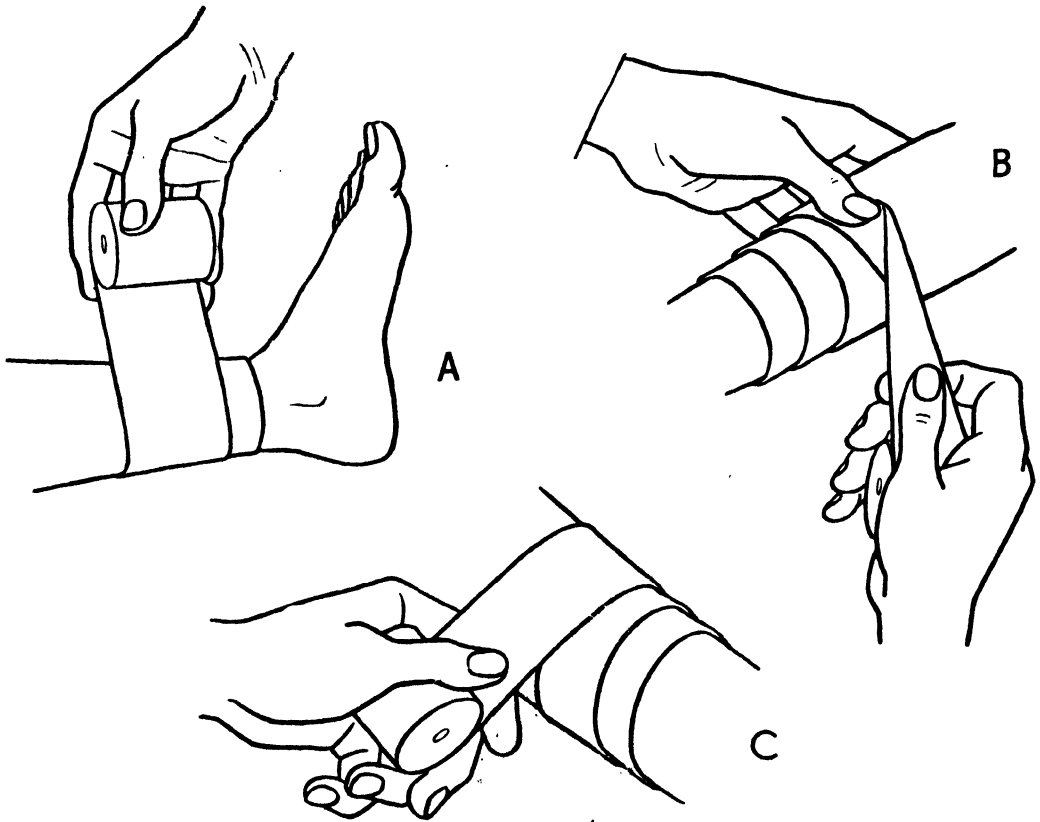

FIG. 7. HOW TO APPLY BANDAGES

- A. Applying a roller bandage. B. Applying a reverse spiral bandage. C. Applying a spiral bandage.

2. The operator should stand in front of the limb to be bandaged, which should be placed as comfortably as possible in the position it is to occupy finally.

3. Always, to start bandaging, the outside of the bandage is applied to the inside of the limb, and a couple of turns are made to obtain a firm hold.

4. Bandaging is always done from the lower part of the limb towards the top. This means that any pressure from the bandage tends to help the venous circulation towards the heart.

5. Bandaging is always done from the inside to the outside, over the front of the limb.

6. Not more than 2 in. to 3 in. of the bandage should be unrolled at a time.

7.* Each succeeding turn of the bandage should overlap the preceding one by two-thirds.

8. While the bandage should be applied firmly, it must not be too tight nor too loose. If the hand is run down the bandage after it is finished and the edges turn down, then it is too loose. On the other hand, if when the bandage is removed, there are red lines on the skin, then the bandage has been applied too tightly.

9. The tips of the fingers and of the toes are left uncovered, so that it can be seen if they turn blue and cold, a sign that the bandage has been applied too tightly and needs to be removed and readjusted.

10. A satisfactory bandage, when finished, should be smooth and unwrinkled.

11. The successive margins of the bandage should be kept parallel and all crossings and reverses (Fig. 8) should be in one line and towards the outside of the limb.

12. A figure of eight is always made over a joint.

13. Bandages should not be applied wet, because they tend to shrink and so to bind the limb too tightly when dry. (For exception see *Sprains*, page 459).

14. In taking off a bandage, the slack should be gathered up into a loose bundle and passed round the part from which it is being removed.

In instructing a class as many of these points as possible should be arrived at by the class, by trial and error or at least by seeing examples of bandaging being executed, and noticing how one example is better than another and why. Points such as 3, 4 and 5, are examples of conventions of bandaging which it will probably be best for the teacher to supply as a comment in the course of a demonstration.

If the part to be bandaged varies considerably in diameter, it is necessary to make a reverse spiral. This consists of a series of spiral turns in which the bandage is reversed on itself, in order to make the bandage lie smoothly and to hold firmly, Fig. 8.

To reverse, a couple of spiral turns should first be taken round the limb; then, holding the head of the bandage lightly in one hand, the thumb of the free hand should be placed over the lower border of the bandage on the outer side of the limb. About three inches of the bandage is now slackened; this slackened part is turned over so that its reverse side is downward. It is then passed under the limb to the opposite side, its lower edge being kept parallel with the turn below. Each time the outer side of the limb is reached this reverse is repeated.

This reversing results in a bandage that fits the limb and is firmer than is the ordinary spiral bandage. It is, however, less elastic and more liable to slip. It is specially useful for fixing splints in place. Reversing is not used over a joint.

A certain amount of work in the use of the triangular and roller bandages lends itself well to being done practically in class.

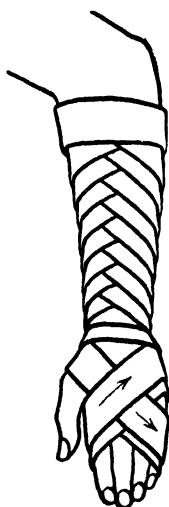

FIG. 8. ROLLER BANDAGING—A FIGURE OF EIGHT BANDAGE FOR THE HAND AND A REVERSED SPIRAL BANDAGE FOR THE FOREARM

A supply of roller and triangular bandages, one bandage between two pupils was obtained for a class of older girls, the girls bringing suitable "squares" and large handkerchiefs. They also brought rulers and rolled up newspapers for splints; physical training mats were used for lying down work.

The application of the small and large arm slings was practised, as well as the adjusting of splints and bandaging for at least one fracture. Other activities included, were the method of supporting a sprained ankle with a figure-of-eight bandage; the application, but not the twisting tight, of a tourniquet on the upper arm; spiral roller bandaging methods; artificial respiration; how to carry a patient with a four and a three-handed seat; how to stifle burning

clothing; how to cross a smoke-filled room and how to convey an insensible patient from such a room. Coaching among other points was necessary to prevent too brusque moving of the injured limbs, and to ensure smooth and properly directed pressure in artificial respiration. There was also a tendency to work too quickly in this. The floor work had to be done in a hall with floor space and not in a classroom and it was found better for all the work to be done away from desks, as it enabled the teacher to move freely round the room from group to group. A special reminder was given to the class that all girls should wash their hands well before the class, so that they should tend to associate the need for clean hands with this work.

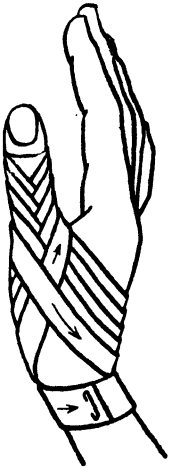

FIG. 9. A SPICA METHOD OF BANDAGING THE THUMB

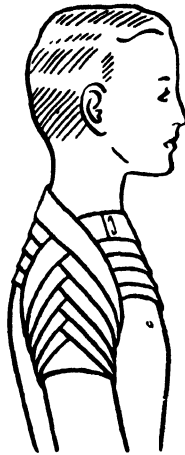

FIG. 10. A SPICA METHOD OF BANDAGING THE SHOULDER

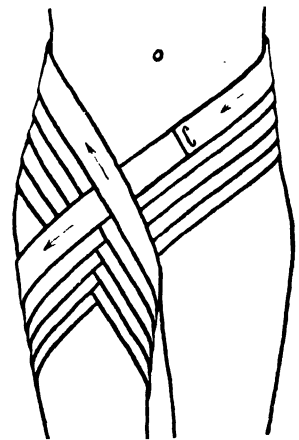

FIG. 11. A SPICA METHOD OF BANDAGING THE GROIN

THE IMMEDIATE TREATMENT OF BLEEDING

BLEEDING, or hæmorrhage, may be caused by injury or disease. The former only will be considered here. Bleeding also may be external or internal, external bleeding from injury being the most common type.

Except in the cases of snake bite or dog bite, the aim should be to *arrest the bleeding as promptly as possible*.

There are three kinds of bleeding; capillary, venous and arterial, and of these, capillary bleeding is the most usual and the least dangerous form. This is the type of bleeding that occurs from small cuts and grazes. In venous bleeding, the blood tends to issue in a steady stream from the cut end of the vessel furthest from the heart, and it is of a dark red colour. In contrast to this, arterial bleeding is more profuse and the bleeding is mainly from the side of the cut nearer to the heart; the blood itself is bright scarlet and it flows from the larger arteries in a characteristic series of spurts, which correspond to beats of the heart. This type of bleeding is always serious.

Bleeding that is not too profuse stops naturally from the clotting of the blood on exposure to air, but properly applied pressure helps to prevent loss of blood. To stop capillary bleeding direct pressure, as from a pad and bandage over the wound, together with raising of the part, if possible, to prevent too rapid a circulation of blood, should be sufficient. For example, a cut finger will bleed less if held up rather than hung down, and in a finger, the bleeding can be further controlled if pressure is applied on either side of the finger (*not* back and front) because in this way the vessels supplying the blood to the finger end are compressed. In school this is of some moment to the teacher, because small cuts

to fingers tend to occur, and if bleeding can be stopped rapidly, the child is less frightened and upset, and the class, as a whole, is less disturbed.

If bleeding is rapid, direct pressure by the fingers may seem to be temporarily necessary; to control venous bleeding the pressure should be applied on the side of the wound *away* from the heart; for arterial bleeding, on the side of the cut *nearer* to the heart. If possible, the operator's hands should be cleansed, wrapped in clean lint or dipped in iodine to prevent any additional infection being carried into the wound. Again the part should be raised if possible.

When a larger artery is cut, it may be necessary to stop the bleeding by indirect pressure on the main artery supplying the part with blood. A diagram of the pressure points for the arteries is given in the *Hygiene* section, page 400. The finding of these pressure points needs to be practised so that the beat of the artery can be found without delay, and pressure applied. Once the pressure point has been found with the fingers, the ball of the thumb should be used for applying pressure rather than the fingers, as a steadier and stronger pressure can thus be maintained.

When the artery has been found and recognised by its beat, it should be pressed firmly against the bone, with just enough force to stop the bleeding. Care should be taken to avoid pressing other structures such as nerves and veins.

This "pressure point" method of controlling bleeding, is of great value because it can be applied without delay, and the wound itself is not touched and contaminated. There are, however, only certain parts of the body (i.e., the "pressure points") where such control can be applied, and the

pressure can only be maintained by one person for about a quarter of an hour on end. The pressure should be, with discretion, relaxed to some extent every fifteen minutes, to allow the parts supplied by the artery to get a supply of blood, thus avoiding serious injury.

A *tourniquet* is an instrument for applying pressure to an artery without unduly constricting the limb as a whole. It is applied to the pressure point nearest to the wound on the heart side of the wound. A tourniquet can be improvised by knotting a triangular bandage loosely round the limb to be constricted, the knot being placed accurately on the artery concerned. A stout stick or ruler is then inserted into the loop of the bandage on the opposite side of the limb from the knot, and when it is required, the stick is twisted and the bandage tightens the

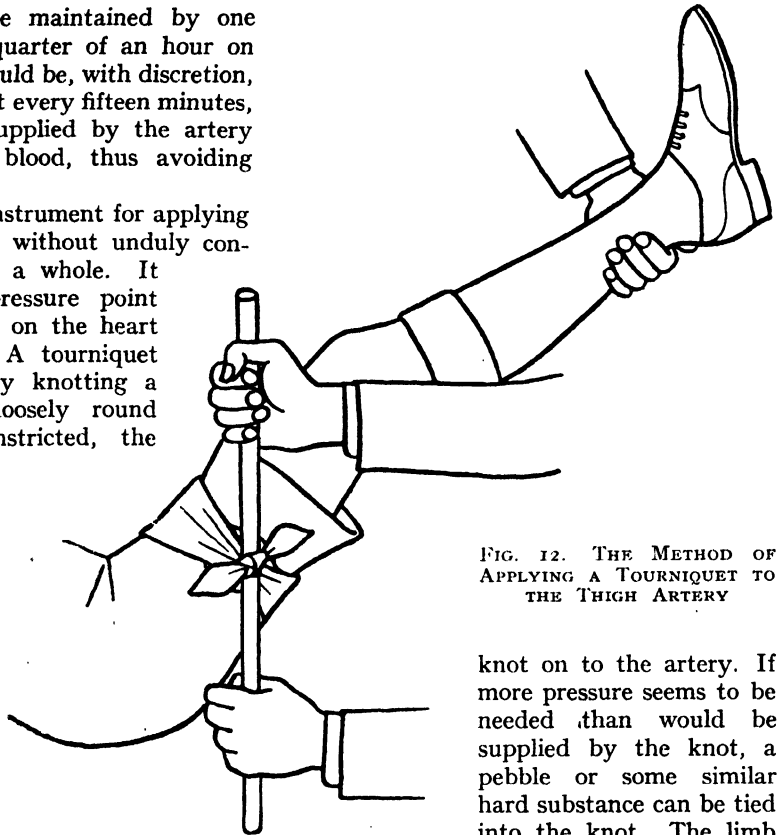

FIG. 12. THE METHOD OF APPLYING A TOURNIQUET TO THE THIGH ARTERY

knot on to the artery. If more pressure seems to be needed than would be supplied by the knot, a pebble or some similar hard substance can be tied into the knot. The limb

to which the tourniquet has been applied should be placed in a raised position.

In applying a tourniquet, only just sufficient tightness should be maintained to stop the bleeding and no more, and the compression of the tourniquet should be relaxed partially or entirely every twenty-five minutes, or injury will be done to the other structures in the limb. A tightened tourniquet, for example, must compress the veins and prevent the return of venous blood to the heart.

A tourniquet may be applied ready in case of emergency but it should not be tightened unless it is clearly necessary. If firm pressure over the wound is sufficient to control the bleeding then a tourniquet is not necessary. If, however, there is broken glass in what would otherwise be a

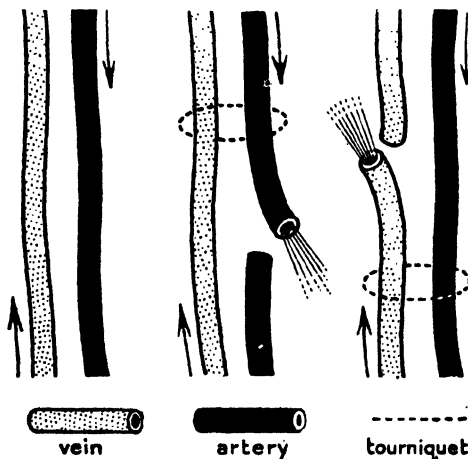

FIG. 13. DIAGRAM TO SHOW HOW AND WHERE TO APPLY A TOURNIQUET IN THE CASES OF A WOUNDED VEIN AND A WOUNDED ARTERY.

relatively slight wound, or if the limb is shattered, it will be necessary to stop the bleeding by a tourniquet instead of by direct pressure on the wound.

The general treatment of external bleeding can be summed up in the following points.

1. The wounded part should be raised to diminish the amount of blood flowing to the part.

2. To stop the bleeding, pressure is applied directly on the wound with clean fingers or lint; or in severe bleeding, by pressure on the artery supplying blood to the part or by a tourniquet.

3. All tight clothing is slacked or removed; this helps to relieve congestion of blood in the wounded part and so lessens the amount of blood round the wound.

4. The wounded part should be kept at rest and moved as gently and as little as possible.

5. No stimulants should be given, for they tend to make the heart beat more quickly and so drive more blood to the wounded part and so encourage bleeding.

Nose bleeding.—Nose bleeding is one of those minor emergencies with

which most teachers may expect to have to deal sometime in their teaching life. The bleeding may start spontaneously, or as the result of a blow or some other form of accident.

The patient should sit down erect, with the head rather thrown back than forward.

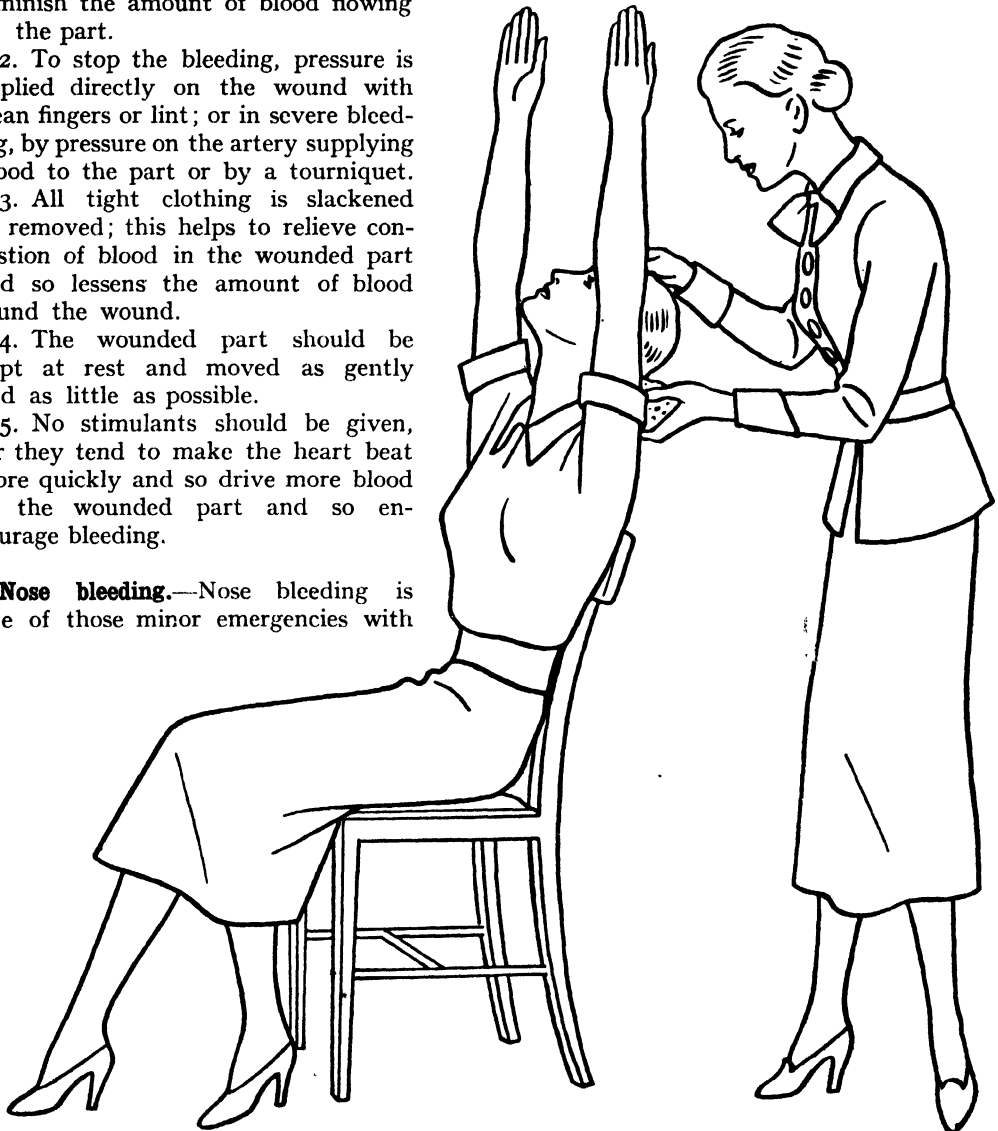

FIG. 14. TREATMENT FOR NOSE BLEEDING

The head should not be bent forward over a basin. The arms should be raised, as this helps to decrease bleeding. Any tight clothes round the neck should be loosened to relieve congestion of blood in the veins from the head.

Ice or a frequently changed cold water sponge or towel should be applied to the root of the nose, the nape of the neck, and between the shoulder blades. Lemon juice and water, or vinegar and water snuffed up the nostrils will often stop continued bleeding; or a gentle syringing of the nostrils

with iced water. When, as is very often the case, the bleeding comes from the front part of the nose, the hæmorrhage can sometimes be stopped by the pinching of the lower half of the nose for a few minutes only. The air in the room should be fresh and cool and helpers should not be allowed to crowd round the patient.

The wish to blow the nose should be inhibited even till some hours after the bleeding has stopped, for to do so will accelerate or restart the bleeding.

THE IMMEDIATE TREATMENT OF WOUNDS, BRUISES AND STINGS

A PART from the stopping of bleeding, there is a continual need to know the correct first aid treatment of wounds, that is, of any injury in which the skin is broken. Wounds may be 1, clean cut; 2, bruised; 3, punctured or 4, lacerated. Any of these wounds may be in an aseptic condition, that is, free from germs or micro-organisms; or septic, that is, in a condition in which germs are present in the wound. The only really aseptic wounds are those made under conditions of surgical asepsis. All wounds occurring in daily life need to be covered with a clean dressing that has been handled as little as possible, and generally some application of an antiseptic to prevent the growth of germs is needed as well. Great care should always be taken not to introduce more germs into a wound than are there already, as, for example, by using soiled dressings or by doing the dressing with dirty hands.

The steps that should be taken in dealing with any wound may be summarised as follows:—

1. Stop any bleeding.
2. Cleanse the wound.
3. Apply a suitable dressing.
4. Keep the wounded part at rest.

5. Make the patient generally comfortable, that is, treat for shock.

If it is impossible to cleanse the operator's hands or the wound, the wound should be covered with some aseptic dressing, improvised if necessary, and the patient conveyed as rapidly as possible to some place where adequate cleansing and dressing materials can be obtained. A scorched or a boiled cloth makes an improvised aseptic dressing.

If there are means of cleansing the wound and the hands of the operator before touching the wound, the operator should wash and scrub his hands and particularly the finger nails in warm soap and water. If possible, this should be finished by rinsing the hands in an antiseptic solution, such as 2 per cent iodine solution or in spirit.

The wound should be exposed by removing the clothing and the actual site of the wound covered with a temporary sterile dressing. Then, if it seems necessary, the skin surface round the wound should be carefully and gently cleansed with soap and warm water, great care being taken that no soapy water runs towards or into the wound.

This should be followed by the cleansing, with warm sterile water, of the actual wound. Any foreign bodies, such as dirt or grit, are

gently removed (provided they are not deeply embedded). The process is finished by gently swabbing the wound with antiseptic solution such as IZAL solution; one tablespoonful to a quart of water. Any clot, which has stopped the bleeding in the wound, should not be removed. If the wound is in the neighbourhood of the eye, boracic acid solution only should be used as an antiseptic.

Dressings.—All wounds have a natural tendency to heal but the dressing should be such as to help this natural process. A dressing may be dry, wet or oily.

Dry dressings include such material as lint (of which always put the smooth side towards the wound) or gauze, both of which should be sterilised by heat. They are thus freed from germs and able to absorb any discharge from the wound. Boracic lint is lint that has been soaked in boracic acid solution. Gauze is not so frequently used in actual first aid as in the medical dressing of deep wounds, when it is used for packing.

Wet dressings are made of lint or other sterile material, which has been soaked in an antiseptic solution. Oily dressings are employed mainly in the treatment of burns.

In applying dressings to a wound the wound should not be closed up too tightly. Cotton wool may be placed round the limb over the dressing to equalise the pressure of the bandage (see section on *Bandaging*) which is applied to retain the dressing in position. Wounds of the upper limb should be put up in a sling appropriate to the injury.

It may be more convenient to maintain some dressings in place by adhesive plaster and care should be taken that the skin is not wrinkled or pulled by the plaster. To remove the plaster, it should be sponged with warm water or the adhesive dissolved by sponging with spirit of turpentine.

If a wound shows signs of inflammation, hot fomentations should be applied until the wound is clean and free from sepsis, but unless rapid improvement shows, a doctor's advice should be sought without delay.

Bruises result from the rupture of capillaries with bleeding beneath the skin. There is no break in the skin. The actual bruised area should be treated by the application of linen or lint material dipped in cold water and frequently renewed. Arnica is also used. The patient should rest and should be reassured robustly.

Small punctured wounds may be caused by *the stings of insects*, such as wasps and bees. The sudden pain is frightening and the patient should be reassured; the sting should be pressed out by pressure with a hollow ring—the top of a key will be found quite suitable for this. It should be noted that the sting is by no means always left in the wound. The part is then swabbed freely with an alkaline solution such as diluted ammonia. Failing this, dabbing the sting with a moistened bag of washing soda or with the blue bag, will help to allay pain. There is almost always some swelling after a sting, but this passes off in a matter of a few hours.



FRACTURES, SPRAINS AND DISLOCATIONS

A FRACTURE or break in a bone may be caused by direct violence such as a blow on the limb, which breaks at that point. It is possible, however, to break a bone by indirect violence, so that the bone breaks at some distance from the seat of the injury. For example when someone falls forward and saves his weight by falling on his outstretched hand, the collar bone may be fractured by the jar. Occasionally muscular action may cause a bone to break, as in a fracture of the kneecap bone.

A simple fracture is a break in which the bone is broken but there is no external wound. In a compound fracture, there is an external wound as well as the fracture, and one of the chief reasons for treating a suspected fracture with extreme gentleness and caution is because of the likelihood of making a simple fracture into a compound one by rough, careless moving of the part.

A bone splintered into several fragments is spoken of as "comminuted;" an impacted fracture is one in which the broken ends are driven into one another. When there is, in addition to the fracture, tearing or injury to other organs, the fracture is known as "complicated." Greenstick fractures occur in children; the bone bends but does not snap through, because children's bones are less brittle and calcified than are the bones of older people.

It is not easy to know whether or not a fracture has occurred, but on the other hand it is not necessary for the person giving first aid to be certain on this point. If there is any suspicion that a fracture has occurred, the safe procedure is to treat the injury as though it were a fracture.

There are, however, certain signs that make one suspect that the injury may be a fracture, though probably not all these signs will be present. The history of the injury seems to be one likely to lead to a broken

bone; a wound or bruise may be present; there may be inability to use the limb or even to move it at all; or the limb may be in an unnatural position. There may also be shortening of the limb because of the contraction of the muscles round the broken bone, or there may be crepitus, that is, grating of the two broken ends of the bone together. Crepitus should on no account be sought for, because further injury may be done in this way by an inexperienced person; moreover it is not a really reliable sign because natural creakings may be heard round a joint without any fracture being present.

In the case of suspected fracture, it is of the first importance, particularly for injuries of the lower limbs, to *treat the case on the spot*. Any attempt to carry a patient to a drier or more convenient spot for treatment before the fracture has been made immobile with splints, may make a simple

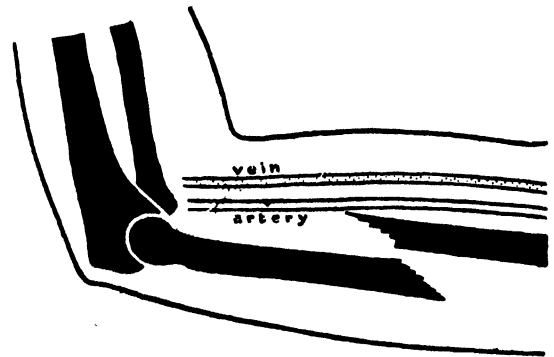

FIG. 15. THIS DIAGRAM SHOWS HOW CARELESS MOVEMENT OF A FRACTURED LIMB CAN READILY PRODUCE FURTHER INJURY

into a compound fracture and even cause injury to blood vessels so that extensive bleeding may occur.

The injured limb should be handled with extreme care, and unless there is a compound

fracture and a wound, the clothing should not be removed. If clothes must be removed, the arm of the uninjured side should be disengaged first in the case of an upper arm injury. If the injury is in the lower limb, the trousers can be slit up by keeping to the seam, and boots are first unlaced and then the stitches up the back seam can be cut. Any bleeding must be dealt with and stopped without delay, any wound dressed as far as it can be and splints applied. Concurrently, the patient is treated for shock, that is to say, he is kept warm and made as comfortable as may be, both physically and mentally.

Splints may have to be improvised, that is, articles of everyday use may have to be used in the emergency, such as a walking stick, or umbrella, or scout's staff. Anything that is sufficiently long and sufficiently rigid to keep the broken ends of the bone from moving on each other will serve.

Rigid surgical splints of wood are used if available. Whether improvised or not, the splints should if possible be a little wider than the injured limb and should be long enough to extend slightly beyond the joints above and below the site of the breakage. The splint should be padded on the side next to the limb.

In certain fractures a natural splint is supplied by another bone; for example if the fibula or splint bone is broken, the tibia or shin bone forms a natural splint.

Fracture of the collar bone.—When the collar bone is broken, the patient has a tendency to try to relieve the injured part from the weight of the arm by supporting the elbow of the injured side with the other hand while bending the head towards the injured side. Great care is needed in dealing with a collar bone fracture as it is very easy to make a simple fracture into a compound fracture in this case.

The coat should be removed carefully, starting with the sound side, the injured arm being supported meanwhile. Two or three triangular bandages are made into a

firm pad, which is placed well up into the armpit. This pad is to take the place of the collar bone in keeping the shoulder out in its normal position. The forearm is then placed across the chest with the fingers pointing to the opposite shoulder. Two triangular bandages, folded narrow, are then needed. The centre of one is placed to the point of the elbow on the injured side and the two ends are carried across the chest and back respectively and tied on the shoulder of the uninjured side. The second

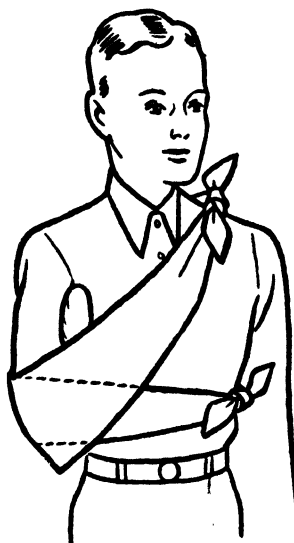

FIG. 16. ONE METHOD OF SUPPORTING A BROKEN COLLAR BONE

The pad under the armpit should be noticed

bandage is then placed with its centre on the elbow and the two ends are carried horizontally across the body back and front and tied on the uninjured side. Thus the arm is supported and the second bandage exercises a certain amount of leverage from the armpit pad to keep the collar bone parts from riding over one another. The pulse at the wrist should be felt to make sure that the armpit pad is not pressing so directly on the armpit artery as to be stopping the flow of blood in the arm.

The patient should be treated for shock;

that is, kept warm, given a stimulant if necessary and reassured. There are a number of variations in method of putting up a broken collar bone, even in first aid practice. The principles of the methods are, however, the same. The patient should be conveyed to a doctor immediately.

Fracture of the upper arm.—All the usual signs of a fracture may be present in a case of an upper arm break. A doctor should be sent for, but in the meantime the arm should be immobilised by two or more splints. One splint should be placed on the inner side of the arm from the armpit to the elbow, a pad being put over the upper

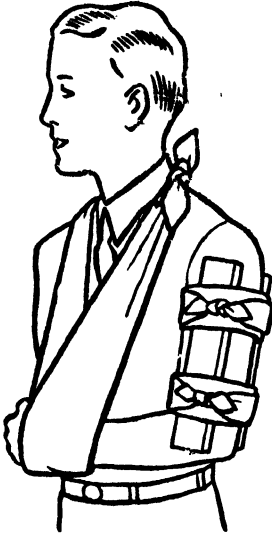

FIG. 17. SUPPORT FOR A BREAK IN THE UPPER ARM

end to prevent discomfort at the armpit. The second splint is placed on the outer side of the arm from the shoulder to the elbow. If further splints are available, additional ones at the front and the back of the arm may be applied.

Temporary splints may be made from rulers, suitable pieces of firewood, folded newspapers, or pieces of stiff cardboard. Failing bandages, handkerchiefs, braces, and neck-ties can be used to affix the splints,

one bandage being placed above and another below the site of the break.

A small arm sling made with a triangular bandage folded wide, should be adjusted, as this allows the weight of the arm to help to overcome the tendency to overlap in the two broken ends of the bone.

Fracture of the forearm.—In a fracture of the forearm, one or both bones may be broken. If both bones are broken there will be marked deformity, whereas there is no alteration in length of the limb if only one bone is affected. The forearm should be supported across the chest so that the hand is slightly higher than the elbow and the thumb points upward to the chin. Two splints are then carefully applied, one on the outer and the other on the inner side of

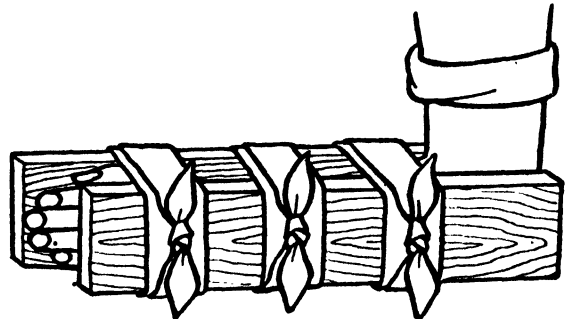

FIG. 18. SPLINTING AND BANDAGING OF A BROKEN FOREARM

the arm. The outer splint should extend only to the wrist but the inner one should reach to the end of the fingers. The arm is supported in a large arm sling.

Fractured ribs.—If the ribs are broken, there will be pain on coughing or breathing; there may be crepitus noise, and if the lung has been injured the patient coughs up blood. A triangular bandage folded wide, should be tied firmly round the chest above the site of the injury and a second one below similarly, the two bandages overlapping. The knots should be arranged to come in front of the arm (not just underneath it) on the uninjured side. The arm on the

injured side is then put in a large arm sling. If it appears from the coughing up of blood that there is lung injury present, the bandages should not be applied in case pressure may cause further injury to the lung. A sling only is put on. In conveying the patient to the doctor, which should be done without delay, the patient should lie supported rather towards the injured side, so that the uninjured lung shall be free for unimpeded breathing. Any tight clothing should be loosened.

Fractured thigh.—The usual signs of fracture are present; the patient cannot stand and the foot tends to be rolled outward. Before splints can be applied, the

by a broad bandage round the body, the splint being at the level of the armpit. A short splint should be applied to the inner side of the thigh to reach from the crutch to the knee. A second broad bandage should be passed round the body and the long splint at a level with the hip line. Two narrow bandages are now tied round the two splints, the first above and the second below the site of the fracture. No bandage is put over the actual site of the fracture. A further bandage now ties the long splint to the middle of the lower leg; the figure of eight bandage round the two feet is readjusted to hold the long splint and additionally and lastly the knees are tied together, the long splint being taken

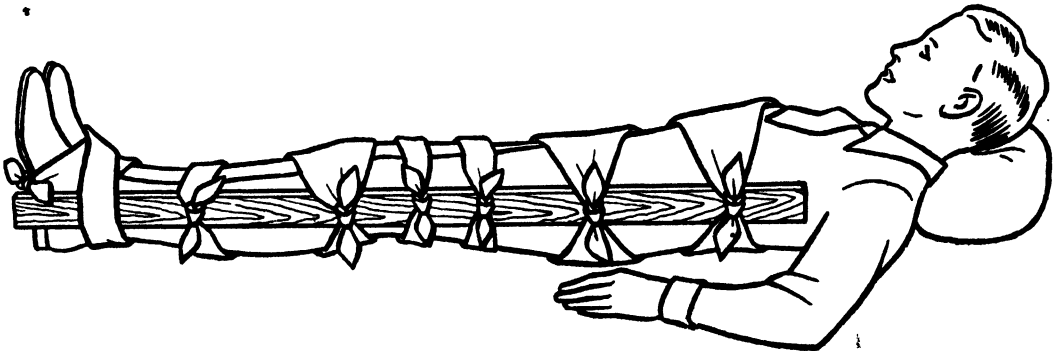

FIG. 19. THE SPLINTING AND BANDAGING OF A FRACTURED THIGH BONE

limb must be very gently and cautiously straightened out so that the two legs lie side by side in their natural position, and the two feet may then be tied together with a figure of eight bandage.

A long splint should be applied so that it reaches on the outer side from the armpit to the foot. Broom handles, walking sticks, billiard cues and umbrellas can be improvised as splints. If the splinting material is too short, two pieces should be tied firmly together so that they overlap in part of their lengths, so that one full-length splint is obtained.

A helper should steady the long splint while the operator adjusts the bandages in turn. The splint is first applied to the chest

in. All the knots are arranged to come on the long splint.

A splint should be used very cautiously to push the bandages under the limb, which should be moved as little as possible. A hand pushed under the limb will cause too much disturbance and lifting. Also, all the bandages should be put in position *before* applying the splint, so that there is a minimum of disturbance for the patient. Clothing should not be taken off unless the occurrence of bleeding makes it necessary. In the case of a broken thigh in a woman, the inner small splint is dispensed with and the outside splint is put on outside the dress and skirt. A doctor should be summoned.

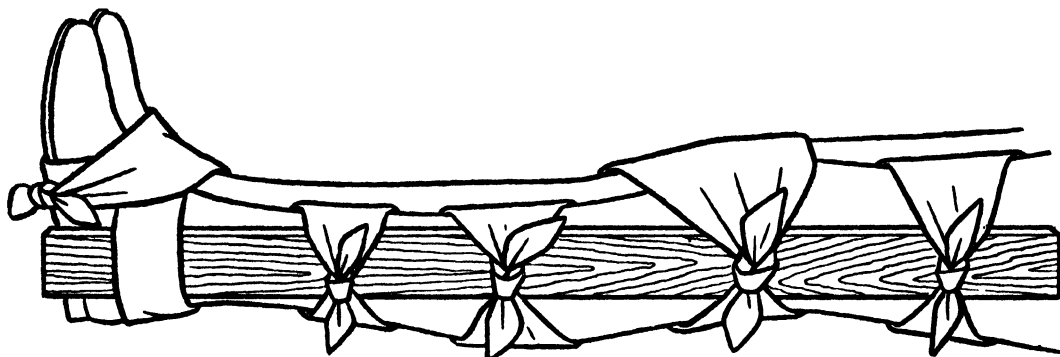

FIG. 20. THE SPLINTING OF A FRACTURE OF THE LOWER LEG

Fractured lower leg.—As in the forearm, if one bone only is broken, the unbroken bone makes a natural splint for the fracture and considerably less deformity shows. The fracture should be treated without taking off the clothes. The lower leg should be fixed between two splints, the outer extending from beyond the knee to the foot and the inner from the knee to the inner ankle. Both feet are tied together; a bandage is affixed round the knee and the inner and outer splints, round the thigh and the outer splint, and round the two splints and the injured leg above and below the site of the fracture.

Fractured knee cap.—If the knee cap is broken, there is loss of power and much swelling round the knee joint. The important thing is for the knee to be kept straight and on no account should the

patient try to straighten the leg himself. It must be done by the operator otherwise the two parts of the broken knee cap will be pulled further apart and more damage be done. The heel should be gently raised and a long splint passed behind the knee to extend from the top of the thigh to a little beyond the heel. The splint should be fixed in place by a narrow bandage round the splint and the thigh and another round the splint and lower leg, the heel being supported on a hassock or low box the while. A third narrow folded bandage is then placed so that its centre is on the thigh in front immediately above the knee cap; the ends are taken behind the limb and crossed behind over the splint, then brought forward and tied in front of the leg, below the site of the fracture. In this case the knots of the bandages are on the front of the limb and not on the splint. Here the patient is best moved in a sitting position.

In all fractures of the lower limb, the patient should be moved on a stretcher or failing this on a door, blackboard, or covered hurdle.

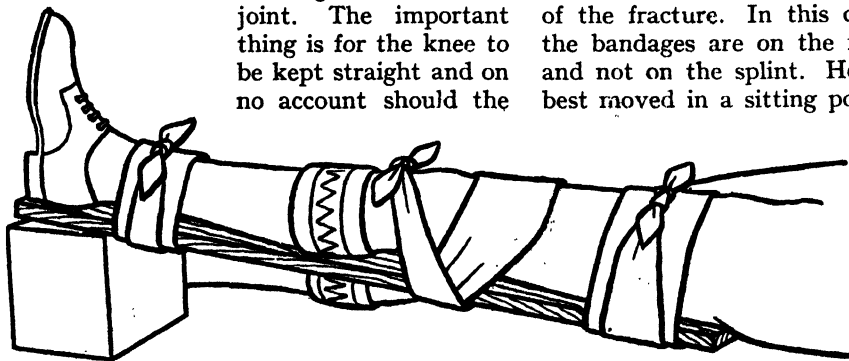

FIG. 21. THE SPLINTING AND BANDAGING OF A BROKEN KNEE CAP

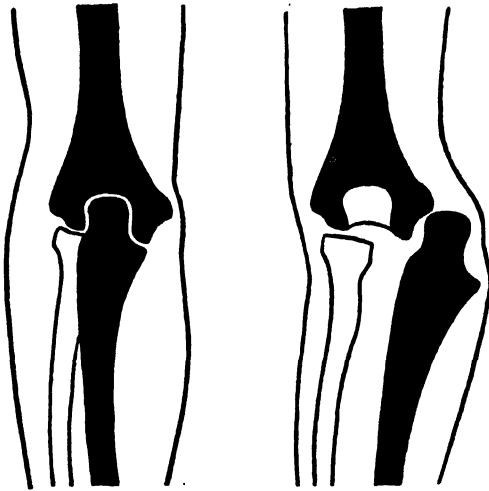

FIG. 22. DIAGRAM TO SHOW WHAT IS MEANT BY THE DISLOCATION OF A JOINT

Dislocations and sprains.—While fractures occur in the length, as it were, of bones, dislocations and sprains are injuries involving joints.

In a dislocation, the ends of two bones which are naturally in contact and move one on the other, are separated, or, to put it another way, the bone has moved out of its socket at the joint. When a dislocation occurs, the ligaments holding the two bones in apposition, and the muscles and tendons round the joint are torn, and there is an escape of blood and lymph which shows as swelling round the joint.

The signs that a dislocation has occurred, apart from the history of the injury, are pain and swelling; change of shape in the joint compared to the corresponding joint on the other side of the body; change of length of the limb; relative loss of movement in the limb and alteration of position assumed by the limb when at rest.

No effort should be made to reduce the dislocation. The patient should be made as comfortable as possible and taken to a doctor without delay, as the longer a dislocation is left unreduced the more difficult is the reduction.

GG—VOL. II-S

The parts should be kept at rest, a bandage being applied to help in maintaining this position of maximum relief. Hot or cold applications should be made, according to which give the greater relief. In the case of upper limb dislocations, the arm should be supported in a sling.

Sprains.—Sprains have been called "half dislocations." The two articulating surfaces of a joint are, by a sudden injury pulled apart and the joint ligaments, and tendons and muscles round the joint are torn and stretched. The swelling is caused mainly by the effusion of blood and lymph into the tissues from the overstretching.

A strain is a stretching of a part so that there is pain but no swelling.

The treatment of a sprain must include rest, the part being raised, if possible, to help the circulation. Cold applications help to prevent inflammation and to decrease bleeding from broken capillaries. If cold applications cannot be borne, then hot applications may give relief.

Sprains of the upper limbs should be put up in a sling with a steadying splint if necessary.



FIG. 23. FIGURE OF EIGHT BANDAGE ROUND FOOTBALL BOOT FOR SPRAINED ANKLE

A sprained ankle should not be used if it can be avoided, for to walk on it only tears the injured tissues further. If the accident happens some distance from home so that some walking is essential, the boot

should not be removed and a figure-of-eight bandage should be put on round the ankle and the boot, and wetted. This, when it dries, tends to tighten the bandage and so gives greater support.

THE IMMEDIATE TREATMENT OF POISONING

IN many cases of poisoning the kind of poison that has been taken cannot be ascertained. The procedure should be, (1) to send for the doctor, stating that the case is one of suspected poisoning; (2) to find whether there are stains or burning round the mouth, inside or out.

If there is staining or burning of the skin present, the patient should *not* be given an emetic to make him sick. Milk, oil, white of eggs, eggs beaten up in milk or barley water should be given. They are non-irritant and will soothe internal local irritation and relieve pain. Milk, by curdling in the stomach, may take up some of the poison and thus prevent it from being absorbed immediately.

If there are no stains present, efforts should be made to make the patient sick, so that the stomach will be emptied before a fatal amount of the poison has been absorbed. Vomiting can be induced by tickling the back of the throat with the finger or with a brush or feather; or an emetic, that is, a substance which will produce vomiting, can be given. Warm soap suds is often readily available; a tablespoonful of mustard in a tumbler of warm water; two tablespoonfuls of table salt in a teacup of tepid water; or a tablespoonful of Ipecacuanha Wine can be used, and if vomiting is not induced rapidly, more of the emetic should be taken without delay.

If the patient is sleepy and drowsy, sickness should be induced by one of the above methods, and he should be kept awake.

Strong coffee should be given to counteract the tendency to go to sleep. For such patients, a teaspoonful of Condly's Fluid in half a tumbler of water is also advised.

Having taken these preliminary steps, the operator should try to find out by questioning the patient or by looking for the remains of possible poison in a glass or cup, what poison has been taken. If it is certain that the patient has taken an acid poison (having corrosive signs round the mouth) then, in order to destroy the poison, he should be given an antidote of two tablespoonfuls of magnesia or kitchen whiting in water, or ceiling plaster in plenty of water.

If it is certain that an alkali corrosive poison has been taken, the patient should be given several tablespoonfuls of vinegar or lemon or orange juice with water.

Any remains of the poison taken or vomited matter should be saved for the doctor to see. Shock should be treated by keeping the patient warm and by giving hot coffee or strong tea to drink.

Poisons can be classed as follows:

1. Corrosives.
2. Irritants.
3. Narcotics.

Corrosive poisons include acids such as salt of lemon; oxalic acid; sulphuric acid or oil of vitriol; hydrochloric acid or spirits of salts; aqua fortis or nitric acid; glacial acetic acid. Corrosive alkalis include caustic soda; caustic potash; ammonia, or spirits

of hartshorn. Phenol or carbolic acid is not really an acid.

In corrosive poisoning there are white patches and a shrivelled look in the skin round the mouth and throat, there is pain in the stomach, faintness, sickness and the pain comes on at once. There is a marked burning feeling in the mouth and throat, an intensely sharp taste and difficulty in swallowing and in speaking.

As stated earlier, no emetic should be given.

The *poison should be diluted* with copious drinks of water, barley water, milk, eggs beaten up, and any non-mineral oil.

Collapse from shock should be combatted with strong coffee and the poison, if an acid, should be destroyed by an antidote of chalk, magnesia, plaster, or whitewash given freely with much water. An alkali poison is destroyed by giving acid with water, vinegar, tartaric or citric acids or lemon or lime juice. Phenol or Carbolic acid poison is destroyed by giving two or three table-spoonfuls of Epsom Salts in warm water.

Irritant poisoning.—Irritant poisons include such substances as tartar emetic, an antimony salt; rat poison and Scheele's green; compounds of arsenic and strychnine; white and red precipitate, that is, mercury compounds; verdigris and blue stone; i.e., copper salts; red match heads and rat pastes which contain phosphorus; poisonous plants such as laburnum seeds, or bad fungi; and tainted food such as bad mussels, and fish.

The general symptoms of such irritant poisons are severe pains in the stomach, which come on at varying times after the poison has been taken. There are often sickness, fainting, and purging and there may be cramps in the muscles. The smell of the patient's breath may help to decide what poison has been taken. There is no staining of the mouth usually.

The doctor should be sent for. The important things are to eliminate the poison from the stomach, and, as even if the patient is sick, it cannot be certain that all the poison

has been eliminated, then a further aim is to dilute the poison as far as possible. It is also important to treat for shock. Any of the emetics already detailed can be used and if sickness does not soon occur, the treatment should be repeated. The longer the patient retains the poison in the stomach, the more poison will be absorbed. The poison can be diluted by giving the patient copious draughts of water, barley water, beaten up eggs, gum and water, and oils such as olive, linseed, cod liver or castor oil. In phosphorus poisoning no oil should be given, as the oil combines with the phosphorus detrimentally to the patient.

Strong tea or coffee is given for collapse and the patient is kept warm.

Strychnine (or nux vomica) produces violent rigid convulsions only. An emetic must be given, and if breathing stops, artificial respiration should, if possible, be started.

Narcotic poisons are those producing drowsiness and, later, insensibility. The pupil of the eye is, in opium poisoning, contracted to pin's head size, the breathing is deep and inclined to be noisy, the face is often flushed, and the skin cold. There is no staining of the lips. The smell of the breath may help in deciding what poison the patient has taken.

An example of a narcotic is opium which occurs in the form of laudanum, and in chlorodyne, morphia, syrup of poppies, child's teething powders, cough mixtures; other narcotics are alcohol, chloral and veronal.

In the case of suspected narcotic poisoning a doctor should be sent for and efforts should be made to get the patient to take an emetic to empty the stomach. The patient must be kept awake without tiring him, and tendency to collapse is treated by giving strong black coffee or strong tea, which also helps to keep the patient awake. If the patient appears to stop breathing, artificial respiration should be started.

A patient who has taken poison should not

be left alone even if he seems better, for further collapse may occur unexpectedly.

Children should be warned on no account to eat any unknown bright-coloured berries which they may find in the hedgerows and elsewhere, particularly in the autumn. Many such berries, though they look attractive, are poisonous to man. There is less danger of children eating fungi promiscuously, because fungi are not palatable unless cooked.

It has been found useful and enjoyable

to children to have a series of lessons in the autumn on poisonous and harmful plants. As plants were collected and studied they were classified by name and drawing in three columns, a red danger one, an orange one to suggest warning and doubt, and a green one as representing safety. Where any part of the plant other than the fruit was poisonous it was noted. Class Pictures numbers 25 and 26 in the Portfolio show examples of POISONOUS PLANTS and COMMON FUNGI.

THE IMMEDIATE TREATMENT OF INSENSIBILITY

INSENSIBILITY occurs in a number of accidents and illnesses, and the first thing to do is to try to find out the cause. Even, however, if the cause cannot be immediately found, general treatment must be begun without delay. A doctor should be summoned. Meanwhile the operator should lay the patient on his back and make him comfortable. If the face is pale, the head should be kept low on a level with the body, but if the face is flushed, the head and shoulders should be raised on a rolled-up coat. Any tight clothing should be loosened, and the patient should have access to fresh moving air. People must not crowd round him.

Any injury or wound should be treated and bleeding stopped. If there is a head injury this may be the cause of the insensibility. If there is convulsive twitching of the face muscles, some hard substance should be put between the teeth, to prevent the tongue being bitten. The patient should be kept as quiet as possible until the doctor arrives and no stimulants given if the original cause of the insensibility is uncertain. No liquid at all should be given if the patient is unconscious, as it may cause choking. If the patient is sick, the shoulders

should be raised and the head turned to one side. If necessary, artificial respiration should be given.

Fainting is due to lack of blood in the brain. The patient feels giddy and looks pale and is uneasy and fidgety. The breathing becomes hurried and shallow and the pulse is feeble. Some children and adults become faint from prolonged standing, as opposed to walking, such as is called for by school assemblies.

The patient should be got into the fresh air or near a current of air, and laid down flat, with no pillow for the head. The legs can be raised a little, to help the blood back to the head. Tight clothes should be loosened. Smelling salts to the nose may help recovery. When consciousness is re-established, a stimulant such as hot coffee should be given.

Concussion, caused by a blow or a fall on the head, may give rise to insensibility. The face is pale and the breathing quiet and the pulse feeble. The skin is clammy and cold. The patient may be sick on returning to consciousness. It is not wise to try to arouse such a patient.

A doctor should be summoned, and tight clothes loosened. If any injury to the head is found this should be treated. If the face is pale the head should not be raised. The body should be kept warm, but cold water cloths or ice should be applied to the head.

If the patient recovers consciousness and wants to move about he should be dissuaded from doing so and made to rest quietly, as the brain will have been jarred.

Sunstroke or heatstroke may cause insensibility. Sunstroke is caused by the direct

rays of the sun; heatstroke by great heat, such as occurs in stokeholes and engine rooms, particularly if the air is moist as well as hot, as this tends to prevent the loss of excessive heat from the skin by perspiration.

The patient has severe throbbing pains in the head, and feels giddy and faint. The pulse is quick, the skin hot and burning, the breathing is rapid and the face flushed. There may also be vomiting.

A doctor should be summoned. Tight clothes should be loosened and the patient removed to a cool place. Fanning will help to make circulation of fresh air immediately. Cold water should be applied to the head, neck, and trunk or the patient should be wrapped in sheets dipped in cold water. This treatment should be carried on for some hours. When the patient is conscious, he should be given water to drink but no stimulants should be given.

Carbon monoxide gas poisoning may cause insensibility. This gas is generated by a running motor and is given off by motor

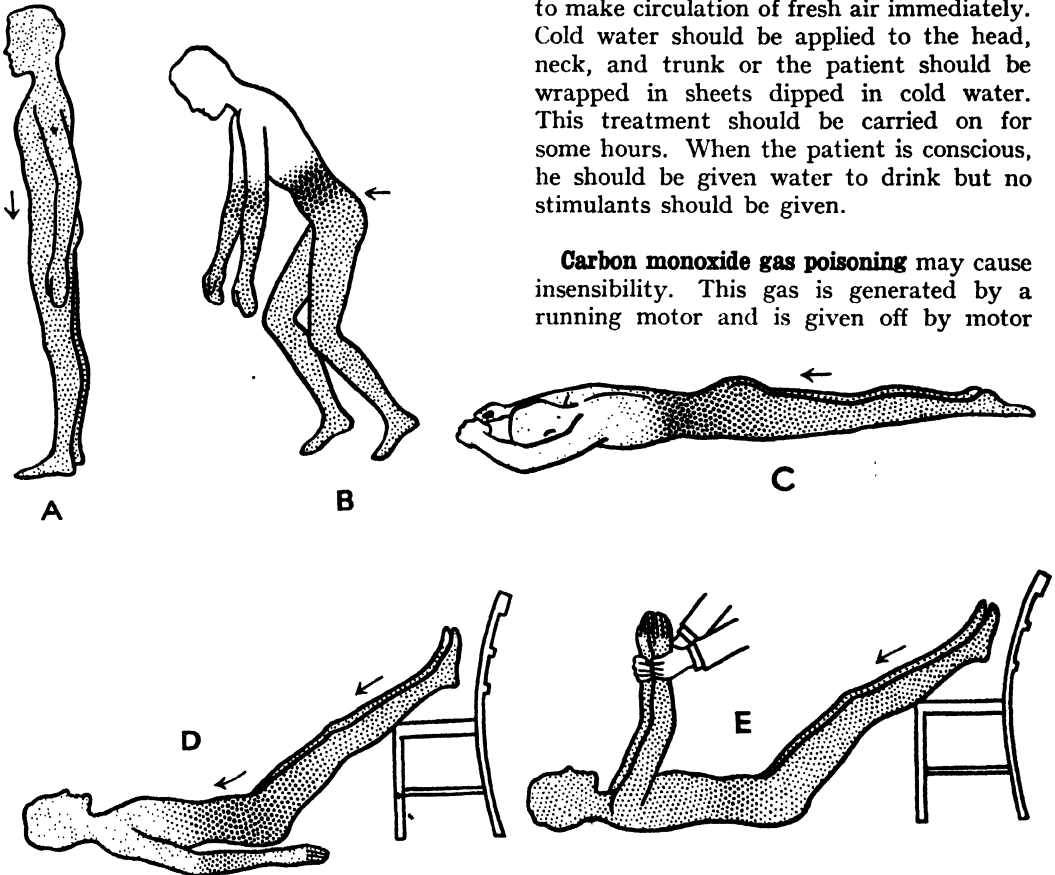

FIG. 24. FIRST AID TREATMENT OF FAINTING

- A. The normal distribution of blood in the body.
- B. For some reason more blood collects in the abdomen, and there is, relatively, less blood in the head.
- C. By lying down flat, the distribution of blood is equalised by gravity.
- D. This can be hastened by raising the legs.
- E. The effect will be even more rapid if the arms and legs are raised.

exhausts, in the open air harmlessly, but in a closed garage, the concentration of CO evolved may be harmful. Gas geysers with defective flues may produce CO and the gas is evolved in some industrial processes.

The first symptoms are giddiness, weakness of the legs and palpitation of the heart. The person affected should be taken into fresh warm air as quickly as possible. A doctor should be sent for and artificial respiration given. In industry, the artificial respiration is combined with the use of an apparatus so that the patient breathes oxygen.

When the patient has recovered consciousness, he should rest for at least two hours. Walking home may produce a return of symptoms. Hot coffee should be given as a stimulant, but no aspirin or phenacetin to relieve the headache, as this may affect the heart adversely.

In all cases of insensibility, it is important that the operator should keep calm and not allow crowding round the patient. To give spectators something to do is a useful way to dispose of them and make use of them too.

THE IMMEDIATE TREATMENT OF THE CESSATION OF BREATHING

IF the breathing is impeded and stops, insensibility soon comes on, and suffocation may occur. No time must be lost. The patient must be taken away from the cause of the suffocation and efforts must be made to restart the normal breathing rhythm.

Drowning is a common cause of such suffocation. Here, artificial respiration must be started without delay, and it should be kept going for at least an hour or until natural breathing is resumed.

Someone should be sent to fetch a doctor; dry clothes and blankets and, if possible, hot water bottles or hot bricks should be procured. All tight clothing should be loosened, particularly from the neck and waist. If the patient is unconscious, time should not be taken up in removing him to a shelter. The artificial respiration should be started on the spot. Any delay may render it useless.

Any weed or obstructions should be removed from the patient's mouth and nostrils, so that breathing is not impeded. If the patient has swallowed much water and there is water in the breathing tubes,

it may be necessary to lift the hips, the patient lying prone, so that water will flow out by gravity. This should take only a second or so.

Artificial respiration may be carried out according to one of several methods.

The Sylvester method of artificial respiration.—The patient lies on the back, with a folded coat under the shoulder blades. The tongue must be pulled out forward by an assistant who grasps it with a handkerchief. Care should be taken to see that it does not fall back and block the air passage to the lungs. The operator then kneels facing the top of the head, and grasps the patient's forearms. He first bends the arms and presses them against the front and sides of the chest firmly, thus counterfeiting the natural expiration, and then pulls the arms steadily upward till the arms are stretched above the patient's head and touch the ground on either side of the operator. This expands the chest and allows an inrush of air as in inspiration.

It is of the utmost importance that the movements should be smooth and complete and not repeated faster than fifteen times a minute, the normal rate of breathing for

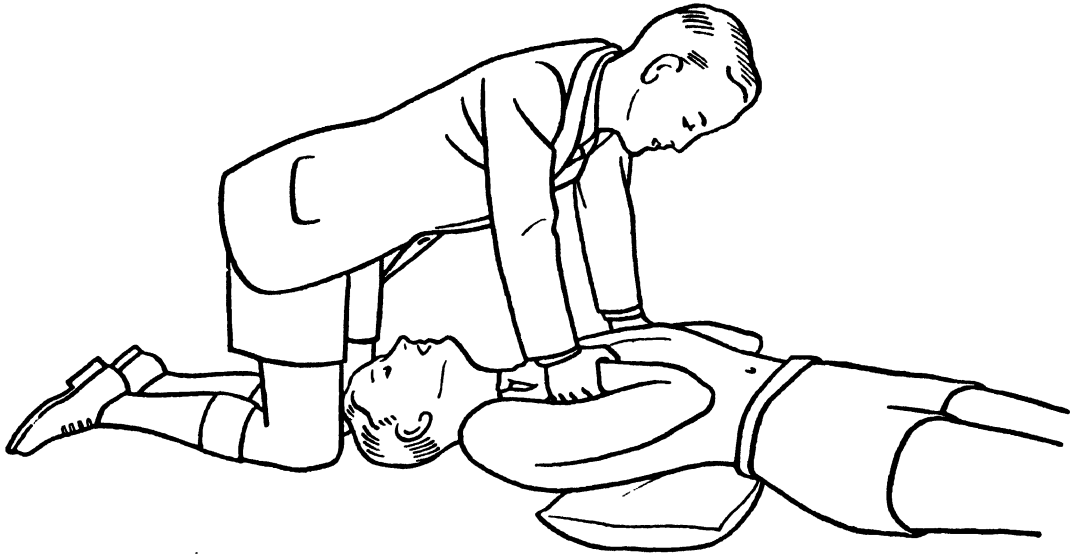

FIG. 25. SYLVESTER METHOD OF ARTIFICIAL RESPIRATION

In this method the arms are bent.

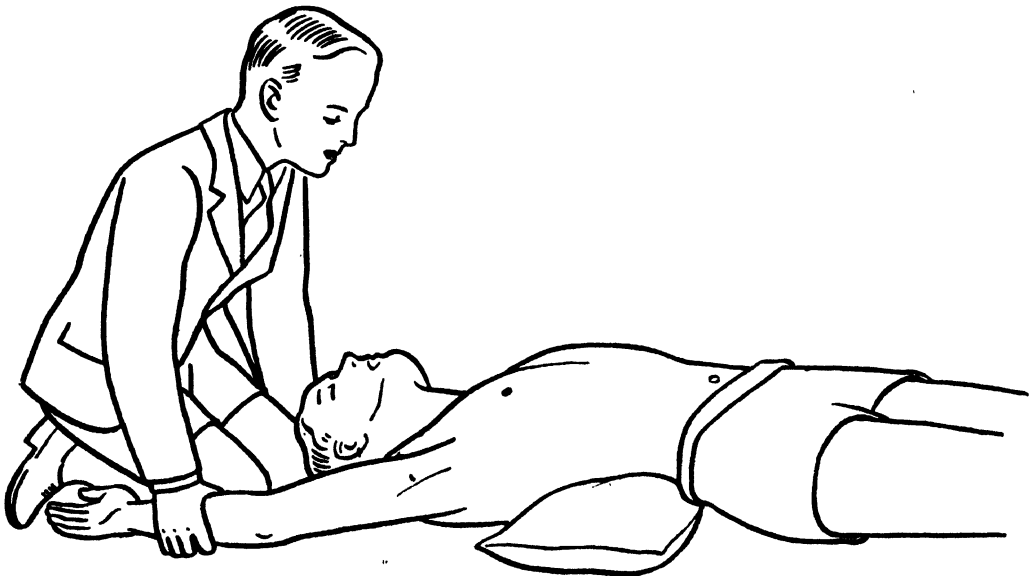

FIG. 26. THE SYLVESTER METHOD OF ARTIFICIAL RESPIRATION

In this method the arms are extended.

an adult when at rest. Quick jerky and superficial movements will not fill and empty the chest of air.

Schafer's method of artificial respiration.—In this method, the patient is placed face downward on the ground, with a folded coat under the lower part of the chest. The operator kneels astride or to one side of the patient, facing the patient's head. The hands are placed over the lower part of the back, that is, over the lowest ribs, one hand on each side of the vertebral column. The hands should not be below the lowest ribs. A common mistake is to place the hands so that the heels of the hands are over the waist line and so over the kidneys. With the hands in position the weight is smoothly thrown forward on to the hands to produce a firm pressure upwards. In this way the air, as well as any water, is driven out of the patient's lungs. The patient's head is turned to one side, and there is now less difficulty that the tongue will obstruct the breathing passages than there is in the Sylvester method.

The weight of the operator's body is now raised slowly to remove the pressure but the hands should not be moved from position. The backward and forward movement should be continued without any break fifteen to eighteen times a minute for at least an hour or until natural breathing restarts.

The advantages of this method are that it needs only one person to carry it out, more air is introduced into the lungs, and the tongue need not be fixed out of the mouth. Also, the arms, if injured, need not be used, and, as stated above, the expulsion of water is facilitated.

Crowding round the patient should be prevented and also any rough handling.

With both these methods, when the patient begins to breathe the operator should time his artificial respiration movements with the patient's rhythm of breathing. Once breathing is re-established, vigorous efforts should be made to restore the circulation. The legs, arms and body should be rubbed briskly from below upwards. Wet clothing

should be removed and the patient covered with dry warm blankets or clothes. Hot water bottles or hot bricks wrapped up should be put to the feet and on each side of the body.

When the patient has become conscious, he should be given some hot coffee or tea. He must be watched carefully, in case breathing stops again. If it does, artificial respiration must be restarted without delay.

In any accident in which suffocation has occurred, artificial respiration should be tried, while medical help is being called.

Fire.—In cases of fire, suffocation from smoke may occur. To remove anyone insensible from a smoke-filled room, the rescuer should tie a moistened towel round his nostrils and mouth, take a deep breath just before entering the room and then crawl on all fours to the patient. Hot smoke tends to rise, so that the atmosphere is less dense nearer the floor.

An insensible patient's wrists should be tied firmly together and the rescuer's head put through the loop of the arms, so that as the rescuer crawls on all fours the patient's body can be dragged along the floor, the patient's legs being between the knees of the rescuer. In this way a small person can drag a much heavier person to safety, and this method of rescuing is one that can usefully be practised in connection with school fire-drill. It is thoroughly enjoyed by the children.

If a room is suspected to be full of smoke, the rescuer should not open the door widely at once and let out a rush of smoke and possibly flames. The rescuer should stand with his body and one foot against the door, so that the door will open only about three inches and can be readily shut again if necessary. This cautious opening of doors should also be taught in fire-drill.

If it is necessary to jump from a window to escape from fire, the escaper should sit on the window-opening, legs outside, from there turn round, so that he faces the room and his weight is on his hands, and from

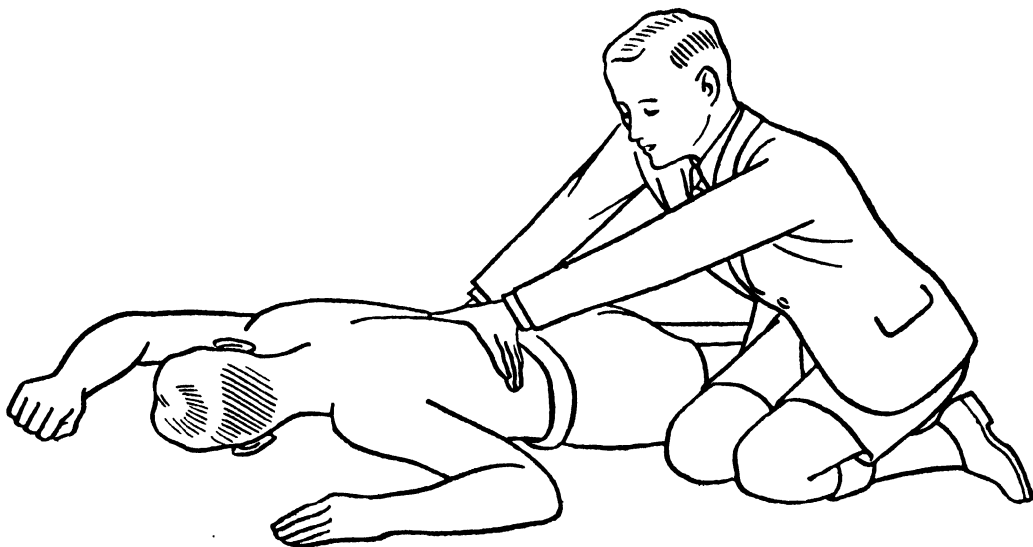

FIG. 27A. SCHAFFER'S METHOD OF ARTIFICIAL RESPIRATION

The patient is prone. The illustration shows the inspiration position.

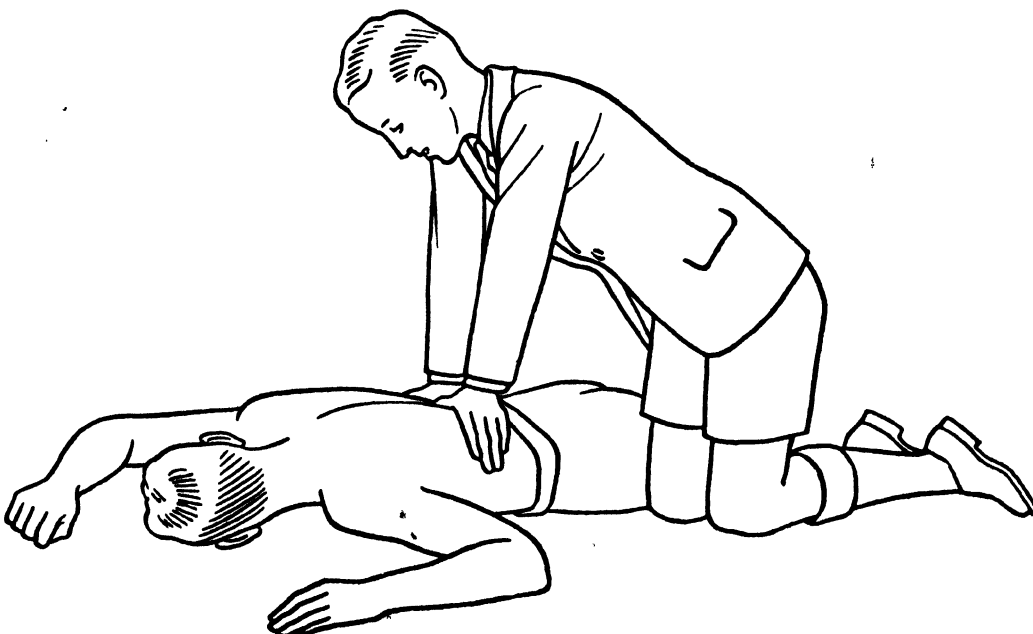

FIG. 27B. SCHAFFER'S METHOD OF ARTIFICIAL RESPIRATION

The patient is prone. The illustration shows the expiration position.

there he slips carefully down until he is hanging on the window-sill by his hands. To drop from this hanging position greatly reduces the distance to drop and the likelihood of accident on landing.

It should be noted that draughts through a building in which a fire has broken out help to fan the fire and make it burn more quickly. Hence, unless they are in use, doors and windows in such a building should be kept shut. While fire extinguishers and water will quench most flames, when oil, spirit or burning fat is the cause of the flames, dry earth or sand are particularly good to put on the flames to smother them.

Inflammable celluloid toys should not be used or given to children. A case is cited of a baby girl who was burned to death

because she poked the fire with a celluloid comb. Coloured electric lights should be used on a Christmas tree for decoration instead of open lights such as small candles. It should be remembered that the fir trees used for Christmas trees contain a great deal of resin and are all too readily inflammable themselves. Similarly, the use of candles in paper lantern shades should be discontinued. The shades should be used over electric light bulbs.

Special care and precautions need to be taken with regard to guards for open fires and ranges in Housecraft kitchens where the children's very enthusiasm sometimes makes them less cautious.

It is a good plan to make some reference to fire precautions a day or so before Guy Fawkes night.

BURNS AND SCALDS

BURNS are caused by fire and dry heat or by the action of corrosive acid or alkalis; scalds by hot liquids or by moist heat, that is, by steam. There are three degrees of burning; painful redness of the skin only; blister formation, and actual destruction of the tissues or charring. The first two degrees are only dangerous to life if their effects are very extensive, so that shock is severe.

If someone's clothing catches on fire, any onlooker should make the person on fire lie down and roll himself round in any rug or mat or table cloth available. Curtains should be torn down and wrapped round the burning person and everything done to try to smother the flames, which are extinguished by lack of oxygen. Anyone who catches fire when by himself should lie down and roll, or crawl on all fours, to help or to sound a bell, rather than run upright. If the burning person keeps upright and moves quickly through the air, the flames are fed with more oxygen and will burn more vigor-

ously and also will burn the face and eyes.

In domestic science centres where there is danger of children's clothing catching fire, it is a routine practice to keep a thick fire blanket ready to wrap round any child whose clothes catch fire.

Treatment of burns.—In the treatment of burns or scalds two factors have to be considered, the shock and the local injury or burning.

In severe burning there is great danger that germs will enter the system through the burnt area and cause blood poisoning. Shock and blood poisoning are the two main causes of death from burns. The burning will have destroyed the germs in and around the area of the wound and the aim of first aid is to prevent fresh germs from entering the open surface. Hence the first aim should be to exclude air, because in the air there will be dust particles infected with spores of bacteria, which will multiply and cause inflammation if they enter the wound.

Great care must be taken in removing the clothing to dress a burn. The clothing should be cut away at some distance from the burn and any scorched material that adheres to the wounded area should be left in place until a doctor sees the patient later. No pieces of clothing should be pulled away. Blisters should also be left and not cut.

If the burnt surface to be dressed is very

required, but this entails some delay in an emergency. Tannin acid ointment is now also supplied. After the spraying, a lint dressing and a light bandage of cotton wool round the wound would complete the dressing.

Linen or lint soaked in *picric acid* solution can also be used. Failing this, dressing of boracic ointment, vaseline, lanoline, olive oil, or carbolic oil (1 in 10) can be used, the

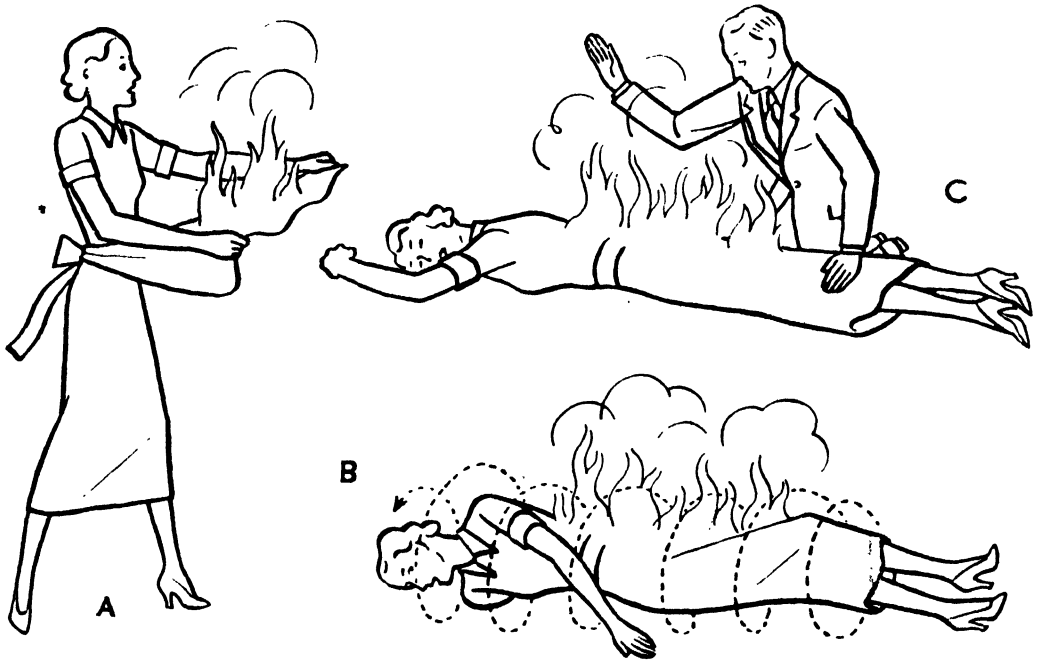

FIG. 28. FIRST AID IN BURNING

- A. If possible the burning piece of clothing should be removed.
 B. The person whose clothes are on fire should lie down and roll, trying to smother the flames.
 C. The hands can be used to beat the flames out.

extensive, only part of it should be exposed and dressed at a time. The dressing should be laid on in overlapping strips so that when the burn is redressed, only a section at a time will be exposed.

The recognised treatment for burn wounds is *spraying with tannin*. This has an astringent effect; it facilitates later treatment, and helps to prevent contraction of the tissues in healing. It must be stored as a powder and a solution made up fresh for use when

lint being soaked in the oil. The tannin or picric acid dressings are, however, much to be preferred because an oily dressing is not aseptic and the oil has to be removed by the doctor to facilitate further treatment. For the same reasons carron oil is not now advised where there is an open wound from a burn.

If the hand or foot is burnt, a luke-warm boracic solution (a teaspoonful to a pint of water) as a bath will give relief from pain

and lessen shock, while the dressing proper is being prepared. The temperature of the bath should be kept at 98°.

Extensive body burns, even if superficial, may cause a high degree of shock and it may be preferable to treat the shock condition first. It should certainly be considered concurrently with the local treatment. Shock may show as a feeble pulse, cold hands and feet, shallow breathing and possibly semi-consciousness. The clothing should not be taken off, and the patient should be kept warm by extra covering, hot water bottles and by being given stimulants such as hot coffee or tea.

If the burning is from chemicals such as acids or alkalis the part should be held under a tap or soaked in warm water to dilute the chemical. This is of more importance as a first step than is the getting and applying of the appropriate antidote. Having got rid of the chemical the wound should be treated as an ordinary burn.

Sometimes children scald the throat by sucking a hot kettle spout, and there is danger of suffocation from

the swelling up of the throat tissues. Hot sponges or flannels should be applied to the front of the neck and chin and the patient should be given olive oil to drink and ice to suck. A doctor should, of course, be summoned.

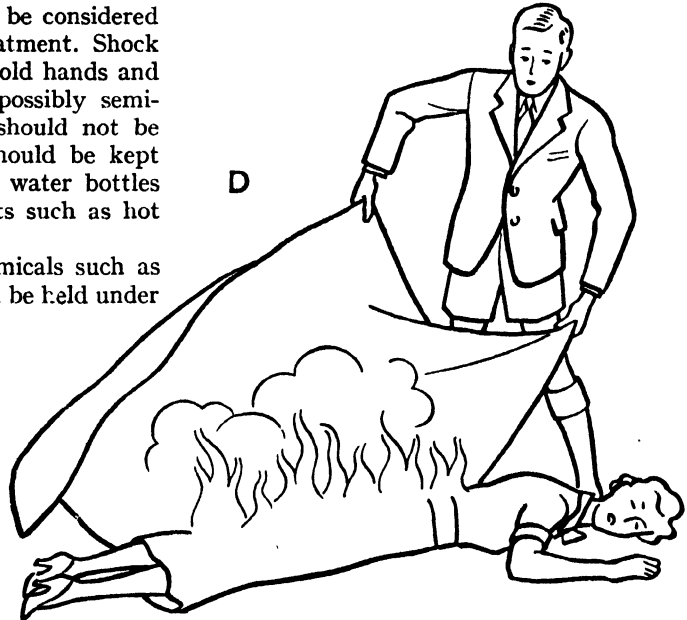

FIG. 29. FIRST AID IN BURNING—CONTINUED

D. The best method of extinguishing the flames is to wrap the burning person in a rug or blanket. The boy should lower the end of the blanket that is in his left hand first, because this way any flames will be directed downwards towards the patient's feet.

ELECTRIC SHOCKS

THIS may be caused by the natural electricity of lightning, or from the artificial electricity of a live wire; that is, an electric cable through which a sufficiently powerful current is passing. The current for the lighting of houses is generally 250 volts; 100 volt current is dangerous and a current of from 20 to 30 volts is as much as can be borne without injury. Normally, electric wires are covered with insulating material such as rubber. If, however, a person touches naked live wires so that the

circuit is closed the current passing through the wires will pass through the body. There is violent convulsion and inability to let go, and there may be insensibility and death. The parts of the clothes or body touching the wire may be burnt or scorched.

The first thing is to remove the affected person from contact with the live wires, and this must be done with extreme caution, or the person helping will receive a shock himself. While the sufferer remains in contact with the wires it is dangerous to touch

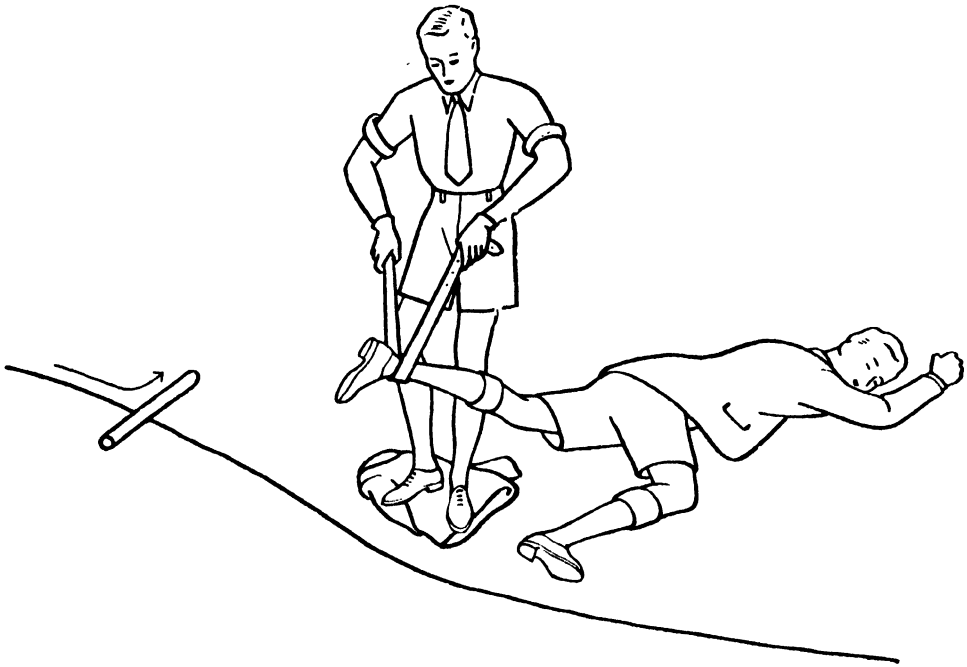

FIG. 30. FIRST AID TREATMENT FOR ELECTRIC SHOCK

The live wire has been earthed by the *dropping* of a metal bar so that the bar crosses the live wire, and one end is earthed by being in contact with the ground. The rescuer stands on a dry folded coat and, wearing rubber gloves if possible, he lifts the injured person away from contact with the live wire by using a dry non-conducting belt.

any part of him, even clothes, without precautions.

An attempt should be made to short circuit the current by *dropping* an iron or other metal bar (note the word *drop*, not *place*) on to the cable so that one end is in contact with the earth. If there are two cables, the bar should be dropped so that it has contact with both and with the earth. The hands should be protected with rubber gloves, or failing these, a rubber mackintosh, or rubber tobacco pouch should be used to touch and grasp the patient, a *dry* woollen

coat being dropped round the patient. Then the helper should stand on an india-rubber mat or a *dry* pile of clothing to insulate himself further, and pull the patient from the danger zone. A doctor should be sent for. The patient should be put in a reclining position to facilitate breathing and fresh air should be supplied by fanning or by opening windows and doors. All tight clothes should be loosened and if breathing is difficult or appears to stop, artificial respiration should be given.



REMOVAL OF FOREIGN BODIES

Foreign bodies in the eye may be of two kinds, those which lie close under the lid and those embedded in the surface of the eye, such as particles of steel or grit. If a foreign body cannot be removed from the eye with reasonable speed it is of the utmost importance to go to a doctor without delay for expert treatment. Otherwise, inflammation may set in and may even cause the loss of the eye. The patient should always be discouraged from rubbing the eye, but told to blow the nose, excess fluid from the eyelids being carried away by the ducts to the nose from each eye.

To remove bodies lying under the lids, the upper lid should be carefully lifted slightly and the eye then closed so that the eye lashes of the lower lid brush the inner surface of the upper lid. Often the particle is removed by this brushing.

Should this method fail, the upper lid may be carefully everted. The patient sits in a good light, the operator standing behind and supporting the patient's head against his shoulder. The patient is directed to look down. A match, or bodkin is placed lengthwise across the lid about half an inch from the margin, and the eyelid is gently rolled back over the match. A camel hair brush dipped in boracic lotion can then be used to brush away the particle. If the particle is on the lower lid, the eyelid can be pulled down and brushed similarly.

If some substance is embedded in the eye tissue, no attempt should be made to remove it; one or two drops of olive oil or castor oil should be put in the outer corner of the eye, the eye should be lightly bandaged over a pad to limit movement of the eye to some extent, and the patient should go to a doctor without delay.

If acid or alkali splashes in the eye, as might happen in a school laboratory, the patient should put his eye under a tap and

be told to open and close the eye rapidly in the running water to remove and dilute the acid as quickly as possible. Any delay may mean permanent impairment of the sight from burning. If an acid has been splashed, the eyes should be bathed in a solution of weak alkali, such as washing soda. If it is an alkali splash, bathing in weak vinegar is indicated (two tablespoonfuls to a pint of water).

Finally, some drops of castor or olive oil should be dropped between the lids, a pad and light bandage applied and the patient taken to a doctor.

Foreign bodies in the nose.—Small children may insert small round objects into the nostril. The child may be made to blow the nose; sneezing may be induced by sniffing pepper. If the body is not discharged spontaneously thus, the child should be taken to a doctor, as harm may be done by attempts to get the foreign body away.

Foreign bodies in the ears.—This again tends to occur in children. It is very important that neither the child nor any adult should poke the child's ear to try to remove the body as the outer drum of the ear may be seriously injured in this way. Pouring liquid into the ear may make an object such as a pea swell up and give further trouble. The child should be taken to a doctor without delay.

Foreign bodies in the stomach.—Children and hysterics may swallow sharp objects, such as a pin, nail, paper fastener. Thick relatively stodgy food, in which the object may become embedded, should be given, such as thick porridge, bread, cake, buns and suet pudding. Purgatives should be avoided and the patient should be taken to the doctor.

GAS DETECTION

ONE of the problems of gas attack is to decide if gas is present and if so, which form of gas, because the procedure for the different classes of gases is very different. The presence of gas can be recognised by the small, but immediate irritant effects, by visible signs such as a coloured cloud of gas, or by splashes of liquid, and by chemical tests of the atmosphere.

The *lung irritant gases* can be fairly readily detected by their characteristic smells; for example, phosgene smells of musty hay. The *nose irritant gases* are almost odourless but their irritant effects on the nose and throat and the tendency to sneeze shows that the gas is present. The *tear gases* also are detected by the immediate effects in making the eyes water. The smell of *mustard gas* (a blister gas) is not pronounced nor are the effects of it immediate, so that it is all too easy for people to underestimate the danger. Its presence can be detected by a faint smell as of onions or horse-radish but some people can only notice this when relatively high concentrations of the gas are present. The liquid splashes from which the mustard gas vapour is given off are of a dark brown to a yellow straw colour and are difficult for the inexperienced to recognise. This, however, combined with the smell and the likelihood of gas attack, should enable the presence of the gas to be recognised. *Lewisite*, another blister gas can be detected by the strong geranium-like smell that it gives off. It also has an irritating effect on the nose and eyes.

The lung irritant gases, such as chlorine, produce a choking feeling and they are fatal if too much is breathed. In the matter of these gases which affect the lungs, a certain minimum must be inhaled before any ill effects occur. In the same concentration of gas, a person moving vigorously would breathe more deeply and rapidly than would

someone sitting quietly. Hence the active person would be affected by the gas present more quickly and to a greater extent than would the sedentary person. There would rarely be enough gas present to make one or two breaths dangerous.

The nose irritant gases—mainly smokes from arsenic compounds—produce intense pain in the throat and nose on breathing the gas, but the effects soon pass off in fresh air.

Tear gas is a general name for any irritant of the eye which produces an immediate flow of tears and smarting so that seeing is handicapped. In the fresh air the effects soon pass off, and no permanent damage is caused.

The blistering gases, such as mustard gas, not only affect the throat and lungs if inhaled, but also produce intense irritation and burning of the skin where the gas has come into contact with it. Such skin contacts do not produce immediate pain; the effects may not appear or be felt until some hours later according to the extent of the contamination. The stronger the gas the greater is the injury produced in the given time, and this applies to all these war gases in their degree.

The gases used in a gas attack are sometimes classified as 1, non-persistent gases and 2, persistent gases.

Non-persistent gases are those that form clouds which drift about with the wind and so become of progressively lower concentration, until the harmful effect is lost. These types of gas will thus be more harmful and persistent in their effects on a still, windless day, when pockets of gas at a high concentration may persist for a long time. On the other hand, the enemy may intentionally avail themselves of a breeze in order that the gas may be carried on to the people attacked.

Chlorine and phosgene are examples of non-persistent gases.

Persistent gases are generally liquids which give off a poisonous vapour and continue to do so for a long period because they evaporate very slowly. (It should be noted that the term "gas" is used for all these irritants and poisons whether they are solids, liquids or vapours.) The ground, or any clothing or article which has been splashed by such a "gas" will thus continue to give off harmful vapour, and steps must be taken immediately to decontaminate as thoroughly as possible.

Tear gases and mustard gas belong to this persistent class. Mustard and similar blister gases will produce skin burns from contact with contaminated clothing and articles until all the blistering liquid has dried up or decontamination has been carried out. In warm weather the vapour from these persistent gases comes off and mixes with and poisons the air around more quickly than on a cold day, but, on the other hand, this has the advantage that the contamination is disposed of more quickly.

Anti-gas precautions.—In the event of a warning of a gas attack or air raid it is everyone's duty to do his best to avoid becoming a gas casualty. Unless tied to any specific duty, everyone should take cover without delay in a gas protected room or shelter; everyone should have his respirator ready at hand in the shelter with him; no one should leave the shelter without carefully trying to find out whether gas is still present. People whose duty compels them to be out during a gas attack should always have their respirators at the "ready" and should wear protective clothing, if necessary.

When moving about in a gas contaminated area, people should be careful to keep to the windward of any shell craters which may still contain pockets of gas, and not to walk on any fresh debris or earth which may be scattered in the street, because this may be

contaminated. If the presence of gas is detected either by smell or by characteristic symptoms, the respirator should be worn. To take risks of becoming a casualty carelessly is to put greater strain on the first aid services, likely at such a time already to be overworked, as well as to upset the carrying out of ordinary work. Hence, for the sake of the community as well as the individual, it is important that all precautions should be taken.

It is suggested that every household should have a gas protected room, of which all crevices of both windows and doors are completely sealed up. How this should be done and the arrangement of air-locks so that people on entering a building do not let in gas in the air, is fully explained in *Air Raid Precautions No. 1, Personal Protection Against Gas*, issued by the Government, price 6d. This handbook also gives clear details of the types of respirators to be used, how they work, how they should be preserved in good condition, and how adjusted. An interesting and enjoyable quest or out of school activity for senior boys would be to find out how a respirator works and should be worn.

Anti-gas treatment and decontamination of clothing.—Anybody who has been contaminated with mustard or any of the blister gases, either by being exposed to the vapour or the liquid, needs to have immediate treatment, both to protect himself from blistering and to prevent the vapour from his contaminated clothing from spreading contamination to other people.

The first thing is to get rid of contaminated clothing and to dispose of it so that it is not dangerous to anyone else. Thus, in specially arranged first aid stations, the clothing is discarded in an outer room and the patient proceeds for treatment, via an air-lock chamber into an adjoining room where the actual treatment needed can be carried out.

The specific for mustard gas contamination is treatment with bleaching powder, a compound of chlorine. For the skin, bleaching

powder ointment is well rubbed into the skin area which has been contaminated and within two minutes, the surplus is wiped off. A thorough washing of the affected area with hot soap and water should be done without delay, and if bleaching ointment is not available, washing alone should be carried out. The application of bleaching powder is only more efficacious than hot soap and water washing if the ointment can be applied within the first five minutes after contamination. As a precaution, the eyes should always be bathed in hot water, in case contamination, not yet apparent, has occurred.

If general contamination is suspected, the clothing should be discarded, and the body bathed in hot soap and water. In any case, the clothing that may be contaminated should not be used again, until it has been decontaminated. A completely fresh and uncontaminated set of clothing should be put on after bathing or treatment. This includes changing of foot wear.

Decontamination of ordinary clothing depends on whether contamination is from vapour only or from liquid.

For clothes contaminated by vapour only, hanging out in the open air for at least

twenty-four hours should be sufficient, but if the garment still smells of gas, treatment as for liquid contamination will be necessary. For washable garments, such as underclothing and light dresses, washing in soap and water for at least a quarter of an hour should be carried out.

Liquid contamination needs to be dealt with by treatment in a steam disinfectant, but washing clothes should be boiled for at least an hour in plain water.

Rubber boots can be decontaminated more readily than can leather foot wear, and should be worn as far as possible.

An important aspect in successfully combating gas attacks, is that the morale of the civilian population should be maintained and panic avoided. This end can best be attained by a wide-spread knowledge of what is to be the procedure in any emergency. People should know where the gas proof shelters are, how to adjust quickly their respirators and where the nearest first aid posts are situated. This knowledge must be reinforced by willingness and goodwill to co-operate in the self-discipline necessary to take the precautions directed and to try not to become a casualty.

SUGGESTIONS FOR LESSONS IN FIRST AID

The first aid box and its contents.—A series of lessons should be devoted to this topic, but these lesson periods will not necessarily be successive ones. The most successful method seems to be to unify the teaching in this direction by means of a chart, which is filled up step by step throughout the course. Some teachers may prefer to treat the topic in a series of revision lessons.

The problem of the first aid box should be introduced by reference to something familiar and already interesting. In the case of boys, the teacher should mention the tool kit of the motorist. He brings out the idea that the

tools are such as will tide the motorist over a difficulty until he can get to a garage. Then he draws the analogy to the first aid box and its contents, which are used to deal with the emergency until the expert aid and special appliances of the doctor are available.

In the case of girls, reference is made to the simple tools supplied with some of the mechanical apparatus in the house, such as a sewing machine or a vacuum cleaner. It is easy to convince the class that the housewife's tools are of limited use, for the most part serving only until the technical expert can repair the machine. The point to stress is that just as we realise the wisdom of having

skilled service for our possessions, lest we do more harm than good in adjusting them, so we ought always to show the same wisdom where human beings are concerned, that is, we ought not to tamper when the expert aid of the doctor is required.

The teacher again refers to the tool kit. He calls attention to the fact that the spanners and other "gadgets" are all stored together in a box or bag, so that the driver can put his hands on them quickly. In the same way, in first aid the apparatus should, as far as possible, be at hand in a box, for prompt action is even more necessary here. The idea of being "at hand" needs developing. It is very necessary that the first aid box should be accessible. The class might be asked to suggest places suitable for accommodating the first aid box.

The next section of the work should deal with the contents of the first aid box. It might be explained that the equipment of such boxes is different in different kinds of factories and workrooms, according to the nature of the injuries likely to occur in the particular shops or rooms. The articles might well be divided into two classes: "constants"

which should be found in every box, for example, a 2 per cent solution of iodine; and "variables" which will be selected according to the environment, such as supplies to make tannin dressing for burns in, say, foundries.

Another and important point to stress about first aid material is that it must be clean and be kept clean and it therefore needs to be stored in a dust proof box.

The chart mentioned earlier should now be discussed and begun. The form below would serve well for such a chart.

All the entries should be elicited from the children, and the spells of work on the chart should be short and vigorous to ensure thoughtful answers from interested children and not just guesses or half-mechanical replies from a bored or tired class.

If the chart is filled up bit by bit as the sessions proceeds it will probably be filled line by line (that is A1, B1, C1, D1) after dealing with a major topic, say, burns or poisons. On the other hand, if the chart is used for revision, successive topics might be *First Aid in the Science Laboratory; First Aid*

FIRST AID EQUIPMENT CHART

A SCIENCE ROOM		B WORKSHOP		C HOUSECRAFT ROOM		D PLAYING FIELD	
<i>Injury</i>	<i>Equipment</i>	<i>Injury</i>	<i>Equipment</i>	<i>Injury</i>	<i>Equipment</i>	<i>Injury</i>	<i>Equipment</i>
1 Poison	Emetic	Splinters in fingers	Tweezers	Burn	Tannin	Sprain	Roller bandages
2							
3							
4							
5							
6							

in the Workshop; and then the entries will be added column by column (A₁, A₂, A₃—, B₁, B₂, B₃, —). It should be noted that under no circumstances should entries be made in the chart until the topic concerned—wounds or insect stings, for instance—has been fully treated in class.

A study of the growing chart will enable the class to make their own decisions as to "constants" and "variables" needed in the first aid box.

Experts often comment on the tendency to supply first aid boxes with equipment which is either too elaborate or unlikely to be used. If this point is discussed with the class, the children will soon see that an overcrowded box defeats its own ends.

The interest in the first aid box, once aroused, needs to be kept alive. The class will realise the need for restocking the box from time to time as bandages and dressings are used up. There will probably be a number of volunteers in the class to take charge of the box. Where the task is allotted to two members of the class, it will, of course, be necessary for the teacher, as the one ultimately responsible for the box, to make sure that it is kept in proper condition. Under the circumstances he would take care

not to destroy the feeling of importance and responsibility of his pupils.

At this stage the teacher can make use of children's love of catalogues. A number of advertisements for first aid sets, which state the contents of each set, could be collected and the class should be told about this some weeks ahead so that they may bring their contributions.

Hectographed or typed carbon copies of these advertisements should be distributed to the class with instructions to make their decisions as to which box they would buy for 1, the science room, 2, the school workshop, 3, the cookery room, 4, the playing-field pavilion, 5, the home. Class discussion would follow individual study.

The work on first aid equipment should be rounded off by a discussion of articles which are often used, and yet not found in the first aid box; for example, the advisability of having a thick rug or blanket accessible for use in case of burns in the kitchen and the laboratory. Such work will provide a natural opening for a discussion on what will serve as splints and bandages in the event of fractures of various kinds. In the same way, the class can decide how best to keep a boy warm and dry if he has had an accident on the playing field.

SAFETY FIRST AND FIRST AID

WHILE, with a little ingenuity, the teacher can generally find some practical way of teaching the various first aid procedures, it is sometimes more difficult to find ways of arousing a right attitude to first aid as a whole. Yet, unless exact knowledge is reinforced by right sentiments and convictions as to the value of the work, there is little likelihood that the boys and girls will use their knowledge and skill when their services are really needed.

For the most part, this training of a sense of service is indirect and largely a matter of

the child's acceptance of the convictions of a sincere teacher. Nevertheless, it is as well, from time to time, to reinforce this indirect training by direct teaching.

A suggestion for such direct teaching is given below.

Sometime towards the end of the term the teacher makes use of one of the lists of holiday *Don'ts and Dangers* supplied by certain education authorities to the head teachers. Here are some of the items from the L.C.C. list. (The numbers in parenthesis are those of the original list.)

1. The danger of drowning,—care is necessary when bathing in the sea, rivers, etc. (2)

2. The danger involved in throwing stones or other missiles at passing trains and in trespassing on railways and canal banks. (3)

3. To refrain from breaking the glass in street lamps by throwing stones. (6)

4. The danger of throwing bottles or broken glass on roadways or into ponds. (8)

5. The danger of lighting fires in or near plantations and woods. (10)

6. The danger of prolonged exposure of the head to the hot sun. (11)

7. The danger of eating plants. There are native to Great Britain many plants one part or another of which is poisonous. (13) (See Class Pictures Nos. 25 and 26 in the Portfolio.)

Any such list when read aloud to large groups of children as an official order may tend to make some children antagonistic and contra-suggestible, as well as suggesting hitherto unthought of activities of a non-communal nature. As lists, they savour too much of "thou shalt not." The information, however, contained in many of these admonitions can be used as the bases of good positive and constructive teaching in first aid.

Children are fundamentally more reasonable than we imagine and they are lovers of law and order. If, therefore, the children can see good reason, "some sense" as they would say, in these suggestions they will be ready to accept the warning.

The children receive teaching in safety first throughout the year, but on the whole the impression left is "my own safety first." Now an opportunity for the social training, that is, for stressing safety first for others as well as ourselves.

Take as an example No. 3 on the list—

"To refrain from breaking the glass in street lamps by throwing stones." If asked why this item was included in the list, the class will probably answer to the effect that it is wrong to destroy public property. In the same way they will probably think of the consequences in terms of punishment. They can soon be led to realise that the major problem is that of danger to persons rather than harm to property.

It is at this point that the first aid teaching really begins. The class discusses the dangers to passers-by from broken lamps and then in greater detail considers the first aid procedure for such cases.

Reference to No. 1 on the list—"The danger of drowning and the need for care when bathing in the sea and in rivers," provides an occasion for additional practice in methods of artificial respiration.

Reference to No. 5—"The danger of lighting fires in or near plantations and woods" can in its turn be dealt with as a precaution against harm to persons and animals and not merely against destruction of property, important though this is. The first aid for burns can be revised. It will to some extent be from a new angle, because the accidents will possibly occur out of doors.

In a similar way, a consideration of No. 7—"The danger of prolonged exposure of the head to the hot sun," will lead to a discussion of sunstroke.

Such work should help to give the children the right attitude towards these warnings. They should realise their own two-fold duty with regard to possible emergencies, namely, to prevent accidents where they can and to treat, or help in the treatment of, accidents arising when others have failed to heed the warning.



HOME NURSING

This Article can form the Basis of a series of Lessons for older Girls. It is an excellent Supplement to the Article on HEALTH EDUCATION.

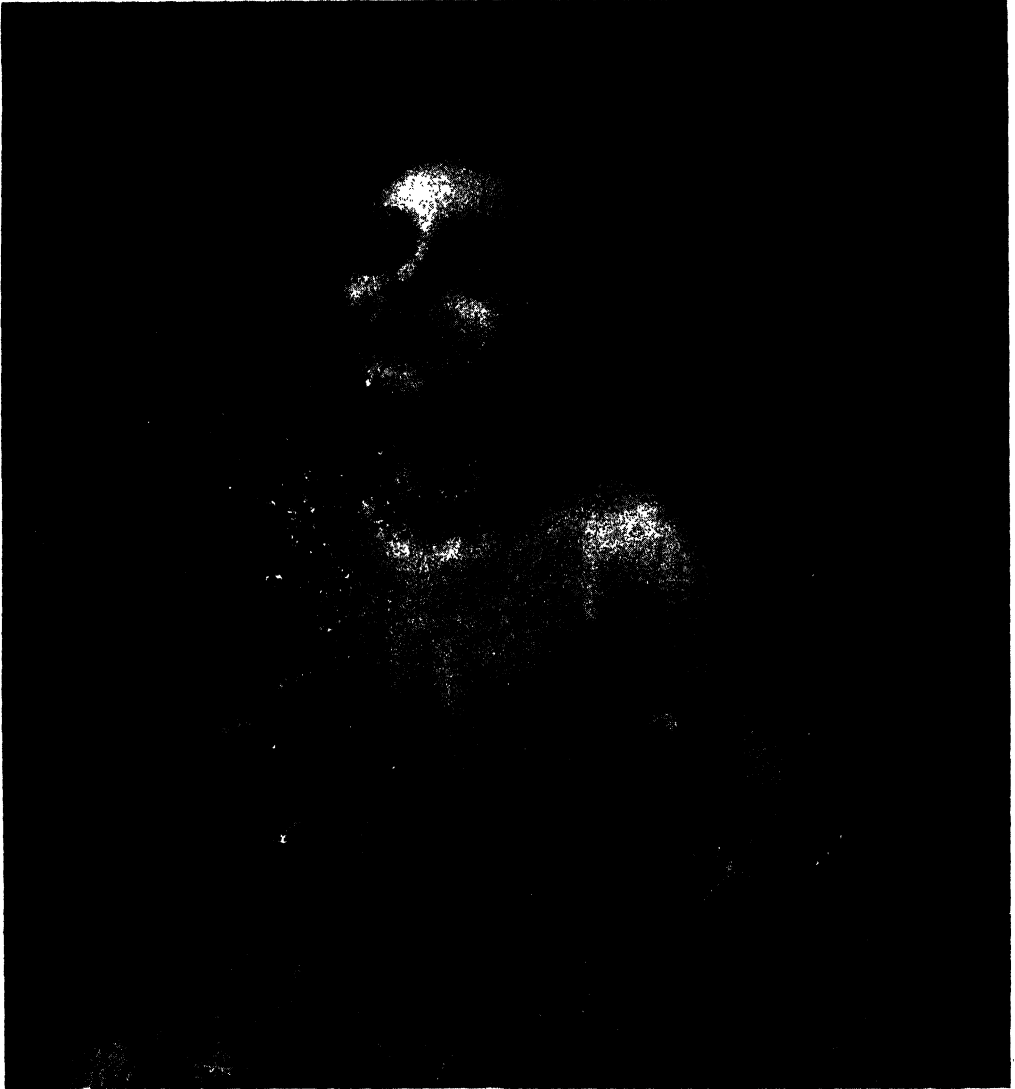

From the painting by Annie L. Swynnerton in the Tate Gallery.]

NEW RISEN HOPE

INTRODUCTION

FOR the purposes of this article, the term "Home Nursing" is considered to include the care of those sick persons who are not ill enough to need the whole-time attention of a trained nurse. A visiting nurse may carry out certain treatments, but the general comfort and well-being of the patient depend on the care given by members of the household.

In nearly every case, of course, a doctor will be in charge, but he will be able to reduce his visits to a minimum if he knows someone capable and well-informed is carrying out his instructions, while serious complications are often averted by sensible observant care of a sick person from the appearance of the very first symptoms of disturbed health.

The HOME NURSE herself is probably responsible for the ordinary running of the household, so that the extra duties of nursing make her a very busy person indeed. She will be well advised to make an early opportunity of sitting down with pencil and paper and working out a routine for her days in which the claims of the sick and the well are carefully balanced. Good organisation will save much wear and tear for everyone and will help her to remain serene in difficult circumstances, and if there are others in the family old enough to take extra responsibility for a time, let each be allotted a suitable task. Young people like to be trusted in this way, and old ones are often glad to be given a definite way of helping. Any such assistance will relieve some of the pressure.

In the sick room the nurse should always appear fresh and neat, calm and cheerful. Overalls are the most useful wear as they are washable and completely cover the dress. Shoes must be quiet, with rubber heels if the room is not carpeted. Needless to say, anything in the way of forced brightness or a perpetual smile should be strictly avoided,

for these are even more irritating to the sick than an air of depression. One should try never to let the patient feel it is anything but a pleasure to attend to him.

The home nurse should remember to take care of her own health and do her best not to get overtired. It may be possible to rest with the feet up for a while in the afternoon, perhaps with the family mending but better still with a book, and sometimes a reliable friend might be found to come in for an hour or two to release the nurse for a walk or an early bedtime, especially if she has disturbed nights. The slight change may even be refreshing to the patient, but any instructions as to medicines due to be given or other details should be clearly written down, so that no mistake may be made.

The nurse may lose interest in her own meals, but it is important to take regular and sufficient nourishment, particularly if the patient's illness is an infectious one, such as influenza.

She will certainly break down if she neglects these points, and if the sick room takes up much time she must make up her mind to "let the house go," and arrange extra cleaning later on.

A nurse must be very observant and accurate in reporting even small points to the doctor, and while she must not let the patient know it when she is worried about him, yet neither must she make him feel that she does not realise how ill he is. Her first resolution should be, "I will not fuss," and her first aim to give the sick person absolute confidence in his attendants and surroundings.

THE BASIC PRINCIPLES OF NURSING

When a person is ill, it is the aim of those responsible for him to assist nature in producing the speediest possible return to

health. Whatever the disease, the fundamental needs of a sick person are:

1. Rest for mind and body.
2. A comfortable surrounding temperature, warm in winter, cool in summer.
3. Good ventilation, so that he always has pure air to breathe.
4. Suitable nourishment in sufficient quantity.
5. Cleanliness of person and surroundings.
6. Medical treatment appropriate to the disease.
7. A gradual return to normal life during convalescence.

1. Rest.—Rest is obtained only when the mind is free from worries and excitements and the body has been made comfortable. **MENTAL REST** for the patient cannot always be achieved by the nurse; there may be business or household worries that she cannot remove, but every effort should be made to arrange the sick person's affairs satisfactorily and to maintain a serene atmosphere around him.

Visitors must be sympathetically controlled, none being allowed to stay long enough to overtire him, and any he does not wish to see tactfully refused admission. **BODILY REST** is the result of all-round good nursing, but it is convenient to consider under these headings:

- (a) The sick room itself.
- (b) Quietness of surroundings.
- (c) The bed and bedmaking.
- (d) Routine for the day.
- (e) Care at night.

(a) *The sick room.*—The ideal sick room is large and airy (not too large to be easily warmed in winter), with a good sized window facing south in winter, or south-east for summer; a coal fire; linoleum and one or two mats on the floor; and not too much furniture. It is on the same level as the bathroom and lavatory but not too near them on account of the noise.

In most modern homes there will be no choice of sick room, especially for a short

illness but, when planning accommodation for a permanent invalid or anyone likely to be confined to bed for some time, it is worth while considering the available rooms and selecting the most suitable.

It should be light and bright; happily modern wall treatments assist in giving this impression and are free from fidgety repetition patterns. There should be a dark blind so that the window can be shaded when desired, but it should not be drawn straight down excluding the air: it can be fixed to a chair set a little away from the window, and this will also prevent the cord from tapping—a most irritating noise. Unless the patient is accustomed to sleeping in a darkened room and would otherwise wake with the dawn, the blind should not be drawn at night. If the room is overlooked by other houses, a screen can be so placed as to give privacy, and a useful one can be improvised from an old-fashioned clothes horse with a sheet thrown over it.

Linoleum on the floor is easily washed or polished and is quite necessary when dealing with infectious illnesses, but a carpet has the great merit of being quiet, and where an electric cleaner is used there is no real objection to it in many cases.

The bed should, if possible, be placed with the head only against the wall as this makes attendance easier, and it should never face the window because the glare becomes most trying to the patient's eyes. It will sometimes help during a long illness to change the position of the bed from time to time, especially if there are two windows with different views, according to the wishes and interests of the occupant.

Furniture is best kept to a reasonable minimum. Unnecessary articles collect dust, make extra cleaning and take up space, but of course a bare look is to be avoided. A bedside table is a necessity. It must stand firmly, and will be most useful if it has a lower shelf for books and papers, a small drawer to hold odds and ends, and a plate glass top under which a doiley can be placed to give a finished appearance. Slight acci-

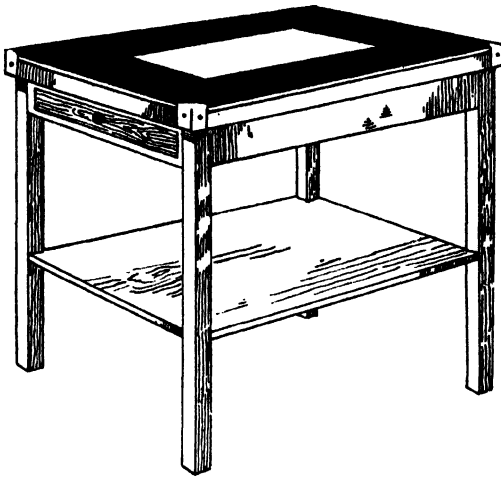

BEDSIDE TABLE

dents will happen, and no harm will be done to a surface that simply needs wiping with a damp cloth. The table should not be too small, 30 in. by 18 in., or 20 in. square are good sizes for the top; height 28 in.

A comfortable armchair and a footrest or hassock for the patient to use when allowed up or while the bed is being made, a small chair for stripping the bed, a washstand or shelf to hold toilet articles, and probably a chest of drawers, are all necessary, and beyond this only enough furniture to make the room look comfortable should be present.

Flowers in the sickroom are a great blessing, and if the home nurse herself is too busy to make the best of those available perhaps someone else in the household could undertake the complete care of them. Heavily scented blooms are not suitable, even the lovely freesias being best avoided, and only vases that stand quite firmly should be used and these placed where they will not be brushed against and overturned. For the bedside table, something small and low of the posy-bowl type is obviously best. All flowers should be removed from the room at night and brought back with fresh water next day. Sprays of spring blossom will last longest if the ends are well crushed and if they are left undisturbed in their vases;

merely fill up the vase when necessary and only occasionally change the water. This is not a strictly hygienic practice to recommend for the sickroom, but as a rule these sprays are not easy to get and they are specially liked by most people, so a little latitude may be allowed.

Cleaning the sickroom should be done with as little noise and disturbance as possible. Cover the bed with a clean dust sheet first, and do all dusting with a damp cloth, polishing where necessary with a dry one afterwards. When the floor is washed see that it is wiped as dry as possible so as not to create a damp atmosphere. On the whole, it is better to polish linoleum than to wash it often, except in infectious illness.

(b) *Quietness of surroundings.*—Quietness of surroundings is not always easily attainable, but in a general way the ordinary reasonable noises of the street and household, to which he is accustomed, will not worry



PAD FOR THE DOOR

the patient. It is not desirable for everyone to creep about on tiptoe and talk in whispers as this can be maddeningly irritating, but avoid running up and down stairs unnecessarily, and especially see that no door is left "on the jar." A useful device for the sickroom itself is to make a folded pad of material with looped ends, which can be hung on the door knobs. This will prevent the door closing completely, incidentally helping the ventilation, and when the patient is resting the



PAD FOR THE DOOR

nurse can look in without disturbing him. It is also convenient for those entering with trays, and so on.

If the door hinges squeak, they can be oiled. The blind cord should be prevented from tapping, and windows should be wedged. A pad of paper does very well if neat rubber or wooden wedges are not at



A COAL GLOVE

hand. For making up a coal fire, a coal glove is useful, simply made from any thick black material, possibly lined, fitted with a good loop by which it is hurg up and drawn on or off the hand.

In serious illness, special measures will suggest themselves, but in all cases the

nurse should cultivate deft, quiet movements and be on the alert to prevent the small irritating sounds which can be so disturbing to a person who is obliged to lie and hear them.

(c) *The bed and bedmaking.*—The bed is obviously a most important factor of the patient's comfort, and is preferably of single size with a good hair or flock mattress (or a luxurious Dunlopillo!), not too low if much nursing attention is needed. Hospital beds are 30 in. high, but many domestic beds are rather lower than this. Wooden blocks can be used to raise a very low bed and thus prevent undue fatigue and back-ache for the nurse, but they must be strongly made and really firm, having a slight hollow to take the castor securely.

Feather beds are unsuitable and are not very common nowadays but, if the patient is elderly and devoted to a large double feather bed, it is better to let him keep to it so long as he is well enough to sit out while it is properly made, rather than to insist on moving him on to a more hygienic

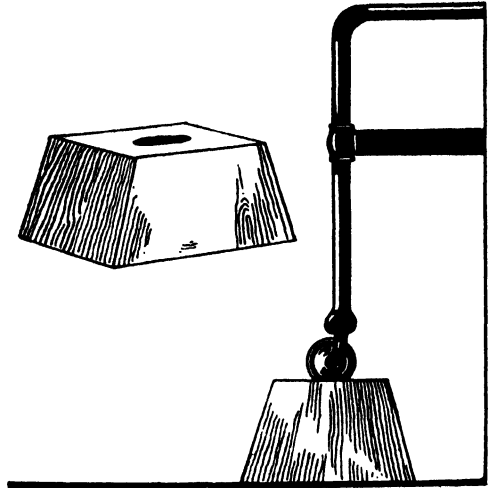

WOODEN BED BLOCKS

mattress that he will find hard and unfriendly.

Firm, well filled feather pillows are the most comfortable. They should be sufficient in number to support the patient in the position desired and, if he is to sit up, a small one about 12 in. by 9 in., to fit into the hollow of the back, is a great comfort. Cheap rubber air-cushions of this size are obtainable, and they are useful also in an armchair or for travelling, and the tension can be adjusted to suit the circumstances.

A circular rubber air ring to sit on, blown

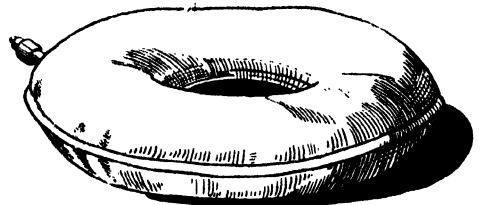

AIR RING WITH AND WITHOUT COVER

up rather tightly, is invaluable in a long illness or for a very thin patient, and helps to prevent soreness of the skin, which is always regarded as a disgrace by a good nurse! An air ring costs about 9s., but one can often be hired through a chemist if needed for a short time only. It should be enclosed in a cotton cover when in use or it will become unpleasantly hot, but the cover must fit exactly, without wrinkles.

A mackintosh and drawsheet are necessary in all cases where bedpans are used and should be about 1 yd. wide, reaching up to the lower edge of the pillow. The drawsheet must completely cover the mackintosh and is most useful if it is at least 2 yds. long; then each time the bed is made a fresh portion can be brought into use, the rest being tucked in. An old double bed sheet, folded in half lengthwise, is excellent for the purpose.

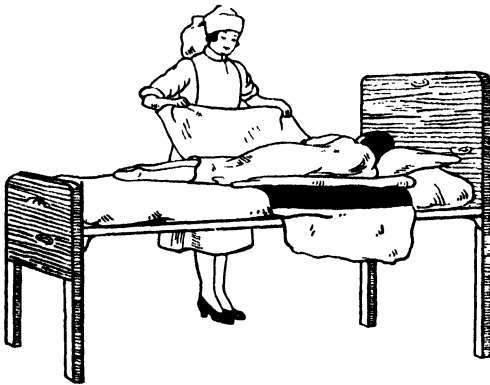

THE DRAWSHEET

For BEDMAKING it is good to have two persons, and if possible the patient should get out while it is done. Very often the doctor will permit him just to sit out in an armchair which has been drawn up to the bedside, even if he is not otherwise allowed up, but of course the room must be quite warm and free from draught, and the patient well covered with a rug, blanket or eiderdown. The change of position will refresh him, and the nurses can make the bed well and easily.

Bedmaking should be done night and morning and carried out quietly and methodically, care being taken not to raise dust by flapping the clothes about. Strip off each layer singly on to a chair, and do not let the things touch the floor. Turn the mattress each time, alternately from top to bottom and from side to side to equalise the wear, and see that the tapes of the mattress cover do not catch and tear in the springs. The bottom blanket and sheet should be tucked in taut, the upper clothes loosely so that the patient can turn comfortably without pulling them out at the sides. Arrange a good tuck-in at the foot and a good depth of sheet to turn over the blanket and counterpane at the top. It is convenient to leave off the counterpane at night, as it will keep fresh for use longer if it is then folded carefully in its creases and hung over the chair back.

Bedmaking, when the patient is too ill to get out of bed, is not a difficult matter if two nurses are available. They should be gentle but definite in their movements, and the process should not be hurried. Stand one on each side of the bed and strip it quietly on to a chair; leave the patient covered with a blanket, and draw out the sheet from beneath the lowest one so that he is never uncovered even for a moment. Remove all pillows but one; untuck both ends of the drawsheet, and then roll the patient gently to the edge of the bed on the side where the sheet is shortest. One nurse should hold him lightly in position while the other untucks the mackintosh sheet, under sheet and under blanket and thoroughly but quietly brushes out any crumbs and bits. She then pulls these taut and tucks them in again in single layers, and moves a fresh portion of the drawsheet across into position, rolling the last used area against the patient's back, and tucking in the end. The patient is rolled over the slight ridge to the other edge of the bed and the second nurse similarly deals with her side. There must be absolutely no crease in the under bedclothes when this part is

finished, otherwise not only discomfort but actual bedsores will be caused.

The pillows are shaken up and arranged next, and if the patient cannot easily sit forward while it is being done each nurse supports him by hooking her hand into one armpit and holding the shoulder. He now leans back against the pillows, the air ring, if used, is inserted, and the top bedclothes are replaced one by one and tucked in neatly but loosely.

To insert a clean bottom sheet or draw-sheet, roll the old one close up to the patient as he lies on the edge of the bed, tuck the new one into position on the clean side and roll up the other half also close to the patient. He is then rolled gently over the double ridge to the other edge, the old sheet is removed and the new one tucked in completely.

In any case where the undersheet is likely to become soiled a long *leak* mackintosh is needed to protect the mattress and this can replace the under blanket. It must be of good quality or it is useless, and as stout rubber sheeting is costly (though it wears well and lasts for years) it will be cheaper to hire it for a short illness. A washable mattress cover should, of course, always be used.

(d) *Routine for the day.*—This must vary in detail in every household, and the home nurse must think out a scheme which will fit in the sickroom duties with as little disturbance to the rest of the family as possible, at the same time considering special preferences of the patient. Some, for instance, like a cup of tea and a newspaper early, with breakfast to follow much later after the morning wash and bedmaking, while others would rather be undisturbed until 8.30 or 9 o'clock and then have breakfast and be washed after that.

The great thing is to evolve a workable routine and stick to it. In this way no duties are overlooked, the patient knows what to expect (sick persons dislike "having things sprung on them") and the day passes more quickly for him.

The following list will apply in many cases, with slight variations in times.

A.M.

7.30 *If awake.* First of all take the temperature and pulse if this is to be done, disturbing the patient as little as possible.

Shake up pillows and straighten bed.

Put on dressing jacket or warm wrap over shoulders.

If a saline aperient has been ordered give it at this time.

Give cup of freshly made tea, newspaper and letters (nothing to eat, not even a biscuit).

Light fire if needed.

8.30 Wash or bath patient; make bed.

9.15 Breakfast.



PATIENT EATING BREAKFAST

9.45 Attend to sickroom. Sweep; dust; arrange flowers. See that all necessary articles are within easy reach, such as bell; clean handkerchief; reading matter; glass of lemonade; ash tray and smoking apparatus; clock correctly adjusted, placed where it can be seen without effort; dressing gown and slippers handy.

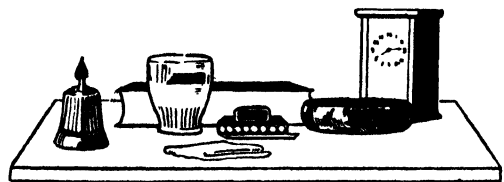

ARTICLES FOR THE DAY

A.M.

- 11.15. Mid-morning drink, usually hot in winter, cold in summer, in accordance with the diet allowed. Time this to come just halfway between breakfast and dinner, and give a small cup only if there is any likelihood of spoiling the appetite for dinner.

This makes a welcome break in the morning and should be varied from day to day so that the invalid never knows what is coming.

P.M.

- 1.15 Dinner.
- 1.45 Settle the patient comfortably to rest for at least an hour. Darken the room and remove a child's toys and books. This provides an opportunity for the nurse herself to rest at the same time.

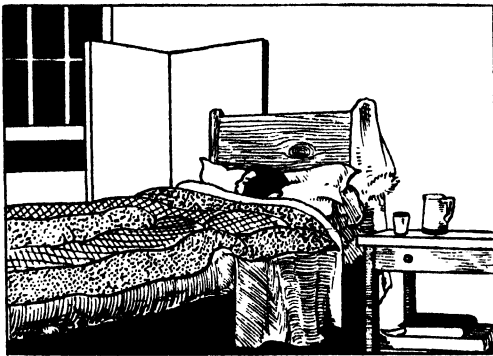

PATIENT RESTING

- 3.0 (or when the patient wakes). Draw up the blind, sponge the hands and face if desired, tidy the hair and neaten the bed. This is the best time for visitors, if allowed, but only those who can be relied on to give pleasurable mild stimulation to the invalid should be admitted; no one should stay long enough to tire him. Great firmness must be exercised in this matter, and the doctor will give full support. Well-meaning but unsuitable callers can be told, "I know you

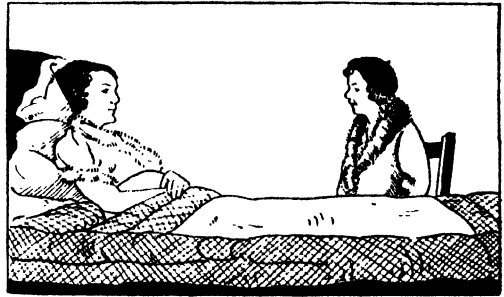

A VISITOR

will understand, Dr. X. is very particular that Mr. Y should be kept quiet for some time yet, but it is most kind of you to call."

P.M.

- 4.15 Tea.
- 6 or 6.30 Evening toilet and bedmaking. Take the evening temperature first if this is required.



NURSE HELPING PATIENT ON WITH DRESSING GOWN

- 7.30 Supper.
- 9.0 Settle patient for the night. Remove flowers if this has not been done earlier, see that everything he may

need is at hand and give a hot soothing drink if it will help him to sleep.

A convalescent may like to continue reading quietly for another hour, but it should be understood that he will not be visited again before morning unless a definite reason arises.

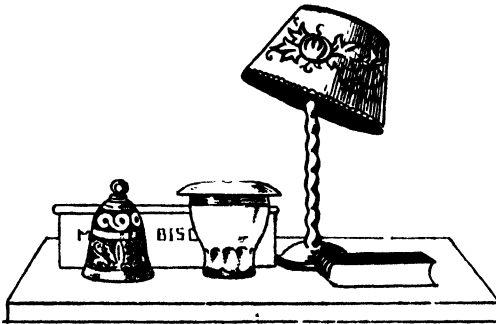

ARTICLES FOR THE NIGHT

During a long illness, see to it that changes creep into the routine. Although a smoothly planned day is always desirable, yet most invalids will find it becomes desperately monotonous to do the same thing at the same time every day for weeks on end, and an occasional break of some kind should be arranged.

(e) *Care at night.*—A point of first importance is to arrange that the nurse is within easy call, for both she and the patient will sleep better if they know that an efficient means of communication exists. Undoubtedly an electric bell to the nurse's room is best, and someone in the family, or a friend, may be able to fit one up temporarily. Otherwise a small handbell will serve if the doors of both bedrooms are left ajar. If the patient is a young child, of course the nurse must sleep in the same room, but this should not be done unless it is really necessary.

The question of lighting is also important. An electric reading lamp is ideal; failing that, candle and matches can be left only if the patient is old enough and well enough to be quite safely trusted with them. A

night-light will sometimes meet the case, and nowadays handy electric torches are available. The local dealer will have two or three types and the most suitable can be selected. In any case, it must be possible for the patient to get a light promptly and without effort whenever he may need it.

If he does not sleep well and yet is not likely to require the nurse's attention, leave a small tin of biscuits on the bedside table, with either a cold drink in a covered glass or a hot one in a thermos flask. In any case it is wise to provide a glass of lemonade or barley water.

See that the room is well ventilated and the patient warm in bed. If there is a fire in the daytime an extra blanket at night will be called for, bedsocks must be tied at the ankle or they will be kicked off, and hot water bottles should be freshly filled last thing before retiring. In some illnesses, where an even temperature is important, it will be necessary to keep a fire alight all night for a time, but the doctor will order this where necessary.

If the patient has a restless night and falls asleep towards morning, leave him undisturbed until he wakes naturally. The early cup of tea can be omitted, but do not serve breakfast late. It is an advantage to arrange this meal not earlier than 9 o'clock, as most people are awake by that time and it is not good to disturb the spacing of meals or medicines.

When a patient is ill enough to need a good deal of attention during the night, the same person should not attempt both day and night nursing if it is at all possible to get suitable help. She will rapidly become overtired, and it is quite unreasonable to expect her to manage singlehanded.

2. The room temperature.—This should be kept as even as possible, usually at about 60° Fahrenheit. It should never be allowed to fall below 50° F., and for children and elderly patients, and in certain diseases, the doctor will wish it to be kept between 65° and 70° F. Do not rely on guesswork but

have a thermometer on the wall and read it daily.

To keep the room warm, a coal fire is probably the best method of heating a sick room, as well as the cheapest, because it helps ventilation. There is, however, no objection to a properly fitted gas fire of up-to-date design, and its labour saving advantages will commend it to many, but electric heaters are not really suitable for prolonged use as they dry the atmosphere, and of course in many districts the cost of electric current is prohibitive.

Bedclothes in winter should not be heavy, the best quality blankets procurable being used for this reason, with an eiderdown if the disease is not infectious. Children, old people, and those who specially feel the cold will benefit by the use of "woollen sheets," which are of the texture of thick flannelette. They wash well and cost about 7s. 6d. a pair, single bed size. Cellular blankets (from 21s. each) and sheets (from 21s. 6d. a pair) can be recommended for use all the year round, as well as cellular nightwear, and when there is a permanent invalid to be cared for the outlay is worth while if it can be managed. Warm bedwear can be made of wincey, viyella, chilprufe, nunsveiling, and similar materials, and sleeping suits are better for children than nightgowns until they are old enough to be relied on to stay properly in bed. Bedsocks are useful and wear best if made with a shaped heel.

The utmost care must be exercised in using HOT WATER BOTTLES, for it is incredibly easy to cause a severe burn to a person in a lowered state of health, and such burns take a very long time to heal. It is really wise to keep a blanket between the patient and the bottle, but this is not always quite convenient: in any case never give a hot water bottle that is not completely enclosed in a thick woollen cover. Make sure the bottle itself is in good condition, not perished if a rubber one, with a satisfactory washer and screw top. Do not put two earthenware bottles in the same bed or they may be kicked against each other and



HOT WATER BOTTLE

cracked; the now popular aluminium ones are to be preferred.

Keeping the sickroom and the patient cool in hot weather is sometimes more difficult than keeping them warm in winter. Do not use a room facing due south if any other is available, and if possible have a sunblind attached. Lower this just before the sun gets round to the window and raise it immediately it has passed over. Windows and door can be widely opened, but see there are no loose papers, etc., to be blown about. If the house is wired for electricity it is worth while hiring a fan in very sultry weather, and if you can also get a block of ice to place near it you will find the room temperature will be substantially lowered.

For bedclothes, a sheet and a thin bedspread only will be sufficient by day, with a very light blanket to replace the counterpane last thing at night.

Cellular bedwear is probably the coolest of all, or thin silk or cotton over a cellular vest; rayon materials are not cool to wear.

Consider the position of the bed and make sure it is placed to the best advantage, but it is better not to leave it too near the window at night as English summers are not altogether to be trusted and there is danger of contracting a chill.

3. Ventilation.—Proper ventilation is an essential of good nursing and often presents difficulties in small rooms. A continuous change of air without draught is to be aimed at, and there should be no difference noticeable in freshness between the outer air and that in the room: there will of course be a difference in warmth.

An open coal fire is extremely useful in promoting this end; the window should always be open about 2 in. at the top except when the patient is being washed or treated, and if the door has a pad in use, as described previously, this also will help. In favourable weather the window will be more widely opened, but when it is very cold the expedient of fitting a board about 6 in. deep under the bottom sash will allow a current of air to enter between the sashes without causing a draught. It is sometimes desirable to air the room more thoroughly once or twice a

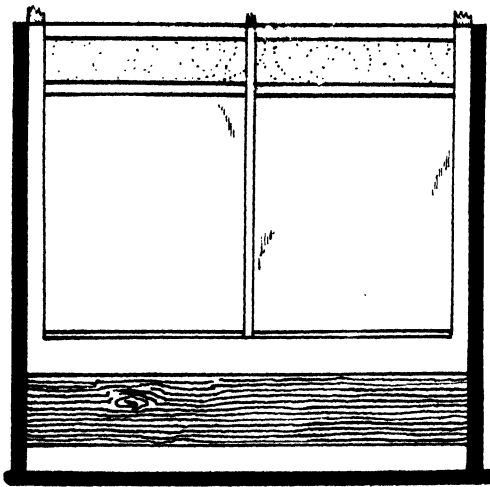

WINDOW OPEN AT THE TOP
BOARD FITTED TO THE BOTTOM

day, first covering the patient warmly—he will be sure to want a light shawl or scarf to put round his head—and then throwing the window wide open for a few minutes. Keep him covered until the room is warm again. Always see that fresh air from outside

enters the room, not stale air from the landing or another room.

4. Diet.—It is obvious that correct diet plays an extremely important part in the successful treatment of the sick. The doctor will say what articles of food are allowed and what forbidden, and the cook and the nurse must unite to produce attractive meals having the utmost variety possible within the prescribed limits. The capricious appetite of the invalid must be tempted so that he will take as much nourishment as his digestive system can absorb without strain, and to this end food must be served attractively, in helpings which are not so large as to be discouraging (better that he should ask for more than leave a portion untouched), and it should be as interesting and varied as ingenuity can make it. Never ask him what he would like to eat—he will spurn all suggestions with loathing—but let meals be a series of pleasant surprises, and he will probably enjoy them.

Food must also be served “comfortably” so that it can be eaten with a minimum of effort. A good sick room tray can be made by the home carpenter by attaching ends to a wooden tray so that it fits over the thighs when the patient is sitting up and rests firmly on the bed. Do not use too small a tray or it will be inconveniently crowded; about 22 in. by 16 in. is a good minimum size, standing

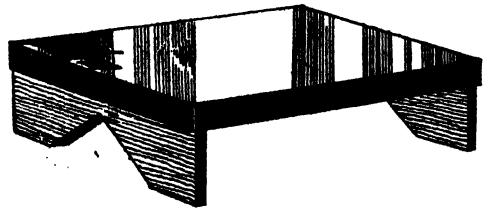

SICKROOM TRAY

6 in. high. It is less trouble to drink soup from a cup than with a spoon, and salt cellars should be low ones not easily overturned.

The prettiest china available in “individual” sizes will do much to make the meal look tempting, and silver, cutlery, china and

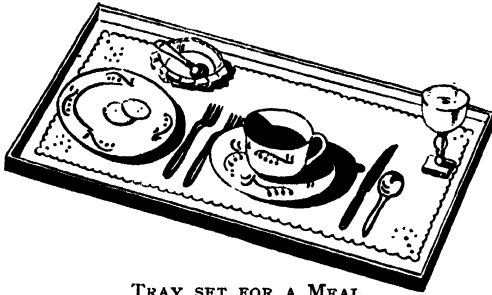

TRAY SET FOR A MEAL

traycloths must, of course, all be spotless. If laundry is a difficulty, use paper cloths; they are very good nowadays and quite inexpensive. If the patient may not sit up, it will be necessary to serve fluids in a feeding cup. Those with a long lip instead of a closed spout are easiest to keep clean and are less clumsy in appearance than the old-fashioned type, and if you have to feed the patient you can see when the fluid reaches his lips; some people, however, still



FEEDING CUPS

prefer the spouted pattern, and special care must be taken to clean them thoroughly. In feeding a helpless patient, use all your imagination and sympathy, for it is unpleasant for him at the best and can be extraordinarily badly done. Never hurry over the meal, and give it gently and deftly.

11—VOL. II-S

Remember that the digestive powers are enfeebled in sickness, particularly in feverish illnesses, so that meals must be chosen for their digestibility, perfectly cooked without heavy seasoning, and not given in too large a quantity at a time. Fried and grilled foods are not recommended until convalescence is well established, and milk may need to be diluted at first.

The diet should be selected from fresh natural foods as far as possible—that is to say, tinned or dried preserved articles must not form any large part of it, though useful for providing variety especially if you do not live near a good shopping centre. Tomatoes are an exception to this rule, for they do not lose their vitamins in the canning process, and strained tomato juice is valuable and is liked by many people. Fresh milk, butter, cream, eggs, fruit, salads, vegetables



VEGETABLES

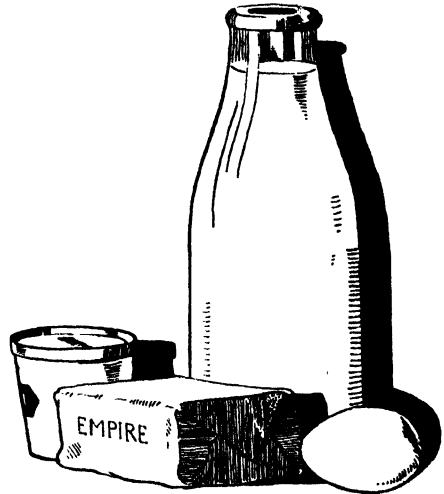

SOME ESSENTIAL FOODS FOR CONVALESCENTS



SALADS



FRUIT

and wholemeal bread (if the patient is already accustomed to this and the doctor allows it) should be staple foods, and then you will not need to worry about those mysterious but essential vitamins for they will be present naturally. Empire butter is considered best for the sick because, having been produced in a sunshine country, it has most Vitamin D, and cream made with the deservedly popular cream machines is quite suitable for most sick persons, Empire butter being used for this also. There is no evidence that imported meat is in any way inferior to home-killed, or any less suitable for the sick. Where the diet must be so restricted that the vitamin content is deficient, the doctor will prescribe a proprietary preparation to make up for this; it must not be taken except on medical advice.

It is not generally realised that clear soups, meat extracts and plain jelly do not contain any appreciable amount of nourishment. Thin soups and meat extracts are stimulating to a poor appetite and provide a welcome change of flavour, but it is better to use Marmite as it contains Vitamin B,

and also it is a vegetable preparation which may be given in cases where meat is not allowed. Jellies should be made with milk or egg, or set with fruit and served with cream, or else used simply for decoration.

See that hot food is really hot when it reaches the patient, not merely when it leaves the kitchen, and serve cold food as cold as you can make it. The doctor will not always allow the latter to be iced, but if he does and you have not a refrigerator yourself, perhaps a friend with one would let you have a batch of ice cubes twice a day. A large block of ice from the fishmonger will last two days if it is wrapped in thick newspaper having a small hole made underneath. The hole in the paper is essential

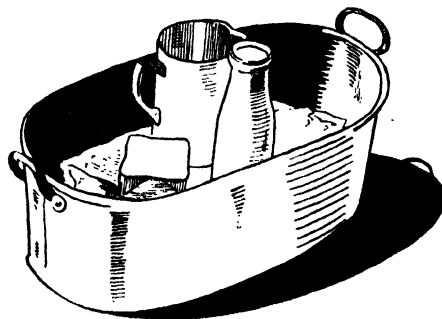

HOME REFRIGERATOR

and the wrapped block should stand preferably in a large fish-kettle so that it does not stand in the water as it melts. Jugs, butter, bottles of milk, etc., can be stood on the block and will be pleasantly cold when required.

Diets in sickness are commonly ordered under the following headings:—

- (a) Special diet.
- (b) Fluid diet.
- (c) Milk diet.
- (d) Light diet.
- (e) Convalescent diet.

It is suggested that the doctor may be shown the appropriate list given below and asked if all the substances there mentioned may be given. Sometimes, for instance, he will forbid all meat and meat extracts, or

all fruit and vegetables, or he will specify the quantity of milk to be taken in the twenty-four hours, and it cannot be too strongly emphasised that his instructions must be strictly followed. One small helping of a forbidden article can be gravely upsetting to a sick person and there are definite reasons behind the orders given.

(a) *Special diet.*—Any special diet will be ordered in detail by the doctor. Almost the entire treatment of some diseases, notably diabetes, consists of rigid dieting on highly specialised lines adapted to each individual. Make quite sure that you fully understand the instructions, and write them down immediately so that there may be no mistake, and when exact quantities are ordered do



FLUID DIET

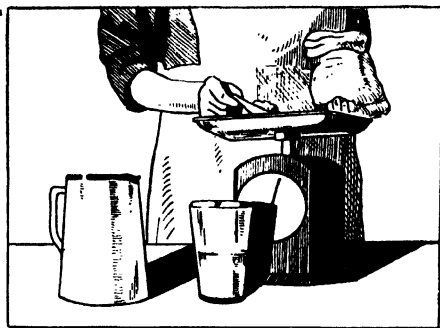

WEIGHING FOOD

not depend on guesswork but weigh and measure carefully. If the patient cannot take the whole quantity, it must be reported.

A large majority of patients nursed at home, however, will be suited by one of the following general diets, with modifications as instanced above.

(b) *Fluid diet.*—This is ordered very often for feverish patients, who are thirsty and at the same time need nourishment in an easily assimilated form. A nourishing drink of about 8 fluid oz. should be given every two hours, with the merely thirst-quenching ones in between. An ordinary breakfast cup or a tumbler holds 8 oz., a teacup 6 oz. For an adult on this diet 3 to 4 pints of milk and 2 raw eggs a day are usually ordered, and

ingenuity must be exercised to make this attractive to the patient or he will not willingly take so much milk. Jelly and junket are counted as fluids and make a slight change, and ice cream of good quality is often allowed; if a little sherry is permitted and is liked, it makes an interesting flavouring.

Always remember to remove the gelatinous strip from a raw egg before using it.

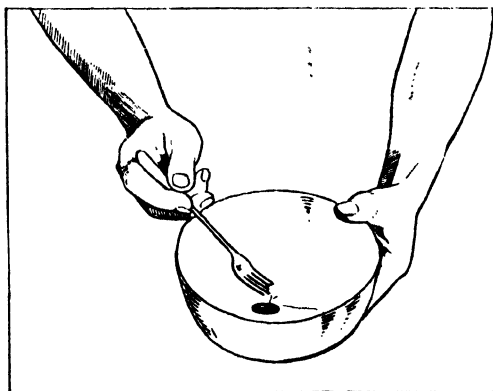

NURSE REMOVING GELATINOUS STRIP FROM RAW EGG

The following list is by no means exhaustive, but gives a good range of fluids which are easily prepared; an experienced cook with time to spare will evolve others on the same lines.

Drinks for assuaging thirst.—

Freshly made TEA; not too strong.

HOME MADE LEMONADE OR ORANGEADE: Make these with cold water, as hot water would destroy part of the vitamin content.

LEMON SYRUP diluted with water, barley water or soda water:

1 lb. loaf sugar;

juice and rind of 2 lemons;

$\frac{1}{2}$ oz. tartaric acid;

1 $\frac{1}{2}$ pints boiling water.

Boil the sugar, tartaric acid and lemon rind together until the sugar is dissolved.

juice and rind of 1 lemon;

1 pint boiling water.

Blanch the barley (i.e., cover with cold water, bring to the boil and strain), put into a jug with the lemon rind and sugar. Pour on the boiling water and when cold add the lemon juice. Strain and serve.

For nourishing or stimulating drinks, made without milk.—

SOUPS AND BROTHS, lightly seasoned.

MARMITE OR BOVRIL, served either piping hot or made with soda water and iced.

EGG BROTH: Beat 1 egg thoroughly and pour into a pint of boiling stock stirring



HOT DRINK



COLD DRINK

Allow to cool; add lemon juice when luke-warm or cold. Strain and bottle. Use about 2 tablespoonfuls to a tumbler. This syrup keeps well and is a useful stock solution.

APPLE DRINK:

4 apples;

2 oz. lump sugar;

1 pint water;

2 or 3 cloves if liked.

Wash and wipe the apples and slice them whole, thinly. Bring to the boil with the water, sugar and cloves. Strain and serve cold.

THIN BARLEY WATER:

2 oz. pearl barley;

1 oz. sugar;

well to prevent curdling. Season to taste and serve hot.

ALBUMEN WATER: Lightly beat the whites of 2 eggs and stir into $\frac{1}{2}$ pint of cold water. This can often be tolerated when nothing else can; it is nourishing, but not interesting in flavour.

LEMONADE WITH EGG: Beat 1 egg thoroughly and strain into $\frac{1}{2}$ pint of lemonade.

WHISKED WHITE OF EGG: Beat the white of an egg to a stiff froth, add a squeeze of lemon, and castor sugar to taste.

EGG JELLY:

2 eggs;

6 oz. lump sugar;

$\frac{3}{4}$ oz. powdered gelatine;
 $\frac{1}{4}$ pint sherry;
 juice and rind of 2 lemons;
 cold water.

Wash the lemons and peel thinly. Squeeze the juice from the lemons and make up to 1 pint with cold water and sherry. Put into a saucepan with the lemon rind and sugar, and heat slightly to dissolve the sugar. Add the gelatine and stir until quite dissolved, but do not boil. Beat the eggs and add to the contents of the saucepan, stirring until the mixture thickens, but do not boil. Cool slightly and strain into a wet mould. Turn out when set.

STRAINED TOMATO JUICE: This can be bought bottled. Otherwise buy a tin of tomatoes, and strain; season lightly; serve cold.

EGG FLIP:

1 egg;
 1 dessertspoonful castor sugar;
 juice of $\frac{1}{2}$ lemon or 1 tablespoonful sherry or brandy.

Beat the yolk and sugar together until creamy and add the lemon juice or wine. Whip the white of egg to a stiff froth and stir it in lightly. Serve immediately.

OATMEAL TEA:

3 tablespoonfuls coarse oatmeal;
 juice and rind of $\frac{1}{2}$ lemon;
 1 tablespoonful castor sugar;
 1 qt. boiling water.

Put the oatmeal, lemon rind and sugar into a jug and pour on the boiling water. Cover and let it stand on the hob for 1 hour or longer; strain; add the lemon juice and serve hot or cold.

For nourishing or stimulating drinks made with milk.—

JUNKET: Flavour with coffee, chocolate, vanilla, almond, or nutmeg. May be served with cream.

MILK JELLY:

1 pint milk;
 1 $\frac{1}{2}$ oz. castor sugar;
 $\frac{1}{2}$ oz. gelatine powdered;
 strip of lemon rind.

Heat the milk with the lemon rind; cover and allow to stand for 5 minutes, to extract the lemon flavour. Add the powdered gelatine and sugar and stir until dissolved. Strain into a basin and stir occasionally until the mixture begins to thicken. Pour into a wet mould and allow to set. Turn out when cold.

COFFEE.

MILK TEA: Warm a small teapot; put in 1 teaspoonful of tea; just cover the leaves with boiling water, then add 1 teacupful of boiling milk. Stand for 3 to 5 minutes and pour out.

CHOCOLATE.

PROPRIETARY SUBSTANCES such as Horlick's Malted Milk, Bourn-Vita, Ovaltine, Fry's Malted Milk Cocoa, etc., all made with milk or milk and water, according to the directions given on the tins. Serve hot or cold.

BENGER'S FOOD: A well-tried favourite. Follow the instructions for making exactly, and sometimes flavour with cinnamon, lemon or orange peel boiled with the milk, or stir in a little sherry just before serving.

SLIPPERY ELM FOOD: This deserves to be more widely known than it is. Especially soothing for use at bedtime. The chemist can easily get it if he has none in stock. Instructions for making are on the tin.

RICE OR SAGO MILK:

$\frac{1}{2}$ oz. rice or sago to 1 pint milk or milk and water;

lemon or orange peel, or other flavouring.

Boil together until well cooked, then strain. Serve very hot. The consistency can be adjusted to taste by varying the proportions.

MARMITE OR BOVRIL MADE WITH MILK.

ARROWROOT: Mix 1 tablespoonful of arrowroot to a paste with a little cold milk; add a little castor sugar. Pour on $\frac{1}{2}$ pint of boiling milk, stir and return the whole to the saucepan. Stir over fire until it thickens. Serve with a grate of nutmeg.

EGG AND MILK: 1 beaten egg to $\frac{1}{2}$ pint of milk, either sweetened slightly or seasoned

with salt. Serve either iced or very hot, as lukewarm it is nauseating.

TREACLE POSSET: Warm $\frac{1}{2}$ pint milk, add 1 large tablespoonful of black treacle and boil for 5 minutes. Strain and serve hot.

MILK PUNCH:

Requirements:— $\frac{1}{2}$ pint cold milk;
2 teaspoonfuls sugar;

2 tablespoonfuls sherry or brandy.

Stir together until the sugar is dissolved.

EGG NOG, COLD: Whip the white of an egg stiffly. Stir in 1 tablespoonful sugar, the yolk of the egg, a little milk, and sherry or brandy to flavour. Stir gently; do not beat.

EGG NOG, HOT: Beat the yolk of 1 egg with 1 dessertspoonful of sugar, then add $\frac{1}{2}$ pint boiling milk. Put in 1 dessertspoonful of brandy and serve hot.

(c) *Milk diet.*—This diet is usually ordered because bland non-irritating food is required, though it may to some extent be solid in character. It is ordinarily understood to include all the fluids listed above except those made with fruit juice or meat essence, or soups and broths, with the addition of milk puddings, porridge, thin bread and butter (white bread unless otherwise definitely mentioned), toast, rusks, plain biscuits, sponge and madeira cake, honey, jam without skins or seeds. The eggs may be lightly cooked by any method, never hard-



MILK DIET

boiled. Marmite may be given as a rule, also cream cheese, good toffee, and milk chocolate.

In some cases the popular breakfast cereals and strained fruit and tomato juice will also be allowed. The quantity of milk an adult on this diet should take is 2 to 2 $\frac{1}{2}$ pints a day, with 2 eggs, unless the doctor orders otherwise. The solid foods should be given at 4-hourly intervals, with fluids between.

(d) *Light diet.*—This diet is held to include everything allowed for fluid and milk diets, with the addition of white fish, fish roe, chicken, tripe, sweetbreads, sheep's and calves' brains, salads, green and root vegetables, stewed and fresh fruit.

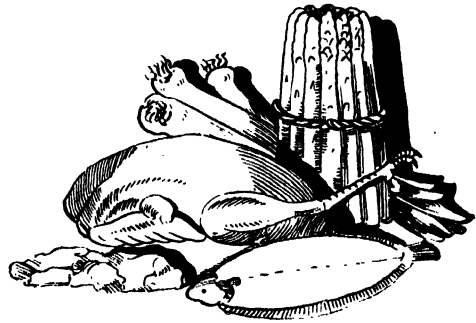

FOODS FOR A LIGHT DIET

By white fish is meant that of which the flesh is not rich in oil. Whiting, sole, turbot, plaice, hake, cod, brill, flounder, dab and fresh haddock are all suitable, also oysters in season. Do not give salmon, herring, mackerel, sprats, pilchards or eels until well on in convalescence.

Needless to say, the fish must be perfectly fresh, and it may be cooked by any method except frying or grilling. Steaming is really best for those on "light diet," but well made creams, soufflés and fish puddings are all good, and sauces must be plain.

(e) *Convalescent diet.*—Convalescent diet simply means adding gradually to the previous diet as the patient gains in strength. Rabbit and steamed lamb chop may be added early, also fried fish and really light steamed

puddings. Homely odds and ends such as a slice of bread and dripping or a piece of crisp fried bread are sometimes welcomed at this stage, and an interesting variety of sandwiches will "help the bread and butter down" at tea time.

A good deal of milk, say a pint a day, should still be included unobtrusively, but on the whole the food of the rest of the household will soon be suitable for the patient, served in individual moulds and dishes with dainty garnishings, though such things as pork, veal, and twice-cooked meat in any form should not be given at all, and pastry only occasionally, and then it must be really light.

Barley sugar is often ordered to be given freely with all diets.

5. Cleanliness.—Cleanliness is a proverbial feature of hospitals, and the home nurse should be no less careful to keep her patient and everything he uses fresh and spotless. It is necessary for his comfort and it also prevents the spread of infection, but there is no need for aggressive scouring and bathing; just be quietly thorough and methodical about cleanliness.

It is desirable that the patient should have either a bath or a blanket bath daily in order to remove waste products from the skin and keep it acting well, and usually before supper in the evening will be the most convenient time for this. The bath will help to make the patient comfortable for the night and the nurse has probably more time to spare then than in the morning, but if there is difficulty about the hot water supply, you must fit it in when you can, or you may in any case prefer the morning. Let it as a rule be done at about the same time each day.

BATHING IN THE BATHROOM, if the patient is well enough for this, is naturally the most refreshing way for him. See that everything is placed ready to hand before he starts; do not have the water too hot or allow him to stay in long or he may feel faint, and unless it is absolutely certain that

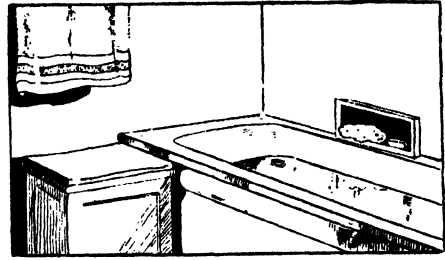

BATHROOM READY FOR PATIENT

he will not require any help do not have the door locked or bolted. A capable person must be within earshot and ready to help, as it is easy to slip in the bath and even a day or two in bed makes one feel unexpectedly shaky. It is by no means safe for anyone who has been confined to bed for some weeks to attempt to manage alone the first time he is allowed out to the bathroom; someone should be in with him. See that he gets straight into bed afterwards, even in hot weather, and of course you will have taken the opportunity of making the bed while it was empty.

A **BLANKET BATH** means washing the whole person in bed, which is protected from getting wet by using two old blankets kept for the purpose and a mackintosh if you have one. One blanket is placed under the patient with the mackintosh beneath, and one covers him. If the under blanket is thick, with care you can manage without the mackintosh, or you might add a large bathsheet. The patient may be well enough to wash himself,



A BLANKET BATH

except for the inaccessible portion of his back which the nurse will do, and when he cannot bath in the bathroom (as when there is not enough hot water available) this is the best method to use because it is too chilling to stand out of bed for so complete a wash.

In this case, the nurse must first close the window and door and arrange a screen if necessary. Then provide a large bowl of good hot water conveniently placed on a chair or table at the bedside; also soap, washcloths and dry bath towel. Strip off the top bedclothes, put in the two warmed bath blankets and mackintosh and help the patient off with his garments. Remain at hand to help as required and to change the water once, and as soon as the bath is finished remove the damp blankets and make the bed.

When the patient is too ill to wash himself the nurse must give him the blanket bath, and this is a real test of nursing skill. He should enjoy it and feel comfortable and soothed afterwards, but if it is clumsily done he will instead feel disturbed and irritated.

Prepare as described above, making sure that the water is really hot and the towel really dry; in cold weather put the bed garment, when removed, to warm by the fire or elsewhere. The patient lies flat, with one pillow, and if he is in a very weak condition there should be an assistant within call. Start with the face and work downwards, quickly and deftly washing one area at a time; neck and ears, chest, arms one at a time, abdomen and each leg singly, and keep the patient well covered with the blanket, only the necessary part being exposed. Take care to dry him thoroughly with firm strokes. Next he should roll over on to his face, the assistant helping if required while the back is washed. Before he rolls back again, rub the "pressure points," shoulders, elbows, sacrum, buttocks and heels, lightly and briskly with a little surgical spirit or good eau de cologne in the palm of the hand, and dust with talcum powder or a dusting powder made of equal quantities of zinc oxide, boracic and starch.

This treatment is to prevent soreness of

the skin which would lead to bedsores, and should be done at least night and morning, and more often in serious illness. It makes for the patient's comfort to do it even if he is not very ill, as the skin at these points becomes surprisingly roughened after only a day or two in bed, and once the skin is broken it takes a very long time to heal. It is important to rub well in order to stimulate the local circulation, and in a long illness it is cheaper to use a mixture of castor oil and surgical spirit in equal parts which is very good; cheap eau de cologne does not contain enough spirit to be satisfactory.

After this, remove the damp blankets and mackintosh, put on the warmed garment and make the bed.

Bath salts, lavender water, etc., are pleasant to use in the water, especially if it is "hard," but take care not to use them to excess, and to vary the perfume. Some preparations are a little irritating to a sensitive skin and, excellent though it is, many people who are ill for long get tired of eau de cologne.

Apart from the daily bath or blanket bath, an invalid will need a less extensive wash in the morning or at night, as the case may be, and will probably like just to sponge the hands and face either after dinner or on waking from the afternoon sleep, and of course attention must be given to the hair and nails.

The CARE OF THE MOUTH is extremely important. Most often the patient will be able to brush his own teeth, using a good toothpaste or powder, and he should also scrub his tongue with the toothbrush, and may like to use a mouthwash as well. Milton, Listerine and glycothymoline are good, and sometimes the doctor will prescribe a special gargle. Patients on a prolonged milk diet need extra care in this way or the parotid gland will become infected and swollen, as in mumps, and they should cleanse the mouth at least three times a day, more often if the tongue is furred.

When the patient is too ill to clean his own teeth, the nurse must carefully attend to this for him. Get some mouth sticks,

which are short sticks rather like thin skewers, and a little cotton wool. Cut this into $1\frac{1}{2}$ in. squares and split them into fairly thin layers, then roll a square firmly round the point of each stick, making a sort of mop well covering the end. Remove any false teeth and clean them separately, then dip a prepared stick into mouthwash and gently swab all round the teeth and gums; take a clean stick and similarly do the roof

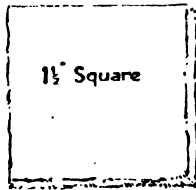
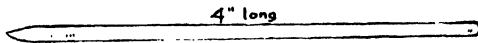

MOUTH STICKS

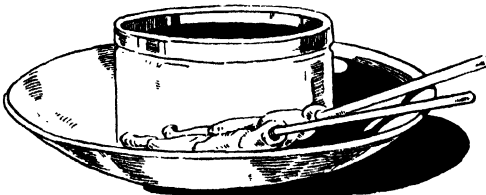

CLEANING THE MOUTH

of the mouth, cheeks and tongue, after which let the patient rinse his own mouth with the mouthwash if he can. If he cannot, repeat the swabbing. Glycerine and borax cleans a furred tongue well, and glycerine and lemon juice is refreshing where the mouth is dry.

PERSONAL AND BED LINEN needs to be changed frequently, according to the circumstances of the case. A full sized table napkin at meals will save the top sheet to some extent, and a drawsheet will save the bottom one. Even where this is not strictly

required, it is quite a good thing to use one without the mackintosh. In feverish illnesses, notably influenza, the patient will sweat heavily from time to time, either in the course of the disease or as a result of a dose of medicine, and you must be prepared for this by keeping a warmed bath towel and bed garment handy. When it occurs, close the window, remove the wet garment, rub the patient dry with the warm towel quickly but thoroughly and put on the dry garment; also offer him a hot drink. As this may happen two or three times in rather quick succession, it is permissible to dry the discarded garment and use it again, but if there is a good supply of clothes and you can get them laundered quickly you will naturally prefer not to do this.

The **CLEANING OF SICKROOM UTENSILS** is effected by the honest application of soap and water and ordinary household cleaning powders, not by the use of disinfectants. When all visible dirt has been removed, you may like to rinse with a disinfectant; it is not strictly necessary in the absence of known infection. Never fall into the common error of thinking that a strong smell of carbolic or Lysol is a sign of efficiency in the sickroom. Where it is desirable to use a disinfectant, choose one that is non-poisonous and apply it in the exact strength recommended by the makers or by the doctor. A stronger solution is wasteful and a weaker will not be efficient, so you will need a graduated measure which should be kept for the purpose. A glass one

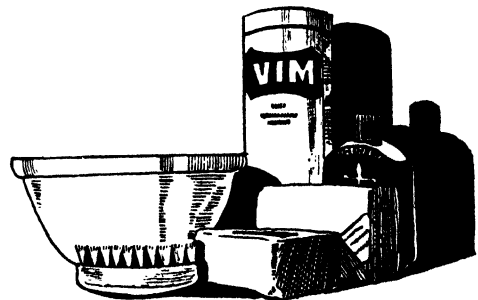

THE CLEANING OF SICKROOM UTENSILS

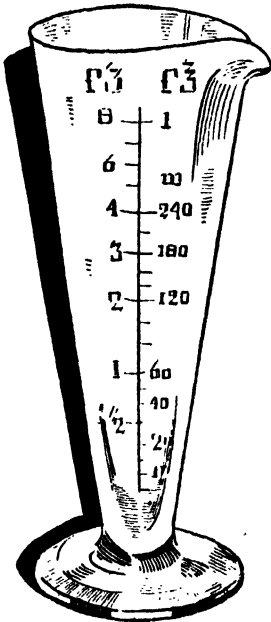

POISON MEASURE

measuring up to 4 fluid oz. is the most useful and costs about 9¢ from the chemist; the water can be measured with a kitchen jug or enamel measure.

Recent research has produced disinfectants which are a great improvement on the older ones. Dettol can be thoroughly recommended for general use, being non-poisonous and non-staining and firmly established in hospital practice; and Zant is a similar product.

If you have a favourite, however, ask the doctor if it is satisfactory and, if so, continue to use it.

6. Medical treatment.—Medical treatment appropriate to the disease will be ordered by the doctor where necessary. In some cases very little is needed; rest and general care will bring about recovery better than too much interference, and you must not feel that nothing is being done for the patient just because no medicine or special treatment is ordered. Masterly inactivity is quite often the best line for the doctor to take, as long as he keeps the patient under observation.

Treatments requiring special skill and knowledge must be carried out by a visiting trained nurse, and you will do well to watch her closely and learn all you can of her methods. She will give you many an idea for making the patient comfortable and will gladly teach you all she can in that way. Sometimes you will be able to continue with the treatment yourself after one or two demonstrations from her, but do not attempt

anything you do not fully understand; it is possible to cause a good deal of harm as well as unnecessary pain or discomfort.

In all but slight illnesses, KEEPING A NOTEBOOK is to be recommended, for the purposes of writing down the doctor's instructions so that no mistake can be made when the nurse is out or busy, and to provide the doctor with an accurate report of the patient's progress. This will be more or less detailed according to the nature of the case, but items should always be recorded as promptly as possible, before inaccuracies have time to creep in. Do not keep the book in the patient's room or leave it lying about for all to read, but find a suitable place for it out of the children's reach where the doctor can get it for himself if he should happen to visit at an awkward moment.

It is a good plan to use the left-hand pages for the doctor's instructions and the right for the nurse's report, or in more serious illness it may be necessary to keep separate pages for the day and night reports. A cheap exercise book, to which a pencil should be tied, answers the purpose well. Use simple language and avoid abbreviations unless you are quite sure they will be understood by all the persons concerned. Useful ones which any doctor will understand at once are:

- T for temperature
- R for respirations
- C/o for "complaining of"
- A.c. for "before meals"
- P for pulse
- B.O. for bowels opened
- P.c. for "after meals"
- T.d.s. for "3 times a day"

Report such points as the temperature and pulse rate morning and evening, amount of sleep, failure to take the whole diet ordered, any untoward occurrence such as vomiting or a shivering fit, and anything the patient complains of, such as headache, nausea, pain in any part of the body. If the doctor visits at about the same time each day, start the fresh pages then; otherwise start them at about 7 a.m.

Example.

Add little steamed fish for dinner.

Stop 4-hourly medicine.

Give new medicine, after meals, t.d.s.

Give 2 of special tablets if much headache, but not more than twice.

5.6.38

1 p.m. Enjoyed fish, took dinner well.

1.50 to 3.10 Slept.

5.45 C/o slight headache.

6.30 T 99.4; P 96.

7.30 Only small supper taken, less than usual.

8.20 Headache worse, 2 tablets given.

9.30 Asleep.

6.6.38.

1.15 a.m. Awake. Hot drink, hot water bottle refilled. Slept again till 6.30.

7.15 T 97.8; P 88.

9.0 Good breakfast.

9.45 B.O., satisfactory.

TAKING THE TEMPERATURE is a simple matter which needs to be carefully done, as an inaccurate record may be seriously misleading. Most people like half-minute thermometers, though slower ones are less easily broken, cheaper, and just as accurate if properly used, but in any case only tested instruments should be bought. During an illness when the thermometer is in regular use, keep it in a small pot of weak

disinfectant, such as Dettol, having a pad of cotton wool at the bottom: empty fishpaste pots are just the size for this purpose.

The temperature may be taken in the mouth, axilla, groin or rectum; it is a full half-degree higher in the rectum than in the mouth, and half a degree higher in the mouth than in the axilla or groin, therefore it must always be taken in the same place throughout one illness. Always see that the mercury is shaken down below the 95° mark before placing the thermometer in position, and leave it in for well over the time marked on the stem; i.e., a whole minute for a half-minute instrument.

The **MOUTH** is generally found most convenient in dealing with adults or responsible children. Place the bulb of the thermometer under the tongue and see that the lips are kept firmly closed.

The **AXILLA** should be used when the patient is very ill or restless, or cannot breathe through the nose easily. First dry the thermometer, then dry the axilla and place the bulb in and cross the arm over the chest.

The **GROIN** may be used for restless children in the same way. Dry the thermometer and the groin, place the bulb in the fold and cross the leg over the abdomen.

The **RECTUM** is best in dealing with infants under about two years of age, and

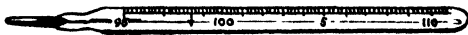

THERMOMETER



THERMOMETER WHEN OUT OF USE



THERMOMETER IN ARMPIT

is generally considered the most accurate method of all. Lie the child on his left side, lubricate the bulb with a little vaseline and insert it for about $\frac{3}{4}$ in. Hold it lightly in position and keep the buttocks gently pressed together.

In England, Fahrenheit thermometers are nearly always used and the normal temperature is marked at 98.4° , corresponding to 37° Centigrade, but in practice anything from 97° F. to 99° F. is regarded as normal.

The doctor will not often ask the home nurse to keep a temperature chart, but should he have reason to do so, get some from the chemist and you will readily see how it is done. Make good clear dots and join them with neat fine lines.

To take the PULSE, approach the patient when he is resting quietly; without disturbing him at all, place your first, second and third fingers lightly at his wrist where you

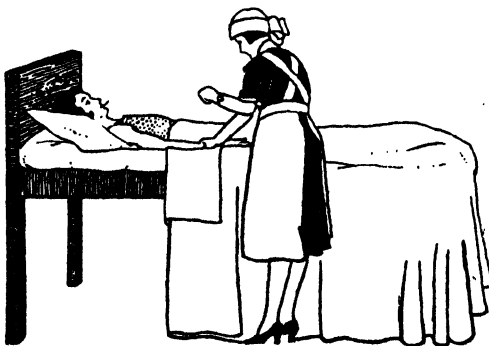

NURSE TAKING PULSE

can feel the artery beating, and count the number of beats for not less than half a minute. Of course you need a watch with a second hand for this; the arm must be resting at the time, not held up in the air; and no pressure must be made on the wrist or the pulse will be extinguished and impossible to feel at all. If the patient is excitable or the pulse rate very rapid, it must be counted for longer than half a minute, while his attention is diverted. The number of beats per minute is recorded; this varies in normal adults from 60 to 90, being slower in men than in women and in old age than adult age. The rate is often much increased when the temperature is raised and may be 120 to 150 or over.

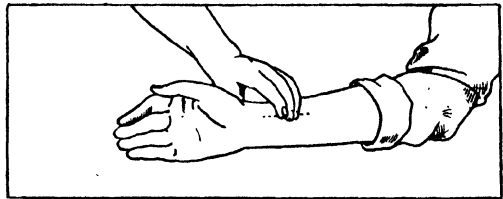

THE PULSE

Only experience can teach the nurse all that should be recognised in the pulse beat, but she should notice whether the rhythm is regular or not, whether the beat is soft or hard, and any points the doctor has asked her to look out for. Any marked and sudden change in the rate or quality should be reported to him at once. When a temperature chart is kept, it is usual to chart the pulse also on the same sheet, or sometimes it is simply entered in figures in a space provided.

The RESPIRATION rate must be taken without the patient's knowledge, possibly as if you were still counting the pulse, as he will not breathe naturally if he knows this is under observation. The breaths can be counted by watching the rise and fall of the chest, and the number per minute is recorded, 16 to 22 being about normal for adults.

On the whole, the respiration rate will not often need to be counted in home nursing. There are many varieties of breathing associated with disease, and the doctor will tell you what to look out for when it is necessary to give attention to this matter. You will, of course, report any change you notice in the character or rate of breathing, and watch it especially in young children.

Once the doctor has been called in, do not take the temperature, pulse, or respiration at all unless he asks you to do so, as in many cases it is quite unnecessary and he may prefer to take it himself on his visit. If he asks for the morning and evening temperature, take it first thing in the morning when the patient wakes before you disturb him for anything else at all, and again at night about 6.30, before the evening toilet is started. Bear in mind that a bath or blanket bath affects the temperature and pulse rate, so that these must be taken before and not afterwards, and also that a recent hot drink will send the mercury soaring if the thermometer is put into the mouth. Sometimes the doctor will want a four-hourly recording for a few days, and most people find either 10 o'clock, 2 o'clock and 6 o'clock, or 11 o'clock, 3 o'clock and 7 o'clock to be convenient hours for this: it is usual not to disturb the patient when he is asleep, but find out the doctor's wishes on this point.

The ADMINISTRATION OF MEDICINES calls for understanding and attention to detail. Never keep medicines within the patient's reach and do not leave him to pour out a dose and take it himself, at least until he is really convalescent. The same person

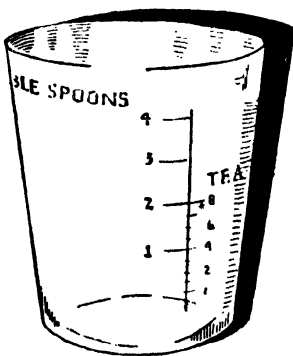

MEDICINE GLASS

should, as far as possible, be responsible for giving all medicines, and should leave very clear instructions when off duty about any dose which falls due in her absence. Never guess a dose, or use domestic spoons for measuring as they vary much in size; glass and china measures to hold two fluid ounces are cheap nowadays and should always be used. China ones are best for oily substances and for giving unattractive-looking mixtures to children, otherwise most people prefer glass.

60 minims ("drops")=1 teaspoonful=1 fluid drachm.

4 fluid drachms=1 tablespoonful= $\frac{1}{2}$ fluid oz.

8 fluid drachms=2 tablespoonfuls=1 fluid oz.

20 fluid oz.=1 pint.

To give a dose of medicine, first read the label, then place a finger on the cork and shake the bottle well. This is important even though the mixture looks absolutely homogeneous: some ingredients are heavier than others, and there would be a deficiency of them in the first-used portion and an overdose as the bottle emptied. Then remove the cork with the little finger of the right hand, in which it should remain, turn the bottle so that the label faces upwards and pour out the exact quantity prescribed. Replace the cork immediately, read the label again, and take the dose in to the patient.

Medicines nowadays are much less nasty than they used to be, but if a distasteful

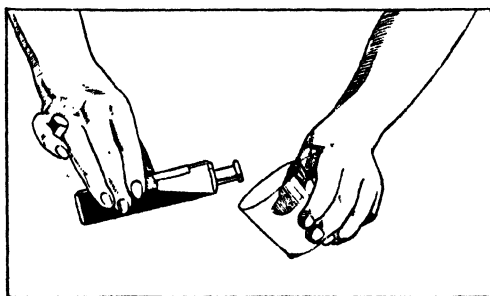

POURING OUT DOSE OF MEDICINE

mixture has to be taken give a plain boiled sweet afterwards. Barley sugar is nearly always allowed, and little barley sugar fishes never fail to please children.

POWDERS can be poured on to the back of the tongue and followed by a little water, or given in a spoonful of jam or sugar, or put between bread.

PILLS may be crushed and given as powders to those persons who find it difficult to swallow them whole, but the taste may be very nasty!

DROPS are occasionally ordered, and the fluid will either be supplied in a special drop-bottle or else can be given from a clean fountain pen filler. Simply hold the filler half full with a steady hand, press the

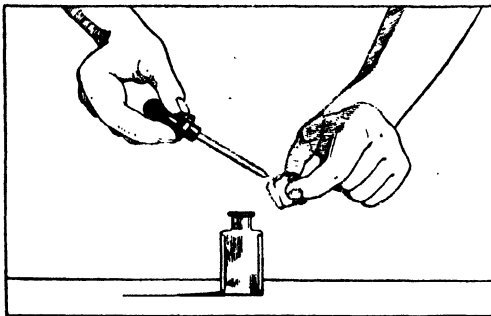

PREPARING DROPS

cap very gently, and let the required number of drops fall slowly and fall on to a lump of sugar or into a little cold water.

CACHETS should be served with a teaspoon and small glass of water. Dip the

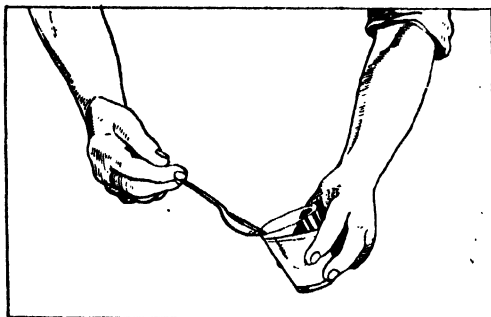

CACHET BEING DIPPED IN WATER

cachet in the spoon quickly into the water to moisten it, then place it on the tongue and follow with water to drink.

OILS are given in various ways. Cod liver oil is probably best given in a measured medicine spoon, and also liquid paraffin unless the patient prefers this floated on a little cold water. Castor oil for children is

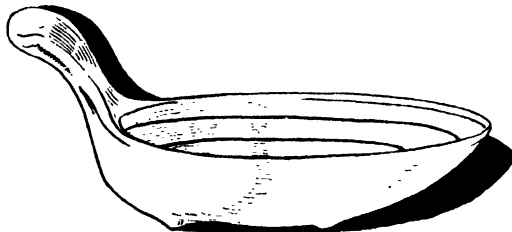

MEDICINE SPOON

least nauseating taken in milk. Use a heated china measure, put in the oil, add an equal or slightly greater quantity of very hot milk, and stir vigorously. Tell the child to drink it up quickly, and follow with a piece of dry bread, a slice of orange or an acid drop. The same method can be followed for adults, except that it makes rather a large quantity for them to drink quickly; they will probably prefer to take it in a little lemon or brandy. Heat the measure thoroughly, pour in half the brandy or lemon, add the oil and then the other half gently so that the oil floats in the middle, and instruct the patient to "swallow it whole." To clean the measure after castor oil, use good hot water and plenty of soap.

The **TIME OF ADMINISTRATION** of medicines must be in precise accordance with instructions, because there is always a reason for the time chosen. "Before meals" means immediately before unless an interval is specified, and "after meals" means within a few minutes afterwards. "Every four hours" usually brings the doses between meals, 11, 3, 7, or 10, 2, 6, and the relation to food probably does not matter. A four-hourly medicine may in some cases be omitted at night if the patient is sleeping;

remember to ask for instructions on this point. Aperients depend largely on correct timing for satisfactory action. Some sleeping draughts are slow-acting and have to be given one or two hours before bedtime, others not until the patient has been finally made comfortable for the night.

APERIENTS are still much misused both in health and in sickness, the tendency being to take too strong laxatives, which only aggravate the trouble and do nothing to cure it. For practical purposes, aperients fall into three groups:

(a) Those with a purely mechanical action.

(b) Salines.

(c) Drugs acting in various ways, which really should not be taken except in the special circumstances for which each is suitable.

(a) *Mechanical action.*—Aperients which act mechanically are paraffin (petroleum), bran, agar-agar (a seaweed), and combinations of these substances such as agarol and petrolagar. All are excellent and can suitably be used in a large majority of cases. They need to be taken regularly, not in occasional doses, at the same time or times each day, in gradually diminishing quantities until no longer needed. They act either by lubricating the bowel contents, or by providing moist non-irritating bulk which gently stimulates intestinal action, or both.

The lack of accustomed exercise and the general disturbance in mild illnesses will upset even naturally regular habits, and a very simple remedy which the doctor will often be able to approve is the use of Kellogg's All-Bran. It is easily procured and not expensive, and can be served in various ways but must be given quite regularly either with breakfast or supper. If the patient tires of this or may not have it, paraffin or one of its emulsions will possibly be ordered, and these are given before meals once, twice or thrice a day. Prepared bran sprinkled over the food is also a good simple method, and all the laxatives in this group can safely be taken by healthy persons who

need them, for as long a period as may be necessary.

(b) *Salines.*—Saline aperients also act mechanically to some extent. They extract water from the body if they are taken with only a small quantity of it, and for this reason the doctor will order them to be so given in some cases. When the dose is taken in a large tumbler of water, or followed by a cup of tea, practically no fluid is absorbed from the body and the whole acts simply as a bowel wash-out, and within a short time (forty minutes or so), and the doctor will state which method is to be followed. Salines should be given on an empty stomach, first thing in the morning, at least half an hour before any solid food is taken.

Epsom salts, the popular health and fruit-salts, and spa-water preparations are the most widely used, and for a healthy person needing just an occasional aperient one of these taken with plenty of water or a fresh cup of tea is harmless and satisfactory. Taken in a little water only they are irritating and not suitable for ordinary use.

(c) *Various drugs.*—Other aperients are many and varied, ranging from senna pods and syrup of figs to complex substances designed for use in special diseases only. All are useful in certain conditions but will do nothing but harm in the long run if taken indiscriminately, as is so often the case.

Never give castor oil unless the doctor orders it, particularly if there is abdominal pain with constipation. In the right circumstances it is most valuable, but it can be a contributory cause of the death of a person having any tendency to appendicitis or intestinal obstruction.

Senna pods should be prepared in cold water, not hot. Soak the required number of pods in a full tumbler of cold water for six hours or more, strain, and drink the whole amount at bedtime.

Nearly all the purgatives in this group should be taken last thing at night, and it is worth repeating that they are not suitable for use except on medical advice.

7. Convalescence.—Care in convalescence needs to be as thorough and well judged as during the illness itself, and everyone who has been ill knows that it is a very trying time to pass through. The patient is eager to get on and disappointed that he tires so quickly and cannot do all he plans. He feels fretful and irritable, and needs really sympathetic handling. "Hasten slowly" should be the watchword, for over-eagerness will surely produce disheartening setbacks, but of course a good nurse will not continually say, "Don't." She will forestall unsuitable suggestions with good ones of her own.

If the convalescent comes to you from a hospital or nursing home, ask the staff when he leaves if there are any special points for you to observe, and let the family doctor see him almost at once. It is usual for the hospital staff to send a report of the case on the discharge of a patient to his own doctor, so that appropriate follow-on care can be given, but in many cases no treatment is needed beyond good nourishing food, sound sleep, fresh air and sunshine and gradually increasing exercise and resumption of the usual work and interests. The doctor will probably see him from time to time, but the home nurse must be on the alert to recognise untoward symptoms and to see that these are quietly dealt with as soon as they arise.

For financial and other reasons, it is often exceedingly difficult for an adult to spend as long a period as he ought in convalescence, and his friends should unite in doing their utmost to make this possible for him. A too early return to full time work may leave its mark for years. Many a busy mother endures constant poor health, which could have been avoided if she had not felt obliged to resume household cares when she was really not fit to do so. Children especially need to spend a much longer time in convalescence than is usually considered necessary for them. Do not let a child go back to school until he is really fit and well; he will soon catch up with his lessons, whereas lifelong dis-

ability may arise from overstraining a temporarily impaired physique.

The patient's convalescence is a period of real responsibility for the home nurse, who no longer has the doctor's frequent visits to rely on, and she should be alive to it and do her best to bring the whole illness to a satisfactory conclusion.

The care of a PERMANENT INVALID calls for good nursing in the highest sense of the term, and ought to bring out the highest qualities of those responsible for it. Try to preserve a balanced outlook so that, while the patient's life is as full and happy as you can make it, the just claims of the other members of the household are recognised and allowed. It is, after all, not in the best interests of the invalid that he, or perhaps more often it is she, should become a fretful autocrat as sometimes happens, and this should not take place if he can be provided with a hobby and some outside contacts, an easier matter in these days of wireless than it used to be.

It is a good thing to have a talk with the district nurse, to make sure you are doing everything possible for his physical comfort in the best way, for she will be able to suggest simple devices and economical methods that make all the difference to both nurse and patient. Consult her also before you buy any special equipment, such as a bedrest or bedpan, as her experience will have taught her which are the best patterns to suit the circumstances. It is by no means easy to choose wisely from the illustrations in a catalogue, and sometimes the home carpenter can produce a simple gadget that will be actually more satisfactory than an expensive and more elaborate one.

If the care of the invalid devolves chiefly on one person, with no one to relieve her very much, it should be understood that she must have a holiday now and then. The patient usually dislikes a change of attendant very much indeed, but so long as the deputy is competent he will actually benefit by the mental stimulus, and will be all the more appreciative of his own nurse on her return.

The nursing of **INFECTIOUS DISEASES** involves special measures designed to prevent the spread of infection; the nursing care itself is as for other illnesses. The patient will probably be a child as far as home nursing is concerned, and perhaps not seriously ill, because in most districts now the more dangerous illnesses are nursed in isolation hospitals.

Keep the patient in a room to himself, having a minimum of furniture, and let no one but the doctor and nurse or mother go in. Hang a washable overall on the door, and put this on always before you attend to anything in the room; take it off on leaving, touching the outside only, and then wash the hands well and rinse them in disinfectant. Use a disinfectant for washing the floor, and wipe the furniture daily with a cloth wrung out in it. All articles used in the sick room must be thoroughly disinfected before they go back into general use, and toys made of such materials that they cannot be satisfactorily treated ought to be burnt. In the case of very favourite toys consult the doctor, who will decide whether or not they can safely be spared.

If the washing is sent to a public laundry, a doctor's certificate will be required to state that it has been properly disinfected, and this is done by soaking it in a disinfectant, such as Dettol, at the recommended strength for the full length of time ordered. If washed at home, cotton and linen articles may be well boiled instead, but other materials will still need treating as above.

Remember that it is not sufficient simply to rinse an article in even a very strong antiseptic; soaking for the correct length of time is necessary, according to the substance used and its strength. Clear instructions are provided with all the modern disinfectants, and if you follow them exactly you can rely on the result. If you prefer boiling for suitable articles, such as crockery, see they are kept completely covered with water and boil steadily for not less than twenty minutes; add soda or borax if the local water is hard, to prevent a harsh deposit forming

on the articles. Never forget that ordinary thorough soap-and-water cleanliness plays a great part in preventing the spread of infection, and nothing can take its place.

COMMON NURSING TREATMENTS

The **MEDICINE CHEST** should be a well made cupboard, having two divisions or shelves, one for medicines and one for substances intended for external application only, and it is convenient if there is also a deep drawer for bandages, etc. The door should fit closely to exclude dust and should have a good lock, and the cupboard ought

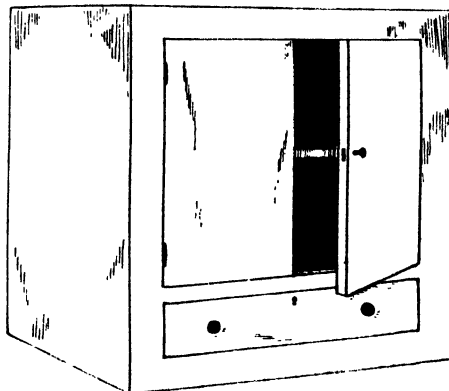

MEDICINE CHEST

to be placed against a cool wall, out of the reach of children, in a well-lighted position. It should be kept locked and the key hung where the responsible members of the household can get it quickly.

Keep small quantities only of anything that is not frequently used, because some things do not keep well. See that all stoppers fit properly and that everything is clearly labelled, and do not have in stock anything poisonous unless it is wanted for a definite purpose. The contents of the chest should be simple to reduce the possibility of error; nothing at all elaborate is needed, and everything ought to be in good condition ready for immediate use.

FIRST SHELF—Remedies for internal use:

1. Aspirin tablets of good quality or, better still, Empirin Compound Tablets which contain also phenacetin and caffeine. This mixture is preferred in modern medical practice on all occasions for which aspirin alone is suitable. Cost, 1s. 4d. for 25 tablets, 4s. 2d. for 100. Adult dose, 1 or 2 tablets.

2. 2 oz. castor oil.

3. An aperient for occasional use. Any specially prescribed one, or Epsom salts or a fruit saline, and milk of magnesia if there are children. If anyone is taking a paraffin preparation regularly, it will probably be more convenient to keep it elsewhere than in the medicine chest, especially as the bottle may become rather oily on the outside.

4. Cinnamon and quinine or other "cold cure" that has been found effective for any individual. They cannot be relied on unless taken immediately the first hint of a cold is noticed: three hours later when the chemist is open will be too late, therefore keep any such remedy in stock.

5. A small quantity of sal volatile or brandy.

6. Any special remedy needed from time to time in your particular household.

7. A 2 oz. measured medicine glass, and perhaps a china measure as well.

8. A measured medicine spoon.

Any medicine in current use which is not absolutely harmless. An overdose of some tonics, for instance, would do harm to a child or irresponsible person who might "taste" them.

SECOND SHELF—Substances for external use only:

1. A non-poisonous disinfectant suitable for all-round use, such as Dettol.

2. A small bottle of Milton unless one is kept in the kitchen.

3. A small tin of antiphlogistine.

4. A tin of ointment suitable for most purposes; e.g., Germolene or your family favourite.

5. A large tube of tannic acid jelly for serious burns.

DRAWER:

1. 2 tested thermometers.

2. Roll of cotton wool, about 4 oz.

3. Roll of plain lint.

4. Packet of plain gauze.

5. Half a dozen cotton bandages, 2 in. or 2½ in. wide. Narrower ones are sometimes useful for very small children, but the above width is better for nearly all purposes, and a cotton bandage can easily be cut in half with a sharp knife.

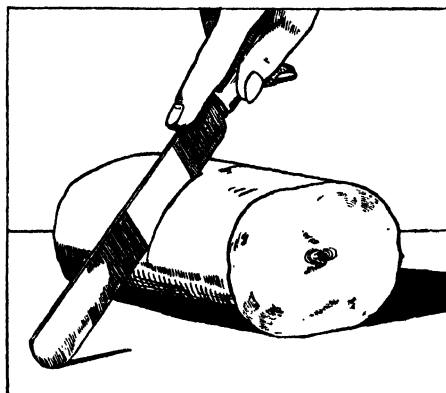

CUTTING BANDAGE IN HALF

6. Box of assorted safety pins.

7. Reel of adhesive plaster, 1 in. wide.

8. Packet of Elastoplast or similar first aid dressings. These are very handy indeed; ask the chemist to show you the range, and select those most suited to your household.

9. A pair of scissors unless you can rely on finding another pair quickly at all times.

Have nothing whatever to do with patent medicines of unknown nature.

All substances used for **EXTERNAL APPLICATION** must be kept on a separate shelf in the medicine cupboard from anything intended for internal use. They must also be in differently shaped bottles, which must be recognisable by touch alone, and bear a "poison" label if the substance is poisonous. They should be kept under lock and key and never be left within the reach of

children; everything in the cupboard ought to bear the original label supplied by the chemist.

Some LINIMENTS are inflammable, so keep them away from any naked flame. They are applied by friction, which materially assists their action. Pour a sufficient quantity into the palm of the hand and rub the area lightly and briskly until the skin is dry, red and glowing. Then cover with a pad of warmed flannel or gamgee tissue (cotton wool enclosed in a single layer of gauze or butter muslin), and bandage in position. Some liniments must not be too frequently applied over the same area or the skin will become roughened and sore. Should such symptoms appear, use talcum powder or plain olive oil for the next one or two rubbings.

OINTMENTS ought to be applied by spreading them on a piece of white lint or old linen cut to the required size, and bandaging over the affected area. A spoon handle or a knife will spread them well if you have not a spatula, and if the ointment

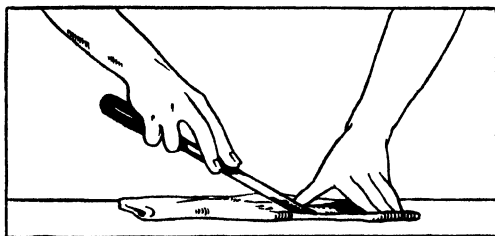

SPREADING OINTMENT

is likely to soak through put a thin layer of cotton wool or a folded pad of linen over it before bandaging, but do not use any waterproof material.

To apply a COLD COMPRESS such as lead lotion, soak a double fold of lint or old flannel in the prescribed lotion, cover with a slightly larger piece of oiled silk or jaconet, mackintosh side next to the lint, and bandage in place. This needs changing at least every four hours.

EVAPORATING LOTIONS are similarly applied, without the waterproof material.

There must be a space round the limb to allow of free evaporation and the lint and bandage must be kept moist with the lotion, which is dropped on from outside from time to time. Something acting as a "cradle" to keep off the bedclothes must be arranged if the affected limb is a leg; a box with one side removed will do quite well for this purpose.

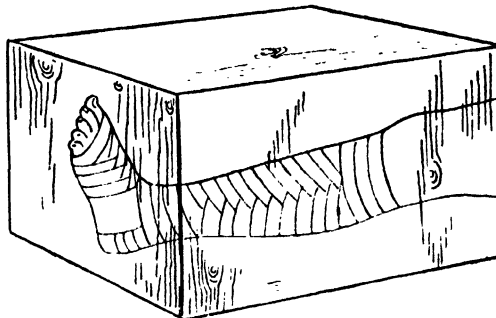

BOX ARRANGED AS CRADLE

POULTICES nowadays are usually of antiphlogistine or some kaolin preparation which is very similar in appearance. Heat them by standing the pot in a small saucepan of boiling water, and when hot enough, stir the contents to equalise the heat; spread thickly on to lint or linen cut a little larger than the required size, turn in the edges quickly, apply and cover with a pad of gamgee or cotton wool and bandage in position. Some experience is needed to get just the right degree of heat, but do not over-heat the jar at all or the volatile oils

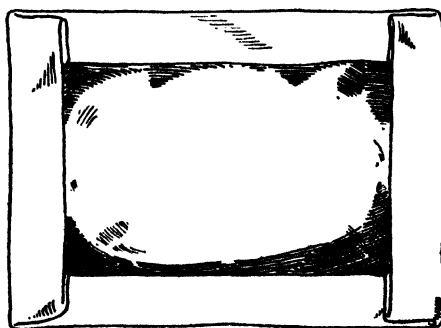

ANTIPHLOGISTINE SPREAD

will be driven off and their value lost, and of course it will produce a severe burn if applied to the skin too hot. These dressings need to be changed twice a day only unless otherwise ordered.

INHALATIONS commonly used for colds are Friar's balsam and menthol. Use a "straight" quart jug, put in the required amount of the medicated substance, together with the proper quantity of cold water in the case of menthol, as stated on the label, add boiling water up to one pint and take to the patient. He should be sitting comfortably propped upright with a firm pillow on his lap if in bed, otherwise seated at a table, and should hold his head over the jug while



PATIENT WITH INHALER

the nurse envelops both in a large bath towel so as to enclose the vapour. He should keep his eyes closed, and inhale the steam for five to ten minutes. Never leave a patient alone with a steam inhaler; he might scald himself badly for lack of help at the right moment. Special "inhalers" cost about 3s. 6d. They have a glass mouthpiece and are perhaps less easily spilt than a jug, but in practice many people think that a jug is to be preferred.

ADHESIVE PLASTER used to keep dressings in place tends to make the skin sore. To prevent this, paint the skin with

Friar's balsam and let it dry thoroughly (which will take at least ten minutes) before applying the plaster.

LYLE'S GOLDEN SYRUP will cure small burns like magic if promptly applied. Put it on thickly and bind with strips of some stout material, like old Bolton sheeting. It may seem a clumsy dressing, but if it is kept on for a few hours it removes pain, redness and blisters, and leaves the skin whole and firm. The treatment is suitable also for larger burns and scalds where the skin is unbroken, and in this case will possibly need to be renewed once or twice at intervals of about eight hours.

FOMENTATIONS are less used than they were because antiphlogistine and kaolin have largely taken their place and have the advantage of not needing to be changed frequently, and also do not make the part sodden. They are still used for some purposes, however, and are often badly applied and thus rendered almost useless, or worse. Fomentations are classed as *medical*, where the skin is unbroken and they are probably required for the relief of pain only, and *surgical* where there is an open wound.

For medical fomentations, do not boil the lint or flannel as it need not be sterile, as there is no broken surface to protect from the



FOMENTATION

entry of infection. Cut a double or treble fold of old flannel or white lint to the right size, enclose it in the centre of a strong dry cloth about 24 in. by 18 in., which is the wringer; twist the ends of this and place the centre in a basin. Pour over enough boiling water to cover, wring the cloth out as dry as possible, remove the fomentation, shake it and apply quickly. Cover with oiled silk or jaconet and a good pad of cotton wool or gamgee, and bandage in place. *If you do not shake out the steam the patient will be scalded.*

Surgical fomentations must be boiled to sterilise them, and white unmedicated lint is the best material to use, as the popular boracic lint gives an entirely false sense of security and is also more expensive. Place the cut lint folded in the wringer in a saucepan of water, arrange the ends up on the lid so that they cannot catch fire, and boil for ten minutes. Strictly speaking, two persons are now needed; one with her hands well scrubbed under running water and left wet, to handle and apply the fomentation itself; the other to take the wringer out of the saucepan, place it in a basin, bring it to the bedside, wring it out and hand it to the scrubbed-up person untwisted, so that she can take it out, shake, and apply as above. Fomentations must be wrung out very dry or the part will soon become sodden, which is most undesirable.

Fomentations do not hold the heat for long and if left cold on the affected area they will do harm; therefore the doctor will perhaps order them to be applied every five minutes or so for half an hour, this to be repeated every two hours, the part being covered with a pad of wool in the meantime; or they may be ordered to be changed every half hour continuously. Anything less frequent than that is not very helpful in most surgical conditions.

TEPID SPONGING is often ordered to reduce a high temperature, and deftly carried out it is very soothing and refreshing to the patient. Prepare as for a blanket bath with the addition of an empty bowl,

and take the temperature and pulse before you start. Use water at 90° F. unless otherwise ordered, and sponge the patient in long single strokes with the sponge very wet. After each stroke, squeeze it into the empty bowl and redip in the water. Spend about ten minutes on the limbs, chest and abdomen, dividing the time evenly between them; then turn the patient and sponge the back for five minutes. Dry him by jabbing gently, not rubbing, and disturb him as little as possible throughout. Take the temperature and pulse again, and if the temperature has not been sufficiently reduced repeat the whole process, unless you have been instructed otherwise. When you have finished, leave the patient covered with a sheet and one thin blanket, and unless he is asleep take the temperature yet again in half an hour's time. Should he start to shiver during the sponging, stop at once, cover him up warmly and give a hot drink and a hot water bottle. Watch him carefully but unobtrusively and remove the bottle and extra coverings when he complains of feeling hot. If he appears really collapsed and does not quickly improve, get into touch with the doctor.

An evacuant ENEMA or bowel washout is a treatment the doctor will occasionally order, but it is not the simple matter it appears to be for an inexperienced person to perform. If you can possibly get a nurse to demonstrate it, do so, and in no circumstances use the popular ball syringe with a rigid nozzle. Attention has recently been drawn in the medical press to two cases in which almost fatal injury, and permanent disability, has been caused in this way, and it is very much safer to use a two-pint enamel douche can fitted with a soft rubber rectal tube and a metal clip to control the flow of fluid. The whole costs about 5s. 6d., but it is possible to manage with a one-pint can which costs a little less.

Use either a piece of green soft soap the size of a walnut, or about twice as much of a pure yellow soap such as Knight's Primrose, shaved, and dissolve in a little boiling water in the douche can. Unsuitable

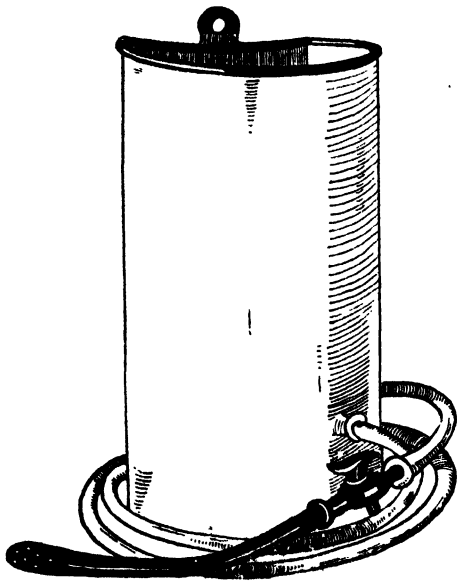

DOUCHE CAN WITH TUBE AND CLIP

soap will cause a rash in some persons; the above-mentioned probably never will. Add water to make a pint of fluid at 105° F., much smaller quantities being used for children, of course. The patient lies on his left side, with the buttocks at the edge of the bed, covered with a blanket or towel. Lubricate the end of the tube with vaseline, let a little fluid flow through to expel the air, then very gently insert the tube into the rectum for two to three inches, and with the can slightly raised above the level of the bed open the clip and allow all the fluid to run into the bowel, then close the clip and withdraw the tube. The patient should be instructed to retain the fluid for a little time, if possible. It is important to avoid injecting air, which causes severe discomfort, and also take care not to hold the can higher than is necessary or the fluid will flow too forcibly.

A QUASSIA ENEMA for threadworms is given in the same way, using an infusion of quassia of prescribed strength instead of the soap and water, at a temperature of 100° F. It should, if possible, be retained

for half an hour, and probably an aperient will have been ordered for use the night before.

NURSING OF CHILDREN

The successful nursing of children calls for special qualities in the nurse, and very much depends on the child's own upbringing. If he is well-disciplined and obedient, and his experience has led him to trust grown-up persons, he will have an excellent chance of making good progress, whereas a badly-managed, spoilt child, who is used to hearing threats and promises which are not carried out, will be an extremely difficult little patient to care for, with much reduced chances of making a quick recovery.

The nurse needs specially keen powers of observation, endless patience, and a real understanding of children. As far as home nursing is concerned, she will probably be the child's mother or usual attendant, and will thus have the advantage of knowing his normal habits and appearance, so that she can fairly easily, estimate just how ill he is. Further advantages are that the small patient knows her and has, or ought to have, absolute confidence in her, and that she wears no alarming uniform. Children are extremely sensitive to "atmosphere," and special care must be taken not to let them realise that their mother is anxious about them, or that they are under observation, but to be calm and cheerful in all circumstances.

It is a good thing to practise taking children's temperatures when they are well, perhaps as a game on a wet day; then they will manage the thermometer safely in illness and will not be alarmed by it. The family attitude towards doctors, nurses, and hospitals should be clearly defined as one of complete trust and friendliness. Not a few educated mothers use the word "hospital" as a dark threat suggesting unknown horrors, but this is obviously unwise, for anyone may have to attend one at some time, especially now that increasing pay-bed accommodation is being supplied. Do not

resort to coaxing or bribery; treatment must be carried out as a matter of course and without fuss "because the doctor says so." Never tell a child that the doctor will not hurt him, or that medicine is not nasty, unless these statements are quite true. It is wiser to say, "This may hurt you a little, but it won't be more than you can bear, and it is to help make you better." Children's medicines are seldom nasty nowadays, but some look dark-coloured and unpalatable,



THE DOSE OF MEDICINE

and the child may not at first like a flavour which is strange to him, so make him understand that medicine is good for us but does not always taste nice, and supply a barley sugar fish or a boiled sweet afterwards. Decorated medicine measures can be picked up at bazaars and handicraft shops, and will make the dose a little more interesting.

MEALS prepared with imagination will be eaten readily when an ordinary looking dish will be scarcely touched. Thin bread and butter can be rolled, or cut into flat fancy shapes, sandwiches are regarded as a treat usually reserved for grown-ups, a tiny rabbit mould makes pleasing blancmanges (particularly in chocolate), and jelly has a special attraction for most children.

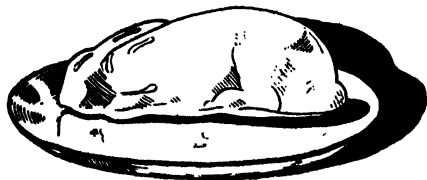

RABBIT-SHAPED BLANCMANGE

Though not itself a food, it is useful for eating with cream and bread and butter, or as "Crystal Palace pudding," made in two layers, one of jelly and one of cornflour, and it makes a palatable childish drink, hot or cold, if made up with about three

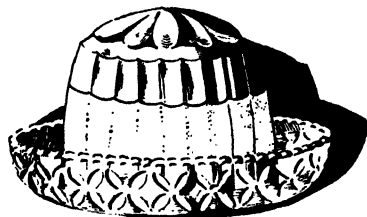

CRYSTAL PALACE PUDDING

times the quantity of water. Pretty china reserved for use in illness helps to make the tray look interesting, and straws for cold drinks are a delight to any right-minded child.

Remember that a young child's temperature is very unstable, and there is not necessarily any need for alarm if it should be high for a short time. Do not take it at all unless you really think the child is not well; it is not a good habit to get into, and if you do find it raised above 99.4° F. put him to bed. Keep him quiet in an airy room, and give plenty of fluid, with nothing more solid than sponge fingers or dry biscuits—and do not press even those, and he will probably soon be himself again. Send for the doctor if the temperature is as high as 102°, or if it persists at 100° to 101° for two or three days in spite of the above treatment, and of course call him in if the child seems really ill, regardless of the temperature.

EARACHE is a symptom too lightly regarded by many mothers, and if a child appears to have it—and even very young babies do have ear trouble—let the doctor see him without delay. Neglect may lead to a serious operation and even a brain abscess. A discharging ear is less urgent, but that also needs investigation and should not be allowed to continue untreated, and never put drops of any kind or any cotton



PAD OF COTTON
WOOL APPLIED
TO EAR

wool into the ear except on medical authority. A good pad of warmed wool will afford a little comfort whilst waiting to see the doctor, but nothing else should be applied without instructions, and on no account give aspirin in any form.

FOREIGN BODIES

pushed into the ear or nose must be left strictly alone and the child taken straight to the doctor. Even though the object appears to be absolutely easy to remove, do not make the attempt, it is certain to be pushed in further and may cause grave damage to the delicate and complicated surrounding structures. Three things at least are needed to remove it safely—a good light, special forceps and an accurate knowledge of anatomy, and only a doctor is likely to have all three.

FOREIGN BODIES IN THE EYE. If a small foreign body, dust for example, finds its way into the eye, it can be removed by dipping the face into a basin of water and opening and shutting the eye under the water. If the body can be seen on the eye ball, it can be removed by carefully wiping it away with the corner of a clean handkerchief, the lids being kept widely open. Very often the body can be felt under the lids. If it is under the lower lid, pull the lid gently down as far as possible, tell the child to look upwards, and the trouble can be removed with the corner of a clean handkerchief. If it is under the upper lid, seat the child in a low chair and get him to look downwards as far as possible. Take hold of the upper lid and very gently roll it upwards, using a small object such as a match over which to roll it, if necessary. The foreign body will often be seen adhering to the lid, and can be removed.

Discomfort frequently occurs after the removal of a foreign body in the eye. On no account must the child be permitted to rub the eye as this may cause severe

inflammation. Bathe the eye with cold water, or drop a little castor oil into the outer corner of the eye.

If the foreign body cannot be removed easily; or if there is severe pain and nothing to be seen, put a little oil in the eye, lightly bandage it and take the child to a doctor.

SWALLOWED SMALL OBJECTS seldom give trouble, though children manage to swallow extraordinary things from time to time. Give a stodgy meal immediately—bread and milk is quickly prepared, and thick porridge is good if available—and then if the article is a small one with no sharp edges, such as a halfpenny, bead or button, do not worry but watch the motions for a day or two until it turns up. If it is something irregularly shaped or sharp, such as a toy soldier or a hair slide, let the doctor know as soon as you have administered the bread and milk.

In no case give an aperient. Sometimes the object sticks in the throat and the child chokes. Then turn him upside down

and shake him hard, holding him by the heels, and if this does not succeed wrap your forefinger in a clean handkerchief to protect it, and try to hook the thing out.

Occasionally articles are accidentally **INHALED** and drawn into the air passages, and this is altogether a more serious matter than being swallowed. The child may be choking and obviously in need of urgent treatment as above or, if the substance is tiny, such as a chip of peanut shell, immediate symptoms will not be noticeable but septic pneumonia or a lung abscess may be set up. Whenever you have reason to think anything may have been thus inhaled, the child should be taken to see the doctor at once.



CHILD BEING SHAKEN UP
BY HEELS

A TELEPHONE PROJECT

INTRODUCTION

Purpose of the project.—This school co-operative activity provides opportunities for the correlation of some branches of school work in English, history, geography, mathematics, art, science, woodwork and metalwork, and the scheme is organised with the telephone as its central feature. "It is essential," says the Consultative Committee of the Board of Education in the *Report on the Education of the Adolescent*, "that children should be aided to regard the work they undertake as a unity, and to avoid the illusion that the world of knowledge consists of a series of separate and unrelated subjects."

A project based on the method to be shown in this article is a practical interpretation of this idea. Instead of starting with a logically arranged body of knowledge called a "subject" and trying to make this interesting to children, the school, in this project, takes a dominant and modern interest and builds round it a series of lessons on a great number of aspects of that interest. There are other advantages to be gained from this simple application of what is called for the sake of convenience the *project method*. There is a likelihood of a real connection being formed in the children's minds between what they learn in school and the outside world. The work of arousing and maintaining the child's interest is simplified, for this fresh approach to school work brings keen endeavour; also, the assertive and direct connection between school subjects and so practical and attractive an instrument as a telephone will undoubtedly implant the knowledge gained in English, history, geography, science and arithmetic firmly in the mind.

This type of project, too, assists in counteracting some of the disadvantages of specialisation—chief of which is a tendency

to split the school into a series of separate compartments—by giving to children and teachers a concrete example of co-operation. Each department, except music and physical training, contributes something to this project and therefore it assists in developing the corporate life of the school.

Furthermore, the telephone and radio-telephony are vital parts of modern industrial, commercial and social life. We cannot ignore their effects, and it seems desirable that some knowledge of their growth and extent should be used as a basis for extending the children's understanding of, and interest in, certain aspects of their history and geography. The project also ensures that the children shall recognise the value of the telephone and radio-telephony in modern world communications.

Finally, the policy of the General Post Office in making every effort to reduce telephone charges and to increase the number of subscribers means that, more and more, the ex-elementary schoolchild will require to use the telephone. Years ago it was a fearsome instrument to the uninitiated, but it is now so much a part of our social life that children must be taught how to use it efficiently, economically and with confidence.

Telephone apparatus.—The possession of a pair of telephone receivers or of a telephone system in the school is not essential to the working of this project, but it is an attractive and useful feature which enhances the interest of the children in the matter in hand. The provision of a telephone system depends upon the facilities available in equipment and on the electrical knowledge of members of the staff. A general indication of methods of building a simple system appears in the science section of this article.

Some local authorities are willing to supply for educational purposes one pair

of telephone receivers as issued to them by the General Post Office, and if these are available the offer should be accepted, for the instruments are of the latest design, unused, and very simple to connect between two classrooms. Full instructions for the non-mechanically minded are included with the set. The only difference between these receivers and those in general use is, that instead of a bell ringing to draw the attention, an electric bulb lights up. Speech received through these telephones is clear and is free from noise interference.

In some areas, there can be obtained from the G.P.O. Sectional Engineer examples of an out-of-date instrument. The price varies, but one school was fortunate enough to obtain fourteen sets at five shillings each set, and from these was able to build up an elaborate internal system for these sets are as efficient for all ordinary purposes as more modern types. They are unused models of obsolete pattern. It has been found from experience that the officials of the General Post Office are willing to help schools in whatever ways they can, and it is with confidence that letters asking advice can be sent to that organisation.

If no instruments are available, the craft-rooms can probably provide a model. As a last resource, a circular tin lid fastened flat at each end of an 8 in. piece of wood will give the children something which they may learn to handle correctly while practising telephone calls in the English lesson.

Outline of the scheme.—This project might be carried out as a definite part of the curriculum during the first term of the third year, or be spread over two terms in the second year. It should appear only once in a child's senior school career, and preferably towards the end of it. When the project is put into operation, science, woodwork and metalwork can take an active part, and the scheme will also apply to English, history, geography, mathematics and art.

The science, woodwork and metalwork departments assist in constructing the system

or in fitting up individual sets. In addition, in science, the basic principles of a telephone's construction and working method are dealt with. Any elaboration from the simplest facts is dependent upon the knowledge of the science teacher and on the time available, but there is no reason why the matter should be dealt with in any great detail, unless it fits in closely with the school's scheme of science teaching.

In English the aims are, to teach accurate use of the telephone instruments, to give practice in original oral English and to improve enunciation and articulation. Many types of calls are dealt with in the English section of this article. In mathematics there are examples of scale drawings of instruments and apparatus, and oral arithmetic work to make the children familiar with the costs of local calls and the more important trunk calls, at the same time keeping the work within the scope of the average arithmetic syllabus. It is an accepted fact that, without special training such as the mathematics section of this article suggests, children and even some adults have little idea of the cost of calls. An example of this occurred when a maidservant rang up a friend in Montreal every night while her master was out, not knowing the cost of the call.

In history, the children are led to appreciate how the modern telephone service is a development of long-distance communication through the centuries. They study briefly the use of fire and smoke, of beacons, of ancient Admiralty telegraphs, signalling by flags, rockets, heliograph, native drums, and semaphores. The work of some pioneers comes under survey, including Wheatstone, Morse, Rees, Bell, Edison and Marconi. There is reference to the British Broadcasting Corporation. The geographical part of the project deals with the extent and position of telephone, cable and radio-telephone services, with special reference to the methods of linking-up when an international call is made from a telephone in England. In art, there is scope for posters,

lino-prints, lettering and bookcraft. Some indications of how these branches of the subject can be used in the project are given in the art section of this article.

Each member of the staff who will be concerned with the development of the project should have a copy of the complete scheme, which might be compiled from the various sections which follow. This will give to the teachers concerned a general view of the whole proposal, and each will then understand how his own section fits into the scheme. There should be an appointed day for the beginning of the project so that the whole of the work starts together and the interest becomes compact and intensified. The classes which are to take the special short course to be outlined should be told beforehand what is to be done, and the work can be given its initial impetus if the classes hear from the head teacher some such comment as the following:—

“The work of our school is divided into

subjects on the time-table so that there shall be system and method in our organisation. But in the story of man's endeavours through the ages there are no artificial divisions. All man's activities are interconnected, and everything that man has achieved in the world has been the result of effort and thought and planning in countless branches of life. The story of the pen on your desk contains material for dozens of lessons in what we call English, history, geography, science, mathematics and engineering. English spreads through all you do. Whenever you read, write, talk or think you are working in the subject which our time-table calls 'English'.

“Soon you will be taking a series of lessons on the telephone, and these lessons will prove to you quite clearly the unity of life and the way in which all our separate subjects are, in reality, one indivisible whole. When the course begins, that is one of the chief aspects which you should keep in view.”

SCIENCE

Introduction.—As a means of teaching the principles of electricity, a set of telephone instruments can be extremely useful. The phenomenon of *electromagnetism* is exemplified in the telephone induction coil or transformer, in the electric bell or buzzer which is used to attract attention, in the telephone receiver itself and in the numerous relays and controls which are to be found in a modern installation. *Electric circuits* in infinite variety are to be traced in the wiring scheme. The standard design of transmitter used by the General Post Office illustrates the influence of a *variable resistance in a circuit*. Other less striking features of the apparatus such as the batteries and indicator lamps are concerned with *electro-chemical action* and the *heating effect of a current*. It is clear therefore that the telephone may be used in school either as a

source of inspiration from which to develop a many sided interest, or as a means of linking together several aspects of electrical science.

In schools where telephone instruments of the usual commercial type are available, the wiring, testing and operating of these as a working system in two or more rooms form a good educational project. However, owing to the limited opportunities for practical work offered by such a project, the greatest possible benefit will not accrue from this sort of plan. Some of the components of every school installation should be school made, as the construction of instruments is valuable in itself, and in actual practice a combination of commercial and school made apparatus is very convenient and effective. In the following paragraphs, suitable circuits for school use are discussed and constructional details of

instruments are given. By making full use of the latter, the project may prove to be of value even in those schools where the stock of ready-made apparatus is strictly limited.

Telephone systems.—A simple telephone system consists of a number of subscribers and an exchange. Each subscriber is linked to the exchange by wire landlines which transmit the operating currents. Through the agency of an operator, or by means of an automatically operated exchange mechan-

contain induction coils or transformers which help to avoid loss of power in the landlines.

Commercial exchanges are very complicated as they incorporate many special devices which help to ensure good service, accuracy and reliability. For the present purpose, however, an exchange may be looked upon merely as a centre to which all landlines lead and at which links are used by an operator to connect an inquirer through to some other person.

There are two varieties of telephone systems which can be installed conveniently

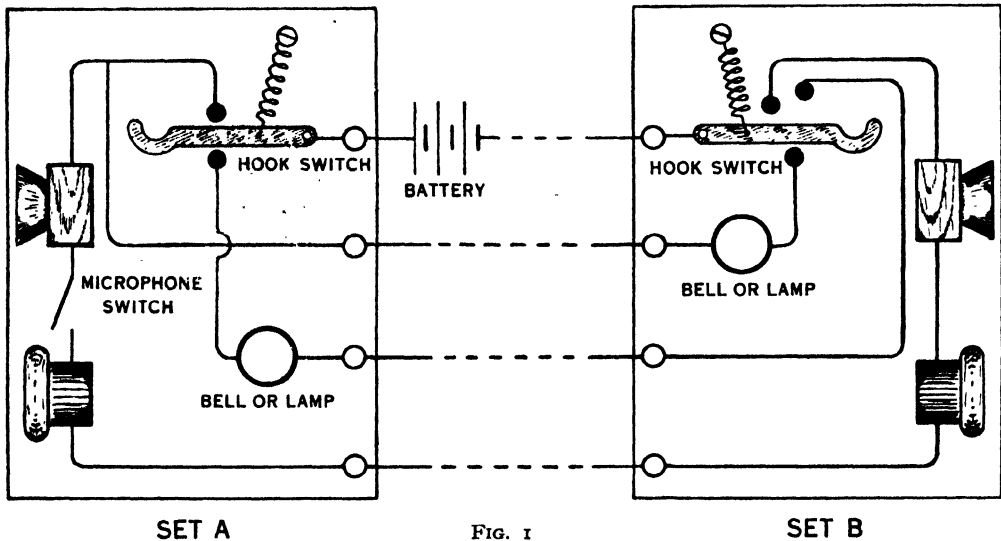

FIG. 1
 A SIMPLE TELEPHONE INSTALLATION, INCORPORATING ALTERNATIVE FORMS OF MICROPHONE SWITCH
 Set A: Manually operated press switch.
 Set B: Automatically operated spring hook switch.

ism, any pair of telephones in the system may be put into communication with each other.

Each telephone set consists of a microphone or transmitter, by means of which the air vibrations set up by the voice are changed into a varying electric current, an earpiece or receiver which transforms the varying currents sent by another microphone into sound, a means of calling the attention of the exchange or another subscriber, and a bell which rings when a call is to be received. The most effective telephones

in school. The simpler of these is a straightforward room-to-room arrangement with no transformers and no exchange. The other follows more closely the practice adopted by the Post Office Telephone Department, and has as many branches as may be desired, all of which are wired to an exchange situated in the science laboratory or in some other convenient central position.

A simple school installation.—Even when it is proposed to construct an exchange-

controlled apparatus, the simple sets illustrated in Fig. 1 can serve very usefully as an intermediate stage. For communication between adjacent rooms in a school the arrangement shown is ideal, and its preparation forms an excellent little project. The number of pieces of apparatus required is reduced to a minimum, so that only a modest outlay is needed, yet the efficiency of the installation is not open to question.

Four wires link the two sets. In one of the lines a flashlamp battery is introduced, as shown. The earpiece or hand combination of each set is intended to hang on a spring hook and so hold it in the *down* position. When the apparatus on the hook of one set is removed, the spring lifts the switch arm. This modifies the circuit and makes the indicator bell or lamp in the other set come into action to attract somebody's attention. Lifting the second instrument from its hook interrupts the ringing and

automatically connects the two stations so that conversation may take place.

Set A in the diagram is fitted with a press switch which controls the current in the microphone circuit. Whilst the apparatus is in use this switch must be held down. The need for separate microphone controls of this kind may be avoided by using three-point switch hooks as shown in the alternative Set B. This design is very convenient as it makes the whole installation entirely self-acting, but it offers no protection for the battery on those occasions when the receivers are accidentally left off the hooks. Set A does not suffer from this disadvantage because its switch interrupts the current as soon as the user releases his hold.

An exchange-controlled installation.—In this form of school apparatus, three or more identical sets of equipment are erected in different rooms in the building, and each is

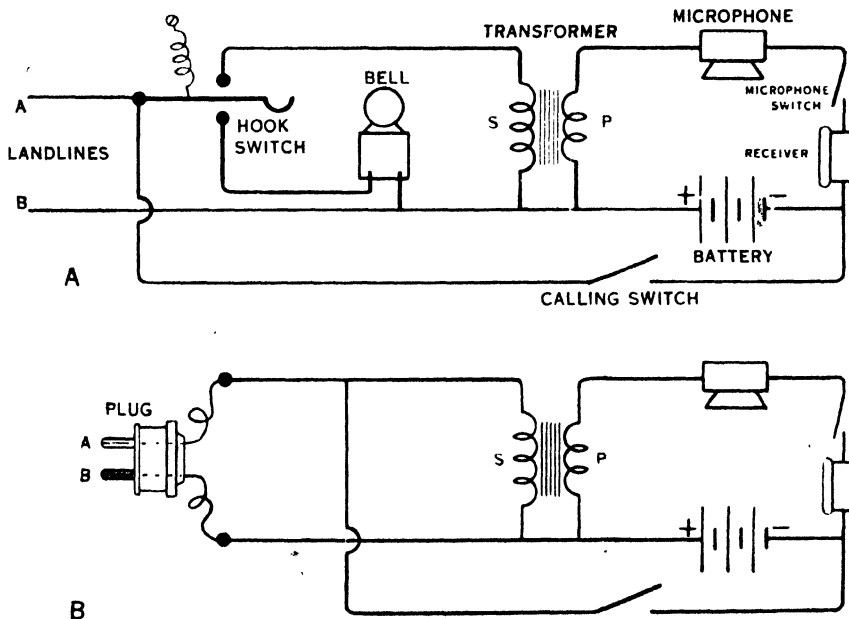

FIG. 2

EXCHANGE-CONTROLLED TELEPHONES

- A: Subscriber's apparatus.
- B: Operator's apparatus.

connected to its own little panel in a central exchange by means of a pair of wires. The circuit of a set is represented in Fig. 2A. The apparatus provided for the use of the exchange operator differs slightly from that of a subscriber, and has its lead-out wires connected to a two-pin plug instead of to a pair of landlines. Each subscriber has a calling switch in his set by means of which he can draw the attention of the operator, and he has a bell by which he himself may be called. The calling switch is retained in the operator's set, but the bell and spring switch are omitted as their functions are performed by apparatus built into the exchange itself. Microphone switches of the kind shown in Fig. 1, Set A, are included in both the sets in Fig. 2.

On a suitable panel at the exchange there is a small lamp, a switch and a two-pin socket for each branch line, Fig. 3. The lamp serves to indicate when a subscriber wishes to make a call, the switch is used to put the lamp out of circuit whilst the line is being used for conversation, and the two-pin socket provides an easy means of inter-connecting different telephones. A relay

which works an exchange bell whenever an indicator lamp lights is introduced in the circuit, so that the operator need not be in constant attendance watching the lamps. The bell apparatus is provided with a switch so that it may be put out of action at will. The relay circuit is shown in Fig. 4, and practical details are included in a later paragraph, page 524. It must be understood, of course, that the use of a relay and bell is optional.

When a subscriber presses his calling switch, the lamp over his number on the exchange panels glows, and the exchange bell rings if it is in circuit. The operator plugs his apparatus into the socket of the caller, turns off the indicator lamp and inquires what number is required. On being given this information, he plugs into the socket of this number, turns off the indicator lamp which is connected to it and sends a call to the branch by pressing the switch in his own set of apparatus. On hearing a response, he takes out his plug and connects the two subscribers by a length of flex fitted with plugs which suit the two sockets. This coupling links the corresponding holes

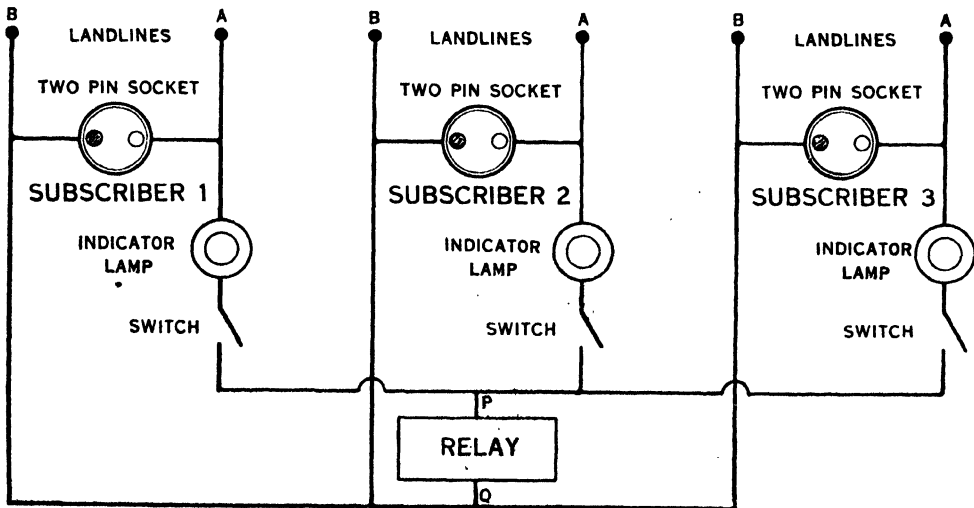

FIG. 3
CIRCUIT OF EXCHANGE APPARATUS FOR THREE SUBSCRIBERS.

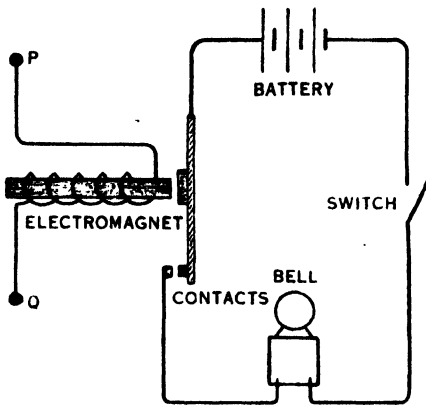

FIG. 4

DETAILS OF THE EXCHANGE BELL RELAY CIRCUIT

in the two sockets together and therefore completes the telephone circuit between the two branch lines. If the exchange is a large one, another call may come in whilst the first conversation is in progress, and this may be dealt with in a similar way to the other, a separate flex, or *cord* as it is termed, being used.

When the operator thinks that the conversation is likely to be at an end, he inserts his plug into the adaptor on one of those on the cord without disturbing any of the connections. The kind of adaptor which permits this is shown in Fig. 5. If nothing is to be heard, then the call is assumed to be at an end, the cord is removed from the sockets, the two indicator lamp switches are moved to the *on* position again, and the whole operation is complete. If, on the other hand, the lines are still engaged the operator detaches his plug from the adaptor and tries again a little later.

The microphone.—Two forms of construction for this instrument are described. Models of the first kind make use of *microphone buttons* and give reliable results, whilst the others incorporate reasonably satisfactory school-made units. A microphone which uses a ready-made button does

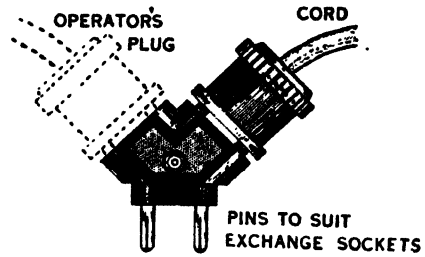

FIG. 5

TWO-WAY ADAPTOR FOR CORD PLUG, WITH SOCKETS FOR OPERATOR

not give as much opportunity for investigation as a school-made one, because the working parts which it contains are very small.

The button microphone.—Most retailers of electrical equipment are able to supply microphone buttons at the price of 1s. each. The instrument as purchased consists of a container full of carbon granules, a small mica diaphragm and two contact studs. The constructional work involved in preparing the button for use includes the making of a suitable case and the fitting of a larger diaphragm to the stud which projects from the mica. The diagram, Fig. 6, shows how

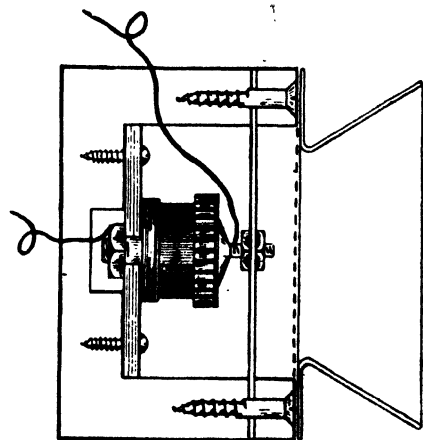

FIG. 6

THE BUTTON MICROPHONE

this work may be carried out. The case is a block of wood in which a hole is sunk to accommodate the button. The exact size is unimportant—a hole of diameter about 2 in. and depth about $\frac{3}{4}$ in. is convenient. The metal stud on the button back is bolted to a metal base plate, which in turn is screwed to the wood at the bottom of the whole in the block. If the stud has no thread and nut, the fixing to the plate may be effected either with a grip screw or with solder.

The stud on the mica front is bolted to a thin diaphragm of mica, celluloid, brass, copper, aluminium or tinfoil. The actual material used is relatively unimportant, provided that it is thin. Results can be obtained with a tin lid for diaphragm, but something rather more pliable is desirable. The edge of the flexible plate is gripped between the surface of the wooden block and a screwed-on cover plate. A gauze protector for the diaphragm and a conical mouthpiece of tinfoil or cardboard are useful refinements which give a professional appearance to the finished instrument.

The carbon disc microphone.—As in the other design, wood is used here for the case, and the electrical parts are inserted in a hole. This hole should be about $\frac{1}{2}$ in. deep and of a diameter which suits the carbon diaphragm that is to be fitted. A thick piece of carbon, wedged at the bottom of the hole, is on top of a strip of copper or other metal foil through which an electrical connection can be made, Fig. 7. The remainder of the hole above the carbon is partly filled with carbon granules, obtained from a dealer. It is important that good granules be used, and a supply prepared by breaking up carbon rods should not be substituted for the commercial article. The space above the carbon block should not be more than three-quarters full. A thin carbon diaphragm clamped over the hole gives a second connection to the granules. Here again, the use of a commercial product is advisable. As carbon laminae are very

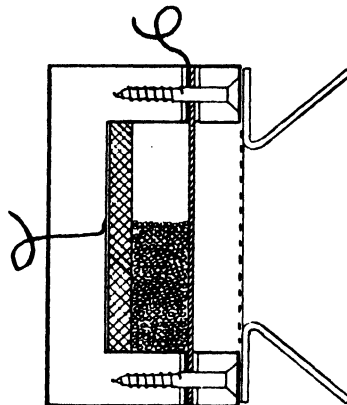

FIG. 7
THE CARBON DISC MICROPHONE

fragile, the risk of fracture whilst tightening the clamping plate should be decreased by inserting thin rubber washers cut from an old cycle inner tube at each side of the carbon diaphragm. A metal foil contact strip mounted between the diaphragm and one washer is used to conduct the current to the microphone. As before, a gauze protector and a mouthpiece are useful.

The telephone receiver.—This component is difficult to construct satisfactorily, and only capable, patient boys should attempt it. Discarded post office telephone earpieces, or single earpieces from wireless headphones give better results than even the best school-made instruments, and the use of commercial apparatus is to be recommended as a general rule. Nevertheless, the receiver shown in Fig. 9 will work when carefully made, and for that reason its inclusion in the project is fully justified.

Post office earpieces and school-made ones have a comparatively low resistance and may therefore be included directly in the circuits, Figs. 1 and 2. The high resistance receivers taken from wireless headphones should be wired rather differently as their inclusion in a normal circuit cuts down the microphone current too much. Three altern-

ative arrangements are shown in Fig. 8, the best for a particular installation being determined by the apparatus to be used.

The school-made receiver shown in Fig. 9 has a single rod magnet mounted in a wooden case. As accuracy in construction is important in this part of the project, it is best to arrange for the main case of the receiver to be turned to shape and drilled in a lathe

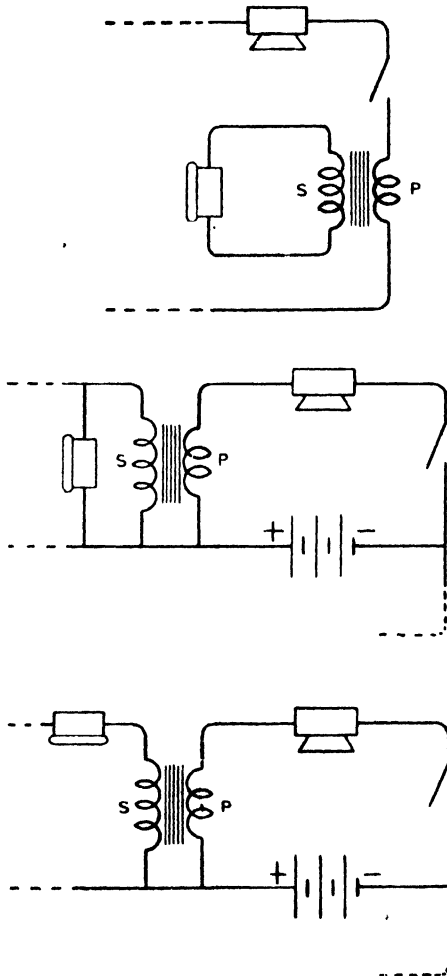

FIG. 8

ALTERNATIVE MODIFICATIONS TO TELEPHONE CIRCUITS (FIGS. 1 AND 2), APPLICABLE WHEN WIRELESS HEADPHONE RECEIVERS ARE TO BE USED

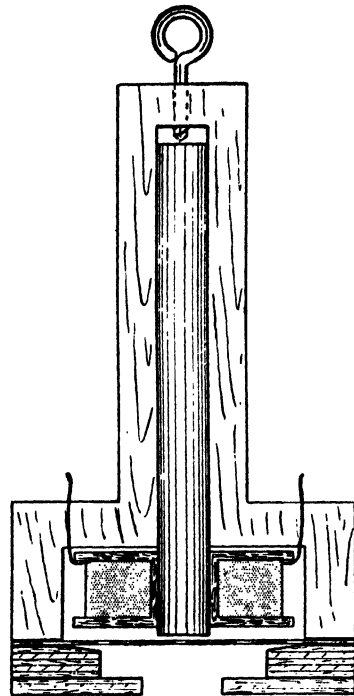

FIG. 9

THE TELEPHONE RECEIVER

in the workshop, although it is possible to do the work without this mechanical assistance. When using simple tools, it is convenient to make the case barrel and head separately and then fix them together with glue. The rod magnet used must be of good quality and should be about $\frac{3}{8}$ in. in diameter. A bobbin built from fibre sheet or insulating card is fitted firmly on one end of the magnet and holds a winding of No. 36 S.W.G. silk-covered copper wire. To wind the coil, the magnet and bobbin may be mounted in the chuck of a hand drill which is clamped firmly to the edge of the bench. As the drill handle is rotated steadily, the wire is fed to the bobbin from a free reel. The beginning and the end of the winding are soldered to short lengths of fine flex, as No. 36 wire will not stand repeated bending and manipulation.

The magnet must fit firmly in its wooden holder and it must be set so that its end is just clear of the ferrotypc diaphragm which encloses it. An adjusting screw at the end of the case can be used to obtain the best setting and can also serve to suspend the receiver from the spring hook of the installation. The diaphragm is held firmly in position on the wooden case by a thick plywood ring which is fixed at several points with screws.

A wireless type earpiece can be fastened on a wooden rod, along with a microphone and switch, and so form a hand combination, but this cannot be done conveniently with a receiver such as that just described. A better plan with the latter is to mount the microphone on a pedestal and hang the receiver only from the spring switch.

The microphone transformer.—This consists of a bundle of soft iron wires about 3 in. long and $\frac{3}{8}$ in. diameter, fitted with wooden end plates and carrying two distinct windings, Fig. 10. The core, the primary

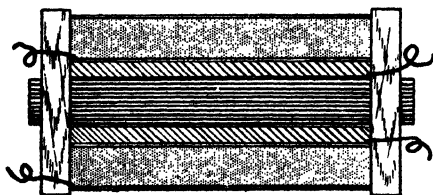

FIG. 10
THE MICROPHONE TRANSFORMER

winding and the secondary are separated from each other by layers of paper which have been shellac-varnished. The number of turns and the gauge of the wire are not critical. For the primary, about six layers of No. 28/32 cotton-covered copper wire will be effective. The space left on the bobbin after the primary has been wound is filled with a secondary of No. 36 silk-covered wire. Flex leads are connected at the start and finish of each coil. The hand drill method of winding suggested in the

paragraph on preparing a telephone receiver coil is helpful when making the secondary of a microphone transformer.

The finish and mounting of a transformer can be arranged to suit circumstances. Four terminals can be fitted to the end plates if desired, and the finished instrument can be held down on a baseboard by screws in the end plates or by a saddle over the windings. A good appearance can be given to the coil and protection can be afforded to the fine wire on the secondary by covering the centre part of the finished transformer with one or two layers of varnished paper or empire cloth.

Switches.—The controls required for the telephone project may be constructed in a variety of ways. The drawings, Fig. 11, suggest some useful forms, but these may be simplified or developed if desired. Sliding contacts on switches are as a rule to be preferred to those which depend solely on simple pressure. Brass and copper should be used in switch construction and the parts which rub together should be plated with nickel or silver in order to reduce the resistance which the contacts introduce into the circuit. The plating process is a simple one and can be undertaken in school.

A special switch called a relay is required in an exchange which incorporates a bell in addition to the set of indicator lamps. The purpose of this relay is shown in the circuit diagram, Fig. 4, and its construction is illustrated in Fig. 12. A bobbin made of iron wires and wooden end plates as used in a microphone transformer is made into an electromagnet by filling it with D.C.C. copper wire of a gauge not thinner than No. 31. An armature of thin brass spring which carries a small iron block and a contact is mounted with the block near the end of the electromagnet core. An adjustable second contact is mounted opposite the first on a screw in a metal pillar. Good contacts are a big help. They may be purchased new or obtained from an old bell, coil or magneto. The strength of the arma-

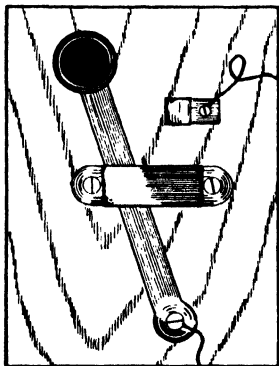
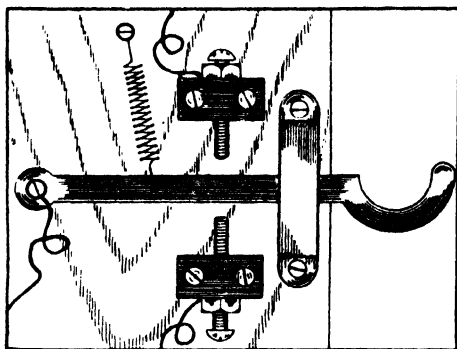
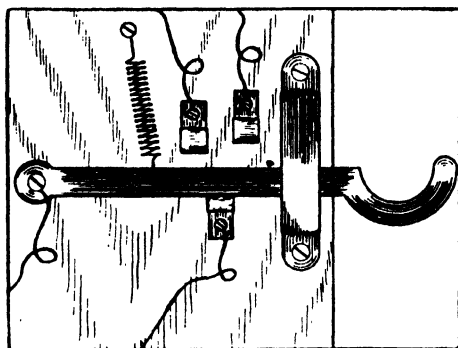

FIG. 11
SWITCHES FOR THE TELEPHONE PROJECT

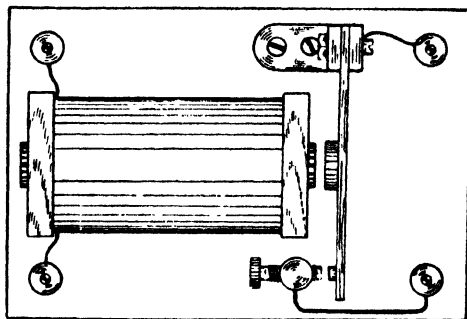

FIG. 12
THE EXCHANGE BELL RELAY

ture spring and the setting of the contacts are chosen so that the relay may operate when the current from one of the exchange indicator lamps passes through the electromagnet winding.

The exchange.—The layout of this part of the apparatus is determined mainly by local conditions, and so long as the appliances which require manual attention are within easy reach, the disposition of the components relative to each other is unimportant, although a neat, balanced, workmanlike appearance is very desirable.

The cables joining the subscribers to the exchange can take many forms. For indoor work, bell wire may be used, but in places where the installation has to withstand the ravages of bad weather the practice adopted by the Post Office engineers should be more closely followed. An economy in cable may be effected by using earth connections instead of wires B, Figs. 2 and 3, or a single wire, common to all subscribers, may be taken round.

Once the set of landlines has been installed, a number of interesting possibilities suggest themselves. Relaying of radio broadcasts from the room in which the set is fixed to a loudspeaker at some other point is feasible, the telephone landlines affording the necessary link. Care must be taken of course to keep high voltage current off the lines by using a choke-capacity output circuit. Time

signals, fire-drill calls and similar communications may also be transmitted by adopting a suitable code.

Conclusion.—The special value of this telephone project lies in its adaptability. A start can be made with a very simple scheme, such as that represented by Fig. 1,

and this may be altered and extended, year after year, as the subject of the telephone comes before successive classes. There is no finality about the apparatus, and so every boy who contributes to the installation can feel that he carries out a piece of new work of real value, and does not merely repeat a routine task.

MATHEMATICS

Scale drawing.—There are two sections in the scheme of mathematics. The first is designed to give opportunities for scale drawing and the second to give practice in finding the cost of various types of telephone calls. There might be scale drawings of such items of equipment as a telephone set, a morse sounder, a tapping key, a telephone table, brackets, stands, etc., and, where possible, a simple technical drawing of a telephone circuit.

Scale drawings, too, are required in the craft work which is dealt with later.

Arithmetic.—The exercises are designed to familiarise the children with costs of local calls, the more important trunk calls and rental charges, at the same time keeping the examples within the scope of the normal syllabus. There follows a list of items of general information upon which the exercises are based. It is suggested that statistics pertaining to the district of the school be obtained from the local telephone directory, and that examples similar to those which follow be compiled to suit local charges.

Rentals.—The following are the charges for renting a telephone in private houses:—London—quarterly, £1 6s. *od.*; monthly, 9s. *od.* Birmingham, Glasgow, Liverpool and Manchester—quarterly, £1 3s. *od.*; monthly, 8s. *od.* Rest of the country—quarterly, £1 0s. *od.*; monthly, 7s. *od.*

Local call charges.—The usual call office charge is 2d. for 3 minutes between 8 a.m. and 7 p.m., and 2d. for 6 minutes between 7 p.m. and 8 a.m. for any call to an exchange within 5 miles. The charge for similar calls by a subscriber (i.e., with a telephone in a private house) is 1d. For other calls up to 15 miles distant the charge increases slightly.

Trunk call charges.—The minimum tariff rates covering a period of not more than 3 minutes for ordinary trunk calls, connected within the periods specified, are as follows:—

For distances up to and including (over 15 miles)	5	9	2	7
	a.m. to 9 a.m.	a.m. 9 to 2 p.m.	p.m. 2 to 7 p.m.	p.m. 7 to 5 a.m.
20 miles	0 5	0 7	0 5	0 4
25 "	0 7	0 9	0 7	0 5
35 "	0 9	1 0	0 9	0 6
50 "	1 0	1 3	1 0	0 9
75 "	1 6	1 6	1 6	1 0
125 "	2 0	2 0	2 0	1 0
Over 125 miles	2 6	2 6	2 6	1 0

The following charges are the minimum covering the first 3 minutes' conversation, after which each minute (or incomplete minute) is charged separately at one-third of these rates:—

A TELEPHONE PROJECT

527

Continental Service (from London Exchanges)

	8 a.m. to 7 p.m.	7 p.m. to 8 a.m.
	<i>s. d.</i>	<i>s. d.</i>
Brussels	7 0	4 0
Paris	6 0	3 6
Berlin	10 0	6 0
Amsterdam	7 6	4 6
Rome	13 3	8 0
Warsaw	12 6	7 6
Moscow	17 6	10 6
Madrid	14 3	8 9
Gibraltar	17 6	10 6

Overseas Services (from London Exchanges)

	<i>£ s. d.</i>		<i>£ s. d.</i>
Australia	4 10 0	Canada	4 4 0
India	4 10 0	Japan	6 0 0
New Zealand	5 2 0	S. Africa	4 10 0
U.S.A.(East)	4 4 0	U.S.A.(West)	6 0 0

Exercises.—The following ten exercises are merely suggestive and the types could be extended at the teacher's discretion. An additional value is that they give children practice in seeking out information.

1. Find how much a resident in each of the following cities pays each year for the rental of one telephone, if he pays (1) quarterly; (2) monthly:—

- | | |
|-------------|-----------------|
| (a) London; | (b) Glasgow; |
| (c) Leeds; | (d) Manchester; |
| (e) Exeter; | (f) Liverpool; |
| (g) York; | (h) Lincoln. |

2. Write the cost of the following 3 minute calls:

<i>Distance in miles</i>	<i>Time</i>
(a) 20	6 a.m.
(b) 22	9 p.m.
(c) 30	8 a.m.
(d) 34	11 a.m.
(e) 60	10 p.m.
(f) 80	3 p.m.
(g) 118	1 p.m.
(h) 136	1 a.m.

3. Mr. Smith began to speak on the telephone at 10 a.m. to a friend 84 miles away. The conversation lasted until 10.12 a.m. How much was Mr. Smith charged?

4. Find the cost of an 8 minute call at 3.20 p.m. to a man 120 miles away.

5. Find the cost of each of the following calls from London:—

<i>Place</i>	<i>Time</i>	<i>Duration</i>
(a) Paris	9.30 a.m.	10 mins.
(b) Berlin	11 p.m.	6 mins.
(c) Rome	3.30 p.m.	8 mins.
(d) Moscow	7.15 p.m.	5 mins.

6. A business man spoke to a friend in Canada for 10 minutes at 8.30 p.m. How much was he charged?

7. If I hold a 3 minute conversation with a man in Paris every day, how much shall I save in one week by ringing him up at 9 p.m. instead of at 9 a.m.?

8. Mr. Jones' friend left New York and went to live on the Pacific coast of U.S.A. How much extra does Mr. Jones now pay for a 3 minute call from London?

9. By how much is it cheaper to call a friend in New Zealand than one in Japan?

10. What is the charge for a 12 minute call from Exeter to Glasgow at midnight?

HISTORY

TALKING THROUGH SPACE

Fire and smoke signals.—The oldest known method of conveying messages over considerable distances was by means of fire and smoke signals. It was used by almost all early peoples soon after men had discovered how to make fire. Pre-historic man signalled across the valleys from hill-top to hill-top using fire by night and the thick smoke given by burning green wood and smouldering leaves by day. The system was in constant use by the Red Indians in North America up to the middle of the last century, and is still employed by many backward native races to this day. According to an ancient Greek legend it was thus that Agamemnon signalled the fall of Troy to Mycenæ; and the Romans during their occupation of Britain communicated warnings of a Saxon or Pict raid by fire or smoke signals from their watch towers on the Yorkshire coast, or along the line of Hadrian's Wall. A few village churches still have an iron cresset, or fire-basket, fixed to the masonry of the tower. In the middle ages the beacon fire was often lighted in these iron baskets to warn the countryside of approaching raiders from the Scottish border, or the Welsh hills.

Perhaps the most famous example of the use of beacon fires in English history occurred in the reign of Queen Elizabeth. In 1588, the coming of Philip of Spain's great armada was daily expected. On all the high peaks and headlands, and on many a city gate and church tower, beacons had been prepared to warn Englishmen that the threatened danger was approaching our shores. Then, one afternoon at four o'clock on the nineteenth of July, news of the sighting of the Spanish fleet was brought into Plymouth. Lord Macaulay in his poem *The Armada* gives a splendid description of the beacon

fires spreading the warning and tells how "All night from tower to tower they sprang, they sprang from hill to hill," until a chain of fires was blazing over the length and breadth of the country, "From Eddystone to Berwick bounds, from Lynn to Milford Bay."

Again, during the Napoleonic wars there was the threat of a French invasion of our island. Beacons were once more set up throughout the country, ready to warn the people that Napoleon had landed. These fortunately were not needed as the French never set foot on our shores, but in one district on the border of England and Scotland a false alarm was given. The man on the watch at Home Castle was deceived by an accidental fire in Northumberland. This he took for the corresponding signal light in that country, and at once fired his own beacon. Soon a chain of fires was seen through the border valleys and the volunteers and militia at once got under arms.

The Admiralty telegraph.—At this same period of the Napoleonic wars a new and quite efficient method of signalling had already been invented in France. This was first used in 1793 for sending messages from Paris to Lille. A huge semaphore was erected on the roof of the Louvre, from which the message was sent out letter by letter. These letters were received at the next station on Montmartre, and from there passed on from height to height, until in a very short space of time the message had reached Lille, one hundred and fifty miles away.

This system was so successful that it was adopted in England by the Admiralty, who set up four chains of stations from London to the chief naval bases, and sent messages in a somewhat similar manner. From London to Portsmouth there were twelve stations,

from London to Plymouth there were thirty-one, north-east to Yarmouth were nineteen, while to Deal in the south-east there were ten. These stations were placed at about an average distance of eight miles apart, though one or two were as far as fourteen miles away from one another. If possible the signalling stations were erected upon hill-tops, but where this was impossible towers were built. The message was sent by means of a hand-worked semaphore, something like a big railway signal. The letters were read by means of powerful telescope, and then passed on to the next point.

The results were often astonishing. From the Admiralty roof in Whitehall, via Putney, Kingston, and other points, to a tower in High Street, Portsmouth, the usual time taken for the transmission of a message was fifteen minutes. On one occasion, as a special experiment, a short signal was sent through at a pre-arranged time, with all watchmen and signallers ready, from London to Plymouth, along the chain of thirty-one stations, and then back to London again. The message was sent and received back again, over a total distance of about five hundred miles in three minutes. Of course, this system had several disadvantages. It could only be used in daylight, and then only in clear weather. In foggy weather or at night it was useless, and further it was often found difficult to read the signals in the haze of the noonday heat. Altogether only on about two hundred days of the year was it possible to transmit a message easily by the method.

Other methods of signalling.— Other methods which have been, and are still, used successfully are signalling by the aid of flags, rockets and the heliograph. Signalling by flags was employed by English ships as far back as the thirteenth century, but it was not until 1665, during the Dutch wars, that a definite system was drawn up. This method was the invention of Sir William Penn, and was used until McArthur, secre-

tary to Lord Howard in the West Indies, during the eighteenth century, improved the old system and also invented a code of lights so that naval messages might be sent during the hours of darkness. Rockets have proved to be of the greatest value at sea in attracting attention, and bringing help to distressed vessels; and during the Great War much use was made of them in the trenches to call for artillery support for men hard pressed in the front line positions.

The heliograph has been, and is still, much used in countries where there is brilliant sunshine and good visibility. This apparatus consists of a mirror upon a tripod, and reflects the rays of the sun, sending flashes of light to a distant point, the long and short flashes representing the dots and dashes of the Morse code. The use of the heliograph is limited to the intervisibility of the stations, but actually in the clear atmosphere of the Himalayas a message was transmitted by a single mirror during the Afghan Wars a distance of no less than seventy miles.

It might be well to note at this point the wonderful system used by the natives of Central Africa. To early explorers in these tropical forests, it was long a mystery how news could travel so fast, and how these primitive people communicated so readily with one another. The natives, it was found, elaborated a code of drum taps, and these were, with astonishing speed, repeated from one village to the next far faster than the swiftest messenger could travel.

The electric telegraph.—The discovery of electricity's power paved the way for all modern means of communication. The first invention of note was the electric telegraph. This we owe to Sir Charles Wheatstone and Sir William Fothergill Cooke who, in 1837, took out a patent for improvements in giving signals to distant places. Their instruments, upon which were five needles, which according to their positions indicated



THE TRANSMISSION OF NEWS—I

(Class Picture No. 69 in the Portfolio.)

certain letters of the alphabet, proved to be of immense value on the early railways where there was a vital need for some method of signalling along the line in all weathers, so that trains might safely proceed at speed. It was first installed on the London and Blackwell Railway in 1838, and was gradually adopted by other railway companies. In 1846 the Electro-Telegraph Com-

pany was formed so that the telegraph might be at the service of the general public, and by 1854 telegraph poles were in the south and midlands becoming familiar objects, and four thousand five hundred miles of wire had been set up.

At this same period, an American named Samuel Morse invented a system of telegraphy by which a pen at the receiving end

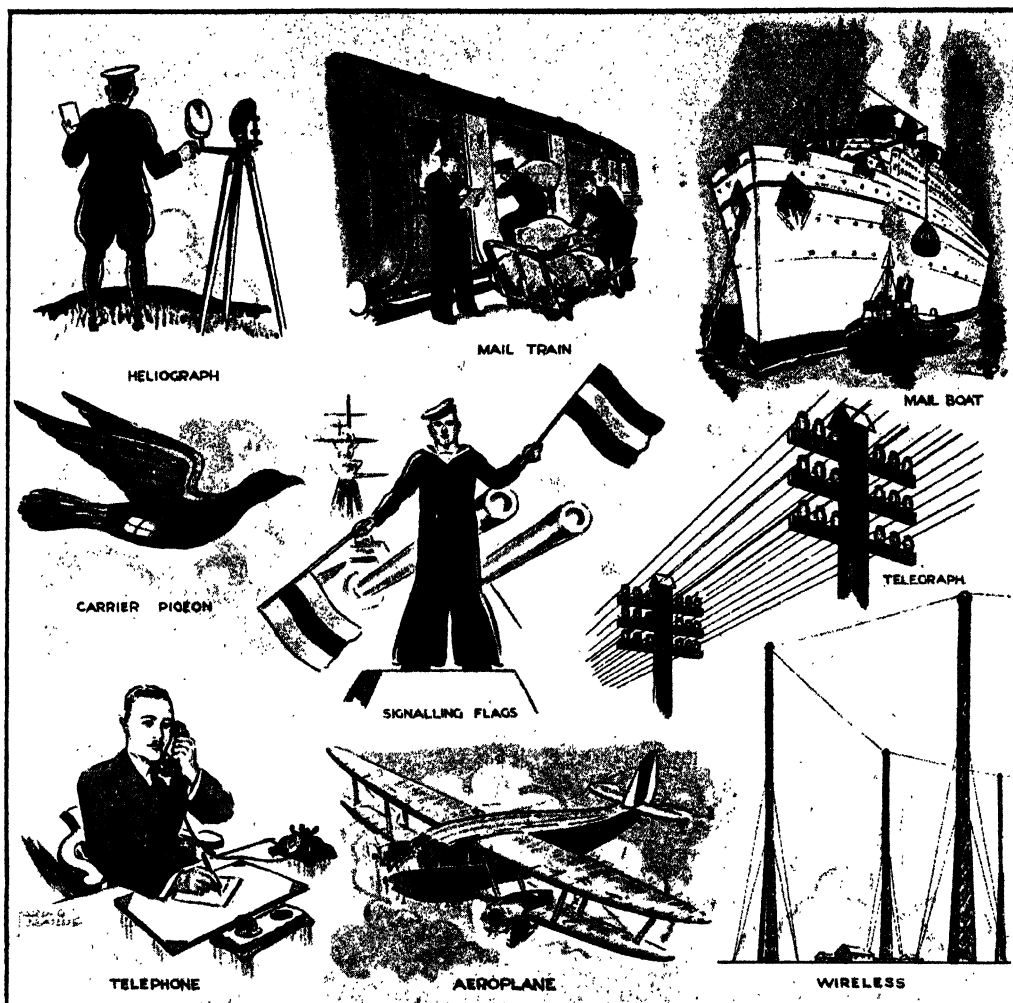

THE TRANSMISSION OF NEWS—2

(Class Picture No. 70 in the Portfolio.)

was caused by the electric current to make a series of dots and dashes on a narrow strip of paper. The famous Morse code, which is now used almost universally, consists of combinations of these dots and dashes arranged to represent letters and figures. The first message to be thus spelled out on paper by this system was sent by Morse in 1844 between Washington and Baltimore.

Men next attempted to send telegraph messages under water, and in August, 1850, the first channel cable was laid between Dover and Calais at a cost of £15,000. After several messages had been transmitted, however, it one day ceased to work, and it was found that a cable had been dragged up in a fisherman's net and broken. A new one was laid once more, and it worked so suc-

cessfully that men began to wonder if it would be possible to connect England and America by this means. After failures, an Atlantic cable was laid in 1858, but after working for two months, during which time seven hundred and thirty-two messages were transmitted, the cable suddenly gave out. It was some years before the two continents were again linked by the telegraph, but this was finally done in 1866 when a new and stronger cable was laid by the steamship *Great Eastern*.

The telephone.—The efforts of inventors were next directed to the transmission by wire of actual sounds and words, to the making of what we know to-day as the telephone. In 1861 a German called Philip Reis discovered the principle of transmission which later developed into the modern telephone, and was able to send musical sounds. His first primitive instrument embodied in its parts such homely articles as the bung of a beer barrel, a knitting needle, a violin, and a piece of German sausage skin.

It was not for several years, however, that the human voice was made to articulate words along the wires. In July, 1875, Graham Bell with the help of a friend first managed to transmit the sounds of human speech. In 1876 he took out a patent for his invention, and the same year showed the instrument at an exhibition at Philadelphia. Bell was extremely disappointed to note in the exhibition hall that very little attention was paid to his instrument, and the judge might have passed it by merely as a strange toy had it not been for the Emperor Pedro II. of Brazil. This royal personage seemed vastly interested in the apparatus, and so Bell, having persuaded him to hold the receiver to his ear, spoke into the further end of the instrument.

"It talks!" cried the astonished Emperor, and almost dropped the receiver in amazement. Bell soon was world famous, and the following year, 1877, saw the installation of many telephones in the United States

of America, the first exchange being set up in Boston, Massachusetts.

In England, the first telephone exchanges were erected in London and Manchester in 1879, but the charges were high and instruments at first were installed only within a four-miles radius of the exchanges. All the early services were operated by private companies such as the Glasgow Telephone Company, and the National Telephone Company, but later when the government allowed telephones to be used over longer distances, these private companies were gradually taken over by the Post Office.

Wireless telegraphy.—Guglielmo Marconi, born of an Italian father and an Irish mother in Bologna in Italy, first conceived the idea of wireless telegraphy, and became "the magician who found a way of transmitting signals from shore to shore and from ship to ship." After some early experiments he was able to transmit wireless messages a distance of a hundred yards, but by a year later he had managed to send them just over ten miles. In 1897, a ship using his apparatus kept up communication with the shore from eighteen miles away, and in 1899 messages were received over a distance of one hundred miles. Early in 1901, he managed to bridge a space of two hundred miles, and in the December of that same year trans-Atlantic wireless signals, sent from Poldhu in Cornwall, were faintly received at St. John's in Newfoundland. Wireless telephony, the actual transmission of the human voice, followed in 1917, and to-day men may speak to their homeland from the ends of the earth.

Wireless telegraphy and telephony have proved to be of inestimable value on ships at sea, and by their use thousands of lives have been saved. National systems of broadcasting have been an exceptional boon to sick and blind persons, and the men and women of this modern world have come to depend upon "the wireless" to a very great extent for their information of everyday happenings, their education, and their entertainment.

GEOGRAPHY

EXTENT AND POSITION OF TELEGRAPH, CABLE AND RADIO TELEGRAPH SERVICES

Rugby Station.—Its equipment and uses.—Rugby contains the largest collection of radio equipment assembled at any station in the world. It is situated in the midlands, and is on the main L.M.S. railway from London to Scotland via Crewe. It is the transmitting station from Great Britain for all the overseas radio-telephone services operated by the British Post Offices, and transmits on long and short waves. Twelve insulated steel masts, each 820 ft. high and each capable of withstanding a wind velocity of 140 miles per hour at the top, support the long-wave aerial system. The wave length is 5,000 metres. Twenty-seven steel lattice towers each support a short-wave aerial and each is constructed for transmission in a certain direction on a definite wavelength. The seven short-wave transmitters can each operate on three or four wave lengths in the 15-60 metre band. Approximately five million units of electricity are used each year. A radio call from Paris to New York is dealt with in some detail below to show how Rugby is utilised by the Continent.

In the case of a call set up on the long-wave radio system, an ordinary telephone line passes the message from Paris to the London trunk switchboard; thence it travels via the London radio terminal at Faraday Building to Rugby, where it is filtered, amplified and then transmitted. The message leaves Rugby several million times stronger than it was when Rugby received it. By the time it has crossed the three thousand miles of the North Atlantic ocean the speech currents are very much weaker than when passed to Rugby from the Paris

line, so on arrival at Houlton (Maine, U.S.A.) the message is again amplified and passed to the American subscriber via the New York radio terminal switchboard. Long- and short-wave systems are used alternately to meet changing atmospheric conditions, and thus maintain continuity of service. Similarly, speech currents from the subscriber in America are passed to the New York radio terminal, thence to Rocky Point (U.S.A.), where they are amplified as in the case of Rugby, and radiated to the receiving station at Cupar in Fifeshire, Scotland.

Radio telephone services to ships.—Rugby transmits private messages to ships out of range of the ordinary coast stations twice a day at definite times. In order to enable captains to check their chronometers Rugby transmits to ships, twice a day, time signals controlled from Greenwich Observatory. News bulletins are transmitted by Rugby and reproduced in the ships' newspapers published on board many vessels. At Portishead (Bristol Channel) the Post Office collects from ships at sea the information on which the Meteorological Office largely bases its forecasts. These forecasts sent out from Rugby are picked up by vessels all over the world. Passengers of the large liners can be connected to subscribers in almost every part of the world by means of the transmitting station at Rugby and the receiving station at Baldock, near London. This service is conducted on short waves, through Cupar and Baldock. Cupar (Fifeshire) and Baldock are receiving stations only. Situations remote from Rugby were chosen, because, in order to prevent interaction between outgoing and incoming speech, the two necessarily follow different paths. Thus Cupar was selected in order to obtain maximum freedom from inter-

ference from atmospheric and unwanted radio signals on the long waves from America. Similarly the short wave services equipment is housed at Baldock. The three radio stations of Rugby, Cupar and Baldock are connected to the overseas telephone exchange in London by underground cables.

The Post Office international telephone exchange is the telephone centre of Great Britain, of the British Empire, and of the greater part of the world. It is situated in London, and from it radiate wire and wireless channels to almost every part of the world. The vast radio telephone network converging on London has been linked up with the large cable system of Europe, so that any subscriber in North America or even Australia can ring up another subscriber in almost any corner of Europe. Radio channels have been opened between Great Britain and Australia, South Africa, Argentine, Brazil, Canada, Egypt, India and Japan, as well as to certain ships on the north Atlantic route. The overseas telephone exchange, established in 1927, has been reconstructed to effect this linking-up of radio telephone services, after first of all providing a channel of communication only between the telephone systems of London and New York. The continental exchange links Great Britain and Ireland with Europe, and is connected to the overseas exchange. There are over one hundred and twenty direct circuits to continental centres, and each country concerned in a call, even if as a transit country, shares in the revenue from that call.

Radio telephone commercial services.—

Twelve coast stations were originally erected for the assistance of navigation, but they are now used more and more for social and business messages. Each station can communicate with ships 300 miles from shore, and in addition Portishead Radio also operates on medium distance (1,500 to 2,000 miles) and long distance (world-wide range) services. Through these the British Post Office handles more than twice as many messages as any other European country.

In 1936, the traffic in all Post Office services was over five million words.

Portishead radio transmitters handle two and a half million words a year, and have communicated with Arctic and Antarctic expeditions, British airships, the Graf Zeppelin in its flights over the south Atlantic, in addition to ships on every sea. These coast stations operate the distress service by which ships sending out S.O.S. (for ships in immediate danger), or XXX (for ships disabled though not in immediate danger), are aided. Ships without a doctor can obtain advice through the coast stations; all language difficulties are overcome by means of a special code. Navigational and meteorological information issued by the Admiralty and Air Ministry are transmitted when necessary. From three to four thousand bearings are given every year by twenty-five radio beacons containing direction finding apparatus. Each beacon has small wireless transmitters working automatically, sending out signals every half hour except in foggy weather, when they operate every six minutes. Passenger ships of 5,000 tons and upwards are now bound by law to carry direction finding apparatus.

Each coast station employs wave lengths of 600–800 metres and 100–200 metres for shorter distances, and 2,000–2,500 metres and 15–50 metres for long distances. All coast stations are connected to the land telegraph and telephone systems, and have at least two operators on duty day and night. An average day's work entails the exchange of messages with over one thousand vessels.

All ships of 1,600 tons gross and over are compelled by law to be fitted with wireless telegraphy equipment, with a range of at least one hundred miles. Over fifteen thousand ships are so fitted and of these four thousand are British. The Post Office, in collaboration with the Board of Trade, inspects the British ships regularly, every ship so equipped being in possession of a certificate of efficiency for its wireless apparatus. In addition, each operator must have a certificate of proficiency before sailing.

Cables.—On the floor of the Straits of Dover is a network of cables connecting the British Isles and the Continent. In order to explain the working of these a typical cable call from London to Rome is explained below.

The switchboards of London and Rome are connected by two pairs of wires, one pair carrying the speech from London to Rome, and the other pair in the reverse direction. The circuit, as it is called, is one thousand three hundred miles long, and weighs about 47 tons; it consists of copper wire insulated with wrappings of paper enclosed in a lead sheath. At every 2,000 yards there is a device known as a loading coil which regulates the flow of current. At every fifty miles is a "Repeater station" which strengthens or amplifies the speech current, which becomes considerably weaker every mile it travels. If it were not for these "Repeater stations," the thickness of copper wire required and the power necessary to transmit the message would be so great as to render the service useless from an engineering and from a commercial point of view. There are twenty-seven such "stations" on the London-Rome circuit; two in England, ten in France, five in Switzerland and ten in Italy. The message is amplified by a valve known as a thermionic valve. The message leaves London after amplification; it reaches Canterbury by underground cables and is then very weak; here it is amplified and carried by another pair of cables to the coast, where it is further amplified, and passes under the English Channel in a submarine cable to Boulogne and thence through France and Switzerland to Italy, being amplified, as stated, at intervals of fifty miles.

Cable ships.—In order to mend the submarine cables two ships, the *Monarch*, and the *Alert* are employed by the Post Office. They fly the Blue Ensign on which is, very appropriately, the figure of Father Time regarding with astonishment his hour glass shattered by an electric spark. These ships

are responsible for the maintenance of two hundred and forty submarine cables with a total length of five thousand miles and containing twenty-five thousand miles of wire. Forty of these cables unite Great Britain with the Continent.

The submarine cables have copper conductors enclosed by paper sheaths, the air between the papers insulating the wires. These are surrounded by a lead sheath, which in turn is wrapped with galvanized armouring wire. The largest submarine telephone cable in the world is that between Great Britain and Belgium, and weighs thirty-three tons per nautical mile. Others, such as those between Scotland and Northern Ireland, and Great Britain and Ireland, weigh much less, from seven to twelve tons per nautical mile.

Laying and repair of cables.—Two or three cables are laid every year after carefully surveying the ocean floor by means of an "echo-sounder" which records the time taken for the sound of a hammer stroke at the bottom of the ship to reach the ocean bed, and be echoed back again. Approximately one hundred repairs are made each year. The "resistance" is measured from shore to a break, the distance of the break from shore varying with this resistance. The cable ship steams to the approximate position of the fault; buoys this position, and then drifts or steams slowly in a zigzag manner with a grapnel trailing. When the cable is found the ship is stopped, the cable hauled and secured by chains. It is then sawn in two and each portion tested by trying to communicate with the shore. The end clear of faults is sealed and buoyed, the fault being traced by the ship steaming slowly along the charted route, meanwhile hauling the faulty section and stowing it in tanks on board until the break appears. It is then mended if not completely broken. If it is completely broken the severed end must be found and then new cable joined on after each section has been tested by attempted communication with the shore.

ART AND CRAFT

Woodwork and metalwork.—The contribution of the woodwork and metalwork rooms to the telephone project depends entirely upon the way in which the actual telephone equipment is developed. In boys' schools and in any school where a telephone system can be built up, the contribution will naturally be greater than in other cases. Therefore, it is appropriate in this article to indicate only the general idea of the part these rooms might play in the project.

The following are verbatim extracts from one school's written record of its telephone project, and consist of notes compiled by the teachers in charge:—

"The part played by the woodwork department in the project was principally in connection with the construction of stands, brackets, casings and tables of various kinds. The wall brackets, with sloping fronts for use when taking notes of a telephone conversation, provided interesting work for second year boys, as did the ornamental base for the set on the headmaster's table. The table in the school hall, built specially to hold the exchange apparatus, was designed and made on the lines of an occasional table by third year boys. The exchange box, approximately 30 in. long and 15 in. wide, was also designed and constructed in oak by thirteen year old boys.

"The bracket supports which carry the wiring round the hall and classrooms are made entirely from scrap material. There are thirty-five such brackets. We found that the co-operation with the metalwork and science departments added greatly to the interest and educational value of the work.

"The contribution of the metalwork shop consisted very largely of the mass production of small metal fittings. In addition, however, the making of various single brackets, switches, and so on provided

interesting and instructive exercises. The equipment of the exchange, with its fourteen separate line connections and complicated switching devices, necessitated the provision of many interchangeable parts, and in the making of these the opportunity was taken to make the boys familiar with modern workshop organisation.

"In some cases simple jigs were constructed and used to ensure accuracy. On one occasion a team of twelve boys manufactured sixty interchangeable parts—contact springs—in just under two hours, under the direction of a captain. It was for them and for the teacher an uncommon and interesting experience. The manufacture of zinc containers for batteries was also useful experience, giving the boys an insight into the processes entailed in the manufacture of simple flashlamp batteries."

Art and Bookcraft.—The telephone project provides opportunities for useful work in drawing, designing and lettering.

Posters to hang round the schoolroom walls can be designed and lettered in varying styles. Such posters might include arresting slogans, such as—

1. KEEP THE CORD FREE OF KNOTS
2. TAKE CARE OF THE TELEPHONE SETS
3. TELEPHONE SETS ARE FRAGILE
4. NEVER SAY "HALLO"
5. IT IS QUICKER BY TELEPHONE

Line blocks can be prepared for illustrating book covers with patterns of telephones, or designs suggesting speed.

Lists of call charges provide good practice in lettering.

Covers for holding telephone directories can be made and illustrated.

INDEX

(Italicised numbers indicate illustrations with or without text.)

BIOLOGY IN THE SENIOR SCHOOL

Appendices	186
Bacteria	140, 143
Birds, Economic Importance	160
Hard-billed	145, 146
Importance to Man	143
Soft-billed	150, 151
Structure	156, 157, 158, 159
Study	143
Blood, Function	104
Breathing in Fishes, Tadpoles and Frogs	88
Man	91, 93
Plants	112
Chick, Development	93, 94, 95
Classification of Animals	76
Plants	184
Course, First Year's	9
Autumn Term	9
Winter-Spring Term	20
Summer Term	49
Course, Second Year's	69
Autumn Term	69
Winter-Spring Term	88
Summer Term	96
Course, Third Year's	118
Autumn Term	118
Winter-Spring Term	140
Summer Term	184
Crayfish	96, 98, 100
Digestion	80
Earthworm, Dissection of	81
Evolution, Adaptability, Heredity	171
Excretion	107
Family and Group Life	169
Feeding Utensils	73
Flesh Feeders	39
Flora, Use of	185
Flower Study	126
Food, How Plants Obtain	28
Movement and Form	69
Plants	18, 118
Young Animals	33
Frog	54, 55
Dissection	82, 83, 84, 85, 86
Function of Living Creatures	161
Fungi	129, 130, 131, 133
Garden Work	9
Geological Record	176, 180, 182
Insects, Water	57, 59, 60
Introduction	3
Jaws, External	73, 74, 76
Laboratory Technique	186
Maize	115, 116

Mammals, Small British	2, 66
Movement	42, 69
Newts	50, 51
Onion	117
Oxygen and Nitrogen Cycles	140
Photosynthesis	118
Plants, Activities in Life	108
Life Histories	62
Pollination and Seed Formation	121, 122
Pond Animals	49
Mussels	100, 104
Practical Work	34, 38, 42, 47, 76, 80, 87, 90, 99, 111, 125, 126, 136
Race Survival	15
Respiration in Plants	112
Soil	26, 133
Syllabus	6
Trees, Distribution and Economic Importance	21, 23, 25
Vegetable Feeders	36
Water Current	28
Wheat	115
Winter, Preparation by	
Animals	9
Preparation by Plants	13
Work	21

DOMESTIC SCIENCE

Acids and Alkalis	322
Air, Chemical Properties	326
Moisture Content	303
Physical Properties	301
Apparatus	283
Balance, Use of the	292
Blood	345, 346
Circulation	346, 347
Cleanliness	349
Course, First Year's	284
Second Year's	305
Third Year's	331
Digestion	339, 341
Excretion	347
Exercise and Rest	350
Flame	318
Food	331, 335
Cooking and digestion	336
Nitrogenous	334
Gas Fire	320
Gases, Expansion	289, 290, 291
Health, Maintenance	342
Heart	344, 345
Heat, Conduction	295, 296
Convection	297, 298, 299
Radiation	299

Heating Methods	300
Housing and Health	351
Hydrogen	312
Incandescence	320
Intestines	340
Introduction	281
Liquid, Expansion	289, 290
Relative Density	294
Lungs	343
Matter, General Properties	284
Metric Scale	292
Milk	335
Oxygen	327
Soda, Borax and Soap	323
Solids, Density	294
Expansion	288, 289
Volume	293
Springs	317
Starch	332, 333
Sugar	333
Syllabus	281
Teeth	338
Thermometer, Use	286
Various Kinds	291
Ventilation	328, 329, 330
Water	305
Hard and Soft	311
Impurities	314
Removing Hardness	311
Solubility of Substances	308, 309
Sources of Supply	315
Wells	317

FIRST AID

Artificial Respiration	464,
.	465, 467
Bandaging	442-448
Bleeding	449
Bruises	452
Burns and Scalds	468, 469
Concussion	462
Dislocation	454
Drowning	464
Electric Shock	470, 471
Fainting	462, 463
Fire	466
Foreign Bodies, Removing	472
Fractures	454
Gas Detection	473
Poisoning	463
Insensibility	462
Introduction	441
Lessons, Suggestions	475
Poisoning	460
Safety First	477

Sprains	454
Stings	452
Sunstroke	463
Wounds	452

HEALTH EDUCATION IN THE SENIOR SCHOOL

Bacteria	377
Beverages	383
Blood	374
Bones	367
Celebrations	438
Cleanliness	378, 388
Clothing	386
Contents of Course	359
Course, First Year's	363
Second Year's	379
Third Year's	396
Diseases, Infectious	399
Ear	394, 395
Excretion	378, 379
Eye	392
Family, The	379
First Aid	397
Foods	376, 379, 383
Framework, Man's	365, 366
Glands and Hormones	407, 408
Growth	364
Heat Balance	384
Heredity	400
Individual, The	365
Infant Welfare	495
Introduction	355
Joints	366, 367
Lessons in Detail	410
Lungs	372
Messages sent round the	
Body	388
Movement	364
Muscles	368, 369
Oxygen	370
Plants and Animals, Functions and Structure	363
Race, The	396
Rest and Sleep	395
Safety First	398
State Co-operation	405
Syllabus	362
Teeth	377, 378

Ventilation	384
Vitamins	380

LESSONS IN DETAIL

FIRST YEAR:	
Bones and Joints	411
Food	413
SECOND YEAR:	
Food	417
Materials for Clothing	420
THIRD YEAR:	
Charts and Graphs	424
Everybody's Fight against	
Infection	430
Food	436
Value of a Healthy Outlook	433

HOME NURSING

Basic Principles	481
Bathing	497
Bed and Bedmaking	484
Children, Nursing	512
Cleanliness	497
Convalescence	506
Diet	490
Diseases, Infectious	507
Drinks, Recipes	494
Introduction	481
Medicinal Treatment	500
Medicines, Administering	504
Night Care	488
Pulse	502
Quietness	483
Rest	482
Routine	486
Sick Room	482
Temperature, Room	488
Taking the	501, 502
Treatments, Common Nursing	507
Ventilation	490

SCIENCE TEACHING IN THE SENIOR SCHOOL

Appendix	277
Bicycle	216
Speed Possible	222
Coal Fire	206
Energy, How a Bicycle Saves	217
Eye	248
Appliances which Help	274
How It Works	260, 262
What it Does	248
What it Fails to do	253
Geyser	213, 214
Heating	205
Hot Water System	209, 210, 211
Introduction	195
Lamp, Bicycle	231
Matches	207
Syllabus, Planning	197
Teaching Method	200
Tyres, Inflated	226, 227
Vacuum Flask	214
TELEPHONE PROJECT, THE	
Apparatus	515
Arithmetic	526
Art and Craft	536
Cables	535
Exchange	525
Geography	533
History	528
Installations	518, 519, 520
Introduction	515
Mathematics	526
Microphone	521, 522
Transformer	524
Radio Telephone	533
Receiver	522, 523
Rugby Station	533
Scale Drawing	526
Science	517
Signals, Fire and Smoke	528
Switches	524, 525
System, Telephone	518
Telegraph, Admiralty	528
Electric	529
Wireless Telegraphy	532

DATE OF ISSUE

This book must be returned within 3, 7, 14 days of its issue. A fine of ONE ANNA per day will be charged if the book is overdue.

--	--	--	--	--

