

Birla Central Library

PILANI (Jaipur State)
Engg College Branch

TA

Class No :- 625.71
Book No :- H252 H V.2
Accession No :- 32160

Page
1698
823

6-9
796

	310
	348, 786
Pavements.....	65, 1125
Ry. Crossing Eliminations.....	648

SURVEY DATA

Adjustment of Instruments.....	852
Radii of Curves.....	855
Tangents and Externals 1° Curve.....	858
Stadia Reduction Table.....	844

ESTIMATE AND DESIGN DATA

REQUEST

IT IS EARNESTLY DES'RD THAT THE BOOK
BE HANDLED WITH CARE AND BE NOT MARKED,
UNDERLINED OR DISFIGURED IN ANY OTHER WAY.
OTHERWISE IT WILL HAVE TO BE REPLACED OR
PAID FOR BY THE BORROWER IN THE INTEREST OF
THE LIBRARY.

LIBRARIAN.

ESTIMATE AND DESIGN DATA (Continued)

	Page
Pavement Widths, Crowns and Banking.....	950-958
Pavement Thickness Different Soils and Traffic....	959-961
Typical Sections.....	951-955
Safe Structural Loads	
Concrete Beams and Slabs.....	1072-1075
Steel Beams.....	1062-1067
Timber Beams and Columns.....	1076-1078
Structural Design Data.....	1026
Dimensions and Weights	
Pipes (All Kinds).....	1079-1084
Steel Bars and I Beams.....	1061-1067
Expanded Metal and Wire Mesh.....	1054-1060
Stone and Sand.....	1180-1182
Quantities	
Table of Sq. Yds. Different Widths.....	1089
Table of Cu. Yds. Different Widths and Depths..	1089
Cost Estimates.....	1125

CONSTRUCTION DATA

Safe Pile Loads (Driving Formulæ).....	1338
Safe Foundation Soil Loads.....	1051
Bridge Construction Joint Practice.....	1357
Output of Concrete Mixers (Speed).....	1277
Stringlining Curves (Form Setting).....	1301
Depths of Pavements Required for Different Soils..	959-961
Depths of Pavements Required over Trenches.....	417
Amounts of Material Required per Cu. Yd.	
Cement Concrete.....	1092
Macadam Pavements.....	1130-1142
Gravel Pavements.....	1139

**HANDBOOK FOR
HIGHWAY ENGINEERS**

**VOLUME II
FIELD AND OFFICE DATA**

OTHER BOOKS

BY

W. G. HARGER

RURAL HIGHWAY PAVEMENTS

613 pages, 6 × 9, 213 Illustrations.

**LOCATION, GRADING AND DRAINAGE OF
HIGHWAYS**

294 pages, 6 × 9, 134 Illustrations.

HANDBOOK
FOR
HIGHWAY ENGINEERS

**CONTAINING INFORMATION ORDINARILY USED
IN THE DESIGN AND CONSTRUCTION
OF RURAL HIGHWAYS**

VOLUME II
FIELD AND OFFICE DATA

BY
WILSON G. HARGER, C. E.
AND
EDMUND A. BONNEY
FORMERLY SUPERVISING ENG., N. Y. STATE DEPT. OF HIGHWAYS

FOURTH EDITION
ENTIRELY REVISED AND ENLARGED
EIGHTH IMPRESSION

McGRAW-HILL BOOK COMPANY, INC.
NEW YORK AND LONDON
1927

COPYRIGHT, 1912, 1916, 1919, 1927, BY THE
MCGRAW-HILL BOOK COMPANY, INC.

PRINTED IN THE UNITED STATES OF AMERICA

THE MAPLE PRESS COMPANY, YORK, PA.

CONTENTS OF VOLUME I

PRINCIPLES AND PRACTICE

	PAGE
CHAPTER I. GENERAL ADMINISTRATIVE, ECONOMIC AND ENGINEERING DATA.	1-73
CHAPTER II. LOCATION, GRADES AND ALIGNMENT	74-121
CHAPTER III. SECTIONS, PAVEMENT WIDTHS, RIGHT OF WAY AND CLEARING.	122-179
CHAPTER IV. DRAINAGE—CULVERTS, BRIDGES, DITCHES UNDERDRAINS AND STORM SEWERS.	180-341
CHAPTER V. EARTH, SAND-CLAY, GRAVEL AND MISCELLANEOUS LOW TYPE ROADS	342-365
CHAPTER VI. MACADAM AND RIGID PAVEMENTS	366-518
CHAPTER VII. MAINTENANCE	519-578
CHAPTER VIII. RECONSTRUCTION	579-598
CHAPTER IX. THE PROTECTION AND ELIMINATION OF RAILROAD GRADE CROSSINGS.	599-675
CHAPTER X. MINOR POINTS OF DESIGN.	676-704
CHAPTER XI. MATERIALS.	705-746

CONTENTS OF VOLUME II

FIELD AND OFFICE DATA

General discussion.	747-748
CHAPTER XII. PRELIMINARY INVESTIGATIONS.	749-830
<i>Introduction</i>	749
<i>High Type Road Investigations in Well Settled Districts</i>	749-781
Probable traffic.	750
General location.	750
Local materials and sampling.	750-757
Cost estimates	756-769
Typical reports.	769-781
<i>Pioneer Roads in Unsettled Districts</i>	781-816
Field work.	781-783

	PAGE
Quantity estimates	783-798
Cost estimates	783-798
Miscellaneous data	796-807
Typical report	807-816
<i>Reconnaissance Surveys.</i>	816-818
Equipment.	816
Methods.	816-817
Cost.	817
<i>Photographic Data</i>	818-830
CHAPTER XIII. SURVEYS.	831-942
<i>High Type Roads (Improvement of Existing Roads)</i>	
Center line.	831
Levels and cross sections.	833
Drainage.	835
Topography	836
Traffic reports	837
Foundation soils	838
Location and character of materials	839
Right of way.	840
Stadia reduction tables.	844
Diversion lines	852
Adjustment of instruments.	852
Curve tables and formulae	854
Examples of curve problems	885-892
<i>Pioneer Roads (New Location)</i>	
Cost and organization	892
Equipment.	893
Locating line	904
Base line.	905
Levels and cross sections.	906
Drainage.	911
Topography	911
Materials.	911
Survey report.	912
<i>Meridian Determination</i>	
By polaris	912-927
By direct solar	927
Stadia work	932
Bridge surveys	940-942
CHAPTER XIV. OFFICE PRACTICE	943-1115
<i>For the Improvement of Existing Roads (High Types).</i>	<i>943-1100</i>
<i>Mapping the Preliminary Survey</i>	
Scales	944
Plotting center line	944
Table of sight distances	945
Plotting topography.	946
Bench level computations	946
Cross-section level computations	946

	PAGE
Plotting cross-sections.	947
Plotting profile	947
<i>The Design</i>	
Maximum grades different pavements.	949
Alignment restrictions.	950
Typical sections.	950-956
Pavement design	958-962
Templets.	962
Economical grade line design.	963
Vertical curves	964-969
Formulae.	966
Sight distance.	965
Radii for plotting.	968
Planimeter work	969-971
Methods.	969
Accuracy.	970
Substitute method	970
Computation of earthwork (tables)	971-994
Shrinkage of earthwork	995
Overhaul.	996
Mass diagram.	997
Structural design tables	1004-1087
Structural plans.	1006
Tables of quantities (stone, macadam, oil, sq. yards of pavement, etc.).	1087-1094
Right of way computations.	1093
Sample final design report	1095
Record maps and plans	1100
<i>(b) Office Practice for Pioneer Road Design</i>	
General methods (graphic or analytic).	1102
Drafting room instructions.	1103
Drafting room supplies.	1103
Detail design instructions	1103
Reasonable speed of design.	1104
Reasonable cost of design	1104
Detail manipulation (organization and meth- ods).	1105
Progress report	1113
Sample estimate forms.	1115
CHAPTER XV. COST DATA	1119-1266
<i>Introduction</i>	<i>1119</i>
<i>Fluctuation in Price Level 1874-1924.</i>	<i>1119-1124</i>
<i>Typical Cost Estimate Forms</i>	<i>1125</i>
<i>Roadway Excavation</i>	
Earth excavation (rough grading)	
Steam shovel.	1126
Scrapers.	1127
Hand and teams	1127
Rock excavation	1127
Overhaul.	1127

	PAGE
Trimming fine grade for pavement	1127
Trimming shoulders and ditches.	1127
<i>Production of Local Materials</i>	
Crushed stone	1130
Screened gravel and sand.	1131
Washed gravel and sand.	1132
<i>Hauling</i>	
Schedule of costs	1128
<i>Pavement Estimates</i>	
<i>Foundation Courses (Sub Base)</i>	
Gravel.	1134
Boulder or quarry stone	1132
<i>Bottom Courses</i>	
Gravel.	1134
Boulder	1133
Macadam	1134
Bituminous concrete (black base).	1138
Portland cement concrete	1138
<i>Surface Courses</i>	
Gravel.	1139
Waterbound macadam	1140
Bituminous macadam	1141
Bituminous concrete.	1142
Cement concrete	1144
Brick	1146
Stone block.	1147
<i>Culverts and Sewers</i>	1148
<i>Small Span Bridges</i>	1150
<i>Incidental Items.</i>	1156
DETAIL COST DATA AND AMOUNTS OF MATERIALS	
<i>Excavation (Roadway)</i>	
Earth	1156
Rock	1159
<i>Unloading Materials from Cars and Boats</i>	
Stone	1159
Sand.	1161
Cement	1161
Steel.	1161
<i>Loading Fence Stone to Wagons</i>	1161
<i>Hauling Costs.</i>	1161
<i>Pavement Work</i>	
Spreading stone.	1167
Spreading filler	1168
Spreading screenings	1168
Spreading bituminous binder	1169
Rolling and puddling	1171
Crushing stone	1172
Weights of crushed stone, sand and gravel.	1182
Stone fill bottom course	1182
Boulder sub base	1183
Kentucky rock asphalt	1183

CONTENTS

ix

	PAGE
McClintock cube pavement.	1183
Amiesite surface.	1185
Bituminous concrete (Topeka)	1187
Hassam concrete	1194
Portland cement concrete pavements	1194
Asphalt block pavement	1208
Brick pavement.	1210
<i>Incidental Items</i>	
Guide rail	1216
Cobble gutter.	1217
Concrete shoulders	1217
<i>Pavement Maintenance</i>	
Scarifying and resurfacing	1218
Oiling	1220
Calcium chloride	1220
<i>Culverts and Bridges</i>	
Culvert construction	1226
Small bridges construction	1227
Piles.	1228
Bridge maintenance	1231
Painting.	1231-1237
Reflooring	1231
<i>Equipment and Overhead Charges</i>	
Interest on payroll and material bills	1231-1238
Bonds and liability insurance.	1238
Equipment	
Introduction	1243
Interest, depreciation and repairs on equip- ment	1253
Typical lists of equipment and costs.	1261
<i>Range in Bid Prices. Ordinary Items (1926)</i>	
Western N. Y.	1268
New Jersey.	1266
Idaho, etc.—See chapter XII, page	765
CHAPTER XVI. NOTES ON CONSTRUCTION 1271-1368	
Introduction	1271
Duties and limitation of authority inspectors and engineers.	1271
Staking out for construction	1272
Culverts.	1273
Pipe.	1273
Concrete.	1275
Rough grading	1288
Fine grading	1290
Sub base.	1291
Macadam bottom stone	1293
Gravel sub base and bottom	1295
Waterbound macadam top.	1295
Penetration bituminous macadam.	1296
Portland cement concrete pavements	1299

	PAGE
Bituminous concretes	1313-1330
Brick pavement.	1330
Bridges	
Staking out.	1334
Bearing power of soils	1337
Test piles	
Actual test loads	1337
Formulae safe loads.	1338
Forms and falsework.	1343
Concrete masonry.	1357
Piles driving	1362
Steel superstructures.	1368

PART III

<i>Specifications.</i>	1371-1572
General outline.	1371-1382
Materials of construction.	1382-1420
Construction methods	
Grading	1420-1424
Pavements.	1424-1492
Bridges and culverts.	1492-1572
Design specifications bridges	1545-1563

PART IV

General Tables and Formulae

Conversion tables	
Linear units	1573
Square units	1573
Volume units.	1573
Weight units	1573
Temperature units.	1573
Inches to feet.	1574
Areas and volumes	1576
Trigometric formulae	1578
Squares and cubes.	1580
Square and cube roots.	1580
Areas and circumferences (circles).	1580
Tables of natural functions	
Tangents and co-tangents	1593
Sines and co-sines.	1604
Secants and cosecants	1616
Logarithmic numbers	1628
Logarithmic sines, cosines, etc.	1653

Appendix A

First aid (accidents).	1698
--------------------------------	------

INDEX. Complete Index for VOLUMES I and II follows page 1722.

PART II

DETAIL DATA FOR SURVEYS-DESIGN AND CONSTRUCTION

Introduction.—Part II takes up a discussion of detail methods of survey, design, estimating, and construction. The essential general attitude in regard to detail methods which must be continually borne in mind and impressed on the engineering force can be briefly summarized as follows:

The survey work must be *accurate and complete*, as it provides the fundamental information for the design and the accurate estimate and measurement of quantities. Satisfactory survey work will range in cost from \$100 to \$400¹ per mile and any effort to cut cost below that required for excellent work is very short-sighted policy. Careless work is often done in order to cut the apparent cost of engineering, but it generally adds to the final total cost and is unsatisfactory to both engineers and contractors.

Effective design is based on the principle of the preparation of *alternate comparative designs* in order to pick the most suitable or economical solution. By the use of this method of alternate designs a good engineer will reduce construction costs at least 10 to 20% below that obtained by the usual stereotyped application of standards with little thought to the local problem. First-class office design costs from \$150 to \$400 per mile and any effort to cut this cost below the amount required for thorough design is poor economy, as the authors know from an experience of over 20 years. Small bridge surveys and design will cost from $\frac{2}{3}$ to 2% of the cost of the structure for careful and economical design.

Estimates of quantities should be liberal in order to avoid the necessity of supplementary agreements during the progress of construction, but in order not to mislead the contractor in making his bid it is necessary for the estimates to show the probable minimum amount for each item, with a statement of the amount allowed for contingencies (see pp. 1011 and 1088). *Cost estimates should be fairly liberal.* They should never be below an amount which will insure reasonable profit with ordinary favorable luck. This matter of cost is very important, as a poor contract price is almost certain to result in inferior work, even with good inspection control.

The essential of construction inspection is insistence on *good quality of work without needless interference with the contractor's choice of methods.* Construction practice is the most essential part of successful highway programs and is generally the poorest managed part of the engineering program. This is largely due to

¹ Average cost of surveys and plans for Kentucky state roads in 1923 was \$287 per mile.

the policy of low pay for field engineers and inspectors. Under this general policy it is impossible to get high-grade men who will give the work their entire undivided attention. Low-grade men are no match for high-grade contractors or even well-paid foremen, and the results are often not very creditable to the inspection force. Effective supervision of construction costs from \$600 to \$1000 per mile and any effort to cut cost on the score of engineering pay-roll economy is political bunkum and very poor economic policy.

Lack of thoroughness and care is a common trait which often shows in extreme form in public works programs. It is most certainly desirable to combat this tendency, which is very well illustrated by the anecdote of the American tourist in Spain, who on hearing that it had taken 500 years to build a famous cathedral remarked, "Well in God's country where I come from we could build one of those things and have it fall down on us all inside of 5 years."

CHAPTER XII

PRELIMINARY INVESTIGATIONS

Introduction.—The object of all preliminary investigations for any type of engineering improvement is to secure basic data on which a reasonable program or detailed design can be worked out.

Preliminary investigations are the most important part of the engineering program, as they set the broad general plan. They should be thoroughly done by the most experienced engineers available, whose judgment has been developed by extended experience with the general conditions to be met. Too often this part of the engineering program is carelessly done due to hesitation in spending money before a project is assumed, but this policy is very short sighted, as it often results in excessive expenditure for detailed surveys of alternate routes and for irrational pavement and bridge designs.

Cost of Preliminary Investigations.—The cost of first-class investigations of this kind ranges from \$5 to \$80 per mile, depending on the country to be traversed. A cost of \$5 to \$15 per mile is a fair average for long mountain road projects similar in character to the road work done by the U. S. Office of Public Roads in the West, and a cost of \$10 to \$20 per mile for high-type road reports in the eastern states. Reconnaissance location surveys in heavily timbered pioneer territory may cost as high as \$50 to \$70 per mile.

The field work and reports deal with the following main features:

1. Probable traffic.
2. General location.
3. Construction materials.
4. Special problems.
5. Cost estimate of alternate types.
6. Report.

HIGH-TYPE ROAD INVESTIGATIONS IN WELL-SETTLED DISTRICTS

The improvement generally consists of betterments to an existing road, the location of which is in most cases fixed by existing rights of way except for short relocations. The choice of which road to improve is made by local boards or the State Highway Commissioner so that when the problem reaches the field engineer his work is usually confined to a definite report on a definite road, although in some cases where there is a dispute as to the relative merits of alternate routes it is necessary to investigate two or more possible routes.

1. **Probable Traffic.**—The probable present and future traffic governs reasonable recommendations as to alignment, grade and type and width of pavement. For principles and methods of estimating traffic, present and future see pages 28 to 33; for reasonable type and width of pavement, pages 6 to 9; for reasonable alignment, pages 113 to 121; for maximum grades, pages 74 to 113; for roadway section, pages 122 to 179; and for maximum allowable expenditure, pages 1 to 16.

2. **General Location.**—The principles of relocation are detailed in pages 74 to 83.

3. **Construction Materials** (*Field Work*).—The investigation for local material is very important. Careless work in this particular results in specifying impracticable or needlessly expensive sources of supply for materials and often in the selection of an unreasonable type of construction. A careless estimate of the quantity of available local material also causes trouble during construction by a shortage in supply.

It is important not only to determine the amount of local material but also its character, as, for example, a local gravel may be suitable for a first-class bottom for macadam construction but not suitable for a concrete pavement, or it may be suitable for a concrete paving base but not for a concrete road taking the traffic directly. A local hard sandstone may be suitable when bound with bitumen and would not act well if water bound with its own screenings, etc. The necessary properties of stones, gravels, sands, etc., are given in the chapter on Materials, and in Specifications.

Any preliminary report should cover the sources of supply and approximate cost at pit or switch of the following materials:

Gravels, suitable for:

- Bottom courses
- Top courses
- Structural concrete
- First-class concrete pavement
- Concrete paving base
- Subbase filler.

Stone, slag, etc., suitable for:

- Subbase
- Bottom course
- Water-bound macadam top
- Bituminous macadam pavement
- First-class concrete pavement
- Concrete paving base
- Structural concrete.

Sand suitable for:

- Bottom-course filler
- Cushion sand
- Structural concrete sand
- First-class concrete paving sand
- Fine and coarse sand for sheet asphalt.

Miscellaneous:

- Bitumens
- Tars
- Paving brick
- Stone block
- Asphalt block
- Wood block
- Stone or brick cubes.

Water supply, location and quality.

A convenient method of recording the location of materials is as follows:

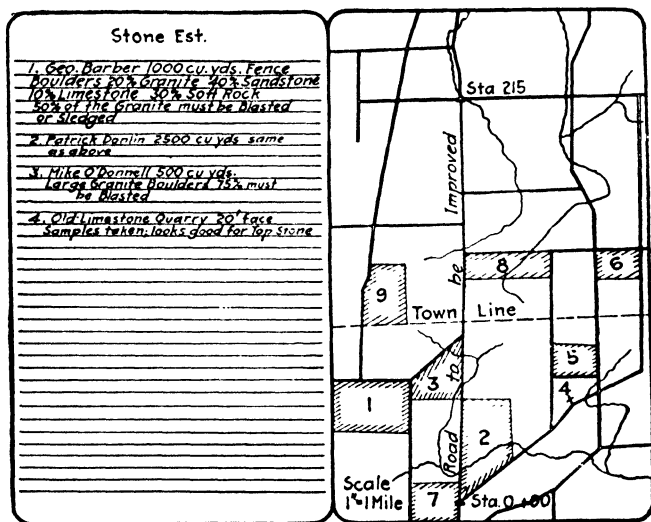

FIG. 258.

Unloading Points for Freight.—Provided U. S. geological maps are obtainable, the position of sidings may be marked on the sheets. The notes for each siding show its car capacity, whether or not an elevator plant can be erected, and, if hand unloading is necessary, whether teams can approach from one side or two. They should also show any coal trestle that can be utilized in unloading and the location and probable cost of any new sidings that will materially reduce the length of the haul. Canal or river unloading points are shown in the same manner.

Sand, Gravel, and Filler Material.—The position of sand and gravel pits and filler material are noted with their cost at the pit; if no

local material is available, the cost, f.o.b. at the nearest siding, is given. Samples are taken and tests made.

Stone Supply.—Provided imported stone is to be used, the work is simplified to determining the rate, f.o.b., to the various sidings for the product of the nearest commercial stone-crushing plant that produces a proper grade of stone.

In case local stone is available, the location of quarries or outcrops is shown, the amount of stripping, if any, and the cost of quarry rights. If the estimate will depend upon rock owned by a single person, an option is obtained to prevent an exorbitant raise in price.

In case of field or fence stone, a careful estimate is made of the number of yards of boulder stone available, the owners' names, what they will charge for it, the position of the fences or piles relative to the road, or side roads, and, if the fences are not abutting on a road or lane, the length of haul through fields to the nearest road or lane. As fences are usually a mixture of different kinds of rock, the engineer estimates the percentage of granite, limestone, sandstone, etc., and the percentage that will have to be blasted or sledged in order to be crushed by an ordinary portable crusher. The amount of field stone required per cubic yard of macadam is given in estimates (p. 1172). If there is a large excess of stone, a careful estimate need not be made, only enough data being collected to determine the probable position of the crusher set-ups and the average haul to each set-up. If a sufficient supply is doubtful, a close estimate is made as outlined above, and options obtained from the various owners.

Samples of the different rocks are tested (see Materials).

Simple field tests can be made, but if the department has a testing laboratory it is better to take samples and have a careful test made and recorded. As these tests are made, the location of the sample and result of the tests are recorded on a large map of the district, which in the course of a few years shows at a glance the different sources of supply of acceptable materials for the entire county or state and saves future duplication of work for reconstruction, maintenance, and adjacent improvements.

The method of sampling and the amounts of material required for a good test are quoted below from the New York State Instructions for Sampling Materials.

"Sampling.—Amounts of material required for laboratory tests are as follows:

"Samples of material will be taken by a duly authorized employee of the department, in its place of occurrence or manufacture or delivery by carrier. These samples must be taken from different parts of the lot of material to be tested, so as to be fairly representative, and must be unmixed with foreign substances and placed in clean and safe receptacles; and they must conform in all respects to the requirements given under the special headings. They must be carefully and securely packed, enclosing notification slip properly protected from wear and injury, and sent express "collect" to the Bureau of Tests, State Highway Commission, Albany, N. Y., a postal card notice being mailed at the same time. Envelopes, scoops, cans, thermometers, etc. for use in taking the samples may be had from the Bureau of Finance and Audit at Albany.

"In the case of materials sampled at the place of manufacture, check samples may be required; these are to be taken and treated the same as ordinary samples, except that the packages must be marked Check Samples,

and the use of the material need not be prohibited pending the results of the check tests.

"Sand and Gravel.—The character of the supply, whether from stream bed, bank, crusher bins, etc., is to be stated; also the use for which it is intended, whether for concrete foundations or other structures, binder for water-bound macadam, filler or wearing carpet or blotter for bituminous macadam, or for aggregate in water-bound or bituminous macadam, etc.

"Material which will all pass through a $\frac{1}{4}$ " screen will be considered sand. Each sample of sand or screenings shall be $\frac{3}{4}$ cu. ft. in volume; of gravel, $1\frac{1}{2}$ cu. ft.

"A small sample shall be taken from each test sample sent, and be kept on the contract as a measure of the quality of material.

"Each sample is to be shipped in a tight box or in a clean, closely woven bag from which there will be no leakage; the usual identification slip is to be enclosed. In numbering samples, sand and gravel are to be treated as one material, not as two.

"Notification of acceptance or rejection may be expected to arrive at the division office 20 days after the submission of the samples and data, provided the need of a retest does not cause delay.

"Cement.—One sample is to be taken from at least every 10 bbl. or every 40 bags, care being taken properly to distribute the sampling over the lot. Each sample shall be not less than 27 cu. in. in volume, or enough to fill a 3" cube. Whenever possible, samples should be forwarded in envelopes furnished by the Commission for that purpose, the envelopes being filled to the line marked thereon.

"The individual samples are not to be numbered, but each group or lot of these samples representing a single boatload or carload is to be given a lot number, and these lot numbers are to run consecutively. Not more than one boatload or carload is to be represented by one lot number.

"Receipt of notification of acceptance or rejection of cement sampled at destination may be expected to arrive at the division engineer's office 12 days after the submission of the samples and data. If cement is held for 28-day tests the division engineer will be notified accordingly.

"Concrete.—The concrete on each highway must be sampled for testing, the samples being taken at random from the batches used and being molded at the place and time of mixing. The work need not be delayed pending the results of the tests.

"Each sample shall be a pair of cubes measuring 6" on the edge, or of cylinders 8" in diameter and 16" long; the sample is to be made in such manner as fairly to represent the concrete going into the structure. At least one sample is to be taken, and as many more as seem to be required by changes in the character of any ingredient or by any other consideration.

"In concrete pavement work (whether foundation or top course) one pair of cubes or cylinders should be sent for every 500 cu. yd. Not less than two pairs are to be sent, however small the pavement.

"The sample must remain in the mold 2 days, then be buried in clean sand to age under the same conditions as the material in the structure. On the twenty-first day the samples shall be taken out and shipped.

"Each sample is to have its number painted on each piece, and is to be shipped in a box, properly protected from breakage and surface chipping, accompanied by the usual included identification and the postal notification. Especially must the class of concrete, the purpose for which it is used (kind of structure and portion), and the date and time of day when sample was mixed be stated.

"Bituminous Material.—When material is shipped in barrels, one sample is to be taken for every 20 or 25 bbl., the sampling being properly distributed over the lot.

"When material is shipped in tank cars one sample is to be taken from every 2000 or 2500 gal., the samples being taken from equally distributed levels in the car.

"When material bitumen is shipped in loose bulk, one sample is to be taken for every 5 or 6 tons, the samples being taken from different levels and different locations in the lot and never from the surface of the material.

"Each sample shall be not less than 14 cu. in. in volume, which volume is slightly less than $\frac{1}{2}$ pt. or about the size of a 1-lb. paint can.

"It should be remembered that the bituminous material will flow at summer temperature or thereabouts, and consequently great care should be used in sealing cans and doing up packages. Whenever possible, samples should be forwarded in cans furnished by the Commission for that purpose.

"The individual samples are not to be numbered, but each group or lot representing a single boatload or carload is to be given a lot number, and these lot numbers are to run consecutively; not more than one boatload or carload of material is to be represented by one lot number.

"In order to check the weighing and marking of bituminous material shipped in barrels, one unopened barrel out of every carload of approximately 65 bbl., or a proportionate number of barrels for each boatload, is to be selected at random and weighed. The gross weight found, and the gross weight marked on the barrel, are to be entered on the Monthly Bituminous Material Reports or the information may be recorded elsewhere and submitted to the Bureau of Tests. Any noticeable difference between the gallonage marked on a barrel and the gallonage found therein must be reported to the Headquarters office at Albany.

"The unit of measure for bituminous material is the gallon measured at the temperature of 60°F. If the volume of material is measured when hot, allowance should be made for expansion according to the following table, which will apply approximately to all of the different classes of bituminous material at present used on the state highways:

"Increase in volume of various classes of bituminous material when heated from 60°F.

To 400°F. is approximately	12 %
To 350°F. is approximately	10 %
To 300°F. is approximately	8 %
To 250°F. is approximately	6 %
To 200°F. is approximately	4 %
To 150°F. is approximately	2 %

"**Stone.**—Rotten or partially disintegrated stone, or weathered specimens from the surface of a quarry or ledge, are not to be submitted.

"Samples of quarry or ledge stone must be representative of the sound, fresh, interior stone of the ledge or quarry. Such samples may be secured either by blasting or by breaking up with the sledge. If all material is of the same variety, texture, etc., one sample will suffice. If, however, there are different varieties, separate samples are to be taken of each and report made as to the extent, giving details as to location and position for use.

"All field stone, whether in walls, piles, or scattered over the ground, which might be used must be examined and a representative sample taken. When two or more varieties of great difference in quality or texture are observed to exist, separate samples are to be taken of each, and report made as to the percentage of each kind, the amount of small stone which might run through the crusher without action, and the percentage of disintegrated or badly weathered rock present.

"In taking samples from the output of crushers, 15 lb. of crushed material not smaller than 1½" in size shall be taken, and also one piece at least 3 by 4 by 5" shall be procured from the source of supply.

"Each sample shall weigh not less than 25 nor more than 35 lb. If the entire sample submitted is a single piece of stone, it should be remembered that a piece about the size of a man's head will weigh 25 or 30 lb. While not less than 25 lb. are absolutely necessary in each sample, care should be taken to see that the samples do not weigh over 35 lb. One piece of each sample shall be at least 3 by 4 by 5".

"Each sample is to be given a number running consecutively in each division. This number must contain both the division number and the sample number; thus, sample 42 from division 1 would be marked 1-42. Paint or Higgins' drawing ink may be used to mark directly on the sample, or a label or tag may be securely fastened thereto.

"Samples may be shipped in boxes, burlap, grain bags, cement bags, etc. It is preferred that stone be shipped in a strong bag or in a double bag which may be formed by placing one bag inside of another. If shipping in a single bag which the sample only partially fills, the bag should be securely tied just above the sample and the remaining unfilled part of the bag folded back so as completely to envelop the stone and the portion of the bag containing it; this folded-back part should then be securely tied on the other side of the sample; this makes a tying of the bag on two sides of the stone and permits two thicknesses of the bag to surround the stone completely, and if securely tied is as satisfactory as a double bag.

"Receipt of notification of acceptance or rejection of stone may be expected to arrive at the division engineer's office 12 days after the submission of the samples and data, provided acceptance or rejection is not deferred awaiting a retest.

"The location of source of supply is to be expressed by an index number according to the system used in the government office at Washington, which is, that each quadrangle of the U. S. Geological Survey sheet is divided into nine sections numbered from 1 to 9, inclusive, as shown in the following plan:

1	2	3
4	5	6
7	8	9

FIG. 259.

1	2	3
4	5	6
7	8	9

"The north and south sides of each section are then divided into 22 spaces designated from A to V and the east and west sides into 32, so that the location of the stone may be closely defined, as, for example, Quadrangle Albany, Section 7, Letter J, Number 13, which when abbreviated would read 'Albany-7-J-13.'

"*Paving Brick.*—A sufficient number of samples in every case is to be taken to insure the use of brick of proper quality, but it should also be borne in mind that the charges for transportation and testing of brick are high, and only the smallest number of samples necessary for the purpose should be submitted. At least one sample is to be taken from every 200,000 brick or less. Each sample shall consist of 30 bricks.

"If in a shipment or several shipments of the same make and kind of brick there appear to be different classes of brick—such as brick of different degrees of burning, for example—a full sample of each class is to be taken.

"Each brick selected for the sample is to be free from cracks or other defects which would prevent its passing inspection at the road, for the sample must represent bricks which will not be culled out. Especially is it forbidden that any person financially interested in the manufacture or use of brick be present when samples are taken.

"Each sample (consisting of 30 bricks) shall receive a number, the numbers to run consecutively for each road.

"The sample shall be shipped in wooden boxes, not more than 10 or 12 bricks being put in one box on account of weight and strength of package.

"Notification of acceptance or rejection of brick sampled at destination may be expected to arrive at the division engineer's office 9 days after the submission of samples and data, providing the need of a retest does not cause delay.

"*Asphalt Block.*—A sufficient number of samples in every case is to be taken to insure the use of block of proper quality, but it should also be borne in mind that transportation and testing costs are high, and only the smallest number of samples necessary should be submitted. At least one sample is to be taken from every 100,000 blocks or less. Each sample shall consist of two blocks.

"If in a shipment or several shipments of the same make and kind of block there appear to be different classes of block, a full sample of each class is to be taken.

"Each block selected for the sample is to be free from every defect that would prevent its passing inspection at the road, for the sample must represent blocks which will not be culled out.

"Each sample (consisting of two blocks) shall receive a number, the numbers to run consecutively for each road.

"The sample shall be shipped in a wooden box, with usual identification card and postal notice.

"Notification of acceptance or rejection of block sampled at destination may be expected to reach the division engineer's office 14 days after submission of samples and data, provide the need of a retest does not cause delay.

"*Field Sampling Steel Reinforcement.*—Two bars 18" long for each 10 tons used. Two longitudinal and two transverse wires 18" long for each 10 tons mesh used. Structural steel (plant inspection tests).

"*Acceptance.*—Upon completion of the testing of any set of samples the division engineer is notified of the acceptance or rejection of the material, and transmits the statement to the engineer in charge of the contract."

SAMPLE MATERIAL REPORT

MEMORANDUM LOCAL MATERIALS SURVEY FOR THE RUSH-MENDON PART 1, ROAD 1392

Made by W. G. Harger, December, 1920 and January, 1921

"Previous investigations covered the availability of local materials for a concrete pavement. This survey considers the availability of local materials for possible macadam construction.

"In 1916, F. C. Koerner made a field estimate of local fence stone and gravel. The result of the new survey (W. G. Harger, 1920) indicates that Mr. Koerner's estimate as to available materials was very thorough, and that his quantities were conservative estimates.

"The main features of the situation are as follows: There is sufficient fence stone and gravel in the territory to construct a local stone macadam road. The farmers, with the exception of Mr. Corcoran No. 8, and part of No. 25, are all willing to give their walls and piles for use on this road, *provided the bottoms are cleaned up thoroughly*. The stone runs about 60% granite or Medina sandstone boulders, fit for top course, and 40% fit for subbase bottom. All stone is fit for subbase bottom, but about 30% of it is too large for economic use in a boulder bottom. About 70% of the stone as a whole can be economically used for subbase bottom with a moderate amount of sledging. The other 30% can most economically be used as crushed top course.

"Considering all the factors, it is probable, if macadam is used for this road, that the most suitable type would be a subbase boulder bottom, filled with coarse gravel, or waste crushed stone of sizes unsuitable for top, and a top course for part of the distance of local selected crushed stone supplemented on the east end by imported limestone.

"Filler gravel can be obtained from three pits close to the road (see map). The price for such gravel set by the owners is 25 cts. per cubic yard.

"Unloading points for imported materials are available at Rochester Junction (triple track main line, six-car capacity), and at Rush (public switch, fifteen-car capacity).

"Water supply: Honeoye Creek the year round, and small creek near Sta. 48 for part of year. The following map and table of quantities indicate the result of the 1920 investigation.

Submitted,
W. G. Harger.
Jan. 4, 1921."

4. Special Problems.—These include grade crossings, special drainage, bridges, etc., the principles of which are discussed on the following pages:

Grade crossings (pp. 599 to 675).

Drainage (pp. 180 to 341).

Bridges (pp. 180 to 341).

5. Approximate Quantity and Cost Estimates.—The length of the road can be obtained from maps (U. S. Geological Survey are convenient) or by autometer distances or pacing. Maps are

RUSH-MENDON MATERIALS

Hanger location on map No.	Property owner	Estimated quantity, cubic yards	Per cent stone	Remarks
1	Ward	220	70 % G. 30 % S.	Hard to get at
2	Mead	300	60 % C. 40 % S.	Moderately easy
3	N. W. Mead	600	60 % C. 40 % S.	Easy to get (not much sledging)
4	550	70 % C. 30 % S.	Moderately easy
5	Fred Stevens	240	60 % G. 40 % S.	Moderately easy
6	Ad Meyers	600	60 % G. 40 % S.	Moderately easy
7	O'Brien	1,500	Will not sell
8	Corcoran	225 + 200	Easy to get
9	Graves	140	Easy to get (gravel pit)
10	Desmond	70	Easy to get
11	Desmond	200	Moderately easy
12	Conor	400	Moderately easy
13	Ward	150	Easy
14	Collins	100	Moderately easy
15	Szatkowski	500	Moderately easy
16	Moran	200	Moderately easy
17	Banks	200	Easy
18	Fetzer	200	Moderately easy
19	300	Moderately easy
20	Kretzer	800	Easy
21	Houck	70	Moderately easy
22	60	Moderately easy
23	Maier Bros.	400	Long haul
24	50	Hard to get
25	Treat	200	Easy
26	Myers	270	Easy
27	Spatahker	600	Moderately easy
28	Yorks	250	Unlimited easy
29	Lord	70	Easy
30	Galvin	Moderately easy
31	Corcoran 1/4	(150) + 150	Moderately easy
32	Galvin 1/3	600	Moderately easy
33	Krenzer and Desmond	40	Moderately easy
34	Krenzer and Chase	250	Moderately easy
35	100	Moderately easy
	Total	10,000	

generally available and serve as a convenient basis for notations. A field inspection by one man, preferably on foot, furnishes the necessary data on required drainage, foundation soils, approximate amount of excavation, condition of existing bridges, and all special features.

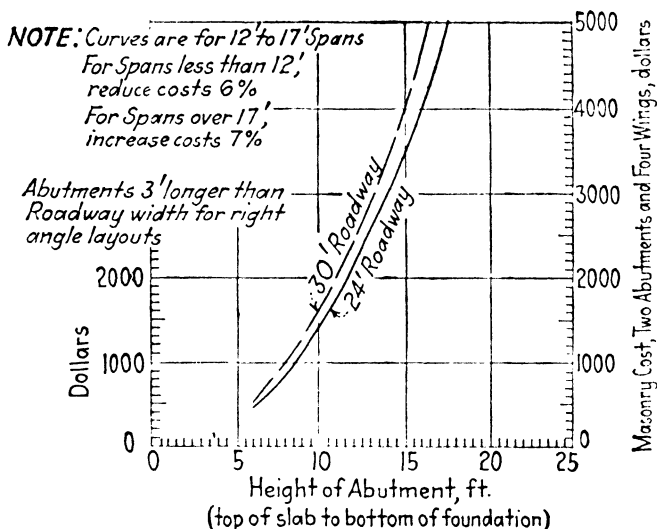

Slab Highway Bridge Abutments

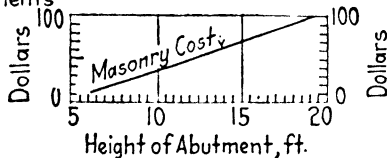

**Per Ft. Extra Cost for Two Abutments for Skew Bridges
 multiply Cost by Extra Length in Ft. due to Skew.**

FIG. 260.—Approx. cost curves. Abutment masonry for slab type bridges. Spans 6' to 25' (unit price of concrete \$18 per c.y.).

Minor drainage features can generally be lumped and assumed to run about \$1500 per mile. (For more detailed cost, estimate each culvert separately. See chapter on Drainage.) Special bridges must be figured in detail. (See chapter on Drainage for Standard Design, and quick-estimating diagrams. For culvert costs see

pp. 669 to 675, for bridge costs, pp. 648 to 669. For the convenience of the field man cost and quantity of the most common cases are reported in this chapter (pp. 758 to 769).

The amount of excavation per mile for ordinary rolling topography is entirely a matter of judgment, which can only be developed by personal experience in similar work. For special long hills requiring a cut and fill reduction a rough profile can be run with an Abney level, and the quantities approximated from the attached diagram. However, the item of excavation on macadam roads in ordinary topography rarely exceeds 20% of total cost, and considerable error in estimating the yardage will not greatly effect the value of the estimate.

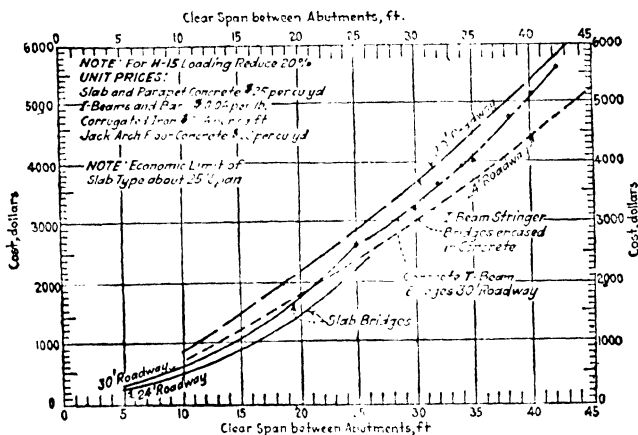
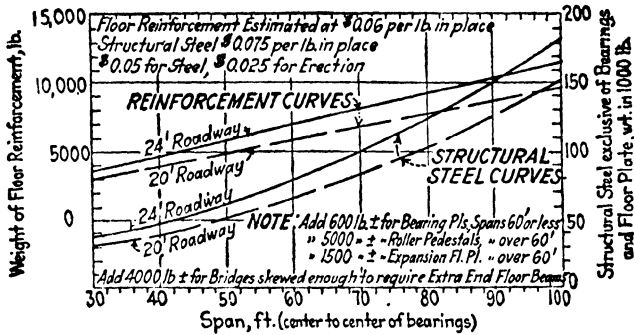

FIG. 260.—Typical cost curves. Small span bridge superstructures. H-20 loading. Based on standard bridges in the following illustrations. Slabs, Fig. 69, page 237. Steel I beam stringers, Fig. 76, page 275. Concrete T beam stringers, Fig. 73, page 252.

The character of the natural road soil has an important bearing on the depths of macadam or the use of subbase and must be carefully recorded. This can best be done by giving the character of the soil, noting whether the improved road will probably be in cut or fill at the points recorded, and specifying the recommended depths of macadam or subbase under rigid pavements. The depths of macadam for different classes of traffic and different soils were indicated in Chap. VI (p. 391), for rigid pavements on page 426. Sample notes on foundation soils are shown on page 838.

Methods of computing costs are given in Chap. XV.

The following tabulations of unit costs show the wide range in different locations and under different specifications. Reasonable unit prices for the district in question should be worked out for general reference purposes.



NOTE: Overall length of Girders 2 ft. ± more than Span as tabulated

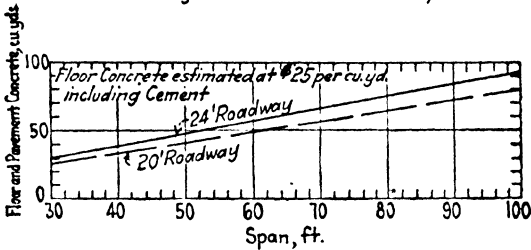

NOTE: Depth of Floor System Center Line Top of Pavement to Bottom of Girder 36" to 42" - Approximate Quantities

FIG. 262.—Approximate quantities typical plate girders. H-20 loading. Structural steel includes girders, floor beams and stringers.

NOTE.—For skew bridge wings quantities remain constant, abutments are lengthened.

$$\text{Length} = \frac{\text{Right angle length}}{\text{Cos. skew angle}}$$

For Spans less than 75 ft. reduce Concrete Quantities by 10%

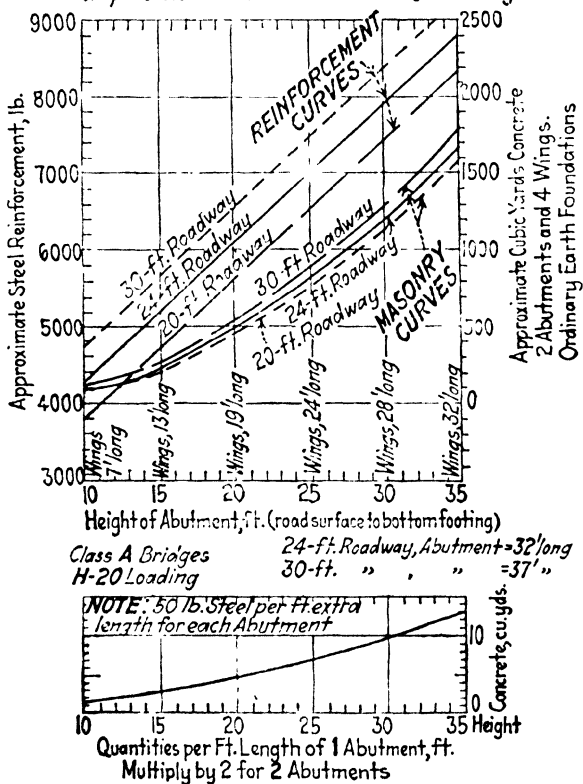

FIG. 263.—Approximate quantities of abutment masonry plate girder. Type of bridge, 40' to 100' spans.

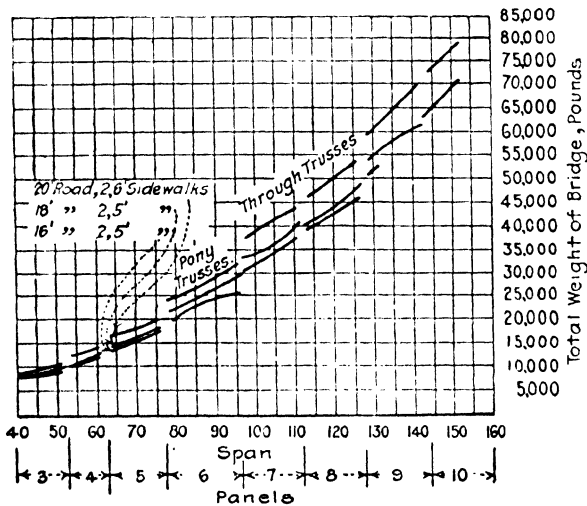
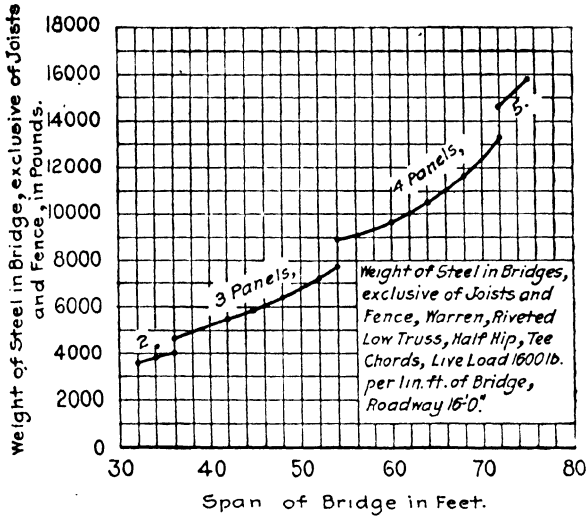
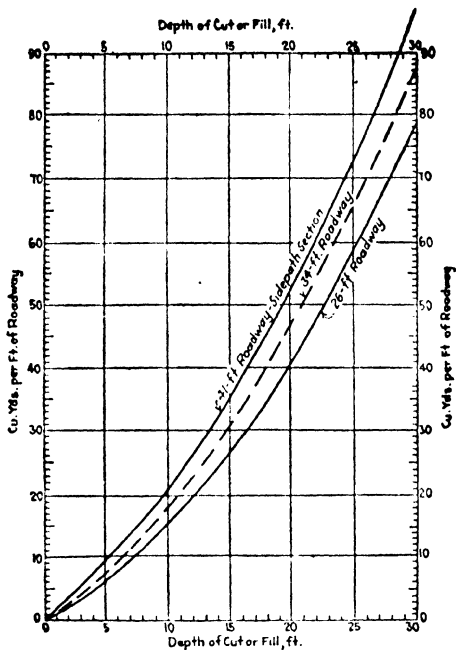

FIG. 264.—Typical weights old style light, steel bridges. Plank floors. Approx. 100 lbs. per sq. ft. live loads.



Graphic for estimating road approach earthwork grade crossing eliminations.

TABLE 126.—UNIT PRICES, 1925

MAINE

Description	Unit	Number of Bids	Average
Earth excavation.....	Cu. yd.	16	\$ 1.19
Rock excavation.....	Cu. yd.	14	4.11
Borrow.....	Cu. yd.	16	1.23
Stone fill.....	Cu. yd.	8	2.34
Gravel base.....	Cu. yd.	9	2.31
Stone base, gravel finish.....	Cu. yd.	9	2.64
Stone base, crushed-stone finish.....	Cu. yd.	4	3.96
Gravel subbase.....	Cu. yd.	13	2.35
Stone V-drain.....	Cu. yd.	1	2.80
Side underdrain.....	Cu. yd.	2	2.65
Class A concrete.....	Cu. yd.	15	30.27
Class B concrete.....	Cu. yd.	16	27.69
Cement rubble masonry.....	Cu. yd.	1	\$15.00
Rip-rap.....	Lin. ft.	1	3.00
Laying 12" corrugated metal pipe.....	Lin. ft.	15	0.83
Laying 14" corrugated metal pipe.....	Lin. ft.	11	0.88
Laying 16" corrugated metal pipe.....	Lin. ft.	11	1.10
Laying 18" corrugated metal pipe.....	Lin. ft.	10	1.22
Laying 20" corrugated metal pipe.....	Lin. ft.	5	1.38
Laying 24" corrugated metal pipe.....	Lin. ft.	8	1.52
Laying 12" cast-iron pipe.....	Lin. ft.	2	1.00
Laying 16" cast-iron pipe.....	Lin. ft.	9	1.50
Laying 18" cast-iron pipe.....	Lin. ft.	7	1.68
Laying 24" cast-iron pipe.....	Lin. ft.	6	1.87
Laying 30" cast-iron pipe.....	Lin. ft.	2	3.00
Drop inlets.....	Each	6	57.50
Cobble gutters.....	Sq. yd.	8	1.44
Gravel road.....	Cu. yd.	11	2.61
Crushed-stone base course.....	Cu. yd.	5	4.83
Bituminous-macadam surface course.....	Cu. yd.	8	5.64
Bituminous-material applied (cars).....	Gal.	8	0.10
Bituminous-material applied (barrels).....	Gal.	8	0.075
Portland-cement-concrete pavement.....	Cu. yd.	3	12.17
Pavement reinforcing.....	Lb.	3	0.0433
Wood guard rail.....	Lin. ft.	14	0.59
Wire-fence guard rail.....	Lin. ft.	2	0.75
Laying 12" vitrified pipe.....	Lin. ft.	1	0.75
Laying 16" vitrified pipe.....	Lin. ft.	1	1.00

NEW HAMPSHIRE

Average Unit Bidding Prices 1925

Items	Quantities	Average Bid
Earth excavation.....	Cu. yd.	\$ 1.36
Structure excavation.....	Cu. yd.	3.33
Borrow.....	Cu. yd.	1.39
Gravel borrow for shoulders.....	Cu. yd.	2.07
Ledge.....	Cu. yd.	4.19
Foundation-course gravel.....	Cu. yd.	2.22
Foundation-course field stone.....	Cu. yd.	3.28
Scarifying.....	Cu. yd.	0.11
Bottom-course gravel.....	Cu. yd.	2.16
Bottom-course crushed gravel.....	Cu. yd.	2.92
Bottom-course modified asphalt.....	Cu. yd.	...
Bottom-course crushed stone.....	Cu. yd.	3.35
Surface-course gravel.....	Cu. yd.	2.35
Surface-course crushed gravel.....	Cu. yd.	3.05
Surface-course modified asphalt.....	Cu. yd.	0.74
Surface-course bituminous-macadam broken stone.....	Cu. yd.	4.05
Surface-course reinforced concrete.....	Sq. yd.	2.78
Surface-course trap rock.....	Cu. yd.	4.04
Applying bituminous material.....	Gallon.	0.07
Concrete Class 1.....	Cu. yd.	27.54

TABLE 126—Continued

NEW HAMPSHIRE

Average Unit Bidding Prices 1925

Items	Quantities	Average Bid
Concrete Class 2.....	Cu. yd.	21.88
Cement stone masonry.....	Cu. yd.	14.14
Rip-rap.....	Cu. yd.	3.20
Cobble gutter.....	Cu. yd.	1.68
Laying 8" corrugated metal pipe.....	Lin. ft.	1.08
Laying 12" corrugated metal pipe.....	Lin. ft.	1.03
Laying 14" corrugated metal pipe.....	Lin. ft.	1.02
Laying 16" corrugated metal pipe.....	Lin. ft.	1.14
Laying 18" corrugated metal pipe.....	Lin. ft.	1.25
Laying 20" corrugated metal pipe.....	Lin. ft.	1.26
Laying 24" corrugated metal pipe.....	Lin. ft.	1.63
Laying 30" corrugated metal pipe.....	Lin. ft.	2.11
Wood guard rail.....	Lin. ft.	0.69
Cable guard rail.....	Lin. ft.	0.80
Reinforcing steel.....	Lbs.	0.09

TEXAS

Unclassified roadway excavation.....	\$	0.17
Common roadway excavation.....		0.20
Solid-rock roadway excavation.....		1.25
Dry-channel excavation.....		0.20
Wet-channel excavation.....		0.70
Excavation for culverts, Class A.....		0.70
Excavation for culverts, Class B.....		1.00
Excavation for culverts, Class C.....		3.00
Excavation for bridges, Class A.....		1.00
Excavation for bridges, Class B.....		2.00
Excavation for bridges, Class C.....		6.00
Borrow.....		0.17
Stripping material pits.....		0.17
Overhaul.....		0.04
Road grader work.....		6.00
Subbase complete in place.....		
Shell furnished, exclusive of freight, etc.....		0.85
Crushing and screening.....		1.40
Extra rolling base and surface courses.....		3.50
Sprinkling.....		2.50
Water hauled additional mile.....		1.50
Material hauled additional quarter.....		0.07
Gravel base course.....		0.47
Crusher-run broken stone furnished.....		1.30
Standard gravel surface course complete in place.....		0.50
Double bituminous surface treatment complete in place.....		0.30
Triple bituminous surface treatment complete in place.....		0.48
Bituminous-macadam surface course complete in place.....		1.10
Two-course limestone rock asphalt surface course.....		0.56
Sheet-asphalt pavement complete in place.....		1.65
Concrete pavement complete in place.....		2.35
Reinforcing steel for pavements complete in place.....		0.05
Untreated bridge timber complete in place.....		80.00
Treated timber complete in place.....	110.00	
Class A concrete complete in place.....		20.50
Class B concrete complete in place.....		20.00
Class C concrete complete in place.....		20.00
Class D concrete complete in place.....		23.00
Reinforcing steel (structures) complete in place.....		0.05
Structural steel complete in place.....		0.08
Treated timber piling complete in place.....		1.10
Precast concrete piling complete in place.....		5.00
Wire-cable guard railing complete in place.....		0.60
Wood guard railing complete in place.....		0.50
Concrete railing for structures, type C complete in place.....		2.20
Concrete railing for structures, type D complete in place.....		2.50

TABLE 126—Continued

IDAHO

Solid rock, \$1.16 per cubic yard.
 Loose rock, 50 cts. per cubic yard.
 Earth, 28 cts. per cubic yard.
 Class A concrete, \$28.34 per cubic yard.
 Class B concrete, \$27.06 per cubic yard.
 Reinforcing steel, 6.5 cts. per pound.
 Hand-placed rip-rap, \$3.50 per cubic yard.
 Loose rip-rap, \$2.44 per cubic yard.
 Guard rail, 78 cts. per linear foot.
 Crushed rock or gravel surfacing, \$1.66 per cubic yard.
 Plain concrete pavement, \$1.84 per square yard.
 Bituminous-concrete pavement \$1.67 per square yard.
 Pavement subgrade preparation, 4.7 cts. per square yard.
 Gravel subbase for pavement, \$1.50 per cubic yard.
 Crushed-gravel shoulders, \$1.85 per cubic yard.
 Hauling and placing galvanized-pipe culverts:
 12", 27 cts.
 15", 35 cts.
 18", 50 cts.
 24", 64 cts.
 30", \$1.38
 36", \$1.40
 Hauling and placing concrete culvert pipe:
 12", 43 cts.
 18", 55 cts.
 24", 55 cts.
 30", 75 cts.
 36", \$1.25

NEW MEXICO

Item	Unit	Average Unit Bid
Class 1 excavation.....	Cu. yd.	\$ 0.296
Class 2 excavation.....	Cu. yd.	0.825
Class 3 excavation.....	Cu. yd.	2.17
Class 1 borrow.....	Cu. yd.	0.265
Overhaul.....	Sta. yd.	0.045
Clearing and grubbing, overhaul.....	Acre	30.00
Class A concrete.....	Cu. yd.	26.16
Class B concrete.....	Cu. yd.	25.61
Concrete 1: 2: 3 (structures).....	Cu. yd.	20.70
Mortar rubble masonry.....	Cu. yd.	10.67
Rip-rap.....	Cu. yd.	2.50
Grouted cobble-stone apron.....	Cu. yd.	10.00
Spillway base course.....	Cu. yd.	2.17
Concrete pavement 1: 2: 3.....	Cu. yd.	14.19
Two-course crushed-rock surfacing.....	Cu. yd.	3.37
Two-course crushed-caliche surfacing.....	Cu. yd.	1.85
One-course gravel surfacing.....	Cu. yd.	1.70
Gravel surfacing (bridge floors).....	Cu. yd.	2.89
Clay or caliche plating.....	Cu. yd.	0.77
18" diameter 16 Ga. C. M. C.....	Lin. ft.	2.45
24" diameter 14 Ga. C. M. C.....	Lin. ft.	3.09
30" diameter 14 Ga. C. M. C.....	Lin. ft.	3.71
36" diameter 14 Ga. C. M. C.....	Lin. ft.	3.47
24" diameter reinforced-concrete pipe.....	Lin. ft.	3.50
30" diameter reinforced-concrete pipe.....	Lin. ft.	5.00

UNIT PRICES BRIDGE AND GRADE-CROSSING WORK
 Compiled, 1925, by W. G. Harger for Western New York Conditions

Item number	Item	Unit price
1	Clearing and grubbing.....	Special each case
2a	Earth excavation (borrow pit).....	\$ 0.70 per cubic yard
2b	Earth excavation roadway, common..	0.90-1.50 per cubic yard
2c	Earth excavation foundations and culverts (dry)	2.00-2.50 per cubic yard
2d	Earth excavation foundations and culverts (wet).....	4.00 per cubic yard
2e	Earth excavation slip scraper ditch work.....	0.75 per cubic yard
2f	Earth excavation sewers.....	Included in pipe price
2g	Backfill (abutments).....	1.25 per cubic yard
3a	Rock excavation common roadway (shale).....	2.00 per cubic yard
3aa	Rock excavation common roadway (hard).....	2.50 per cubic yard
3b	Rock excavation in foundations (dry)	6.00 per cubic yard
3c	Rock excavation in foundations (wet)	8.00 per cubic yard
3d	Rock excavation removing old masonry.....	4.00 per cubic yard
5	Overhaul.....	0.007-0.01 per station yard
6	Sewer pipe.....	(See sewer diagrams)
7a	4" underdrain.....	0.25 per linear foot
7b	6" underdrain.....	0.35 per linear foot
10	Relaying old pipe.....	0.20 per linear foot
13a	12" cast-iron pipe (medium weight)..	3.50 per linear foot
13b	14" cast-iron pipe (medium weight)..	4.50 per linear foot
13c	16" cast-iron pipe (medium weight)..	5.70 per linear foot
13d	18" cast-iron pipe (medium weight)..	7.00 per linear foot
13e	20" cast-iron pipe (medium weight)..	8.50 per linear foot
13f	24" cast-iron pipe (medium weight)..	10.00 per linear foot
13g	30" cast-iron pipe (medium weight)..	15.00 per linear foot
13h	36" cast-iron pipe (medium weight)..	20.00 per linear foot
	Pointing old masonry.....	0.05 per square foot
16	Rip-rap.....	2.50 per cubic yard
17	Piles.....	0.90-1.20 per linear foot
18	Timber and lumber.....	80.00 per thousand
19	Portland cement.....	3.20 per barrel
20a	1: 2: 4 concrete ¹ (jack arch floor).....	18.00 per cubic yard
20b	1: 2: 4 concrete ¹ (formed floor).....	20.00 per cubic yard
20c	1: 2: 4 concrete ¹ (slabs).....	20.00 per cubic yard
20d	1: 2: 4 concrete ¹ (trestle designs).....	25.00 per cubic yard
21a	1: 2½: 5 concrete ¹ foundations.....	10.00 per cubic yard
21b	1: 2½: 5 concrete ¹ abutments (large work).....	14.00 per cubic yard
21c	1: 2½: 5 concrete ¹ abutments and pedestals (small).....	16.00 per cubic yard
22a	1: 3: 6 concrete ¹ pipe jackets.....	10.00 per cubic yard
27	Concrete ¹ curbing.....	25.00 per cubic yard
27a	Curb bar.....	0.30 per linear foot
28	Concrete gutter (cement incl.).....	18.00 per cubic yard
29	Cobble gutter (cement joints).....	1.25 per square yard
30	Metal reinforcement concrete pavement.....	0.035 per square foot
31	Bar reinforcement concrete pavement	0.05 per pound
32b	Structural steel	
	Truss bridges.....	0.075 per pound
	Plate girders.....	0.07 per pound
	Rolled stringers.....	0.06 per pound

¹ Concrete prices do not include cement.

UNIT PRICES—Continued

Item number	Item	Unit price
32a	Bar steel (in structures)	\$0.06 to \$0.07 per pound
33	Miscellaneous iron and steel	0.10 per pound
33½	Corrugated iron for bridge floor jack arches	0.20 per square foot
34	Wooden guide rail	0.75 per foot
35	Cable guide rail	1.25 per foot
36	Concrete guide posts	3.25 each
37	2" pipe railing	3.00 per foot
38	Preparing fine grade	0.10 per square yard
39	Run-of-bank gravel foundation	3.00 per cubic yard
41	Field or quarry-stone foundation	4.00 per cubic yard
42	Run-of-bank gravel bottom	3.50 per cubic yard
44	Broken-slag bottom	6.00 per cubic yard
45	Broken-stone bottom	7.00 per cubic yard
46	Concrete foundation for pavement (cement not included)	7.00 per cubic yard
47	Bituminous-macadam top (bitumen not included)	9.00 per cubic yard
51c	Concrete pavement (cement not included)	10.00 per cubic yard
54	Brick pavement*	3.50 per square yard
55	Stone-block pavement*	5.50 per square yard
56	Trimming shoulders	0.10 per linear foot of road
61	Broken slag (loose)	4.00 per cubic yard
62	Screened gravel (loose)	3.00-4.00 per cubic yard
63	Broken stone (loose)	4.50 per cubic yard
66	Bituminous material A (penetration)	0.15 per gallon
71	Bituminous material T (penetration)	0.17 per gallon
75	Maintaining traffic	0.20 per foot
76	Resetting wooden guide rail	0.50 per foot
	Waterproofing	0.10 per square foot

* Does not include concrete base.

Miscellaneous Items

Labor raising track \$ 0.80 per linear foot per foot raise.
 Pile temporary track protection during construction of railway bridges 30.00 per foot per track.

Cost of Interurban Electric Track Work

Ballast, ties, poles and wiring \$5 per ft. single track.
 Steel rails \$1.50 per ft. single track.

The sample preliminary reports following illustrate the methods in common use for high-type roads covering pavements, bridges and railroad-crossing problems. Reports of this character will rarely differ from the final cost of construction by more than 15%. While photographs increase the value of these reports, they are not so essential as for new locations. Notes on photography are given on page 818.

6. Sample Preliminary Pavement Design Report

MT. MORRIS VILLAGE STATE-COUNTY HIGHWAY, LIVINGSTON COUNTY, NEW YORK STATE

"1. Location and Length.—The proposed improvement extends from the south corporation line at Buck Run northerly along Main Street to State Street, a distance of approximately 4800', and on Chapel Street from Main Street to Clinton Street, a distance of approximately 400'. This construction will complete the state system through Mt. Morris Village and furnish the final connecting link between the following previously improved roads: Nos. 482, 855, 5270, and 5665.

"2. Grades and Alignment.—The grades are easy and the alignment straight. No grade reductions will be required nor will any rights of way be necessary to improve the alignment.

"3. Traffic Classification (Based on Traffic Classification Map).—This road is Class II from Stas. 0 to 26 (Buck Run to Erie Street) and on the verge between Class II and Class I from Stas. 26 to 48 (Erie Street to State Street). From Stas. 26 to 48 it lies in the business section of the village and takes all traffic to the Erie Ry. station.

"4. Suitable Types of Pavement (in Respect to Traffic Classification).—Between Stas. 0 and 26 (Class II traffic) either bituminous macadam or reinforced cement concrete are suitable.

"Between Stas. 26 and 48 (Class I traffic) either brick or asphaltic concrete on concrete bases or reinforced cement concrete are suitable. (For suitability of pavements see Table 2, p. 6.)

"5. Soils.—The subgrade soils are as follows:

Stas. 0- 4	Ordinary loam
Stas. 4- 7	Quicksand
Stas. 7- 22	Ordinary loam
Stas. 22- 48	Gravelly soil
Stas. 880-884	Gravelly soil

"6. Equal Strength Design (Based on Tables 153, and 154, pp. 959).—Considering the above list of soils and that the road is entirely in cut, the following depths of pavement are recommended:

TOTAL PAVEMENT THICKNESS IN INCHES

Location	Type			
	Bituminous macadam	Reinforced concrete 0.65 lb. per square foot	3" asphaltic-concrete surface on concrete base	4" brick on concrete base
Stas. 0- 4	13	8	10	11
Stas. 4- 7	24	8 ¹	10 ¹	11 ²
Stas. 7- 22	13	8	10	11
Stas. 22- 48	10	7	9	10
Stas. 880-884	10	7	9	10

¹ Bottom and top reinforcement and subbase.

² Gravel subbase.

"7. Materials Available.—Local sand and gravel fit for concrete paving base, culverts, or subbase bottom courses are available as follows:

"Gravel pit owned by village of Mt. Morris located 2000' (downhill haul) west of Sta. 46. This gravel if screened ought to be suitable for the coarse aggregate for concrete paving base, but is not probably good enough for concrete pavement. This pit has been sampled 7-914 and submitted to Albany for approval. The price of this gravel is 75 cts. per cubic yard at the pit. This gravel is suitable (pit run) for subbase under macadam, Stas. 0 to 22. Seven thousand cubic yards are available.

TABLE OF COMPARATIVE COSTS

1 Type	2 Location, Sta. to Sta.	3 Estimated con- struction cost per square yard	4 Interest on con- struction cost at 5%	5 Maintenance and renewal yearly charges per square yard		6 Maintenance ¹ of shoulders, culverts, ditches, etc., per square yard of pavement ²	7 Comparative total final yearly cost (sum of columns 4, 5, and 6)
				Mainte- nance	Renewal		
Bituminous macadam	0-26	\$1.60	\$0.08	\$0.040	\$0.12	\$0.005	\$0.25
Bituminous macadam	26-48	1.90	0.095	0.050	0.18 ²	0.005	0.33
Reinforced cement concrete	0-48	2.70	0.135	0.010	0.16 ²	0.005	0.32
3" asphaltic concrete on 6" concrete base	26-48	3.10	0.155	0.025	0.17	0.005	0.35
4" brick, $\frac{3}{4}$ " cement-sand cushion, 5" concrete base	26-48	4.10	0.205	0.015	0.15	0.005	0.37

¹ Based on \$100 per mile divided by the number of square yards of pavement in the job.
² Eventually sheet-asphalt resurfacing.

"Sand pit, owned by Jerry Donovan, located 2 miles west of Sta. 46. Unlimited quantity. Rather uniform fine-grained sand. Field test showed 3% loam. Probably good for any grade of concrete except concrete pavement. Sample 7-913 taken and submitted to Albany for approval. Price at pit 50 cts. per cubic yard.

"Imported sand fit for any grade of concrete can be obtained from the valley sand, Pennsylvania Ry. delivery at \$1.45 per ton, f.o.b. Mt. Morris. Screened gravel from the same source, \$1.35 per ton, f.o.b. Mt. Morris.

"Imported crushed limestone acceptable for all work can be obtained from Le Roy, \$2.05 per ton, f.o.b. Mt. Morris, Erie Ry. delivery.

"Crushed slag fit for macadam bottom course, \$2.35 per ton Erie Ry. delivery.

"Brick.—\$41.50 per 1000, f.o.b. Mt. Morris, any railroad.

"Cement.—\$2.35, f.o.b. Mt. Morris (bags returned).

"Water.—Village water supply. Hydrants located at frequent intervals.

"Old Macadam.—In order that the new grade line be placed at the proper elevation to fit the sidewalks about 900 cu. yd. old macadam will have to be excavated. This can be screened and reused as macadam bottom course between Stas. 0 and 26.

"8. Comparative Cost Estimates.—The comparative cost estimates are based on the equal-strength depths recommended in Art. 6 of this report and on the material prices quoted in Art. 7 of this report. Labor at 35 cts. per hour.

"The maintenance and renewal estimates are based on modified department records (see Table 97, p. 520).

"The difference in motor operation cost for the different types of surface (see Table, p. 68) would not add over 2 cts. per square yard per year to the total yearly cost of macadam as compared with Class A surfaces, which brings the total estimated cost of the last column up to 27 cts., for bituminous macadam, Stas. 0 to 26.

"From the standpoint of both original and final cost there is a very evident advantage for macadam Stas. 0 to 26. The local people have no particular preference as to type of pavement for this portion of the road. Local preference would be the only factor entitled to modify decisions based on the cost analysis, provided the additional cost is paid locally. As this factor need not be considered, bituminous-macadam pavement is recommended from Stas. 0 to 26.

"From Stas. 26 to 48, local preference must be considered. The village proposes to pay the additional cost introduced by such preference as to type and extra width desired. Under these conditions the cost analysis is of value only as indicating proper state cooperation. Article 10 gives alternate total estimates of cost to enable the village to come to a reasonable decision as to the type they will ask for.

"9. Recommended State and County Cooperation Based on Final Cost (Art. 8).—The state would be justified in limiting their cooperation to the cost of 16' bituminous-macadam pavement, Stas. 0 to 26, and an 18' reinforced-concrete pavement, Stas. 26 to 48 and 880 to 883, with ordinary surface-drainage provisions. This would amount to approximately \$35,000. This is not an excessive amount if the funds are available (see Table 7, p. 15), considering the volume of traffic served (about 1500 daily).

"I understand that the rules of the Department limit cooperation to the construction of a 16' road of the same type already constructed outside of the village. This rule would limit cooperation to a 16' bituminous macadam which would cost approximately \$30,000 for this locality. Under these circumstances it seems desirable to set the cooperation at \$30,000.

"10. Preliminary Cost Estimates.—The following estimates have been prepared to give the village authorities some basis for decision as to type and width. These estimates are rough preliminary figures subject to final revision after the plans are worked out in detail. They are, however, liberal and will in all probability exceed the final figures by from 10 to 15%. Sidewalks, curbing, and storm sewers are itemized separately to permit the village to estimate general and local charges. The pavement widths used have been tentatively approved by the village board and are listed as follows:

SAMPLE REPORTS

773

Width, feet	
18 (no curb).....	Stas. 0 - 16
20 (no curb).....	Stas. 16 - 26
34 (curb).....	Stas. 26 - 36
34-60 (curb).....	Stas. 36 - 39
60 (curb).....	Stas. 39 - 48
40 (curb).....	Stas. 880 + 37-883 + 66-

A complete system of storm sewers is provided. The unit prices for the major items are as follows:

ADOPTED UNIT PRICES

Excavation.....	\$1.00 cu. yd.
Gravel subbase.....	2.20 cu. yd.
Macadam bottom (old macadam reused).....	2.50 cu. yd.
Macadam bottom (new slag).....	4.80 cu. yd.
Bituminous-macadam top (limestone).....	8.00 cu. yd.
Bituminous Mat. A (penetration macadam).....	0.12 gal.
7" reinforced-cement-concrete pavement.....	2.70 sq. yd.
3" asphaltic concrete on 6" cement-concrete base.....	3.10 sq. yd.
4" brick, cement-sand cushion, 5" cement-concrete base.....	4.10 sq. yd.
Sidewalk.....	0.25 sq. ft.
Curb (concrete).....	0.90 lin. ft.

ALTERNATE TOTAL ESTIMATES

Estimate 1

Bituminous macadam 10, 13, and 24" thick

1. Excavation.....	\$12,000
2. Curbing.....	6,000
3. Sidewalks.....	3,000
4. Special drainage.....	9,000
19,200 sq. yd. bituminous-macadam pavement at \$1.90.....	36,000
Incidentals.....	3,000
Total.....	\$60,000
State and county cooperation.....	30,000
Total village share.....	\$30,000

Estimate 2

Bituminous macadam, Stas. 0 to 26.

Reinforced cement concrete, Stas. 26 to 48 and Chapel Street:

Items 1-4 (Estimate 1).....	\$30,000
13,600 sq. yd. reinforced-concrete pavement at \$2.70.....	37,000
5,600 sq. yd. bituminous macadam at \$1.60.....	9,000
Incidentals.....	3,000
Total.....	\$79,000
State and county.....	30,000
Total village share.....	\$49,000

Estimate 3

Bituminous macadam, Stas. 0 to 26.

3" asphaltic concrete on 6" concrete base, 26 to 48 Chapel Street:

Items 1-4 (Estimate 1).....	\$30,000
13,600 sq. yd. asphalt pavement at \$3.10.....	42,000
5,600 sq. yd. bituminous macadam at \$1.60.....	9,000
Incidentals.....	3,000
Total.....	\$84,000
State and county cooperation.....	30,000
Total village share.....	\$54,000

Estimate 4

Bituminous macadam, Stas. 0 to 26.

4" brick, cement-sand cushion, and 5" concrete base:

Items 1-4 (Estimate 1).....	\$30,000
13,600 sq. yd. brick pavement at \$4.10	56,000
5,600 sq. yd. bituminous macadam at \$1.60	9,000
Incidentals.....	3,000
Total.....	\$98,000
State and county cooperation	30,000
Village total	\$68,000

Signed
Designing Engineer."

Remarks.—For the interest of the reader actual procedure on this road was as follows: The contract was let for reinforced-cement-concrete pavement, Stas. 0 to 26, and brick pavement, Stas. 26 to 48, the local people paying the excess cost over and above the state-fund limit advised in the foregoing report. This was a rational solution, considering local preference and willingness to assume added cost.

**PRELIMINARY INSPECTION AND DESIGN REPORT, BRIDGE 1,
ROAD 767, MONROE COUNTY, TOWN OF PERINTON**

"Location.—O. K., provided channel is straightened as per general layout and 10° skew bridge used. See page 1007, Typical Bridge Plans.

"Waterway Area.—Drainage area, 27 sq. miles. Probable maximum run-off 3500 sec.-ft., from natural watershed. Takes also spillway run-off from barge canal. Probable total maximum 4000 sec.-ft. High-water data very definite at the bridge. No doubt but what 500-sq. ft. flow area is about right with flood velocity about 8' per second. Old structure 42' clear span. Use 45' clear span with 2' debris clearance above 392.2 extreme maximum flood elevation.

"Channel Improvements.—Inlet channel needs straightening to increase flow capacity and reduce scour at southwest wing. Approximately 4000 cu. yd. of excavation are required for channel and abutments. Of this amount approximately 2500 cu. yd. are fit for road-approach fills.

"Road-approach Grades.—The future reconstruction grade and alignment have been worked out at this bridge. This alignment is used for the new bridge. The west approach grade agrees with the proposed future grade. There is not enough good channel excavation to raise the east approach to the future grade, so an easy run-off has been designed utilizing all the good channel excavation and making this grade as near as possible to the future grade, considering limitation of fill material. For a separate bridge job we did not feel justified in stipulating additional east approach work, which is strictly a road reconstruction charge.

"Road-approach Pavement.—Same type as existing pavement—gravel bottom, macadam top.

"Bridge-foundation Conditions.—Fine sand (almost quicksand). Piles will be needed. Figure on 30' piles. Length ordered in leads to be determined by test piles.

"Type of Structure.—Steel I-beam superstructure adopted as the most suitable and economical type.

"Through plate girder rejected on account possible future widening.

"Concrete T-beam design rejected on account of difficulty of forming; depth.

1926 traffic count 2000
th gives approx. 4000 to
5000 vehicles in 12 hrs. A 30' bridge will easily handle 7000 to 9000 in 10 hrs. No sidewalks needed. No gas mains at bridge. Provide contingent allowance for maintaining traffic.

COST OF STRUCTURE

Estimated contract cost.....	\$35,000
Engineering and contingencies.....	4,000
Total appropriation.....	\$39,000
Actual final cost, allowing for bid cuts and the elimination of contingent items probably not needed about.....	\$26,000
Engineering.....	2,000
Probable final cost.....	\$28,000

COST OF PRELIMINARY ENGINEERING

Survey (Harger and Anderson).....	\$ 11
Borings (Anderson).....	80
Design and estimate (Harger).....	68
Tracing (Leonard).....	22
Checking and right-of-way maps (Anderson).....	60
Total.....	\$241

= 3½% of the estimated contract cost.

"Equipment Required:

- Clam-shell excavator (general-utility truck crane)
- Pile driver (steam or drop hammer)
- 1- or 2-bag batch concrete mixer
- Roller
- Necessary trucks, teams, and wagons
- Necessary small tools, plows, scrapers, etc.
- Power pump for foundation drainage.

"Materials:

- Bottom-course gravel (local), short haul
- Crushed-stone macadam (imported)
- Concrete materials (imported)
- Piles (local)
- Rip-rap (local fence stone), 5-mile haul maximum.

(Signed)

Bridge Eng.

SAMPLE PRELIMINARY GRADE CROSSING ELIMINATION REPORT

The following report illustrates specific cases where elimination by relocation on structure seems the proper solution. Preliminary reports of this nature set the general scheme. Detail design reports are given in Chap. IX, page 642.

REPORT FOR CROSSING 68 GENESEE & WYOMING VALLEY RY. ROAD 5021, TOWN OF CALEDONIA, COUNTY OF LIVINGSTON, PUBLIC SERVICE CASE 3385

Assessed valuation town of Caledonia (1925).....	\$3,400,000
Maximum permissible town share of construction cost permitting mandatory order.....	\$ 28,000
Maximum permissible total cost of elimination permitting mandatory order.....	\$ 113,000

LIST OF ELIMINATION PROJECTS IN CALEDONIA ON THE STATE ROAD SYSTEM IN THEIR ORDER OF IMPORTANCE ON COMPLETION OF THE STATE SYSTEM

Order of town importance	Index map crossing number	Danger index in 1930	Road number	Railroad	Order of importance of railroad in question	Approximate total estimated cost (includes property damage)
1 ¹	38	24,000	5273	Penn & Erie	Penn 2	\$ 105,000 to 160,000
2	16	18,000	5021	Erie	2	130,000
3	93	15,000	Scotts-ville-S	Lehigh, M. L.	10	115,000
4 ²	68	14,000	5021	G. & W. V.	1	100,000
5	41	5,000	5021	N. Y. Central	41	180,000
6	40	4,000	5273	Erie	13	180,000
7	94	3,000	Scotts-ville-S	N. Y. Central	44	90,000
8	95	3,000	Scotts-ville-S	Erie	17	100,000
9	76	2,000	5593	G. & W. V.	2	90,000
10	180	1,000	5593	Erie	21	Road relocation
			Total	All eliminations in town		\$1,140,000

¹ Considers completing routes as well as relative danger.

² Cost will probably be reduced to \$105,000 due to Erie abandonment of switch.

³ P.S. Case 3385.

Discussion.—The proper solution of Crossing 68 Public Service Case 3385, Genesee and Wyoming Valley Ry. at Road 5021, Town of Caledonia, depends on the proposed treatment of three other Erie Ry. Crossings 16, 40, 180 and two town road crossings (see attached map); that is, Crossing 68 cannot be considered as an independent separate project.

There is no question but what from the standpoint of safety it is desirable sometime in the future to relocate Road 5021 keeping it south of the Erie tracks from Crossing 16 to Road 5273 crossing the Genesee and Wyoming Valley Ry. south of the Erie Junction (Crossing 68a on map). This relocation with one elimination 68a Genesee and Wyoming Valley will eliminate three state road crossings on State Touring Route 5, one crossing on State Road 5593 and two town road crossings. It will reduce the crossings on travel to Rochester from the west by one crossing and will increase the safety at the remaining Crossing 40, as this crossing is much safer than any other on the route due to station stop, wide street, etc. When Road 5021 is relocated, the first town road, about 800' east of Crossing 16, will be left open for local outlet; this is a comparatively safe crossing at right angles to track, with level grade and good sight distance. Crossings 16, 180, and Church Street will be closed to traffic and Crossing 68a eliminated by overhead bridge.

This relocation scheme will be difficult to work out immediately but should be worked in on reconstruction of Road 5021 and it therefore seems desirable to take care of Crossings 16, 68, 40, and 180 by means of flash signals at once which will serve very well until the relocation can be worked out.

The most important elimination needed at once in Caledonia is Crossing 38 Penn Ry. Road 5273.

At the last hearing a study was suggested of the possibility of a short relocation of Road 5021 from Crossing 16 keeping south of the Erie tracks to the junction with the G. & W. V. Ry. and making one elimination across both Erie and G. W. at the junction coming back on Road 5021 east of Crossing 68. This solution seems obviously short sighted from a study of the

map and the preceding statement of the general problem and this would also materially increase motor operation costs on Route 5. Increase in motor operation costs for year would be approximately \$12,000; capitalized value of increased cost, approximately \$245,000.

Signed
Grade Crossing Engineer
Div. No 4

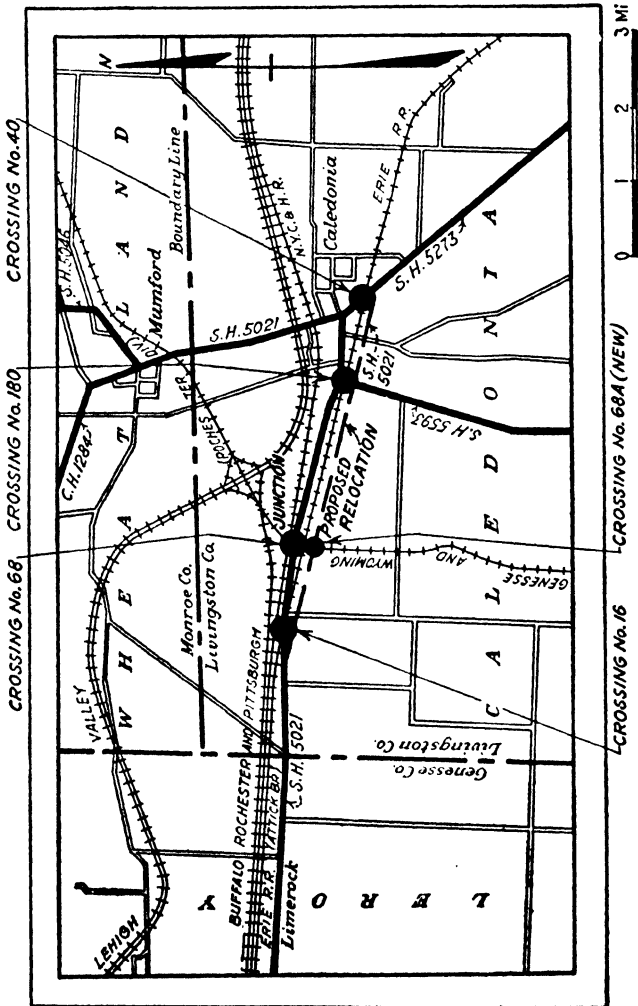

Map to accompany report on elimination of crossing No. 68.

TABULATION ONTARIO COUNTY TOWN ROAD BRIDGES (ESTIMATED SAFE LOADS)
INSPECTED JULY, 1926, W. G. HARGER

	Town	Bridge name	Stream	Span, feet	Length, feet	Roadway width, feet	Age (years)	Approximate safe gross vehicle load, tons				Estimated safe gross vehicle load of structure, July, 1926, factor of safety 4, in tons
								Stringers, total vehicle load, tons	Floor beams, tons	Floor beam hangers, tons	Trusses (1 truck only), tons	
1	Gorham	Shuman	Flint Creek	62.5	12.5	16	50	2	2½	4	6½	2
2	Gorham	State Road	Flint Creek	45	15	18	30	4½	6	..	10	4½
3	Gorham	Lake to Lake	Flint Creek	54	13.5	18	30	3½	5	..	6½	3
4	Gorham	Gizzardville	Flint Creek	66	13.3	16	40	2½	3	8	8	2½
5	Seneca	Charlton	Flint Creek	64	12.8	14	40	2½	3	7	6½	2½
6	Seneca	Gristmill	Flint Creek	52	13	13	50	2	3	4	3½	2
7	Seneca	Vogt	Flint Creek	52	13	14	30	3	4	6	8	3
8	Seneca	Otley	Flint Creek	40	11.5	15	50	7	4½	6	4½	4½
9	Phelps	Orleans	Flint Creek	64	12.8	16	40	4	4	5	7½	4
10	Phelps	Wheat	Flint Creek	48	12	16	30	3½	4	..	10	4
11	Phelps	Avery	Canandaugua Creek	72.5	1.45	12	40	2½	3	8	8½	2½
12	Phelps	Miller	Canandaugua Creek	93+56	13.4	16	50	3	5	8	9	3
13	Phelps	Banester	Canandaugua Creek	93	9.7	16	60	2	2½	6	4	3
14	Phelps	Holbrook	Canandaugua Creek	109	12.8	16	40	3½	5	10	8	3½
15	Phelps	Cuddeback	Canandaugua Creek	100	11	16	60	2	2	3	1½	1½
16	Phelps	Mott	Canandaugua Creek	90	12.8	12	50	½	3	6	8	½
17	Phelps	Mott 2	Mill Race	52	..	12	60	½
18	Phelps	O'Brien	Flint Creek	76	12.5	15	30	5½	6	12	12	5½
19	Phelps	Strowbridge Glen Bridge	Grimes Creek	33-9	11.0	14	20	5½	6	13	13½	5½

NOTE.—It is impossible to estimate the exact strength of these old bridges due to badly rusted steel. The results given are for a factor of safety of 4 for the truss and floor systems members as measured with an arbitrary reduction of from 20 to 50 % for deterioration due to rust and vibratory fatigue.

CONDEMNATION AND TEMPORARY REPAIR OF WEAK BRIDGES

The determination of safe load for old bridges is a very difficult matter due to uncertainty as to the condition of old steel and timber. The reduction in strength of standard shapes due to

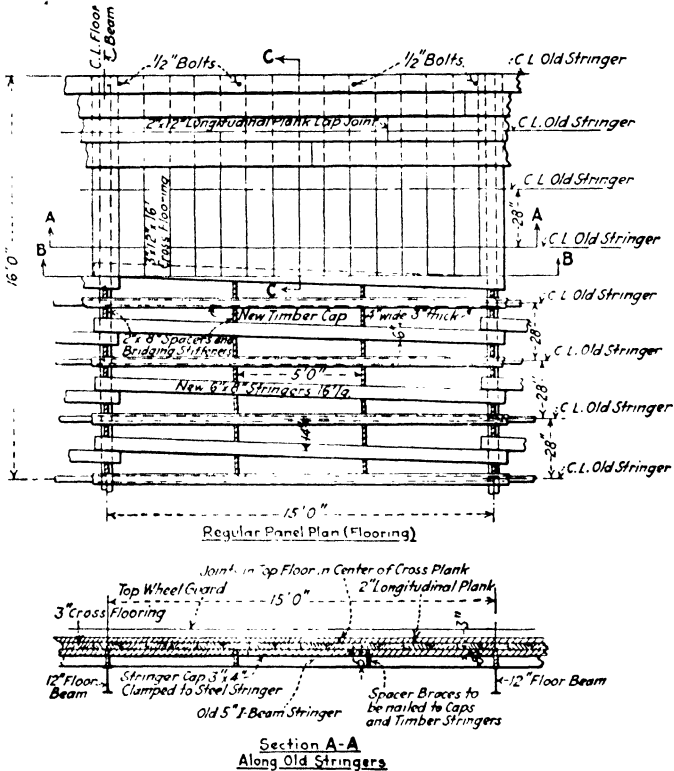

Typical bridge floor repair and strengthening road 485.
(Details of repair continued on page 780.)

age and fatigue is so indefinite that very conservative assumptions should be made and a large factor of safety used.

In computing safe loads for old bridges the structure should be very carefully examined and measured up for condition of floor planking, stringers, and their connections; floor beams and connections, and all truss members.

As a general rule, old steel bridges are weakest in the items of stringers, somewhat stronger for the floor beam design and floor

beam hangers, and the strongest generally in the trusses (see table page 778 giving the analysis of a number of old bridges inspected in 1926).

This general condition of relative weakness makes it possible in many cases to quite materially increase strength without complete rebuilding by strengthening the floor system.

For the effect of depth and type of flooring on distribution of wheel loads to stringers, see Chap. XIV, page 1042. Chapter XIV

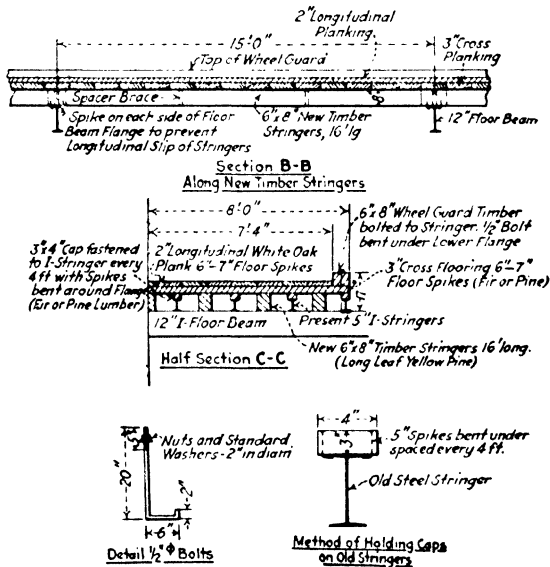

Typical bridge floor repair and strengthening road 485.

also contains all necessary tables for computing safe loads on stringers, floor beams, hangers, etc. (see pp. 1026 to 1087).

Sketch Rd 485 shows a typical temporary repair which reduces impact by the use of double flooring, increases stringer strength by the use of additional timber stringers, and reduces noise by timber stringer caps. In this particular case new floor beam hangers were not required nor was it necessary to strengthen trusses by supporting bents.

**MEMORANDUM FOR H. E. SMITH: REPAIR OF BRIDGE
1, ROAD 485, TOWNS OF BLOOMFIELD AND LIMA,
COUNTIES OF ONTARIO AND LIVINGSTON**

Pursuant to your request of recent date, Bridge 1 Sta. 0 + 00 Road 485 was inspected by W. G. Harger and R. W. Anderson on May 25, 1926.

Recommendation.—We recommend that the floor on this bridge be rebuilt at once, that the diagonal tension members and cross-braces be tightened up at once, and that the bridge be replaced with a new modern structure as soon as funds become available.

The life of the existing bridge can be increased by proper floor construction which will reduce the impact of rapidly moving road vehicles. Sketch of suggested floor construction is attached (pages 779-780.)

We also recommend that this bridge be posted for 6 tons gross load after the floor has been repaired or for a gross load of 2 tons in its present condition and that a speed limit of 5 miles per hour be required for loads of over 2 tons gross weight.

(Signed)

W. G. HARGER
May 25, 1926.

**PRELIMINARY INVESTIGATIONS FOR ROADS IN
PIONEER DISTRICTS**

Reports of this nature cannot be figured so accurately as for high-type roads, but if carefully done should not vary over 25% from the final construction cost. The cost of preliminary investigations depends very largely on the character of the country, the methods employed, and the travel necessary to get to the work, and will range from \$2 to \$40 per mile. A fair average cost for work similar to that done by the U. S. Office of Public Roads in the mountainous districts of the West is \$10 per mile for ordinary cases and \$30 per mile for a plane table sketch survey in difficult country.

Ordinary Preliminary Investigations.—The improvement to be investigated generally consists of a combination of betterments of existing roads with a large percentage of relocation of the old road or the new location of a highway where no road of any kind traverses the territory. The length of these projects ranges from 5 to 150 miles. The engineer generally receives orders to report on the best general route and approximate cost of a road between definite terminals, which requires more general investigation than that called for in the preliminary reports on the high-type roads previously discussed.

The field work is usually done by one or two men on foot or on horseback. All possible different routes are examined. As a rule, this general examination eliminates all but one or two possibilities, which are examined with care, sufficient notes, photographs, etc., being taken to make a reasonably close estimate of cost.

The selection of general route is based on a comparison of the following factors for the different routes:

1. Best location for the development of the country.
2. Longest open season for use.
3. Least rise and fall.
4. Feasible ruling grades.
5. Length and cost.

The following engineering equipment will cover all requirements for obtaining the general data and the detailed information required for a reasonably close cost estimate.

- 2 aneroid barometers 2½ or 3" dial in leather carrying cases.
Tested for range of altitude needed.
- 1 Abney level reading to degrees and per cent.
- 1 pocket compass 2" floating card dial or, if desired,
- 1 prismatic compass (card dial preferred).
- 1 4A Kodak with folding tripod.
- Notebooks, existing maps, etc.

In rolling topography it makes no difference in which direction the line is traced, but where elevation is developed on a ruling grade the work should be done from the highest point downhill.

Where aneroid elevations must be depended on, considerable care must be exercised. If one aneroid can be left at a stationary point and its fluctuations read at intervals during the day, very accurate results can be obtained when the field aneroid is corrected for the fluctuations, but this is not feasible for work of this kind, as a rule, and aneroid elevations are, to say the least, uncertain. Where used, two instruments should be carried; when reading they should be held horizontal and the crystal rapped sharply with the finger nail to free the needle if caught, which often happens. Any important elevations should be determined at least twice, and a return trip made to the original datum point to check the instrument.

The general rise and fall can be determined by the aneroids.

The approximate location of the road for different ruling grades can be traced with the Abney level.

A rough traverse can be run with the pocket compass or prismatic compass.

Distances can be obtained by pacing (pedometer or hand counter) by timing if on horseback, by scaling from reliable maps, or by auto-meter if on an existing road.

Cross-sections are determined by the Abney level and are taken and recorded at sufficient intervals to show the general slope of the side hill.

Classification of excavation and the cut slopes at which excavation will stand depends on the judgment of the engineer but must be systematically recorded.

Drainage should be carefully estimated, particularly the larger structures, as this item forms a large percentage of the cost of low-type roads.

Clearing and grubbing are recorded by section.

Each engineer has his own ideas about notes and it makes little difference how the data are recorded so long as they are clearly and

definitely set down in such a way that anyone can retrace the route and reestimate the cost without additional field work.

The main faults of reports and notes are that they are not sufficiently clear on facts; they generally run strong on generalities and judgment and are not worth the paper they are written on if the author is not available to explain in detail.

A well-arranged report should either summarize the conclusions at the beginning and explain in detail later or be indexed so that the conclusions can be readily located. A preliminary estimate should be rounded out to even figures, as amounts figured to single yards or costs figured to odd figures of less amount than 10% of the total cost are merely ridiculous and show that the estimator has lost track of the relative accuracy of his work.

The following form of notes serves in a satisfactory way when supplemented by photographs, sketches, and text descriptions.

Detail suggestions on photography are given on page 818.

Tables 128 and 129 (pp. 786 and 795) serve to give a rough approximation of the amount of excavation required.

Drainage costs can be estimated on the standard structures required by the state or government for whom the work is being done or can be approximated by reference to the various standard structures and costs shown in Chap. IV and Table 133 (p. 797). Various miscellaneous information convenient for preliminary estimates are given on page 796. A rough approximation of magnetic declination can be determined from the isogonic charts (pp. 800 to 806).

Explanation of Table 128 (Pages 786 to 793)

NOTE.—Quantities determined graphically, using one-way crown for single-track roads on all cross-slopes; the two-way crown for double-track roads on cross-slopes of 5, 10, and 15° and the one-way crown on cross-slopes above 15°.

If for any reason it is desired to use a two-way crown on single-track roads for cross-slopes below 15°, reduce the quantities shown in the table by about 25%. For the use of a two-way crown above 15° cross-slope, special computations will have to be made.

To illustrate the use of this table the approximate excavation for the notes shown in Fig. 265 (p. 784) will be figured.

From Stas. 0 to 5 the natural side or cross-slope of the ground is given as 5°. In this case a turnpike section can be used, say T-12. Turn to page 786 and under Sec. T-12 for a 5° cross-slope the excavation is given as 33 cu. yd. per 100', or 165 cu. yd. for 500 ft. This will be increased 20% according to judgment for profile inequalities which gives 200-cu. yd. earth excavation from Stas. 0 to 5.

From Stas. 5 to 10 there is a 15° cross-slope. Suppose an estimate for a minimum-width single-track road S-10 is being figured. Look on page 787, and for a cross-slope of 15° and a cut slope of 1:1 the table gives 46 cu. yd. per 100', or 230 cu. yd. for 500'. Increase this by, say, 20% for inequalities in profile, which gives 276 cu. yd. Estimate the percentage of this classed as rock,

say, 10%, and the result is 250 cu. yd. for common excavation and 26 cu. yd. of solid rock.

In a similar way estimate Stas. 10 to 20.

From Stas. 20 to 25 the notes record a ground cross-slope of 35° . This calls for a retaining-wall section (see p. 792), Sec. W-8 for a 35° cross-slope. The table gives the following quantities for 100': 55 cu. yd. of wall masonry, 100 cu. yd. of excavation.

Multiply this by 5 for 500', add a percentage for inequalities of profile, and estimate per cent of solid rock.

From Stas. 25 to 30 the notes show a rock ledge with a face slope of 50° . This calls for a section benched out of the solid ledge. See page 793, use Sec. S-8, the minimum single-track section for a cross-slope of 50° , which gives 350 cu. yd. Rock excavation per 100', or 1750 cu. yd. for 500'.

If turnout sections for passing rigs are desired, figure the excess quantities by referring to the parts of the table dealing with the double-track widths.

TABLE 128.—BALANCED TURNPIKE SECTIONS USING T-12, T-61, AND T-20

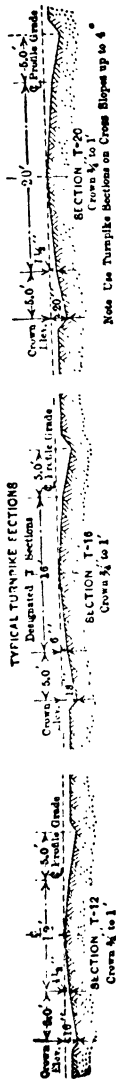

NOTE.—Add from 10% to 50% to the following quantities for inequalities in profile requiring through cuts and fills. These sections are recommended only when the natural cross ground slope is 4% or less.

NATURAL GROUND SURFACE CROSS SLOPE		APPROXIMATE EXCAVATION PER 100' AND PER MILE FOR T-12, T-16 AND T-20		
Degrees	Per Cent.	Cu.yd. per 100'	Cu.yd. per mile	Cu.yd. per 100' Cu.yd. per mile
			Section T-12	Section T-16
				Section T-20
Level	0%	20 cu. yd.	1050 cu. yd.	24 cu. yd.
	5%	33 "	1750 "	41 "
	10%	66 "	3500 "	95 "
				1250 cu. yd.
				2150 "
				4800 "
				35 cu. yd.
				59 "
				115 "
				1850 cu. yd.
				3100 "
				6100 "

NOTE.—For light scraper work of this kind 1.3 yd. of excavation are assumed to make 1 cu. yd. of fill. This ratio is used in computing the balanced section in this table.

TABLE OF APPROXIMATE QUANTITIES BALANCED SIDEHILL SECTIONS MOUNTAIN ROADS USING SECTION S-10 (Single Track)

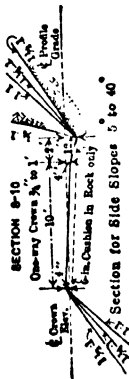

NOTE.—Add from 10% to 50% to the following quantities for inequities in profile due to the alignment not exactly following the grade contour. An addition of 25% is normally about right for moderately rough country. Good judgment in this matter can only be developed by comparing the results obtained from this table with actual finished location designs.

NATURAL GROUND CROSS SLOPE	APPROXIMATE EXCAVATION PER 100' AND PER MILE FOR DIFFERENT CUT AND FILL SLOPES																
	Per Deg. Cent.	Cut Slope	Fill Slope	Cu. yd. per 100'	Cu. yd. per mile	Cut Slope	Fill Slope	Cu. yd. per 100'	Cu. yd. per mile	Cut Slope	Fill Slope	Cu. yd. per 100'	Cu. yd. per mile	Cut Slope	Fill Slope	Cu. yd. per 100'	Cu. yd. per mile
5°	9%	1 1/2:1	1 1/2:1	17	900	1:1	1 1/2:1	16	850	3/2:1	1 1/2:1	13	740	1 1/2:1	1 1/2:1	13	600
10°	18%	1 1/4:1	1 1/4:1	34	1650	1:1	1 1/4:1	30	1600	4:1	1 1/2:1	26	1400	1 1/4:1	1 1/4:1	23	1150
15°	27%	1 1/2:1	1 1/2:1	53	2600	1:1	1 1/2:1	46	2400	4:1	1 1/2:1	42	2200	1 1/2:1	1 1/2:1	37	1850
20°	36%	1 1/2:1	1 1/2:1	90	4200	1:1	1 1/2:1	70	3700	3/2:1	1 1/2:1	63	3300	1 1/2:1	1 1/2:1	47	2550
25°	47%	1 1/2:1	1 1/2:1	137	7200	1:1	1 1/2:1	115	6100	3/2:1	1 1/2:1	97	3100	1 1/2:1	1 1/2:1	70	3700
30°	58%	1 1/2:1	1 1/2:1	137	7200	1:1	1 1/2:1	115	6100	3/2:1	1 1/2:1	97	3100	1 1/2:1	1 1/2:1	70	3700
35°	70%	1 1/2:1	1 1/2:1	137	7200	1:1	1 1/2:1	115	6100	3/2:1	1 1/2:1	97	3100	1 1/2:1	1 1/2:1	70	3700
40°	84%	1 1/2:1	1 1/2:1	137	7200	1:1	1 1/2:1	115	6100	3/2:1	1 1/2:1	97	3100	1 1/2:1	1 1/2:1	70	3700

As a general rule a retaining wall section should be used when the natural ground surface cross slope exceeds 30°, except for a solid rock fill which can be raised up to a 40° slope. These balanced sections are computed on the basis that 1.2 cu. yd. of earth excavation will make 1.0 cu. yd. of fill. Where the cut slopes will stand 1/2:1 or 3/4:1 we have assumed that there is sufficient rock so that 1.0 cu. yd. of excavation will make 1.0 cu. yd. of fill allowing for some rock waste that will occur.

TABLE OF APPROXIMATE QUANTITIES BALANCED SIDEHILL SECTIONS MOUNTAIN ROADS SECTION S-14 (Double Track)

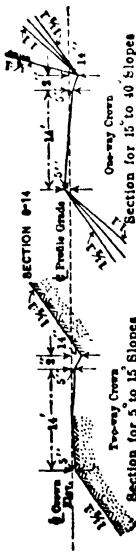

NOTE.—Add from 10% to 50% to the following quantities for inequalities in profile due to alignment not exactly following the grade contour. An addition of 25% is normally about the right value for moderately rough country.

NATURAL GROUND CROSS SLOPE		APPROXIMATE EXCAVATION PER 100' AND PER MILE FOR DIFFERENT CUT AND FILL SLOPES (S-14)															
Deg.	Per Cent.	Cut Slope	Fill Slope	Cu. Yd. per 100'	Cu. Yd. per Mile	Cut Slope	Fill Slope	Cu. Yd. per 100'	Cu. Yd. per Mile	Cut Slope	Fill Slope	Cu. Yd. per 100'	Cu. Yd. per Mile	Cut Slope	Fill Slope	Cu. Yd. per 100'	Cu. Yd. per Mile
5°	9%	1 1/2:1	1 1/2:1	18	1100	1 1/2:1	1 1/2:1	17	900	1 1/2:1	1 1/2:1	13	790	1 1/2:1	1 1/2:1	13	690
10°	18%	1 1/2:1	1 1/2:1	38	2000	1 1/2:1	1 1/2:1	35	1900	1 1/2:1	1 1/2:1	33	1700	1 1/2:1	1 1/2:1	24	1300
15°	27%	1 1/2:1	1 1/2:1	68	3600	1 1/2:1	1 1/2:1	63	3300	1 1/2:1	1 1/2:1	55	2900	1 1/2:1	1 1/2:1	45	2400
20°	36%	1 1/2:1	1 1/2:1	132	7000	1 1/2:1	1 1/2:1	115	6100	1 1/2:1	1 1/2:1	105	5600	1 1/2:1	1 1/2:1	85	4500
25°	47%	1 1/2:1	1 1/2:1	220	11700	1 1/2:1	1 1/2:1	190	10200	1 1/2:1	1 1/2:1	163	8600	1 1/2:1	1 1/2:1	118	6200
30°	58%	1 1/2:1	1 1/2:1	370	17000	1 1/2:1	1 1/2:1	330	15800	1 1/2:1	1 1/2:1	300	15800	1 1/2:1	1 1/2:1	185	9800
35°	70%	1 1/2:1	1 1/2:1	500	22000	1 1/2:1	1 1/2:1	450	21000	1 1/2:1	1 1/2:1	400	18000	1 1/2:1	1 1/2:1	275	14600
40°	84%	1 1/2:1	1 1/2:1	700	30000	1 1/2:1	1 1/2:1	600	28000	1 1/2:1	1 1/2:1	500	24000	1 1/2:1	1 1/2:1	375	17000

As a general rule a retaining wall section should be used when the natural ground slope exceeds 30°, except for solid rock fill which can be used up to 40° slope. These balanced sections are computed and balanced on the basis that 1 cu. yd. of excavation will make 1 cu. yd. of fill. Where the cut slopes will stand at 1 1/2:1 or 1 1/4:1 we have assumed that 1 cu. yd. of excavation will make 1 cu. yd. of fill allowing for rock waste that will probably occur.

TABLE OF APPROXIMATE QUANTITIES BALANCED SIDEHILL SECTIONS MOUNTAIN ROADS USING SECTION S-16



NOTE.—Add from 10% to 50% to the following quantities for inequalities in profile due to alignment not exactly following the grade contour. An addition of 25% is normally about right for moderately rough country. Good judgment in this matter can only be developed by comparing the results obtained from this table with actual finished location designs.

NATURAL GROUND CROSS SLOPE	APPROXIMATE EXCAVATION PER 100' AND PER MILE FOR DIFFERENT CUT AND FILL SLOPES (S-16)														
	Cut Slope		Fill Slope		Cut Slope		Fill Slope		Cut Slope		Fill Slope		Cut Slope		Fill Slope
Deg.	Per Cent.	Cu. Yd. per 100'	Per Mile	Cu. Yd. per 100'	Per Mile	Cu. Yd. per 100'	Per Mile	Cu. Yd. per 100'	Per Mile	Cu. Yd. per 100'	Per Mile	Cu. Yd. per 100'	Per Mile	Cu. Yd. per 100'	Per Mile
5°	9%	1430	1430	2	200	1430	1430	2	200	1430	1430	2	200	1430	1430
10°	18%	2350	2350	5	500	2350	2350	5	500	2350	2350	5	500	2350	2350
15°	27%	5000	5000	15	1500	5000	5000	15	1500	5000	5000	15	1500	5000	5000
20°	35%	10300	10300	40	4000	10300	10300	40	4000	10300	10300	40	4000	10300	10300
25°	47%	17000	17000	100	10000	17000	17000	100	10000	17000	17000	100	10000	17000	17000
30°	58%	24000	24000	200	20000	24000	24000	200	20000	24000	24000	200	20000	24000	24000
35°	70%	30000	30000	300	30000	30000	30000	300	30000	30000	30000	300	30000	30000	30000
40°	84%	35000	35000	400	40000	35000	35000	400	40000	35000	35000	400	40000	35000	35000

As a general rule a retaining wall section should be used when the natural ground slope exceeds 30°, except for solid rock fill which can be used up to 40° slope. These balanced sections are computed and balanced on the basis that 1.2 cu. yd. of excavation will make 1 cu. yd. of fill. Where the cut slopes will stand at 3:1 or 4:1 we have assumed that 1 cu. yd. of excavation will make 1 cu. yd. of fill allowing for rock waste that will probably occur.

APPROXIMATE QUANTITIES BALANCED SIDEHILL SECTIONS MOUNTAIN ROADS USING SECTION S-18

NOTE.—Add from 10% to 50% to the following quantities for inequalities in profile due to alignment not exactly following the grade contour. An addition of 25% is normally about right for moderately rough country. Good judgment in this matter can only be developed by comparing the results obtained from this table with actual finished location designs.

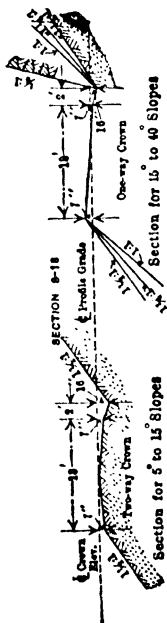

NATURAL GROUND CROSS SLOPE		APPROXIMATE EXCAVATION PER 100' AND PER MILE FOR DIFFERENT CUT AND FILL SLOPES (S-18)															
		Section for 5° to 15° Slopes		Section for 15° to 40° Slopes		Section for 40° to 60° Slopes		Section for 60° to 75° Slopes		Section for 75° to 90° Slopes		Section for 90° to 100° Slopes					
Deg.	Per Cent.	Cut Slope	Fill Slope	Cu. Yd. per 100'	Cu. Yd. per Mile	Cut Slope	Fill Slope	Cu. Yd. per 100'	Cu. Yd. per Mile	Cut Slope	Fill Slope	Cu. Yd. per 100'	Cu. Yd. per Mile	Cut Slope	Fill Slope	Cu. Yd. per 100'	Cu. Yd. per Mile
5°	9%	1 1/2:1	1 1/2:1	33	1750	1 1/2:1	1 1/2:1	32	1700	1 1/2:1	1 1/2:1	32	1700	1 1/2:1	1 1/2:1	27	1430
10°	18%	1 1/2:1	1 1/2:1	67	3500	1 1/2:1	1 1/2:1	60	3200	1 1/2:1	1 1/2:1	57	2950	1 1/2:1	1 1/2:1	41	2200
15°	27%	1 1/2:1	1 1/2:1	115	6200	1 1/2:1	1 1/2:1	102	5400	1 1/2:1	1 1/2:1	94	5000	1 1/2:1	1 1/2:1	80	4200
20°	36%	1 1/2:1	1 1/2:1	240	12700	1 1/2:1	1 1/2:1	185	9800	1 1/2:1	1 1/2:1	170	9000	1 1/2:1	1 1/2:1	128	6800
25°	47%	1 1/2:1	1 1/2:1	410	21100	1 1/2:1	1 1/2:1	292	15400	1 1/2:1	1 1/2:1	242	12800	1 1/2:1	1 1/2:1	185	9800
30°	58%	1 1/2:1	1 1/2:1	630	30500	1 1/2:1	1 1/2:1	435	22900	1 1/2:1	1 1/2:1	351	18700	1 1/2:1	1 1/2:1	278	14700
35°	70%	1 1/2:1	1 1/2:1	900	45000	1 1/2:1	1 1/2:1	600	32400	1 1/2:1	1 1/2:1	500	27000	1 1/2:1	1 1/2:1	380	20400
40°	84%	1 1/2:1	1 1/2:1	1260	63000	1 1/2:1	1 1/2:1	840	45000	1 1/2:1	1 1/2:1	700	37800	1 1/2:1	1 1/2:1	520	28800

As a general rule a retaining wall section should be used when the natural ground slope exceeds 30°, except for solid rock fill which can be used up to 40° slope. These balanced sections are computed and balanced on the basis that 1.2 cu. yd. of excavation will make 1 cu. yd. of fill. Where the cut slopes will stand at 1/2:1 or 1/4:1 we have assumed that 1 cu. yd. of excavation will make 1 cu. yd. of fill allowing for rock waste that will probably occur.

PRELIMINARY INVESTIGATIONS

APPROXIMATE QUANTITIES WALL SECTION MINIMUM

SINGLE-TRACK ROAD, SEC. W-8
DOUBLE-TRACK ROAD, SEC. W-12

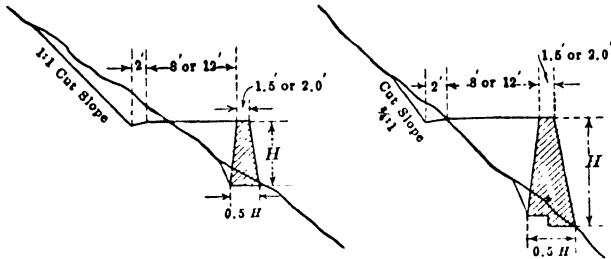

TYPICAL SECTIONS
30° & 35° Slopes
Ditch Excavation Makes
Fill Back of Wall

TYPICAL SECTIONS
40° & 45° Cross Slopes
Borrow Fill Required

NOTE.—Rough rubble masonry walls to have outside face batter of 3" to 1' and a bottom width of $\frac{1}{2}$ the height. The foundation to be carried to a firm strata.

NATURAL GROUND CROSS SLOPE	APPROXIMATE QUANTITIES PER 100' OF ROAD FOR W-8 SECTION				
	Wall Masonry	Ditch Excavation Used in Fill	Borrow Excavation for Balance of Fill	Wall Excavation Waste	Total Excavation
30°	46 cu. yd.	55 cu. yd.	None	15 cu. yd.	70 cu. yd.
35°	55 " "	80 " "	None	20 " "	100 " "
40°	100 " "	30 " "	90 cu. yd.	35 " "	155 " "
45°	135 " "	45 " "	100 " "	45 " "	200 " "

TABLE FOR MINIMUM DOUBLE TRACK SECTION W-12

NATURAL GROUND CROSS SLOPE	APPROXIMATE QUANTITIES PER 100'				
	Wall Masonry	Ditch Excavation Used in Fill	Borrow Excavation for Balance of Fill	Wall Excavation Waste	Total Excavation
30°	65 cu. yd.	100 cu. yd.	None	15 cu. yd.	115 cu. yd.
35°	90 " "	140 " "	None	20 " "	160 " "
40°	180 " "	30 " "	200 cu. yd.	45 " "	275 " "
45°	250 " "	45 " "	250 " "	80 " "	375 " "

NOTE.—Above 45° ground slope use Rock Bench Sections, except in unusual cases.

* Retaining wall section on 30° cross slope is not usually economical.

TABLE OF APPROXIMATE QUANTITIES ROAD BENCHED OUT OF ROCK

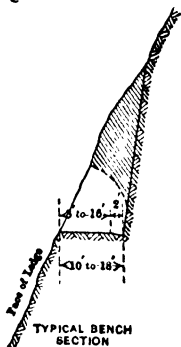

Using S-8, S-10, S-12, S-14, S-16

Natural Slope of Face of Rock Ledge	Cut Slope	Approximate Excavation in Cu. Yd. per 100' for Different Sections				
		*S-8	S-10	**S-12	S-14	S-16
50°	3/4:1	350 cu yd	500 cu yd	660 cu yd	370 cu yd	1,100 cu yd
60°	3/4:1	600 " "	850 " "	1,200 " "	1,550 " "	2,000 " "
70°	Vertical	560 " "	800 " "	1,050 " "	1,400 " "	1,800 " "
80°	Half Tunnel	460 " "	550 " "	680 " "		

* Minimum width single track in rock.

** Minimum width double track in rock.

APPROXIMATE AMOUNTS OF EMBANKMENT AND EXCAVATION FOR DIFFERENT CENTER-LINE CUTS AND FILLS, GROUND SURFACE ASSUMED LEVEL

(See page 794.)

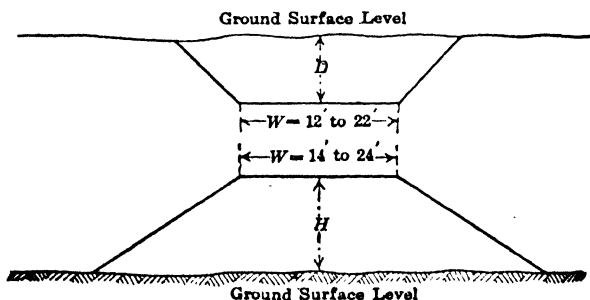

TABLE 129.—APPROXIMATE YARDAGE PER 100 FEET FOR CUT SECTIONS

Center Line Cut in Feet	W = 12'		W = 14'		W = 16'		W = 18'		W = 20'		W = 22'	
	Cut Slope 1½:1	Cut Slope 1:1	Cut Slope 1½:1	Cut Slope 1:1	Cut Slope 1½:1	Cut Slope 1:1	Cut Slope 1½:1	Cut Slope 1:1	Cut Slope 1½:1	Cut Slope 1:1	Cut Slope 1½:1	Cut Slope 1:1
0.5	24	23	27	27	31	30	35	34	38	38	42	42
1.0	50	48	57	55	65	63	72	70	80	80	87	85
1.5	79	75	90	86	101	97	112	108	124	120	135	131
2.0	111	104	126	119	141	134	156	149	170	163	185	178
2.5	146	134	164	152	183	171	201	189	220	208	238	226
3.0	183	167	205	189	228	212	250	234	272	256	294	278
3.5	224	201	250	227	276	253	302	279	328	305	354	331
4.0	266	237	296	267	325	296	355	326	385	356	414	385
4.5	312	275	345	308	379	342	412	375	445	408	479	442
5.0	361	315	398	352	435	389	472	426	510	463	546	500
6.0	467	400	511	444	556	489	600	533	645	578	689	622
7.0	583	492	635	544	687	596	738	647	790	699	842	751
8.0	711	592	770	651	830	711	889	770	948	829	1007	888
9.0	850	690	916	766	982	832	1050	900	1116	966	1183	1033
10.0	1000	814	1074	888	1148	962	1222	1036	1296	1110	1370	1184
12.0	1333	1067	1422	1156	1511	1245	1600	1334	1689	1423	1778	1512
14.0	1711	1348	1815	1452	1919	1556	2023	1660	2127	1764	2231	1868
16.0	2133	1660	2251	1778	2369	1896	2488	2015	2607	2134	2726	2253
18.0	2600	2000	2733	2133	2866	2266	3000	2400	3133	2533	3266	2666
20.0	3111	2370	3259	2518	3497	2666	3555	2814	3703	2902	3852	3111

TABLE 129.—APPROXIMATE YARDAGE PER 100 FEET FOR FILL SECTIONS—Continued

Center Line Fill = H in Feet	W = 14' W	W = 15' W	W = 16' W	W = 17' W	W = 18' W	W = 19' W	W = 20' W	W = 21' W	W = 22' W	W = 23' W	W = 24' W	W = 26'
	Fill Slope 1½:1	Fill Slope 1½:1	Fill Slope 1½:1	Fill Slope 1½:1	Fill Slope 1½:1	Fill Slope 1½:1	Fill Slope 1½:1	Fill Slope 1½:1	Fill Slope 1½:1	Fill Slope 1½:1	Fill Slope 1½:1	Fill Slope 1½:1
0.5	27	29	31	33	35	37	38	40	42	44	46	50
1.0	57	61	65	69	72	76	80	84	87	91	95	102
1.5	90	95	101	106	112	118	124	129	135	140	146	157
2.0	126	134	141	149	156	164	170	178	185	193	200	215
2.5	164	173	183	192	201	210	220	229	238	247	256	275
3.0	205	216	228	239	250	261	272	283	294	305	316	339
3.5	250	263	276	289	302	315	328	341	354	367	380	406
4.0	296	310	325	340	355	369	385	400	414	429	444	474
4.5	345	362	379	396	412	429	445	462	479	496	513	546
5.0	398	416	435	453	472	490	510	528	546	564	582	620
6.0	511	533	556	578	600	622	645	667	689	711	733	778
7.0	635	661	687	712	738	764	790	816	842	868	894	945
8.0	779	800	830	860	889	919	948	978	1007	1037	1067	1126
9.0	916	949	982	1015	1050	1083	1116	1149	1183	1216	1250	1317
10.0	1074	1111	1148	1185	1222	1259	1296	1333	1370	1407	1444	1518
12.0	1422	1466	1511	1555	1600	1644	1689	1733	1778	1823	1867	1956
14.0	1815	1867	1919	1971	2023	2075	2127	2179	2231	2284	2336	2439
16.0	2251	2310	2369	2429	2488	2547	2607	2666	2726	2785	2844	2963
18.0	2733	2800	2866	2933	3000	3067	3133	3200	3266	3333	3400	3533
20.0	3259	3333	3407	3481	3555	3629	3703	3777	3852	3926	4000	4148

MISCELLANEOUS INFORMATION OF VALUE IN MAKING PRELIMINARY INVESTIGATIONS AND ESTIMATES

TABLE 130.—CONVERSION PER CENT OF GRADE TO DEGREES OF
VERTICAL ANGLE

(For use in tracing grade with transit or Abney Level)

Per Cent.	Degrees	Per Cent.	Degrees
1	0° 35'	9	5° 09'
2	1° 09'	10	5° 43'
3	1° 43'	11	6° 17'
4	2° 18'	12	6° 51'
5	2° 52'	13	7° 24'
6	3° 26'	14	7° 58'
7	4° 00'	15	8° 32'
8	4° 35'		

TABLE 131.—TABLE OF ACRES PER STATION OF 100 FEET AND PER
MILE FOR DIFFERENT WIDTHS OF CLEARING OR RIGHT
OF WAY

Width of Strip	ACREAGE	
	Per 100'	Per Mile
30 ft	0.069 acres	3.636 acres
40 "	0.092 "	4.849 "
50 "	0.115 "	6.061 "
60 "	0.138 "	7.273 "
70 "	0.161 "	8.485 "
80 "	0.184 "	9.697 "
90 "	0.207 "	10.900 "
100 "	0.230 "	12.121 "

TABLE 132.—RANGE IN UNIT ESTIMATE PRICES (1918 COST
CONDITIONS ROCKY MOUNTAIN DISTRICT)

Clearing and grubbing:

Sage brush.....	\$ 10—\$ 50 per mile
Light clearing.....	20— 60 per acre
Medium clearing.....	60— 150 per acre
Heavy clearing.....	150— 300 per acre

Excavation:

Common:	
Machine turnpiking.....	\$ 0.15—\$ 0.25 per cu. yd.
Wheel scraper and machine finish	0.25— 0.35 per cu. yd.
Wagon haul and machine finish	0.40— 0.60 per cu. yd.
Side-hill plow, scraper, and machine.....	0.35— 0.75 per cu. yd.

TABLE 132—Continued

<i>Disintegrated rock or dry, hard clay:</i>	
Considerable hand work or shooting.....	0.75- 1.00 per cu. yd.
<i>Solid rock:</i>	
Blasting open cut, per cubic yard	0.80- 2.00 per cu. yd.
Tunnel work.....	4.00- 5.00 per cu. yd.
Retaining walls:	
Rough dry rubber masonry.....	1.00- 3.00 per cu. yd.
Mortar rubber.....	4.00- 8.00 per cu. yd.
Concrete.....	6.00-20.00 per cu. yd.
Timber and lumber.....	30.00-80.00 per cu. yd.
Carpenter work:	
Simple structures.....	\$ 5.00-10.00 per M ft. B.M.
Truss framing, etc.....	10.00-20.00 per M ft. B.M.

TABLE 133.—APPROXIMATE COST PER FOOT OF LENGTH, SMALL DRAINAGE STRUCTURES

Size of Opening	KIND OF STRUCTURES				
	Vitrified Pipe	Corrugated Metal Pipe	Cast Iron Pipe	Concrete Boxes	Log Culverts
12"	\$0.60	\$1.25	\$2.00		
15" or 16"	0.90	1.50	2.90		
18"	1.10	1.80	3.40		
24"	2.00	2.75	5.50		
36"	3.75	4.00			
48"		6.50			
2' X 2'				3.75	\$1.50
2' X 3'				4.80	1.70
3' X 3'				5.40	2.30
3' X 4'				6.00	2.80
4' X 4'				6.75	3.00
4' X 5'				8.00	3.60
5' X 5'				8.70	4.00

* Based on \$50 per ton in place.

** Based on \$10 per cubic yard in place.

Culvert Data.—Local conditions must be considered in prices of materials, haul, etc., for a close estimate.

Table 199 (p. 1080) gives weights of corrugated pipe.

Table 197 (p. 1079) gives weights of cast-iron pipe.

Quantities of concrete can be figured from standard designs given in Chap. IV.

Timber in superstructures can be figured from standard designs in Chap. IV.

The summarized data shown in Table 133 will, however, act as a rough guide.

TABLE 134.—AMOUNTS OF MASONRY IN TWO ABUTMENTS AND FOUR WINGS FOR VARIOUS HEIGHTS OF ABUTMENT FOR SMALL-SPAN TIMBER BRIDGE SUPERSTRUCTURES WITH 16' ROADWAY

(*H* = height from bottom of foundation to bridge seat)

<i>H</i> in Feet	CUBIC YARDS	
	Concrete	Masonry
6	24 cu. yd.	29 cu. yd.
7	32 " "	38 " "
8	40 " "	49 " "
9	52 " "	60 " "
10	62 " "	74 " "
12	90 " "	105 " "
14	133 " "	153 " "
16	180 " "	200 " "
18	230 " "	260 " "
20	295 " "	325 " "

Compiled from Plate 74, (p. 265).

TABLE 135.—APPROXIMATE AMOUNT OF TIMBER IN SMALL-SPAN STRINGER BRIDGE SUPERSTRUCTURES HAVING 16' ROADWAY AND FIGURED TO CARRY A 20-TON LOAD

(Figured from Plate 79, p. 294)

Clear Span	Feet B. M.	Pounds Hardware
6 ft.	1000	70 pounds
8 "	1400	90 "
10 "	1700	110 "
14 "	2500	130 "
18 "	3300	150 "

NOTE.—For timber spans 30 to 50', see Plates 81 and 82 (pp. 301 to 302).

Pile abutments can be figured from Plate 79, (p. 294).

Net Volume of Logs in Board Measure.—A convenient approximate rule for computing the net number of feet, board measure, of sawed timbers in logs is as follows:

$\frac{\text{Diameter in inches} \times \text{radius in inches}}{12} = \text{Feet, board measure, per foot of log.}$

Example.

Suppose a log 10' long, 12" in diameter.

$\frac{\text{Diameter} \times \text{radius}}{12}$ = number of feet, board measure, per foot
of log.

$$\frac{12 \times 6}{12} = 6' \text{ B. M. per foot} \times 10' = 60' \text{ B. M.}$$

Steel Bridges.—The diagrams on page 763 taken from various sources will serve as a basis for rough estimates on longer-span steel highway bridges. They are figured for a live load of 100 lb. per square foot and presumably for a plank floor. They are of much lighter construction than called for on heavy-traffic roads where solid floors and a heavier loading are gaining favor.

These diagrams are useful as a basis of estimating dead loads of old bridges. The amounts of steel for modern bridges is given on pages 760 and 761.

Magnetic Declination.—The following isogonic charts give the approximate magnetic declination for states east and west of the Mississippi for Jan. 1, 1915. The yearly change is given. These charts will give a value close enough for preliminary investigation purposes. For meridian determination for location surveys, see Chap. XIII, Polaris and Solar Meridians.

Explanation of Plates pages 800 and 806 (Taken from U. S. Coast and Geodetic Chart)

The solid lines on these charts are lines of equal magnetic declination.

The dot and dash lines are lines of equal yearly rate of change in the magnetic declination.

The charts show the magnetic declination for Jan. 1, 1915.

Lines marked "East Declination" mean that the north end of the magnetic needle points east of true north.

Lines marked "West Declination" mean that the north end of the needle points west of true north.

For localities east of the line of no annual change the north end of the magnetic needle is moving west. For localities west of this line it is moving east at the rate shown by the lines of annual change. The location of the line of no annual change is shown on pages 804 to 806.

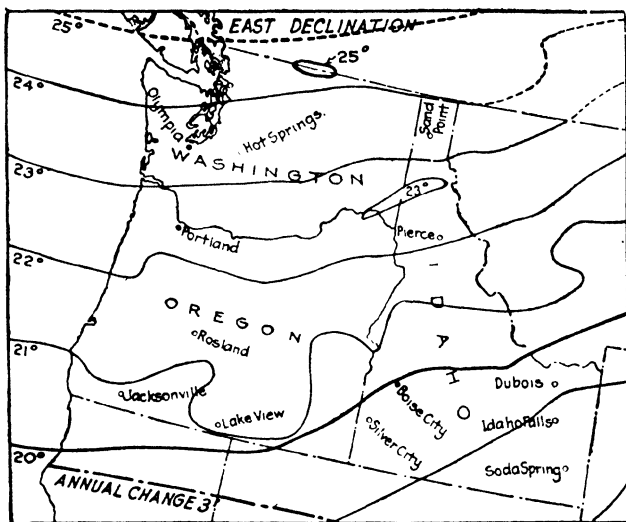

FIG. 266.—Magnetic declinations (1915).

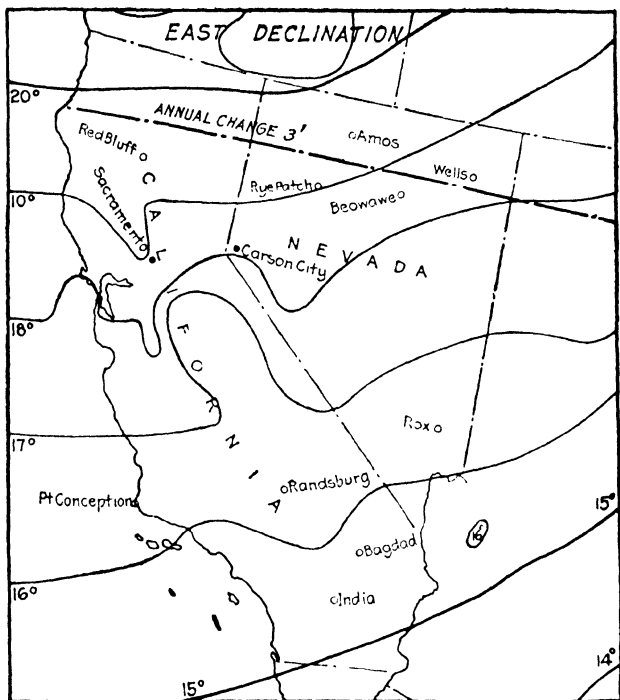

FIG. 266.—Magnetic declinations (1915).—(Continued.)

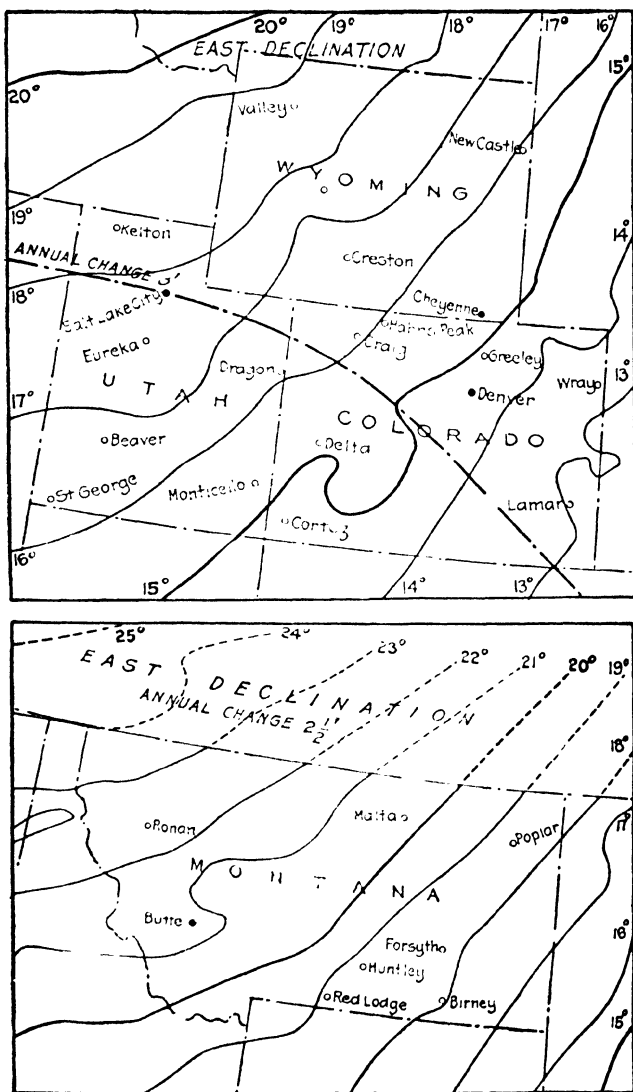

FIG. 266 —Magnetic declinations (1915).—(Continued.)

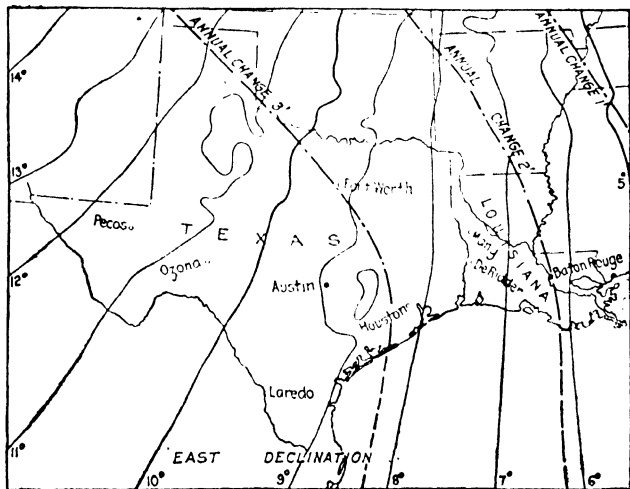
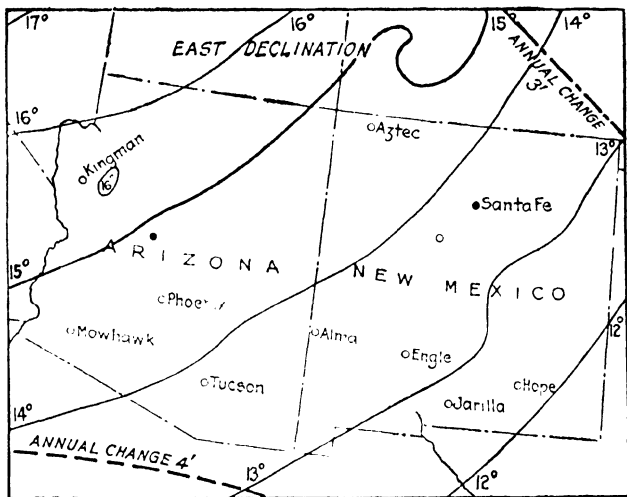

FIG. 266.—Magnetic declinations (1915).—(Continued.)

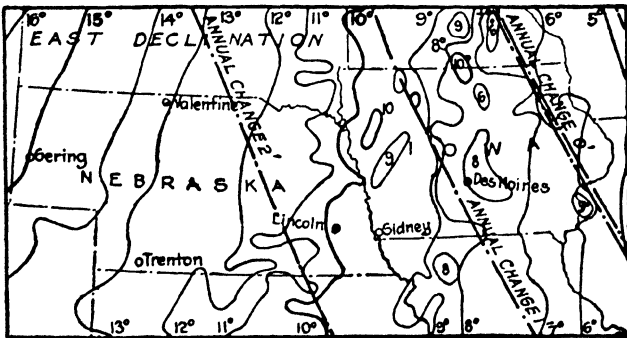
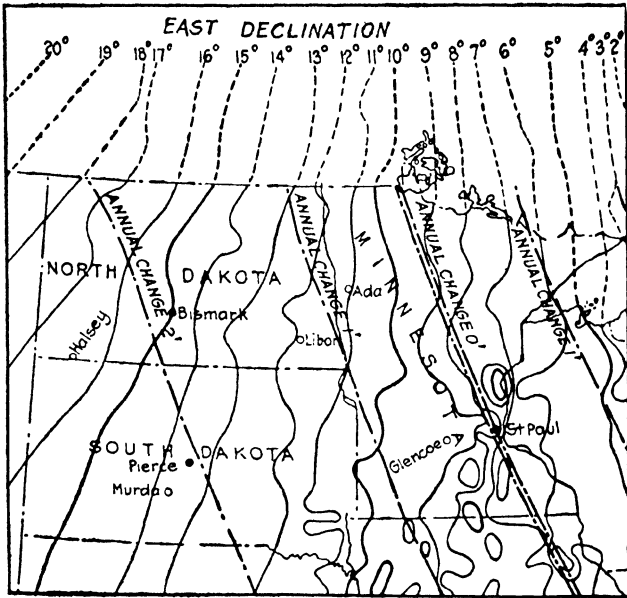

FIG. 266.—Magnetic declinations (1915).—(Continued.)

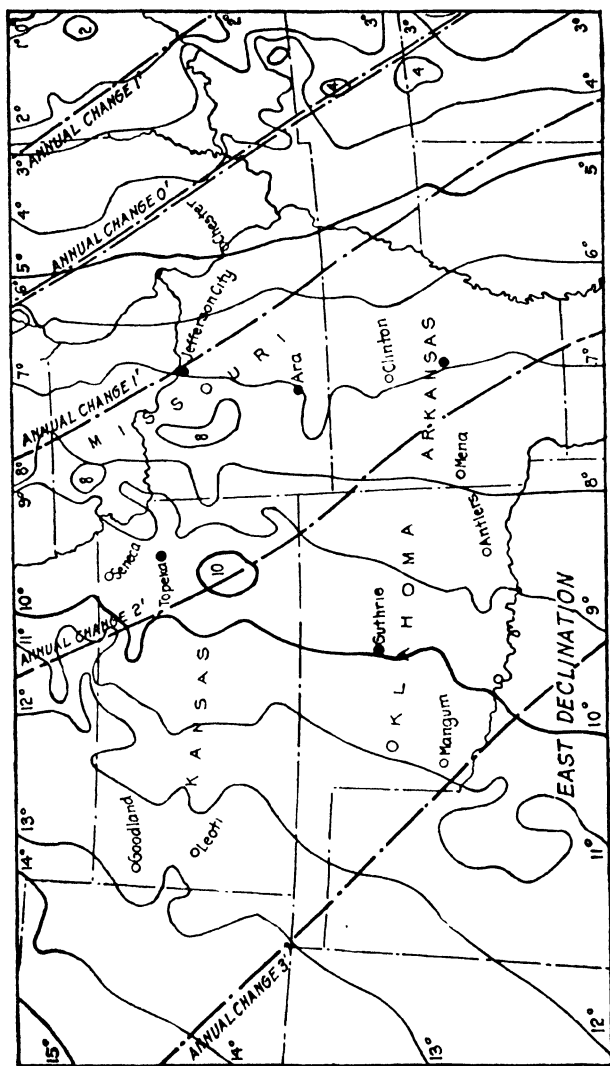

FIG. 266.—Magnetic declinations (1915).—(Continued.)

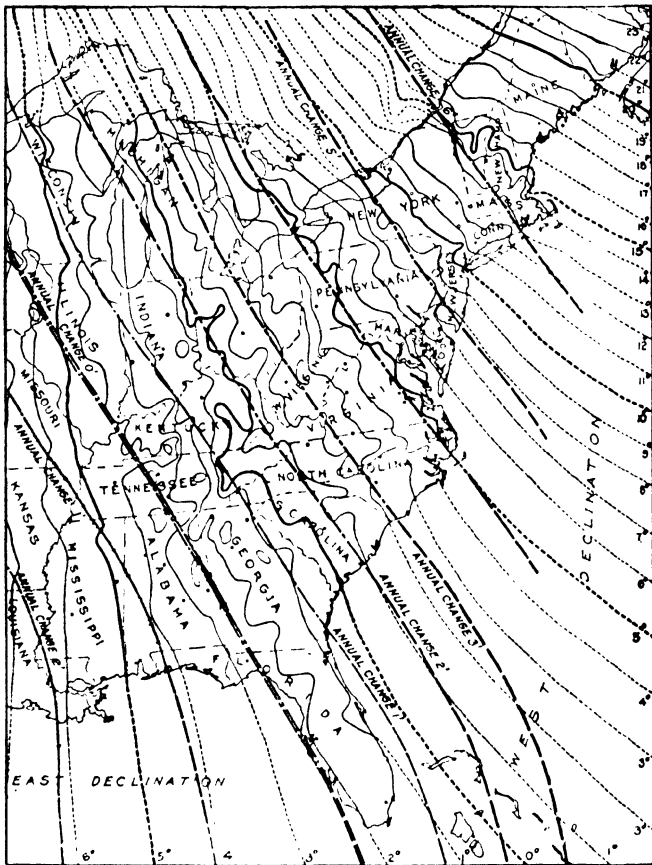

FIG. 266.—Magnetic declinations (1915).—(Continued.)

The following sample report shows a form in ordinary use for preliminary investigations, which covers the information required.

REPORT ON PRELIMINARY INVESTIGATION OF THE RED GAP-BIG BEAR RANCH HIGHWAY IN PATERSON AND GRANT COUNTIES, STATE OF _____, 1919

"State Commissioner of Highways,

"Dear Sir:

"Complying with your request of May 10, a preliminary investigation of the proposed Red Gap-Big Bear Ranch Highway was made June 1 to 10.

"There is only one feasible route, via Clear River Ranch, Coal Basin, Stray Horse Divide, See Creek, and Blackwater River, a total distance of 30 miles. This route is free from snow 7 months in the year. A double-track road from Red Gap to Coal Basin and a single-track road with turnouts and permanent drainage structures for the remaining distance will cost approximately \$175,000.

"In case the entire project cannot be undertaken by one appropriation, I recommend the following order of construction of the various sections shown on the accompanying map (p. 268).

- First in importance G 4, G 5,
 - Second in importance G 7,
 - Third in importance G 6,
 - Fourth in importance G 2, G 3,
 - Fifth in importance G 1, P 1, P 2,
 - Sixth in importance P 3, P 4,
 - Seventh in importance P 5.
- The report in detail follows.

Signed,
Field Engineer.

TABLE OF CONTENTS

	Page
1. Introduction	807
2. Length in Counties and Benefits.	808
3. Methods of Investigation.	808
4. Present Condition Roads and Trails	808
5. General Topography.	808
6. Proposed General Route	809
7. Controlling Points.	810
8. Description between Controlling Points.	810
9. Recommendations and General Costs.	811
10. Detail Estimate.	811
(a) Classification of Material	811
(b) Unit Prices Used.	812
(c) Division into Sections.	812
(d) Estimate by Sections.	812
11. Maps and Photographs.	

"The field notes on which this report is based can be found in Field Book 153, Preliminary Investigation file.

1. Introduction

"It is proposed to build a new road over Stray Horse Divide connecting the valleys of the Clear and Blackwater Rivers and to improve the location, grade, and width of the existing roads in these valleys. The highway will extend from Red Gap in Paterson County to Big Bear Ranch in Grant County, a distance of approximately 30 miles. It will open up a valuable farming section on the upper Blackwater River and will afford more direct communication between these two counties.

2. Length in Counties and Benefits

"**Paterson County.**—Red Gap to Stray Horse Divide, 8 miles.

"**Grant County.**—Big Bear Ranch to Stray Horse Divide, 22 miles.

"Paterson County will be benefited by a better and quicker connection with communities to the south and by the large amount of tourist travel which will undoubtedly use this road.

"Grant County will gain a more direct route to an isolated portion of its territory and will help the development of a promising farming section on the upper Blackwater River.

"While none of this road lies in Socorro County, this county will be more directly benefited than Paterson County, as the natural outlet for trade and produce up the Blackwater lies toward Lochiel.

3. Methods of Investigation

"**Field Work.**—The entire line was covered twice on foot June 1 to 10, noting the controlling points (aneroid elevations), the general classification of materials, the side-hill slopes, and reasonable ruling grades.

"**Office Work.**—The office estimate is based on paced distances checked by Forest Service maps and maps of the Clear River R. R.

"The excavation per running foot on side-hill work is based on cross-slopes taken with an Abney level at frequent intervals and is figured on the principle of balanced side-hill sections, adding different percentages for inequalities in profile.

"The classification of excavation is made roughly from notes on the general character of the formations.

"The drainage is approximated for the smaller structures. The larger bridges are noted in more detail.

"Estimates have been prepared for various widths of roadway.

4. Present Condition of Roads and Trails

"**Paterson County** (Red Gap to Stray Horse Divide).—There is a fair wagon road from Red Gap to Clear River Ranch, about 2 miles south; a solid but poor wagon road from this point to Coal Basin; a fair road from Coal Basin to Stray Horse Station, and a well-marked but steep trail from this point to the top of Stray Horse Divide.

"**Grant County** (Stray Horse Divide to Big Bear Ranch).—There is an easy trail from Stray Horse Divide to Blackwater River, approximately 8 miles; a very poor wagon road down Blackwater River from See Creek to Adams Ranch, approximately 9 miles. The road between these points crosses the river eight or ten times by fords and cannot be used at all if the water is much above low stage. Under the best conditions a good team cannot haul over 1 ton.

"From Adams Ranch to Big Bear Ranch (about 5 miles) the road is poor and dangerous in many places. It is so steep that 1½ tons is about the maximum load for an exceptionally good team under the best conditions.

"While this project ends at Big Bear Ranch it should be noted that if the road from this point to Lochiel in Socorro County, the nearest railroad point, is not improved the value of this project will be practically lost. The present road to Lochiel is dangerous, limits a team load to about 1½ tons, and will be an expensive road to improve. I estimate roughly that \$40,000 will be required to put it into reasonably good shape.

5. General Topography

"**Paterson County** (Red Gap to Stray Horse Divide. See photographs 1 to 10).—From Red Gap south for about 2½ miles the topography is abrupt. Red sandstone and conglomerate cliffs and dykes hold the road location closely to the Clear River. From this point to about ½ mile south of Coal Basin occasional cliffs occur, but a careful location will avoid them and it will be possible to gain some elevation along the sides of the valley. From the point to Stray Horse Divide and for a couple of miles south of the pass there are no cliffs, and while the slopes are steep, averaging 25 to 40°, the location can be placed at any desired elevation. This strip of country is fortunately favorable to location.

"Grant County (See photographs 11 to 30).—From Stray Horse Divide to Thompson's Ranch the formation is favorable for location on any desired grade. Few rock outcrops occur. The slopes average 20 to 25°.

"From Thompson's Ranch down See Creek is an ideal road location. No solid rock, very little loose rock, easy water grade. The side slopes average 10° for one-half the distance and 20° for the balance of the way.

"From the junction of See Creek and Blackwater River down the east side of the Valley to Buck Creek the location is easy on a side hill, averaging 25° side slope. There are no rock outcrops and very little loose rock. An easy grade can be obtained.

"From Buck Creek to Spring Creek along the side hill on the east side of Blackwater River the following conditions prevail: Average side-hill slope 30°; $\frac{1}{2}$ mile of rock-ledge slope of face approximately 60°. Expensive work cannot well be avoided, but an easy grade can be obtained.

"From Spring Creek to Adams' Ranch the formation on the east side of the valley is favorable for location at some distance away from the river. A ruling grade of 5% can be obtained at the worst places and ordinarily the grade is light. Benches and side-hill slopes are easy, averaging 15° for one-half the distance and 30° for the remainder.

"From Adams' Ranch to Big Bear Ranch the best location lies on the west side of the valley. Difficult country is encountered—heavy scrub-oak brush, many large boulders, and considerable solid rock. The river changes its channel frequently and any permanent road location must be placed beyond its reach, necessitating expensive work.

"The natural soil from Big Bear Ranch to Adams' Ranch is very slippery when wet. To get a good safe road Creek Gravel should be used as surfacing. Unless the roadbed is sloped toward the hill (one-way crown) any of this location will be dangerous in wet weather. This same condition applies in a less marked degree all the way up Blackwater River to See Creek.

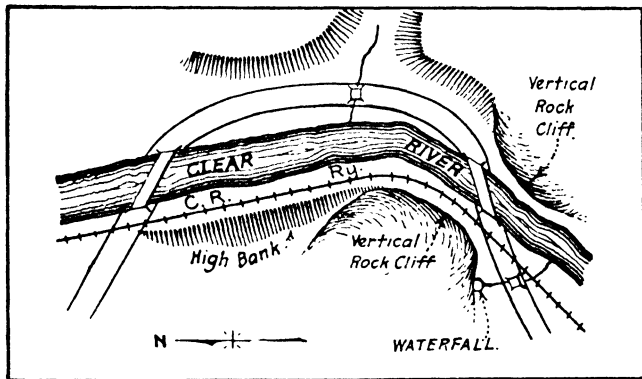

FIG. 267.

6. Proposed General Route

"Paterson County.—From Red Gap, the proposed road follows the present road, with some modifications to avoid unnecessary rise and fall, to the first crossing of the Clear River about 1 $\frac{1}{4}$ miles south of Red Gap. From this point to the mouth of the Canyon, about $\frac{1}{2}$ mile, the location is open to argument. The existing road crossed the river twice (see sketch). Both of these bridges were wrecked by the flood of 1918 and temporarily the travel is using the railroad track between these points.

"With the permission of the railroad it would be possible to widen out the cut on the west side of the track and tunnel or half tunnel for about 500' around the rock bluff point, eliminating the two bridges and two railroad

crossings. On the other hand, the road would be very close to the track for $\frac{1}{4}$ mile and would in my opinion be more dangerous for horse traffic than the old location requiring two bridges. The bridge location is recommended.

"From the mouth of the gorge the road will follow approximately the location of the present highway to the top of Canyon Hill and thence on a new location along the west side of the Clear River Valley to Stray Horse Divide.

"Grant County.—Beginning at the county line at Stray Horse Divide a new location will follow down the north side of See Creek to a point about $2\frac{1}{2}$ miles southwest of Thompson's Ranch and thence along the south and east side of See Creek and Blackwater River to Adams' Ranch. At Adams' Ranch the road will cross to the west side of the valley and remain on this side to Big Bear Ranch, the end of the proposed improvement varying somewhat from the location of the present road to better short sharp grades and to avoid creek flood areas.

7. Controlling Points (Aneroid Elevations)

Paterson County:	
Stray Horse Divide	9200
Bench between cliffs at Coal Basin.....	8200
Top of Canyon Hill	8100
Bottom of Canyon Hill.....	7930
Red Gap	7800
Grant County:	
Stray Horse Divide.....	9200
Thompson's Ranch.....	7900
$2\frac{1}{2}$ miles southwest of Thompson's (see Creek Crossing).....	7500
Bench between cliffs between Buck and Spring Creek	7150
Adams Ranch	6780
Big Bear Ranch.....	6600

8. Description of Location Problems between Controlling Points Paterson County

"Stray Horse Divide to Coal Basin.—The difference in elevation of these two points is approximately 1000'. The direct distance is about $1\frac{1}{2}$ miles. In order to get a good grade and come somewhere near Coal Basin, which is probably desirable, it will be necessary to run south from Stray Horse Divide and then turn north. In this way any required ruling grade can be obtained and the length of road will depend entirely on the grade selected. The switchback can be made without too great cost by a careful location. I recommend a 5% grade with a length of 4 miles. The road, in general, will follow the contours. Two pronounced gulleys are crossed which can be bridged or filled as determined on the location survey.

"By the use of a 6 to 7% grade it is possible to run direct from Stray Horse Divide to the top of Canyon Hill. This solution should be carefully investigated, but does not seem to be as good as the 5% location, as the topography is not as favorable for location and, while it is shorter, the lighter grade is to be preferred and the extra length of road south of the divide will be utilized in the future as a part of the road to Stone Quarry.

"Coal Basin to Top of Canyon Hill.—Approximate length $1\frac{3}{4}$ miles. Along contour of steep side hill for approximately $\frac{3}{4}$ mile and then along bench cut up by small swales and knolls. No special features. Grade any convenient to fit topography. No grade problem on this section. Excavation largely earth and loose rock. One 20' span bridge required.

"Top of Canyon Hill to Bottom of Canyon Hill at Mouth of Gorge.—Approximate length 0.6 mile. Along side of Canyon following present highway closely. Largely a question of equalizing grade by cut and fill. From aneroid elevations and Abney level, I judge that a 6% grade can be obtained. Certainly, a 7% can be built. This section of the road will be expensive and will govern the ruling grade from Red Gap to Stray Horse Divide. The excavation will be approximately 50% solid rock. One 20' span bridge will be required.

"Mouth of Gorge (at Bottom of Hill) to Red Gap.—Approximate length 2 miles. From mouth of gorge $\frac{1}{4}$ mile south to wagon road on the west side of the river the location is the most expensive of the entire project. This strip will require either two bridges or heavy rock work, as previously dis-

cussed. The bridges are recommended. From this point to Red Gap there are no difficult problems, as the road will follow, in general, the present location and can be cheaply built. Another bridge at Red Gap will better the location and increase the convenience of the road.

Grant County

"Stray Horse Divide to Thompson's Ranch.—The difference in elevation is approximately 1300'. It is desirable to get down to a natural bench at Thompson's ranch. The length of road between these points will depend on the ruling grade selected. As it is a long climb, I recommend 5% with a length of 5 miles, which can be obtained with one switchback turn. The country is favorable for location. Excavation is largely earth and some loose rock.

"Thompson's Ranch to See Creek Crossing.—Approximate length 2½ miles. Ideal road location on bench. Easy grade. Excavation practically all earth. Plow and machine scraper work. No grade problem. One 20' span bridge required.

"See Creek Crossing to Buck Creek.—Easy side-hill location except for ¼ mile of rock ledge near Buck Creek. The location should keep upon the side hill to avoid abrupt river banks and slides due to freshet scour.

"Buck Creek to Adams' Ranch.—Easy sidehill and bench location. No difficulty in obtaining grades less than the maximum. Excavation earth and loose rock.

"Adams' Ranch to Big Bear Ranch.—Location problem one of protecting road from river floods, also avoiding ledge and large boulder rock work. No hard grade problem. Excavation 50% loose rock, boulders, and solid ledge.

9. General Recommendations and Costs

"The cost of construction under present conditions is uncertain. The prices used in the following detail estimates should be carefully noted in considering the possibility of cheapening the work by the use of convict labor. The costs used are for contract work and may vary greatly in a short time.

"I recommend for this project a double-track side-hill section (S-14') from Big Bear Ranch to Coal Creek; a single-track side-hill section (S-10) with turnouts from Coal Creek up to Blackwater River, See Creek over the Divide, and down to the top of Canyon Hill in Paterson County. A double-track road from this point to Red Gap. Permanent culverts and bridges. Ruling grades of short 7% and long 5%. Alignment limited, as a rule, to a minimum curvature of 100' radius with a few 40' radii at exceptionally bad places.

"The cost of this type of road is estimated at approximately \$175,000, divided as follows:

Clearing and excavation.....	\$108,000
Permanent culverts.....	20,000
Permanent bridges over 10' span.....	35,000
Engineering.....	12,000
Total.....	\$175,000

"If it is not possible to construct the entire project by one appropriation, it would be well worth while to build from Big Bear Ranch to See Creek at once to open up the new farming section on the Upper Blackwater. The cost of this portion of the road would be about \$70,000.

"For details and various combinations of design see the following estimates by sections.

10. Detail Estimates

"Classification of Materials.—The classification of excavation cannot be accurately made; it is based on the following assumptions.

"Where the road is located on a bench near the bottom of a slope which appears to be slide or wash formation and no rock outcrops are visible, the excavation is classed as 99% common and 1% rock.

"Where the location is on a steep main mountain slope of 25 to 35° covered with loose rock but no solid rock outcrops are visible, the assumption has been that solid rock will be encountered 6' back of the slope surface.

"Where occasional outcrops occur rock is assumed 4' back of the surface.

"Any extended rock ledge has been noted.

UNIT PRICES

Clearing:	
Sage brush.....	\$ 30 per mile
Light brush and trees.....	30 per acre
Medium brush and trees.....	100 per acre
Excavation:	
Solid rock.....	\$1.00-\$1.50 per cubic yard
Tunnel rock.....	4.00 per cubic yard
Common excavation:	
Turnpike in earth.....	0.18 per cubic yard
Side-hill plow and scraper.....	0.30-0.40 per cubic yard
Wagon haul and scraper.....	0.40 per cubic yard
Concrete.....	12.00 per cubic yard
18" corrugated pipe.....	2.00 per foot
Rough rubber retaining wall.....	2.00 per cubic yard
"Division into Sections.—For purpose of estimating, the road is divided into the following sections:	

PATERSON COUNTY

	Miles
Sec. P-1 Stray Horse Divide to Coal Basin.....	4.0
Sec. P-2 Coal Basin to top of Canyon Hill.....	1.8
*Sec. P-3 Canyon Hill.....	0.6
*Sec. P-4 Canyon Hill to Clear River Ranch.....	0.25
*Sec. P-5 Clear River Ranch to Red Gap.....	1.75
Total Paterson County.....	8.40

GRANT COUNTY

Sec. G-1 Stray Horse to Thompson's Ranch.....	5.0
Sec. G-2 Thompson's Ranch to See Creek Crossing.....	2.5
Sec. G-3 See Creek Crossing to Blackwater River.....	1.0
*Sec. G-4 See Creek and Blackwater to Buck Creek.....	2.5
*Sec. G-5 Buck to Spring Creek.....	2.0
*Sec. G-6 Spring Creek to Adams' Ranch.....	4.5
*Sec. G-7 Adams' Ranch to Big Bear Ranch.....	4.3
Total Grant County.....	21.8

"NOTE.—See map for location of these sections. The sections marked with a * have a poor wagon road at present, which, however, can be used. Sections having no star require new construction to permit wagon traffic.

"Estimate of Sections. Sec. P-1.—(Length 4.0 miles.)

"Clearing.—Six acres per mile for 3 miles = 18 acres at \$100 = \$1800.

"Drainage.—Say 10 culverts per mile for 4 miles at \$700 per mile = \$2800.

"Excavation for Double-track Road.—Side-hill slope averages 27°. Excavation per mile for balanced section S = 14 equals approximately 13,000 cu. yd. for a 1:1 cut slope, which is considered safe for this material. Add 25% for inequalities of profile, giving 16,200 cu. yd. per mile, or 55,000 cu. yd. for 4 miles. It is estimated that 20% of this, or 11,000 cu. yd., is rock excavation and the balance, 44,000 cu. yd., is common.

44,000 cu. yd. common at \$0.40.....	\$17,600
11,000 cu. yd. rock at 1.20.....	13,200

Total excavation.....	\$30,800
Excavation for single-track road S-10:	
Excavation per mile balanced section.....	7,400 cu. yd.
Add for profile 25%.....	1,850 cu. yd.
	<hr/>
	9,200 cu. yd.

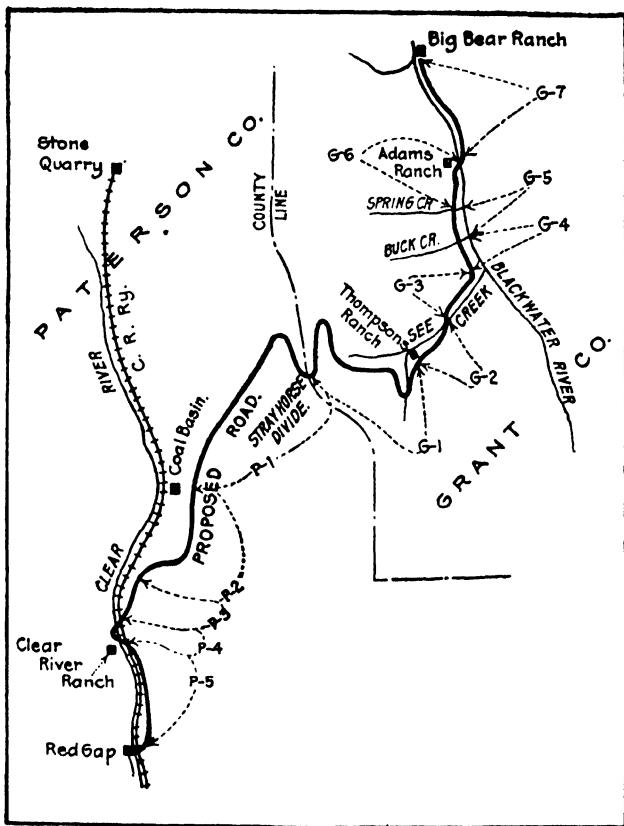

FIG. 268.

Assume 10% rock.....	900 cu. yd. per mile
Assume common excavation.....	8,300 cu. yd. per mile
Cost of excavation for 4 miles:	
3,600 cu. yd. rock at \$1.50.....	\$ 5,400
33,000 cu. yd. common at \$0.33.....	11,000
Add for turnouts, five to the mile:	
500 cu. yd. rock at \$1.20.....	600
1,500 cu. yd. common at \$0.40.....	600
Total.....	\$17,600

Summary of cost, Sec. P-1:

Double-track Road		Single-track Road	
Clearing.....	\$ 1,800	Clearing.....	\$ 1,800
Drainage.....	2,800	Drainage.....	2,800
Excavation.....	30,800	Excavation.....	17,600
	<u>\$35,400</u>		<u>\$22,200</u>
Contingencies, wall, etc.....	2,600	Contingencies.....	1,800
	<u>\$38,000</u>		<u>\$24,000</u>

Equals \$9,500 per mile

Equals \$6,000 per mile

Estimate Sec. P-2 (length 1.8 miles):

0.8 mile similar to Sec. P-1	
1.0 miles average side slope 15°	
Estimate of the easy mile (side slope 15°)	
Clearing 6 acres at \$50.....	\$300
Drainage (ordinary).....	500
20' span bridge.....	800
Excavation (see S-14) 3,300 cu. yd. per mile	
Add for profile 25% 800 cu. yd. per mile	
Rock excavation 4,100 cu. yd. per mile	
Common excavation 100 cu. yd. at \$1.50.....	\$ 150
Common excavation 4,000 cu. yd. at 0.30.....	1,200
	<u>\$2,950</u>
Contingencies.....	150
Total.....	\$3,100

Summary P-2:

Double Track	Part Single and Part Double
0.8 mile similar to P-1	
at \$9,500 per mile = \$7,600	
at \$6,000 per mile =	\$4,800
1.0 miles as per	3,100
estimate above	<u>3,100</u>
	\$7,900
Say.....	11,000
	<u>8,000</u>

Estimate Sec. P-3 (length 0.6 mile). Double-track road

based on hand-level profile:	
Clearing 3 acres at \$100.....	\$ 300
3,000 cu. yd. common at \$0.40.....	1,200
3,000 cu. yd. rock at \$1.25.....	3,750
Ordinary drainage.....	500
1 20' span bridge.....	800
	<u>\$6,550</u>
Contingencies.....	150
Total.....	\$6,700

Estimate Sec. P-4 (length 0.25 mile):

Estimate 1, based on location requiring two bridges over the Clear River.

Clearing.....	\$ 20
1,000 cu. yd. common excavation at \$0.40	400
200 cu. yd. rock at \$1.50	300
400 cu. yd. rip-rap at \$1.00	400
2 (80' span solid-floor steel-truss bridges)	16,000
1 (20' span concrete bridge).....	800
	<hr/>
	\$17,920
Say.....	18,000

Estimate 2, based on half tunnel west of track.

Clearing	\$ 30
5,000 cu. yd. of common exc. at \$0.40 ..	2,000
4,500 cu. yd. rock tunnel work at \$4.00 ..	18,000
Stone wall between track and road ..	900
	<hr/>
	\$20,930
Say.....	\$21,000

Estimate Sec. P-5 (length 1.75 miles). Double-track road

Approximately same cost per mile as Sec. P-2 on the easy mile:

1.75 miles at \$3,100 per mile	\$ 5,425
Possible bridge at Rip Gap	8,000
	<hr/>
	\$13,425
Say.....	14,000

SUMMARY OF COSTS, PATERSON COUNTY

Section	Double track	Single track with turnouts
P-1	\$38,000	\$24,000
P-2	\$11,000	8,000
P-3 ¹	7,000	
P-4 ¹	18,000	
P-5 ¹	14,000	
	<hr/>	
	\$88,000	
Engineering.....	\$ 4,000	
	<hr/>	
Total appropriation .	\$92,000	

¹ Sections have usable wagon road at present.

"Estimated total cost for double-track road, Secs. P-3, P-4, and P-5, and single-track road to the divide, Secs. P-1 and P-2, is \$75,000.

"Estimated cost of cheap single-track road connecting present road to the divide, Secs. P-1 and P-2, with temporary drainage structures and 6% ruling grade instead of 5%, \$25,000.

Cost Estimate, Grant County

"In a similar manner detail estimates are made for the sections in Grant County, as summarized below. These estimates can be found in computation file P-32. They are not included in this report, as they are bulky.

SUMMARY OF COSTS, GRANT COUNTY

Section	Double track (S-14)	Single track (S-10) with turnouts (S-14)
G-1	\$ 32,000	\$ 22,000
G-2	33,000	3,000
G-3	5,000	3,000
G-4	10,000	7,000
G-5	20,000	12,000
G-6	26,000	20,000
G-7	36,000	25,000
	<u>\$132,300</u>	<u>\$ 92,000</u>
Engineering	7,700	8,000
Appropriation. ...	<u>\$140,000</u>	<u>\$100,000</u>

TOTAL SUMMARY OF RECOMMENDED CONSTRUCTION

Paterson County.....	\$ 75,000
Grant County.....	100,000
Total	<u>\$175,000"</u>

RECONNAISSANCE SURVEYS

The methods described for ordinary investigations can be used for most cases, but for heavily wooded country or extremely difficult and rough topography a more careful survey is desirable.

Methods.—For open barren country the transit stadia method is preferred by the author, using magnetic bearings, stadia distance, vertical angle profile and cross-slopes, and ordinary notebook sketches and recording. The map is plotted up on a scale 1000' to the inch and the profile 100' to the inch. The line is marked in the field by tall stakes or lathes with a strip of cloth attached.

Work of this kind can be done by two men with very simple equipment. In remote regions a third man to move and care for camp equipment is required (see Chap. XIII).

Engineering Equipment.

Light mountain transit with stadia and verticle circle.

Light stadia rod, 8 to 10' long.

Camera.

Notebooks, maps, etc.

100' steel tape.

2 aneroid barometers.

For heavily wooded country the U. S. Geological methods are the cheapest and most satisfactory, using a light 15" sketch plane table and tripod oriented with a magnetic needle; 6" gun sight alidade; 500' linen tape coated with paraffin for distance. Aneroid intermediate elevations checked by flying lines of spirit levels or stadia levels along trails.

The main advantage of this method is that it requires no cutting, as direction is obtained by sighting by ear to a yell or whistle. It also gives a complete contour map of all the territory that the road can possibly traverse and makes it possible to lay out a better final

location then any amount of scouting where the engineer depends on his memory and sense of direction for his final location. The projected line is then followed with a rough plane table traverse, slopes, etc., taken, and the estimate made.

Work of this kind can be done by two men with very simple equipment for a cost ranging from \$10 to \$30 per square mile mapped. A convenient scale to work on is 2000' to the inch and a contour interval ranging from 10 to 50'.

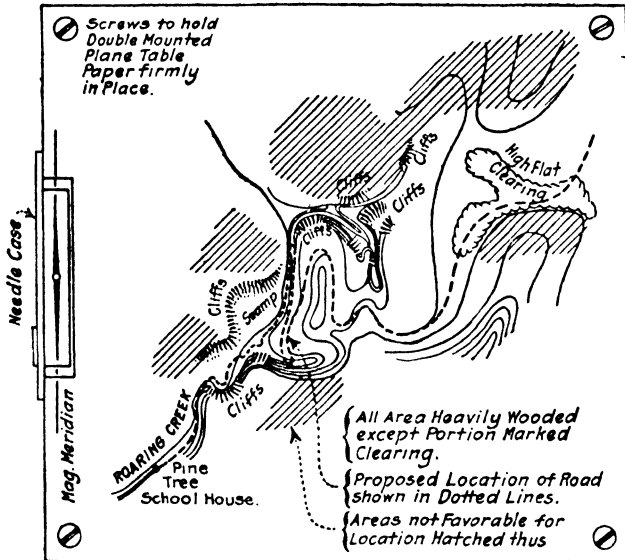

FIG. 269.

A third man to move and care for camp is desirable.

The engineering equipment required is:

15" plane table with tripod.

500' linen tape.

6" gun sight alidade in leather case.

100 steel tape.

Plane table map paper.

2 aneroid barometers.

Light mountain transit with stadia (for flying levels).

Stadia rod.

Conclusion.—It should be borne in mind that if engineering is to be of value it must be thorough and that new locations will often fix roads for generations.

There should be no hesitation in spending whatever is needed, even if it seems all out of proportion to the cost of the actual construction work to be performed within a year or so. Government programs carry out this principle and they are often criticized for high engineering cost, but is well worth while looking to the future.

The engineering program must be complete or it might just as well be discarded entirely.

PHOTOGRAPHIC DATA

EDITOR'S NOTE.—Photographs are often as important as survey notes, particularly on reconnaissance work and the failure of a negative is comparable to the loss of field notes. The following data have been inserted to help the inexperienced photographer reduce his percentage of failures. A green hand is puzzled chiefly by diaphragm opening and time of exposure and does not understand the effect of latitude, altitude, time of year, light, etc., on the problem. The following simple notes have been prepared by a man who has taken engineering photographs all over the world and should be helpful. There are a number of very excellent exposure charts and mechanical sensitized paper exposure meters on the market which consider all these points in more detail than can be given in a book of this character.

General.—The following discussion of the subject of photography in connection with engineering operations has been prepared with the idea of giving to the engineer the foundations and principles upon which he may make exposures in the field under most all conditions, and secure fairly uniform results. The engineer is, in the day's work, required to make exposures under some very adverse conditions, and it is not rare that the exposure most needed or the most important point along the line of survey or construction is reached when weather and light conditions are at their worst. In many cases the results are failures, poor, or only fair. This fact, under the ordinary procedure of having the film developed after the point has been passed, or the survey completed, is discovered weeks or months afterward, and a return to the point would either be expensive—so much so as to make it prohibitive—or impossible on account of adverse weather conditions.

Views on preliminary surveys are of more importance and should receive corresponding attention. Views on construction and location are important, but the opportunities for making successful exposures on location and construction are many. This is due to the fact that the engineer is located longer at one camp on location than on preliminary, while on construction he is constantly on the job.

It is urged that all work be done in the field at the time of making the exposures on preliminary investigations or reconnaissance surveys in order that failures may be discovered and additional exposures made which will supply the omissions, and assure a continuity of views. By so doing the finished view may then and there be properly identified and notations made as to its value in connection with the surveyed line, and the subsequent report and estimate. With this end in view the following equipment is suggested.

- Equipment.**—1. Camera with good stout leather case and tripod.
2. Tank developing outfit complete.
3. Films, chemicals, and sufficient paper of photograph length of the line.

This outfit has been used for a number of years by men who have had a wide experience, and it has been found to be a convenient and complete camp kit to care for the picture end of a survey properly.

Roughly the films should be estimated at three exposures to the mile of line.

Camera.—The best-sized camera, that is, the one which produces the largest picture in proportion to the bulk of outfit and cost of operation, is the $4\frac{1}{4}$ by $6\frac{1}{2}$ " film camera—Eastman 4A. Cameras having smaller dimensions produce views so small as to be of little value from an engineering standpoint, while the outfit necessary to carry on development is practically the same in size and weight as that required for the camera above mentioned. Enlargements may be made, but this is an additional expense and delay. What is required is speed and accuracy.

This sized film when properly masked will give a picture $4\frac{1}{8}$ by $6\frac{3}{8}$ " exclusive of legend. If the roll is cut so as to leave the unexposed portions between the exposures, on the bottom of vertical views, or the left-hand end of horizontal views, space is left for filing number and legend. This information is put on the face of the film with india ink as soon as it is dry and is a clear but concise statement of (*a*) station from which the view was taken, (*b*) direction of the camera, (*c*) general description of features shown, or purpose for which taken, and (*d*) index number by which the same may be identified. This information is obtained from the exposure record which is made and kept at the time of the exposure and regarding which description is given on page 825.

Autographic backed cameras are in use but are not specially desirable unless the films are to be developed by some other person at a later date. The writing that may be done, while specific, is generally so large as to take up all the space between the exposures which should be devoted to more detail. If used it is better to record merely the roll and exposure number, as R 23-2, and depend on the exposure record for detail data.

Lens.—The camera should be equipped with a standard lens of known value. In the matter of lenses nothing empirical may be said. Generally, however, the regular B. & L. f 16 rectilinear lens gives excellent results. As speed is not essential, the higher-priced rapid lenses are not necessary, and the investment of money in such a refinement which the work in hand does not call for is a luxury to say the least. Given a well-made and flawless lens, an equally good picture may be secured, provided the proper time is given, as with the more expensive lens. As there are no moving objects in the class of views that the engineer will photograph, exposures may be properly timed.

Shutter.—The shutter should be of the ordinary variety, operated or snapped with a bulb or cable. For rough handling the bulb release is considered the best. There are a number of standard

shutters on the market, any one of which gives entirely satisfactory results. Improvements are being continually made, and it is advisable to purchase the most durable pattern on the market. There is less liability of making errors with the shutter that sets and releases automatically with a bulb or cable. Those that have to be set by hand oft times produce no exposure, the photographer forgetting to set the shutter.

Diaphragm.—Most all cameras are now equipped with the iris diaphragm, and this attachment is the best with which to control the stop.

The stop is the technical term for regulating the size of opening in the diaphragm. There are two systems of indicating the different stops. The "Universal Standard" (U. S.) and "f" for focal speed of lens. The following list shows the usual equivalent stops for both systems.

U. S.....	1.2	2.0	2.5	4	8	16	32	64
f.....	4.5	5.6	6.3	8	11	16	22	32

Ordinary kodak stops:

1 2 3

Stop	U. S. 1.2 gives the largest opening.
Stop	U. S. 64 gives the smallest opening.

Manipulation.—The most important factors that enter into making an exposure are:

1. Composition.
2. Distance.
3. Aperture.
4. Time.
5. Strength and direction of light.
6. Phases of views.
7. Recording all operations in the exposure record.

Taking up these operations in their order:

Composition.—A photo should not be looked upon as a miscellaneous lot of black and white spots on a piece of paper. In order that the photo should properly show the information required, it should in most instances be taken from some station along the line of work, or from some point which has been definitely located without the line of work. The most desirable position from which to make the exposure is one from which professional as well as artistic points may be seen. The selection of such a point is made after carefully studying the composition of the view as seen in the finder. If a view is required along the survey line, select, if possible, that station where the light will come from behind or from the side. Carefully study the composition.

If on a survey line, along a stream bank, on the edge of a mesa, at the shore of a lake or bay, bring the important features into the middle of the finder. No picture should be taken that does not contain some life, as only professionals can make a good picture of still life. Picket a rodman with a level rod or stadia board of known length on a station 50 or 100' away on line—or more particularly at the point it is intended to feature. This not only gives life to

the view, but provides a medium by which distances in the view may be estimated. Have, if possible, one-third of your view composed of sky. Balance your picture. Guard against having the center view obstructed by a 6' tree 15' from the camera, while the feature you are trying to photograph is 100' away. Such a composition blurs the foreground, reduces the field of view, and, in general, spoils what might have been a successful photo.

Hold or set the camera level. If it is necessary to obtain some feature that is below or above the outline as shown in the finder, manipulate the shifting front of the camera. Never tip the camera up or down, for to do so will produce distorted photos on account of the vanishing point lying outside of the horizontal plane.

Distance.—Ascertain the distance from the camera to the object to be photographed. Do this with reasonable care, as too many poor negatives result from carelessness in estimating distances. Set the indicator at the proper point on the scale of distance. The nearer the subject is to the camera the more care should be exercised in ascertaining the distance. For universal focus use stop U. S. 16, 32, or 64 and set focusing indicator at 25 to 30'.

Aperture and Time.—The aperture (stop) and time of exposure are the governing points in making an exposure.

For a given condition a number of different combinations of aperture and time will give satisfactory results. The larger the aperture the shorter the time. The smaller the aperture the better the detail of the picture becomes. In general, it is desirable to use a fairly small aperture to get detail and as long a time as conditions permit.

The correct combination of aperture and time is affected by the use of a tripod, movement of objects, speed of plate or films used, altitude, latitude, season of the year, intensity of light, and composition of the picture. This sounds complicated and is for the best results, but fortunately considerable variation from the best timing will still produce a fairly good negative for all practical purposes.

Effect of Use of Tripod.—It is advisable to use a tripod for all engineering photography, as it prevents blurring by movements of the camera during exposures and makes it possible to use a small aperture, with the necessary time of exposure, to get good detail. If the camera is held in the hands, the time of exposure should be $\frac{1}{25}$ sec. or less and the aperture will have to be made large enough to allow this speed.

Effect of Motion of Objects.—As a rule, moving objects need not be photographed, but if necessary the following speeds of exposure will stop motion.

$\frac{1}{25}$ sec. will stop wind in foliage.

$\frac{1}{50}$ sec. will stop pedestrians and slow-moving rigs.

$\frac{1}{300}$ sec. will stop distant trains.

$\frac{1}{500}$ to $\frac{1}{1000}$ a sec. will stop near trains, automobiles, etc.

The aperture must be regulated to allow these speeds.

That is, time governs aperture where motion is encountered. Under most conditions, however, where a tripod is used aperture

governs time and a small aperture is desirable in order to obtain detail. For most landscape engineering survey work a U. S. stop 16, 32, or 64 is used and the time is varied to correspond with the stop selected:

Bright sun, use stop U. S. 64 or 32.

Fair light, use stop U. S. 32 or 16.

Moderate light, use stop U. S. 16 or 8.

An aperture of U. S. 8 will give moderately good detail.

Speed of Plate or Film.—Different makes have different speeds but there is no great variation in the speed of the ordinary roll films or speed pack films and the following exposure chart is based on the commercial film in ordinary use.

Effect of Altitude.—Altitude has a marked effect on time of exposure. Exposure charts are worked out for sea level.

Wilson topographic surveying quotes E. Deville as stating that altitude has practically no effect on timing when the sun is near the zenith in the middle of the day but that as the sun approaches the horizon the effect becomes evident. He gives the following relative time of exposure at sea level and 10,000' altitude.

Altitude of Sun	Relative Time of Exposure	
	At 10,000 ft. Altitude	At Sea Level
90°	1 second	1 second
40°	1 "	1 $\frac{1}{4}$ "
25°	1 "	2 "
15°	1 "	3 $\frac{1}{2}$ "

The rule generally used for ordinary engineering photography is to cut the time of exposure in half when working at an elevation of 5000 to 10,000'.

Effect of Latitude.—Exposures at the equator require the shortest timing.

As the latitude increased, the time of exposure increases.

For example, conditions requiring $\frac{1}{25}$ sec. at the equator require $\frac{3}{4}$ sec. in Alaska.

Effect of Season of the Year.—The summer months require less exposure than the winter months.

For example conditions requiring an exposure of $\frac{1}{10}$ sec. in summer will require $\frac{1}{5}$ sec. in winter, except that it must be remembered that snow on the ground changes the classification of "phase" discussed below.

The chart on page 823 is prepared for sea level at average conditions of latitude and season in the United States and the effect of latitude and season can be disregarded for all practical purposes except for extreme cases, as they have a relatively small effect for this territory as compared to light intensity and phase of the picture.

The extreme variation from the chart will be approximately as follows: for winter months along the Canadian boundary, double

the time of exposure given in the chart. For southern Florida in midsummer use one-half the time given in the chart.

When it is borne in mind that this variation in relative exposure does not ruin a negative, it can be seen that unless these extreme

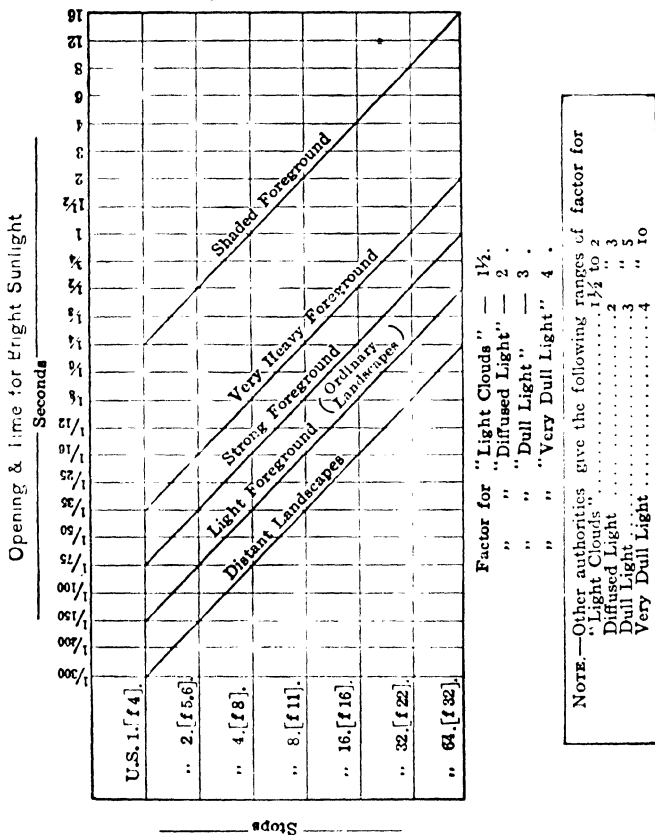

This chart copyrighted by E. S. Wheeler.

conditions of combined location and season prevail the chart time without correction should give reasonably good results. Altitude should, however, be considered.

EFFECT OF LIGHT AND PHASE

Light Values.—Judgment and experience are essential if good, average negatives are to be secured. However, the following dis-

cussion of light values of different lights and phases of views may be of use. Five distinct conditions of light are generally taken into consideration when calculating for an exposure.

(A). *Bright Sunlight*.—When the sun is shining brightly in a cloudless sky.

(B). *Light Clouds*.—When a thin film of white clouds partially obscures the sun, but fairly well-defined shadows are discernible.

(C). *Diffused Light*.—An even light but no shadows.

(D). *Dull*.—Sky covered with dull clouds with no sunlight penetrating.

(E). *Very Dull*.—Sky overcast with very dark clouds. Gloomy.

Phases of Views.—For classifying views or subjects in a view—the five following phases are given:

1. *Landscapes*.—This view contains distant landscapes, sea-scapes, snowclad hills, or broad expanses of river scenery. Such views reflect a large percentage of actinic light, and should be short timed or stopped down accordingly.

2. *Light Foreground*.—This view contains open fields and woods, flocks of live stock, buildings, and small expanses of water.

3. *Strong Foreground*.—This view contains a large percentage of foliage, buildings close enough to make strong and distinct outlines, fences, figures, animals, well-defined roadways, rock cliffs, or well-defined hill slopes not over 400' from the camera, urban scenes where the sky line is serrated with buildings, or full views of concrete structures.

4. *Very Heavy Foreground*.—This view contains close-ups of the following: landscapes having dark-green foliage and shadows, bridges and other structures with heavy shadows, and rock cliffs which are generally located in canyons where considerable direct light is shut out.

5. *Shaded Foreground*.—Under this caption come ravines, wooded hillsides, standing timber, under trees, and small dark box canyons where sunlight is shut out by shadows.

Caution.—Great care must be exercised in making exposures for views under condition *c*. Give plenty of time, and should doubt exist double the time taken from the chart and make another exposure.

Bearing in mind the five conditions of light and the five phases of views, enter the chart with the view as an argument. Along this line a number of combinations for time and stop may be had which will give satisfactory negatives. If detail is required, select a small stop, and from this get the time for Bright Sunlight. Should light conditions be other than these multiply the time obtained by the proper factor given below the chart.

For Example.—Condition of light, diffused ("C"). Phase of view, strong foreground. Suppose it is desired to use stop U. S. 8, the time for bright sunlight is given as $\frac{1}{8}$ sec. Multiply this time by 2, the factor for diffused light, getting $\frac{1}{4}$ sec. as the exposure required.

NOTE.—There are a number of meters now published which go into detail as to time, aperture, conditions of light, and phases of view, all of which give excellent results. These may be purchased from most any photo supply depot.

Exposure Record.—In order that the photographer may have something upon which to check up his failures, identify each view in connection with the project in hand, and properly reference them in the files. An exposure record should be used and each exposure carefully recorded. This record may take any number of forms, but from experience the following is suggested, which has been filled out to show how it is intended the columns should be used.

ROLL 36.

Exposure Made by Bill Jones — Sept. —

No. of Film	Job	Date	Hour	Light	Stop "f"	Time	Subject. Descriptive Notes
1	Rabbit Ears	5/6	9.00	A	16	1/10	Sta. 1007+40. Looking Az. 170 deg. along tang. Rodman on Sta. 1006.
2	Rabbit Ears	5/6	10.00	B	11	1/4	Old timber br. at Sta. 1020. Camera 60' to right of 1019-50 looking Az. 130 deg. (out of focus).
3	Rabbit Ears	5/6	10.30	B	22	1/6	Sta. 1025 looking Az. 90 deg., showing proposed Ning of river. Solid rock in extreme left of view.
4	Rabbit Ears	5/8	4 00	A	11	1/10	Sta. 1091 looking Az. 270 deg., showing Amazon Pass, Hopland and Big River Valley.
5	Tyeras Canyon	5/6	10.00	C	8	1 sec.	Sta. 1107-45 looking Az. 210 deg. Dense timber along tangent.
6	Tyeras Canyon	5/6	3 00	D	22	1/2	Sta. 1136 looking Az. 226 deg. along tangent showing houses on right-of-way. Close up view. Rodman on Sta. 1137.

DON'TS

Don't expect good results from snapshots taken before 9 a. m or after 5 p. m. even with sun shining brightly.

Don't try to make snapshots under trees or in a shadow. Make a time exposure, resting the camera on a firm base, or, better still, use a tripod. Get the proper time from the chart.

Don't hold the camera in your hand when making exposures over 1/25 sec.

Don't attempt to make snapshots indoors.

Never face the camera at the sun unless necessary and then be sure to shade your lens from direct rays of the sun.

Always use small stops if detail is desired.

Don't give time exposures to distant landscapes. The farther away the subject the less time is required.

Buy only fresh films which will exactly fit your camera, and observe the date on same beyond which no guarantee of value is given.

Always turn the key bringing a new unexposed film into correct position after having made an exposure.

After having exposed a roll take it from the camera, and before putting in a new roll, examine the lens, try shutter, and blow out any particles of dust that might have worked into the bellows.

If, after having made an exposure, the least doubt arises as to whether it was an overexposure, underexposure, or double exposure, calculate for a stop and time, and proceed to make an exposure that will be satisfactory. This advice is of particular value to engineers, as it is not infrequent that the picture most needed is the one failure on the roll. The second exposure costs but 10 cts. To secure it after the camp or work has been abandoned may cost a hundred dollars.

Developing.—Fairly good prints may be secured from average negatives, but the best prints are obtained from good negatives. To obtain good negatives the exposure must be reasonably correct, and development must be done with fresh and pure chemicals in quantities called for in the respective formulas recommended by the makers of the plates or films used.

The simplest, most convenient, and most certain method of development that has been worked out for films is what is generally known as tank development.

The equipment necessary properly to handle films of the size suggested in the beginning of this article is as follows:

- 1 E. C. Eastman tank No. 5E7 complete.
- 1 5 by 7 gutta-percha tray
- 1 32-oz. measuring glass.
- 1 stirring rod.
- 1 thermometer.
- 1 or more pairs of film clips.
- 1 dripping pan enameled, about 9 by 12".

The chemicals required for one roll of films are:

- 1 Tank developing powder for 5 by 7" tank
- 4 oz. of hypo with acidifier.

Plenty of clear pure water having a temperature of 65°F.

As no dark room is required, the development may be carried on at any time, and the process is as follows.

Dissolve the developing powder as per directions, using the developing tank, testing the same with the thermometer so that the solution when ready shall have temperature of 65°F. Set this aside.

Thoroughly rinse the measuring glass, and in 16 fl. oz. of water dissolve the 4 oz. of hypo and acidifier. Pour this solution, known as fixer, into the 5 by 7 tray. Thoroughly rinse the measuring and glass stirring rod.

Prepare the films as directed in instructions accompanying the developing tank outfit, and wind it onto the opaque curtain.

This operation takes place in the lightproof box.

Remove the spool containing the curtain and film, and place it in the tank containing developing solution, firmly fastening the top on the tank. Turn the tank end for end two or three times, holding it vertically for 5 or 10 sec. each time, so as to expel all air from between the folds of the curtain, and insure complete contact between the developing solution and the film. At the moment of immersion, record the time, and permit development to go on for the specified time given for the temperature of the solution. If using Eastman tank developing powder, and solution is 65°F., the time of development should be 20 min. Invert the tank every 5 or 7 min. so that even development may be obtained.

Development having been completed, fill the dripping pan with fresh water, take the spool from the tank, and, working rapidly, unroll the apron or curtain until the end of the film is visible. Firmly clamp a film clip to this end of the film. Now lift the end of the film by this clip, unrolling it from the curtain until the other end of the film is free, and clamp another clip on this end. Rinse the film in the dripping pan of fresh water, running it through three or four times. Change to fixing bath, and run film through rapidly three or four times, making sure that the entire surface of the film is flooded with the solution, thus insuring that development is completely arrested.

Continue washing in the fixer until the film is clear. This will take from 7 to 10 min. Rinse in clear, cool, running water for $\frac{1}{2}$ hr., or in 20 changes of water allowing the film to remain 3 to 5 min. in each change. After rinsing, suspend the film from a wire or hook, so that the same will hang free and permit it to dry. Do not touch the surface until perfectly dry. If the film has a tendency to curl during drying, leave it alone. The weight of the clip at the lower end will be sufficient to correct this.

When perfectly dry, trim the ends so as to leave as much unexposed film as there is between the exposures. Before cutting the film, place it on a table, back up, and under vertical views, or to the left of horizontal views, inscribe the information contained in the eighth column of the exposure record, together with the index or filing number, using india ink. Place the index or filing number in a convenient space, usually the upper left-hand corner.

Cut the film, taking particular care that in so doing the legend and the view to which it applies are together. Do not use scissors to cut the film, as this, unless cleverly done, is apt to produce an irregular edge which is difficult to fit into the mask. Use straight edge and sharp-pointed knife, or better still a trimmer, the latter costing about \$1.75.

If all operations to this point are correctly performed, films will be uniform, have a neat and workman-like appearance, and bear complete information as to date, subject, station from where taken, and index number. The film so labeled will be special, specific, and sufficient; special because it applies to a certain project, specific because it pertains to a particular point of feature of the project, and sufficient because it gives complete information.

Causes of Failures.*Not sharp:*

1. Objects moving or moving too fast.
2. Out of focus.
3. Camera being moved during exposure.

Undertimed:

1. Use of too small stop.
2. Light too weak.
3. Exposures too short.

No exposure:

1. Failure to set shutter.
2. Failure to release shutter.
3. Something in front of lens.

Double exposure:

1. Failing to wind up film after making exposure.

Fogged:

1. Camera leaks light.
2. Carelessness in loading or unloading.
3. Taking pictures against sun.

Overtimed:

1. Stop too large.
2. Too much time given.

Printing.—Equipment additional to that required for film developing:

- 1 Printing frame 5 by 7.
- 1 Gutta-percha tray 5 by 7.
- 1 Orange light.
- 1 Dish pan from camp kitchen.
- Developing powders. (One tube of M-Q develops 18 prints of the size herein mentioned.)
- 4-oz. hypo with acidifier.
- 4-oz. bottle potassium bromide, 10% solution.
- Quantity of 5 by 7 developing out paper, Azo preferred.

Procedure.—Prepare the developer by dissolving the contents of the tube as per direction thereon, and pour the solution into one tray, not the one used for fixing bath. In order that no doubt may arise as to which tray is for the fixer, take a sharp instrument and scratch the letter H in the bottom, so the same may be seen when the tray is in use.

Prepare the fixing bath by dissolving the 4 oz. of hypo and acidifier in 16 oz. of water. The temperature of the developing solution should be normal, or 65°F. If too cold it retards the development, and if too warm the development is too rapid, and prints are apt to show steaks. A warm developing solution, fixing bath, or rinsing bath produces blisters, due to too rapid action, which produces gas under the filament on the paper. The fixer and rinsing water may have a temperature as low as 40°F. In fact, the writer has had the best success working with the fixing bath and rinsing water at this temperature. Prints may be left in running water at this temperature all night without blistering or raveling.

Arrange the pans and trays in a row in the following order from left to right: (1) dish pan of water in which to rinse the hands and finished prints, (2) dripping pan of water in which to immerse the prints before placing them in the developing solution, (3) tray containing developing solution, and (4) tray containing fixing bath.

Provide a towel to dry the hands on before taking up new, undeveloped prints.

Take one sheet of paper and cut the same into strips about $\frac{1}{2}$ " wide, and keep the same in a lightproof box. These strips are for making a trial of the negative, if doubt exists as to the length of time to print. Clean the glass of your printing frame and provide a mask having a width inside of $4\frac{1}{8}$ ", if using $4\frac{1}{4}$ by $6\frac{1}{2}$ films. The mask should be open at one end so as to allow the legend, which has previously been written or printed on the film, to print. The mask should be provided with paper guides of about 2 by $\frac{1}{4}$ " pasted on one side and top at the corner back from the edge of the opening—a distance equal to the white margin that should surround the print on the top and the two sides. These guides are generally the thickness of medium-weight detail paper, and serve to hold the paper and film together when the same are placed in the frame, and also during printing. Printing frames are now made, provided with adjustable guides by means of which any desired size of mask may be had. These are convenient, and their purchase is suggested.

Working in subdued light only, and with orange light in position, place the film and a sheet of paper in the printing frame, and print in accordance with the light used and density of the film.

Printing should be done in accordance with directions contained in the container of the paper purchased. Artificial light is preferable to daylight, and electric, gas, or oil lamps may be used. The proper time and distance from light are always given by the manufacturer of the paper.

If daylight be used, hang a sheet over the north window so as to diffuse the light and by experiment deduce correct time for printing. Usually medium negatives will print in such a light in from 2 to 4 sec. Note the time taken to print, and remove the paper, and rinse in pan 2, in order to moisten and prepare the surface. Immerse in the developing solution, tray 3. When the desired tone is obtained take the print from the developing solution, rinse for a second or two in tray 2, and then immerse in fixing-bath tray 4. Should abrasion marks appear on the print, add from 5 to 10 drops of the 10% solution of potassium bromide to the developer. This will make the development a little slower, but will correct this trouble.

Prints should be left in the fixing bath for 20 min. At the end of this time, remove them and place in rinsing bath, pan 1. If running water is available, rinse the prints for 1 hr., or longer if possible. If no running water is at hand, rinse in a dozen changes of water, keeping the prints moving so as to remove all traces of hypo.

When washed, collect the prints as you would a deck of cards, and taking not more than a dozen at a time, lay them on one fold of a towel, placing another fold over them. With an ordinary rolling pin, or in the absence of this, a round bottle, roll and press out the

excess water. Separate and lay them face down on cheese cloth, muslin, or even a clean piece of paper which has been placed on a smooth surface, and permit them to dry. When thoroughly dry, place on a table face down and draw them separately backward and upward under a not too sharp straight edge or triangle. This will leave them either flat or slightly convex. The prints may now be trimmed as desired.

Two grades of paper are recommended—one grade for average negatives, and one for contrasty negatives. Provide sufficient paper based on the ratio of average to contrasty negatives of 6 to 1. There are several grades of paper with a number of finishes. The glossy finish generally gives the best results for engineering purposes, and its use is recommended. To go to the expense of providing more grades of paper than above mentioned is an unnecessary refinement.

With practice the operator will soon be able to judge the destiny of negatives so that the use of trial strips will rarely be necessary. After sufficient practice, and when the operator is able to judge his negatives so as to print to within a reasonable degree of correctness, printing should be carried on until all the prints required have been made, inserting them in a lightproof box or between the leaves of a book. Then develop the batch, and perform all operations through to the hypo bath. The batch after 20 min. may be taken from this bath and placed in rinsing water. The white light may be turned on as soon as all are in the hypo. By this method a large number of prints may be handled in a short time.

Rinse the hands each time after having them in hypo, for hypo is a strong restrainer, and should you handle prints without so doing white finger prints will appear when development is carried on.

After developing films or prints, wash up all equipment and scrub hypo and developing trays with salt—this will remove all traces of chemicals.

CHAPTER XIII

THE SURVEY

The chapter on Survey will be handled under two main divisions:

- a. Improvement of existing roads.
- b. Location of new roads.

FOR THE IMPROVEMENT OF EXISTING ROADS

As the survey furnishes the information for the design, it must be carefully made in regard to the essential features. These are alignment, levels and cross-sections, drainage, information concerning foundation soils, available stone supply, available sand, gravel, filler, etc.; direction and amount of traffic, railroad unloading points, the location of possible new sidings, and such topography along the road as will have a bearing on the design. The survey should be made not more than a year before construction starts and during the open season, as a snowfall of any depth makes the work unreliable and only fit for a rough estimate. When contracts based on winter surveys are awarded it is always necessary to take new cross-sections to insure a fair estimate of the excavation.

A party of five men is a well-balanced force for surveys of this character.

Force	Equipment	Stationery
Engineer	Transit	Reports
Instrument man	Level	Pencils
Three helpers	2 100' steel tapes	Notebook
	3 50' metallic tapes	U. S. Geological Survey map.
	3 pickets	
	2 level rods	Stakes
	Pocket compass	For preliminary survey:
	Hatchet	110 stakes per mile
	Sledge	For construction:
	Ax	220 stakes per mile
	Keel	

The Center Line.—The placing of the center-line hubs (transit points) requires good judgment and should be done by the chief of the party. In locating them he considers the principles of alignment discussed in Chap. II. The hubs are placed at tangent intersections and sometimes at the P. C.'s and P. T.'s of curves and are referenced to at least three permanent points that will not

be disturbed during construction (see sample page of notes, Fig. 270).

The deflection angles at the tangent intersections are usually read to the nearest minute, taking a double angle to avoid mistakes; the magnetic bearing of each course is recorded. For all deflection angles over 4° it is good practice to figure and run in on the ground the desired curve. Curves with central angles of less than 4° can be run in with the eye during construction.

The center line is marked at intervals of either 50 or 100' (see cross-section, p. 833) in any convenient manner; the alignment of these points should be correct to within 0.2 and the distance along the line to within 0.1 per 100' of the length; any attempt to get

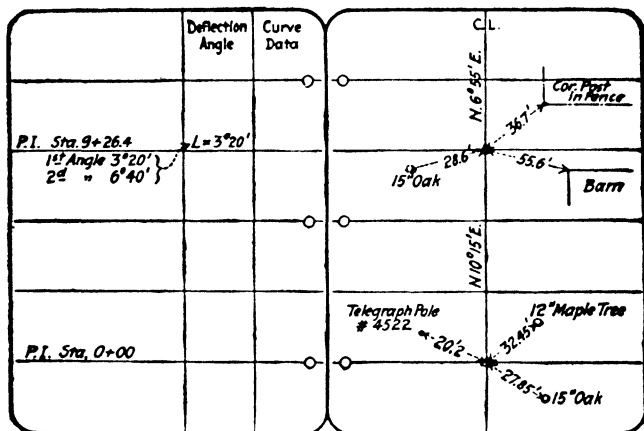

FIG. 270.—Alignment notes.

more accurate stationing is a waste of time. The chaining may be done on the surface of the ground up to a grade of 5% with no objectionable error; beyond that slope, however, the tape should be leveled and plumbed. Steel tapes should be used for chaining the center line and referencing the hubs.

A convenient method of marking the actual center-line stations is to use a nail and piece of flannel, red flannel for the 100' stations and white flannel for the intermediate 50' stations, if needed. Where the soil is sandy or muddy, and these nails would be kicked out or covered, a line of stakes can be set outside of the traveled way on a specific offset from the center line. If an offset line is used, however, the chaining of all curves should be done on the center line to insure a correct center-line distance and the stakes placed radially on the desired offset. Railroad spikes make good permanent transit points and are easily placed.

At the same time that the line is run it is just as well to paint the 100' station numbers on any convenient place where they

The distance of the shots from the center line of the road is read to the nearest 1.0' where the ground has no abrupt change of slope, and to the nearest 0.5' where there is a well-defined abrupt change. The elevations are read to the nearest 0.1'. The sections should extend from fence line to fence line, or in villages from sidewalk to sidewalk, and the position of the pole lines, tree lines, curbs, etc., noted. Engineers differ as to whether the sections should be taken at a normal interval of 50 or 100'.

Table 136 gives the difference in the computed quantity of earthwork, using 50 and 100' sections with intermediate sections at well-defined breaks in the grade.

TABLE 136

Name of Road	Length Figured	Character of Road	Excavation 50' Section	Excavation 100' Section	Approximate Difference	Per cent of Difference
Scottsville			Cu. Ft.	Cu. Ft.	Cu. Ft.	
Mumford ..	1 mile	flat	61,444	61,995	550	+ 1.5%
Mumford ..	1 "	hilly	111,109	111,700	600	+ 1/2 %
Leroy						
Caledonia	1 "	rolling	57,840	60,560	2700	+ 4 1/2 %
*Leroy						
Caledonia ...	1 "	flat	77,841	78,659	800	+ 1 %
Clarence						
Center ...	1 "	rolling	73,727	73,043	700	- 1 %
Clarence						
Center ...	1 "	flat	38,037	39,415	1400	+ 3 1/2 %
Lockport						
Tonawanda	1 "	flat	59,096	59,470	400	+ 1/2 %
*East Henrietta						
Rochester	1 "	rolling	37,275	36,075	1200	- 3 1/2 %

The following tabulation shows the variation for shorter sections of the starred roads.

Name of road	Station and to Station	Quantities by 50' sections	Quantities by 100' sections	Approximate Difference	Per cent of Difference
		Cu. Ft.	Cu. Ft.	Cu. Ft.	
Leroy					
Caledonia, 80-90 ...		19,151	19,525	400	+ 2 %
" 90-100 ...		21,915	23,415	1500	+ 7 %
" 100-110 ...		21,555	20,639	900	- 4 %
" 110-120 ...		15,220	15,030	200	- 1 1/2 %
Total and averages		77,841	78,659	800	+ 1 %
East Henrietta					
Rochester, 0-19 ...		14,625	14,300	300	- 2 %
" 32-49 ...		11,950	11,575	350	- 3 %
" 49-66 ...		10,700	10,200	500	- 5 %
Total and averages		37,275	36,075	1200	- 3 1/2 %

The question of quantities is not the only factor in determining the interval. Where it is important to fit the local conditions, as in a village, or to utilize an old, hard foundation, the designer is helped by 50' sections.

In taking cross-sections the work becomes mechanical, and unless the engineer in charge is unusually alert to all the intermediate changes better results will be obtained by the use of the shorter interval. For these reasons the author believes that a 50' interval is advisable except on long, uniform stretches of road.

A party of three men will run from 4000 to 7000' of 50' cross-sections per day; a party of four men from 5000 to 9000' depending on the country.

Sta.	B.S.	F.S.	H.I.	Elev.	Left						Right					
B.M. #3				926.32	926.7	926.4	925.7	926.5	926.6	926.3	926.2	925.8	926.4	925.2		
10+00	5.41		931.73		50	53	60	52	51	54	55	59	53	65		
					40	14	12	5	0	5	9	11	19	24		
					926.2	925.7	925.2	925.4	925.7	925.7	925.4	924.7	924.7	924.1	923.7	
10+50					55	60	65	63	60	60	63	70	70	76	80	
					28	20	14	11	8	0	8	11	12	20	28	
T.P. #65 Rock on R?		2.10		929.63	922.8	922.3	921.9	922.2	922.4	922.5	922.0	921.7	922.1	923.0		
11+00	1.32		930.95		82	87	91	88	86	85	90	93	89	80		
					30	20	13	9	5	0	10	14	18	30		

FIG. 272.—Cross-section notes.

Drainage.—The drainage notes show the position and size of all the existing culverts; the area of the watersheds draining to them and a recommendation of the size culvert to be built; the location, drainage area, and size of desirable new culverts; the necessity for outlet ditches and their length, if required; the elevation of flood water near streams, and the condition of the abutments and superstructure of long-span bridges. The cross-section levels are supplemented to show these points fully. Where the U. S. geological maps are available the areas of watersheds can be easily determined; where no such maps have been made the drainage areas can be easily mapped with a small 15" plane table oriented with a magnetic needle; the distances can be paced and the divides determined with a hand level. One inch to 2000' is a convenient scale.

The drainage scheme should be carefully worked out by the chief of party, as the possibilities of friction with local people are greater on this part of the design than any other. In the chapter on Drainage this fact was mentioned and designers were cautioned not to use new culverts unless necessary. For special features of bridge survey see page 942.

Drainage Old Structures	Notes New Structures
Sta 15+25 Present 12" V.T.P. Bad Condition ○	Sta 15+25 ○ Drainage Area 40 Acres Hilly Farm Land, Slope approx. 20' to 1000. Use 18" C.T.P.
Sta 24+00 Present Concrete Culvert Built by Town in 1911 2' x 2' x 30'; Carries Water Satisfactorily ○	Sta 24+00 No New Culvert Needed ○
Sta 45+50 - 49+00 Flood Backwater Covers Present Road 1.5' in Spring of Year, no Current. Raise Road 2.5' and make Fill of Boulder Stone or Gravel	
Sta 55+10 Present 24" V.T.P. does not Carry Water in Freshets ○	Sta 55+10 Drainage Area 300 A. ○ Rolling Farm Land, Slope about 30' per 1000 Use 3 x 3 Concrete Box.

FIG. 273.

Topography.—The topography notes show the features of the adjacent territory that might affect the design. These include the location of buildings, drives, intersecting roads, streams, railroads, poles, trees, sidewalks, crosswalks, and property lines. The names of property owners are recorded.

A simple method of locating these points is to refer them directly to the previously run center line by right-angle offsets; such notes are easily taken and quickly plotted.

In taking the topography the plus stationing along the center line and the offset distances to all points inside of the road fences should be measured by tape to the nearest foot; the distances to and the dimensions of buildings, etc., outside of these limits, can be paced or estimated; the bearings of the property lines can be read near enough with a pocket compass, except for right-of-way surveys, which are described on page 840.

The instruments needed for work of this kind are a pocket compass reading to 2°, steel picket, and metallic tape.

Station	Left	Center Line	Right
62	$\frac{3.5'}{20}$	$\frac{2.5'}{00}$	$\frac{0.5'}{20}$
63	$\frac{1.5'}{25}$	$\frac{1.2'}{00}$	$\frac{1.0'}{22}$

The note $\frac{3.5'}{20}$ means that 20' to the left of the proposed center line of the improvement the rock is 3.5' below the present surface; from these notes the rock can be readily plotted on the cross-sections. Its character can be determined from adjacent outcrops or from test pits, if required.

Location and Character of Materials.—The selection of materials and the estimate of the construction cost depend on a knowledge of the available materials and their location relative to the road.

Provided these data have not been well gathered on the preliminary investigation work, it should be obtained at this stage. The methods were described in chapter on Preliminary Investigation but will be repeated at this point for convenience.

Unloading Points for Freight.—Provided U. S. geological maps are obtainable, the position of sidings may be marked on the sheets. The notes for each siding show its car capacity, whether or not an elevator unloading plant can be erected, and if hand unloading is necessary whether teams can approach from one side or two. They should also show any coal trestles that can be utilized in unloading, and the location and probable cost of any new sidings that will materially reduce the length of the haul. Canal or river unloading points are shown in the same manner.

Sand, Gravel, and Filler Material.—The position of sand and gravel pits and filler material are noted with their cost at the pit; if no local material is available the cost f.o.b. at the nearest siding is given.

Stone Supply.—Provided imported stone is to be used the work is simplified to determining the rate f.o.b. to the various sidings for the product of the nearest commercial stone-crushing plant that produces a proper grade of stone.

In case local stone is available the location of the quarries or outcrops is shown, the amount of stripping, if any, and the cost of quarry rights. If the estimate will depend upon rock owned by a single person, an option is obtained to prevent an exorbitant raise in price.

For field or fence stone a careful estimate is made of the number of yards of boulder stone available, the owners' names, what they will charge for it, the position of the fences or piles relative to the road, or side roads, and if the fences are not abutting on a road or lane the length of haul through fields to the nearest road or lane. As fences are usually a mixture of different kinds of rock, the engineer estimates the percentage of granite, limestone, sandstone,

etc., and the percentage that will have to be blasted or sledged in order to be crushed by an ordinary portable crusher. The amount of field stone required per cubic yard of macadam is given in estimates (p. 1130). If there is a large excess of stone a careful estimate need not be made, only enough data being collected to determine the probable position of the crusher set-ups and the average haul to each set-up. If a sufficient supply is doubtful, a close estimate is made as outlined above and options obtained from the various owners.

Samples of the different rocks are tested (see Materials).

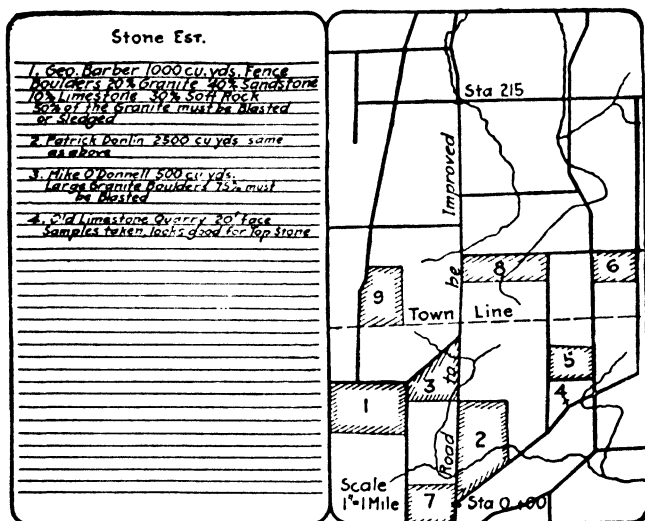

FIG. 275A.—Location of local materials.

Cost of Preliminary Surveys.—Preliminary surveys of the preceding description should be made at a speed of from 2 to 4 miles per week at a cost of from \$70 to \$150 per mile, allowing \$10 per day for the engineer, \$7 for the instrument man, \$4 per man for three laborers, \$2 per day board per man, and \$4 per day for livery.

Right-of-way and diversion-line surveys are often needed, but are usually not made at this time; if the designer believes that additional land must be acquired or that a diversion line is necessary, he indicates the information desired and the surveys are made.

Right-of-way Surveys.—These surveys are used not only to show the amount of land to be acquired, but also the damage to property from altering the shape of a field, cutting a farm in two, changing the position of a house or barn relative to the road, etc.

The acreage to be taken is shown by an ordinary land survey in which the road lines, property lines, corners, etc., are located

in relation to the proposed center line of the improvement, and their lengths and bearings carefully determined. It is often difficult to locate the road boundaries, as town records are carelessly kept and there is a general tendency to encroach on the road. As the amount paid for new right of way is rarely settled on an acreage basis, it is customary to take the existing fence lines as the road line unless it is very evident that the fence has been moved. This produces better feeling on the part of the property owner and does not affect the price paid. The lines between adjoining properties are usually well defined.

In cases where an orchard is damaged the position and size of the trees are noted; where a field or farm is cut the whole field is shown, with the shape and acreage of the pieces remaining after the land actually appropriated has been taken out.

As is usually done in all land surveys, the parcel to be bought is traversed and the survey figured for closure error to insure the description against mistakes.

The standard form of map and description of the N. Y. State Department is shown in the following illustration: No. 276.

Figure 276 A shows another simple method which ties in the back line by offset distance. This method is easier and serves the purpose very well.

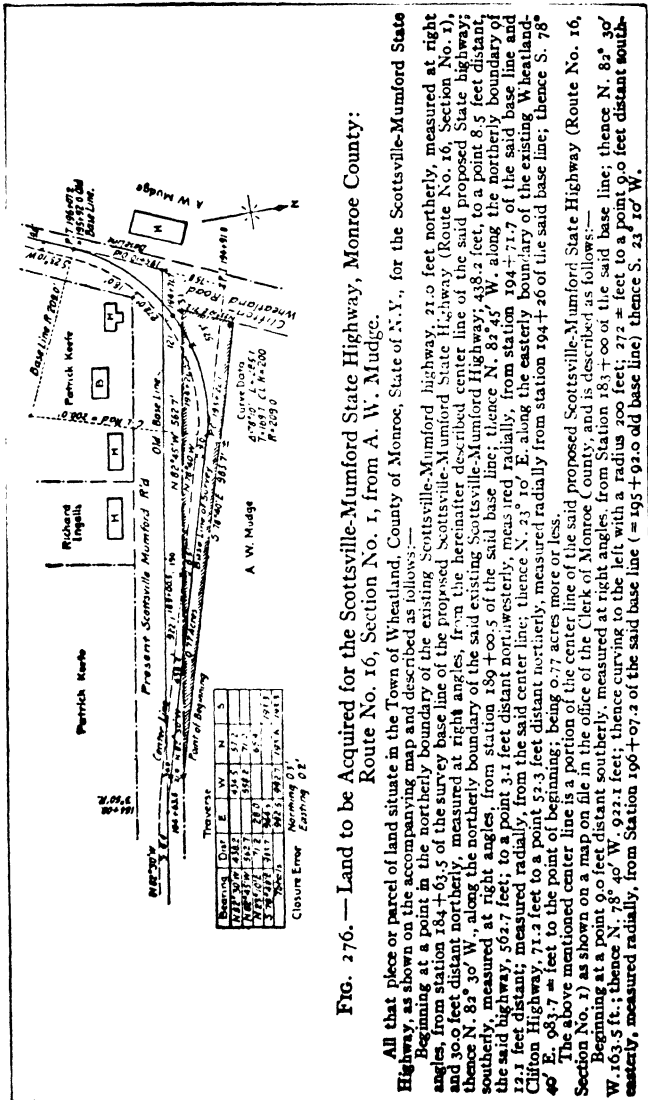

FIG. 276. — Land to be Acquired for the Scotsville-Mumford State Highway, Monroe County: Route No. 16, Section No. 1, from A. W. Mudge.

All that piece or parcel of land situate in the Town of Wheatland, County of Monroe, State of N. Y., for the Scotsville-Mumford State Highway, as shown on the accompanying map and described as follows:—
 Beginning at a point in the northerly boundary of the existing Scotsville-Mumford highway, 21.0 feet northerly, measured at right angles, from station 184+63.5 of the survey base-line of the proposed Scotsville-Mumford State Highway (Route No. 16, Section No. 1), and 30.0 feet distant northerly, measured at right angles, from the hereinafter described center line of the said proposed State highway; thence N. 83° 30' W., along the northerly boundary of the said existing Scotsville-Mumford Highway; 438.2 feet, to a point 8.5 feet distant southerly, measured at right angles, from station 189+00.5 of the said base line; thence N. 83° 45' W., along the northerly boundary of the said highway, 562.7 feet; to a point 3.1 feet distant northwesterly, measured radially, from the northerly boundary of the said highway, 12.1 feet distant; measured radially, from the said center line; thence N. 23° 10' E., along the easterly boundary of the existing Wheatland-Clifton Highway, 71.2 feet to a point 52.3 feet distant northerly, measured radially from station 194+26 of the said base line; thence S. 78° 40' E., 983.7 = feet to the point of beginning; being 0.77 acres more or less.
 The above mentioned center line is a portion of the center line of the said proposed Scotsville-Mumford State Highway (Route No. 16, Section No. 1) as shown on a map on file in the office of the Clerk of Monroe County, and is described as follows:—
 Beginning at a point 9.0 feet distant southerly, measured at right angles, from Station 183+00 of the said base line; thence N. 83° 30' W., 163.5 ft.; thence N. 78° 40' W., 922.1 feet; thence curving to the left with a radius 200 feet; 272 = feet to a point 9.0 feet distant south-easterly, measured radially, from Station 190+07.2 of the said base line (= 195 + 02.0 old base line) thence S. 23° 10' W.

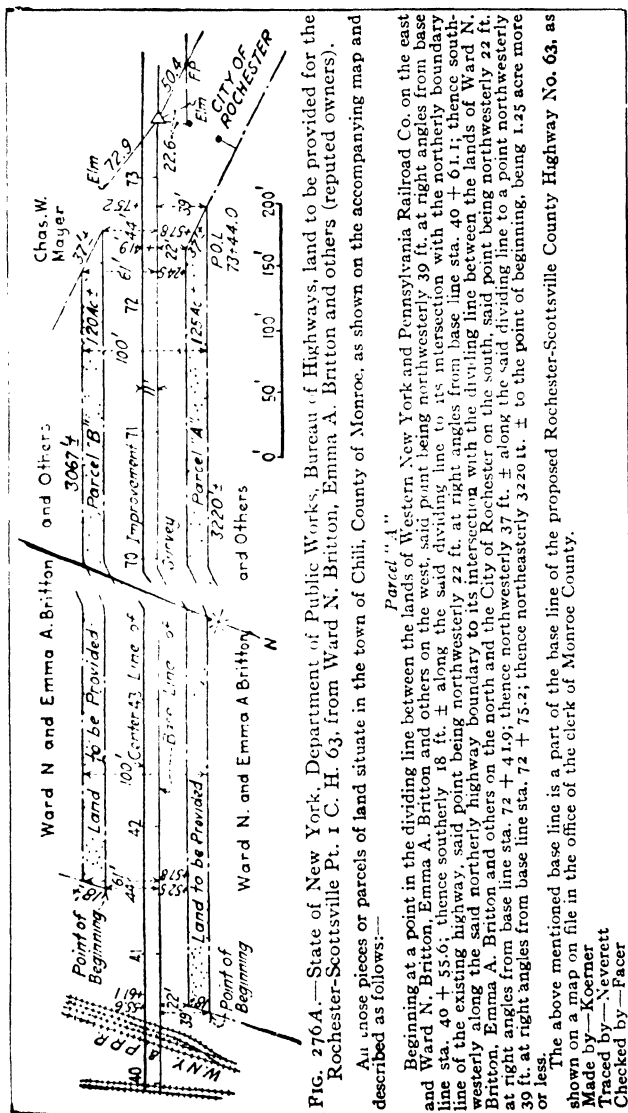

FIG. 276A.—State of New York, Department of Public Works, Bureau of Highways, land to be provided for the Rochester-Scottsville Pt. I C. H. 63, from Ward N. Britton, Emma A. Britton and others (reputed owners).

All those pieces or parcels of land situate in the town of Chili, County of Monroe, as shown on the accompanying map and described as follows:—

Beginning at a point in the dividing line between the lands of Western New York and Pennsylvania Railroad Co. on the east and Ward N. Britton, Emma A. Britton and others on the west, said point being northwesterly 39 ft. at right angles from base line sta. 40 + 55.6; thence southerly 18 ft. ± along the said dividing line to its intersection with the northerly boundary line of the existing highway, said point being northwesterly 22 ft. at right angles from base line sta. 40 + 61.1; thence southwesterly along the said northerly highway boundary to its intersection with the dividing line between the lands of Ward N. Britton, Emma A. Britton and others on the north and the City of Rochester on the south, said point being northwesterly 22 ft. at right angles from base line sta. 72 + 41.9; thence northwesterly 37 ft. ± along the said dividing line to a point northwesterly 39 ft. at right angles from base line sta. 72 + 75.2; thence northeasterly 3220 ft. ± to the point of beginning, being 1.25 acre more or less.

The above mentioned base line is a part of the base line of the proposed Rochester-Scottsville County Highway No. 63, as shown on a map on file in the office of the clerk of Monroe County.

Made by—Koerner
Traced by—Neverett
Checked by—Facer

TABLE 137.—HORIZONTAL DISTANCES AND ELEVATIONS FROM STADIA READINGS¹

Minutes	0°		1°		2°		3°	
	Hor. Dist.	Diff. Elev.	Hor. Dist.	Diff. Elev.	Hor. Dist.	Diff. Elev.	Hor. Dist.	Diff. Elev.
0	100.00	0.00	99.97	1.74	99.88	3.49	99.73	5.23
2	100.00	0.06	99.97	1.80	99.87	3.55	99.72	5.28
4	100.00	0.12	99.97	1.86	99.87	3.60	99.71	5.34
6	100.00	0.17	99.96	1.92	99.87	3.66	99.71	5.40
8	100.00	0.23	99.96	1.98	99.86	3.72	99.70	5.46
10	100.00	0.29	99.96	2.04	99.86	3.78	99.69	5.52
12	100.00	0.35	99.96	2.09	99.85	3.84	99.69	5.57
14	100.00	0.41	99.95	2.15	99.85	3.90	99.68	5.63
16	100.00	0.47	99.95	2.21	99.84	3.95	99.68	5.69
18	100.00	0.52	99.95	2.27	99.84	4.01	99.67	5.75
20	100.00	0.58	99.95	2.33	99.83	4.07	99.66	5.80
22	100.00	0.64	99.94	2.38	99.83	4.13	99.66	5.86
24	100.00	0.70	99.94	2.44	99.82	4.18	99.65	5.92
26	99.99	0.76	99.94	2.50	99.82	4.24	99.64	5.98
28	99.99	0.81	99.93	2.56	99.81	4.30	99.63	6.04
30	99.99	0.87	99.93	2.62	99.81	4.36	99.63	6.09
32	99.99	0.93	99.93	2.67	99.80	4.42	99.62	6.15
34	99.99	0.99	99.93	2.73	99.80	4.48	99.62	6.21
36	99.99	1.05	99.92	2.79	99.79	4.53	99.61	6.27
38	99.99	1.11	99.92	2.85	99.79	4.59	99.60	6.33
40	99.99	1.16	99.92	2.91	99.78	4.65	99.59	6.38
42	99.99	1.22	99.91	2.97	99.78	4.71	99.59	6.44
44	99.98	1.28	99.91	3.02	99.77	4.76	99.58	6.50
46	99.98	1.34	99.90	3.08	99.77	4.82	99.57	6.56
48	99.98	1.40	99.90	3.14	99.76	4.88	99.56	6.61
50	99.98	1.45	99.90	3.20	99.76	4.94	99.56	6.67
52	99.98	1.51	99.89	3.26	99.75	4.99	99.55	6.73
54	99.98	1.57	99.89	3.31	99.74	5.05	99.54	6.78
56	99.97	1.63	99.89	3.37	99.74	5.11	99.53	6.84
58	99.97	1.69	99.88	3.43	99.73	5.17	99.52	6.90
60	99.97	1.74	99.88	3.49	99.73	5.23	99.51	6.96
c = 0.75	0.75	0.01	0.75	0.02	0.75	0.03	0.75	0.05
c = 1.00	1.00	0.01	1.00	0.03	1.00	0.04	1.00	0.06
c = 1.25	1.25	0.02	1.25	0.03	1.25	0.05	1.25	0.08

¹ From "Theory and Practice of Surveying," by Prof. J. B. Johnson, New York; John Wiley & Sons. We are enabled to use this form through the courtesy of Prof. J. B. Johnson.

TABLE 137.—HORIZONTAL DISTANCES AND ELEVATIONS FROM STADIA READINGS.—Continued

Minutes	4°		5°		6°		7°	
	Hor. Dist.	Diff. Elev.	Hor. Dist.	Diff. Elev.	Hor. Dist.	Diff. Elev.	Hor. Dist.	Diff. Elev.
0	99.51	6.96	99.24	8.68	98.91	10.40	98.51	12.10
2	99.51	7.02	99.23	8.74	98.90	10.45	98.50	12.15
4	99.50	7.07	99.22	8.80	98.88	10.51	98.48	12.21
6	99.49	7.13	99.21	8.85	98.87	10.57	98.47	12.26
8	99.48	7.19	99.20	8.91	98.86	10.62	98.46	12.32
10	99.47	7.25	99.19	8.97	98.85	10.68	98.44	12.38
12	99.46	7.30	99.13	9.03	98.83	10.74	98.43	12.43
14	99.46	7.36	99.17	9.03	98.82	10.79	98.41	12.49
16	99.45	7.42	99.16	9.14	98.81	10.85	98.40	12.55
18	99.44	7.48	99.15	9.20	98.80	10.91	98.39	12.60
20	99.43	7.53	99.14	9.25	98.78	10.96	98.37	12.66
22	99.42	7.59	99.13	9.31	98.77	11.02	98.36	12.72
24	99.41	7.65	99.11	9.37	98.76	11.08	98.34	12.77
26	99.40	7.71	99.10	9.43	98.74	11.13	98.33	12.83
28	99.39	7.76	99.09	9.48	98.73	11.19	98.31	12.88
30	99.38	7.82	99.03	9.54	98.72	11.25	98.29	12.94
32	99.38	7.88	99.07	9.60	98.71	11.30	98.28	13.00
34	99.37	7.94	99.06	9.65	98.69	11.36	98.27	13.05
36	99.36	7.99	99.05	9.71	98.68	11.42	98.25	13.11
38	99.35	8.05	99.04	9.77	98.67	11.47	98.24	13.17
40	99.34	8.11	99.03	9.83	98.65	11.53	98.22	13.22
42	99.33	8.17	99.01	9.88	98.64	11.59	98.20	13.28
44	99.32	8.22	99.00	9.94	98.63	11.64	98.19	13.33
46	99.31	8.28	98.99	10.00	98.61	11.70	98.17	13.39
48	99.30	8.34	98.98	10.05	98.60	11.76	98.16	13.45
50	99.29	8.40	98.97	10.11	98.58	11.81	98.14	13.50
52	99.28	8.45	98.96	10.17	98.57	11.87	98.13	13.56
54	99.27	8.51	98.94	10.22	98.56	11.93	98.11	13.61
56	99.26	8.57	98.93	10.28	98.54	11.98	98.10	13.67
58	99.25	8.63	98.92	10.34	98.53	12.04	98.08	13.73
60	99.24	8.68	98.91	10.40	98.51	12.10	98.06	13.78
c = 0.75.	0.75	0.06	0.75	0.07	0.75	0.08	0.74	0.10
c = 1.00.	1.00	0.08	0.99	0.09	0.99	0.11	0.99	0.13
c = 1.25.	1.25	0.10	1.24	0.11	1.24	0.14	1.24	0.16

TABLE 137.—HORIZONTAL DISTANCES AND ELEVATIONS FROM STADIA READINGS.—*Continued*

Minutes	8°		9°		10°		11°	
	Hor. Dist.	Diff. Elev.	Hor. Dist.	Diff. Elev.	Hor. Dist.	Diff. Elev.	Hor. Dist.	Diff. Elev.
0	98.00	13.78	97.55	15.45	96.98	17.10	96.30	18.73
2	98.05	13.84	97.53	15.51	96.96	17.16	96.34	18.78
4	98.03	13.89	97.52	15.56	96.94	17.21	96.32	18.84
6	98.01	13.95	97.50	15.62	96.92	17.26	96.29	18.89
8	98.00	14.01	97.48	15.67	96.90	17.32	96.27	18.95
10	97.98	14.06	97.46	15.73	96.88	17.37	96.25	19.00
12	97.97	14.12	97.44	15.78	96.86	17.43	96.23	19.05
14	97.95	14.17	97.43	15.84	96.84	17.48	96.21	19.11
16	97.93	14.23	97.41	15.89	96.82	17.54	96.18	19.16
18	97.92	14.28	97.39	15.95	96.80	17.59	96.16	19.21
20	97.90	14.34	97.37	16.00	96.78	17.65	96.14	19.27
22	97.88	14.40	97.35	16.06	96.76	17.70	96.12	19.32
24	97.87	14.45	97.33	16.11	96.74	17.76	96.09	19.38
26	97.85	14.51	97.31	16.17	96.72	17.81	96.07	19.43
28	97.83	14.56	97.29	16.22	96.70	17.86	96.05	19.48
30	97.82	14.62	97.28	16.28	96.68	17.92	96.03	19.54
32	97.80	14.67	97.26	16.33	96.66	17.97	96.00	19.59
34	97.78	14.73	97.24	16.39	96.64	18.03	95.98	19.64
36	97.76	14.79	97.22	16.44	96.62	18.08	95.96	19.70
38	97.75	14.84	97.20	16.50	96.60	18.14	95.93	19.75
40	97.73	14.90	97.18	16.55	96.57	18.19	95.91	19.80
42	97.71	14.95	97.16	16.61	96.55	18.24	95.89	19.86
44	97.69	15.01	97.14	16.66	96.53	18.30	95.86	19.91
46	97.68	15.06	97.12	16.72	96.51	18.35	95.84	19.96
48	97.66	15.12	97.10	16.77	96.49	18.41	95.82	20.02
50	97.64	15.17	97.08	16.83	96.47	18.46	95.79	20.07
52	97.62	15.23	97.06	16.88	96.45	18.51	95.77	20.12
54	97.61	15.28	97.04	16.94	96.42	18.57	95.75	20.18
56	97.59	15.34	97.02	16.99	96.40	18.62	95.72	20.23
58	97.57	15.40	97.00	17.05	96.38	18.68	95.70	20.28
60	97.55	15.45	96.98	17.10	96.36	18.73	95.68	20.34
<i>c</i> = 0.75	0.74	0.11	0.74	0.12	0.74	0.14	0.73	0.15
<i>c</i> = 1.00	0.99	0.15	0.99	0.16	0.98	0.18	0.98	0.20
<i>c</i> = 1.25	1.23	0.18	1.23	0.21	1.23	0.23	1.22	0.25

TABLE 137.—HORIZONTAL DISTANCES AND ELEVATIONS FROM STADIA READINGS.—Continued

Minutes	12°		13°		14°		15°	
	Hor. Dist.	Diff. Elev.	Hor. Dist.	Diff. Elev.	Hor. Dist.	Diff. Elev.	Hor. Dist.	Diff. Elev.
0	95.68	20.34	94.94	21.92	94.15	23.47	93.30	25.00
2	95.65	20.39	94.91	21.97	94.12	23.52	93.27	25.05
4	95.63	20.44	94.89	22.02	94.09	23.58	93.24	25.10
6	95.61	20.50	94.86	22.08	94.07	23.63	93.21	25.15
8	95.58	20.55	94.84	22.13	94.04	23.68	93.18	25.20
10	95.56	20.60	94.81	22.18	94.01	23.73	93.16	25.25
12	95.53	20.66	94.79	22.23	93.98	23.78	93.13	25.30
14	95.51	20.71	94.76	22.28	93.95	23.83	93.10	25.35
16	95.49	20.76	94.73	22.34	93.93	23.88	93.07	25.40
18	95.46	20.81	94.71	22.39	93.90	23.93	93.04	25.45
20	95.44	20.87	94.68	22.44	93.87	23.99	93.01	25.50
22	95.41	20.92	94.66	22.49	93.84	24.04	92.98	25.55
24	95.39	20.97	94.63	22.54	93.81	24.09	92.95	25.60
26	95.36	21.03	94.60	22.60	93.79	24.14	92.92	25.65
28	95.34	21.08	94.58	22.65	93.76	24.19	92.89	25.70
30	95.32	21.13	94.55	22.70	93.73	24.24	92.86	25.75
32	95.29	21.18	94.52	22.75	93.70	24.29	92.83	25.80
34	95.27	21.24	94.50	22.80	93.67	24.34	92.80	25.85
36	95.24	21.29	94.47	22.85	93.65	24.39	92.77	25.90
38	95.22	21.34	94.44	22.91	93.62	24.44	92.74	25.95
40	95.19	21.39	94.42	22.96	93.59	24.49	92.71	26.00
42	95.17	21.45	94.39	23.01	93.56	24.55	92.68	26.05
44	95.14	21.50	94.36	23.06	93.53	24.60	92.65	26.10
46	95.12	21.55	94.34	23.11	93.50	24.65	92.62	26.15
48	95.09	21.60	94.31	23.16	93.47	24.70	92.59	26.20
50	95.07	21.66	94.28	23.22	93.45	24.75	92.56	26.25
52	95.04	21.71	94.26	23.27	93.42	24.80	92.53	26.30
54	95.02	21.76	94.23	23.32	93.39	24.85	92.49	26.35
56	94.99	21.81	94.20	23.37	93.36	24.90	92.46	26.40
58	94.97	21.87	94.17	23.42	93.33	24.95	92.43	26.45
60	94.94	21.92	94.15	23.47	93.30	25.00	92.40	26.50
c = 0.75	0.73	0.16	0.73	0.17	0.73	0.19	0.72	0.20
c = 1.00	0.98	0.22	0.97	0.23	0.97	0.25	0.96	0.27
c = 1.25	1.22	0.27	1.21	0.29	1.21	0.31	1.20	0.34

TABLE 137.—HORIZONTAL DISTANCES AND ELEVATIONS FROM STADIA READINGS.—Continued

Minutes	16°		17°		18°		19°	
	Hor. Dist.	Diff. Elev.	Hor. Dist.	Diff. Elev.	Hor. Dist.	Diff. Elev.	Hor. Dist.	Diff. Elev.
0	92.40	26.50	91.45	27.96	90.45	29.39	89.40	30.78
2	92.37	26.55	91.42	28.01	90.42	29.44	89.36	30.83
4	92.34	26.59	91.39	28.06	90.38	29.48	89.33	30.87
6	92.31	26.64	91.35	28.10	90.35	29.53	89.29	30.92
8	92.28	26.69	91.32	28.15	90.31	29.58	89.26	30.97
10	92.25	26.74	91.29	28.20	90.28	29.62	89.22	31.01
12	92.22	26.79	91.26	28.25	90.24	29.67	89.18	31.06
14	92.19	26.84	91.22	28.30	90.21	29.72	89.15	31.10
16	92.15	26.89	91.19	28.34	90.18	29.76	89.11	31.15
18	92.12	26.94	91.16	28.39	90.14	29.81	89.08	31.19
20	92.09	26.99	91.12	28.44	90.11	29.86	89.04	31.24
22	92.06	27.04	91.09	28.49	90.07	29.90	89.00	31.28
24	92.03	27.09	91.06	28.54	90.04	29.95	88.96	31.33
26	92.00	27.13	91.02	28.58	90.00	30.00	88.93	31.38
28	91.97	27.18	90.99	28.63	89.97	30.04	88.89	31.42
30	91.93	27.23	90.96	28.68	89.93	30.09	88.86	31.47
32	91.90	27.28	90.92	28.73	89.90	30.14	88.82	31.51
34	91.87	27.33	90.89	28.77	89.86	30.19	88.78	31.56
36	91.84	27.38	90.86	28.82	89.83	30.23	88.75	31.60
38	91.81	27.43	90.82	28.87	89.79	30.28	88.71	31.65
40	91.77	27.48	90.79	28.92	89.76	30.32	88.67	31.69
42	91.74	27.52	90.76	28.96	89.72	30.37	88.64	31.74
44	91.71	27.57	90.72	29.01	89.69	30.41	88.60	31.78
46	91.68	27.62	90.69	29.06	89.65	30.46	88.56	31.83
48	91.65	27.67	90.66	29.11	89.61	30.51	88.53	31.87
50	91.61	27.72	90.62	29.15	89.58	30.55	88.49	31.92
52	91.58	27.77	90.59	29.20	89.54	30.60	88.45	31.96
54	91.55	27.81	90.55	29.25	89.51	30.65	88.41	32.01
56	91.52	27.86	90.52	29.30	89.47	30.69	88.38	32.05
58	91.48	27.91	90.48	29.34	89.44	30.74	88.34	32.09
60	91.45	27.96	90.45	29.39	89.40	30.78	88.30	32.14
c = 0.75	0.72	0.21	0.72	0.23	0.71	0.24	0.71	0.25
c = 1.00	0.96	0.28	0.95	0.30	0.95	0.32	0.94	0.33
c = 1.25	1.20	0.35	1.19	0.38	1.19	0.40	1.18	0.42

TABLE 137.—HORIZONTAL DISTANCES AND ELEVATIONS FROM STADIA READINGS.—*Continued*

Minutes.	20°		21°		22°		23°	
	Hor. Dist.	Diff. Elev.	Hor. Dist.	Diff. Elev.	Hor. Dist.	Diff. Elev.	Hor. Dist.	Diff. Elev.
0	88.30	32.14	87.16	33.46	85.97	34.73	84.73	35.97
2	88.26	32.18	87.12	33.50	85.93	34.77	84.69	36.01
4	88.23	32.23	87.08	33.54	85.89	34.82	84.65	36.05
6	88.19	32.27	87.04	33.59	85.85	34.86	84.61	36.09
8	88.15	32.32	87.00	33.63	85.80	34.90	84.57	36.13
10	88.11	32.36	86.96	33.67	85.76	34.94	84.52	36.17
12	88.08	32.41	86.92	33.72	85.72	34.98	84.48	36.21
14	88.04	32.45	86.88	33.76	85.68	35.02	84.44	36.25
16	88.00	32.49	86.84	33.80	85.64	35.07	84.40	36.29
18	87.96	32.54	86.80	33.84	85.60	35.11	84.35	36.33
20	87.93	32.58	86.77	33.89	85.56	35.15	84.31	36.37
22	87.89	32.63	86.73	33.93	85.52	35.19	84.27	36.41
24	87.85	32.67	86.69	33.97	85.48	35.23	84.23	36.45
26	87.81	32.72	86.65	34.01	85.44	35.27	84.18	36.49
28	87.77	32.76	86.61	34.06	85.40	35.31	84.14	36.53
30	87.74	32.80	86.57	34.10	85.36	35.36	84.10	36.57
32	87.70	32.85	86.53	34.14	85.31	35.40	84.06	36.61
34	87.66	32.89	86.49	34.18	85.27	35.44	84.01	36.65
36	87.62	32.93	86.45	34.23	85.23	35.48	83.97	36.69
38	87.58	32.98	86.41	34.27	85.19	35.52	83.93	36.73
40	87.54	33.02	86.37	34.31	85.15	35.56	83.89	36.77
42	87.51	33.07	86.33	34.35	85.11	35.60	83.84	36.80
44	87.47	33.11	86.29	34.40	85.07	35.64	83.80	36.84
46	87.43	33.15	86.25	34.44	85.02	35.68	83.76	36.88
48	87.39	33.20	86.21	34.48	84.98	35.72	83.72	36.92
50	87.35	33.24	86.17	34.52	84.94	35.76	83.67	36.96
52	87.31	33.28	86.13	34.57	84.90	35.80	83.63	37.00
54	87.27	33.33	86.09	34.61	84.86	35.85	83.59	37.04
56	87.24	33.37	86.05	34.65	84.82	35.89	83.54	37.08
58	87.20	33.41	86.01	34.69	84.77	35.93	83.50	37.12
60	87.16	33.46	85.97	34.73	84.73	35.97	83.46	37.16
c = 0.75.	0.70	0.26	0.70	0.27	0.69	0.29	0.69	0.30
c = 1.00.	0.94	0.35	0.93	0.37	0.92	0.38	0.92	0.40
c = 1.25.	1.17	0.44	1.16	0.46	1.15	0.48	1.15	0.50

TABLE 137.—HORIZONTAL DISTANCES AND ELEVATIONS FROM STADIA READINGS.—Continued

Minutes	24°		25°		26°		27°	
	Hor. Dist.	Diff. Elev.	Hor. Dist.	Diff. Elev.	Hor. Dist.	Diff. Elev.	Hor. Dist.	Diff. Elev.
0	83.46	37.16	82.14	38.30	80.78	39.40	79.39	40.45
2	83.41	37.20	82.09	38.34	80.74	39.44	79.34	40.49
4	83.37	37.23	82.05	38.38	80.69	39.47	79.30	40.52
6	83.33	37.27	82.01	38.41	80.65	39.51	79.25	40.55
8	83.28	37.31	81.96	38.45	80.60	39.54	79.20	40.59
10	83.24	37.35	81.92	38.49	80.55	39.58	79.15	40.62
12	83.20	37.39	81.87	38.53	80.51	39.61	79.11	40.66
14	83.15	37.43	81.83	38.56	80.46	39.65	79.06	40.69
16	83.11	37.47	81.78	38.60	80.41	39.69	79.01	40.72
18	83.07	37.51	81.74	38.64	80.37	39.72	78.96	40.76
20	83.02	37.54	81.69	38.67	80.32	39.76	78.92	40.79
22	82.98	37.58	81.65	38.71	80.28	39.79	78.87	40.82
24	82.93	37.62	81.60	38.75	80.23	39.83	78.82	40.86
26	82.89	37.66	81.56	38.78	80.18	39.86	78.77	40.89
28	82.85	37.70	81.51	38.82	80.14	39.90	78.73	40.92
30	82.80	37.74	81.47	38.86	80.09	39.93	78.68	40.96
32	82.76	37.77	81.42	38.89	80.04	39.97	78.63	40.99
34	82.72	37.81	81.38	38.93	80.00	40.00	78.58	41.02
36	82.67	37.85	81.33	38.97	79.95	40.04	78.54	41.06
38	82.63	37.89	81.28	39.00	79.90	40.07	78.49	41.09
40	82.58	37.93	81.24	39.04	79.86	40.11	78.44	41.12
42	82.54	37.96	81.19	39.08	79.81	40.14	78.39	41.16
44	82.49	38.00	81.15	39.11	79.76	40.18	78.34	41.19
46	82.45	38.04	81.10	39.15	79.72	40.21	78.30	41.22
48	82.41	38.08	81.06	39.18	79.67	40.24	78.25	41.26
50	82.36	38.11	81.01	39.22	79.62	40.28	78.20	41.29
52	82.32	38.15	80.97	39.26	79.58	40.31	78.15	41.32
54	82.27	38.19	80.92	39.29	79.53	40.35	78.10	41.35
56	82.23	38.23	80.87	39.33	79.48	40.38	78.06	41.39
58	82.18	38.26	80.83	39.36	79.44	40.42	78.01	41.42
60	82.14	38.30	80.78	39.40	79.39	40.45	77.96	41.45
c = 0.75.	0.68	0.31	0.68	0.32	0.67	0.33	0.66	0.35
c = 1.00.	0.91	0.41	0.90	0.43	0.89	0.45	0.88	0.46
c = 1.25.	1.14	0.52	1.13	0.54	1.12	0.56	1.11	0.58

TABLE 137.—HORIZONTAL DISTANCES AND ELEVATIONS FROM STADIA READINGS.—*Concluded*

Minutes	28°		29°		30°	
	Hor. Dist.	Diff. Elev.	Hor. Dist.	Diff. Elev.	Hor. Dist.	Diff. Elev.
0	77.96	41.45	76.50	42.40	75.00	43.30
2	77.91	41.48	76.45	42.43	74.95	43.33
4	77.86	41.52	76.40	42.46	74.90	43.36
6	77.81	41.55	76.35	42.49	74.85	43.39
8	77.77	41.58	76.30	42.53	74.80	43.42
10	77.72	41.61	76.25	42.56	74.75	43.45
12	77.67	41.65	76.20	42.59	74.70	43.47
14	77.62	41.68	76.15	42.62	74.65	43.50
16	77.57	41.71	76.10	42.65	74.60	43.53
18	77.52	41.74	76.05	42.68	74.55	43.56
20	77.48	41.77	76.00	42.71	74.49	43.59
22	77.42	41.81	75.95	42.74	74.44	43.62
24	77.38	41.84	75.90	42.77	74.39	43.65
26	77.33	41.87	75.85	42.80	74.34	43.67
28	77.28	41.90	75.80	42.83	74.29	43.70
30	77.23	41.93	75.75	42.86	74.24	43.73
32	77.18	41.97	75.70	42.89	74.19	43.76
34	77.13	42.00	75.65	42.92	74.14	43.79
36	77.09	42.03	75.60	42.95	74.09	43.82
38	77.04	42.06	75.55	42.98	74.04	43.84
40	76.99	42.09	75.50	43.01	73.99	43.87
42	76.94	42.12	75.45	43.04	73.93	43.90
44	76.89	42.15	75.40	43.07	73.88	43.93
46	76.84	42.19	75.35	43.10	73.83	43.95
48	76.79	42.22	75.30	43.13	73.78	43.98
50	76.74	42.25	75.25	43.16	73.73	44.01
52	76.69	42.28	75.20	43.18	73.68	44.04
54	76.64	42.31	75.15	43.21	73.63	44.07
56	76.59	42.34	75.10	43.24	73.58	44.09
58	76.55	42.37	75.05	43.27	73.52	44.12
60	76.50	42.40	75.00	43.30	73.47	44.15
c = 0.75..	0.66	0.36	0.65	0.37	0.65	0.38
c = 1.00..	0.88	0.48	0.87	0.49	0.86	0.51
c = 1.25..	1.10	0.60	1.09	0.62	1.08	0.64

Diversion-line Surveys.—Where there is no doubt as to the grade to be adopted, or the alignment to be used, the location is made directly in the field and the center line is run and the cross-sections taken in the same manner as for a preliminary survey. If, however, the country is badly cut up and it is difficult to make a field location direct, a transit stadia survey is made covering the territory that will include all the possible, locations, and from the resulting contour map the different locations are projected and approximate estimates figured. The adopted line is then run in the field, cross-sections taken in the usual manner, and an accurate estimate made. This method is used so seldom that the author does not feel justified in giving much space to the theory of stadia measurements or the methods of stadia surveys (see p. 932). If the reader is not familiar with this class of work he is referred to the standard works on surveying.

A convenient scale for a contour map for the projection work mentioned above is $1'' = 20'$ with a contour interval of 1 to 5', depending on the country. Table 137 is useful for reducing stadia notes. For a small number of shots this table and a slide rule will answer the purpose; for any extended amount of work a stadia reduction diagram or Noble & Casgrain's tables are recommended.

If the stadia work is well done very satisfactory projections can be made. A reasonable closure error for stadia surveys is 5 ft. per mile horizontal distances line closure. 0.3 ft. per mile vertical elevation closure and individual contour shots 0.2 in error.

Adjustment of Instruments

Instruments must be kept in perfect adjustment and the first page of survey notes for any job should contain the signed statement of the Engineer in charge that all instruments were in good adjustment at all times.

Y-level. *To Make the Line of Collimation Parallel to the Telescope Rings.*—Level the instrument roughly. Loosen the Y-clamps so the telescope can turn freely in them; clamp the horizontal motion and by means of the leveling screws and tangent motion bring the intersection of the cross-hairs on some well-defined point. Then, without lifting from the Y's, turn the telescope over 180° , watching to see if the cross-wires remain on the point during the operation; if they do, the adjustment is correct; if they do not, correct one-half the apparent error for both vertical and horizontal wires by means of the cross-hair ring, adjusting screws, and repeat until the wires remain on the point for a complete revolution.

To Make the Longitudinal Axis of the Level Bubble Parallel to the Plane of the Line of Collimation.—Level the machine over either pair of leveling screws; unclamp the Y's; rotate the telescope in the Y's until the bubble tube is on one side of the bar. If the bubble remains in the center, the adjustment is correct. If it runs from the center bring it to its correct position by means of the sidewise adjusting screw at one end of the bubble case.

To Make the Bubble Parallel to the Rings and Line of Collimation.—Level the machine; unclamp the Y's; lift the telescope carefully from the Y's and reverse end for end; if the bubble runs to the center

after the telescope has been reversed the adjustment is correct; if not, correct one-half the error by means of the adjusting nuts on the bubble case and one-half the error with the leveling screws and repeat the test until the bubble remains in the center.

To Adjust the Y's so the Level Bubble Will Be at Right Angles to the Axis of the Instrument.—Level the machine approximately over both sets of screws; level carefully over one set; rotate on the spindle 180° ; if the bubble remains in the center the adjustment is correct; if not, correct one-half the error by means of the adjusting nuts on the Ys and one-half by the leveling screws. Repeat until the bubble remains in the center when reversed over either pair of leveling screws.

To Test the Horizontal Wire.—Be sure that the pin in the Y-clamp is in the notch of the telescope ring to keep the telescope from rotating; level the machine and compare the horizontal wire with any level line; if the wire is not level loosen the cross-wire ring and turn to the correct position. Adjust again for collimation and the level adjustments are complete.

Dumpy Level. *To Make the Bubble Perpendicular to the Axis of the Instrument.*—Level the machine roughly over both sets of leveling screws and carefully over one set; rotate on the pinion 180° ; if the bubble stays in the center the adjustment is correct; if not, correct one-half the error by means of the bubble adjusting nut and one-half by the leveling screws, and repeat until correct.

To Make the Horizontal Line of Collimation Parallel to the Level Bubble.—Level the machine; drive a stake about 150 or 200' from instrument and set the level rod target by the horizontal wire; rotate the instrument 180° and set another stake at the same distance from the machine as the first one; drive it until a rod reading taken on it is the same as the reading on the first stake. These stakes will then be level even though the machine is out of adjustment. Then set the level up near one of the stakes; level carefully and take rod readings on both; if these readings are the same the level is in adjustment; if not, correct the position of the horizontal wire by means of the cross-wire ring screws until the readings on both stakes are the same.

Test the horizontal wire on a level line in the same manner as for the Y-level.

Transit. Plate Levels.—Level the machine with each plate level bubble parallel to one set of leveling screws; rotate on the spindle 180° ; if the bubbles remain in the center the adjustment is correct; if not, correct one-half the error with the bubble adjusting screws and one-half with the leveling screws. Repeat until correct.

Line of Collimation, Ordinary Distances.—Level the machine; clamp the horizontal motion; with the slow-motion screw set the vertical cross-wire on some well-defined point 500 or 600' away; transit the telescope and set a mark the same distance in the opposite direction; then rotate the machine on the spindle, set on the first mark, and transit the telescope; if the vertical wire strikes the second point the adjustment is correct; if not, correct one-fourth the error by means of cross-wire ring adjusting screws and repeat until correct.

To Make the Standards the Same Height.—Level the machine carefully; set the vertical wire on some well-defined point as high as can be seen; bring the telescope down and set a point; rotate the machine 180° ; transit the telescope set on the low point and raise the telescope; if the wire bisects the original high point the adjustment is correct; if not, correct one-half the error by means of the standard adjusting screw.

Test the vertical wire by means of a plumb line to see that it is vertical; if not, loosen the cross-hair ring and turn to the correct position; test again for collimation.

If the transit is to be used as a level make the level bubble parallel to the horizontal wire by the two-peg method in the same manner as described for the Dumpy level.

Explanation of Curve Tables and Development of Curve Formulas.—Curves for road work need not be so carefully worked out as



FIG. 277.

in railroad surveying. Except for long curves the external is usually measured and the curve run in by the eye, and for this reason many of the tables given in the railway field manuals are omitted and those used are tabulated in a different form.

Table 138, Radii of Curves.—The curve radii are computed on a basis of $5730'$ as the radius of a 1° curve and are inversely proportional to the degree of curvature; they are tabulated to the nearest $0.1'$. The usual columns showing logarithm of radius, tangent offset, and middle ordinate are replaced by the deflection angle per foot of arc, per $25'$ of arc, and per $50'$ of arc, which saves considerable time in the computation of deflections. These values are tabulated only for even degree, 20 , 30 and $40'$ curves, as there is always sufficient leeway both in the external and tangent to select a suitable curve from this list.

Table 139, Functions of 1° Curve.—Column 1 gives the central angle Δ for every $10'$ from $0'$ to 4° , every minute 4 to 100° , and every $10'$ 100 to 120° .

Column 2 gives the same central angle as in column 1 expressed in decimals of a degree. This simplifies figuring the curve length.

Columns 3 and 4 give the tangent and external for the central angles of column 1 to the nearest 0.1'. By the use of the chord lengths recommended at the top of each page of this table no correction need be made for tangent length or external distance of any desired curve, figured by dividing the value given in the table by the degree of curvature required.

The error that is introduced by the use of these chords is less than 0.1' per 100', which is the allowable limit of error in chaining center line.

For the convenience of readers not familiar with the theory of curves and the computation of curve notes, the following brief demonstration is made:

Radii of Curves and Degree of Curvature.—A 1° curve is defined as a curve having such a radius that 100' of arc will subtend a 1° central angle.

There are 360° of central angle for a complete circle. The circumference of a circle is expressed by the formula $2\pi R$. Therefore the radius of 1° curve is determined by the formulas

$$2\pi R = 360 \times 100$$

$$R = \frac{36,000}{2\pi} = \frac{36,000}{2(3.14159)} = 5729.6' \quad (1)$$

TABLE 138.—RADI AND DEFLECTIONS
Figured on a basis of $R = 5730'$ for a 1° curve.

Degree of Curve	Radius of Curve	Deflection per foot of Arc	Deflection per 25' of Arc		Deflection per 90' of Arc	
			Deg.	Minutes	Deg.	Minutes
	Feet	Minutes				
0° 30'	11,460.0	00.15	—	—	0	07.5
0° 40'	8,595.0	00.2	—	—	0	10.0
0° 50'	6,876.0	00.25	—	—	0	12.5
1° 00'	5,730.0	00.3	—	—	0	15.0
1° 20'	4,297.5	00.4	—	—	0	20.0
1° 30'	3,820.0	00.45	—	—	0	22.5
1° 40'	3,438.0	00.5	—	—	0	25.0
2° 00'	2,865.0	00.6	—	—	0	30.0
2° 20'	2,455.7	00.7	—	—	0	35.0
2° 30'	2,292.0	00.75	—	—	0	37.5
3° 40'	2,148.8	00.8	—	—	0	40.0
3° 00'	1,910.0	00.9	—	—	0	45.0

TABLE 138.—Continued.

Degree of Curve	Radius of Curve	Deflection per foot of Arc	Deflection per 25' of Arc		Deflection per 90' of Arc	
			Deg.	Minutes	Deg.	Minutes
	Feet	Minutes				
3° 20' ..	1,719.0	01.0	—	—	0	50.0
3° 30' ..	1,637.1	01.05	—	—	0	52.5
3° 40' ..	1,562.7	01.1	—	—	0	55.0
4° 00' ..	1,432.5	01.2	—	—	1	00.0
4° 20' ..	1,322.3	01.3	—	—	1	05.0
4° 30' ..	1,273.3	01.35	—	—	1	07.5
4° 40' ..	1,227.9	01.4	—	—	1	10.0
5° 00' ..	1,146.0	01.5	—	—	1	15.0
5° 30' ..	1,041.8	01.65	—	—	1	22.5
6° 00' ..	955.0	01.8	—	—	1	30.0
6° 30' ..	881.5	01.95	—	—	1	37.5
7° 00' ..	818.6	02.1	—	—	1	45.0
7° 30' ..	764.0	02.25	—	—	1	52.5
8° 00' ..	716.3	02.4	—	—	2	00.0
8° 30' ..	674.1	02.55	—	—	2	07.5
9° 00' ..	636.6	02.7	—	—	2	15.0
9° 30' ..	603.2	02.85	—	—	2	22.5
10° 00' ..	573.0	03.0	—	—	2	30.0
10° 30' ..	545.7	03.15	—	—	2	37.5
11° 00' ..	520.9	03.3	—	—	2	45.0
11° 30' ..	498.3	03.45	—	—	2	52.5
12° 00' ..	477.5	03.6	—	—	3	00.0
12° 30' ..	458.4	03.75	—	—	3	07.5
13° 00' ..	440.8	03.9	—	—	3	15.0
13° 30' ..	424.4	04.05	—	—	3	22.5
14° 00' ..	409.3	04.2	—	—	3	30.0
14° 30' ..	395.2	04.35	—	—	3	37.5
15° 00' ..	382.0	04.5	—	—	3	45.0
15° 30' ..	369.6	04.65	—	—	3	52.5
16° 00' ..	358.1	04.8	2	00.0	4	00.0
16° 30' ..	347.3	04.95	2	03.8	4	07.5
17° 00' ..	337.0	05.1	2	07.5	4	15.0
17° 30' ..	327.4	05.25	2	11.2	4	22.5
18° 00' ..	318.3	05.4	2	15.0	4	30.0
18° 30' ..	309.7	05.55	2	18.7	4	37.5

TABLE 138.—Continued

Degree of Curve	Radius of Curve	Deflection per ft. of Arc	Deflection per 25' of Arc		Deflection per 50' of Arc	
		Minutes	Degree	Minutes		
19° 00'	301.6	05.7	2	22.5		
19° 30'	293.8	05.85	2	26.2		
20° 00'	286.5	06.0	2	30.0		
20° 30'	279.5	06.15	2	33.7		
21° 00'	272.9	06.30	2	37.5		
21° 30'	266.5	06.45	2	41.2		
22° 00'	260.5	06.6	2	45.0		
22° 30'	254.7	06.75	2	48.7		
23° 00'	249.1	06.9	2	52.5		
23° 30'	243.8	07.05	2	56.2		
24° 00'	238.8	07.2	3	00.0		
24° 30'	233.9	07.35	3	03.7		
25° 00'	229.2	07.5	3	07.5		
26° 00'	220.4	07.8	3	15.0		
27° 00'	212.2	08.1	3	22.5		
28° 00'	204.6	08.4	3	30.0		
29° 00'	197.6	08.7	3	37.5		
30° 00'	191.0	09.0	3	45.0		
31° 00'	184.8	09.3	3	52.5		
32° 00'	179.1	09.6	4	00.0		
33° 00'	173.6	09.9	—	—	1°	36'
34° 00'	168.5	10.2	—	—	1°	39'
35° 00'	163.7	10.5	—	—	1°	42'
					1°	45'
36° 00'	159.2	10.8	—	—	1°	48'
37° 00'	154.9	11.1	—	—	1°	51'
38° 00'	150.8	11.4	—	—	1°	54'
39° 00'	146.9	11.7	—	—	1°	57'
40° 00'	143.2	12.0	—	—	2°	00'
42° 00'	136.4	12.6	—	—	2°	06'
44° 00'	130.2	13.2	—	—	2°	12'
46° 00'	124.6	13.8	—	—	2°	18'
48° 00'	119.4	14.4	—	—	2°	24'
50° 00'	114.6	15.0	—	—	2°	30'
52° 00'	110.2	15.6	—	—	2°	36'
54° 00'	106.1	16.2	—	—	2°	42'
56° 00'	102.3	16.8	—	—	2°	48'

For all practical purposes the value of 5730 can be used.

In the same manner a 2° curve is one having such a radius that 100' of arc will subtend 2° of central angle, and its radius is

$$2\pi R = \frac{360}{2} \times 100$$

$$R = \frac{18,000}{2\pi},$$

or one-half of the radius of a 1° curve. The radius of a 3° curve will be one-third of 5730. The radius of a 4° curve will be one-fourth of 5730.

The formula for the radius of any degree of curve is, therefore,

$$R = \frac{5730}{D}. \quad (2)$$

The degree of curvature for any specified radius is, therefore,

$$D = \frac{5730}{R}. \quad (3)$$

In general, the degree of curvature is expressed by the central angle subtended by 100' of arc, and the radius for that degree of curve is found by dividing 5730', the radius of a 1° curve, by the degree of curve desired expressed in degrees and decimals of a degree; that is, if the radius of a 3° 30' curve is wanted, divide 5730 by 3.5, which equals 1637.1'. The radii given in Table 138 are computed in this manner.

Length of Curve.—For a 5° curve a central angle of 5° subtends 100' of arc; a central angle of 10°, 200' of arc; a central angle of 12° 30', 250' or arc; that is, for a specified central angle the length of any specified curve equals that central angle expressed in degrees and decimals of a degree divided by the degree of curve expressed in degrees and decimals multiplied by 100; i.e., the length of a 10° 15' curve for a central angle of 20° 45' = $\frac{20.75}{10.25} \times 100' = 202.4'$ and is expressed by the formula (continued on p. 885).

TABLE 139.—FUNCTIONS OF A 1° CURVE FIGURED ON A BASIS OF $R = 5730'$ AND TABULATED TO TENTHS OF FEET

Use 100' chords up to 8° Curves
Use 50' chords up to 16° Curves

Use 25' chords up to 32° Curves
Use 10' chords above 32° Curves

Miles	0°		1°		2°		3°		Miles
	Ext.	Tan.	Ext.	Tan.	Ext.	Tan.	Ext.	Tan.	
0	0.0	0.0	0.2	50.0	0.9	100.0	2.0	150.1	0
10	0.0	8.3	0.3	58.3	1.0	108.4	2.2	158.4	10
20	0.0	16.7	0.4	66.7	1.2	116.7	2.4	166.8	20
30	0.1	25.0	0.5	75.0	1.4	125.0	2.7	175.1	30
40	0.1	33.3	0.6	83.3	1.6	133.4	2.9	183.4	40
50	0.2	41.7	0.7	91.7	1.8	141.7	3.2	191.7	50
60	0.2	50.0	0.8	100.0	2.0	150.1	3.5	200.1	60

FUNCTIONS : DEGREE CURVE

Use 100' chords up to 8° Curves
Use 50' chords up to 16° Curves

Use 25' chords up to 32° Curves
Use 10' chords above 32° Curves

Minutes	Dec. of Degree	4°		5°		6°		7°		Minutes
		Ext.	Tan.	Ext.	Tan.	Ext.	Tan.	Ext.	Tan.	
0	.0000	3.5	200.1	5.5	250.2	7.9	300.3	10.7	350.4	0
1	.0167	3.5	200.0	5.5	251.0	7.9	301.1	10.8	351.3	1
2	.0333	3.6	201.8	5.5	251.8	8.0	302.0	10.8	352.1	2
3	.0500	3.6	202.6	5.6	252.7	8.0	302.8	10.9	352.9	3
4	.0667	3.6	203.4	5.6	253.5	8.0	303.6	10.9	353.8	4
5	.0833	3.6	204.3	5.6	254.3	8.1	304.5	11.0	354.6	5
6	.1000	3.7	205.1	5.7	255.2	8.1	305.3	11.0	355.5	6
7	.1167	3.7	205.9	5.7	256.0	8.2	306.1	11.1	356.3	7
8	.1333	3.7	206.8	5.8	256.8	8.2	307.0	11.1	357.1	8
9	.1500	3.8	207.6	5.8	257.7	8.3	307.8	11.2	358.0	9
10	.1667	3.8	208.4	5.8	258.5	8.3	308.6	11.2	358.8	10
11	.1833	3.8	209.3	5.9	259.3	8.4	309.5	11.3	359.6	11
12	.2000	3.9	210.1	5.9	260.2	8.4	310.3	11.3	360.5	12
13	.2167	3.9	210.9	5.9	261.0	8.4	311.1	11.4	361.3	13
14	.2333	3.9	211.8	6.0	261.9	8.5	312.0	11.4	362.2	14
15	.2500	3.9	212.6	6.0	262.7	8.5	312.8	11.5	363.0	15
16	.2667	4.0	213.4	6.1	263.5	8.6	313.7	11.5	363.8	16
17	.2833	4.0	214.3	6.1	264.4	8.6	314.5	11.6	364.7	17
18	.3000	4.0	215.1	6.1	265.2	8.7	315.3	11.7	365.5	18
19	.3167	4.1	215.9	6.2	266.0	8.7	316.2	11.7	366.3	19
20	.3333	4.1	216.8	6.2	266.9	8.8	317.0	11.8	367.2	20
21	.3500	4.1	217.6	6.2	267.7	8.8	317.8	11.8	368.0	21
22	.3667	4.2	218.4	6.3	268.5	8.9	318.7	11.9	368.8	22
23	.3833	4.2	219.3	6.3	269.4	8.9	319.5	11.9	369.7	23
24	.4000	4.2	220.1	6.4	270.2	9.0	320.3	12.0	370.5	24
25	.4167	4.3	220.9	6.4	271.0	9.0	321.2	12.0	371.4	25
26	.4333	4.3	221.8	6.4	271.9	9.0	322.0	12.1	372.2	26
27	.4500	4.3	222.6	6.5	272.7	9.1	322.8	12.1	373.0	27
28	.4667	4.4	223.5	6.5	273.5	9.1	323.7	12.2	373.9	28
29	.4833	4.4	224.3	6.5	274.4	9.2	324.5	12.2	374.7	29
30	.5000	4.4	225.1	6.6	275.2	9.2	325.4	12.3	375.5	30
31	.5167	4.5	226.0	6.6	276.1	9.3	326.2	12.4	376.4	31
32	.5333	4.5	226.8	6.7	276.9	9.3	327.0	12.4	377.2	32
33	.5500	4.5	227.6	6.7	277.7	9.4	327.9	12.5	378.1	33
34	.5667	4.6	228.5	6.8	278.6	9.4	328.7	12.5	378.9	34
35	.5833	4.6	229.3	6.8	279.4	9.5	329.5	12.6	379.7	35
36	.6000	4.6	230.1	6.8	280.2	9.5	330.4	12.6	380.6	36
37	.6167	4.7	231.0	6.9	281.1	9.6	331.2	12.7	381.4	37
38	.6333	4.7	231.8	6.9	281.9	9.6	332.0	12.7	382.2	38
39	.6500	4.7	232.6	7.0	282.7	9.7	332.9	12.8	383.1	39
40	.6667	4.8	233.5	7.0	283.6	9.7	333.7	12.9	383.9	40
41	.6833	4.8	234.3	7.1	284.4	9.8	334.6	12.9	384.7	41
42	.7000	4.8	235.1	7.1	285.2	9.8	335.4	13.0	385.6	42
43	.7167	4.9	236.0	7.1	286.1	9.9	336.3	13.0	386.4	43
44	.7333	4.9	236.8	7.2	286.9	9.9	337.1	13.1	387.3	44
45	.7500	4.9	237.6	7.2	287.7	10.0	337.9	13.1	388.1	45
46	.7667	5.0	238.5	7.3	288.6	10.0	338.7	13.2	388.9	46
47	.7833	5.0	239.3	7.3	289.4	10.1	339.6	13.2	389.8	47
48	.8000	5.0	240.1	7.3	290.3	10.1	340.4	13.3	390.6	48
49	.8167	5.1	241.0	7.4	291.1	10.2	341.2	13.4	391.4	49
50	.8333	5.1	241.8	7.4	291.9	10.2	342.1	13.4	392.3	50
51	.8500	5.1	242.6	7.5	292.8	10.3	342.9	13.5	393.1	51
52	.8667	5.2	243.5	7.5	293.6	10.3	343.7	13.5	394.0	52
53	.8833	5.2	244.3	7.5	294.4	10.4	344.6	13.6	394.8	53
54	.9000	5.2	245.2	7.6	295.3	10.4	345.4	13.7	395.6	54
55	.9167	5.3	246.0	7.6	296.1	10.5	346.3	13.7	396.5	55
56	.9333	5.3	246.8	7.7	296.9	10.5	347.1	13.8	397.3	56
57	.9500	5.3	247.7	7.7	297.8	10.6	347.9	13.8	398.1	57
58	.9667	5.4	248.5	7.8	298.6	10.6	348.8	13.9	399.0	58
59	.9833	5.4	249.3	7.8	299.4	10.7	349.6	13.9	399.8	59

Use 100' Chords up to 8° Curves
Use 50' Chords up to 16° CurvesUse 25' Chords up to 32° Curves
Use 10' Chords above 32° Curves

Minutes	Dec. of Degree	8°		9°		10°		11°		Minutes
		Ext.	Tan.	Ext.	Tan.	Ext.	Tan.	Ext.	Tan.	
0	.0000	14.0	400.7	17.7	450.0	21.9	501.3	26.5	551.7	0
1	.0167	14.0	401.5	17.8	451.8	21.9	502.2	26.6	552.6	1
2	.0333	14.1	402.4	17.8	452.6	22.0	503.0	26.7	553.4	2
3	.0500	14.2	403.2	17.9	453.4	22.1	503.8	26.7	554.3	3
4	.0667	14.2	404.0	18.0	454.3	22.2	504.7	26.8	555.1	4
5	.0833	14.3	404.8	18.0	455.1	22.3	505.5	26.9	555.9	5
6	.1000	14.3	405.7	18.1	456.0	22.3	506.4	27.0	556.8	6
7	.1167	14.4	406.5	18.2	456.8	22.4	507.2	27.1	557.6	7
8	.1333	14.5	407.4	18.3	457.7	22.5	508.0	27.2	558.5	8
9	.1500	14.5	408.2	18.3	458.5	22.6	508.9	27.2	559.3	9
10	.1667	14.6	409.0	18.4	459.3	22.6	509.7	27.3	560.1	10
11	.1833	14.6	409.9	18.4	460.2	22.7	510.6	27.4	561.0	11
12	.2000	14.7	410.7	18.5	461.0	22.8	511.4	27.5	561.8	12
13	.2167	14.8	411.5	18.6	461.8	22.9	512.2	27.6	562.7	13
14	.2333	14.8	412.4	18.7	462.7	22.9	513.1	27.7	563.5	14
15	.2500	14.9	413.2	18.7	463.5	23.0	513.9	27.7	564.3	15
16	.2667	14.9	414.1	18.8	464.4	23.1	514.8	27.8	565.2	16
17	.2833	15.0	414.9	18.9	465.2	23.2	515.6	27.9	566.0	17
18	.3000	15.1	415.7	18.9	466.0	23.2	516.4	28.0	566.9	18
19	.3167	15.1	416.6	19.0	466.9	23.3	517.3	28.1	567.7	19
20	.3333	15.2	417.4	19.1	467.7	23.4	518.1	28.1	568.5	20
21	.3500	15.2	418.2	19.1	468.5	23.5	519.0	28.2	569.4	21
22	.3667	15.3	419.1	19.2	469.4	23.5	519.8	28.3	570.2	22
23	.3833	15.4	419.9	19.3	470.2	23.6	520.6	28.4	571.1	23
24	.4000	15.4	420.8	19.3	471.1	23.7	521.5	28.5	571.9	24
25	.4167	15.5	421.6	19.4	471.9	23.8	522.3	28.6	572.8	25
26	.4333	15.6	422.4	19.5	472.8	23.8	523.2	28.6	573.6	26
27	.4500	15.6	423.3	19.5	473.6	23.9	524.0	28.7	574.4	27
28	.4667	15.7	424.1	19.6	474.4	24.0	524.9	28.8	575.3	28
29	.4833	15.7	424.9	19.7	475.3	24.1	525.7	28.9	576.1	29
30	.5000	15.8	425.8	19.8	476.1	24.1	526.5	29.0	577.0	30
31	.5167	15.9	426.6	19.8	476.9	24.2	527.4	29.1	577.8	31
32	.5333	15.9	427.5	19.9	477.8	24.3	528.2	29.1	578.6	32
33	.5500	16.0	428.3	20.0	478.6	24.4	529.0	29.2	579.5	33
34	.5667	16.0	429.1	20.0	479.5	24.5	529.9	29.3	580.3	34
35	.5833	16.1	430.0	20.1	480.3	24.5	530.7	29.4	581.2	35
36	.6000	16.2	430.8	20.2	481.1	24.6	531.6	29.5	582.0	36
37	.6167	16.2	431.7	20.2	482.0	24.7	532.4	29.6	582.8	37
38	.6333	16.3	432.5	20.3	482.8	24.8	533.3	29.7	583.7	38
39	.6500	16.4	433.3	20.4	483.6	24.8	534.1	29.7	584.5	39
40	.6667	16.4	434.2	20.5	484.5	24.9	534.9	29.8	585.4	40
41	.6833	16.5	435.0	20.5	485.3	25.0	535.8	29.9	586.2	41
42	.7000	16.6	435.9	20.6	486.2	25.1	536.6	30.0	587.1	42
43	.7167	16.6	436.7	20.7	487.0	25.1	537.5	30.1	587.9	43
44	.7333	16.7	437.5	20.7	487.9	25.2	538.3	30.2	588.7	44
45	.7500	16.7	438.4	20.8	488.7	25.3	539.1	30.3	589.6	45
46	.7667	16.8	439.2	20.9	489.6	25.4	540.0	30.3	590.4	46
47	.7833	16.9	440.0	21.0	490.4	25.5	540.8	30.4	591.3	47
48	.8000	16.9	440.9	21.0	491.2	25.5	541.7	30.5	592.1	48
49	.8167	17.0	441.7	21.1	492.0	25.6	542.5	30.6	592.9	49
50	.8333	17.1	442.5	21.2	492.9	25.7	543.3	30.7	593.8	50
51	.8500	17.1	443.4	21.2	493.7	25.8	544.2	30.8	594.6	51
52	.8667	17.2	444.2	21.3	494.6	25.9	545.0	30.9	595.5	52
53	.8833	17.3	445.1	21.4	495.4	25.9	545.9	31.0	596.3	53
54	.9000	17.3	445.9	21.5	496.3	26.0	546.7	31.0	597.2	54
55	.9167	17.4	446.7	21.5	497.1	26.1	547.5	31.1	598.0	55
56	.9333	17.5	447.6	21.6	498.0	26.2	548.4	31.2	598.8	56
57	.9500	17.5	448.4	21.7	498.8	26.3	549.2	31.3	599.7	57
58	.9667	17.6	449.3	21.8	499.6	26.3	550.1	31.4	600.5	58
59	.9833	17.6	450.1	21.8	500.4	26.4	550.9	31.5	601.4	59

FUNCTIONS : DEGREE CURVE

Use 100' Chords up to 8° Curves Use 25' Chords up to 32° Curves
 Use 50' Chords up to 16° Curves Use 10' Chords above 32° Curves

Minutes	Dec. of Degree	12°		13°		14°		15°		Minutes
		Ext.	Tan.	Ext.	Tan.	Ext.	Tan.	Ext.	Tan.	
0	.0000	31.6	602.2	37.1	652.0	43.0	703.5	49.4	754.4	0
1	.0167	31.7	603.1	37.2	653.7	43.1	704.4	49.6	755.2	1
2	.0333	31.7	603.9	37.3	654.6	43.2	705.2	49.7	756.1	2
3	.0500	31.8	604.7	37.4	655.4	43.3	706.1	49.8	756.9	3
4	.0667	31.9	605.6	37.5	656.3	43.4	706.9	49.9	757.7	4
5	.0833	32.0	606.4	37.6	657.1	43.5	707.8	50.0	758.6	5
6	.1000	32.1	607.3	37.7	657.9	43.7	708.6	50.1	759.4	6
7	.1167	32.2	608.1	37.7	658.8	43.8	709.5	50.2	760.3	7
8	.1333	32.3	609.0	37.8	659.6	43.9	710.3	50.3	761.1	8
9	.1500	32.4	609.8	37.9	660.5	44.0	711.2	50.5	762.0	9
10	.1667	32.5	610.7	38.0	661.3	44.1	712.0	50.6	762.8	10
11	.1833	32.5	611.5	38.1	662.2	44.2	712.9	50.7	763.7	11
12	.2000	32.6	612.4	38.2	663.0	44.3	713.7	50.8	764.5	12
13	.2167	32.7	613.2	38.3	663.8	44.4	714.6	50.9	765.4	13
14	.2333	32.8	614.0	38.4	664.7	44.5	715.4	51.0	766.2	14
15	.2500	32.9	614.9	38.5	665.5	44.6	716.3	51.1	767.1	15
16	.2667	33.0	615.7	38.6	666.4	44.7	717.1	51.2	767.9	16
17	.2833	33.1	616.6	38.7	667.2	44.8	718.0	51.3	768.8	17
18	.3000	33.2	617.4	38.8	668.1	44.9	718.8	51.5	769.6	18
19	.3167	33.3	618.3	38.9	668.9	45.0	719.6	51.6	770.5	19
20	.3333	33.4	619.1	39.0	669.8	45.1	720.5	51.7	771.3	20
21	.3500	33.4	619.9	39.1	670.6	45.2	721.3	51.8	772.2	21
22	.3667	33.5	620.8	39.2	671.4	45.3	722.2	51.9	773.0	22
23	.3833	33.6	621.6	39.3	672.3	45.4	723.1	52.0	773.9	23
24	.4000	33.7	622.5	39.4	673.1	45.5	723.9	52.1	774.7	24
25	.4167	33.8	623.3	39.5	674.0	45.6	724.7	52.3	775.6	25
26	.4333	33.9	624.2	39.6	674.8	45.8	725.6	52.4	776.4	26
27	.4500	34.0	625.0	39.7	675.7	45.9	726.5	52.5	777.3	27
28	.4667	34.1	625.9	39.8	676.5	46.0	727.3	52.6	778.1	28
29	.4833	34.2	626.7	39.9	677.4	46.1	728.1	52.7	778.9	29
30	.5000	34.3	627.6	40.0	678.2	46.2	729.0	52.8	779.8	30
31	.5167	34.4	628.4	40.1	679.0	46.3	729.8	52.9	780.6	31
32	.5333	34.5	629.2	40.2	679.9	46.4	730.7	53.1	781.5	32
33	.5500	34.5	630.1	40.3	680.7	46.5	731.5	53.2	782.3	33
34	.5667	34.6	630.9	40.4	681.6	46.6	732.4	53.3	783.2	34
35	.5833	34.7	631.8	40.5	682.4	46.7	733.2	53.4	784.0	35
36	.6000	34.8	632.6	40.6	683.3	46.8	734.0	53.5	784.9	36
37	.6167	34.9	633.5	40.7	684.1	46.9	734.9	53.6	785.7	37
38	.6333	35.0	634.3	40.8	685.0	47.0	735.7	53.7	786.6	38
39	.6500	35.1	635.1	40.9	685.8	47.2	736.6	53.9	787.4	39
40	.6667	35.2	636.0	41.0	686.6	47.3	737.4	54.0	788.3	40
41	.6833	35.3	636.8	41.1	687.5	47.4	738.3	54.1	789.1	41
42	.7000	35.4	637.7	41.2	688.3	47.5	739.1	54.2	790.0	42
43	.7167	35.5	638.5	41.3	689.2	47.6	740.0	54.3	790.8	43
44	.7333	35.6	639.4	41.4	690.0	47.7	740.8	54.4	791.7	44
45	.7500	35.7	640.2	41.5	690.9	47.8	741.7	54.6	792.5	45
46	.7667	35.8	641.1	41.6	691.7	47.9	742.5	54.7	793.4	46
47	.7833	35.8	641.9	41.7	692.5	48.0	743.4	54.8	794.2	47
48	.8000	35.9	642.7	41.8	693.4	48.1	744.2	54.9	795.1	48
49	.8167	36.0	643.6	41.9	694.2	48.2	745.1	55.0	795.9	49
50	.8333	36.1	644.4	42.0	695.1	48.3	745.9	55.1	796.8	50
51	.8500	36.2	645.3	42.1	695.9	48.5	746.7	55.3	797.6	51
52	.8667	36.3	646.1	42.2	696.8	48.6	747.6	55.4	798.5	52
53	.8833	36.4	647.0	42.3	697.6	48.7	748.4	55.5	799.3	53
54	.9000	36.5	647.8	42.4	698.5	48.8	749.3	55.6	800.2	54
55	.9167	36.6	648.6	42.5	699.3	48.9	750.1	55.7	801.0	55
56	.9333	36.7	649.5	42.6	700.1	49.0	751.0	55.8	801.9	56
57	.9500	36.8	650.3	42.7	701.0	49.1	751.8	56.0	802.7	57
58	.9667	36.9	651.2	42.8	701.8	49.2	752.7	56.1	803.6	58
59	.9833	37.0	652.0	42.9	702.7	49.3	753.5	56.2	804.4	59

Use 100' Chords up to 8° Curves
Use 50' Chords up to 16° Curves

Use 25' Chords up to 32° Curves
Use 10' Chords above 32° Curves

Minutes	Dec. of Degree	16°		17°		18°		19°		Minutes
		Ext.	Tan.	Ext.	Tan.	Ext.	Tan.	Ext.	Tan.	
0	.0000	56.3	805.3	63.6	856.4	71.4	907.5	79.7	958.9	0
1	.0167	56.4	806.2	63.8	857.2	71.6	908.4	79.8	959.7	1
2	.0333	56.5	807.0	63.9	858.1	71.7	909.2	79.9	960.6	2
3	.0500	56.7	807.8	64.0	858.9	71.8	910.1	80.1	961.4	3
4	.0667	56.8	808.6	64.2	859.8	72.0	910.9	80.2	962.3	4
5	.0833	56.9	809.5	64.3	860.6	72.1	911.8	80.4	963.2	5
6	.1000	57.0	810.4	64.4	861.5	72.2	912.7	80.5	964.0	6
7	.1167	57.1	811.2	64.5	862.3	72.4	913.5	80.7	964.9	7
8	.1333	57.3	812.1	64.7	863.2	72.5	914.4	80.8	965.7	8
9	.1500	57.4	812.9	64.8	864.0	72.6	915.2	80.9	966.6	9
10	.1667	57.5	813.8	64.9	864.9	72.8	916.1	81.1	967.4	10
11	.1833	57.6	814.6	65.0	865.7	72.9	916.9	81.2	968.3	11
12	.2000	57.7	815.5	65.2	866.6	73.0	917.8	81.4	969.2	12
13	.2167	57.9	816.3	65.3	867.4	73.2	918.6	81.5	970.0	13
14	.2333	58.0	817.2	65.4	868.3	73.3	919.5	81.7	970.9	14
15	.2500	58.1	818.0	65.6	869.1	73.4	920.3	81.8	971.7	15
16	.2667	58.2	818.9	65.7	870.0	73.6	921.2	81.9	972.6	16
17	.2833	58.3	819.7	65.8	870.8	73.7	922.0	82.1	973.4	17
18	.3000	58.5	820.6	65.9	871.7	73.9	922.9	82.2	974.3	18
19	.3167	58.6	821.4	66.1	872.5	74.0	923.8	82.4	975.1	19
20	.3333	58.7	822.3	66.2	873.4	74.1	924.6	82.5	976.0	20
21	.3500	58.8	823.1	66.3	874.2	74.3	925.5	82.7	976.9	21
22	.3667	58.9	824.0	66.4	875.1	74.4	926.3	82.8	977.7	22
23	.3833	59.1	824.8	66.6	875.9	74.5	927.2	82.9	978.6	23
24	.4000	59.2	825.7	66.7	876.8	74.7	928.1	83.1	979.4	24
25	.4167	59.3	826.5	66.8	877.6	74.8	928.9	83.2	980.3	25
26	.4333	59.4	827.4	67.0	878.5	74.9	929.8	83.4	981.2	26
27	.4500	59.6	828.2	67.1	879.3	75.1	930.6	83.5	982.0	27
28	.4667	59.7	829.1	67.2	880.2	75.2	931.5	83.7	982.9	28
29	.4833	59.8	829.9	67.3	881.0	75.4	932.3	83.8	983.7	29
30	.5000	59.9	830.8	67.5	881.9	75.5	933.2	84.0	984.6	30
31	.5167	60.0	831.6	67.6	882.7	75.6	934.0	84.1	985.4	31
32	.5333	60.2	832.5	67.7	883.6	75.8	934.9	84.3	986.3	32
33	.5500	60.3	833.3	67.9	884.5	75.9	935.7	84.4	987.2	33
34	.5667	60.4	834.2	68.0	885.3	76.1	936.6	84.6	988.0	34
35	.5833	60.5	835.1	68.1	886.2	76.2	937.5	84.7	988.9	35
36	.6000	60.7	835.9	68.2	887.0	76.3	938.3	84.8	989.7	36
37	.6167	60.8	836.8	68.4	887.9	76.5	939.2	85.0	990.6	37
38	.6333	60.9	837.6	68.5	888.7	76.6	940.0	85.1	991.5	38
39	.6500	61.0	838.5	68.6	889.6	76.7	940.9	85.3	992.3	39
40	.6667	61.1	839.3	68.8	890.4	76.9	941.7	85.4	993.2	40
41	.6833	61.3	840.2	68.9	891.3	77.0	942.6	85.6	994.0	41
42	.7000	61.4	841.0	69.0	892.2	77.1	943.5	85.7	994.9	42
43	.7167	61.5	841.9	69.2	893.0	77.3	944.3	85.9	995.8	43
44	.7333	61.6	842.7	69.3	893.9	77.4	945.2	86.0	996.6	44
45	.7500	61.8	843.6	69.4	894.7	77.6	946.0	86.2	997.5	45
46	.7667	61.9	844.4	69.6	895.6	77.7	946.9	86.3	998.3	46
47	.7833	62.0	845.3	69.7	896.4	77.8	947.7	86.5	999.2	47
48	.8000	62.1	846.1	69.8	897.3	78.0	948.6	86.6	1000.0	48
49	.8167	62.3	847.0	70.0	898.1	78.1	949.4	86.8	1000.9	49
50	.8333	62.4	847.8	70.1	899.0	78.3	950.3	86.9	1001.8	50
51	.8500	62.5	848.7	70.2	899.8	78.4	951.1	87.1	1002.6	51
52	.8667	62.6	849.5	70.4	900.7	78.5	952.0	87.2	1003.5	52
53	.8833	62.8	850.4	70.5	901.5	78.7	952.9	87.4	1004.3	53
54	.9000	62.9	851.2	70.6	902.4	78.8	953.7	87.5	1005.2	54
55	.9167	63.0	852.1	70.8	903.3	79.0	954.6	87.7	1006.0	55
56	.9333	63.1	852.9	70.9	904.1	79.1	955.4	87.8	1006.9	56
57	.9500	63.3	853.8	71.0	905.0	79.2	956.3	88.0	1007.7	57
58	.9667	63.4	854.7	71.2	905.8	79.4	957.2	88.1	1008.6	58
59	.9833	63.5	855.5	71.3	906.7	79.5	958.0	88.2	1009.5	59

FUNCTIONS 1 DEGREE CURVE

Use 100' Chords up to 8° Curves
Use 50' Chords up to 16° Curves

Use 25' Chords up to 32° Curves
Use 10' Chords above 32° Curves

Minutes	Dec. of Degrees	20°		21°		22°		23°		Minutes
		Ext.	Tan.	Ext.	Tan.	Ext.	Tan.	Ext.	Tan.	
0	.0000	88.4	1010.4	97.6	1062.0	107.2	1113.8	117.4	1165.8	0
1	.0167	88.5	1011.2	97.7	1062.8	107.4	1114.6	117.6	1166.6	1
2	.0333	88.7	1012.1	97.9	1063.7	107.6	1115.5	117.7	1167.5	2
3	.0500	88.8	1012.9	98.1	1064.5	107.7	1116.4	117.9	1168.3	3
4	.0667	89.0	1013.8	98.2	1065.4	107.9	1117.3	118.1	1169.2	4
5	.0833	89.1	1014.6	98.4	1066.3	108.0	1118.1	118.3	1170.1	5
6	.1000	89.3	1015.5	98.5	1067.2	108.2	1119.0	118.4	1171.0	6
7	.1167	89.4	1016.3	98.7	1068.0	108.4	1119.8	118.6	1171.8	7
8	.1333	89.6	1017.2	98.8	1068.9	108.6	1120.7	118.8	1172.7	8
9	.1500	89.7	1018.1	99.0	1069.7	108.7	1121.5	118.9	1173.5	9
10	.1667	89.9	1019.0	99.2	1070.6	108.9	1122.4	119.1	1174.4	10
11	.1833	90.0	1019.8	99.3	1071.5	109.0	1123.3	119.3	1175.3	11
12	.2000	90.2	1020.7	99.5	1072.4	109.2	1124.2	119.5	1176.2	12
13	.2167	90.3	1021.5	99.6	1073.2	109.4	1125.0	119.7	1177.0	13
14	.2333	90.5	1022.4	99.8	1074.1	109.6	1125.9	119.8	1177.9	14
15	.2500	90.6	1023.2	99.9	1074.9	109.7	1126.7	120.0	1178.8	15
16	.2667	90.8	1024.1	100.1	1075.8	109.9	1127.6	120.2	1179.7	16
17	.2833	90.9	1024.9	100.2	1076.6	110.0	1128.5	120.4	1180.5	17
18	.3000	91.1	1025.8	100.4	1077.5	110.2	1129.4	120.5	1181.4	18
19	.3167	91.2	1026.7	100.5	1078.4	110.4	1130.2	120.7	1182.2	19
20	.3333	91.4	1027.6	100.7	1079.3	110.6	1131.1	120.9	1183.1	20
21	.3500	91.6	1028.4	100.9	1080.1	110.7	1131.9	121.0	1184.0	21
22	.3667	91.7	1029.3	101.1	1081.0	110.9	1132.8	121.2	1184.9	22
23	.3833	91.9	1030.1	101.2	1081.8	111.0	1133.7	121.4	1185.7	23
24	.4000	92.0	1031.0	101.4	1082.7	111.2	1134.6	121.6	1186.6	24
25	.4167	92.2	1031.8	101.5	1083.5	111.4	1135.4	121.7	1187.5	25
26	.4333	92.3	1032.7	101.7	1084.4	111.6	1136.3	121.9	1188.4	26
27	.4500	92.5	1033.5	101.8	1085.3	111.7	1137.1	122.1	1189.2	27
28	.4667	92.6	1034.4	102.0	1086.2	111.9	1138.0	122.3	1190.1	28
29	.4833	92.8	1035.2	102.1	1087.0	112.1	1138.8	122.4	1190.9	29
30	.5000	92.9	1036.1	102.3	1087.9	112.3	1139.7	122.6	1191.8	30
31	.5167	93.1	1037.0	102.5	1088.7	112.4	1140.6	122.8	1192.7	31
32	.5333	93.2	1037.9	102.7	1089.6	112.6	1141.5	123.0	1193.6	32
33	.5500	93.4	1038.7	102.8	1090.4	112.7	1142.3	123.2	1194.4	33
34	.5667	93.5	1039.6	103.0	1091.3	112.9	1143.2	123.3	1195.3	34
35	.5833	93.7	1040.4	103.1	1092.2	113.1	1144.0	123.5	1196.2	35
36	.6000	93.9	1041.3	103.3	1093.1	113.3	1144.9	123.7	1197.1	36
37	.6167	94.0	1042.1	103.4	1093.9	113.4	1145.8	123.9	1197.9	37
38	.6333	94.2	1043.0	103.6	1094.8	113.6	1146.7	124.1	1198.8	38
39	.6500	94.3	1043.9	103.8	1095.6	113.7	1147.5	124.3	1199.6	39
40	.6667	94.5	1044.8	104.0	1096.5	113.9	1148.4	124.4	1200.5	40
41	.6833	94.6	1045.6	104.1	1097.4	114.1	1149.2	124.6	1201.4	41
42	.7000	94.8	1046.5	104.3	1098.3	114.3	1150.1	124.8	1202.3	42
43	.7167	94.9	1047.3	104.4	1099.1	114.4	1151.0	124.9	1203.1	43
44	.7333	95.1	1048.2	104.6	1100.0	114.6	1151.9	125.1	1204.0	44
45	.7500	95.2	1049.0	104.7	1100.8	114.8	1152.7	125.3	1204.9	45
46	.7667	95.4	1049.9	104.9	1101.7	115.0	1153.6	125.5	1205.8	46
47	.7833	95.6	1050.8	105.1	1102.5	115.2	1154.5	125.7	1206.7	47
48	.8000	95.7	1051.7	105.3	1103.4	115.3	1155.4	125.8	1207.5	48
49	.8167	95.9	1052.5	105.4	1104.3	115.5	1156.2	126.0	1208.3	49
50	.8333	96.0	1053.4	105.6	1105.2	115.7	1157.1	126.2	1209.2	50
51	.8500	96.2	1054.2	105.7	1106.0	115.8	1157.9	126.4	1210.1	51
52	.8667	96.3	1055.1	105.9	1106.9	116.0	1158.8	126.6	1211.0	52
53	.8833	96.5	1055.9	106.1	1107.8	116.1	1159.7	126.7	1211.8	53
54	.9000	96.7	1056.8	106.3	1108.6	116.3	1160.6	126.9	1212.7	54
55	.9167	96.8	1057.7	106.4	1109.4	116.5	1161.4	127.1	1213.6	55
56	.9333	97.0	1058.6	106.6	1110.3	116.7	1162.3	127.3	1214.5	56
57	.9500	97.1	1059.4	106.7	1111.2	116.8	1163.1	127.5	1215.3	57
58	.9667	97.3	1060.3	106.9	1112.1	117.0	1164.0	127.6	1216.2	58
59	.9833	97.4	1061.1	107.0	1112.9	117.2	1164.9	127.8	1217.1	59

Use 100' Chords up to 8° Curves
Use 50' Chords up to 16° Curves

Use 25' Chords up to 32° Curves
Use 10' Chords above 32° Curves

Minutes	Dec. of Degree	24°		25°		26°		27°		Minutes
		Ext.	Tan.	Ext.	Tan.	Ext.	Tan.	Ext.	Tan.	
0	.0000	128.0	1218.0	130.1	1270.3	150.7	1322.9	162.8	1375.6	0
1	.0167	128.2	1218.8	130.3	1271.1	150.9	1323.7	163.0	1376.5	1
2	.0333	128.4	1219.7	130.5	1272.0	151.1	1324.6	163.2	1377.4	2
3	.0500	128.5	1220.5	130.7	1272.9	151.3	1325.5	163.5	1378.3	3
4	.0667	128.7	1221.4	130.9	1273.8	151.5	1326.4	163.7	1379.2	4
5	.0833	128.9	1222.3	140.1	1274.6	151.7	1327.3	163.9	1380.0	5
6	.1000	129.1	1223.2	140.3	1275.5	151.9	1328.1	164.1	1380.9	6
7	.1167	129.3	1224.0	140.4	1276.4	152.1	1329.0	164.3	1381.8	7
8	.1333	129.5	1224.9	140.6	1277.3	152.3	1329.9	164.5	1382.7	8
9	.1500	129.7	1225.8	140.8	1278.2	152.5	1330.7	164.7	1383.6	9
10	.1667	129.8	1226.7	141.0	1279.1	152.7	1331.6	164.9	1384.5	10
11	.1833	130.0	1227.5	141.2	1279.9	152.9	1332.5	165.1	1385.3	11
12	.2000	130.2	1228.4	141.4	1280.8	153.1	1333.4	165.3	1386.2	12
13	.2167	130.4	1229.3	141.6	1281.6	153.3	1334.3	165.5	1387.1	13
14	.2333	130.6	1230.2	141.8	1282.5	153.5	1335.2	165.7	1388.0	14
15	.2500	130.7	1231.0	142.0	1283.4	153.7	1336.0	165.9	1388.9	15
16	.2667	130.9	1231.9	142.2	1284.3	153.9	1336.9	166.1	1389.8	16
17	.2833	131.1	1232.7	142.3	1285.2	154.1	1337.8	166.3	1390.6	17
18	.3000	131.3	1233.6	142.5	1286.1	154.3	1338.7	166.5	1391.5	18
19	.3167	131.5	1234.5	142.7	1286.9	154.5	1339.5	166.7	1392.4	19
20	.3333	131.7	1235.4	142.9	1287.8	154.7	1340.4	167.0	1393.3	20
21	.3500	131.9	1236.2	143.1	1288.7	154.9	1341.3	167.2	1394.1	21
22	.3667	132.0	1237.1	143.3	1289.6	155.1	1342.2	167.4	1395.0	22
23	.3833	132.2	1238.0	143.5	1290.4	155.3	1343.0	167.6	1395.9	23
24	.4000	132.4	1238.9	143.7	1291.3	155.5	1343.9	167.8	1396.8	24
25	.4167	132.6	1239.7	143.9	1292.2	155.7	1344.8	168.0	1397.7	25
26	.4333	132.8	1240.6	144.1	1293.1	155.9	1345.7	168.2	1398.6	26
27	.4500	133.0	1241.5	144.3	1293.9	156.1	1346.5	168.4	1399.4	27
28	.4667	133.1	1242.4	144.5	1294.8	156.3	1347.4	168.6	1400.3	28
29	.4833	133.3	1243.2	144.7	1295.7	156.5	1348.3	168.8	1401.2	29
30	.5000	133.5	1244.1	144.9	1296.6	156.7	1349.2	169.1	1402.1	30
31	.5167	133.7	1244.9	145.1	1297.4	156.9	1350.1	169.3	1403.0	31
32	.5333	133.9	1245.8	145.3	1298.3	157.1	1351.0	169.5	1403.9	32
33	.5500	134.0	1246.7	145.5	1299.2	157.3	1351.8	169.7	1404.7	33
34	.5667	134.2	1247.6	145.6	1300.1	157.5	1352.7	169.9	1405.6	34
35	.5833	134.4	1248.4	145.8	1300.9	157.7	1353.6	170.1	1406.5	35
36	.6000	134.6	1249.3	146.0	1301.8	157.9	1354.5	170.3	1407.4	36
37	.6167	134.9	1250.2	146.2	1302.7	158.1	1355.3	170.5	1408.3	37
38	.6333	135.0	1251.1	146.4	1303.6	158.3	1356.2	170.8	1409.2	38
39	.6500	135.2	1251.9	146.6	1304.4	158.5	1357.1	171.0	1410.0	39
40	.6667	135.4	1252.8	146.8	1305.3	158.7	1358.0	171.2	1410.9	40
41	.6833	135.6	1253.7	147.0	1306.2	158.9	1358.9	171.4	1411.8	41
42	.7000	135.7	1254.6	147.2	1307.1	159.1	1359.8	171.6	1412.7	42
43	.7167	135.9	1255.4	147.4	1307.9	159.3	1360.6	171.8	1413.6	43
44	.7333	136.1	1256.3	147.6	1308.8	159.5	1361.5	172.0	1414.5	44
45	.7500	136.3	1257.2	147.8	1309.7	159.7	1362.4	172.2	1415.4	45
46	.7667	136.5	1258.1	148.0	1310.6	160.0	1363.3	172.5	1416.3	46
47	.7833	136.7	1258.9	148.2	1311.5	160.2	1364.2	172.7	1417.2	47
48	.8000	136.9	1259.8	148.4	1312.4	160.4	1365.1	172.9	1418.0	48
49	.8167	137.1	1260.7	148.6	1313.3	160.6	1366.0	173.1	1418.9	49
50	.8333	137.2	1261.5	148.8	1314.1	160.8	1366.8	173.3	1419.8	50
51	.8500	137.4	1262.4	149.0	1315.0	161.0	1367.7	173.5	1420.7	51
52	.8667	137.6	1263.3	149.2	1315.9	161.2	1368.6	173.7	1421.6	52
53	.8833	137.8	1264.1	149.4	1316.7	161.4	1369.5	173.9	1422.5	53
54	.9000	138.0	1265.0	149.5	1317.6	161.6	1370.4	174.1	1423.4	54
55	.9167	138.2	1265.9	149.7	1318.5	161.8	1371.2	174.4	1424.2	55
56	.9333	138.4	1266.8	149.9	1319.4	162.0	1372.1	174.6	1425.1	56
57	.9500	138.6	1267.6	150.1	1320.3	162.2	1373.0	174.8	1426.0	57
58	.9667	138.7	1268.5	150.3	1321.1	162.4	1373.9	175.0	1426.9	58
59	.9833	138.9	1269.4	150.5	1322.0	162.6	1374.7	175.2	1427.7	59

FUNCTIONS : DEGREE CURVE

Use 100' Chords up to 8° Curves
Use 50' Chords up to 16° Curves

Use 25' Chords up to 32° Curves
Use 10' Chords above 32° Curves

Minutes	Dec. of Degree	28°		29°		30°		31°		Minutes
		Ext.	Tan.	Ext.	Tan.	Ext.	Tan.	Ext.	Tan.	
0	.0000	175.4	1428.6	188.5	1481.0	202.1	1535.3	216.3	1589.0	0
1	.0167	175.6	1429.5	188.7	1482.8	202.3	1536.2	216.5	1590.0	1
2	.0333	175.8	1430.4	189.0	1483.7	202.6	1537.1	216.8	1590.8	2
3	.0500	176.0	1431.3	189.2	1484.5	202.8	1538.0	217.0	1591.7	3
4	.0667	176.3	1432.2	189.4	1485.4	203.1	1538.9	217.2	1592.6	4
5	.0833	176.5	1433.1	189.6	1486.3	203.3	1539.8	217.4	1593.5	5
6	.1000	176.7	1434.0	189.9	1487.2	203.5	1540.7	217.7	1594.4	6
7	.1167	176.9	1434.8	190.1	1488.1	203.7	1541.6	217.9	1595.3	7
8	.1333	177.1	1435.7	190.3	1489.0	204.0	1542.5	218.2	1596.2	8
9	.1500	177.3	1436.6	190.5	1489.9	204.2	1543.4	218.4	1597.1	9
10	.1667	177.6	1437.5	190.8	1490.8	204.5	1544.3	218.7	1598.0	10
11	.1833	177.8	1438.4	191.0	1491.7	204.7	1545.2	218.9	1598.9	11
12	.2000	178.0	1439.3	191.2	1492.6	204.9	1546.0	219.2	1599.8	12
13	.2167	178.2	1440.2	191.5	1493.4	205.1	1546.9	219.4	1600.7	13
14	.2333	178.4	1441.1	191.7	1494.3	205.4	1547.8	219.6	1601.6	14
15	.2500	178.6	1441.9	191.9	1495.2	205.6	1548.7	219.8	1602.5	15
16	.2667	178.9	1442.8	192.1	1496.1	205.9	1549.6	220.1	1603.4	16
17	.2833	179.1	1443.7	192.3	1497.0	206.1	1550.5	220.3	1604.3	17
18	.3000	179.3	1444.6	192.5	1497.9	206.3	1551.4	220.6	1605.2	18
19	.3167	179.5	1445.5	192.7	1498.8	206.5	1552.3	220.8	1606.1	19
20	.3333	179.7	1446.4	193.0	1499.7	206.8	1553.2	221.1	1607.0	20
21	.3500	179.9	1447.3	193.2	1500.6	207.0	1554.1	221.3	1607.9	21
22	.3667	180.2	1448.2	193.5	1501.5	207.3	1555.0	221.6	1608.8	22
23	.3833	180.4	1449.0	193.7	1502.3	207.5	1555.9	221.8	1609.7	23
24	.4000	180.6	1449.9	193.9	1503.2	207.7	1556.8	222.1	1610.6	24
25	.4167	180.8	1450.8	194.1	1504.1	207.9	1557.7	222.3	1611.5	25
26	.4333	181.0	1451.7	194.4	1505.0	208.2	1558.6	222.6	1612.4	26
27	.4500	181.2	1452.6	194.6	1505.9	208.4	1559.5	222.8	1613.3	27
28	.4667	181.5	1453.5	194.8	1506.8	208.7	1560.4	223.0	1614.2	28
29	.4833	181.7	1454.3	195.0	1507.7	208.9	1561.3	223.2	1615.1	29
30	.5000	181.9	1455.2	195.3	1508.6	209.1	1562.2	223.5	1616.0	30
31	.5167	182.1	1456.1	195.5	1509.5	209.3	1563.1	223.7	1616.9	31
32	.5333	182.3	1457.0	195.7	1510.4	209.6	1564.0	224.0	1617.8	32
33	.5500	182.5	1457.9	195.9	1511.3	209.8	1564.9	224.2	1618.7	33
34	.5667	182.8	1458.8	196.2	1512.1	210.1	1565.7	224.5	1619.6	34
35	.5833	183.0	1459.7	196.4	1513.0	210.3	1566.6	224.7	1620.5	35
36	.6000	183.2	1460.6	196.7	1513.9	210.5	1567.5	225.0	1621.4	36
37	.6167	183.4	1461.4	196.9	1514.8	210.7	1568.4	225.2	1622.3	37
38	.6333	183.6	1462.3	197.1	1515.7	211.0	1569.3	225.5	1623.2	38
39	.6500	183.8	1463.2	197.3	1516.6	211.2	1570.2	225.7	1624.1	39
40	.6667	184.1	1464.1	197.6	1517.5	211.5	1571.1	226.0	1625.0	40
41	.6833	184.3	1465.0	197.8	1518.4	211.7	1572.0	226.2	1625.9	41
42	.7000	184.5	1465.9	198.0	1519.3	212.0	1572.9	226.5	1626.8	42
43	.7167	184.7	1466.8	198.2	1520.1	212.2	1573.8	226.7	1627.7	43
44	.7333	185.0	1467.7	198.5	1521.0	212.4	1574.7	227.0	1628.6	44
45	.7500	185.2	1468.6	198.7	1521.9	212.6	1575.6	227.2	1629.5	45
46	.7667	185.4	1469.5	198.9	1522.8	212.9	1576.5	227.5	1630.4	46
47	.7833	185.6	1470.3	199.1	1523.7	213.1	1577.4	227.7	1631.3	47
48	.8000	185.9	1471.2	199.4	1524.6	213.4	1578.3	228.0	1632.2	48
49	.8167	186.1	1472.1	199.6	1525.5	213.6	1579.2	228.2	1633.1	49
50	.8333	186.3	1473.0	199.8	1526.4	213.9	1580.1	228.4	1634.0	50
51	.8500	186.5	1473.9	200.0	1527.3	214.1	1581.0	228.6	1634.9	51
52	.8667	186.8	1474.8	200.3	1528.2	214.4	1581.9	228.9	1635.8	52
53	.8833	187.0	1475.7	200.5	1529.1	214.6	1582.8	229.1	1636.7	53
54	.9000	187.2	1476.6	200.8	1530.0	214.8	1583.7	229.4	1637.6	54
55	.9167	187.4	1477.4	201.0	1530.9	215.0	1584.6	229.6	1638.5	55
56	.9333	187.6	1478.3	201.2	1531.7	215.3	1585.5	229.9	1639.4	56
57	.9500	187.8	1479.2	201.4	1532.6	215.5	1586.3	230.1	1640.3	57
58	.9667	188.1	1480.1	201.7	1533.5	215.8	1587.2	230.4	1641.2	58
59	.9833	188.3	1481.0	201.9	1534.4	216.0	1588.1	230.6	1642.1	59

Use 100' Chords up to 8° Curves
Use 50' Chords up to 16° CurvesUse 25' Chords up to 32° Curves
Use 10' Chords above 32° Curves

Minutes	Dec. of Degree	32°		33°		34°		35°		Minutes
		Ext.	Tan.	Ext.	Tan.	Ext.	Tan.	Ext.	Tan.	
0	.0000	230.0	1643.1	246.1	1697.3	261.8	1751.8	278.1	1806.7	0
1	.0167	231.1	1644.0	246.3	1698.2	262.0	1752.7	278.4	1807.6	1
2	.0333	231.4	1644.9	246.6	1699.1	262.3	1753.7	278.6	1808.5	2
3	.0500	231.6	1645.8	246.8	1700.0	262.6	1754.6	278.9	1809.4	3
4	.0667	231.9	1646.7	247.1	1700.9	262.9	1755.5	279.2	1810.3	4
5	.0833	232.1	1647.6	247.4	1701.8	263.1	1756.4	279.4	1811.2	5
6	.1000	232.4	1648.5	247.7	1702.7	263.4	1757.3	279.7	1812.2	6
7	.1167	232.6	1649.4	247.9	1703.6	263.7	1758.2	280.0	1813.1	7
8	.1333	232.9	1650.3	248.2	1704.5	264.0	1759.1	280.3	1814.0	8
9	.1500	233.1	1651.2	248.4	1705.4	264.2	1760.0	280.6	1814.9	9
10	.1667	233.4	1652.1	248.7	1706.4	264.5	1761.0	280.8	1815.8	10
11	.1833	233.6	1653.0	248.9	1707.3	264.7	1761.9	281.1	1816.7	11
12	.2000	233.9	1653.9	249.2	1708.2	265.0	1762.8	281.4	1817.7	12
13	.2167	234.1	1654.8	249.4	1709.1	265.3	1763.7	281.6	1818.6	13
14	.2333	234.4	1655.7	249.7	1710.0	265.6	1764.6	281.9	1819.5	14
15	.2500	234.6	1656.6	249.9	1710.9	265.9	1765.5	282.2	1820.4	15
16	.2667	234.9	1657.5	250.2	1711.8	266.1	1766.4	282.5	1821.3	16
17	.2833	235.1	1658.4	250.5	1712.7	266.4	1767.3	282.7	1822.2	17
18	.3000	235.4	1659.3	250.8	1713.6	266.7	1768.2	283.0	1823.1	18
19	.3167	235.6	1660.2	251.0	1714.5	266.9	1769.1	283.3	1824.1	19
20	.3333	235.9	1661.1	251.3	1715.5	267.2	1770.1	283.6	1825.0	20
21	.3500	236.1	1662.0	251.5	1716.4	267.4	1771.0	283.9	1825.9	21
22	.3667	236.4	1662.9	251.8	1717.3	267.7	1771.9	284.2	1826.8	22
23	.3833	236.6	1663.8	252.0	1718.2	268.0	1772.8	284.4	1827.7	23
24	.4000	236.9	1664.7	252.3	1719.1	268.3	1773.7	284.7	1828.7	24
25	.4167	237.1	1665.6	252.6	1720.0	268.6	1774.6	285.0	1829.6	25
26	.4333	237.4	1666.5	252.9	1720.9	268.8	1775.5	285.3	1830.5	26
27	.4500	237.6	1667.4	253.1	1721.8	269.1	1776.5	285.6	1831.4	27
28	.4667	237.9	1668.3	253.4	1722.7	269.3	1777.4	285.9	1832.3	28
29	.4833	238.1	1669.2	253.6	1723.6	269.6	1778.3	286.1	1833.2	29
30	.5000	238.4	1670.1	253.9	1724.6	269.9	1779.2	286.4	1834.1	30
31	.5167	238.7	1671.0	254.1	1725.5	270.1	1780.1	286.7	1835.1	31
32	.5333	239.0	1671.9	254.4	1726.4	270.4	1781.0	287.0	1836.0	32
33	.5500	239.2	1672.8	254.7	1727.3	270.7	1781.9	287.3	1836.9	33
34	.5667	239.5	1673.7	255.0	1728.2	271.0	1782.9	287.5	1837.8	34
35	.5833	239.7	1674.6	255.2	1729.1	271.2	1783.8	287.8	1838.7	35
36	.6000	240.0	1675.5	255.5	1730.0	271.5	1784.7	288.1	1839.7	36
37	.6167	240.2	1676.4	255.7	1730.9	271.7	1785.6	288.4	1840.6	37
38	.6333	240.5	1677.4	256.0	1731.8	272.0	1786.5	288.7	1841.5	38
39	.6500	240.7	1678.3	256.2	1732.7	272.3	1787.4	289.0	1842.4	39
40	.6667	241.0	1679.2	256.5	1733.6	272.6	1788.4	289.2	1843.4	40
41	.6833	241.2	1680.1	256.8	1734.5	272.9	1789.3	289.5	1844.3	41
42	.7000	241.5	1681.0	257.1	1735.5	273.1	1790.2	289.8	1845.2	42
43	.7167	241.7	1681.9	257.3	1736.4	273.4	1791.1	290.1	1846.1	43
44	.7333	242.0	1682.8	257.6	1737.3	273.7	1792.0	290.4	1847.1	44
45	.7500	242.2	1683.7	257.8	1738.2	274.0	1792.9	290.6	1848.0	45
46	.7667	242.5	1684.6	258.1	1739.1	274.2	1793.9	290.9	1848.9	46
47	.7833	242.7	1685.5	258.3	1740.0	274.5	1794.8	291.2	1849.8	47
48	.8000	243.0	1686.4	258.6	1740.9	274.8	1795.7	291.5	1850.7	48
49	.8167	243.2	1687.3	258.9	1741.8	275.0	1796.6	291.8	1851.6	49
50	.8333	243.5	1688.2	259.2	1742.7	275.3	1797.5	292.0	1852.6	50
51	.8500	243.8	1689.1	259.4	1743.6	275.6	1798.4	292.3	1853.5	51
52	.8667	244.1	1690.0	259.7	1744.6	275.9	1799.3	292.6	1854.4	52
53	.8833	244.3	1690.9	259.9	1745.5	276.1	1800.2	292.9	1855.3	53
54	.9000	244.6	1691.8	260.2	1746.4	276.4	1801.2	293.2	1856.3	54
55	.9167	244.8	1692.7	260.5	1747.3	276.7	1802.1	293.4	1857.2	55
56	.9333	245.1	1693.7	260.8	1748.2	277.0	1803.0	293.7	1858.1	56
57	.9500	245.3	1694.6	261.0	1749.1	277.3	1803.9	294.0	1859.0	57
58	.9667	245.6	1695.5	261.3	1750.0	277.5	1804.8	294.3	1859.9	58
59	.9833	245.8	1696.4	261.5	1750.9	277.8	1805.7	294.6	1860.8	59

FUNCTIONS : DEGREE CURVE

Use 100' Chords up to 8° Curves
Use 50' Chords up to 16° Curves

Use 25' Chords up to 32° Curves
Use 10' Chords above 32° Curves

Minutes	Dec. of Degree	36°		37°		38°		39°		Minutes
		Ext.	Tan.	Ext.	Tan.	Ext.	Tan.	Ext.	Tan.	
0	.0000	294.0	1861.8	312.3	1917.3	339.2	1973.0	348.7	2029.1	0
1	.0167	295.2	1862.7	312.5	1918.2	339.5	1973.9	349.0	2030.0	1
2	.0333	295.4	1863.6	312.8	1919.1	339.8	1974.9	349.3	2031.0	2
3	.0500	295.7	1864.5	313.1	1920.0	331.1	1975.8	349.6	2031.9	3
4	.0667	296.0	1865.5	313.4	1921.0	331.4	1976.7	349.9	2032.9	4
5	.0833	296.3	1866.4	313.7	1921.9	331.7	1977.6	350.3	2033.8	5
6	.1000	296.6	1867.3	314.0	1922.8	332.0	1978.6	350.6	2034.7	6
7	.1167	296.9	1868.2	314.3	1923.7	332.3	1979.5	350.9	2035.6	7
8	.1333	297.2	1869.2	314.6	1924.7	332.6	1980.5	351.2	2036.6	8
9	.1500	297.5	1870.1	314.9	1925.6	332.9	1981.4	351.5	2037.5	9
10	.1667	297.7	1871.0	315.2	1926.5	333.2	1982.3	351.8	2038.5	10
11	.1833	298.0	1871.9	315.5	1927.4	333.5	1983.2	352.1	2039.4	11
12	.2000	298.3	1872.9	315.8	1928.4	333.8	1984.2	352.4	2040.4	12
13	.2167	298.6	1873.8	316.1	1929.3	334.2	1985.1	352.8	2041.3	13
14	.2333	298.9	1874.7	316.4	1930.2	334.5	1986.1	353.1	2042.3	14
15	.2500	299.2	1875.6	316.7	1931.1	334.8	1987.0	353.4	2043.2	15
16	.2667	299.5	1876.5	317.0	1932.1	335.1	1987.9	353.7	2044.1	16
17	.2833	299.7	1877.4	317.2	1933.0	335.4	1988.8	354.0	2045.0	17
18	.3000	300.0	1878.4	317.5	1933.9	335.7	1989.8	354.3	2046.0	18
19	.3167	300.3	1879.3	317.8	1934.8	336.0	1990.7	354.6	2046.9	19
20	.3333	300.6	1880.2	318.1	1935.8	336.3	1991.7	354.9	2047.9	20
21	.3500	300.9	1881.1	318.4	1936.7	336.6	1992.6	355.3	2048.8	21
22	.3667	301.2	1882.1	318.7	1937.6	336.9	1993.6	355.6	2049.8	22
23	.3833	301.5	1883.0	319.0	1938.5	337.2	1994.5	355.9	2050.7	23
24	.4000	301.8	1883.9	319.3	1939.5	337.5	1995.4	356.2	2051.7	24
25	.4167	302.0	1884.8	319.6	1940.4	337.8	1996.3	356.6	2052.6	25
26	.4333	302.3	1885.8	319.9	1941.3	338.1	1997.3	356.9	2053.5	26
27	.4500	302.6	1886.7	320.2	1942.2	338.4	1998.2	357.2	2054.4	27
28	.4667	302.9	1887.6	320.5	1943.2	338.7	1999.2	357.5	2055.4	28
29	.4833	303.2	1888.5	320.8	1944.1	339.1	2000.1	357.8	2056.3	29
30	.5000	303.5	1889.5	321.1	1945.0	339.4	2001.0	358.1	2057.3	30
31	.5167	303.8	1890.4	321.4	1945.9	339.7	2001.9	358.4	2058.2	31
32	.5333	304.1	1891.3	321.7	1946.9	340.0	2002.8	358.8	2059.2	32
33	.5500	304.3	1892.2	322.0	1947.8	340.3	2003.8	359.1	2060.1	33
34	.5667	304.6	1893.2	322.3	1948.8	340.6	2004.8	359.4	2061.1	34
35	.5833	304.9	1894.1	322.6	1949.7	340.9	2005.7	359.8	2062.0	35
36	.6000	305.2	1895.0	322.9	1950.6	341.2	2006.6	360.1	2063.0	36
37	.6167	305.5	1895.9	323.2	1951.5	341.5	2007.5	360.4	2063.9	37
38	.6333	305.8	1896.9	323.5	1952.5	341.8	2008.5	360.7	2064.8	38
39	.6500	306.1	1897.8	323.8	1953.4	342.1	2009.4	361.0	2065.7	39
40	.6667	306.4	1898.7	324.1	1954.4	342.4	2010.4	361.3	2066.7	40
41	.6833	306.7	1899.6	324.5	1955.3	342.8	2011.3	361.6	2067.6	41
42	.7000	307.0	1900.6	324.8	1956.2	343.1	2012.3	361.9	2068.6	42
43	.7167	307.2	1901.5	325.1	1957.1	343.4	2013.2	362.3	2069.5	43
44	.7333	307.5	1902.4	325.4	1958.1	343.7	2014.1	362.6	2070.5	44
45	.7500	307.8	1903.3	325.7	1959.0	344.0	2015.0	363.0	2071.4	45
46	.7667	308.1	1904.3	326.0	1960.0	344.3	2016.0	363.3	2072.4	46
47	.7833	308.4	1905.2	326.3	1960.9	344.6	2016.9	363.6	2073.3	47
48	.8000	308.7	1906.1	326.6	1961.8	344.9	2017.9	363.9	2074.2	48
49	.8167	309.0	1907.0	326.9	1962.7	345.3	2018.8	364.2	2075.1	49
50	.8333	309.3	1908.0	327.2	1963.7	345.6	2019.7	364.5	2076.1	50
51	.8500	309.6	1908.9	327.5	1964.6	345.9	2020.6	364.9	2077.0	51
52	.8667	309.9	1909.8	327.8	1965.5	346.2	2021.6	365.2	2078.0	52
53	.8833	310.2	1910.7	328.1	1966.4	346.5	2022.5	365.5	2079.0	53
54	.9000	310.5	1911.7	328.4	1967.4	346.8	2023.5	365.8	2079.9	54
55	.9167	310.8	1912.6	328.7	1968.3	347.1	2024.4	366.2	2080.8	55
56	.9333	311.1	1913.5	329.0	1969.3	347.4	2025.4	366.5	2081.8	56
57	.9500	311.4	1914.4	329.3	1970.2	347.8	2026.3	366.8	2082.7	57
58	.9667	311.7	1915.4	329.6	1971.1	348.1	2027.2	367.1	2083.7	58
59	.9833	312.0	1916.3	329.9	1972.0	348.4	2028.1	367.4	2084.6	59

SURVEY DATA

Use 100' Chords up to 8° Curves
Use 50' Chords up to 16° CurvesUse 25' Chords up to 32° Curves
Use 10' Chords above 32° Curves

Minutes	Dec. of Degree	40°		41°		42°		43°		Minutes
		Ext.	Tan.	Ext.	Tan.	Ext.	Tan.	Ext.	Tan.	
0	.0000	367.7	2085.5	387.4	2142.3	407.7	2199.5	428.6	2257.1	0
1	.0167	368.0	2086.4	387.8	2143.2	408.0	2200.4	429.0	2258.0	1
2	.0333	368.4	2087.4	388.1	2144.2	408.3	2201.4	429.3	2259.0	2
3	.0500	368.7	2088.3	388.5	2145.1	408.7	2202.3	429.7	2260.0	3
4	.0667	369.0	2089.3	388.8	2146.1	409.0	2203.3	430.0	2261.0	4
5	.0833	369.4	2090.2	389.1	2147.0	409.4	2204.3	430.4	2262.0	5
6	.1000	369.7	2091.2	389.4	2148.0	409.7	2205.3	430.7	2262.9	6
7	.1167	370.0	2092.1	389.8	2148.9	410.1	2206.2	431.1	2263.8	7
8	.1333	370.3	2093.1	390.1	2149.9	410.4	2207.2	431.4	2264.8	8
9	.1500	370.7	2094.0	390.4	2150.9	410.8	2208.1	431.8	2265.7	9
10	.1667	371.0	2095.0	390.7	2151.0	411.1	2209.1	432.1	2266.7	10
11	.1833	371.3	2095.9	391.1	2152.8	411.5	2210.0	432.4	2267.7	11
12	.2000	371.6	2096.9	391.4	2153.8	411.8	2211.0	432.8	2268.7	12
13	.2167	372.0	2097.8	391.8	2154.7	412.2	2211.9	433.2	2269.6	13
14	.2333	372.3	2098.8	392.1	2155.7	412.5	2212.9	433.5	2270.6	14
15	.2500	372.6	2099.7	392.4	2156.6	412.9	2213.9	433.9	2271.5	15
16	.2667	372.9	2100.7	392.7	2157.6	413.2	2214.9	434.2	2272.5	16
17	.2833	373.3	2101.6	393.1	2158.5	413.6	2215.8	434.6	2273.5	17
18	.3000	373.6	2102.6	393.4	2159.5	413.9	2216.8	434.0	2274.5	18
19	.3167	374.0	2103.5	393.7	2160.4	414.3	2217.7	435.3	2275.4	19
20	.3333	374.3	2104.5	394.1	2161.4	414.6	2218.7	435.6	2276.4	20
21	.3500	374.6	2105.4	394.4	2162.3	415.0	2219.6	436.0	2277.3	21
22	.3667	374.9	2106.3	394.7	2163.3	415.3	2220.6	436.3	2278.3	22
23	.3833	375.3	2107.2	395.1	2164.2	415.7	2221.5	436.7	2279.2	23
24	.4000	375.6	2108.2	395.4	2165.2	416.0	2222.5	437.0	2280.2	24
25	.4167	375.9	2109.1	395.8	2166.1	416.3	2223.4	437.4	2281.2	25
26	.4333	376.2	2110.1	396.1	2167.1	416.6	2224.4	437.8	2282.2	26
27	.4500	376.6	2111.0	396.5	2168.0	417.0	2225.4	438.2	2283.1	27
28	.4667	376.9	2112.0	396.8	2169.0	417.3	2226.4	438.5	2284.1	28
29	.4833	377.2	2112.9	397.2	2169.9	417.7	2227.3	438.9	2285.0	29
30	.5000	377.5	2113.9	397.5	2170.9	418.0	2228.3	439.2	2286.0	30
31	.5167	377.9	2114.8	397.8	2171.8	418.4	2229.2	439.6	2287.0	31
32	.5333	378.2	2115.8	398.1	2172.8	418.7	2230.2	439.9	2288.0	32
33	.5500	378.5	2116.7	398.5	2173.7	419.1	2231.1	440.3	2288.9	33
34	.5667	378.8	2117.7	398.8	2174.7	419.4	2232.1	440.6	2289.9	34
35	.5833	379.2	2118.6	399.2	2175.6	419.8	2233.0	441.0	2290.8	35
36	.6000	379.5	2119.6	399.5	2176.6	420.1	2234.0	441.4	2291.8	36
37	.6167	379.8	2120.5	399.9	2177.5	420.5	2235.0	441.8	2292.8	37
38	.6333	380.1	2121.5	400.2	2178.5	420.8	2236.0	442.1	2293.8	38
39	.6500	380.5	2122.4	400.6	2179.4	421.2	2236.9	442.5	2294.7	39
40	.6667	380.8	2123.4	400.9	2180.4	421.5	2237.9	442.8	2295.7	40
41	.6833	381.1	2124.3	401.2	2181.4	421.9	2238.8	443.2	2296.7	41
42	.7000	381.4	2125.3	401.5	2182.4	422.2	2239.8	443.5	2297.7	42
43	.7167	381.8	2126.2	401.9	2183.3	422.6	2240.7	443.9	2298.6	43
44	.7333	382.1	2127.2	402.2	2184.3	422.9	2241.7	444.2	2299.6	44
45	.7500	382.5	2128.1	402.6	2185.2	423.3	2242.6	444.6	2300.5	45
46	.7667	382.8	2129.1	402.9	2186.2	423.6	2243.6	445.0	2301.5	46
47	.7833	383.1	2130.0	403.3	2187.1	424.0	2244.6	445.4	2302.5	47
48	.8000	383.4	2131.0	403.6	2188.1	424.3	2245.6	445.7	2303.5	48
49	.8167	383.8	2131.9	404.0	2189.0	424.7	2246.5	446.1	2304.4	49
50	.8333	384.1	2132.9	404.3	2190.0	425.0	2247.5	446.4	2305.4	50
51	.8500	384.5	2133.8	404.6	2190.9	425.4	2248.4	446.8	2306.3	51
52	.8667	384.8	2134.7	404.9	2191.9	425.7	2249.4	447.1	2307.3	52
53	.8833	385.1	2135.6	405.3	2192.8	426.1	2250.3	447.5	2308.3	53
54	.9000	385.4	2136.6	405.6	2193.8	426.4	2251.3	447.8	2309.3	54
55	.9167	385.8	2137.5	406.0	2194.7	426.8	2252.3	448.2	2310.3	55
56	.9333	386.1	2138.5	406.3	2195.7	427.1	2253.3	448.6	2311.3	56
57	.9500	386.5	2139.4	406.7	2196.6	427.5	2254.2	449.0	2312.3	57
58	.9667	386.8	2140.4	407.0	2197.6	427.8	2255.2	449.3	2313.3	58
59	.9833	387.1	2141.3	407.4	2198.5	428.2	2256.1	449.7	2314.3	59

FUNCTIONS 1 DEGREE CURVE

Use 100' Chords up to 8° Curves
Use 50' Chords up to 16° Curves

Use 25' Chords up to 32° Curves
Use 10' Chords above 32° Curves

Minutes	Dec. of Degrees	44°		45°		46°		47°		Minutes
		Ext.	Tan.	Ext.	Tan.	Ext.	Tan.	Ext.	Tan.	
0	.0000	450.0	2315.1	472.1	2375.4	494.8	2432.2	518.3	2491.5	0
1	.0167	450.4	2316.0	472.5	2374.4	495.2	2433.2	518.7	2492.4	1
2	.0333	450.7	2317.0	472.9	2373.4	495.6	2434.2	519.0	2493.4	2
3	.0500	451.1	2318.0	473.3	2376.3	496.0	2435.1	519.4	2494.4	3
4	.0667	451.5	2319.0	473.6	2377.3	496.4	2436.1	519.8	2495.4	4
5	.0833	451.9	2320.0	474.0	2378.3	496.7	2437.1	520.2	2496.4	5
6	.1000	452.2	2320.0	474.4	2379.3	497.2	2438.1	520.6	2497.4	6
7	.1167	452.6	2321.8	474.8	2380.2	497.6	2439.1	521.0	2498.4	7
8	.1333	452.9	2322.8	475.1	2381.2	497.9	2440.1	521.4	2499.4	8
9	.1500	453.3	2323.8	475.5	2382.2	498.3	2441.1	521.8	2500.4	9
10	.1667	453.7	2324.8	475.9	2383.2	498.7	2442.1	522.2	2501.4	10
11	.1833	454.1	2325.7	476.3	2384.2	499.1	2443.0	522.6	2502.4	11
12	.2000	454.4	2326.7	476.6	2385.2	499.5	2444.0	523.0	2503.4	12
13	.2167	454.8	2327.7	477.0	2386.1	499.9	2445.0	523.4	2504.4	13
14	.2333	455.1	2328.7	477.4	2387.1	500.3	2446.0	523.8	2505.4	14
15	.2500	455.5	2329.6	477.8	2388.1	500.7	2447.0	524.2	2506.3	15
16	.2667	455.9	2330.6	478.1	2389.1	501.0	2448.0	524.6	2507.3	16
17	.2833	456.3	2331.6	478.5	2390.0	501.4	2449.0	525.0	2508.3	17
18	.3000	456.6	2332.6	478.9	2391.0	501.8	2449.0	525.4	2509.3	18
19	.3167	457.0	2333.5	479.3	2392.0	502.2	2450.0	525.8	2510.3	19
20	.3333	457.3	2334.5	479.6	2393.0	502.6	2451.0	526.2	2511.3	20
21	.3500	457.7	2335.4	480.0	2393.9	503.0	2452.0	526.6	2512.3	21
22	.3667	458.1	2336.4	480.4	2394.0	503.4	2453.0	527.0	2513.3	22
23	.3833	458.5	2337.4	480.8	2395.0	503.8	2454.0	527.4	2514.3	23
24	.4000	458.8	2338.4	481.1	2396.0	504.1	2455.0	527.8	2515.3	24
25	.4167	459.2	2339.3	481.5	2397.8	504.5	2456.8	528.2	2516.3	25
26	.4333	459.5	2340.3	481.9	2398.8	504.9	2457.8	528.6	2517.3	26
27	.4500	459.9	2341.3	482.3	2399.8	505.3	2458.8	529.0	2518.3	27
28	.4667	460.3	2342.3	482.6	2400.8	505.7	2459.8	529.4	2519.3	28
29	.4833	460.7	2343.2	483.0	2401.8	506.1	2460.8	529.8	2520.3	29
30	.5000	461.0	2344.2	483.4	2402.8	506.5	2461.8	530.2	2521.3	30
31	.5167	461.4	2344.1	483.8	2403.7	506.9	2462.8	530.6	2522.2	31
32	.5333	461.7	2344.1	484.2	2404.7	507.3	2463.8	531.0	2523.2	32
33	.5500	462.1	2344.1	484.6	2405.7	507.7	2464.7	531.4	2524.2	33
34	.5667	462.5	2344.1	484.9	2406.7	508.0	2465.7	531.8	2525.2	34
35	.5833	462.9	2344.0	485.3	2407.6	508.4	2466.7	532.2	2526.2	35
36	.6000	463.2	2350.0	485.7	2408.6	508.8	2467.7	532.6	2527.2	36
37	.6167	463.6	2351.0	486.1	2409.6	509.2	2468.7	533.0	2528.2	37
38	.6333	463.9	2352.0	486.5	2410.6	509.6	2469.7	533.4	2529.2	38
39	.6500	464.3	2352.0	486.9	2411.6	510.0	2470.7	533.8	2530.2	39
40	.6667	464.7	2353.0	487.2	2412.6	510.4	2471.7	534.2	2531.2	40
41	.6833	465.0	2354.0	487.6	2413.5	510.8	2472.6	534.6	2532.2	41
42	.7000	465.4	2355.0	488.0	2414.5	511.1	2473.6	535.0	2533.2	42
43	.7167	465.8	2356.8	488.4	2415.5	511.5	2474.6	535.4	2534.2	43
44	.7333	466.2	2357.8	488.7	2416.5	511.9	2475.6	535.8	2535.2	44
45	.7500	466.5	2358.8	489.1	2417.5	512.3	2476.6	536.2	2536.2	45
46	.7667	466.9	2359.8	489.5	2418.5	512.7	2477.6	536.6	2537.2	46
47	.7833	467.3	2360.7	489.9	2419.4	513.1	2478.6	537.0	2538.2	47
48	.8000	467.7	2361.7	490.3	2420.4	513.5	2479.6	537.4	2539.2	48
49	.8167	468.0	2362.7	490.7	2421.4	513.9	2480.6	537.8	2540.2	49
50	.8333	468.4	2363.7	491.0	2422.4	514.3	2481.6	538.2	2541.2	50
51	.8500	468.8	2364.6	491.4	2423.4	514.7	2482.5	538.6	2542.2	51
52	.8667	469.1	2365.6	491.8	2424.4	515.1	2483.5	539.0	2543.2	52
53	.8833	469.5	2366.6	492.2	2425.3	515.5	2484.5	539.4	2544.2	53
54	.9000	469.9	2367.6	492.5	2426.3	515.9	2485.5	539.8	2545.2	54
55	.9167	470.3	2368.5	492.9	2427.3	516.3	2486.5	540.2	2546.2	55
56	.9333	470.6	2369.5	493.3	2428.3	516.7	2487.5	540.6	2547.2	56
57	.9500	471.0	2370.5	493.7	2429.3	517.1	2488.5	541.0	2548.2	57
58	.9667	471.4	2371.5	494.1	2430.3	517.5	2489.5	541.4	2549.2	58
59	.9833	471.8	2372.4	494.5	2431.3	517.9	2490.5	541.8	2550.2	59

Use 100' Chords up to 8° Curves
Use 50' Chords up to 16° Curves

Use 25' Chords up to 32° Curves
Use 10' Chords above 32° Curves

Minutes	Dec. of Degree	48°		49°		50°		51°		Minutes
		Ext.	Tan.	Ext.	Tan.	Ext.	Tan.	Ext.	Tan.	
0	.0000	542.3	2551.1	567.0	2611.3	592.4	2671.0	618.5	2733.0	0
1	.0167	542.7	2552.1	567.4	2612.3	592.8	2672.0	618.9	2734.1	1
2	.0333	543.1	2553.1	567.8	2613.3	593.2	2673.0	619.3	2735.1	2
3	.0500	543.5	2554.1	568.3	2614.3	593.7	2675.0	619.8	2736.1	3
4	.0667	543.9	2555.1	568.7	2615.3	594.1	2676.0	620.2	2737.1	4
5	.0833	544.3	2556.1	569.1	2616.3	594.5	2677.0	620.7	2738.2	5
6	.1000	544.7	2557.1	569.5	2617.3	594.9	2678.0	621.1	2739.2	6
7	.1167	545.1	2558.1	569.9	2618.3	595.4	2679.0	621.6	2740.2	7
8	.1333	545.5	2559.1	570.3	2619.3	595.8	2680.0	622.0	2741.2	8
9	.1500	545.0	2560.1	570.8	2620.4	596.2	2681.1	622.5	2742.3	9
10	.1667	546.4	2561.1	571.2	2621.4	596.7	2682.1	622.9	2743.3	10
11	.1833	546.8	2562.1	571.6	2622.4	597.1	2683.1	623.3	2744.3	11
12	.2000	547.2	2563.1	572.0	2623.4	597.5	2684.1	623.7	2745.3	12
13	.2167	547.6	2564.1	572.4	2624.4	598.0	2685.1	624.2	2746.4	13
14	.2333	548.0	2565.1	572.8	2625.4	598.4	2686.1	624.6	2747.4	14
15	.2500	548.4	2566.1	573.3	2626.4	598.9	2687.2	625.1	2748.4	15
16	.2667	548.8	2567.1	573.7	2627.4	599.3	2688.2	625.5	2749.4	16
17	.2833	549.2	2568.1	574.1	2628.4	599.7	2689.2	626.0	2750.5	17
18	.3000	549.6	2569.1	574.5	2629.4	600.1	2690.2	626.4	2751.5	18
19	.3167	550.1	2570.1	574.9	2630.4	600.6	2691.3	626.9	2752.5	19
20	.3333	550.5	2571.1	575.3	2631.4	601.0	2692.3	627.3	2753.5	20
21	.3500	550.9	2572.1	575.8	2632.5	601.5	2693.3	627.8	2754.6	21
22	.3667	551.3	2573.1	576.2	2633.5	601.9	2694.3	628.2	2755.6	22
23	.3833	551.7	2574.1	576.6	2634.5	602.3	2695.3	628.7	2756.7	23
24	.4000	552.1	2575.1	577.0	2635.5	602.7	2696.3	629.1	2757.7	24
25	.4167	552.5	2576.1	577.5	2636.5	603.2	2697.4	629.6	2758.7	25
26	.4333	552.9	2577.1	577.9	2637.5	603.6	2698.4	630.0	2759.7	26
27	.4500	553.3	2578.1	578.3	2638.5	604.1	2699.4	630.5	2760.8	27
28	.4667	553.7	2579.1	578.7	2639.5	604.5	2700.4	630.9	2761.8	28
29	.4833	554.2	2580.1	579.2	2640.5	604.9	2701.4	631.4	2762.8	29
30	.5000	554.6	2581.1	579.6	2641.5	605.3	2702.4	631.8	2763.8	30
31	.5167	555.0	2582.1	580.0	2642.5	605.8	2703.5	632.3	2764.9	31
32	.5333	555.4	2583.1	580.4	2643.5	606.2	2704.5	632.7	2765.9	32
33	.5500	555.8	2584.1	580.9	2644.6	606.6	2705.5	633.2	2766.9	33
34	.5667	556.2	2585.1	581.3	2645.6	607.0	2706.5	633.6	2767.9	34
35	.5833	556.6	2586.2	581.7	2646.6	607.5	2707.6	634.1	2769.0	35
36	.6000	557.0	2587.2	582.1	2647.6	607.9	2708.6	634.5	2770.0	36
37	.6167	557.4	2588.2	582.6	2648.6	608.4	2709.6	634.9	2771.0	37
38	.6333	557.8	2589.2	583.0	2649.6	608.8	2710.6	635.3	2772.0	38
39	.6500	558.3	2590.2	583.4	2650.6	609.3	2711.6	635.8	2773.1	39
40	.6667	558.7	2591.2	583.8	2651.6	609.7	2712.6	636.2	2774.1	40
41	.6833	559.1	2592.2	584.3	2652.7	610.1	2713.7	636.7	2775.2	41
42	.7000	559.5	2593.2	584.7	2653.7	610.5	2714.7	637.1	2776.2	42
43	.7167	559.9	2594.2	585.1	2654.7	611.0	2715.7	637.5	2777.2	43
44	.7333	560.3	2595.2	585.5	2655.7	611.4	2716.7	638.0	2778.2	44
45	.7500	560.8	2596.2	586.0	2656.7	611.9	2717.8	638.5	2779.3	45
46	.7667	561.2	2597.2	586.4	2657.7	612.3	2718.8	638.9	2780.3	46
47	.7833	561.6	2598.2	586.8	2658.7	612.8	2719.8	639.4	2781.3	47
48	.8000	562.0	2599.2	587.2	2659.7	613.2	2720.8	639.8	2782.3	48
49	.8167	562.4	2600.2	587.7	2660.8	613.7	2721.8	640.3	2783.4	49
50	.8333	562.8	2601.2	588.1	2661.8	614.1	2722.8	640.7	2784.4	50
51	.8500	563.2	2602.2	588.5	2662.8	614.5	2723.8	641.2	2785.4	51
52	.8667	563.7	2603.2	588.9	2663.8	614.9	2724.9	641.6	2786.4	52
53	.8833	564.1	2604.2	589.4	2664.8	615.4	2725.9	642.1	2787.5	53
54	.9000	564.5	2605.2	589.8	2665.8	615.8	2726.9	642.5	2788.5	54
55	.9167	564.9	2606.2	590.2	2666.8	616.3	2728.0	643.0	2789.6	55
56	.9333	565.3	2607.2	590.6	2667.8	616.7	2729.0	643.4	2790.6	56
57	.9500	565.8	2608.2	591.1	2668.9	617.2	2730.0	643.9	2791.6	57
58	.9667	566.2	2609.2	591.5	2669.9	617.6	2731.0	644.3	2792.6	58
59	.9833	566.6	2610.2	591.9	2670.9	618.1	2732.0	644.8	2793.7	59

FUNCTIONS I DEGREE CURVE

Use 100' Chords up to 8° Curves
Use 50' Chords up to 16° Curves

Use 25' Chords up to 32° Curves
Use 10' Chords above 32° Curves

Minutes	Deg. of Degree	52°		53°		54°		55°		Minutes
		Ext.	Tan.	Ext.	Tan.	Ext.	Tan.	Ext.	Tan.	
0	.0000	645.2	2794.7	672.7	2856.9	700.9	2919.5	729.9	2982.8	0
1	.0167	645.7	2795.8	673.2	2857.9	701.4	2920.6	730.4	2983.9	1
2	.0333	646.1	2796.8	673.7	2858.0	701.9	2921.6	730.9	2984.9	2
3	.0500	646.6	2797.8	674.2	2860.0	702.4	2922.7	731.4	2986.0	3
4	.0667	647.0	2798.8	674.6	2861.0	702.8	2923.8	731.9	2987.1	4
5	.0833	647.5	2799.9	675.1	2862.1	703.3	2924.9	732.4	2988.2	5
6	.1000	647.9	2800.9	675.5	2863.1	703.8	2925.9	732.9	2989.2	6
7	.1167	648.4	2802.0	676.0	2864.2	704.3	2927.0	733.4	2990.3	7
8	.1333	648.9	2803.0	676.4	2865.2	704.8	2928.0	733.8	2991.3	8
9	.1500	649.4	2804.0	676.9	2866.3	705.3	2929.1	734.3	2992.4	9
10	.1667	649.8	2805.0	677.4	2867.3	705.7	2930.1	734.8	2993.4	10
11	.1833	650.3	2806.1	677.9	2868.4	706.2	2931.2	735.3	2994.5	11
12	.2000	650.7	2807.1	678.3	2869.4	706.7	2932.2	735.8	2995.5	12
13	.2167	651.2	2808.2	678.8	2870.5	707.2	2933.3	736.3	2996.6	13
14	.2333	651.6	2809.2	679.2	2871.5	707.7	2934.3	736.8	2997.7	14
15	.2500	652.1	2810.2	679.7	2872.5	708.2	2935.4	737.3	2998.8	15
16	.2667	652.5	2811.2	680.2	2873.5	708.6	2936.4	737.8	2999.8	16
17	.2833	653.0	2812.3	680.7	2874.6	709.1	2937.5	738.3	3000.9	17
18	.3000	653.4	2813.3	681.1	2875.6	709.6	2938.5	738.7	3001.9	18
19	.3167	653.9	2814.4	681.6	2876.7	710.1	2939.6	739.2	3003.0	19
20	.3333	654.3	2815.4	682.0	2877.7	710.5	2940.6	739.7	3004.0	20
21	.3500	654.8	2816.4	682.5	2878.8	711.0	2941.7	740.2	3005.1	21
22	.3667	655.2	2817.4	683.0	2879.8	711.5	2942.7	740.7	3006.2	22
23	.3833	655.7	2818.5	683.5	2880.9	712.0	2943.8	741.2	3007.3	23
24	.4000	656.2	2819.5	683.9	2881.9	712.5	2944.8	741.7	3008.3	24
25	.4167	656.7	2820.6	684.4	2883.0	713.0	2945.9	742.2	3009.4	25
26	.4333	657.1	2821.6	684.9	2884.0	713.4	2946.9	742.7	3010.4	26
27	.4500	657.6	2822.6	685.4	2885.1	713.9	2948.0	743.2	3011.5	27
28	.4667	658.0	2823.6	685.8	2886.1	714.4	2949.0	743.7	3012.5	28
29	.4833	658.5	2824.7	686.3	2887.1	714.9	2950.1	744.2	3013.6	29
30	.5000	658.9	2825.7	686.7	2888.1	715.3	2951.1	744.7	3014.7	30
31	.5167	659.4	2826.8	687.2	2889.2	715.8	2952.2	745.2	3015.8	31
32	.5333	659.8	2827.8	687.7	2890.2	716.3	2953.2	745.7	3016.8	32
33	.5500	660.3	2828.8	688.2	2891.3	716.8	2954.3	746.2	3017.9	33
34	.5667	660.7	2829.8	688.6	2892.3	717.3	2955.3	746.7	3018.9	34
35	.5833	661.2	2830.9	689.1	2893.4	717.8	2956.4	747.2	3020.0	35
36	.6000	661.6	2831.9	689.6	2894.4	718.2	2957.5	747.7	3021.1	36
37	.6167	662.1	2833.0	690.1	2895.5	718.7	2958.6	748.2	3022.1	37
38	.6333	662.5	2834.0	690.5	2896.5	719.2	2959.6	748.7	3023.2	38
39	.6500	663.0	2835.1	691.0	2897.6	719.7	2960.7	749.2	3024.3	39
40	.6667	663.5	2836.1	691.5	2898.6	720.2	2961.7	749.7	3025.3	40
41	.6833	664.0	2837.2	692.0	2899.7	720.7	2962.8	750.2	3026.4	41
42	.7000	664.4	2838.2	692.4	2900.7	721.1	2963.8	750.7	3027.5	42
43	.7167	664.9	2839.2	692.9	2901.8	721.6	2964.9	751.2	3028.6	43
44	.7333	665.3	2840.2	693.4	2902.8	722.1	2965.9	751.7	3029.6	44
45	.7500	665.8	2841.3	693.9	2903.9	722.6	2967.0	752.2	3030.7	45
46	.7667	666.2	2842.3	694.3	2904.9	723.1	2968.0	752.7	3031.7	46
47	.7833	666.7	2843.4	694.8	2906.0	723.6	2969.1	753.2	3032.8	47
48	.8000	667.2	2844.4	695.3	2907.0	724.1	2970.1	753.7	3033.8	48
49	.8167	667.7	2845.5	695.8	2908.1	724.6	2971.2	754.2	3035.0	49
50	.8333	668.1	2846.5	696.2	2909.1	725.0	2972.2	754.7	3036.0	50
51	.8500	668.6	2847.5	696.7	2910.2	725.5	2973.3	755.2	3037.1	51
52	.8667	669.0	2848.5	697.1	2911.2	726.0	2974.4	755.7	3038.1	52
53	.8833	669.5	2849.6	697.6	2912.3	726.5	2975.5	756.2	3039.2	53
54	.9000	669.9	2850.6	698.1	2913.3	727.0	2976.5	756.7	3040.2	54
55	.9167	670.4	2851.7	698.6	2914.4	727.5	2977.6	757.2	3041.3	55
56	.9333	670.9	2852.7	699.0	2915.4	728.0	2978.6	757.7	3042.4	56
57	.9500	671.4	2853.8	699.5	2916.5	728.5	2979.7	758.2	3043.5	57
58	.9667	671.8	2854.8	700.0	2917.5	729.0	2980.7	758.7	3044.5	58
59	.9833	672.3	2855.9	700.5	2918.5	729.5	2981.8	759.2	3045.6	59

Use 100' Chords up to 8° Curves
Use 50' Chords up to 16° Curves

Use 25' Chords up to 32° Curves
Use 10' Chords above 32° Curves

Minutes	Dec. of Degree	56°		57°		58°		59°		Minutes
		Ext.	Tan.	Ext.	Tan.	Ext.	Tan.	Ext.	Tan.	
0	.0000	759.6	3046.6	790.2	3111.1	821.4	3176.1	853.5	3241.0	0
1	.0167	760.1	3047.7	790.7	3112.2	821.9	3177.2	854.0	3243.0	1
2	.0333	760.6	3048.8	791.2	3113.3	822.5	3178.3	854.6	3244.1	2
3	.0500	761.1	3049.9	791.7	3114.4	823.0	3179.4	855.1	3245.2	3
4	.0667	761.6	3050.0	792.2	3115.4	823.5	3180.5	855.7	3246.3	4
5	.0833	762.2	3052.0	792.8	3116.5	824.1	3181.6	856.2	3247.4	5
6	.1000	762.7	3053.1	793.3	3117.6	824.6	3182.7	856.8	3248.5	6
7	.1167	763.2	3054.2	793.8	3118.7	825.2	3183.8	857.3	3249.6	7
8	.1333	763.7	3055.2	794.3	3119.7	825.7	3184.9	857.9	3250.7	8
9	.1500	764.2	3056.3	794.8	3120.8	826.2	3186.0	858.5	3251.8	9
10	.1667	764.7	3057.4	795.3	3121.9	826.7	3187.1	859.0	3252.9	10
11	.1833	765.2	3058.5	795.8	3123.0	827.3	3188.2	859.5	3254.0	11
12	.2000	765.7	3059.5	796.3	3124.1	827.8	3189.2	860.0	3255.1	12
13	.2167	766.2	3060.6	796.9	3125.2	828.4	3190.3	860.6	3256.2	13
14	.2333	766.7	3061.6	797.4	3126.2	828.9	3191.4	861.1	3257.3	14
15	.2500	767.2	3062.7	797.9	3127.3	829.4	3192.5	861.7	3258.4	15
16	.2667	767.7	3063.8	798.4	3128.4	829.9	3193.6	862.2	3259.5	16
17	.2833	768.2	3064.9	798.9	3129.5	830.5	3194.7	862.8	3260.6	17
18	.3000	768.7	3065.9	799.4	3130.6	831.0	3195.8	863.3	3261.7	18
19	.3167	769.2	3067.0	799.9	3131.7	831.5	3196.9	863.8	3262.8	19
20	.3333	769.7	3068.1	800.5	3132.7	832.1	3198.0	864.4	3263.9	20
21	.3500	770.3	3069.2	801.0	3133.8	832.5	3199.1	864.9	3265.0	21
22	.3667	770.8	3070.2	801.5	3134.9	833.1	3200.2	865.5	3266.1	22
23	.3833	771.3	3071.3	802.0	3136.0	833.6	3201.3	866.0	3267.2	23
24	.4000	771.8	3072.4	802.5	3137.0	834.2	3202.4	866.6	3268.3	24
25	.4167	772.3	3073.5	803.1	3138.1	834.7	3203.5	867.1	3269.4	25
26	.4333	772.8	3074.5	803.6	3139.2	835.3	3204.5	867.7	3270.5	26
27	.4500	773.3	3075.6	804.2	3140.3	835.8	3205.6	868.2	3271.6	27
28	.4667	773.8	3076.6	804.7	3141.4	836.3	3206.7	868.8	3272.7	28
29	.4833	774.3	3077.7	805.2	3142.5	836.8	3207.8	869.3	3273.8	29
30	.5000	774.8	3078.8	805.7	3143.5	837.4	3208.9	869.9	3274.9	30
31	.5167	775.3	3079.9	806.3	3144.6	837.8	3210.0	870.5	3276.0	31
32	.5333	775.8	3080.9	806.8	3145.7	838.4	3211.1	871.0	3277.1	32
33	.5500	776.3	3082.0	807.3	3146.8	838.9	3212.2	871.6	3278.2	33
34	.5667	776.8	3083.1	807.8	3147.9	839.5	3213.3	872.1	3279.3	34
35	.5833	777.3	3084.2	808.3	3149.0	840.0	3214.4	872.7	3280.4	35
36	.6000	777.8	3085.2	808.8	3150.0	840.6	3215.5	873.2	3281.5	36
37	.6167	778.4	3086.3	809.4	3151.1	841.1	3216.6	873.8	3282.6	37
38	.6333	778.9	3087.4	809.9	3152.2	841.6	3217.7	874.3	3283.7	38
39	.6500	779.4	3088.5	810.4	3153.3	842.1	3218.8	874.9	3284.8	39
40	.6667	779.9	3089.6	810.9	3154.4	842.7	3219.9	875.4	3285.9	40
41	.6833	780.4	3090.7	811.5	3155.5	843.1	3221.0	876.0	3287.1	41
42	.7000	780.9	3091.7	812.0	3156.6	843.8	3222.1	876.5	3288.2	42
43	.7167	781.4	3092.8	812.5	3157.7	844.2	3223.2	877.0	3289.3	43
44	.7333	781.9	3093.9	813.0	3158.7	844.9	3224.3	877.6	3290.5	44
45	.7500	782.5	3095.0	813.6	3159.8	845.5	3225.4	878.1	3291.6	45
46	.7667	783.0	3096.0	814.1	3160.9	846.0	3226.5	878.7	3292.7	46
47	.7833	783.5	3097.1	814.6	3162.0	846.5	3227.6	879.2	3293.8	47
48	.8000	784.0	3098.2	815.1	3163.1	847.0	3228.7	879.8	3294.9	48
49	.8167	784.5	3099.3	815.7	3164.2	847.6	3229.8	880.3	3296.0	49
50	.8333	785.0	3100.3	816.2	3165.3	848.1	3230.9	880.9	3297.1	50
51	.8500	785.5	3101.4	816.7	3166.4	848.7	3232.0	881.5	3298.2	51
52	.8667	786.0	3102.5	817.2	3167.4	849.2	3233.1	882.0	3299.3	52
53	.8833	786.6	3103.6	817.8	3168.5	849.8	3234.2	882.6	3300.4	53
54	.9000	787.1	3104.6	818.3	3169.6	850.3	3235.3	883.1	3301.5	54
55	.9167	787.6	3105.7	818.8	3170.7	850.9	3236.4	883.7	3302.6	55
56	.9333	788.1	3106.8	819.3	3171.8	851.4	3237.5	884.2	3303.7	56
57	.9500	788.6	3107.9	819.9	3172.9	852.0	3238.6	884.8	3304.8	57
58	.9667	789.1	3108.9	820.4	3174.0	852.5	3239.7	885.3	3305.9	58
59	.9833	789.7	3110.0	820.9	3175.1	853.0	3240.8	885.9	3307.0	59

FUNCTIONS : DEGREE CURVE

Use 100' Chords up to 8° Curves
Use 50' Chords up to 16° Curves

Use 25' Chords up to 32° Curves
Use 10' Chords above 32° Curves

Minutes	Dec. of Degree	60°		61°		62°		63°		Minutes
		Ext.	Tan.	Ext.	Tan.	Ext.	Tan.	Ext.	Tan.	
0	.0000	886.4	3308.2	920.2	3375.2	954.8	3442.0	990.3	3511.3	0
1	.0167	886.0	3300.3	920.8	3376.3	955.4	3444.1	990.0	3512.4	1
2	.0333	887.5	3310.4	921.4	3377.4	956.0	3445.2	991.5	3513.6	2
3	.0500	888.1	3311.5	922.0	3378.5	956.6	3446.3	992.1	3514.8	3
4	.0667	888.7	3312.7	922.5	3379.7	957.2	3447.5	992.7	3515.9	4
5	.0833	889.3	3313.8	923.0	3380.8	957.7	3448.6	993.3	3517.1	5
6	.1000	889.8	3314.9	923.6	3381.9	958.3	3449.7	993.9	3518.2	6
7	.1167	890.3	3316.0	924.2	3383.1	958.9	3450.9	994.5	3519.3	7
8	.1333	890.9	3317.1	924.8	3384.2	959.5	3452.0	995.1	3520.5	8
9	.1500	891.5	3318.2	925.3	3385.3	960.1	3453.2	995.7	3521.6	9
10	.1667	892.0	3319.3	925.9	3386.4	960.7	3454.3	996.3	3522.8	10
11	.1833	892.6	3320.5	926.5	3387.5	961.3	3455.4	996.9	3524.0	11
12	.2000	893.1	3321.6	927.1	3388.7	961.9	3456.6	997.5	3525.1	12
13	.2167	893.7	3322.7	927.6	3389.8	962.4	3457.7	998.1	3526.3	13
14	.2333	894.3	3323.8	928.2	3390.9	963.0	3458.8	998.7	3527.4	14
15	.2500	894.8	3324.9	928.7	3392.1	963.6	3460.0	999.3	3528.6	15
16	.2667	895.4	3326.0	929.3	3393.2	964.2	3461.1	999.9	3529.7	16
17	.2833	895.9	3327.1	929.9	3394.3	964.8	3462.3	1000.5	3530.9	17
18	.3000	896.5	3328.3	930.5	3395.4	965.4	3463.4	1001.1	3532.0	18
19	.3167	897.0	3329.4	931.0	3396.6	966.0	3464.6	1001.7	3533.1	19
20	.3333	897.6	3330.5	931.6	3397.7	966.6	3465.7	1002.3	3534.3	20
21	.3500	898.2	3331.6	932.2	3398.8	967.2	3466.8	1002.9	3535.4	21
22	.3667	898.8	3332.7	932.8	3399.9	967.8	3467.9	1003.5	3536.6	22
23	.3833	899.3	3333.8	933.3	3401.1	968.3	3469.0	1004.1	3537.8	23
24	.4000	899.9	3334.9	933.9	3402.2	968.9	3470.2	1004.7	3538.9	24
25	.4167	900.5	3336.1	934.5	3403.3	969.5	3471.3	1005.3	3540.0	25
26	.4333	901.0	3337.2	935.1	3404.4	970.1	3472.5	1005.9	3541.2	26
27	.4500	901.6	3338.3	935.7	3405.6	970.7	3473.6	1006.5	3542.3	27
28	.4667	902.1	3339.4	936.3	3406.7	971.3	3474.7	1007.1	3543.5	28
29	.4833	902.7	3340.5	936.8	3407.8	971.9	3475.9	1007.8	3544.6	29
30	.5000	903.2	3341.6	937.4	3408.9	972.5	3477.0	1008.4	3545.8	30
31	.5167	903.8	3342.7	938.0	3410.1	973.0	3478.1	1009.0	3546.9	31
32	.5333	904.4	3343.9	938.6	3411.2	973.6	3479.3	1009.6	3548.1	32
33	.5500	904.9	3345.0	939.1	3412.3	974.2	3480.5	1010.2	3549.2	33
34	.5667	905.5	3346.1	939.7	3413.5	974.8	3481.6	1010.8	3550.4	34
35	.5833	906.1	3347.2	940.4	3414.6	975.4	3482.7	1011.4	3551.6	35
36	.6000	906.6	3348.3	940.9	3415.7	976.0	3483.9	1012.0	3552.7	36
37	.6167	907.2	3349.5	941.5	3416.8	976.6	3485.0	1012.6	3553.8	37
38	.6333	907.7	3350.6	942.1	3418.0	977.2	3486.2	1013.2	3555.0	38
39	.6500	908.2	3351.7	942.6	3419.2	977.8	3487.4	1013.9	3556.2	39
40	.6667	908.8	3352.8	943.2	3420.3	978.4	3488.5	1014.5	3557.3	40
41	.6833	909.4	3353.9	943.8	3421.4	979.0	3489.6	1015.1	3558.4	41
42	.7000	910.0	3355.0	944.4	3422.5	979.6	3490.7	1015.7	3559.6	42
43	.7167	910.6	3356.1	944.9	3423.6	980.2	3491.9	1016.3	3560.8	43
44	.7333	911.1	3357.3	945.5	3424.8	980.8	3493.0	1016.9	3562.0	44
45	.7500	911.7	3358.4	946.1	3426.0	981.4	3494.2	1017.5	3563.2	45
46	.7667	912.3	3359.5	946.7	3427.1	982.0	3495.3	1018.1	3564.3	46
47	.7833	912.8	3360.6	947.2	3428.2	982.6	3496.4	1018.7	3565.5	47
48	.8000	913.4	3361.8	947.8	3429.3	983.2	3497.6	1019.3	3566.6	48
49	.8167	913.9	3362.9	948.4	3430.4	983.8	3498.7	1020.0	3567.7	49
50	.8333	914.5	3364.0	949.0	3431.6	984.4	3499.9	1020.6	3568.9	50
51	.8500	915.1	3365.1	949.6	3432.8	984.9	3501.0	1021.2	3570.0	51
52	.8667	915.7	3366.2	950.2	3433.9	985.5	3502.2	1021.8	3571.2	52
53	.8833	916.2	3367.3	950.7	3434.0	986.1	3503.3	1022.4	3572.3	53
54	.9000	916.8	3368.5	951.3	3436.1	986.7	3504.5	1023.0	3573.5	54
55	.9167	917.4	3369.6	951.9	3437.2	987.3	3505.6	1023.6	3574.6	55
56	.9333	918.0	3370.7	952.5	3438.4	987.9	3506.8	1024.2	3575.8	56
57	.9500	918.6	3371.9	953.0	3439.6	988.5	3507.9	1024.8	3576.9	57
58	.9667	919.1	3373.0	953.6	3440.7	989.1	3509.0	1025.4	3578.1	58
59	.9833	919.6	3374.1	954.2	3441.8	989.7	3510.1	1026.0	3579.3	59

SURVEY DATA

Use 100' Chords up to 8° Curves
Use 50' Chords up to 16° CurvesUse 25' Chords up to 32° Curves
Use 10' Chords above 32° Curves

Minutes	Dec. of Degree	64°		65°		66°		67°		Minutes
		Ext.	Tan.	Ext.	Tan.	Ext.	Tan.	Ext.	Tan.	
0	.0000	1026.7	3580.4	1064.0	3650.4	1102.2	3721.1	1141.5	3791.6	0
1	.0167	1027.3	3581.6	1064.6	3651.6	1102.9	3722.3	1142.2	3792.8	1
2	.0333	1027.9	3582.8	1065.2	3652.8	1103.5	3723.4	1142.8	3793.9	2
3	.0500	1028.6	3583.9	1065.9	3654.0	1104.2	3724.6	1143.5	3795.2	3
4	.0667	1029.2	3585.1	1066.5	3655.1	1104.8	3725.8	1144.1	3796.4	4
5	.0833	1029.8	3586.3	1067.1	3656.3	1105.5	3727.0	1144.8	3797.6	5
6	.1000	1030.4	3587.4	1067.7	3657.5	1106.1	3728.2	1145.4	3798.8	6
7	.1167	1031.1	3588.6	1068.4	3658.6	1106.8	3729.4	1146.1	3800.0	7
8	.1333	1031.7	3589.7	1069.0	3659.8	1107.4	3730.6	1146.7	3801.2	8
9	.1500	1032.3	3590.9	1069.6	3661.0	1108.1	3731.7	1147.4	3802.4	9
10	.1667	1032.9	3592.1	1070.2	3662.2	1108.7	3732.9	1148.1	3803.6	10
11	.1833	1033.5	3593.3	1070.9	3663.4	1109.4	3734.1	1148.8	3804.8	11
12	.2000	1034.1	3594.4	1071.5	3664.5	1110.0	3735.3	1149.4	3806.0	12
13	.2167	1034.8	3595.5	1072.1	3665.7	1110.7	3736.5	1150.1	3807.2	13
14	.2333	1035.4	3596.7	1072.7	3666.9	1111.3	3737.7	1150.7	3808.4	14
15	.2500	1036.0	3597.9	1073.4	3668.0	1112.0	3738.9	1151.4	3809.6	15
16	.2667	1036.6	3599.1	1074.0	3669.2	1112.6	3740.1	1152.0	3810.8	16
17	.2833	1037.3	3600.3	1074.6	3670.4	1113.3	3741.3	1152.7	3812.0	17
18	.3000	1037.9	3601.4	1075.2	3671.6	1113.9	3742.4	1153.3	3813.2	18
19	.3167	1038.5	3602.6	1075.9	3672.8	1114.6	3743.6	1154.0	3814.4	19
20	.3333	1039.1	3603.7	1076.6	3673.0	1115.2	3744.8	1154.7	3815.6	20
21	.3500	1039.7	3604.8	1077.2	3674.2	1115.9	3746.0	1155.4	3816.8	21
22	.3667	1040.3	3606.0	1077.8	3675.4	1116.5	3747.2	1156.0	3818.0	22
23	.3833	1041.0	3607.2	1078.5	3676.6	1117.2	3748.4	1156.7	3819.2	23
24	.4000	1041.6	3608.4	1079.1	3677.8	1117.8	3749.6	1157.4	3820.4	24
25	.4167	1042.2	3609.5	1079.8	3679.0	1118.5	3750.7	1158.1	3821.6	25
26	.4333	1042.8	3610.7	1080.4	3680.2	1119.1	3751.9	1158.7	3822.8	26
27	.4500	1043.5	3611.9	1081.1	3681.4	1119.8	3753.1	1159.4	3824.0	27
28	.4667	1044.1	3613.0	1081.7	3682.6	1120.4	3754.3	1160.1	3825.2	28
29	.4833	1044.7	3614.1	1082.4	3683.8	1121.1	3755.5	1160.8	3826.4	29
30	.5000	1045.3	3615.3	1083.0	3685.0	1121.7	3756.7	1161.4	3827.6	30
31	.5167	1045.9	3616.5	1083.6	3686.2	1122.3	3757.9	1162.1	3828.8	31
32	.5333	1046.5	3617.7	1084.2	3687.4	1123.0	3759.1	1162.8	3830.0	32
33	.5500	1047.2	3618.9	1084.9	3688.6	1123.7	3760.3	1163.5	3831.2	33
34	.5667	1047.8	3620.0	1085.5	3689.8	1124.3	3761.5	1164.1	3832.4	34
35	.5833	1048.4	3621.1	1086.2	3691.0	1125.0	3762.7	1164.8	3833.6	35
36	.6000	1049.0	3622.3	1086.8	3692.2	1125.6	3763.9	1165.5	3834.8	36
37	.6167	1049.7	3623.5	1087.5	3693.4	1126.3	3765.1	1166.2	3836.0	37
38	.6333	1050.3	3624.7	1088.1	3694.6	1126.9	3766.3	1166.8	3837.2	38
39	.6500	1050.9	3625.8	1088.8	3695.8	1127.6	3767.5	1167.5	3838.4	39
40	.6667	1051.5	3627.0	1089.4	3697.0	1128.3	3768.7	1168.2	3839.6	40
41	.6833	1052.1	3628.2	1090.0	3698.2	1129.0	3769.9	1168.9	3840.8	41
42	.7000	1052.7	3629.4	1090.6	3699.4	1129.6	3771.1	1169.5	3842.0	42
43	.7167	1053.4	3630.5	1091.3	3701.0	1130.3	3772.3	1170.2	3843.2	43
44	.7333	1054.0	3631.7	1091.9	3702.2	1130.9	3773.4	1170.9	3844.4	44
45	.7500	1054.6	3632.8	1092.6	3703.4	1131.6	3774.6	1171.6	3845.6	45
46	.7667	1055.2	3634.0	1093.2	3704.5	1132.2	3775.8	1172.2	3846.8	46
47	.7833	1055.9	3635.2	1093.9	3705.7	1132.9	3777.0	1172.9	3848.0	47
48	.8000	1056.5	3636.4	1094.5	3706.9	1133.5	3778.2	1173.6	3849.2	48
49	.8167	1057.1	3637.5	1095.2	3708.1	1134.2	3779.4	1174.3	3850.4	49
50	.8333	1057.7	3638.7	1095.8	3709.3	1134.9	3780.6	1174.9	3851.6	50
51	.8500	1058.4	3639.9	1096.4	3710.5	1135.6	3781.8	1175.6	3852.8	51
52	.8667	1059.0	3641.1	1097.0	3711.6	1136.2	3783.0	1176.3	3854.0	52
53	.8833	1059.6	3642.3	1097.7	3712.8	1136.9	3784.2	1177.0	3855.2	53
54	.9000	1060.2	3643.4	1098.3	3714.0	1137.5	3785.4	1177.6	3856.4	54
55	.9167	1060.9	3644.6	1099.0	3715.1	1138.2	3786.6	1178.3	3857.6	55
56	.9333	1061.5	3645.7	1099.6	3716.3	1138.8	3787.8	1179.0	3858.8	56
57	.9500	1062.1	3646.9	1100.3	3717.5	1139.5	3789.0	1179.7	3860.0	57
58	.9667	1062.7	3648.1	1100.9	3718.7	1140.1	3790.2	1180.3	3861.2	58
59	.9833	1063.4	3649.3	1101.6	3719.9	1140.8	3791.4	1181.0	3862.4	59

FUNCTIONS 1 DEGREE CURVE

Use 100' Chords up to 8° Curves
Use 50' Chords up to 16° Curves

Use 25' Chords up to 32° Curves
Use 10' Chords above 32° Curves

Minutes	Dec. of Degree	68°		69°		70°		71°		Minutes
		Ext.	Tan.	Ext.	Tan.	Ext.	Tan.	Ext.	Tan.	
0	.0000	1181.6	3864.0	1222.0	3938.1	1265.0	4012.1	1308.4	4087.1	0
1	.0167	1181.3	3866.1	1223.6	3939.4	1265.7	4013.4	1309.2	4088.4	1
2	.0333	1181.0	3867.3	1224.3	3940.6	1266.4	4014.6	1309.9	4089.7	2
3	.0500	1183.7	3868.5	1225.0	3941.8	1267.2	4015.9	1310.6	4091.0	3
4	.0667	1184.4	3869.7	1225.7	3943.0	1267.9	4017.1	1311.3	4092.2	4
5	.0833	1185.1	3870.9	1226.4	3944.2	1268.6	4018.4	1312.1	4093.5	5
6	.1000	1185.7	3872.2	1227.1	3945.5	1269.3	4019.6	1312.8	4094.7	6
7	.1167	1186.4	3873.4	1227.8	3946.7	1270.1	4020.8	1313.5	4096.0	7
8	.1333	1187.1	3874.6	1228.5	3947.9	1270.8	4022.1	1314.2	4097.2	8
9	.1500	1187.8	3875.8	1229.2	3949.2	1271.5	4023.4	1315.0	4098.5	9
10	.1667	1188.5	3877.0	1229.9	3950.4	1272.2	4024.6	1315.7	4099.8	10
11	.1833	1189.2	3878.2	1230.6	3951.6	1272.9	4025.8	1316.5	4101.1	11
12	.2000	1189.8	3879.5	1231.3	3952.9	1273.6	4027.1	1317.2	4102.3	12
13	.2167	1190.5	3880.7	1232.0	3954.1	1274.4	4028.4	1317.9	4103.6	13
14	.2333	1191.2	3881.9	1232.7	3955.3	1275.1	4029.6	1318.6	4104.8	14
15	.2500	1191.9	3883.1	1233.4	3956.6	1275.8	4030.8	1319.4	4106.1	15
16	.2667	1192.6	3884.3	1234.1	3957.8	1276.5	4032.1	1320.1	4107.3	16
17	.2833	1193.3	3885.6	1234.8	3959.0	1277.3	4033.4	1320.8	4108.6	17
18	.3000	1193.9	3886.8	1235.5	3960.2	1278.0	4034.6	1321.5	4109.8	18
19	.3167	1194.6	3888.0	1236.2	3961.5	1278.7	4035.9	1322.3	4111.1	19
20	.3333	1195.3	3889.2	1236.9	3962.7	1279.4	4037.1	1323.0	4112.4	20
21	.3500	1196.0	3890.4	1237.6	3964.0	1280.1	4038.4	1323.7	4113.7	21
22	.3667	1196.7	3891.6	1238.3	3965.2	1280.8	4039.6	1324.4	4114.9	22
23	.3833	1197.4	3892.9	1239.0	3966.4	1281.6	4040.9	1325.2	4116.2	23
24	.4000	1198.0	3894.1	1239.7	3967.6	1282.3	4042.1	1325.9	4117.4	24
25	.4167	1198.7	3895.3	1240.4	3968.9	1283.0	4043.4	1326.7	4118.7	25
26	.4333	1199.4	3896.5	1241.1	3970.1	1283.7	4044.6	1327.4	4119.9	26
27	.4500	1200.1	3897.7	1241.8	3971.3	1284.5	4045.9	1328.2	4121.2	27
28	.4667	1200.8	3898.9	1242.5	3972.5	1285.2	4047.1	1328.9	4122.4	28
29	.4833	1201.5	3900.2	1243.2	3973.8	1285.9	4048.4	1329.7	4123.7	29
30	.5000	1202.1	3901.4	1243.9	3975.0	1286.6	4049.6	1330.4	4125.0	30
31	.5167	1202.8	3902.6	1244.6	3976.3	1287.3	4050.9	1331.1	4126.3	31
32	.5333	1203.5	3903.8	1245.3	3977.5	1288.0	4052.1	1331.8	4127.5	32
33	.5500	1204.2	3905.0	1246.0	3978.8	1288.8	4053.4	1332.6	4128.7	33
34	.5667	1204.9	3906.3	1246.7	3980.0	1289.5	4054.6	1333.3	4130.0	34
35	.5833	1205.6	3907.5	1247.4	3981.2	1290.2	4055.9	1334.1	4131.5	35
36	.6000	1206.2	3908.7	1248.1	3982.4	1290.9	4057.1	1334.8	4132.6	36
37	.6167	1206.9	3909.9	1248.8	3983.7	1291.7	4058.4	1335.6	4133.9	37
38	.6333	1207.6	3911.2	1249.5	3984.9	1292.4	4059.6	1336.3	4135.1	38
39	.6500	1208.3	3912.4	1250.2	3986.1	1293.1	4060.9	1337.1	4136.4	39
40	.6667	1209.0	3913.6	1250.9	3987.4	1293.8	4062.1	1337.8	4137.7	40
41	.6833	1209.7	3914.9	1251.6	3988.7	1294.6	4063.4	1338.5	4139.0	41
42	.7000	1210.3	3916.1	1252.3	3990.0	1295.3	4064.6	1339.2	4140.2	42
43	.7167	1211.0	3917.3	1253.0	3991.1	1296.0	4065.9	1340.0	4141.5	43
44	.7333	1211.7	3918.5	1253.7	3992.3	1296.7	4067.1	1340.7	4142.7	44
45	.7500	1212.4	3919.8	1254.4	3993.6	1297.5	4068.4	1341.5	4144.0	45
46	.7667	1213.1	3921.0	1255.1	3994.8	1298.2	4069.6	1342.2	4145.3	46
47	.7833	1213.8	3922.2	1255.8	3996.0	1298.9	4070.9	1343.0	4146.6	47
48	.8000	1214.5	3923.4	1256.5	3997.3	1299.6	4072.1	1343.7	4147.8	48
49	.8167	1215.2	3924.7	1257.2	3998.6	1300.4	4073.4	1344.5	4149.1	49
50	.8333	1215.9	3925.9	1257.9	3999.8	1301.1	4074.6	1345.2	4150.4	50
51	.8500	1216.6	3927.1	1258.6	4001.0	1301.9	4075.9	1346.0	4151.7	51
52	.8667	1217.3	3928.3	1259.3	4002.2	1302.6	4077.1	1346.7	4152.9	52
53	.8833	1218.0	3929.6	1260.0	4003.4	1303.3	4078.4	1347.5	4154.2	53
54	.9000	1218.7	3930.8	1260.7	4004.7	1304.0	4079.6	1348.2	4155.4	54
55	.9167	1219.4	3932.0	1261.4	4006.0	1304.8	4080.9	1349.0	4156.7	55
56	.9333	1220.1	3933.2	1262.1	4007.2	1305.5	4082.1	1349.7	4158.0	56
57	.9500	1220.8	3934.4	1262.8	4008.5	1306.2	4083.4	1350.5	4159.3	57
58	.9667	1221.5	3935.7	1263.5	4009.7	1306.9	4084.6	1351.2	4160.5	58
59	.9833	1222.2	3936.9	1264.3	4010.9	1307.7	4085.9	1352.0	4161.8	59

Use 100' Chords up to 8° Curves
Use 50' Chords up to 16° Curves

Use 25' Chords up to 32° Curves
Use 10' Chords above 32° Curves

Minutes	Dec. of Degree	72°		73°		74°		75°		Minutes
		Ext.	Tan.	Ext.	Tan.	Ext.	Tan.	Ext.	Tan.	
0	.0000	1352.7	4163.1	1398.1	4240.0	1444.7	4317.8	1492.5	4396.7	0
1	.0167	1353.5	4164.4	1398.9	4241.3	1445.5	4319.2	1493.3	4398.1	1
2	.0333	1354.2	4165.6	1399.6	4242.6	1446.2	4320.5	1494.1	4399.4	2
3	.0500	1355.0	4166.9	1400.4	4243.9	1447.0	4321.8	1494.9	4400.8	3
4	.0667	1355.7	4168.2	1401.2	4245.1	1447.8	4323.1	1495.7	4402.1	4
5	.0833	1356.5	4169.5	1402.0	4246.4	1448.6	4324.4	1496.5	4403.4	5
6	.1000	1357.2	4170.7	1402.7	4247.7	1449.4	4325.7	1497.3	4404.7	6
7	.1167	1358.0	4172.0	1403.5	4249.0	1450.2	4327.0	1498.2	4406.1	7
8	.1333	1358.7	4173.3	1404.2	4250.3	1451.0	4328.3	1499.0	4407.4	8
9	.1500	1359.5	4174.5	1405.0	4251.6	1451.8	4329.6	1499.8	4408.7	9
10	.1667	1360.2	4175.8	1405.8	4252.9	1452.6	4330.9	1500.6	4410.0	10
11	.1833	1361.0	4177.1	1406.6	4254.2	1453.4	4332.3	1501.4	4411.4	11
12	.2000	1361.7	4178.4	1407.3	4255.5	1454.1	4333.6	1502.2	4412.7	12
13	.2167	1362.5	4179.7	1408.1	4256.8	1454.9	4334.9	1503.0	4414.0	13
14	.2333	1363.2	4181.0	1408.8	4258.1	1455.7	4336.2	1503.8	4415.3	14
15	.2500	1364.0	4182.3	1409.6	4259.4	1456.5	4337.5	1504.6	4416.6	15
16	.2667	1364.7	4183.5	1410.4	4260.7	1457.3	4338.8	1505.4	4418.0	16
17	.2833	1365.5	4184.8	1411.2	4262.0	1458.1	4340.1	1506.2	4419.4	17
18	.3000	1366.2	4186.1	1411.9	4263.2	1458.9	4341.4	1507.0	4420.7	18
19	.3167	1367.0	4187.4	1412.7	4264.5	1459.7	4342.7	1507.9	4422.0	19
20	.3333	1367.7	4188.6	1413.5	4265.8	1460.5	4344.0	1508.7	4423.3	20
21	.3500	1368.5	4189.9	1414.3	4267.1	1461.3	4345.4	1509.5	4424.6	21
22	.3667	1369.2	4191.2	1415.1	4268.4	1462.1	4346.7	1510.3	4426.0	22
23	.3833	1370.0	4192.5	1415.9	4269.7	1462.8	4348.0	1511.2	4427.3	23
24	.4000	1370.7	4193.7	1416.6	4271.0	1463.6	4349.3	1512.0	4428.6	24
25	.4167	1371.5	4195.0	1417.4	4272.3	1464.4	4350.6	1512.8	4430.0	25
26	.4333	1372.2	4196.3	1418.2	4273.6	1465.2	4351.9	1513.6	4431.3	26
27	.4500	1373.0	4197.6	1419.0	4274.9	1466.0	4353.2	1514.5	4432.7	27
28	.4667	1373.7	4198.8	1419.7	4276.2	1466.8	4354.5	1515.3	4434.0	28
29	.4833	1374.5	4200.1	1420.5	4277.5	1467.6	4355.8	1516.1	4435.3	29
30	.5000	1375.2	4201.4	1421.3	4278.8	1468.4	4357.1	1516.9	4436.6	30
31	.5167	1376.0	4202.7	1422.1	4280.1	1469.2	4358.5	1517.7	4438.0	31
32	.5333	1376.7	4204.0	1422.9	4281.4	1469.9	4359.8	1518.5	4439.3	32
33	.5500	1377.5	4205.3	1423.7	4282.7	1470.7	4361.1	1519.4	4440.7	33
34	.5667	1378.2	4206.5	1424.4	4284.0	1471.5	4362.4	1520.2	4442.0	34
35	.5833	1379.0	4207.8	1425.2	4285.3	1472.3	4363.8	1521.0	4443.3	35
36	.6000	1379.7	4209.1	1426.0	4286.6	1473.1	4365.1	1521.8	4444.6	36
37	.6167	1380.5	4210.4	1426.8	4287.9	1473.9	4366.4	1522.7	4446.0	37
38	.6333	1381.2	4211.7	1427.5	4289.2	1474.7	4367.7	1523.5	4447.3	38
39	.6500	1382.0	4213.0	1428.3	4290.5	1475.6	4369.0	1524.3	4448.7	39
40	.6667	1382.8	4214.3	1429.1	4291.8	1476.4	4370.3	1525.1	4450.0	40
41	.6833	1383.6	4215.6	1429.9	4293.1	1477.2	4371.7	1525.9	4451.4	41
42	.7000	1384.3	4216.8	1430.7	4294.4	1478.0	4373.0	1526.7	4452.7	42
43	.7167	1385.1	4218.1	1431.5	4295.7	1478.8	4374.3	1527.6	4454.0	43
44	.7333	1385.8	4219.4	1432.2	4297.0	1479.6	4375.6	1528.4	4455.3	44
45	.7500	1386.6	4220.7	1433.0	4298.3	1480.4	4377.0	1529.2	4456.7	45
46	.7667	1387.4	4222.0	1433.8	4299.6	1481.2	4378.3	1530.0	4458.0	46
47	.7833	1388.2	4223.3	1434.6	4300.9	1482.0	4379.6	1530.9	4459.4	47
48	.8000	1388.9	4224.5	1435.3	4302.2	1482.8	4380.9	1531.7	4460.7	48
49	.8167	1389.7	4225.8	1436.1	4303.5	1483.6	4382.2	1532.5	4462.1	49
50	.8333	1390.4	4227.1	1436.9	4304.8	1484.4	4383.5	1533.3	4463.4	50
51	.8500	1391.2	4228.4	1437.7	4306.1	1485.2	4384.9	1534.1	4464.7	51
52	.8667	1392.0	4229.7	1438.5	4307.4	1486.0	4386.2	1534.9	4466.0	52
53	.8833	1392.8	4231.0	1439.3	4308.7	1486.9	4387.5	1535.8	4467.4	53
54	.9000	1393.5	4232.3	1440.0	4310.0	1487.7	4388.8	1536.6	4468.7	54
55	.9167	1394.3	4233.6	1440.8	4311.3	1488.5	4390.2	1537.4	4470.1	55
56	.9333	1395.0	4234.8	1441.6	4312.6	1489.3	4391.5	1538.2	4471.4	56
57	.9500	1395.8	4236.1	1442.4	4313.9	1490.1	4392.8	1539.1	4472.7	57
58	.9667	1396.6	4237.4	1443.1	4315.2	1490.9	4394.1	1539.9	4474.1	58
59	.9833	1397.4	4238.7	1443.9	4316.5	1491.7	4395.4	1540.7	4475.4	59

FUNCTIONS 1 DEGREE CURVE

Use 100' Chords up to 8° Curves
Use 50' Chords up to 16° Curves

Use 25' Chords up to 32° Curves
Use 10' Chords above 32° Curves

Minutes	Dec. of Degree	76°		77°		78°		79°		Minutes
		Ext.	Tan.	Ext.	Tan.	Ext.	Tan.	Ext.	Tan.	
0	.0000	1541.5	4476.7	1591.7	4557.8	1643.1	4640.0	1606.0	4723.4	0
1	.0167	1542.4	4478.1	1592.6	4559.2	1644.0	4641.4	1606.9	4724.8	1
2	.0333	1543.2	4479.4	1593.4	4560.5	1644.8	4642.8	1607.7	4726.2	2
3	.0500	1544.1	4480.8	1594.3	4561.9	1645.7	4644.2	1608.6	4727.6	3
4	.0667	1544.9	4482.1	1595.1	4563.3	1646.6	4645.6	1609.5	4729.0	4
5	.0833	1545.7	4483.5	1596.0	4564.7	1647.5	4647.0	1700.4	4730.4	5
6	.1000	1546.5	4484.8	1596.8	4566.0	1648.3	4648.3	1701.3	4731.8	6
7	.1167	1547.4	4486.2	1597.7	4567.4	1649.2	4649.7	1702.2	4733.3	7
8	.1333	1548.2	4487.5	1598.5	4568.7	1650.1	4651.1	1703.1	4734.7	8
9	.1500	1549.1	4488.9	1599.4	4570.1	1651.0	4652.5	1704.0	4736.1	9
10	.1667	1549.9	4490.2	1600.2	4571.5	1651.8	4653.9	1704.9	4737.5	10
11	.1833	1550.7	4491.6	1601.1	4572.9	1652.7	4655.3	1705.8	4738.9	11
12	.2000	1551.5	4492.9	1601.9	4574.2	1653.6	4656.7	1706.6	4740.3	12
13	.2167	1552.4	4494.3	1602.8	4575.6	1654.5	4658.1	1707.5	4741.7	13
14	.2333	1553.2	4495.6	1603.6	4576.9	1655.3	4659.4	1708.4	4743.1	14
15	.2500	1554.1	4497.0	1604.5	4578.3	1656.2	4660.8	1709.3	4744.5	15
16	.2667	1554.9	4498.3	1605.3	4579.7	1657.1	4662.2	1710.2	4745.9	16
17	.2833	1555.7	4499.7	1606.2	4581.1	1658.0	4663.6	1711.1	4747.3	17
18	.3000	1556.5	4501.0	1607.0	4582.4	1658.8	4665.0	1712.0	4748.7	18
19	.3167	1557.4	4502.4	1607.9	4583.8	1659.7	4666.4	1712.9	4750.1	19
20	.3333	1558.2	4503.7	1608.7	4585.1	1660.6	4667.7	1713.8	4751.5	20
21	.3500	1559.0	4505.0	1609.6	4586.5	1661.5	4669.1	1714.7	4752.9	21
22	.3667	1559.9	4506.3	1610.4	4587.9	1662.3	4670.5	1715.6	4754.3	22
23	.3833	1560.7	4507.7	1611.3	4589.3	1663.2	4671.9	1716.5	4755.7	23
24	.4000	1561.5	4509.0	1612.1	4590.6	1664.1	4673.3	1717.4	4757.1	24
25	.4167	1562.4	4510.4	1613.0	4592.0	1665.0	4674.7	1718.3	4758.5	25
26	.4333	1563.2	4511.7	1613.8	4593.3	1665.8	4676.0	1719.2	4760.0	26
27	.4500	1564.1	4513.1	1614.7	4594.7	1666.7	4677.4	1720.1	4761.4	27
28	.4667	1564.9	4514.4	1615.5	4596.0	1667.6	4678.8	1721.0	4762.8	28
29	.4833	1565.7	4515.8	1616.4	4597.4	1668.5	4680.2	1721.9	4764.2	29
30	.5000	1566.5	4517.1	1617.3	4598.8	1669.3	4681.6	1722.8	4765.6	30
31	.5167	1567.4	4518.5	1618.2	4600.2	1670.2	4683.0	1723.7	4767.0	31
32	.5333	1568.2	4519.8	1619.0	4601.5	1671.1	4684.4	1724.6	4768.4	32
33	.5500	1569.1	4521.1	1619.9	4602.9	1672.0	4685.8	1725.5	4769.8	33
34	.5667	1569.9	4522.5	1620.7	4604.3	1672.8	4687.2	1726.4	4771.2	34
35	.5833	1570.7	4523.9	1621.6	4605.7	1673.7	4688.6	1727.3	4772.6	35
36	.6000	1571.5	4525.3	1622.4	4607.0	1674.6	4690.0	1728.2	4774.0	36
37	.6167	1572.4	4526.7	1623.3	4608.4	1675.5	4691.3	1729.1	4775.5	37
38	.6333	1573.2	4528.0	1624.1	4609.8	1676.3	4692.7	1730.0	4776.9	38
39	.6500	1574.0	4529.4	1625.0	4611.2	1677.3	4694.1	1731.0	4778.3	39
40	.6667	1574.8	4530.7	1625.9	4612.5	1678.2	4695.5	1731.9	4779.7	40
41	.6833	1575.6	4532.1	1626.8	4613.9	1679.1	4696.9	1732.8	4781.1	41
42	.7000	1576.4	4533.4	1627.6	4615.3	1679.9	4698.3	1733.7	4782.6	42
43	.7167	1577.3	4534.8	1628.5	4616.7	1680.8	4699.7	1734.6	4784.0	43
44	.7333	1578.1	4536.1	1629.3	4618.0	1681.7	4701.1	1735.5	4785.4	44
45	.7500	1579.0	4537.5	1630.2	4619.4	1682.6	4702.5	1736.4	4786.8	45
46	.7667	1579.8	4538.8	1631.0	4620.8	1683.5	4703.9	1737.3	4788.2	46
47	.7833	1580.7	4540.2	1631.9	4622.2	1684.4	4705.3	1738.2	4789.6	47
48	.8000	1581.5	4541.5	1632.7	4623.5	1685.3	4706.7	1739.1	4791.0	48
49	.8167	1582.4	4542.9	1633.6	4624.9	1686.2	4708.1	1740.0	4792.5	49
50	.8333	1583.2	4544.2	1634.5	4626.3	1687.1	4709.5	1740.9	4793.9	50
51	.8500	1584.1	4545.6	1635.4	4627.7	1688.0	4710.9	1741.8	4795.3	51
52	.8667	1584.9	4547.0	1636.2	4629.0	1688.8	4712.2	1742.7	4796.7	52
53	.8833	1585.8	4548.4	1637.1	4630.4	1689.7	4713.6	1743.6	4798.1	53
54	.9000	1586.6	4549.7	1637.9	4631.8	1690.6	4715.0	1744.5	4799.5	54
55	.9167	1587.5	4551.1	1638.8	4633.2	1691.5	4716.4	1745.4	4801.0	55
56	.9333	1588.3	4552.4	1639.6	4634.5	1692.4	4717.8	1746.3	4802.4	56
57	.9500	1589.2	4553.8	1640.5	4635.9	1693.3	4719.2	1747.2	4803.8	57
58	.9667	1590.0	4555.1	1641.3	4637.3	1694.2	4720.6	1748.1	4805.2	58
59	.9833	1590.9	4556.5	1642.2	4638.7	1695.1	4722.0	1749.1	4806.6	59

Use 100' Chords up to 8° Curves
Use 50' Chords up to 16° Curves

Use 25' Chords up to 32° Curves
Use 10' Chords above 32° Curves

Minutes	Dec. of Degree	80°		81°		82°		83°		Minutes
		Ext.	Tan.	Ext.	Tan.	Ext.	Tan.	Ext.	Tan.	
0	.0000	1750.0	4808.0	1805.5	4803.0	1862.3	4981.0	1920.6	5060.4	0
1	.0167	1750.9	4809.5	1806.4	4805.4	1863.3	4982.5	1921.6	5070.0	1
2	.0333	1751.8	4810.9	1807.3	4806.8	1864.2	4983.0	1922.6	5079.4	2
3	.0500	1752.8	4812.3	1808.3	4808.3	1865.2	4985.4	1923.6	5079.5	3
4	.0667	1753.7	4813.7	1809.2	4809.7	1866.1	4986.8	1924.6	5079.4	4
5	.0833	1754.6	4815.2	1810.2	4901.2	1867.1	4988.3	1925.6	5079.0	5
6	.1000	1755.5	4816.6	1811.1	4902.6	1868.1	4989.8	1926.5	5078.4	6
7	.1167	1756.5	4818.0	1812.1	4904.0	1869.1	4991.3	1927.5	5079.0	7
8	.1333	1757.4	4819.4	1813.0	4905.4	1870.0	4992.7	1928.5	5081.4	8
9	.1500	1758.3	4820.9	1814.0	4906.9	1871.0	4994.2	1929.5	5082.9	9
10	.1667	1759.2	4822.3	1814.9	4908.3	1871.9	4995.7	1930.5	5084.4	10
11	.1833	1760.1	4823.7	1815.9	4909.8	1872.9	4997.2	1931.5	5085.9	11
12	.2000	1761.0	4825.1	1816.8	4911.2	1873.9	4998.6	1932.4	5087.3	12
13	.2167	1762.0	4826.6	1817.7	4912.7	1874.9	5000.1	1933.4	5088.8	13
14	.2333	1762.9	4828.0	1818.6	4914.1	1875.8	5001.5	1934.4	5090.3	14
15	.2500	1763.8	4829.4	1819.6	4915.5	1876.8	5003.0	1935.4	5091.8	15
16	.2667	1764.7	4830.8	1820.5	4917.0	1877.7	5004.5	1936.4	5093.3	16
17	.2833	1765.7	4832.3	1821.5	4918.5	1878.7	5006.0	1937.4	5094.8	17
18	.3000	1766.6	4833.7	1822.4	4919.9	1879.7	5007.4	1938.4	5096.3	18
19	.3167	1767.5	4835.1	1823.3	4921.4	1880.7	5008.9	1939.4	5097.8	19
20	.3333	1768.4	4836.5	1824.2	4922.8	1881.6	5010.3	1940.4	5099.3	20
21	.3500	1769.3	4838.0	1825.2	4924.3	1882.6	5011.8	1941.4	5100.8	21
22	.3667	1770.2	4839.4	1826.1	4925.7	1883.5	5013.3	1942.4	5102.3	22
23	.3833	1771.2	4840.8	1827.1	4927.2	1884.5	5014.8	1943.4	5103.8	23
24	.4000	1772.1	4842.2	1828.0	4928.6	1885.5	5016.2	1944.4	5105.3	24
25	.4167	1773.0	4843.7	1829.0	4930.1	1886.5	5017.7	1945.4	5106.7	25
26	.4333	1773.9	4845.1	1829.9	4931.5	1887.4	5019.2	1946.4	5108.2	26
27	.4500	1774.9	4846.5	1830.9	4933.0	1888.4	5020.7	1947.4	5109.7	27
28	.4667	1775.8	4847.9	1831.8	4934.4	1889.3	5022.1	1948.4	5111.2	28
29	.4833	1776.7	4849.4	1832.8	4935.8	1890.3	5023.6	1949.4	5112.7	29
30	.5000	1777.6	4850.8	1833.7	4937.2	1891.3	5025.0	1950.4	5114.2	30
31	.5167	1778.5	4852.3	1834.7	4938.7	1892.3	5026.5	1951.4	5115.7	31
32	.5333	1779.4	4853.7	1835.6	4940.2	1893.2	5028.0	1952.4	5117.2	32
33	.5500	1780.4	4855.1	1836.6	4941.7	1894.2	5029.5	1953.4	5118.7	33
34	.5667	1781.3	4856.5	1837.5	4943.1	1895.1	5031.0	1954.4	5120.2	34
35	.5833	1782.2	4858.0	1838.5	4944.6	1896.1	5032.5	1955.4	5121.7	35
36	.6000	1783.1	4859.4	1839.4	4946.0	1897.1	5033.9	1956.4	5123.2	36
37	.6167	1784.1	4860.9	1840.4	4947.5	1898.1	5035.4	1957.4	5124.7	37
38	.6333	1785.0	4862.3	1841.3	4948.9	1899.0	5036.9	1958.4	5126.2	38
39	.6500	1785.9	4863.7	1842.3	4950.4	1900.0	5038.4	1959.4	5127.7	39
40	.6667	1786.8	4865.1	1843.2	4951.8	1901.0	5039.8	1960.4	5129.2	40
41	.6833	1787.7	4866.6	1844.2	4953.3	1902.0	5041.3	1961.4	5130.7	41
42	.7000	1788.6	4868.0	1845.1	4954.7	1902.9	5042.8	1962.4	5132.2	42
43	.7167	1789.6	4869.5	1846.1	4956.2	1903.9	5044.3	1963.4	5133.7	43
44	.7333	1790.5	4870.9	1847.0	4957.6	1904.9	5045.8	1964.4	5135.2	44
45	.7500	1791.5	4872.4	1848.0	4959.1	1905.9	5047.3	1965.4	5136.7	45
46	.7667	1792.4	4873.8	1848.9	4960.6	1906.9	5048.7	1966.4	5138.2	46
47	.7833	1793.4	4875.2	1849.9	4962.1	1907.9	5050.2	1967.4	5139.7	47
48	.8000	1794.3	4876.6	1850.8	4963.5	1908.8	5051.7	1968.4	5141.2	48
49	.8167	1795.3	4878.1	1851.8	4965.0	1909.8	5053.2	1969.4	5142.7	49
50	.8333	1796.2	4879.5	1852.7	4966.4	1910.8	5054.6	1970.4	5144.2	50
51	.8500	1797.1	4880.9	1853.7	4967.9	1911.8	5056.1	1971.4	5145.7	51
52	.8667	1798.0	4882.4	1854.6	4969.3	1912.8	5057.6	1972.4	5147.2	52
53	.8833	1799.0	4883.9	1855.6	4970.8	1913.8	5059.1	1973.4	5148.7	53
54	.9000	1799.9	4885.3	1856.5	4972.2	1914.7	5060.6	1974.4	5150.2	54
55	.9167	1800.9	4886.7	1857.5	4973.7	1915.7	5062.1	1975.4	5151.7	55
56	.9333	1801.8	4888.1	1858.4	4975.1	1916.7	5063.5	1976.4	5153.2	56
57	.9500	1802.8	4889.6	1859.4	4976.6	1917.7	5065.0	1977.4	5154.7	57
58	.9667	1803.7	4891.0	1860.3	4978.0	1918.7	5066.5	1978.4	5156.2	58
59	.9833	1804.6	4892.5	1861.3	4979.5	1919.7	5068.0	1979.4	5157.7	59

FUNCTIONS 1 DEGREE CURVE

Use 100' Chords up to 8° Curves
Use 50' Chords up to 16° Curves

Use 25' Chords up to 32° Curves
Use 10' Chords above 32° Curves

Minutes	Dec. of Degree	84°		85°		86°		87°		Minutes
		Ext.	Tan.	Ext.	Tan.	Ext.	Tan.	Ext.	Tan.	
0	.0000	1980.5	5159.3	2041.8	5250.6	2104.8	5343.3	2160.5	5437.5	0
1	.0167	1981.5	5160.8	2042.9	5252.1	2105.0	5344.0	2170.6	5439.1	1
2	.0333	1982.5	5162.3	2043.0	5253.6	2106.9	5346.4	2171.6	5440.7	2
3	.0500	1983.5	5163.8	2045.0	5255.2	2108.0	5348.0	2172.7	5442.3	3
4	.0667	1984.5	5165.3	2046.0	5256.7	2109.1	5349.5	2173.8	5443.9	4
5	.0833	1985.6	5166.9	2047.0	5258.3	2110.1	5351.1	2174.9	5445.5	5
6	.1000	1986.6	5168.4	2048.0	5259.8	2111.2	5352.7	2176.0	5447.1	6
7	.1167	1987.6	5169.9	2049.1	5261.4	2112.3	5354.3	2177.1	5448.7	7
8	.1333	1988.6	5171.4	2050.1	5262.9	2113.4	5355.8	2178.2	5450.3	8
9	.1500	1989.6	5172.9	2051.2	5264.5	2114.5	5357.4	2179.3	5451.9	9
10	.1667	1990.6	5174.4	2052.2	5266.0	2115.5	5358.9	2180.4	5453.4	10
11	.1833	1991.7	5175.9	2053.2	5267.5	2116.6	5360.5	2181.5	5455.0	11
12	.2000	1992.7	5177.5	2054.2	5269.0	2117.6	5362.0	2182.5	5456.6	12
13	.2167	1993.7	5179.0	2055.3	5270.6	2118.7	5363.6	2183.6	5458.2	13
14	.2333	1994.7	5180.5	2056.3	5272.1	2119.8	5365.2	2184.7	5459.8	14
15	.2500	1995.7	5182.0	2057.4	5273.7	2120.9	5366.8	2185.8	5461.4	15
16	.2667	1996.7	5183.5	2058.4	5275.2	2121.9	5368.3	2186.9	5463.0	16
17	.2833	1997.8	5185.0	2059.5	5276.8	2123.0	5369.9	2188.0	5464.6	17
18	.3000	1998.8	5186.6	2060.5	5278.3	2124.1	5371.4	2189.1	5466.2	18
19	.3167	1999.8	5188.0	2061.6	5279.9	2125.2	5373.0	2190.2	5467.8	19
20	.3333	2000.8	5189.6	2062.6	5281.4	2126.2	5374.6	2191.3	5469.4	20
21	.3500	2001.8	5191.0	2063.7	5282.9	2127.3	5376.2	2192.4	5471.0	21
22	.3667	2002.8	5192.6	2064.7	5284.4	2128.3	5377.7	2193.5	5472.5	22
23	.3833	2003.9	5194.0	2065.8	5286.0	2129.4	5379.3	2194.6	5474.1	23
24	.4000	2004.9	5195.6	2066.8	5287.5	2130.5	5380.8	2195.7	5475.7	24
25	.4167	2005.0	5197.2	2067.9	5289.1	2131.6	5382.4	2196.8	5477.3	25
26	.4333	2006.0	5198.7	2068.9	5290.6	2132.6	5383.9	2197.9	5478.9	26
27	.4500	2007.0	5200.2	2070.0	5292.2	2133.7	5385.5	2199.0	5480.5	27
28	.4667	2008.0	5201.7	2071.0	5293.7	2134.8	5387.1	2200.1	5482.1	28
29	.4833	2010.0	5203.2	2072.1	5295.2	2135.9	5388.7	2201.2	5483.7	29
30	.5000	2011.0	5204.7	2073.1	5296.7	2136.9	5390.2	2202.3	5485.3	30
31	.5167	2012.0	5206.3	2074.2	5298.3	2138.0	5391.8	2203.4	5486.9	31
32	.5333	2013.0	5207.8	2075.2	5299.8	2139.0	5393.4	2204.5	5488.5	32
33	.5500	2014.0	5209.3	2076.3	5301.4	2140.1	5395.0	2205.6	5490.1	33
34	.5667	2015.0	5210.8	2077.3	5302.9	2141.2	5396.5	2206.8	5491.7	34
35	.5833	2016.0	5212.4	2078.4	5304.5	2142.3	5398.1	2207.9	5493.3	35
36	.6000	2017.0	5213.9	2079.4	5306.1	2143.3	5399.7	2209.0	5494.9	36
37	.6167	2018.0	5215.4	2080.5	5307.7	2144.4	5401.3	2210.1	5496.5	37
38	.6333	2019.0	5216.9	2081.5	5309.2	2145.5	5402.8	2211.2	5498.1	38
39	.6500	2020.1	5218.4	2082.6	5310.8	2146.6	5404.4	2212.3	5499.7	39
40	.6667	2021.2	5220.0	2083.7	5312.3	2147.7	5406.0	2213.4	5501.3	40
41	.6833	2022.2	5221.6	2084.8	5313.9	2148.8	5407.6	2214.5	5502.9	41
42	.7000	2023.2	5223.1	2085.8	5315.4	2149.8	5409.1	2215.6	5504.5	42
43	.7167	2024.3	5224.6	2086.9	5317.0	2150.9	5410.7	2216.7	5506.1	43
44	.7333	2025.3	5226.1	2087.9	5318.5	2152.0	5412.3	2217.8	5507.7	44
45	.7500	2026.4	5227.7	2089.0	5320.1	2153.1	5413.9	2218.9	5509.3	45
46	.7667	2027.4	5229.2	2090.0	5321.6	2154.2	5415.4	2220.0	5510.9	46
47	.7833	2028.4	5230.7	2091.1	5323.2	2155.3	5417.0	2221.2	5512.5	47
48	.8000	2029.4	5232.2	2092.1	5324.7	2156.4	5418.6	2222.3	5514.1	48
49	.8167	2030.5	5233.8	2093.2	5326.3	2157.5	5420.2	2223.4	5515.7	49
50	.8333	2031.5	5235.3	2094.2	5327.8	2158.6	5421.8	2224.5	5517.3	50
51	.8500	2032.6	5236.8	2095.3	5329.4	2159.7	5423.4	2225.6	5518.9	51
52	.8667	2033.6	5238.3	2096.3	5330.9	2160.7	5424.9	2226.7	5520.5	52
53	.8833	2034.6	5239.9	2097.4	5332.5	2161.8	5426.5	2227.9	5522.1	53
54	.9000	2035.6	5241.4	2098.4	5334.0	2162.9	5428.1	2229.0	5523.7	54
55	.9167	2036.7	5243.0	2099.5	5335.6	2164.0	5429.7	2230.0	5525.3	55
56	.9333	2037.7	5244.5	2100.6	5337.1	2165.1	5431.2	2231.1	5526.9	56
57	.9500	2038.7	5246.0	2101.7	5338.7	2166.2	5432.8	2232.2	5528.5	57
58	.9667	2039.8	5247.5	2102.7	5340.2	2167.3	5434.4	2233.3	5530.1	58
59	.9833	2040.8	5249.1	2103.8	5341.8	2168.4	5436.0	2234.4	5531.7	59

Use 100' Chords up to 8° Curves
Use 50' Chords up to 16° CurvesUse 25' Chords up to 32° Curves
Use 16' Chords above 32° Curves

Minutes	Dec. of Degree	8°		8 1/2°		9°		9 1/2°		Minutes
		Ext.	Tan.	Ext.	Tan.	Ext.	Tan.	Ext.	Tan.	
0	.0000	2235.6	5533.3	2303.6	5630.8	2373.4	5730.0	2445.1	5830.0	0
1	.0167	2236.7	5535.0	2304.7	5632.5	2374.6	5731.7	2446.3	5832.6	1
2	.0333	2237.8	5536.6	2305.0	5634.1	2375.8	5733.3	2447.5	5834.3	2
3	.0500	2238.9	5538.2	2307.2	5635.8	2377.0	5735.0	2448.8	5836.0	3
4	.0667	2240.1	5539.8	2308.1	5637.4	2378.2	5736.7	2450.0	5837.7	4
5	.0833	2241.2	5541.5	2309.4	5639.1	2379.4	5738.4	2451.2	5839.4	5
6	.1000	2242.3	5543.1	2310.5	5640.7	2380.5	5740.0	2452.4	5841.1	6
7	.1167	2243.5	5544.7	2311.6	5642.4	2381.7	5741.7	2453.6	5842.8	7
8	.1333	2244.6	5546.3	2312.8	5644.0	2382.9	5743.4	2454.8	5844.5	8
9	.1500	2245.7	5547.9	2314.0	5645.7	2384.1	5745.1	2456.0	5846.2	9
10	.1667	2246.8	5549.5	2315.1	5647.3	2385.3	5746.7	2457.2	5847.9	10
11	.1833	2248.0	5551.2	2316.3	5649.0	2386.4	5748.4	2458.5	5849.6	11
12	.2000	2249.1	5552.8	2317.4	5650.6	2387.6	5750.0	2459.7	5851.3	12
13	.2167	2250.2	5554.4	2318.6	5652.3	2388.8	5751.7	2460.9	5853.0	13
14	.2333	2251.3	5556.0	2319.7	5653.9	2390.0	5753.4	2462.1	5854.7	14
15	.2500	2252.5	5557.6	2320.9	5655.5	2391.2	5755.1	2463.3	5856.4	15
16	.2667	2253.6	5559.2	2322.0	5657.1	2392.4	5756.7	2464.5	5858.1	16
17	.2833	2254.7	5560.9	2323.2	5658.8	2393.5	5758.4	2465.8	5859.8	17
18	.3000	2255.8	5562.5	2324.3	5660.4	2394.7	5760.1	2467.0	5861.5	18
19	.3167	2257.0	5564.1	2325.6	5662.1	2395.9	5761.8	2468.2	5863.2	19
20	.3333	2258.1	5565.7	2326.7	5663.7	2397.1	5763.4	2469.4	5864.9	20
21	.3500	2259.3	5567.3	2327.9	5665.4	2398.3	5765.1	2470.6	5866.6	21
22	.3667	2260.4	5568.9	2329.0	5667.0	2399.5	5766.8	2471.9	5868.3	22
23	.3833	2261.5	5570.6	2330.1	5668.7	2400.7	5768.5	2473.1	5870.1	23
24	.4000	2262.7	5572.2	2331.3	5670.3	2401.9	5770.1	2474.3	5871.8	24
25	.4167	2263.8	5573.8	2332.5	5672.0	2403.1	5771.8	2475.5	5873.5	25
26	.4333	2264.9	5575.4	2333.7	5673.6	2404.3	5773.5	2476.7	5875.2	26
27	.4500	2266.0	5577.0	2334.8	5675.3	2405.5	5775.2	2478.0	5876.9	27
28	.4667	2267.2	5578.6	2336.0	5676.9	2406.6	5776.9	2479.2	5878.6	28
29	.4833	2268.4	5580.3	2337.1	5678.6	2407.8	5778.6	2480.4	5880.3	29
30	.5000	2269.5	5581.9	2338.3	5680.2	2409.0	5780.2	2481.6	5882.0	30
31	.5167	2270.6	5583.5	2339.5	5681.9	2410.2	5781.9	2482.9	5883.7	31
32	.5333	2271.7	5585.1	2340.7	5683.5	2411.4	5783.6	2484.1	5885.4	32
33	.5500	2272.8	5586.8	2341.9	5685.2	2412.6	5785.3	2485.3	5887.2	33
34	.5667	2273.9	5588.4	2343.0	5686.8	2413.8	5787.0	2486.5	5888.9	34
35	.5833	2275.1	5590.1	2344.1	5688.5	2415.0	5788.7	2487.8	5890.6	35
36	.6000	2276.2	5591.7	2345.3	5690.2	2416.2	5790.3	2489.0	5892.3	36
37	.6167	2277.3	5593.3	2346.5	5691.9	2417.4	5792.0	2490.3	5894.0	37
38	.6333	2278.5	5594.9	2347.7	5693.5	2418.6	5793.7	2491.5	5895.7	38
39	.6500	2279.7	5596.6	2348.9	5695.2	2419.8	5795.4	2492.7	5897.5	39
40	.6667	2280.8	5598.2	2350.0	5696.8	2421.0	5797.1	2493.9	5899.2	40
41	.6833	2282.0	5599.8	2351.2	5698.5	2422.2	5798.8	2495.2	5900.9	41
42	.7000	2283.0	5601.4	2352.3	5700.1	2423.4	5800.4	2496.4	5902.6	42
43	.7167	2284.1	5603.1	2353.5	5701.8	2424.6	5802.1	2497.7	5904.3	43
44	.7333	2285.3	5604.7	2354.7	5703.4	2425.8	5803.8	2498.9	5906.0	44
45	.7500	2286.5	5606.4	2355.8	5705.1	2427.0	5805.5	2500.1	5907.7	45
46	.7667	2287.6	5608.0	2357.0	5706.8	2428.2	5807.2	2501.3	5909.4	46
47	.7833	2288.7	5609.6	2358.1	5708.5	2429.4	5808.9	2502.6	5911.2	47
48	.8000	2289.9	5611.2	2359.3	5710.2	2430.6	5810.6	2503.8	5912.9	48
49	.8167	2291.1	5612.9	2360.5	5711.8	2431.8	5812.3	2505.1	5914.6	49
50	.8333	2292.2	5614.5	2361.7	5713.4	2433.0	5814.0	2506.3	5916.3	50
51	.8500	2293.3	5616.2	2362.9	5715.1	2434.2	5815.7	2507.5	5918.1	51
52	.8667	2294.4	5617.8	2364.0	5716.7	2435.4	5817.4	2508.7	5919.8	52
53	.8833	2295.6	5619.4	2365.1	5718.4	2436.6	5819.0	2510.0	5921.5	53
54	.9000	2296.7	5621.0	2366.3	5720.0	2437.9	5820.7	2511.2	5923.2	54
55	.9167	2297.9	5622.7	2367.5	5721.7	2439.1	5822.4	2512.5	5925.0	55
56	.9333	2299.0	5624.3	2368.7	5723.4	2440.3	5824.1	2513.7	5926.7	56
57	.9500	2300.2	5625.9	2369.9	5725.0	2441.5	5825.8	2515.0	5928.4	57
58	.9667	2301.3	5627.5	2371.0	5726.7	2442.7	5827.5	2516.2	5930.1	58
59	.9833	2302.4	5629.2	2372.2	5728.4	2443.9	5829.2	2517.5	5931.9	59

FUNCTIONS 1 DEGREE CURVE

Use 100' Chords up to 8° Curves
Use 50' Chords up to 16° Curves

Use 25' Chords up to 32° Curves
Use 10' Chords above 32° Curves

Minutes	Dec. of Degree	92°		93°		94°		95°		Minutes
		Ext.	Tan.	Ext.	Tan.	Ext.	Tan.	Ext.	Tan.	
0	.0000	2518.7	5033.6	2504.2	6038.2	2671.8	6144.7	2751.5	6253.2	0
1	.0167	2520.0	5035.3	2505.5	6040.0	2673.1	6146.5	2752.9	6255.1	1
2	.0333	2521.2	5037.0	2506.8	6041.7	2674.4	6148.3	2754.2	6256.9	2
3	.0500	2522.4	5038.8	2508.1	6043.5	2675.7	6150.1	2755.6	6258.7	3
4	.0667	2523.6	5040.5	2509.3	6045.2	2677.0	6151.9	2756.9	6260.5	4
5	.0833	2524.9	5042.3	2600.6	6047.0	2678.4	6153.7	2758.3	6262.4	5
6	.1000	2526.1	5044.0	2601.9	6048.7	2679.7	6155.4	2759.6	6264.2	6
7	.1167	2527.4	5045.7	2603.2	6050.5	2681.0	6157.2	2761.0	6266.0	7
8	.1333	2528.6	5047.4	2604.4	6052.2	2682.3	6158.9	2762.3	6267.8	8
9	.1500	2529.9	5049.2	2605.7	6054.0	2683.6	6160.8	2763.7	6269.7	9
10	.1667	2531.1	5050.9	2607.0	6055.8	2684.9	6162.6	2765.0	6271.5	10
11	.1833	2532.4	5052.7	2608.3	6057.5	2686.3	6164.4	2766.4	6273.4	11
12	.2000	2533.6	5054.4	2609.6	6059.3	2687.6	6166.2	2767.7	6275.2	12
13	.2167	2534.9	5056.1	2610.9	6061.1	2688.9	6168.0	2769.1	6277.0	13
14	.2333	2536.1	5057.8	2612.1	6062.8	2690.2	6169.8	2770.4	6278.8	14
15	.2500	2537.4	5059.6	2613.4	6064.6	2691.5	6171.6	2771.8	6280.7	15
16	.2667	2538.6	5061.3	2614.7	6066.4	2692.8	6173.4	2773.1	6282.5	16
17	.2833	2539.9	5063.1	2616.0	6068.2	2694.2	6175.2	2774.5	6284.4	17
18	.3000	2541.1	5064.8	2617.3	6069.9	2695.6	6177.0	2775.8	6286.2	18
19	.3167	2542.4	5066.5	2618.6	6071.7	2696.9	6178.8	2777.2	6288.0	19
20	.3333	2543.6	5068.2	2619.8	6073.4	2698.1	6180.6	2778.5	6289.8	20
21	.3500	2544.9	5070.0	2621.1	6075.2	2699.5	6182.4	2779.9	6291.7	21
22	.3667	2546.1	5071.7	2622.4	6077.0	2700.8	6184.2	2781.2	6293.5	22
23	.3833	2547.4	5073.5	2623.7	6078.8	2702.1	6186.0	2782.6	6295.4	23
24	.4000	2548.6	5075.2	2625.0	6080.5	2703.4	6187.8	2784.0	6297.2	24
25	.4167	2549.9	5077.0	2626.3	6082.3	2704.8	6189.7	2785.4	6299.1	25
26	.4333	2551.2	5078.7	2627.6	6084.1	2706.1	6191.5	2786.7	6300.9	26
27	.4500	2552.5	5080.5	2628.9	6085.9	2707.4	6193.3	2788.1	6302.7	27
28	.4667	2553.7	5082.2	2630.2	6087.6	2708.7	6195.1	2789.4	6304.6	28
29	.4833	2555.0	5083.9	2631.5	6089.4	2710.1	6196.9	2790.8	6306.4	29
30	.5000	2556.2	5085.6	2632.7	6091.2	2711.4	6198.7	2792.1	6308.2	30
31	.5167	2557.5	5087.4	2634.0	6093.0	2712.7	6200.5	2793.5	6310.1	31
32	.5333	2558.7	5089.1	2635.3	6094.7	2714.0	6202.3	2794.9	6311.9	32
33	.5500	2560.0	5090.9	2636.6	6096.5	2715.4	6204.1	2796.3	6313.8	33
34	.5667	2561.2	5092.6	2637.9	6098.3	2716.7	6205.9	2797.6	6315.6	34
35	.5833	2562.5	5094.4	2639.2	6100.1	2718.0	6207.7	2799.0	6317.5	35
36	.6000	2563.8	5096.1	2640.5	6101.8	2719.3	6209.5	2800.3	6319.3	36
37	.6167	2565.1	5097.9	2641.8	6103.6	2720.7	6211.4	2801.7	6321.2	37
38	.6333	2566.3	5099.6	2643.1	6105.4	2722.0	6213.2	2803.1	6323.0	38
39	.6500	2567.6	6001.4	2644.4	6107.2	2723.4	6215.0	2804.5	6324.9	39
40	.6667	2568.8	6003.1	2645.7	6109.0	2724.7	6216.8	2805.8	6326.7	40
41	.6833	2570.1	6004.9	2647.0	6110.8	2726.0	6218.6	2807.2	6328.6	41
42	.7000	2571.3	6006.6	2648.3	6112.5	2727.3	6220.4	2808.6	6330.4	42
43	.7167	2572.6	6008.4	2649.6	6114.3	2728.7	6222.3	2810.0	6332.3	43
44	.7333	2573.9	6010.1	2650.9	6116.1	2730.0	6224.1	2811.3	6334.1	44
45	.7500	2575.2	6011.9	2652.2	6117.9	2731.4	6225.9	2812.7	6336.0	45
46	.7667	2576.4	6013.6	2653.5	6119.7	2732.7	6227.7	2814.1	6337.8	46
47	.7833	2577.7	6015.4	2654.8	6121.5	2734.1	6229.5	2815.5	6339.7	47
48	.8000	2578.9	6017.1	2656.1	6123.2	2735.4	6231.3	2816.8	6341.5	48
49	.8167	2580.2	6018.9	2657.4	6125.0	2736.7	6233.1	2818.2	6343.4	49
50	.8333	2581.5	6020.6	2658.7	6126.8	2738.0	6235.0	2819.6	6345.2	50
51	.8500	2582.8	6022.4	2660.0	6128.6	2739.4	6236.8	2821.0	6347.1	51
52	.8667	2584.0	6024.1	2661.3	6130.4	2740.7	6238.6	2822.3	6349.0	52
53	.8833	2585.3	6025.9	2662.6	6132.2	2742.1	6240.5	2823.7	6350.9	53
54	.9000	2586.6	6027.6	2663.9	6133.9	2743.4	6242.3	2825.1	6352.7	54
55	.9167	2587.9	6029.4	2665.3	6135.7	2744.8	6244.2	2826.5	6354.6	55
56	.9333	2589.1	6031.1	2666.6	6137.5	2746.1	6246.0	2827.8	6356.4	56
57	.9500	2590.4	6032.9	2667.9	6139.3	2747.5	6247.8	2829.2	6358.3	57
58	.9667	2591.7	6034.6	2669.2	6141.1	2748.8	6249.6	2830.6	6360.1	58
59	.9833	2593.0	6036.4	2670.5	6142.9	2750.2	6251.4	2832.0	6362.0	59

Use 100' Chords up to 8° Curves
Use 50' Chords up to 16° Curves

Use 25' Chords up to 32° Curves
Use 10' Chords above 32° Curves

Minutes	Dec. of Degree	96°		97°		98°		99°		Minutes
		Ext.	Tan.	Ext.	Tan.	Ext.	Tan.	Ext.	Tan.	
0	.0000	2833.4	6363.8	2917.5	6476.6	3004.0	6591.6	3092.9	6709.0	0
1	.0167	2834.8	6365.7	2918.9	6478.5	3005.5	6593.6	3094.4	6711.0	1
2	.0333	2836.1	6367.5	2920.3	6480.4	3006.9	6595.5	3095.9	6712.9	2
3	.0500	2837.5	6369.4	2921.8	6482.3	3008.4	6597.5	3097.4	6714.9	3
4	.0667	2838.9	6371.3	2923.2	6484.2	3009.8	6599.4	3098.9	6716.9	4
5	.0833	2840.3	6373.2	2924.6	6486.1	3011.3	6601.3	3100.4	6718.9	5
6	.1000	2841.7	6375.0	2926.0	6488.0	3012.8	6603.2	3101.9	6720.8	6
7	.1167	2843.1	6376.9	2927.5	6490.0	3014.3	6605.2	3103.4	6722.8	7
8	.1333	2844.5	6378.7	2928.9	6491.8	3015.7	6607.1	3104.9	6724.8	8
9	.1500	2845.9	6380.6	2930.3	6493.7	3017.2	6609.1	3106.4	6726.8	9
10	.1667	2847.2	6382.5	2931.7	6495.6	3018.6	6611.0	3107.9	6728.8	10
11	.1833	2848.6	6384.4	2933.2	6497.5	3020.1	6613.0	3109.5	6730.8	11
12	.2000	2850.0	6386.2	2934.6	6499.4	3021.6	6614.9	3111.0	6732.7	12
13	.2167	2851.4	6388.1	2936.1	6501.3	3023.1	6616.9	3112.5	6734.7	13
14	.2333	2852.8	6389.9	2937.5	6503.2	3024.5	6618.8	3114.0	6736.7	14
15	.2500	2854.2	6391.8	2938.9	6505.2	3026.0	6620.8	3115.5	6738.7	15
16	.2667	2855.6	6393.7	2940.3	6507.1	3027.5	6622.7	3117.0	6740.7	16
17	.2833	2857.0	6395.6	2941.8	6509.0	3029.0	6624.7	3118.5	6742.7	17
18	.3000	2858.4	6397.4	2943.2	6510.9	3030.4	6626.6	3120.0	6744.6	18
19	.3167	2859.8	6399.3	2944.7	6512.8	3031.9	6628.6	3121.5	6746.6	19
20	.3333	2861.2	6401.2	2946.1	6514.7	3033.3	6630.5	3123.1	6748.6	20
21	.3500	2862.6	6403.1	2947.5	6516.6	3034.8	6632.5	3124.6	6750.6	21
22	.3667	2864.0	6404.9	2948.9	6518.5	3036.3	6634.4	3126.1	6752.6	22
23	.3833	2865.4	6406.8	2950.4	6520.4	3037.8	6636.4	3127.6	6754.6	23
24	.4000	2866.7	6408.7	2951.8	6522.3	3039.3	6638.3	3129.1	6756.6	24
25	.4167	2868.1	6410.6	2953.3	6524.3	3040.8	6640.3	3130.7	6758.6	25
26	.4333	2869.5	6412.4	2954.7	6526.2	3042.2	6642.2	3132.2	6760.6	26
27	.4500	2870.9	6414.3	2956.2	6528.1	3043.7	6644.2	3133.7	6762.6	27
28	.4667	2872.3	6416.2	2957.6	6530.0	3045.2	6646.1	3135.2	6764.6	28
29	.4833	2873.7	6418.1	2959.0	6531.9	3046.7	6648.1	3136.7	6766.6	29
30	.5000	2875.1	6419.9	2960.4	6533.8	3048.1	6650.0	3138.3	6768.6	30
31	.5167	2876.5	6421.8	2961.9	6535.8	3049.6	6652.0	3139.8	6770.6	31
32	.5333	2877.9	6423.7	2963.3	6537.7	3051.1	6653.9	3141.3	6772.6	32
33	.5500	2879.4	6425.6	2964.8	6539.6	3052.6	6655.9	3142.9	6774.6	33
34	.5667	2880.8	6427.5	2966.2	6541.5	3054.1	6657.8	3144.4	6776.6	34
35	.5833	2882.2	6429.4	2967.7	6543.4	3055.6	6659.8	3145.9	6778.6	35
36	.6000	2883.6	6431.2	2969.1	6545.3	3057.0	6661.7	3147.4	6780.6	36
37	.6167	2885.0	6433.1	2970.6	6547.3	3058.5	6663.7	3149.0	6782.6	37
38	.6333	2886.4	6435.0	2972.0	6549.2	3060.0	6665.7	3150.5	6784.6	38
39	.6500	2887.8	6436.9	2973.5	6551.1	3061.5	6667.7	3152.0	6786.6	39
40	.6667	2889.2	6438.8	2974.9	6553.0	3063.0	6669.6	3153.5	6788.6	40
41	.6833	2890.6	6440.7	2976.4	6555.0	3064.5	6671.6	3155.1	6790.6	41
42	.7000	2892.0	6442.5	2977.8	6556.9	3066.0	6673.5	3156.6	6792.6	42
43	.7167	2893.4	6444.4	2979.3	6558.8	3067.5	6675.5	3158.2	6794.6	43
44	.7333	2894.8	6446.3	2980.7	6560.7	3068.9	6677.4	3159.7	6796.6	44
45	.7500	2896.3	6448.2	2982.2	6562.7	3070.4	6679.4	3161.2	6798.6	45
46	.7667	2897.7	6450.1	2983.6	6564.6	3071.9	6681.4	3162.7	6800.6	46
47	.7833	2899.1	6452.0	2985.1	6566.5	3073.4	6683.4	3164.3	6802.6	47
48	.8000	2900.5	6453.9	2986.5	6568.4	3074.9	6685.3	3165.8	6804.6	48
49	.8167	2901.9	6455.8	2988.0	6570.4	3076.4	6687.3	3167.4	6806.6	49
50	.8333	2903.3	6457.6	2989.4	6572.3	3077.9	6689.2	3168.9	6808.6	50
51	.8500	2904.7	6459.5	2990.9	6574.3	3079.4	6691.2	3170.5	6810.6	51
52	.8667	2906.1	6461.4	2992.3	6576.2	3080.9	6693.2	3172.0	6812.6	52
53	.8833	2907.5	6463.3	2993.8	6578.1	3082.4	6695.2	3173.6	6814.6	53
54	.9000	2909.0	6465.2	2995.2	6580.0	3083.9	6697.1	3175.1	6816.6	54
55	.9167	2910.4	6467.1	2996.7	6581.9	3085.4	6699.1	3176.6	6818.6	55
56	.9333	2911.8	6469.0	2998.1	6583.9	3086.9	6701.1	3178.1	6820.6	56
57	.9500	2913.3	6470.9	2999.6	6585.8	3088.4	6703.1	3179.7	6822.6	57
58	.9667	2914.7	6472.8	3001.1	6587.7	3089.9	6705.2	3181.2	6824.6	58
59	.9833	2916.1	6474.7	3002.6	6589.7	3091.4	6707.2	3182.8	6826.6	59

Use 100' Chords up to 8° Curves
Use 50' Chords up to 16° Curves

Use 25' Chords up to 32° Curves
Use 10' Chords above 32° Curves

Minutes	Dec. of Degree	100°		Minutes
		Ext.	Tan.	
0	.0000	3184.3	6828.8	0
1	.0167	3185.9	6830.8	1
2	.0333	3187.4	6832.8	2
3	.0500	3189.0	6834.8	3
4	.0667	3190.5	6836.8	4
5	.0833	3192.1	6838.9	5
6	.1000	3193.6	6840.9	6
7	.1167	3195.2	6842.9	7
8	.1333	3196.7	6844.9	8
9	.1500	3198.3	6847.0	9
10	.1667	3199.8	6849.0	10
11	.1833	3201.4	6851.0	11
12	.2000	3202.9	6853.0	12
13	.2167	3204.5	6855.1	13
14	.2333	3206.0	6857.1	14
15	.2500	3207.6	6859.1	15
16	.2667	3209.1	6861.1	16
17	.2833	3210.7	6863.2	17
18	.3000	3212.2	6865.2	18
19	.3167	3213.8	6867.2	19
20	.3333	3215.4	6869.2	20
21	.3500	3217.0	6871.3	21
22	.3667	3218.5	6873.3	22
23	.3833	3220.1	6875.4	23
24	.4000	3221.6	6877.4	24
25	.4167	3223.2	6879.4	25
26	.4333	3224.7	6881.4	26
27	.4500	3226.3	6883.5	27
28	.4667	3227.9	6885.5	28
29	.4833	3229.5	6887.6	29
30	.5000	3231.0	6889.6	30
31	.5167	3232.6	6891.7	31
32	.5333	3234.1	6893.7	32
33	.5500	3235.7	6895.7	33
34	.5667	3237.3	6897.8	34
35	.5833	3238.9	6899.8	35
36	.6000	3240.4	6901.8	36
37	.6167	3242.0	6903.9	37
38	.6333	3243.5	6905.9	38
39	.6500	3245.1	6908.0	39
40	.6667	3246.7	6910.0	40
41	.6833	3248.3	6912.1	41
42	.7000	3249.8	6914.1	42
43	.7167	3251.4	6916.2	43
44	.7333	3253.0	6918.2	44
45	.7500	3254.6	6920.3	45
46	.7667	3256.2	6922.3	46
47	.7833	3257.8	6924.4	47
48	.8000	3259.3	6926.4	48
49	.8167	3260.9	6928.5	49
50	.8333	3262.5	6930.5	50
51	.8500	3264.1	6932.6	51
52	.8667	3265.7	6934.6	52
53	.8833	3267.3	6936.7	53
54	.9000	3268.8	6938.7	54
55	.9167	3270.4	6940.8	55
56	.9333	3272.0	6942.8	56
57	.9500	3273.6	6944.9	57
58	.9667	3275.2	6946.9	58
59	.9833	3276.8	6949.0	59

SURVEY DATA

Use 100' Chords up to 8° Curves
Use 50' Chords up to 16° Curves

Use 25' Chords up to 32° Curves
Use 10' Chords above 32° Curves

Minutes	101°		102°		103°		104°		105°		Minutes
	Ext.	Tan.	Ext.	Tan.	Ext.	Tan.	Ext.	Tan.	Ext.	Tan.	
0	3278.3	6951.0	3375.1	7076.0	3474.6	7203.6	3577.1	7334.1	3682.6	7467.5	0
10	3294.3	6971.7	3391.5	7097.1	3491.5	7225.1	3594.4	7356.1	3700.4	7490.0	10
20	3310.3	6992.4	3407.9	7118.2	3508.4	7246.8	3611.9	7378.2	3718.4	7512.6	20
30	3326.4	7013.2	3424.5	7139.4	3525.5	7268.5	3629.4	7400.4	3736.5	7535.3	30
40	3342.5	7034.0	3441.1	7160.7	3542.6	7290.3	3647.1	7422.7	3754.6	7558.1	40
50	3358.8	7055.0	3457.8	7182.1	3559.8	7312.1	3664.8	7445.0	3772.9	7581.0	50
60	3375.1	7076.0	3474.6	7203.6	3577.1	7334.1	3682.6	7467.5	3791.2	7604.0	60
Minutes	106°		107°		108°		109°		110°		Minutes
	Ext.	Tan.	Ext.	Tan.	Ext.	Tan.	Ext.	Tan.	Ext.	Tan.	
0	3791.2	7604.0	3903.1	7743.7	4018.5	7886.7	4137.4	8033.2	4260.0	8183.3	0
10	3806.6	7627.0	3922.1	7767.3	4038.0	7910.8	4157.5	8057.0	4280.8	8208.7	10
20	3822.1	7650.2	3941.2	7791.0	4057.7	7935.1	4177.8	8082.8	4301.7	8234.2	20
30	3846.7	7673.4	3960.4	7814.7	4077.5	7959.5	4198.2	8107.8	4322.7	8259.8	30
40	3865.4	7696.7	3979.6	7838.6	4097.3	7983.0	4218.7	8132.8	4343.8	8285.5	40
50	3884.2	7720.1	3999.0	7862.6	4117.3	8008.5	4239.3	8158.0	4365.1	8311.3	50
60	3903.1	7743.7	4018.5	7886.7	4137.4	8033.2	4260.0	8183.3	4386.4	8337.2	60
Minutes	111°		112°		113°		114°		115°		Minutes
	Ext.	Tan.	Ext.	Tan.	Ext.	Tan.	Ext.	Tan.	Ext.	Tan.	
0	4386.4	8337.2	4516.9	8495.1	4651.6	8657.1	4790.7	8823.4	4934.4	8994.3	0
10	4407.9	8363.2	4539.1	8521.8	4674.5	8684.5	4814.4	8851.6	4958.9	9023.2	10
20	4429.5	8389.4	4561.3	8548.6	4697.5	8712.0	4838.1	8879.0	4983.4	9052.3	20
30	4451.2	8415.6	4583.7	8575.6	4720.6	8739.7	4862.0	8908.3	5008.1	9081.5	30
40	4473.0	8442.0	4606.2	8602.6	4743.9	8767.5	4885.0	8936.8	5032.9	9110.8	40
50	4494.9	8468.5	4628.9	8629.8	4767.2	8795.4	4910.2	8965.5	5057.9	9140.3	50
60	4516.9	8495.1	4651.6	8657.1	4790.7	8823.4	4934.4	8994.3	5083.0	9169.9	60
Minutes	116°		117°		118°		119°		120°		Minutes
	Ext.	Tan.	Ext.	Tan.	Ext.	Tan.	Ext.	Tan.	Ext.	Tan.	
0	5083.0	9160.2	5236.6	9350.5	5395.4	9536.3	5559.7	9727.6	5730.0	9924.6	0
10	5108.2	9190.7	5262.6	9381.1	5422.4	9567.8	5587.7	9760.0	5758.0	9958.1	10
20	5133.6	9220.6	5288.0	9411.0	5449.5	9599.5	5613.8	9792.6	5788.0	9990.6	20
30	5159.1	9250.0	5313.3	9441.3	5476.8	9631.3	5644.1	9825.4	5817.3	10025.0	30
40	5184.8	9280.0	5341.8	9473.8	5504.3	9663.2	5672.6	9858.3	5848.8	10059.7	40
50	5210.6	9310.1	5368.5	9507.2	5532.0	9695.3	5702.2	9891.4	5876.4	10093.7	50
60	5236.6	9350.5	5395.4	9536.3	5559.7	9727.6	5730.0	9924.6	5906.1	10127.7	60

$$L = 100 \times \frac{\Delta}{D} = \frac{\text{Central angle}}{\text{Degree of curvature}} \times 100.$$

For the convenience of the field engineer column 1, Table 139, gives the central angle Δ in degrees and minutes (as read by the transit); column 2 gives the same angle expressed in degrees and decimals for figuring curve lengths.

Tangent Length and Externals.—Figure 278 shows a general curve problem. The deflection angle between the tangents at the point of intersection (P. I.) = the central angle of the curve that will fit these tangents; it is referred to as Δ .

The tangent distances equal the distance from the P. C. (beginning of curve) to the P. I. or P. I. to P. T. (end of curve) and are expressed by the formula

$$T = \text{Radius} \times \text{tangent of } \frac{\Delta}{2} \tag{4}$$

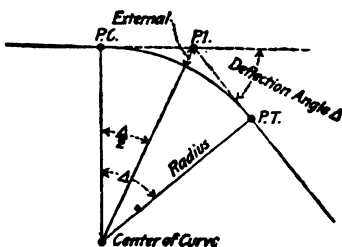

FIG. 278.

Therefore, for a given central angle Δ , the tangent length is directly proportional to the radius. If the tangent lengths of a 1° curve for different Δ 's are tabulated, the tangent length for any desired degree of curve equals tangent length for 1° curve for the specified Δ divided by the degree of the desired curve expressed in degrees and decimals of a degree.

Expressed as a formula this reads:

$$\text{Tangent for desired curve} = \frac{\text{Tangent } 1^\circ \text{ curve for specified } \Delta}{D} \tag{5}$$

and reversing the formula the desired degree of curve for a specified tangent length can be determined by the formula

$$D = \frac{\text{Tangent } 1^\circ \text{ curve for specified } \Delta}{\text{Specified tangent length desired}} \tag{6}$$

The external is the distance from the P. I. to the curve arc on the line between the P. I. and the center of the curve. It is determined by the formula:

$$\text{External} = \frac{\text{Radius}}{\text{Cos } \frac{\Delta}{2}} - \text{Radius} = \text{Radius} \left(\frac{1}{\text{Cos } \frac{\Delta}{2}} - 1 \right) \tag{7}$$

and is directly proportional to the radius in the same manner as the tangent length; therefore, the external of any desired curve for a specified Δ equals the external of a 1° curve for that Δ divided by the degree of curvature.

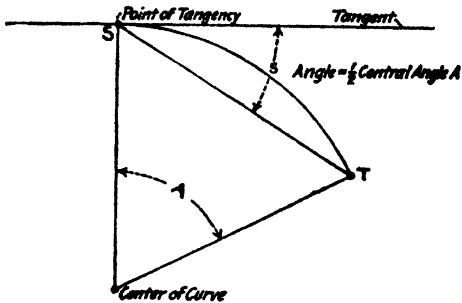

FIG. 279.

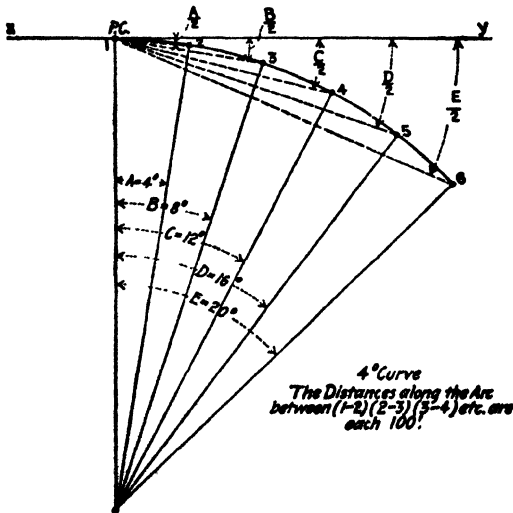

FIG. 280.

Expressed as a formula this reads:

$$\text{External for desired curve} = \frac{\text{External } 1^\circ \text{ curve for specified } \Delta}{D} \quad (8)$$

and reversing, as for tangents, the desired degree of curvature is obtained that gives a specified external distance, by the formula,

$$D = \frac{\text{External } 1^\circ \text{ curve for specified } \Delta}{\text{Specified external distance desired}} \quad (9)$$

Methods of Running Curves.—Curves are run in the field by tangent offsets, middle ordinates, or deflection angles. Deflection angles is the simplest method and is almost universally used. It is based on the principle that the angle S between the tangent and arc chord, one end of which is at the point of tangency, is equal to one-half the central angle subtended by that chord. Suppose the angle A is 4° and the arc length $ST = 100'$. This curve would then be a 4° curve. From the previous definitions locate the point T (Fig. 279) by turning the deflection angle $S = 2^\circ$ from the tangent and measuring $100'$ of arc in such a position that the end of the arc would be on the line of the chord ST . It is impossible to measure the arc distance conveniently and for all practical purposes a chord length of $100'$ will answer for a 4° curve (see discussion, p. 855).

Suppose it is desired to locate the points 2, 3, 4, 5, and 6 on the 4° curve from point 1 or the P.C. of a curve (Fig. 280).

Set the transit at the P.C.; if a deflection $\frac{A}{2} = 2^\circ$ from the tangent xy is turned the line of sight will pass through the point 2; if $\frac{B}{2} = 4^\circ$ is turned the line of sight will pass through point 3; 6° , point 4, etc.; it only remains to measure to these points to locate them definitely. This can be done in two ways, by measuring the distances 1-2, 1-3, 1-4, 1-5, etc., or by measuring 1-2, 2-3, 3-4, 4-5, etc.

In the first case the difference between the length of arc and the chord length becomes so great that, unless a correction is made, the points are not exactly located; that is, the length of arc between points 1, 2, 3, 4, 5, 6, = $500'$ while the chord length 1-6 = $497.5'$; also, it takes longer to measure the distances 1-2, 1-3, 1-4, 1-5, 1-6, etc., than it would 1-2, 2-3, 3-4, 4-5, etc.

In the second method we can use chords of $100'$ from 1-2, 2-3, etc., with no appreciable error, as the distance measured by chords 1, 2, 3, 4, 5, 6, = $499.94'$.

Therefore, the method usually adopted is to turn the deflection angle $\frac{A}{2}$ and measure the chord 1-2, which locates the point 2; then turn the deflection angle $\frac{B}{2}$ and measure the chord distance 2-3, locating point 3, etc.

The fact has been mentioned that the use of the chord distance as equal to the arc introduces an error but that this error is of no importance for a 4° curve: As the degree of curvature increases, the difference between an arc length of $100'$ and the chord length becomes greater, and it is necessary to determine the limit of

curvature that will allow the use of 100' chords in locating curve points. On page 832 the statement is made that center-line chaining should be correct to within 0.1' per 100' of length, which allows a difference in arc and chord of 0.1. This occurs when the degree of curvature reaches 9° per 100'. The difference can then be reduced by the simple expedient of using 50' chords, which reduces the error for this degree of curvature from 0.10' per 100' of length using 100' chords to 0.02' using 50' chords; 50' chords can be used up to 18° curves and beyond that point 25' chords.

It is better not to use the full limit of allowable error, and a good working rule is 100' chords up to 8° curves, 50' chords up to 16° curves, 25' chords to 32°, and beyond that 10' chords.

For any given curve the deflection angle and central angle are directly proportional to the length of the arc, and if the deflection angle for 100' arc of 10° curve equals 5° the deflection angle for 1 foot of arc of 10° curve equals $\frac{5}{100} = \frac{300'}{100} = 3'$.

An example of a typical simple curve problem can now be given:

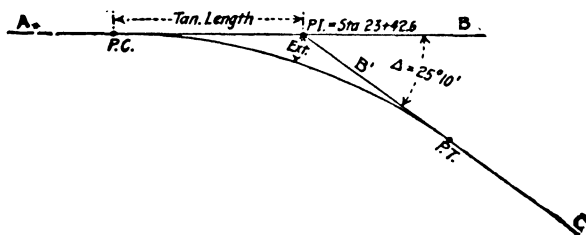

FIG. 281.

To Determine the Degree of Curvature Desired from a Fixed External Distance.—At Sta. 23 + 42.6 there is a deflection angle of 25° 10' between tangents AB and B'C; suppose upon examining the ground it is decided that to fit the old roadbed and give good alignment the curve should be located somewhere between 13.5 and 14.5' to the right of the transit point at Sta. 23 + 42.6. Proceed as follows: From table 139 pick out the external for a 1° curve for Δ = 25° 10'; this equals 141.0'.

The problem is to determine the degree of curvature that will give an external of between 13.5 and 14.5'. Use formula (9).

$$D = \frac{\text{External } 1^\circ \text{ curve for } 25^\circ 10'}{13.5'} = \frac{141.0'}{13.5'} = 10.44^\circ \text{ curve.}$$

$$D = \frac{\text{External } 1^\circ \text{ curve for } 25^\circ 10'}{14.5'} = \frac{141.0'}{14.5} = 9.72^\circ \text{ curve.}$$

To fit the conditions some curve must be selected between a 10.44 and a 9.72°. A 10° curve would be naturally selected as being the simplest to figure.

To Determine the Required Degree of Curvature for a Fixed Tangent Length.—Take the same problem as above except there must be a tangent length of between 127 and 129'. Use formula (6).

$$D = \frac{\text{Tangent } 1^\circ \text{ curve for } 25^\circ 10'}{127'} = \frac{1279.1'}{127'} = 10.07^\circ \text{ curve.}$$

$$D = \frac{\text{Tangent } 1^\circ \text{ curve for } 25^\circ 10'}{129'} = \frac{1279.1'}{129'} = 9.91^\circ \text{ curve.}$$

Table 139 gives tangent for $25^\circ 10' = 1279.1'$.

These limiting values would result in the selection of a 10° curve. The degree of the desired curve is usually selected in one of these two ways; ordinarily it is determined by the external distance.

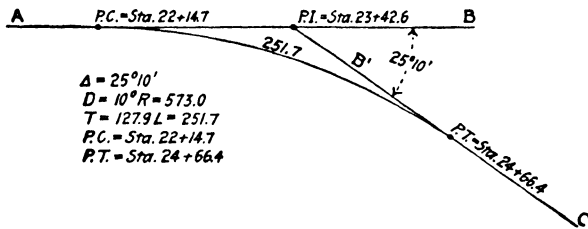

FIG. 282.

Simple Curve Problem. Case 1.—To compute the notes for a 10° curve for a deflection angle of $25^\circ 10'$ between tangents at Sta. 23 + 42.6.

Central angle = $25^\circ 10'$.

Table 139 gives the tangent 1° curve for $25^\circ 10' = 1279.1$.

$$\text{Tangent } 10^\circ \text{ curve} = \frac{1279.1}{10} = 127.91.$$

The station of the P.C. then equals Sta. 23 + 42.6 P.I. minus 127.9' = Sta. 22 + 14.7.

$$\text{The length of curve} = \frac{\Delta}{D} = \frac{25.16667^\circ}{10^\circ} \times 100' = 251.7'.$$

The station of the P.T. (tangent point, or end of the curve) as measured around the arc is then Sta. (22 + 14.7 P.C.) + 251.7' = Sta. 24 + 66.4.

The rule for running curves requires the use of 50' chords for a 10° curve. The deflections for the even stations and the 50' stations must, therefore, be figured as follows:

Stations 22 + 50, 23 + 00, 23 + 50, 24 + 00, 24 + 50, and to check the curve Sta. 24 + 66.4.

For a 10° curve, Table 138:

- The deflection for 100' of arc = 5°
- The deflection for 50' of arc = $2^\circ 30'$
- The deflection for 1' of arc = $0^\circ 03'$

The distance from the P.C., Stas. $22 + 14.7$ to $22 + 50$, is $35.3'$; the deflection per foot = $0^\circ 03'$, for $35.3' = 35.3 \times 0^\circ 03' = 105.9' = 1^\circ 46'$.

The distance P.C. to Sta. $23 + 00$ equals $85.3'$, or $50'$ farther than for Sta. $22 + 50$; the deflection per $50'$ of arc equals $2^\circ 30'$; therefore, the deflection for Sta. $23 + 00$ equals the deflections for Sta. $22 + 50$ ($1^\circ 46'$) plus $2^\circ 30'$, the deflection for $50'$ of arc or $4^\circ 16'$; in a like manner the deflection for Sta. $23 + 50$ is $6^\circ 46'$; for $24 + 00$, $9^\circ 16'$; for $24 + 50$, $11^\circ 46'$; the distance from Sta. $24 + 50$ to the P.T., Sta. $24 + 66.4$, is 16.4 ; the deflection for $16.4'$ equals $16.4 \times 0^\circ 03' = 49.2'$; the deflection for Sta. $24 + 66.4$ is, therefore, ($11^\circ 46' + 49'$) = $12^\circ 35'$; if the deflection notes have been properly figured this last deflection to the P.T. should always be one-half the central angle of the curve; in this case one-half of $25^\circ 10'$, which equals $12^\circ 35'$, checking the notes.

To Run the Curve.—Set up the transit at the P.I.; sight along the tangent (BA), measure off the distance 127.9 (tangent length) along this line and set the P.C. exactly on the line. In a like manner set the P.T. on the forward tangent ($B'C$) $127.9'$ from the P.I. Then set up the transit on the P.C. and with the vernier at $0^\circ 00'$ sight on the P.I., using the lower plate motion. Loosen the upper motion and deflect $1^\circ 46'$; measure along this line $35.3'$, which locates Sta. $22 + 50$ on the curve arc; then loosen the upper motion and set the vernier to read $4^\circ 16'$; measure $50'$ from the just located Sta. $22 + 50$, so that the forward end of the tape is in line with the transit deflection of $4^\circ 16'$; this locates Sta. $23 + 00$ on the curve arc. In a like manner deflect $6^\circ 46'$ and measure forward $50'$ from Stas. $23 + 00$ to $23 + 50$, etc., until the P.T. is reached. If the curve has been correctly run the last deflection of $12^\circ 35'$ will strike the previously located P.T. and the distance from Sta. $24 + 50$ to this P.T. will be $16.4'$; if the distance checks within $0.2'$ it is sufficiently close.

The above problem and method of laying out a curve are the simplest form encountered; it is assumed that the P.I., P.T. and all intermediate points on the curve are visible from the P.C. and that the P.I. is accessible.

In nine cases out of ten this method is applicable to road curves, but where the P.I. occurs outside of the road fences it sometimes is located in a stream, pond, building, etc., and cannot be occupied. This is known as the problem of the inaccessible P.I. More often it is impossible to see the P.T., or some intermediate point on the curve from the P.C., which necessitates intermediate transit points on the curve. The problem of inaccessible P.C.'s or P.T.'s is so rare it will not be illustrated.

Problem of the Inaccessible P.I. Case 2.—The point I (P.I.) cannot be occupied. Locate any two convenient points s and t on the tangents AB and $B'C$ and measure the distance st equals, say, $110.5'$.

Set the transit at s and measure the angle between the line As produced and st , say, $5^\circ 10'$; in a similar manner measure the angle at t between st produced and the forward tangent tC , say, $20^\circ 00'$. The total deflection then between the tangent AsB and $B'tC$ or the

central angle of the curve to be run is the sum of these two deflections, angles $5^{\circ} 10' + 20^{\circ} 00' = 25^{\circ} 10'$.

Assuming a 10° curve is desired we must locate the P.C. from the point s and the P.T. from the point t .

In the preceding simple curve problem the tangent length of a 10° curve with a central angle of $25^{\circ} 10'$ was figured to be $127.9'$; it, therefore, remains to compute the distance sH , which subtracted from $127.9'$ will give the distance from s along the tangent sA to the P.C. of the curve. In a similar manner compute Ht , which subtracted from $127.9'$ gives the distance along the forward tangent tC to the P.T. of the curve.

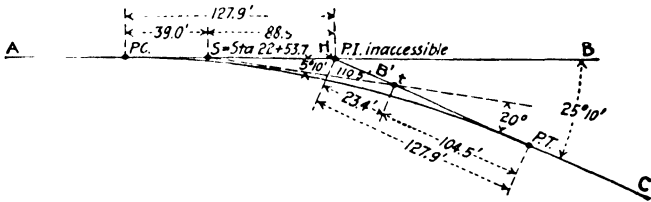

FIG. 283.

Knowing the station of the point s as measured along the tangent AB the station of the P.C. is determined; then figure the deflections in the usual manner and run the curve.

For the values given, the computations are as follows:

To determine sH and Ht . Use the law of sines (see Trigonometric formulas, p. 157⁸).

$$sH : st :: \sin 20^{\circ} 00' :: \sin 25^{\circ} 10'$$

$$sH = \frac{st \sin 20^{\circ} 00'}{\sin 25^{\circ} 10'} = \frac{110.5 \times 0.34202}{0.42525} = 88.87'$$

$$Ht = \frac{st \sin 5^{\circ} 10'}{\sin 25^{\circ} 10'} = \frac{110.5 \times 0.09005}{0.42525} = 23.4'$$

Therefore, the distance from s to the P.C. is $127.9' - 88.9' = 39.0'$.

The distance from t to the P.T. is $127.9 - 23.4 = 104.5$.

Having these distances, the P.C. and P.T. are located. Assume that station of s was measured along the tangent AB and found to be Sta. $22 + 53.7$.

The station of the P.C. then equals $22 + 14.7$

The station of the P.I. then equals $23 + 42.6$

The station of the P.T. then equals $24 + 66.4$, using the length of curve figured in Case 1.

The deflections are figured and the curve run as in Case 1, assuming that all the curve points are visible from the P.C.

Case 3. Where the P.T. or Intermediate Points on the Curve Are Not Visible from the P.C. a. Where an Intermediate Set-up Is Required.—Use the same curve as in Case 1.

The deflections for the different curve points were figured as follows:

Deflections.—Instrument at P.C., foresight on P.I.

P.C. Sta.	Deflection
22 + 14.7	0° 00'
22 + 50	1° 46'
23 + 00	4° 16'
23 + 50	6° 46'
24 + 00	9° 16'
24 + 50	11° 46'
24 + 66.4	12° 35'

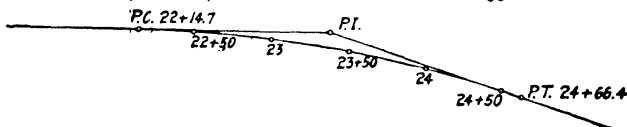

FIG. 284.

Set up the instrument at the P.C. and locate the points 22 + 50, 23 + 00, and 23 + 50; suppose 24 + 00 is not visible, set up at Sta. 23 + 50, set the vernier at 0° 00', and back sight on the P.C.; transit the telescope and finish the curve, using the same deflections as figured for the instrument set up at the P.C.; that is, turn the deflection of 9° 16' for Sta. 24 + 00, 11° 46' for 24 + 50, and 12° 35' for the P.T. In general, it can be said that whenever the P.C. is used as a backsight from the intermediate set-up, set the vernier at 0° 00' when sighting on the P.C.; transit the telescope and use original notes for the balance of the curve.

b. Where Two or More Intermediate Set-ups Are Required.—For the first set-up, say, at 23 + 50, proceed as above and set Sta. 24 + 00; suppose 24 + 50 is not visible from Sta. 23 + 50; set up at Sta. 24 + 00 and with the vernier reading 6° 46', back sight on Sta. 23 + 50; transit the telescope, set the vernier to read 11° 46' for Sta. 24 + 50, and proceed, using the same deflections as originally figured. In general, where the P.C. is not visible from the intermediate set-up, set the vernier to read the deflection figured for the point used as a backsight; transit the telescope and proceed with the curve, using the notes originally figured; that is, if the instrument is set up at Sta. 24 + 00 and 22 + 50 used as a backsight, the vernier is set at 1° 46', and using the lower motion the wire is set on Sta. 22 + 50; then transiting the telescope the curve is run by setting the vernier at 11° 46' for Sta. 24 + 50, etc.

If Sta. 23 + 00 is used as a backsight, set the vernier at 4° 16' when sighting the machine; then transit and proceed as above.

These three cases cover any ordinary road curve problems.

NEW LOCATION SURVEYS

General.—The details of survey work depend entirely on the character of the improvement and range from simple alignment determination on mesa wagon trails to the complete surveys

required for difficult mountain locations which are to be constructed by contract on unit price bids. The following data are for complete first-class surveys. The same methods are used for more incomplete surveys, but parts of the procedure can often be omitted if the work is to be done by force account or convict labor.

Organization and Equipment.—Eight- to ten-men parties are a convenient and efficient force:

- Locating engineer
- Transitman
- Levelman
- 3 Chainmen, rodmen, etc.
- 1 to 3 Axmen.
- Cook

If drafting is to be done in the field, add a draftsman and computer to the party, but this is not advised, as field drafting is rarely satisfactory.

Organization—first stage of work:

Locating engineer	}	Picking out line and general supervision.
Transitman	} Running base line.
2 Chainmen		
Necessary axmen		
1 Stake man		
Levelman	}	Running bench levels and check profile levels keeping all this work close up to base-line party.
Rodman		

Organization—second stage of work:

Locating engineer	} Drainage areas, classification of materials and topography.
1 Assistant		
Transitman	} Cross-sections.
2 Assistants		
Levelman	} Cross-sections.
2 Assistants		

Extra men moving camp, odd jobs, etc.

The first stage of the work varies in speed from $\frac{1}{2}$ to 3 miles per day, depending on the character of the county. Three-fourths mile per day is a fair average for ordinary mountain work.

The second stage should make a speed of from 1 to 2 miles per day. A fair average is about $1\frac{1}{2}$ miles per day.

Allowing for unavoidable loss of time, moving camp, etc., 10 miles a month for an eight-man party is a fair average when they are doing first-class work.

Cost of Survey.—The cost of first-class complete mountain road location surveys runs from \$75 to \$150 per mile exclusive of railroad transportation to the job, allowing \$150 per month for the locating engineer, \$120 per-month for transitman, \$100 per month

for leveler, and \$70 to \$90 for laborers, etc. Meals are furnished free to the men at an average cost of 75 cts. per man per day exclusive of labor, or about \$1 to \$1.30 per day including cooks salary.¹

The average speed for a party of eight men is approximately 10 miles per month of completed survey, at an average cost of \$100 to \$120 per mile exclusive of railroad transportation. In easy flat country this speed can be easily doubled and the cost halved.

DEPRECIATION ON ENGINEERING EQUIPMENT PER MILE OF SURVEY
(Assumed 50 miles of survey per season)

Quantity	Item	Value	Approx. Life, Years	Annual Depreciation and Repairs	Rental Charge per Mile Survey
1	Transit (mountain) tripod	\$300 00	10	\$30 00	
1	Level (dumpy or Y).....	150 00	10	25 00	
1	Locke level.....	7 00	3	2 50	
2	Abney levels @ \$16.50.	33 00	5	6 00	
3	100' chains @ \$12.00	36 00	2	18 00	
4	Range poles (8' wooden) @ \$2.25.....	9 00	2	5 00	
2	Level rods, Philadelphia 13' extension.....	30 00	1	30 00	
2	Chain repair kits.....	20 00	5	4 00	
3	Metallic tape boxes, \$2.45	7 00	1	7 00	
6	Metallic fillers.....	6 00	1	6 00	
1	Set sounding bars (1 3/4"-1" and 3/4" tool steel)....	10 00	10	1 00	
4	Plumb bobs.....	4 00	2	2 00	
2	Pocket compasses.....	4 00	3	1 50	
1	Kodak 3-A.....	24 00	4	6 00	
1	Engineer's trunk.....	10 00	1	10 00	
	Totals.....	\$650 00		\$164 00	\$3 30 (Say \$3.00)

* Marking crayon.

* Use a grain having a large amount of oil, as it will last longer. "Stay-On-All" is a good brand.

¹ These costs are for 1914 cost conditions. In 1926 costs are approximately double for salaries and subsistence.

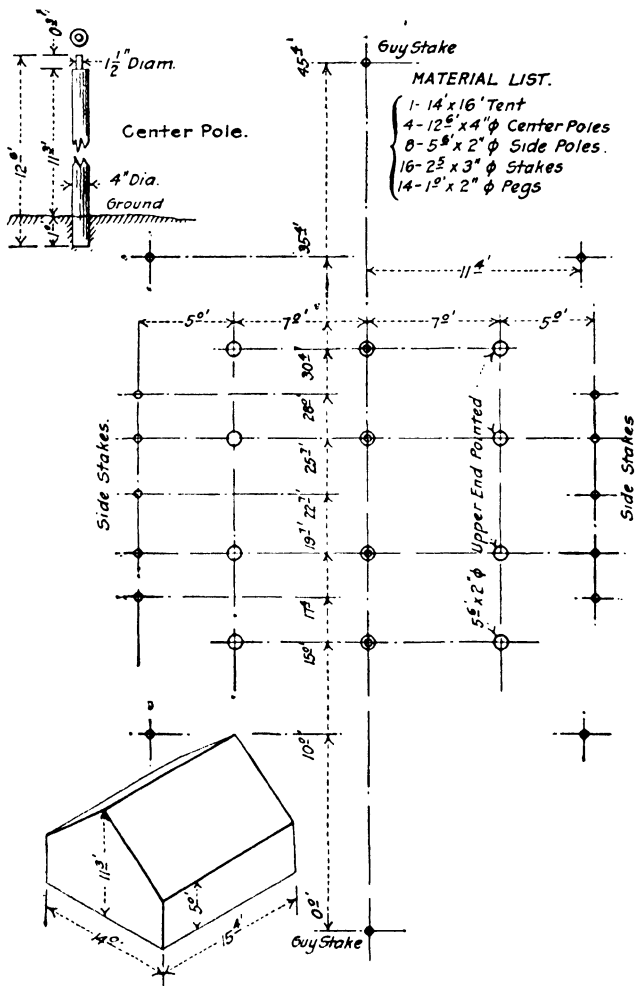

FIG. 285.—Layout diagram.

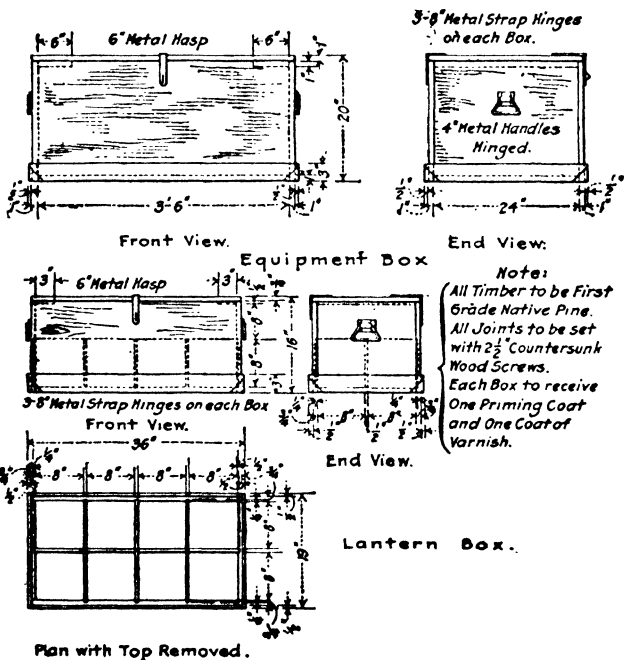

FIG. 286.

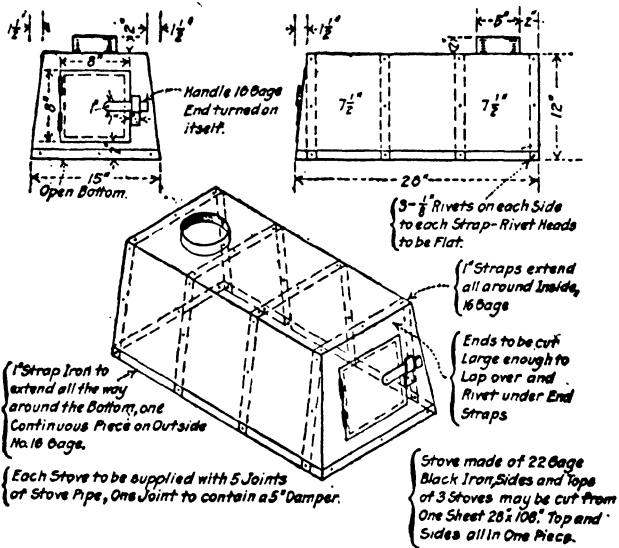

FIG. 287.—Tent heater

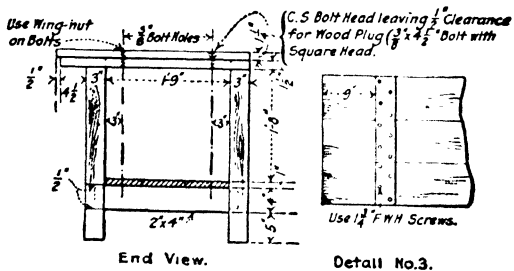
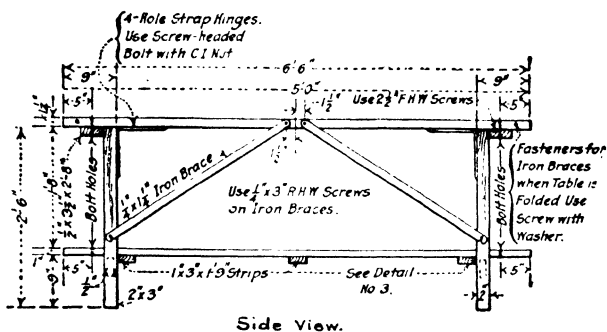

FIG. 288.—Folding kitchen camp table.

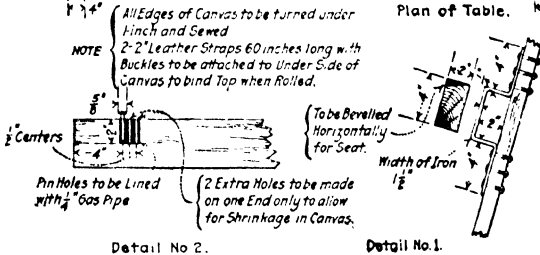
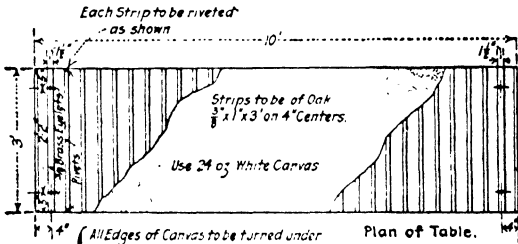
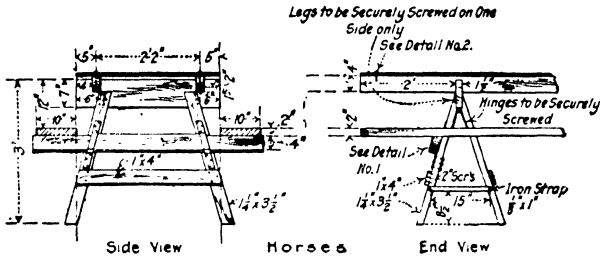

FIG. 289.— Portable mess tables.

Camp Equipment.—The authors would not have the temerity to recommend camp equipment any more than to dare advise a woman on cooking utensils. It is a delicate subject on which most campers have their own pet notions. The following lists are more in the nature of reminders than anything else and are based on outfits in ordinary use on mountain road surveys in the West where equipment can be moved by wagon.

TABLE 141.—OUTFIT FOR AN EIGHT- OR TEN-MAN PARTY ON LOCATION SURVEYS TABLE WARE

White enamelware dishes unless otherwise noted.

Item	Approx. Value
12 Cups, 3½" diameter.....	\$2.00
12 Saucers, 6".....	1.80
3 Salt shakers (large) aluminum.....	0.60
1 " shaker (small).....	0.10
12 Table forks (retinned).....	1.50
24 Tea spoons.....	0.60
2 Meat platters, 16".....	1.00
3 Pepper shakers (small) aluminum.....	0.60
1 " shaker (large).....	0.60
12 Plates, 9".....	2.50
12 Table knives (retinned).....	1.80
12 " spoons.....	0.50
2 Water pitchers.....	1.50
2 Syrup.....	1.50
12 Soup bowls, 5".....	2.50
12 Sauce dishes, 5".....	1.80
2 Sugar bowls, 6".....	1.50
Total value tableware.....	\$22.40
Say.....	\$25.00

1916 Scale of Costs.

1926 would be approx. twice as much.

COOKING UTENSILS

Item	Approximate Value
1 Butcher knife 10".....	\$1.00
2 " knives 8".....	1.00
1 " knife 18" (steel).....	1.00
1 Bread board.....	0.50
2 Basting spoons, 14" (retinned).....	0.20
2 Berlin kettles, 10 quart (aluminum).....	3.00
3 " " 6 " ".....	4.00
1 " " 5 " ".....	1.00
1 " " 4 " ".....	1.00
3 Bowls, 10" diameter earthenware.....	1.50
4 Buckets, 10 quart galvanized iron.....	1.50
1 Coffee boiler, 1½ gallon, gray enamel.....	0.70
1 " " 3 quart (aluminum).....	10.00
2 Carving forks, wire (3 prong).....	0.30
1 Cake turner (retinned, perforated).....	0.10
3 Can openers.....	0.50
1 Collander, 9" (aluminum).....	1.80
1 Dishpan, 17 quart (retinned).....	0.75
1 " " 14 " ".....	0.60
3 Dippers, 1 pint ".....	0.50
1 Drip pan, 9" X 11" ".....	0.25
1 " " 10" X 12" ".....	0.25
1 " " 11" X 16" ".....	0.25
12 Dish towels.....	2.00
1 Egg beater (family size).....	0.15
2 Frying pans, 13" diameter steel.....	0.65

CAMP EQUIPMENT

901

1	Frying pan 11½" diameter steel	0.25
1	Flour sieve (tin) 2 quart	0.20
2	Funnels (large)	0.40
2	" (small)	0.10
1	Grater	0.10
1	Jar for bread yeast, 3 gallon	0.75
1	Iron griddle, 20" × 12" cast iron	2.50
1	Meat saw	1.80
1	" chopper	0.50
1	" grinder	1.50
1	" cleaver, 8"	1.50
1	Milk pan, 6 quart (retinned)	0.50
3	Paring knives	0.40
12	Pie tins	2.25
1	Quart cup (retinned)	0.30
1	Rolling pin, 2½" × 10¾"	0.15
1	Stove pot	2.10
1	Skimmer (aluminum)	0.25
2	Soup ladles, 3" diameter	0.40
3	Serving pans, 12" diameter white enamel	1.75
4	" " 7"	1.75
1	Tea pot, 1 gallon white enamel	0.60
1	Cook stove, 6 hole range, 18" × 18" × 12" oven, top 26" × 31" (30" high), weight approx. 250 lb.	25.00
	Total cooking utensils	\$77.75
	Say	\$80.00

1916 Scale of Costs.
1926 would be approx. twice as much.

HARDWARE

Item	Approx. Value	
4	Axes, 3½ lb.	\$6.00
4	" 1½ lb. with sheath (hand)	5.00
6	Axe handles	2.00
2	Brush hooks or machetes	3.00
1	Cold chisel, small, 6"	0.10
1	Carborundum stone	1.20
1	Claw hammer, standard, 16 oz	0.80
4	Camp beaters with 5 joints nestible pipe (Sibley)	16.00
2	Files, mill bastard, 8"	0.50
1	Hasp	0.50
5	Oil lanterns 1¼"-1½" wick Stalite	5.00
3	Gasoline lanterns, "Quicklite"	17.00
2	Picks, railroad	2.50
2	Pick handles	1.60
1	Pliers, 7" lineman's	1.10
5	Piece nestible stove pipe for cooking stove	1.05
1	Screw driver, 18"	0.40
3	Sheath blocks C. I., ¼" or ¾" rope	3.00
2	Shovels, sharp pointed, long handles	2.50
1	Saw, 4', one man in case	3.20
2	Sledges, 8 lb.	2.50
6	" handles	2.40
1	Saw, 26", 7 point, No. 7 Diston	1.80
4	Stove pipe protectors, asbestos	9.00
1	Tool grinder, No. 6 American	0.50
6	Boxes tacks, carpet, 8 oz	1.00
	Nails, 8d and 20d	0.50
3	Balls twine	2.50
2	Tubs, 24" diameter galvanized iron	0.10
1	Whetstone	0.60
1	Washboard brass, 10½" × 11½"	1.00
4	Washbasins, enameled ware	0.25
100'	Wire baling	1.10
1	Wedge, splitting, No. 5 Truckee	1.00
1	Wrench, monkey, 8"	0.60
	Say	\$96.70
		\$100.00

1916 Scale of Costs.
1926 would be approx. twice as much.

SURVEY DATA

TENTS, TABLES, AND MISCELLANEOUS

Item	Approx. Value
2 Tents, 14' X 16'.....	\$180 00
3 " 10' X 12'.....	110 00
1 Tent, 7' X 9'.....	20 00
1 Kitchen table (see Figure 87, page 442).....	15 00
1 Canvas mess table (see Figure 88, page 443).....	25 00
3 Equipment chests (see Figure 86, page 440).....	40 00
1 Mess box with padlock.....	5 00
1 Lantern box (see page 440).....	5 00
2 Lunch baskets.....	3 80
6 Canvas chairs.....	6 00
4 " saddle bags.....	16 00
4 " note book shoulder bags.....	6 00
2 " water bags, 2½ gal.....	2 50
3 Canteens, 2 qt. with webbing and strap.....	5 00
100' ¼" rope.....	1 00
48 Clothes pins.....	0 20
1 Alarm clock.....	2 50
2 Scrub brushes, 1½" X 4".....	0 25
125' ½" rope.....	4 00
5 Yards oil cloth, white.....	1 40
2 Brooms.....	1 60
1 Spring balance, 50 lb.....	0 40
1 Sailmaker's palm with needles, twine and wax ...	1 05
1 Shoemaker's outfit containing semi-steel, stand, 2 lasts and pegging awl ...	2 00
12 Hand towels.....	2 50
1 Medicine chest with remedies.....	30 00
	<hr/>
Say.....	\$486 80
	<hr/>
	\$500 00

1916 Scale of Costs.
1926 would be approx. twice as much.

DEPRECIATION ON CAMP EQUIPMENT

Table ware.....	\$ 25.00
Hardware.....	100.00
Cooking utensils.....	80.00
Tents, etc.....	495.00
	<hr/>
Total.....	\$700.00

1916 Scale of Costs.
1926 would be approx. twice as much.

Allowing for ordinary wear, accident, loss etc., this equipment is probably good for 3 years. Allowing 50 miles of survey per season for each party, which is a fair average, the equipment is good for 150 miles of survey, or at the rate of \$4.50 per mile, which is a reasonably close charge for the use of camp equipment on survey work of this character.

TABLE 142.—SURVEY PARTY
Ration—(one man one day)

Article	Unit	Quantity
Fresh meat.....	pounds	0.70
Cured meat.....	"	0.30
Lard.....	"	0.14
Flour.....	"	0.70
Corn meal.....	"	0.05
Baking powder.....	"	0.02
Sugar.....	"	0.35
Coffee.....	"	0.05
Tea.....	"	0.01
Butter.....	"	0.14
Dried fruit.....	"	0.10
Rice, beans or hominy.....	"	0.10
Potatoes.....	"	1.00
Salt.....	"	0.04
Flav. extracts.....	ounces	0.03
Spices.....	"	0.05
Milk, condensed.....	cans	0.40
Canned fruits.....	"	0.18
Vegetables (fresh or canned)....	pounds	0.50
Syrup.....	"	0.06
Pickles.....	"	0.03
Eggs.....	nos.	2½
Breakfast foods.....	pounds	0.08
*Miscellaneous cost.....		2½c.

* Miscellaneous includes, crackers, yeast, chile powder, soda, salad, oil, catsup, chocolate, lemons, soap, sapolio, candles, matches, oil, and wood. An allowance of 2½ cts. per ration should easily supply these items.

NOTE.—Fresh milk may be substituted for condensed at a rate of 1 qt. for one can.

Cost of Ration.—The cost of feeding one man per day, including cook's salary, based on 5000 man-day rations in 1918 on western mountain location surveys averaged \$1.30.

PRELIMINARY INVESTIGATION OUTFIT

Where one man is traveling alone on foot and will be out of touch with habitation for a day or so at a time a simple outfit carried in a knapsack or pack basket will serve very satisfactorily.

1 Waterproof canvas sleeping bag.....	\$15.00
1 Light belt ax.....	1.00
1 Small fry pan.....	0.25
1 Cup with long handle for heating water...	0.25
Knife, fork, and spoon.....	0.50
Matches in bottle or waterproof case.....	0.10
Small emergency food supply.....	2.00
Personal supplies.....	
Canteen in arid regions.....	

This whole pack will not weigh over 30 lb. and can be easily carried.

Camp Drafting Equipment (if desired).—Camp equipment is listed on *page 900*.

Survey Methods.—The chief of party should precede the men to the work and go over the entire line as outlined in the preliminary investigation report, picking out his camp sites and making all necessary arrangements for transportation of camp equipment and supplies. He should also mark the base-line location for 2 or 3 miles so that when the party arrives there will be no delay in making camp and starting the line work.

First Stage of Survey

- a. Tracing the location.
- b. Running base line.
- c. Running bench levels and base-line profile.

a. **Locating Line.**—This work is done by the locating engineer, who considers all the principles of grade, alignment, etc., discussed in Chapter II. In high altitudes he pays particular attention to

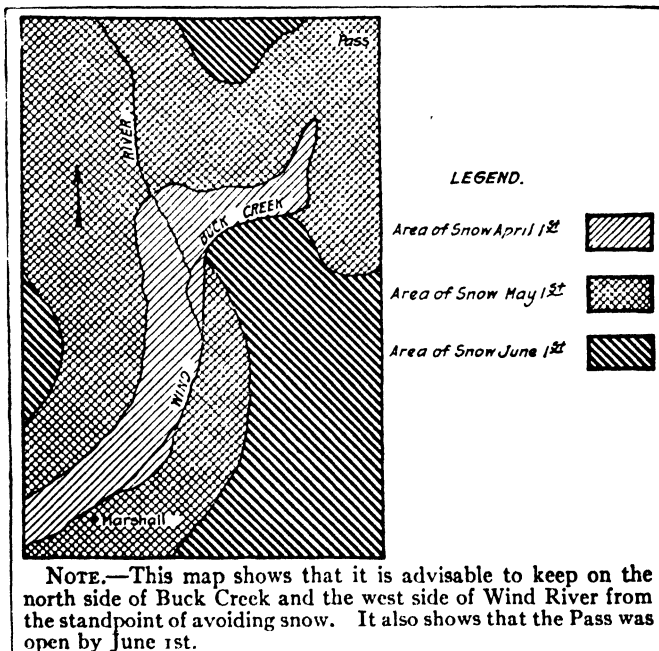

FIG. 290.

avoiding bad snow conditions which, in general, means avoiding north exposure as much as possible. Very often he can be helped in this part of the problem by making a snow map the spring preceding the survey. This is done by sketching in the areas where snow lies at different dates, say Apr. 1, May 1, June 1. When furnished with a map of this kind he avoids the areas of late snow where possible. Lacking a definite investigation for snow conditions the best available local data should be obtained from hunters, etc.

The different trial lines are traced with an Abney level in open country and a combination of Abney level and aneroid in timbered country. The line that he decides to adopt is marked at sufficiently close intervals either by blazing trees or tall stakes with flags on them, so that the base line party will have no difficulty in following the correct location. This work must be kept far enough ahead of the base line party so that there is no danger of the work of the main party becoming worthless by the line getting into a location which has to be abandoned and relocated.

When working on a ruling grade the line should be traced down hill from the highest point on the route. When working on a ruling grade the line in the field should always be traced at a less rate of grade than the maximum allowed; that is, if the maximum grade is set at 7% the locator should trace his line on a $6\frac{1}{2}$ or 6% grade in order to give the designer a little leeway for economical variations from the field grade and yet keep within the maximum rate. When working on portions of the route requiring less than the ruling grade it makes no difference in which direction the line is traced so long as the base line is run in one direction with continuous stationing.

b. Base Line.—The base line follows the marked route of the location. It is a chained, transit line marked on the ground by stakes at least every 100' well driven and marked with crayon (Stay-on-All) with the station or plus of each stake. Stakes are placed at each point on the line where a profile shot or cross-section will be required and should be well made and well driven so that they will remain in place at least 3 years. The transit points (angle points) are marked with well-driven hubs with tack centering; every third or fourth transit point should be permanently and carefully referenced by both azimuth and distance (see sample notes). The angles in the line are determined by transit readings and the bearings of the courses are recorded by azimuth, using true north as the zero azimuth. The use of true north as the reference line in these surveys is desirable on account of permitting a check on the accuracy of the transit work at any time, on account of retracing a lost line, and on account of right-of-way descriptions in localities laid out on the U. S. land system. The methods of determining true meridian by Polaris and solar observations are explained (pp. 912 to 932). In fairly flat or rolling topography the base line should follow the center line of the proposed improvement exactly and all curves at tangent intersections should be run in the field. It has been found from experience that for the topographic conditions mentioned the field men can pick the best location in easy country and also that where the center line is actu-

ally run and staked that it simplifies the work of cross-sectioning, the office design and the staking for construction.

On side-hill locations, however, or any kind of difficult work experience has shown that the field men cannot pick an exact center line which will be economical in design and that under these conditions it is a waste of time and money to run in curves. Under these conditions the base line is run as a series of tangents, keeping as close to the probable center line as possible and using short tangents in going around any natural features that will require a sharp curve in the finished road. Later when the cross-sections are taken they must be extended far enough from the line to allow

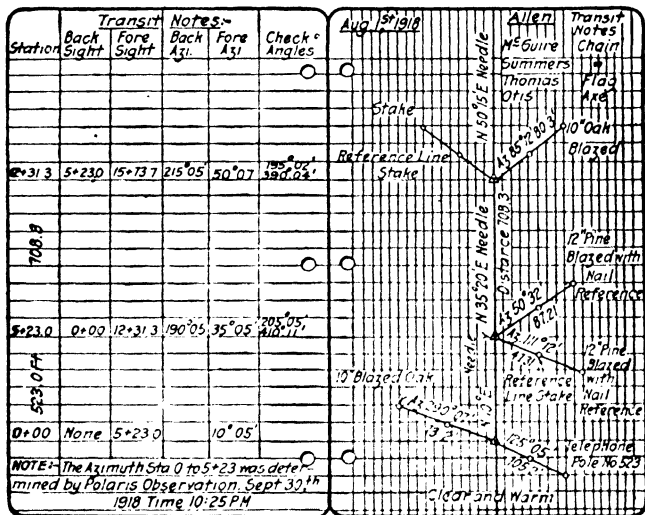
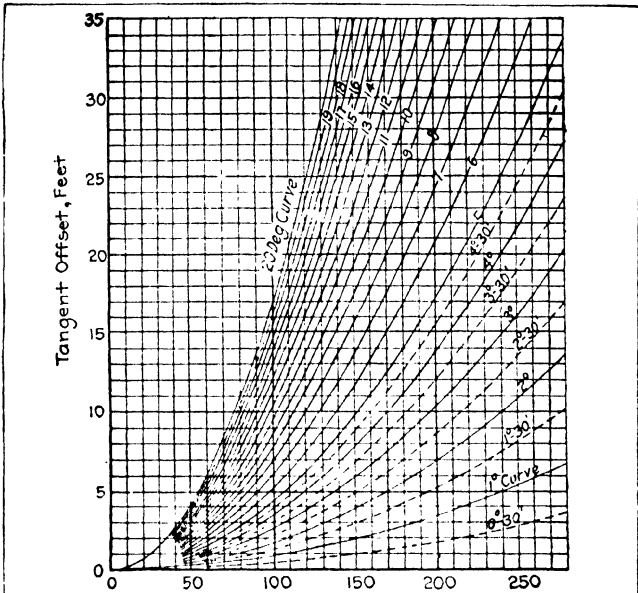

FIG. 291.

the designer to shift the center line from the base line as far as he desires as well as varying his vertical grade from the field grade. This requires considerable extra work in cross-sectioning, as will be taken up later, but is well worth while, as in difficult country a paper location is always more economical to construct than a field location.

Bench Levels.—Ordinary engineers spirit level work, reading turning points to nearest 0.01'. Benches are figured to nearest 0.01' in elevation (see sample notes, Fig. 293).

Permanent benches should be established at least every 1/2 mile and preferably at 1/4-mile intervals. The datum for the levels should be referred to U. S. Geological Survey datum if possible, or lacking this reference a datum can be assumed, but in any case the method of arriving at the elevation of the initial bench mark



Distance in feet measured along the curve from the P.C. or P.T.

The following instructions accompany the chart:

In measuring up to the P. I., leave temporary markers at enough points so that the line of the tangent can be readily located by eye. From the newly located P. I. turn off the desired deflection angle. Determine the degree of curve necessary to fit the conditions from the external and tangent length and take from table the tangent and length of curve, and record the station of the P.C. and P.T. Make the curve correction for difference in length of the sum of the tangents and distance on the curve at the P.I., and start measurements along next tangent, leaving temporary markers up to the P.T. of the curve. To lay out curve, start at the station or plus station near the P.C. and measure along the curve, using standard chord lengths, and using the offsets from tangent as read from chart, which increases as the distance from the P.C. or P.T. increases.

To be useful a chart of this kind should be drawn to a larger scale than we can reproduce in a handbook of this size and this has been inserted more to show a convenient method than for actual use. In the same manner a chart can be prepared for short radii curves from 40' radius to 150' radius that is very useful in mountain road location.

FIG. 202.

SURVEY DATA

Sta.	Sample Bench Levels			Elev.	Aug. 4, 1918 Remarks	Cate Thomas	Level Rod
	+	H.I.	-				
B.M. 0				5248.21	USGS Bench at Heber. Bronze Tablet in School House.		
κ	10.43	5258.64					
T.P.			2.14	5256.50			
κ	8.91	5265.41					
T.P.			7.22	5258.19			
κ	9.33	5267.52					
B.M. No 1			5.16	5262.36	Spike in Blazed Pine Tree 100' W of Sta 10+20		
κ	1.47	5263.83					
T.P.			8.72	5255.11			

FIG. 293.

Station	Profile Level			Profile Rod	Elev.	Aug. 4, 1918 Remarks	McGuire Thomas	Level Rod
	+	-	H.I.					
B.M. 0					5248.21	USGS School House, Heber		
κ	10.20		5258.41					
0				11.2	47.2	Sta. 0 to 5 No Clearing or Grubbing		
1				10.7	47.7			
2				9.5	48.9			
2+25				8.2	50.2			
3				5.1	53.3			
4				2.7	55.7	Put in 12" Cor. Iron Pipe		
5				2.4	56.0			
T.P.		2.33			5256.08			
κ	8.10		5264.18			Clearing Sta 5 to 10 Scrub Oak		
6				8.0	56.2			
6+25				6.9	57.3			
7				6.0	58.2			
8				5.3	58.9			
9				4.1	60.1			
10				3.1	61.1			
B.M. No 1		1.85			5262.33	Bench Levels 5262.36 Use this Elevation Forward		
κ	5.27		5261.63	Corrected.				

FIG. 294.

should be fully explained in the notes. The computations of level notes should be made in the field and checked each night.

Profile Levels.—These levels also act as a check on the bench levels and therefore require an independent line, preferably run in the opposite direction. The turns are read to the nearest 0.01' and the profile ground elevations of the base line to the nearest 0.1'. In case there is no radical difference in the two lines of levels (bench and profile) the profile levels are corrected to agree with the bench levels at each bench and carried ahead on the bench elevations. This is done so that there will be no cumulative difference in the levels. An error of 0.1' in running between benches is allowable (see Fig. 294 for sample profile level notes). Level computations should be figured and checked each night and a pencil profile plotted for the convenience of the locator.

Second Stage of Work

- a. Cross-sections.
- b. Topography.
- c. Drainage.
- d. Classification of materials.
- e. Field drafting.

a. Cross-sections.—Cross-sections are the most important part of the detail work on survey. The tendency is to slight this part of the work, as it is tedious and uninteresting. The author has seen so much trouble experienced in the office design due to inadequate cross-section field work that he wishes to emphasize the importance of taking wide enough sections, particularly where a paper location is contemplated.

In level country where center line is exactly run, 30' each side of the center line is enough.

In hilly country on side slopes averaging 25° where the center line is exactly located, 60' each side of the line is enough.

Where the center line is not exactly located the engineer must use his judgment but, as a rule, it is not safe to use less than 100' each side of the line and care must be taken that they are taken exactly at right angles to the line.

For switchback turns or where a large variation from the survey base line is probable, a careful stadia survey is desirable.

In flat country, cross-sections are taken with the engineer's level, rod, and metallic tape in a similar way to the methods described in the first of this chapter for high-class improvements.

In rough country they are generally taken with a hand level, rod, and tape and each section is referred to the profile ground elevation of the base line (see sample notes, Fig. 295). The absolute elevation of each point is figured from the base-line ground elevation. This is important, as, while it entails more field computation, they can be done at night, and by the use of the absolute elevations the office and design work is made simpler, cheaper, and more accurate. Experience has demonstrated that the method of absolute elevations for cross-sections is much superior and cheaper in the end than relative elevations. In very rough

country transit stadia cross sections are the cheapest and most reliable preliminary survey method.

Cross-sections are taken at all breaks in the profile and in uniform topography at least every 100' and preferably at shorter intervals.

Cross Section Notes:		Aug. 12, 1912				Allen, Level Hoover, Tape Summer, Rod			
Station	Classification	L	C	R	R	R	R	R	R
	Poor Road Soil								
5	Ash Earth 100% needs Gravel Surfacing	-10.1	-5.2	-3.7	-1.2	+1.5	+9.4	+10.5	+20.8
	Earth 20%	1.0	4.5	2.3	1.2	7	15	23	30
4	Loose Rock 80%	-9.3	-4.5	-3.3	-0.8	+1.2	+10.3	+15.7	+19.6
	Earth 20%	6.0	3.5	1.8	1.5	10	18	33	43
3	Solid Rock 100%	-25.0	-4.6	-10.2	-5.8	+9.1	+27	+30.2	+30.2
	Earth 20%	4.4	3.1	1.7	0.1	12	19	29	45
2+25	Loose Rock 50% Solid Rock 30%	-11.2	-1.8	-5.7	-2.3	+2.3	+11.2	+21.1	+20.7
	Earth 50%	4	3.2	1.5	1.0	11	40	62	75
2	Loose Rock 50%	-12.2	-7.1	-3.1	0	+1.5	+1.9	+5.9	+9.5
	Earth 50%	6.0	4.0	1.5	0	3.0	4.0	6.0	6.0
1	Earth 100%	-10	-0.5	-0.5	-0.5	+0.5	+0.5	+5.5	+5.5
	Earth 100%	4.5	3.0	1.5	1.7	10	30	4.5	
0	Earth 100%	+10	+1.2	-0.7	0	-0.3	-0.3	+1.7	
		4.5	1.7	1.9	0	7	14	50	

FIG. 295.

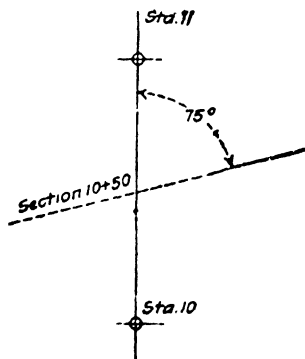

FIG. 295A.

Special cross-sections are taken for all drainage crossings and show the skew angle of the proposed structure (see Fig. 295A).

Cross-section notes should be computed and checked each night.

b. Topography.—Taken in the same manner as previously described (see sample notes, Fig. 296).

c. Drainage.—Field drainage notes on new locations must be detailed and specific, as the recommendations determine the office design absolutely; there is no possibility of the designer checking the conclusions.

Such notes should be made personally by the chief of party and should indicate exactly where he wants the culverts or bridges

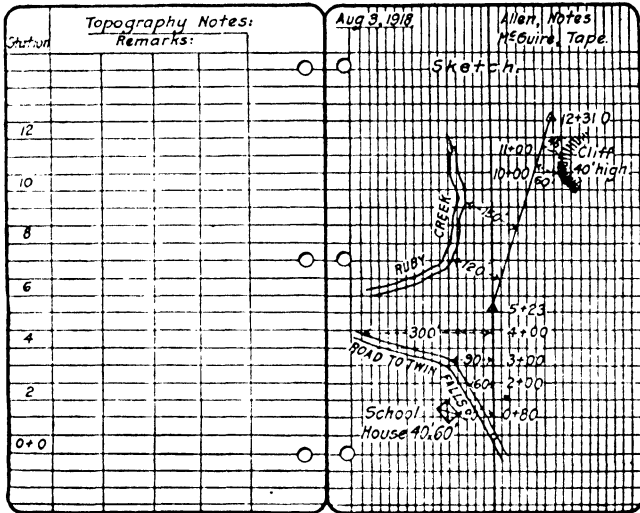

FIG. 296.

placed and the size of opening of the structure. He uses the principles discussed in the chapter on Drainage, and determines the size of waterway either from the physical evidence of high water or from the area of the drainage basin. Areas can be run out by paced, hand compass traverses, determining the divide lines with a hand level, or can be plotted directly in the field on a small 9 or 15" plane table.

The type of structure, as log, corrugated pipe, concrete box, etc., should be stipulated for each structure, as the field man is the only one who can decide on the best type, considering the local materials that are available.

d. Classification of Material.—The classification of material has a marked effect on office design and should be handled by the chief. The expenditure of considerable time and money is justified in determining the subsurface conditions within the probable limits of proposed excavation where there is reason to believe that

solid rock will be encountered. This is done by bar soundings and test pits. Where the soil contains a large percentage of boulders, bar soundings are of little value. As a rule, it is impracticable to determine more than a general classification for the largest part of the distance unless rock outcrops show on the surface.

e. Field Drafting.—The field drafting should be confined to special problems desired by the chief and should only be done where there is doubt as to whether sufficient field data have been obtained for the office design.

Complete design in the field is costly and is rarely as satisfactory as office design. Camp is no place for careful design.

Location Survey Reports.—A report should be worked up as the survey progresses. The object of this part of the record is to make it possible for a man not personally familiar with the ground to make a reasonable design. It should include all information of a general or special nature not shown in the survey notes such as:

1. A description of the general topography.
2. A description of alternate locations and the reasons in detail for the selection of the route surveyed.
3. A statement of the portions of the line where the survey alignment should be rigidly adhered to and an undulating grade used.
4. A statement of the portions of the line where the alignment can be shifted to fit a grade contour and a ruling grade adhered to.
5. The portions of the line where both line and grade can be varied in the final design.
6. Snow conditions and how bad exposure is avoided or why it cannot be avoided.
7. Special designs to fit unusual conditions.
8. Special designs utilizing supplies of nearby local materials.
9. Photographs to illustrate special features or to give a general idea of conditions.

Determination of True North.—The simplest method of determining the true meridian is by observation on Polaris at elongation. For all practical purposes fairly close results can be obtained by observation on Polaris or the sun at any time. The following tables and explanation of simple methods are quoted or briefed from the Manual of the U. S. Geodetic Survey on Magnetism and the determination of the true meridian, and the Metro Manual of the Bausch & Lomb Optical Co.

Meridian by Polaris at Elongation.—For all practical road survey purposes a determination of the meridian to the nearest minute of angle is sufficiently close. For $\frac{1}{2}$ hr. before elongation to a half hour after elongation the azimuth of Polaris does not vary over 30 sec. of angle, which gives plenty of time for check determinations, and the element of exact standard time is of little importance.

DETERMINATION OF THE TRUE MERIDIAN

Because of the irregular distribution of the earth's magnetism, only an approximate value of the magnetic declination can be given for a place at which it has not been determined by observation. When a more accurate value is needed the true meridian must be determined, as the declination is the angle between the true meridian

and the magnetic meridian. This may be done by observations of the sun or Polaris. Five methods will be explained, three involving the use of a surveyor's transit and two requiring no instrumental equipment.

With care the methods involving the use of surveyor's transit should give the true meridian within 1 min. of arc, the other methods within 2 or 3 min., an accuracy ample for ordinary compass surveys.

a. With a Plumb Line and Peep Sight.—(1) By observations of Polaris at elongation; (2) by noting when Polaris and another star are in the same vertical plane.

b. With a Surveyor's Transit.—(3) By observations of Polaris at elongation; (4) by observations of Polaris at any hour; (5) by observations of the sun.

As a result of the rotation of the earth about its axis, Polaris, like other stars, appears to move in a circle about the pole of the heavens. It is said to be at culmination when it is in the vertical plane defined by the observer and the pole (upper culmination when it is above the pole) and at elongation when it reaches its extreme easterly and westerly positions with respect to the pole. At culmination its apparent motion is nearly horizontal, from east to west at upper culmination and from west to east at lower culmination. At elongation its apparent motion is nearly vertical, upward at eastern elongation and downward at western elongation.

The azimuth of Polaris is the angle at the observing station between the vertical plane through the pole and the one through the star. For a short time before and after elongation there is practically no change in the azimuth of Polaris and that time is usually selected for observing it for the purpose of determining the true meridian.

APPROXIMATE METHOD NO I

Observations of Polaris at Elongation.—Attach the plumb line to a support situated as far above the ground as practicable, such as the limb of a tree or a piece of board fastened to a telegraph pole or a building, affording a clear view in a north and south direction.

The plumb bob may consist of any heavy material, a brick or a piece of iron or stone weighing 4 or 5 lb. serving to keep the plumb line straight and vertical as well as one of turned and finished metal.

Strongly illuminate the plumb line just below its support by a flash light or lantern, care being taken to obscure the source of light from the view of the observer.

For a peep sight nail two strips of tin or thin board with straight edges to a squared block of wood so that they will stand vertical about $\frac{3}{16}$ " apart when the block rests on a horizontal surface.

Provide a rest for the peep sight at a convenient height above the ground, at such a distance south of the plumb line that when viewed through the peep sight Polaris will appear about a foot below the support of the plumb line. The top of this rest must be level and large enough to allow for sliding the peep sight east or west. The position of the rest should be fixed by trial the night preceding that set for observations, and it should be firmly secured in the proper position.

About 30 min. before the time of elongation, as given in Table 143, bring the peep sight into the same line of sight with the plumb line and Polaris.

The star will move off the plumb line to the east as it approaches eastern elongation; to the west for western elongation. Move the peep sight to the west or east, as the case may be, keeping it in line with the star and the plumb line, until the star appears stationary, thus indicating that it has reached elongation. The peep sight will then be secured in place by a clamp or weight and further operations will be deferred until daylight.

By daylight place a slender rod at a distance of 200 or 300' from the peep sight and exactly in range with it and the plumb line; carefully measure this distance. (Text continued on Page 918.)

TABLE 143.—LOCAL CIVIL TIME OF UPPER CULMINATION OF POLARIS IN THE YEAR 1931
Computed for 90°, or 6 hours west of Greenwich

Date	Civil time of upper culmination	Variation per day	Date	Civil time of upper culmination	Variation per day
	h. m. s.	m. s.		h. m. s.	m. s.
Jan. 1	18 54 26	-3 57	July 10	6 27 12	-3 55
Jan. 11	18 14 56	-3 57	July 20	5 48 05	-3 55
Jan. 21	17 35 25	-3 57	July 30	5 08 57	-3 55
Jan. 31	16 55 54	-3 57	Aug. 9	4 29 50	-3 55
Feb. 10	16 16 24	-3 57	Aug. 19	3 50 41	-3 55
Feb. 20	15 36 55	-3 57	Aug. 29	3 11 31	-3 55
Mar. 2	14 57 27	-3 57	Sept. 8	2 32 21	-3 55
Mar. 12	14 18 00	-3 57	Sept. 18	1 53 10	-3 55
Mar. 22	13 38 36	-3 56	Sept. 28	1 13 57	-3 55
Apr. 1	12 59 14	-3 56	Oct. 8	0 34 42	-3 56
Apr. 11	12 19 54	-3 56	Oct. 17	23 55 25	-3 56
Apr. 21	11 40 36	-3 56	Oct. 27	23 16 07	-3 56
May 1	11 01 21	-3 56	Nov. 6	22 36 47	-3 56
May 11	10 22 06	-3 55	Nov. 16	21 57 25	-3 56
May 21	9 42 54	-3 55	Nov. 26	21 18 01	-3 56
May 31	9 03 44	-3 55	Dec. 6	20 38 35	-3 57
June 10	8 24 34	-3 55	Dec. 16	19 59 08	-3 57
June 20	7 45 27	-3 55	Dec. 26	19 19 40	-3 57
June 30	7 06 19	-3 55	Jan. 5, 1932	18 40 10	-3 57

TABLE 143A.—MEAN TIME INTERVAL BETWEEN UPPER CULMINATION AND ELONGATION

Latitude	Time interval	Latitude	Time interval	Latitude	Time interval	Latitude	Time interval
°	h. m.	°	h. m.	°	h. m.	°	h. m.
10	5 58.2	35	5 56.1	48	5 54.3	58	5 52.3
15	5 57.9	40	5 55.4	50	5 53.9	60	5 51.7
20	5 57.4	42	5 55.2	52	5 53.6	62	5 51.1
25	5 57.0	44	5 54.9	54	5 53.2	64	5 50.4
30	5 56 5	46	5 54.6	56	5 52.8		

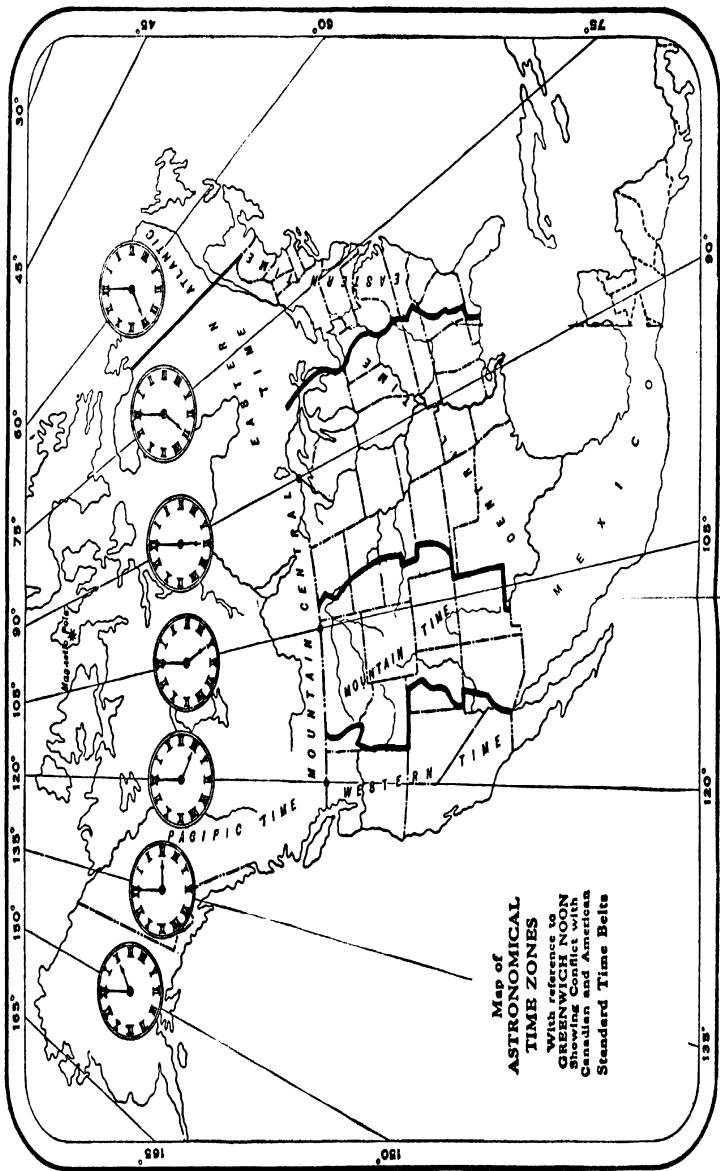

(Between Pages 914 and 915).

Fig. 207.

Footnote for Tables 143, 143A.

Eastern elongation precedes and western elongation follows upper culmination by the time interval given in Table 143A. Lower culmination precedes or follows upper culmination by 11^h 58^m.0. It should be noted that there are two upper culminations on one day in October (15th in 1931) and two lower culminations in April (16th in 1931). There are also two western elongations on one day in January and two eastern elongations on one day in July.

a. To Refer the Times in Table 143 to Other Years.—

1932, up to Mar. 1....	m.	1936, on and after Mar. 1	m.
1932, on and after Mar. 1	add 1.5		add 0.1
	subtract 2.4	1937.....	add 1.8
1933.....	subtract 0.8	1938.....	add 3.5
1934.....	add 0.8	1939.....	add 5.2
1935.....	add 2.4	1940, up to Mar. 1....	add 6.8
1936, up to Mar. 1....	add 4.0	1940, on and after Mar.	
		1.....	add 2.8

b. To Refer to Other Than the Tabular Days.—Subtract from the time for the preceding tabular day the product of the variation per day and the days elapsed, as given below:

Days elapsed	Variation per day			Days elapsed	Variation per day		
	3 ^m 57 ^s	3 ^m 56 ^s	3 ^m 55 ^s		3 ^m 57 ^s	3 ^m 56 ^s	3 ^m 55 ^s
1	m. s. 3 57	m. s. 3 56	m. s. 3 55	6	m. s. 23 42	m. s. 23 36	m. s. 23 30
2	7 54	7 52	7 50	7	27 39	27 32	27 25
3	11 51	11 48	11 45	8	31 36	31 28	31 20
4	15 48	15 44	15 40	9	35 33	35 24	35 15
5	19 45	19 40	19 35				

c. To Refer to Any Other Than the Tabular Longitude (90°).—Add 0^m.1 for each 10° east of the ninetieth meridian or subtract 0^m.1 for each 10° west of the ninetieth meridian.

d. To Refer to Standard Time.—Add to the quantities in Table 143 four minutes for every degree of longitude the place of observation is west of the standard meridian (60°, 75°, 90°, etc.). Subtract when the place is east of the standard meridian.

Table 144 was computed using the mean declination of Polaris for the beginning of each year. A more accurate result will be obtained by applying to the tabular values the following corrections, which depend on the difference between the mean and apparent place of the star.

Month	Correc- tion	Month	Correc- tion	Month	Correc- tion
January.....	-0.6	May.....	0.0	September...	-0.2
February.....	-0.5	June.....	+0.1	October.....	-0.4
March.....	-0.4	July.....	+0.1	November.....	-0.7
April.....	-0.2	August.....	0.0	December.....	-0.9

TABLE 144.—AZIMUTH OF POLARIS AT ELONGATION, 1931 TO 1940

Latitude	1931	1932	1933	1934	1935	1936	1937	1938	1939	1940
0	0	0	0	0	0	0	0	0	0	0
10	I 05.0	I 04.7	I 04.4	I 04.1	I 03.8	I 03.4	I 03.1	I 02.8	I 02.5	I 02.2
11	I 05.2	I 04.9	I 04.6	I 04.3	I 04.0	I 03.6	I 03.3	I 03.0	I 02.7	I 02.4
12	I 05.4	I 05.1	I 04.8	I 04.5	I 04.2	I 03.9	I 03.6	I 03.2	I 02.9	I 02.6
13	I 05.7	I 05.3	I 05.0	I 04.7	I 04.4	I 04.1	I 03.8	I 03.5	I 03.2	I 02.9
14	I 05.9	I 05.6	I 05.3	I 05.0	I 04.7	I 04.4	I 04.1	I 03.8	I 03.5	I 03.2
15	I 06.2	I 05.9	I 05.6	I 05.3	I 05.0	I 04.7	I 04.4	I 04.1	I 03.8	I 03.5
16	I 06.6	I 06.2	I 05.9	I 05.6	I 05.3	I 05.0	I 04.7	I 04.4	I 04.1	I 03.8
17	I 06.9	I 06.6	I 06.3	I 06.0	I 05.7	I 05.3	I 05.0	I 04.7	I 04.4	I 04.1
18	I 07.3	I 07.0	I 06.6	I 06.3	I 06.0	I 05.7	I 05.4	I 05.0	I 04.7	I 04.4
19	I 07.7	I 07.3	I 07.0	I 06.7	I 06.4	I 06.1	I 05.7	I 05.4	I 05.0	I 04.7
20	I 08.1	I 07.8	I 07.4	I 07.1	I 06.8	I 06.5	I 06.2	I 05.8	I 05.4	I 05.1
21	I 08.5	I 08.2	I 07.9	I 07.6	I 07.2	I 06.9	I 06.6	I 06.3	I 05.9	I 05.6
22	I 09.0	I 08.7	I 08.4	I 08.0	I 07.7	I 07.4	I 07.0	I 06.7	I 06.3	I 06.0
23	I 09.5	I 09.2	I 08.9	I 08.5	I 08.2	I 07.9	I 07.5	I 07.2	I 06.8	I 06.5
24	I 10.0	I 09.7	I 09.4	I 09.0	I 08.7	I 08.4	I 08.1	I 07.7	I 07.3	I 07.0
25	I 10.6	I 10.3	I 09.9	I 09.6	I 09.3	I 08.9	I 08.6	I 08.3	I 07.9	I 07.5
26	I 11.2	I 10.9	I 10.5	I 10.2	I 09.9	I 09.5	I 09.2	I 08.8	I 08.4	I 08.0
27	I 11.8	I 11.5	I 11.1	I 10.8	I 10.5	I 10.1	I 09.8	I 09.4	I 09.0	I 08.6
28	I 12.5	I 12.1	I 11.8	I 11.4	I 11.1	I 10.8	I 10.4	I 10.1	I 09.7	I 09.3
29	I 13.2	I 12.8	I 12.5	I 12.1	I 11.8	I 11.4	I 11.1	I 10.7	I 10.3	I 09.9
30	I 13.9	I 13.5	I 13.2	I 12.8	I 12.5	I 12.1	I 11.8	I 11.4	I 11.0	I 10.6
31	I 14.6	I 14.3	I 13.9	I 13.6	I 13.2	I 12.9	I 12.5	I 12.2	I 11.8	I 11.4
32	I 15.4	I 15.1	I 14.7	I 14.4	I 14.0	I 13.7	I 13.3	I 12.9	I 12.6	I 12.2
33	I 16.3	I 15.9	I 15.6	I 15.2	I 14.9	I 14.5	I 14.1	I 13.8	I 13.4	I 13.0
34	I 17.2	I 16.8	I 16.4	I 16.1	I 15.7	I 15.4	I 15.0	I 14.6	I 14.2	I 13.8

35	I	18.1	I	17.7	I	17.4	I	17.0	I	16.6	I	16.3	I	15.9	I	15.5	I	15.1	I	14.7
36	I	19.1	I	18.7	I	18.3	I	18.0	I	17.6	I	17.2	I	16.8	I	16.5	I	16.1	I	15.7
37	I	20.1	I	19.7	I	19.4	I	19.0	I	18.6	I	18.2	I	17.8	I	17.5	I	17.1	I	16.7
38	I	21.2	I	20.8	I	20.4	I	20.0	I	19.7	I	19.3	I	18.9	I	18.5	I	18.1	I	17.7
39	I	22.3	I	21.9	I	21.6	I	21.2	I	20.8	I	20.4	I	20.0	I	19.6	I	19.2	I	18.8
40	I	23.5	I	23.1	I	22.7	I	22.3	I	22.0	I	21.6	I	21.2	I	20.8	I	20.4	I	20.0
41	I	24.8	I	24.4	I	24.0	I	23.6	I	23.2	I	22.8	I	22.4	I	22.0	I	21.6	I	21.2
42	I	26.1	I	25.7	I	25.3	I	24.9	I	24.5	I	24.1	I	23.7	I	23.2	I	22.8	I	22.4
43	I	27.5	I	27.1	I	26.7	I	26.3	I	25.8	I	25.4	I	25.0	I	24.6	I	24.2	I	23.7
44	I	29.0	I	28.5	I	28.1	I	27.7	I	27.3	I	26.8	I	26.4	I	26.0	I	25.6	I	25.1
45	I	30.5	I	30.1	I	29.6	I	29.2	I	28.8	I	28.4	I	27.9	I	27.5	I	27.1	I	26.6
46	I	32.1	I	31.7	I	31.2	I	30.8	I	30.4	I	29.9	I	29.5	I	29.1	I	28.7	I	28.2
47	I	33.8	I	33.4	I	32.9	I	32.5	I	32.0	I	31.6	I	31.2	I	30.7	I	30.3	I	29.8
48	I	35.6	I	35.2	I	34.7	I	34.3	I	33.8	I	33.4	I	32.9	I	32.5	I	32.0	I	31.5
49	I	37.5	I	37.1	I	36.6	I	36.1	I	35.7	I	35.2	I	34.8	I	34.3	I	33.8	I	33.3
50	I	39.5	I	39.1	I	38.6	I	38.1	I	37.7	I	37.2	I	36.7	I	36.2	I	35.7	I	35.2

(Text continued from Page 914.)

Find from Table 144 the azimuth of Polaris for the year of observation and the latitude of the place.

Find from the table on page 918 the natural tangent of this angle and multiply it by the distance from the peep sight to the rod. The product will be the distance to be laid off from the rod, to the west in the case of eastern elongation, or to the east for western elongation, to a point which with the peep sight will define the direction of the true meridian with a fair degree of accuracy. Set a stake at this point and another exactly below the deep sight, if the meridian is needed for future use.

NATURAL TANGENT OF ANGLES FROM 1° 00' TO 1° 50'

Angle	Tan- gent	Angle	Tan- gent	Angle	Tan- gent	Angle	Tan- gent	Angle	Tan- gent
00	0.01746	100	0.2036	200	0.2328	300	0.2619	400	0.2910
01	0.01775	110	0.2066	210	0.2357	310	0.2648	410	0.2939
02	0.01804	120	0.2095	220	0.2386	320	0.2677	420	0.2968
03	0.01833	130	0.2124	230	0.2415	330	0.2706	430	0.2997
04	0.01862	140	0.2153	240	0.2444	340	0.2735	440	0.3026
05	0.01891	150	0.2182	250	0.2473	350	0.2764	450	0.3055
06	0.01920	160	0.2211	260	0.2502	360	0.2793	460	0.3084
07	0.01949	170	0.2240	270	0.2531	370	0.2822	470	0.3114
08	0.01978	180	0.2269	280	0.2560	380	0.2851	480	0.3143
09	0.02007	190	0.2298	290	0.2589	390	0.2881	490	0.3172
10	0.02036	200	0.2328	300	0.2619	400	0.2910	500	0.3201

METHOD NO 2

Noting When Polaris and Another Star are in the Same Vertical Plane.—For places north of latitude 35° , the true meridian may be determined by taking advantage of the fact that two bright stars in the northern heavens cross the meridian on opposite sides of the pole only a few minutes before Polaris. These stars are the ones known as Zeta (ζ) Ursæ Majoris or Mizar and Delta (δ) Cassiopeiæ. Their positions in the constellations are shown in the accompanying diagram page 920.

Select that one of the two stars which at the time of the year when observations are to be made passes the meridian below the pole. When the star passes the meridian above the pole it is too near the zenith to be used. Delta Cassiopeiæ is on the meridian below the pole at midnight about Apr. 10, and is, therefore, the proper star to use at that date and for 3 months before and after. For the other 6 months of the year Zeta Ursæ Majoris will be the proper star to use. In the long days of June and July the lower culmination of both stars occurs during daylight, so that the method cannot be used.

Using the apparatus described under Observations of Polaris at Elongation, keep the peep sight in line with the plumb line and Polaris until the selected star also appears upon the plumb line. Carefully note the time when this occurs. Then, by moving the peep sight, continue to preserve its alignment with Polaris and the plumb line (paying no further attention to the other star). At the expiration of 12.5 min. (in 1922) Polaris will be on the meridian and the peep sight and plumb line will then define a true north and south line, which may be permanently marked for future use. *For each year subsequent to 1922 the interval increases approximately half a minute.*

As the pole distance of Delta Cassiopeiæ is 35° and that of Zeta Ursæ Majoris is 40° , this method cannot be used for the southern part of the United States where the stars are below the horizon at lower culmination. See page 920 for Star diagram.

USUAL METHOD NO. 3

Observations of Polaris at Elongation.—With a surveyor's transit the true meridian may be determined by observing Polaris at elongation as follows:

Select a station for observing which affords a good view of the northern sky and with the ground clear for at least 100 yd. to the north.

If the station is to be used for determining the magnetic declination, care should be taken to have it well removed from electric car lines, buildings, and other possible sources of disturbance. If a meridian line is to be established for future use, the ends should be placed so that they may be protected from disturbance.

Mark the observing station in a suitable manner; for example, by a stone post with a drill hole in the top, set firmly in the ground. *Be sure the transit is in perfect adjustment (see page 853).*

About 30 min. before the time of elongation of Polaris, derived from Table 143, set up the transit with its vertical axis exactly

SURVEY DATA

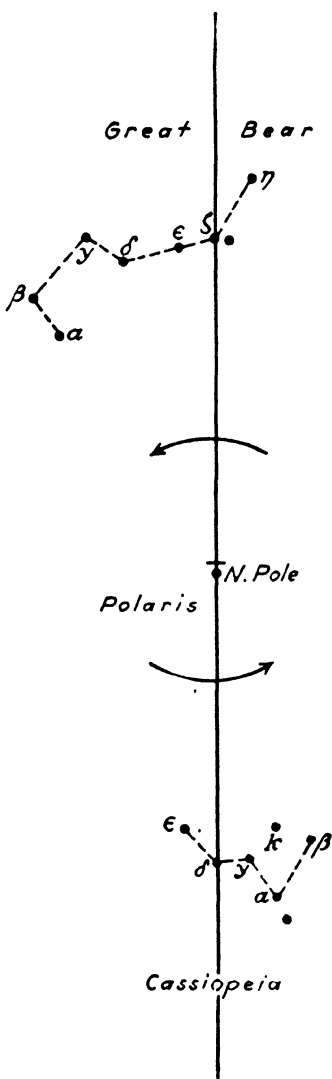

over the station mark and carefully level the instrument. It is essential that the transverse axis of the telescope be horizontal. This should be tested in the daytime by pointing on the vertical edge of a house and noting whether the vertical cross-wire continues to coincide with the edge of the house as the telescope is turned in altitude.

Illuminate the cross-wires by the light from a bull's-eye lantern or a pocket flashlight directed obliquely into the object end of the telescope by an assistant.

Point the telescope at the star and clamp the horizontal circle. Keep the star covered by the vertical cross-wire by means of the tangent screw of the vernier plate, until a point is reached where it appears to move up or down along the wire without moving away from it, thus indicating that elongation has been reached.

Depress the telescope to the horizontal position; about 100 yd. north of the instrument drive a stake and mark a point on its top exactly coincident with the vertical wire of the telescope. This will require a second assistant and light. Turn the vernier plate 180° and again set the vertical wire on the star, clamp the horizontal circle, depress the telescope, and mark another point on the stake. The point midway between the two marks, with the point under the instrument, will define on the ground the vertical plane through Polaris at its eastern or western elongation, as the case may be.

Near elongation the azimuth of the star changes very slowly, not more than $0'.1$ in the 10 min. before or after elongation in the United States, so that there is plenty of time to make the second pointing after reversal, if there is no unnecessary delay.

By daylight lay off the proper angle taken from Table 144, to the east for western elongation and to the west for eastern elongation, and place a suitable marker to mark the north end of a meridian line of which the station marker will be the south end. The angle should be measured both before and after reversal, as in the case of the star.

METHOD No. 4

Observations of Polaris at Any Hour.—The methods thus far described have the great advantage that an accurate knowledge of the time is not required, but they are not always convenient, as the elongation or culmination of Polaris does not always come at a convenient time for observing and the star may happen to be obscured just at that time.

The true meridian may be determined to the nearest minute of arc by observations of Polaris at any hour when the star is visible, provided the local mean time is known within 1 minute, as in the extreme case when Polaris is at culmination its azimuth changes $1'$ of arc in about 2 minutes of time in latitude 50° , and $1'$ of arc in about 3 minutes of time in latitude 20° . The standard time can usually be obtained at a telegraph office or directly by radio from the signals sent out from observatories. From this the local mean time may be derived by subtracting 4 min. of time for every degree of longitude west of the standard time meridian for the place of the observation (see page 914 for time zones) or adding 4 min. for every degree east of the standard meridian.

TABLE 145.—AZIMUTH OF POLARIS AT ALL HOUR ANGLES

Computed for declination 88° 53' 25". For hour angles 0h to 12h the star is west of north, and from 12h to 24h it is east of north.

Lat. H.A.	10°	15°	20°	25°	30°	32°	34°	36°	38°	40°	42°	44°	46°	48°	50°	Lat.
	H.A.	H.A.	H.A.	H.A.	H.A.	H.A.	H.A.	H.A.	H.A.	H.A.	H.A.	H.A.	H.A.	H.A.	H.A.	H.A.
0 00	00.0	00.0	00.0	00.0	00.0	00.0	00.0	00.0	00.0	00.0	00.0	00.0	00.0	00.0	00.0	h. m.
0 10	03.0	03.0	03.1	03.2	03.4	03.5	03.5	03.6	03.7	03.9	04.0	04.1	04.3	04.4	04.6	24 00
0 20	05.0	06.0	06.2	06.4	06.8	06.9	07.1	07.3	07.5	07.7	07.9	08.2	08.5	08.9	09.2	23 50
0 30	08.9	09.1	09.3	09.7	10.1	10.4	10.6	10.9	11.2	11.5	11.8	12.3	12.8	13.3	13.8	30
0 40	11.8	12.0	12.4	12.9	13.5	13.8	14.1	14.5	14.9	15.3	15.8	16.4	17.0	17.7	18.4	20
0 50	14.7	15.0	15.4	16.1	16.8	17.2	17.6	18.1	18.6	19.1	19.7	20.4	21.2	22.0	22.9	10
1 00	17.6	17.0	18.5	19.2	20.1	20.6	21.0	21.6	22.2	22.9	23.6	24.4	25.3	26.3	27.4	23 00
1 10	20.4	20.8	21.5	22.3	23.4	23.0	24.4	25.1	25.8	26.6	27.4	28.3	29.4	30.5	31.8	22 50
1 20	23.2	23.7	24.4	25.4	26.6	27.2	27.8	28.5	29.3	30.2	31.2	32.2	33.4	34.7	36.2	40
1 30	26.0	26.5	27.3	28.4	29.7	30.4	31.1	31.9	32.8	33.8	34.9	36.0	37.4	38.8	40.5	30
1 40	28.7	29.3	30.1	31.3	32.8	33.5	34.3	35.2	36.2	37.3	38.5	39.8	41.3	42.9	44.7	20
1 50	31.3	32.0	32.9	34.2	35.8	36.6	37.5	38.5	39.5	40.7	42.0	43.5	45.1	46.8	48.8	10
2 00	33.9	34.6	35.6	37.0	38.8	39.7	40.6	41.7	42.8	44.1	45.5	47.0	48.8	50.7	52.8	22 00
2 10	36.4	37.2	38.3	39.8	41.7	42.6	43.6	44.8	46.0	47.4	48.9	50.5	52.4	54.5	56.7	21 50
2 20	38.9	39.7	40.9	42.5	44.5	45.4	46.6	47.8	49.1	50.5	52.1	53.9	55.9	58.1	60.5	40
2 30	41.3	42.1	43.4	45.1	47.2	48.3	49.4	50.7	52.1	53.6	55.3	57.2	59.3	61.6	64.2	30
2 40	43.0	44.5	45.8	47.6	49.8	50.9	52.1	53.5	55.0	56.6	58.4	60.4	62.6	65.0	67.8	20
2 50	45.8	46.8	48.1	50.0	52.4	53.5	54.8	56.2	57.7	59.4	61.3	63.4	65.7	68.3	71.2	10
3 00	47.9	48.9	50.4	52.3	54.8	56.0	57.3	58.8	60.4	62.1	64.1	66.3	68.7	71.4	74.5	21 00
3 10	50.0	51.0	52.5	54.5	57.1	58.4	59.7	61.3	62.9	64.8	66.8	69.1	71.6	74.4	77.6	20 50
3 20	51.9	53.0	54.5	56.6	59.3	60.6	62.0	63.8	65.3	67.3	69.4	71.8	74.4	77.3	80.6	40
3 30	53.7	54.9	56.5	58.6	61.4	62.8	64.2	66.0	67.6	69.6	71.8	74.3	77.0	80.0	83.4	30
3 40	55.5	56.6	58.3	60.5	63.4	64.8	66.3	68.0	69.8	71.9	74.1	76.6	79.4	82.5	86.0	20
3 50	57.1	58.3	60.0	62.3	65.2	66.7	68.2	70.0	71.8	74.0	76.3	78.8	81.7	84.9	88.4	10

POLARIS MERIDIAN

4	00	0	58.7	0	59.9	01.6	03.9	07.0	08.4	10.0	11.8	13.7	15.9	18.3	20.9	23.8	27.1	30.7	20	00
	10	1	00.1	1	01.3	03.1	05.4	08.6	10.0	11.7	13.5	15.5	17.7	20.1	22.8	25.8	29.1	32.8	19	50
	20	0	1.4	0	2.6	04.4	06.8	10.0	11.5	13.2	15.0	17.1	19.3	21.8	24.5	27.6	31.0	34.8	40	00
	30	0	2.6	0	3.8	05.6	08.1	11.3	12.9	14.6	16.4	18.5	20.8	23.3	26.1	29.2	32.7	36.5	30	30
	40	0	3.6	0	4.9	06.7	09.2	12.5	14.1	15.8	17.7	19.8	22.1	24.7	27.5	30.7	34.2	38.1	20	20
	50	0	4.5	0	5.9	07.7	10.2	13.6	15.2	16.9	18.8	20.9	23.3	25.9	28.8	32.0	35.5	39.5	10	10
5	00	05.4	06.7	08.6	11.1	14.5	18.1	21.9	26.1	30.3	35.1	40.6	46.8	53.6	60.9	68.8	77.1	85.8	19	00
	10	06.1	07.4	09.3	11.9	15.3	19.0	23.0	27.2	31.5	36.3	41.7	47.6	54.0	60.9	68.4	76.7	85.5	18	50
	20	06.6	08.0	09.9	12.5	15.9	19.5	23.4	27.8	32.1	36.9	42.3	48.1	54.4	61.3	68.8	77.1	85.9	40	40
	30	07.1	08.4	10.3	12.9	16.4	19.8	23.9	28.3	32.6	37.4	42.6	48.3	54.5	61.4	68.9	77.2	86.0	30	30
	40	07.4	08.7	10.6	13.2	16.7	18.3	20.1	22.1	24.3	26.7	29.4	32.4	35.6	39.3	43.4	47.9	52.6	20	20
	50	07.6	08.9	10.8	13.4	16.9	18.5	20.3	22.3	24.5	26.9	29.6	32.5	35.8	39.5	43.6	48.1	52.8	10	10
6	00	07.6	08.9	10.8	13.5	16.9	18.5	20.3	22.3	24.5	26.9	29.6	32.5	35.8	39.5	43.6	48.1	52.8	18	00
	10	07.5	08.8	10.7	13.4	16.8	18.4	20.2	22.2	24.4	26.8	29.4	32.2	35.1	38.4	42.1	46.0	50.1	17	50
	20	07.3	08.6	10.5	13.1	16.5	18.1	19.9	21.9	24.1	26.5	29.1	31.8	34.6	37.5	40.5	43.6	46.9	40	40
	30	07.0	08.3	10.2	12.7	16.1	17.7	19.5	21.4	23.6	26.0	28.6	31.5	34.5	37.5	40.6	43.8	47.1	30	30
	40	06.5	07.8	09.7	12.2	15.6	17.2	18.9	20.8	23.0	25.4	28.0	30.8	33.7	36.6	39.6	42.7	45.9	20	20
	50	05.9	07.2	09.1	11.6	14.9	16.5	18.2	20.1	22.2	24.6	27.2	30.0	32.8	35.7	38.6	41.6	44.6	10	10
7	00	05.2	06.5	08.3	10.8	14.1	15.6	17.3	19.2	21.3	23.6	26.2	29.0	31.8	34.6	37.4	40.3	43.2	17	00
	10	04.4	05.6	07.4	09.9	13.1	14.6	16.3	18.2	20.2	22.5	25.0	27.8	30.9	34.3	38.1	41.6	45.2	16	50
	20	03.5	04.7	06.4	08.8	12.0	13.5	15.1	17.0	19.0	21.2	23.7	26.4	29.5	32.8	36.6	40.1	43.7	40	40
	30	02.4	03.6	05.3	07.6	10.7	12.2	13.8	15.6	17.6	19.8	22.2	24.9	27.9	31.2	34.9	38.4	42.4	30	30
	40	01.2	02.3	04.0	06.3	09.3	10.8	12.4	14.1	16.1	18.2	20.6	23.2	26.1	29.4	33.0	36.0	39.0	20	20
	50	00.9	01.0	02.6	04.9	07.8	09.3	10.8	12.5	14.4	16.5	18.8	21.4	24.2	27.4	30.9	34.0	37.0	10	10
8	00	58.5	59.5	1	01.1	03.3	06.2	07.6	09.1	10.8	12.6	14.7	16.9	19.4	22.2	25.3	28.7	32.4	16	00
	10	59.9	58.0	0	00.0	01.7	04.5	05.8	07.3	09.0	10.7	12.7	14.9	17.3	20.0	23.0	26.3	30.0	15	50
	20	55.3	56.3	0	03.9	02.6	03.9	05.9	06.9	08.6	10.5	12.7	15.0	17.6	20.5	23.7	27.0	30.5	40	40
	30	53.5	54.5	0	05.6	01.8	03.2	04.7	06.4	08.3	10.3	12.6	15.1	17.9	21.0	24.2	27.4	30.9	30	30
	40	51.7	52.6	0	05.0	01.0	02.5	04.1	05.9	07.9	10.1	12.5	15.2	18.2	21.2	24.4	27.6	30.9	20	20
	50	49.7	50.6	0	02.0	01.1	01.7	03.4	05.2	07.4	09.7	12.3	15.2	18.2	21.2	24.4	27.6	30.9	10	10
9	00	47.7	48.6	0	49.8	51.6	53.9	55.0	56.3	57.6	59.1	60.8	62.6	64.6	66.8	69.3	72.1	75.1	15	00
	10	45.6	46.4	0	47.6	49.3	51.5	52.6	53.7	55.0	56.5	58.0	59.8	61.7	63.8	66.0	68.4	71.0	14	50
	20	43.3	44.1	0	45.3	46.9	49.0	50.0	51.1	52.3	53.7	55.2	56.8	58.6	60.5	62.5	64.6	66.8	40	40
	30	41.0	41.8	0	42.9	44.4	46.4	47.3	48.4	49.6	50.8	52.2	53.7	55.2	56.8	58.5	60.3	62.1	30	30
	40	38.7	39.4	0	40.4	41.8	43.7	44.6	45.6	46.7	47.9	49.2	50.7	52.3	54.1	55.9	57.6	59.4	20	20
	50	36.2	36.9	0	37.8	39.2	40.9	41.8	42.7	43.7	44.8	46.1	47.4	48.9	50.6	52.5	54.5	56.6	14	10

The selection and marking of the observing station and the adjustment of the theodolite will be done as in the case of observations of Polaris at elongation. As the observations are to be made when the azimuth of the star is changing, it will be preferable to provide an azimuth mark, such as a light showing through a slit in a box, and make a series of measures of the angle between the mark and the star. The light used to illuminate the cross-wires of the telescopes may be used also in reading the horizontal circle.

Begin by pointing on the mark and reading the horizontal circle. Point on the star, record the exact time and the reading of the circle. Turn the vernier plate 180° in azimuth and again point on the star, recording the time and circle reading as before. Finally, point on the mark again and read the circle. The number of pointings in a set may be increased or additional sets may be taken to secure greater accuracy. The azimuth of Polaris for the local mean time of observation will be derived from Table 145 in the manner explained below.

The following example explains the use of the table and the derivation of the hour angle of Polaris:

Position, latitude $36^\circ 20'$ N., longitude $80^\circ 07'.5$ or $5^h 20^m 30^s$ W. of Greenwich.			
Time of observation, July 10, 1923, standard (75th meridian) mean time.....	h.	m.	s.
Reduction to local time.....	8	52	40 p. m.
	-	20	30
Local mean time.....	8	32	10
Reduction to sidereal time (table 3, American Ephemeris)	+	01	24
Sidereal time mean noon, Greenwich, July 10, 1923.....	7	09	33
Correction for longitude $5^h 20^m 30^s$ (table 3, American Ephemeris).....	+	00	53
Local sidereal time.....	15	44	00
Apparent right ascension of Polaris, July 10, 1923.....	1	33	47
Hour angle before upper culmination.....	9	49	47
Declination for which Table 145 applies.....	88	53	25
Apparent declination, July 10, 1923.....	88	53	19
Decrease in declination.....			06
Azimuth from Table 145 (interpolated).....	0	44.0	
Correction for $6''$ decrease in declination, table on page 927.....	+	0	1
Computed azimuth.....	0	44.1	east of north.

It is to be remembered that Polaris is east of the meridian for 12 hr. before, and west of the meridian for 12 hr. after, upper culmination.

Without the American Ephemeris the table may be conveniently used for obtaining the true meridian, in connection with Table 143 giving the approximate mean times of culminations of Polaris.

Time of observation, July 10, 1923, standard (75th meri-				
dian) mean time.....		h.	m.	s.
Reduction to local mean time.....		8	52	40 p. m.
		-	20	30
Local mean time.....		8	32	10
Local mean time of upper culmination of Polaris (Table 143 and A).....		18	20	18
Mean time of observation before upper culmination		9	48	08
Reduction to sidereal time.....		+	01	38
Hour angle before upper culmination.....		9	49	46
Declination for which Table 145 applies.....	88	53	25	
Declination July 15, 1923.....	88	53	19	
Decrease in declination.....			06	
Azimuth from Table 145.....	0	44.0		
Correction for 6" decrease in declination, table on page 927.....	+	0.1		
Computed azimuth.....	0	44.1	east of north.	

Tables are generally given in books on surveying for reducing mean solar to sidereal time, but for this computation it is near enough to consider the correction 10^a an hour, as the stars gain very nearly 4 min. on the sun each day.¹

Table 145 is taken from the American Ephemeris for 1922, and was computed for a declination of Polaris of $88^{\circ} 53' 25''$. For other declinations the corrections given in the following table should be applied. The correction is very nearly proportional to the azimuth and amounts to a decrease of $0'.9$ in azimuth for an increase of declination of $1'$ for an azimuth of $60'$. The above declination is very nearly a mean value for the year 1922, the declination varying during the year as follows:

	°	'	"		°	'	"
January 15.....	88	53	35	July 15.....	88	53	03
February 15.....		53	33	August 15.....		53	07
March 15.....		53	26	September 15.....		53	16
April 15.....		53	17	October 15.....		53	27
May 15.....		53	08	November 15.....		53	38
June 15.....		53	03	December 15.....		53	47

The annual increase in declination of Polaris is about $16''$.

¹ The sidereal correction always increases the hour angle.

CORRECTION TO TABULAR AZIMUTHS FOR OTHER DECLINATIONS

Azimuth.....	0'	20'	40'	60'	80'	100'	120'
Declination:	/	/	/	/	/	/	/
88 53 25	0.0	0.0	0.0	0.0	0.0	0.0	0.0
53 30	0.0	0.0	-0.1	-0.1	-0.1	-0.1	-0.2
53 35	0.0	0.0	0.1	0.2	0.2	0.3	0.3
53 40	0.0	-0.1	0.2	0.2	0.3	0.4	0.5
53 45	0.0	0.1	0.2	0.3	0.4	0.5	0.6
53 50	0.0	0.1	0.3	0.4	0.5	0.6	0.8
53 55	0.0	0.2	0.3	0.5	0.6	0.8	0.9
54 00	0.0	0.2	0.4	0.5	0.7	0.9	1.1
54 05	0.0	0.2	0.4	0.6	0.8	1.0	1.2
54 10	0.0	0.2	0.5	0.7	0.9	1.1	1.4
54 15	0.0	0.2	0.5	0.8	1.0	1.3	1.5
54 20	0.0	0.3	0.6	0.8	1.1	1.4	1.7
54 25	0.0	-0.3	-0.6	-0.9	-1.2	-1.5	-1.8

METHOD No. 5

Solar Meridian by Direct Observation with an Ordinary Transit.

Where the method of Polaris at elongation is not used, direct solar observation is the most convenient method of meridian determination, as, while it involves more computation and introduces more chances of error, the work can be done during daylight hours and the accuracy that can be attained (within 01' of arc) with the usual facilities is close enough for all practical purposes of ordinary surveys.

There are a number of different forms of the fundamental formulas governing the determination; the following form has found considerable favor:

$$\tan^2 \frac{1}{2}A = \frac{\sin [S - (90^\circ - \text{alt.})] \sin [S - (90^\circ - \text{lat.})]}{\sin S \sin [S - (90^\circ - \text{dec.})]}$$

In the formula, A is the angle of the sun from the true north measured to the right in the morning and to the left in the afternoon.

S is one-half the sum of (90° - the observed altitude of the sun corrected for refraction) plus (90° - the latitude of the point of observation) plus (90° - the declination of the sun at the time of observation).

NOTE.—Notice carefully the sign of the declination. A south declination is a - declination which would make the expression ($90^\circ - (-\text{south declination}) = 90^\circ + \text{south declination}$).

A solar ephemeris from which the sun's declination is found is necessary for the computations. All instrument makers publish small pocket editions each year which can be obtained from them for 10 cts.

An ordinary well-regulated watch set for standard time at the nearest telegraph office serves for the time determination on which

the sun's declination depends and any good transit with vertical circle can be used for observing the horizontal angle and altitude of the sun, but observers are cautioned that it must be in good adjustment and the observer must work with reasonable care.

If standard time is not available, mean local time can be determined by observation, as explained later on page 930.

The latitude of the point of observation can generally be determined closely enough from U. S. Geological Survey maps or Land Office maps, and if these are not available can be determined by observation as explained on page 929.

Longitude for standard time correction can be taken from any good map. If these are not available, determine local mean time by observation.

Considering all the different sources of error, time, latitude and observed altitude the best time of day to make the observation is between 9 and 10 a. m. and between 2 and 3 p. m.

Table 146 gives the correction for observed altitude due to atmospheric refraction. This correction is always minus as the sun always appears to be higher than it actually is.

TABLE 146.—MEAN REFRACTIONS DUE TO ALTITUDE
Barometer 30", Thermometer 50°F.

App. Alt.	Ref.	App. Alt.	Ref.	App. Alt.	Ref.	App. Alt.	Ref.
5°	9' 46"	10°	5' 16"	20°	2' 37"	50°	0' 48"
6°	8' 23"	12°	4' 25"	25°	2' 03"	60°	0' 33"
7°	7' 20"	14°	3' 47"	30°	1' 40"	70°	0' 21"
8°	6' 30"	16°	3' 19"	35°	1' 22"	80°	0' 10"
9°	5' 49"	18°	2' 56"	40°	1' 09"	90°	0' 0"

A TABLE OF SEMIDIAMETERS OF THE SUN

Jan. 1, 16'18"	Apr. 1, 16'02"	July 1, 15'46"	Oct. 1, 16'01"
Feb. 1, 16'16"	May 1, 15'54"	Aug. 1, 15'48"	Nov. 1, 16'09"
Mar. 1, 16'10"	June 1, 15'48"	Sept. 1, 15'53"	Dec. 1, 16'15"

Effect of Errors in Latitude and Declination on Meridian Determination.—It is well to bear in mind the effect of wrong latitude, or time (which affects the declination), on your meridian computations.

Table 147 prepared by Prof. J. B. Johnson of Washington University, St. Louis, Mo., reprinted in the Metro Manual of the Bausch & Lomb Optical Co., shows the effect of error in latitude and declination for different latitudes and different hours in the day.

TABLE 147.—ERRORS IN AZIMUTH (BY SOLAR OBSERVATION) FOR 1' ERRORS IN DECLINATION AND LATITUDE

Hour	For 1 Min. Error in Declination				For 1 Min. Error in Latitude			
	Lat. 30°	Lat. 40°	Lat. 50°	Lat. 60°	Lat. 30°	Lat. 40°	Lat. 50°	Lat. 60°
11.30 A. M.	8.85	10.00	11.92	14.07	8.87	9.92	11.82	13.56
12.30 P. M.								
11.00 A. M.	4.46	5.04	6.01	7.68	4.31	4.87	5.81	6.37
1.00 P. M.								
10.00 A. M.	2.31	2.61	3.11	4.00	2.00	2.26	2.69	3.46
2.00 P. M.								
9.00 A. M.	1.63	1.85	2.20	2.83	1.15	1.31	1.56	2.00
3.00 P. M.								
8.00 A. M.	1.33	1.51	1.80	2.31	0.67	0.75	0.90	1.15
4.00 P. M.								
7.00 A. M.	1.20	1.35	1.61	2.07	0.31	0.35	0.42	0.54
5.00 P. M.								
6.00 A. M.	1.15	1.31	1.56	2.00	0.00	0.00	0.00	0.00
6.00 P. M.								

Stated simply, this means that, if the observations are taken between 9 and 10 o'clock as recommended, for the most unfavorable conditions of fast-changing declination an error of time of 15 min. will result in an error of 01' of arc on the meridian computations.

It is well to check the latitude by observation unless your location is well fixed on a very reliable map. A simple method of latitude determination is quoted from the Metro Manual of the Bausch & Lomb Optical Co.

LATITUDE DETERMINATIONS

"Latitude may be variously determined by observing the transit of a star, by a mean altitude of Polaris, or by a direct observation on the altitude of the sun at apparent noon.

"Owing to the earth's annual motion in its orbit, the sun changes his position along the ecliptic with respect to the stars at a not altogether uniform rate, so that some solar days are either longer or shorter than others.

"For the reason that a chronometer could not conveniently be made to change its speed to suit this solar phenomenon, there has been established a uniform system of time called 'mean solar time.' The difference between mean noon, when the sun should be on the meridian, and apparent noon when the sun actually is on the meridian, is called the 'Equation of Time.' The tabular corrections will be found in the Ephemeris tables.

"Thus, in early November the sun has passed the meridian more than 16 min. before mean noon. It is always well to begin latitude observations some 20 min. before local noon, although there will be seasons of the year when the sun will not attain its greatest altitude until after local noon.

"Standard time will also qualify the argument, but this should be studied out by reference to the map on page 914. In western Texas, for instance observations need not begin until nearly 1 o'clock standard time; whereas in Erie, Pa., they should begin shortly after 11.

"Procedure.—Follow up the lower limb of the sun, and when the maximum altitude is found add the sun's semidiameter, as given on page 928, to the reading on the vertical circle; subtract correction for atmospheric refraction,

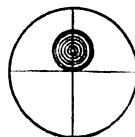

FIG. 298.

as figured by interpolation from the table (p. 928), and correct this result by the sun's declination, adding if south and subtracting if north. The final result is the colatitude or the polar distance ($90^\circ - \text{latitude}$).'

To find the latitude subtract the colatitude from 90° , *i.e.*, latitude = $90^\circ - \text{colatitude}$.

Time.—In case telegraphic standard time is not available determine the meridian by Polaris at elongation and then the mean local time can be obtained by the transit of Polaris across the meridian by referring to Table 143 (p. 914) or by the apparent sun time when it crosses the meridian at noon connected to mean time as given in the Ephemeris referred to on page 927 which can be obtained from any instrument maker.

SOLAR MERIDIAN BY DIRECT OBSERVATION, PROCEDURE, AND EXAMPLE OF COMPUTATION

Procedure.—An ordinary transit with one-half vertical circle in good adjustment will give satisfactory results, although it is convenient to have a machine with a full vertical circle and a masked prismatic eyepiece for direct observation.

When using an ordinary transit remove the cap from the eyepiece and then by focusing the eyepiece and objective lenses correctly

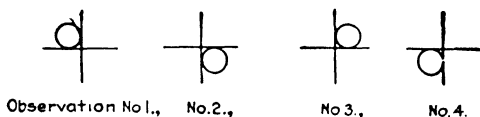

a sharp well-defined image of both cross-wires and sun can be projected onto a piece of white paper held a few inches back of the eyepiece. The vertical and horizontal angles to the sun can then be read by bringing the image of the sun tangent to the image of the vertical and horizontal wires simultaneously and the time recorded. Two, four, or six observations are made as rapidly as possible with the image of the sun alternately in opposite quadrants and the average time, average vertical angle, and average horizontal angle used in the computations.

Example.—Solar meridian observations at Lima, Ohio, Jan. 18, 1918.

Average time of four observations, 2.42 p. m. Central Standard time.

Average horizontal angle (mark to sun).....	132° 22' 00''
Average vertical angle to sun.....	16° 37' 00''
Longitude of Lima.....	84° 07' 00''
Latitude of Lima.....	40° 45' 00''
Observed altitude of sun.....	16° 37' 00''
Refraction correction.....	— 3' 00''
Corrected altitude.....	16° 34' 00''
Latitude.....	40° 45' 00''
Declination at time of observation.....	S. 20° 34' 30''

Declination Computation.—Observed standard time (central 90th meridian) 2.42 p. m. Lima is $5^{\circ} 53'$ east of the 90th meridian. To get the correct local mean time add to the recorded time 4 min. for each degree of longitude east of the 90th meridian or $4 \times 5.9^{\circ} = 23.6$ min. (say 24 min.).

Correct local mean time of observation 3.06 p. m.

Take from the Ephemeris the sun's declination at Greenwich mean noon of Jan. 18, 1918 = S. $20^{\circ} 38.9'$.

Lima is $84^{\circ} 07'$ west of Greenwich, or its mean local time is 5 hr. and 36 min. earlier, that is, the local mean time of Lima at Greenwich mean noon is 6.24 a. m. and the sun's declination for 6.24 a. m. Lima local mean time is S. $20^{\circ} 38.9'$.

The declination is decreasing at the rate of $30''$ per hour. The time of observation 3.06 p. m. local mean time is 8 hr. and 42 min. later than 6.24 a. m. and the declination for the time of observation is therefore:

$$\begin{aligned} \text{Declination at 6.24 a. m. Lima} &= \text{S. } 20^{\circ} 38.9' \\ 8.7 \text{ hr.} \times 0.5' \text{ (} 30'' \text{ hourly change)} &= \text{--- } 4.3' \\ \text{Declination at time of observation} &= \text{S. } 20^{\circ} 34.6' \\ &= \text{S. } 20^{\circ} 34' 36'' \\ \text{Say} &= \text{S. } 20^{\circ} 34' 30'' \end{aligned}$$

It should be remembered that a south declination is a minus declination. Be careful of your signs in the following formula: Applying the formula

$$\begin{aligned} \tan^2 \frac{1}{2}A &= \frac{\sin [S - (90^{\circ} - \text{alt.})] \sin [S - (90^{\circ} - \text{lat.})]}{\sin S \sin [S - (90^{\circ} - \text{dec.})]} \\ S &= (90^{\circ} - 16^{\circ} 34') + (90^{\circ} - 40^{\circ} 45') + (90^{\circ} - (-20^{\circ} 34' 33'')) \\ &= 73^{\circ} 26' + 49^{\circ} 15' + 110^{\circ} 34' 30'' = 116^{\circ} 37' 45'' \\ S - (90^{\circ} - \text{alt.}) &= 43^{\circ} 11' 45'' \\ S - (90^{\circ} - \text{lat.}) &= 67^{\circ} 22' 45'' \\ S - (90^{\circ} - \text{dec.}) &= 6^{\circ} 03' 15'' \\ \log \sin 43^{\circ} 11' 45'' &= 9.835 3697 \\ \log \sin 67^{\circ} 22' 45'' &= 9.965 2348 \\ \text{colog sin } (180^{\circ} - 116^{\circ} 37' 45'') &= 0.048 6988 \\ \text{colog sin } 6^{\circ} 03' 15'' &= 0.076 8768 \\ \log \tan^2 \frac{1}{2}A &= 2 \overline{) 20.826 1801} \\ \log \tan \frac{1}{2}A &= 0.413 0900 \\ \frac{1}{2}A &= 68^{\circ} 52' 45'' \\ A &= 137^{\circ} 45' 30'' \end{aligned}$$

As the observation was in the afternoon the angle between the sun and true north is $137^{\circ} 45' 30''$ to the west of north. The azimuth from the instrument to the sun is therefore $360^{\circ} - 137^{\circ} 45' 30'' = 222^{\circ} 14' 30''$.

The true azimuth from the instrument to the mark is therefore $222^{\circ} 14' 30'' - 132^{\circ} 22' = 89^{\circ} 52' 30''$.

To mark the true meridian on the ground turn off an angle of $89^{\circ} 52' 30''$ to the left from the reference mark used in the observation.

The Ross Meridiograph.—If much meridian work is being done it will pay to obtain the Ross Meridiograph, which graphically solves the solar meridian to the nearest minute. It is quick and simple to use and eliminates the one drawback of the direct observation, namely, the extended computations.

STADIA MEASUREMENTS

An expert instrumentman with a first-class transit can get more accurate results in rough country, providing the atmospheric conditions are steady, by the use of the stadia method of measurement than by the ordinary chaining of the average survey gang. The author has for a number of years worked under a restriction of a closure of less than $5.0'$ to the mile, which is better than can be attained by ordinary chainmen in hard topography. The method is quick and reliable and is to be preferred in open country. Chaining is to be preferred in heavy cutting or where curves must be run in.

For an ordinary tangent preliminary survey the stadia method is very satisfactory. To get good results, however, the observer should be expert. The ordinary garden variety of instrumentman cannot use stadia successfully; he should check his main line by both back and foresight readings. He must keep his instrument in first-class shape and

FIG. 299.—Sketch of circular plumbing level for stadia rods.

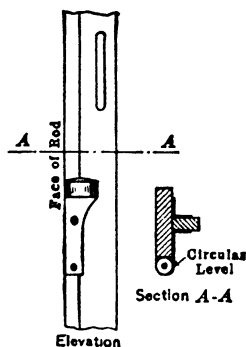

must use a rod with a fairly broad face with clear distinctive markings; this rod must be held steady and vertical, which can be

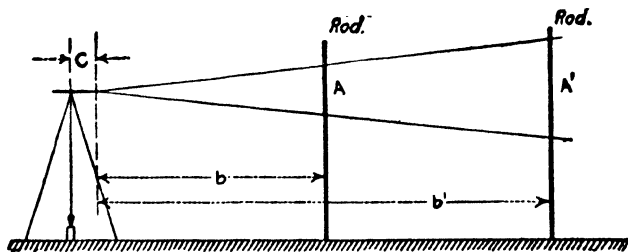

FIG. 300.

accomplished by the use of a small universal circular level attached to the rod, and steadiness can be secured by a short hand rod (about $4'$ long) that the rodman uses as a shifting brace.

The transit must be steady, must have a first-class lense, and must be equipped with *fixed* stadia wires. Adjustable stadia wires are worthless if good work is required. Distances between hubs should, as a rule, not exceed 500 to 600' for close line measurements, but side slots can be taken up to 1500'.

The essential elements of the theory of stadia measurement are briefly as follows:

The measurement depends on the optical angle of the stadia wires. This angle is governed by the distance apart of the stadia wires. The rod intervals A and A' subtended between the stadia wires are directly proportional to the distances b and b' from the apex of the optical angle. The apex of this optical angle is always a certain fixed distance in front of the instrument and is different for different makes of transit. Call this distance C , which can be determined, as later explained, by test or is generally noted in instructions furnished by the instrument maker. The actual rod interval as read by the observer is therefore proportional to

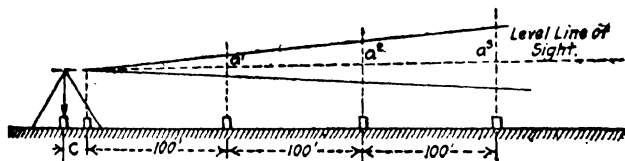

FIG. 301.

the distance from a point ahead of the instrument and not from the center of the transit. For close work, this distance C must be known and also the rod interval per 100' of distance beyond the apex of the optical angle. The rod interval per 100' of distance is desirably 1.0' but unless unusual care is exercised in setting the wires it is rarely exactly this value. To determine the actual value of this interval proceed as follows:

Case 1.—Where the value of C is known.

NOTE.— C generally ranges between 0.75 and 1.25'.

Pick out a level line about 800 to 1000' long. Drive a transit hub; place a foresight picket. Measure from the transit hub toward the foresight the distance C , which will be assumed in this case to be 1.25', and drive a hub. This hub represents on the ground the apex of the optical angle. From this hub measure carefully with a steel chain 100' and set a hub on line with the foresight and continue to set points at intervals of exactly 100' until you have a test line 800 to 1000' long.

Now level the telescope and read the rod intervals when the rod is held on each of the stakes and record this interval to the nearest fraction of a foot that you are sure you can actually see. As the length of sight increases it becomes less and less possible to determine the interval exactly, and when you are not certain of the reading to a 0.01' stop attempting to lengthen the sight and you have practically determined the safe length of sight for actual

ine work that the instrument is capable of handling. To determine the rod interval record your readings and take the average value. Assume your rod intervals to be as follows:

a^1	0.997' ÷ 1 = 0.997
a^2	1.995' ÷ 2 = 0.9975
a^3	2.99' ÷ 3 = 0.9967
a^4	3.99' ÷ 4 = 0.9975
a^5	4.985' ÷ 5 = 0.997
a^6	5.97' ÷ 6 = 0.995
a^7	6.95' ÷ 7 = 0.993
a^8	8.02' ÷ 8 = 1.002

This indicates that beyond 500' the readings become uncertain and that about 600' is the limit of practical line sight for close work. Good stadia work requires that the instrument man is perfectly honest with himself and recognizes his limitation when it is reached. The rod interval per 100' is therefore 0.997 in this case and every foot on the rod when the line of sight is level means an actual distance from the apex of the optical angle of $\frac{1.000}{0.997} = 100.3'$.

To get the actual distance then for a level line of sight rod reading of 2.45' multiply $2.45 \times 100.3 = 245.73'$.

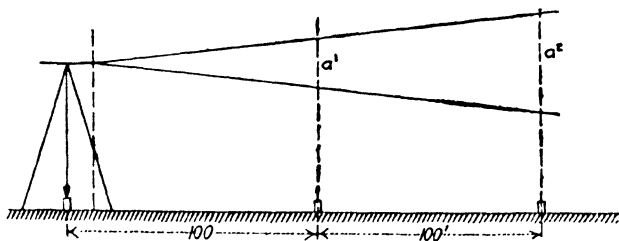

FIG. 302.

Say 245.7' from the apex of the optical angle and the distance from the center of the instrument will be 245.7' plus the constant C (1.25) equals 246.95' from the center of the instrument.

The effect of the inclined line of sight will be discussed later.

Case 2.—Where the constant C is not known. To determine the constant C and the rod interval per 100' of distance beyond the apex of the optical angle.

Measure a base line 800 to 1000' long placing hubs every 100' and every 10' for the first 100', but measuring these distances from the center of the instrument, as C is not known.

Set the transit up over the first hub and with a level line of sight read the stadia wire rod interval at each of the stakes on the line which are at actually measured known distances from the center of the instrument of 20', 30', 40', 50', etc., and 100', 200', 300', etc.

The problem is to determine two unknown quantities, C the constant and X (the rod interval per 100' of distance beyond the apex of the optical angle). According to Case 1, $\frac{1.00'}{X}$ = the actual distance beyond the apex represented by a rod interval of 1'. Therefore the constant C can be determined from two equations using the actual rod intervals at two different stakes. The constant C can be most accurately determined by short sights 20 to 40' and the rod interval per 100' from the longer sights 100 to 300'. The method is illustrated as follows, using rod readings taken at points 100' and 200' from the center of the instrument.

$$100' - C = \text{observed rod interval } a^1 \times \frac{1.00'}{X}$$

$$200' - C = \text{observed rod interval } a^2 \times \frac{1.00'}{X}$$

Suppose the rod interval $a^1 = 0.9845$

Suppose the rod interval $a^2 = 1.9815$

$$100.0 - C = 0.9845 \frac{1.00}{X}$$

$$200.0 - C = 1.9815 \frac{1.00}{X}$$

call $\left(\frac{1.00}{X}\right)$ the symbol Y .

$$100.0 - C = 0.9845 Y \quad \text{Eq. (1)}$$

$$200.0 - C = 1.9815 Y \quad \text{Eq. (2)}$$

$$\begin{array}{r} 100.0 - C = 0.9845 Y \\ 200.0 - C = 1.9815 Y \\ \hline 100.0 = 0.997 Y \end{array} \quad \begin{array}{l} \text{Subtract Eq.} \\ \text{(1) from (2).} \end{array}$$

$$Y = \frac{100.00}{0.997}$$

$$Y = 100.3'$$

That is, a 1' rod interval equals 100.3' of distance beyond the apex of the optical angle.

To determine C , substitute this value of Y in Eq. (1).

$$100.0 - C = 0.9845 \times 100.3$$

$$-C = -100 + 98.75$$

$$C = 100 - 98.75$$

$$C = 1.25'$$

Apply this principle to three or four sets of readings and take the mean values.

You now have the basic constants of the instruments for close work.

Effect of Inclined Sight on Stadia Readings.—The previous discussion is based on a level line of sight. It should be borne in mind that the stadia distance as previously discussed refers to the distance along the line of sight when the rod is perpendicular to the line of sight.

In case the line of sight is inclined, the rod reading must be corrected to a true rod reading perpendicular to the inclined

Procedure.—Measure the height of the center of the telescope axis at the standards above the top of the transit hub; this is called the height of instrument. Assume this, for example, to be 5.3'.

To get the vertical angle to the next hub sight on the rod with the middle horizontal wire set on 5.3' on the rod held on the fore-sight hub and read the vertical angle, say $+10^{\circ} 13'$; level the telescope by the large telescope bubble and record the index error, say $+0^{\circ} 01'$; the correct vertical angle is then $+10^{\circ} 12'$.

To get the rod interval reading corresponding to the vertical angle of $+10^{\circ} 12'$, sight on the rod with the middle horizontal wire on 5.3'; then shift the vertical line of sight so that the lower stadia wire is exactly on one of the main rod divisions and read the rod interval between the two stadia wires. Say in this case 3.37 or 337' distance. Look in Table 137 (p. 844), which gives for a vertical angle of $10^{\circ} 12'$ the correct horizontal and vertical distance per 100' of stadia reading as horizontal distance 96.86'; vertical difference in elevation 17.43'. The total horizontal distance for the stadia reading of 337' is therefore $(337 \times 96.86 = 326.42) + (\text{constant } C \times \cos 10^{\circ} 12')$ given at bottom of page in table as 1.23) = 327.65 *total horizontal distance*.

The vertical difference in elevation is $(337 \times 17.43' = 58.74') + ((\text{constant } C \times \sin 10^{\circ} 12')$ given at bottom of page in Table 137 as 0.22) = 58.96' *total difference in elevation*. The elevation of the new hub is therefore $5230.3 + 58.96 = 5289.26$.

Case 2.—Where a stadia interval must be corrected for poor wire interval.

Suppose the instrument used measures 100.3' for each foot on the rod and the rod reading for a vertical angle of $10^{\circ} 12'$ is 3.36'. The correct stadia distance is found by multiplying $3.36' \times 100.3 = 337'$ in distance. Then proceed as in Case 1.

Stadia Rods.—Stadia rods can be divided in innumerable ways and it makes little difference what symbols are used so long as they are clear and distinct. The principle of bisection for the smallest readings is a good system. The face of the rods should be wider than the ordinary level rod; a width of $2\frac{1}{2}$ to 3" is about right. They should have a very brilliant white background and jet-black face markings with large numbers for the even feet *mark-the tenths should not be numbered*.

The practice of special graduations to fit the wire interval of the instrument is not desirable, particularly in rough country where rods are often broken.

A standard 1.0' division is safer, as any standard rod can then be used.

The following system of face markings has been used by the author and is given merely as an example in case the reader has no preference of his own.

The rods should be as light as possible with a back brace to prevent warping and provide hand holes. A length of 10' is ample for all practical purposes.

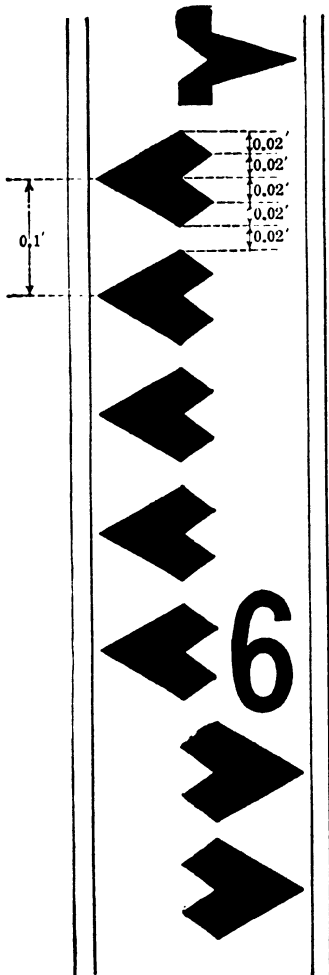
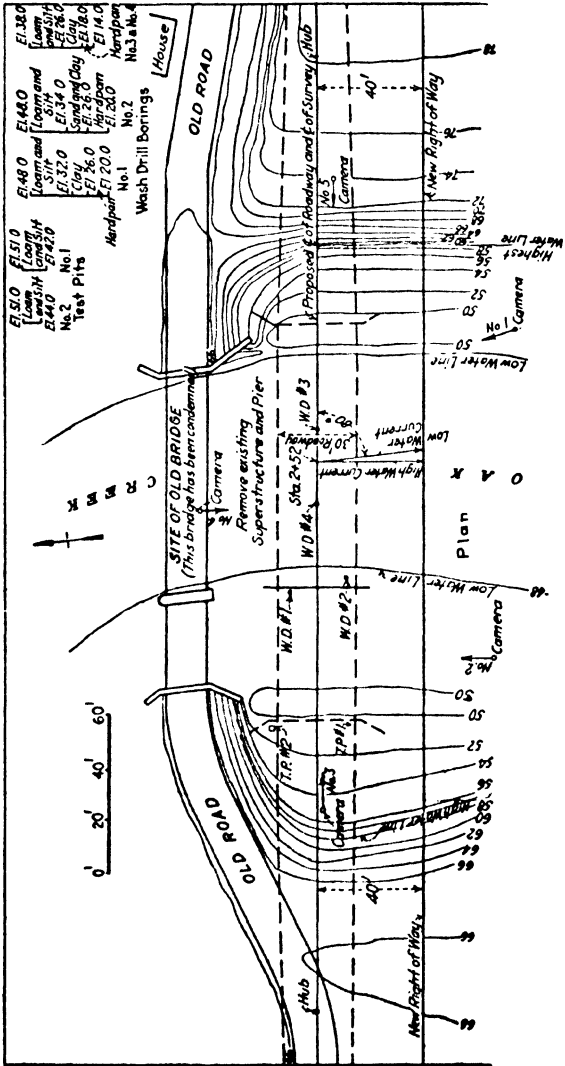

FIG. 305.—Stadia rod.

<i>Left Page</i>				<i>Right Page</i>				
<p>A at Hub B. Elevation Hub B-725.7 Height of instrument above hub 4.9'. All vertical angles taken at rod readings of 4.9 unless otherwise noted. Back sight on Hub A. (F + C = 1.0')</p>				<p>Nearest 0.1 for hub shots Nearest 1.0 for ordinary shots</p>				
Shot	Distance	Horizontal angle	Vertical angle	Special vertical angle rod readings	Corrected horizontal distance	Difference in elevation	Elevation of shot	Location of shot
Hub A	247'	0° 00'	-2° 10'	...	247.6	- 9.4	716.3	
1	155	10° 20'	-1° 16'	...	156	- 3.4	722.3	North Bank Creek
2	140	10° 30'	-3° 44'	...	140	- 9.2	716.5	Waters edge
3	370	276° 35'	+6° 10'	6.9	366	+37.0	763.3	N. E. cor. house

FIG. 305A.—Sample Stadia Notes.



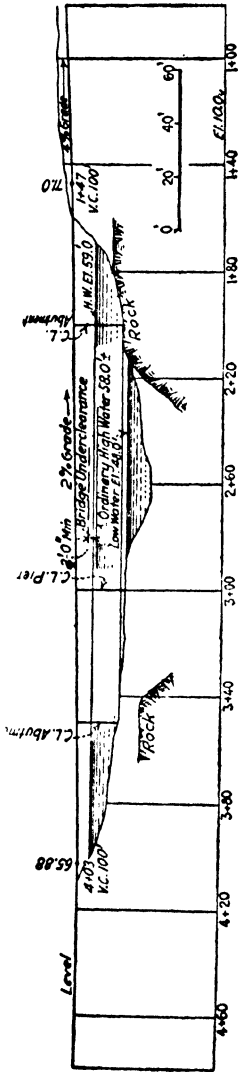

FIG. 305B.—Typical bridge layout plan for design purposes.

Clear waterway at existing bridge = 2060 square feet.
 Clear waterway at other bridges over stream. 2100 at bridge 1 mile north of present bridge
 Is waterway at existing bridge sufficient or too large? Sufficient
 Is stream ever dry? No. Elev. of permanent ground water: El. 46.0 ±
 Velocity of current. Sluggish most of the time, very rapid during spring floods.
 Does erosion occur? No. Best way of preventing erosion—
 Does stream carry light, medium or heavy drift? Light drift.
 What clearance above highest water? 2' minimum is O.K.
 Foundation data. See test pits and wash drill borings
 Should piles be used? Yes, for pier only.
 Recommend spans: 1'-50' span and 1'-100' span
 Material in stream banks. Rock east side, clay in west bank.
 Proposed type and width of pavement = Concrete, 18' width.
 Width of embankment = 28 feet
 Will side walls be required? No.
 Should provisions be made for water pipes, etc.? No.
 Does stream come under jurisdiction of war dept. No.
 Can a portion of existing abut. be used for new bridge? No.
 Type of foundation under existing bridge. Abutment on rock and center pier on timber crib
 Estimate safe load on foundation. 10 tons per square foot about for abutments
 Slope of embankment on approaches. 1 on 1 1/2
 If it is proposed to use a portion of existing bridge abutments for new bridge, the existing abutments should be shown to a scale of 1" = 10'

Plan and profile of proposed bridge and approaches Scale: 1" = 20'-0"
 Dec. 18, 1925.
 Cross section of proposed bridge site for bridge over Oak Creek at Sta. 2 + 52 on Ada-Kent Co. Highway, Apple County.

Bridge Surveys.—The base line for the bridge survey should be a very carefully measured line, correct to within 1" for the span proper and with the hubs well referenced. Direct steel-tape measurements are preferred, but if this is not feasible and triangulation is required two independent systems of triangulation should be used as checks on each other. Steel tapes should be certified standard and distances should be corrected for temperature. The topography along the stream and adjacent to the bridge site can generally be most easily and properly located by careful stadia survey methods.

Enough data should be obtained to permit the preparation of a plan containing all the information shown in Fig. 305*B*. This covers all data in regard to the location condition and size of the existing structure; stream channel for a sufficient distance above and below the proposed bridge site to cover all possible channel improvements and to permit a reasonable bridge location layout to be made; foundation elevations and character of soil; high- and low-water elevations; all adjacent topographic features and property owners; waterway area of adjacent bridges and general type of opening which has served satisfactorily on the stream, considering ice and débris jams.

Ordinary survey methods and notes previously described will serve for this class of survey. It is desirable to record all stadia horizontal angles on the basis of azimuth angles (0° to 360°) measured to the right from the north point or back site. Permanent benches must be established correct in elevation to 0.01'.

CHAPTER XIV

OFFICE PRACTICE

Introduction.—Effective design is based on the principle of the preparation of alternate comparative designs in order to pick the most suitable or economical solution (see design report, pp. 770 and 1095). By the use of this method of alternate designs a good engineer will reduce construction costs at least 10 to 20% below those obtained by the usual stereotyped application of standards with little thought to the local problem. First-class office design costs from \$150 to \$400 per mile and any effort to cut cost below the amount required for thorough design is poor economy, as indicated by experience of over 20 years.

Estimates of quantities should be liberal in order to avoid the necessity of supplementary agreements during the progress of construction, but in order not to mislead the contractor in making his bid, it is necessary for the estimate to show the probable minimum amount for each item with a statement of the amount allowed for contingencies. Cost estimates should be fairly liberal. They should never be below an amount which will insure a reasonable profit with ordinarily favorable luck and foresight. This matter of cost is important, as a poor price is almost certain to result in inferior work.

The discussion of office practice will be handled in the same general manner as the discussion of the survey, namely, under the general divisions of:

- a. The improvement of existing roads.
- b. The location of new pioneer roads.

It is impossible in a book of this character and size of page to illustrate exactly the detail methods of design which carry out the principles of economy discussed in Part I, but an effort has been made to give an idea of the practical methods by restricted examples and rather full explanations of drafting-room procedure. The tabular data in connection with design and estimating quantities have been found from experience to be very useful.

THE IMPROVEMENT OF EXISTING ROADS

Office practice includes:

1. Mapping the preliminary surveys.
2. Designing the improvement.
3. Estimating quantities and cost.
4. Finished contract plans.
5. Records and record maps.

1. Mapping the Preliminary Survey

The mapping of the preliminary survey serves as a base from which the design of the new work, and the quantities necessary thereto, can be built up. It consists of three views of the road: the plan, showing the topographic features; the profile, showing the longitudinal differences of elevation, and the cross-sections, showing the constantly changing transverse shape.

The scales in general use are as follows:

TABLE 148

Plan	Profile	Cross-sections
1" = 100'	1" = 100' horizontal 1" = 10' vertical	1" = 10'
1" = 50'	1" = 50' horizontal 1" = 10' vertical	1" = 5' or 1" = 4'
1" = 20'	1" = 20' horizontal 1" = 5' vertical	1" = 5' or 1" = 4'
1" = 10'	1" = 10' horizontal 1" = 10' vertical	1" = 2'

NOTE.—Distorted profile scales have a strong tendency to increase grading costs, as it is a matter of common experience that if a grade line is designed by the same man for the same road using a distorted profile in one case and a natural scale profile in the other case, the quantities resulting from the distorted profile are much in excess of the natural scales. Some distortion is necessary but the designer should ride over the road and from visual inspection determine what rolls in the natural grade can be properly retained and what sharp grade changes must be reduced. With a little experience of this kind he can coordinate actually good riding profiles with the distorted profile on which he is working and he will not needlessly cut and fill small changes in the natural grades (see also pp. 109 and 963).

For court cases it is not permissible to use distorted scales, as the average judge or jury do not understand them and are misled by their use.

The 100' scale is too small for convenience in design, and earthwork quantities figured from cross-sections plotted 1" to 10' are not reliable. For work on ordinary country roads, the 50' scale is generally adopted, using cross-sections plotted 1" to 5' or 1" to 4'; this scale is satisfactory for laying the grade line and computing the earthwork.

The larger scales of 1" = 20' or 1" = 10' are useful in village work where a large amount of detail must be shown.

Plotting the Center Line.—The survey center line can be plotted by deflection angles at the transit points, using a table of natural tangents, a vernier protractor or an ordinary paper protractor graduated to 15'.

Where the center line has been well located in the field and there seems to be no necessity for a paper relocation, no great care need be taken in plotting the deflection angles, as in such a case the map serves more as a picture of the topographic features than as a basis for alignment.

Where a random line has been run in the field and some shifting of the center line is necessary, both angles and distances must be accurately plotted. If any extensive change of alignment is made, the new deflections and distances should be checked by figuring the difference of latitude and longitude for both the survey line and the office line between the points of equality.

Where the consideration of sight distance (see p. 114) governs Table 149 will be of service.

TABLE 149

Table 149 gives the approximate distance that an automobile driver can see an approaching car, assuming that he is driving in the center of the road and that the approaching car is also in the center. Two distances are given for each curve, the first assuming that the line of sight is six feet from the ground, which is about right if the curve is on a straight grade, and makes the line of sight tangent to the cut slope of 1 on $1\frac{1}{2}$, 19 feet off center for the narrow section shown in Fig. 15, page 115, and, second, assuming that the line of sight is close to the ground, as occurs on rounding the top of a hill, in which case the line of sight will be tangent to the side slope at, approximately, 11' off center.

Degree of Curvature	Radius of Curve Feet	Sight Distance Case One. Feet	Sight Distance Case Two. Feet
5	1146.0	400	310
6	955.0	375	290
7	818.6	350	270
8	716.3	330	250
9	636.6	310	235
10	573.0	295	220
12	477.5	270	200
14	409.3	245	185
16	358.1	230	175
18	318.3	220	165
20	286.5	210	160
30	191.0	170	130
40	143.2	145	110
50	114.6	130	100

For convenience in plotting the topography, the 100' survey stations are plainly marked.

The most common mistakes in plotting the map are made by reversing the deflection, as right instead of left and *vice versa*, or in adding or omitting 100' in scaling long-tangent distances.

The work should be checked for mistakes of this nature.

All curve data are marked plainly on the map near the P.I. and show:

- The deflection angle Δ
- The degree of curve D
- The radius of curve R
- The tangent length T
- The length of curve L
- The station of the P.I.
- The station of the P.C.
- The station of the P.T.

If the curves have been figured in the office and have not been run in the field it is good practice to scale the offsets from the tangent to the curve and mark them on the map.

These offsets from the center line as run are then transferred to the cross-sections and the profile plotted from center-line elevations on the cross-sections.

Plotting the Topography.—If the topography has been recorded by a system of right-angle offsets, as suggested and illustrated on page 837, it can be easily and quickly plotted by using the transparent scale shown here.

This scale gives the plus distance along the survey base line, or center line, and the offset distance from the line in one operation.

As a general rule, the plotting of the topography need not be checked.

Level Computations.—The survey computations of the bench levels are checked and a list of bench elevations prepared; these elevations are used in cross section level notes and from them the notes are computed between benches. As each bench is reached these notes are corrected to agree with the elevation adopted for that bench and then carried forward on the corrected basis. The allowable error for cross-section levels, as mentioned in the chapter on surveys, is less than 0.1'. The correction of the levels at each bench prevents any cumulative error and makes the elevations of the cross-section shots agree with the adopted bench elevations with an error of less than 0.1'. This is as close as the readings can be plotted and as close as they can be read in the field.

FIG. 306.—Convenient transparent scale for plotting topography.

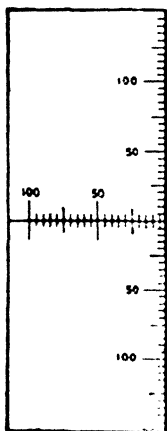

The computation of the bench levels and the adjustment of the cross-section notes should be checked by a competent man. The most common mistake in figuring the cross-section readings is to use the wrong height of instrument for a section. Such a mistake cannot be detected in plotting the sections, but is generally discovered when the profile is plotted.

In checking the notes particular care should be taken on this one point.

Plotting the Cross-sections.—The cross-sections must be *very carefully* plotted, as the reliability of the earthwork computation depends largely on their accuracy.

The cross-section paper used should be exact in the divisions and should be printed or engraved from plates.

Ruled paper is inaccurate.

The plotting is checked by reliable men. Reading the shots back from the plotted cross-section is preferable to reading them from the book. The elevations of the center line and of the ditch line are written over the section. The station number or plus of each section is written on the right margin. The fact that the section has been graveled within the traveled way, that stone has been spread to a certain thickness, or any other fact that would influence the designer when laying a grade line, is noted on the section (see Fig. 307).

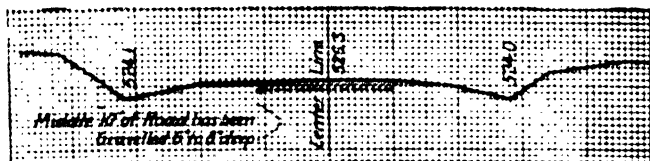

FIG. 307.

It is common practice to allow the inexperienced men to plot and check the cross-sections. This is a mistake. This part of mapping is the most important of the preliminary plans, and the work should be plotted and checked so that the points are correct to the nearest 0.1' in elevation.

These points are then connected with a fine ink line.

Plotting the Profile.—The profile is plotted from the center-line elevations given in the cross-section notes unless the proposed center line does not coincide with the survey center line, in which case the elevations of the proposed line are projected from the previously plotted cross sections.

It is not necessary to spend so much time for accuracy in plotting as on the sections, as the profile only serves as a guide in laying the grade line and no quantities depend upon its correctness. An error of 0.2' is allowable.

The elevation of each plotted center-line point is recorded with its stationing (see Fig. 322, p. 1106).

The profile should show all existing culverts and bridges with elevations of both present roadway, top and bottom of existing waterway opening, and elevations of high water. It should show all rails of grade crossings, the location of houses and barns effecting cuts and fills, and all crossroads or streets. Supplementary profiles of crossroads should also be shown to insure good intersection designs for both grade and drainage.

2. Designing the Improvement

The completion of the profile finishes the preliminary mapping. The first operations of the office design are as follows:

- A. Selection of grading section.
- B. Depth, width, and crown of pavement.
- C. Final alignment.
- D. Laying the grade line.

These four points are so dependent on each other that they cannot be separated, as they all vary from point to point on the road, depending on soil, traffic, grade, special topographic features, bridges, etc.

The most experienced man available should do this part of the work. He should be thoroughly familiar with the road from field inspection, and in designing he should follow the general principles laid down in Part I, in the chapters on Grades, Alignment, Sections, Pavements, and Reconstruction. For convenience the most-used data from these chapters are repeated at this point in tabular and diagrammatic form.

Table 150 (p. 949), maximum grades.

Table 151 (p. 950), maximum curvature.

Figure 308 (p. 951), typical grading sections.

Table 152 (p. 950), typical crowns.

Figure 309 (p. 956), typical superelevations on curves.

Table 152C (p. 958), typical pavement widths.

Table 153 (p. 959), depths of flexible pavements.

Table 154 (p. 960), depths of concrete foundations.

Table 155 (p. 962), limiting gradients, different pavements.

Table 156 (p. 962), special qualifications, different pavements.

TABLE 150.—RECOMMENDED PRACTICE MAXIMUM GRADES

Recommended Practice, Maximum Grade Design.—From the standpoints of horse traffic, single unit motor traffic or trucks with one trailer, safe footing, and economy of construction and maintenance, the following recommended rates of maximum grades will give moderately good satisfaction. In unusual cases the possibility of the extensive use of long trailer trains would tend to reduce these recommended rates, but the author wishes to emphasize the opinion that very few roads need be designed at this time primarily for long trailer trains. The following rates are satisfactory for the ordinary motor equipment used by the great majority of road users and additional expenditure would not be warranted for the benefit of a few men. *For the effect of dangerous alignment on maximum grade see page 118. For Effect of grade on motor operation cost see pages 12 and 96.*

Main Commercial Roads in Flat Country.—Long 2% ruling grades are desirable but do not justify much additional construction cost. Any long ruling grade up to 5% will probably be satisfactory. Short 6% are not inconsistent. A large volume of hauling by trailer trains might warrant reductions below usual practice provided the interests operating such haulage paid the increased cost of construction.

Main Commercial Roads in Hilly Country (Well-settled Districts).—Long 5% ruling grades are desirable and justify considerable expenditure provided they do not increase the total distance; 7% grades are probably justified to prevent increase in distance for a fixed rise. Long 6% grades are fairly satisfactory but as a rule if 5% cannot be reasonably obtained it is just as well to jump to 7%. Short 7 or 8% grades are not inconsistent in connection with long 5 and 6% grades provided the element of safe team footing is considered.

Main Roads, Pioneer Districts.—Long 5% grades are very desirable provided they do not increase the total distance, particularly if the road is a natural soil road and considerable horse traffic prevails. Any long grade up to 7% is fairly satisfactory. Short 7 and 10% grades are not inconsistent except for trailer trains. Grades higher than 7% are not, however, in much favor on account of danger and high maintenance cost.

Side Agricultural Roads or Unimportant Pioneer Roads.—Any long grade up to 7% is satisfactory. Short 10% grades are consistent in connection with a 7% ruling provided the element of safe footing is considered. Grades steeper than 7%, however, have a high maintenance cost.

Steeple Roads.—Long 6% grades are convenient on account of preventing gear shifts; 10% is not unreasonable for such roads except that on a 10% grade, the alignment should be easy, see page 118, and the maintenance cost is high.

Compensation of Steep Grades.—On sharp curves maximum grades must be reduced (see page 118).

Recommended Alignment Practice.—The following summary agrees with general current practice and can often be used without raising the cost beyond the bounds of reason. A summary of this nature is of course of only general value. Each case must be worked out on its own merits. Broad generalizations of detail requirements are dangerous if used indiscriminately.

TABLE 151.—RECOMMENDED ALIGNMENT PRACTICE

<i>Main Commercial Roads (Well-settled Districts).</i>	
Minimum sight distance.....	300 to 400'
Minimum radius of curvature at right-angle turns on level outside of villages where sight distance does not control.....	250 to 400'
Minimum radius of curvature on steep grades or at the foot of such grades depending on the central angle where the sight distance is not the controlling factor.....	600 to 800'
<i>Ordinary Agricultural Roads. (Local Service.)</i>	
Minimum sight distance.....	200 to 250'
Minimum radius of curvature at right-angle turns on level outside of villages.....	100 to 200'
Minimum radius of curvature on steep grades where sight distance does not govern.....	400 to 600'
<i>Mountain Roads.</i>	
No limitations on sight distance.	
Warning signs used where necessary.	
Minimum radius on steep grades.....	100'
Minimum radius in extremely rough country 40 ft. Grades not to exceed 3% for a 40-ft. radius and not to exceed 4% for an 80-ft. radius. Any grade up to 8% on a 100-ft. radius, although it is desirable not to exceed 5% on a 100-ft. radius curve with a large central angle.	
NOTE.—There is no more object in long perfectly straight tangents than there is in long uniform rates of grade. In a great many cases small angles in long stretches of comparatively straight road are eliminated by the adoption of a long single tangent resulting in a noticeable increase in cost and often in the loss of retention of the existing solid roadbed. In a great many cases the only value of such changes seems to be the pleasure derived by the office engineer in laying his straightedge on the plan and drawing a nice long straight line.	

TABLE 152.A.—RURAL HIGHWAYS—TYPICAL NORMAL PAVEMENT CROWNS

Parabolic or Circular arc suitable			
Kind of pavement	Average maximum crown slope, inches per foot	Average minimum crown slope, inches per foot	Average recommended crown slope, inches per foot
Earth roads	1	1/2	3/4
Sand-clay roads	3/4	1/2	3/4
Gravel roads	3/4	1/2	1/2
Single-track water-bound macadam	3/4	3/4	3/4
Double-track water-bound macadam	1/2	3/4	3/4
Double-track bituminous macadam	3/4	3/4	3/4
Double-track bituminous concrete	3/4	1/2	3/4
Double-track cement concrete	1/2	1/2	3/4
Double-track brick	3/4	1/2	3/4
Double-track asphalt block	3/4	1/2	3/4
Double-track stone block	3/4	3/4	3/4

¹ For the 1/4" crown use a straight-line crown slope.

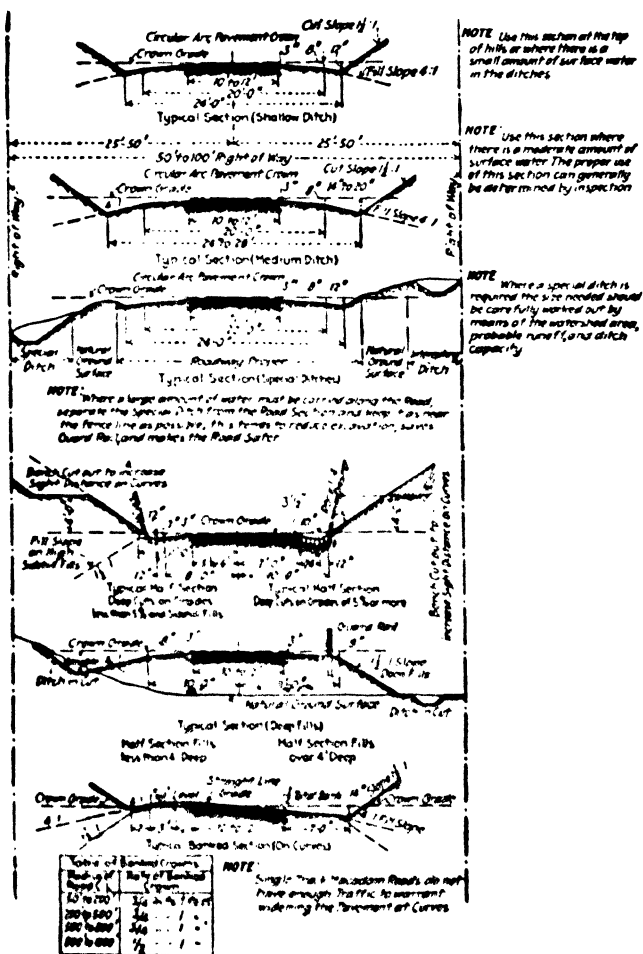

FIG. 308A.—Single track macadam or gravel roads (suitable for roads carrying up to about 300 vehicles per day).

NOTE.—For discussion of sections see Chapter III.

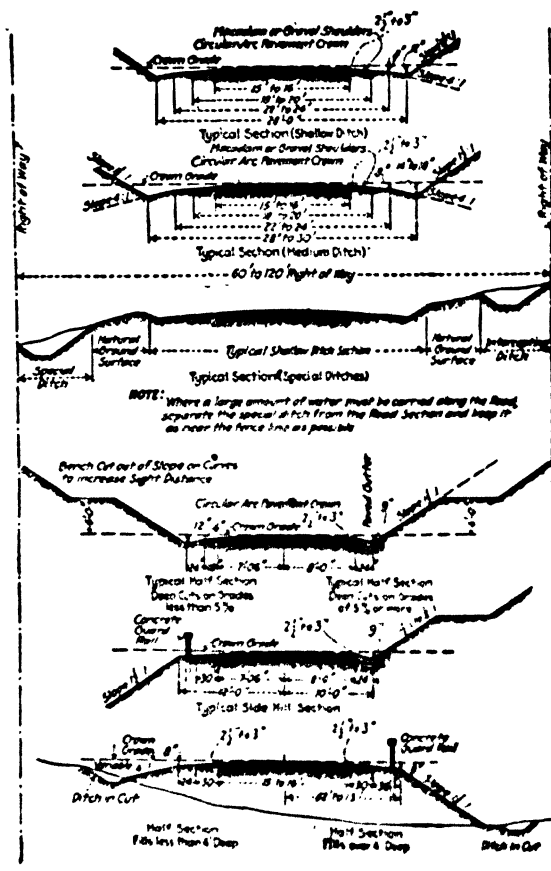

FIG. 308B.—Double track macadam roads. Suitable for local service or secondary State Roads carrying from 300 to 2000 vehicles per day (12 hour count in summer).

NOTE.—For roads carrying over 1500 vehicles daily use 7 ft. shoulder to permit parking off the pavement.

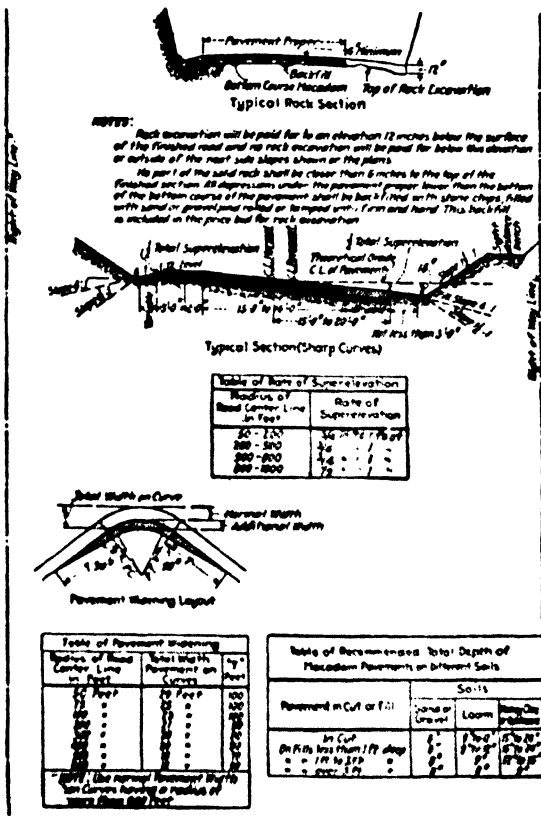
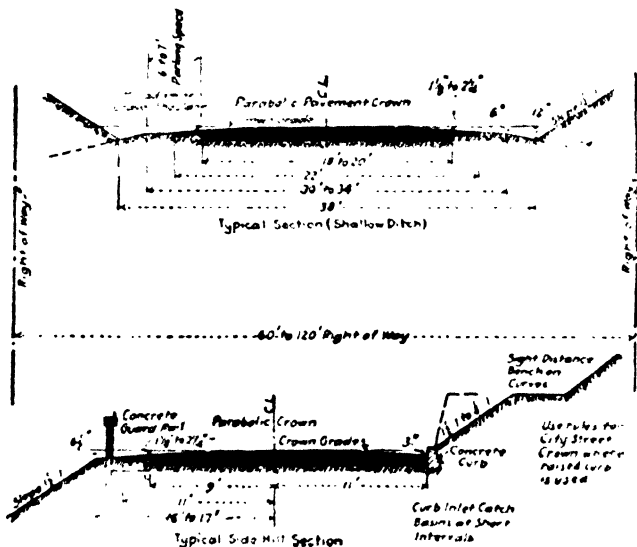

FIG. 308B.—Double track macadam roads.



TYPICAL MEDIUM DITCH SECTION } Similar to Fig. 308 except that
 " SPECIAL " } the Overall Width dimensions
 " FILL SECTION " } are 6' to 8' ft. greater than given
 " BANKED " } in Fig. 308

ROCK EXCAVATION: Method of Payment similar to Fig. 308 except that none of the Solid Rock shall project above the bottom of the Pavement Base

NOTE: For this class of Pavements and Design of Pavement Base and Surfacing See Volume 2

FIG. 308C.—Special sections rigid pavement roads (roads carrying over 2000 vehicles per day).

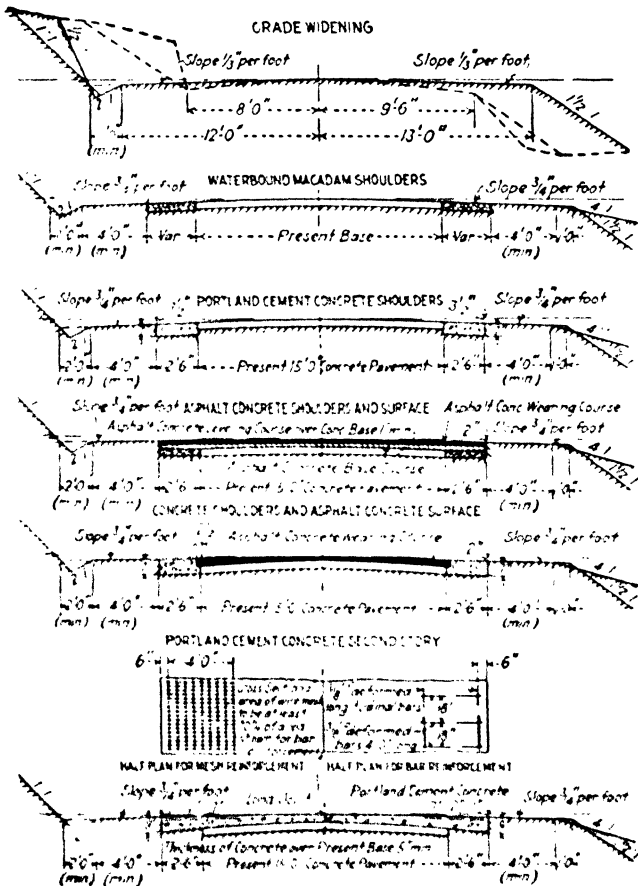
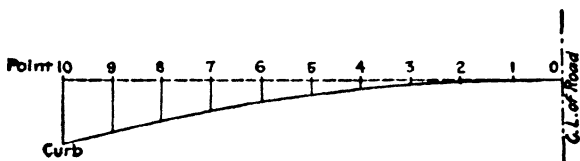

FIG. 308D.—Reconstruction sections, state of California 1926. Widening and thickening old state roads.

NOTE.—See Chapter VIII for discussion of reconstruction design.

Parabolic Crowns for Pavements.—It is often convenient to have the following data on parabolic crown ordinates in making templates for pavement work.

Divide the distance from the center of the road to the curb or edging into ten equal parts and call the total crown 1.0; the distance down to the surface of the pavement from the crown elevation at each of these ten points expressed in terms of the total crown will be



Parabolic crown ordinates.

Center of road, point No. 0	0.00
1	0.01
2	0.04
3	0.09
4	0.16
5	0.25
6	0.36
7	0.49
8	0.64
9	0.81
Curb point 10	1.00

For area Parabolic Segments see page 1576.

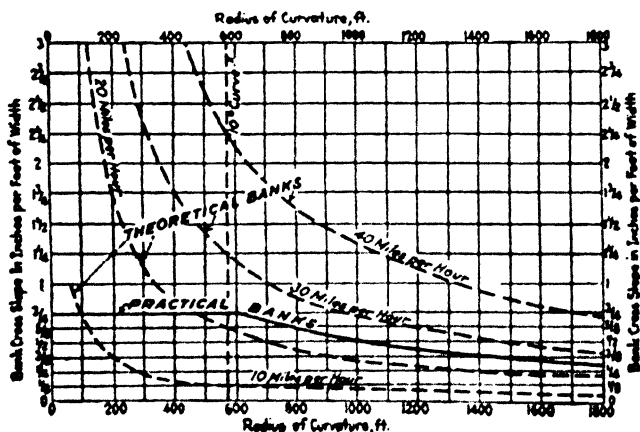

FIG. 309.—Graph of theoretical and practical bank slopes on curves.

NOTE.—For discussion of superelevation see page 124.

TABLE 152B.—STREET CROWNS

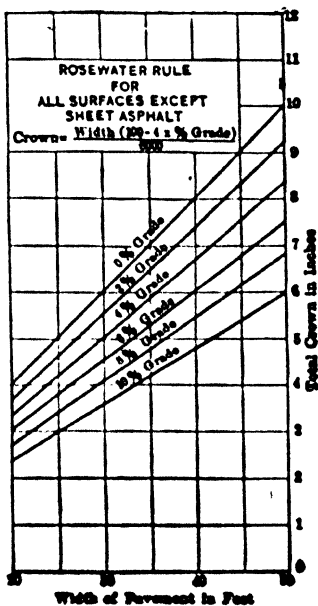
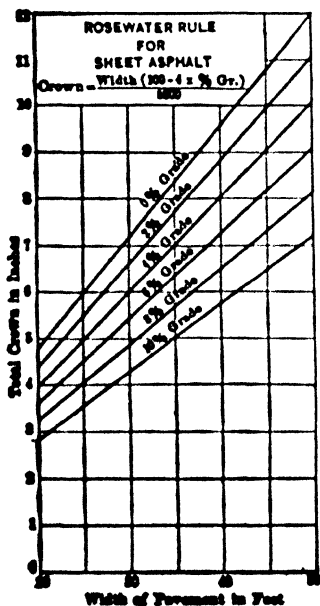
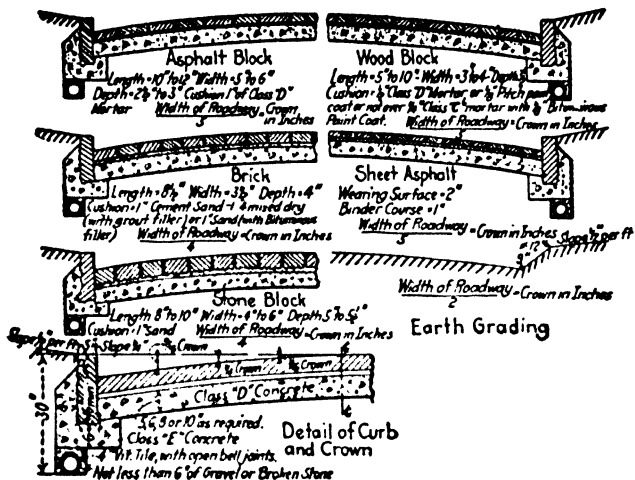

TABLE 152C.—NORMAL PAVEMENT WIDTHS (IN FEET)

Class of road	Rigid pavements		Macadam or gravel	
	Pavement proper	Out-to-out width armored shoulders	Pavement proper	Out-to-out width armored shoulders
Class I	18-20	22-24	18-20	22-24
Class II	17-18	20-22	15-16	20-22
Class III	16	16	12-16	16
Class IV			8-12	

¹ For traffic of over 6,000 daily (10-hour count in summer) increase pavement width to 27 or 36', see also page 28 for capacity 3 and 4 lane pavements.

CLASS I TRAFFIC (SHARP CURVES)

Radius of road center line in feet	Total pavement width in feet	Length tangent run-off in feet
100	25	100
150	24	90
200	23	90
300	22	80
400	22	80
500	21	70
600	21	70

NOTE.—Normal pavement widths of 18 to 20' used on all curves having a radius greater than 1000'.

CLASS II AND III TRAFFIC (SHARP CURVES)

Radius of road center line, in feet	Total pavement width on curves for a double-track road (local service) in feet	Length tangent run-off in feet
50	20	100
75	25	100
100	23	100
150	22	90
200	21	90
300	20	80
400	20	80
500	19	70
600	18	50

NOTE.—Normal pavement width (15 to 18') used on all curves having a radius greater than 800'.

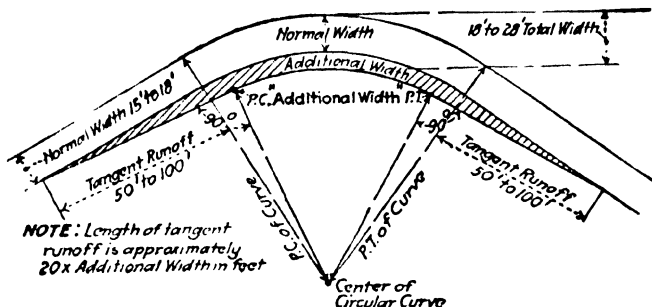

FIG. 310.—(Table 152C.)

TABLE 153.—RECOMMENDED TOTAL DEPTHS OF FLEXIBLE PAVEMENTS IN LOCALITIES SUBJECT TO SEVERE WINTERS (IN INCHES)

(Class I traffic over 2000 vehicles daily, 10-hr. count in summer; (M. macadam not usually economical on Class I roads))

Soil	Location of road		
	In cuts or on shallow fills less than 1' deep	On intermediate fills 1 to 3' deep	On high fills over 3' deep
Coarse sand and fine gravel	9-10	9-10	9
Loams	10-14	10-12	10
Ordinary clays	15-21	12-16	11
Heavy clays and fine sands	22-30	14-18	13
Class II traffic (800 to 2000 vehicles daily, 10-hr. count in summer)			
Sand and gravel	8-9	8-9	8
Loams	9-12	9-11	9
Ordinary clays	12-18	11-15	10
Heavy clays and fine sands	18-28	13-16	12
Class III traffic (300 to 800 vehicles daily, 10-hr. count in summer)			
Sand and gravel	7-8	7-8	7
Loams	8-10	8-9	8
Ordinary clays	12-16	9-14	9
Heavy clays and fine sands	18-24	12-15	11
Class IV traffic (less than 300 vehicles daily)			
Sand and gravel	6-7	6-7	6
Loams	7-9	7-8	7
Ordinary clays	10-15	8-12	8
Heavy clays and fine sands	15-22	10-14	9

TABLE 154.—COMPARISON OF RECOMMENDED THEORETICAL DEPTHS OF CEMENT-CONCRETE BASES FOR DIFFERENT PAVEMENTS UNDER DIFFERENT MAXIMUM LOADS ON DIFFERENT SOILS (IN INCHES)
NOTE.—The last column gives prevailing practice in base depth for each type (1919 to 1922).

Pavement	Recommended depths of cement-concrete bases based on modified corner-load formula $d = P \sqrt{JW/S}$ (Chap. VI)					Current practice 1919-1923, inches
	3½-ton truck 16,000-lb. gross load	5-ton truck 22,000-lb. gross load	7-ton truck 28,000-lb. gross load	Gravel or macadam, inches	Gravel or macadam, subsoils, inches	
Plain concrete: (1:1½:3 mix).....	Ordinary subsoils, inches	Ordinary subsoils, inches	Ordinary subsoils, inches	Gravel or macadam, inches	Gravel or macadam, subsoils, inches	6 to 10
Plain concrete: (1:2:4 mix).....	7.2 & 7.8 7.6 & 8.2	6.5 & 7.0 6.9 & 7.4	7.9 & 8.8 8.4 & 9.2	7.2 & 8.0 7.6 & 8.3	8.7 & 9.7 9.2 & 10.0	
Reinforced concrete (mesh and bar): Central longitudinal joint (1:1½:3 mix)	6.3 & 6.9	6.0 & 6.4	6.7 & 7.5	6.2 & 6.8	7.3 & 8.2	6.5 & 7.3
Reinforced concrete (corner and exterior tie bars only): Central longitudinal joint 1:1½:3 mix. 1:2:4 mix.....	6.5 & 7.0 6.9 & 7.4	6.0 & 6.4 6.4 & 6.8	7.0 & 7.8 7.4 & 8.2	6.3 & 7.1 6.7 & 7.4	7.7 & 8.5 8.1 & 9.0	7.0 & 7.7 7.4 & 8.1
Monolithic brick 4-in. brick on 1:1½:3 concrete base.....	4.5	4.0	5.0	4.5	6.0	5.5
						4.0

2-in. to 3-in. asphaltic concrete on concrete base:	(1:3:6 mix).....	6.5	6.0	7.0	6.3	7.5	6.8	5 to 8
	(1:2½:5 mix).....	6.0	6.0	6.5	6.0	7.0	6.3	
	2-in. asphalt block on cement-concrete base:							
	(1:2½:5 mix).....	6.5	6.0	7.0	6.3	7.5	6.8	5 to 8
4-in. brick (mastic joint filler) on cement-concrete base:	(1:3:6 mix).....	6.8	6.2	7.6	6.0	8.3	7.5	6 to 8
	(1:2½:5 mix).....	6.5	6.0	7.0	6.3	7.8	7.1	
	4-in. brick (cement grout filler):							
	(1:3:6) concrete base.....	5.5	5.0	6.1	5.5	6.7	6.2	5 to 8
	(1:2½:5) concrete base.....	5.2	5.0	5.7	5.2	6.3	5.7	
5-in. stone block: cement grout filler:								5 to 7
	(1:2½:5) concrete base.....	5.2	5.0	5.7	5.2	6.3	5.7	

NOTE: Where two depths are given the smaller is for interior areas and the larger for exterior edge depths. Where one is given it applies to interior areas.

Typical recommended pavement sections showing details are given in Chap. VI under the discussion of each type of pavement. The object of this table is to give a tentative basis of estimating the amount of materials and the cost per square yard for the different types suitable for different maximum load conditions.

Table 154 in conjunction with Table 153, p. 959, provides a means of computing reliable comparative cost estimates for all ordinary standard types based on equal strength.

TABLE 155A.—LIMITING GRADES FOR DIFFERENT TYPES OF PAVEMENT

(Taken from Agg's "Roads and Pavements")

Surface Material	Per Cent
Wood block	3
Asphalt block	6
Brick	10
Sheet asphalt	5
Asphaltic concrete	7
Bituminous macadam (seal coat)	8
Bituminous macadam (no seal coat)	10
Cement concrete ¹	8
Hillside brick	12
Stone brick	12

TABLE 155B.

Surface Material	Per Cent
Wooden block	2
Asphalt block	4
Brick (grout joint)	5
Brick (mastic joints)	8
Concrete ¹	5 to 7
Bituminous macadam with flush or squeegee coat (In sandy country, 6% when coarse sand is sprinkled on surface.)	5
Bituminous macadam without squeegee	8
Waterbound macadam	8
"Hillside" brick	12
Stone block with open joints	12

¹ Hard to construct on grades over 5%.

Recommended Pavement Types.—Bituminous macadams are recommended for Class II traffic and resident village streets.

Water-bound macadam (oiled) for Class III traffic.

Concrete for Class I outside of villages.

Brick, for village business streets.

Stone block for hills on Class I traffic.

Asphalt block, for extremely heavy Class I traffic.

Sheet Asphalt, Topoka, etc., are to be avoided for original construction where traffic travels at high speed on account of skidding but its use for reconstruction has decided advantages from an economic standpoint and the use of coarse aggregate "Topoka" or "Amiesite" reduces danger of skidding. Its most suitable location is a resident village or city street or for heavy slow traffic.

Templets.—For the convenience of the designer in drawing the shape of the finished road on the cross-sections, a number of trans-

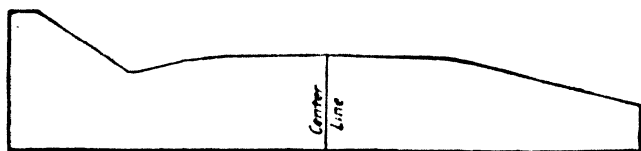

FIG. 311.—Transparent templet for use on cross-sections giving finished shape of road.

parent composition templets are made, cut to proper scale, representing the different-shaped sections to be used (see Figs. 311 and 312).

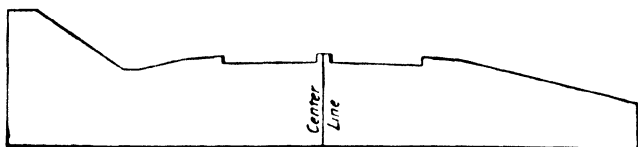
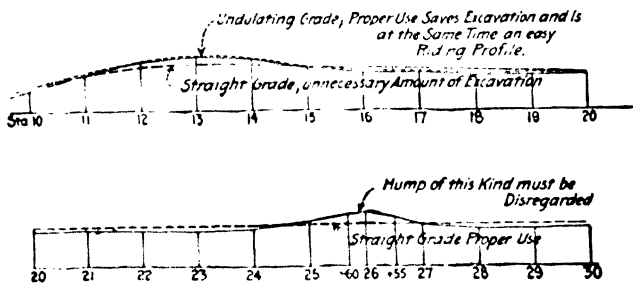

FIG. 312. - Transparent templet with stone trench cut; saves time in drawing in sections for figuring cut and fill.



Illustrating Proper Use of Straight and Undulating Grades

FIG. 313.

Economical Grade Line (New Construction). - On page 106, the most economical grading conditions were mentioned. A convenient method of laying a grade line that will approximate these conditions is as follows: Take the case of determining an economical profile for a road from Stas. 11 to 16, where the grade can be placed

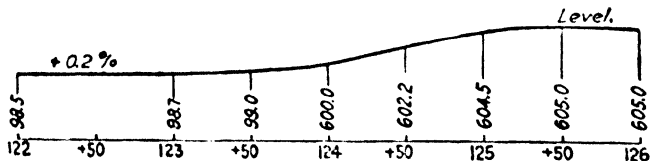

FIG. 313A. - Actual profile road 5046 New York State, illustrating maximum abutness in short roll which is satisfactory for traffic.

at any desired elevation (see p. 964). Place the adopted templet on each cross-section so that the cut will just make the fill (this position is estimated) and note the elevation of the center line of the proposed finished road for this position of the templet; mark this elevation on the profile for each section between Stas. 11 and 16;

to connect these points would give the most economical grade line, but this can rarely be done with a resulting smooth profile. The

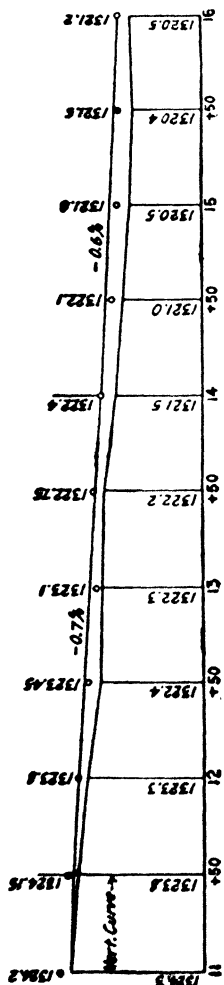

FIG. 314.—Sample profile illustrating method of placing economical grade line.
NOTE.—The small circles show the elevation of grade at each section that would make the proposed cut just make the proposed fill at that section.

adopted grade is obtained by drawing in a smooth grade line that averages the elevation of these points and varies in elevation above and below them as little as possible.

The adopted grade elevation at each station is then figured, the shape of the finished road drawn to the cross-sections at these elevations, and the excavation and embankment computed. If the ratio of cut to fill is not correct, the grade is raised or lowered slightly to produce the desired ratio. The method is illustrated in Fig. 314.

For each stretch of road where economy of grading governs the profile, this procedure is repeated, and for the sections of road where other considerations govern, the grade is placed at the required elevation and the borrow, waste, or overhaul is figured.

Grade-line Reconstruction Designs.—The grade line for reconstruction of old improved roads follows the old grade line very closely for most cases and the elevation of the new pavement is adjusted to utilize to best advantage the old pavement as a foundation; that is, the earthwork of the shoulders and ditches does not govern the grade line as in new construction and no effort is made to balance cuts and fills. Excess excavation is wasted or overhauled and excess fill is cared for by borrow-pit excavation. For good typical reconstruction sections and relative grade of old and new pavements see Chap. VIII, Part I, Reconstruction.

Vertical Curves.—To obtain a smooth grade line, vertical curves are used at the intersection of the tangent rates of grade. Vertical

curves are not usually used where the difference in gradient is less than one-half of 1%. Vertical curves should be made as long as
(*ext continued on page 966.)

TABLE 157.—RECOMMENDED MINIMUM LENGTHS OF VERTICAL CURVES BETWEEN TANGENT GRADES

Algebraic difference in rates of tangent grades, %	Minimum length of vertical curves on local service roads, feet	Minimum length of vertical curves on special service commercial roads, feet
5 or less	100	100-150
8	150	200
10	200	300
12	250	400
14	270	450
16	300	

NOTE.—Rough rule for minimum length of vertical curves:

100' length for each 4% difference in gradients in hollows.

125' length for each 4% difference in gradients at top of hills.

That is, if two ascending 6% grades are to be connected with a minimum-length vertical curve this rule would result in $\frac{12\%}{4\%} \times 125' = 375'$ length of vertical curve.

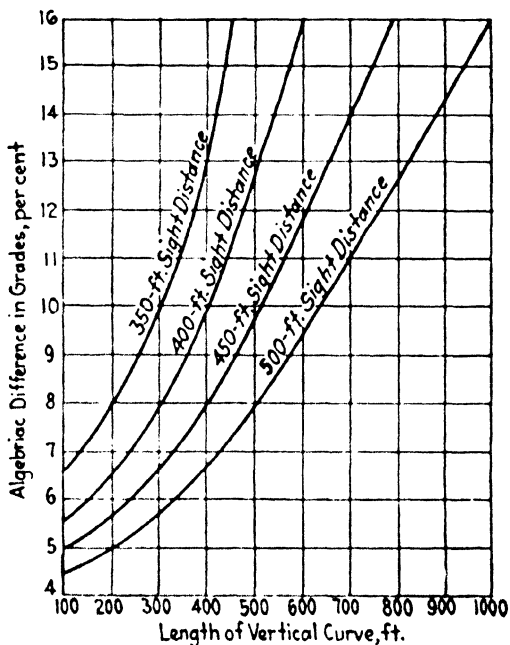

Required length of vertical curves for different sight distances U. S. Bureau Public Roads Standard. (Based on line of sight 5 ft. above ground at both ends and tangent to road surface at middle.)

possible without needlessly increasing the grading; that is, for all normal cases they should follow the natural surface closely. Table 157 gives minimum lengths of vertical curves satisfactory from the standpoints of sight distance and easy-riding qualities.

For the final plans these vertical-curve elevations may be computed by the following formulas, but for the trial grade line they can be scaled from the profile, drawing in the curve by means of a regular curve templet, with which all modern offices are equipped, and in all ordinary cases this graphic method serves for the final grade line, as with reasonable care the elevations are closer than can be constructed.

Vertical-curve Formulas. Formula A.—Difference in elevation at center of curve. d expressed in feet = $\frac{1}{8}$ algebraic difference of the tangent grades expressed in feet per 100 \times length of curve expressed in stations of 100'.

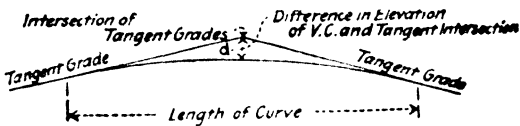

FIG. 315A.

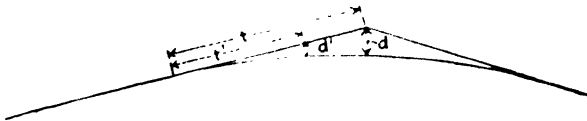

FIG. 315B.

Formula B. Intermediate differences of elevations between tangent grades and points on vertical curve.

$$d' : d :: l'^2 : l^2$$

$$d' = \frac{dl'^2}{l^2}$$

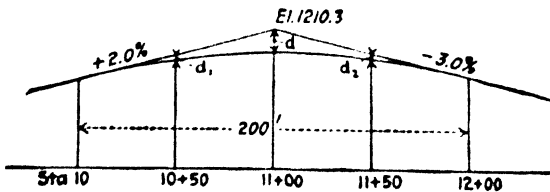

FIG. 315C.

Example of Vertical-curve Computation.—It is required to figure the vertical-curve elevations for a vertical curve 200' long between

tangent grades of +2.0 and -3.0% meeting at Sta. 11 + 00 at an elevation of 1210.3.

First, find the middle correction d . Use Formula A.

$$d = \frac{1}{8}(2.0 - (-3.0)) \times (2)$$

$$d = \frac{1}{8}(5) \times (2) = 1\frac{1}{8} = 1.25'$$

Second, determine the corrections d_1 and d_2 . Use Formula B.

$$d_1 = \frac{dl'^2}{l^2} = 1.25 \frac{50^2}{100^2} = 1.25 \times \frac{1}{4} = 0.31'$$

$$d_2 = 1.25 \frac{50^2}{100^2} = 0.31'$$

Third, determine the elevation of the tangent grades at 10 + 50 and 11 + 50.

Fourth, subtract the vertical-curve corrections d_1 , d , and d_2 from these tangent grades at 10 + 50, 11 + 00, and 11 + 50.

VERTICAL-CURVE ELEVATIONS

Sta. 10 + 50 = tangent elevation 1209.3 - 0.31 = 1208.99

Sta. 11 + 00 = tangent elevation 1210.3 - 1.25 = 1209.05

Sta. 11 + 50 = tangent elevation 1208.8 - 0.31 = 1208.49

Table 158 is useful for draftsmen for picking out the correct curve to use in inking in the vertical curves. This table is compiled for a horizontal scale of 1" = 50', and a vertical scale of 1" = 10'. For other scales a similar table can be constructed.

Explanation of Table 158.—Suppose it is required to pick out the correct curve templet to draw in a vertical curve 300' long between two tangent grades having an algebraic difference of 5% (say a +2.0 and a -3.0% grade). On the line opposite 5.0 in column 1 representing the algebraic difference of rate pick out the value 24 in the column headed 300' curve; this means that a curve having a radius of 24" will fit the conditions. This curve can be found easily from the collection of curve templates which have been previously marked with their radii in inches.

TABLE 158.—TABLE OF RADII FOR PLOTTING VERTICAL CURVES ON PROFILES

Algebraic Diff.	100' Curve Rad.	200' Curve Rad.	300' Curve Rad.	400' Curve Rad.
1.0	40	80	120	160
1.2	33	67	100	132
1.4	29	57	85	116
1.6	25	50	75	100
1.8	22	44	65	88
2.0	20	40	60	80
2.2	18	36	55	72
2.4	16½	33	50	66
2.6	15½	30	46	62
2.8	14½	29	43	58
3.0	13½	27	40	54
3.2	12½	25	37	50
3.4	12	23	35	48
3.6	11	22	33	44
3.8	10½	21	32	42
4.0	10	20	30	40
4.5	9	18	27	36
5.0	8	16	24	32
5.5	7	14½	22	28
6.0	6½	13½	20	26
7.0	6	11½	17	24
8.0	5	10	16	20
9.0	4½	9	13½	18
10.0	4	8	12	16
11.0	3½	7	11	14½
12.0	3½	6½	10	13½
13.0	3	6	9	12½
14.0	3	5½	8½	11½

NOTE.—See page 967 for explanation of this table.

TABLE 159.—REQUIRED MINIMUM LENGTH OF VERTICAL CURVES FOR A SPECIFIED SIGHT DISTANCE BASED ON A LINE OF SIGHT 5' 6" ABOVE THE GROUND AT BOTH ENDS

Algebraic difference in rates of grade per cent	Minimum length of vertical curve in feet for a sight distance of 250'	Minimum length of vertical curve in feet for a sight distance of 350', in feet
6		
8	...	150
10	50	250
12	135	330
14	190	400
16	225	450

The limit of sight due to vertical curves is shown in Table 159.

Table 159 gives the distance ahead that a driver can see on a straight road, assuming that his eye is 5' 06" above the road, for vertical curves of 200, 150, and 100' long between grades having a large difference of rate. See also diagram (p. 965) for length of curve required, assuming driver's eye 5' above the road.

Example.—Suppose a +5% grade meets a -7% grade and that it is desired to put in the minimum length curve that will allow a sight ahead of 350'. The difference in gradient is $5 + 7 = 12\%$. From Table 159, opposite 12%, the length required can be readily picked; it will be about 330', and 350' would probably be used. It is rare that the sight distance governs in the selection of length of curve except for overhead railroad elimination projects. See also Table 157, page 965.

Placing the Templates and Planimentering the Areas.—After the trial grade line has been placed the center-line elevations of the proposed finished road are figured for each point on the profile where cross-sections have been taken, and the section selected is drawn on the original cross-sections at these elevations, using the templates mentioned on page 962.

Because it is comparatively easy to make a mistake of 1 or 5' in elevation, the elevation of new grade, as shown by the position of the templet, should be checked from the profile before computing the cuts and fills.

Because of the small, irregular shape of these areas it is not possible to compute them arithmetically and the areas are determined by planimeters. Great care must be exercised if the work is to be reliable; a double run is made and the second run should be twice the first area. A certain limit of error in the second area is adopted.¹ This method is sufficiently accurate for preliminary estimating. On final estimate work, where the payment for earth excavation depends on the planimeter work, a satisfactory method is to have two men, using separate planimeters, compute the areas independently without any knowledge of each other's result. If the

¹ A satisfactory rule has been to allow a difference of 0.4 sq. ft. for areas up to 50 sq. ft., and 1.0-sq. ft. error above 50 sq. ft.

amount of excavation as figured separately varies more than 2%, a third run is made.

It is difficult to get accurate planimeter results because the work is monotonous, confining, and hard on the eyes, and the men tend to be careless unless they know that their work is being checked.

The temptation is strong to make the second reading equal twice the first, and unless some such method is used to check up, small errors will be passed over.

As a matter of interest, 3 miles of planimeter work, checked in this matter, was examined to see the average difference in areas where two careful men using different planimeters computed their results separately.

The sections used were plotted 1" = 5'; areas read to nearest 0.1 sq. ft.

The average percentage of difference for single areas was:

	Per Cent of Difference
1. Small areas below 10 sq. ft.	5
2. Small areas 10-30 sq. ft.	2
3. Areas above 30 sq. ft.	1

These differences for single areas compensate, however, as some are above and some below the mean value, and computing the two separate results for the 3 miles gave the following result:

Percentage differences for work of two men for 3 miles, showing the reduction of error due to compensation:

	Per Cent of Difference
1. Small areas below 10 sq. ft.	1 0
2. Small areas 10-30 sq. ft.	0 5
3. Areas above 30 sq. ft.	0 05

The average excavation per mile will run about 3000 cu. yd., which means the average area of cut is about 16 sq. ft.

This comes under the second division and makes the probable error of final estimate planimeter work sufficiently close for all practical purposes.

Areas by Measuring the Depth of Cut or Fill at Intervals of 1' across the Section.—It is often necessary for the field men to make a change in grade or alignment, and the following method of estimating section areas is convenient when no planimeter is available. The method is illustrated in the figures shown below:

Measure the depth of the cutting on vertical 1. Call this depth 1'. It can be readily seen that this depth is the average depth for the first foot of the cross-section, and if multiplied by 1' equals the area of the first foot of the section. In like manner measure the depth of the section on vertical 2. This is the average depth of the second foot of the section, and multiplied by 1' equals the area of the second foot of the section. If the sum of the depths

1', 2', 3', etc., is obtained for the entire width of the section, it is evident that the sum must equal the area of the section.

This summation can readily be made graphically, as shown below, by marking off on the edge of a piece of paper the successive depths.

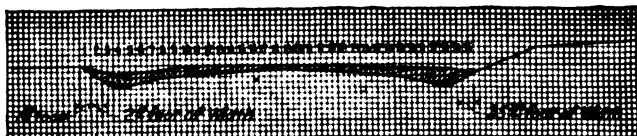

FIG. 316.

Scale the distance from the reference mark to the end mark, using the same scale by which the cross-section is plotted and the area of the section is obtained. This method is as reliable as planimeter work, but is necessarily slower.

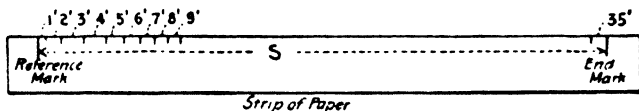

FIG. 317.

Computation of Earthwork.—Earthwork is usually computed from the planimeter results by the method of end areas; where 50' sections are used Table 160 is convenient.

Explanation of Table 160.—Suppose the area of excavation at, say, Sta. 22 + 00 is 30.6 sq. ft.; suppose the excavation area at Sta. 22 + 50 is 20.1 sq. ft. To get the number of cubic feet of excavation from Stas. 22 + 00 to 22 + 50 add $30.6 + 20.1 = 50.7$. In Table 160 an area of 50.7 gives an excavation quantity of 1267.5 cu. ft. Where the normal cross-section interval is 50' this table is a great time saver.

Table 161 is convenient in changing cubic feet to cubic yards.

Table 162 is convenient for preliminary estimates, as it gives the cubic yards directly for the sum of the end areas in square feet. It, however, is not figured exactly and is not suitable for final estimate work.

TABLE 160.—VOLUME OF 50' SECTIONS IN CUBIC FEET FOR SUM OF END AREAS

COMPILED BY J. E. HUBER, ASSISTANT ENGINEER, BUFFALO, N. Y.

Sum of End Areas Sq. Ft.	0.0	0.1	0.2	0.3	0.4	0.5	0.6	0.7	0.8	0.9
0	—	2.5	5.0	7.5	10.0	12.5	15.0	17.5	20.0	22.5
1	25.0	27.5	30.0	32.5	35.0	37.5	40.0	42.5	45.0	47.5
2	50.0	52.5	55.0	57.5	60.0	62.5	65.0	67.5	70.0	72.5
3	75.0	77.5	80.0	82.5	85.0	87.5	90.0	92.5	95.0	97.5
4	100.0	102.5	105.0	107.5	110.0	112.5	115.0	117.5	120.0	122.5
5	125.0	127.5	130.0	132.5	135.0	137.5	140.0	142.5	145.0	147.5
6	150.0	152.5	155.0	157.5	160.0	162.5	165.0	167.5	170.0	172.5
7	175.0	177.5	180.0	182.5	185.0	187.5	190.0	192.5	195.0	197.5
8	200.0	202.5	205.0	207.5	210.0	212.5	215.0	217.5	220.0	222.5
9	225.0	227.5	230.0	232.5	235.0	237.5	240.0	242.5	245.0	247.5
10	250.0	252.5	255.0	257.5	260.0	262.5	265.0	267.5	270.0	272.5
11	275.0	277.5	280.0	282.5	285.0	287.5	290.0	292.5	295.0	297.5
12	300.0	302.5	305.0	307.5	310.0	312.5	315.0	317.5	320.0	322.5
13	325.0	327.5	330.0	332.5	335.0	337.5	340.0	342.5	345.0	347.5
14	350.0	352.5	355.0	357.5	360.0	362.5	365.0	367.5	370.0	372.5
15	375.0	377.5	380.0	382.5	385.0	387.5	390.0	392.5	395.0	397.5
16	400.0	402.5	405.0	407.5	410.0	412.5	415.0	417.5	420.0	422.5
17	425.0	427.5	430.0	432.5	435.0	437.5	440.0	442.5	445.0	447.5
18	450.0	452.5	455.0	457.5	460.0	462.5	465.0	467.5	470.0	472.5
19	475.0	477.5	480.0	482.5	485.0	487.5	490.0	492.5	495.0	497.5
20	500.0	502.5	505.0	507.5	510.0	512.5	515.0	517.5	520.0	522.5
21	525.0	527.5	530.0	532.5	535.0	537.5	540.0	542.5	545.0	547.5
22	550.0	552.5	555.0	557.5	560.0	562.5	565.0	567.5	570.0	572.5
23	575.0	577.5	580.0	582.5	585.0	587.5	590.0	592.5	595.0	597.5
24	600.0	602.5	605.0	607.5	610.0	612.5	615.0	617.5	620.0	622.5
25	625.0	627.5	630.0	632.5	635.0	637.5	640.0	642.5	645.0	647.5
26	650.0	652.5	655.0	657.5	660.0	662.5	665.0	667.5	670.0	672.5
27	675.0	677.5	680.0	682.5	685.0	687.5	690.0	692.5	695.0	697.5
28	700.0	702.5	705.0	707.5	710.0	712.5	715.0	717.5	720.0	722.5
29	725.0	727.5	730.0	732.5	735.0	737.5	740.0	742.5	745.0	747.5
30	750.0	752.5	755.0	757.5	760.0	762.5	765.0	767.5	770.0	772.5
31	775.0	777.5	780.0	782.5	785.0	787.5	790.0	792.5	795.0	797.5
32	800.0	802.5	805.0	807.5	810.0	812.5	815.0	817.5	820.0	822.5
33	825.0	827.5	830.0	832.5	835.0	837.5	840.0	842.5	845.0	847.5
34	850.0	852.5	855.0	857.5	860.0	862.5	865.0	867.5	870.0	872.5
35	875.0	877.5	880.0	882.5	885.0	887.5	890.0	892.5	895.0	897.5
36	900.0	902.5	905.0	907.5	910.0	912.5	915.0	917.5	920.0	922.5
37	925.0	927.5	930.0	932.5	935.0	937.5	940.0	942.5	945.0	947.5
38	950.0	952.5	955.0	957.5	960.0	962.5	965.0	967.5	970.0	972.5
39	975.0	977.5	980.0	982.5	985.0	987.5	990.0	992.5	995.0	997.5
40	1000.0	1002.5	1005.0	1007.5	1010.0	1012.5	1015.0	1017.5	1020.0	1022.5
41	1025.0	1027.5	1030.0	1032.5	1035.0	1037.5	1040.0	1042.5	1045.0	1047.5
42	1050.0	1052.5	1055.0	1057.5	1060.0	1062.5	1065.0	1067.5	1070.0	1072.5
43	1075.0	1077.5	1080.0	1082.5	1085.0	1087.5	1090.0	1092.5	1095.0	1097.5
44	1100.0	1102.5	1105.0	1107.5	1110.0	1112.5	1115.0	1117.5	1120.0	1122.5
45	1125.0	1127.5	1130.0	1132.5	1135.0	1137.5	1140.0	1142.5	1145.0	1147.5
46	1150.0	1152.5	1155.0	1157.5	1160.0	1162.5	1165.0	1167.5	1170.0	1172.5
47	1175.0	1177.5	1180.0	1182.5	1185.0	1187.5	1190.0	1192.5	1195.0	1197.5
48	1200.0	1202.5	1205.0	1207.5	1210.0	1212.5	1215.0	1217.5	1220.0	1222.5
49	1225.0	1227.5	1230.0	1232.5	1235.0	1237.5	1240.0	1242.5	1245.0	1247.5
50	1250.0	1252.5	1255.0	1257.5	1260.0	1262.5	1265.0	1267.5	1270.0	1272.5

NOTE.—For volumes larger than those given, use figures in the table, moving decimal point one place to the right and add proportional part.

EARTHWORK QUANTITIES

973

TABLE 160.—VOLUME OF 50' SECTIONS IN CUBIC FEET FOR SUM OF END AREAS.—Continued

COMPILED BY J. H. HUBER, ASSISTANT ENGINEER, BUFFALO, N. Y.

Sum of End Areas Sq. Ft.	0.0	0.1	0.2	0.3	0.4	0.5	0.6	0.7	0.8	0.9
50	1250.0	1252.5	1255.0	1257.5	1260.0	1262.5	1265.0	1267.5	1270.0	1272.5
51	1275.0	1277.5	1280.0	1282.5	1285.0	1287.5	1290.0	1292.5	1295.0	1297.5
52	1300.0	1302.5	1305.0	1307.5	1310.0	1312.5	1315.0	1317.5	1320.0	1322.5
53	1325.0	1327.5	1330.0	1332.5	1335.0	1337.5	1340.0	1342.5	1345.0	1347.5
54	1350.0	1352.5	1355.0	1357.5	1360.0	1362.5	1365.0	1367.5	1370.0	1372.5
55	1375.0	1377.5	1380.0	1382.5	1385.0	1387.5	1390.0	1392.5	1395.0	1397.5
56	1400.0	1402.5	1405.0	1407.5	1410.0	1412.5	1415.0	1417.5	1420.0	1422.5
57	1425.0	1427.5	1430.0	1432.5	1435.0	1437.5	1440.0	1442.5	1445.0	1447.5
58	1450.0	1452.5	1455.0	1457.5	1460.0	1462.5	1465.0	1467.5	1470.0	1472.5
59	1475.0	1477.5	1480.0	1482.5	1485.0	1487.5	1490.0	1492.5	1495.0	1497.5
60	1500.0	1502.5	1505.0	1507.5	1510.0	1512.5	1515.0	1517.5	1520.0	1522.5
61	1525.0	1527.5	1530.0	1532.5	1535.0	1537.5	1540.0	1542.5	1545.0	1547.5
62	1550.0	1552.5	1555.0	1557.5	1560.0	1562.5	1565.0	1567.5	1570.0	1572.5
63	1575.0	1577.5	1580.0	1582.5	1585.0	1587.5	1590.0	1592.5	1595.0	1597.5
64	1600.0	1602.5	1605.0	1607.5	1610.0	1612.5	1615.0	1617.5	1620.0	1622.5
65	1625.0	1627.5	1630.0	1632.5	1635.0	1637.5	1640.0	1642.5	1645.0	1647.5
66	1650.0	1652.5	1655.0	1657.5	1660.0	1662.5	1665.0	1667.5	1670.0	1672.5
67	1675.0	1677.5	1680.0	1682.5	1685.0	1687.5	1690.0	1692.5	1695.0	1697.5
68	1700.0	1702.5	1705.0	1707.5	1710.0	1712.5	1715.0	1717.5	1720.0	1722.5
69	1725.0	1727.5	1730.0	1732.5	1735.0	1737.5	1740.0	1742.5	1745.0	1747.5
70	1750.0	1752.5	1755.0	1757.5	1760.0	1762.5	1765.0	1767.5	1770.0	1772.5
71	1775.0	1777.5	1780.0	1782.5	1785.0	1787.5	1790.0	1792.5	1795.0	1797.5
72	1800.0	1802.5	1805.0	1807.5	1810.0	1812.5	1815.0	1817.5	1820.0	1822.5
73	1825.0	1827.5	1830.0	1832.5	1835.0	1837.5	1840.0	1842.5	1845.0	1847.5
74	1850.0	1852.5	1855.0	1857.5	1860.0	1862.5	1865.0	1867.5	1870.0	1872.5
75	1875.0	1877.5	1880.0	1882.5	1885.0	1887.5	1890.0	1892.5	1895.0	1897.5
76	1900.0	1902.5	1905.0	1907.5	1910.0	1912.5	1915.0	1917.5	1920.0	1922.5
77	1925.0	1927.5	1930.0	1932.5	1935.0	1937.5	1940.0	1942.5	1945.0	1947.5
78	1950.0	1952.5	1955.0	1957.5	1960.0	1962.5	1965.0	1967.5	1970.0	1972.5
79	1975.0	1977.5	1980.0	1982.5	1985.0	1987.5	1990.0	1992.5	1995.0	1997.5
80	2000.0	2002.5	2005.0	2007.5	2010.0	2012.5	2015.0	2017.5	2020.0	2022.5
81	2025.0	2027.5	2030.0	2032.5	2035.0	2037.5	2040.0	2042.5	2045.0	2047.5
82	2050.0	2052.5	2055.0	2057.5	2060.0	2062.5	2065.0	2067.5	2070.0	2072.5
83	2075.0	2077.5	2080.0	2082.5	2085.0	2087.5	2090.0	2092.5	2095.0	2097.5
84	2100.0	2102.5	2105.0	2107.5	2110.0	2112.5	2115.0	2117.5	2120.0	2122.5
85	2125.0	2127.5	2130.0	2132.5	2135.0	2137.5	2140.0	2142.5	2145.0	2147.5
86	2150.0	2152.5	2155.0	2157.5	2160.0	2162.5	2165.0	2167.5	2170.0	2172.5
87	2175.0	2177.5	2180.0	2182.5	2185.0	2187.5	2190.0	2192.5	2195.0	2197.5
88	2200.0	2202.5	2205.0	2207.5	2210.0	2212.5	2215.0	2217.5	2220.0	2222.5
89	2225.0	2227.5	2230.0	2232.5	2235.0	2237.5	2240.0	2242.5	2245.0	2247.5
90	2250.0	2252.5	2255.0	2257.5	2260.0	2262.5	2265.0	2267.5	2270.0	2272.5
91	2275.0	2277.5	2280.0	2282.5	2285.0	2287.5	2290.0	2292.5	2295.0	2297.5
92	2300.0	2302.5	2305.0	2307.5	2310.0	2312.5	2315.0	2317.5	2320.0	2322.5
93	2325.0	2327.5	2330.0	2332.5	2335.0	2337.5	2340.0	2342.5	2345.0	2347.5
94	2350.0	2352.5	2355.0	2357.5	2360.0	2362.5	2365.0	2367.5	2370.0	2372.5
95	2375.0	2377.5	2380.0	2382.5	2385.0	2387.5	2390.0	2392.5	2395.0	2397.5
96	2400.0	2402.5	2405.0	2407.5	2410.0	2412.5	2415.0	2417.5	2420.0	2422.5
97	2425.0	2427.5	2430.0	2432.5	2435.0	2437.5	2440.0	2442.5	2445.0	2447.5
98	2450.0	2452.5	2455.0	2457.5	2460.0	2462.5	2465.0	2467.5	2470.0	2472.5
99	2475.0	2477.5	2480.0	2482.5	2485.0	2487.5	2490.0	2492.5	2495.0	2497.5
100	2500.0	2502.5	2505.0	2507.5	2510.0	2512.5	2515.0	2517.5	2520.0	2522.5

PROPORTIONAL PART } 0.0 0.1 0.2 0.3 0.4 0.5 0.6 0.7 0.8 0.9
 } 2.5 5.0 7.5 10.0 12.5 15.0 17.5 20.0 22.5

TABLE 161.—CUBIC FEET AND CUBIC YARDS

0-1350		1350-2700		2700-4050		4050-5400	
Feet	Yds.	Feet	Yds.	Feet	Yds.	Feet	Yds.
27	1	77	51	2,727	101	77	151
54	2	1,404	2	54	2	4,104	2
81	3	31	3	81	3	31	3
108	4	58	4	2,808	4	58	4
35	5	85	5	35	5	85	5
62	6	1,512	6	62	6	4,212	6
80	7	30	7	80	7	30	7
216	8	66	8	2,010	8	66	8
43	9	93	9	43	9	93	9
70	10	1,620	60	70	110	4,320	160
97	1	47	1	97	1	47	1
324	2	74	2	3,024	2	74	2
51	3	1,701	3	51	3	4,401	3
78	4	28	4	78	4	28	4
405	5	55	5	3,105	5	55	5
33	6	82	6	33	6	82	6
50	7	1,800	7	50	7	4,500	7
86	8	36	8	86	8	36	8
513	9	63	9	3,213	9	63	9
40	10	90	70	40	120	90	120
67	1	1,017	1	67	1	4,617	1
94	2	44	2	94	2	44	2
621	3	71	3	3,321	3	71	3
48	4	98	4	48	4	98	4
75	5	2,025	5	75	5	4,725	5
702	6	52	6	3,402	6	52	6
20	7	70	7	20	7	70	7
56	8	2,106	8	56	8	4,806	8
83	9	33	9	83	9	33	9
810	30	60	80	3,510	130	60	180
37	1	87	1	37	1	87	1
64	2	2,214	2	64	2	4,014	2
91	3	41	3	91	3	41	3
918	4	68	4	3,618	4	68	4
45	5	95	5	45	5	95	5
72	6	2,322	6	72	6	5,022	6
90	7	40	7	90	7	40	7
1,026	8	76	8	3,726	8	76	8
53	9	2,403	9	53	9	5,103	9
80	40	30	90	80	140	30	190
1,107	1	57	1	3,807	1	57	1
34	2	84	2	34	2	84	2
61	3	2,511	3	61	3	5,211	3
88	4	38	4	88	4	38	4
1,215	5	65	5	3,015	5	65	5
42	6	92	6	42	6	92	6
60	7	2,610	7	60	7	5,310	7
96	8	46	8	96	8	46	8
1,323	9	73	9	4,023	9	73	9
50	50	2,700	100	50	150	5,400	200

EARTHWORK QUANTITIES

TABLE 161—Continued

5400-6750		6750-8100		8100-9450		9450-10,800	
Feet	Yds.	Feet	Yds.	Feet	Yds.	Feet	Yds.
5,427	201	77	251	8,127	301	77	351
54	2	6,804	2	54	2	9,504	2
81	3	31	3	81	3	31	3
5,508	4	58	4	8,208	4	58	4
35	5	85	5	35	5	85	5
62	6	6,912	6	62	6	9,612	6
89	7	39	7	89	7	39	7
5,616	8	66	8	8,316	8	66	8
43	9	93	9	43	9	93	9
70	210	7,020	260	70	310	9,720	360
97	1	47	1	97	1	47	1
5,724	2	74	2	8,424	2	74	2
51	3	7,101	3	51	3	9,801	3
78	4	28	4	78	4	28	4
5,805	5	55	5	8,505	5	55	5
32	6	82	6	32	6	82	6
59	7	7,209	7	59	7	9,909	7
86	8	36	8	86	8	36	8
5,913	9	63	9	8,613	9	63	9
40	220	90	270	40	320	90	370
67	1	7,317	1	67	1	10,017	1
94	2	44	2	94	2	44	2
6,021	3	71	3	8,721	3	71	3
48	4	98	4	48	4	98	4
75	5	7,425	5	75	5	10,125	5
6,102	6	52	6	8,802	6	52	6
20	7	79	7	20	7	79	7
56	8	7,506	8	56	8	10,206	8
83	9	33	9	83	9	33	9
6,210	230	60	280	8,910	330	60	380
37	1	87	1	37	1	87	1
64	2	7,614	2	64	2	10,314	2
91	3	41	3	91	3	41	3
6,318	4	68	4	9,018	4	68	4
45	5	95	5	45	5	95	5
72	6	7,722	6	72	6	10,422	6
99	7	40	7	99	7	40	7
6,426	8	76	8	9,126	8	76	8
53	9	7,803	9	53	9	10,503	9
80	240	30	290	80	340	30	390
6,507	1	57	1	9,207	1	57	1
34	2	84	2	34	2	84	2
61	3	7,911	3	61	3	10,611	3
88	4	38	4	88	4	38	4
6,615	5	65	5	9,315	5	65	5
42	6	92	6	42	6	92	6
69	7	8,019	7	69	7	10,719	7
96	8	46	8	96	8	46	8
6,723	9	73	9	9,423	9	73	9
50	250	8,100	300	50	350	10,800	400

TABLE 161—Continued

10,800-12,150		12,150-13,500		13,500-14,850		14,850-16,200	
Feet	Yds.	Feet	Yds.	Feet	Yds.	Feet	Yds.
10,827	401	77	451	13,527	501	177	551
54	2	12,204	2	54	2	14,904	2
81	3	31	3	81	3	31	3
10,908	4	58	4	13,608	4	58	4
35	5	85	5	35	5	85	5
62	6	12,312	6	62	6	15,012	6
80	7	30	7	80	7	30	7
11,016	8	66	8	13,716	8	66	8
43	9	93	9	43	9	93	9
70	410	12,420	460	70	510	15,120	560
97	1	47	1	97	1	47	1
11,124	2	74	2	13,824	2	74	2
51	3	12,501	3	51	3	15,201	3
78	4	28	4	78	4	28	4
11,205	5	55	5	13,905	5	55	5
32	6	82	6	32	6	82	6
50	7	12,609	7	50	7	15,309	7
86	8	16	8	86	8	36	8
11,313	9	61	9	14,013	9	61	9
40	420	90	470	40	520	90	570
67	1	12,717	1	67	1	15,417	1
94	2	44	2	94	2	44	2
11,421	3	71	3	14,121	3	71	3
48	4	98	4	48	4	98	4
75	5	12,825	5	75	5	13,525	5
11,502	6	52	6	14,202	6	52	6
20	7	79	7	20	7	79	7
56	8	12,906	8	56	8	15,606	8
83	9	31	9	83	9	31	9
11,610	430	60	480	14,310	530	60	580
37	1	87	1	37	1	87	1
64	2	13,014	2	64	2	15,714	2
91	3	41	3	91	3	41	3
11,718	4	68	4	14,418	4	68	4
45	5	95	5	45	5	95	5
72	6	13,122	6	72	6	15,822	6
99	7	49	7	99	7	49	7
11,826	8	76	8	14,526	8	76	8
53	9	13,203	9	53	9	15,003	9
80	440	30	490	80	540	30	590
11,907	1	57	1	14,607	1	57	1
34	2	84	2	34	2	84	2
61	3	13,311	3	61	3	16,011	3
88	4	38	4	88	4	38	4
12,015	5	65	5	14,715	5	65	5
42	6	92	6	42	6	92	6
69	7	13,419	7	69	7	16,119	7
96	8	46	8	96	8	46	8
12,123	9	73	9	14,823	9	73	9
50	450	13,500	500	50	550	16,200	600

EARTHWORK QUANTITIES

TABLE 161—Continued

16,900-17,550		17,550-18,000		18,000-20,250		20,250-21,600	
Feet	Yds.	Feet	Yds.	Feet	Yds.	Feet	Yds.
16,227	601	77	651	18,927	701	77	751
54	2	17,604	2	54	2	20,304	2
81	3	31	3	81	3	31	3
16,308	4	58	4	19,008	4	58	4
35	5	85	5	35	5	85	5
62	6	17,712	6	62	6	20,412	6
80	7	39	7	80	7	39	7
16,416	8	66	8	10,116	8	66	8
43	9	93	9	43	9	93	9
70	610	17,820	660	70	710	20,520	760
97	1	47	1	97	1	47	1
16,524	2	74	2	19,224	2	74	2
51	3	17,901	3	51	3	20,601	3
78	4	28	4	78	4	28	4
16,605	5	55	5	19,305	5	55	5
32	6	82	6	32	6	82	6
59	7	18,009	7	59	7	20,709	7
86	8	36	8	86	8	36	8
16,713	9	63	9	19,413	9	63	9
40	620	90	670	40	720	90	770
67	1	18,117	1	67	1	20,817	1
94	2	41	2	94	2	44	2
16,821	3	71	3	10,521	3	71	3
48	4	98	4	48	4	98	4
75	5	18,225	5	75	5	20,925	5
16,902	6	52	6	19,602	6	52	6
29	7	79	7	29	7	79	7
56	8	18,306	8	56	8	21,006	8
83	9	31	9	83	9	31	9
17,010	630	60	680	19,710	730	60	780
37	1	87	1	37	1	87	1
64	2	18,414	2	64	2	21,114	2
91	3	41	3	91	3	41	3
17,118	4	68	4	19,818	4	68	4
45	5	95	5	45	5	95	5
72	6	18,522	6	72	6	21,222	6
99	7	40	7	99	7	40	7
17,226	8	76	8	19,926	8	76	8
53	9	18,603	9	53	9	21,303	9
80	640	30	690	80	740	30	790
17,307	1	57	1	20,007	1	57	1
34	2	84	2	34	2	84	2
61	3	18,711	3	61	3	21,411	3
88	4	38	4	88	4	38	4
17,415	5	65	5	20,115	5	65	5
42	6	92	6	42	6	92	6
69	7	18,819	7	69	7	21,519	7
96	8	46	8	96	8	46	8
17,523	9	73	9	20,223	9	73	9
50	630	18,900	700	50	750	21,600	800

TABLE 161—Continued

21,600-22,050		22,050-24,300		24,300-25,650		25,650-27,000	
Feet	Yds.	Feet	Yds.	Feet	Yds.	Feet	Yds.
21,627	801	77	851	24,327	901	77	951
54	2	23,004	2	54	2	25,704	2
81	3	31	3	81	3	31	3
21,708	4	53	4	24,408	4	58	4
35	5	85	5	35	5	85	5
62	6	23,112	6	62	6	25,812	6
89	7	39	7	89	7	39	7
21,816	8	66	8	24,516	8	66	8
43	9	93	9	43	9	93	9
70	810	23,220	860	70	910	25,920	960
97	1	47	1	97	1	47	1
21,924	2	74	2	24,624	2	74	2
51	3	23,301	3	51	3	26,001	3
78	4	28	4	78	4	28	4
22,005	5	55	5	24,705	5	55	5
32	6	82	6	32	6	82	6
59	7	23,409	7	59	7	26,109	7
86	8	36	8	86	8	36	8
22,113	9	61	9	24,813	9	61	9
40	820	90	870	40	920	90	970
67	1	23,517	1	67	1	26,217	1
94	2	44	2	94	2	44	2
22,221	3	71	3	24,921	3	71	3
48	4	98	4	48	4	98	4
75	5	23,625	5	75	5	26,325	5
22,302	6	52	6	25,002	6	52	6
29	7	79	7	29	7	79	7
56	8	23,706	8	56	8	26,406	8
83	9	33	9	83	9	33	9
22,410	830	60	880	25,110	910	60	980
37	1	87	1	37	1	87	1
64	2	23,814	2	64	2	26,514	2
91	3	41	3	91	3	41	3
22,518	4	68	4	25,218	4	68	4
45	5	95	5	45	5	95	5
72	6	23,922	6	72	6	26,622	6
99	7	49	7	99	7	49	7
22,626	8	76	8	25,326	8	76	8
53	9	24,003	9	53	9	26,703	9
80	840	30	890	80	940	30	990
22,707	1	57	1	25,407	1	57	1
34	2	84	2	34	2	84	2
61	3	24,111	3	61	3	26,811	3
88	4	38	4	88	4	38	4
22,815	5	65	5	25,515	5	65	5
42	6	92	6	42	6	92	6
69	7	24,219	7	69	7	26,919	7
96	8	46	8	96	8	46	8
22,923	9	73	9	25,623	9	73	9
50	850	24,300	900	50	950	27,000	1000

EARTHWORK QUANTITIES

TABLE 161—Continued

27,000-28,350		28,350-29,700		29,700-31,050		31,050-32,400	
Feet	Yds.	Feet	Yds.	Feet	Yds.	Feet	Yds.
27,027	1001	77	1051	29,727	1101	77	1151
54	2	28,404	2	54	2	31,104	2
81	3	31	3	81	3	31	3
27,108	4	58	4	29,808	4	58	4
35	5	85	5	35	5	85	5
62	6	28,512	6	62	6	31,212	6
89	7	39	7	89	7	39	7
27,216	8	66	8	29,916	8	66	8
43	9	93	9	43	9	93	9
70	1010	28,620	1060	70	1110	31,320	1160
97	1	47	1	97	1	47	1
27,324	2	74	2	30,024	2	74	2
51	3	28,701	3	51	3	31,401	3
78	4	28	4	78	4	28	4
27,405	5	55	5	30,105	5	55	5
32	6	82	6	32	6	82	6
59	7	28,800	7	59	7	31,500	7
86	8	36	8	86	8	36	8
27,513	9	63	9	30,213	9	63	9
40	1020	90	1070	40	1120	90	1170
67	1	28,917	1	67	1	31,617	1
94	2	44	2	94	2	44	2
27,621	3	71	3	30,321	3	71	3
48	4	98	4	48	4	98	4
75	5	29,025	5	75	5	31,725	5
27,702	6	52	6	30,402	6	52	6
29	7	79	7	29	7	79	7
56	8	29,106	8	56	8	31,806	8
83	9	33	9	83	9	33	9
27,810	1030	60	1080	30,510	1130	60	1180
37	1	87	1	37	1	87	1
64	2	29,214	2	64	2	31,914	2
91	3	41	3	91	3	41	3
27,918	4	68	4	30,018	4	68	4
45	5	95	5	45	5	95	5
72	6	29,322	6	72	6	32,022	6
99	7	49	7	99	7	49	7
28,026	8	76	8	30,726	8	76	8
53	9	29,403	9	53	9	32,103	9
80	1040	30	1090	80	1140	30	1190
28,107	1	57	1	30,807	1	57	1
34	2	84	2	34	2	84	2
61	3	29,511	3	61	3	32,211	3
88	4	38	4	88	4	38	4
28,215	5	65	5	30,915	5	65	5
42	6	92	6	42	6	92	6
69	7	29,619	7	69	7	32,319	7
96	8	46	8	96	8	46	8
28,323	9	73	9	31,023	9	73	9
50	1050	29,700	1100	50	1150	32,400	1200

TABLE 161—Continued

32,400-33,750		33,750-35,100		35,100-36,450		36,450-37,800	
Feet	Yds.	Feet	Yds.	Feet	Yds.	Feet	Yds.
32,427	1201	77	1251	35,127	1301	77	1351
54	2	33,804	2	54	2	36,504	2
81	3	31	3	81	3	31	3
32,508	4	58	4	35,208	4	58	4
35	5	85	5	35	5	85	5
62	6	33,912	6	62	6	36,612	6
89	7	30	7	89	7	30	7
32,616	8	60	8	35,316	8	60	8
43	9	93	9	43	9	93	9
70	1210	34,020	1260	70	1310	36,720	1360
97	1	47	1	97	1	47	1
32,724	2	74	2	35,424	2	74	2
51	3	34,101	3	51	3	36,801	3
78	4	28	4	78	4	28	4
32,805	5	55	5	35,505	5	55	5
32	6	82	6	32	6	82	6
59	7	34,209	7	59	7	36,909	7
86	8	36	8	86	8	36	8
32,913	9	63	9	35,613	9	63	9
40	1220	90	1270	40	1320	90	1370
67	1	34,317	1	67	1	37,017	1
94	2	44	2	94	2	44	2
33,021	3	71	3	35,721	3	71	3
48	4	98	4	48	4	98	4
75	5	34,425	5	75	5	37,125	5
33,102	6	52	6	35,802	6	52	6
29	7	79	7	29	7	79	7
56	8	34,506	8	56	8	37,206	8
83	9	31	9	83	9	31	9
33,210	1230	60	1280	35,910	1330	60	1380
37	1	87	1	37	1	87	1
64	2	34,614	2	64	2	37,314	2
91	3	41	3	91	3	41	3
33,318	4	68	4	36,018	4	68	4
45	5	95	5	45	5	95	5
72	6	34,722	6	72	6	37,422	6
99	7	49	7	99	7	49	7
33,426	8	76	8	36,126	8	76	8
53	9	34,803	9	53	9	37,503	9
80	1240	30	1290	80	1340	30	1390
33,507	1	57	1	36,207	1	57	1
34	2	84	2	34	2	84	2
61	3	34,911	3	61	3	37,611	3
88	4	38	4	88	4	38	4
33,615	5	65	5	36,315	5	65	5
42	6	92	6	42	6	92	6
69	7	35,019	7	69	7	37,719	7
96	8	46	8	96	8	46	8
33,723	9	73	9	36,423	9	73	9
50	1250	35,100	1300	50	1350	37,800	1400

EARTHWORK QUANTITIES

981

TABLE 161—*Concluded*

37,800-39,150		39,150-40,500		40,500-41,850		41,850-43,200	
Feet	Yds.	Feet	Yds.	Feet	Yds.	Feet	Yds.
37,827	1401	77	1451	40,527	1501	77	1551
54	2	39,204	2	54	2	41,904	2
81	3	31	3	81	3	31	3
37,908	4	58	4	40,608	4	58	4
35	5	85	5	35	5	85	5
62	6	39,312	6	62	6	42,012	6
89	7	39	7	89	7	39	7
38,016	8	66	8	40,716	8	66	8
43	9	93	9	43	9	93	9
70	1410	39,420	1460	70	1510	42,120	1560
07	1	47	1	07	1	47	1
38,124	2	74	2	40,824	2	74	2
51	3	39,501	3	51	3	42,201	3
78	4	28	4	78	4	28	4
38,205	5	55	5	40,905	5	55	5
32	6	82	6	32	6	82	6
59	7	39,600	7	59	7	42,309	7
86	8	36	8	86	8	36	8
38,313	9	63	9	41,013	9	63	9
40	1420	90	1470	40	1520	90	1570
67	1	39,717	1	67	1	42,417	1
94	2	44	2	94	2	44	2
38,421	3	71	3	41,121	3	71	3
48	4	08	4	48	4	08	4
75	5	39,825	5	75	5	42,525	5
38,502	6	52	6	41,202	6	52	6
29	7	79	7	29	7	79	7
56	8	39,906	8	56	8	42,606	8
83	9	33	9	83	9	33	9
38,610	1430	60	1480	41,310	1530	60	1580
37	1	87	1	37	1	87	1
64	2	40,014	2	64	2	42,714	2
91	3	41	3	91	3	41	3
38,718	4	68	4	41,418	4	68	4
45	5	95	5	45	5	95	5
72	6	40,122	6	72	6	42,822	6
99	7	40	7	99	7	40	7
38,826	8	76	8	41,526	8	76	8
33	9	40,203	9	33	9	42,003	9
80	1440	30	1490	80	1540	30	1590
38,907	1	57	1	41,607	1	57	1
34	2	84	2	34	2	84	2
61	3	40,311	3	61	3	43,011	3
88	4	38	4	88	4	38	4
39,015	5	65	5	41,715	5	65	5
42	6	92	6	42	6	92	6
69	7	40,419	7	69	7	43,119	7
96	8	46	8	96	8	46	8
39,123	9	73	9	41,823	9	73	9
50	1450	40,500	1500	50	1550	43,200	1600

TABLE 162.—NEW YORK STATE DEPARTMENT OF HIGHWAYS
EARTHWORK COMPUTATION TABLES

Distance horizontal. Sum of areas vertical. Quantities in cubic yards

2	3	4	5	6	7	8	9	10	11	12	13	14	D'uble Areas
0.0	0.1	0.1	0.1	0.1	0.1	0.1	0.2	0.2	0.2	0.2	0.2	0.3	1.0
0.0	0.1	0.1	0.1	0.1	0.1	0.2	0.2	0.2	0.2	0.3	0.3	0.3	2
0.1	0.1	0.1	0.1	0.1	0.2	0.2	0.2	0.3	0.3	0.3	0.3	0.4	4
0.1	0.1	0.1	0.1	0.2	0.2	0.2	0.3	0.3	0.3	0.4	0.4	0.4	6
0.1	0.1	0.1	0.2	0.2	0.2	0.3	0.3	0.3	0.4	0.4	0.4	0.5	8
0.1	0.1	0.1	0.2	0.2	0.2	0.3	0.3	0.4	0.4	0.4	0.5	0.5	2.0
0.1	0.1	0.2	0.2	0.2	0.3	0.3	0.4	0.4	0.4	0.5	0.5	0.6	2
0.1	0.1	0.2	0.2	0.3	0.3	0.4	0.4	0.4	0.5	0.5	0.6	0.6	4
0.1	0.1	0.2	0.2	0.3	0.4	0.4	0.4	0.5	0.5	0.6	0.6	0.7	6
0.1	0.2	0.2	0.3	0.3	0.4	0.4	0.5	0.5	0.6	0.6	0.7	0.7	8
0.1	0.2	0.2	0.3	0.3	0.4	0.4	0.5	0.5	0.6	0.7	0.7	0.8	3.0
0.1	0.2	0.2	0.3	0.4	0.4	0.5	0.5	0.6	0.7	0.7	0.8	0.8	2
0.1	0.2	0.3	0.3	0.4	0.4	0.5	0.6	0.6	0.7	0.8	0.8	0.9	4
0.1	0.2	0.3	0.3	0.4	0.5	0.5	0.6	0.7	0.7	0.8	0.9	0.9	6
0.1	0.2	0.3	0.4	0.4	0.5	0.6	0.6	0.7	0.8	0.8	0.9	1.0	8
0.1	0.2	0.3	0.4	0.4	0.5	0.6	0.7	0.7	0.8	0.9	1.0	1.0	4.0
0.2	0.2	0.3	0.4	0.5	0.5	0.6	0.7	0.8	0.9	0.9	1.0	1.1	2
0.2	0.2	0.3	0.4	0.5	0.6	0.7	0.7	0.8	0.9	1.0	1.1	1.1	4
0.2	0.3	0.3	0.4	0.5	0.6	0.7	0.8	0.9	0.9	1.0	1.1	1.2	6
0.2	0.3	0.4	0.4	0.5	0.6	0.7	0.8	0.9	1.0	1.1	1.2	1.2	8
0.2	0.3	0.4	0.5	0.6	0.6	0.7	0.8	0.9	1.0	1.1	1.2	1.3	5.0
0.2	0.3	0.4	0.5	0.6	0.7	0.8	0.9	1.0	1.1	1.2	1.3	1.3	2
0.2	0.3	0.4	0.5	0.6	0.7	0.8	0.9	1.0	1.1	1.2	1.3	1.4	4
0.2	0.3	0.4	0.5	0.6	0.7	0.8	0.9	1.0	1.1	1.2	1.3	1.5	6
0.2	0.3	0.4	0.5	0.6	0.8	0.9	1.0	1.1	1.2	1.3	1.4	1.5	8
0.2	0.3	0.4	0.6	0.7	0.8	0.9	1.0	1.1	1.2	1.3	1.4	1.6	6.0
0.2	0.3	0.5	0.6	0.7	0.8	0.9	1.1	1.1	1.3	1.4	1.5	1.6	2
0.2	0.4	0.5	0.6	0.7	0.8	0.9	1.1	1.2	1.3	1.4	1.5	1.7	4
0.2	0.4	0.5	0.6	0.7	0.9	1.0	1.1	1.2	1.3	1.5	1.6	1.7	6
0.3	0.4	0.5	0.6	0.7	0.9	1.0	1.1	1.3	1.4	1.5	1.6	1.8	8
0.3	0.4	0.5	0.6	0.8	0.9	1.0	1.2	1.3	1.4	1.6	1.7	1.8	7.0
0.3	0.4	0.5	0.7	0.8	0.9	1.1	1.2	1.3	1.5	1.6	1.7	1.9	2
0.3	0.4	0.5	0.7	0.8	1.0	1.1	1.2	1.4	1.5	1.6	1.8	1.9	4
0.3	0.4	0.6	0.7	0.8	1.0	1.1	1.3	1.4	1.5	1.7	1.8	2.0	6
0.3	0.4	0.6	0.7	0.9	1.0	1.2	1.3	1.4	1.6	1.7	1.9	2.0	8
0.3	0.4	0.6	0.7	0.9	1.0	1.2	1.3	1.5	1.6	1.8	1.9	2.1	5.0
0.3	0.5	0.6	0.8	0.9	1.1	1.2	1.4	1.5	1.7	1.8	2.0	2.1	2
0.3	0.5	0.6	0.8	0.9	1.1	1.2	1.4	1.6	1.7	1.9	2.0	2.2	4
0.3	0.5	0.6	0.8	1.0	1.1	1.3	1.4	1.6	1.7	1.9	2.1	2.2	6
0.3	0.5	0.7	0.8	1.0	1.1	1.3	1.5	1.6	1.8	2.0	2.1	2.3	8
0.3	0.5	0.7	0.9	1.0	1.2	1.3	1.5	1.7	1.8	2.0	2.2	2.5	9.0
0.3	0.5	0.7	0.9	1.0	1.2	1.4	1.5	1.7	1.9	2.0	2.2	2.4	2
0.3	0.5	0.7	0.9	1.0	1.2	1.4	1.6	1.7	1.9	2.1	2.3	2.4	4
0.4	0.5	0.7	0.9	1.1	1.2	1.4	1.6	1.8	2.0	2.1	2.3	2.5	6
0.4	0.5	0.7	0.9	1.1	1.3	1.5	1.6	1.8	2.0	2.2	2.4	2.5	8
0.4	0.6	0.7	0.9	1.1	1.3	1.5	1.7	1.9	2.0	2.2	2.4	2.6	10.0
0.4	0.6	0.8	1.0	1.2	1.4	1.6	1.8	1.9	2.1	2.3	2.5	2.7	5
0.4	0.6	0.8	1.0	1.2	1.4	1.6	1.8	2.0	2.2	2.4	2.6	2.9	11.0
0.4	0.6	0.9	1.1	1.3	1.5	1.7	1.9	2.1	2.3	2.5	2.8	3.0	5
0.4	0.7	0.9	1.1	1.3	1.6	1.8	2.0	2.2	2.4	2.7	2.9	3.1	12.0
0.5	0.7	0.9	1.2	1.4	1.6	1.9	2.1	2.3	2.5	2.8	3.0	3.2	5
0.5	0.7	1.0	1.2	1.5	1.7	2.0	2.2	2.4	2.6	2.9	3.1	3.4	13.0
0.5	0.7	1.0	1.3	1.5	1.8	2.0	2.3	2.5	2.7	3.0	3.3	3.5	5
0.5	0.8	1.0	1.3	1.6	1.8	2.1	2.3	2.6	2.8	3.1	3.4	3.6	14.0

EARTHWORK QUANTITIES

983

TABLE 162.—Continued

15	16	17	18	19	20	21	22	23	24	25	26	27	D'uble Areas
0.3	0.3	0.3	0.3	0.4	0.4	0.4	0.4	0.4	0.4	0.5	0.5	0.5	1.0
0.3	0.4	0.4	0.4	0.4	0.4	0.5	0.5	0.5	0.5	0.6	0.6	0.6	2
0.4	0.4	0.4	0.5	0.5	0.5	0.5	0.6	0.6	0.6	0.6	0.7	0.7	4
0.4	0.5	0.5	0.5	0.6	0.6	0.6	0.7	0.7	0.7	0.7	0.8	0.8	6
0.5	0.5	0.6	0.6	0.6	0.7	0.7	0.7	0.8	0.8	0.8	0.9	0.9	8
0.6	0.6	0.6	0.7	0.7	0.7	0.8	0.8	0.9	0.9	1.0	1.0	1.0	2.0
0.6	0.7	0.7	0.8	0.8	0.8	0.9	0.9	1.0	1.0	1.1	1.1	1.1	2
0.7	0.7	0.8	0.8	0.8	0.9	0.9	1.0	1.0	1.1	1.1	1.2	1.2	4
0.7	0.8	0.8	0.9	0.9	1.0	1.0	1.1	1.1	1.1	1.2	1.2	1.3	6
0.8	0.8	0.9	1.0	1.0	1.0	1.1	1.1	1.2	1.2	1.2	1.3	1.4	8
0.8	0.9	0.9	1.0	1.1	1.1	1.2	1.2	1.3	1.3	1.4	1.4	1.5	3.0
0.9	0.9	1.0	1.1	1.1	1.2	1.2	1.3	1.4	1.4	1.5	1.5	1.6	2
0.9	1.0	1.1	1.1	1.2	1.3	1.3	1.4	1.4	1.5	1.6	1.6	1.7	4
1.0	1.1	1.1	1.2	1.3	1.3	1.4	1.5	1.5	1.6	1.7	1.7	1.8	6
1.1	1.1	1.2	1.3	1.3	1.4	1.5	1.5	1.6	1.7	1.8	1.8	1.9	8
1.1	1.2	1.3	1.3	1.4	1.5	1.6	1.6	1.7	1.8	1.9	1.9	2.0	4.0
1.2	1.2	1.3	1.4	1.5	1.6	1.6	1.7	1.8	1.9	1.9	2.0	2.1	2
1.2	1.3	1.4	1.5	1.5	1.6	1.7	1.8	1.9	2.0	2.0	2.1	2.2	4
1.3	1.4	1.4	1.5	1.6	1.7	1.8	1.9	2.0	2.0	2.1	2.2	2.3	6
1.3	1.4	1.5	1.6	1.7	1.8	1.8	2.0	2.0	2.1	2.2	2.3	2.4	8
1.4	1.5	1.6	1.7	1.8	1.9	1.9	2.0	2.1	2.2	2.3	2.4	2.5	5.0
1.4	1.5	1.6	1.7	1.8	1.9	2.0	2.1	2.2	2.3	2.4	2.5	2.6	2
1.5	1.6	1.7	1.8	1.9	2.0	2.1	2.2	2.3	2.4	2.5	2.6	2.7	4
1.5	1.7	1.8	1.9	2.0	2.1	2.2	2.3	2.4	2.5	2.6	2.7	2.8	6
1.6	1.7	1.8	2.0	2.0	2.2	2.3	2.4	2.5	2.6	2.7	2.8	2.9	8
1.7	1.8	1.9	2.0	2.1	2.2	2.3	2.4	2.6	2.7	2.8	2.9	3.0	6.0
1.7	1.8	1.9	2.1	2.2	2.3	2.4	2.5	2.6	2.8	2.9	3.0	3.1	2
1.8	1.9	2.0	2.1	2.2	2.4	2.5	2.6	2.7	2.8	3.0	3.1	3.2	4
1.8	2.0	2.1	2.2	2.3	2.5	2.6	2.7	2.8	2.9	3.1	3.2	3.3	6
1.9	2.0	2.1	2.3	2.4	2.5	2.6	2.8	2.9	3.0	3.2	3.3	3.4	8
1.9	2.1	2.2	2.3	2.5	2.6	2.7	2.9	3.0	3.1	3.2	3.4	3.5	7.0
2.0	2.1	2.3	2.4	2.5	2.7	2.8	2.9	3.1	3.2	3.3	3.5	3.6	2
2.1	2.2	2.3	2.5	2.6	2.7	2.9	3.0	3.1	3.3	3.4	3.6	3.7	4
2.1	2.3	2.4	2.5	2.7	2.8	3.0	3.1	3.2	3.4	3.5	3.7	3.8	6
2.2	2.3	2.5	2.6	2.7	2.9	3.0	3.2	3.3	3.5	3.6	3.8	3.9	8
2.2	2.4	2.5	2.7	2.8	3.0	3.1	3.3	3.4	3.6	3.7	3.9	4.0	8.0
2.3	2.4	2.6	2.7	2.9	3.0	3.2	3.3	3.5	3.6	3.8	4.0	4.1	2
2.3	2.5	2.6	2.8	2.9	3.1	3.3	3.4	3.6	3.7	3.9	4.1	4.2	4
2.4	2.5	2.7	2.9	3.0	3.2	3.3	3.5	3.7	3.8	4.0	4.1	4.3	6
2.4	2.6	2.8	2.9	3.1	3.3	3.4	3.6	3.8	3.9	4.1	4.2	4.4	8
2.5	2.7	2.8	3.0	3.2	3.3	3.5	3.7	3.8	4.0	4.2	4.3	4.5	9.0
2.6	2.7	2.9	3.1	3.2	3.4	3.6	3.8	3.9	4.1	4.3	4.4	4.6	2
2.6	2.8	3.0	3.1	3.3	3.5	3.7	3.8	4.0	4.2	4.4	4.5	4.7	4
2.7	2.8	3.0	3.2	3.4	3.6	3.7	3.9	4.1	4.3	4.5	4.6	4.8	6
2.7	2.9	3.1	3.3	3.4	3.6	3.8	4.0	4.2	4.4	4.5	4.7	4.9	8
2.8	3.0	3.1	3.3	3.5	3.7	3.9	4.1	4.2	4.4	4.6	4.8	5.0	10.0
2.9	3.1	3.3	3.5	3.7	3.9	4.1	4.3	4.5	4.6	4.9	5.0	5.3	5
3.1	3.3	3.5	3.7	3.9	4.1	4.3	4.5	4.7	4.9	5.1	5.3	5.5	11.0
3.2	3.4	3.6	3.8	4.0	4.3	4.5	4.7	4.9	5.1	5.3	5.5	5.7	5
3.3	3.6	3.8	4.0	4.2	4.5	4.7	4.9	5.1	5.3	5.5	5.8	6.0	12.0
3.5	3.7	3.9	4.2	4.4	4.6	4.9	5.1	5.3	5.5	5.8	6.0	6.2	5
3.6	3.8	4.1	4.3	4.6	4.8	5.0	5.3	5.5	5.8	6.0	6.3	6.5	13.0
3.7	4.0	4.2	4.5	4.8	5.0	5.2	5.5	5.8	6.0	6.3	6.5	6.7	5
3.9	4.1	4.4	4.7	4.9	5.2	5.4	5.7	6.0	6.2	6.5	6.7	7.0	14.0

TABLE 162.—Continued

28	29	30	31	32	33	34	35	36	37	38	39	40	D'uble Areas
0.5	0.5	0.6	0.6	0.6	0.6	0.7	0.7	0.7	0.7	0.7	0.7	0.7	1.0
0.6	0.6	0.7	0.7	0.7	0.7	0.8	0.8	0.8	0.8	0.9	0.9	0.9	2
0.7	0.8	0.8	0.8	0.8	0.9	0.9	0.9	0.9	1.0	1.0	1.0	1.0	4
0.8	0.9	0.9	0.9	1.0	1.0	1.0	1.0	1.1	1.1	1.1	1.2	1.2	6
0.9	1.0	1.0	1.0	1.1	1.1	1.2	1.2	1.2	1.2	1.3	1.3	1.3	8
1.0	1.1	1.1	1.2	1.2	1.2	1.3	1.3	1.3	1.4	1.4	1.5	1.5	2.0
1.1	1.2	1.2	1.3	1.3	1.3	1.4	1.4	1.5	1.5	1.6	1.6	1.6	2
1.2	1.3	1.3	1.4	1.4	1.5	1.5	1.6	1.6	1.7	1.7	1.7	1.8	4
1.4	1.4	1.4	1.5	1.5	1.6	1.6	1.7	1.7	1.8	1.8	1.9	1.9	6
1.5	1.5	1.6	1.6	1.7	1.7	1.8	1.8	1.9	1.9	2.0	2.0	2.1	8
1.6	1.6	1.7	1.7	1.8	1.8	1.9	1.9	2.0	2.1	2.1	2.2	2.2	3.0
1.7	1.7	1.8	1.8	1.9	2.0	2.0	2.1	2.1	2.2	2.3	2.3	2.4	2
1.8	1.8	1.9	2.0	2.0	2.1	2.1	2.2	2.2	2.3	2.4	2.5	2.5	4
1.9	1.9	2.0	2.1	2.1	2.2	2.2	2.3	2.4	2.5	2.5	2.6	2.7	6
2.0	2.0	2.1	2.2	2.3	2.3	2.4	2.5	2.5	2.6	2.7	2.8	2.8	8
2.1	2.2	2.2	2.3	2.4	2.5	2.5	2.6	2.7	2.7	2.8	2.9	3.0	4.0
2.2	2.3	2.3	2.4	2.5	2.6	2.6	2.7	2.8	2.9	3.0	3.0	3.1	2
2.3	2.4	2.4	2.5	2.6	2.7	2.8	2.9	2.9	3.0	3.1	3.2	3.3	4
2.4	2.5	2.6	2.6	2.7	2.8	2.9	3.0	3.1	3.2	3.2	3.3	3.4	6
2.5	2.6	2.7	2.8	2.8	2.9	3.0	3.1	3.2	3.3	3.4	3.5	3.6	8
2.6	2.7	2.8	2.9	3.0	3.1	3.1	3.2	3.3	3.4	3.5	3.6	3.7	5.0
2.7	2.8	2.9	3.0	3.1	3.2	3.3	3.4	3.5	3.6	3.7	3.8	3.9	2
2.8	2.9	3.0	3.1	3.2	3.3	3.4	3.5	3.6	3.7	3.8	3.9	4.0	4
2.9	3.0	3.1	3.2	3.3	3.4	3.5	3.6	3.7	3.8	3.9	4.1	4.2	6
3.0	3.1	3.2	3.3	3.4	3.6	3.7	3.8	3.9	4.0	4.1	4.2	4.3	8
3.1	3.2	3.3	3.5	3.6	3.7	3.8	3.9	4.0	4.1	4.2	4.3	4.5	6.0
3.2	3.3	3.5	3.6	3.7	3.8	3.9	4.0	4.1	4.1	4.4	4.5	4.6	2
3.3	3.4	3.6	3.7	3.8	3.9	4.0	4.2	4.3	4.4	4.5	4.6	4.7	4
3.4	3.5	3.7	3.8	3.9	4.0	4.2	4.3	4.4	4.5	4.7	4.8	4.9	6
3.5	3.7	3.8	3.9	4.0	4.2	4.3	4.4	4.5	4.7	4.8	4.9	5.0	8
3.6	3.8	3.9	4.0	4.2	4.3	4.4	4.5	4.7	4.8	4.9	5.1	5.2	7.0
3.7	3.9	4.0	4.1	4.3	4.4	4.4	4.7	4.8	4.9	5.1	5.2	5.3	2
3.8	4.0	4.1	4.3	4.4	4.5	4.7	4.8	4.9	5.1	5.2	5.4	5.5	4
3.9	4.1	4.2	4.4	4.5	4.7	4.8	4.9	5.1	5.2	5.4	5.5	5.6	6
4.0	4.2	4.3	4.5	4.6	4.8	4.9	5.1	5.2	5.4	5.5	5.6	5.8	8
4.2	4.3	4.4	4.6	4.7	4.9	5.0	5.2	5.3	5.5	5.6	5.8	5.9	8.0
4.3	4.4	4.6	4.7	4.9	5.0	5.2	5.3	5.5	5.6	5.8	5.9	6.1	2
4.4	4.5	4.7	4.8	5.0	5.1	5.3	5.5	5.6	5.8	5.9	6.1	6.2	4
4.5	4.6	4.8	4.9	5.1	5.3	5.4	5.6	5.7	5.9	6.1	6.2	6.4	6
4.6	4.7	4.9	5.1	5.2	5.4	5.5	5.7	5.9	6.0	6.2	6.4	6.5	8
4.7	4.8	5.0	5.2	5.3	5.5	5.7	5.8	6.0	6.2	6.3	6.5	6.7	9.0
4.8	4.9	5.1	5.3	5.5	5.6	5.8	6.0	6.1	6.3	6.5	6.7	6.8	2
4.9	5.1	5.2	5.4	5.6	5.8	5.9	6.1	6.3	6.5	6.6	6.8	7.0	4
5.0	5.2	5.3	5.5	5.7	5.9	6.1	6.2	6.4	6.6	6.8	6.9	7.1	6
5.1	5.3	5.5	5.6	5.8	6.0	6.2	6.3	6.5	6.7	6.9	7.1	7.3	8
5.2	5.4	5.6	5.8	5.9	6.1	6.3	6.5	6.7	6.9	7.0	7.2	7.4	10.0
5.4	5.6	5.8	6.0	6.2	6.4	6.6	6.8	7.0	7.2	7.4	7.6	7.8	5
5.7	5.9	6.1	6.3	6.5	6.7	6.9	7.1	7.3	7.5	7.8	7.9	8.2	11.0
6.0	6.2	6.4	6.6	6.8	7.0	7.2	7.5	7.7	7.9	8.1	8.3	8.5	5
6.2	6.4	6.7	7.0	7.1	7.3	7.6	7.8	8.0	8.2	8.5	8.7	8.9	12.0
6.5	6.7	7.0	7.2	7.4	7.7	7.9	8.1	8.3	8.6	8.8	9.0	9.5	5
6.7	7.0	7.2	7.5	7.7	8.0	8.2	8.4	8.7	8.9	9.2	9.4	9.6	13.0
7.0	7.3	7.5	7.8	8.0	8.3	8.5	8.8	9.0	9.3	9.5	9.8	10.0	5
7.2	7.5	7.8	8.0	8.3	8.6	8.8	9.1	9.3	9.6	9.8	10.1	10.4	14.0

TABLE 162.—Continued

41	42	43	44	45	46	47	48	49	50	75	100		D'uble Areas
0.8	0.8	0.8	0.8	0.8	0.9	0.9	0.9	0.9	0.9	1.4	1.9		1.0
0.9	0.9	1.0	1.0	1.0	1.0	1.0	1.1	1.1	1.1	1.6	2.2		2
1.1	1.1	1.1	1.1	1.2	1.2	1.2	1.2	1.3	1.3	1.9	2.6		4
1.2	1.2	1.3	1.3	1.3	1.4	1.4	1.4	1.5	1.5	2.2	3.0		6
1.4	1.4	1.4	1.5	1.5	1.5	1.6	1.6	1.6	1.7	2.5	3.3		8
1.5	1.6	1.6	1.6	1.7	1.7	1.7	1.8	1.8	1.8	2.8	3.7	2.0	2
1.7	1.7	1.8	1.8	1.8	1.9	1.9	2.0	2.0	2.0	3.1	4.1	2	2
1.8	1.9	1.9	2.0	2.0	2.0	2.1	2.1	2.2	2.2	3.3	4.4	4	4
2.0	2.0	2.1	2.1	2.2	2.2	2.3	2.3	2.4	2.4	3.6	4.8	6	6
2.1	2.2	2.2	2.3	2.3	2.4	2.4	2.5	2.5	2.6	3.9	5.2	8	8
2.3	2.3	2.4	2.4	2.5	2.6	2.6	2.7	2.7	2.8	4.2	5.6	3.0	2
2.4	2.5	2.6	2.6	2.7	2.7	2.8	2.9	2.9	3.0	4.4	5.9	2	2
2.6	2.6	2.7	2.8	2.8	2.9	3.0	3.0	3.1	3.2	4.7	6.3	4	4
2.7	2.8	2.9	2.9	3.0	3.1	3.1	3.2	3.3	3.3	5.0	6.7	6	6
2.9	3.0	3.0	3.1	3.2	3.2	3.3	3.4	3.5	3.5	5.3	7.0	8	8
3.0	3.1	3.2	3.3	3.3	3.4	3.5	3.6	3.6	3.7	5.6	7.4	4.0	2
3.2	3.3	3.4	3.4	3.5	3.6	3.7	3.7	3.8	3.9	5.9	7.9	2	2
3.3	3.4	3.5	3.6	3.7	3.8	3.8	3.9	4.0	4.0	6.1	8.2	4	4
3.5	3.6	3.7	3.8	3.8	3.9	4.0	4.1	4.2	4.3	6.4	8.5	6	6
3.6	3.7	3.8	3.9	4.0	4.1	4.2	4.3	4.4	4.5	6.7	8.9	8	8
3.8	3.9	4.0	4.1	4.2	4.3	4.4	4.5	4.6	4.6	7.0	9.3	5.0	2
4.0	4.1	4.1	4.2	4.3	4.4	4.5	4.6	4.7	4.8	7.2	9.7	2	2
4.1	4.2	4.3	4.4	4.5	4.6	4.7	4.8	4.9	5.0	7.5	10.0	4	4
4.3	4.4	4.5	4.6	4.7	4.8	4.9	5.0	5.1	5.2	7.8	10.4	6	6
4.4	4.5	4.6	4.7	4.8	4.9	5.0	5.1	5.2	5.4	8.1	10.8	8	8
4.6	4.7	4.8	4.9	5.0	5.1	5.2	5.3	5.4	5.6	8.3	1.1	6.0	2
4.7	4.8	4.9	5.0	5.2	5.3	5.4	5.5	5.6	5.7	8.6	1.5	2	2
4.9	5.0	5.1	5.2	5.3	5.5	5.6	5.7	5.8	6.0	8.9	1.8	4	4
5.0	5.1	5.2	5.4	5.5	5.6	5.7	5.9	6.0	6.1	9.2	2.2	6	6
5.2	5.3	5.4	5.5	5.7	5.8	5.9	6.0	6.2	6.3	9.5	2.6	8	8
5.3	5.4	5.6	5.7	5.8	5.9	6.1	6.2	6.3	6.5	9.7	3.0	7.0	2
5.5	5.6	5.7	5.8	6.0	6.1	6.3	6.4	6.5	6.7	10.0	3.4	2	2
5.6	5.7	5.9	6.0	6.2	6.3	6.4	6.6	6.7	6.8	10.3	3.7	4	4
5.8	5.9	6.0	6.2	6.3	6.5	6.6	6.7	6.9	7.0	10.6	4.1	6	6
5.9	6.1	6.2	6.3	6.5	6.6	6.8	6.9	7.1	7.2	10.8	4.4	8	8
6.1	6.2	6.4	6.5	6.7	6.8	7.0	7.1	7.2	7.4	11.1	4.8	8.0	2
6.2	6.3	6.5	6.6	6.8	7.0	7.1	7.3	7.4	7.6	1.4	5.2	2	2
6.4	6.5	6.7	6.8	7.0	7.2	7.3	7.5	7.6	7.8	1.7	5.6	4	4
6.5	6.7	6.8	7.0	7.2	7.3	7.5	7.7	7.8	8.0	2.0	6.0	6	6
6.7	6.9	7.0	7.2	7.3	7.5	7.7	7.8	8.0	8.2	2.2	6.3	8	8
6.8	7.0	7.2	7.3	7.5	7.7	7.8	8.0	8.2	8.3	12.5	6.6	9.0	2
7.0	7.2	7.3	7.5	7.7	7.8	8.0	8.2	8.3	8.5	2.8	7.0	2	2
7.1	7.3	7.5	7.7	7.8	8.0	8.2	8.4	8.5	8.7	3.1	7.4	4	4
7.3	7.5	7.6	7.8	8.0	8.2	8.4	8.5	8.7	8.9	3.3	7.8	6	6
7.4	7.6	7.8	8.0	8.2	8.4	8.5	8.7	8.9	9.1	3.6	8.2	8	8
7.6	7.8	8.0	8.1	8.3	8.5	8.7	8.9	9.1	9.3	13.9	8.5	10.0	2
8.0	8.2	8.4	8.6	8.8	8.9	9.1	9.3	9.5	9.7	4.6	9.5	5	5
8.3	8.5	8.7	8.9	9.2	9.4	9.6	9.8	10.0	10.2	5.3	10.3	11.0	2
8.7	8.9	9.1	9.4	9.6	9.8	10.0	10.2	10.4	10.7	6.0	1.3	5	5
9.1	9.3	9.5	9.8	10.0	10.2	10.4	10.7	10.9	1.1	6.7	2.2	12.0	2
9.5	9.7	10.0	10.2	10.4	10.6	10.8	11.1	11.4	11.6	17.4	23.2	5	5
9.9	10.1	0.4	0.6	0.8	1.1	1.3	1.6	1.8	2.1	8.0	4.1	13.0	2
10.3	0.5	0.8	1.0	1.3	1.5	1.8	2.0	2.3	2.5	8.8	5.0	5	5
0.6	0.9	1.2	1.4	1.7	1.9	2.2	2.4	2.7	3.0	9.4	6.0	14.0	2

TABLE 162.—Continued

2	3	4	5	6	7	8	9	10	11	12	13	14	D'uble Areas
0.5	0.8	1.1	1.3	1.6	1.9	2.1	2.4	2.7	3.0	3.2	3.5	3.8	14.5
0.6	0.8	1.1	1.4	1.7	2.0	2.2	2.5	2.8	3.1	3.3	3.6	3.9	15.0
0.6	0.9	1.2	1.5	1.7	2.0	2.3	2.6	2.9	3.2	3.4	3.7	4.0	5
0.6	0.9	1.2	1.5	1.8	2.1	2.4	2.7	3.0	3.3	3.6	3.8	4.1	16.0
0.6	0.9	1.2	1.5	1.8	2.1	2.4	2.7	3.1	3.4	3.7	4.0	4.3	5
0.6	0.9	1.3	1.6	1.9	2.2	2.5	2.8	3.1	3.5	3.8	4.1	4.4	17.0
0.6	1.0	1.3	1.6	2.0	2.3	2.6	2.9	3.2	3.6	3.9	4.2	4.5	5
0.7	1.0	1.3	1.7	2.0	2.3	2.7	3.0	3.3	3.7	4.0	4.3	4.7	18.0
0.7	1.0	1.4	1.7	2.1	2.4	2.7	3.1	3.4	3.8	4.1	4.4	4.8	5
0.7	1.1	1.4	1.8	2.1	2.5	2.8	3.2	3.5	3.9	4.2	4.6	4.9	19.0
0.7	1.1	1.4	1.8	2.2	2.5	2.9	3.2	3.6	4.0	4.3	4.7	5.0	5
0.7	1.1	1.5	1.9	2.2	2.6	3.0	3.3	3.7	4.1	4.4	4.8	5.2	20.0
0.8	1.2	1.6	2.0	2.3	2.7	3.1	3.5	3.9	4.3	4.7	5.1	5.4	1
0.8	1.2	1.6	2.0	2.4	2.8	3.3	3.7	4.1	4.5	4.9	5.3	5.7	2
0.9	1.3	1.7	2.1	2.6	3.0	3.4	3.8	4.3	4.7	5.1	5.5	6.0	3
0.9	1.3	1.8	2.2	2.7	3.1	3.6	4.0	4.4	4.9	5.3	5.8	6.2	4
0.9	1.4	1.9	2.3	2.8	3.2	3.7	4.2	4.6	5.1	5.6	6.0	6.5	25.0
1.0	1.4	1.9	2.4	2.9	3.4	3.9	4.3	4.8	5.3	5.8	6.3	6.7	6
1.0	1.5	2.0	2.5	3.0	3.5	4.0	4.5	5.0	5.5	6.0	6.5	7.0	7
1.0	1.6	2.1	2.6	3.1	3.6	4.2	4.7	5.2	5.7	6.2	6.7	7.3	8
1.1	1.6	2.1	2.7	3.2	3.8	4.3	4.8	5.4	5.9	6.4	7.0	7.5	9
1.1	1.7	2.2	2.8	3.3	3.9	4.4	5.0	5.5	6.1	6.7	7.2	7.8	30.0
1.2	1.7	2.3	2.9	3.4	4.0	4.6	5.2	5.7	6.3	6.9	7.5	8.0	1
1.2	1.8	2.4	3.0	3.6	4.2	4.7	5.3	6.0	6.5	7.1	7.7	8.3	2
1.2	1.8	2.4	3.0	3.7	4.3	4.9	5.5	6.1	6.7	7.3	8.0	8.6	3
1.3	1.9	2.5	3.1	3.8	4.4	5.0	5.7	6.3	6.9	7.5	8.2	8.8	4
1.3	1.9	2.6	3.2	3.9	4.5	5.2	5.8	6.5	7.1	7.8	8.4	9.1	35.0
1.3	2.0	2.7	3.3	4.0	4.7	5.3	6.0	6.7	7.3	8.0	8.7	9.3	6
1.4	2.1	2.7	3.4	4.1	4.8	5.5	6.2	6.9	7.5	8.2	8.9	9.6	7
1.4	2.1	2.8	3.5	4.2	4.9	5.6	6.3	7.0	7.7	8.4	9.2	9.8	8
1.4	2.2	2.9	3.6	4.3	5.0	5.8	6.5	7.2	7.9	8.7	9.4	10.1	9
1.5	2.2	3.0	3.7	4.4	5.2	5.9	6.7	7.4	8.1	8.9	9.7	10.4	40.0
1.5	2.3	3.0	3.8	4.5	5.3	6.1	6.8	7.6	8.3	9.1	9.9	10.6	1
1.6	2.3	3.1	3.9	4.7	5.4	6.2	7.0	7.8	8.5	9.3	10.1	10.9	2
1.6	2.4	3.2	4.0	4.8	5.6	6.4	7.2	8.0	8.8	9.6	10.4	11.2	3
1.6	2.4	3.3	4.1	4.9	5.7	6.5	7.3	8.2	9.0	9.8	10.6	11.4	4
1.7	2.5	3.3	4.2	5.0	5.8	6.7	7.5	8.3	9.2	10.0	10.9	11.7	45.0
1.7	2.6	3.4	4.3	5.1	6.0	6.8	7.7	8.5	9.4	10.2	11.1	11.9	6
1.7	2.6	3.5	4.3	5.2	6.1	7.0	7.8	8.7	9.6	10.5	11.3	12.2	7
1.8	2.7	3.6	4.4	5.3	6.2	7.1	8.0	8.9	9.8	10.7	11.6	12.4	8
1.8	2.7	3.6	4.5	5.4	6.4	7.3	8.2	9.1	10.0	10.9	11.8	12.7	9
1.8	2.8	3.7	4.6	5.6	6.5	7.4	8.3	9.3	10.2	11.1	12.1	13.0	50.0
1.9	2.9	3.9	4.8	5.8	6.7	7.7	8.7	9.6	10.6	11.6	12.5	13.5	2
2.0	3.0	4.0	5.0	6.0	7.0	8.0	9.0	10.0	11.0	12.0	13.0	14.0	4
2.1	3.1	4.1	5.2	6.2	7.3	8.3	9.3	10.4	11.4	12.5	13.5	14.5	6
2.2	3.2	4.3	5.4	6.4	7.5	8.6	9.7	10.7	11.8	12.9	13.9	15.0	8
2.2	3.3	4.4	5.5	6.7	7.8	8.9	10.0	11.1	12.2	13.3	14.4	15.5	60.0
2.3	3.4	4.6	5.7	6.9	8.0	9.2	10.3	11.5	12.6	13.8	14.9	16.1	2
2.4	3.6	4.7	5.9	7.1	8.3	9.5	10.7	11.9	13.0	14.2	15.4	16.6	4
2.4	3.7	4.9	6.1	7.3	8.6	9.8	11.0	12.2	13.4	14.7	15.9	17.1	6
2.5	3.8	5.0	6.3	7.5	8.8	10.1	11.4	12.6	13.8	15.1	16.4	17.6	8
2.6	3.9	5.2	6.5	7.8	9.1	10.4	11.7	13.0	14.3	15.5	16.8	18.2	70.0
2.7	4.0	5.3	6.7	8.0	9.3	10.7	12.0	13.4	14.7	16.0	17.3	18.6	8
2.7	4.1	5.5	6.9	8.2	9.6	10.9	12.3	13.7	15.1	16.5	17.8	19.2	4

EARTHWORK QUANTITIES

TABLE 162.—Continued

15	16	17	18	19	20	21	22	23	24	25	26	27	D'uble Areas
4.0	4.3	4.6	4.8	5.1	5.4	5.6	5.9	6.2	6.5	6.7	6.9	7.3	14.5
4.2	4.4	4.7	5.0	5.3	5.6	5.8	6.1	6.4	6.7	6.9	7.2	7.5	15.0
4.3	4.6	4.9	5.2	5.5	5.7	6.0	6.3	6.6	6.9	7.2	7.5	7.8	5
4.5	4.7	5.0	5.3	5.6	5.9	6.2	6.5	6.8	7.1	7.4	7.7	8.0	16.0
4.6	4.9	5.2	5.5	5.8	6.1	6.4	6.7	7.0	7.3	7.7	8.0	8.3	5
4.7	5.1	5.3	5.7	6.0	6.3	6.6	6.9	7.2	7.6	7.9	8.2	8.5	17.0
4.9	5.2	5.5	5.8	6.2	6.5	6.8	7.1	7.5	7.8	8.1	8.4	8.8	5
5.0	5.3	5.7	6.0	6.3	6.7	7.0	7.4	7.7	8.0	8.4	8.7	9.0	18.0
5.1	5.5	5.8	6.2	6.5	6.8	7.2	7.5	7.9	8.2	8.6	8.9	9.3	5
5.3	5.6	6.0	6.3	6.7	7.0	7.4	7.7	8.1	8.5	8.8	9.2	9.5	19.0
5.4	5.8	6.1	6.5	6.8	7.2	7.6	7.9	8.3	8.7	9.0	9.4	9.8	5
5.6	5.9	6.3	6.7	7.0	7.4	7.8	8.2	8.5	8.9	9.3	9.7	10.0	20.0
5.8	6.2	6.6	7.0	7.4	7.8	8.2	8.6	9.0	9.3	9.7	10.1	0.5	1
6.1	6.5	6.9	7.3	7.7	8.1	8.6	9.0	9.4	9.8	10.2	0.6	1.0	2
6.4	6.8	7.2	7.7	8.1	8.5	8.9	9.4	9.8	10.2	0.6	1.1	1.5	3
6.7	7.1	7.5	8.0	8.4	8.9	9.3	9.8	10.2	10.7	11.1	11.6	12.0	4
7.0	7.4	7.9	8.3	8.8	9.3	9.7	10.2	0.7	1.1	1.6	2.1	2.5	25.0
7.2	7.7	8.2	8.7	9.1	9.6	10.1	0.6	1.1	1.6	2.0	2.5	3.0	6
7.5	8.0	8.5	9.0	9.5	10.0	0.5	1.0	1.5	2.0	2.5	3.0	3.5	7
7.8	8.3	8.8	9.3	9.8	0.4	0.9	1.4	1.9	2.4	3.0	3.5	4.0	8
8.1	8.6	9.1	9.7	10.2	10.7	11.3	11.8	12.4	12.9	13.4	13.9	14.5	9
8.3	8.9	9.5	10.0	0.5	1.1	1.7	2.2	2.8	3.3	3.9	4.5	5.0	30.0
8.6	9.2	9.8	0.3	0.9	1.5	2.1	2.6	3.2	3.8	4.3	4.9	5.5	1
8.9	9.5	10.1	0.7	1.3	1.9	2.5	3.0	3.6	4.2	4.8	5.4	6.0	2
9.2	9.8	0.4	1.0	1.6	2.2	2.9	3.5	4.1	4.7	5.3	5.9	6.5	3
9.5	10.1	10.7	11.3	12.0	12.6	13.3	13.9	14.5	15.1	15.7	16.4	17.0	4
9.7	0.3	1.0	1.7	2.3	2.9	3.6	4.3	4.9	5.5	6.2	6.9	7.5	35.0
10.0	0.7	1.3	2.0	2.7	3.3	4.0	4.7	5.3	6.0	6.7	7.3	8.0	6
0.3	0.9	1.7	2.3	3.0	3.7	4.4	5.1	5.8	6.5	7.1	7.8	8.5	7
0.6	1.3	2.0	2.7	3.4	4.1	4.8	5.5	6.2	6.9	7.6	8.3	9.0	8
10.8	11.6	12.3	13.0	13.7	14.5	15.2	15.9	16.6	17.3	18.1	18.8	19.5	9
1.2	1.8	2.6	3.3	4.1	4.8	5.6	6.3	7.1	7.8	8.5	9.3	10.0	40.0
1.4	2.1	2.9	3.7	4.4	5.2	6.0	6.7	7.5	8.1	9.0	9.7	0.5	1
1.7	2.4	3.2	4.0	4.8	5.5	6.3	7.1	7.9	8.7	9.4	20.2	1.0	2
2.0	2.7	3.5	4.3	5.1	5.9	6.7	7.5	8.3	9.1	9.9	0.7	1.5	3
12.2	13.1	13.9	14.7	15.5	16.3	17.1	17.9	18.7	19.6	20.4	21.2	22.0	4
2.5	3.3	4.2	5.0	5.9	6.7	7.5	8.3	9.2	20.0	0.8	1.7	2.5	45.0
2.9	3.6	4.5	5.3	6.2	7.1	7.9	8.7	9.6	0.4	1.3	2.2	3.0	6
3.1	3.9	4.9	5.7	6.5	7.4	8.3	9.1	20.1	0.9	1.7	2.6	3.5	7
3.4	4.2	5.1	6.0	6.9	7.8	8.7	9.6	0.4	1.3	2.2	3.2	4.0	8
13.6	14.5	15.4	16.3	17.2	18.1	19.1	20.0	20.8	21.8	22.7	23.6	24.5	9
3.9	4.8	5.7	6.7	7.6	8.5	9.5	0.4	1.3	2.3	3.2	4.1	5.0	50.0
4.4	5.4	6.4	7.4	8.3	9.3	20.2	1.2	2.2	3.2	4.1	5.1	6.0	2
5.0	6.0	7.0	8.0	9.0	20.0	1.0	2.0	3.0	4.0	5.0	6.0	7.0	4
5.6	6.6	7.6	8.7	9.7	0.8	1.8	2.8	3.8	4.8	5.9	6.9	8.0	6
16.1	17.2	18.3	19.4	20.4	21.5	22.5	23.6	24.7	25.7	26.8	27.8	29.0	8
6.7	7.8	8.9	20.0	1.1	2.2	3.4	4.4	5.6	6.6	7.7	8.8	30.0	60.0
7.2	8.4	9.5	0.7	1.8	2.9	4.2	5.2	6.4	7.6	8.7	9.8	1.0	2
7.8	8.9	20.2	1.4	2.5	3.7	4.9	6.0	7.3	8.4	9.6	30.8	3.0	4
8.4	9.5	0.8	2.0	3.2	4.4	5.7	6.8	8.1	9.3	30.6	1.7	3.0	6
18.9	20.1	21.4	22.6	23.9	25.2	26.4	27.7	29.0	30.2	31.5	32.7	34.0	8
9.4	0.7	2.0	3.4	4.6	5.9	7.2	8.5	9.8	1.1	2.4	3.7	5.0	70.0
20.0	1.4	2.6	4.0	5.4	6.7	8.0	9.4	30.7	2.0	3.4	4.6	6.0	2
0.6	1.8	3.3	4.7	6.0	7.4	8.8	30.2	1.5	2.9	4.3	5.7	7.0	4

TABLE 162.—Continued

28	29	30	31	32	33	34	35	36	37	38	39	40	Double Areas
7.5	7.8	8.1	8.3	8.6	8.8	9.1	9.4	9.7	9.9	10.2	10.5	10.7	14.5
7.8	8.0	8.3	8.6	8.9	9.2	9.5	9.7	10.0	10.3	0.6	0.9	1.1	15.0
8.0	8.3	8.6	8.9	9.2	9.5	9.8	10.0	0.3	0.6	0.9	1.2	1.5	5
8.3	8.6	8.9	9.2	9.5	9.8	10.1	0.3	0.7	1.0	1.3	1.6	1.9	16.0
8.5	8.9	9.2	9.5	9.8	10.1	0.4	0.7	1.0	1.3	1.6	1.9	2.2	5
8.8	9.1	9.4	9.8	10.1	10.4	10.7	11.0	11.3	11.7	11.9	12.3	12.6	17.0
9.1	9.4	9.7	10.1	0.4	0.7	1.0	1.3	1.7	2.0	2.3	2.6	3.0	5
9.3	9.7	10.0	0.3	0.7	1.0	1.3	1.7	2.0	2.3	2.7	3.0	3.3	18.0
9.6	9.9	0.3	0.6	1.0	1.3	1.7	2.0	2.3	2.7	3.0	3.3	3.7	5
9.8	10.2	0.5	0.9	1.3	1.6	1.9	2.3	2.7	3.0	3.3	3.7	4.1	19.0
10.1	10.5	10.8	11.2	11.6	11.9	12.3	12.6	13.0	13.3	13.7	14.1	14.4	5
0.4	0.7	1.1	1.5	1.9	2.2	2.6	2.9	3.3	3.7	4.1	4.5	4.8	20.0
0.9	1.3	1.7	2.1	2.5	2.8	3.2	3.6	4.0	4.4	4.8	5.2	5.5	1
1.4	1.8	2.2	2.6	3.1	3.4	3.9	4.2	4.7	5.1	5.5	5.9	6.3	2
1.9	2.4	2.8	3.2	3.6	4.1	4.5	4.9	5.3	5.7	6.2	6.6	7.1	3
12.5	12.9	13.3	13.8	14.2	14.7	15.1	15.5	16.0	16.4	16.9	17.3	17.8	4
2.9	3.4	3.9	4.4	4.8	5.3	5.7	6.2	6.7	7.1	7.6	8.1	8.6	25.0
3.5	3.9	4.4	4.9	5.4	5.9	6.4	6.8	7.3	7.9	8.3	8.8	9.3	6
4.0	4.5	5.0	5.5	6.0	6.5	7.0	7.5	8.0	8.5	9.0	9.5	20.0	7
4.5	5.1	5.5	6.1	6.6	7.1	7.6	8.1	8.7	9.2	9.7	20.2	0.7	8
15.1	15.5	16.1	16.6	17.2	17.7	18.3	18.8	19.3	19.9	20.4	20.9	21.5	9
5.5	6.1	6.7	7.2	7.8	8.3	8.9	9.4	9.9	20.6	1.2	1.7	2.2	30.0
6.1	6.6	7.2	7.8	8.4	8.9	9.5	20.1	20.7	1.2	1.8	2.4	2.9	1
6.6	7.2	7.7	8.3	8.9	9.6	20.2	0.6	1.3	1.9	2.5	3.2	3.7	2
7.1	7.7	8.3	8.9	9.5	20.2	0.7	1.4	1.9	2.6	3.2	3.8	4.4	3
17.6	18.3	18.9	19.5	20.2	20.7	21.4	22.0	22.7	23.3	23.8	24.6	25.2	4
8.1	8.7	9.5	20.1	0.7	1.3	2.1	2.7	3.3	3.9	4.7	5.3	5.9	35.0
8.7	9.3	20.0	0.7	1.3	1.9	2.7	3.3	3.9	4.6	5.3	6.0	6.7	6
9.2	9.9	0.6	1.2	1.6	2.6	3.2	3.9	4.6	5.3	6.0	6.7	7.4	7
9.7	20.4	1.1	1.8	2.5	3.2	3.9	4.6	5.3	6.0	6.7	7.4	8.1	8
20.2	20.9	21.7	22.3	23.2	23.8	24.6	25.3	25.9	26.7	27.4	28.2	28.9	9
0.7	1.4	2.2	2.9	3.7	4.4	5.2	5.9	6.6	7.4	8.1	8.8	9.6	40.0
1.3	1.9	2.8	3.6	4.3	5.1	5.7	6.5	7.3	8.1	8.8	9.6	30.4	1
1.8	2.6	3.3	4.2	4.8	5.6	6.4	7.2	7.9	8.7	9.6	30.3	1.8	2
2.3	3.1	3.8	4.7	5.4	6.2	7.1	7.8	8.6	9.4	30.2	1.1	1.8	3
22.8	23.6	24.4	25.2	26.1	26.8	27.7	28.4	29.3	30.2	30.9	31.7	32.6	4
3.3	4.2	5.0	5.8	6.6	7.5	8.4	9.2	9.9	0.8	1.7	2.5	3.4	45.0
3.8	4.7	5.6	6.4	7.2	8.1	8.9	9.8	30.6	1.5	2.4	3.2	4.1	6
4.3	5.2	6.1	6.9	7.8	8.7	9.6	30.4	1.3	2.2	3.0	3.9	4.8	7
4.8	5.7	6.7	7.6	8.4	9.3	30.2	1.1	2.0	2.8	3.7	4.7	5.5	8
25.4	26.3	27.2	28.1	29.0	29.9	30.8	31.7	32.6	33.6	34.5	35.4	36.3	9
5.9	6.8	7.8	8.7	9.6	30.5	1.4	2.4	3.4	4.2	5.2	6.2	7.1	50.0
6.9	7.8	8.8	9.8	30.8	1.7	2.7	3.7	4.6	5.6	6.6	7.5	8.5	2
7.9	8.9	9.9	30.9	2.0	3.0	4.0	5.0	5.9	6.9	8.0	9.0	40.0	4
9.0	30.1	31.1	2.1	3.2	4.2	5.2	6.2	7.3	8.3	9.4	40.4	1.5	6
30.1	31.1	32.2	33.2	34.4	35.4	36.5	37.5	38.6	39.6	40.8	41.8	42.9	8
1.1	2.2	3.3	4.4	5.6	6.6	7.7	8.9	40.0	41.1	2.2	3.4	4.4	60.0
2.1	3.2	4.4	5.6	6.7	7.8	9.0	40.1	1.3	2.4	3.6	4.8	5.9	2
3.2	4.4	5.5	6.6	7.8	9.1	40.2	1.4	2.6	3.8	5.0	6.2	7.4	4
4.2	5.4	6.6	7.8	9.1	40.2	1.5	2.7	3.9	5.2	6.4	7.6	8.8	6
35.2	36.4	37.7	39.0	40.2	41.5	42.8	44.0	45.2	46.5	47.8	49.0	50.4	8
6.3	7.6	8.8	40.1	1.4	2.8	4.0	5.4	6.6	8.0	9.2	50.5	1.8	70.0
7.3	8.7	9.9	1.3	2.6	4.0	5.3	6.6	8.0	9.2	50.6	2.0	3.1	2
8.4	9.7	41.1	2.5	3.8	5.2	6.6	7.9	9.4	50.7	2.1	3.4	4.7	4

EARTHWORK QUANTITIES

TABLE 162.—Continued

41	42	43	44	45	46	47	48	49	50	75	100		D'uble Areas
11.0	11.3	11.5	11.8	12.1	12.3	12.6	12.9	13.1	13.4	20.2	26.8	—	14.5
1.4	1.7	1.9	2.2	2.5	2.8	3.0	3.3	3.6	3.9	0.8	7.8	—	15.0
1.8	2.1	2.3	2.6	2.9	3.2	3.5	3.8	4.1	4.4	1.5	8.7	—	5
2.1	2.4	2.7	3.0	3.3	3.6	3.9	4.2	4.5	4.8	2.2	9.6	—	16.0
2.5	2.8	3.1	3.4	3.7	4.1	4.5	4.7	4.9	5.3	2.8	30.5	—	5
12.9	13.2	13.5	13.8	14.2	14.5	14.8	15.1	15.4	15.7	23.6	31.4	—	17.0
3.3	3.6	3.9	4.3	4.6	4.9	5.2	5.5	5.9	6.2	4.3	2.4	—	5
3.7	4.0	4.3	4.7	5.0	5.3	5.7	6.0	6.3	6.7	4.9	3.3	—	18.0
4.1	4.4	4.7	5.1	5.4	5.7	6.1	6.4	6.7	7.1	5.7	4.2	—	5
4.4	4.7	5.1	5.5	5.8	6.1	6.5	6.9	7.2	7.6	6.4	5.2	—	19.0
14.8	15.1	15.5	15.9	16.3	16.6	16.9	17.3	17.7	18.1	27.1	36.1	—	5
5.2	5.5	5.9	6.3	6.7	7.1	7.4	7.7	8.1	8.5	7.8	7.0	—	20.0
5.9	6.3	6.7	7.1	7.5	7.9	8.3	8.7	9.0	9.5	9.2	8.8	—	1
6.7	7.1	7.5	7.9	8.3	8.7	9.1	9.5	9.9	20.1	30.6	40.7	—	2
7.5	7.9	8.3	8.7	9.1	9.6	20.0	20.4	20.8	1.3	1.9	2.6	—	3
18.2	18.6	19.1	19.5	20.0	20.4	20.8	21.3	21.8	22.2	33.2	44.4	—	4
9.0	9.5	9.9	20.3	0.8	1.3	1.7	2.2	2.7	3.2	4.7	6.2	—	25.0
9.7	20.2	20.7	1.2	1.7	2.2	2.6	3.1	3.6	4.1	6.1	8.2	—	6
20.5	1.0	1.5	2.0	2.5	3.0	3.5	4.0	4.5	5.0	7.5	50.0	—	7
1.3	1.8	2.3	2.8	3.3	3.8	4.4	4.8	5.4	5.9	8.8	1.8	—	8
22.0	22.6	23.1	23.7	24.2	24.7	25.2	25.8	26.3	26.8	40.3	53.7	—	9
2.8	3.3	3.8	4.4	5.0	5.5	6.1	6.7	7.2	7.8	1.6	5.5	—	30.0
3.5	4.1	4.7	5.2	5.8	6.4	6.9	7.6	8.1	8.7	3.2	7.3	—	1
4.3	4.8	5.4	6.1	6.6	7.2	7.8	8.4	9.1	9.6	4.4	9.2	—	2
5.0	5.7	6.3	6.8	7.5	8.1	8.7	9.3	9.9	30.6	5.8	61.0	—	3
25.7	26.4	27.0	27.7	28.3	28.9	29.6	30.2	30.8	31.4	47.2	62.9	—	4
6.6	7.2	7.8	8.5	9.2	9.8	30.4	1.1	1.7	2.4	3.0	4.8	—	35.0
7.3	8.0	8.6	9.3	10.0	30.6	1.3	2.0	2.6	3.3	9.0	6.7	—	6
8.1	8.8	9.4	30.1	0.8	1.5	2.2	2.8	3.6	4.3	51.4	8.5	—	7
8.8	9.6	30.2	1.0	1.6	2.4	3.1	3.7	4.5	5.2	2.8	70.4	—	8
30.6	30.4	31.0	31.7	32.5	33.2	33.8	34.6	35.4	36.1	54.1	72.1	—	9
30.4	1.2	1.8	2.6	3.3	4.0	4.8	5.6	6.3	7.0	5.5	4.0	—	40.0
1.2	1.8	2.6	3.4	4.2	4.8	5.6	6.4	7.2	8.0	6.9	5.8	—	1
1.8	2.7	3.4	4.2	5.0	5.8	6.6	7.3	8.2	8.9	8.3	7.8	—	2
2.6	3.4	4.2	5.0	5.8	6.6	7.4	8.2	9.0	9.8	9.6	9.6	—	3
33.4	34.2	35.0	35.8	36.7	37.4	38.3	39.2	39.9	40.8	61.1	81.5	—	4
4.2	4.9	5.8	6.7	7.4	8.3	9.2	9.9	40.7	1.6	2.4	3.4	—	45.0
4.8	5.7	6.6	7.4	8.3	9.1	40.0	0.9	1.7	2.6	3.8	5.1	—	6
5.7	6.6	7.4	8.1	9.2	40.0	0.9	1.8	2.7	3.5	5.3	7.0	—	7
6.4	7.3	8.2	9.2	40.0	0.8	1.7	2.6	3.5	4.4	6.7	8.9	—	8
37.2	38.1	39.0	39.9	40.8	41.7	42.6	43.5	44.4	45.3	68.1	90.6	—	9
7.9	8.8	9.8	40.7	1.6	2.6	3.5	4.4	5.3	6.4	9.3	2.6	—	50.0
9.5	40.4	41.3	2.3	3.3	4.2	5.2	6.2	7.2	8.2	72.2	6.3	—	2
41.0	2.0	3.0	4.0	5.0	6.0	7.0	8.0	9.0	50.0	5.0	100.0	—	4
2.5	3.5	4.6	5.6	6.6	7.7	8.7	9.8	50.8	1.8	7.8	93.6	—	6
44.1	45.2	46.2	47.3	48.4	49.4	50.5	51.5	52.6	53.7	80.5	107.3	—	8
5.6	6.7	7.8	8.9	50.0	51.1	2.2	3.3	4.4	5.5	3.4	11.0	—	60.0
7.1	8.2	9.4	50.5	1.6	2.8	4.0	5.1	6.2	7.4	6.1	14.8	—	2
8.6	9.7	50.9	2.1	3.3	4.5	5.7	6.9	8.1	9.3	8.9	18.6	—	4
50.2	51.3	2.5	3.7	5.0	6.1	7.4	8.6	9.9	61.1	91.7	22.1	—	6
51.6	52.8	54.1	55.4	56.7	58.0	59.2	60.4	61.7	63.0	94.5	125.9	—	8
3.1	4.4	5.7	7.0	8.3	9.6	60.9	2.2	3.5	4.8	7.2	29.5	—	70.0
4.7	6.0	7.3	8.6	60.0	61.3	2.6	4.0	5.4	6.6	100.0	33.2	—	2
6.2	7.6	8.9	60.3	1.7	3.1	4.4	5.8	7.2	8.6	92.0	37.1	—	4

TABLE 162.—Continued

2	3	4	5	6	7	8	9	10	11	12	13	14	D'uble Areas
2.8	4.2	5.6	7.0	8.5	9.0	11.3	12.7	14.1	15.5	16.0	18.3	19.7	76.0
2.9	4.3	5.8	7.2	8.7	10.1	1.6	3.0	4.5	5.9	7.4	8.8	20.2	8
3.0	4.4	5.9	7.4	8.9	0.4	1.9	3.3	4.9	6.3	7.8	9.3	0.8	80.0
3.0	4.6	6.1	7.6	9.1	0.7	2.2	3.7	5.2	6.7	8.2	9.8	1.3	2
3.1	4.7	6.2	7.8	9.3	0.9	2.5	4.0	5.6	7.1	8.7	20.2	1.7	4
3.2	4.8	6.4	8.0	9.6	11.2	12.7	14.3	15.9	17.5	19.1	20.7	22.3	6
3.3	4.9	6.5	8.1	9.8	1.4	3.1	4.7	6.3	7.9	9.5	1.2	2.8	8
3.3	5.0	6.7	8.3	10.0	1.7	3.3	5.0	6.7	8.3	20.0	1.7	3.4	90.0
3.4	5.1	6.8	8.5	0.2	1.9	3.6	5.4	7.1	8.7	0.4	2.1	3.8	2
3.5	5.2	7.0	8.7	0.5	2.2	3.9	5.7	7.4	9.2	0.8	2.6	4.4	4
3.5	5.3	7.1	8.9	10.7	12.5	14.2	16.0	17.8	19.5	21.3	23.1	24.9	6
3.6	5.4	7.3	9.1	0.9	2.7	4.5	6.4	8.2	9.9	1.8	3.6	5.4	8
3.7	5.6	7.4	9.3	1.1	3.0	4.8	6.7	8.5	20.4	2.2	4.1	6.0	100.0
3.9	5.8	7.8	9.7	1.7	3.6	5.5	7.5	9.5	1.4	3.3	5.3	7.2	05
4.1	6.1	8.1	10.2	2.2	4.3	6.3	8.4	20.4	2.4	4.4	6.5	8.6	10
4.3	6.4	8.5	10.7	12.8	14.9	17.0	19.1	21.3	23.4	25.5	27.7	29.8	15
4.4	6.7	8.9	1.1	3.3	5.5	7.8	20.0	2.3	4.4	6.6	8.8	31.2	20
4.6	6.9	9.2	1.6	3.9	6.2	8.5	0.8	3.2	5.4	7.7	30.2	2.4	125.0
4.8	7.2	9.6	2.1	4.5	6.9	9.3	1.7	4.1	6.5	8.8	1.4	3.7	30
5.0	7.5	10.0	2.5	5.0	7.5	20.0	2.5	5.0	7.5	9.9	2.5	5.0	35
5.2	7.8	10.4	12.9	15.5	18.2	20.8	23.4	25.9	28.5	31.1	33.7	36.4	40
5.4	8.0	0.7	3.4	6.1	8.8	1.5	4.2	6.8	9.5	2.2	4.8	7.6	45
5.6	8.3	1.1	3.9	6.7	9.5	2.3	5.0	7.8	30.6	3.4	6.2	8.8	150.0
5.7	8.6	1.5	4.3	7.2	20.1	2.9	5.8	8.7	1.6	4.5	7.3	40.2	55
5.9	8.9	1.9	4.8	7.8	0.7	3.7	6.7	9.6	2.6	5.6	8.5	1.5	60
6.1	9.2	12.3	15.3	18.3	21.4	24.4	27.5	30.6	33.6	36.6	39.7	42.8	65
6.3	9.5	2.6	5.8	8.9	2.1	5.2	8.3	1.5	4.6	7.7	40.0	4.1	70
6.5	0.7	3.0	6.2	9.4	2.7	5.9	9.2	2.4	5.6	8.9	2.1	5.5	175.0
6.7	10.0	3.3	6.7	20.0	3.3	6.7	30.0	3.3	6.7	40.0	3.3	6.6	80
6.9	0.3	3.7	7.1	0.6	4.0	7.4	0.9	4.2	7.7	1.2	4.5	8.0	85
7.0	10.5	14.1	17.6	21.2	24.6	28.2	31.7	35.2	38.7	42.2	45.7	49.3	90
7.2	0.8	4.5	8.1	1.6	5.2	8.8	2.5	6.2	9.7	3.3	7.0	50.5	95
7.4	1.1	4.9	8.5	2.2	5.9	9.6	3.4	7.1	40.8	4.4	8.2	1.0	200.0
7.8	1.7	5.6	9.5	3.4	7.2	31.1	5.0	8.9	2.8	6.7	50.5	4.4	10
8.1	2.2	6.3	20.4	4.4	8.5	2.6	6.7	40.8	4.8	8.8	3.0	7.1	20
8.5	12.7	17.1	21.3	25.6	29.8	34.1	38.4	42.6	46.8	51.1	55.4	59.6	30
8.9	3.3	7.7	2.2	6.6	31.1	5.6	40.0	4.4	8.8	3.3	7.8	62.1	40
9.2	3.9	8.5	3.1	7.8	2.4	7.0	1.7	6.4	50.9	5.6	60.2	4.8	250.0
9.6	4.5	9.3	4.1	8.9	3.7	8.5	3.4	8.2	2.9	7.8	2.7	7.4	60
10.0	5.0	20.0	5.0	30.0	5.0	9.0	5.0	50.0	5.0	60.0	4.0	70.0	70
10.4	15.6	20.7	25.9	31.1	36.3	41.4	46.7	51.9	57.0	62.2	67.4	72.5	80
0.8	6.1	1.4	6.8	2.2	7.6	3.0	8.3	3.8	9.1	4.4	9.8	5.2	90
1.1	6.7	2.2	7.8	3.3	8.8	4.4	50.0	5.6	61.1	6.8	72.2	7.0	300.0
1.5	7.2	2.9	8.6	4.4	40.2	5.9	1.8	7.4	3.1	8.8	4.5	80.4	10
1.9	7.8	3.6	9.6	5.5	1.4	7.4	3.3	9.3	5.2	71.1	7.0	3.0	20
12.2	18.3	24.4	30.6	36.6	42.8	48.8	55.0	61.2	67.2	73.3	79.4	85.6	30
2.6	8.0	5.2	1.4	7.7	4.1	50.5	6.7	2.9	9.2	5.5	81.8	8.2	40
3.0	9.5	5.9	2.4	8.1	5.3	1.8	8.3	4.8	71.3	7.8	4.2	90.8	150.0
3.3	20.0	6.6	3.3	9.0	6.6	3.4	60.0	6.8	3.3	80.0	6.8	3.3	60
3.7	0.6	7.4	4.3	41.1	7.0	4.8	1.6	8.5	5.3	2.1	9.0	6.0	70
14.1	21.2	28.2	35.2	42.2	49.2	56.3	63.3	70.3	77.4	84.3	91.5	98.5	80
4.4	1.6	8.8	6.1	3.3	50.6	7.8	5.0	2.3	9.4	6.6	3.9	101.1	90
4.8	2.2	9.6	7.1	4.4	1.8	9.2	6.7	4.1	81.5	8.9	6.3	3.6	400.0

EARTHWORK QUANTITIES

TABLE 162.—Continued

15	16	17	18	19	20	21	22	23	24	25	26	27	D'uble Areas
21.2	22.5	23.0	25.3	26.7	28.2	29.6	31.0	32.4	33.8	35.2	36.6	38.0	76.0
1.7	3.1	4.6	6.0	7.4	8.9	30.3	1.8	3.2	4.7	6.0	7.5	9.0	8
2.2	3.7	5.2	6.7	8.2	9.6	1.1	2.6	4.1	5.6	7.0	8.5	40.0	80.0
2.8	4.3	5.8	7.3	8.9	30.4	1.8	3.4	4.9	6.4	7.9	9.4	1.0	2
3.3	4.8	6.4	8.0	9.6	1.2	2.7	4.2	5.8	7.3	8.8	40.4	2.0	4
23.8	25.5	27.1	28.6	30.2	31.8	33.4	35.0	36.6	38.2	39.8	41.4	43.0	6
4.4	6.1	7.7	9.3	0.9	2.6	4.2	5.8	7.5	9.1	40.7	2.3	4.0	8
5.0	6.7	8.3	30.0	1.7	3.4	5.0	6.6	8.4	40.0	1.6	3.3	5.0	90.0
5.6	7.2	8.9	0.6	2.3	4.1	5.8	7.5	9.2	0.0	2.6	4.3	6.0	2
6.1	7.8	9.6	1.3	3.1	4.8	6.5	8.2	40.0	1.8	3.5	5.2	7.0	4
26.7	28.4	30.2	32.0	33.7	35.5	37.3	39.0	40.8	42.7	44.4	46.2	48.0	6
7.2	9.0	0.8	2.6	4.4	6.3	8.0	9.8	1.7	3.6	5.4	7.1	9.0	8
7.8	9.6	1.5	3.3	5.2	7.0	8.9	40.8	2.6	4.4	6.3	8.1	50.0	100.0
9.2	31.2	3.0	5.0	7.0	8.9	40.8	2.7	4.7	6.6	8.5	50.5	2.5	05
30.6	2.6	4.6	6.6	8.7	40.7	2.7	4.7	6.8	8.8	50.9	2.9	5.0	10
32.0	34.1	36.2	38.4	40.5	42.6	44.7	46.8	48.9	51.0	53.2	55.4	57.5	15
3.3	5.5	7.7	9.9	2.2	4.4	6.6	8.8	51.0	3.3	5.5	7.8	60.0	20
4.6	7.0	9.3	41.6	3.9	6.3	8.6	50.9	3.2	5.5	7.8	60.1	2.5	125.0
6.1	8.5	40.9	3.3	5.7	8.2	50.5	2.9	5.3	7.8	60.2	2.6	5.0	30
7.5	40.0	2.5	5.0	7.5	50.0	2.5	5.0	7.5	60.0	2.5	5.0	7.5	35
38.8	41.4	44.0	46.6	49.2	51.8	54.4	57.0	59.6	62.2	64.8	67.4	70.0	40
40.2	2.9	5.6	8.3	51.0	3.7	6.3	9.0	61.7	4.4	7.0	9.8	2.5	45
1.6	4.4	7.2	9.0	2.8	5.7	8.2	61.1	3.9	6.6	9.3	72.2	5.0	150.0
3.0	5.9	8.7	51.6	4.5	7.6	60.3	3.1	6.0	8.8	71.8	4.6	7.5	55
4.4	7.3	50.4	3.3	6.2	9.3	2.1	5.1	8.1	71.1	4.0	7.0	80.0	60
45.8	48.8	52	55.0	58.0	61.0	64.2	67.1	70.3	73.4	76.2	79.3	82.5	65
7.2	50.5	3.5	6.6	9.8	3.0	6.0	9.2	2.3	5.5	8.7	81.8	5.0	70
8.6	1.8	5.6	8.3	61.5	4.8	8.0	71.2	4.6	7.7	81.0	4.3	7.5	175.0
50.0	3.3	6.6	60.0	3.3	6.8	9.9	3.2	6.7	80.0	3.2	6.7	90.0	80
1.4	4.8	8.1	1.6	5.0	8.5	71.9	5.3	8.8	2.2	5.6	9.0	2.5	85
52.8	56.2	59.8	63.3	66.8	70.4	73.8	77.3	80.9	84.3	87.9	91.7	95.0	90
4.0	7.8	61.3	5.0	8.7	2.1	5.7	9.4	3.0	6.7	90.2	3.0	7.5	95
5.5	9.2	2.9	6.7	70.3	4.0	7.7	81.4	5.1	8.9	2.8	6.4	100.0	200.0
8.3	62.1	6.0	70.0	3.8	7.8	81.7	5.5	9.4	93.4	7.2	101.2	05.0	10
61.0	5.1	9.3	3.2	7.4	81.5	5.5	9.5	93.7	7.8	101.9	06.0	10.0	20
63.9	68.0	72.4	76.6	80.9	85.2	89.4	93.7	98.0	102.2	106.5	110.8	115.0	30
6.5	71.0	5.5	9.9	4.3	8.9	93.2	7.8	102.2	106.8	11.1	15.5	20.0	40
9.4	4.0	8.6	83.2	7.9	92.5	7.1	101.9	06.5	11.1	15.9	20.5	25.0	250.0
72.1	7.0	81.8	6.5	91.4	6.5	101.2	06.0	10.7	15.5	20.4	25.3	30.0	60
5.0	80.0	5.0	90.0	4.9	100.0	05.0	10.0	15.1	20.0	25.0	30.0	35.0	70
77.8	82.9	88.1	93.2	98.4	103.8	108.9	114.1	119.2	124.5	129.5	134.8	140.0	80
80.6	5.9	91.2	6.5	102.1	07.4	12.0	18.1	23.5	28.9	34.3	39.8	45.0	90
3.2	8.9	4.4	100.0	05.7	11.1	16.8	22.2	29.7	33.3	38.9	44.5	50.0	300.0
6.0	91.8	7.5	93.3	09.2	14.8	20.6	26.3	32.1	37.9	43.5	49.3	55.0	10
9.0	4.7	100.9	06.8	12.7	18.6	24.3	30.3	36.2	42.2	48.1	54.1	60.0	20
91.5	97.7	103.9	110.0	116.1	122.2	128.3	134.5	140.6	146.8	152.8	158.9	165.0	30
4.5	100.7	07.1	13.2	19.6	26.0	32.2	38.5	44.0	51.1	57.2	63.8	70.0	40
7.2	03.8	10.2	16.7	23.2	29.7	36.2	42.5	49.1	55.5	62.0	68.5	75.0	350.0
100.0	06.8	13.4	20.0	26.8	33.3	40.0	46.6	53.2	60.0	66.8	73.4	80.0	60
02.8	09.6	16.4	23.2	30.2	37.0	43.8	50.7	57.5	64.5	71.2	78.1	85.0	70
105.6	112.5	119.6	126.8	133.8	140.8	147.8	154.8	161.8	168.9	175.9	183.0	190.0	80
08.1	15.5	22.9	30.0	37.2	44.3	51.7	58.0	66.1	73.4	80.5	87.8	95.0	90
11.1	18.5	25.9	33.3	40.7	48.1	55.6	63.0	70.4	77.8	85.2	92.6	200.0	400.0

TABLE 162.—Continued

28	29	30	31	32	33	34	35	36	37	38	39	40	D'uble Ar.as
39.4	40.8	42.3	43.6	45.1	46.5	47.9	49.3	50.7	52.1	53.5	54.0	56.3	76.0
40.4	1.8	3.3	4.8	6.2	7.7	9.1	50.5	2.0	3.5	4.9	6.4	7.8	8
1.5	3.0	4.4	5.9	7.4	8.8	50.3	1.8	3.3	4.8	6.3	7.8	9.2	80.0
2.5	4.1	5.0	7.1	8.6	50.1	1.7	3.2	4.7	6.2	7.7	9.2	60.8	2
3.6	5.2	6.7	8.2	9.8	1.3	2.9	4.5	6.0	7.5	9.1	60.7	2.3	4
44.6	46.2	47.8	49.3	51.0	52.5	54.2	55.7	57.3	58.9	60.5	62.1	63.7	6
5.6	7.2	8.8	50.5	2.1	3.7	5.4	7.0	8.7	60.3	1.9	3.5	5.2	8
6.7	8.3	50.0	1.7	3.3	5.0	6.7	8.3	60.0	1.6	3.3	5.0	6.6	90.0
7.7	9.4	1.1	2.8	4.5	6.2	7.9	9.6	1.3	3.0	4.7	6.4	8.2	2
8.8	50.5	2.2	4.0	5.7	7.5	9.2	61.0	2.7	4.4	6.2	7.9	9.7	4
49.8	51.5	53.3	55.1	56.9	58.7	60.4	62.2	64.0	65.8	67.6	69.4	71.1	6
50.8	2.6	4.4	6.2	8.1	9.9	1.7	3.5	5.3	7.2	8.9	70.8	2.6	8
1.8	3.7	5.5	7.4	9.3	61.1	3.0	4.8	6.6	8.5	70.2	2.2	4.0	100.0
4.4	6.1	8.0	60.3	62.2	4.2	6.1	8.1	70.0	72.0	3.9	5.8	7.8	05
7.0	9.1	61.1	3.2	5.2	7.2	9.3	71.3	3.4	5.4	7.4	9.5	81.5	10
59.7	61.8	64.0	66.0	68.1	70.4	72.5	74.5	76.7	78.8	81.0	83.1	85.2	15
62.3	4.5	6.7	8.9	71.1	3.4	5.5	7.8	80.0	82.2	4.5	6.7	9.0	20
4.8	7.2	0.5	71.8	4.1	6.5	8.8	81.0	3.4	5.6	8.0	90.3	9.2	125.0
7.3	9.8	72.1	4.5	7.0	9.4	81.8	4.2	6.6	9.0	91.4	3.9	6.1	30
70.0	72.5	5.0	7.5	80.0	82.5	5.0	7.5	90.0	92.5	5.0	7.5	100.0	35
72.6	75.2	77.8	80.5	83.0	85.6	88.1	90.7	93.4	96.0	98.5	101.1	103.7	40
5.2	7.9	80.5	3.2	5.9	8.6	91.3	4.0	6.7	9.4	102.0	01.6	07.5	45
7.8	80.6	3.4	6.1	8.9	91.7	4.5	7.2	100.0	102.8	05.6	08.3	11.1	150.0
80.4	3.2	6.2	9.0	91.9	4.7	7.6	100.5	01.4	06.2	09.1	12.0	14.8	55
2.9	5.9	8.8	91.8	4.7	7.7	100.8	03.8	06.7	09.7	12.6	15.6	18.5	60
85.5	88.5	91.6	94.7	97.7	100.9	103.0	107.0	110.0	113.1	116.1	119.2	122.2	65
8.1	91.3	4.4	7.6	100.8	05.9	07.1	10.2	13.3	16.6	19.7	22.8	26.0	70
90.8	4.0	7.3	100.5	01.6	70.0	10.2	13.4	16.7	20.0	23.2	26.4	29.6	175.0
3.4	6.0	100.0	01.3	06.8	111.1	13.4	16.8	20.0	23.3	26.7	30.1	33.4	80
6.0	9.4	02.8	06.2	09.6	13.2	16.5	19.9	23.4	26.8	30.2	33.7	37.1	85
98.6	102.1	105.6	109.2	112.8	116.1	119.7	123.2	126.7	130.2	133.8	137.3	140.8	90
101.2	04.8	08.4	12.0	15.6	19.2	22.8	26.4	30.0	33.6	37.2	40.9	44.5	95
01.7	07.4	11.1	14.9	18.6	22.2	26.0	29.6	33.3	37.0	40.6	44.4	48.1	200.0
08.8	12.8	16.6	20.6	24.4	28.4	32.2	36.2	40.0	44.0	47.8	51.6	55.6	10
14.0	18.2	22.2	26.4	30.4	34.4	38.6	42.6	46.8	50.8	54.8	59.0	63.0	20
119.4	123.6	127.8	132.0	136.2	140.6	145.0	149.0	153.4	157.6	162.0	166.2	170.4	30
24.6	29.0	33.4	37.8	42.2	46.6	51.0	55.6	60.0	64.4	69.0	73.4	78.0	40
29.6	34.4	39.0	43.6	48.2	52.8	57.6	62.0	66.8	71.4	76.0	80.6	85.4	250.0
34.6	39.4	44.2	49.0	54.0	58.8	63.6	68.4	73.2	78.0	82.8	87.8	92.5	60
40.0	45.0	50.0	55.0	60.0	65.0	70.0	75.0	80.0	85.0	90.0	95.0	100.0	70
145.2	150.4	155.6	161.0	166.0	171.2	176.2	181.4	186.8	192.0	197.0	202.2	207.4	80
50.4	55.8	61.0	66.4	71.8	77.2	82.6	88.0	93.3	98.1	104.0	109.6	114.6	90
55.6	61.2	66.8	72.2	77.8	83.4	89.0	94.0	200.0	205.6	11.2	16.6	22.2	300.0
60.8	66.4	72.4	78.0	83.8	89.4	95.2	201.0	06.8	12.4	18.2	24.0	29.6	10
65.8	71.8	77.6	83.6	89.4	95.4	201.6	07.6	13.6	19.4	25.2	31.2	37.0	20
171.0	177.0	183.2	189.4	195.4	201.8	207.8	214.0	220.0	226.2	232.2	238.4	244.4	30
76.2	82.6	88.8	95.2	201.6	07.8	14.2	20.4	26.7	33.2	39.4	45.6	52.0	40
81.6	88.0	94.6	201.0	07.6	14.0	20.4	26.8	33.4	40.0	46.4	52.8	59.2	350.0
86.8	93.2	200.0	06.6	13.6	22.2	26.8	33.6	40.0	46.6	53.4	60.2	66.8	60
92.0	98.8	05.6	12.4	19.2	26.4	33.0	39.8	46.8	53.6	60.4	67.4	74.2	70
107.2	204.2	211.2	218.4	225.6	232.2	239.4	246.4	253.4	260.4	267.6	274.6	281.6	80
207.4	09.6	16.8	24.0	31.2	38.4	45.8	52.8	60.2	67.6	74.4	81.8	89.2	90
07.4	14.8	22.2	29.6	37.0	44.4	51.8	59.2	66.6	74.0	81.4	88.8	96.2	200.0

EARTHWORK QUANTITIES

993

TABLE 162.—*Concluded*

41	42	43	44	45	46	47	48	49	50	75	100		D'uble Areas
57.7	59.2	60.6	61.9	63.4	64.8	66.2	67.6	69.0	70.4	105.7	140.7	—	76.0
9.2	60.7	2.1	3.6	5.0	6.4	7.8	9.3	70.7	2.3	08.4	44.4	—	8.0
60.8	2.2	3.7	5.2	6.7	8.2	9.7	71.2	2.6	4.1	11.2	48.1	—	80.0
2.2	3.8	5.3	6.8	8.3	9.8	71.4	2.9	4.4	5.9	14.0	51.8	—	2
3.8	5.4	6.9	8.4	70.0	71.6	3.2	4.7	6.2	7.8	10.8	55.5	—	4
65.3	66.8	68.4	70.1	71.7	73.3	74.8	76.4	78.0	79.6	119.5	159.2	—	6
6.8	8.4	70.1	1.7	3.4	5.0	6.6	8.3	9.8	81.5	22.3	63.0	—	8
8.4	70.0	1.7	3.3	5.0	6.7	8.4	80.0	81.7	3.4	25.1	66.7	—	90.0
0.8	1.6	3.3	4.9	6.7	8.4	80.1	1.8	3.5	5.2	27.9	70.6	—	2
71.4	3.2	4.8	6.6	8.4	80.2	1.9	3.6	5.3	7.1	30.7	74.1	—	4
72.8	74.7	76.4	78.2	80.0	81.8	83.6	85.3	97.1	83.9	133.4	177.7	—	6
4.4	6.3	8.1	9.9	1.7	3.5	5.3	7.2	8.9	90.8	39.2	81.6	—	8
5.9	7.7	9.7	81.4	3.3	5.2	7.0	8.8	90.7	2.6	33.9	85.1	—	100.0
0.8	81.7	83.0	5.6	7.5	9.4	91.4	93.4	95.3	7.2	45.9	91.4	—	05
83.5	5.6	7.6	9.6	91.7	93.7	5.7	7.8	9.8	101.9	52.8	203.7	—	10
87.3	89.4	91.6	93.7	95.8	97.9	100.1	102.2	104.4	106.5	150.8	212.9	—	15
91.2	93.4	5.6	7.8	100.0	102.2	04.5	06.7	08.9	11.5	66.7	22.2	—	20
5.0	7.3	9.7	101.9	01.2	04.5	08.9	11.2	13.5	15.6	73.7	31.4	—	125.0
8.8	101.2	103.6	05.9	08.4	10.7	13.1	15.5	17.9	20.2	80.5	40.7	—	30
102.5	05.0	07.5	10.0	12.5	15.0	17.5	20.0	22.5	25.0	87.5	50.0	—	35
106.3	108.0	111.5	114.2	116.7	119.3	121.9	124.4	127.1	129.8	194.5	259.2	—	40
11.2	12.9	15.5	18.2	20.8	23.6	26.2	28.0	31.7	34.3	201.5	63.5	—	25
14.0	16.7	19.5	22.3	25.0	27.8	30.6	33.4	36.2	38.9	08.5	77.7	—	150.0
17.8	20.6	23.5	26.3	29.2	32.1	34.9	37.8	40.8	43.6	15.4	87.0	—	55
21.5	24.5	27.4	30.4	33.4	36.4	39.4	42.3	45.2	48.2	22.4	96.3	—	60
25.3	128.4	131.5	134.4	137.6	140.6	143.8	146.8	149.8	152.8	220.3	305.5	—	65
129.1	32.3	35.4	38.5	41.7	44.9	48.0	51.2	54.3	57.4	36.2	14.8	—	70
32.9	36.1	39.4	42.5	45.6	48.9	52.2	55.5	58.8	62.0	43.0	24.0	—	175.0
36.8	40.0	43.4	46.8	50.0	53.4	56.8	60.0	63.4	66.8	50.0	33.3	—	80
40.5	43.9	47.4	50.8	54.2	57.7	61.0	64.5	67.9	71.4	56.9	42.6	—	85
144.4	147.8	151.4	154.9	158.4	161.9	165.4	168.9	172.4	176.0	263.0	351.8	—	90
48.1	51.8	55.3	58.9	62.5	66.2	69.8	73.4	77.0	80.5	70.8	61.1	—	95
51.8	55.6	59.3	63.0	66.8	70.4	74.1	77.8	81.4	85.2	77.7	70.3	—	200.0
59.5	63.4	67.1	71.1	75.0	78.9	82.8	86.7	90.5	94.5	91.6	88.9	—	10
67.0	71.2	75.2	79.3	83.4	87.5	91.5	95.6	99.7	203.7	305.5	407.4	—	20
174.7	178.9	183.3	187.5	191.8	196.0	200.1	204.4	208.8	213.0	319.4	425.9	—	30
82.2	86.8	91.1	95.5	200.0	204.5	03.8	13.3	17.8	22.2	33.3	44.4	—	40
80.8	94.5	99.0	203.7	03.3	13.0	17.5	22.2	26.8	31.5	47.1	62.9	—	250.0
97.4	202.3	207.0	11.9	16.6	21.6	26.3	31.1	36.0	40.8	61.0	81.5	—	60
205.0	10.0	15.0	20.0	25.0	30.0	35.0	40.0	45.0	50.0	75.0	100.0	—	70
212.7	217.8	223.0	228.2	233.3	238.6	243.7	248.9	254.1	259.2	388.7	518.5	—	80
20.2	25.6	30.9	36.3	41.7	47.1	52.4	57.8	63.2	68.5	402.7	37.0	—	90
27.8	33.4	38.9	44.5	50.0	55.6	61.1	66.7	72.3	77.8	16.5	55.5	—	300.0
35.4	41.2	46.9	52.6	58.3	64.2	69.8	75.6	81.3	87.0	30.4	74.0	—	10
43.0	49.0	54.8	60.8	66.7	72.7	78.5	84.4	90.4	96.3	44.3	92.6	—	20
250.6	256.7	262.8	268.9	275.0	281.2	287.3	293.3	299.5	305.5	458.2	611.0	—	30
58.2	64.5	70.7	77.1	83.3	89.7	95.9	102.2	308.3	14.8	72.1	29.6	—	40
65.7	72.3	78.7	85.2	91.7	98.2	304.6	11.1	17.6	24.1	85.9	46.1	—	350.0
73.3	80.1	86.7	93.4	300.0	306.8	13.3	20.0	26.7	33.0	99.8	66.0	—	60
80.9	87.9	94.6	301.5	08.3	15.3	22.0	28.9	35.8	42.6	513.7	85.2	—	70
288.5	295.6	302.6	309.7	316.7	323.8	330.7	337.8	344.8	351.8	527.6	701.6	—	80
96.1	303.4	10.5	17.8	20.0	32.3	339.4	46.7	53.9	61.1	41.5	22.2	—	90
303.7	11.1	18.5	23.9	33.3	40.7	48.1	55.5	62.9	70.3	55.5	40.6	—	400.0

TABLE 163.—CONVERSION TABLE, LINEAL FEET TO MILES

1 to 9		10-99		100-999		1000-9999		10,000-99,999	
Feet	Miles	Feet	Miles	Feet	Miles	Feet	Miles	Feet	Miles
1	0.00019	10	0.00189	100	0.01894	1000	0.18939	10,000	1.8939
2	0.00038	20	0.00379	200	0.03788	2000	0.37870	20,000	3.7879
3	0.00057	30	0.00568	300	0.05682	3000	0.56818	30,000	5.6818
4	0.00076	40	0.00758	400	0.07576	4000	0.75758	40,000	7.5758
5	0.00095	50	0.00947	500	0.09470	5000	0.94697	50,000	9.4697
6	0.00114	60	0.01136	600	0.11364	6000	1.13636	60,000	11.3636
7	0.00132	70	0.01326	700	0.13258	7000	1.32576	70,000	13.2576
8	0.00152	80	0.01515	800	0.15152	8000	1.51515	80,000	15.1515
9	0.00171	90	0.01705	900	0.17046	9000	1.70455	90,000	17.0455

Shrinkage of Earthwork.—No mention has been made of the shrinkage of earth cut when placed in fill. This is an important factor of an economical grading design.

Trautwine states that for railroad work it takes 1.08 cu. yd. of gravel or sand excavation, 1.10 cu. yd. of clay excavation, 1.12 cu. yd. of loam excavation, and 1.15 cu. yd. of vegetable surface soil excavation to make 1 cu. yd. of embankment.

The quantities 1.08 cu. yd. of gravel, etc., refer to the volume occupied by the material before removal.

Trautwine also states that in loosening earth and loading into wagons or cars 1 cu. yd. of earth swells about one-fifth and measures loose practically 1.2 cu. yd.

These values, however, cannot be used in road work, as a certain percentage of the excavation is sod or vegetable matter that is not suitable for embankment and must be wasted.

This waste material raises the percentage of cut necessary to make the fill.

The correct ratio for road work has been a source of contention among engineers, and it is believed that the use of too high a value has resulted in needless waste of thousands of dollars during the last 5 years in New York State alone.

Under this head it may be stated that on several roads under the supervision of W. G. Harger a careful study of this point was made, unusual care being taken with the original and final cross-sections, the plotting, and planimeter work, and it was found that for the cases investigated the ratio of cut to fill varied from 1.15 in heavy cuts to 1.27 in light skimming work.

It is the general opinion among engineers of Division 4, New York State Department of Highways, that the percentage formerly used (namely 1.35) is too high. In nearly all cases where the work was at all heavy a large excess of dirt had to be wasted. There have been some roads designed on a basis of 1.35 where more dirt was needed, but in the authors' opinions this was due to discrepancies in the field or office work or by allowing the contractor to use the roadbed excavation for filler or concrete material. If the soil encountered is suitable for such purposes, it is plainly up to the contractor to furnish other material for the places excavated.

The authors believe that the following ratios will be satisfactory for ordinary cases: Earth excavation where sod is rejected for fill.

TABLE 164

	Cubic Yards per Station	Ratio Exca- vation to Com- pacted Fill
Light skimming work, large amount of heavy sod	50	1.35
Light skimming work, considerable sod.....	60	1.30
Light skimming work, not much sod.....	60	1.25
Medium work.....	100	1.20
Heavy work.....	150-200	1.15

Trautwine's earth ratios are correct where earth borrow is obtained from a pit.

Trautwine states that 1.0 cu. yd. of solid rock, when broken up, will make 1.66 to 1.75 cu. yd. of rock fill.

In this statement he assumes that the fill is made of stone alone and that the voids are not filled. In most road work, the small quantities of rock encountered are dumped in with the earth as embankment, and as the voids are all filled with earth it is evident that 1 cu. yd. of rock will make only 1 cu. yd. of fill; however, if a large unmixed stone fill is made, his ratio holds.

In shale rock excavation, 1 cu. yd. will make from 1 to 1.2 cu. yd. of compacted fill, depending on its hardness and how it is excavated, that is, whether it comes out in large blocks or is considerably pulverized.

The discussion of these ratios has been carried out to some length because it is believed that they illustrate the advantage of careful engineering. Several of the New York State plans, the cost of which has ranged from \$100 to \$200 per mile, have been revised with this end in view, the revision costing an additional \$15 to \$30 per mile, with a resultant saving in construction cost of from \$400 to \$1000 per mile.¹

The use of a rolling grade was recommended in the chapter on Grades. The designer is cautioned, however, not to carry this to extremes, as there are many short, small hummocks which must be disregarded if a reasonably good profile is to be obtained. Figure 313 (p. 963) indicates a proper and improper use of an undulating grade.

Figure 313A illustrates the actual profile on Road 5046 New York State for a short, sharp roll which has proved entirely satisfactory for traffic but which is about the limit of permissible abruptness.

Overhaul.—If dirt must be hauled more than a stated distance (free haul) to place it in fill, the additional distance over the free haul length is called overhaul and is paid for at an agreed price. The amount of overhaul is usually estimated as Sta. yd., meaning the number of cubic yards of excavation that have to be overhauled multiplied by the length of the overhaul expressed in stations of 100' each; that is, if 20 cu. yd. of excavation have to be hauled 1500' (15 stations) to place in fill and the free haul is stipulated as 1000', overhaul would be computed as

$$20 \text{ cu. yd.} \times (15 \text{ Sta.} - 10 \text{ Sta.}) = 100 \text{ sta. yd.}$$

If the cut from which the dirt is excavated is short and well defined and the fill likewise well defined the overhaul can be figured with reasonable accuracy by taking the distance from the center of gravity of the cut to the center of gravity of the fill which can be easily located by inspection. If, however, the cuts and fills are not well defined and the cut from two or three locations is hauled to a number of fills it is necessary to adopt a standard method of computing haul. Also, due to the methods of making fills it is generally impossible to determine exactly the distance actually hauled by the contractor and the usual basis of measuring

¹ 1912 scale of costs.

overhaul is the mass-diagram method, which assumes that each yard of earth is hauled the minimum theoretical distance to place it in the fill.

Mass Diagram.—The mass diagram merely represents graphically the location and amount of each cut and its direction and length of haul to place it in fill. Vertical ordinates on the diagram represent cut or fill, cut being plotted upward and fill downward. Fills must be converted into equivalent excavation before being plotted. Distance is represented by the horizontal dimensions.

The steps in determining overhaul from mass diagrams are as follows:

1. Compute total excavation and embankment for the roadway and all borrow pits.
2. Determine ratio between total excavation and total embankment.
3. Convert embankment into equivalent excavation, using ratio just determined.
4. Compile mass-diagram tabulation station by station for both roadway and borrow pits
5. Plot mass diagram.
6. Divide mass diagram into a series of sections where cut balances fill.
7. Eliminate free haul from each of these balances.
8. Compute overhaul from remaining area of diagram.

Figures 318, 310, and 320 illustrate three typical cases and are explained as follows.

Case I. Earth from a Well-defined Borrow Pit, the Center of Which Is Located by Inspection at Sta. 0, Is Used in Making a Fill Extending from Stas. 0 to 10. Free Haul Specified as 500'.—The first step is to compute from the cross-sections the total excavation in the borrow pit and the fill quantities station by station. This is shown in columns 1 to 4, Table 165, to be 1520-cu. yd. excavation and 1384 cu. yd. fill in place. The ratio of cut to fill, for example, in question is 1.10. The embankment quantities must next be changed to equivalent excavation, as the overhaul is figured in terms of excavation yardage. This is done by multiplying each embankment quantity in column 4 by the factor 1.10 and recording the results in column 5. If correctly done the total of column 5 should equal the total of column 3, although, due to the factor ratio not being exact, a slight difference not totaling over 1% is of no practical consequence. The next step is to fill in columns 6 and 7, which represent the net excess of excavation or fill for each station figured and are the differences between columns 3 and 5. This net excess represents the quantity of material that must be moved by haulage. For this case with simple cuts and fills the totals of columns 6 and 7 should agree and be the same as for columns 3 and 5. The next step is to compute the algebraic total to each station as shown in column 8, considering excess excavation, column 6, as a plus quantity and excess embankment, column 7, as a minus quantity. The last quantity in column 8 should be zero, although a variation of less than 1% of the total is allowable—in this particular tabulation one-fifth of 1%

TABLE 165.—MASS-DIAGRAM COMPUTATIONS, CASE I

Station to station	(1)	(2)	Excavation, cubic yards	(3)	Embankment, cubic yards	(4)	Embankment converted to equivalent excavation	Excess per station		Algebraic total
								Excavation	Embankment	
0				1520				1520		+ 1520
1		Borrow pit		108		119	119		119	+ 1401
2				200		220	220		220	+ 1181
3				151		166	166		166	+ 1015
4				175		193	193		193	+ 822
5				60		66	66		66	+ 750
6				40		44	44		44	+ 712
7				30		33	33		33	+ 679
8				170		187	187		187	+ 492
9				250		275	275		275	+ 217
10				200		220	220		220	- 3
Totals.....				1520	1384	1523	1523	1520	1523	

Ratio cut to fill, 1.10.

TABLE 166.—MASS-DIAGRAM COMPUTATIONS, CASE II

Station to station	Excavation, cubic yards	Embankment, cubic yards	Embankment converted to equivalent excavation, cubic yards	Excess per station		Algebraic total, cubic yards
				Excavation	Embankment	
(1)	(3)	(4)	(5)	(6)	(7)	(8)
0	+ 200	+ 200	+ 200
1	+ 50	+ 30	+ 239
2	+ 182
3	- 387
4	- 729
5	+ 1,305	+ 1,305	+ 570
Borrow west Sta. 5	+ 348
6	+ 50	+ 341
7	+ 60	+ 49	+ 390
8	+ 30	+ 386
9	+ 25	+ 343
10	+ 218
11	+ 1
Totals.....	+ 1720	- 1510	- 1719	+ 1593	- 1592	

Ratio cut to fill, 1.14.

NOTE.—Columns 6 and 7 quantities are obtained by subtracting column 5 quantities from column 3 quantities for the same station.

sq. in. \times 2500 sta. yds. per sq. inch = 1500 sta. yd. overhaul, Stas. 0 to 5.

In a similar way from Stas. 5 to 12 there is a small distance, Stas. 7 to 10, where the cut makes the fill (area *MNO*). For the balance of the distance overhaul is required from the borrow pit. The limit of free haul from the pit is marked by the line *KQ* and the overhaul is measured by the area *KLMOPQK*, which equals 1.08 sq. in. \times 2500 sta. yd. per square inch = 2700 total sta. yd. overhaul, Stas. 5 to 12.

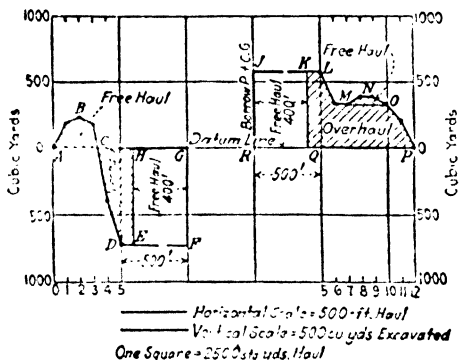

FIG. 319.—Mass diagram, Case II.

Scales 1" = 500 cu. yd. excavated, vertical
 1" = 500' haul, horizontal
 1 sq. in. = 2500 sta. yd. haul

Case III. Borrow Obtained from a Long Variable Section Pit and Placed in a Long Section of Road Fill with a Long Intermediate Section of Road Where the Cut Makes the Fill. Free Haul 400'.—For a borrow pit of the kind it is necessary to compute and plot the pit in the same manner used for the roadway computations. These computations are made in the direction of haul in the pit; that is, the zero cut quantity is taken at the point in the pit farthest from the road. The tabulation of quantities for this case is given as follows:

Figure 320 shows the completed diagram for Case 3. It is explained as follows. Line *ABCDEFGHJ* is plotted from the tabulation of quantities. The next step is to determine and eliminate from the diagram any sections of the road where the cut makes the fill with a haul of less than 400' free haul. Bearing in mind that cut is plotted up and fill down, it is evident that roadway excavation *DF* makes the fill line *FH* and no borrow-pit material is required from *D* to *H* (Stas. 3 to 9+70). Bearing in mind that the horizontal line *DH* represents the length of haul for a yard excavated at *D* and placed at *H*, which is 670' and that the free haul is only 400', it is evident that between Stas. 3 and 9+70 some of the roadway excavation must be overhauled. A horizontal line *EG* is therefore drawn, locating it by shifting up, so that it is exactly 400' long (free haul

TABLE 167.—MASS-DIAGRAM COMPUTATION, CASE III

Station to station	Excavation, cubic yards	Embankment, cubic yards	Embankment converted to equivalent excavation, cubic yards	Excess per station		Algebraic total	
				Excavation	Embankment		
(1)	(2)	(3)	(4)	(5)	(6)	(7)	(8)
Borrow pit							
0B		800	+ 800	+ 800
1B		900	+ 900	+ 1700
2B		150	+ 150	+ 1850
3B		85	+ 85	+ 1935
4B		1353	+ 1353	+ 3288
5B			+ 3288
Distance Sta. 5B to Sta. 0 of road is 800'			+ 3176
Roadway			+ 3042
0		+ 3038
1		100	+ 3188
2		120	+ 3560
3		30	+ 3710
4		+ 3675
5		+ 3451
6		+ 2892
7		+ 1964
8		40	+ 565
9		200	+ 0
10		500	
11		830	
12		1250	
13		500	
Totals.....		4000	3570	3994	+ 3960	- 3954	

Ratio cut to fill, 1.12.

distance), where it cuts the diagram line. This means that the roadway excavation from *E* (Sta. 5) to *F* (Sta. 7) just makes the fill from *F*, Sta. 5, to *G*, Sta. 9, without any overhaul. To get the overhaul on excavation from *D*, Sta. 3, to *H*, Sta. 9+70, take out the free-haul area *EGTS* and the overhaul is given by the sum of the areas *DFS* and *GHT*.

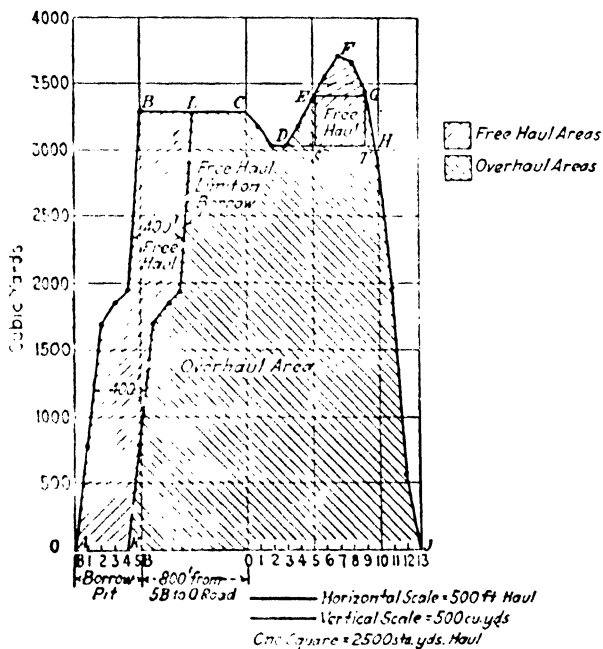

FIG. 320.—Mass diagram, Case III.

Scales 1" = 500 cu. yd., vertical
 1" = 500' haul, horizontal
 1 sq. in. = 2500 sta. yd. of haul

The next step is to take out the free haul from the borrow-pit haul which is accomplished by drawing the line *KL* parallel to *AB* and 400' away from it. The overhaul on the borrow-pit excavation is then the area *KLCDHJK*.

The total overhaul for Case 3 is area *KLCDESTGHJK*, which equals 22.7 sq. in. multiplied by 2500 sta. yd. per square inch = 56,700 sta. yd.

These three cases outline the general principle of the work and if the fundamentals have been grasped minor modifications in conditions will give no trouble.

Structures.—This book is not intended as a textbook of structural design (culverts, bridges, etc.). Most cases can be handled by the use of standard designs for small-span bridges given in Chap. IV, (pp. 214 to 310) or by the use of the state or federal standards applicable to the locality in question. Basic data for types of structures, waterway areas, etc., are given in Chap. IV, Drainage, Part I. The following tables and basic design data will, however, be useful for cases where special designs are required or where it is necessary to figure the safe load of existing structures for repair or condemnation purposes, provided the reader is familiar with design methods. If the reader is not familiar with design methods he is referred to Ketchum's "Highway Bridges," for culvert, bridge, and retaining-wall design, and to "Concrete Engineer's Handbook," by Hool and Johnson for concrete arch design.

The cost of surveys, designs, final plans, and estimates for small-span bridges of less than 45' span will range from $\frac{3}{8}$ to 2% of the cost of the structure. This cost permits proper economic alternate design investigations.

Bridge Designs.—The steps of ordinary small-span bridge design with references in regard to location of required data are as follows:

	Pages
Channel straightening.....	181
Location of structure	181
Waterway area.....	186
Débris clearance.....	186
Possible utilization of parts of old structure	210
Economical type of structure	205
Final road surface grade considering high-water débris, clearance, and depth of floor system.....	1025
Foundation and abutments	207
Superstructures { Loading	200
{ Roadway widths.....	203
{ Standard details.....	214-310
Protection from scour.....	211
Cost estimates.....	1150

A design report should be prepared discussing alternate possibilities for each part of the design and giving the reason for the adopted design (see p. 774).

In training designers the author has been in the habit of starting out by telling them that there are a number of satisfactory ways of solving any problem and that their designs would be accepted without requests for revision, provided they mastered the broad general principles outlined in Chap. IV and actually used their brains to get a reasonably suitable and economical design. Designs are never accepted merely because they comply with standards, but any reasonable design is accepted which shows careful analysis and an effort to produce an economical structure suitable to local conditions.

GENERAL STATEMENT OF DESIRABLE ECONOMIC TYPES OF SUPERSTRUCTURES (SMALL SPAN)

Div. No. 4, N. Y. S. Div. of Highways

Spans 5 to 25'.—Slab type of bridge preferred for all ordinary foundation conditions. For soft foundations requiring piles I beam stringer type generally preferable on account of difficulty of forming (liability of settlement of deck bents). In case slab type used on soft foundations forms must be supported on piles or framed trusses supported by abutment toe. On hard foundations use rigid frame type of slab.

Spans 25 to 45'.—Hard pan or rock foundations with excessive headroom creek to road grade use reinforced concrete arches or I beams.

Hard pan or rock foundations at low stream crossings use double span slabs with pier where there is no danger of stream clogging. Use T beam superstructures or I beam superstructures where single spans are required. The use of T beams or I beams depending on cost considering the effect of difference in depth of floor for the two types on approach costs as well as the comparative cost of the superstructures.

For ordinary foundation soils it is rarely advisable to use piers for spans less than 45 feet. For these conditions use T beam or I beam structures the selection depending on economic costs considering effect of depth of floor on approach costs as well as cost of bridge proper. If piers are used on ordinary soil foundations each span should be designed with free ends. Felt construction joints are advisable to permit minor settlement without crushing or cracking of parapets. Pipe rail parapets are to be preferred to solid concrete for this condition. On hard pan or rock foundations the continuous beam design is desirable making reinforcement continuous with no provision for expansion or contraction up to 50' total length of multiple spans.

Spans 45 to 100'.—Multiple or single spans as determined by economy of design and suitability of piers. Piers to be spaced not closer than 4 times range of depth between high and low water. Arches preferred on rock or hard pan foundations. T beams next choice. On the soft foundations I beams stringers or plate girders.

Loading.—Use H-15 for roads carrying less than 2000 vehicles daily (10 hour count in summer). Use H-20 for roads over 2000 vehicles, allowing for 60 year traffic increase.

GENERAL BASIS OF DESIGN

State Road Bridge Widths & Pedestrian Traffic

(Division No. 4 New York State 1927)

Allow for 30 years traffic increase on types of bridges that can be widened without entire rebuilding (slabs, T beams, stringers & arches) class A bridges.

Allow for 60 years traffic increase for trusses and plate girders (class B bridges).

The following satisfactory bridge widths for different volumes of traffic are based on 12 hour traffic counts in August. Allow 70% increase for 30 years and 100% increase for 60 years for roads on portions of the system which are completed and traffic routes fixed. Make special increases or decreases for future adjacent improved roads which will radically change normal increase which is based on population increase (see future traffic chart for Division No. 4, page 31).

Maximum future traffic volume (12 hr. count in August) allow for 30 to 60 years increase	Recommended roadway width			
	Class A bridges			Class B bridges over 45' span
	10'-25' span	25'-45' span	Over 45' span	
Class I AA, over 9000 vehicles.....	40'	40'	40'	40'
Class IA, 5000-9000 vehicles.....	40'	40'	30'	30'
Class I, 2000-5000 vehicles.....	30'	30'	24'	24'
Class II, 1000-2000 vehicles.....	30'	24'	22'	22'
Class III, 300-1000 vehicles.....	30'	24'	22'	22'
Class IV, under 300 vehicles.....	24'	22'	20'	20'

Pedestrian Traffic

Where there is immediate necessity for sidewalks use either separate foot bridge or walks on bridge are required by the layout to fit local conditions. Where there is no immediate necessity for walks on the bridge make no special provision on Class A bridges as these bridges can either be widened or separate foot bridges near the road lines can be easily provided in the future for spans under 45 feet. Where class B bridges are used provide connections for future sidewalk brackets as it is practically certain that within a few years sidepaths for pedestrians will be common practice on State Roads.

Signed.....
Bridge Eng.

Bridge Plans (see pp. 1007 to 1012).—Bridge plans should include a general layout showing location of structure, channel improvements, road approaches, etc., a set of detail sheets carefully dimensioned and elevationed to give all necessary construction data, and sheets giving the estimate of quantities, bill of materials, detail bar lists, and bending diagrams. The size of sheet is the same as for road plans. Scales for general layout are generally 50' to the inch horizontal and 10' to the inch vertical. Scales for details are varied to bring out the necessary data, and generally range from $\frac{1}{4}$ to 1" per foot. For small simple structures where the regular road cross-sections are plotted 1" to 5' it is just as well to retain this same scale, as it corresponds with the road plan cross-sections.

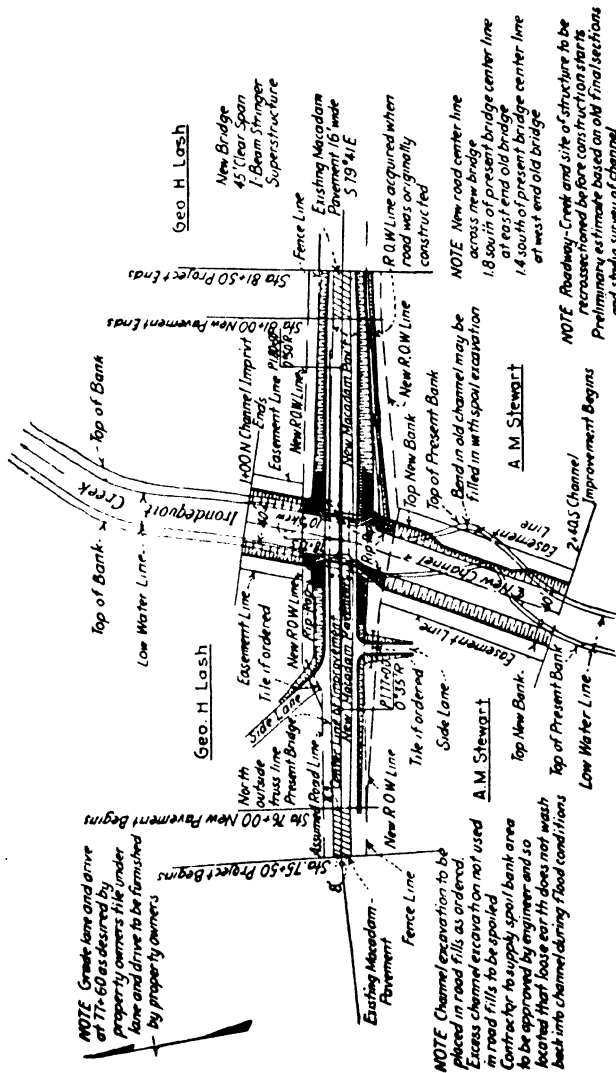

Typical plans (1). General layout.

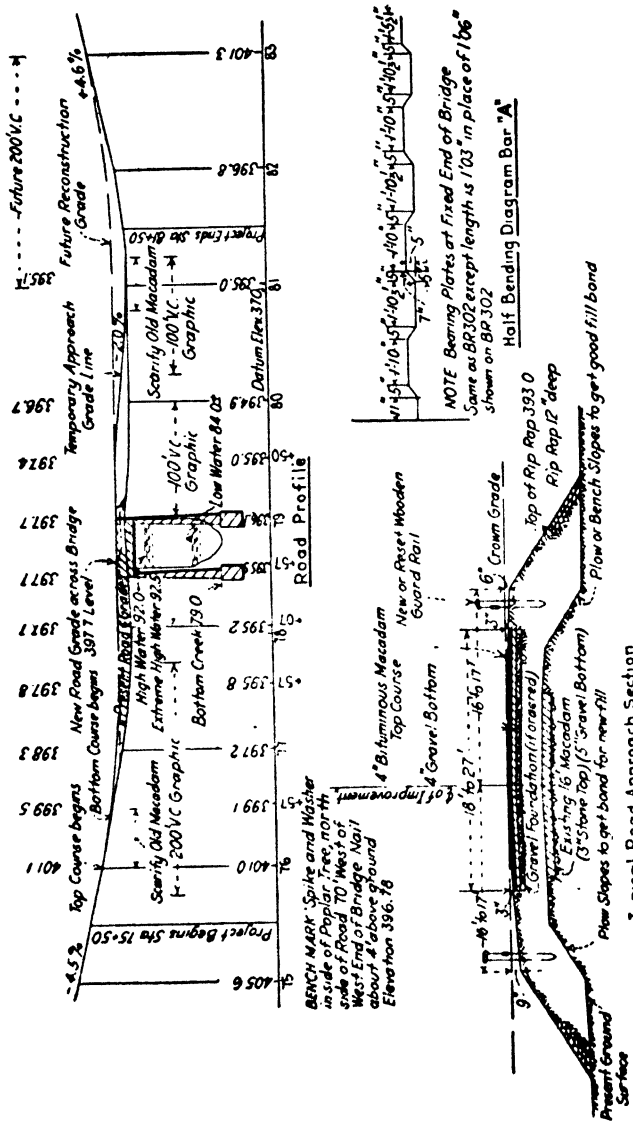

Typical plans (2). Approach profile and typical approach road section.

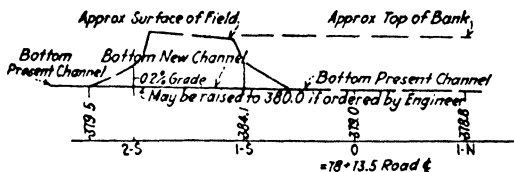

New Channel Profile

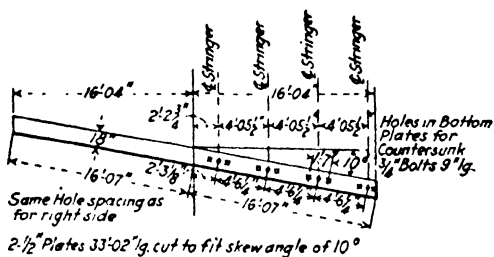

NOTE: Holes in Bottom Plate on center line of Stringers countersunk on top.
Holes in Upper Plate on each side of Stringer Flange countersunk on bottom
For size of length of Anchor Bolts see B.R.302

Expansion Plate Details

Typical plans (3). Creek profile and expansion plate.

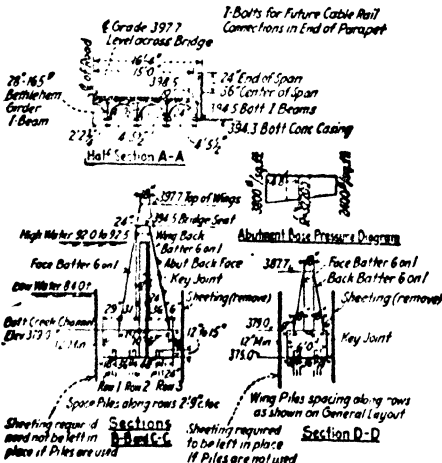
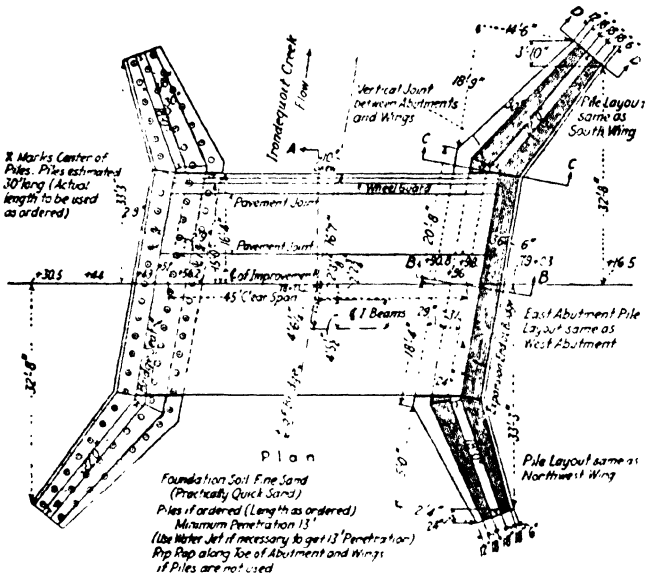

Typical plans (4). Bridge details.

General Notes

General clauses B.R. 302 & 702 to apply.

All concrete rub finished.

Earth excavation maximum limit of payment as per B.R. 702.

SPECIAL FORM NOTE

Abutment and wing forms shall have the following minimum requirements.

Face forms 1½" tongue and grooved lumber plained on one side.

Vertical studding at least 2" X 6" spaced not over 24".

Horizontal studding at least 4" X 6" spaced not over 24".

Forms tied with rods. Wire ties not permitted.

Tie rods spaced not more than 42" along whailers.

Studs spaced 16" c. to c. for ⅞" facing.

Wire ties 2— No. 6 or 4—No. 9 spaced 36" along wales.

PRELIM. SUMMARIZED ESTIMATE

No.	Item	Unit	Net	Cont.	Gross
1	Clearing and grubbing.....	L. S.	Nec.	Nec.
2	Earth excavation.....	C. Y.	4,000	500	4,500
3	Rock excavation.....	C. Y.	10	10
7b	4" Pipe underdrain.....	lin. ft.	100	100
10	Relaying pipe.....	lin. ft.	100	100
15	Portland cement.....	bbl.	950	150	1,100
16	Cement concrete for structures	C. Y.	95	5	100
17	Cement concrete for parapets.	C. Y.	6.1	0.9	7
21	2nd class concrete.....	C. Y.	580	60	640
30	Metal reinforcement for pavement.....	sq. yd.	151	9	160
30A	Bar reinforcement for structures.....	lbs.	6,200	300	6,500
32B	Structural steel.....	lbs.	66,430	570	67,000
34	Wooden guide rail.....	lin. ft.	100	200	300
38	Preparing fine grade.....	sq. yd.	1,050	50	1,100
39	Foundation course (run of bank gravel).....	C. Y.	150	150
42	Bottom course (run of bank gravel).....	C. Y.	100	20	130
47	Top course bituminous macadam.....	C. Y.	120	10	130
51D	Cement concrete pavement.....	C. Y.	14	1	15
56	Trimming shoulders.....	lin. ft. rd.	500	50	550
59	Scarifying old macadam.....	sq. yd.	100	100
60A	Bituminous material waterproofing.....	sq. yd.	1,350	50	1,400
62	Screened gravel (loose measure)	C. Y.	50	50
72	Bituminous material T penetration.....	gal.	3,300	300	3,500
78	Maintaining traffic (if ordered)	L. S.	Nec.	Nec.
80	Rip rap.....	C. Y.	150	10	160
82	Dismantling superstructure and steel abut.....	L. S.	Nec.	Nec.
83	Coffer dams, etc.....	L. S.	Nec.	Nec.
84	Timber piles.....	lin. ft.	4,000	4,000
87	Test piles.....	each	2	2	4
89	Resetting wooden guide rail...	lin. ft.	600	100	700

Typical Plans (5). General notes and summarized estimates.

APPROX. BILL OF MATERIALS

Item	Net est.	Gross est.
Cement.....	950 bbl. ±	1,100 bbl. ±
Concrete stone.....	700 C. Y. ±	760 C. Y. ±
Concrete sand.....	350 C. Y. ±	380 C. Y. ±
Rip rip stone.....	150 C. Y.	160 C. Y.
4" Drain tile if ordered.....	100 lin. ft.
Screened drain gravel if ordered.....	50 C. Y.
Steel (see special list).....

DETAIL BAR LIST

Bar designation (see BR 302)	Size of bar	Number of bars	Length each bar	Location of bars
a	1 1/4" φ	69	35'-02"	Bent traverse slab bar
b	1 1/4" φ	136	32'-10"	Straight traverse slab bar
c	1 1/2" φ	8	48'-08"	Straight longitudinal bar in parapet and curb
d	1 1/4" φ	2	48'-00"	Top longitudinal bar in parapet and curb
e	1 1/2" φ	20	3'-03"	Vertical bar in parapet and curb
f	1 1/2" φ	16	3'-06"	Vertical bar in parapet and curb
g	1 1/2" φ	16	3'-00"	Vertical bar in parapet and curb
h	1 1/2" φ	16	4'-00"	Vertical bar in parapet and curb
m	1 1/2" φ	29	48'-06"	Longitudinal top and bottom slab bars
n	1 1/4" φ	48	15'-05"	Longitudinal bar under I beams

TABLE OF EXCAVATION AND EMBANKMENT
Road Approaches

Sta. to sta.	Exc. cy.	Emb. Cy.	Required borrow	Remarks
75+50-78+50	700	800	Obtain from channel exc. preferably above elev. 384.0
Drives	300 ±	400	Obtain from channel exc. preferably above elev. 384.0
78+95-81+50	100	1,000	1,200	Obtain from channel exc. preferably above elev. 384.0

Creek Channel and Structural Excavation
Backfill

2+40-S-1+00-N	4,300 ±	600 ±	Use best materials for road fills and abutment backfills
---------------	---------	-------	-------	--

Typical Plans (7). Tabular information for contractors and inspectors.

Utilization of Old Structures. Case 1.—Where abutments and superstructure are properly located and of standard strength, but the roadway is too narrow, the structure is widened (see Fig. A, below).

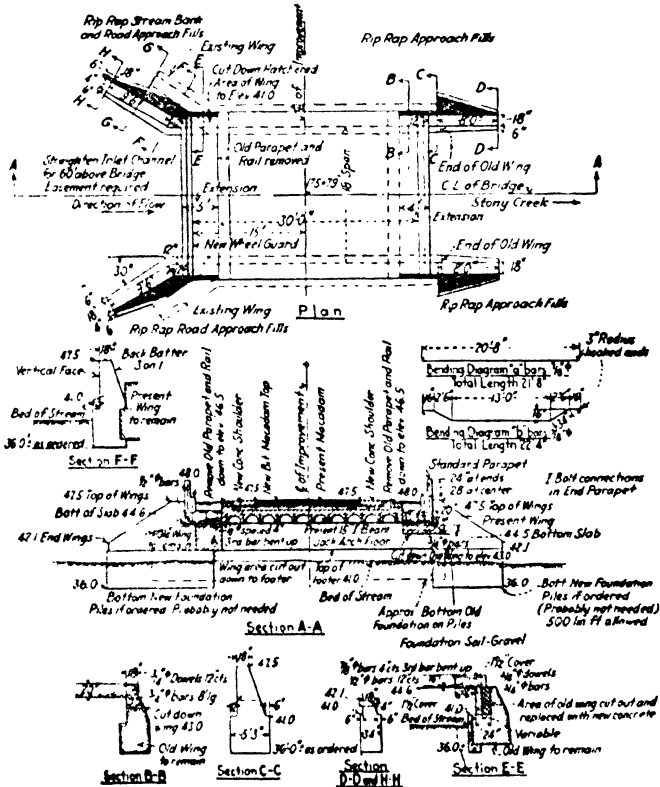

FIG. A.—Utilization of old structures, Case 1. Old superstructure and abutments retained and extended.

Note.—In this particular case the widening cost \$3000 less than a new structure.

Case 2.—Where the abutments are good but the superstructure too weak for modern loads the method used in Fig. B is often desirable and is a money saver.

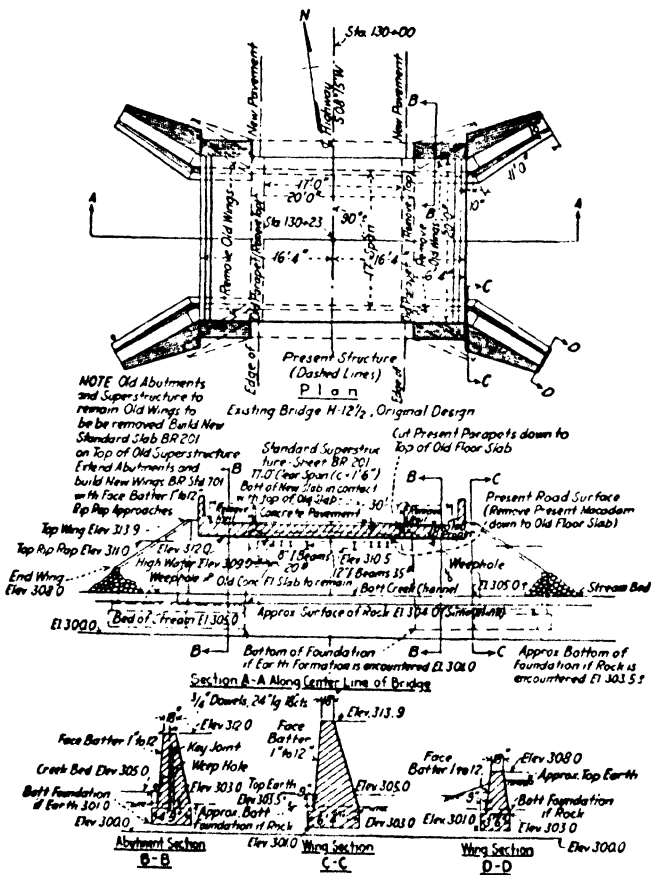

FIG. B.—Utilization of old structures, Case 2. Saved \$1500 over entire new structure.

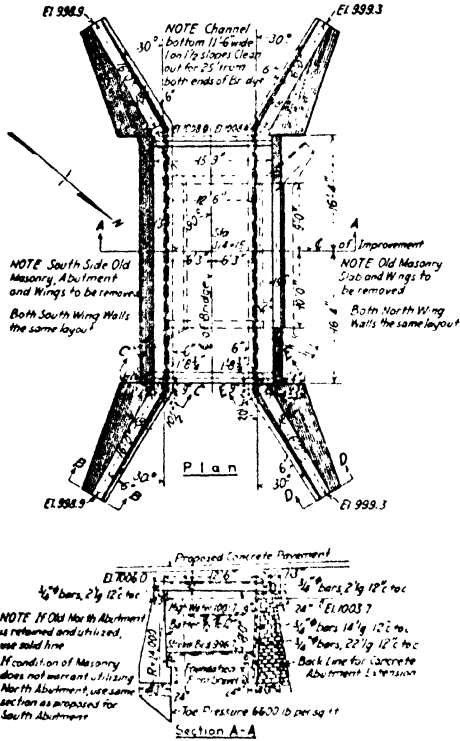

FIG. D.—Utilization of old structures, Case 3. Face and extend one abutment.

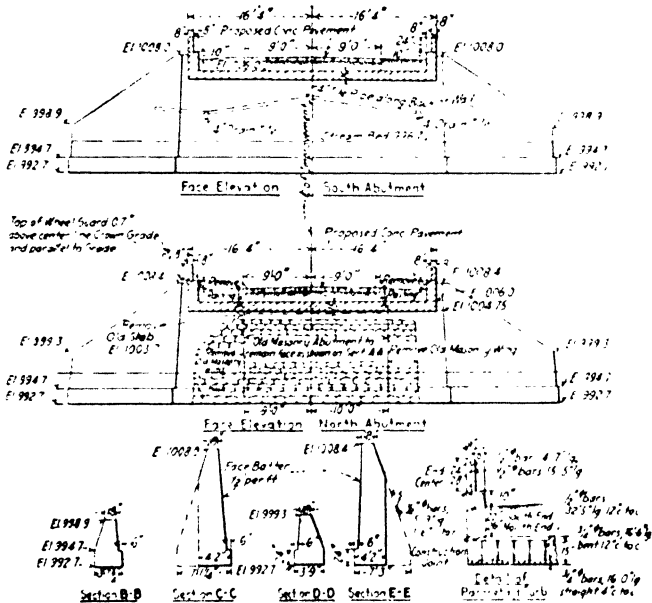

FIG. D.—(Continued.)

Case 4.—Where the arch type of bridge is suitable the abutment design can be radically cheapened as shown in Fig. E if the old abutments are solid and firm.

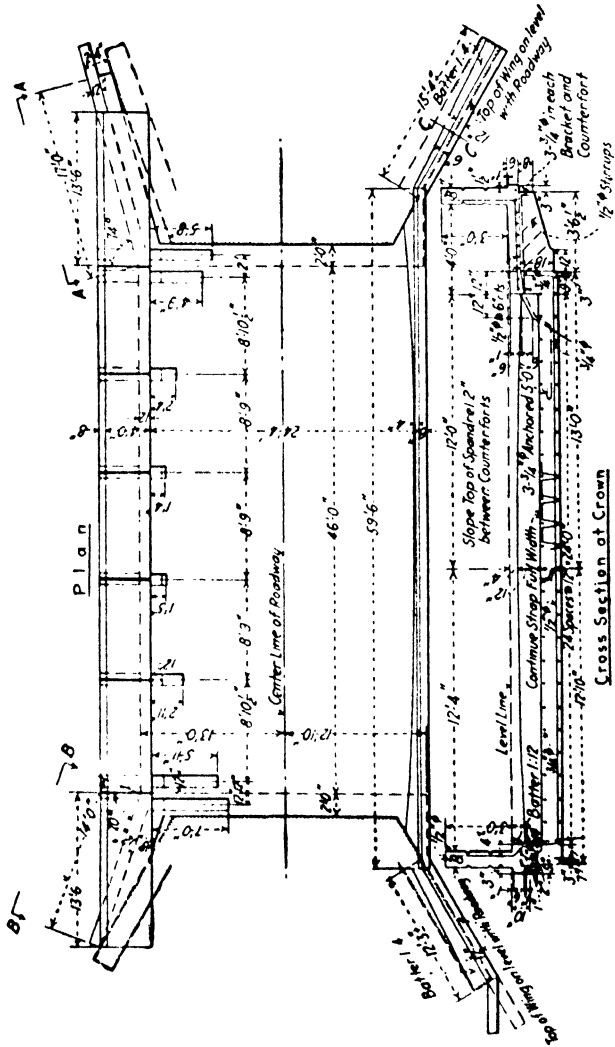

FIG. E.—Utilization of old structures, Case 4.

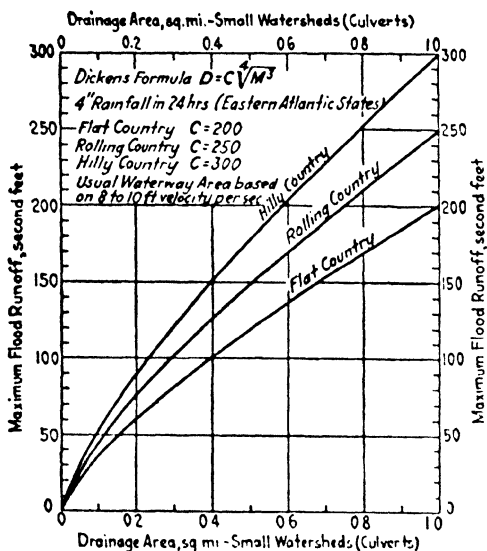
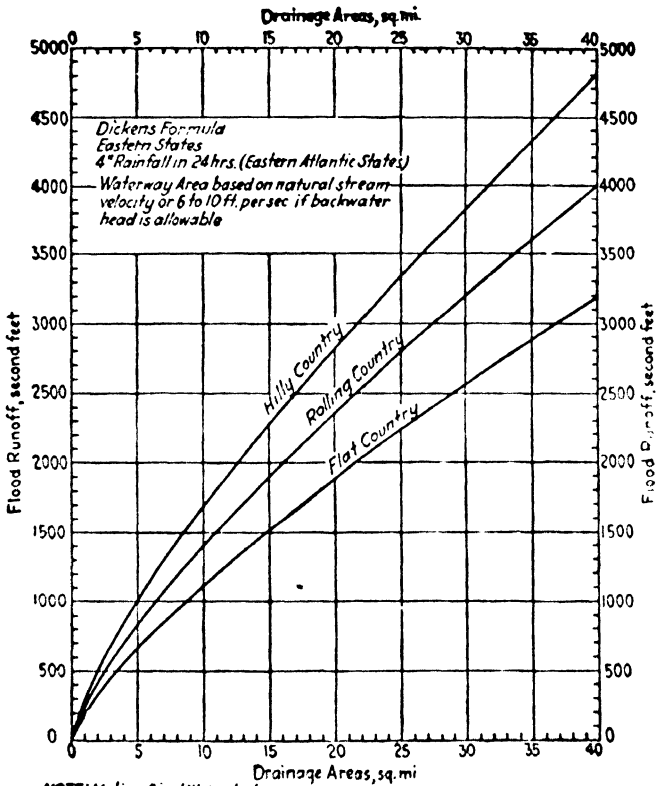

DIAGRAM 1.—Flood runoff for small streams. N. Eastern States (See Table 47, page 189.)



NOTE: Medium Sized Watersheds
Small Span Bridges

DIAGRAM 2.—Flood runoff for streams. Medium size watersheds. N. Eastern States.

(see table 47 on page 189.)

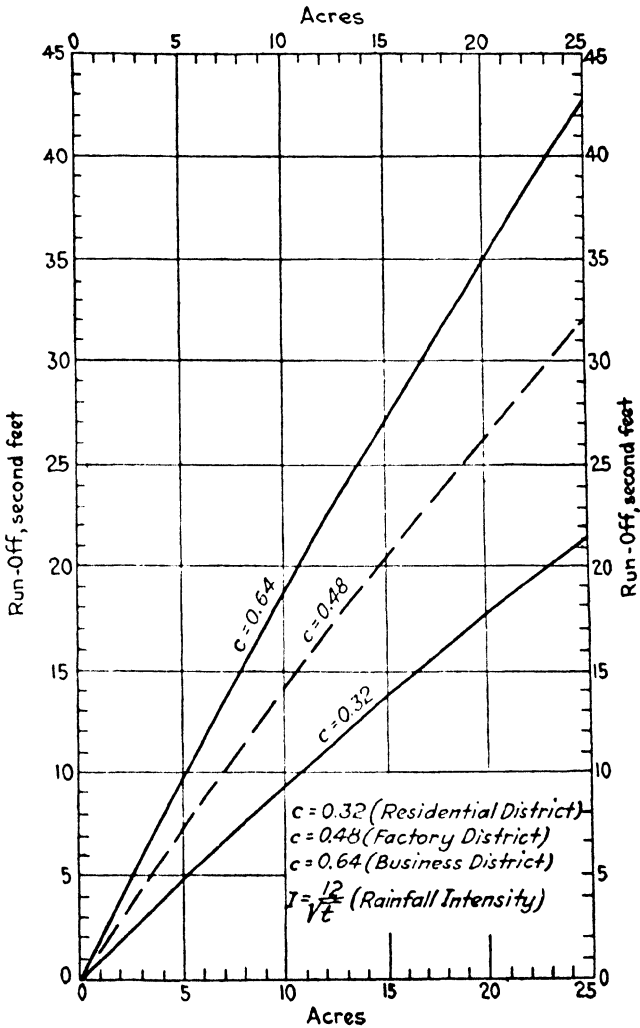

DIAGRAM 3.—Typical storm sewer runoffs. Lima, Ohio. (Rather flat topography.)

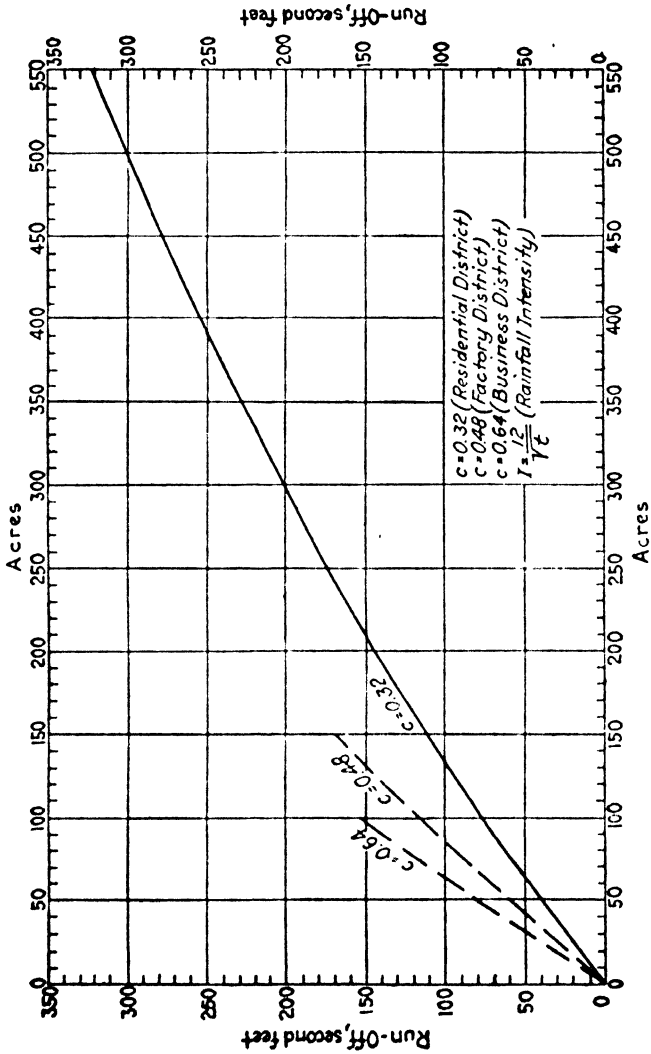

DIAGRAM 4.—Typical storm sewer runoffs. Lima, Ohio. (Rather flat topography.)

Elevation of Road Grade across Bridge.—The elevation of road grade across structure depends on elevation of high water, debris clearance and floor depth. The following data which was compiled for New York Standards (1926) gives a good general idea of the clearance data required for this part of the design. Similar data can be compiled for each locality using the prevailing clearances for that district. For special cases standard floor depths can be reduced 6" to 9" for approx. \$200 to \$400.

CLEARANCES ABOVE HIGHWATER¹ TO DETERMINE APPROXIMATE ROAD GRADE OVER BRIDGES

New York State Standards (1926) H-20 loading

Span (ft.)	Minimum debris clearance (ft.)	Depth floor slab bridges	Depth floor I-beam bridges	Depth floor T-beam bridges
6	0.5	1.2'		
10	0.5	1.4'	2.0'	
15	0.8	1.7'	2.5'	
20	0.8	2.0'	2.7'	
25	0.9	2.4'	3.0'	2.6'
30	1.0	...	3.0'	3.0'
35	1.2	...	3.4'	3.7'
40	1.5	...	3.4'	4.5'
45	2.0	...	3.4'	

	Depth road surface to bottom steel	Debris and ice clearance
22' roadway plate girders (50 to 90' spans)...	3.0'-3.5'	2.0' to 4.0'
30' roadway plate girders (50 to 90' spans)...	3.5'-4.0'	2.0' to 4.0'
40' roadway plate girders.....	4.0'-4.5'	2.0' to 4.0'
22' roadway truss bridges (90' or more spans)...	3.5'	2.5' to 4.0'
30' roadway truss bridges (90' or more spans)...	4.3'	2.5' to 4.0'

¹ NOTE: Highwater elevation is the upstream backwater head elevation to produce desired velocity through opening for sluggish streams or normal upstream highwater where natural stream velocity is maintained. Approx. backwater head in feet = $\frac{V^2}{64}$ where V equals desired increase in natural flow velocity in feet per second. (For table see page 196.)

Example.—Assume that new bridge is to be built across outlet stream emptying into a lake with dead water at bridge site. Assume 6' per second is desired at bridge opening and that lake highwater is 248.3. Assume that an 80' plate girder bridge with 22' roadway is to be built. Assume debris clearance of 2.5'.

$$\text{Backwater head} = \frac{6^2}{64} = \frac{36}{64} = 0.57' = \text{say } 0.6'$$

$$\text{Backwater head elevation } 248.3 + 0.6 = 248.9$$

$$\text{Required elevation of bottom of steel} =$$

$$248.9 + 2.5 \text{ debris clearance} = 251.4$$

$$\text{Road grade} = 251.4 + 3.0 \text{ floor depth} = 254.4$$

Design of Forms.—Design of strength of concrete forms for abutments and wings depends entirely on the speed with which the concrete is deposited. If these structures are constructed in short sections and poured monolithic from bottom to top in a short time (less than 2 hr.) they should be designed for horizontal pressures resulting from the depth of concrete laid in that time. If a small mixer is used and the level of the concrete is raised in successive shallow layers, each one of which has time to set before the next layer is placed, less studding, walers and ties are required. Figures 348 to 354 (pp. 1346 to 1353) show common practice for structures of different types.

Deck and girder forms are generally designed for total weight of concrete plus 50 lb. per square foot live load and assume that the concrete is carefully deposited and not dropped in large masses.

Table 181 (p. 1052) gives usual design values for horizontal fluid pressure of concrete against forms.

LIST OF STRUCTURAL DESIGN AND ESTIMATING DATA

Table 168 (p. 1028), general flexure formulas
Table 169 (p. 1030), moment of inertia formulas
Table 170 (p. 1031), centers of gravity formulas
Table 171 (p. 1033), allowable design stresses
Table 172 (p. 1038), weights of materials
Table 173 (p. 1039), live loads
Table 174 (p. 1040), impact allowances
Table 175 (p. 1042), distribution live loads
Table 176 (p. 1043), earth pressure formulas
Table 177 (p. 1045), distribution of base pressure
Table 178 (p. 1051), safe bearing power of soils
Table 179 (p. 1051), maximum pile loading
Table 180 (p. 1052), sliding friction resistance
Table 181 (p. 1052), wet concrete pressure against forms
Table 182 (p. 1053), coefficients of expansion
Table 183 (p. 1053), temperature stresses
Table 184 (p. 1054), wire gages and areas
Table 185 (p. 1060), expanded metal
Table 186 (p. 1061), reinforcing bars
Table 187 (p. 1062), steel I-beams, old standard (Cambria) (1918)
Table 188 (p. 1064), special girder rolled beams (Bethlehem) (1926)
Table 189 (p. 1068), steel plates
Table 190 (p. 1072), corrugated metal
Table 191 (p. 1073), strength concrete slabs
Table 192 (p. 1074), strength concrete beams
Table 193 (p. 1075), effect depth of fill on culvert slabs
Table 194 (p. 1076), strength timber beams
Table 195 (p. 1077), deflection timber beams
Table 196 (p. 1078), timber long columns
Table 197 (p. 1079), cast-iron water pipe
Table 198 (p. 1080), cast-iron culvert pipe
Table 199 (p. 1080), corrugated metal pipe
Table 200 (p. 1083), reinforced-concrete pipe
Table 201 (p. 1084), vitrified pipe
Table 202 (p. 1086), concrete arch axis (trial)
Table 203 (p. 1087), concrete arch thickness (trial)

For trial dimensions for preliminary computations of retaining walls see page 682; for abutments and bridge details see Chap. IV, Part I.

Structural Plans.—Structural plans should be completely detailed and very thoroughly dimensioned so that the contractor and inspector will have no difficulty in constructing to the correct lines and grades. All foundation plans should show the base-pressure diagram, so that reasonable decisions in regard to foundation modifications in widths of footage and pile layouts can be made by the constructing engineer when unexpected foundation conditions develop (see Fig. 321 illustrating base-pressure diagram).

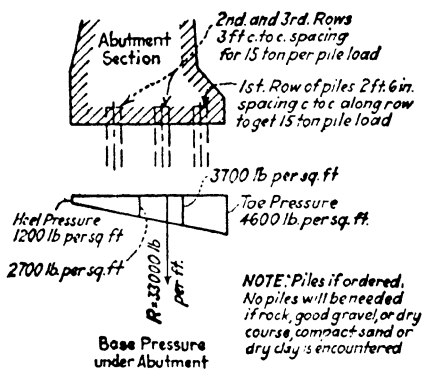

FIG. 321.—Typical base pressure diagram.

NOTE.—Piles if ordered. No piles will be needed if rock, good gravel, or dry, coarse, compact sand or dry clay is encountered.

TABLE 168.—UNIFORM BEAMS. MAXIMUM BENDING MOMENT AND DEFLECTIONS (SIMPLE CASES)

Case 1. Beam with ends free. Single concentrated load P in middle of span; weight of beam disregarded.

The maximum moment occurs at the center of the span.

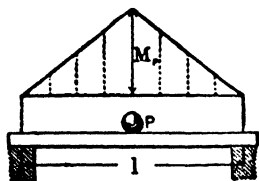

Concentrated Load in Center of span

$$M_p = \frac{Pl}{4}$$

The maximum deflection occurs at the center of the span.

$$D = \frac{Pl^3}{48EI}$$

Where D = the deflection in inches

P = load in pounds

l = span in inches

E = modulus of elasticity in lbs. per sq. inch

I = moment of inertia in inches⁴

M_p = maximum moment in inch pounds.

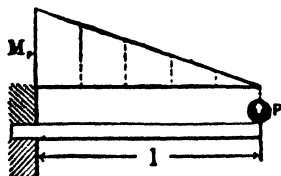

Cantilever Beam

Case 2. Cantilever beam concentrated load P ; weight of beam disregarded.

The maximum moment occurs at the support.

$$M_p = Pl$$

$$D = \frac{Pl^3}{3EI}$$

Case 3. Beam with ends free. Uniformly distributed load. The maximum moment occurs at the center of the span.

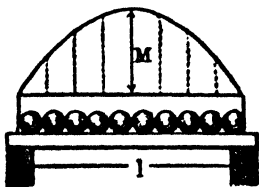

Uniform Load

$$M = \frac{Wl}{8}$$

The maximum deflection occurs at the center of the span.

$$D = \frac{5}{384} \frac{Wl^4}{EI}$$

In these formulæ W equals the total uniformly distributed load.

Case 4. Cantilever beam. Uniform load W .
 Maximum moment occurs at the point of support.

$$M = \frac{Wl}{2}$$

The maximum deflection occurs at the free end.

$$D = \frac{WP^3}{8EI}$$

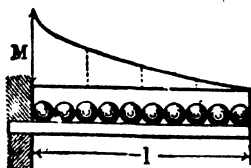

Case 5. Beam with fixed ends, concentrated load P in center of span; weight of beam disregarded.

The maximum bending moment occurs at the points of support and at the middle of the beam.

$$M = \frac{Pl}{8}$$

$$D = \frac{P^3}{192EI}$$

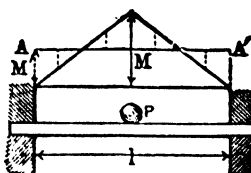

Case 6. Beam with fixed ends and a uniformly distributed load. Maximum bending moment occurs at the supports.

$$M' = \frac{Wl}{12}$$

$$M = \frac{Wl}{24}$$

Maximum deflection

$$= \frac{WP^3}{384EI}$$

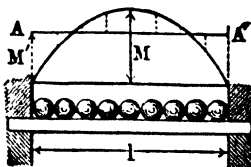

Resisting Moment of a beam is expressed by the formula

$$M_r = \frac{pl}{c}$$

Where M_r = moment of resistance in inch pounds

p = maximum allowable fiber stress in lbs. per sq. inch.

I = moment of inertia of the beam in inches⁴

c = distance in inches from the neutral axis to the outer fiber

TABLE 169.—MOMENTS OF INERTIA OF SIMPLE SECTIONS

$I =$ Moment of Inertia $I = \frac{bd^3}{12}$	
 Square	$I = \frac{b^4}{12}$
 Triangles	$I = \frac{bd^3}{36}$
 Circles	$I = 0.7854 R^4$
	$I = \frac{bd^3 - b'd'^3}{12}$

TABLE 170.—CENTERS OF GRAVITY OF ORDINARY PLANE FIGURES



Squares, rectangles, parallelograms. Center of gravity is at the intersection of the diagonals or midway between the bases on a line drawn between the centers of those bases.

Triangles

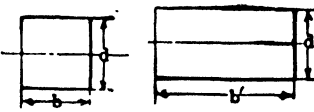
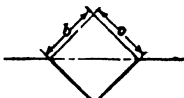
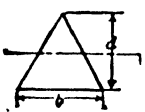
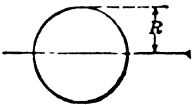
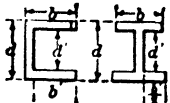
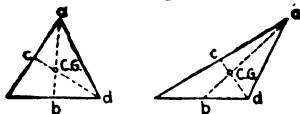

Center of gravity is at the intersection of the medial lines $a b$ and $c d$; a medial line is a line drawn from any apex to the middle of the opposite side. The distance $b (C. G.) = \frac{1}{3} a b$; that is, the center of gravity is on the medial line $\frac{1}{3}$ of the distance from the base to the apex.

Trapezoid

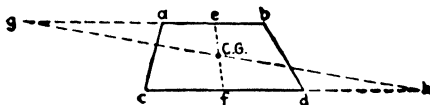

Graphic Method. Prolong $b a$ to g , making $a g = c d$. Prolong $c d$ to h , making $d h = a b$. Connect $g h$. Bisect $a b$ at e . Bisect $c d$ at f . Connect $e f$; the intersection of $g h$ and $e f$ is the center of gravity.

$$\text{The distance } f (C. G.) = \frac{e f}{3} \times \frac{2 a b + c d}{a b + c d}$$

Any Quadrilateral

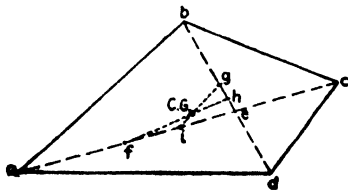

Graphic Method. Draw the diagonals $a c$ and $b d$ intersecting at e .

Lay off $a f = e c$

Lay off $b g = e d$

Bisect $e g$ at h ; bisect $e f$ at i .

The intersection of $f h$ and $g i$ is the center of gravity of the figure.

Circles

Center of gravity at the center

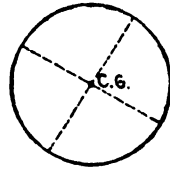
*Semicircle*

The center of gravity lies on the radius perpendicular to the diameter. The distance c (C.G.) = radius $\times 0.4244$

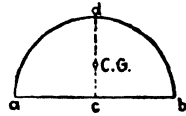
*Quadrant*

The center of gravity lies on the radius which bisects the $\angle acb$. The distance c (C.G.) = radius $\times 0.6002$

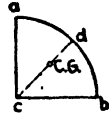
*Sector*

The center of gravity lies on the radius bisecting the $\angle acb$. The distance c (C.G.) = $\frac{2}{3}$ radius \times chord ab / $\frac{\text{radius}^2 \times \text{chord}}{3 \times \text{area}}$

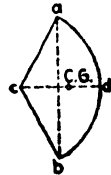
*Segment*

The center of gravity lies on the perpendicular erected at the center of the chord ab .

The distance c (C.G.) = $\frac{\text{chord } ab^3}{12 \times \text{area of segment}}$

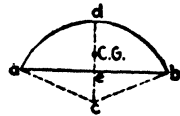

TABLE 171A.—GIVING MODULI OF ELASTICITY, WORKING STRESS AND ULTIMATE STRENGTH

MODULI OF ELASTICITY			
Material	Lbs. per Sq. In.		
Concrete	2,000,000		
Hemlock	900,000		
Iron (cast)	17,500,000		
Iron (wrought)	29,000,000		
Oak	1,500,000		
Pine (white)	1,600,000		
Pine (yellow)	1,600,000		
Steel (medium)	30,000,000		
Spruce	1,600,000		

WORKING STRESSES IN LBS. PER SQUARE INCH			
Material	Tension	Compression	Shear
Concrete	60	600	60 to 100
Hemlock	600	W. G. ¹ 600 A. G. ² 150	W. G. 100 A. G. 600
Iron (cast)	3,000	18,000	5,000
" (wrought)	10,000	8,000	8,000
Oak	1,200	W. G. 1,200 A. G. 500	W. G. 200 A. G. 1,000
Pine (white)	700	W. G. 700 A. G. 200	W. G. 100 A. G. 500
" (yellow)	1,200	W. G. 1,200 A. G. 350	W. G. 150 A. G. 1,250
Steel (medium)	12,000	12,000	12,000
Spruce	800	W. G. 800 A. G. 200	W. G. 100 A. G. 750

ULTIMATE STRENGTH IN LBS. PER SQUARE INCH			
Material	Tension	Compression	Shear
Concrete	300	3,000	1300
Hemlock	6,000	W. G. 6,000 A. G. 600	W. G. 350 A. G. 2,500
Iron (cast)	18,000	90,000	20,000 to 30,000
" (wrought)	50,000	40,000	35,000 to 55,000
Oak	12,000	W. G. 7,000 A. G. 2,000	W. G. 800 A. G. 4,000
Pine (white)	7,000	W. G. 5,500 A. G. 700	W. G. 400 A. G. 2,000
" (yellow)	12,000	W. G. 7,000 A. G. 1,400	W. G. 600 A. G. 5,000
Steel (medium)	60,000	60,000	50,000 to 70,000
Spruce	8,000	W. G. 6,000 A. G. 700	W. G. 400 A. G. 3,200

¹ W. G. — With Grain.

² A. G. — Across Grain.

TABLE 171B
UNIT STRESSES
Pounds per square inch

Steel Structures

Structural grade and rivet steel:

Tension:

Axial tension, structural members, net section	16,000
Rivets in tension, where permitted—50% of single shear values	
Bolts, area at root of thread	10,000

Axial compression:

Axial compression, gross section	15,000-50 L/r
But not to exceed	13,500
L = length of member, in inches	
r = least radius of gyration; in inches	

Bending on extreme fiber:

Rolled shapes, built sections and girders, net section	16,000
Pins	24,000

Shear:

Girder webs, gross section	10,000
Pins and shop-driven rivets	12,000
Power-driven field rivets and turned bolts	10,000
Hand-driven rivets and unfinished bolts	7,500

Bearing:

Pins, steel parts in contact and shop-driven rivets	24,000
Power-driven field rivets and turned bolts	20,000
Hand-driven rivets and unfinished bolts	15,000
Expansion rollers, pounds per linear inch, where d = diameter or roller in inches	600d

Countersunk rivets:

In metal $\frac{3}{8}$ " thick and over, half the depth of countersink shall be omitted in calculating bearing area	
In metal less than $\frac{3}{8}$ " thick, countersunk rivets shall not be assumed to carry stress	

Diagonal Tension

In webs of girders and rolled beams, at sections where maximum shear and bending occur simultaneously	16,000
---	--------

Other metals:

Axial Tension:

Wrought iron	12,000
--------------	--------

Bending on extreme fiber:

Cast steel	12,000
Cast iron	3,000

Shear:

Cast steel	10,000
Cast iron	3,000

Bearing:

Cast steel	14,000
Cast iron	10,000
Bronze sliding expansion bearings	3,000

Bearing on bridge seats:

Bearing on concrete masonry limestone masonry and better	500
--	-----

Concrete Structures

Concrete:

Direct compression:

Columns reinforced with longitudinal bars and separate lateral ties	600-15 L/D
But not to exceed	450
L = unsupported length of column	
D = least diameter of column	

Piers and pedestals	450
---------------------	-----

Compression due to bending:

Beams and slabs	650
Archs rings, including temperature and rib shortening	800

Tension	0
---------	---

TABLE 171B—Continued.

Shear (diagonal tension):	
Beams without shear reinforcement:	
Longitudinal bars not anchored.....	40
Longitudinal bars anchored.....	60
Beams with shear reinforcement.....	120
Punching shear.....	120
Reinforcement:	
Tension:	
Beams and slabs.....	16,000
Arch rings, including temperature and rib shortening.....	20,000
Compression—15 times stress in surrounding concrete.	
Bond:	
Bars not anchored.....	80
Bars adequately anchored by hooks or otherwise.....	120

TABLE 171C.—ALLOWABLE WORKING STRESSES

(Ketchum's "Design of Highway Bridges") 1:2:4 concrete
(2000-lb. compression, 28-day age)

"The following working stresses are for static loads and are based on a concrete composed of 1 part Portland Cement, 2 parts sand or fine aggregate, and 4 parts stone or coarse aggregate, that will develop an ultimate compressive strength of 2000 lb. per square inch at an age of 28 days in cylinders 8" in diameter and 16" long, when made and stored in moist air under laboratory conditions. Concretes of different mixtures shall have allowable stresses proportional to their ultimate compressive strengths determined under the above conditions.

"**Bearing.**—When compression is applied to a surface of concrete having at least twice the loaded area, a stress of 700 lb. per square inch may be allowed on the area actually under load.

"**Axial Compression.**—For concentric compression on a plain concrete pier, the length of which does not exceed four diameters, a stress of 450 lb. per square inch may be allowed.

"**Columns.**—Reinforced-concrete columns may have allowable stresses as follows:

"a. Columns with longitudinal reinforcement of not less than 1 and not more than 4 %, and with lateral ties of not less than $\frac{1}{4}$ " in diameter, 12" apart, nor more than 15 diameters of longitudinal bar may have an allowable stress in the concrete of 450 lb. per square inch.

"b. Columns with longitudinal reinforcement of not less than 1 and not more than 4 %, and with circular hoops or spirals not less than 1 % of the volume of the concrete, where the hoops are spaced not more than one-sixth the diameter of the enclosed column or more than 2½", may have an allowable stress in the concrete of 700 lb. per square inch.

"**Compression on Extreme Fiber.**—The extreme fiber stress of a beam, calculated on the assumption of a constant modulus of elasticity of concrete, shall not exceed 650 lb. per square inch. Adjacent to the support of continuous beams, stresses 15 % higher may be used.

"**Shear and Diagonal Tension.**—As a measure of diagonal tension the following allowable shearing stresses may be used.

"a. For beams with horizontal bars only and without web reinforcement, a shearing stress of 40 lb. per square inch may be allowed.

"b. For beams with web reinforcement of stirrups looped about longitudinal reinforcing bars in the tension side of the beam and spaced horizontally, not more than one-half the depth of the beam or for beams in which longitudinal bars are bent up at an angle of not more than 45 nor less than 20° with the axis of the beam, and the points of bending are spaced horizontally not more than three-quarters the depth of the beam, a shearing stress of 90 lb. per square inch may be allowed.

"c. For a combination of bent bars and vertical stirrups looped about reinforcing bars on the tension side of the beam and spaced horizontally not more than one-half the depth of the beam, a shearing stress of 100 lb. per square inch may be allowed.

"d. For beams with web reinforcement (either vertical or inclined) securely attached to the longitudinal bars on the tension side of the beam in such a way as to prevent slipping of bar past the stirrups, vertical stirrups

FIG. 171C—Continued

to be spaced not more than one-half and inclined members not more than three-fourths the depth of the beam, either with longitudinal bars bent up or not, a shearing stress of 120 lb. per square inch may be allowed.

"e. For punching or pure shear, 120 lb. per square inch may be allowed.

"In calculating the stresses in web reinforcement two-thirds of the external vertical shear is to be assumed as taken by the stirrups or bent-up bars. The stresses in stirrups when combined with bent-up bars are to be determined by finding the total amount of shear that may be allowed by reason of the bent-up bars, and subtracting this shear from the total external vertical shear. Two-thirds of the remainder will be the shear to be carried by the stirrups.

"**Bond Stress.**—The bond stress between concrete and plain reinforcing bars may be assumed at 80 lb. per square inch; on drawn wire 40 lb. per square inch; on deformed bars 100 lb. per square inch. Bars with ends hooked by bending through 180° around a radius of two diameters of bar may have a bond stress of 120 lb. per square inch.

"**Stresses in Steel Reinforcement.**—The tensile or compressive stress in steel reinforcement shall not exceed 16,000 lb. per square inch. The tensile stress in stirrups shall not exceed 12,000 lb. per square inch."

TABLE OF VALUES OF MODULUS OF RUPTURE OF REINFORCED CONCRETE

Per cent of reinforcement	Modulus of rupture, pounds per square inch	Design value for factor of safety of 4, pounds per square inch
0 to 0.2	400 to 600	100
0.4	1,000	250
0.5	1,250	310
0.6	1,350	340
0.7	1,500	380
0.8	1,600	400
0.9	1,675	420
1.0	1,750	440

1: 2: 4 mix concrete.

TABLE 171D.— AVERAGE SAFE ALLOWABLE WORKING UNIT STRESSES OF TIMBER IN POUNDS PER SQUARE INCH

Kind of timber	Tension		Compression			Transverse			Shearing	
	With grain	Across grain	With grain		Across grain	Extreme fiber stress	Modulus of elasticity	With grain	Across grain	
			End bearing	Columns under 15" diameters						
Factor of safety.....	10	10	5	5	4	6	2	4	4	
White oak.....	1,200	200	1,400	1,000	500	1,200	750,000	200	1,000	
White pine.....	700	50	1,100	700	200	700	500,000	100	500	
Southern longleaf or Georgia pine.....	1,200	60	1,400	1,000	350	1,200	750,000	150	1,250	
Douglas fir.....	800	...	1,100	900	200	800	750,000	130	...	
Short-leaf yellow pine.....	900	50	1,200	900	250	1,000	600,000	100	1,000	
Red pine (Norway pine).....	800	50	1,000	800	200	800	505,000	
Spruce and eastern fir.....	800	50	1,200	800	200	700	600,000	100	750	
Hemlock.....	600	800	150	600	450,000	100	600	
Cypress.....	600	...	1,000	800	200	800	450,000	
Cedar.....	700	...	1,100	700	200	700	350,000	100	400	
Chestnut.....	850	800	250	800	500,000	150	500	
California redwood.....	700	800	150	750	350,000	100	...	
California spruce.....	800	...	800	600,000	

The above tables are based on those recommended by the committee on Strength of Bridge and Trestle Timbers of the Association of Railway Superintendents of Bridges Buildings at their Fifth Annual Convention in October, 1895, but the arrangement and values in many cases are now modified by later data from various sources.

TABLE 172.—DEAD LOAD WEIGHTS OF DIFFERENT MATERIALS PER CUBIC FOOT¹

MATERIAL	Weight per Cu. Ft.
Ash timber	40 lbs.
Brick (pressed)	150 "
" (common building)	125 "
Cement (Portland)	75 to 90 "
" (Natural)	50 to 56 "
Concrete 1: 2: 4 Mixture (Trap rock)	155 "
" (Gravel)	152 "
" (Limestone)	150 "
" (Sandstone)	145 "
" (Cinder)	110 "
" 1: 3: 6 Mixture (about 5 lbs. less)	— "
Earth (common loam, loose and dry)	70 "
" (common loam, moist and rammed)	100 "
" (sand or gravel loose and dry)	100 "
" (sand or gravel rammed)	120 "
" (sand or gravel wet)	120 "
Hemlock timber	25 "
Hickory "	50 "
Iron (cast)	450 "
" (wrought)	480 "
Maple timber	50 "
Oak " (white)	48 "
" " (black)	40 "
Masonry (dressed granite or limestone)	165 "
" (mortar rubble)	155 "
" (dry ")	125 "
Pine (white)	25 "
" (northern yellow)	34 "
" (southern yellow)	40 "
Steel	400 "
Water	62. "

¹ For weight of road rocks, see Tables 120 and 121 (p. 709).*Miscellaneous Weights*

1 bbl. Portland cement	376	lbs.
1 bbl. natural cement	235	lbs.
1 gal. water	8.345	lbs.

TABLE 173.—LIVE LOADS, HIGHWAY BRIDGES

Floor Loads:

H-20 = 20-ton gross truck load.

H-15 = 15-ton gross truck load.

H-12½ = 12½-ton gross truck load.

H-10 = 10-ton gross truck load.

14' front to rear axle.

6' gage between rear wheels.

0.8 of gross load on rear axle.

0.2 of gross load on front axle

Width of rear tires, 1" per ton of gross load.

Total area occupied by single truck 9' wide 25' long (see also Girder and Truss Loads):¹

Fig. 64B, Chap. IV, for electric cars and freight cars).

H-20 = total load on each traffic lane 9' wide, of 600 lb., per linear foot plus 28,000 lb. concentrated.

H-15 = 450 lb. per linear foot plus 21,000 lb. concentrated.

H-12½ = 375 lb. per linear foot plus 17,500 lb. concentrated.

H-10 = 300 lb. per linear foot plus 14,000 lb. concentrated.

Sidewalk Loads:

Class A bridges,

$$P = \left(25 + \frac{2250}{L} \right) \left(\frac{W + 5}{W} \right)$$

not to exceed a maximum of 100 lb. per square foot.

 P = live load, in pounds per square foot. L = loaded length, in feet. W = width of sidewalk, in feet.

Class B and C bridges, use 80% of this loading.

¹ For proper use of these different classes of loading see Chap. IV (p. 202).

TABLE 174.—IMPACT LOADS

Impact:

The extra design load allowance for impact of moving loads is subject to considerable difference in practice ranging from 0 to 60% of the static weight of the vehicles.

As a general rule, the following values represent conservative practice in impact allowance:

Floor systems of bridges having timber plank floor surface..... 30-50%

Floor systems of bridges and trestles having concrete floor slabs supported by stringers or floor beams.... 20-30%

For end floor beams, floor beam hangers, or connections..... 60% of live load.

For stringers, floor beams, girders, and trusses on concrete floor bridges the impact allowance shall not exceed 30% and, in general, may be determined by the formula

$$\text{Impact} = \frac{L + 250}{10L + 500}$$

L = loaded length in feet producing the maximum static stress in the member considered.

N. Y. STATE 1926 STANDARD BRIDGES APPROXIMATE
EQUIVALENT UNIFORM STATIC DESIGN LIVE LOADS

(H-20 loading plus impact in pounds per square foot of bridge floor)

Span, feet	Type of bridge superstructure		
	Concrete slab bridges, pounds	Steel-beam stringers, pounds	Girders and trusses, pounds
6	1,200		
8	850		
10	650	650	
15	400	400	
20	250	300	
25	200	250	
30	200	
40	170	220
45	150	210
50	200
100	160
150	140
200	120

LIVE LOADS

TABLE OF UNIFORM LIVE LOADS FOR HIGHWAY BRIDGES¹

Illinois Highway Commission		Iowa Highway Commission		Wisconsin Highway Commission		American Concrete Institute, 1916		Ketchum's Specifications, 1918			
Class A		Class B		Class C ₁		Class C ₂		Class D ₁		Class D ₂	
Span, ft.	Load, lb./sq. ft.	Span, ft.	Load, lb./sq. ft.	Span, ft.	Load, lb./sq. ft.	Span, ft.	Load, lb./sq. ft.	Span, ft.	Load, lb./sq. ft.	Span, ft.	Load, lb./sq. ft.
Up to 50	125	Up to 50	100	Up to 40	125	Up to 80	125	Up to 80	100	30	125
50-100	100	50-100	90	50	120	80-100	110	80-100	90	50	106
100-150	100	100-150	80	75	106	100-125	100	100-125	80	80	85
150-200	85	150-200	70	100	93	125-150	90	125-150	75	100	80
Over 200	85	200-250	50	150	60	150-200	85	150-200	65	160	68
		Over 250	50	180 and over	50	Over 200	80	Over 200	60	200 and over	60
											200 and over

Class D₁ and D₂ bridge loadings to be increased for impact.

¹ Compiled by Ketchum and reproduced from Ketchum Highway Bridges, McGraw-Hill Book Company, Inc., by permission.

TABLE 175.—DISTRIBUTION OF LIVE LOADS ON SLABS, FLOOR BEAMS, AND STRINGERS (NEW YORK SPECIFICATIONS)

"Through Earth Fills.—When the depth of fill is 3' 0" or more, concentrated loads shall be considered as uniformly distributed over a square, the sides of which are equal to one and three-fourth times the depth of fill. When such areas from several concentrations overlap, the total load shall be considered as uniformly distributed over the area defined by the outside limits of the individual areas, but the total width of distribution shall not exceed the total width of the supporting slab. For single spans, the effect of live load may be neglected when the depth of fill is more than 4' and exceeds the span length; for multiple spans it may be neglected when the depth of fill exceeds the distance between faces of end supports or abutments.

"In Concrete Slabs.—In calculating bending stresses due to wheel loads on concrete slabs no distribution in the direction of the span of the slab shall be assumed. In the direction perpendicular to the span of the slab the wheel load shall be considered as distributed uniformly over a width of slab which is known as the "effective width."

"In the following equations

Let S = span of slab, in feet.

W = width of wheel or tire, in feet.

X = distance, in feet, from the center of the near support to the center of wheel.

E = effective width, in feet, for one wheel.

"Case I. Main Reinforcement Parallel to Direction of Traffic.

$$E = 0.7 S + W.$$

"For this case the value of E shall not exceed 5'.

"When two wheels are so located on a transverse element of the slab that their effective widths overlap, the effective width for each wheel shall be $\frac{1}{2}(E + a)$, where a is the distance between centers of wheels.

"Case II. Main Reinforcement Perpendicular to Direction of Traffic.

$$E = 0.7 (2x + W)$$

"For this case the bending moment on a strip of slab r' in width shall be determined by placing the wheel loads in the position to produce maximum bending, determining the effective width for each wheel, and assuming the load delivered by each wheel to the r' strip to be the wheel load divided by its respective effective width.

"This investigation assumption does not provide for the effect of loads near unsupported edges.

In Longitudinal Beams or Stringers and in Transverse Floor Beams

"Shear.—In calculating end shears and end reactions in transverse floor beams and longitudinal beams or stringers, no lateral or longitudinal distribution of the wheel loads shall be assumed.

"Bending Moment in Longitudinal Beams or Stringers.—In determining bending moments in longitudinal beams or stringers no longitudinal distribution of the wheel loads shall be assumed. The lateral distribution may be determined in one of the following ways:

"a. Absolute Method.—For investigations in which extreme accuracy is desired the lateral distribution may be very closely determined by considering the flooring as continuous over a series of elastic supports and forming upon this hypothesis a series of work equations.

"b. Approximate Method.—For ordinary construction the lateral distribution may be determined by the following approximate method:

Let M = one-half the bending moment produced by one truck.

S = spacing of beams, in feet.

M_1 = bending moment in one interior beam when floor system is designed for one truck.

M_2 = bending moment in one interior beam when floor system is designed for two or more trucks.

$$M_1 = \frac{MS}{4}$$
 for plank floors.

$$M_1 = \frac{MS}{4.5}$$
 for strip floors 4" in thickness and for wood blocks on a 4" plank subfloor.

TABLE 175.—Continued

$M_1 = \frac{MS}{5.5}$ for strip floors 6" or more in thickness.

$M_1 = \frac{MS}{6}$ for reinforced-concrete floors.

$M_2 = 1.2M_1$ for the type of floor involved.

"When the stringer spacing is such that M_1 or M_2 , as the case may be, exceeds M , the stringer loads shall be determined by the reactions of the truck wheels, assuming the flooring between stringers to act as simple beams.

"c. *Outside Stringers.*—The live load supported by the outside stringer shall be the reaction of the truck wheels, assuming the flooring to act as a simple beam, but this live load shall in no case be less than would be required for interior stringers under the requirements specified above.

"d. *Total Capacity of Stringers.*—The combined load capacity of the beams in a panel shall not be less than the total live and dead load in the panel.

"*Bending Moment in Floor Beams.*—In determining bending moments in transverse floor beams, no transverse distribution of the wheel loads shall be assumed . . .

"When longitudinal stringers are omitted and the floor is supported directly on the floor beams, the longitudinal distribution shall be determined as follows:

Let M = total maximum bending moment due to the superimposed rear axle loads.

S = longitudinal spacing of floor beams, in feet.

M_1 = bending moment in one floor beam.

$M_1 = \frac{MS}{4}$ for plank floors.

$M_1 = \frac{MS}{4.5}$ for strip floors 4" in thickness and for wood blocks on a 4" plank subfloor.

$M_1 = \frac{MS}{5.5}$ for strip floors 6" or more in thickness.

$M_1 = \frac{MS}{6}$ for reinforced-concrete floors.

"When the floor-beam spacing is such that M_1 as given by the above equations exceeds M the floor-beam loads shall be determined by the reactions of the truck wheels, assuming the flooring between floor beams to act as simple beams."

TABLE 176.—EARTH PRESSURE FORMULAE¹

1a. Rankine's Formula for resultant Active Earth Pressure.—Rankine has developed the following formula² for the case in which (1) the total active thrust P acts upon a vertical plane, (2) acts parallel to the surface of the earth for all cases in which $\theta \geq 0$, (3) acts in a material of indefinite extent, and (4) the earth carries no load except its own weight (Fig. 2):

$$P = C_r \frac{wh^2}{2}$$

in which

P = total active thrust of earth against the vertical plane as described above.

w = weight per cubic foot of retained material.

h = height of vertical section considered, as AC .

$$C_r = \cos \theta \frac{\cos \theta - \sqrt{\cos^2 \theta - \cos^2 \phi}}{\cos \theta + \sqrt{\cos^2 \theta - \cos^2 \phi}}$$

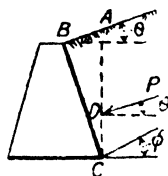

¹ Hool and Johnson's Concrete Engineers Handbook, by permission of authors.

² For development see BAKER'S "Masonry Construction," 10th Ed., p. 493.

TABLE 176.—Continued

where

θ = angle of surcharge.
 ϕ = angle of internal friction.

Diagram 1 gives the values of C_e for various values of θ and ϕ . It should be noted that P is parallel to the surface AB , when θ is either positive, or zero; and that it acts at a point D , $\frac{h}{3}$ above C , or in other words, $CD = \left(\frac{AC}{3}\right)$.

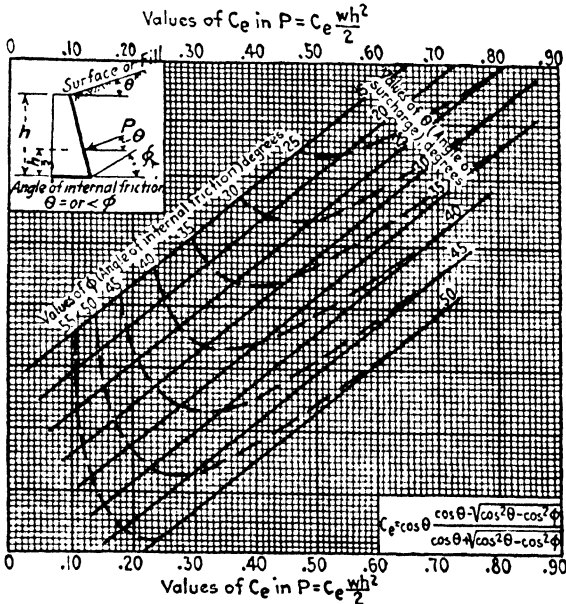

DIAGRAM 1.

When $\theta = \phi$, then

$$P = \frac{1}{2}wh^2 \cdot \cos \phi$$

When $\theta = 0$

$$P = C_e' \frac{wh^2}{2}$$

in which

$$C_e' = \tan^2 (45^\circ - \frac{1}{2}\phi)$$

The following table gives values of C_e' for varying values of ϕ .

ϕ	C_e'	ϕ	C_e'	ϕ	C_e'	ϕ	C_e'
20°	0.400	30°	0.3333	40°	0.2174	50°	0.1325
25°	0.406	35°	0.2710	45°	0.1718	55°	0.0994

TABLE 177.—DISTRIBUTION OF BASE PRESSURE

NOTE.— R_v = total resultant vertical pressure on base.

A = area of base.

b = width of base (toe to heel).

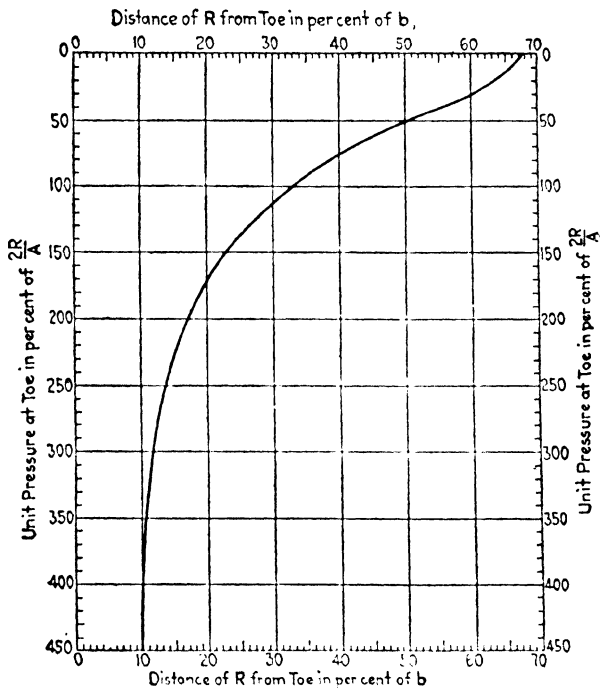

Base pressure distribution.
(Toe pressures.)

In abutment design resultant pressure should be near center of base to produce even settlement under vibrating loads where soil is compressible.

In retaining-wall design on compressible soils resultant should never be outside of middle third even if toe pressure can be safely increased.

On rock foundations resultant can fall outside of middle third provided toe pressure does not exceed safe crushing strength of materials.

$$\text{Heel pressure} = \frac{R_v}{A} - \text{toe pressure.}$$

Table 177A gives useful data for figuring base pressure under abutments, and the appended explanation (p. 1047) explains in detail the method of figuring base pressure.

TABLE 177A.—USEFUL DATA FOR COMPUTATION OF BASE PRESSURE UNDER ABUTMENTS

Approximate pressure per linear foot length of abutment due to weight of superstructure and live load for different spans

Span, feet	H-15 loading		H-20 loading	
	Dead load, pounds ¹	Live load, pounds ²	Dead load, pounds ¹	Live load, pounds ²
Concrete slabs:				
5	500	2,700	600	3,600
10	1,000	2,700	1,300	3,600
15	1,800	2,700	2,300	3,600
20	2,900	2,700	3,600	3,600
25	4,000	2,700	5,100	3,600
Steel I-beam bridges:				
30	3,500	2,700	4,400	3,600
35	4,200	2,700	5,300	3,600
40	5,000	2,700	6,200	3,600
45	5,700	2,800	7,100	3,700
Girders and trusses:				
50	3,500	3,000	4,400	4,000
75	5,600	3,600	7,000	5,400
100	7,800	4,300	9,700	6,500
150	10,400	5,600	13,000	8,500
200	14,000	6,400	17,500	9,600

¹ Deadload equals weight $\frac{1}{2}$ superstructure divided by length of abutment. No fill over slab.

² Live load assumes back wheels of trucks directly over abutment with 30% impact up to 45' span. Beyond 45' span uniform live load given in Table 173 is used. One-half total live load divided by length of abutment.

Approximate horizontal earth pressure against back of abutment assuming equivalent live load of 150 lb. and that earth weighs 100 lb. per cubic foot.

$$P = 15h^2 \text{ (modified Rankine).}$$

P = total horizontal earth pressure per foot length of abutment applied $\frac{1}{3}h$ above bottom of foundation concrete.

h = vertical distance in feet from bottom of foundation to a level $1\frac{1}{2}'$ above the roadway surface of the bridge floor.

h , in feet	P , in pounds	h , in feet	P , in pounds
5	375	16	3,840
6	540	17	4,335
7	735	18	4,860
8	960	19	5,415
9	1,215	20	6,000
10	1,500	21	6,615
11	1,815	22	7,260
12	2,160	23	7,935
13	2,460	24	8,640
14	2,840	25	9,375
15	3,375	26	10,140
		27	10,935
		28	11,760
		29	12,615
		30	13,500

Base-pressure Computations.—Retaining walls and wings consider horizontal earth pressure. Abutment design for slab bridges less than 20' spans where the slab is doweled or keyed into the abutment generally consider vertical loads only on the assumption that the slab acts as a brace and neutralizes horizontal earth pressure (see Figs. 69A and 69B, Chap. IV), but for all spans where the superstructure is designed with expansion and contraction bearings the horizontal earth pressure is considered. The following example illustrates the design of abutments where horizontal as well as vertical pressures are considered.

Example of Base-pressure Computations for Bridge Abutments.
 45' clear span I-beam superstructure.
 H-20 loading. Depth floor system 3' 00".

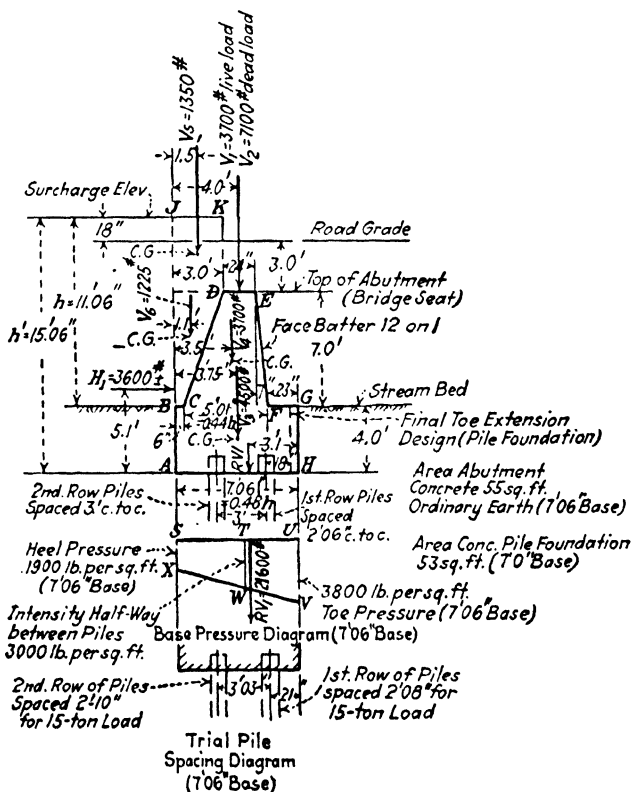

Trial design bridge 2, Road 191, New York State.

Section of abutment as shown.

The steps to be gone through are as follows:

1. Trial abutment section.
2. Determine the amount and location of the vertical forces acting on the abutment.
3. Determine the amount and location of horizontal forces acting on the abutment.
4. Determine the amount and location of the resultant pressure on the base.
5. Determine the toe and heel intensity of pressure on the base.
6. Pile spacing if piles are required.
7. Test for horizontal slip.
8. Final abutment section.

1. *Trial Abutment Section.*—Trial dimensions can be closely approximated from standard designs (see Chap. IV). The usual rules for trial dimensions call for a minimum width of abutment at the top of footing course (level with stream bed) of from 0.4 to $0.45h$, where h equals the vertical height from the top of the footer course to the road surface, plus 1.5' equivalent surcharge. The total width of the bottom of the footer course is generally about $0.5h'$ for ordinary soils, $0.45h'$ for pile foundations, or gravel and about $0.4h'$ for hardpan or rock where h' equals the vertical height bottom of footer to road grade plus 1.5' surcharge.

It is desirable to keep the resultant of all forces near the center of the base of the footer on compressible soils, so that if settlement does occur the abutment will not tip forward and under no circumstances should the resultant fall outside of the middle third of the footer base where the foundation is ordinary soil or piles. To keep the resultant well inside the middle third a face batter of from 1 to 3" per foot of height is used with a toe footer extension. Where rock or hardpan foundation soil is encountered (non-compressible) it is permissible to permit the resultant to fall at the limit of the middle third of the footer base or slightly outside the middle third so long as the toe pressure does not exceed the safe bearing value of the rock or concrete. These conditions result in a smaller toe extension or in a vertical face. Bridge seat widths and thickness of back walls depend on type of bridge and depth of floor system (see Chap. IV).

2. *Vertical Forces.*—The amount and location of the vertical forces per linear foot of abutment are next determined. These vertical forces consist of the live and dead superstructure loads V_1 and V_2 located at the middle of the bridge seat. From Table 177A, $V_1 = 3700$ lb., $V_2 = 7100$ lb. located 4.0' from the line JA .

The other vertical loads are merely the weight of concrete and earth directly over the base allowing for the equivalent live load surcharge and are located at the centers of gravity of the areas. These forces are determined by getting the areas of the earth load and multiplying by 100 lb. per cubic foot and the areas of concrete and multiplying by 150 lb. per cubic foot. The location of the center of gravities of the various areas are determined as given in Table 170 (p. 1031).

In this way the following earth and concrete forces were determined

- $V_1 = 4500$ lb. located 3.75' from line JA (area $ABGHA$).
- $V_2 = 3700$ lb. located 3.5' from line JA (area $CDEFC$).
- $V_3 = 1350$ lb. located 1.5' from line JA (area $IJKDI$).
- $V_4 = 1225$ lb. located 1.1' from line JA (area $BIDCB$).

3. *Horizontal Force*.—Horizontal earth pressure by Rankine's formulas can be approximated from Table 177A, which for $h' 15' 06'' =$ approximately 3600 lb. per linear foot of abutment located $\frac{1}{3}h' = 5.1'$ above the line AH .

4. *Location and Amount of Vertical Resultant*.—The total amount of the vertical resultant is merely the sum of the vertical forces V_1 to V_4 inclusive, and equals 21,600 lb. RV_1 extreme maximum or 17,900 lb. RV_2 exclusive of superstructure live load.

The location of the resultant is determined by taking moments about the point A as follows:

	Foot-pounds
V_1	$3,700 \times 4.0' = 14,800$
V_2	$7,100 \times 4.0 = 28,400$
V_3	$4,500 \times 3.75 = 16,875$
V_4	$3,700 \times 3.5 = 12,950$
V_5	$1,350 \times 1.5 = 2,025$
V_6	$1,225 \times 1.1 = 1,350$
HI	$3,600 \times 5.1 = 18,360$
Max. total	= 94,760
Total exclusive of live load V_1	= 79,960

The locations of RV_1 and RV_2 are, therefore,

$$\text{Distance } RV_1 \text{ from } A \text{ along line } AH = \frac{94,760}{21,600} = 4.4'$$

$$\text{Distance } RV_2 \text{ from } A \text{ along line } AH = \frac{79,960}{17,900} = 4.5'$$

That is, for this abutment both conditions of loading give practically the same location of resultant, and it is only necessary to investigate toe pressure for the maximum load condition RV_1 .

5. *Intensity of Pressure on Toe and Heel of Abutment Foundation*. The average pressure on the base per square foot equals the total vertical pressure RV_1 (21,600 lb.), divided by the area of the base $7.5'$ width $\times 1'$ length $= \frac{21,600}{7.5} = 2880$ lb. per square foot $= \frac{RV_1}{A}$.

Twice the average pressure $\frac{2RV_1}{A} = 5760$ lb. per square foot.

The distance of the resultant RV_1 from the toe equals $7.5' - 4.4' = 3.1'$ and $3.1'$ is 41% of the total base width $AH(7.5')$.

From Table 177 the intensity of the toe pressure where the resultant is 41% of the base width from the toe is 70% of $\frac{2RV_1}{A}$ (5760 lb.). Toe pressure therefore equals 70% of 5760 lb. $= 3820$ lb. per square foot.

Heel pressure equals 30% of 5760 lb. = 1940 lb.

With these two values the base-pressure diagram is constructed as shown in the figure (p. 1047).

An examination of Table 178 shows that the trial design is safe for all ordinary soils. If coarse gravel, stiff dry clay, hardpan, or rock is encountered the toe extension can be safely reduced 6 to 12" till the toe pressure rises to a reasonable value for the stiffer soils. If unstable foundation is encountered, piles will be required.

6. *Pile Layout.*—Common pile spacing along single rows varies from 2' 06" to 3' 06" with 3' common practice. Distance between rows of piles varies from 2' 06" to 4' with 3' common practice without special reinforcing in the concrete. Table 179 shows the maximum desirable pile load for a structure of the character at about 15 tons.

The width of base in this abutment limits us to two rows of piles. It is desirable to have the piles in each row carry about the same load per pile to equalize settlement. This is accomplished by a study of the base-pressure diagram with different location and spacing of piles. The front row of piles is never less than 18" center of pile to toe. Here 21" will be assumed with 3' 03" between the first and second rows of piles. The first row of piles then carries the load area of the base diagram (p. 1047) *TUVW*, which equals,

$$\frac{3000 + 3800}{2} \times 3.3' = 11,200 \text{ lb. per foot length of abutment.}$$

$$= 5.6 \text{ tons per foot length of abutment.}$$

Assuming the piles carry all the load and that a load of 15 tons per pile is reasonable, this would require a pile every 2' 08" $\left(\frac{15}{5.6} = 2.7'\right)$

The second row of piles carries the load area

$$STWX = \frac{1900 + 3000}{2} \times 4.2' = 10,690 \text{ lb. per foot length}$$

$$= 5.3 \text{ tons per foot length,}$$

which would require a pile every 2' 10".

Considering that all earth-pressure formulas are indefinite and that the underlying soil carries some of the load, it would be entirely safe to reduce the toe extension to 18", place the first row of piles 18" from the toe spaced 2' 06" C. to C. Place the second row 3' back of the first row and space the piles in the second row 3' 0" C. to C., which reduces the cost about \$100 to \$200.

Resistance to Horizontal Slip.—See Table 180 (p. 1052), using a factor of safety of at least 2 and preferably 3.

Modification of Trial Abutment Section.—Modifications are usually limited to change in toe extension length to produce reasonably high toe pressure for non-compressible hardpan and rock.

Depths of Foundations.—The following tabulation indicates minimum depth of foundations for small bridges.

MINIMUM DEPTH OF BOTTOM CONCRETE FOUNDATIONS BELOW STREAM BED. (SMALL SPAN BRIDGES)

	Abutments	Piers
Ordinary soils.....	4.0'+	6.0'
Hard pan.....	3.0'+	4.0'
Shale rock.....	2.0'+	3.0'
Solid rock.....	0.5 below surface of solid rock	1.0'

TABLE 178.—SAFE LOAD ON FOUNDATION SOILS IN TONS (2000 LB. PER SQUARE FOOT OF BEARING AREA)

Authority	Quicksand and alluvial silt	Clean, dry sand	Confined sand and fine gravel	Coarse gravel	Ordinary mixture sand and clay	Soft, damp clay	Dry clay	Cemented gravel or hardpan	Soft rock	Hard rock
Baker's "Foundations"	1/2	2	4	1	4	8	5	25
Hool and Johnston	1/2-1	2-4	4	1-2	4-8	8-10	5-10	15-30
Ketchum	3	4	4-5	2	3-4	8	20
State of Iowa	3	3	3	1.5	3	5	7	25
State of Washington	0 1/2	3	3-3 1/2	4-7	1 1/2-2	0-2	3-5	5-8	8-15	25
New York Building Code	3	4	4	2	1	4
Division 4, New York State Highway	1/2	2	3	4-5	2	1	3-4	6-7	8	20

¹ Confined.

TABLE 179.—DESIGN LOAD ON PILES (TONS PER PILE)

Type of structure	Type of pile	Ordinary load	Extreme maximum load
Slab girder or trusses.....	Timber	12-15	20
Slab girder or trusses.....	Concrete	25	30
Trestles and viaducts.....	Timber	15	20
Trestles and viaducts.....	Concrete	25	30
Arches or continuous girders.....	Timber ¹	10-12	15
Arches or continuous girders.....	Concrete ¹	20	25

¹ Piles for these structures to be driven to practical refusal (see p. 1339, Part 2), 25- to 30-ton resistance.

NOTE.—For minimum dimensions of piles see Specifications (p. 1501). Pile spacing generally 3 to 3 1/2' C. to C. Maximum 4' without special reinforcing design. Spacing closer than 2 1/2' worthless. Increase size of footer to get minimum spacing of 2 1/2'.

TABLE 180.—SLIDING FRICTION RESISTANCE

Resistance to sliding varies for different materials and depends on the pressure between the two surfaces. The following data gives common values for the coefficients of friction. To get the resistance to sliding, multiply the proper coefficient by the pressure normal to the plane of contact. A factor of safety of 2 to 3 is usually stipulated for retaining-wall and abutment design.

COEFFICIENTS OF FRICTION¹

Materials	Coefficients	Materials	Coefficients
Dry masonry on dry masonry.....	0.6 to 0.7	Masonry on dry clay.	0.5 to 0.6
Masonry on masonry with wet mortar...	0.75	Masonry on moist clay.....	0.33
Timber on stone.....	0.4	Earth on earth.....	0.25 to 1.0
Iron on stone.....	0.3 to 0.7	Hard brick on hard brick.....	0.7
Timber on timber...	0.2 to 0.5	Concrete blocks on concrete blocks.....	0.65

¹ Ketchum's Highway Bridges.

COEFFICIENTS AND ANGLES OF FRICTION BETWEEN EARTH AND OTHER MATERIALS¹

Materials	$f = \tan \phi$	ϕ
Masonry upon masonry.....	0.65	33°
Masonry upon wood, with grain.....	0.60	31°
Masonry upon wood, across grain.....	0.50	26° 40'
Masonry on dry clay.....	0.50	26° 40'
Masonry on wet clay.....	0.33	18° 20'
Masonry on sand.....	0.40	21° 50'
Masonry on gravel.....	0.60	31°

¹ Hool & Johnson, Concrete Eng. Handbook.

TABLE 181.—PRESSURE WET CONCRETE AGAINST FORMS

Vertical load, 150 lb. per cubic foot concrete plus 50 lb. live load per square foot.

Horizontal fluid pressure:

85 lb. per cubic foot for mass concrete.

130 lb. per cubic foot for thin walls and slab and girder construction.

NOTE.—For typical standard forms see chapter on Construction and Inspection (pp. 1346 to 1353).

TABLE 182.—COEFFICIENTS OF EXPANSION AND CONTRACTION OF MORTAR AND CONCRETE

Coefficients for steel, 0.0000065

Mortars		Concretes	
Mixture	Coefficient of expansion per degree Fahrenheit	Mixture	Coefficient of expansion per degree Fahrenheit
Neat	0.000,007,83	1:1½:3	0.000,006,77
1:1	0.000,007,43	1:2 :4	0.000,006,60
1:2	0.000,006,00	1:2½:5	0.000,005,58
1:3	0.000,006,05	1:3 :6	0.000,005,37
1:4	0.000,005,94		
1:5	0.000,005,77		

TABLE 183.—TEMPERATURE STRESSES

Stresses are generally figured for 40° above and below mean temperature.

For slabs, beams, etc., with confined ends and no movement of ends the stress per degree change in temperature can be computed by multiplying the modulus of elasticity, Table 171A, by the coefficient of expansion and contraction, Table 182, of the material in question.

APPROXIMATE TEMPERATURE STRESS IN CONCRETE BEAMS AND SLABS (CONFINED ENDS)

Change in Temperature, Degrees	Approximate Stress per Square Inch, Pounds
0	0
10	120
20	240
30	360
40	480
50	600

TABLE 184.—WIRE AND WIRE GAGES
 Sizes and Weights of Steel Wire
 American Steel and Wire Co.'s Gage

Number of gage	Diameters			Sectional area, square inch	Weight		Number of feet per pound
	Fractions of inch	Decimals of inch	Millimeters		Pounds per foot	Pounds per mile	
.....	$\frac{1}{2}$	0.5000	12.70	0.19635	0.6668	3521	1.500
0000000	0.4000	12.45	0.18857	0.6404	3381	1.562
.....	$\frac{1}{32}$	0.46875	11.91	0.17257	0.5861	3094	1.706
0000000	0.4615	11.72	0.16728	0.5681	2999	1.76
.....	$\frac{1}{16}$	0.4375	11.11	0.15033	0.5105	2696	1.959
000000	0.4305	10.93	0.14550	0.4943	2610	2.023
.....	$\frac{1}{32}$	0.40625	10.32	0.12962	0.4404	2324	2.272
0000	0.3938	10.00	0.12180	0.4136	2184	2.418
.....	$\frac{3}{8}$	0.3750	9.525	0.11045	0.3751	1980	2.666
000	0.3625	9.2075	0.10321	0.3505	1851	2.853
.....	$\frac{1}{32}$	0.34375	8.731	0.092806	0.3152	1664	3.173
00	0.3310	8.407	0.086049	0.2922	1543	3.422
.....	$\frac{1}{16}$	0.3125	7.938	0.076699	0.2605	1375	3.839
0	0.3065	7.785	0.073782	0.2506	1323	3.991
1	0.2830	7.188	0.062902	0.2136	1128	4.681
.....	$\frac{3}{32}$	0.28125	7.144	0.062126	0.2110	1114	4.74
2	0.2625	6.668	0.054119	0.1838	970.4	5.441
.....	$\frac{1}{4}$	0.2500	6.350	0.049087	0.1667	880.2	5.999
3	0.2437	6.190	0.046545	0.1584	836.4	6.313
4	0.2253	5.723	0.039867	0.1354	714.8	7.386
.....	$\frac{3}{32}$	0.21875	5.556	0.037583	0.1276	673.9	7.835
5	0.2070	5.258	0.033654	0.1143	603.4	8.750
6	0.1920	4.877	0.028953	0.09832	519.2	10.17
.....	$\frac{1}{16}$	0.1875	4.703	0.027612	0.09377	495.1	10.66
7	0.1770	4.496	0.024606	0.08356	441.2	11.97
8	0.1620	4.115	0.020612	0.07000	369.6	14.29
.....	$\frac{3}{32}$	0.15625	3.969	0.019175	0.06512	343.8	15.36
9	0.1483	3.767	0.017273	0.05866	309.7	17.05
10	0.1350	3.429	0.014314	0.04861	256.7	20.57
.....	$\frac{1}{8}$	0.125	3.175	0.012272	0.04168	220.0	24.00
11	0.1205	3.061	0.011404	0.03873	204.5	25.82
12	0.1055	2.68	0.0087417	0.02909	156.7	33.69
.....	$\frac{3}{32}$	0.09375	2.381	0.0069029	0.02344	123.8	42.66
13	0.0915	2.324	0.0065755	0.02233	117.9	44.78
14	0.0800	2.032	0.0050266	0.01707	90.13	58.58
15	0.0720	1.829	0.0040715	0.01383	73.01	72.32
16	0.0625	1.588	0.0030680	0.01042	55.01	95.98
17	0.0540	1.372	0.0022902	0.007778	41.07	128.60
18	0.0475	1.207	0.0017721	0.006018	31.77	166.20
19	0.0410	1.041	0.0013203	0.004484	23.67	223.00
20	0.0348	0.8839	0.00095115	0.003230	17.05	309.60
21	0.0317	0.8052	0.00078924	0.002680	14.15	373.10
.....	$\frac{1}{32}$	0.03125	0.7938	0.00076699	0.002605	13.75	383.00
22	0.0286	0.7264	0.00064242	0.002182	11.52	458.40
23	0.0258	0.6553	0.00052279	0.001775	9.374	563.30
24	0.0230	0.5842	0.00041548	0.001411	7.45	708.70

For iron wire multiply columns 6 and 7 by 0.98.

For copper wire multiply columns 6 and 7 by 1.12.

For other wire gages see next page.

NOTE.—Tables 184 and 185 from American Civil Engineers' Pocketbook.
 John Wiley & Sons Co.

TABLE 184A.—COMPARISON OF STANDARD GAGES

Number of gage	Thickness in decimals of an inch						
	Birmingham	Browne & Sharpe	United States Standard Plate Iron and Steel	British Imperial	American Steel & Wire	Trenton Iron Co.	Stubs steel wire
0000000	0.500	0.500	0.4900		
000000	0.58	0.46875	0.464	0.4615		
00000	0.500	0.5165	0.4375	0.432	0.4305	0.45	
0000	0.454	0.46	0.40625	0.400	0.3938	0.40	
000	0.425	0.40064	0.375	0.372	0.3625	0.35	
00	0.380	0.3648	0.34375	0.348	0.3310	0.33	
0	0.340	0.32486	0.3125	0.324	0.3065	0.305	
1	0.300	0.2893	0.28125	0.300	0.2830	0.285	0.227
2	0.284	0.25703	0.265625	0.276	0.2625	0.265	0.219
3	0.259	0.22942	0.25	0.252	0.2437	0.245	0.212
4	0.238	0.20431	0.234375	0.232	0.2253	0.225	0.207
5	0.220	0.18194	0.21875	0.212	0.2070	0.205	0.204
6	0.203	0.16202	0.203125	0.192	0.1920	0.190	0.201
7	0.180	0.14428	0.1875	0.176	0.1770	0.175	0.199
8	0.165	0.12849	0.171875	0.160	0.1620	0.160	0.197
9	0.148	0.11443	0.15625	0.144	0.1483	0.145	0.194
10	0.134	0.10189	0.140625	0.128	0.1350	0.130	0.191
11	0.120	0.090742	0.125	0.116	0.1205	0.1175	0.188
12	0.109	0.080808	0.109375	0.104	0.1055	0.1050	0.185
13	0.095	0.071961	0.09375	0.092	0.0915	0.0925	0.182
14	0.083	0.064084	0.078125	0.080	0.0800	0.0800	0.180
15	0.072	0.057068	0.0703125	0.072	0.0720	0.0700	0.178
16	0.065	0.05082	0.0625	0.064	0.0625	0.0610	0.175
17	0.058	0.045257	0.05625	0.050	0.0540	0.0525	0.172
18	0.049	0.040303	0.05	0.048	0.0475	0.0450	0.168
19	0.042	0.03589	0.04375	0.040	0.0410	0.0400	0.164
20	0.035	0.031961	0.0375	0.036	0.0348	0.0350	0.161
21	0.032	0.028462	0.034375	0.032	0.03175	0.0310	0.157
22	0.028	0.025347	0.03125	0.028	0.0286	0.0280	0.155
23	0.025	0.022571	0.028125	0.024	0.0258	0.0250	0.153
24	0.022	0.0201	0.025	0.022	0.0230	0.0225	0.151
25	0.020	0.0179	0.021875	0.020	0.0204	0.0200	0.148
26	0.018	0.01594	0.01875	0.018	0.0181	0.0180	0.146
27	0.016	0.014195	0.0171875	0.0164	0.0173	0.0170	0.143
28	0.014	0.012641	0.015625	0.0148	0.0162	0.0160	0.139
29	0.013	0.011257	0.0140625	0.0136	0.0150	0.0150	0.134
30	0.012	0.010025	0.0125	0.0124	0.0140	0.0140	0.127
31	0.010	0.008928	0.0109375	0.0116	0.0132	0.0130	0.120
32	0.009	0.00795	0.01015625	0.0108	0.0128	0.0120	0.115
33	0.008	0.00708	0.009375	0.0100	0.0118	0.0110	0.112
34	0.007	0.006304	0.00859375	0.0092	0.0104	0.0100	0.110
35	0.005	0.005614	0.0078125	0.0084	0.0095	0.0095	0.108
36	0.004	0.005	0.00703125	0.0076	0.0090	0.0090	0.106
37	0.004453	0.006640625	0.0068	0.0085	0.0085	0.103
38	0.003965	0.00625	0.0060	0.0080	0.0080	0.101
39	0.003531	0.0052	0.0075	0.0075	0.099
40	0.003144	0.0048	0.0070	0.0070	0.097

In the U. S. Standard, the numbers correspond to the weight in ounces per square feet and an equal number of 640ths of an inch in thickness.

TABLE 184B.—NATIONAL STEEL FABRIC STANDARD STYLES
 For buildings and other structures—cement gun work, beam wrapping, temperature reinforcement,
 canal lining, levee work, concrete pipe, etc.

Suggested uses	Style	Spacing, inches		Gage of wire		Section area square inches per linear foot		Weight per 100 sq. ft.
		Long.	Trans.	Long.	Trans.	Long.	Trans.	
Cement, gun work, composition, floors, etc.	AA 1414	2	2	14	14	0.030	0.030	21.1
	AA 1212	2	2	12	12	0.052	0.052	36.8
	BB 1212	4	4	12	12	0.026	0.026	18.7
	BB 1010	4	4	10	10	0.043	0.043	30.6
	BB 88	4	4	8	8	0.062	0.062	44.1
	BB 06	4	4	6	6	0.087	0.087	61.9
Cement, gun work, levee, lining, etc.....	BB 55	4	4	5	5	0.101	0.101	72.0
	BB 44	4	4	4	4	0.120	0.120	85.3
	CC 1212	6	6	12	12	0.017	0.017	12.7
	CC 1111	6	6	11	11	0.023	0.023	16.5
Temperature, reinforcement, etc.....	CC 1010	6	6	10	10	0.029	0.029	20.7
	CC 99	6	6	9	9	0.035	0.035	25.1
	BH 1212	4	16	12	12	0.026	0.007	11.8
Slab, reinforcement, fireproofing, retaining walls, etc.	BH 1012	4	16	10	12	0.043	0.007	17.9
	BH 912	4	16	9	12	0.052	0.007	21.1
	BH 812	4	16	8	12	0.062	0.007	24.7
	BH 711	4	16	7	11	0.074	0.008	20.7
	BH 610	4	16	6	10	0.087	0.011	35.2
	BH 510	4	16	5	10	0.101	0.011	40.4
	BH 49	4	16	4	9	0.120	0.013	47.9
	BH 38	4	16	3	8	0.140	0.015	56.1
	BH 28	4	16	2	8	0.162	0.015	64.3
	BH 17	4	16	1	7	0.189	0.018	74.8
	BH 06	4	16	0	6	0.221	0.022	87.8

WIRE MESH

1057

Slab reinforcement, fireproofing, drive-ways and walks, etc.	BF 1212	4	12	12	12	0.026	0.009	12.6
	BF 1112	4	12	11	12	0.034	0.009	15.5
	BF 1012	4	12	10	12	0.043	0.009	18.6
	BF 912	4	12	9	12	0.052	0.009	21.8
	BF 812	4	12	8	12	0.062	0.009	25.5
	BF 712	4	12	7	12	0.074	0.009	29.8
	BF 611	4	12	6	11	0.087	0.011	35.5
	BF 610	4	12	6	10	0.087	0.014	36.5
	BF 510	4	12	5	10	0.101	0.014	41.6
BF 49	4	12	4	9	0.120	0.017	49.4	
Beam wrapping, fireproofing, etc.....	BD 1212	4	8	12	12	0.026	0.013	14.1
	BD 1112	4	8	11	12	0.034	0.013	17.0
	BD 1012	4	8	10	12	0.043	0.013	20.2
Concrete pipe, etc.....	BD 912	4	8	9	12	0.052	0.013	23.4
	BD 812	4	8	8	12	0.062	0.013	27.0
	BD 712	4	8	7	12	0.074	0.013	31.3
Slab reinforcement, fireproofing, etc.....	TH 610	3	16	6	10	0.116	0.011	45.1
	TH 510	3	16	5	10	0.035	0.011	51.8
	TH 49	3	16	4	9	0.169	0.013	61.4
	TH 38	3	16	3	8	0.187	0.015	72.0
	TH 28	3	16	2	8	0.217	0.015	82.6
	TH 17	3	16	1	7	0.252	0.018	96.2
TH 06	3	16	0	6	0.295	0.022	112.9	

Furnished with plain or galvanized finish; unless ordered galvanized, plain wire will be furnished.

Width, 56 or 60" C-C outside main wires, 1" overhang; total width, 58 or 62" for 4" spacing of main wires.

Width, 54 or 60" C-C outside main wires, 1" overhang; total width, 56 or 62" for 6" spacing of main wires.

Length of rolls, 125 to 300 lin. ft. depending on the weight of style selected. It is recommended that styles with longitudinal wires of No. 3 gage or heavier be furnished in flat sheets.

TABLE 184C.—AREA IN SQUARE INCHES PER FOOT OF WIDTH FOR VARIOUS SPACING OF WIRES
Wire Fabric

Gage W & M ¹	Center to center spacing													
	Wire	2"	3"	4"	5"	6"	7"	8"	9"	10"	12"	14"	16"	18"
	Diam- eter, inches	Area, square inches												
6-0	0.4615	0.16728	1.004	0.600	0.502	0.402	0.335	0.287	0.251	0.223	0.201	0.167	0.143	0.112
5-0	0.4305	0.14550	0.874	0.582	0.437	0.340	0.291	0.250	0.218	0.191	0.175	0.146	0.125	0.097
4-0	0.3938	0.12180	0.731	0.487	0.365	0.292	0.244	0.209	0.183	0.162	0.146	0.122	0.104	0.081
3-0	0.3625	0.10321	0.610	0.413	0.310	0.248	0.200	0.177	0.155	0.138	0.124	0.103	0.088	0.069
2-0	0.3310	0.08005	0.510	0.344	0.258	0.207	0.172	0.148	0.129	0.115	0.103	0.086	0.074	0.057
0	0.3065	0.07378	0.443	0.295	0.221	0.177	0.148	0.126	0.111	0.099	0.089	0.074	0.063	0.049
1	0.2830	0.06500	0.377	0.252	0.189	0.151	0.126	0.107	0.094	0.084	0.075	0.063	0.054	0.041
2	0.2625	0.05411	0.325	0.217	0.162	0.130	0.108	0.093	0.081	0.072	0.065	0.054	0.047	0.036
3	0.2437	0.04604	0.286	0.187	0.140	0.112	0.093	0.088	0.070	0.062	0.056	0.047	0.035	0.031
4	0.2253	0.03986	0.239	0.160	0.120	0.096	0.080	0.068	0.059	0.053	0.048	0.040	0.030	0.026
5	0.2070	0.03365	0.202	0.135	0.101	0.081	0.067	0.058	0.050	0.045	0.040	0.034	0.025	0.022
6	0.1920	0.02895	0.174	0.116	0.087	0.069	0.058	0.050	0.043	0.039	0.035	0.029	0.025	0.019
7	0.1770	0.02460	0.148	0.098	0.074	0.059	0.049	0.042	0.037	0.033	0.030	0.025	0.021	0.018
7½	0.1695	0.02250	0.135	0.090	0.068	0.054	0.045	0.039	0.034	0.030	0.027	0.023	0.019	0.015
8	0.1620	0.02061	0.124	0.082	0.062	0.049	0.041	0.035	0.031	0.027	0.025	0.021	0.018	0.014
9	0.1483	0.01727	0.104	0.069	0.052	0.041	0.035	0.029	0.026	0.023	0.021	0.017	0.015	0.011
9½	0.1416	0.01575	0.095	0.063	0.047	0.038	0.032	0.027	0.024	0.021	0.019	0.016	0.014	0.010
10	0.1350	0.01431	0.086	0.057	0.043	0.034	0.029	0.025	0.021	0.019	0.017	0.014	0.012	0.009
11	0.1295	0.01140	0.068	0.045	0.034	0.027	0.023	0.020	0.017	0.015	0.014	0.011	0.009	0.007
11½	0.1130	0.01002	0.060	0.040	0.030	0.024	0.020	0.017	0.015	0.013	0.012	0.010	0.009	0.006
12	0.1055	0.00874	0.052	0.035	0.026	0.021	0.017	0.015	0.013	0.011	0.010	0.009	0.007	0.006
12½	0.0985	0.00762	0.046	0.030	0.023	0.018	0.015	0.013	0.011	0.010	0.009	0.008	0.006	0.005
13	0.0915	0.00657	0.040	0.027	0.020	0.016	0.013	0.011	0.010	0.009	0.008	0.006	0.005	0.004
14	0.0860	0.00502	0.030	0.020	0.015	0.012	0.010	0.009	0.008	0.007	0.006	0.005	0.004	0.003

¹ Washburn & Moen.

TABLE 184D.—APPROXIMATE WEIGHTS PER 100 SQ. FT.
Longitudinal wires

Gage of wires	Center to center spacing of longitudinal wires, in inches						
	2"	3"	4"	5"	6"	10"	12"
6-0	352.22	238.60	181.79	147.71	124.98	79.53	68.17
5-0	306.47	207.61	158.18	128.52	108.75	69.20	59.32
4-0	256.43	173.71	132.35	107.54	90.99	57.90	49.63
3-0	217.31	147.21	112.16	91.13	77.11	49.07	42.06
2-0	181.16	122.72	93.50	75.07	64.28	40.91	35.06
0	155.37	105.25	80.19	65.16	55.13	35.08	30.07
1	132.43	89.71	68.35	55.54	46.99	29.90	25.63
2	113.96	77.20	58.82	47.79	40.44	25.73	22.06
3	98.21	66.53	50.60	41.18	34.85	22.18	19.01
4	83.95	56.87	43.33	35.20	29.79	18.96	16.25
5	70.87	48.01	36.58	29.72	25.15	16.00	13.72
6	60.96	41.29	31.46	25.56	21.63	13.76	11.80
7	51.81	35.10	26.74	21.73	18.38	11.70	10.03
8	43.40	29.40	22.40	18.20	15.40	9.80	8.40
9	36.37	24.64	18.77	15.25	12.91	8.21	7.04
10	30.14	20.42	15.56	12.64	10.60	6.81	5.83
11	24.01	16.27	12.39	10.07	8.52	5.42	4.65
12	18.41	12.47	9.50	7.72	6.53	4.16	3.56
13	13.84	9.38	7.15	5.81	4.91	3.13	2.68
14	10.58	7.17	5.46	4.44	3.76	2.39	2.05

Transverse wires

Gage of wires	Center to center spacing of transverse wires, in inches					
	2"	4"	6"	8"	12"	16"
0	155.37	77.69	51.79	38.84	25.80	19.42
1	132.43	66.22	44.14	33.11	22.07	16.55
2	113.96	56.98	37.98	28.40	18.99	14.24
3	98.21	49.10	32.74	24.55	16.37	12.28
4	83.95	41.97	27.98	20.99	13.99	10.49
5	70.87	35.43	23.61	17.72	11.81	8.86
6	60.96	30.48	20.32	15.24	10.16	7.62
7	51.81	25.90	17.27	12.95	8.63	6.48
8	43.40	21.70	14.47	10.85	7.23	5.43
9	36.37	18.18	12.12	9.09	6.06	4.55
10	30.14	15.07	10.05	7.53	5.02	3.77
11	24.01	12.01	8.00	6.00	4.00	3.00
12	18.41	9.20	6.13	4.60	3.07	2.30
13	13.84	6.92	4.61	3.46	2.31	1.73
14	10.58	5.29	3.53	2.65	1.76	1.32

Above weights to be used in computing the weights per 100 sq. ft. of National steel fabric.

Example.—Weight per 100 sq. ft. of 6 by 12" fabric with longitudinal wires No. 0, transverse wires No. 6. Add to weight of longitudinal wire No. 0 spaced 6" (55.13 lb.), the weight of transverse wire No. 6 spaced 12" (10.16 lb.), making total of 65.29 lb. per 100 sq. ft.

TABLE 185.—WEIGHTS OF EXPANDED METAL

TRADE CATALOGUE WEIGHTS				WEIGHT AND SECTIONAL AREA TAKEN FROM I. C. S. HANDBOOK			
Gauge	Size Mesh	Weight in Pounds per Sq. Ft.	U. S. Stand- ard Gauge	Size Mesh	Sectional Area in Sq. In. per Foot of Width	Weight in Pounds per Sq. Ft.	
10	3" X 7"	0.63	18	3" X 13"	0.203	0.69	
12	3" X 7"	0.54	12	3" X 2"	0.253	0.86	
10	2" X 5"	0.86	12	1" X 3"	0.188	0.64	
12	2" X 5"	0.68	16	2" X 6"	0.087	0.29	
14	2" X 5"	0.48	16	3" X 8"	0.130	0.44	
16	1" X 3"	0.37	16	3" X 8"	0.059	0.20	
16	1" X 3"	0.40	12	3" X 8"	0.109	0.37	
16	1" X 2"	0.50	10	3" X 8"	0.162	0.55	
15	1" X 2"	0.57	10	3" X 8"	0.243	0.81	
14	1" X 2"	0.64	10	3" X 8"	0.324	1.07	
13	1" X 2"	0.78	7	3" X 8"	0.400	1.36	
			4	6" X 12"	0.245	0.84	
			4	6" X 12"	0.368	1.20	
Mesh	Strand Standard or Extra	Section Area per Foot of Width	Weight per Sq. Ft.	Size of Standard Sheets	No. of Sheets in Bundle	No. of Sq. Ft. in 8' Bundle	
1"	Standard	0.209	.74	5' or 6' X 8'	5	120	
1 1/2"	"	0.225	.83	6' X 8' or 12'	5	240	
1 3/4"	"	0.207	.70	4' X 8' or 12'	5	100	
2"	"	0.166	.56	5' X 8' or 12'	5	200	
3"	"	0.108	.38	6' X 8' or 12'	10	480	
3 1/2"	Light	0.148	.50	6' X 8' or 12'	5	240	
3 3/4"	Heavy	0.178	.60	6' X 8' or 12'	5	240	
3 1/2"	Ex "	0.267	.90	4' X 8' or 12'	5	160	
3 3/4"	Standard	0.356	1.20	5' X 8' or 12'	3	144	
3 1/2"	Heavy	0.400	1.38	5' X 8' or 12'	3	120	
3 3/4"	Old Style	0.000	2.07	4 1/2' X 8' or 9'	6	216	
4"	Standard	0.003	.84	5' X 8' or 12'	5	200	
6"	Heavy	0.245	1.26	5' X 8' or 12'	3	120	
6"	Standard	0.368	1.26				

NOTE.—Expanded metal for small culverts is generally specified as weighing a certain number of pounds per square foot and having a mesh approximately the size shown on the plans.

TABLE 186.—TABLE OF ROUND AND SQUARE BAR WEIGHTS¹

Round Bars			Plain Square Bars and Twisted Square Bars		
Diameter	Area	Weight	Dimension	Area	Weight
$\frac{1}{8}$.0491	.167	$\frac{1}{8}$.0625	.212
$\frac{3}{16}$.0767	.261	$\frac{3}{16}$.0977	.332
$\frac{1}{2}$.1104	.376	$\frac{1}{2}$.1406	.478
$\frac{3}{4}$.1503	.511	$\frac{3}{4}$.1914	.651
$\frac{7}{8}$.1963	.668	$\frac{7}{8}$.2500	.850
$1\frac{1}{8}$.2485	.845	$1\frac{1}{8}$.3164	1.076
$1\frac{3}{8}$.3068	1.043	$1\frac{3}{8}$.3906	1.328
$1\frac{1}{2}$.3712	1.262	$1\frac{1}{2}$.4727	1.607
$1\frac{3}{4}$.4418	1.502	$1\frac{3}{4}$.5625	1.913
$1\frac{7}{8}$.5185	1.763	$1\frac{7}{8}$.6602	2.245
1	.6013	2.044	1	.7656	2.603
$1\frac{1}{8}$.6903	2.347	$1\frac{1}{8}$.8789	2.988
$1\frac{1}{4}$.7854	2.670	1	1.0000	3.400
$1\frac{3}{8}$.9940	3.380	$1\frac{1}{8}$	1.2656	4.303
$1\frac{1}{2}$	1.2272	4.172	$1\frac{1}{4}$	1.5625	5.313
$1\frac{3}{4}$	1.4849	5.049	$1\frac{3}{8}$	1.8906	6.428
$1\frac{7}{8}$	1.7671	6.008	$1\frac{1}{2}$	2.2500	7.650

¹ Stock sizes of 1926 are printed in bold-face type.



Ransome Bar.



Kahn Cup Bar.



Corrugated Bars.



Diamond Bar.



Thacher Bar.

Diameters expressed in inches. Areas expressed in square inches. Weights expressed in pounds per foot of length.

The twisted square bar is known as the Ransome Bar.

Corrugated bar weights very closely approximate the weights given for the plain bars. See makers catalogue for any special brand.

Steel Beams.—Tables 187 and 188 give data on the strength of steel beams. To avoid objectionable deflection in bridge floors the following specifications for minimum depth of stringers, girders and trusses indicate the desirable minimum depths of steel beams.

Depth Ratios of Steel Floor and Truss Members¹

Trusses preferably not less than $\frac{1}{10}$ of span

Plate girders preferably not less than $\frac{1}{12}$ of span

Rolled beams used as girders preferably not less than $\frac{1}{10}$ of span

If less depth is used section area to be increased so that deflection is not greater than if these limiting ratios had been used.

¹ American Soc. Specifications 1925.

TABLE 187A.—PROPERTIES OF CAMBRIA STANDARD I-BEAMS¹

Depth of Beam	Weight per Foot	Area of Section	Thick-ness of Web	Width of Flange	For Fiber Stress of 12,500 lbs. per Sq. In. for Bridges
Inches	Pounds	Sq. Inches	Inch	Inches	Coefficient of Strength
3	5.50	1.63	.17	2.33	13,790
3	6.50	1.91	.26	2.42	14,950
3	7.50	2.21	.36	2.52	16,180
4	7.50	2.21	.10	2.66	24,850
4	8.50	2.50	.26	2.73	26,480
4	9.50	2.79	.34	2.81	28,110
4	10.50	3.09	.41	2.88	29,750
5	9.75	2.87	.21	3.00	40,300
5	12.25	3.60	.36	3.15	45,390
5	14.75	4.34	.50	3.29	50,490
6	12.25	3.61	.23	3.33	60,520
6	14.75	4.34	.35	3.45	66,610
6	17.25	5.07	.47	3.57	72,740
7	15.00	4.42	.25	3.66	86,260
7	17.50	5.15	.35	3.76	93,290
7	20.00	5.88	.46	3.87	100,430
8	18.00	5.33	.27	4.00	118,490
8	20.25	5.96	.35	4.08	125,400
8	22.75	6.69	.44	4.17	133,570
8	25.25	7.43	.53	4.26	141,740
9	21.00	6.31	.29	4.33	157,260
9	25.00	7.35	.41	4.45	170,260
9	30.00	8.82	.57	4.61	188,640
9	35.00	10.29	.73	4.77	207,020
10	25.00	7.37	.31	4.66	203,500
10	30.00	8.82	.45	4.80	223,630
10	35.00	10.29	.60	4.95	244,050
10	40.00	11.76	.75	5.10	264,480
12	31.50	9.26	.35	5.00	299,740
12	35.00	10.29	.44	5.09	317,030
12	40.00	11.76	.56	5.21	341,540

¹ 1912 Standards.

TABLE 187.—Continued

Depth of Beam	Weight per Foot	Area of Section	Thick-ness of Web	Width of Flange	For Fiber Stress of 12,500 lbs. per Sq. In. for Bridges
Inches	Pounds	Sq. Inches	Inch	Inches	Coefficient of Strength
15	42.00	12.48	.41	5.50	490,840
15	45.00	13.24	.46	5.55	506,490
15	50.00	14.71	.56	5.65	537,130
15	55.00	16.18	.66	5.75	567,770
15	60.00	17.65	.75	5.84	598,410
18	55.00	15.03	.46	6.00	736,620
18	60.00	17.65	.56	6.10	779,440
18	65.00	19.12	.64	6.18	816,200
18	70.00	20.59	.72	6.26	852,970
20	65.00	19.08	.50	6.25	974,600
20	70.00	20.59	.58	6.33	1,016,490
20	75.00	22.06	.65	6.40	1,057,340
24	80.00	23.32	.50	7.00	1,449,460
24	85.00	25.00	.57	7.07	1,505,430
24	90.00	26.47	.63	7.13	1,554,450
24	95.00	27.94	.69	7.19	1,603,470
24	100.00	29.41	.75	7.25	1,652,490

Explanation of the coefficient of strength in the above table and examples showing use in practice.

The coefficient of strength for each sized beam represents the maximum uniformly distributed load, in pounds, that will produce a fiber stress not exceeding 12,500 lb. per square inch multiplied by the span in feet.

If the load to be investigated is a concentrated load it must be changed to an equivalent uniform load in order to use the values given. This is done by multiplying the concentrated load by 2.

Example.—Suppose that it is required to determine the size I-beam that will carry a 40,000-lb. load in the center of a 15' span and a uniformly distributed load of 20,000 lb. The coefficient of resistance for the concentrated load will be $2(40,000) \times 15 = 1,200,000$

$$\text{Uniform load } 20,000 \times 15 = \frac{300,000}{1,500,000}$$

The required beam must have a coefficient of resistance of 1,500,000 plus the coefficient due to its own weight. A 24" beam weighing 90 lb. per foot has a coefficient of 1,554,450.

The beam weighs $90 \times 15 = 1350$. The coefficient for the beam weight is $1350 \times 15 = 20,250$, which deducted from 1,554,450 gives a coefficient of 1,534,200, which is slightly greater than required and is safe.

TABLE 187B.—BETHLEHEM STAND-

Section number	Depth of beam, inches	Weight, lbs. per foot	Area of section, square inches	Thickness of web, inches	Width of flange, inches	Axis XX*		
						Moment of inertia <i>I</i>	Radius of gyration <i>r</i>	Section modulus <i>S</i>
B30	30 $\frac{1}{8}$	129.0	37.52	.580	10.530	5,566.5	12.18	369.6
	30	121.0	35.36	.550	10.500	5,213.6	12.14	347.6
B28	29 $\frac{7}{8}$	115.0	33.50	.530	10.480	4,880.8	12.08	327.1
	28 $\frac{1}{8}$	113.0	32.98	.540	10.030	4,285.5	11.40	304.8
B26	27 $\frac{3}{8}$	106.0	30.93	.510	10.000	3,993.8	11.36	285.3
	26 $\frac{1}{8}$	100.0	29.18	.490	9.980	3,723.4	11.30	267.1
B24b	24 $\frac{3}{4}$	98.0	28.47	.500	9.530	3,200.9	10.60	245.1
	24 $\frac{3}{32}$	91.0	26.55	.470	9.500	2,962.8	10.56	227.9
B24a	25 $\frac{7}{8}$	85.5	24.89	.450	9.480	2,742.2	10.50	211.9
	24 $\frac{3}{32}$	104.5	30.63	.550	9.775	2,967.7	9.84	240.4
B24	24	99.5	29.15	.525	9.750	2,811.7	9.82	234.3
	23 $\frac{3}{8}$	95.5	27.79	.505	9.730	2,663.1	9.79	222.8
B22	24	84.5	24.80	.460	9.250	2,381.9	9.80	198.5
	24	83.0	24.59	.520	9.130	2,240.9	9.55	185.7
B20a	24	73.5	21.47	.390	9.000	2,091.0	9.87	174.3
	22 $\frac{1}{8}$	71.5	20.88	.420	8.535	1,705.2	9.04	154.2
B20	22 $\frac{1}{16}$	68.5	20.04	.405	8.520	1,629.3	9.02	147.7
	22	65.5	19.08	.385	8.500	1,549.5	9.01	140.9
B18a	20	82.0	24.17	.570	8.890	1,559.8	8.03	156.0
	20	73.0	21.37	.430	8.750	1,466.5	8.28	146.7
B18	20	69.0	20.26	.520	8.145	1,268.9	7.91	126.9
	20	64.5	18.86	.450	8.075	1,222.1	8.05	122.2
B15b	20	59.5	17.36	.375	8.000	1,172.2	8.22	117.2
	18 $\frac{1}{8}$	74.0	21.61	.440	8.770	1,238.0	7.57	136.6
B15a	18 $\frac{3}{8}$	69.0	20.20	.420	8.750	1,142.5	7.52	126.9
	18	64.5	18.79	.400	8.730	1,048.5	7.47	117.3
B12	18	59.0	17.40	.495	7.675	883.3	7.12	98.1
	18	54.5	15.87	.410	7.590	842.0	7.28	93.6
B10	18	52.0	15.24	.375	7.555	825.0	7.36	91.7
	18	49.0	14.25	.320	7.500	798.3	7.48	88.7
B8	15	71.5	20.95	.520	7.500	796.2	6.16	106.2
	15	64.0	18.81	.605	7.195	664.9	5.95	88.6
B7	15	54.5	15.88	.410	7.000	610.0	6.20	81.3
	15	46.0	13.52	.440	6.810	484.8	5.99	64.6
B6	15	41.0	12.02	.340	6.710	456.7	6.16	60.9
	15	38.5	11.27	.290	6.660	442.6	6.27	59.0
B5	12	36.5	10.61	.310	6.300	269.2	5.04	44.9
	12	32.0	9.44	.335	6.205	228.5	4.92	38.1
B4	12	28.5	8.42	.250	6.120	216.2	5.07	36.0
	10	28.5	8.34	.390	5.990	134.6	4.02	26.9
B3	10	23.5	6.94	.250	5.850	122.9	4.21	24.6
	9	24.0	7.04	.305	5.555	92.1	3.62	20.5
B2	9	20.5	6.01	.250	5.440	85.1	3.76	18.9
	8	19.5	5.78	.325	5.325	60.6	3.24	15.1
B1	8	17.5	5.18	.250	5.250	57.4	3.33	14.3

W = Safe load in pounds, uniformly distributed, including weight of beam.

L = Span, in feet.

M = Moment of forces, in foot pounds.

f = Allowable fiber stress, in lbs. per square inch.

S = Section modulus about axis XX.

* Axis XX parallel to flange. Axis YY parallel to web.

ARD I-BEAMS (1926 STANDARD)

Coefficients of strength			Maximum safe shear on web, in pounds	Axis YY*			Section number
For fiber stress of 16,000 lbs. per sq. in. Usual building code requirement	For fiber stress of 12,000 lbs. per sq. in. For moving loads	For fiber stress of 18,000 lbs. per sq. in. For quiescent loads		Moment of inertia	Radius of gyration	Section modulus	
C	C'	C''	I'	r'	S'		
3,943,000	2,957,000	4,435,000	119,100	177.5	2.18	33.7	B30
3,707,000	2,781,000	4,171,000	107,300	164.3	2.16	31.3	
3,489,000	2,617,000	3,925,000	99,500	151.8	2.13	29.0	
3,251,000	2,438,000	3,658,000	103,300	142.3	2.08	28.4	B28
3,043,000	2,282,000	3,423,000	92,300	130.9	2.06	26.2	
2,849,000	2,137,000	3,205,000	85,000	120.2	2.03	24.1	B26
2,614,000	1,961,000	2,941,000	88,500	110.6	1.97	23.2	
2,431,000	1,823,000	2,735,000	78,300	100.9	1.95	21.2	B24b
2,260,000	1,695,000	2,543,000	71,600	91.6	1.92	19.3	
2,628,000	1,971,000	2,957,000	104,300	132.9	2.08	27.2	B24a
2,499,000	1,874,000	2,812,000	95,900	124.8	2.07	25.6	
2,376,000	1,782,000	2,673,000	80,300	117.1	2.05	24.1	B24
2,117,000	1,588,000	2,382,000	75,100	91.1	1.92	19.7	
1,992,000	1,494,000	2,241,000	93,100	78.0	1.78	17.1	B22
1,859,000	1,394,000	2,091,000	54,000	74.4	1.86	16.5	
1,645,000	1,233,000	1,850,000	62,500	65.8	1.78	15.4	B20a
1,576,000	1,182,000	1,773,000	58,200	62.3	1.76	14.6	
1,503,000	1,127,000	1,690,000	52,600	58.8	1.76	13.8	B20
1,664,000	1,248,000	1,872,000	102,400	79.9	1.82	18.0	
1,564,000	1,173,000	1,760,000	64,900	75.9	1.88	17.3	B18a
1,354,000	1,015,000	1,523,000	88,200	51.2	1.59	12.6	
1,304,000	977,700	1,467,000	60,400	49.8	1.62	12.3	B18
1,250,000	937,700	1,407,000	50,000	48.3	1.66	12.1	
1,458,000	1,093,000	1,640,000	66,100	82.9	1.96	18.9	B15b
1,354,000	1,016,000	1,523,000	60,800	75.6	1.93	17.3	
1,251,000	938,000	1,407,000	55,600	68.4	1.91	15.7	B15a
1,047,000	785,200	1,178,000	78,000	39.1	1.50	10.2	
997,900	748,400	1,123,000	57,500	37.7	1.54	9.92	B15
977,700	733,300	1,100,000	49,200	37.1	1.56	9.82	
946,100	709,600	1,064,000	36,700	36.2	1.59	9.66	B12a
1,132,000	849,300	1,274,000	77,900	61.3	1.71	16.3	
945,600	700,200	1,064,000	90,800	41.9	1.49	11.6	B12
867,600	650,700	976,100	54,800	38.3	1.55	10.9	
689,500	517,100	775,700	60,000	25.2	1.36	7.40	B10
649,400	487,100	730,600	39,900	24.0	1.41	7.15	
629,500	472,100	708,200	30,100	23.4	1.44	7.03	B9
478,600	350,000	538,400	32,200	21.3	1.42	6.77	
406,200	304,700	457,000	35,800	16.0	1.30	5.14	B8
384,400	288,300	432,500	22,200	15.3	1.35	4.98	
287,100	215,300	323,000	30,000	12.1	1.21	4.05	B8
262,200	196,700	295,000	21,000	11.2	1.27	3.83	
218,300	163,700	245,600	32,900	8.8	1.12	3.17	
201,800	151,400	227,000	20,100	8.2	1.17	3.02	
161,600	121,200	181,800	26,000	6.7	1.08	2.51	
153,000	114,800	172,100	18,900	6.4	1.11	2.43	

C, C', and C'' = coefficients given in the table.

$$W = \frac{C}{L}, \text{ or } \frac{C'}{L}, \text{ or } \frac{C''}{L}; M = \frac{C}{8}, \text{ or } \frac{C'}{8}, \text{ or } \frac{C''}{8}$$

$$C, \text{ or } C', \text{ or } C'' = WL = 8M = \frac{3}{8}S$$

TABLE 188.—BETHLEHEM GIRDER

Section number	Nominal depth of beam, inches	Weight, lbs. per foot	Area of section, square inches	Thickness of web, inches	Width of flange, inches	Axis XX*		
						Moment of inertia <i>I</i>	Radius of gyration <i>r</i>	Section modulus <i>S</i>
G30	30 $\frac{3}{8}$	200.0	58.52	.76	15.04	9,148.8	12.50	607.5
	30	190.0	55.52	.72	15.00	8,657.1	12.48	576.7
G28	28 $\frac{3}{8}$	181.0	52.82	.60	14.07	8,181.0	12.45	547.6
	28 $\frac{3}{8}$	175.0	51.02	.70	14.20	6,988.7	11.70	407.1
G26	26 $\frac{3}{8}$	165.0	48.19	.66	14.25	6,577.9	11.68	409.9
	26 $\frac{3}{8}$	160.0	46.85	.67	13.79	5,576.6	10.91	427.0
G24a	24 $\frac{3}{8}$	151.0	44.16	.63	13.75	5,237.1	10.89	402.9
	24 $\frac{3}{8}$	144.0	41.99	.61	13.73	4,930.6	10.84	381.0
G24	24 $\frac{3}{8}$	149.0	43.57	.65	13.29	4,451.1	10.11	309.1
	24 $\frac{3}{8}$	141.0	41.02	.61	13.25	4,174.2	10.09	347.9
G20a	23 $\frac{7}{8}$	133.0	38.71	.58	13.22	3,912.4	10.05	327.7
	23 $\frac{7}{8}$	129.0	37.74	.58	12.29	3,844.8	10.09	318.8
G20	24 $\frac{3}{8}$	121.0	35.30	.54	12.25	3,585.3	10.08	298.8
	23 $\frac{7}{8}$	114.0	33.12	.51	12.22	3,340.6	10.04	279.8
G18	20 $\frac{3}{8}$	149.0	43.44	.69	12.78	3,106.6	8.46	308.8
	20 $\frac{3}{8}$	142.0	41.31	.66	12.75	2,932.3	8.43	293.2
G15b	19 $\frac{7}{8}$	135.0	39.18	.63	12.72	2,760.6	8.39	277.7
	20 $\frac{3}{8}$	120.0	34.95	.59	12.03	2,505.5	8.47	249.1
G15a	20 $\frac{3}{8}$	113.0	32.90	.56	12.00	2,340.2	8.43	234.0
	18 $\frac{3}{8}$	107.0	31.06	.54	11.98	2,184.0	8.39	219.7
G12a	18 $\frac{3}{8}$	100.0	29.25	.52	11.54	1,725.7	7.68	190.5
	18 $\frac{3}{8}$	93.0	27.14	.48	11.50	1,593.4	7.66	177.0
G12	17 $\frac{3}{8}$	87.5	25.40	.46	11.48	1,472.8	7.61	164.7
	15 $\frac{3}{8}$	147.0	42.73	.83	11.78	1,666.2	6.24	220.4
G10	15 $\frac{3}{8}$	141.0	40.86	.80	11.75	1,577.7	6.21	210.4
	14 $\frac{3}{8}$	135.0	39.01	.77	11.72	1,499.7	6.18	200.4
G9	15 $\frac{3}{8}$	111.0	32.40	.64	11.29	1,306.3	6.35	172.8
	15 $\frac{3}{8}$	105.0	30.45	.60	11.25	1,218.2	6.32	162.4
G8	14 $\frac{3}{8}$	99.0	28.65	.57	11.22	1,134.7	6.29	152.5
	15 $\frac{3}{8}$	80.5	23.44	.48	10.79	968.5	6.43	128.1
G7a	15 $\frac{3}{8}$	74.0	21.55	.44	10.75	883.8	6.40	117.8
	14 $\frac{3}{8}$	69.0	19.96	.42	10.73	806.4	6.36	108.4
G7	12 $\frac{3}{8}$	76.5	22.29	.51	10.29	589.0	5.14	97.2
	12 $\frac{3}{8}$	70.5	20.57	.47	10.25	538.4	5.12	89.7
G6	11 $\frac{3}{8}$	66.0	19.11	.45	10.23	491.7	5.07	82.8
	12 $\frac{3}{8}$	61.0	17.77	.41	10.03	479.9	5.20	79.2
G5	12	55.5	16.21	.38	10.00	431.8	5.16	72.0
	11 $\frac{3}{8}$	51.5	15.07	.36	9.98	396.9	5.13	66.6
G4	10 $\frac{1}{8}$	50.0	14.51	.36	9.04	275.5	4.36	54.4
	10	44.5	13.03	.32	9.00	244.7	4.33	48.9
G3	9 $\frac{3}{8}$	41.5	12.12	.31	8.99	223.8	4.30	45.2
	9	43.5	12.62	.35	8.54	193.8	3.92	42.5
G2	9	38.5	11.23	.31	8.50	170.3	3.89	37.9
	8 $\frac{1}{8}$	36.0	10.55	.29	8.48	158.9	3.88	35.5
G1	8 $\frac{1}{8}$	37.0	10.77	.33	8.03	131.1	3.49	32.3
	8	33.0	9.57	.30	8.00	114.2	3.45	28.6
	7 $\frac{1}{8}$	31.0	9.01	.29	7.99	106.2	3.43	26.7

W = Safe load in pounds, uniformly distributed, including weight of beam.

L = Span, in feet.

M = Moment of forces, in foot pounds.

f = Allowable fiber stress, in lbs. per square inch.

S = Section modulus about axis XX.

* Axis XX parallel to flange. Axis YY parallel to web.

BEAM (1926 STANDARD)

Coefficients of strength			Maximum safe shear on web, in pounds	Axis YY*			Section number
For fiber stress of 16,000 lbs. per sq. in. Usual building code requirement	For fiber stress of 12,000 lbs. per sq. in. For moving loads	For fiber stress of 18,000 lbs. per sq. in. For quiescent loads		Moment of inertia	Radius of gyration	Section modulus	
C	C'	C''		I'	r'	S'	
6,480,000	4,860,000	7,290,000	103,200	628.5	3.28	83.6	
6,152,000	4,614,000	6,921,000	176,400	589.4	3.26	78.6	G30
5,341,000	4,381,000	6,571,000	163,700	552.0	3.23	73.7	
5,302,000	3,976,000	5,965,000	164,800	496.2	3.12	69.4	G28
5,012,000	3,750,000	5,638,000	140,100	462.8	3.10	65.0	
4,555,000	3,416,000	5,124,000	149,500	432.8	3.04	62.8	
4,207,000	3,223,000	4,834,000	134,900	402.7	3.02	58.6	G26
4,064,000	3,048,000	4,572,000	127,300	375.0	2.99	54.6	
4,037,000	2,953,000	4,429,000	138,200	383.3	2.97	57.7	
3,710,000	2,783,000	4,174,000	124,600	356.4	2.95	53.8	G24a
3,495,000	2,621,000	3,932,000	114,400	330.7	2.92	50.0	
3,401,000	2,550,000	3,826,000	114,800	278.2	2.72	45.3	
3,187,000	2,390,000	3,585,000	101,400	256.9	2.70	41.9	G24
3,084,000	2,238,000	3,357,000	91,400	236.7	2.67	38.7	
3,094,000	2,470,000	3,706,000	138,100	384.5	2.97	60.2	
3,128,000	2,346,000	3,519,000	120,200	360.9	2.96	56.6	G20a
2,962,000	2,222,000	3,333,000	120,500	337.6	2.94	53.1	
2,657,000	1,992,000	2,989,000	100,800	260.1	2.73	43.2	
2,496,000	1,872,000	2,808,000	101,000	240.8	2.71	40.1	G20
2,344,000	1,758,000	2,637,000	95,100	222.3	2.68	37.1	
2,032,000	1,524,000	2,286,000	86,300	202.6	2.63	35.1	
1,888,000	1,416,000	2,125,000	76,000	185.1	2.61	32.2	G18
1,757,000	1,318,000	1,977,000	70,700	168.9	2.58	29.4	
2,351,000	1,763,000	2,645,000	125,500	347.3	2.85	59.0	
2,244,000	1,683,000	2,524,000	120,000	328.3	2.83	55.9	G15b
2,137,000	1,603,000	2,404,000	114,600	309.5	2.82	52.8	
1,843,000	1,382,000	2,074,000	96,800	231.2	2.67	41.0	
1,733,000	1,290,000	1,949,000	90,000	214.3	2.65	38.1	G15a
1,627,000	1,220,000	1,830,000	84,800	198.4	2.63	35.4	
1,367,000	1,025,000	1,537,000	69,700	143.0	2.47	26.5	
1,257,000	942,800	1,414,000	61,100	128.9	2.45	24.0	G15
1,156,000	867,100	1,301,000	56,600	115.8	2.41	21.6	
1,037,000	777,600	1,166,000	61,800	132.1	2.43	25.7	
957,100	717,800	1,077,000	56,400	119.7	2.41	23.4	G12a
883,000	662,300	993,400	53,500	108.3	2.38	21.2	
844,700	633,500	950,300	49,100	95.8	2.32	19.1	
767,700	575,800	863,600	43,800	84.9	2.29	17.0	G12
710,800	533,100	799,700	40,300	76.9	2.26	15.4	
580,800	435,600	653,300	36,400	66.4	2.14	14.7	
522,100	391,500	587,300	31,100	58.2	2.11	12.9	G10
481,900	361,400	542,100	20,500	52.6	2.08	11.7	
453,400	340,000	510,000	31,900	51.3	2.02	12.0	
403,800	302,800	454,300	27,900	44.4	1.99	10.4	G9
379,200	284,400	426,600	25,300	41.0	1.97	9.67	
344,500	258,400	387,600	26,800	38.7	1.90	9.65	
304,500	228,400	342,600	24,000	33.2	1.86	8.29	G8
285,200	213,900	320,900	23,000	30.5	1.84	7.63	

C, C', and C'' = coefficients given in the table.

$$W = \frac{C}{L} \text{ or } \frac{C'}{L} \text{ or } \frac{C''}{L}; M = \frac{C}{8} \text{ or } \frac{C'}{8} \text{ or } \frac{C''}{8}$$

$$C, \text{ or } C', \text{ or } C'' = WL = 8M = \frac{3}{4}fS$$

TABLE 189A.—WEIGHTS OF FLAT ROLLED STEEL BARS, POUNDS PER LINEAR FOOT

One cubic foot of steel weighs 489.6 lb. For thicknesses from $\frac{3}{16}$

Thickness in inches	1"	1 $\frac{1}{4}$ "	1 $\frac{1}{2}$ "	1 $\frac{3}{4}$ "	2"	2 $\frac{1}{4}$ "	2 $\frac{1}{2}$ "	2 $\frac{3}{4}$ "	3"
$\frac{3}{16}$	0.638	0.797	0.956	1.12	1.28	1.43	1.59	1.75	7.65
$\frac{7}{16}$	0.850	1.06	1.28	1.49	1.70	1.91	2.13	2.34	10.20
$\frac{5}{16}$	1.06	1.33	1.59	1.86	2.13	2.39	2.66	2.92	12.75
$\frac{3}{8}$	1.28	1.59	1.91	2.23	2.55	2.87	3.19	3.51	15.30
$\frac{7}{8}$	1.49	1.86	2.23	2.60	2.98	3.35	3.72	4.09	17.85
$\frac{1}{2}$	1.70	2.13	2.55	2.98	3.40	3.83	4.25	4.68	20.40
$\frac{9}{16}$	1.91	2.39	2.87	3.35	3.83	4.30	4.78	5.26	22.95
$\frac{5}{8}$	2.13	2.66	3.19	3.72	4.25	4.78	5.31	5.84	25.50
$1\frac{1}{16}$	2.34	2.92	3.51	4.09	4.68	5.26	5.84	6.43	28.05
$\frac{3}{4}$	2.55	3.19	3.83	4.46	5.10	5.74	6.38	7.01	30.60
$1\frac{1}{8}$	2.76	3.45	4.14	4.83	5.53	6.22	6.91	7.60	33.15
$\frac{7}{8}$	2.98	3.72	4.46	5.21	5.95	6.69	7.44	8.18	35.70
$1\frac{1}{16}$	3.19	3.98	4.78	5.58	6.38	7.17	7.97	8.77	38.25
1	3.40	4.25	5.10	5.95	6.80	7.65	8.50	9.35	40.80
$1\frac{1}{8}$	3.61	4.52	5.42	6.32	7.23	8.13	9.03	9.93	43.35
$1\frac{1}{16}$	3.83	4.78	5.74	6.69	7.65	8.61	9.56	10.52	45.90
$1\frac{3}{8}$	4.04	5.05	6.06	7.07	8.08	9.08	10.09	11.10	48.45
$1\frac{1}{2}$	4.25	5.31	6.38	7.44	8.50	9.56	10.63	11.69	51.00
$1\frac{5}{8}$	4.46	5.58	6.69	7.81	8.93	10.04	11.16	12.27	53.55
$1\frac{3}{4}$	4.68	5.84	7.01	8.18	9.35	10.52	11.69	12.86	56.10
$1\frac{7}{8}$	4.89	6.11	7.33	8.55	9.78	11.00	12.22	13.44	58.65
$1\frac{1}{2}$	5.10	6.38	7.65	8.93	10.20	11.48	12.75	14.03	61.20
$1\frac{9}{8}$	5.31	6.64	7.97	9.30	10.63	11.95	13.28	14.61	63.75
$1\frac{5}{4}$	5.53	6.91	8.29	9.67	11.05	12.43	13.81	15.19	66.30
$1\frac{11}{16}$	5.74	7.17	8.61	10.04	11.48	12.91	14.34	15.78	68.85
$1\frac{3}{4}$	5.95	7.44	8.93	10.41	11.90	13.39	14.88	16.36	71.40
$1\frac{13}{16}$	6.16	7.70	9.24	10.78	12.33	13.87	15.41	16.95	73.95
$1\frac{7}{8}$	6.38	7.97	9.56	11.16	12.75	14.34	15.94	17.53	76.50
$1\frac{15}{16}$	6.59	8.23	9.88	11.53	13.18	14.82	16.47	18.12	79.05
2	6.80	8.50	10.20	11.90	13.60	15.30	17.00	18.70	81.60

STEEL PLATES

1069

TABLE 189A.—Continued

Thickness in inches	3"	3¼"	3½"	3¾"	4"	4¼"	4½"	4¾"	12"
¾	1.91	2.07	2.23	2.39	2.55	2.71	2.87	3.03	7.65
	2.55	2.76	2.98	3.19	3.40	3.61	3.83	4.04	10.20
⅝	3.19	3.45	3.72	3.98	4.25	4.52	4.78	5.05	12.75
	3.83	4.14	4.46	4.78	5.10	5.42	5.74	6.06	15.30
⅜	4.46	4.83	5.21	5.58	5.95	6.32	6.69	7.07	17.85
	5.10	5.53	5.95	6.38	6.80	7.22	7.65	8.08	20.40
⅓	5.74	6.22	6.69	7.17	7.65	8.13	8.61	9.08	22.95
	6.38	6.91	7.44	7.97	8.50	9.03	9.56	10.09	25.50
⅔	7.01	7.60	8.18	8.77	9.35	9.93	10.52	11.10	28.05
	7.65	8.29	8.93	9.56	10.20	10.84	11.48	12.11	30.60
1⅓	8.29	8.98	9.67	10.36	11.05	11.74	12.43	13.12	33.15
	8.93	9.67	10.41	11.16	11.90	12.64	13.39	14.13	35.70
1½	9.56	10.36	11.16	11.95	12.75	13.55	14.34	15.14	38.25
	10.20	11.05	11.90	12.75	13.60	14.45	15.30	16.15	40.80
1⅞	10.84	11.74	12.64	13.55	14.45	15.35	16.26	17.16	43.35
	11.48	12.43	13.39	14.34	15.30	16.26	17.21	18.17	45.90
2	12.11	13.12	14.13	15.14	16.15	17.16	18.17	19.18	48.45
	12.75	13.81	14.88	15.94	17.00	18.06	19.13	20.19	51.00
2¼	13.30	14.50	15.62	16.73	17.85	18.97	20.08	21.20	53.55
	14.03	15.10	16.36	17.53	18.70	19.87	21.04	22.21	56.10
2½	14.66	15.88	17.11	18.33	19.55	20.77	21.99	23.22	58.65
	15.30	16.58	17.85	19.13	20.40	21.68	22.95	24.23	61.20
2⅞	15.92	17.27	18.59	19.92	21.25	22.58	23.91	25.23	63.75
	16.58	17.96	19.34	20.72	22.10	23.48	24.86	26.24	66.30
3	17.21	18.65	20.08	21.52	22.95	24.38	25.82	27.25	68.85
	17.85	19.34	20.83	22.31	23.80	25.29	26.78	28.26	71.40
3¼	18.49	20.03	21.57	23.11	24.65	26.19	27.73	29.27	73.95
	19.13	20.72	22.31	23.91	25.50	27.09	28.69	30.28	76.50
3½	19.76	21.41	23.06	24.70	26.35	28.00	29.64	31.29	79.05
	20.40	22.10	23.80	25.50	27.20	28.90	30.60	32.30	81.60

TABLE 189B.—WEIGHTS OF 100 MACHINE BOLTS WITH SQUARE HEADS AND NUTS

Wrought iron, manufacturers' standard sizes. Basis, Hoopes & Townsend's list

Length under head to point, inches	Diameter of bolt, in inches							
	$\frac{3}{8}$	1	$1\frac{1}{8}$	$1\frac{1}{4}$	$1\frac{3}{8}$	$1\frac{1}{2}$	$1\frac{3}{4}$	2
2	98	145						
$2\frac{1}{2}$	106	153						
3	114	163	240	309	350	480		
$3\frac{1}{2}$	122	174	253	325	370	500		
4	130	185	267	342	390	520	800	
$4\frac{1}{2}$	138	196	281	359	410	545	833	
5	147	207	295	376	430	570	866	1370
$5\frac{1}{2}$	155	218	309	394	450	595	900	1414
6	163	229	323	412	470	620	934	1458
$6\frac{1}{2}$	172	240	337	430	490	645	968	1502
7	180	251	351	448	510	670	1002	1546
$7\frac{1}{2}$	187	262	365	466	530	695	1036	1590
8	195	273	379	484	550	725	1070	1634
9	212	295	407	518	590	775	1138	1722
10	229	317	435	552	630	825	1206	1810
11	246	339	463	586	670	875	1274	1898
12	263	361	491	620	710	925	1342	1986
13	280	383	519	655	751	975	1410	2074
14	297	405	547	690	793	1025	1478	2162
15	314	427	575	725	835	1075	1548	2250
16	331	449	603	760	877	1125	1616	2338
17	348	471	631	795	919	1175	1684	2426
18	365	493	659	830	961	1225	1752	2514
19	382	515	687	86	1003	1275	1820	2602
20	399	537	715	900	1045	1325	1888	2690
21	416	559	743	935	1087	1375	1956	2778
22	437	581	771	970	1129	1425	2024	2866
23	454	603	799	1005	1171	1475	2092	2954
24	470	625	827	1040	1213	1525	2160	3042
25	487	647	855	1075	1255	1575	2228	3130

Bolts from $1\frac{1}{4}$ to 2", inclusive, are fitted with nuts made to U. S. standard

WEIGHTS OF 100 ROUND-HEADED RIVETS OR ROUND-HEADED BOLTS WITHOUT NUTS

Wrought iron, basis—1 cu. ft. iron = 480 lb.

Length under head to point, inches	Diameter of rivet, in inches						
	3/8	1/2	5/8	3/4	7/8	1	1 1/8
1	4.7	9.3	16.0	25.2	37.2	52.6	71.3
1 1/4	5.5	10.7	18.1	28.3	41.3	58.0	78.2
1 1/2	6.2	12.1	20.2	31.3	45.5	63.5	85.1
1 3/4	7.0	13.4	22.4	34.4	49.7	68.9	92.0
2	7.8	14.8	24.5	37.5	53.9	74.4	98.0
2 1/4	8.5	16.2	26.6	40.5	58.0	79.8	105.8
2 1/2	9.3	17.5	28.8	43.6	62.2	85.3	112.7
2 3/4	10.1	18.9	30.9	46.7	66.4	90.7	119.6
3	10.8	20.3	33.0	49.8	70.6	96.2	126.5
3 1/4	11.6	21.6	35.1	52.8	74.7	101.6	133.4
3 1/2	12.4	23.0	37.3	55.9	78.9	107.1	140.3
3 3/4	13.1	24.3	39.4	59.0	83.1	112.6	147.2
4	13.9	25.7	41.5	62.0	87.3	118.0	154.1
4 1/4	14.7	27.1	43.7	65.1	91.4	123.5	161.0
4 1/2	15.4	28.4	45.8	68.2	95.6	128.9	167.9
4 3/4	16.2	29.8	47.9	71.2	99.8	134.4	174.8
5	17.0	31.2	50.1	74.3	104.0	139.8	181.7
5 1/4	17.7	32.5	52.2	77.4	108.2	145.3	188.6
5 1/2	18.5	33.9	54.3	80.4	112.3	150.7	195.6
5 3/4	19.3	35.3	56.4	83.5	116.5	156.2	202.5
6	20.0	36.6	58.6	86.6	120.7	161.6	209.4
6 1/4	20.8	38.0	60.7	89.6	124.8	167.1	216.3
6 1/2	21.6	39.3	62.8	92.7	129.0	172.5	223.2
6 3/4	22.3	40.7	65.0	95.8	133.2	178.0	230.1
7	23.1	42.1	67.1	98.8	137.4	183.5	237.0
7 1/4	23.9	43.4	69.2	101.9	141.6	188.9	243.9
7 1/2	24.6	44.8	71.4	105.0	145.7	194.4	250.8
7 3/4	25.4	46.2	73.5	108.0	149.9	199.8	257.7
8	26.2	47.5	75.6	111.1	154.1	205.3	264.6
8 1/4	27.7	50.2	79.9	117.2	162.4	216.2	278.4
9	29.2	53.0	84.1	123.4	170.8	227.1	292.2
9 1/4	30.8	55.7	88.4	129.5	179.1	238.0	306.0
10	32.3	58.4	92.7	135.6	187.5	248.8	319.8
10 1/4	33.8	61.2	96.0	141.8	195.8	259.8	333.6
11	35.4	63.9	101.2	147.0	204.2	270.7	347.4
11 1/4	36.9	66.6	105.4	154.1	212.5	281.6	361.2
12	38.4	69.3	109.7	160.2	220.9	292.5	375.0
1" in length of 100 rivets	3.07	5.45	8.52	12.27	16.70	21.82	27.61
Weight of 100 rivet heads.....	1.78	4.82	9.95	16.12	24.29	34.77	47.67

TABLE 190.—WEIGHT OF CORRUGATED METAL GALVANIZED SHEETS

Weight in pounds per 100 sq. ft.

Corrugations, inches		Thickness, U. S. Standard gage															
Width	Depth	10	12	14	16	18	20	21	22	23	24	25	26	27	28	29	
5	$\frac{7}{8}$...	486	352	285	231	178	164	151	137	124	111	97	90	84	77	
3	$\frac{9}{16}$...	488	353	286	232	178	165	151	138	125	111	98	91	84	77	
$2\frac{1}{2}$	$\frac{7}{8}$	631	404	358	290	235	181	167	153	140	126	113	99	92	85	78	
$2\frac{1}{2}$	$\frac{7}{8}$	623	488	353	286	232	178	165	151	138	125	111	98	91	84	77	
2	$\frac{7}{8}$	286	232	178	165	151	138	125	111	98	91	84	77	
$1\frac{1}{4}$	$\frac{5}{8}$	186	172	158	144	130	116	102	95	88	81	
$\frac{5}{8}$	$\frac{3}{8}$	130	116	102	95	88	81	

NOTE.—Painted sheets weigh about 16 lb. less per 100 sq. ft. than the galvanized sheets.

TABLE 191.—CONDENSED TABLE OF STRENGTH OF REINFORCED-CONCRETE SLABS (Free End Supports)

Safe uniformly distributed superimposed load per square foot of slab for the span noted, exclusive of weight of slab

Factor of safety 5 which is *very conservative*.

(NOTE.—For factor of safety of 4 add one-fourth to the tabular loads.)

Concrete 1:2:4 mix.

Allowable unit stress in concrete . . . 500 lb. per square inch.

Allowable unit stress in steel . . . 14,000 lb. per square inch.

NOTE.—The safe concentrated load is one-half of the total uniformly distributed load over the effective width of slab resisting a concentrated load (see page 1042).

TABLE 191.—Continued

Span in Feet	Depth of Slab in Inches											
	6"	8"	10"	12"	14"	16"	18"	20"	22"	24"		
2	3,810	1,760	2,810	4,300	5,840							
4	895	725	1,180	1,830	2,500	3,300	4,420					
6	355	365	600	960	1,320	1,810	2,380	2,860	3,570			
8	163	197	340	550	780	1,090	1,440	1,730	2,180	2,670		
10	80											
12		100	200	340	490	690	930	1,120	1,420	1,750		
14			110	210	310	450	620	760	970	1,210		
16				120	190	300	420	520	680	750		
18					190		280	350	470	610		
20							200	230	330	430		
22								180	220	310		
24									150	210		
Resisting moment of slab in ft. lb. per ft. width of slab.....	1,925	3,770	5,890	8,500	12,030	16,170	20,960	24,940	30,800	37,260		
Net area of rods (sq. in.).....	0.25	0.25	0.39	0.39	0.56	0.56	0.77	0.77	1.00	1.00		
Spacing of rods (in.)...	6"	5"	6"	5"	6"	5"	6"	5"	5"	5"		
Depth below steel.....	1.00"	1.00"	1.25"	1.50"	1.50"	1.50"	1.50"	2.00"	2.00"	2.00"		
Weight of slab per sq. ft.....	77	103	128	154	180	206	232	257	283	310		

TABLE 192.—CONDENSED TABLE OF STRENGTH OF REINFORCED-CONCRETE BEAMS (Free End Supports)
 Safe uniformly distributed superimposed load per foot length of beam per inch width of beam, exclusive of weight of beam.
 To get the total superimposed load per foot length of the beam multiply the tabular load by the width of beam in inches.
 Factor of safety 5 (conservative practice). (1:2:4 mix)

Span in Feet	Depth of Beam in Inches						
	12"	18"	24"	30"	36"	42"	48"
6	152	370					
8	80	200	362				
10	46	120	222	370	540	760	
12	28	73	146	247	360	510	690
14	17	51	100	173	255	360	490
16		35	70	125	190	270	360
18			50	92	140	200	280
20				70	110	160	210
25					55	80	120
30						45	70
35							35
Resisting moment of beam in ft. lb. per inch width	740	1,740	3,100	5,030	7,200	10,000	13,300
Area of steel (sq. in.) per inch width	0.066	0.101	0.134	0.171	0.210	0.240	0.278
Distance from steel to bottom of beam	1.5"	1.5"	2.0"	2.0"	2.5"	2.5"	2.5"
Weight of beam 1" wide, 1' long	12.8 lb.	19.2 lb.	25.7 lb.	32.1 lb.	38.5 lb.	44.9 lb.	51.4 lb.

TABLE 193.—RECOMMENDED THICKNESS OF CONCRETE SLAB WHEN USED IN HIGHWAY BRIDGES UNDER DIFFERENT DEPTHS OF EARTH OR MACADAM FILL (Conservative Practice)

Span of Slab in Feet	Depth of Fill Over Slab in Feet						
	1'	2'	4'	6'	8'	10'	12'
2	6"	6"	6"	6"	6"	6"	6"
4	7"	7"	7"	7"	7"	7"	7"
6	9"	9"	9"	10"	10"	10"	11"
8	10"	10"	10"	11"	12"	13"	13"
10	12"	12"	13"	14"	15"	16"	17"
12	14"	14"	15"	16"	17"	18"	20"
14	16"	16"	17"	18"	19"	20"	22"
16	18"	18"	19"	20"	22"	24"	
18	20"	20"	22"	23"	24"		
20	22"	22"	23"	24"			

NOTE.—Side walls must be designed for beam action due to horizontal earth pressure—deep fills (see Fig. 67, p. 224, Chap. IV Part I).

Design of Structures under Deep Fills.—Design culverts and slab bridges under deep fills on the principle of rigid frames pin connected at the bottom of side walls.

Stresses are indeterminate and the usual formulæ are very complicated. The following simple formulæ have been found to be satisfactory and are conservative.

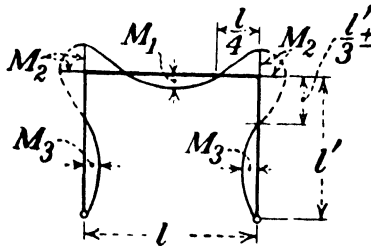

Approximate moment diagram.

$M_1 = 0.09 Wl$, vertical loads.

$M_2 = 0.06 Wl$, vertical loads + $0.06 W'l'$ horizontal pressure on sidewalls.

$M_3 = 0.12 W'l'$, horizontal pressure.

TABLE 194.—CONDENSED TABLE OF STRENGTH OF WOODEN BEAMS

Based on a very complete table published in the Cambria Steel Handbook to which the reader is referred if he is using much data of this kind.

This tabulation based on factor of safety of 6.

Allowable fiber stress 1200 lb. per square inch.

The loads given are the safe total uniformly distributed loads per inch width of beam for the span noted including the weight of the beam.

This table applies directly to white oak and long-leaf yellow pine.

For hemlock use one-half of the load given.

For Douglas fir, Norway pine, cypress, chestnut, and spruce, use two-thirds of the load given.

NOTE.—The safe concentrated superimposed load is one-half of the total superimposed uniformly distributed load exclusive of the weigh. of the beam.

For weight of timber see page 1038.

Span in Feet	Depth of Beam in Inches											
	4"	6"	8"	10"	12"	14"	16"	18"	20"	22"	24"	
4	535	1200										
6	355	800	1420									
8	270	600	1070	1670	2400							
10	215	480	850	1330	1920	2610						
12	180	400	710	1110	1600	2180	2840	3600				
14	150	340	610	950	1370	1870	2440	3090	3810			
16	135	300	530	830	1200	1630	2130	2700	3330	4030	4800	
18	120	270	480	740	1070	1450	1900	2400	2960	3590	4270	
20	105	240	430	670	960	1310	1710	2160	2670	3230	3840	
22	95	220	390	610	870	1190	1550	1960	2420	2930	3490	
24	90	200	360	560	800	1090	1420	1800	2220	2690	3200	
26		185	330	510	740	1000	1310	1660	2050	2480	2950	
28		170	305	480	690	930	1220	1540	1900	2300	2740	
30		160	285	440	640	870	1140	1440	1780	2150	2560	

NOTE.—If a deep beam is used for a shorter span than shown in the table figure the limiting load on the basis of shear along the neutral axis. By the formula

$$W = \frac{4bds}{3}$$

In which W = safe load in pounds uniformly distributed.

d = depth of beam in inches.

b = breadth of beam in inches.

S = allowable shear in the direction of the grain in pounds per square inch.

White pine..... 100 lb. per square inch.

Long-leaf yellow pine..... 150 lb. per square inch.

White oak..... 200 lb. per square inch.

The Deflection formula for a beam 1" wide under uniform load may be written $f = 270 (l/d)^3 W/E$. Following table gives values of $270 (l/d)^3$ for various spans and widths. In this formula, l is expressed in feet, f and d in inches, W in pounds of total load on beam divided by width in inches.

TABLE 195.—DEFLECTION OF TIMBER BEAMS

Values of C in the Formula, Deflection = CW/E for Beams 1" Wide and Uniformly Loaded

Span in feet	Depth in inches										
	4	6	8	10	12	14	16	18	20	22	24
5	530	160	66	34	20	12					
6	910	270	110	58	34	20	14				
7	1,450	430	180	93	54	33	23				
8	2,160	640	270	140	80	50	34				
9	3,080	910	380	200	110	71	48				
10	4,220	1,250	530	270	160	98	66	46	34	25	20
11	5,620	1,660	700	360	210	130	88	61	45	33	26
12	7,310	2,160	910	470	270	170	110	79	59	43	34
13	9,270	2,750	1,160	590	340	220	150	100	75	55	43
14	11,580	3,430	1,450	740	430	270	180	130	93	69	53
15	14,240	4,220	1,780	910	530	330	220	160	120	84	66
16	17,280	5,120	2,160	1,110	640	400	270	190	140	100	80
17		6,140	2,590	1,330	770	480	330	230	170	120	96
18		7,290	3,070	1,580	910	570	390	270	200	150	110
19		8,570	3,610	1,850	1,070	670	450	320	230	170	130
20		10,000	4,220	2,160	1,250	780	530	370	270	200	160
21			4,880	2,500	1,450	910	610	430	320	230	180
22			5,610	2,880	1,660	1,050	700	490	360	270	210
23			6,410	3,280	1,900	1,200	800	560	410	300	230
24			7,290	3,730	2,160	1,350	910	640	470	350	270
25				4,220	2,440	1,540	1,030	720	530	390	310
26				4,740	2,740	1,730	1,160	810	590	440	340
27				5,310	3,070	1,930	1,300	910	660	500	390
28				5,930	3,420	2,160	1,450	1,020	740	550	430
29				6,590	3,810	2,390	1,610	1,130	820	620	480
30				7,290	4,210	2,650	1,780	1,250	910	680	530
31							1,970	1,380	1,010	750	580
32							2,160	1,520	1,110	830	640
33							2,370	1,660	1,220	900	710
34							2,590	1,820	1,330	990	770
35							2,830	1,980	1,450	1,080	840
36							3,080	2,160	1,580	1,170	910

Since E varies considerably for woods of the same species, and for different degrees of seasoning and for variations in moisture content, the constants for intermediate depth may be selected by inspection. For a concentrated load at the middle of a beam multiply the value of C by 1.6.

NOTE.—American Civil Engineers' Handbook, John Wiley & Sons Co.

TABLE 196.—CONDENSED TABLE OF STRENGTH OF TIMBER UNDER LONG COLUMN ACTION

Based on the Formula of the U. S. Department of Agriculture, Division of Forestry.

$$P = F \times \frac{700 + 15C}{700 + 15C + C^2}$$

P = ultimate strength in pounds per square inch

F = " crushing strength of timber

$C = \frac{l}{d}$ in which l = length of column in inches

d = least diameter in inches

Safe load per square inch on the basis of a factor of safety of 8 is given below. A factor of safety of 6 is often used in good practice.

$\frac{l}{d}$	Safe Load in Pounds per Square Inch			
	White Oak and Long Leaf Yellow Pine	Douglas Fir and Short Leaf Yellow Pine	Red Pine, Spruce Hemlock, Cypress, Chestnut	White Pine and Cedar
5	600	550	480	420
10	560	500	450	390
15	510	450	400	350
20	450	400	360	310
25	400	360	320	280
30	350	320	280	250

NOTE.— $\frac{l}{d}$ over 30 is not advised.

TABLE 197.—STANDARD THICKNESS AND WEIGHTS OF CAST-IRON PIPE ADOPTED MAY 12, 1908, BY AMERICAN WATER WORKS ASSOCIATION

Inside Diameter Z Inches	LIGHT 100 Foot Head			MEDIUM 200 Foot Head			HEAVY 300 Foot Head			EXTRA HEAVY 400 Foot Head		
	43 Pounds Pressure			86 Pounds Pressure			130 Pounds Pressure			173 Pounds Pressure		
	Thick- ness	Weight per Foot Length		Thick- ness	Weight per Foot Length		Thick- ness	Weight per Foot Length		Thick- ness	Weight per Foot Length	
3	.39	14.5	175	.42	16.2	194	.45	17.1	205	.48	18.0	216
4	.42	20.0	240	.45	21.7	260	.48	23.3	280	.52	25.0	300
6	.44	30.8	370	.48	33.3	400	.51	35.8	430	.55	38.3	460
8	.46	42.9	515	.51	47.5	570	.56	52.1	625	.60	55.8	670
10	.50	57.1	685	.57	63.8	765	.62	70.8	850	.68	76.7	920
12	.54	72.5	870	.62	82.1	985	.68	91.7	1,100	.75	100.0	1,200
14	.57	89.6	1,075	.66	102.5	1,230	.74	116.7	1,400	.82	129.2	1,550
16	.60	108.3	1,300	.70	125.0	1,500	.80	143.8	1,725	.89	158.3	1,900
18	.64	129.2	1,550	.75	159.0	1,800	.87	175.0	2,100	.96	191.7	2,300
20	.67	150.0	1,800	.80	175.0	2,100	.92	208.3	2,500	1.03	229.2	2,750
24	.76	204.2	2,450	.89	233.3	2,800	1.04	270.2	3,350	1.16	306.7	3,680
30	.88	291.7	3,500	1.03	333.3	4,000	1.20	400.0	4,800	1.37	450.0	5,400
36	.99	391.7	4,700	1.15	454.2	5,450	1.36	545.8	6,550	1.58	625.0	7,500
42	1.10	512.5	6,150	1.28	591.7	7,100	1.54	716.7	8,600	1.78	825.0	9,900
48	1.26	666.7	8,000	1.42	750.0	9,000	1.71	908.3	10,900	1.96	1,050.0	12,600

TABLE 198.—LOCK JOINT CAST-IRON CULVERT PIPE

Inside diameter, inches	Thickness of pipe, inches	Face of hub, inches	Weight per foot, pounds	Length of units, feet
12	$\frac{3}{16}$	$\frac{9}{16}$	60	4
16	$\frac{3}{8}$	$\frac{5}{8}$	80	4
18	$\frac{3}{8}$	$\frac{5}{8}$	90	4
24	$\frac{9}{16}$	$1\frac{1}{16}$	115	3
30	$1\frac{1}{16}$	$\frac{3}{4}$	185	3 and 5
36	$\frac{3}{4}$	$1\frac{3}{16}$	250	3 and 5
42	$1\frac{3}{16}$	$1\frac{5}{16}$	350	4
48	$\frac{7}{8}$	1	450	5

TABLE 199.—AREAS AND WEIGHTS "ARMCO" CORRUGATED CULVERTS

(These weights are founded upon careful records made with respect to several thousand feet of each diameter, and very closely approximate the actual weights.)

Diameter in inches	Area in square feet	Weight per foot No. 16 gage	Weight per foot No. 14 gage	Weight per foot No. 12 gage	Weight per foot No. 10 gage
8	0.349	7.4			
10	0.545	9.2	11.3		
12	0.785	10.8	13.2		
15	1.227	13.1	16.0		
18	1.767	15.7	19.3	26.4	
21	2.405	18.4	22.6	30.9	
24	3.142	20.7	25.4	34.9	43.7
30	4.909	31.9	43.6	54.4
36	7.069	38.1	52.0	64.9
42	9.621	44.4	60.6	75.6
48	12.566	51.7	70.6	88.1
54	15.904	57.9	79.0	98.6
60	19.635	87.5	109.1
66	23.758	95.8	119.7
72	28.274	105.0	130.2
78	33.183	141.4
84	38.485	151.8

NOTE.—The only safe way to determine whether culvert pipes are of the correct gage and diameter is to weigh them.

**DIAMETER, AREAS, AND RECOMMENDED MINIMUM GAGES OF
ARMCO CULVERTS (WITH WEIGHTS PER FOOT), HIGHWAY
PRACTICE**

Nominal diameter	Area in square feet	Gage	Weight per foot
12	0.785	16	10.8
15	1.227	16	13.1
18	1.767	16	15.7
21	2.405	16	18.4
24	3.142	14	25.4
30	4.909	14	31.9
36	7.069	14	38.1
42	9.621	14	44.4
48	12.566	12	70.6
54	15.904	12	79.0
60	19.635	12	87.5
66	23.758	12	95.8
72	28.274	10	130.2
78	33.183	10	141.4
84	38.485	10	151.8

NOTE.—For very severe conditions culverts 48" and larger in diameter can be supplied in 8-gage Armco ingot iron.

TABLE 200.—TYPICAL REINFORCED-CONCRETE PIPE CULVERTS

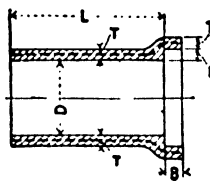
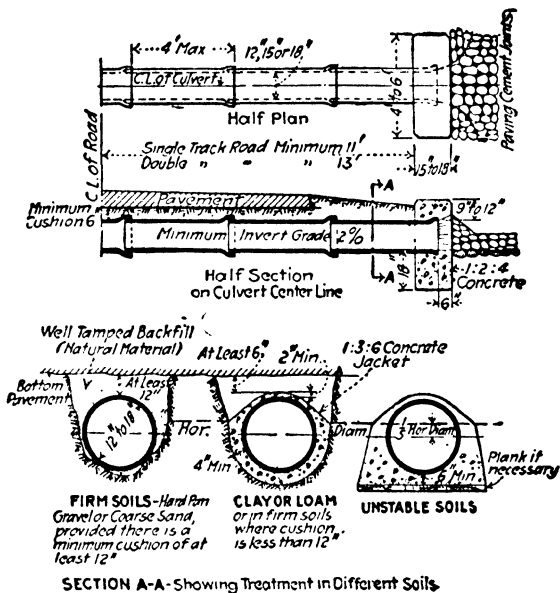
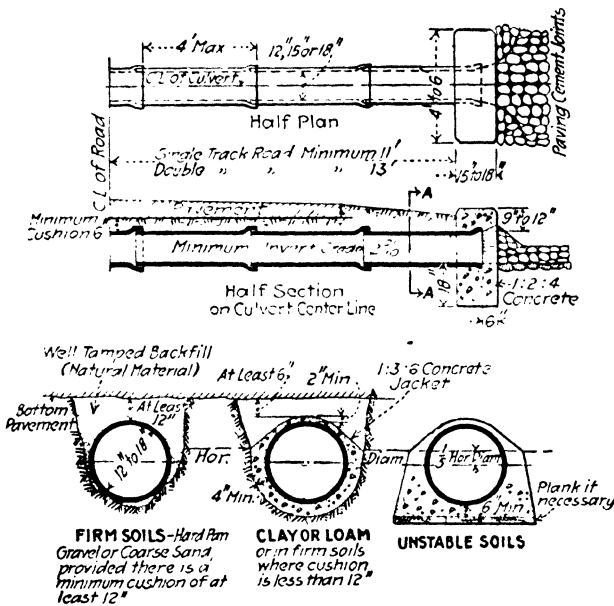

TABLE OF DIMENSIONS AND REINFORCEMENT FOR PIPE

Table of Dimensions				
D Inches	L-Max. Feet	T Inches	B-Min. Inches	E Inches
12	4	2	2 1/2	2 1/2
15	4	2	2 1/2	2 1/2
18	4	2 1/2	3	3
24	4	3	3	3 1/2
Effective Area of Circumferal Reinforcement Per Foot Length of Pipe				
12		0.058 Sq. Inches		
15		0.058 " "		
18		0.080 " "		
24		0.126 " "		
Approximate Weight Per Linear Foot of Pipe				
12		80 lbs		
15		110 "		
18		140 "		
24		260 "		



SECTION A-A—Showing Treatment in Different Soils

TABLE 201.—STANDARD VITRIFIED PIPE
APPROXIMATE WEIGHTS, DIMENSIONS, ETC. OF STANDARD SEWERS
PIPE

Caliber, in.	Price per foot	Weight, per foot, lbs.	Depth of socket, in.	Annular space, in.	Thick-ness, in.
12	\$1.35	45	2 1/4	1/2	1
15	1.80	60	2 3/4	1/2	1 1/4
18	2.50	85	2 3/4	1/2	1 1/4
20	3.00	100	3	1/2	1 3/4
22	4.00	130	3	1/2	1 3/4
24	4.50	140	3 1/4	1/2	1 3/4

DOUBLE-STRENGTH PIPE

Caliber, in.	Price per foot	Weight per foot, lbs.	Depth of socket, in.	Annular space, in.	Thick-ness, in.
15	\$1.80	75	2 1/4	1/2	1 1/4
18	2.50	118	2 3/4	1/2	1 3/4
20	3.00	138	3	1/2	1 3/4
22	4.00	157	3	1/2	1 3/4
24	4.50	190	3 1/4	1/2	2

GENERAL SPECIFICATIONS, REINFORCED-CONCRETE ARCHES,
DIVISION 4

Rock or hardpan foundations:

- Maximum pressure, hardpan..... 6 tons per square foot
- Maximum pressure, soft rock..... 8 tons per square foot
- Maximum pressure, hard rock..... 10-20 tons per square foot.

Arches not recommended on pile foundations (12 ton maximum).

Arches not permitted on earth foundations.

Arches not permitted with bottom ties (false arch) for spans over 10'.

QUANTITY AND COST DIAGRAMS BASED ON FOLLOWING DESIGN
ASSUMPTIONS (see page 324)

(Trial Empirical)

Road grade 2.0' above crown of arch extrados. Crown thickness not less than one-sixtieth of span and varied to agree approximately with Schwada's formulas for highway arches (Ketchum, p. 417).

Approximate spring thickness of arch ring.

3.0 × crown thickness for rise ratio of 0.125.

2.8 × crown thickness for rise ratio of 0.15.

2.5 × crown thickness for rise ratio of 0.25.

Curve of trial arch axis based approximately on Cochran's formulas for filled spandrel arches.

$$Y = \frac{4rL}{1 + 3r} (C^2 + 24C^{3/2}) \text{ (Hool and Johnson, p. 671).}$$

Final arch axis to correspond with dead load force polygon.

Minimum longitudinal arch reinforcement 1% at crown.

Transverse reinforcement to take full thrust of earth against spandrels and never less than $\frac{1}{3}C_c$ of section area.

Arch reinforcement symmetrical.

Spandrel walls cantilever design (see p. 326 and 1019).

Stirrups $\frac{1}{4}$ " circular spaced twice the depth of the arch ring at crown.

Empirical Test Stability Arch Rings.—A good quick test for the stability of the usual highway arch ring up to 80' spans, with rise ratios of 0.15 to 0.20 where the arch axis coincides with the dead load force polygon, and where the arch ring has at least the crown thickness shown on page 1087 and the intermediate ring thicknesses are proportioned approximately as per table on page 1087, with symmetrical reinforcement equal to at least 1% of area at crown, is to compute compression in concrete for full dead plus full live load at crown and spring considering load uniformly distributed over section. Uniform compression at crown should not exceed 200 lb. per square inch and at spring 120 lb. per square inch. These limits will automatically take care of distorted live loading, temperature stresses, etc.

TABLE 202.—TABLE OF COORDINATES, TRIAL ARCH AXIS
 FILLED SPANREL ARCHES
 Based on Cochran's Formula

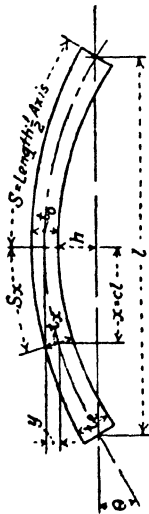

$$y = \frac{4r^l}{1 + 3r} (C^2 + 24C^4)$$

$$\tan \theta = \frac{4r}{1 + 3r} (1 + 7.5r)$$

$r = \text{Rise ratio} = \frac{h}{l}$

$u = \text{Ratio of thickness at any point to crown} = \frac{t}{t_0}$

$u_5 = \frac{t_5}{t_0}$

C ³	24C ³	z Coordinate in terms of total span l	Partial table y coordinate in terms of span l for different rise ratios															
			r = 0.10	0.12	0.14	0.15	0.16	0.18	0.20	0.25	0.30	0.35	0.40					
0.000	0.0000	C = 0.0 crown	0.0000	0.0000	0.0000	0.0000	0.0000	0.0000	0.0000	0.0000	0.0000	0.0000	0.0000	0.0000	0.0000	0.0000	0.0000	
0.0025	0.00007	C = 0.05	0.0031	0.00395	0.00414	0.00469	0.0050	0.00536	0.005734	0.00619	0.00669	0.00734	0.00811	0.00899	0.00999	0.01111	0.01234	
0.010	0.00024	C = 0.1	0.01256	0.01618	0.017	0.01933	0.02077	0.02269	0.02511	0.02811	0.03169	0.03586	0.04063	0.04603	0.05206	0.05883	0.06634	
0.022	0.00236	C = 0.15	0.02952	0.03868	0.0408	0.04693	0.05083	0.056783	0.06389	0.07226	0.08191	0.09283	0.10513	0.11891	0.13417	0.15091	0.16914	
0.040	0.00768	C = 0.20	0.05685	0.07600	0.0812	0.09538	0.10457	0.11748	0.13311	0.15056	0.16994	0.19126	0.21461	0.24099	0.27051	0.30317	0.33906	
0.062	0.02344	C = 0.25	0.100	0.120	0.140	0.1500	0.160	0.180	0.200	0.220	0.250	0.300	0.350	0.400	0.450	0.500	0.550	
0.090	0.05832	C = 0.30	0.100	0.120	0.140	0.1500	0.160	0.180	0.200	0.220	0.250	0.300	0.350	0.400	0.450	0.500	0.550	
0.122	0.12605	C = 0.35	0.100	0.120	0.140	0.1500	0.160	0.180	0.200	0.220	0.250	0.300	0.350	0.400	0.450	0.500	0.550	
0.160	0.24576	C = 0.40	0.100	0.120	0.140	0.1500	0.160	0.180	0.200	0.220	0.250	0.300	0.350	0.400	0.450	0.500	0.550	
0.202	0.41287	C = 0.45	0.100	0.120	0.140	0.1500	0.160	0.180	0.200	0.220	0.250	0.300	0.350	0.400	0.450	0.500	0.550	
0.250	0.75000	C = 0.50 sprn	0.100	0.120	0.140	0.1500	0.160	0.180	0.200	0.220	0.250	0.300	0.350	0.400	0.450	0.500	0.550	
Approx. angle θ			28° 20'	33° 50'	38° 45'	41° 10'	43° 20'	47° 35'	51° 20'	58° 40'	64° 00'	67° 54'	71° 00'	74° 00'	77° 00'	80° 00'	83° 00'	
Values of $\frac{4r}{1 + 3r}$			0.308	0.352	0.394	0.413	0.432	0.467	0.500	0.571	0.631	0.682	0.727	0.767	0.802	0.832	0.857	

This rule should not be used for economic design but it affords a good quick check on designs submitted for approval.

Readers are referred to Hool and Johnson's "Concrete Engineers' Handbook"¹ for full details of Cochran's method of arch design, which is probably the best and most practical method at present in use (1926).

TABLE 203.—TABLE OF ARCH THICKNESS
Cochran's Formula

Half axis divided into to parts $V = \frac{sx}{s}$	Thickness in terms of crown thickness for different values of U_s *					
	U_s 2.0	U_s 2.25	U_s 2.50	U_s 2.75	U_s 3.0	U_s 3.25
Crown	1.000	1.000	1.000	1.000	1.000	1.000
0.05s	1.005	1.004	1.003	1.002	1.001	1.000
0.15s	1.015	1.012	1.009	1.006	1.003	1.000
0.25s	1.025	1.020	1.015	1.010	1.005	1.000
0.35s	1.035	1.028	1.023	1.021	1.023	1.030
0.45s	1.048	1.048	1.057	1.070	1.083	1.101
0.55s	1.085	1.105	1.133	1.165	1.193	1.231
0.65s	1.168	1.215	1.269	1.328	1.385	1.455
0.75s	1.311	1.403	1.508	1.625	1.737	1.865
0.85s	1.547	1.700	1.862	2.025	2.185	2.355
0.95s	1.837	2.055	2.277	2.495	2.709	2.932
1.00 spring	2.000	2.250	2.500	2.750	3.000	3.250

* U_s = Arch thickness at spring
Arch thickness at crown

APPROXIMATE TRIAL ARCH THICKNESS AT CROWN (2.0' FILL OVER ARCH)
Based on Schwada's Rules (Modified)

Span, feet	Crown thickness, in inches, for different rise ratios					
	0.10	0.15	0.20	0.25	0.30	0.40
20	9	8	7	7	7	7
30	10	9	9	9	8	8
40	11	10	10	10	9½	9
50	12	11	11	11	10½	10
60	14	13	12½	12½	12	12
70	16	15	14½	14	14	14
80	19	18	17	16	16	16
Trial type U_s =	3.25	3.00	2.75	2.50	2.25	2.0

Preliminary Quantity Estimates.—The estimates of quantities are merely arithmetical procedure. The estimating of earth work and overhaul has already been explained in detail (pp. 971 to 1004).

¹ McGraw-Hill Book Company, Inc.

The following tables provide good quick checks on the detail arithmetical computations of pavements, and incidental items.

- Table 163 (p. 994), conversion lineal feet to miles.
 Table 204 (p. 1080), square yards per 100' and per mile.
 Table 205 (p. 1080), cubic yards pavement per 100'.
 Table 206 (p. 1090), gallons of bitumen per 100' road.
 Table 207 (p. 1092), materials required for concrete.

In estimating concrete or steel for culverts and bridges it generally pays to prepare a table of quantities for the different standard structures of different lengths which are sufficiently close for preliminary estimates. Tables 184 to 207 cover most incidental elements of ordinary drainage structures.

On the completion of the estimate of net quantities the contract estimate is prepared and tabulated as in following table showing the net quantities, contingent allowance, and gross quantity on which bids are taken.

ENGINEER'S APPROX. ESTIMATE OF QUANTITIES, ROAD 5021,
 COUNTY OF LIVINGSTON

Item No.	Item	Quantities		
		Net	Contingent	Gross bid
1	Cleaning and grubbing.....	L. S.	L. S.
2	Earth excavation, cubic yards.....	52,100	4,900	57,000
3	Rock excavation, cubic yards.....		100	100
7	Pipe underdrain, lineal feet.....	500	2,000	2,500
19	Portland cement, barrels.....	10,500	500	20,000
51	Cement-concrete pavement, cubic yards, etc., etc.	9,760	240	10,000

Cost estimates are then prepared (see Chap. XV for computation of unit costs).

Construction Plans.—The construction plans should give sufficient information to show the contractor what he is expected to do and to enable the constructing engineer to stake out and to build the road.

A finished set of plans consists of a map, profile, and cross-sections showing the alignment in relation to the preliminary survey line, the proposed grade elevations, the shape of the finished road, the widths and depths of road metaling, the crowns to be used, the existing structures and the proposed structures, and all the minor points of design. Each department has its own method of giving this information, and it makes little difference how it is shown so long as it is complete and clear. In general, it may be said that the

scales used are the same as in mapping the preliminary survey and that the size of sheets or rolls must be convenient to handle in the field; sheets larger than 24 by 30' are clumsy.

Miscellaneous Information. *Railroad Crossings.*—The special design of grade crossings or elimination is discussed in detail in Chap. IX, Part I.

TABLE 204.—SQUARE YARDS PER 100' AND PER MILE FOR DIFFERENT WIDTH OF SURFACE

Width in Feet	Number of Square Yards		Width in Feet	Number of Square Yards	
	Per 100 Feet	Per Mile		Per 100 Feet	Per Mile
8	88.889	4,603	26	288.889	15,253
10	111.111	5,867	28	311.111	16,427
12	133.333	7,040	30	333.333	17,600
14	155.556	8,213	32	355.556	18,773
15	166.667	8,800	34	377.778	19,947
16	177.778	9,387	36	400.000	21,120
18	200.000	10,560	38	422.222	22,293
20	222.222	11,734	40	444.444	23,466
22	244.444	12,907	42	466.667	24,640
24	266.667	14,080	44	488.889	25,813

TABLE 205.—GIVING THE NUMBER OF CUBIC YARDS OF MACADAM PER 100' OF ROAD FOR DIFFERENT WIDTHS AND DEPTHS

Width of Macadam	DEPTH							
	2"	2½"	3"	3½"	4"	5"	6"	7"
10'	6.17	7.71	9.26	10.80	12.34	15.43	18.52	21.61
12'	7.41	9.26	11.11	12.96	14.82	18.52	22.22	25.93
14'	8.64	10.80	12.96	15.12	17.28	21.61	25.92	30.25
15'	9.26	11.58	13.89	16.20	18.52	23.16	27.78	32.41
16'	9.88	12.35	14.81	17.28	19.76	24.70	29.63	34.57
18'	11.11	13.90	16.67	19.44	22.22	27.79	33.34	38.89
20'	12.35	15.44	18.52	21.60	24.70	30.87	37.04	43.21
22'	13.58	16.98	20.37	23.76	27.16	33.96	40.74	47.53

TABLE 206.—GALLONS PER 100' OF ROAD FOR DIFFERENT WIDTHS AND RATES OF APPLICATION

Width in Feet	NUMBER OF GALLONS TO THE SQUARE YARD											
	0.1	0.2	0.25	0.3	0.33½	0.4	0.5	0.6	0.66½	0.7	0.8	0.9
8	8.89	17.78	22.22	26.67	29.63	35.56	44.44	53.33	59.26	62.22	71.11	80.00
10	11.11	22.22	27.77	33.33	37.04	44.44	55.56	66.67	74.08	77.78	88.89	100.00
12	13.33	26.67	33.33	40.00	44.45	53.33	66.67	80.00	88.89	93.33	106.67	120.00
14	15.56	31.11	38.89	46.67	51.55	62.22	77.78	93.33	103.71	108.89	124.44	140.00
15	16.67	33.33	41.67	50.00	55.56	66.67	83.33	100.00	111.11	116.67	133.33	150.00
16	17.78	35.56	44.44	53.33	59.26	71.11	88.89	106.67	118.52	124.44	142.22	160.00
18	20.00	40.00	50.00	60.00	66.67	80.00	100.00	120.00	133.33	140.00	160.00	180.00
20	22.22	44.44	55.56	66.67	74.07	88.89	111.11	133.33	148.45	155.56	177.78	200.00
22	24.44	48.89	61.11	73.33	81.48	97.78	122.22	150.67	162.97	171.11	195.56	220.00
24	26.67	53.33	66.67	80.00	88.89	106.67	133.33	160.00	177.78	186.67	213.33	240.00
26	28.89	57.78	72.22	86.67	96.39	115.56	144.44	173.33	192.60	202.22	231.11	260.00
28	31.11	62.22	77.78	93.33	103.70	124.44	155.56	180.00	207.41	217.78	248.89	280.00
30	33.33	66.67	83.33	100.00	111.11	133.33	166.67	200.00	222.22	233.33	266.67	300.00
32	35.56	71.11	88.89	106.67	118.51	142.22	177.78	213.33	237.04	248.89	284.44	320.00
34	37.78	75.56	94.44	113.33	125.92	151.11	188.89	226.67	251.86	264.44	302.22	340.00
36	40.00	80.00	100.00	120.00	133.33	160.00	200.00	240.00	266.67	280.00	320.00	360.00
38	41.11	84.44	105.56	126.67	140.73	168.89	211.11	253.33	281.49	295.56	337.78	380.00
40	43.33	88.89	111.11	133.33	148.14	177.78	222.22	266.67	296.30	311.11	355.56	400.00
42	45.56	93.33	116.67	140.00	155.55	186.67	233.33	280.00	311.11	326.67	373.33	420.00
44	48.89	97.77	122.22	146.67	162.96	195.56	244.44	293.33	325.92	342.22	391.11	440.00

TABLE 206.—Continued

Width in Feet	NUMBER OF GALLONS TO THE SQUARE YARD												
	1.0	1.1	1.2	1.25	1.3	1.33½	1.4'	1.5	1.6	1.66½	1.7	1.8	
8	83.89	67.73	106.77	111.11	115.56	118.52	124.44	133.33	142.22	148.15	151.11	160.00	
10	111.11	122.22	133.33	138.89	144.44	148.15	155.56	166.67	177.78	185.19	188.89	200.00	
12	133.33	146.67	160.00	166.67	173.33	177.78	186.67	200.00	213.33	222.22	226.67	240.00	
14	155.56	171.11	186.67	194.44	202.22	207.41	217.78	233.33	248.89	259.26	264.44	280.00	
15	166.67	183.33	200.00	208.33	216.67	222.22	233.33	250.00	266.67	277.77	283.33	300.00	
16	177.78	195.56	213.33	222.22	231.11	237.04	248.89	266.67	284.44	296.30	302.22	320.00	
18	200.00	220.00	240.00	250.00	260.00	266.67	280.00	300.00	320.00	333.33	340.00	360.00	
20	222.22	244.44	266.67	277.78	288.89	296.30	311.11	333.33	355.56	370.37	377.78	400.00	
22	244.44	268.89	293.33	305.56	317.78	325.93	342.22	366.67	391.11	407.41	415.56	440.00	
24	266.67	293.33	320.00	333.33	346.67	355.56	373.33	400.00	430.67	444.44	453.33	480.00	
26	288.89	317.78	346.67	361.11	375.56	385.10	404.44	433.33	467.22	481.48	491.11	520.00	
28	311.11	342.22	373.33	388.81	404.44	414.82	435.56	466.67	497.78	511.51	528.89	560.00	
30	333.33	366.67	400.00	416.67	433.33	444.44	466.67	500.00	533.33	555.55	566.67	600.00	
32	355.56	391.11	426.67	444.44	462.22	474.08	497.78	533.33	568.89	592.58	604.44	640.00	
34	377.78	415.56	453.33	472.22	491.11	503.71	528.89	566.67	604.44	629.62	642.22	680.00	
36	400.00	440.00	480.00	500.00	520.00	533.33	560.00	600.00	640.00	666.67	680.00	720.00	
38	422.22	464.44	506.67	527.78	548.89	562.97	591.11	633.33	675.56	703.70	717.78	760.00	
40	444.44	488.89	533.33	555.56	577.78	592.60	622.22	666.67	711.11	740.73	755.56	800.00	
42	466.67	513.33	560.00	583.33	606.67	622.22	653.33	700.00	746.67	777.78	793.33	840.00	
44	488.89	537.78	586.67	611.11	635.56	651.85	684.44	733.33	782.22	814.81	831.11	880.00	

TABLE 207.—MATERIALS REQUIRED FOR 1 CU. YD. OF CONCRETE

Mixture	Cement	Sand	Stone
1-1½-3.....	1.9 bbls.	0.42 cu. yds.	0.85 cu. yds.
1-2-3.....	1.7 "	0.52 " "	0.77 " "
1-2-4.....	1.5 "	0.45 " "	0.90 " "
1-2½-5.....	1.2 "	0.46 " "	0.92 " "
1-3-6.....	1.0 "	0.47 " "	0.95 " "

The amount of water used per cu. yd. of concrete will vary greatly. A plastic mixture usually requires about 30 gals. per cu. yd., according to Baker, 40 gals. according to Barnes.

Where boulders are embedded in the foundations and side walls of small culverts similar to Plate 15, less cement, sand, and stone are required; our experience with work of this kind shows that only 0.8 to 0.9 bbls. of cement are needed per cu. yd. for the total amount of concrete in these culverts including cover and parapets. For all classes of work where boulders cannot be embedded these proportions are about right.

Fuller's Rule.—An approximate rule for ready calculation is the one originated by William B. Fuller, and is as follows: Divide 11 by the sum of the parts (by volume) of all the ingredients; the quotient is the number of barrels of Portland cement required per cubic yard of concrete. Multiplying this by the number of parts of sand and of stone will give the number of barrels of each. To reduce barrels to cubic yards, multiply by 0.14 (since a barrel contains 3.8 cu. ft. and there are 27 cu. ft. in a cubic yard).

For example, suppose it is wished to mix a concrete in the proportion 1-3-6. Then

$$6 + 3 + 1 = 10.$$

$$11 \div 10 = 1.1 \text{ bbl. of cement required per cubic yard of concrete.}$$

$$3 \times 1.1 \times 0.14 = 0.462 \text{ cu. yd. of sand required per cubic yard of concrete.}$$

$$6 \times 1.1 \times 0.14 = 0.924 \text{ cu. yd. of crushed stone required per cubic yard of concrete.}$$

Fuller's rule gives slightly more cement per cubic yard than is given in Table 207.

Wastage.—The quantities given by this rule and Table 207 are net quantities and do not allow for waste in unloading, hauling, etc. Wastage of sand and stone will amount to 2% to 10% depending on method of handling.

TABLE 207A.—AMOUNT OF CEMENT AND SAND PER CU. YD. OF MORTARS

Mortar mix	Cement, bbls.	Sand, c. y.
1:1	4.7	0.72
1:1.5	3.9	0.86
1:2	3.2	0.95
1:3	2.4	1.07
1:4	1.9	1.15

Right-of-way Computations.—The form of traverse computation and closure was shown on page 842.

The areas of rights of way are generally figured by dividing the parcel into rectangles, trapezoids, triangles, sectors, or segments, and figuring these shapes from the formulas given on page 1576. These areas are checked by planimeter. They are usually figured to the nearest 0.01 acre.

The method of double-meridian distances can, however, be used if desired. The following formula and example are given to illustrate this method. It is not often necessary and is a tedious computation.

The rule is: *Twice the area of the figure is equal to the algebraic sum of the products of the double-meridian distances of each course multiplied by its latitude*, in which the double-meridian distance equals the sum of the meridian distances of the two ends of each course referred to the meridian drawn through the most westerly point of the parcel, and the latitude of each course is reckoned as plus if the course runs north and minus if it runs south. Take as an example the right-of-way parcel shown in Fig. 276 (p. 842) for which the traverse has been figured, and refer the meridian distances to the meridian drawn through the corner 3.1' distance from Sta. 194 + 71.7.

EXAMPLE OF DOUBLE-MERIDIAN DISTANCE AREA COMPUTATION OF THE PARCEL SHOWN IN FIG. 276 (P. 842), AND FIG. GIVEN BELOW

Course number	Bearing	Distance	N	S	E	W	Lat.	D.M.D.	+ Areas	- Areas
1	N 23° 10' E	71.2	65.4	193.3	28.0	...	+ 65.4	28.0	1,831
2	S 78° 40' E	983.7	904.5	...	- 193.3	1,020.5	88,688
3	N 82° 30' W	438.2	57.2	434.5	+ 57.2	1,550.5	39,632
4	N 82° 45' W	562.7	71.0	558.2	+ 71.0	558.2

197,263 sq. ft. = 130,151 sq. ft. = 67,112 sq. ft.
 This equals twice the area of the parcel.
 Area of parcel = $\frac{67,112}{2} = 0.770$ acre.
 Area of parcel = $2 \times 43,560$

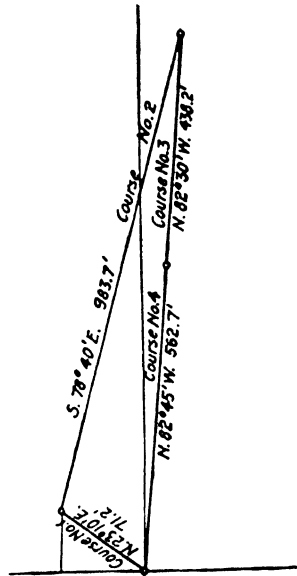

TYPICAL DESIGN REPORT

Table of Contents

	Page
Condensed General Recommendations	1095
Detail Report	
1. Location and Length	1095
2. Traffic Classification	1095
3. Grades and Alignment	1095
4. Suitable Pavement Types	1096
5. Soils (Detail List by Stations)	1097
6. Uniform Strength Design, Alternate Pavement Types	1097
7. Amounts of Material Required	1097
8. Local and Imported Materials Available	1098
9. Comparative Cost Estimates (Alternate Types)	1098
a. Construction	
b. Maintenance	
c. Renewal	
d. Motor Operation Costs	
10. Reasonable Maximum Expenditures and Recommended Design	1099
a. Economic Value of Improvement	
b. Intangible Value	
11. Bridges	1099
12. Railroad Grade Crossings	1099

Sample Design Report

"Rush-Mendon, Part 1, Road 1392.
 Monroe County, New York,
 Division Engineer,
 Rochester, N. Y.

"Dear Sir:

Find attached design report, Road 1392.

"Considering traffic, soil, and local material conditions, we recommend a 16' penetration-bituminous-macadam pavement varying in depth from 10 to 20" and averaging 11" for the entire road with gravel shoulders, 6% maximum grade, 301' minimum radius of curvature, 350' minimum sight distance, 24 to 32' width of grading section, 1½ to 1 slopes and cut to fill ratios of 1.10 to 1.30. A satisfactory pavement of this character is estimated to cost approximately \$1.60 per square yard for construction, 3.5 cts. per square yard per year for ordinary maintenance and 11 cts. per square yard per year for renewals over a long term of years. The total estimated construction cost is \$100,000. The detail report follows:

Detail Report

"1. Location and Length.—Proposed Road 1392 extends from Road 1393 to Road 1187, a distance of 3.69 miles. It completes the east-and-west state system in this locality and gives a continuous road from Caledonia to Canandaigua via Scottsville. It is not likely that this route will change the volume of traffic on Route 6 (Canandaigua to Caledonia via Avon), as Route 6 is shorter, but it will serve as a convenient pass during times of reconstruction on Route 6.

"2. Traffic Classification.—Road 1392 is on the verge between Classes II and III traffic according to classification map. It will probably carry about 400 to 1000 vehicles daily, which is lower-limit Class II or upper-limit Class III.

"3. Grades and Alignment.—The existing alignment is quite good and requires only minor improvements. The existing grades are in the main easy, with a few short steep grades of 8 to 9%. The new profile, as a rule, follows the existing road closely with short grade reductions. The total rise and fall for the old and new road is about the same. The proposed grading will have some effect on motor operation cost, but is largely useful in providing a convenient width for traffic and a smooth bed for the pavement. In figuring the economic value of the improvement, grade reductions can be given some weight for this road (see accompanying tabulation based on Curve 1, Fig. 2, p. 13). Total grading cost estimated at \$32,000. Maximum economic benefit of grading estimated at \$18,000.

COMPARISON CAPITALIZED MOTOR OPERATION COST, OLD AND NEW PROFILE

(Based on Curve 1, Fig. 2, p. 13)

Rate of grade, per cent	Estimated capitalized cost per 100 vehicles daily per foot of distance	Old profile		New profile	
		Length, feet	Amount 100 vehicles daily	Length, feet	Amount 100 vehicles daily
1.0 or less	\$ 9.10	8,300	\$ 75.430	7,900	\$ 71.800
1.5	9.12	800	7,290	400	3,648
2.0	9.15	1,200	10,980	1,700	15,555
2.2	9.17	200	1,834	800	7,336
2.4	9.19	500	4,505	700	6,433
2.6	9.21	600	5,526	300	2,763
2.8	9.23	1,000	9,230	800	7,384
3.0	9.25	800	7,400	1,600	14,800
3.2	9.28	800	7,424	500	4,640
3.4	9.31	500	4,655	500	4,655
3.6	9.34	400	3,736	1,000	9,340
3.8	9.37	100	937		
4.0	9.40	400	3,760	700	6,580
4.2	9.45	300	2,835	200	1,890
4.4	9.50	400	3,800	400	3,800
4.6	9.56	500	4,780	100	956
4.8	9.63	200	1,926	200	1,926
5.0	9.70	300	2,910	100	970
5.2	9.80	100	980	100	980
5.4	9.90	100	990		
5.6	10.00	400	4,000	300	3,000
5.8	10.00	400	4,040	400	4,040
6.0	10.20	800	8,160
6.5	10.70				
7.0	11.20	100	1,120		
7.5	11.85	500	5,925		
8.0	12.50	300	2,500		
8.5	13.25	100	1,325		
9.0	14.00	100	1,400		
9.5	14.75				
10.0	15.50	200	3,100		
100 vehicles daily total.....			\$184,534	\$180,746
500 vehicles daily total.....			\$922,534	\$904,000

Maximum economic value of grading \$18,000. (\$22,000-\$904,000)

4. Suitable Types of Pavement (Based on Traffic Classification).—For lower-limit Class II traffic, either penetration bituminous macadam or water-bound macadam oiled is suitable (see Table 13, p. 58). Reinforced cement concrete might be considered under specially favorable conditions of material supply, but for the volume of traffic expected there would probably have to be unusually strong reasons of expediency to warrant consideration of this type. For comparative estimate purposes the cheapest possible type of this pavement will be used (see Fig. 156, p. 454), 7" uniform depth, 1:2:4 mix, 1.7 cement content, 50-lb. reinforcement per 100 sq. ft. of pavement.

5. Soils.—The subgrade soils are as follows:

SOIL ON ROAD 1392

(Named in order of greatest amount of each first)

Station	Soils	Station	Soils
0- 2	Muck	142-154	Loam clay
2- 72	Loam gravel sand	154-157	Loam sand
72-106	Loam gravel	157-160	Loam muck
106-110	Sand loam	160-165	Loam clay
110-126	Loam clay	165-172	Loam sand
126-130	Loam muck	172-181	Clay loam
130-142	Loam gravel	181-194	Loam clay

"6. Uniform Strength Design (Alternate Pavement Estimates).—Macadam depths based on Table 153 (p. 959), concrete pavement based on Fig. 156 (p. 454).

Station to station	Soil	Grading conditions	Total pavement depths	
			Macadam, inches	Concrete 1:2:4 mix, 0.5-lb. reinforcement per square foot, inches
0- 2	Muck	Gravel fill 4'	8	7
2- 49	Loam gravel	Light cuts and fills	10	7
49- 51	Loam gravel	Fill 2 to 4'	9	7
51- 72	Loam gravel	Light cuts and fills	10	7
72- 89	Loam gravel	Light cuts and fills	10	7
89- 91	Loam gravel	Fill 2 to 5'	9	7
91-106	Loam gravel	Light cuts and fills	10	7
106-110	Sand loam	Light cuts and fills	9	7
110-112	Loam clay	Fill 2 to 4'	10	7
112-123	Loam clay	Light cuts and fills	12	7
123-126	Loam clay	Fill 2' deep	11	7
126-130	Loam muck	Light cuts and fills	20	8 ¹
130-142	Loam gravel	Light cuts and fills	10	7
142-149	Loam clay	Light cuts and fills	12	7
149-153	Loam clay	Fill 1.5' deep	11	7
153-157	Loam sand	Light cuts and fills	10	7
157-160	Loam muck	Light cuts and fills	20	8 ¹
160-165	Loam clay	Light cuts and fills	12	7
165-172	Loam sand	Light cuts and fills	10	7
172-181	Clay loam	Light cuts and fills	13	7
181-194	Loam clay	Light cuts and fills	12	7

¹ 12-in. gravel subbase under concrete.

Average depth macadam 11". Use normal 10" with extra subbase allowance.

NOTE.—The average of 11" is liberal, as Road 502 at east end of this road has served same class of traffic with same general soil conditions with a depth of 9" for the last 10 years with only minor area weakness.

"Road 502 has a 6" boulder base and a 3" penetration-bituminous-macadam top.

"We recommend for this road a boulder base 6¼ to 16¼" deep laid in layers not exceeding 8" depth filled with coarse gravel or crushed stone and capped with a 3¼" penetration-bituminous-macadam top.

"7. Amounts of Material Required.—There are 37,000 sq. yd. of pavement on this road.

"Macadam type of pavement will require approximately:

7,800 cu. yd. gravel or boulder foundation
 3,700 cu. yd. 3½" top course
 75,000 gal. bitumen (binder) or
 12,000 gal. surface oil

"Concrete pavement will require approximately:

7,250 cu. yd. 1:2:4 concrete
 12,300 bbl. cement
 166,000 lb. steel
 10,000 lin. ft. expansion joints
 400 cu. yd. gravel foundation.

"8. Materials Available.—For details, see Survey Field Book 1392. A limited supply of local boulder fence stone fit for subbase or crushed bituminous macadam top is available. Unlimited supplies of coarse hard gravel fit for subbase, subbase filler, or concrete are available. Imported materials can be unloaded at Rochester Junction or Rush and delivered with short hauls. Water supply abundant year round from Honeye Creek.

"For purposes of estimating concrete pavement, use Mead's gravel pit, Sta. 50.

"For purposes of estimating macadam, use local boulder subbase bottom entire length filled with gravel or local crushed stone and capped with 3½" consolidated depth of local granite top, Stas. 0 to 100, and imported limestone top, Sta. 100 to 195. There are 10,000 to 12,000 cu. yd. of boulder available, but in order to get this amount the farmers will insist on bottoms being cleaned up, which will necessitate blasting large granite boulders which can be used to best advantage for local stone top bituminous macadam type. For water-bound macadam, imported limestone will have to be used.

"On this basis, fair comparative preliminary estimates of cost are given in Art. 9. Detail cost figures are on file in estimate book under Road 1392.

"9. Comparative Cost Estimates.

Type	Cost per square yard of pavement					
	Average thickness, inches	Estimated construction cost	Yearly interest 5%	Yearly maintenance, Table 97 (p. 520)	Yearly renewal Table 97 (p. 520)	Total yearly charge
Water-bound macadam ¹	11	\$1 50	\$0 075	\$0 065	\$0 10	\$0 24
Bituminous macadam ²	11	1 60	0 008	0 035	0 11	0 225
Cement concrete	7	2 30	0 115	0 010	0 12	0 245

¹ Limestone top (oiled).

² Part granite, part limestone top.

"Grading, culverts, and incidental items are estimated at \$43,000 for all types of pavement.

"Total estimated construction costs for different widths of different types are tabulated below:

Type of pavement	Widths of pavement					
	8'	10'	12'	14'	16'	18'
Water-bound macadam.....	\$70,000	\$78,000	\$85,000	\$90,000	\$90,000	\$105,000
Bituminous macadam.....	73,000	80,000	88,000	94,000	102,000	109,000
Cement concrete.....	85,000	96,000	108,000	116,000	128,000	138,000

EFFECT OF MOTOR OPERATION ON TOTAL COST OF TYPES TO THE COMMUNITY (Based on Table, p. 551, Chap. VII)

"For a volume of 500 vehicles daily the comparative total yearly charge against the different types proposed is as follows:

Water-bound macadam.. \$0.24 + \$0.01 = \$0.25
 Bituminous macadam... 0.225 + 0.01 = 0.235
 Cement concrete..... 0.245 + 0.00 = 0.245

"10. Reasonable Maximum Expenditure.—Reasonable expenditures based on reduction in traffic operation cost can be estimated approximately as follows:

"Grade reduction value (Art. 3 of this report) is estimated at not to exceed \$18,000.

"Pavement value is roughly estimated as follows: The old existing road is a narrow gravel road in fairly good condition; the new pavement will not probably reduce the cost of operation over 1 ct. per vehicle mile, but it will add materially to the safety and convenience of operation, which are classed as intangible benefits. Actual reductions in operation cost (see Table 7, p. 15) will not probably justify construction expenditures of over \$16,000 per mile for 500 vehicles daily, or a total of approximately \$60,000. The total maximum economic value, including grading and pavement, does not probably exceed \$75,000. Any expenditure over this amount must be charged to convenience, pleasure, and other desirable intangible benefits. This indicates that caution should be exercised in running the cost up needlessly. Article 9 indicates that, in order not to exceed the economic limit, a 10' width of water-bound macadam is the most feasible solution. A pavement as narrow as this is not in accord with the general highway policy, which is based on a minimum width of 16' on the score of intangible benefits. We therefore recommend the use of 16' width of bituminous macadam estimated to cost \$100,000. This recommendation seems to be warranted, as this type will satisfy traffic demands without running the construction cost up needlessly and without increasing the total final cost of road, including maintenance, renewal, and motor operation over and above the final cost resulting from the use of a more expensive first-cost pavement.

"11. Bridges.—There are no bridges on this road.¹

"12. Railroad Crossings.—At Sta. 91 the road crosses the Rochester branch of the Lehigh Valley R. R. at grade. This crossing is a blind one and has no protection. It is 69 in order of importance in this division for elimination, which means it will not be eliminated for a number of years, but in the meantime it is entitled to better protection than now exists; we recommend the immediate installation of automatic flash signals located on the side of the road outside of the pavement area.²

(Signed)
 Designing Engineer"

REMARKS.—For the interest of the reader, actual procedure on this road was as follows: Plans were first prepared for cement-concrete pavement. Before these were let, the administration changed and the plans

¹ For typical bridge report see p. 327, Chap. IV, and p. 774, Chap. XII.

² For detailed discussion of grade crossings see Chap. IX.

were revised for bituminous macadam 7" boulder base, 3" imported slag middle course, and 2½" imported limestone top, engineer's estimate of cost, \$123,000. The road was constructed on this basis for \$102,000 actual contract cost; the pavement proper cost \$65,000, or approximately \$1.75 per square yard. This final solution was an improvement over the first plans. A careful engineering design could probably have decreased the cost at least \$8000 to \$10,000 as shown in the body of this report, by a more complete utilization of local materials and more variation in depth to meet varying soil conditions and a somewhat more economical grading design. An automatic signal has recently been erected at the railroad crossing as recommended.

Record Plans and Maps

No generalization can be made as to records except that they must be complete and be kept up to date.

On the completion of construction the original plans are amended to show all construction charges, subgrade soils, depths of pavement

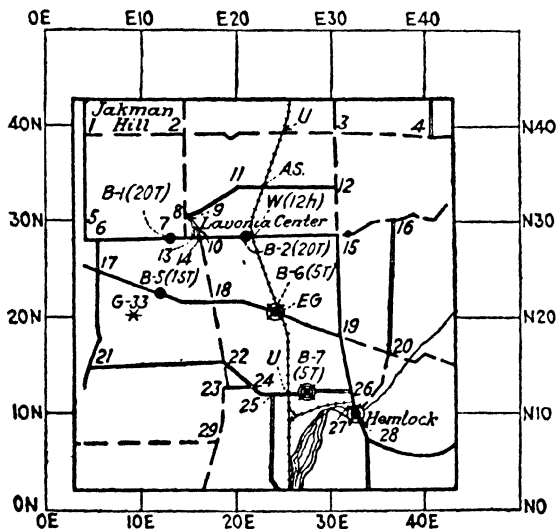

Partial Index of Location of Road Corners

Corner Number	North Coordinate	East Coordinate
1	N39	E4
2	N39	E14
Etc.	—	—
20	N16	E36

Sample record map, showing location of bridges, railway crossings etc.

station by station, etc. Similar plan records are kept for reconstruction so that it is possible to determine subsoil and pavement thicknesses at all points.

Accurate district road maps giving local names and with all road intersections numbered are necessary in order to locate structures, detours, grade crossings, bridges, etc. by a definite designation which can be easily followed in correspondence. The accompanying sketch illustrates a convenient method for such maps.

Similar maps showing location and condition of bridges and grade crossings help materially in laying out reasonable programs. Sample map of this nature is shown on page 1100.

MAP SYMBOLS AND LEGENDS

Bridges:

- Masonry and concrete:
- Ample width and strength..... ●
 - Narrow but strong..... ●
 - Ample width but weak..... ●
 - Narrow and weak..... ●
 - Safe load in tons-brackets..... (5T)

- Steel:
- Ample width and strength..... ⊙
 - Narrow but strong..... ⊙
 - Ample width but weak..... ⊙
 - Narrow and weak..... ⊙
 - Safe load in tons-brackets..... (10T)

- Wooden:
- Ample width and strength..... ⊙
 - Same symbols for width and strength as for other types.

- Railroad Crossings:
- U*—Unprotected
 - W*.—Watchmen—no. hours (12)
 - A.S.*—Automatic signals.
 - E.G.*—Elimination—good.
 - E.F.*—Elimination—fair.
 - E.P.*—Elimination—poor.

- Location of Materials:
- ×—Sand.
 - ✕—Gravel.
 - *—Stone.
 - Etc.
 - Sample number after symbol.

- Pavements:
- Any symbols desired.
 - On sample map as follows:
 - ===== earth.
 - -- Gravel.
 - Macadam.
 - Concrete.

Explanation of Sample Record Road Map.—The main value of record highway maps is to show the location and general condition of the pavements, bridges, railroad crossings, detours, unloading

points, and local material supplies. After the base map is prepared it is possible by means of various symbols and legends to include any class of information desired.

As a general rule, it is desirable to avoid cluttering the map up too much, which results in separate maps for pavement records, material supplies, bridges, grade crossings, etc. The sample map given includes all these types of information merely to illustrate the value of such maps and is explained as follows:

Detours.—Suppose bridge 6 between corners 18 and 19 is closed for repair and it is desired to indicate the detour by letter or by telephone message. Detour is as follows corner 18-14-15-19 by good gravel and macadam roads.

Bridge Data.—Suppose it is desired to move heavy machinery; such movements can be routed by means of the bridge data and corner numbers.

Grade-crossing Data.—General condition of territory in the matter of protection can be easily visualized by a map bearing these data.

Location of Local Materials.—Gravel pit (official sample G-33) suitable for gravel bottom and top courses but unsuitable for concrete is located N20 East 10.

Requests for Expenditure Authorization.—Location of culverts, bridges, etc. can be easily made as follows:

Culvert located 320' from corner 21 towards corner 22.

Rural Directory Location.—Corner 21 towards 22 (3-R) meaning third house on right side of road.

Any number of other uses desired.

THE LOCATION OF NEW ROADS

Detail instructions compiled by the author for drafting-room procedure in connection with the design of mountain roads.

Notes for Designers on the Preparation of Plans

In the preparation of plans, the quickest and easiest methods which will be sufficiently accurate for the purpose should be used.

In this connection, it should be borne in mind that, as a rule, graphic methods are to be preferred to computations wherever such methods are sufficiently accurate. This will probably occur in nine cases out of ten.

Considering the methods which will be employed in constructing mountain roads and in staking them out for construction, localized errors in paper locations are not important factors in determining the value of the design.

A localized error in length of 1 or even 2' per 100' on one curve will not materially affect the accuracy of the layout or the quantity of excavation, particularly as these errors tend to balance and they are never cumulative.

A localized error of 0.1 or even 0.2' on the profile grade line will not destroy the value of the plans or the value of the estimate, as it is not cumulative.

Careful graphic methods will not exceed these limits and the average error should be well within the necessary accuracy.

A sample sheet of plan and profile using graphic methods is attached (see p. 1106). This shows a uniform method of procedure which is to be followed wherever, according to best judgment, the method can be used.

Instructions for Drafting Room

It is necessary in drafting-room work to keep all records and computations in as neat and orderly condition as possible.

Have on your desk only as much material as you need for the work you are doing. *Keep the rest in the files.*

At night clean off the tables completely and place your working material either in your table drawers or in the files. Cover tables with cover.

All computations and maps must be marked plainly with the name of the job.

All office computations which will become part of the permanent records are to be made on the forms provided or on letter-sized sheets.

The designing chief for each project will be responsible for the following notations on all records:

Name of job on each separate sheet or roll of computations and plans

Name of computer on each sheet.

Name of checker on each sheet.

The methods employed in all work should be shown in enough detail to make it possible for anyone to check the results.

Drafting-room Supplies

Tracing cloth, plain, 25" wide.	1.7 yd. per mile
Detail paper (36" wide) (1 lb. = 8' of 36" paper) $\frac{1}{3}$ lb.	$\frac{1}{3}$ lb. per mile
Cross-section paper (opaque) (used for profiles) 22" wide	1.7 yd. per mile
Transparent cross-section paper (22" wide)	6 yd. per mile
Cross-section sheets (18 by 24")	12 sheets per mile
Cost per mile, office supplies, \$1.50. ¹	

Detail Instructions, Mountain Road Design

These instructions have been prepared in detail, as many of the men have no idea of the order of work or reasonable speeds on the various parts of the design and in many cases they waste time by needless work on the rough plans. The cost of design work is often high on account of the inexperience of the force. By a careful study of these instructions some improvement in speed and cost should be obtained.

¹ 1918 scale of costs.

Speed of Work.—The following list of reasonable speed is based on a 7-hr. working day for the average man. If you are not equaling this rate ask the chief draftsman to see if he can help you find the cause.

General Speed.—Two miles per month per man of completed plans when men are experienced.

About $1\frac{1}{4}$ miles per month per man when force is not used to road design.

TABLE 208.—DETAIL REASONABLE SPEED

Division of Work	Approximate Miles per Day per Man
1. (a) Plotting, checking, and inking base line and plotting topography.....	1.5
¹ (b) Base-line profile complete.....	3.0
Computing and checking cross-section notes, 140 sections approx., per day per man..	1.5
¹ (c) Plotting and checking cross-sections.....	1.0
(d) Inking cross-sections.....	1.5
2. (a) Trial grade line.....	7.0
¹ (b) Projecting grade contour on map.....	1.5
(c) Projecting final center line.....	1.0
3. ¹ (a) New center-line profile.....	1.0
¹ (b) Balanced section profile.....	1.5
(c) Trial final grade based on balanced profile	1.5
(d) Drawing templates on sections.....	2.0
(e) Planimeter sections and compute quantities.....	0.8
¹ (f) Determine final grade line and balance quantities.....	0.4
(g) Ink final grade line.....	7.0
4. (a) Compiling estimate.....	2.0
5. (a) Tracing plans.....	0.6

¹ Indicates work that can be done to advantage by two men working together.

REASONABLE COST

General Cost } \$40 to \$50 per mile with experienced men
 Completed Plans } \$80 to \$100 per mile with inexperienced men

DETAIL COSTS

Based on the following wages:

Designer.....	\$150 per month
Draftsman.....	110 per month
Tracers.....	90 per month
Computers.....	80 per month

1917 SCALE OF COSTS. COSTS IN 1926 ABOUT 80% HIGHER THAN 1917

	Cost per Mile
1. (a) Detailed paper map.....	\$ 2.50
(b) Base-line profile.....	1.00
Computing sections.....	2.00
(c) Plotting and checking cross-sections.....	3.00
(d) Inking cross-sections.....	2.00
2. (a) Laying trial grade.....	1.00
(b) Projecting grade contour.....	3.00
(c) Projecting final center line.....	8.00
3. (a) New center-line profile.....	3.50
(b) Balanced section profile.....	4.00
(c) Trial final grade based on balanced profile.....	4.00
(d) Templates drawn on.....	3.00
(e) Planimeter and computation of quantities.....	4.00
(f) Determine final grade line and balance quantities.....	10.00
(g) Ink in final grade line.....	.50
4. (a) Compile estimate.....	3.00
5. (a) Trace plans.....	5.00
Total.....	\$59.50

STADIA SURVEYS

(Reasonable speeds)

Field work.....	400 to 600 shots per day (three-man party)
Office work:	
Reducing and checking shots.....	350 shots (two men)
Plotting shots.....	500 shots (two men)

Detail Office Design, Manipulation

General Note.—Get all information on rough plans and profiles needed by the tracer, but do not ink anything not likely to be erased during the design and do not attempt to print notes, etc. A great deal of time is being wasted every day by unnecessary work on the rough plans. It is appreciated that good work has been done, but further improvement can be made.

Be careful to mark the name of the road on all rolls, sheets, etc., before starting work.

It is not expected that these instructions will be followed absolutely, but the system outlined has been proved in practice and it is expected that you will follow the principles, give the information called for, and that you will eliminate useless work.

1. Preliminary Work. a. Map.—(See sample map. One man working alone.)

The map is drawn on a roll of detail paper 18" wide.

Scale 1" = 100'. In exceptionally hard locations use 1" = 50'

Order of Work.—(1) Plot base line in pencil (6H) using vernier protractor or tangent method in plotting angles and careful scaling

for distances between transit points. Plot bearing of each course from north line drawn through each transit point.

(2) Check this plotting.

(3) Ink in the base line with a fine, solid black line and mark the transit points with small circles.

(4) Mark the even stations with a short ink dash and number every fifth station in black ink. Mark station of transit points in black ink.

(5) Mark true bearing or azimuth on each course in black ink and check.

(6) Show the location of each cross-section by a fine red-ink line extending far enough from the base line to reach any center line shift and check. Do this work very carefully as your center-line distances will be affected.

(7) Plot topography in pencil (4H) making the lines heavy and firm so it can be easily traced without inking. *DO NOT INK.* Write all notes, property names, etc., in large plain longhand. *DO NOT PRINT.* Use 4H pencil with a blunt point so tracer can read easily.

b. Base-line Profile.—(See sample profile.)

Use heavy white paper roll 22" wide ruled in squares 10 to the inch.

Scales.—Use 1" = 100' horizontal or 1" = 50' horizontal to agree with the map scale. Use 1" = 10' vertical.

Order of Work.—(1) One man mark even stations in pencil along upper margin. Use 4H pencil with blunt point and make the figures large and distinct, but don't be fussy.

(2) (Two men.) One man calling from notes. Other man write in pencil on profile the elevations of base line at even stations and pluses.

Record these elevations in tens, units, and tenths. Do not record hundreds and thousands. These can be easily determined by the datum on the profile and their omission saves time.

Also, write pluses of stationing on margin. Use 4H pencil, large plain figures, but do not be fussy. Check back these figures.

(3) (One man.) Plot profile points by referring to elevations marked in pencil. If reasonable care is taken in plotting, this need not be checked.

(4) Ink in ground line with light, firm black-ink line.

c. Cross-sections.—(See sample sheet.)

Plot on transparent cross-section paper cut in sheets 22 by 36" and ruled 1" = 10 parts or 1" = 5 parts heavy and 5 subdivisions lighter.

Scale.—Use 1" = 5' except for exceptionally heavy work when 1" = 10' may be used.

Elevations.—Points must be plotted by their absolute elevation referred to the datum used for the bench levels. The heavy lines outlining each square inch must be used as an even 5 or 10' of absolute elevation.

Order of Work.—(Two men work together.) (1) Mark base-line verticals and use same vertical for all sections in each row. Generally two rows of sections can be placed on each sheet.

SCALE	PROFILES	VERTICAL CURVE	PIVOTS	STAKES
1" = 100'	1" = 100'	1" = 100'	1" = 100'	1" = 100'

COLORED SURVEYING

SHOW IN BLUE: Rivers, Streams, Etc.
SHOW IN RED: Topography and existing structures
SHOW IN BLACK: Lines, Letters and figures relating to
 Survey Station, Bench Marks, etc.
SHOW IN GREEN: Center Line, New Grade Line, New
 Structures and all Lines, Letters and
 Blue, Black-India Ink and Thick
 Water-color Vermilion.

SAMPLE SHEET

Standard Plan, Profile, Etc. for Pioneer
 To be used where the Center Line does not
 and where the Center Line for Construction
 will be staked out by offsets from the Survey
 Line.

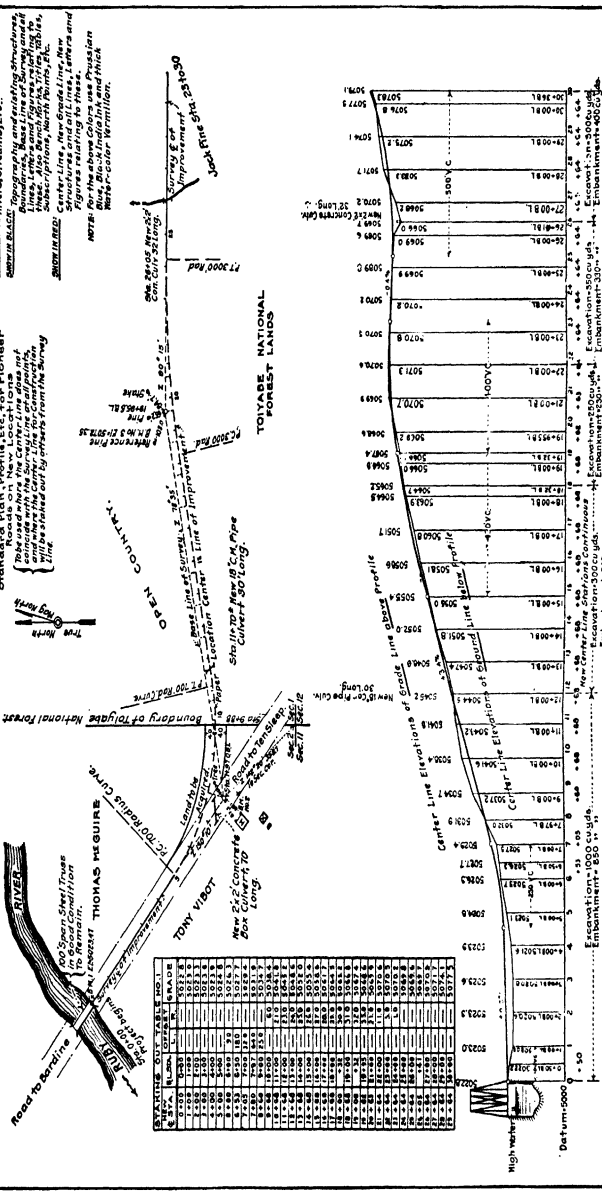

STATION	GRADE	OFF SET	PIVOT
5022.0	0.00	0.00	0.00
5022.5	0.50	0.50	0.50
5023.0	1.00	1.00	1.00
5023.5	1.50	1.50	1.50
5024.0	2.00	2.00	2.00
5024.5	2.50	2.50	2.50
5025.0	3.00	3.00	3.00
5025.5	3.50	3.50	3.50
5026.0	4.00	4.00	4.00
5026.5	4.50	4.50	4.50
5027.0	5.00	5.00	5.00
5027.5	5.50	5.50	5.50
5028.0	6.00	6.00	6.00
5028.5	6.50	6.50	6.50
5029.0	7.00	7.00	7.00
5029.5	7.50	7.50	7.50
5030.0	8.00	8.00	8.00
5030.5	8.50	8.50	8.50
5031.0	9.00	9.00	9.00
5031.5	9.50	9.50	9.50
5032.0	10.00	10.00	10.00
5032.5	10.50	10.50	10.50
5033.0	11.00	11.00	11.00
5033.5	11.50	11.50	11.50
5034.0	12.00	12.00	12.00
5034.5	12.50	12.50	12.50
5035.0	13.00	13.00	13.00
5035.5	13.50	13.50	13.50
5036.0	14.00	14.00	14.00
5036.5	14.50	14.50	14.50
5037.0	15.00	15.00	15.00
5037.5	15.50	15.50	15.50
5038.0	16.00	16.00	16.00
5038.5	16.50	16.50	16.50
5039.0	17.00	17.00	17.00
5039.5	17.50	17.50	17.50
5040.0	18.00	18.00	18.00
5040.5	18.50	18.50	18.50
5041.0	19.00	19.00	19.00
5041.5	19.50	19.50	19.50
5042.0	20.00	20.00	20.00
5042.5	20.50	20.50	20.50
5043.0	21.00	21.00	21.00
5043.5	21.50	21.50	21.50
5044.0	22.00	22.00	22.00
5044.5	22.50	22.50	22.50
5045.0	23.00	23.00	23.00
5045.5	23.50	23.50	23.50
5046.0	24.00	24.00	24.00
5046.5	24.50	24.50	24.50
5047.0	25.00	25.00	25.00
5047.5	25.50	25.50	25.50
5048.0	26.00	26.00	26.00
5048.5	26.50	26.50	26.50
5049.0	27.00	27.00	27.00
5049.5	27.50	27.50	27.50
5050.0	28.00	28.00	28.00
5050.5	28.50	28.50	28.50
5051.0	29.00	29.00	29.00
5051.5	29.50	29.50	29.50
5052.0	30.00	30.00	30.00
5052.5	30.50	30.50	30.50
5053.0	31.00	31.00	31.00
5053.5	31.50	31.50	31.50
5054.0	32.00	32.00	32.00
5054.5	32.50	32.50	32.50
5055.0	33.00	33.00	33.00
5055.5	33.50	33.50	33.50
5056.0	34.00	34.00	34.00
5056.5	34.50	34.50	34.50
5057.0	35.00	35.00	35.00
5057.5	35.50	35.50	35.50
5058.0	36.00	36.00	36.00
5058.5	36.50	36.50	36.50
5059.0	37.00	37.00	37.00
5059.5	37.50	37.50	37.50
5060.0	38.00	38.00	38.00
5060.5	38.50	38.50	38.50
5061.0	39.00	39.00	39.00
5061.5	39.50	39.50	39.50
5062.0	40.00	40.00	40.00
5062.5	40.50	40.50	40.50
5063.0	41.00	41.00	41.00
5063.5	41.50	41.50	41.50
5064.0	42.00	42.00	42.00
5064.5	42.50	42.50	42.50
5065.0	43.00	43.00	43.00
5065.5	43.50	43.50	43.50
5066.0	44.00	44.00	44.00
5066.5	44.50	44.50	44.50
5067.0	45.00	45.00	45.00
5067.5	45.50	45.50	45.50
5068.0	46.00	46.00	46.00
5068.5	46.50	46.50	46.50
5069.0	47.00	47.00	47.00
5069.5	47.50	47.50	47.50
5070.0	48.00	48.00	48.00
5070.5	48.50	48.50	48.50
5071.0	49.00	49.00	49.00
5071.5	49.50	49.50	49.50
5072.0	50.00	50.00	50.00
5072.5	50.50	50.50	50.50
5073.0	51.00	51.00	51.00
5073.5	51.50	51.50	51.50
5074.0	52.00	52.00	52.00
5074.5	52.50	52.50	52.50
5075.0	53.00	53.00	53.00
5075.5	53.50	53.50	53.50
5076.0	54.00	54.00	54.00
5076.5	54.50	54.50	54.50
5077.0	55.00	55.00	55.00
5077.5	55.50	55.50	55.50
5078.0	56.00	56.00	56.00
5078.5	56.50	56.50	56.50
5079.0	57.00	57.00	57.00
5079.5	57.50	57.50	57.50
5080.0	58.00	58.00	58.00
5080.5	58.50	58.50	58.50
5081.0	59.00	59.00	59.00
5081.5	59.50	59.50	59.50
5082.0	60.00	60.00	60.00
5082.5	60.50	60.50	60.50
5083.0	61.00	61.00	61.00
5083.5	61.50	61.50	61.50
5084.0	62.00	62.00	62.00
5084.5	62.50	62.50	62.50
5085.0	63.00	63.00	63.00
5085.5	63.50	63.50	63.50
5086.0	64.00	64.00	64.00
5086.5	64.50	64.50	64.50
5087.0	65.00	65.00	65.00
5087.5	65.50	65.50	65.50
5088.0	66.00	66.00	66.00
5088.5	66.50	66.50	66.50
5089.0	67.00	67.00	67.00
5089.5	67.50	67.50	67.50
5090.0	68.00	68.00	68.00
5090.5	68.50	68.50	68.50
5091.0	69.00	69.00	69.00
5091.5	69.50	69.50	69.50
5092.0	70.00	70.00	70.00
5092.5	70.50	70.50	70.50
5093.0	71.00	71.00	71.00
5093.5	71.50	71.50	71.50
5094.0	72.00	72.00	72.00
5094.5	72.50	72.50	72.50
5095.0	73.00	73.00	73.00
5095.5	73.50	73.50	73.50
5096.0	74.00	74.00	74.00
5096.5	74.50	74.50	74.50
5097.0	75.00	75.00	75.00
5097.5	75.50	75.50	75.50
5098.0	76.00	76.00	76.00
5098.5	76.50	76.50	76.50
5099.0	77.00	77.00	77.00
5099.5	77.50	77.50	77.50
5100.0	78.00	78.00	78.00
5100.5	78.50	78.50	78.50
5101.0	79.00	79.00	79.00
5101.5	79.50	79.50	79.50
5102.0	80.00	80.00	80.00
5102.5	80.50	80.50	80.50
5103.0	81.00	81.00	81.00
5103.5	81.50	81.50	81.50
5104.0	82.00	82.00	82.00
5104.5	82.50	82.50	82.50
5105.0	83.00	83.00	83.00
5105.5	83.50	83.50	83.50
5106.0	84.00	84.00	84.00
5106.5	84.50	84.50	84.50
5107.0	85.00	85.00	85.00
5107.5	85.50	85.50	85.50
5108.0	86.00	86.00	86.00
5108.5	86.50	86.50	86.50
5109.0	87.00	87.00	87.00
5109.5	87.50	87.50	87.50
5110.0	88.00	88.00	88.00
5110.5	88.50	88.50	88.50
5111.0	89.00	89.00	89.00
5111.5	89.50	89.50	89.50
5112.0	90.00	90.00	90.00
5112.5	90.50	90.50	90.50
5113.0	91.00	91.00	91.00
5113.5	91.50	91.50	91.50
5114.0	92.00	92.00	92.00
5114.5	92.50	92.50	92.50
5115.0	93.00	93.00	93.00
5115.5	93.50	93.50	93.50
5116.0	94.00	94.00	94.00
5116.5	94.50	94.50	94.50
5117.0	95.00	95.00	95.00
5117.5	95.50	95.50	95.50
5118.0	96.00	96.00	96.00
5118.5	96.50	96.50	96.50
5119.0	97.00	97.00	97.00
5119.5	97.50	97.50	97.50
5120.0	98.00	98.00	98.00
5120.5	98.50	98.50	98.50
5121.0	99.00	99.00	99.00
5121.5	99.50	99.50	99.50
5122.0	100.00	100.00	100.00

RECOMMENDED FOR APPROVAL
 ENGINEER.

CLASSIFICATION OF MATERIALS
 Work to be done: 94% Gravel, 4% Sand, 2% Silt, 1% Clay
 Excavation: 200 cu yds. ± Embankment: 200 cu yds. ±
 Excavation: 200 cu yds. ± Embankment: 200 cu yds. ±
 Excavation: 200 cu yds. ± Embankment: 200 cu yds. ±

Scale: 1" = 100'
 Plan (Horizontal) 1" = 100'
 Profile (Vertical) 1" = 10'

Made by: J. H. Meyer Date: 1/11/11
 Checked by: J. H. Meyer Date: 1/11/11
 Checked by: J. H. Meyer Date: 1/11/11

FIG. 322.

(Between pages 1100 and 1107)

(2) Plot ground-line section points by dot surrounded by small circle and write in pencil, vertically, on the base line the elevation of the ground at the base line. Write on the right-hand margin directly opposite and level with the intersection of the ground line and base line, the base-line station and note it as B. L. Sta. 123 + 20.

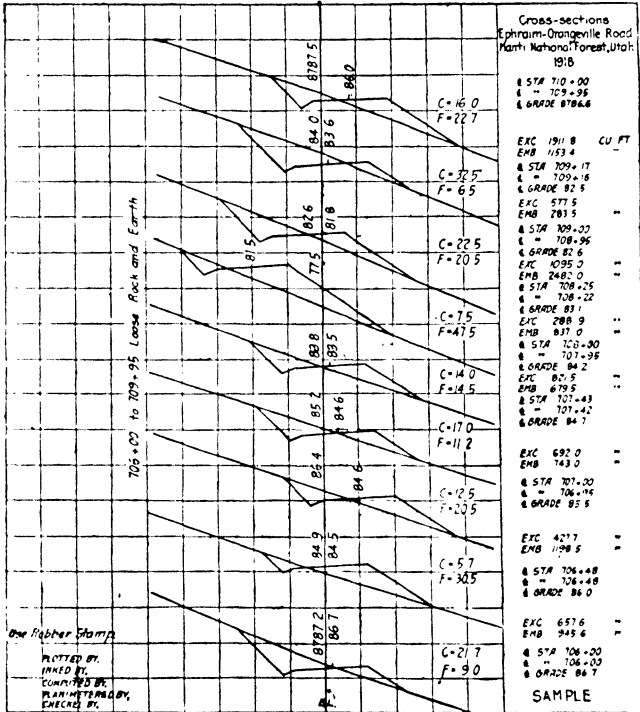

FIG. 323.

(3) Check all operations of plotting and recording by reading back from the actual plotted elevations. No corrections need be made for errors of 0.1'. Correct for any larger errors. It is extremely important that the cross-sections be accurately plotted and carefully checked, as the design depends more on this phase of the work than on any other part.

Elevation and distances farther than 40' from B. L. should be written in pencil, viz., $\frac{37.6}{45}$ Elev. Dist.

d. Inking Cross-sections.—(One man.) Ink in checked pencil cross-sections.

Use firm, moderately heavy line (black ink) for the ground line.

Use large black-ink heavy-line letters and figures in marking base-line elevations and station numbers.

NOTE.—*The cross-sections must be inked before they are used in the design.*

3. Grade-line Design. a. Trial Grade Line.—(One man, the designer.)

On the base-line profile draw on a trial grade in pencil (6H), using fairly long straight grades and cutting every bump and filling every hollow.

Remember that the object of the trial grade is to smooth out the profile on side-hill work by center-line shift. It is fundamentally different from the final grade line which endeavors to follow the new center-line profile as closely as possible.

b. Projecting Grade Contour on Map.—(Two men.) The grade contour should only be determined on side-hill work where the center line can be shifted to advantage. *Designers are cautioned not to use the grade contour method in flat or rolling country. Never destroy good alignment in easy country. It is preferable to use an undulating grade.*

Order of Work.—1. On each cross-section determine the distance right or left of the base line where the trial grade-line elevation for that particular section hits the ground line. Locate this by means of the absolute elevation of trial grade determined graphically from the grade profile.

Do not determine this point by the method of base-line profile, cut or fill as this latter method introduces more chance of error.

(2) Note the location of these points by a light pencil vertical dash and write in pencil lightly the number of feet from the base line.

(3) *Check this work.*

(4) Plot these points on the detail map and mark them by a pin hole surrounded by a small red-ink circle.

(5) *Check this plotting.*

c. Projecting Final Center Line.—(One man, designer.) (1) Draw on map the proposed center line in pencil (6H), following as closely as possible the grade contour marked with the red circles, considering the limitations of alignment imposed by reasonable engineering considerations and the type of road desired. This work should be very carefully studied and is a slow operation. The curves should be drawn with the standard office curves or compass and their radii noted in pencil. The approximate locations of the P. C.'s and P. T.'s should be shown by short pencil lines perpendicular to the tangent. If possible, short tangents should separate curves, but this limitation must be used with judgment and is not intended to apply to extremely difficult or costly locations.

Make this projection with sufficient care so that the center line is practically settled on at this point of the design. *This is important.*

(2) Mark the even stations on the new center line continuously by scaling. Use a standard scale on the tangents and the stepping method with dividers on curves. *Check this. Do not use the stepping method on tangents, as it generally introduces a cumulative error.* Number every fifth station plainly in large figures.

(3) Mark lightly in pencil the new center-line stationing where each base-line cross-section line previously drawn in red on the map intersects the new center line. *Check this.*

(4) Mark lightly in pencil at each of these cross-sections the distance from the new center line to the base line and *check this.* You are now ready to transfer the location of the final center line to the cross-sections and plot the final center-line profile.

3. *a. New Center-line Profile.* (Two men.) *Order of Work.*—
(1) Mark on cross-sections with a short vertical distinct pencil arrow the location of the adopted center line determined by the previously scaled and noted offset marked on the plan. *Check them.*

(2) Directly under the noted base-line station on the right-hand margin of the cross-section sheet write in pencil the new center-line station for each corresponding base-line station as previously determined and shown on the map. *Check this.*

(3) Mark in pencil the absolute elevation of the ground at the new center line. *Check this.*

(4) Plot the true center-line profile, using the true center-line horizontal distances and stationing, the true center-line ground elevations as shown on the cross-sections and showing (as per sample profile) the equivalent B. L. stationing at each section.

Use the same manipulation methods as regards pencil and ink as described for base-line profile.

b. Balanced Section Profile.—(Made by designer and one helper.)

NOTE.—At this point eliminate from all further consideration the base-line profile and trial grade. A great many men attempt to make the final grade similar to the trial grade, which is absolutely the wrong principle, except where a ruling grade governs.

Order of Work.—(1) Select the templet suitable to the cross-section under investigation.

(2) Shift this templet up and down (with the center line always coinciding with the final center-line location previously marked on the cross-section) till it reaches a point where by inspection you judge that the cut area will make the fill area as shown. Mark the center-line elevation of the templet lightly in pencil with a short horizontal dash and write lightly the absolute elevation of this dash.

(3) Plot the center-line elevations of these balanced templets on the new center-line profile for each section by a pencil dash, using the absolute elevation previously determined. *Do not plot by plus or minus from the ground line, as this introduces more chance of error.*

(4) Check this plotting very carefully.

(5) Ink the short dashes with red ink but do not connect these points.

NOTE.—This portion of the work is very important, particularly on a fairly uniform profile. By the use of these balanced templet elevations the final grade can generally be balanced with less work,

shorter hauls, and from 10 to 30% less excavation than if a hit-or-miss method based on ground line is used. The value of this part of the design cannot be over-emphasized. On an extremely rough profile requiring a succession of heavy cuts and fills it is not applicable nor advised.

c. Trial Final Grade Based on Balanced Templet Elevation.—(Designer must do this personally.)

Order of Work.—(1) Lay grade line on center-line profile (in fine pencil 6H) following as nearly as possible the balanced elevations shown by the red dashes previously plotted on the profile.

Except where a ruling grade is encountered or where a tangent grade will hit the majority of the indicated balanced elevations, a rolling grade is to be preferred. This can be laid out most economically by a succession of vertical curves selected to fit the conditions. These curves are drawn on the profile by the standard office railroad curve templates and the radius noted. There is no necessity of drawing the tangent grades to intersection, as all the elevations on the vertical curves can be determined graphically. The tangent rates of grade should be laid out to some even tenth and figured between the ends of the vertical curves.

(2) Determine elevations of grade line at each point where a section occurs and write this elevation in heavy pencil above the grade line. Do not record hundreds or thousands in these elevations. Determine these elevations graphically on vertical curves and by figuring on tangent grades.

(3) *Check these elevations.*

(4) Transfer each elevation to the cross-sections by recording it in pencil directly under the center-line stationing on the right-hand margin of the sheet. *Check this transfer.*

d. Drawing in Templates.—(Designer should do this.)

NOTE.—This work should be done by the designer, as considerable judgment must be exercised in the selection and variation of the standard sections.

Order of Work.—(1) Draw in proper templet making its center-line elevation agree with grade elevation previously recorded under the station number. Use a 4H pencil with a fine point, as many of these templates will have to be changed before the design is accepted.

e. Planimentering Areas. *Methods.*—Various methods can be used, depending on the kind of planimeter. So long as care is taken and a double run is made to check the initial run any desired method will be satisfactory.

With a fixed-arm planimeter reading directly to square inches a double run divided by 8 is the usual practice for a 5' scale.

With an adjustable-arm planimeter it can be set to read square feet directly on the second run or can be set to read cubic yards per 100' directly. The last method is a great time saver.

Order of Work.—(1) Check the correctness of templet plotting by comparing templet elevation with grade elevation marked on the margin. *The planimeter man is responsible for checking the templet plotting.*

(2) Test planimeter before using and at frequent intervals to see it is recording correctly.

- (3) Planimeter the areas checking by a double run.
 (4) Record the areas of cut and fill in pencil at the right of the sections to nearest foot as $C = 21$
 $F = 20$.

Computation of Grading Quantities. Order of Work.—(1) (Two men.) Transfer center-line stationing and areas for each cross-section to the standard computation sheets. *Check this transfer.*

(2) (One man.) Compute quantities. If areas are in square feet compute quantities in cubic feet. *This is an order; no discretion is allowed.* The reason this is specified is because it has been determined from practice that it is quicker and more accurate. The more or less prevalent method of computing each quantity in yards will not be allowed. The use of cubic feet keeps all work in full units and eliminates 90% of the transfers, feet to yards. From checking it has been proved that too many mistakes are made in the decimal point on detail yardage quantities.

(3) *Check Detail Computations.*—This means check every phase of the computations, *distances* between sections, extensions, additions, etc.

f. Balancing Final Grade Line.—(Designer and one helper.)

This portion of the design is very slow and requires more judgment than any other feature.

(1) It is desirable to balance in as short sections as possible, as this results in cheaper excavation methods. A continuous balance means plow and road machine turnpiking, which is very cheap.

Short balances mean scraper longitudinal haul and machine finish, which is moderately cheap.

Long balances mean wagon haul, which is expensive.

(2) It is desirable to balance with a downhill haul on noticeable grades.

(3) It is desirable to proportion the cut to fill so that dirt is not wasted.

This last is entirely a matter of judgment.

If the ground is bare and classed as common the following ratios will not be far out:

Volume of Excavation per Station	Ratio Cut to Fill
30-50 yd.	1.30:1.25
60-100 yd.	1.25:1.18
Above 100 yd.	1.15:1.10

If the ground has a thick carpet of humus or a heavy stand of large trees the grading conditions cannot be definitely determined until the clearing and grubbing are completed. In such a case the grade line should be noted as tentative and the resident engineer on construction will have to recross-section and redesign the grade after the mold and stumps are removed. The quantities in such a case can only be approximated and should be made on the **safe** side.

(4) In balancing quantities it is usually desirable to reduce the larger quantity.

(5) It is often cheaper and more desirable to waste at places and borrow at others. This should be borne in mind. The ratio of borrow excavation from pits to borrow fill is generally taken at 1.10.

(6) In considering rock cuts and fills use Trautwines' figures—1 cu. yd. solid rock makes approximately 1.7 cu. yd. rock fill. Where the fill is a mixture of earth and rock, 1 cu. yd. rock will make 1 cu. yd. of fill. The order of work and detail manipulation for the portions of the grade line that have to be changed to accomplish a balance are the same as for the original grade line.

g. **Inking Final Grade.**—After the grade line is balanced, ink it in with red ink on the profile so it can be easily traced.

4. Estimate.—(Designer.)

(1) *Drainage.*—From survey notes locate culverts on profile and draw them on the proper cross-section to determine length and invert elevations and outlet ditches if necessary. Do this work in pencil. Make notes clear and complete.

(2) *Bridges.*—Use standard designs up to 25'; above that have design made by department bridge designer.

(3) *Compilation.*—Compile data on forms provided, using center-line station to locate all structures quantities, etc.

(4) Unit costs will be determined by the office engineer in charge of the drafting room and reviewed by the district engineer.

(5) Check all operations.

5. a. Tracing Plans.

Size of Sheets:

Outside 22" by 36"

Border $\frac{1}{2}$ " top, bottom, and right.

2" binding edge on left.

All work in black ink.

Make heavy and plain.

Lay out as per sample sheet.

Check all tracing.

b. **Finishing Cross-section Sheets.**—Do not ink in final grade, templets, or center-line ground elevation till contract is let and cross-section blueprints are needed in the field. This delay is advisable, as it is often necessary to revise even after the original design has been accepted.

Explanation of Table of Relative Weights of Office Design

To obtain the equivalent mileage of completed office design multiply the actual mileage complete to date of each subdivision of the work by the percentage shown. Add all these products which will give you the total equivalent mileage of completed design.

Example.—Suppose at the time a report is due you have 10 miles of map completed, 20 miles of base line done, and 5 miles of cross-sections plotted, checked, and inked.

TABLE 209.—ILLUSTRATIVE TABLE FOR DETERMINING THE PERCENTAGE OF COMPLETION OF OFFICE WORK FOR WEEKLY OR MONTHLY PROGRESS REPORTS
Relative Weights Office Design

	Pioneer	Per Cent. of Total Completed Plans
1. Preliminary Work (20% of Complete Plans):		
(a) Plotting map, checking and inking base line.....		5%
(b) Plotting, checking and inking base line profile.....		2%
(c) Plotting and checking cross-sections.....		10%
(d) Inking cross-sections.....		4%
2. Final Center Line (15% of Complete Plans):		
(a) Lay trial grade line on base line profile.....		1%
(b) Project trial grade line contour on map.....		4%
(c) Project final center line location on map.....		10%
3. Final Grade Line (50% of Complete Plans):		
(a) Make new center line profile on true center line elevations and distances, ink and check. (NOTE: At this point eliminate trial grade from all further consideration.)		7%
(b) Spot elevation of balanced cross-sections on new profile.....		5%
(c) Lay final grade line based on balanced section profile.....		5%
(d) Draw in templates.....		3%
(e) Planimeter and compute quantities and check.....		10%
(f) Balance quantities by grade line shift.....		19%
(g) Ink in final grade line.....		1%
4. Compile Estimate (5% of Complete Plans).....		5%
5. Trace Plans (10% of Complete Plans).....		10%
		100%

This work will be equivalent to the following mileage of complete office design:

Item	Miles
1. (a) Map 10 miles \times 5%.....	0.50
1. (b) Base-line profile 20 miles \times 2%.....	0.40
1. (c) Cross-sections plotted and checked 5 miles \times 10%.....	0.50
1. (d) Cross-section inked 5 miles \times 4%.....	0.20
Equivalent miles total completed plans	1.60

Suppose the project is 20 miles long.

The per cent completion office design is $1.6/20 = 8\%$ complete.

Basis of Table of Relative Weights Office Design. *General Speed*—Two miles per month per man of completed plans when men are experienced.

About $1\frac{1}{4}$ miles per month per man when force is not used to road design.

ASSUMED SPEED PER MAN PER DAY ON VARIOUS DIVISIONS OF WORK

	Miles	
1. (a)	1.5	Detail map
* (b)	3.0	Base-line profile
* (c)	1.0	Cross-sections plotting and checking
(d)	1.5	Inking cross-sections
2 (a)	7.0	Trial grade
* (b)	1.5	Grade contour
(c)	0.8	Center-line projection
*3. (a)	1.0	Center-line profile
* (b)	1.5	Balanced section profile
(c)	1.5	Final grade line
(d)	2.0	Templets
(e)	0.8	Planimeter and quantities
(f)	0.4	Balance quantities
(g)	7.0	Ink final grade line
4.	2.0	Compiling estimate
5.	0.7	Tracing plans

*Indicates work that can be done better by two men working together which will result in twice speed shown.

ESTIMATE FORMS

1115

SAMPLE ESTIMATE FORMS

SHEET NO.

ESTIMATE SHEET (LETTER SIZE)

Road Computed by
Date Checked by

GENERAL SUMMARY			
ITEM	QUANTITY	UNIT PRICE	ESTIMATED COST
			\$
Length..... miles		Total cost of Items \$ -	
Cost per mile.....		+ 10% for Eng. Adv. & Cont. -	
		Cost to date for	
		Surveys & Plans -	
		Appropriation	=

SHEET NO.

ESTIMATE SHEET

Road Computed by
Date Checked by

SUMMARY CLEARING & GRUBBING						
STATION TO STATION	LENGTH	WIDTH	ACRES	CLASSIFICATION	PRICE PER ACRE	ESTIMATED COST
Totals						
	Average Unit Price per Acre					

CHAPTER XV

TYPICAL COST ESTIMATE FORMS, COST DATA, AND EQUIPMENT

The cost data given in this chapter have been gathered since 1907 and cover most of the items necessary for estimating the cost of ordinary rural highway improvements and small span bridges. Each statement of cost gives the labor rates and the conditions of work or the year performed. There has been a large rise in general cost standards 1910 to 1926 and Fig. 324 will help coordinate present costs with the examples given.

Cost data must be used intelligently in order not to be misleading. Local conditions always govern, and in presenting cost data the reader is cautioned to compare conditions to be met with the conditions described in the data given. The cases given have been selected to represent average costs. A well-equipped efficient force can often do the work cheaper than shown, while inexperienced men will run the cost up above the amounts shown.

The most common mistake in figuring cost is to underestimate the overhead charges caused by insurance, liability, plant depreciation, interest on idle machinery, etc. These items are quite thoroughly discussed on pages 1231 to 1270. Net profit is a variable amount depending on the size of contract and the type of bidder to be interested.

Percentage of net profit should be larger for a small job than for a large job. Where large state or municipal programs are in progress, sufficient profit must be allowed to interest large organizations which will get the work out rapidly. For small slow town road jobs, less profit is necessary, as this class of contractor is satisfied with less yearly income. For most state road programs a profit item on 5 miles of road (average length of contract) which will insure a reasonable year's income for the class of contractors desired is a fair basis of estimate.

This chapter will give standard estimate forms for the usual road items based on 1926 cost conditions as given on page 1125 followed by detail cost data from which they were derived, and plant, equipment and other sources of overhead expense.

Explanation of Price (Fig. 324) Eng. News Record.—The dotted portion of the steel curve represents wrought-iron I-beams at the Pittsburgh mill, which in 1885 reached \$3.12 per 100 lb., a price only slightly below the cost of structural steel at Pittsburgh in 1917.

Portland cement when first placed on the market in 1879 was higher in price than it is today, and until 1882 remained higher than for any year except 1920. In 1879, however, cement was sold in

wooden barrels as compared with the present system of calling four 94-lb. sacks a barrel of cement. Until as late as 1907 a single wooden barrel of cement cost about 30 cts. more than a barrel consisting of four sacks. The 1874 to 1879 quotations are for Rosendale cement.

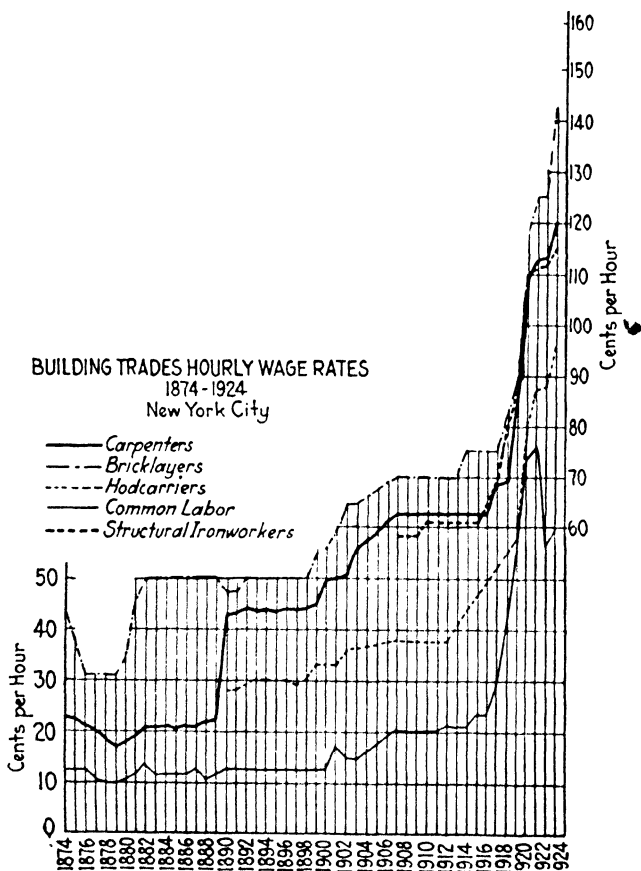

FIG. 324A.

The lumber prices from 1874 to 1909, inclusive, are for long-leaf yellow pine boards, 1 by 12"; from 1910 to date for long-leaf yellow pine timbers, 3 by 12"; all per M ft., b.m., in approximately

20' lengths. In 1912 pine lumber prices had reached a point not touched again until 1918. The slump, which occurred meantime, reached the lowest point between 1914 and 1915. It was caused by the opening of the Panama Canal, when Douglas fir shippers on the west coast could send the lower-priced lumber through to the Atlantic seaboard in competition with southern pine.

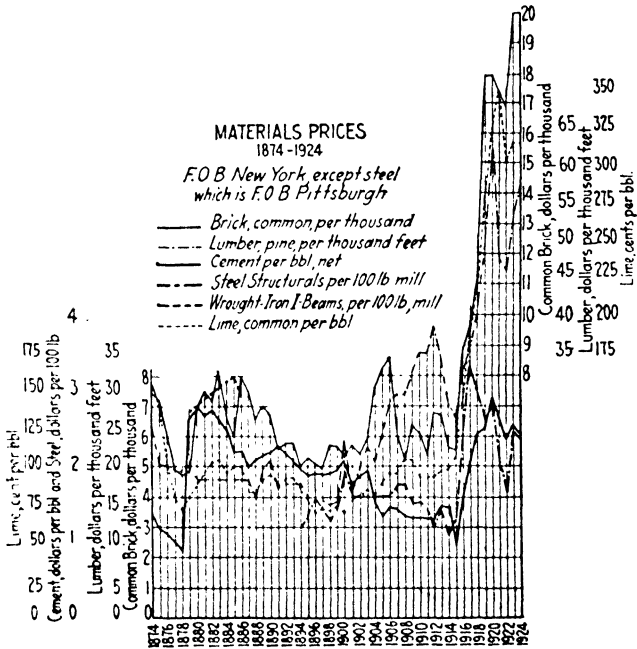

FIG. 324B.

The pig-iron curve from 1874 to 1897 inclusive, covers No. 1 foundry Southern. From 1898 to date prices are for No. 2 foundry Southern, with the following exceptions: No. 1 foundry Southern is used for 1905 and No. 2 foundry Northern for the year 1912. The price difference between the grade is only 25 to 50 cts.

In September, 1918, prices of building materials were fixed by the War Industries Board of the United States Government. This action controlled foreign government purchases as well as domestic buying. The ban was lifted in March, 1919.

The lime prices here given are for a "large barrel" (280 lb.).

TABLE 210.¹—(FIG. 3244).

Comparison of basic building materials prices—1874 to 1924. Average yearly prices, wholesale to dealers or contractors, in carload lots, f.o.b. New York, except in the case of steel structurals, which are f.o.b. Pittsburgh.

	Pig iron No. 1 fdry. anthra- citate, per gross ton	Brick common building, per M.	Cement Rosen- da e, per bbl.	Lime common, per bbl.	Lumber yellow pine 1-in., per M. ft. b.m.	Wrought- iron I-beams, channels, etc., per 100 lb.
1874	\$30.25	\$7.41	\$1.48	\$1.50	\$26.00	
1875	25.50	7.12	1.25	1.40	21.00	
1876	22.25	5.87	1.20	1.00	21.00	
1877	18.88	4.93	1.10	.80	20.00	
1878	17.63	4.71	.95	.70	20.00	
			Portland, per bbl.			
1879	18.03	4.08	2.70	.80	20.96	\$2.78
1880	28.50	7.00	2.88	.87	19.00	
1881	25.12	7.50	2.72	.95	19.00	
1882	25.75	7.12	2.82	1.01	19.00	
1883	22.38	8.28	1.05	19.00	
1884	19.88	6.65	2.60	.95	19.00	
1885	18.00	6.10	2.28	1.00	18.66	3.12
1886	18.71	7.51	2.28	1.00	19.00	3.00
1887	20.92	7.43	2.07	.82	19.00	
1888	18.88	6.50	2.16	.83	16.75	
1889	17.75	7.06	2.23	.92	20.31	
1890	18.40	6.65	2.25	.95	21.75	
1891	17.52	5.53	2.38	.87	18.00	
1892	15.75	5.7793	18.50	
1893	14.52	5.8393	18.50	
						Structural steel f.o.b. Pitts- burgh
1894	12.75	5.0085	18.50	1.20
1895	11.50	5.31	1.97	.78	16.92	1.35
1896	12.50	5.06	2.00	.69	16.42	1.60
1897	12.10	4.94	1.97	.72	16.44	
	No. 2 fdry. southern					
1898	10.75	5.75	2.00	.70	15.75	1.27½
1899	15.50	5.69	2.05	.75	16.25	1.45
1900	22.00	5.25	2.16	.68	24.50	1.95
1901	14.37½	5.77	1.89	.77	17.50	1.60
1902	17.25	5.39	1.95	.81	21.00	1.60
1903	22.37½	5.91	2.03	.79	23.50	1.70
1904	13.75	7.50	1.67½	.80	21.50	1.60
1905	17.89 (No. 1)	8.10	1.43	.89	24.92	
1906	17.75	8.55	1.55	.95	29.33	1.60
1907	26.25	6.16	1.55	.95	30.50	1.75
1908	16.50	5.10	1.46	1.05	30.50	1.76
1909	15.50	6.39	1.41	1.05	33.04	1.50

¹ Engineering News Record.

TABLE 210.—Continued

	Pig iron No. 1 fdry. anthra- cite, per gross ton	Brick common building, per M.	Cement Rosen- dale, per bbl.	Lime common, per bbl.	Lumber yellow pine 1-in., per M. ft. b.m.	Wrought- iron I-beams, channels, etc., per 100 lb.
					Long- leaf yellow pine 3-in.	
1910	17.10	6.12½	1.43	.92	36.00	1.52½
1911	15.37½	5.31	1.43	.92	36.00	1.42½
1912	14.75 (Norh.)	6.75	1.34	.92	40.00	1.20
1913	16.43½	6.75	1.58	.97	35.25	1.46
1914	14.56	5.60	1.58	.97	29.50	1.11
1915	15.29	5.50	1.04	1.06	27.75	1.33
1916	22.20	8.69	1.62	32.62	2.48
1917	33.75	9.40	2.16	37.33	3.39
1918	39.90	10.98	2.53	2.21	42.66	3.00
1919	39.01	17.90	2.63	2.65	50.87	2.61
1920	47.73	18.00	3.00	3.18	63.73	2.79
1921	38.28	17.40	2.73	3.49	48.16	2.05
1922	30.77	16.91	2.45	3.00	47.05	1.69
1923	32.12	20.00	2.66	3.12	55.22	2.50
Apr. 24 1924	28.00	20.00	2.55	3.12	58.00	2.40

Explanation of Labor Rates (Fig. 324).—Wages in the building trades began to ascend definitely between 1899 and 1907. From that period until the war years the curves are generally flat. The soaring began in 1917. At present, wage rates of the skilled trades in New York are the highest in the half-century. Common labor dropped 14½ cts. in value (to 59½ cts.) in 1922, and now stands at 60½ cts.

Bricklayers began the 8-hr. day in 1872, as against 10-hr. formerly, and changed from the 48-hr. week to the 44-hr. in 1899. Then, as now, the bricklayers were first to gain labor advantages. That wages in this craft were usually in advance of most of the other trades during the last 50 years is shown in the chart. Hod carriers began the 44-hr. week in 1900.

Carpenters were working 10 hr. per day in 1874, changing to 8 hr. in 1890. The 44-hr. week began in 1900.

Common laborers (excavating) changed from the 10-hr. to the 9-hr. day in 1890. Since 1919 the 8-hr. day has been in force.

Wages remained at the high rates reached in the latter part of 1920 and the first part of 1921, throughout 1922. Skilled building trades' wage schedules remained unchanged during the 1921 depression despite widespread unemployment.

COST DATA

TABLE 210.—(FIG. 324B).—Continued
 Building trades wage rates—1874 to 1924
 New York, per hour

	Carpenter's 10 hr. day	Brick- layers' 8 hr. day	Hod- carriers	Common laborer's 10 hr. day	Structural- iron workers
1874	\$0.23	\$0.43	\$0.14	
1875	.22½	.3714	
1876	.21	.3114	
1877	.20	.3112	
1878	.18	.3111	
1879	.17	.3111	
1880	.18	.3412	
1881	.19	.4613	
1882	.21	.5015	
1883	.21	.5013	
1884	.21	.5013	
1885	.20	.5013	
1886	.21	.5013	
1887	.21	.5014	
1888	.22	.5012	
1889	.22	.5013	
	8 hr. day		8 hr. day	9 hr. day	
1890	.43	.47	\$0.28	.14	
1891	.43	.47	.28	.14	
1892	.44	.50	.29	.14	
1893	.43	.50	.30	.14	
1894	.44	.50	.30	.14	
1895	.43	.50	.30	.14	
1896	.44	.50	.30	.14	
1897	.44	.50	.29	.14	
1898	.44	.50	.30	.14	
1899	.45	.55	.33	.14	
1900	.50	.56	.33	.14	
1901	.50	.59	.33	.19	
1902	.51	.65	.36	.17	
1903	.56	.65	.36	.16	
1904					
1905					
1906	8 hr. day
1907	.62½	.70	.37½	.22	\$0.60
1908	.62½	.70	.37½	.22	.60
1909	.62½	.70	.37½	.22	.60
1910	.62½	.70	.37½	.22	.62½
1911	.62½	.70	.37½	.22	.62½
1912	.62½	.70	.37½	.23	.62½
1913	.62½	.7022½	.62½
1914	.62½	.7522½	.62½
1915	.62½	.7525	.62½
1916	.62½	.7525	.66
1917	.69	.7530	.69
1918	.69	.8140½	.80
1919	.81¼	.87½	.57¼	.55	.87½
1920	1.08	1.17	.77½	.75	1.11
1921	1.12½	1.25	.87½	.77	1.12½
1922	1.12½	1.25	.87½	.58	1.12½
1923	1.20	1.42	.95	.61	1.16
1924	1.31¼	1.50	1.00	.68¼	1.25

INDEX STANDARD ESTIMATE FORMS AND SAMPLE ESTIMATES

	Page
Roadway Excavation	1126
Earth (rough grading)	1126
Steam shovel	1126
Scrapers	1127
Hand and teams	1127
Rock excavation	1127
Overhaul	1127
Trimming fine grade for pavement	1127
Trimming shoulders and ditches	1127
Production of Local Materials	1130
Crushed stone	1130
Screened gravel and sand	1131
Washed gravel and sand	1132
Hauling	1128
Schedule of costs	1128
Pavement Estimates	1132
Foundation courses: (subbase)	1132
Gravel	1134
Boulder	1132
Bottom courses	1134
Gravel	1134
Boulder	1133
Macadam	1134
Bituminous concrete ("black base")	1138
Portland cement concrete	1138
Surface Courses	1139
Gravel	1139
Water bound macadam	1140
Bituminous macadam	1141
Bituminous concrete	1142
Cement concrete	1144
Brick (cement grout)	1146
Brick (bituminous filler)	1147
Stone block	1147
Incidental Items (Reasonable contract prices, Western New York, ..	1268
1926) Culverts and Sewers	1148
Small-span Bridges	1150
Minor Items (Curbs, gutters, guide rail, etc.)	1156

STANDARD ESTIMATE FORMS 1926 COST CONDITIONS

Common labor	\$0.45 per hour
Teams	0.85 per hour
5-ton trucks	3.00 per hour
1½-ton trucks	1.50 per hour

Estimates based on following overhead and profit allowances:

- Cost of imported materials plus 6 % for interest and profit.
- Cost of freight plus 6 %.
- Cost of local materials produced by contractor plus 20 % profit.
- Cost of labor plus 20 % profit.
- Overhead on labor costs (10 % of pay roll).¹
- Equipment overhead (see Table 224, p. 1261)
- Moving plant on job, \$500 to \$1000.

¹ Includes interest on pay roll, insurance, liability, etc.

GRADING EQUIPMENT
Ordinary road. Earth excavation

Item	Approximate value	Approximate yearly charge including interest, depreciation, repairs, etc.
Keystone grader or steam shovel 10 to 20 dump wagons or trucks.	\$ — to \$ 9,000 \$2,000 to 10,000	\$ — to \$ 3,000 \$1,000 to 5,000
Road scrapers.	500 to 1,000	200 to 400
Tractors or traction engine	— to 5,000	— to 1,000
Wheel and slush scrapers.	500 to 1,000	200 to 500
Plows, hand tools, etc.	500 to 1,000	200 to 500
10-ton roller.	5,000 to 6,000	1,000 to 1,200
Totals	\$8,500 to \$33,000	\$2,600 to \$11,600

Average amount of work 5 to 8 miles per year, amounting to 15,000 to 100,000 cu. yd. per year.

Approximate equipment overhead charge on excavation from 10 to 20 cts per cu. yd. depending on amount excavated.

ROUGH GRADING ESTIMATES

Heavy Steam-shovel Work (Earth Excavation):

	Per Cubic Yard
¾-yd. shovel averaging 350 cu. yd. per day.	
Labor, fuel, and water at shovel.....	\$0.11
Labor on dump.....	0.07
Hauling up to 300' lead.....	0.10
Hauling beyond 300' lead (1 ct. per Sta.) say.....	0.05
Total pay roll.....	0.33
Profit.....	0.07
Overhead on pay roll 10 %.....	0.03
Overhead on equipment (100 days per year).....	0.07
Total estimate.....	\$0.50

Medium Steam-shovel Work (Earth Excavation):

	Per Cubic Yard
¾-yd. shovel averaging 200 cu. yd. per day.	
Labor, fuel, and water at shovel.....	\$0.17
Labor on dump.....	0.08
Hauling up to 300' lead.....	0.10
Hauling beyond 300' lead (1 ct. per Sta. yard) say.....	0.05
Total pay roll.....	\$0.40
Profit.....	0.08
Overhead on pay roll 10 %.....	0.04
Overhead on equipment (100 days per year).....	0.13
Total Estimate.....	\$0.65

Medium and heavy steam-shovel work is commonly bid for 50 to 80 cts. per cubic yard, Western New York, 1925.

Light Keystone Grader Work (Earth Excavation):

	Per Cubic Yard
Average 150 cu. yd. per day.	
Labor, fuel, and water at shovel.....	\$0.20
Labor on dump.....	0.10
Hauling up to 300' lead.....	0.10
Hauling beyond 300' lead (1 ct. per Sta. yd.) say.....	0.05
Total pay roll.....	\$0.45
Profit.....	0.09
Overhead 10 % pay roll.....	0.05
Overhead on equipment (100 days per year).....	0.16
Total estimate.....	\$0.75

Scraper Work (Short Haul):

Reasonable contract price 50 to 70 cts. per cubic yard.

Road Machine Turnpiking:

Reasonable contract price 20 to 40 cts. per cubic yard.

Plow, Hand Shoveling, Team Hauling (500' lead):

Easy soil (all ordinary conditions)..... \$1.30 per cubic yard
 Hard soil (hard clay and cemented soils)..... 1.75 per cubic yard

In estimating the price for any road the number of yards of earth to be excavated by the different foregoing methods are estimated roughly, the proper price applied to each class of excavation, and the composite price determined by the total estimate divided by the total yardage.

ROCK EXCAVATION

Open cut. Reasonable contract price, Western New York, 1925.

	Per Cubic Yard
Large quantities solid rock.....	\$2.00 to \$2.50
Small quantities solid rock.....	4.00
Large quantities shale or disintegrated solid rock.....	1.50 to 2.00
Small quantities shale or disintegrated solid rock.....	3.00

NOTE.—There is such a wide variation in the cost of roadway rock excavation that any detailed form would be merely misleading.

Trimming Fine Grade for Pavement:

Depends largely on how well road is rough graded. Following cost assumes rough grade correct to within 1" of finished grade.

	Per Square Yard
Labor cost.....	\$0.06
Profit 20 % of labor.....	0.012
Overhead 10 % of labor.....	0.006
Roller overhead.....	0.002
Total.....	\$0.080

Ordinary bids run from 5 to 10 cts. per square yard.

Trimming Shoulders and Ditches:

Depends largely on completeness of rough grading. Following cost assumes rough grading well done and trimming finished by hand labor including back slopes.

Easy Grading (Ordinary Earth):

	Per Linear Foot of Road
Labor and teams.....	\$0.12
Profit 20 %.....	0.02
Overhead 10 % of pay roll.....	0.01
Total.....	\$0.15

Difficult Grading (Small Boulders Mixed with Earth):

	Per Linear Foot of Road
Labor and teams.....	\$0.15
Profit 20 %.....	0.03
Overhead 10 % of pay roll.....	0.015
Total.....	\$0.195

Ordinary bids run 10 to 20 cts. per linear foot of road.

Overhaul:

New construction (Bad hauling conditions):

	Per Station Yard
Cost of hauling.....	\$0.008
Profit 20 %.....	0.002
Overhead.....	0.001
Total.....	\$0.011

Reconstruction (Excellent hauling conditions):

	Per Station Yard
Cost of hauling.....	\$0.004
Profit.....	0.001
Overhead.....	0.001
	\$0.006

Ordinary bids run from 0.5 to 1.5 cts. per station yard.

HAULING SCHEDULE OF APPROXIMATE COST

	Cents per ton mile	Cents per yard mile
Teams:		
Hand loading, short hauls out of fields.....	55	70
Bin loading, average hauls.....	45	55
Bin loading, long hauls.....	40	50
Trucks (cost includes overhead charge):		
Hand loading, short hauls less than 1.5 miles.....	30	40
Bin loading, short hauls.....	20	25
Bin loading, long hauls over 1.5 mile.....	16	20

NOTE.—Length of haul is the length for hauling load; that is, if truck is loaded, runs 3 miles, dumps, and returns empty, the cost is 3 miles times cost per mile given in the above schedule.

CALCULATION OF AVERAGE HAUL DISTANCE CASE I

Condition of road uniform Material to be distributed in proportion to mileage

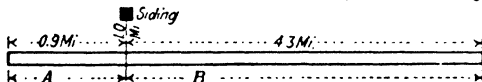

1st. Method: Assume a shipment of 100 tons

$$\text{Tonnage for A} = \frac{0.9}{0.9+4.3} \times 100 = 17 \text{ tons.}$$

$$\text{Total ton miles} = 286.10$$

$$\text{Tonnage for B} = \frac{4.3}{0.9+4.3} \times 100 = 83 \text{ tons.}$$

$$\text{Total tonnage} = 100.00$$

$$A \cdots 17 \text{ tons} \times (1.0 + \frac{0.9}{2}) \text{ miles} = 24.65 \text{ ton miles}$$

$$B \cdots 83 \text{ tons} \times (1.0 + \frac{4.3}{2}) \text{ miles} = \frac{261.45}{286.10} \text{ ton miles}$$

AVERAGE HAUL

$$= \frac{286.10}{100} = 2.86 \text{ miles}$$

2nd. Method: Assume a tonnage of 1 ton per mile.

$$A \cdots 0.9 \text{ ton} \times (1.0 + \frac{0.9}{2}) \text{ miles} = 1.305 \text{ ton miles}$$

$$\text{Total ton miles} = 14.85$$

$$B \cdots 4.3 \text{ tons} \times (1.0 + \frac{4.3}{2}) \text{ miles} = \frac{13.545}{14.850} \text{ ton miles}$$

$$\text{Total tonnage} = 0.9 + 4.3 = 5.2$$

AVERAGE HAUL

$$= \frac{14.85}{5.2} = 2.86 \text{ miles}$$

CALCULATION OF AVERAGE HAUL DISTANCE CASE II

Conditions of road not uniform. Proper tonnage for separate stretches of road to be estimated.

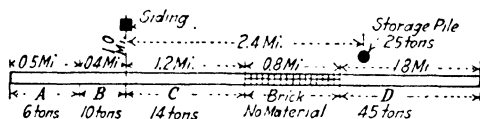

Assume a shipment of 100 tons

$$\begin{aligned}
 A &= 6 \text{ tons} \times (1.0 + 0.4 + \frac{0.5}{2}) \text{ miles} &= 9.90 \text{ ton miles} \\
 B &= 10 \text{ tons} \times (1.0 + \frac{0.4}{2}) \text{ miles} &= 12.00 \text{ " " } \\
 C &= 14 \text{ tons} \times (1.0 + \frac{1.2}{2}) \text{ miles} &= 22.40 \text{ " " } \\
 D &= 45 \text{ tons} \times (1.0 + 1.2 + 0.8 + \frac{1.8}{2}) \text{ miles} &= 175.50 \text{ " " } \\
 \text{Storage Pile} &= 25 \text{ tons} \times (1.0 + 2.4) \text{ miles} &= 85.00 \text{ " " } \\
 \hline
 \text{Total ton miles} &= 304.80 \\
 \text{Total tonnage} &= 100.00 \quad \text{AVERAGE HAUL} = \frac{304.80}{100} = 3.05 \text{ miles}
 \end{aligned}$$

CALCULATION OF AVERAGE HAUL DISTANCE CASE III

Condition of road uniform. Material to be distributed in proportion to area.

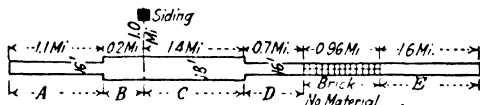

Assume 1 ton per mile for a 16' width. Then an 18' width will require $\frac{18}{16}$ tons per mile.

$$\begin{aligned}
 A &= 11 \text{ ton} \times (1.0 + 0.2 + \frac{1}{2}) \text{ miles} &= 1.925 \text{ ton miles} \\
 B &= (0.2 \times \frac{18}{16}) \text{ ton} \times (1.0 + \frac{0.2}{2}) \text{ miles} &= 0.247 \text{ " " } \\
 C &= (1.4 \times \frac{18}{16}) \text{ ton} \times (1.0 + \frac{1.4}{2}) \text{ miles} &= 2.678 \text{ " " } \\
 D &= 0.7 \text{ ton} \times (1.0 + 1.4 + \frac{0.7}{2}) \text{ miles} &= 1.925 \text{ " " } \\
 E &= 1.6 \text{ ton} \times (1.0 + 1.4 + 0.7 + \frac{1.6}{2}) \text{ miles} &= 7.776 \text{ " " } \\
 \hline
 \text{Total ton miles} &= 14.551
 \end{aligned}
 \quad \left\{ \begin{array}{l} \text{Tonnage for A} = \frac{11}{5.20} \times \text{total shipment} \\ \text{" " B} = \frac{0.2 \times \frac{18}{16}}{5.20} \times \text{"} \\ \text{Etc.} \end{array} \right.$$

Total ton miles = 14.551

Total tonnage = $1.1 + (0.2 \times \frac{18}{16}) + (1.4 \times \frac{18}{16}) + 0.7 + 1.6 = 5.20$

AVERAGE HAUL = $\frac{14.551}{5.20} = 2.80 \text{ miles}$

**PRODUCTION OF CRUSHED STONE
SMALL LOCAL PORTABLE PLANTS**

Proportion of Sizes:

For proportion of sizes and weights of crusher outputs, see pages 1173 to 1182.

COST ESTIMATES

Cost of Quarrying:

Stripping (use earth excavation prices, pp. 1126 to 1127) for amount required.

Cost of stone per ton..... 5 ± cts.

Quarrying and delivery to crusher (includes overhead and equipment charge):

	Per Ton
Sandstone.....	\$0.40
Limestone.....	0.45
Conglomerate.....	0.60
Trap and granite.....	0.55

Crushing (includes overhead charge):

	Per Ton
Sandstone.....	\$0.25
Limestone.....	0.30
Conglomerate.....	0.30
Trap and granite.....	0.45

Subtotal.....

Net profit..... \$0.20 ±

Estimate per ton¹

¹Total output of crusher.

NOTE.—If any part of the total output cannot be used and is wasted, the price per ton for the stone actually used must include cost of waste.

SAMPLE ESTIMATE [Limestone]

Stripping.....	\$0.05
Quarry rights.....	0.06
Quarrying.....	0.45
Crushing.....	0.30
Subtotal.....	\$0.86
Profit.....	0.20

Estimate..... = \$1.06 per ton

= 1.30 per cubic yard loose measure.

¹Total output of crusher.

Crushing Field-stone Boulders:

1 cu. yd. boulders = 1 cu. yd. crushed stone

1.8 cu. yd. boulders = 1 cu. yd. (1¼ to 3¼" crushed stone consolidated measure)

COST ESTIMATE

	Per Cubic Yard
Cost of field stone.....	\$0.15
Blasting or sledging per cubic yard actually blasted or sledged....	0.60
Loading to wagons or trucks.....	0.30
Hauling to crusher 1 mile.....	0.60
Subtotal.....	1.65
10 % overhead.....	0.17
Subtotal delivery to crusher.....	<u>1.82</u>

	Per Cubic Yard
<i>Crushing</i> (includes overhead charge)	
Sandstone.....	\$0.30
Limestone.....	0.35
Trap and granite.....	0.50
¹ Total per cubic yard (loose measure) screened-out sizes.....	<hr/>
Profit.....	\$0.25

Estimate per cubic yard loose screened sizes.....
¹NOTE.—If any part of the total output cannot be used and is wasted, the price per cubic yard for the stone actually used must include the cost of the wasted product.

SAMPLE ESTIMATE (Limestone)

Cost of stone.....	\$0.15
0.1 cu. yd. sledged.....	0.06
Loading.....	0.30
Haul $\frac{1}{2}$ mile.....	0.35
Subtotal.....	<hr/> \$0.86
10 % overhead.....	0.09
Crushing.....	0.95
	<hr/> 0.35
Profit.....	\$1.30
	<hr/> 0.25
	\$1.55 per cubic yard
	\$1.20 per ton

PRODUCTION OF SCREENED GRAVEL AND SAND IN SMALL PLANTS

The total cost of output depends on the amount of waste product. In most pits there is an excess of sand which must be wasted. For weights of screened gravel and proportions of sand and gravel in pits, see page 1182.

COST ESTIMATES

	Per Ton
Stripping ¹ (use excavation prices, pp. 1126 to 1127).....	\$0.05
Excavating and delivery ¹ to screening plant.....	0.25
Screening ¹	0.15
Subtotal.....	<hr/>
Profit.....	0.15
Estimate per ton total output.....	<hr/>
Price per ton + 30 % \pm equals price per cubic yard loose measure.....	<hr/>

¹ Includes overhead.

SAMPLE ESTIMATE

	Per Ton
Stripping.....	\$0.05
Excavating and delivery.....	0.25
Screening.....	0.15
Subtotal.....	<hr/> 0.45
Profit.....	0.15
Estimate total output of plant ...	\$0.60 per ton screened sizes
	0.80 per cubic yard screened sizes
For 10 % waste estimate = 67 cts. per ton 90 cts. per cubic yard	
For 20 % waste estimate = 75 cts. per ton \$1 per cubic yard	

Washing Sand and Gravel:

Cost of washing varies greatly depending on amount of dirt to be removed, water supply, etc. It will vary from 15 to 50 cts. per ton and no standard estimates can be formulated. Each case is a special problem. Small portable plants are rarely satisfactory and good plant for the production of satisfactory screened and washed gravel will cost at least from \$10,000 to \$15,000.

Commercial washing plants in Western New York use about 500 gal. of water per ton of gravel.

STANDARD ESTIMATE FORM FOR BOULDER SUBBASE (FIELD STONE)**Amounts of Material:**

A subbase course 6" deep made of the usual size fence stone requires 1 cu. yd. loose for 1 cu. yd. rolled; 12" depth of finished base requires 1.25 cu. yd. loose rolled measure.

$\frac{1}{3}$ cu. yd. gravel or small stone and screenings filler required per cubic yard of finished base course.

COST ESTIMATE

Cost of cobbles per loose cubic yard.....	\$0.20 ±	} Multiply these items by 1.25 for 12" depth of subbase.
Loading cobbles to wagons by hand per cubic yard.	0.30	
Hauling ¹ cobbles 1 cu. yd. loose measure 60 cts. per mile, short hauls 50 cts. per mile long hauls		
Placing cobbles.....	0.20	
Rolling.....	0.10	
Filler (see below)		

Total.....	\$.....
20% profit.....
10% overhead.....
Estimate.....

¹ Teams out of fields, bad conditions, short hauls less than 1.5 miles.

Filler:

Cost $\frac{1}{3}$ cu. yd. at pit or crusher:		
Loading $\frac{1}{3}$ cu. yd. (by hand from pile)	\$0.10	}
Loading (from bins)	0.01	
Hauling $\frac{1}{3}$ cu. yd. per mile	0.20	
Spreading $\frac{1}{3}$ cu. yd.		
Filler total.....		\$.....

SAMPLE ESTIMATE

(12" consolidated depth)

Cost of cobbles, \$0.20 × 1.25 cu. yd.	\$0.24	
Loading cobbles, 0.30 × 1.25 cu. yd.	0.38	
Hauling 2 miles average (\$0.50 × 2 × 1.25)....	1.25	
Placing, \$0.20 × 1.25 cu. yd.	0.24	
Rolling, 0.10 × 1.25 cu. yd.	0.12	
Filler:		
Cost $\frac{1}{3}$ cu. yd. at pit	\$0.10	
Loading.....	0.10	
Haul 3 miles.....	0.60	
Spreading.....	0.08	0.88
Total.....	\$3.11	
20% profit.....	0.62	
10% overhead.....	0.32	
Estimate.....		\$4.05 per cubic yard

BOTTOM COURSES

1133

STANDARD ESTIMATE FORM FOR BOULDER BOTTOM COURSE (FIELD STONE)

Same relation of loose and rolled depths as for boulder base. 0.4 cu. yd. gravel or crushed-stone filler required.

COST ESTIMATE

Cost of cobbles per loose cubic yard.....	\$0.20 ±
Loading to wagons by hand per loose cubic yard.....	0.30
Hauling ¹ at 60 cts. per yard-mile	0.40
Placing and sledging	0.10
Rolling.....	0.10
First subtotal.....	<hr/>
First subtotal X consolidation (0 for 6" depth) (0.25 for 12" depth)
Second subtotal.....	<hr/>
Filler (see below).....
Total.....	<hr/>
20% profit.....
10% overhead.....	<hr/>
Estimate.....

Filler:

Cost 0.4 cu. yd., loose measure in pit or at crusher.....
Loading 0.4 cu. yd. by hand, 10 cts.
Loading 0.4 cu. yd. from bins, 1 ct.
Hauling ¹ 0.4 cu. yd. at 20 cts. per mile.....
Spreading and brooming 0.4 cu. yd.....	<hr/> 0.16

Filler total.....

¹ NOTE.—Hauling by teams out of fields, bad conditions, and short hauls less than 1.5 miles.

SAMPLE ESTIMATE (12" consolidated depth)

Cobbles.....	\$0.20 per loose cubic yard
Loading.....	0.30 per loose cubic yard
Hauling 2 miles.....	1.00
Placing and sledging.....	0.40
Rolling.....	<hr/> 0.10
Subtotal.....	\$2.00 per loose cubic yard
Consolidation 25%.....	<hr/> 0.50
Subtotal.....	<hr/> \$2.50 per consolidated cubic yard

Filler:

Cost 0.4 cu. yd. at pit (gravel).....	0.12
Loading.....	0.12
Haul 3 miles.....	0.60
Spreading.....	<hr/> 0.16
Total.....	\$3.50
20% profit.....	0.70
10% overhead.....	<hr/> 0.35
Estimate.....	\$4.55 per consolidated cubic yard

GRAVEL FOUNDATION (PIT-RUN GRAVEL)

Gravel foundation courses require 1.2 cu. yd. loose measure per yard consolidated measure.

COST ESTIMATE

Cost of gravel in pit per loose cubic yard.....	
Loading gravel by hand 30 cts. per cubic yard } by steam shovel 17 cts. per cubic yard }	
Hauling gravel (includes overhead):	
Teams (short hauls).....	0.50 per cubic yard mile
Trucks (hauls less than 1.5 miles).....	0.26 per cubic yard mile
Trucks (hauls over 1.5 miles).....	0.21 per cubic yard mile
Spreading gravel 15 cts. per loose cubic yard.....	\$0.15
Loam filler $\frac{1}{8}$ cu. yd. if ordered.....	0.10
Rolling gravel.....	0.10
Reshaping gravel.....	0.10
First total per loose cubic yard.....	
Consolidation 0.2.....	
Second total per consolidated yard.....	
20% profit.....	
10% overhead (pay roll).....	
Plant overhead.....	0.50 ±
Third total estimate per consolidated cubic yard.....	

SAMPLE ESTIMATE

Cost gravel in pit.....	\$0.50 per cubic yard (loose)
Loading (steam shovel).....	0.17
Haul (2 miles).....	0.40
Spread.....	0.15
Loam filler.....	0.10
Rolling.....	0.10
Reshaping.....	0.10
First total.....	\$1.52 per cubic yard (loose)
Consolidation 0.2.....	0.30
Second total.....	\$1.82 per cubic yard (consolidated)
20% profit.....	0.36
10% overhead.....	0.18
Equipment overhead.....	0.50
Estimate.....	\$2.86

SCREENED GRAVEL BOTTOM COURSE**Materials Required:**

1 cu. yd. consolidated gravel bottom requires 1.25 cu. yd. screened gravel plus 0.35 cu. yd. sand and loam filler.

COST ESTIMATE

Same as for screened gravel top making due correction for amounts of material required (see p. 1139).

LOCAL STONE MACADAM BOTTOM COURSE**Materials Required:**

1 cu. yd. of consolidated bottom course requires approximately 1.27 cu. yd. loose measure for a 3" consolidated depth and approximately 1.30 cu. yd. loose measure for a 4" consolidated depth.

The amount of filler required per cubic yard of consolidated bottom is 0.35 cu. yd. of sand or screenings or a mixture of the two depending on how the screenings are utilized. For proportion of sizes in crusher output, see page 1181.

COST ESTIMATE

For material total, use crushing estimate on page 1130.

Manipulation:

Transfer to trucks or wagons.....	\$0.01 per cubic yard
Hauling:	
Teams {	Bad conditions 60 cts. per yard mile } Good conditions 50 cts. per yard mile }
Trucks {	

Spreading:

5 1/2" loose depth 15 cts. per cubic yard } 4 1/2" loose depth 19 cts. per cubic yard }
Rolling.....	0.10
First subtotal..... per cubic yard
Consolidation 0.27 to 0.30.....
Second subtotal consolidated stone.....
Filler (see below).....
Total.....
Labor overhead 10%
Profit 20%.....
Manipulation total.....

Screenings (filler):

Cost 0.35 ± cu. yd. in bins.....
Loading to trucks (from bins) 50 005.....
Loading to trucks (from piles) 0.12.....
Hauling (use regular hauling rates).....
Spreading and brooming.....	0.15
Total cost screening filler.....

Sand Filler:

Cost 0.35 cu. yd. in pit.....
Loading.....	0.12
Hauling (use regular hauling rates).....
Spreading and brooming.....	0.15
Total cost sand filler.....

NOTE.—If both sand and screenings are used, work out a composite price for the percentage of each kind used.

Summary:

Material total (includes overhead).....
Manipulation total (includes labor overhead).....
Equipment overhead (exclusive crushing) (see p. 1261).....	\$0.60 ±
Estimate per cubic yard consolidated measure.....

COST DATA

SAMPLE ESTIMATE

Filler 50 % screenings; 50 % sand.

Small limestone quarry (total crusher output used. No waste).

Material Estimate:

Quarrying and crushing (see p. 1130). \$1.30 per cubic yard
 Consolidation 0.3 %..... 0.40

Material total..... 1.70 per cubic yard consolidated

Manipulation:

Transfer to trucks..... \$0.01 per cubic yard loose
 Haul (2 miles) (2 X 20)..... 0.40 per cubic yard loose
 Spread..... 0.15 per cubic yard loose
 Rolling..... 0.10 per cubic yard loose

First subtotal..... \$0.66 per cubic yard loose
 Consolidation 0.3..... 0.20

Second subtotal..... \$0.86 per cubic yard consolidated
 Filler (see below)..... 0.90

Total..... \$1.76
 10 % overhead..... 0.18
 Profit..... 0.30

Manipulation total..... \$2.30

Filler	Screenings	Sand
Cost 0.35 cu. yd.....	\$0.44	\$0.10
Load.....	0.01	0.12
Haul 2 miles.....	0.40	0.40
Spread.....	0.15	0.15
Totals.....	\$1.00	\$0.77

Composite price half sand, half screenings = \$0.88—say \$0.00

Summary:

Material consolidated total..... \$1.70
 Manipulation consolidated total..... 2.30
 Equipment overhead..... 0.60

Estimate..... \$4.60 per cubic yard consolidated

MACADAM BOTTOM COURSE—IMPORTED MATERIALS**Amount of Material Required:**

Total weight crushed limestone (specific gravity 2.7 or 170 lb. per cubic foot solid) according to our records is 3050 lb. per consolidated cubic yard of bottom course 3" thick and 3150 lb. per cubic yard finished bottom 4" thick.
 Approximately 0.35 cubic yard sand or screenings required for filler.

COST ESTIMATE

Materials (Limestone):

3" course 3050 lb. f.o.b. unloading points }
 4" course 3150 lb. f.o.b. unloading points }
 6 % on material and freight.....

Material total.....

Manipulation:

Unloading:	
Under 2000 tons (shoveling)	35 cts. per ton
Over 2000 tons (elevator)	16 cts. per ton
Hauling:	
Teams {	Bad conditions 55 cts. per ton mile
	Average conditions 50 cts. per ton mile
	Good conditions 40 cts. per ton mile
Trucks, short hauls	20 cts. per ton mile
Hauls over 1.5 mile	16 cts. per ton mile
Spreading stone:	
5 1/3" loose depth,	12 cts. per ton
4" loose depth,	16 cts. per ton
Rolling,	08 cts. per ton

Filler:

Cost 0.35 cu. yd. at pit or crusher	
Loading 0.35 cu. yd. by hand shoveling	12 cts.
Loading 0.35 cu. yd. from bins	01 ct.
Hauling 0.35 cu. yd. at 7 to 20 cts. per mile (see hauling conditions)	
Spreading and brooming 0.35 cu. yd.	15 cts.
Subtotal	
10 % labor overhead	
20 % profit ±	

Manipulation total.....

Summary:

Material total	
Manipulation total	
Equipment overhead (see p. 1262)	60 cts. to \$1.00

Total estimate per consolidated cubic yard.....

SAMPLE ESTIMATE

4" consolidated depth limestone

Materials:

1 6 tons stone f.o.b. unloading @ \$1.15 + \$1.00 freight per ton	\$3.44
6% on materials	0.20
Material total	\$3.64

Manipulation:

Unloading (1.6 tons × 16 cts.)	\$0.26
Hauling 2 miles (2.0 × 1.6 × 16 cts.)	0.51
Spreading (1.6 × 12 cts.)	0.20
Rolling (1.6 × 8 cts.)	0.13

Filler (Sand Pit):

Cost (0.35 cu. yd. × 30 cts.)	0.10
Loading	0.12
Hauling 2 miles (2.0 × 0.35 × 30 cts.)	0.21
Spreading and brooming	0.15
Subtotal	\$1.68
10 % overhead	0.17
20 % profit	0.34

Manipulation total..... \$2.19

Summary:

Material total	\$3.64
Manipulation total	2.19
Equipment overhead	0.77

Estimate..... \$6.60 per consolidated cubic yard

BITUMINOUS CONCRETE BLACK BASE (HOT MIX)

Materials required per ton of finished product generally about 1260 lb. stone, 650 lb. sand, and 90 lb. of asphalt. For weight per consolidated cubic yard, see page 496.

SAMPLE ESTIMATE

Materials (f.o.b. plant switch):

1200 lb. stone at \$ 2.15 per ton	\$1.29
700 lb. sand at 1.75 per ton	0.61
100 lb. asphalt at 15.00 per ton	0.75
Subtotal	\$2.65
6% on materials and freight	0.15
Material total	\$2.80

Manipulation (per ton):

Unload	\$0.16
Mixing (labor and fuel)	0.80
Hauling 2 miles (2 X 18 cts. per ton mile)	0.36
Spreading, rolling, and finishing	0.60
Subtotal	\$1.92
Labor overhead	0.20
Profit	0.78
Manipulation total	\$2.90

Summary:

Material total	\$2.80 per ton
Manipulation total	2.90 per ton
Equipment overhead	1.00 per ton
Estimate	\$6.70 per ton

CEMENT CONCRETE FOUNDATIONS—IMPORTED MATERIALS

Materials Required (per cubic yard concrete base):

Mix	Cement, barrels	Stone or gravel, cubic yards	Sand, cubic yards
1:3:6	1.1	0.95	0.47
1:2½:5	1.3	0.92	0.46
1:2:4	1.6	0.90	0.45

Allow 10% waste and excess for net sections for sand and stone.
Steel as ordered.

TYPICAL ESTIMATE

Materials:

. bbl. cement f.o.b. unloading switch	
. cu. yd. stone or gravel unloading switch	
. cu. yd. sand unloading switch	
. lb. steel	
Subtotal	
10% waste sand and stone	
6% on materials and freight	
Material total	

GRAVEL TOP

1139

Manipulation:

Unloading:	
. bbl. cement at 8 cts. per barrel.	\$0.11 ±
1.5 cu. yd. stone and sand at 20 ct.	0.30
Hauling:	
. bbl. cement at 3.5 cts. per barrel mile.	
1.5 cu. yd. stone and sand at 22 cts. per yard mile.	
Mixing, placing, curing:	0.70
Subtotal.	
10% overhead.	
Profit.	0.70 ±
Manipulation total.	

Summary:

Material total.	
Manipulation total.	
Equipment overhead.	\$1.00 ±
Estimate per cubic yard.	

SAMPLE ESTIMATE

(1:2½:5 Mix)

Materials (Imported):

1.3 bbl. cement at \$2.50 f.o.b. switch.	\$3.25
0.40 cu. yd. sand at 2.50 f.o.b. switch.	1.15
0.92 cu. yd. stone at 2.60 f.o.b. switch.	2.40
Subtotal.	\$6.80
10% wastage stone and sand.35
6% on materials and freight.45
Material total.	\$7.60

¹ NOTE.—Where local materials are used, use local material estimate forms, p. 1130 to 1132.

Manipulation:

Unloading:	
1.3 bbl. cement at 8 cts. per barrel.	\$0.11
1.5 cu. yd. stone and sand at 20 cts.	0.30
Hauling (2 miles):	
1.3 bbl. cement at 3.5 cts. per lbl. mile.	0.10
1.5 cu. yd. stone and sand at 21 cts.	0.64
Manipulation placing and finishing.	0.70
Subtotal.	\$1.85
10% labor overhead.	0.20
Profit.	0.70
Manipulation total.	\$2.75

Summary:

Material total.	\$ 7.60
Manipulation total.	2.75
Equipment overhead.	0.97
Estimate per cubic yard.	\$11.32

SCREENED GRAVEL TOP COURSE—LOCAL MATERIALS

Materials Required:

1 cu. yd. consolidated measure of finished top course screened gravel requires approximately 1.25 cu. yd. loose screened gravel plus 0.5 cu. yd. sand and loam.

COST ESTIMATE

Materials (see p. 1131):

1 Cost 1.25 cu. yd. screened gravel.....	
1 Cost 0.5 cu. yd. sand.....	

Material total.....

Manipulations:

Loading 1.75 cu. yd. from bins.....	\$0.04
Hauling (use schedule, p. 1128) 1.75 cu. yd.....	
Spreading gravel 1.25 cu. yd. at 20 cts.....	0.25
Spreading and brooming sand and loam 0.5 cu. yd.....	0.25
Rolling.....	0.12
Reshaping.....	0.10

Subtotal.....
 10 % labor overhead.....
 Profit 20 % =.....

Manipulation total.....

Summary:

Material total.....	
Manipulation total.....	
Equipment overhead (exclusive screening).....	0.50 ±

Estimate per cubic yard consolidated.....

1 Includes overhead and profit.

LOCAL STONE WATER-BOUND MACADAM TOP

Same as for imported top using estimate forms (p. 1130) for production of local material and making due allowance for amount of screenings produced by local crusher. See also sample estimate local stone macadam at the bottom of page 1134.

WATER-BOUND MACADAM TOP COURSE—IMPORTED MATERIALS**Materials Required:**

1 cu. yd. consolidated top course requires approximately 3200 lb. of coarse stone and 1250 lb. of screenings where limestone is used (sp. gr. 2.7 or 170 lb. per cubic foot solid rock). See page 442 for weights of different rocks of different sizes.

COST ESTIMATE

Materials:

4450 lb. limestone f.o.b. unloading point.....	
6 % on stone and freight.....	

Materials total.....

Manipulation:

Unloading from cars at 16 cts. per ton.....	
Hauling (regular schedule p. 1128).....	
Spreading stone at 18 cts. per ton.....	
Spreading screenings at 30 cts. per ton (hand).....	
Spreading screenings at 10 cts. per ton (mechanical).....	
Rolling at 05 cts. per ton.....	
Puddling at 08 cts. per ton.....	

Subtotal.....
 10 % overhead.....
 20 % profit ±.....

Total manipulation.....

Summary:

Material total.....	
Manipulation total.....	
Equipment overhead.....	60 cts. to \$1.00

Estimate per consolidated cubic yard.....

BITUMINOUS MACADAM

1141

SAMPLE ESTIMATE

Materials:

2.22 tons limestone at \$2.25 per ton f.o.b. switch.....	\$5.00
6 % on materials.....	0.30
Materials total.....	\$5.30

Manipulation:

Unloading 2.22 X 16 cts.....	\$0.36
Hauling 2 miles (2.22 X 2.0 X 16 cts)	0.71
Spreading stone 1.6 tons X 18 cts.....	0.29
Spreading screenings 0.62 tons X 20 cts.....	0.12
Rolling 2.22 tons X 5 cts.....	0.11
Puddling 2.22 tons X 8 cts.....	0.18
Subtotal.....	\$1.77
10 % overhead.....	0.18
Profit 20% ±	0.36
Manipulation total.....	\$2.31

Summary:

Material total.....	\$5.30
Manipulation total.....	2.31
Equipment overhead.....	0.69

Estimate..... **\$8.30 per cubic yard**

LOCAL STONE BITUMINOUS MACADAM TOP

Same as for imported bituminous macadam using estimate (see p. 1130) for production of local material. See also local stone macadam, sample estimate, page 1134.

BITUMINOUS MACADAM TOP—IMPORTED MATERIALS

Amounts of Material Required:

Stone:

Total weight of limestone (sp. gr. 2.7 or 170 lb. per cubic foot solid) according to our best records is 4250 lb. per cubic yard of finished bituminous macadam 2½" consolidated depth and 4350 lb. per cubic yard of 3" consolidated depth. The percentage of different sizes are as follows.

- 1½ to 2½" size crushed stone 65 to 75 % of total.
- ¾ to 1½" size crushed stone 20 to 15 % of total.
- Dustless screenings 15 to 10 % of total.

Bitumen:

- 1.5 to 1.75 gal. single coat per square yard.
- 2.0 to 2.25 gal. double coat per square yard.
- Single coat recommended on steep grades.

Cost of Manipulation:

Overhead charge (interest, depreciation, repairs, bonds, etc.).

Short jobs (1½ miles or less, eliminations) \$1.00 per consolidated cubic yard.

Long jobs (ordinary contracts)..... \$0.60 per consolidated cubic yard.

Interest on Cost of Materials and Freight 6 %.

Profit:

Allow enough to give 15 % net profit for job over and above overhead and interest charge.

Unit prices based on:

- Labor 50 cts. per hour.
- Teams 90 cts. per hour.
- 5-ton trucks \$3.00 per hour.
- 1½-ton trucks \$1.50 per hour.

Unloading Stone:

- Small jobs 2.2 tons at 35 cts. per ton.
- Large contracts 2.2 tons at 16 cts. per ton.

Hauling:

Teams	{	Bad conditions	2.2 tons at 55 cts. per ton mile
		Average conditions	2.2 tons at 50 cts. per ton mile
		Good conditions	2.2 tons at 40 cts. per ton mile
Trucks	{	Short haul, 20 cts. per ton mile	
		Long haul (over 1.5 miles)	16 to 18 cts. per ton mile.

Spreading Stone:

No. 3 stone 1.5 tons at 18 cts. per ton.
 Screenings and
 No. 2 stone 0.7 tons at 70 cts. per ton.

Rolling:

2.2 tons at 12 cts. per ton.

Heating and Spreading Bitumen.

Small jobs 2.25 gal. at 5 cts. per gallon.
 Long jobs 2.25 gal. at 3 cts. per gal.

Hauling Bitumen:

0.1 ct. per gallon per mile.

BITUMINOUS MACADAM TOP—IMPORTED MATERIALS SHORT JOBS ELIMINATIONS

SAMPLE ESTIMATE

Materials:

2.2 tons f.o.b. delivery point	\$1.15 + \$1.00 per ton freight	\$4.73
27 gallons bitumen f.o.b. delivery point at 10 cts. per gallon.		2.70
6 % on materials and freight		0.45
Materials total.....		<u>\$7.88</u>

Manipulation:

Unloading stone (2.2 tons) at 35 cts. per ton.....	\$0.77
Hauling stone 2.2 tons 2 miles at 16 cts. per ton mile.....	0.70
Spreading:	
1.5 tons No. 3 stone at 18 cts. per ton.....	0.27
0.7 tons screenings No. 2 at 70 cts. per ton.....	0.50
Rolling 2.2 tons at 12 cts. per ton.....	0.26
Hauling bitumen 27 gal. at 0.1 ct. per gallon mile.....	1.35
Heating and spreading bitumen 27 gal. at 0.05 cts.....	1.35
Manipulation total.....	<u>\$3.90</u>

Summary:

Material total.....	\$ 7.88
Manipulation total.....	3.90
Overhead.....	1.00
Net profit.....	0.80

Total..... \$13.58 per cubic yard in place.

Say \$13.60 per cubic yard including bitumen or \$1.15 per square yard.

Long contracts run about \$1 to \$1.10 per square yard 3' consolidated depth.

BITUMINOUS CONCRETE SURFACE—HOT MIX**Materials Required:**

The amount of materials will vary considerably depending on the source of supply (see Design of Bituminous Concretes p. 495). For weight per consolidated cubic yard see page 496.

BITUMINOUS CONCRETE

I 143

COST ESTIMATE (PER TON)

Materials (f.o.b. plant switch):

Stone.....
Sand.....
Dust (filler).....
Asphalt.....
Subtotal.....	
6 % on materials and freight.....

Material total per ton.....

Manipulation (Per ton):

Unloading.....	\$0.16
Mixing (labor and fuel).....	1.00
Hauling at 18 cts. per ton mile.....
Spreading (labor).....	0.60
Rolling and finishing (labor and fuel).....	0.20
Subtotal.....	
10 % overhead.....
Profit.....	\$1.00 ±

Manipulation total.....

Summary:

Material total.....
Manipulation total.....
Plant overhead, etc.....	\$0.80 to \$2.00 (see p. 1264)

Estimate per ton.....

TOPEKA TOP COURSE—IMPORTED MATERIALS

SAMPLE ESTIMATE

Materials (Per ton finished pavement):

500 lb. stone at \$ 2.15 per ton (f.o.b. plant).....	\$0.54
1160 lb. sand at 1.75 per ton (f.o.b. plant).....	1.02
170 lb. dust at 0.00 per ton (f.o.b. plant).....	0.51
170 lb. asphalt at 15.00 per ton (f.o.b. plant).....	1.28
6 % on material and freight.....	
	0.20
Material total.....	\$3.55

Manipulation (Per ton finished pavement):

Unloading.....	\$0.16
Mixing.....	1.00
Hauling 2 miles.....	0.40
Spreading.....	0.60
Rolling and finishing.....	0.20
Subtotal.....	
Overhead labor.....	0.24
Profit.....	\$1.00

Manipulation total..... \$3.60

Summary:

Material total.....	\$3.55
Manipulation total.....	3.60
Equipment overhead.....	1.05

Estimate per ton..... \$8.20

SHEET ASPHALT SURFACING

Cost data from city pavements by Besson

Recapitulation of Cost.—For a surface $1\frac{1}{2}$ " in thickness, sheet asphalt pavement costs may be tabulated as follows; that for materials, of course, depending greatly upon local conditions, while the other costs should fluctuate to a much less degree.

Sand at \$0.80 ton, 120 lb. =	\$0.048 per sq. yd.	
Dust at \$5.00 ton, 30 lb. =	0.075	
Asphalt at \$15.00 ton, 15 lb. =	0.113	
Total for materials.....		\$0.236
Plant charges at 100 days per year.....	0.075	
Labor at the plant.....	0.090	
Fuel.....	0.030	
Total at the plant.....		0.195
Transportation at \$9 per ton.....		0.075
Spreading the mixture.....		0.045
Surface finishing.....		0.015
Total for operating.....		\$0.566
10% foreman and overhead.....		0.057
10% contingencies.....		0.057
15% contractor's profit.....		0.085
Estimated bid price per sq. yd.....		\$0.77

CEMENT-CONCRETE PAVEMENT—IMPORTED MATERIALS

TYPICAL EQUIPMENT—PAVEMENT PROPER

Item	Approximate value	Approximate yearly charge including interest, depreciation, repairs, storage, taxes, etc.	
		Minimum	Maximum
Clam shovel or elevator unloader..	\$ 2,000 to \$ 8,000	\$ 600	\$ 2,400
Bin and batcher.....	1,000 to 3,000	300	900
10 to 20 Ford trucks or smaller number of large trucks.....	5,000 to 10,000	3,500 ¹	7,000
Six- to seven-bag batch concrete mixer.....	6,000 to 7,000	3,000	3,500
3,000 lin. ft. steel forms.....	2,000 to 3,000	1,600	2,400
Small tools for mixing, placing, and finishing.....	200 to 300	200	300
25,000' ± water pipe line.....	4,000 to 6,000	2,000	3,000
Pumping equipment.....	800 to 1,500	200	500
First totals.....	\$21,000 to \$38,000	\$11,400	\$20,000
Second totals exclusive trucks...	16,000 to 31,000	8,000	13,000
Moving plant and installing on job.....		\$ 500	\$ 1,000

Average yearly output 5 to 8 miles of road = 10,000 to 20,000 cu. yd. per year.

First total..... \$12,000 to \$21,000

Second total..... \$ 8,500 to \$14,000

Approximate average overhead on equipment per cubic yard of pavement..... \$1.00 to \$1.50

Approximate¹ average overhead exclusive of haulage which is often sublet..... \$0.70 to \$1.20

¹ NOTE.—Haulage is often sublet or trucks hired by the day which becomes pay-roll charge.

Materials Estimate per Cubic Yard of Pavement:

Cement:		
1:1½:3 mix....	1.9 bbl.	} at per bbl. f.o.b. unloading point, bags returned.
1:2 :3 mix....	1.7 bbl.	
1:2 :4 mix....	1.6 bbl.	
Sand (Loose measure):¹		
1:1½:3 mix....	0.42 cu. yd.	} at per cubic yard f.o.b. unloading point
1:2 :3 mix....	0.52 cu. yd.	
1:2 :4 mix....	0.45 cu. yd.	
Crushed Stone or Screened Gravel (Loose measure):¹		
1:1½:3 mix....	0.85 cu. yd.	} at per cubic yard f.o.b. unloading point
1:2 :3 mix....	0.77 cu. yd.	
1:2 :4 mix....	0.90 cu. yd.	
Expansion Joints		\$0.10
Steel Reinforcement: ... to ... lb. per cubic yard concrete f.o.b. unloading point		_____
Total		_____
Allow 10 % for wastage and excess of actual quantities over net section.....		_____
Allow 6 % for demurrage, interest, and profit on materials		_____

Material estimate total.....

¹ NOTE.—Sand and stone is usually sold by the ton and the weights will vary considerably for different sources of supply, sizes ordered, and whether sand is washed or taken directly from pit. The weight per cubic yard loose measure as shipped must be determined for each separate case (see pp. 1180 and 1182).

Labor and Fuel Costs (per cubic yard concrete):

Unloading and batching:		
Cement:		
70% direct car to trucks	5 cts. per bbl.	
30% storage and rehandling	15 cts. per bbl.	
1:1½:3 mix.....	2 bbl. at 8 cts.	} = \$0.16—
1:2 :3 mix.....	1.8 bbl. at 8 cts.	
1:2 :4 mix.....	1.7 bbl. at 8 cts.	
Sand and Coarse Aggregate:		
1.5 cu. yd. at 20 cts. per cubic yard (loose measure).....		\$0.30 ±
Steel reinforcement — lb. at .02 ct. per pound.....		_____
Hauling (Trucks including depreciation, repair, etc.):		
Cement:		
1.7 to 2.0 bbl. at 3.5 cts. per barrel mile.....		_____
Sand and Stone:		
1.5 cu. yd. at 21 cts. per cubic yard mile over 1.5 miles	}.....	_____
26 cts. per cubic yard mile under 1.5 miles		
Steel:		
— to — lb. at 0.02 ct. per pound mile.....		_____

Manipulation:

Forms.....	per cubic yard pavement	\$0.12	} \$0.85
Mixing.....	per cubic yard pavement	0.11	
Placing concrete.....	per cubic yard pavement	0.15	
Placing steel and joints.....	per cubic yard pavement	0.045	
Finishing steel and joints.....	per cubic yard pavement	0.105	
Cover and curing.....	per cubic yard pavement	0.25	
Water supply.....	per cubic yard pavement	0.07	_____
Total		_____	
10% overhead.....		_____	
Profit		\$1.00 to \$1.50	

Pay roll total estimate.....

Summary:

Pay roll total.....	
Material total.....	
Equipment total (exclusive hauling)...	\$1.00 ±

Estimate..... per cubic yard pavement*

SAMPLE ESTIMATE

(7½" - 6½" - 7½") (1:1½:3 mix) (Imported materials)
Large job 10 miles in length.

Materials (Imported):¹

1.9 bbl. cement f.o.b. switch at \$2.50 per bbl.....	\$4.75
0.42 cu. yd. sand f.o.b. switch at \$2.50 per cubic yard.....	1.05
0.85 cu. yd. stone f.o.b. switch at \$2.60 per cubic yard.....	2.20
Expansion joints per cubic yard pavement.....	0.10
25-lb. steel per cubic yard pavement at 3 cts.....	0.75
Total.....	\$8.85
10% wastage.....	0.30
6% on materials.....	0.60
Materials total.....	\$9.75

¹ NOTE.—Where local materials are used, use material estimate forms,
pp. 1130 to 1132

Manipulation:

Unloading:	
Cement.....	\$0.16
Sand and stone.....	0.30
Steel.....	0.01
Hauling (2 miles):	
Cement 2 × 1.9 × 3.5 cts.....	\$0.14
Sand and stone 2 × 1.5 × 21 cts.....	0.63
Steel 25 × 0.02 ct.....	0.01
Mixing, placing, curing, etc.....	0.85
Subtotal.....	\$2.10
Profit.....	1.00
10% overhead.....	0.21
Pay roll total.....	\$3.31

Summary:

Pay roll total... \$	3.31
Material total..	9.75
Equipment overhead.....	1.04
Estimate....	\$14.10 per cubic yard = \$2.75 per square yard 7" depth.

BRICK SURFACING

Materials Required:

Brick: 40 per sq. yd. usual standard (3½" by 4" by 9").
Sand cushion (1" thick): 0.028 cu. yd. per square yard.
Cement grout (1 to 1): 0.03 bbl. cement 0.05 cu. yd. sand per square yard.
Sand cover (1" thick): 0.028 cu. yd. per square yard.

AMOUNT OF CEMENT AND SAND DIFFERENT MORTARS (PER CUBIC YARD MORTAR)

1:1 mix.....	4.8 bbl. cement	0.77 cu. yd. sand
1:1½ mix.....	3.88 bbl. cement	0.86 cu. yd. sand
1:2 mix.....	3.20 bbl. cement	0.95 cu. yd. sand
1:3 mix.....	2.40 bbl. cement	1.07 cu. yd. sand
1:4 mix.....	1.90 bbl. cement	1.12 cu. yd. sand

¹For typical estimates, see below and page 1214.

BRICK AND STONE BLOCK

1147

Cost Data from City Pavements

By Besson

Cost Data.—Typical data (1922) for the cost of a brick surface per square yard are as follows:

	Per Square Yard
36 bricks at \$50 per thousand (3" depth).....	\$1.80
Handling to trucks.....	0.02
Hauling.....	0.20
Piling on street.....	0.02
Laying and rolling.....	0.10
Bituminous filler (plus 10 to 15 cts. if poured).....	0.18
Sand cushion (plus 10 cts. if cement is added).....	0.08
	\$2.40
15% contingencies and overhead.....	0.36
15% profit.....	0.36
Estimate.....	\$3.12

Cost Data from City Pavements

By Besson

STONE BLOCK SURFACING

Cost Data.—Typical data (1922) for the cost of a granite-block surface are:

	Per Square Yard
30 blocks at \$120 per thousand.....	\$3.60
Handling to trucks.....	0.03
Hauling.....	0.32
Piling on street.....	0.02
Laying and ramming.....	0.30
Mastic filler.....	0.30
Sand cushion (plus 25 cts. if cement is added).....	0.13
	\$4.60
Contingencies and overhead.....	0.50
Profit.....	0.70
Total estimate.....	\$5.80

SAMPLE ESTIMATE FORM FOR PIPE CULVERTS WESTERN NEW YORK

Size and kind	Approximate price per foot ¹ f.o.b. unloading point	Approximate costs per foot of length				
		Unloading	Hauling per mile	Installation not including trenching	Joints	Average bid price, Western New York, 1926
Light-weight standard water pipe (\$50 per ton):						
12" cast iron	2.00	0.07	0.01	0.09	0.02	\$3.00
14" cast iron	2.50	0.07	0.01	0.09	0.03	3.50
16" cast iron	3.00	0.08	0.02	0.10	0.03	4.00
18" cast iron	3.75	0.12	0.03	0.15	0.04	5.00
Lock joint cast-iron culvert pipe:						
12"	2.75	0.03	0.01	0.06	0.02	3.80
14"	2.65	0.04	0.01	0.06	0.03	3.70
16"	3.26	0.05	0.01	0.07	0.03	4.00
18"	3.67	0.06	0.015	0.09	0.04	5.00
24"	6.52	0.08	0.02	0.12	0.06	7.50
Corrugated metal						
12" }	1.20	0.03	0.01	0.03	...	1.60
14" }		0.03	0.01	0.03
16" } 15"	1.60	0.03	0.015	0.03	...	2.00
18" }	1.90	0.04	0.02	0.04	...	2.50
24" }	2.80	0.05	0.02	0.05	...	3.50
Reinforced concrete:						
12"	0.90	0.02	0.01	0.06	0.02	1.70
15"	1.10	0.03	0.01	0.06	0.03	2.00
18"	1.40	0.04	0.02	0.07	0.04	2.30
24"	2.20	0.06	0.02	0.08	0.06	3.50
Double-strength ² vitrified pipe:						
12"	0.70	0.02	0.01	0.06	0.02	0.90
15"	0.90	0.03	0.01	0.06	0.03	1.30
18"	1.40	0.04	0.02	0.07	0.04	1.60
24"	2.40	0.06	0.02	0.08	0.06	3.00

¹ Prices for pipe are for car load lots.

² Where vitrified pipe is used it is generally jacketed with concrete the cost of which must be added to the figures given in the tabulation. For weights and dimensions of culvert pipe, see Chap. XIV, pp. 1079 to 1084.

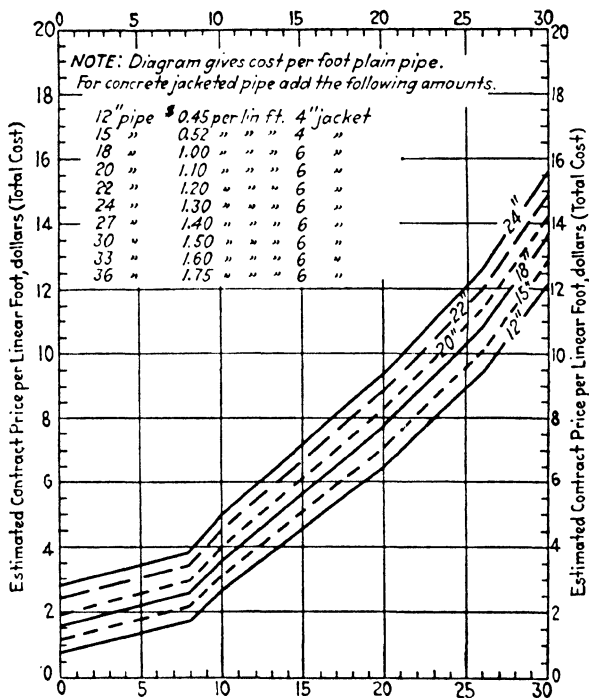

Average cost sewers. (Lima, Ohio, 1921.)

FIG. 325.

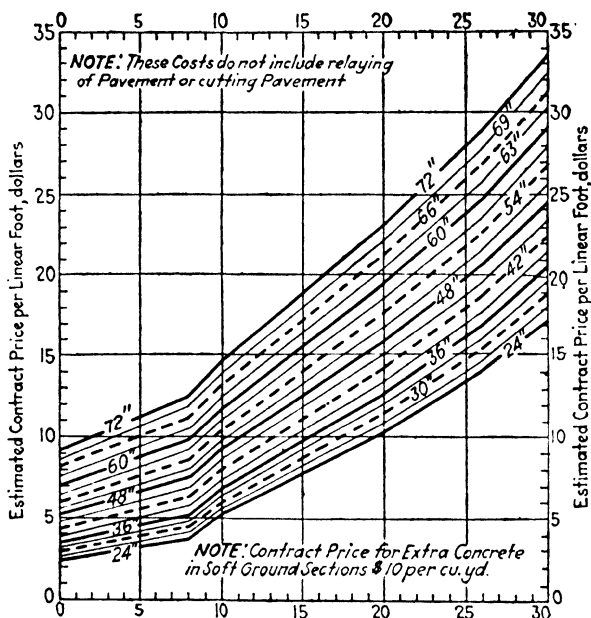

Average cost sewers. (Lima, Ohio, 1921.)

FIG. 325.—(Continued.)

COST ESTIMATE FORMS--BRIDGE AND CULVERTS

Earth Excavation (Foundations):

Dry-earth hand work.....	\$2.50 per cubic yard
Wet-earth hand work.....	3.50 per cubic yard
Dry-earth steam shovel.....	0.80 per cubic yard
Dry-earth slip scrapper.....	0.60 per cubic yard

Rock Excavation:

Removing old masonry.....	4.00 per cubic yard
Rock in foundations.....	5.00 to 6.00 per cubic yard
Shale in foundations.....	4.00 per cubic yard

Cofferdams or Flumes:

\$80 per M ft. b.m. in place required for protection.

Timber Piles:

\$1.00 per foot for driving (small jobs).
0.50 per foot for driving (large jobs).
0.40 per foot delivered at bridge.

Bar Steel: Use 6 cts. per pound in place except for thin reinforced side wall culverts in which case use 8 cts. per pound.

CONCRETE CULVERTS

1151

Rolled Beams (Usual bid 6 cts. per pound):

Cost f.o.b. switch.....	\$0.032 per pound
Unload to trucks.....	0.001
Hauling per mile.....	0.001 per pound
Erecting.....	0.005 per pound
<hr/>	
Total.....	\$0.039
10 % overhead.....	0.005
Profit.....	0.008

Total..... \$0.052

NOTE.—Add \$0.001 per mile for each mile over first mile.

Structural Steel (In place):

Usual estimate { 7 cts. per pound plate girders.	
{ 7.5 cts. per pound trusses.	
Dismantling steel superstructure.....	\$10.00 per ton
Repainting old masonry.....	0.05 per sq. ft.

Cement: Allow 30 cts. per barrel net profit.

Cost per barrel f.o.b. unloading switch.....	\$2.44
Unload to trucks.....	0.08
Haul at 3.5 cts. per mile per barrel.....	0.04
Incorporating in mix (included in concrete manipulation)	0.00
<hr/>	
Total.....	\$2.56
5 % overhead.....	0.14
Profit.....	0.30

Estimate per barrel for 1-mile haul \$3.00

Add 3.5 cts. for each mile over 1-mile haul.

COST ESTIMATE FORMS—CONCRETE CULVERTS AND BRIDGES

Profit:

Allow \$2 per cubic yard net profit over and above all costs including equipment, overhead bonds, liability, etc.

Materials (10% wastage allowed on sand and stone):

1: 2½: 5 abutment concrete:	
0.5 cu. yd. (0.75 ton) sand f.o.b. switch }	
1.0 cu. yd. (1.2 tons) stone f.o.b. switch }	
1: 2: 4 culvert concrete:	
0.48 cu. yd. (0.73 ton) sand f.o.b. switch }	
0.95 cu. yd. (1.14 tons) stone f.o.b. switch }	
1: 2: 3½ concrete:	
0.52 cu. yd. (0.77 ton) sand }	
0.92 cu. yd. (1.1 tons) stone }	
<hr/>	
Total.....	
6% overhead.....	

Material total.....

Manipulation (per cubic yard concrete):

Unload (1.5 cu. yd. sand and stone):	
By hand (small jobs) 60 cts. per cubic yard.....	\$0.90
By machinery (large jobs) 20 cts. per cubic yard.....	0.30 ±
Hauling (1.5 cu. yd.):	
Hand loading less than 1.5 miles at 40 cts. per yard mile	
Bin loading less than 1.5 miles at 25 cts. per yard mile	
Bin loading hauls over 1.5 miles at 20 cts. per yard mile	

Forms:

	Per Cubic Yard
Small culverts 5' span or less.....	\$ 3.00
BR 101 standard culverts.....	4.00
701 abutments.....	2.50
703 abutments.....	2.00
Slab decks.....	6.00
T-beam decks.....	8.00
Jack-arch decks (corrugated metal).....	5.00
Trestles (25 height).....	13.00
Parapets (fancy).....	10.00
Reinforced-concrete arch rings.....	10.00

	Per Cubic Yard
Mixing and Placing:	
Culverts (standard).....	\$ 2.00
Abutments.....	1.50
Superstructures slab.....	2.00
Superstructures T and Jack arch.....	2.50
Parapets.....	3.00
BR 101 culverts.....	2.50
Rub Finish:	
Abutments and wings.....	\$ 0.30
Parapets and copings (fancy).....	3.00
Total.....
10% overhead.....
Manipulation total.....

CONCRETE SUMMARY

	Per Cubic Yard
Material total.....
Manipulation total.....
Equipment overhead.....	\$1.00
Profit.....	2.00
Total estimate.....

CONDENSED SCHEDULE OF CULVERT AND BRIDGE CONCRETE PRICES DIVISION 4, WESTERN NEW YORK, 1926

(Compiled by W. G. Harger from Cost Data Collected in 1926)

General Basis of Costs:

0.75 ton sand per cubic yard concrete.

1 15 tons stone or gravel per cubic yard, concrete.

Cost of sand and stone per cubic yard concrete, \$3.60 f.o.b. unloading point.

Unloading by hand shoveling from cars.

Average haul 4 miles switch to work.

NOTE.—To correct for other conditions of cost, proceed as follows:

Correct prices directly for difference in cost of materials f.o.b. switch unloading point.

If stone and sand and unloaded mechanically, reduce prices of concrete 60 cts. per cubic yard.

If haul is not 4 miles, either add or subtract 35 cts. for each mile over or under the 4 miles estimated.

Typical Unit Costs of Concrete (4-mile haul)

(Cement and reinforcement not included)

	Per Cubic Yard
Standard culverts (under 5' span) Fig. 65, page 221.....	\$15.00
BR 101 culverts (6 to 10' span) Fig. 67, p. 224.....	17.00
Abutment and wings (Br 701 to 703) Fig. 69B, page 241.....	13.50
Slab floor concrete (Br 201) Fig. 69A, page 237.....	18.00
Jack-arch floor concrete (Br 301) Fig. 70A, page 276.....	18.00
T-beam floor concrete (Br 401) Fig. 73A, page 252.....	21.50
Parapet concrete (Br 201, 301, and 401) Fig. 73A, page 252.....	27.00
Reinforced-concrete arch rings Fig. 71A, page 249.....	23.50
Trestle concrete-railway crossing designs, approximately.....	28.50

Typical Cost Estimates

Small jobs assuming material unloaded by hand before regular unloading equipment is installed.

Culverts (Less than 5' span) (mass concrete)

1:2:4 mix:

Sand \$1.70 per ton f.o.b. switch.

Stone \$2.10 per ton f.o.b. switch.

CONCRETE CULVERTS

1153

Materials:

0.73 tons sand at \$1.70.....	\$1.24
1.14 tons stone at \$2.10.....	2.40

Total.....	\$3.64
6 %.....	0.22

Material total.....	\$3.86
---------------------	--------

Manipulation:

Unload by hand 1.43 cu. yd. at 60 cts.....	\$0.86
Haul 1.43 cu. yd. 4 miles at 25 cts. per mile.....	1.43
Forms.....	3.00
Mixing and placing.....	2.00
Rub finish.....	0.30

Total.....	\$7.59
Exclusive of hauling 10% overhead.....	0.62

Manipulation total.....	\$8.21
-------------------------	--------

NOTE.—Add or subtract 35 cts. for every mile over or less than 4 miles as shown.

Summary:

Material total.....	\$ 3.86
Manipulation total.....	8.21
Equipment overhead.....	1.00
Profit.....	2.00

\$15.07, say \$15, does not include cement or reinforcement.

Culverts (BR 101 standard 6 to 10' span reinforced side walls and bottom):

1. 2' 3 $\frac{1}{2}$ mix:
 Sand \$1.70 per ton f.o.b. switch.
 Stone \$2.10 per ton f.o.b. switch.

Materials:

0.77 ton sand at \$1.70.....	\$1.32
1.1 tons stone at \$2.10.....	2.32

Total.....	\$3.64
6 %.....	0.22

Material total.....	\$3.86
---------------------	--------

Manipulation:

Unload 1.44 cu. yd. stone and sand at 60 cts.....	\$0.86
Haul 1.44 cu. yd. 4 miles at 25 cts. per mile.....	1.43
Forms.....	4.00
Mixing and placing.....	2.50
Rub finish.....	0.30

Exclusive of hauling 10 % overhead.....	\$0.09
	0.77

Manipulation total.....	\$9.86
-------------------------	--------

NOTE.—Add or subtract 35 cts. for every mile over or under a 4-mile haul

Summary:

Material total.....	\$ 3.86
Manipulation.....	9.86
Equipment overhead.....	1.00
Profit.....	2.00

\$16.72, say \$17, does not include cement or reinforcement.

Abutment Costs (BR 701-703) see Fig. 69B, page 241.

1: 2 $\frac{1}{4}$ 5 mix:
 Sand \$1.70 per ton f.o.b. switch.
 Stone \$2.10 per ton f.o.b. switch.

Materials:

0.75 ton sand at \$1.70.....	\$1.27
1.2 tons stone at \$2.10.....	2.52

Total.....	\$3.79
6 %.....	0.23

Material total..... \$4.02

Manipulation:

Unload by hand 1.43 cu. yd. at 60 cts.....	\$0.86
Haul 1.5 cu. yd. 4 miles at 25 cts. per yard mile.....	1.50
Forms.....	2.00
Mixing and placing.....	1.50
Rub finish.....	0.30

\$6 16

Exclusive of hauling 10% overhead..... 0.47

Manipulation total..... \$6 63

NOTE.—Add or subtract 37 cts. per mile for each mile of haul over or under 4 miles.

Summary:

Materials.....	\$ 4 02
Manipulation.....	6.63
Equipment overhead.....	1.00
Profit.....	2.00

\$13 65, say \$13.50 per cubic yard, does not include cement or reinforcement.

Slab Deck Concrete (BR 201) and Jack-arch Deck Concrete (BR 302) Fig.

76A, page 276:

1: 2: 3½ mix:

Sand \$1.70 per ton f.o.b. switch.

Stone \$2.10 per ton f.o.b. switch.

Materials:

0.77 ton sand at \$1.70.....	\$ 1.32
1.1 tons stone at \$2.10.....	2.32

Total.....	\$ 3.64
6 %.....	0.22

Material total..... \$ 3.86

Manipulation:

Unload by hand 1.44 cu. yd.....	\$ 0.86
Haul 1.44 cu. yd. 4 miles.....	1.43
Forms.....	6.00
Mixing and placing.....	2.00

\$10.29

Exclusive of hauling 10% overhead..... 0.88

Manipulation total..... \$11.17

NOTE.—Add or subtract 35 cts. for each mile hauled over or under 4 miles.

Summary:

Material total.....	\$ 3.86
Manipulation total.....	11.17
Equipment overhead.....	1.00
Profit.....	2.00

\$18.03, say \$18, exclusive of cement and reinforcement.

T-beam Superstructures (BR 401) and Reinforced-concrete Arches:

1: 2: 3½ mix:

Sand \$1.70 per ton f.o.b. switch.

Stone \$2.10 per ton f.o.b. switch.

CONCRETE BRIDGES

1155

Materials:

0.77 ton sand at \$1.70.....	\$ 1.32
1.1 tons stone at \$2.10	2.32

Total.....	\$ 3.64
6%.....	0.22

Material total..... \$ 3.86

Manipulation:

Unload by hand 1.44 cu. yd.....	\$ 0.86
Haul 1.44 cu. yd. 4 miles.....	1.43
Forms (T-beam construction).....	8.00
Mixing and placing.....	2.50
Finishing.....	0.50

Total.....	\$13.29
Overhead 10% exclusive of hauling.....	1.18

Manipulation total..... \$14.47

NOTE.—Add or subtract 35 cts. for each mile hauled over or under 4 miles as estimated.

Summary:

Materials.....	\$ 3.86
Manipulation.....	14.47
Equipment.....	1.00
Profit.....	2.00

\$21.33 T-beam.
23.50 arch rings.

Parapet Concrete (BR 201, 302, and 401):

1: 2: 3½ mix:
Sand \$1.70 per ton f.o.b. switch.
Stone \$2.10 per ton f.o.b. switch.

Materials:

0.77 ton at \$1.70	\$ 1.32
1.1 tons at \$2.10.....	2.32

6%.....	\$ 3.64
	0.22

Materials..... \$ 3.84

Manipulation:

Unload	\$ 0.86
Haul 4 miles.....	1.43
Forms.....	10.00
Placing.....	3.00
Finishing	3.00

Labor overhead.....	\$18.29
	1.68

Manipulation... \$19.97

NOTE.—Add or subtract 35 cts. per mile over or less than the 4 miles estimated.

Summary:

Materials.....	\$ 3.84
Manipulation.....	19.97
Equipment.....	1.00
Profit.....	2.00

\$26.81, say \$27.

Incidental Items.—Incidental minor item prices should be compiled for the locality in question and the specifications and design used locally. The following list is for items in Western New York (1926):

SAMPLE COST ESTIMATES

Incidental Items (see also Chap. XII, p. 768):

Clearing and Grubbing:	
Sage brush.....	\$ 20 to \$ 60 per acre
Small trees and brush.....	100 to 150 per acre
Large trees, heavy growth.....	300 to 500 per acre
Pipe underdrain (exclusive excavation and porous filling):	
4" vitrified pipe.....	\$0.25 per linear foot
6" vitrified pipe.....	0.35 per linear foot
Relaying old pipe.....	0.20 per linear foot
Manholes.....	10.00 per foot height
Manhole covers.....	0.10 per pound
Pipes, all kinds (see p. 1148).	
Curbing:	
6" medium sandstone.....	\$2.10 per foot
Concrete curb, includes cement.....	25 per cubic yard
Resetting old curb.....	1.00 per foot
Curb bar for concrete curb.....	0.30 per foot
Gutters:	
Cobble, cement joints.....	\$ 1.25 per square yard
Concrete, includes cement.....	18 per cubic yard
Guard rail:	
Wooden.....	\$ 0.75 per linear foot
Resetting old rail.....	0.50 per linear foot
Steel cable, concrete posts.....	1.50 per linear foot
Concrete guide posts set 6' to 8' centers.....	3.00 each, \$0.50 per lin. ft.
(Cost at plant \$1.60)	
2" pipe rail.....	\$ 3.00 per linear foot
Scarifying and reshaping macadam.....	0.10 per square yard
Maintaining traffic.....	0.20 per linear foot
Timber and lumber in place.....	80 per M ft. b.m.
Rip-rap.....	2.00 to 4.00 per cubic yard
Grouted rip-rap.....	7.00 per cubic yard exclusive of cement
Repointing masonry.....	\$ 0.05 per sq. ft.
Refinishing old concrete.....	0.15 per sq. ft.
Repair disintegrated concrete.....	0.50 per sq. ft.
Gunite refinish.....	0.30 to 80

Land Damage Costs.—It is desirable to establish schedules of reasonable values for locality in question and to use these schedules in making initial offers. If property owner is not reasonable, condemnation should be resorted to.

Land acquired, twice prevailing acreage value.

Fruit trees, twice capitalized value from average crop, or loss from time required to plant and grow other trees.

Moving houses, one and one-half times cost of moving to suitable location.

WESTERN NEW YORK APPROXIMATE SCHEDULES (CONDEMNATION)

Poor gully land.....	\$ 50 per acre
Ordinary farm land.....	150 per acre
Vineyards.....	500 per acre
Orchards.....	700 per acre
Moving houses.....	1000 each

DETAIL COST DATA AND AMOUNTS OF MATERIALS

Cost of Earth Excavation.—Table 211 shows the cost of earthwork on four roads in New York State which represent easy, average, and difficult work. The cost per cubic yard includes excavation, placing in fill, fine grading for pavement, and trimming shoulders and ditches. For heavy fills with short hauls, wheel scrapers were used but the largest part of the work was done by team plowing, hand shovelling and wagon haul.

Table 212 shows the cost of steam-shovel rough grading including excavation, haul, placing, and compacting. This job was not particularly well handled and is somewhat more costly than well-managed work.

TABLE 211.—EARTH EXCAVATION

Road No.	Length, Miles	Total Excavation Cu. Yds.	Wages per Hour		Cost per Cu. Yd.	Kind of Soil	Engineer
			Men	Teams			
1	2.5	8,600	\$0.175	\$0.45	\$0.452	Loam and gravel, easy work Largely clay, hard excavation Gravel, sand, clay, loam, etc., average work 25% of excavation, small boulders, unusually hard excavation	E. E. Kidder S. O. Steere W. G. Harger W. G. Harger
2	5.5	28,000	0.175	0.45	0.484		
3	6.0	18,000	0.15	0.45	0.46		
4	4.0	10,000	0.175	0.40	0.65		

Fine Grading for Pavement.—Geneva-Dresden Road, New York State, season of 1925.

Average daily output.....220 sq. yd. of fine grading.
 Labor cost per day (7 men), \$28\$0.125 per square yard.
 Common labor wage.....\$0.40 per hour.

Rock Excavation.—Rock excavation is so variable in cost that no effort is made in the book to attempt to cover this item. Readers are referred to "Rock Excavation" by Gillette, Myron C. Clark Publishing Company and other excellent books for detail data on rock excavation costs.

Cost of Unloading Broken Stone.—For making estimates of the quantity of stone required the following data on imported limestone used on Road 5021 will be useful. The approximate sizes and actual weights of stone on this work were as follows:

No. 1 screenings, $\frac{5}{8}$ " screen.....	2,550 lb. per loose cubic yard
No. 1A dustless screenings,	
$\frac{5}{8}$ " screen with dust jacket.....	2,350 lb. per loose cubic yard
No. 2, $1\frac{1}{4}$ " screen.....	2,470 lb. per loose cubic yard
No. 3, $2\frac{1}{2}$ " screen.....	2,350 lb. per loose cubic yard
No. 4, $3\frac{1}{2}$ " screen.....	2,420 lb. per loose cubic yard

For purposes of estimating the cost of handling imported crushed limestone, the following weights for a cubic yard, based on railroad weights, will be used: No. 1, 2,000 lb.; No. 1A, 2,400 lb.; No. 2, 2,500 lb.; No. 3, 2,400 lb.; No. 4, 2,400 lb.

Unloading Cars by Hand.—On Road 5021, with the author as engineer, a number of short-time (10-hr.) estimates made the cost of unloading per ton 12 to 13.5 cts.; and the cost per cubic yard 14 to 16 cts. This work was in 1910, and labor cost 17.5 cts. per hour. The shoveling was done from a steel platform, where it was dumped from hopper-bottom cars. When shoveled from inside the cars the cost may run as high as 20 cts. per cubic yard. The cost of shoveling is usually estimated at 15 cts. per cubic yard.

The time of loading $1\frac{1}{2}$ cu. yd. wagons by hand shoveling will range from 8 to 12 min.

Unloading Cars with Continuous Bucket Conveyor Elevator Plant.—Where there is a large quantity of stone to be unloaded and it is not possible to install an elevator plant on the existing track, it often pays to put in a switch. Six-car switches can be usually built for about \$300. Where there are competing railroads no charge is usually made.

The following data are from Road 5046, season of 1910, with labor at 17.5 cts. per hour. The plant consisted of an ordinary continuous bucket conveyor operated by a 6-hp. gasoline engine; the bin had a capacity of 100 tons.

The average fuel consumption was 5 gal. of gasoline per day. Cost of fuel and oil averaged \$1 per day.

The average force at the elevator was one foreman and three helpers.

A total of 4,670 tons, or 3,890 cu. yd., was unloaded at 8.4 cts. per ton, or 10.1 cts. per cubic yard.

The cost was divided as follows:

Setting up elevator at Scottsville.....	\$ 60.00
Setting up elevator at Mumford.....	40.00
Setting up elevator at Wheatland.....	75.00
Labor of operation.....	194.00
Gasoline and oil.....	<u>25.00</u>
Total.....	\$394.00

This method of unloading is not only cheaper than hand methods but also cheapens the cost of hauling, as no time is lost in loading the wagons. The time of loading a 1½ cu. yd. wagon from bins ranges from 45 to 55 sec. There is also a saving in car demurrage if the bin holds two or three carloads.

Elevator unloading saves about 4 cts. per cubic yard on team time and about 5 cts. on the unloading, making a total saving per cubic yard of about 9 cts. It usually costs about \$150 to ship the plant and install it the first time, so elevator unloading is not adopted unless there are, at least, 2,000 cu. yd. of stone handled.

Unloading Cars from Coal Trestle.—These data are taken from the Scottsville road repair work, Harold Spelman, engineer, season of 1910; labor at 20 cts. per hour; average force, two or three men. A total of 4,400 tons was unloaded. The cost divided as follows:

Rent of trestle.....	\$125.00
Labor.....	<u>232.00</u>
Total.....	\$357.00
Cost per ton.....	0.081
Cost per cubic yard.....	0.098

Unloading from Canal Boats.—The plant used consisted of a portable bin and a horse-operated derrick; Road 5014; James Anderson, contractor. The average amount of stone unloaded per day was 150 tons. The cost was 11.5 cts. per ton, or 14 cts. per cubic yard, divided as follows:

1 team and driver.....	\$ 4.00 (10-hr. day)
1 foreman.....	2.50 (10-hr. day)
6 laborers, at \$1.75 per day....	<u>10.50 (10-hr. day)</u>
Total.....	\$17.00 (10-hr. day)

Unloading Stone and Sand from Cars to Bin.—Clamshell crane, Erie Type B. 10,000 tons stone and 6,000 tons sand unloaded in 50 working days. Average 320 tons per day.

Equipment, Erie clam Type B.

Force:

1 operator at 81 cts. per hour.....	\$ 8.10
1 foreman at 45 cts. per hour.....	4.50
2 men in cars at 40 cts. per hour.....	8.00
Fuel and oil approximate.....	<u>5.00</u>
	\$25.60

Approximate cost per ton 8 cts. exclusive of overhead and equipment charge.

Unloading Sand.—Hand shovelling from cars to trucks, Road 188, New York State, season of 1926, Geo. B. Gregg, cost inspector. Average 47 man-hours per car of 60 tons. 600 tons unloaded at a cost of 40.7 cts. per ton, exclusive of overhead.

Unloading Stone from Cars.—Hand shovelling to trucks. Road 188, New York State, season of 1926. Average 58 man hours per car of 60 tons; 720 tons unloaded at cost of 48.5 cts. per ton, exclusive of overhead.

Unloading Cement by Hand from Cars to Trucks.—On the Geneva-Dresden Road, New York State, 1926, with a common labor rate of 40 cts. per hour, 20,000 bbl. were unloaded at 6 cts. per barrel, exclusive of overhead.

On the Road 1639, New York State, season of 1922, with a common labor rate of 50 cts. per hour, 11,000 lb. were unloaded at 5.3 cts. per barrel, exclusive of overhead.

Cost of Loading Local Fence Stone into Wagons.—Road 5046, W. G. Harger, engineer, season of 1911, Labor 17.5 cts. per hour.

2,200 cu. yd., boulders loaded at a cost of 14 cts. per cu. yd.

A gang of six men will take from 9 to 13 min. in loading 1½ cu. yd., depending upon the size of the stone.

Road 495, E. E. Kidder, engineer, season of 1911, Labor 1.75 cts. per hour.

1080 cu. yd., boulders loaded at a cost of 18.4 cts. per cu. yd.

Road No. 492, E. E. Kidder, Engineer, season of 1911, Labor 17.5 cts. per hour, 300 cu. yd., loaded at 13.7 cts. per cu. yd.

Cost of Loading Filler at Pit.—On the Clover Street Road, Section 1, during the season of 1908, with the author as engineer and labor at 15 cts. per hour, 400 cu. yd. of sand filler were loaded at a cost of 12 cts. per cu. yd. On the Scottsville-Mumford Road, with labor 17.5 cts. per hour, 200 cu. yd. were loaded at a cost of 13 cts. per cu. yd.

Unloading Steel Beams.—On Road 188, New York State, season of 1926, with labor at 60 cts. per hour. 66,000 lb. of 30" Bethlehem girder I-beams, 8 beams, 48' long each were unloaded from cars to trucks by hand methods (jacks and bars).

96 man hours	\$57.60
	= 1.75 per ton
	= 0.0009 per pound

Loading Plank.—Loading trucks from piles or cars, 2 men, 100 planks per hour, is average speed.

TEAM HAULING

Cost of Hauling Broken Stone.—Table 213 shows the cost of hauling stone on good roads as for repair work. The wagons were loaded from bins, so no time was lost in loading.

TABLE 213.—HAUL OF STOVE ON GOOD ROADS FOR REPAIR WORK

Road No.	Engineer in Charge	Price per Hour of Teams	Length of Haul, Miles*	Cost per Ton, Mile	Cost per Yard, Mile
1	Harold Spelman . . .	\$0.50	1.8	\$0.20	\$0.24
1	Harold Spelman . . .	0.50	1.2	0.24	0.288
2	G. G. Miller	0.62	2.0	0.20	0.24
2	G. G. Miller	0.62	1.7	0.215	0.26
2	G. G. Miller	0.62	1.1	0.23	0.275
2	G. G. Miller	0.62	0.6	0.25	0.30
2	G. G. Miller	0.62	0.2	0.50	0.60
3	G. G. Miller	0.62	3.0	0.17	0.205
3	G. G. Miller	0.62	2.75	0.175	0.21
3	G. G. Miller	0.62	2.5	0.175	0.21
3	G. G. Miller	0.62	2.0	0.19	0.23
3	G. G. Miller	0.62	1.75	0.215	0.26
3	G. G. Miller	0.62	1.5	0.23	0.28

* This length of haul is the loaded length, complete round trip is twice this length cost is figured for length of loaded haul.

Road 1, 10-hr. day.

Roads 2 and 3, 8 hr. per day.

NOTE.—Cost per ton mile on Roads 2 and 3 equals the cost per yard mile, for teams at 50 cts. per hour.

For hauling on bad roads for new construction, I have the following personal data:

Clover Street Road, Section 1, season 1908; teams at 45 cts. per hour; dump wagons loaded from bins; no time lost.

6,000 cu. yd., 0.6-mile haul cost 26 cts. per ton, or 31 cts. per yard mile.

4,500 cu. yd., 0.6-mile haul, cost 24 cts. per ton, or 29 cts. per cubic yard mile.

Scottsville-Mumford Road, season of 1911; teams, 45 cts. per hour. 300 cu. yd., 1-mile haul (including a 5% sandy hill 1,200' long) cost 30 cts. per yard mile.

500 cu. yd., 0.5-mile haul (level road in bad condition) cost 30 cts. per yard-mile.

Hauling Field Stone and Filler.—This material was hauled from fields and pits where it was loaded by hand. Considerable time was thus lost.

On the Clover Street Road, Section 1, season of 1908, with the author as engineer, and teams at 45 cts. per hour, 10,000 cu. yd. of field stone were hauled an average of 1 mile for 36 cts. per yard mile.

On the Scottsville-Mumford Road, season of 1911, with the author as engineer, and teams at 45 cts. per hour, 500 yd. of field stone were hauled 0.2 mile at 14 cts. per cu. yd., or 70 cts. per yard mile. On the same work 200 cu. yd. of filler were hauled 0.2 mile for 15 cts. per cubic yard, or 75 cts. per yard mile.

For all short hauls under $\frac{1}{4}$ mile the cost is high and practically the same on account of the larger percentage of time lost in loading.

"Truck Hauling, 5 Ton Trucks.*—The daily mileage averaged 40.5 miles. The figures given are the average from over 100 trucks and are based on 1919 prices. They ran on an average 265 days of the year.

For some reason not stated the item of taxes has been left out.

RELATIVE IMPORTANCE OF OPERATING COST ITEMS

Rank	Cost item	Cost per day	Per cent of total cost
1	Depreciation	\$ 5.29	20.3
2	Repairs and overhaul	5.11	19.6
3	Drivers' wages	4.96	19.0
4	Gasoline	3.42	13.1
5	Tires	2.29	8.8
6	Overhead	1.74	6.7
7	Insurance	1.25	4.8
8	Interest	0.76	2.9
9	Garage	0.74	2.8
10	Lubricants	0.42	1.6
11	License	0.11	0.4
	Totals	\$26.09	100.0

Two of the largest items of cost, as shown above, are depreciation and drivers' wages; yet many one-truck operators establish their hauling rates without considering these items at all. It is little wonder that many of them fail in business ever before their trucks are fully paid for.

The fixed charges in this table total about 38%. With this fact in mind the loss due to idle time can readily be visualized. Fixed charges continue whether the truck is operating or not, and the truck operating the most time will render greatest returns, other conditions being equal.

"Analysis of Factors Governing Motor Truck Operating Costs.—There are four principal methods by which truck operating costs are figured, namely, cost per mile, cost per day, cost per unit (ton, box, bag, gallon, bale, or other similar units) and cost per unit mile (ton mile, gallon mile, etc.). A great deal of confusion has resulted in the past through comparison of operating costs without considering the variable factors which increase or decrease costs on these various bases.

The following table shows how these four items vary through an increase in the factors listed in the first column. It is assumed, of course that operating conditions are equal.

TABLE.—VARIATION OF COST ITEMS

Variable factors	Cost per mile	Cost per day	Cost per unit	Cost per unit mile
Increase in daily mileage.	Decrease	Increase	Increase	Decrease
Increase in truck capacity	Increase	Increase	Decrease	Decrease

* From Engineering Contracting.

In discussing these four cost bases it must be remembered that the daily fixed costs are constant regardless of mileage, while the daily variable costs increase with an increase in mileage.

"Cost per Mile.—The "cost per mile" varies with the miles operated per day. Obviously this cost will decrease as the mileage increases. The variable costs per mile should be practically the same whether the truck travels 10 or 50 miles in a day. But the fixed costs will be divided among a greater number of miles in the latter case, thereby reducing the total "cost per mile" under what it would be if only 10 miles were traveled. A 5-ton truck operating 50 miles per day may have a smaller "cost per mile" than a 3-ton truck operating only 10 miles per day. However, an increase in truck capacity on the same daily mileage would naturally increase the "cost per mile."

"Cost per Day.—The "cost per day" will vary with the miles operated per day. It is quite evident that this daily cost will increase as the daily mileage increases. To the daily fixed charges must be added the daily variable charges which of course increase with the mileage, thereby increasing the "cost per day."

In comparing operating costs of different-sized trucks on the "cost per day basis" it is essential that the daily mileage of each truck be known. It can readily be seen that a 5-ton truck operating only 10 miles per day should have a lower "cost per day" than a 3-ton truck operating 50 miles daily under similar conditions.

The "cost per day" is affected also by the total number of days in the year that the truck is in actual operation. It is commonly assumed that a truck will operate 300 days a year, neglecting Sundays and holidays. In most cases this is much too high. Due to such factors as weather conditions, accidents, strikes, variation in business demands, etc., this assumed total of 300 working days is frequently cut to 200 or less.

Assuming yearly fixed charges of \$1800 on a 300-day basis would give a daily fixed charge of \$6. But if the truck operates only 200 days out of the year, the fixed charges will be \$9 per day. This increase will be reflected in the "cost per mile."

"Cost per Unit.—Where mileage records are not kept, truck operators must be content with operating cost on the "cost per unit" basis. The unit will vary with the kind of hauling involved. This unit may be tons, gallons, boxes, head of livestock, etc.

The "cost per unit" will increase as the average haul mileage increases. It is obvious that a ton hauled 10 miles will cost more than a ton hauled 1 mile under the same conditions. There is very little difference in the fixed costs for each of the sizes of heavy trucks and since the variable costs on the various sizes do not increase in direct ratio with increase in size, the "cost per unit" will vary with the truck capacity. The daily "cost per unit" will decrease with an increase in truck capacity and will increase as the average haul mileage is increased.

"Cost per Unit Mile.—As a means of comparing operating costs of different trucks, there is probably no better basis than that of the "cost per unit mile." This is commonly worked out on the ton-mile basis. It involves a record of units hauled and mileage

covered. Costs by this method will vary with the truck capacity and the daily mileage. This "unit-mile cost" will decrease both with an increase in truck capacity and with an increase in daily mileage. A 5-ton truck loaded to capacity will give a lower "unit-mile cost" when operating 40 miles daily than when operating only 20 miles daily. Likewise, a 5-ton truck loaded to capacity and operating 20 miles daily should give a lower "unit-mile cost" than a 3-ton truck with capacity load covering the same mileage. Large truck capacity and high daily mileage tend to produce lower costs per unit mile.

Apparently there is a great variation in the methods used in arriving at the "unit-mile" or, as it is commonly figured, the "ton-mile" cost. This involves not only a record of total tonnage and total mileage, but also a record of the number of trips.

During the war one of our large motor truck companies sent out a circular letter on operating costs to their sales representatives in which instructions were given to figure total cost per ton mile by dividing total cost per day by the number of miles driven times the number of tons carried. This apparently is the method frequently employed, but it leads to serious inaccuracies as can easily be illustrated.

Assume that a truck starts from point *A* and during the day makes stops at points *B*, *C*, *D*, and *E* respectively, covering distances and carrying loads as follows:

TABLE.—TRIP-MILE-TON TABLE

Trip	Miles	Tons
A—B.....	10	4
B—C.....	5	1
C—D.....	5	2
D—E.....	10	3
Totals 4.....	30	10

By the method outlined in the sales letter the ton miles would be $30 \times 10 = 300$. Actually the ton-miles would be:

TABLE

Trip 1.....	$10 \times 4 = 40$ ton-miles
Trip 2.....	$5 \times 1 = 5$ ton-miles
Trip 3.....	$5 \times 2 = 10$ ton-miles
Trip 4.....	$10 \times 3 = 30$ ton-miles
Total.....	85 ton-miles

The first method is correct for a truck making one trip per day with one load, but is entirely wrong in the case of a truck making many trips daily with varying loads. In the latter case, if ton-mile costs are desired, it will be necessary to keep accurate records of mileage and loads between each stop where the load is changed. However, in this type of trucking the cost per mile or cost per day is usually more satisfactory.

When a truck is running on a regular route making a trip out to a certain point with a given load and back to the starting point with the same or a different load, the ton miles can be computed by multiplying the total mileage by the total load carried and dividing by twice the number of round trips. Suppose a truck travels from *A* to *B*, a distance of 10 miles, and returns with the following loads:

TABLE.—ROUND TRIP LOADING TABLE

Round trip	Load out	Load in
1.	5 tons	1 ton
2.	2 tons	3 tons
3.	4 tons	0 ton
4.	1 ton	5 tons
Totals 4 round trips.	12 tons	9 tons

The total mileage is 80 and the total load is 21 tons. Then by the formula as given the ton miles

$$\frac{80 \times 21}{2 \times 4} = 210.$$

Figured on the basis of the individual trips, the result is the same.

From the foregoing it can readily be seen that the basis of ton-mile costs must be correct before dependable comparisons can be made.

Hauling Batched Concrete.—Geneva-Dresden Road, season of 1925. 15 Ford trucks, carrying 1 batch (21 cu. ft.) quick bin loading. Average haul bin to mixer 1.5 miles. Average 20 trips per day per truck or 30 miles loaded 60 miles total.

Initial cost of trucks.	\$360
Value at end of season.	\$150 ±
Drivers' wages.	40 cts. per hour
Liability on trucks.	\$40 per season per truck

NOTE.—With longer hauls each truck travels about 100 miles per day (50 miles loaded).

Hauling Sand and Stone.—Road 188, New York State, season of 1926. 3½-ton trucks loaded by hand shoveling from cars. 3½-mile haul from cars to job. Rent of trucks \$30 per 10-hr. day. 750 tons of crushed stone hauled for \$649,

Average.	24. cts. per ton mile
Average time of trip 60 min.	
600 tons of sand hauled for \$410.55	
Average.	20.5 cts. per ton mile
Average time of trip 50 min.	

Cost of Spreading Stone, Sand, and Screenings.—The following costs are for hand-shoveling methods. By the use of so-called man-ger spreaders in conjunction with truck hauling, the cost of spreading crushed stone for macadam construction can be reduced 50% from hand-shoveling and raking methods.

COST OF SPREADING STONE AND BINDER

Table 214, page 1167, gives the cost of spreading broken stone on several New York State roads.

The ratio of the loose to the rolled depths varies with the size of the fragments and the depth of the course. Table 215, page 1168, gives the averages of the results obtained from 1000 test holes made by the writer on three separate roads. The last column of the table also gives the weights of No. 3¹ and 4² stone required to make a cubic yard of rolled macadam. The amount of filler or binder per cubic yard of rolled macadam is given in Table 216, page 1168.

The excessive amount of filler required for the 2-inch bituminous macadam, Table 216, was due to a layer of screenings placed under the No. 3 stone, all of which did not act as a filler. The small amount required for the 3-inch bituminous macadam was due to the fact that the bituminous binder partially filled the voids before the screenings were applied.

The ratio of loose to rolled depth for boulder subbase is variable.

If the size of boulders is practically the same as the depth of the course, that is, if there is only one layer of stone, the loose depth and the rolled depth will be the same. Where there are two or three layers of boulders the ratio is, approximately, 1:1.25, *i. e.*, a 12-inch, rolled depth would require 15-inch loose depth for boulders averaging 5 to 6 inches in diameter.

TABLE 214.—SPREADING STONE

Reference No.	Engineer	Labor Wage	Depth of Loose Spread	Amount Spread	Cost per Ton	Cost per Cu. Yd.
1	Harold Spelman	\$0.20	4 in.	7000 tons	\$0.066	\$0.08
2	W. G. Harger	0.175	5 1/2 in.	6000 cu. yds.	0.05	0.06
2	W. G. Harger	0.175	4 in.	4500 " "	0.07	0.083
3	W. G. Harger	0.20	6 "	1000 " "	—	0.05
Placing sub-base stone						
3	W. G. Harger	0.175	7 in.	100 " "	—	0.10
3	W. G. Harger	0.175	10 " gravel	200 " "	—	0.04
4	E. E. Kidder	0.175	6 "	267 " "	—	0.07
15	E. E. Kidder	0.175	6 "	1082 " "	—	0.12

¹ Sub-base bottom course. The cost includes sledging of all large stone.

² No. 3 stone 1 1/4" to 2 1/4".

³ No. 4 stone 2 1/4" to 3 1/4".

TABLE 215.—RATIO OF LOOSE TO ROLLED DEPTH

Size of Stone	Rolled Depth	Loose Depth	Ratio	Weight per Cubic Yard Rolled Measure ¹
No. 4	4 in.	5.2 in.	1.3	3120 lbs.
No. 4	3 "	3.8 "	1.27	3050 "
No. 3	3 "	3.9 "	1.3	3120 "
No. 3	2 "	2.4 "	1.2	2880 "

¹ Weight of cubic yard (loose measure) 2400 lb.

TABLE 216.—AMOUNT OF FILLER AND BINDER REQUIRED

Kind of Course	Kind of Filler	Amount of Filler per Cu. Yd. of Rolled Macadam	Weight of Screenings per Cu. Yd. of Rolled Macadam
Bottom stone	Sand	0.35 cu. yds.	—
Waterbound top ¹	No. 1	0.50 " "	1300 lbs.
3-in. Bit. mac. top ¹	Nos. 1A and 2	0.37 " "	900 "
2-in. Bit. mac. top ¹	No. 1A	0.60 " "	1440 "
Sub-base	Gravel	0.33 " "	—

¹ Weight of cubic yard (loose measure) 2400 lb. Filler for top course includes wearing coat.

Cost of Spreading Filler by Hand from Piles Spaced 20' to 30' Apart.—On the Clover Street Road, Section 1, during the season of 1908, with labor at .15 cts. per hour, 400 cu. yd. of sand filler were spread at a cost of .10 cts. per cu. yd. On the Scottsville-Mumford Road, with labor at 17.5 cts. per hour, the cost of spreading 200 cu. yd. was 20 cts. per cubic yard. This includes some hand brooming, but most of the brooming was done by a broom attachment on the roller.

Cost of Spreading No. 1A and No. 2 Stone for Bituminous Macadam Top Courses and Brooming Same.—A layer of No. 1A, $\frac{1}{2}$ " deep, was spread over the bottom course. On this was spread $2\frac{1}{2}$ " of No. 3 stone. After rolling, bitumen was poured over this course and a $\frac{3}{4}$ " layer of No. 2 stone spread and rolled; the excess of No. 2 was broomed off and a $\frac{3}{8}$ " wearing coat of No. 1A placed.

The cost of spreading for a 2" top was as follows:

Cost¹ of No. 1A and No. 2 per cubic yard. \$0.282

Cost² per ton of No. 1A and No. 2. 0.210

Eight hundred tons of this material was handled with labor costing 17.5 cts. per hour.

¹ No. 1A are dustless screenings.

² No. 2 is $\frac{5}{8}$ " to $1\frac{1}{2}$ " size.

For a 3" top course the procedure was the same, omitting the layer of No. 1A under the No. 3 stone. The cost of handling 400 tons for the 3" course was as follows:

Cost per cubic yard of No. 1A and No. 2.....	0.31
Cost per ton of No. 1A and No. 2.....	0.26

Cost of Spreading Screenings with Cross-dump Wagons.—Wet dust screenings for water-bound macadam cannot be successfully spread in this manner. For spreading dry dust screenings, No. 2 stone or dustless screenings for bituminous macadam, this method has proved the cheapest and most satisfactory. On Road 5046, season of 1910, a number of short-time estimates made the cost of spreading by this method about 6 cts. per cubic yard. The cost of brooming is slightly increased over that required by the hand-spreading method, but not enough to counteract the advantage in the use of the wagon spreading. On the Clover Street Road, season of 1908, 1,000 cu. yd. of screenings were thus spread for about 7 cts. per cubic yard.

SPREADING BITUMINOUS BINDER AND SURFACE COATS

Hand Methods.—The following data are taken from Road 5021, season of 1910. Bituminous macadam, penetration method:

Labor.

Kettleman	\$0.20	per hour
Spreaders.....	0.20	per hour
Plain labor.....	0.175	per hour
Teams.....	0.45	per hour

Apparatus.

4-bbl. kettle (coal burner).....	Bitumen heated
2-bbl. kettle (wood burner).....	to 400°F.
12-ton Kelly roller.....	
Spreading pots having a vertical slot $\frac{1}{8}$ " wide.	

Organization.

Rollerman acting as foreman
1 spreader
1 kettleman
3 laborers

Average speed 350' of 16' road, per day.

Quantities.

16,850 gal. laid in one coat covered 13,330 sq. yd., or 1.26 gal. per sq. yd.

Cost per gallon	Unloading and hauling $\frac{1}{2}$ mile.....	\$0.0015
	Heating.....	0.0032
	Spreading.....	0.0032
	Rolling and supervision.....	0.0051

	Total.....	\$0.0130
Bituminous material f.o.b. Caledonia.....		0.0950
	Total per gallon.....	\$0.1080

Second quantity.

Forty-two thousand gallons covered 24,000 sq. yd. in one coat, an average of 1.75 gal. per square yard.

Cost per gallon	Unloading and hauling 1 ³ / ₄ miles.	\$0.0032
	Heating.	0.0040
	Spreading	0.0039
	Rolling and supervision.	0.0042
	Total.	\$0.0153
Bituminous material f.o.b. Caledonia.		0.0950
	Total per gallon.	\$0.1103

Cost of Applying Bituminous Binder. Road 5046, Penetration Method.

18,890 gal. spread on 12,378 sq. yd. in one coat, of 1.52 gal. per sq. yd.

Apparatus.

- 5 2-bbl. kettles (wood burners). Fuel. Used barrel staves and some extra wood.
- 1 10-ton Buffalo Pitts Roller.
- Spreading hods.

Organization.

	Per Hour
1 foreman.	\$0 30
2 pourers, each.	0 25
5 kettlemen, each.	0 20
2 spreaders of No. 2, each.	0 20
4 helpers, each.	0 175
<i>Labor of Placing.</i> Cost per gallon.	
Fuel.	\$0 001
Kettlemen.	0 005
Pouring.	0 003
Helpers.	0 007
Supervision.	0 002
Total.	\$0.018
Material f.o.b. Scottsville.	0 093
Total per gallon.	\$0.111

Mechanical Application.—Barrett Company is doing this work (1925 in western New York) for 4 cts. per gallon for cold tar work and 5 cts. per gallon for binder grade (hot tar). This price includes hauling up to a maximum 50-mile limit and the price is probably based on an average 20- to 25-mile haul (plant to job). The cost of hauling is approximately 2 cts. per gallon which makes the cost of applying from 2 to 3 cts. per gallon.

ROLLING AND PUDDLING

COST OF ROLLING

In the following costs lubricating oil is not included, as no reliable data were obtained as to the quantity used. Gillette's "Handbook of Cost Data" gives this item as 30 cts. per day; using this amount would increase the costs given below from 0.2 to 0.3 ct. per cubic yard. The amount of coal used was variously estimated at from 450 to 500 lb. per day. As before mentioned, items of depreciation, repairs of plant and equipment, and interest are not included in the cost per cubic yard of stone consolidated.

On Road 5025, under E. E. Kidder, engineer, during the season of 1910, the cost of rolling 3,400 cu. yd. of bottom stone and 1,700 cu. yd. of top stone, loose measure, was as follows:

Rollerman, 4 months, at \$90.....	\$360
Coal, $\frac{1}{4}$ ton per day, at \$2.70 per ton, 80 days	55
	<u>\$415</u>

The time and cost were divided as follows:

$\frac{1}{6}$ on subgrade.....	\$ 69
$\frac{1}{3}$ on bottom stone 4" deep.....	138
$\frac{1}{2}$ on bituminous top stone, 2" deep.....	208

There was no cost for water. The roller worked 80 days in 4 months. The cost of rolling per cubic yard of loose material was: bottom stone, 4 cts., and top (bituminous macadam) 12 cts.

On Road 492, E. E. Kidder, engineer, season of 1910, the cost of rolling 3,700 cu. yd. of 4" bottom course was 3 cts. per cubic yard, and for 3,200 cu. yd. of water-bound top stone 5 cts. per cubic yard. Both quantities refer to loose measure. The roller worked 74 days in 3 months. The puddling was done by a pipe line and hose and brooms attached to the roller. The rollerman's wages were \$90 per month and coal \$2.75 per ton.

On Road 5021 the cost of rolling a 3" bituminous top course per cubic yard of loose material was 9 cts.; for a 2" top 11 cts.

On Road 5046 a roller working 111 days consolidated 1,850 cu. yd. of field stone subbase, 4,300 cu. yd. of bottom stone, and 2,150 cu. yd. of top stone, loose measure. The depth of the subbase was 6" (rolled measure), the bottom course 4", and the top course 2 $\frac{1}{2}$ ", bituminous macadam. The rollerman's wages were \$90 per month and coal cost \$2.75 per ton for $\frac{1}{4}$ ton per day. There was no cost for water. The costs were divided as follows: subbase, 3.5 cts.; bottom stone, 4.5 cts.; top stone, 10.5 cts. per cu. yd., loose measure.

PUDDLING WATER-BOUND ROADS

There are two methods of puddling: first, by pipe line and hose; second, by sprinkling carts.

In the first method a 1 $\frac{1}{2}$ " or 2" pipe is laid along the road with taps every 200 to 300'. The road is wet down by a hose fastened to these taps and sprayed on by a nozzle, or the hose is fastened

to a sprinkling attachment on the roller, which throws the water directly onto the wheels; this method is cheaper and more satisfactory than using sprinkling carts, but to work well a pressure of 125 lb. should be maintained at the pump, which requires a better pumping apparatus than contractors usually have. A very satisfactory plant, used near Rochester, N. Y., consisted of a Gould Triplex Pump, operated by a 6-hp. gasoline engine; the relief valve at the pump was set at 120 lb.

The cost of such puddling on Road 492 for 3,000 cu. yd. of top course was 5 cts. per cu. yd.; on Road 294 for 4,000 cu. yd. of top course it was 6 cts. This cost includes pumping, helper tending hose, and rollerman. Brooms on the roller were used which materially reduced the cost of brooming the screenings. No charge for water, no allowance made for laying the pipe line; this last charge is included in the lump-sum item of installing plant for a water-bound road, page 1261.

Gillette, in his handbook, gives sprinkling by carts approximately 10 cts. per cu. yd. of top course, which includes sprinkling the subgrade as well as puddling the top course. As the subgrade is rarely sprinkled, his data reduced to the conditions cited on Roads 492 and 294 would give approximately 6 cts. per cubic yard of top course. To this is added the cost of rolling, or about 4 cts. which makes the cost of puddling by this method about 10 to 12 cts., or about twice the amount of the first method.

E. A. Bonney, on the Hamburg-Buffalo Road, from a metered supply of water, states the amount required to first puddle a 3" top course varies from 50 to 55 gal. per cubic yard of top course, and the amount needed for the second puddle will be considerably less.

H. P. Gillette states, in a monograph on the Economics of Road Construction, that 30 gal. of water per cubic yard will puddle a road. E. E. Kidder states that approximately 80 gal. are required per cubic yard of top course for two puddles. The author's experience agrees with the larger quantities.

COST OF CRUSHING STONE

As a basis for all cost estimates for crushing, it is necessary to crusher know something of the percentage of the different sizes of the output. Tables 218 and 219, pages 1179 and 1181, give typical data on size output. Table 217, page 1173, gives the results of tests made by Archer White during the season of 1910 on ordinary limestone and sandstone boulders composing the average field stone. The crusher used was the largest Acme portable crusher. The tailings were recrushed and the stone divided into four grades: No. 1, $\frac{3}{4}$ " screen; No. 2, $1\frac{1}{2}$ "; No. 3, $2\frac{1}{2}$ ", and No. 4, $3\frac{1}{2}$ ". From these data it may be seen that 1 cu. yd. of field stone makes 1 cu. yd. of crushed stone, and that it takes approximately 1.8 cu. yd. of field stone to make 1 cu. yd. rolled measure of sizes Nos. 3 and 4. The crusher toggle was set to produce both top and bottom stone sizes.

The cost of labor was 20 cts. per hour. The engineman of the crusher plant received 25 cts. per hour and the foreman 30 cts. per

CRUSHER OUTPUT

TABLE 217.—SIZES AND PROPORTIONS OF CRUSHER RUN

Reference No.	Cu. Yds. Field Stone Delivered to Crusher	Cu. Yds. Crushed Stone Produced	Number 1 1" Screen		Number 2 1 1/2" to 1"		Number 3 1 1/2" to 2 1/2"		Number 4 2 1/2" to 3 1/2"		Kind of Material
			Cu. Yds. Produced	% of Total Output	Cu. Yds. Produced	% of Total Output	Cu. Yds. Produced	% of Total Output	Cu. Yds. Produced	% of Total Output	
1.....	195	190	36	19	13	9	64	72	38	Sandstone and limestone	
2.....	187	182	32	17 1/2	10	5 1/2	70	70	38 1/2	Limestone	
3.....	196	202	36	18	14	7	76	76	37	Limestone and sandstone	
4.....	190	216	40	18	18	8	79	79	37	Sandstone	
5.....	173	172	32	19	28	16	62	50	29	Poor sandstone	
6.....	189	184	36	19 1/2	16	9	*	132	71 1/2	Limestone	
7.....	165	170	32	19	22	13	*	116	68	"	
8.....	—	—	30	16	24	13	*	60	63	Soft sandstone	

*No. 3 and No. 4 size mixed and placed on grade.

hour. The field stone was loaded from a pile near the crusher into small dump cars running on a movable track. The loaded cars were drawn to the crusher by a small hoisting engine. The cost of bringing the field stone to the crusher pile is not included. The force loading consisted of one foreman, eleven laborers, and one engineman. The force crushing consisted of one foreman, four laborers, and one engineman. In 8 days 1,500 cu. yd. were crushed. The cost of the entire output per cubic yard of loose measure was divided as follows:

Loading stone for crusher.	\$o 133
Hauling to crusher.	o 013
Feeding to crusher.	o 061
Engineer to crusher.	o 013
Fuel and oil.	o 030
Loading crushed stone from bins.	o 010
	<hr/>
Total.	\$o. 260

Crushing Granite Hardheads and Sandstone.—The following data are from the records of the Clover Street Road, Section 1, season of 1908. Labor cost 15 cts. per hour and the engineman received \$3 per day. The crusher used was a 10" X 20" Climax. A total of 5,000 cu. yd. of granite were crushed at a cost per cubic yard, loose measure, of 19 cts.; 7,000 cu. yd. of sandstone boulders were crushed at a cost of 10.3 cts. per cu. yd., loose measure. These figures are for the total output of the crusher and include the cost of feeding to the crusher, the pay of the engineman, coal, oil, but not the delivery to the crusher. On the Scottsville-Mumford Road under similar conditions the cost varied from 13 cts. for granite and sandstone to 19 cts. for granite hardheads per cubic yard of loose measure.

Crusher force on the Clover Street and Scottsville-Mumford roads as follows:

1 foreman.	\$4.00
5 men feeding crusher.	2 00 each
1 man tending screen.	2.00
1 engineer.	3.00
Fuel and oil.	4.00

Where bottom stone alone is being crushed from local material the crusher is set to produce a larger amount of No. 4 stone, and the proportion of the screenings to the No. 3 and No. 4 sizes is different than given in Table 217.

In the following data from Road 5046, Scottsville-Mumford, mentioned above, the No. 3 and No. 4 and tailings were used as the bottom course stone, the tailings being broken into proper sizes after the stone was spread by knapping hammers. The cost of knapping will vary from 1 to 3 cts. per cubic yard of loose bottom stone, depending on the number of tailings produced. When the crusher is set correctly to deliver a good grade of stone for bottom course, this charge should not amount to over 1 ct. per cubic yard

of total output and is properly chargeable against crushing, which increases the crushing costs given above from 13 to 14 cts. and from 19 to 20 cts.

The sizes of screens were $\frac{5}{8}$ " , $1\frac{1}{4}$ " , $2\frac{1}{2}$ " , and $3\frac{1}{2}$ " .

Crusher Set-up, No. 1.—60% granite, 30% sandstone, 10% soft rock.

Total screenings, No. 1..... 240 cu. yd.
 Total No. 2..... no record
 Total No. 3, 4, and tailings..... 1,500 cu. yd.

Crusher Set-up, No. 2.—50% granite, 40% sandstone, 10% soft rock.

Total screenings..... 350 cu. yd.
 Total No. 2..... no record
 Total No. 3, 4, and tailings..... 2,600 cu. yd.

For this same road the amount of field stone required per loose yard of bottom stone is shown by the following figures. Approximately 1.5-yard loads were drawn to and from crusher.

Date	Number Loads of Field Stone Crushed	Number Loads of No. 3 and No. 4 and Tailings Drawn from the Crusher
1911		
April 24	114	93
" 25	86	70
" 26	87	69
May 5	104	84
" 6	101	82
" 8	106	85
" 9	99	78
" 10	86	72
" 11	107	95
" 12	110	80
" 13	102	83
Totals.....	1102 loads 1653 cu.yds.	891 loads 1336 cu. yds.

On this work 1.24 cu. yd. field stone produced 1 cu. yd. loose measure bottom stone, and 1.61 cu. yd. field stone produced 1 cu. yd. bottom stone rolled measure.

Table 217, page 1173, gives 1.8 cu. yd. field stone to 1 cu. yd. rolled macadam, but this apparent difference is explained by the fact that the tailings were recrushed and the crusher set closer to produce top as well as bottom stone, consequently the per cent of No. 1 and No. 2 is higher than for the data just given.

Data obtained by Frank Bristow, First Assistant Engineer, New York State Department of Highways, indicates that 1 cu. yd. of field stone produces 1.1 cu. yd. crushed stone when separated by screens of $\frac{1}{2}$ " , $1\frac{1}{4}$ " , $2\frac{1}{2}$ " , and $3\frac{1}{2}$ " ; this is slightly more than the writer's experience has indicated.

When local stone is crushed for bottom only, the screenings are used as filler for that course, and in a case of this kind it is necessary to know how much additional filler must be estimated. Take the case of the Scottsville-Mumford Road (crusher set-up No. 2) given above. Twenty-six hundred cubic yards loose measure will consolidate under the roller to approximately 2,000 cu. yd. of rolled bottom stone. This will require $2,000 \times 0.35 = 700$ cu. yd. filler. The amount of screenings produced in crushing 2,600 cu. yd. of bottom was 350 cu. yd., showing that for cases similar to the one given, half of the total filler required must be obtained from other sources.

Cost of Sledging Boulders.—A certain percentage of the fence stone must be broken to reduce them to a proper size for crushing. This is done by blasting or sledging; where the boulders need to be broken only two or three times to reduce them to usable sizes, sledging is the cheaper method. The cost of both of these methods is so variable that any cases cited would not be of much value. As given on page 1130, under Standard Estimates, the author allows arbitrarily 60 cts. per cu. yd. for all boulders actually sledged or blasted, and in making estimates the per cent to be treated in this manner is approximated roughly.

As a matter of interest Gillette, in his cost data on rockwork, gives the cost of sledging small sandstone boulders as approximately 5 cts. per cu. yd., and the cost of mud capping at about 35 cts. per cu. yd. 1910 scale of costs.

COST OF CRUSHING (Continued)

The following data are taken from the Report of the Massachusetts Highway Commission and refers to work done in Newton, Mass. The crushed stone was divided into the following sizes:

Tailings.....	205 cu. yd.	17.5%
$2\frac{1}{2}$ " stone.....	692 cu. yd.	57.0%
Screenings and 1".....	300 cu. yd.	25.5%
Totals.....	1,197	100.0%

The material was cobblestones and labor probably cost 20 cts. per hour, teams, 45 cts. The cost per cubic yard at the crusher was 44.5 cts., or 33 cts. per ton.

The cost per cubic yard was divided as follows:

Teaming to crusher.....	\$0.314	70.6%
Feeding to crusher.....	0.033	7.4%
Engineer of crusher.....	0.029	6.5%
Repairs, coal, oil, etc.....	0.045	10.1%
Watchman.....	0.024	5.4%
Total.....	\$0.445	100.0%

CRUSHING STONE

1177

Material. Conglomerate.

Amount broken..... 1,288 cu. yd.
 Amount broken per hour..... 8.9 cu. yd.

Divided as follows:

		Weight per Cubic Yard
		Loose
Tailings, 378 cu. yd.....	29.3%	2,549 lb.
2½" stone, 668 cu. yd.....	51.9%	2,368 lb.
Screenings and 1", 242 cu. yd.....	18.8%	2,727 lb.
Cost per cubic yard in bins at crusher.....		\$1.112
Cost per ton in bins at crusher.....		0.885
Divided as follows:	Cost	Per Cent
Powder and repairs.....	\$0.018	1.6
Labor drilling.....	0.249	22.3
Sharpening drills and tools.....	0.023	2.1
Breaking stone for crusher.....	0.420	37.8
Loading stone for crusher.....	0.127	11.4
Hauling stone for crusher.....	0.062	5.6
Feeding crusher.....	0.053	4.7
Engineer for crusher.....	0.038	3.5
Coal, oil, and waste.....	0.050	4.5
Moving and setting crusher.....	0.023	2.1
Watchman.....	0.049	4.4
Total.....	\$1.112	100.0

Material. Greenish trap.

Amount broken..... 3,155 cu. yd.
 Amount broken per hour..... 7.7 cu. yd.

Divided as follows:

		Weight per Cubic Yard
		Loose
Tailings, 1,004 cu. yd.....	31.8%	2,457 lb.
2½" stone, 1618 cu. yd.....	51.3%	2,383 lb.
1" stone, 323 cu. yd.....	10.2%	2,277 lb.
Screening, 210 cu. yd.....	6.7%	2,585 lb.
Cost per cubic yard in bins at crusher.....		\$0.898
Cost per ton in bins at crusher.....		0.745
Divided as follows:	Cost	Per Cent
Labor, steam, drilling.....	\$0.092	10.3
Coal, oil, water, powder, etc.....	0.084	9.4
Sharpening drills and tools.....	0.069	7.7
Breaking stone for crusher.....	0.279	31.0
Loading stone for crusher.....	0.098	11.0
Hauling stone for crusher.....	0.072	8.0
Feeding crusher.....	0.053	5.9
Engineer of crusher.....	0.031	3.4
Coal, oil, waste, and repairs of crusher....	0.079	8.8
Other repairs.....	0.041	4.5
Total.....	\$0.898	100.0

W. E. McClintock, engineer, Chelsea, Mass., season 1887:

Labor.....	\$0.20 per hour
Teams.....	0.45 per hour

Material. Trap rock.

Amount broken..	1,718 tons
-----------------	------------

Stone delivered at crusher by subcontractor for 75 cts. per ton

<i>Cost.</i> Tools.....	\$0.013
Oil, waste, etc.....	0.016
Fuel.....	0.050
Stone at crusher	0.750
Crushing (labor).	0.194

Total per ton... .. \$1.023

Dustless Screenings.—The construction of bituminous macadam requires a dustless screening product referred to in the beginning of the chapter as No. 1A; it is obtained by rescreening the ordinary screenings ($3/4$ " product) to remove the dust; the percentage of dust in the ordinary screenings will vary according to the stone crushed and the setting of the crusher jaws. The author has no reliable data for small crushing plants, but through the courtesy of the Buffalo Cement Company the following data are given for their output of limestone screenings at Buffalo, N. Y.

Size of screen opening for ordinary screenings ..	$3/4$ "
Size of dust screen openings.....	$1/8$ "

Cubic yard of dust for 1 cu. yd. ordinary screenings..... 0.35

Cubic yard of dustless screening 1 cu. yd. ordinary screening 0.65

The same data from the Leroy plant of the General Crushed Stone Company give:

Size of screen openings for ordinary screenings..... $5/8$ to $1 1/16$ "

Size of dust screen openings..... $1/4$ to $5/16$ "

Cubic yard of dust per cubic yard ordinary screenings..... 33%

Cubic yard of dustless screenings per cubic yard ordinary screenings..... 67%

Percentage of screenings to total output for Leroy limestone approximates 15%.

The above furnished to the writer through the courtesy of the General Crushed Stone Company, of Easton, Pa.

QUARRYING AND CRUSHING—SMALL QUARRIES

Cost Data.—New York State, season of 1925, Roads 5270 and 5271, Francis Carroll, engineer.

Local Quarry.—3' depth stripping. Soft sandstone (French coefficient of wear 7 to 13). Quarry face 8 to 10' high.

Total Quantities and Sizes of Output.

19,000 tons crushed stone $1 1/2$ " to $4 1/2$ " in size.

7,000 tons screenings passing $3/4$ " round screen.

4,000 tons No. 2 stone ($3/4$ to $1 1/2$ " size).

30,000 tons total output.

Approximate average daily output 300 tons.

Stone used for macadam bottom course.

Quarrying and Delivery to Crusher. Equipment.

Team and slip scrapper for stripping.
 Ingersoll-Rand portable air compressor and 2-drill outfit for drilling.
 Osgood steam shovel for loading to Kopple Cars Champion friction hoist.

Cost of Quarrying per Day.

Stripping 1 man and team.	\$ 6.00
Drilling outfit, rent per day.	20.00
15 gal. gas per day.	3.00
Steam shovel with runner and fireman (rent)	52.50
Coal and oil.	3.50
Dynamite 60 lb. at 20 cts.	12.00
2 drillers at \$5	10.00
2 men breaking big stone at \$4.50	9.00
1 man operating cars at \$5.	5.00
Total	\$120.00 = 40 cts. per ton.
Cost of quarrying exclusive of labor overhead	\$0.40 per ton
Labor overhead (approximately)	0.05
Cost of stone (quarry rights)	0.06
Total cost of quarrying.	\$0.51 per ton total output of crusher

Crushing. Equipment.

No. 6 Champion 12 X 26" (300-ton capacity).
 50-hp. electric motor (initial cost \$500).
 15' screen, 4 sections.
 3/4" screen 4' long.
 1 1/2" screen 4' long.
 4 1/4" screen 7' long.
 Tailing belt for stones over 4 1/2".
 Bin 24' long, 12' high, 11' wide.
 Elevator 39' long, 18 buckets.

Cost of Crushing per Day.

Electric power	\$10.00
2 men on platform	12.00
1 man on hoist	5.00
1 mechanic	7.00
1 man tending loading	5.00
	\$39.00
Labor overhead	5.00
Approximate rental value of equipment	40.00
	\$84.00
Approximate total per day	\$84.00
Per ton of total output	0.28
Total cost per ton quarry and crushing 80 cts. per ton total output of crusher.	

TABLE 218.—APPROXIMATE PER CENT OUTPUT OF ORDINARY ROAD CRUSHER (VOLUME)

Rock	Passing 3/4" screen, %	3/4" to 1 1/2", %	1 1/2" to 2 1/2", %	Above 2 1/2", %
Limestone.	15 to 20	5 to 13	30 to 40	30 to 40
Sandstone.	16 to 22	8 to 15	30 to 40	25 to 35
Granite.	10 to 15	10 to 15	35 to 40	35 to 40
Gneiss.	8 to 15	9 to 15	35 to 40	35 to 45
Trap rock.	6 to 10	8 to 12	35 to 45	40 to 50
¹ Mixed sandstone and limestone.	16 to 21	7 to 14	30 to 40	30 to 40
¹ Mixed granite and sandstone (cobble).	12 to 17	8 to 12	30 to 40	35 to 40

¹ Fence stone output.

NOTE.—1 cu. yd. field stone cobbles makes 1 cu. yd. crushed stone screened-out sizes (loose measure).

1 cu. yd. solid quarry stone makes approximately 1.9 cu. yd. crushed stone screened-out sizes (loose measure).

1 cu. yd. field stone cobbles will produce from 0.85 to 0.92 cu. yd. (0.9 cu. yd. average) loose measure crusher run with the smaller amount for soft rocks and the larger amount for hard rocks.

1 cu. yd. solid quarry excavation will produce from 1.6 to 1.75 cu. yd. (1.7 cu. yd. average) loose measure crusher run.

Consolidation.

The ratio of loose to roiled depth for crushed stone and gravel is about as follows:

Gravel 1.2

Crusher run 1.2 to 1.3 (average 1.25)

Screened uniform sizes 1.3

APPROXIMATE AMOUNT OF BOULDERS AND QUARRY STONE PER CUBIC YARD MACADAM ROLLED MEASURE

	1½ to 3½"	Boulders	Solid quarry
1 cu. yd. rolled measure	Screened sizes	1.7 cu. yd. ±	0.9 cu. yd. ±
1 cu. yd. rolled measure	Crusher run	1.4 cu. yd. ±	0.74 cu. yd. ±

WEIGHTS OF SOLID ROCK (NEW YORK STATE)

	Pounds per cubic foot	Pounds per cubic yard
Limestone.....	167 to 171	4500 to 4600
Sandstone.....	155 to 169	4200 to 4600
Granite.....	165 to 171	4500 to 4600
Gneiss.....	167 to 185	4500 to 5000
Trap rock.....	180 to 185	4800 to 5000
Syenite.....	171 to 184	4600 to 5000

APPROXIMATE WEIGHTS OF CRUSHED STONE PER LOOSE CUBIC YARDS

Rock	Passing ¾" screen, ordinary screenings	¾ to 1½"	1½ to 2½"	Above 2½"
Limestone.....	2550 ±	2350 ±	2400 ±	2400 ±
Sandstone.....	2450 ±	2300 ±	2350 ±	2350 ±
Granite.....	2500 ±	2350 ±	2400 ±	2400 ±
Gneiss.....	2600 ±	2500 ±	2550 ±	2550 ±
Trap rock.....	2650 ±	2550 ±	2600 ±	2600 ±

Crusher run 200 to 500 lb. per loose cubic yards more than weight of screened sizes. Average 300 lb. heavier.

NOTE.—Some authorities give the screened size weights about 100 lb. per cubic yard more or less than this table.

CRUSHER OUTPUT

1181

**TABLE 219.— TYPICAL CRUSHER OUTPUT—DIFFERENT ARRANGEMENTS OF SCREENS AND MIXED SIZES—
SANDSTONE (FRENCH COEFFICIENT OF HARDNESS 7.0) TOTAL SCREENED-OUT SIZE OUTPUT 1,000
CUBIC YARD LOOSE MEASURE**

Dust ¹ passing $\frac{1}{8}$ " screen	No. 1 dustless screenings $\frac{1}{4}$ to $\frac{3}{8}$ "	No. 2 $\frac{1}{2}$ to $1\frac{1}{2}$ "	No. 3 $1\frac{1}{2}$ to $2\frac{3}{4}$ "	No. 4 $2\frac{3}{4}$ to $3\frac{3}{4}$ "	Remarks
90 cu. yd. ±	130 cu. yd. ±	120 cu. yd. ±	350 cu. yd. ±	310 cu. yd. ±	Screened-out sizes
← 200 cu. yd. ± →	← →	← →	← 760 cu. yd. →	← →	Mixed sizes
← 90 cu. yd. ± →	← →	← 820 cu. yd. ± →	← →	← →	Mixed sizes
← 110 to 120 cu. yd. →	← →	← 780 cu. yd. ± →	← →	← →	No. 4 recrushed
← →	← →	← 890 cu. yd. ± →	← →	← →	Crusher run

¹ Of the material passing $\frac{1}{8}$ " screen approximately 10% passes No. 80 screen and 20% passes No. 40 screen.

WEIGHTS OF GRAVEL

CONTINENTAL SAND COMPANY, ROCHESTER N. Y.—DOLOMITE GRAVEL

Pit-run gravel.....	3,000 lb. per cubic yard (loose)
Washed sand.....	2,700 lb. per cubic yard (loose)
Washed gravel:	
15 % passing $\frac{1}{2}$ " screen	} 2,500 lb. per cubic yard (loose)
35 % $\frac{1}{2}$ " to $1\frac{1}{2}$ " screen	
50 % $1\frac{1}{2}$ " to $2\frac{1}{2}$ " screen	
Output 45 % washed sand, 55 % screened gravel.	

VALLEY SAND COMPANY

Washed sand.....	2,700 lb. per cubic yard (loose)
Washed gravel (mixed sizes).....	2,500 lb. per cubic yard (loose)
Output 33 % sand, 66 % gravel.	

NOTE.—Above weights are for dry material. Wet sand will run as high as 3,200 lb. per cubic yard.

WEIGHTS OF CRUSHED STONE

Crusher Run Stone.—Crusher run stone will run from 200 to 500 lb. per yard higher than the weight of screened-out uniform sizes.

For limestone weighing 170 lb. per solid cubic foot and approximate 2,400 lb. per loose cubic yard screened sizes. Crusher run will weigh from 2,650 to 2,800 lb. per cubic yard loose measure, according to Harger, Gilmore, and Whitmore Rauber and Vicinus. See page 1159 for weights of uniform screened sizes of limestone.

COST OF STONE-FILL BOTTOM COURSE

The following data are taken from Road 5021, season of 1910; labor cost 17.5 cts. per hour, teams 40 cts. per hour.

The amount placed was 10,000 cu. yd. rolled measure. The average rolled depth was 1.1'. The surface was carefully brought to line and grade, allowing a variation of 1" either above or below, which inequality was taken out with the top stone. A 3" bituminous top course was placed directly on this fill. The top layer of bottom stone was sledged to reduce all stones to 8" or under. Flint stone was used to fill the top 6" and to surface the rough fill. The bottom course was of fence stone, hauled, on an average, about $\frac{1}{2}$ mile. I estimate that 1 cu. yd. rolled measure requires 1.25 cu. yd. loose. The cost of the bottom course per cubic yards rolled measure was \$1.03, divided as follows:

Loading 1.25 cu. yd.....	\$0.19
Hauling 1.25 cu. yd. $\frac{1}{2}$ mile.....	0.20
Placing 1.25 cu. yd. and rolling.....	0.24
Sledging.....	0.15
Flint.....	0.10
Cost of fence stone.....	0.15
Total, per cubic yard.....	\$1.03

Cost of Subbase Bottom Course.—Road 495, Parma Corners-Spencerport. E. E. Kidder, engineer. 1082 cu. yd. placed, average depth 6". Not much sledging required.

Cost of stone, 1 cu. yd.	\$0.10
Loading, per 1 cu. yd.	0.184
Hauling 1 mile.	0.30
Laying, sledging, and spreading filler.	0.136
Rolling.	0.02
Superintendence.	0.02
Cost of filler in pit nothing (gravel used).	0.00
Loading $\frac{1}{3}$ cu. yd.	0.04
Hauling $\frac{1}{3}$ cu. yd. 1 mile.	0.10
<hr/>	
Total.	\$0.90

Kentucky Rock Asphalt.—The following data are from the Clarence Center Road, John D. Rust, engineer, collected during the season of 1910. In this work an 8-ton tandem roller was found to do better than a 6-ton tandem. The cost of handling, spreading, and rolling this material, from data of 5 days selected, varied from 3.3 to 3.6 cts. per sq. yd.; the average being 3.4 cts. The following may be taken as a typical analysis of this cost:

- Abbreviations. L. Laborers.
 F. Foreman.
 T. Teams.
 E. Roller engineer.

Asphalt \$10.25 per ton f.o.b. unloading point.

Run of July 20, 1909.

69.22 tons hauled and placed.

1,730 sq. yd. covered.

80 lb. asphalt per sq. yd.

5 L. at cars, 10 hr. at \$1.50 each.	\$ 7.50
$\frac{1}{2}$ F. at cars at \$2.25 per day.	\$ 1.12
5 T. haul 2 miles at \$4 per team.	20.00
5 L. on wheelbarrows, 11 hr., each 15 cts. per hour.	8.25
1 T. at shredding machine.	4.40
3 L. on rakes, 11 hr. at 15 cts. per hour.	4.95
3 L. shoveling, 11 hr., at 15 cts. per hour.	4.95
1 F. at shredder, 11 hr. at 22.5 cts. per hour.	2.48
1 E. on roller, 11 hr. at 30 cts. per hour.	3.30
<hr/>	

Total. \$56.95
 Cost per square yard, \$0.033.

McClintock Cube Pavement.—The general costs of this experimental pavement were given in Chap. VI. We here give the detailed cost of the vitrified-clay cubes and clay-ash cubes only, as the concrete cubes have not worn satisfactorily.

Vitrified Shale Cubes.—During 1909, 74,000 2½" vitrified shale cubes manufactured at Reynoldsville, Pa., were laid at a cost as follows:

	Teams at 50 cts. per hour
74,000 cubes f.o.b. Reynoldsville.. . . .	\$231.25
Freight.....	68.41
Carting.....	67.00
Laying.....	20.00
	<hr/>
Total.....	\$386.66

NOTE.—331 sq. yd. were covered at a cost of \$1.17 per square yard.

Clay and Ash Cubes.—In 1910, cubes made of a local clay mixed with ashes and burned were tried in the effort to get a cheap, tough clay product. As far as known, this is the first time bricks made in this way have been used on roadwork.

The ash-clay process has been worked out and patented by Karl Langenbeck of Boston, Mass. Many local clays used for ordinary brick or farm tile will not stand up under vitrification without the addition of expensive, imported refractory clays; but the substitution of coal ashes for the more expensive clays has a similar effect and the cost is materially reduced. Some of the local clay was sent to Mr. Langenbeck, who turned out a few cubes that compare favorably in toughness with the best paving bricks on the market.

The Standard Sewer Pipe Company, of Rochester, N. Y., undertook to furnish 400,000 2" cubes of this description for Mr. McClintock. It was necessary for them to experiment to determine a practical method of molding, the correct temperature to use, and the best proportion of ashes, which naturally raised the price above ordinary practice. In molding they used a modification of the ordinary pipe-molding machine, which produced a hollow square of cubes, at the rate of 30,000 cubes per hour. The scoring knives were so set that the cubes were nearly cut apart, leaving just enough uncut clay to hold them together during the burning, after which a light blow separated them cleanly. The toughness of the resulting cubes can probably be increased by further experiment; but the product was good, although not up to the standard of the sample cubes made by Mr. Langenbeck.

The cost of the ash-clay cubes was as follows:

400,000 cubes f.o.b. Rochester, N. Y.	\$1200.00	\$0.711 per sq. yd.
Carting, 6 miles.....	247.75	0.147 per sq. yd.
Filler.....	27.00	0.016 per sq. yd.
Labor of laying.....	191.77	0.113 per sq. yd.
Roller.....	12.94	0.008 per sq. yd.
	<hr/>	
Total.....	\$1679.46	\$0.995 per sq. yd.

NOTE.—1688 sq. yd. covered
 Labor, 22 cts. an hour } for laying and carting.
 Teams, 50 cts. an hour }

Mr. McClintock has stated, in discussing the cost, that in large quantities he believes the cubes can be delivered f.o.b. at the plant for \$1.50 per 1,000, which would reduce the cost as shown above to about 60 cts. per square yard, and that the high cost of laying was due to the irregular shape of the first batch, due to not scoring the cubes deeply enough.

Amiesite Cost Data.—Road 1319, Honeoye Village, season of 1915. H. W. Baker, engineer in charge. 4,700 sq. yd. laid 16' wide 2 $\frac{3}{4}$ " deep. Laid in two courses. Bottom course 2 $\frac{1}{4}$ " thick coarse material; surface $\frac{1}{2}$ " thick fine material.

Material:

588 tons at \$4 per ton f.o.b. plant.....	\$2352.00
588 tons freight 54 cts. per ton.....	<u>341.04</u>

Total cost materials..... \$2693.04

Labor—force at cars unloading:

6 laborers at \$2 per day.....	\$12.00
1 foreman at \$2.50 per day.....	2.50
1 fireman at \$3 per day.....	3.00
1 night fireman at \$2.50 per day.....	<u>2.50</u>
	\$20.00

Equipment at cars:

1 boiler and pipe line per day.....	8.00
$\frac{1}{2}$ ton coal and oil.....	<u>2.50</u>

Total daily cost of unloading..... \$30.50

Hauling $\frac{3}{4}$ mile:

4 teams at \$5 per day.....	\$20.00
-----------------------------	---------

Spreading and compacting:

1 asphalt raker.....	3.00
4 laborers at \$2 per day.....	8.00
1 rollerman.....	<u>3.00</u>

Per day..... \$14.00

Equipment:

1 roller (10-ton tandem).....	10.00
Coal, oil, etc.....	<u>0.80</u>

Daily cost spreading and compacting..... \$24.80

Summary daily force account:

Unloading.....	30.50
Hauling.....	20.00
Spreading and compacting.....	<u>24.80</u>
	\$75.30

Number of days worked, 15

Total labor 15 days..... \$1129.50

Total materials cost..... 2693.04

Total cost..... \$3822.54

Cost per square yard..... 0.81

Bid price square yard..... 0.85

TABLE 220.—DEPTHS AND WEIGHTS OF AMIESITE.
(Weights given are per square yard)

	Amiesite Loose	Weight Pounds	Amiesite Sq. Yds. Per Ton	Filler Loose	Weight Pounds	Filler Sq. Yds. per Ton	Total Depth Loose	Total Weight Pounds	Ultimate Compress- ion	Square Yds. Per Ton
SANDSTONE	2 1/2"	153	13	1"	67 1/2	29.5	3 1/2"	220 1/2	2"	9.06
	3 1/2"	178 1/2	11.3	1"	67 1/2	20.5	3 1/2"	246 1/2	2 1/2"	8.12
	3"	204	0.8	1"	67 1/2	20.5	4"	271 1/2	2 1/2"	7.36
	3 1/2"	220 1/2	8.7	1"	67 1/2	20.5	4 1/2"	297 1/2	2 1/2"	6.73
	3 1/2"	255	7.8	1"	67 1/2	29.5	4 1/2"	322 1/2	3"	6.2
TRAP ROCK	2 1/2"	168 1/2	11.8	1"	75	26.0	3 1/2"	243 1/2	2"	8.2
	2 1/2"	190 1/2	10.2	1"	75	26.0	3 1/2"	271 1/2	2 1/2"	7.36
	3 1/2"	225	8.9	1"	75	26.0	4"	300	2 1/2"	6.66
	3 1/2"	253 1/2	7.0	1"	75	26.0	4 1/2"	328 1/2	2 1/2"	6.1
	3 1/2"	281 1/2	7.1	1"	75	26.0	4 1/2"	356 1/2	3"	5.6
LIMESTONE	2 1/2"	164 1/2	12.2	1"	73	27.4	3 1/2"	237 1/2	2"	8.43
	2 1/2"	191 1/2	10.4	1"	73	27.4	3 1/2"	264 1/2	2 1/2"	7.56
	3"	219	0.1	1"	73	27.4	4"	292	2 1/2"	6.85
	3 1/2"	246 1/2	8.1	1"	73	27.4	4 1/2"	319 1/2	2 1/2"	6.26
	3 1/2"	273 1/2	7.3	1"	73	27.4	4 1/2"	346 1/2	3"	5.77

To find the amount of loose Amiesite necessary for any compressed thickness subtract $1/2$ " from compressed thickness multiply by $1 1/4$ which equals loose thickness, to which add 1 " for filler.
To find what compressed thickness any given amount of loose Amiesite will give, subtract 1 " from loose thickness, multiply by $3/4$ and add $1/2$ " for Filler.

Conditions:

This work was done under bad weather conditions the night temperature being below freezing and only 2 days with an air temperature above 55°F.

It was necessary to keep a night fireman at the cars to keep up steam and to move the steam pipes to different parts of the cars to insure the amiesite being in a condition to loosen and shovel in the morning. The material was loosened by bars and sledges to the bottom of the cars steamed 10 to 30 min. and then shoveled into dump wagons, covered with canvas and hauled to the street.

Under favorable weather conditions the cost of unloading from the cars would probably be reduced 40%.

Table of Amounts of Amiesite required for different thicknesses and materials, page 1186.

BITUMINOUS CONCRETE

Topeka Mix.—The following data on output and organization is quoted from *Engineering Contracting*.

The wearing surface paving mixture was prepared in a Cummer standard one-car portable paving plant of 2,000 sq. yd. of 2" top per day (10 hr.) rated capacity, having a twin-pug mill (10 cu. ft.) capable of handling a 1,000-lb. batch of material. The total weight of this plant ready for transporting is 100 tons.

When the plant is working at its full capacity, 3 tons of coal are required per day.

The organization at the plant is as follows:

- 1 foreman.
- 1 engineer.
- 1 fireman and 1 blacksmith.
- 2 men at scales weighing materials.
- 2 men feeding stone to elevator to drier.
- 2 men feeding sand to elevator to drier.
- 2 men shoveling stone from car.
- 2 men shoveling sand from car.
- 2 men stripping barrels, etc.
- 1 man with horse, conveying sand from pile to elevator.
- 1 man with horse, conveying stone from car to elevator.

On a good day's work (8 hr.) the following quantities of material were used: 16 tons of asphalt, 132 tons of stone, 47 tons of sand, 11 tons of dust or filler, making a total of 206 tons of mixture.

FIELD COST DATA—BITUMINOUS MACADAM, MIXING METHOD. NEW YORK STATE RECONSTRUCTION, ASPHALTIC CONCRETE, 1925

E. A. Close, engineer in charge

General information

Length and Type.—Two miles of water-bound macadam, 20 years old, and 6.5 miles of bituminous macadam, 16 to 18 years old, was to be resurfaced and widened.

An evener course of black base (asphaltic concrete) was used to fill pot holes, widen old macadam, and reduce excessive crown.

Top course was a modified Topeka mix or stone-filled sheet asphalt.

Cross-section.—Black base course was 19' top and 20' bottom width; $1\frac{1}{2}$ " minimum thickness.

Top course was 18' wide, $1\frac{1}{2}$ " uniform thickness.

An edging of black base 6" wide, $1\frac{1}{2}$ " thick was placed on each side of the top course after side forms had been removed to protect the edges of top course. Cost of this edging is included in the black-base course.

Mix.—Black-base mix, in general, was proportioned 600 lb. stone, 300 lb. sand, and 45 lb. asphalt.

Top-course mix, in general, was proportioned 265 lb. stone, 650 lb. sand, and 85 lb. asphalt.

Haul.—The average haul for all material was 6.2 miles from plant to spread.

Progress.—55,833 sq. yd. top course were placed. 13,579 tons black base (including edging) were placed. Average 2 sq. yd. and 0.4887 ton per linear foot road. Job 65% complete.

95 working days on black base. 38 working days on top course. 38 days on repairs. Plant operated a total of 133 days on both courses.

Distribution of General Charges.—Certain general charges shown in Tables A and B could not be directly assigned to either course, and are distributed in the proportion of the number of days plant time charged to each course, viz., $\frac{95}{133}$ to black base and $\frac{38}{133}$ to top course.

Main office, financing charges, and other overhead figures were not available and are not included.

TABLE OF GENERAL COSTS

Description	Quantity	Rate	Amount	Remarks
Salaries:				
Manager asphalt department.....	3.69 mo.	\$500.	\$1,845.00	Rate estimated
Office manager.....	6 $\frac{1}{2}$ mo.	150.	955.00	
Rent:				
Storage space, office, etc.....	8 mo.	40.	320.00	Rate estimated
Office supplies:				
Telephone, postage, etc.....	8 mo.	25.	200.00	Rate estimated
General supplies:				
Coal.....	561.02 tons	3.40	1,907.47	
Coal.....	20 tons	4.50	90.00	Purchased locally
Fuel oil.....	39,000 gal.	0.045	1,755.00	Rate estimated
Lubricating oil and waste.....			200.00	Estimated
Truck covers, tarpalins.....	6	15.00	90.00	
General hauling:				
1 $\frac{1}{2}$ -ton truck.....	7 $\frac{1}{2}$ mo.	375.00	2,750.00	Rate estimated including driver, gas, oil, repairs, tires, interest depression, etc.
Property damage:				
Residence property damaged by smoke and dust.	65% of \$1500.00		975.00	Estimate including two new dust collectors, special oil burner, etc.

Insurance: Estimated 4% of pay roll \$39,749.31 \$1,589.97

Labor: See Table A..... 4,511.94

Equipment: See Table B..... 13,210.00

Total general charges..... \$30,399.38

TABLE A.—PLANT COSTS—LABOR
(Assembling, erecting, and repairing)

Title	Rate	Time	Amount	Remarks
Plant foreman..	\$333.33 per month	81 days	\$ 800.00	
Foremen	7.00 per day	76 days	532.00	
Crane operator.	225.00 per month	81 days	700.96	Rate estimated to include overtime
Mechanic.....	7.00 per day	46 days	322.00	Rate estimated to include overtime
Raker.....	160.00 per month	1 month	160.00	
Tamper.....	5.83 per day	4 days	23.32	
Fireman.....	5.00 per day	87 days	435.00	
Laborers.....	5.00 per day	100 days	500.00	
Mixerman.....	40.00 per week	28 days	186.67	
Boilermakers	12.00 per day	14 days	168.00	Rate estimated
Bricklayers.	12.00 per day	2 days	24.00	Rate estimated
Rollermen.	40.00 per week	84 days	560.00	
Total....			\$4511.94	Carry forward to Table of General costs

TABLE B.—PLANT COSTS—EQUIPMENT
(Interest, depreciation and repairs)

Equipment	Value	Interest	Depreciation	Repairs	Totals
Asphalt plant....	\$25,000 ¹	Estimated at 40% of valuation		\$10,000
Crane.....	5,000 ¹	\$300	\$ 800 ¹	\$200	1,300
Roller.....	4,000 ¹	240	500 ¹	50	700
Small tools....	2,000 ¹	120	1,000 ¹	1,120
Total—Carry Forward to Table of General Costs.....					\$13,210

¹ NOTE.—These figures were estimated.

TABLE OF TOP COURSE COSTS
Labor—mixing and hauling

Title	Rate	Time days	Amount	Totals
Plant foreman.....	\$333.33 per month	38	\$ 422.22	
Crane operator.....	225.00 per month	38	285.00	
Mechanic.....	7.00 per day	38	266.00	
Fireman.....	5.00 per day	59	295.00	
Mixerman.....	40.00 per week	38	253.33	
Laborers.....	0.50 per hour	122	610.00	
Watchmen.....	5.00 per day	38	190.00	
Trucks, 6-ton.....	30.00 per day	98	2,940.00	
				\$ 5,261.55
Labor—spreading and compacting				
	Rate per week	Time, days	Amount	Totals
Foreman.....	\$40.00	15	\$ 100.00	
Foreman.....	50.00	23	191.66	
Rakers.....	40.00	15	100.00	
Rakers.....	50.00	28	233.33	
Tamper.....	35.00	14	81.67	
Tamper.....	40.00	10	60.67	
Laborers.....	6.00	283	1,698.00	
Rollerman.....	45.00	38	285.00	
			\$2,756.33	\$ 2,756.33

(continued on next page.)

Materials (top course)

Material	Price	Quantity	Amount	Totals
Crushed stone.....	\$ 2.01 ¹ per ton	1,153.567 tons	\$2,318.67	
Sand.....	1.40 per cu. yd.	1,998.17 cu. yd.	2,797.44	
Portland cement.....	2.70 per bbl. ¹	60.00 bbl.	162.00	
Form lumber.....	42.00 per M. feet	0.994 M. ft. b. m.	30.05	
Form lumber.....	50.00 per M. feet	0.800 M. ft. b. m.	40.00	
Asphalt.....	0.069 per gal. ²	85,988 gal.	5,933.17	
Delivery charge lumber.....	5.00	2	10.00	
				\$11,300.93

Summary (top course)

Prorated from Table, page 1189, #1 as X \$30,399.38.....	8,685.54
Mixing and hauling.....	\$ 5,261.55
Spreading and compacting.....	2,756.34
Materials.....	11,300.93
General charges prorated.....	8,685.54
	Total \$28,004.35

Unit costs

\$28,004.35 ÷ 55,833 =	\$0.5015 per square yard 1½" thick
2 sq. yd. per linear foot of road, 2 X \$0.5015.....	1.003 per linear foot of road.
	6.50 per ton including asphalt

¹ This rate estimated.

² These prices estimated including delivery.

TABLE OF BLACK BASE COSTS
Labor—mixing and hauling

Title	Rate	Time, days	Amount	Totals
Plant foreman.....	\$333.33 per month	97	\$ 1,077.70	
Crane operator.....	225.00 per month	99	856.73	
Mechanic.....	7.00 per day	95	665.00	
Firemen.....	5.00 per day	191	955.00	
Mixerman.....	40.00 per week	95	633.33	
Laborers.....	.50 per hour	392	1,960.00	
Watchmen.....	5.00 per day	95	475.00	
Trucks, 6-ton	30.00 per day	337	10,110.00	
Foremen.....	7.00 per day	11	77.00	
				\$16,809.83

Labor—spreading and compacting

Title	Rate	Time, days	Amount	Totals
Foreman	\$ 40.00 per week	52	\$ 346.67	
Foreman	50.00 per week	58	483.33	
Raker.....	40.00 per week	80	533.33	
Raker.....	50.00 per week	45	375.00	
Tamper.....	35.00 per week	79	460.83	
Laborers.....	6.00 per day	783	4,698.00	
Rollerman.....	45.00 per week	95	712.50	
				\$7,609.66

Materials

Material	Price	Quantity	Amount	Totals
Crushed stone...	\$2.01 per ton	9,028.925 tons	\$18,148.14	
Sand.....	1.40 per cu. yd.	3,209.48 cu. yd.	4,493.27	
Asphalt..	0.069 per gal.	162,037 gal.	11,180.55	
				\$33,821.96

General charges

Prorated from Table of General Costs, $\frac{92}{100} \times \$30,399.38 = \$21,713.84$

Total \$79,955.29

Unit costs

$\$79,955.29 + 13,579 = \5.888 per ton.

0.4887 tons per linear foot of road $\$5.888 \times 0.4887 = \2.877 per linear foot of road.

NOTE.—Prices and rates in top course table apply also to this table.

COST DATA, CONCRETE ROADS

MATERIALS

Stone.—Cost of stone varied greatly during the year, from 62 to 85 cts. per cubic yard at the Blissville docks. To obtain a low void-age contractors ordered a mixture of No. 2 and No. 3 stone. This mixture weighed approximately 2700 lb. per cubic yard; therefore, cost of stone f.o.b. car at destination would be:

1 cu. yd. stone at Blissville (say).....	\$0.80
Transfer (17 cts. per ton), 1.35×0.17	0.23
Freight (63 cts. per ton), 1.35×0.63 (rate to Patchogue) ..	0.85
Total.....	\$1.88

NOTE.—Arrigoni paid \$1.81 delivered f.o.b., on rate made in 1914 before stone raised. Freight rate to Patchogue then 60 cts.

Organization
Concrete 1-14-3, 4 bag batch

Letter	Position	Number	Rate
A	Foreman	2	\$3.00
B	Engineer	1	4.00
C	Fireman	1	2.50
D	Chute	1	2.00
E	Placing cone	3	2.00
F	Screeding	2	2.00
G	Flotting	1	2.50
H	Brooming and general help	1	1.85
J	Cement (to hopper)	2	2.00
K	Cement (getting ready)	1	1.85
L	Stone (barrows)	4 or 5	1.85
M	Stone (shovelling)	8	1.85
N	Sand (barrows)	2 or 3	1.85
O	Sand (shovelling)	3	1.85
P	Forms	2	2.00
R	Pump	1	2.35
T	Trimming grade	3	1.85
W	Watchmen, covering and wetting down	2	1.85

Also charge $\frac{1}{2}$ Supt. and $\frac{1}{2}$ timekeeper
Trimmers "T" place expansion joints

Haul varied from 12 cts. per yd. mile using tractor roller and 5 cu. yd. trailers (3), to as high as 35 cts. per yd. mile with teams.

Transfer from cars to wagons 15 to 20 cts. per cubic yard dependent mostly on rate of wages; therefore, cost on job, with stone as per above, and a 2-mile haul would be approximately \$1.88 + 0.60 + 0.20 = \$2.68 per cubic yard.

Gravel.—Cost of same at bank, screened, and in bin varied from 45 to 85 cts. (dependent mostly on per cent of gravel). Haul same as stone.

Sand.—Cost of same at bank, (in wagons—screening unnecessary) varied from 35 to 60 cts.

Haul: 25 to 35 cts. per yd. mile.

NOTE.—When obtained from same pit as gravel I would consider its cost in bin as one-third the cost of all material leaving the plant, gravel in this case two-thirds of same total (say 25 cts. [sand] and 50 cts. [gravel] where gravel would be 75 cts. + were all sand wasted).

Cement.—Cost of cement varied greatly during the year; a good average was \$1.20 per barrel net. Actual practice with graded stone has shown 1.75 bbl. per cubic yard of concrete a safe factor.

Haul varied from 3½ cts. (truck) to 5 cts. (wagon) per barrel mile. Handling: average 2 cts. per bbl. when handled direct from car to job.

Plant.—Exclusive of forms and water line.

1 mixer—4-bag mix, 1:1½:3, at least 20 cu. ft. capacity

1 screed—10' by 4" by 12", with ¼" iron plate.

1 bridge—18' × 3" × 12".

3 floats—(one split); and one trowel.

1 doz. forks—close tined for stone.

10 square shovels.

16 wheelbarrows (2 or 2¼ cu. ft. capacity)

1 canvas—160' × 20'—with frame.

2 tampers.

1 template to test subgrade.

1 doz. pins to hold expansion joints (or special template for that purpose).

Small tools, other than noted.

1 Straightedge, 24' × 10" × 4", for extra width on curves.

Total cost of above approximately \$2300.

MANIPULATION

Exclusive of water, forms and trimming subgrade.

Superintendent (one-half).....	\$3.00
Timekeeper (one-third).....	1.00
Foremen (2) (see Fig., p. 1196).....	7.00
Engincer (1) (see Fig., p. 1196)....	3.00
Fireman (1) (see Fig., p. 1196)....	2.50
Mason (1) (see Fig., p. 1196).....	2.50
Laborers (8 at 2.00) (see Fig., p. 1196).....	16.00
Laborers (21 at 1.85) (see Fig., p. 1196).....	38.85

Total..... **\$73.85**

Based on an average day's work of 182 cu. yd. (10-hr. day), the manipulation of a cubic yard of concrete would cost with the above organization, 40.6 cts.

NOTE.—The above organization has laid over 780 lin. ft. of 16½" pavement (outside dimensions), in a 10-hr. day. (The 182 cu. yd. is based on a length of 600' of pavement with a cross-section of 8.2 sq. ft.)

WATER

Plant should be capable of supplying 30 gal. per minute. Pipe: 10,000 (at least) lin. ft. 2" pipe, galvanized at 16 cts.... \$1600.00
Black, at 14½ cts..... 1450.00
35 "Ts" for same (one each 300') at 50 cts..... 17.50

Pumps: 3 to 25 hp., dependent on conditions. For lower power, gas engine O. K.; for higher, steam the best (latter, best for surety of supply).

Outfits \$150 to \$1000.

Where wells were necessary, 2" supply pipe. Driving same \$1.40 per foot for depths not greater than 40'; \$1.50 to 70' depth. This includes pipe and point.

Shaughnessy paid a lump sum for water from Bayshore to Islip (\$300, I believe) from hydrants. On 5232A, water was bought from private parties for part of the work at \$3 per day.

Cost of running steam pump located at well or surface water supply, including operator, varies from \$5 to \$8 per day dependent on weather conditions.

200' of rubber hose at 34 cts. per foot necessary for connection with mixer and sprinkling road. Of this a 15' section should be connected on intake pipe of mixer, with which to sprinkle subgrade.

FORMS

1. 6" Channel forms (steel) 32 cts. per ft. including pins, 8' sections.

2. Patent steel forms with bevel, 24 cts. per ft. Pins for same \$1 each, one necessary for each section. Sections 12' long.

3. Wooden forms with bevel about 12 cts. per linear foot.

Cost of placing same, 2 men at \$2 per day, \$4 per day (see P, Fig., p. 1196).

At least 1200' of forms necessary, so that 600 lin. ft. of road can be built without forms being moved. Based on (2) forms would cost:

1200' of forms.....	\$288.00
Say 110 pins.....	110 00
Total.....	<u>\$398.00</u>

SUBGRADE

Three men generally necessary at \$1.85 per day (see T, Fig., p. 1196).

GENERAL

A steam roller (\$2200) might justly be, partially at least, charged to concrete. Cost of operating same, including rollerman, not greater than \$12 per day if owned by contractor.

CONCRETE PAVEMENT COST DATA

Name of Road, Main Street, Sec. III, County Highway 130,
Erie County, New York State.

Length, 3.68 miles. Thickness, average 7" parabolic crown.

Width, 16'. Proportions of mix, 1:1½:3.

Total cubic yards, 7038.

1. Labor, exclusive of water supply, including supervision	\$0.6818
2. Plant forms and tools	0.3091
3. Expansion joint material	0.2077
	{ steel plates 0.1782
	{ tarred paper 0.0295
	0.2077
4. Water supply, including labor	0.0625
5. Cement placed on roadside ready for mixer	2.3379
6. Sand placed on roadside ready for mixer	0.8359
7. Stone placed on roadside ready for mixer	1.0518
8. Reinforcement, if any	0.0000

Total cost per cubic yard. \$5.4867

Labor, rate per hour, 16½ cts.; teams, rate per hour, 50 cts.; hours
in day worked, 10.

Remarks: Work done by state day labor. Materials unloaded
by hand. Plant charges included proportionate to life of plant.
Seven-tenths mile average haul.

Name of Road, Huntington-Amityville, Part 2, 1219, Suffolk
County

Length, 4.69 miles. Thickness, 4¾" and 6¾" = av. 5¾".

Width, 16'. Proportions of mix, 1:1½:3.

Total cubic yards, 7409.

1. Labor, exclusive of water supply, including supervision	\$0.52
2. Plant forms and tools	0.58
3. Expansion joint material	0.05
4. Water supply, including labor	0.10
5. Cement placed on roadside ready for mixer	2.36
6. Sand placed on roadside ready for mixer	0.23
7. Stone gravel placed on roadside ready for mixer	1.05
8. Reinforcement, if any	0.00
Total per cubic yard	\$4.89
Contractor's bid price	5.30

Labor, rate per hour, 20 cts.; teams, rate per hour, 55 cts.; hours in
day worked, 10.

Remarks: Auto truck for most of haul. Gravel furnished by
large screening and washing plant accounts for high plant cost.
Only proportionate part charged for this plant as it is to be used to
produce commercial output.

Road 1201—Nassau County Concrete Pavement**(1) Sand:**

In bins Heling Bros. per cubic yard.....	\$0.15
Haul by auto (contractor owner) 2½ mi. at 15 cts.	0.38

Sand on road per cubic yard..... 0.53

Gravel:

In bins Heling Bros. per cubic yard.....	0.85
Haul by auto (contractor owner) 2½ mi. at 15 cts.	0.38

Gravel on road per cubic yard..... \$1.23

Cement:

Cement stored at \$1 per day for 150 days....	\$150.00
Approximately 1170 bbl. stored. Storage per barrel.....	0.13
f.o.b. Farmingdale (estimate).....	1.30
Handling and hauling (10 cts. estimate) double handling in most cases.....	0.10

Cement per barrel on road..... \$1.53

This price also approximate cost of cement bought from Parker, Nassau County.

Plant:

(2) 1 auto truck (Sauer).....	\$6,500.00
1 concrete mixer.....	1,200.00
2 doz. shovels.....	21.00
2 teams at \$700, 2 bottom dumpers at \$400....	2,200.00
Forms (wooden) 800 lin. ft.....	40.00
8 barrows.....	24.00
2 doz. picks.....	42.00
1 bucket conveyor, loader.....	600.00
1 screed.....	15.00
Incidentals.....	20.00

\$10,672.00

(3) Pressure water from fire plugs	
Pavement per cubic yard concrete 10 cts.....	\$100.00
1500 ft. (lin.) 2" pipe at 8 cts.....	120.00
100' 2" rubber hose.....	50.00
300' 1" rubber hose.....	45.00

\$315.00

(4) Manipulation per cubic yard in place. This does not include covering, uncovering, sprinkling ..	\$0.92
---	--------

(5) Forms:

Setting and resetting forms per linear foot of road.....	\$0.03
--	--------

$$\frac{3 \times 1.75 \times 20 \text{ days}}{3093} = 0.03$$

CEMENT CONCRETE

(6) *Trimming:*

Per cubic yard of concrete.....	\$0.28
6 men at \$ 1.75 20 days = \$210	
roller at 12.00 6 days = <u>72</u>	
	\$282
	<u> </u> = 0.23
	990
cubic yard of concrete	
Expansion joints at 40 cts. apiece every 30'	
Covering and uncovering and wetting concrete	
during curing season	
2 men to cover at \$1.75.....	\$3.50
2 men to uncover at \$1.75.....	3.50
1 man to sprinkle.....	1.75
	<u> </u>
	\$8.75

$$\frac{8.75 \times 20}{990} = \$0.18 \text{ per cubic yard concrete}$$

Road No. 1203—Nassau County Concrete Pavement

(1) *Sand:*

In pit of Mr. Bennett per cubic yard.....	\$0.15
Screening and loading (estimated).....	0.22
Haul 2 mile (auto truck) contractor owner at	
12 cts.....	<u>0.24</u>
Cost per cubic yard on road.....	\$0.61

Trap rock (imported):

F.o.b. Baldwin \$1.50 per cubic yard.....	\$1.50
Unloading 15 cts.....	0.15
Haul 1.6 mile at 25 cts. teams and auto truck..	<u>0.40</u>
Stone per cubic yard on road.....	\$2.14

Cement:

F.o.b. Baldwin per barrel.....	\$1.38
Handling and hauling per barrel 5 cts.....	<u>0.05</u>
Cement per barrel on road.....	\$1.43

(2) *Plant:*

1 screed.....	\$ 20.00
1 concrete mixer.....	1800.00
1 steam roller.....	3000.00
1 doz. wheelbarrows.....	36.00
2 doz. shovels.....	21.00
3 teams at \$700, 3 bottom dumpers at \$400....	3300.00
1 auto truck.....	5000.00
2 doz. picks.....	42.00
Forms (wooden \$20; steel \$126).....	146.00
Incidentals.....	50.00
Water wagon.....	<u>400.00</u>
	\$13,815.00

<i>Water:</i>	
Pressure line fire plugs, total.....	\$100.00
4000' 2" pipe 6 cts.....	240.00
100' 2" rubber hose.....	50.00
300' 1" rubber hose.....	45.00
	<hr/>
	\$435.00
(4) <i>Manipulation:</i>	
Includes all works, sprinkling, covering, uncovering, in place complete per cubic yard.....	\$0.67
(5) <i>Forms:</i>	
Setting and resetting forms per linear foot of road.....	0.05
(6) <i>Trimming</i> (Subgrade)	
Per cubic yard concrete in place.....	0.24
Expansion joints at 40 cts. apiece every 30'	
Road No. 1219.—Suffolk County Concrete Pavement	
(1) <i>Sand:</i>	
In bins Heling Bros. pit cubic yard.....	\$0.10
Haul by auto (contract) 1.5 miles estimate 30 cts.....	0.30
	<hr/>
Cost per cubic yard on road.....	\$0.40
<i>Gravel:</i>	
In bins Heling Bros. pit cubic yard.....	\$0.75
Haul by auto (contract) estimated 30 cts.....	0.30
	<hr/>
Cost per cubic yard on road.....	\$1.05
<i>Cement:</i>	
Bbl. f o. b. Farmingdale.....	\$1.27
Handling and hauling.....	0.08
	<hr/>
Cement on road per barrel.....	\$1.35
(2) <i>Plant:</i>	
Same as on 1218	
(3) <i>Water:</i>	
Cost of water.....	\$700.00
1 mile 2" pipe at 6 cts. per foot.....	320.00
100' 2" rubber hose.....	50.00
400' 1" rubber hose.....	60.00
1 pump and gas engine (estimate).....	1000.00
	<hr/>
	\$2130.00
(4) <i>Manipulation:</i>	
Includes all work; sprinkling, covering, uncovering, in place complete per cubic yard.....	\$0.50
(5) <i>Forms, setting and resetting per linear foot of road</i>	0.02
(6) <i>Trimming:</i>	
Per linear foot of road.....	0.06
Expansion joints at 40 cts. apiece every 30'	

Road 1218—Suffolk County Concrete Pavement**(1) Sand:**

In bins Heling Bros. pit cubic yard.....	\$0.10
Haul by auto (by contract) 1.7 miles approxi- mate.....	0.40

Sand per cubic yard on road..... **\$0.50**

Gravel:

In bins Heling Bros. pit cubic yard.....	\$0.75
Haul by auto (by contract) approximately.....	0.40

Cost per cubic yard on road..... **\$1.15**

Cement.

F.o.b. Farmingdale.....	\$1.27
Handling and hauling.....	0.08

Cement on road per barrel..... **\$1.35**

(2) Plant:

Gravel and sand screening complete, including various set ups.....	\$15,000.00
1 concrete mixer.....	1,800.00
1 roller.....	2,800.00
1 screed.....	20.00
18 wheelbarrows.....	54.00
2 doz. shovels.....	21.00
3 teams at \$700, 3 bottom dumpers at \$400.....	3,300.00
2 doz. picks.....	42.00
1 road planer and scarifier.....	600.00
Forms (steel).....	630.00
Tarpaulins.....	100.00
Incidentals.....	75.00

\$24,442.00

(3) Water:

Total paid for water approximately.....	\$130.00
1 mile 2" pipe at 6 cts.....	320.00
100' 2" rubber hose.....	50.00
400' 1" rubber hose.....	60.00

\$560.00

(4) Manipulation:

Includes all work, sprinkling, covering, uncovering,
in place complete per cubic yard..... **\$0.54**

(5) Forms:

Setting and resetting form per lineal foot of road... 0.02

(6) Trimming:

Per lineal foot of road..... 0.06
Expansion joints 40 cts. apiece every 30'.

COST DATA

Name of Road, **Huntington Town Line-Farmingdale, Part 1, Suffolk County**

Length, 1.27 miles.

Thickness, 5" and 7" = Av. 6"

Width, 16'.

Proportions of mix, 1:1½:3.

Total cubic yards 2051.

1. Labor, exclusive of water supply, including supervision..	\$0 56
2. Plant forms and tools.....	0 61
3. Expansion joint material.....	0 06
4. Water supply, including labor.....	0 12
5. Cement, placed on roadside ready for mixer.....	2 13
6. Sand, placed on roadside ready for mixer.....	0 22
7. Stone, placed on roadside ready for mixer.....	1 01
8. Reinforcement, if any.....	0 00

Total per cubic yard..... \$4 71

Contractor's bid price..... 5.30

Labor, rate per hour, 20 cts.; teams, rate per hour, 55 cts.; hours in day worked 10.

Remarks: Auto truck for most of haul. Gravel furnished by large screening and washing plant accounts for high plant cost. Only proportionate part charged for this plant as it is to be used to produce commercial output.

Road 1202—Nassau County(1) *Sand:*

Estimated at 10 cts. per cubic yard in bins.....	\$0 10
Haul (by contract) estimated at 40 cts. per cubic yard.....	0 40
	<u>\$0 50</u>

Gravel:

Stiff-leg derrick set up (in bins).....	\$2 00
Haul (by contract) estimated at 40 cts. per cubic yard.....	0 40
	<u>\$2 40</u>
First set up per cubic yard on road.....	\$1 20
Drag line set up per cubic yard.....	0 40
Haul (by contract) estimated 40 cts. per cubic yard.....	0 40
	<u>\$1 60</u>

Imported gravel per cubic yard scow Long Island City.....	0 85
Unloading from scow Long Island City.....	0 15
Freight Long Island City to Central Park.....	0 78
Unloading at Central Park.....	0 10
Haul (by contract) at 20 cts. per cubic yard.....	0 20

Cost per cubic yard on road..... \$2 08

Average cost per cubic yard on road \$1.92.

<i>Cement:</i>	
Bbl. f.o.b. Central Park estimated by market.....	\$1.20
Haul by contract per barrel.....	0.06
Handling.....	0.02
Per barrel on road.....	\$1.28
(2) <i>Plant</i> estimated.....	\$12,000.00
(3) <i>Water:</i>	
Cost of water.....	\$1,000.00
4 mile 2" pipe at 6 cts. per foot.....	1,270.00
100' 2" rubber hose at 50 cts.....	50.00
400' 1" rubber hose at 15 cts.....	60.00
1 pump, boiler, etc.....	1,000.00
	<u>\$3,380.00</u>
(4) <i>Manipulation:</i>	
Includes all work, sprinkling, covering and uncovering; in place complete per cubic yard.....	\$0.64
(5) <i>Forms:</i>	
Setting and taking up per lineal foot of road.....	0.04
(6) <i>Trimming:</i>	
Per lineal foot of road.....	0.075
Expansion joints at 40 cts. apiece every 30'.	

COST DATA

Name of Road, Little Valley-Cattaraugus, Part 1, Cattaraugus County

Length, 5.35 miles. $\left\{ \begin{array}{l} 3900 \text{ lineal feet } 16'. \\ 9700 \text{ lineal feet } 14'. \end{array} \right\}$

Thickness, $\left\{ \begin{array}{l} 6'' \text{ and } 8'' = \text{Av. } 7''. \\ 5'4'' \text{ and } 7'' = \text{Av. } 6\frac{1}{8}''. \end{array} \right\}$

2.575 miles completed.

Width, 16 and 14. Proportions of mix. 1:1½:3.

Total cubic yard 8280—This cost covers 4165 cu. yd.

1. Labor, exclusive of water supply, including supervision	\$0.423
2. Plant forms and tools 66.2 + 15.8 cts. for coal.....	0.820
3. Expansion joint material.....	0.045
4. Water supply, including labor.....	0.030
5. Cement, placed on roadside ready for mixer.....	1.984
6. Sand, placed on roadside ready for mixer.....	0.522
7. Stone, placed on roadside ready for mixer.....	1.505
8. Reinforcement, if any.....	0000

Total cost per cubic yard..... \$5.324

Contractor's bid price..... 6.30

Labor, rate per hour, 18½ cts.; teams, rate per hour, none used;
Hours in day worked, 10.

Remarks: Industrial railway plant delivering sand, stone, and cement into hopper of concrete mixer, clam-shell unloader used to take material off cars. Material delivered alongside mixer in buckets proportioned for one-batch size.

For plant layout see illustration.

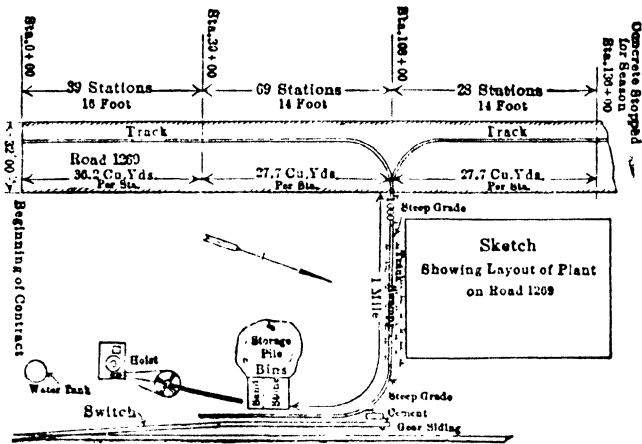

Concrete Pavement Work.—Geneva-Dresden Road, New York State, season of 1925. Length 5.27 miles. 18' width of pavement laid in two 9' strips. 9,900 cu. yd. of concrete placed from July 1 to Sept. 2, 50 working days. Average output per day, 200 cu. yd. Average length of haul, switch to mixer, 1.5 miles.

Concrete Organization at Mixer:

Rex mixer (6-bag batch), \$7000 initial cost.

1 operator at 75 cts. per hour.	\$ 7.50
2 derrick men at 40 cts.	8.00
1 foreman at \$1.	10.00
1 oiling forms at 40 cts.	4.00
2 placing reinforcement and joint at 40 cts.	8.00
4 men placing concrete at 45 cts.	18.00
2 men on screeds at 45 cts.	9.00
3 finishers.	19.50
5 men setting forms at 40 cts.	20.00
<hr/>	
Total labor.	\$104.00
20 gal. of gasoline for mixer ±	5.00
Oil for mixture, (approximately)	1.00
<hr/>	
Total per day.	\$110.00
Cost per cubic yard.	\$ 0.55

Exclusive of overhead and equipment charge.

This cost does not include cover and curing.

LITTLE VALLEY-CATTARAUGUS PART I.—C. H. No. 1209
Cement-concrete Pavement.—3900 Ft. of 6" and 8"-16 Ft. and 9700 Ft. of 5 1/4" and 7"-14 Ft.

Item	Amount	Amt. per Cu. Yd. Conc.	Amt. per Unit	Avg. Haul	Per Yd. Amount	Concrete		Haul		Unloading		Remarks
						Unload	Haul	Yd. Mi.	TonMi	Yd.	Ton	
Cement (Net).....	\$8036.00	\$1.030	\$1.00 bbl.	1.95 mi.	1.95 bbl.	0.23	0.31					Includes Setting Forms, Covering and Watering Conc.
Sand.....	1837.50	0.441	1.05 yd.	1.95 "	0.42 yd.	0.15	0.16	.043		.082	.063	
Stone.....	5547.04	1.332	1.23 ton	1.95 "	0.9 yds.	.074	.069					
Joints.....	187.95	0.045	0.025 ft.									
Manipulation.....	1764.00	0.423										
Unloading.....	540.50	0.132										
Hauling.....	735.00	0.176		(Assumed)								
Coal (240 ton).....	660.00	0.158	2.75 per ton									
Water.....	124.92	0.030										

\$4,667 — Cost per Cu. Yd. Excluding Cost of Plant. (See Below)
PLANT

Item	No.	Cost per	Amt.
Dinkey Engines.....	3	\$6.50 each	2,550.00 Est.
Buckets.....	90	0.26 ft.	585.00 Act 1
Trucks.....	20,000	25.00 each	5,000.00 "
Kopples.....	6	50.00 "	300.00 "
			\$9,335.00

NOTE. Values attached to plant are estimated by Engineer where noted.
Unloading

Item	Cost	Remarks
Bins	1 Double \$1000.00 Est.	
Derrick and Hoist	1800.00 "	
	\$2800.00	Pictures 1 and 2
		Manipulation
Mixer (Austin Cube)	1 Yd. \$1000.00 New	Picture 5
		Total Cost of Plant = \$14,035.00

Concrete Pavement Cost.—Road 1639, New York State, season of 1922. 3.25 miles laid. Average daily output 105 cu. yd. 2-bag batch mixer. Concrete pavement 16' wide laid full width in one operation. 6" uniform thickness.

Organization at Mixer:

	10-hr. Day
1 operator.....	\$ 9.00
1 foreman.....	5.00
1 man tending skip.....	4.50
1 man oiling forms, etc.....	4.50
3 men placing concrete and steel.....	18.00
2 men on screeds, roller and belt.....	10.00
1 finisher.....	7.00

Forms:

2 men on forms (setting).....	12.00
Removing and moving forward.....	4.00

Earth Cover and Sprinkling:

Daily average.....	14.00
--------------------	-------

Total..... \$60.00

= \$0.86 per cu. yd.

Exclusive of overhead and equipment charge.

Brick Cost Data on Country Roads.—The cost of brick pavements on country roads differs somewhat from similar work on city streets. There are not many data available for this class of work, but through the courtesy of William C. Perkins, First Assistant Engineer, New York State Department of Highways, the author is able to give some unusually reliable data obtained from 15 miles of brick paving averaging 14' wide, built near Buffalo, N. Y., in 1910. Mr. Perkins' method of estimating, as given on page 1214, assumes that 20% profit on both materials and labor will take care of the plant and pay-roll charges and give a reasonable profit. The method of estimating is different from that given on macadam roads. His results are good.

Excavation.—Where brick pavement is built on an ordinary unimproved country road, the excavation is of the same class and will cost the same as given for macadam roads.

Where pavements are built over macadam roads and the old surface must be cut into 2 or 3" and reshaped, the excavation is much more expensive. For this class of work see page 1218 (scarifying and reshaping).

Labor Manipulation for Different Items of Brick Pavement Laid during 1910, in the Buffalo Residency.—These items figured from force accounts kept by the different engineers in charge of roads.

Labor averaged 17.5 cts. per hour.

Concrete Base, 5" thick (exclusive of edging).

Machine mixing, laying same in place, including labor of tamping, etc.

Road 2-R, Buffalo-Hamburg.....	\$0.0853 per sq. yd.	
Road 128, Buffalo-Aurora.....	0.0991 per sq. yd.	(gravel concrete)
Road 863, Blasdell Village.....	0.1228 per sq. yd.	
Road 87, Main Street, Sec. 2.....	0.1129 per sq. yd.	(3" base)
Road 862, Hamburg Village.....	0.0655 per sq. yd.	(28' and 30' wide)

The excessive cost on Blasdell Village due to a poor concrete mixer (gasoline) which was constantly breaking down.

On Main Street, Sec. 2, poor organization and too high priced men; also, lack of water, causing delays.

On Hamburg Village low price due to width of base 28' and 30', allowing work to progress faster.

On Road 69, Main Street, Sec. 1, edging and base were laid in one operation; gasoline mixer; plenty of water; cement, \$1.12; sand \$1.40; labor, \$1.90 per day; stone, \$1.12 per cubic yard; base 3" thick; 8" edgings; cost in place, including edging \$4.696 per cu. yd., or 50.6 cts. per square yard, or 88.6 cts. per lineal foot of road.

Assumption.—If 9 cts. per square yard is assumed as an average cost for 16' road (exclusive of edging) the manipulation would be 64.8 cts. per cubic yard.

If 6.55 cts. per square yard is assumed for street work (Hamburg Village), the manipulation would be 47.2 cts. per cubic yard.

Concrete Edging. 8" thick.

Hand mixed; placing same, including erecting of forms, and removing same; tamping, placing steel, and all labor necessary.

Road 2-R, Buffalo-Hamburg, \$0	07.30 per lineal foot of edging.	
	0 0821 per square yard of pavement	(road 16' wide).
Road 128, Buffalo-Aurora...	0 0555 per lineal foot of 5" edging.	
	0.0713 per square yard pavement	(road 14' wide).
Road 863, Blasdell Village...	0 0826 per lineal foot edging.	
	0 0920 per square yard pavement	(road 16' wide).
Road 87, Main Street, Sec. 2	0.0748 per lineal foot edging.	
	0 0842 per square yard pavement	(road 16' wide).

Concrete Curb.—On Road 862, Hamburg Village, concrete curb 6" top, 10" bottom, 15" deep; hand mixed, exposed curbing, all including erection and removal of forms, 12.94 cts. per lineal foot.

Assumption.—If it is assumed that 8.2 cts. per square yard of paving is the cost of edging and 9 cts. per square yard cost of base, the total cost per square yard, 16' road (including edging) would be 17.2 cts. per square yard, or the manipulation would be \$1.238 per cubic yard.

If \$0.073 per lineal foot of 8" edging 10½" deep is assumed, the manipulation would be \$3.379 per cubic yard of the edging in place. (This high cost due to forms, etc., and the small amount of concrete per lineal foot.)

Sand Cushion.—Spreading sand, rolling, and making bed ready for work.

Road 2-R, Buffalo-Hamburg,	\$0.0102 per square yard
Road 128, Buffalo-Aurora,	0.0082 per square yard
Road 863, Blasdell Village,	0.0187 per square yard
Road 87, Main St., Sec. 2,	0.0151 per square yard
Road 862, Hamburg Village,	0.0160 per square yard (28' and 30' wide)

On Main Street, Sec. 1, Road 69; sand, \$1.40; labor, \$1.90; cost per square yard 2" thick, 8.38 cts., including material.

Assumption.—From the above I would assume 1.3 cts. per square yard as cost of preparing sand cushion.

Brick Pavement.—Laying brick, including all labor of handling from the piles, removing all culls, and the rolling of the brick.

Road 2-R, Buffalo-Hamburg,	\$0.0611 per sq. yd.
Road 128, Buffalo-Aurora,	0.0544 per sq. yd.
Road 863, Blasdell Village,	0.0969 per sq. yd.
Road 87, Main St., Sec. 2,	0.0965 per sq. yd.
Road 862, Hamburg Village,	0.0700 per sq. yd. (28' and 30' wide)
Road 69, Main St., Sec. 1,	0.0983 per sq. yd.

Assumption.—I consider Blasdell and Main Street, Sec. 1 and Sec. 2, too high and the engineer claims that the force was cut up and wasted time.

I would assume 7 cts. per square yard as cost of laying brick, etc.

Grouting.—Necessary grouting to obtain flush joints, scoop method, including the placing of the protecting sand covering.

Road 2-R, Buffalo-Hamburg,	\$0.0219 per sq. yd.
Road 128, Buffalo-Aurora,	0.0211 per sq. yd.
Road 863, Blasdell Village,	0.0322 per sq. yd.
Road 87, Main St., Sec. 2,	0.0321 per sq. yd.
Road 69, Main St., Sec. 1,	0.0285 per sq. yd.
Road 862, Hamburg Village,	0.0273 per sq. yd. (28' and 30' wide)

On Main St., Sec. 1, Road 69; sand, \$1.40; cement, \$1.12; labor, \$1.90; actual cost 8.48 cts. per square yard, including materials.

Assumption.—From the above I would assume 2.8 cts. per square yard, as the cost of applying grout.

Expansion Joints.—Removing strips, cleaning joints, and pouring tar.

Road 2-R, Buffalo-Hamburg,	\$0.0067 per linear foot of joint.
	0.0076 per square yard pavement (road 16' wide).
Road 128, Buffalo-Aurora,	\$0.0057 per linear foot of joint.
	0.0073 per square yard pavement (road 14' wide).
Road 863, Blasdell Village,	\$0.0115 per linear foot of joint.
	0.0129 per square yard pavement (road 16' wide).

On Main Street, Sec. 1, Road 69, the expansion joints cost 2.96 cts. per linear foot, or 3.3 cts. per square yard (road 16' wide), including material, labor, etc.

Assumption.—From the above I would assume 0.75 ct. per square yard as the cost of expansion joints.

Unloading.—Data for unloading not reliable.

Road 2—R Buffalo-Hamburg, 1.4 cts. per square yard.

Road 863, Hamburg Village, Contract taken for \$1.50 per 1000 brick; unloaded, haul $\frac{1}{2}$ mile, and pile; this would be 6 cts. per square yard.

Road 69, Main St., Sec. 1... 1.9 cts. per square yard.

Assumption.—I would assume 2.8 cts. square yard as on and off

Hauling.—No reliable data.

If 600 brick per load, \$5 per day for teams, 10 loads per day, are allowed haul 1 mile costs 3.4 cts. per square yard.

Summary, Labor Cost of Brick Pavement.

MANIPULATION OF CONCRETE

Pavement 16' wide; edging 8" \times 10 $\frac{1}{2}$ ".

¹ Concrete base.	\$0.09 per sq. yd.	\$0.648 per cu. yd.
Concrete edge.	0.082 per sq. yd.	3.378 per cu. yd.
Concrete base and edging	\$0.172 per sq. yd.	1.238 per cu. yd.

BRICK WORK LABOR

Preparing sand cushion.	\$0.0130 per sq. yd.
Laying brick.	0.0700 per sq. yd.
Grouting.	0.0280 per sq. yd.
Expansion joints.	0.0075 per sq. yd.
On and off.	0.0280 per sq. yd.
Haul one mile.	0.0340 per sq. yd.

Cost of labor. \$0.1805 per sq. yd

Useful Data for Brick Roads.

6" \times 10 $\frac{1}{2}$ " edging per linear foot of edging..	0.016203 cu. yd.
8" \times 10 $\frac{1}{2}$ " edging per linear foot of edging. . . .	0.021605 cu. yd.
5" \times 16' concrete foundation per linear foot	
16' road.	0.24691 cu. yd.
2" sand cushion loose per square yard.	0.0555 cu. yd.
1 barrel of cement will grout 36 square yards of pavement.	
1 barrel of paving pitch will fill 130 linear feet of joints 1" wide.	

Amount of Grout Required for Stone Block Paving.—For blocks similar to Medina sandstone blocks running about 26 to the square yard, Gillette states that 0.6 cu. ft. of joint filler is required per square yard of pavement with joints averaging $\frac{1}{2}$ " wide. Second quality blocks with wider joints require proportionally more.

¹ Recent cost data indicates that 35 cts. per cubic yard is ample.

Amount of Grout Required for Some Block Paving.—For blocks similar to Medina sandstone blocks, running about 26 to the sq. yd., Gillette states that 0.6 cu. ft. of joint filler is required per sq. yd. of pavement with joints averaging $\frac{1}{2}$ " wide. Second quality blocks with wider joints require proportionally more.

STANDARD ESTIMATE, BRICK SURFACING, EXCLUSIVE OF FOUNDATION

Materials.

	Per Sq. Yd.
Cost of brick, f.o.b. unloading point	\$
“ “ sand for sand cushion, on job	
“ “ “ grout, on job	
“ “ cement for grout, on job	
“ “ paving pitch for expansion joints, on job	

Labor and Teaming.

Unloading brick and piling along road	\$0 035
Hauling brick per mile	0 040
Preparing sand cushion	0 020
Laying brick	0 070
Grouting	0 028
Expansion joints	0 007
Total	\$ —
Add 20% profit	—
Estimate	\$ —

SAMPLE—STANDARD ESTIMATE, BRICK PAVEMENT— WM. C. PERKINS

Brick: \$22.50 per 1000 f.o.b. cars at Road siding,
bricks lay 40 to the sq. yd.

Labor, \$0.175 per hour, 10 hours.

Sand, 1.00 per cu. yd. on cars at siding.

Stone, 1.25 per cu. yd. on cars at siding.

Cement, 1.30 per bbl. delivered on work.

Sand:

f.o.b. cars	\$1 00
Unloading	0 15
Haul 1 mile @ \$0.30	0 30
Cost cu. yd. sand	\$1 45

Stone:

f.o.b. cars	\$1.25
Unloading	0.15
Haul 1 mile @ \$0.30	0 30
Cost cu. yd. stone	\$1.70

BRICK PAVEMENTS

1215

Concrete: 1 - 2½ - 5.

Use any standard mixing tables, stone 1" and under, dust screened out.

Cement, 1.19 bbl.	×	\$1.30 =	\$1.55
Sand, 0.46 cu. yd.	×	1.45 =	0.67
Stone, 0.91 " "	×	1.70 =	1.55
*Manipulation			0.50
			\$4.27
20% profit			0.85
			\$5.12

The manipulation is based on machine-mixing and is for base alone laid 5" thick. The concrete edging is estimated separately and runs from \$0.13 to \$0.15 per lin. ft.

Material per Square Yard

Brick f.o.b. cars.		\$0.000	
Sand cushion and cover		0.080	
Grout (sand and cement).		0.042	
Material expansion joint		0.008	
			\$1.030

Labor per Square Yard

Unloading and piling		\$0.035	
Haul 1 mile		0.040	
Laying and rolling		0.070	
Making sand cushion.		0.020	
Grouting		0.028	
Expansion joints.		0.007	
Culling, replacing, etc		0.005	0.205
			\$1.235
20% profit			0.247
			\$1.482

Therefore, standard 16' road is estimated to cost, per square yard (exclusive of edging):

Concrete base.		\$0.711	
Brick		1.482	
Total		\$2.193 per sq. yd.	
		Say, \$2.20 per sq. yd.	

*Recent cost data indicates that \$0.35 is ample with labor at \$0.175 per hour.

INCIDENTAL ITEMS

Guard-rail Paint

15 lb. white lead }
 ¾ gal. oil } 1 gal. paint.
 25 to 30 lb. white lead and 1½ gal. oil to paint 100 ft. guard rail
 3 coats.

In Report of 1901 the Massachusetts Highway Commission gives the following costs for repainting guard rail:

Lineal feet of guard rail painted.....	350,330
Cost of paint per gallon (freight not included).....	\$ 1.05
Cost of paint per lineal foot of guard rail.....	0.0084
Cost of paint and painting per lineal foot of guard rail . . .	0.0165
Lineal foot of guard rail painted per gal.....	134.4
Number gallons of paint used per lineal foot of guard rail . . .	0.0077
Time required to paint 1', in decimals of an hour.....	0.0269

Concrete Guard Rail.—Style of rail shown in sketch on page 681, chapter on Minor Points.

Labor, 22.5 cts per hour.

Cost of manufacturing 1233 lin. ft. of rail of the above description. Taken from the Report of the New York Highway Commission of 1910.

Lumber	\$ 32.46	0.026 per lin. foot
Steel . . .	139.64	0.114 per lin. foot
Cement	57.62	0.046 per lin. foot
Gravel	10.00	0.008 per lin. foot
Metal cores	77.00	0.063 per lin. foot
Labor	231.83	0.188 per lin. foot
Miscellaneous	5.35	0.004 per lin. foot
Total	\$553.90	\$0.449

These data apply to small quantities; if manufactured on a large scale the cost should be reduced to about 30 cts. per lineal foot.

The cost of setting the above rail varied from 9 to 12.5 cts. per lineal foot: labor 22.5 cts. per hour. This does not include hauling from the factory to the intended position on the road.

Guard Rail.—In the following data the labor cost alone is given, for the materials will vary so much at different times and places that any quotations would be of little value.

The style of rail erected is similar to sketch, page 676. Road 715, 9760 lin. ft. were built at the following cost, according to S. O. Steere, engineer in charge: Post-hole auger diggers and ordinary shovels were used; the holes were dug in medium hard clay; labor at 20 cts. per hour, foreman \$3 per day; unskilled labor used in painting fence.

Digging post holes, setting posts, nailing on rails (erecting fence complete):

Cost.....	\$0.0428 per lineal foot
Painting three coats.....	0.0094 per lineal foot
Total for erecting and painting	\$0.0522 per lineal foot

Road 5046, W. G. Harger, as engineer. 2448 lin. ft. Built by subcontractor, Max Weller.

Force: Max Weller acted as foreman. In these data he has been arbitrarily allowed salary of \$4 per day..... \$4.00
 1 helper..... 2.50
 1 helper..... 2.00
 1 helper..... 1.75
 Cost of erecting and painting complete, per lineal foot 6.6 cts.

CONCRETE SHOULDERS AND SLOPE PROTECTION 1920

Road 1393A, Scottsville-rush

Concrete shoulders 12" thick.

1:2½:5 mix (1-bag batch).

2 strips of concrete 3' wide and 6' wide.

½ cu. yd. per lineal foot.

6 men placing and finishing at	\$5.50	\$ 33.00
1 boom	5.00	5.50
1 drum	5.50	5.50
1 engineer	8.00	8.00
1 fireman	5.50	5.50
1 hopper	6.00	6.00
2 cement	6.00	12.00
2 sand (wheelers and shovelers)	5.50	11.00
6 stone (wheelers and shovelers)	5.50	33.00
2 forms	5.50	11.00
2 grading	5.50	11.00
1 foreman	8.00	8.00

Labor total \$149.50

Interest, depreciation, and repairs on mixer allow 20.00

Total \$170.00

80 cu. yd. placed on an average.

Cost per cubic yard for labor of placing \$2.10.

Cobble Gutter.—Road 5046, W. G. Harger, engineer.

Labor, 17.5 cts. per hour. Foreman, \$3.50 per day.

Cobbles averaged 6" in size; no sand cushion required, as gutter was built in a sand cut. Gutter was laid by ordinary laborers using paver's tools; tamped with a paving rammer, and the top voids filled with No. 2 stone crushed on the job.

430 sq. yd. were laid at the following cost per square yard:

Cobbles, free.....	\$0.000
Loading ½ cu. yd. of cobbles.....	0.030
Hauling ½ cu. yd. of cobbles ½ mile.....	0.024
Laying and tamping.....	0.080
Filler.—Cost of 0.05 cu. yd. No. 2 stone at crusher bin, approximately.....	0.030
Hauling 0.05 cu. yd. 1 mile.....	0.015
Spreading and brooming, 0.05 per cu. yd. No. 2 stone.....	0.010

Total..... \$0.180

PAVEMENT MAINTENANCE AND REPAIR COST DATA

Cost Data on Reshaping Road

Work was done on Main Street Road 69, Erie County, N. Y., between July 15 and Sept. 13, 1907.

The road had been built as a water-bound macadam. It was worn out, particularly in the center. There were few ruts, but the road was nearly level; in some stretches the center was lower than the sides. It was proposed to reshape the road and to lay a new top course treated with tarvia.

The work of reshaping was done by loosening the old surface with spiked wheels of roller; this separated the crust into chunks of various sizes which were broken up by men with picks. The stone was then raked from the sides to the center, brought to the required crown, and rolled ready for the new course of stone.

The cost of the complete operation included the number of men picking and the rollerman's salary.

Labor.....	\$0.175 per hour
Rollerman.....	0.300 per hour

The roller was rented at a flat rate of \$5 per day, and a portion of the time it was used on other parts of the work. This cost plus the coal and oil is not included.

The data were compiled daily, and as the work was performed practically every working day between the dates named an average of the square yard price should be nearly correct. The highest cost on any one day was 6 cts. per square yard, the lowest cost 1.6 cts. and the general average 3 cts. per square yard.

Through the courtesy of Halbert P. Gillette,¹ author of "Handbook of Cost Data," the following is published:

Cost of Resurfacing Old Limestone Macadam.—"In *Engineering News*, June 6, 1901, I gave the following data to show that the intermittent method of repairing macadam is the most economic. The data were taken from my timebooks and can be relied upon as being well within the probable cost of similar work done by contract under a good foreman. It will be noted that the cost of operating the roller is estimated at \$10 per day. This includes interest and depreciation as well as fuel and engineman's wages.

"The road was worn unevenly, but as it still had sufficient metal left, very little new metal was added.

"The roller used was a 12-ton Buffalo Pitts, provided with steel picks on the rear wheels. It required 80 hours of rolling with the picks in to break up the crust of a surface 19,400 sq. yd. in area, 240 sq. yd. being loosened per hour. The crust was exceedingly hard, and, at times, the picks rode the surface without sinking in, so that a lighter roller would probably have been far less efficient. In fact, a 10-ton roller had been used a few years previous for the same purpose at more than double the expense per square yard, I am told. The picks simply open up cracks in the crust to a depth

¹ Gillette's *Handbook of Cost Data*, Myron C. Clark Publishing Company, edition of 1907, page 147. Pages 288 and 289, edition of 1910, in slightly different form.

of about 4", and it is necessary to follow the roller with a gang of laborers using hand picks to complete the loosening process. The labor of loosening and spreading anew the metal was 1.880 man hours, or a trifle more than 10 sq. yd., per man hour. About 60% of this time was spent in picking and 40% in respreading with shovels and potato hooks.

"After the material had been respread, the short section was drenched with a sprinkling cart, water being put on in such abundance that when the roller came upon the metal the screenings which had settled at the bottom in the spreading process were floated up into the interstices. The roller and sprinkling cart were engaged only 63 hrs. in this process, 300 sq. yd. being rolled per hour; an exceptionally fast rate. The rapidity of rolling was due to four factors: (1) the great abundance of water used, the water being a very short haul; (2) the unyielding foundation (telford) beneath; (3) the abundance of screenings and fine dust, the road not having been swept for some time; (4) the great weight of the roller, which was run at a high rate of speed. I am not prepared to say that longer rolling would not have secured a harder surface, but I doubt very much whether it would. The metal, I should add, was hard limestone. Summing up, we have the cost of resurfacing the road per square yard to have been as follows:

	Cents per Square Yard
Picking with roller at \$1 per hour	0 40
Picking by hand labor at 20 cts. per hour	1 20
Respreading by hand labor at 20 cts. per hour	0 80
Rolling with roller at \$1 per hour	0 33
Sprinkling with cart at 40 cts. per hour	0 13
Foreman, 1.43 hours at 30 cts. for 10,400 sq. yd.	0 44
Total	3 30

"At this rate a macadam road 16' wide can be resurfaced for a little more than \$300 per mile. The frequency with which such resurfacing is necessary will, of course, depend upon several factors, chief of which are the amount of traffic and the quality of the road metal. I should say that 5 years would not be far from the average for a country road built of hard limestone. Unless the road has had an excess of metal used in its construction, new metal should be added at the time of resurfacing to replace that worn out.

"I am unable to see how any system of continuous repair with its pattering work here and there can be as economical as work done in the manner above described. I would not be understood, however, as favoring an entire neglect of the road between repair periods. At times of heavy rains and snows, ditches and culverts need attention and there should be some one whose duty it is to look after such matters. What I do question is the economy of having a man continuously at work putting in patches upon the road."

Recapping.—The cost of recapping with any style of macadam is practically the same as original construction for that style of work except the item of scarifying and reshaping the old road.

COST DATA SURFACE TREATMENT

It will be noted in the following table that the tendency of surface oiling practice is to each year reduce the amount of oil and cover used. This is in line with the data set forth in the chapter on Maintenance.

Hot-tar Flush Coats.—The cost of applying hot-tar flush coats by hand is practically the same as given for applying bituminous-binder penetration method. See page 1169.

The cost of machine application is given on page 1170.

Calcium Chloride.—The cost of applying calcium chloride as a temporary dust layer on ten miles of road in Monroe County, New York, as given by Frank Bristow, First Assistant Engineer, New York State Department of Highways, is as follows:

The material was applied by an ordinary agricultural drill. The force used was, 1 horse and driver, 30 cts. per hour; 1 helper, 20 cts. per hour. No preliminary work of sweeping was done; the material was spread on the middle 12' of macadam, using approximately 0.75 lb. to the square yard, the average speed being 0.5 miles, or 3500 sq. yd., per day, at a cost of 0.15 cts. per sq. yd.

Cost of calcium chloride at plant.....	\$13.00	net ton
Freight.....	1.60	per ton
Unloading from cars, approximately...	0.15	per ton
Hauling 3 miles, approximately.....	0.90	per ton
	<hr/>	
Total, delivered on road.....	\$15.65	per ton
Total per square yard delivered on road	0.0059	
Labor of spreading.....	0.0015	
	<hr/>	
Total per square yard in place..	\$ 0.0074	
Total per mile 12' wide, approximately.....		\$52.00

Cost of Applying Calcium Chloride

Road 5507 Scottsville—Canawagus. Season 1915. W. G. Harger, engineer in charge.

15 tons were applied at the rate of 1½ lb. per square yard on a 16' road for \$22 or at the rate of \$1.50 per ton.

Force used: 1 team hauling agricultural plaster spreader. 2 laborers helping driver. Calcium chloride in metal drums had been previously distributed along the road.

Wages: Team, \$5 per day; laborers, \$2 per day

MAINTENANCE AND REPAIR COSTS

Cold Oiling.—The following data is furnished by Mr. Frank Bristow, Supt. of Repairs, Division No. 5, New York State Department of Highways. The work was done in 1910. Labor averaged \$0.20 per hour; teams, \$0.50 per hour.

Oiling. Actual Cost Data.—No. 6 stock or 65% asphaltic base oils applied cold by Studebaker Oiler upon macadam road which

had been swept by horse sweeper, oil being broomed by hand where necessary and then covered by a thin coat of dustless screenings, or gravel, spread by hand.

The labor costs include pumping oil from the car tank, hauling same to road, applying same, sweeping road and spreading screenings; also, demurrage on cars and moving tools and repairs, but not cost of the plant

TABLE 221

County			Average cost of materials		Average Quantities of Materials Used		Average Cost	
	No. Jobs Average	Average Haul, Miles	Oil per Gal. on siding	Cover per Cu. Yd. Along Road	Gallons per Sq. Yd.	C. Y. Cover per Sq. Yd.	Labor per Sq. Yd.	Total Labor and Material per Sq. Yd.
Orleans	7	2.48	\$0.0435	\$1.82	0.42	0.016	\$0.013	\$0.057
Niagara	4	2.24	0.0425	1.57	0.43	0.016	0.014	0.057
Erie	12	2.00	0.0437	1.88	0.34	0.012	0.007	0.045
Erie	3	4.43	0.0455	1.83	0.42	0.015	0.019	0.066

Other information would show that cost per mile to sweep average road is \$8.33; cost per gallon applying oil 0.75 cts.; cost all labor sweeping, hauling, applying oil and cover about 25 cts. per gallon used.

TABLE 221A.—DIVISION 7 NEW YORK STATE DEPARTMENT OF HIGHWAYS.

H. G. HOTCHKISS, SUPERINTENDENT OF MAINTENANCE

Cost data for oiling, surface treatment 1915

Miles	No. Sq. Yds.	Kind Bit. Mat.	Gals. per Sq. Yd.	No. Tons of Cover per Mile	Total Cost per Sq. Yd.	Total Av. Cost per Sq. Yd.	Cost per Mile 16' Surface
20.54	158144	C. O.	0.25	62	0.0344	0.026	244.06
23.63	188208	C. O.	0.25	41	0.0250		
17.75	146734	C. O.	0.24	37	0.0237		
19.94	172775	C. O.	0.19	43	0.0189		
21.47	200995	C. O.	0.19	59	0.0264	0.0183	171.78
16.22	190925	C. O.	0.28	74	0.0287		
22.51	188601	L. C. O.	0.20	31	0.0195	0.0183	171.78
41.09	382330	L. C. O.	0.20	27	0.0177		
15.44	126657	H. C. T.	0.25	40	0.0323	0.0330	309.77
13.42	126056	H. C. T.	0.25	40	0.0337		
17.19	143846	L. C. T.	0.25	47	0.0319		

TABLE 221B.—DIVISION 7 NEW YORK STATE DEPARTMENT OF HIGHWAYS

Cost data repainting and rebuilding guard rail 1914

No. Lin. Ft. Painted One Coat	Cost per Lin. Ft.	No. Lin. Ft. Painted Two Coats	Cost per Lin. Ft.
15325	\$0.0212	26428	\$0.0425
79925	0.0233	8433	0.0300
17486	0.0251	12824	0.0352
42027	0.0264	13160	0.0442
Rebuilding Wooden Guard Rail		Rebuilding Concrete Guard Rail	
No. Lin. Ft.	Cost per Ft.	No. Lin. Ft.	Cost per Ft.
160	0.219	100	\$0.896
554	0.189	335	0.764
360	0.200		
272	0.141		

COST DATA SURFACE TREATMENT WITH OIL AND TAR New York State Department of Highways Division No. 7						
CONTRACT WORK						
Year	Miles	Total Number Gallons Used	Total Average Cost per Mile	Total Average Cost per Sq. Yd.	Cover Lb. per Sq. Yd.	Cover Cost per Sq. Yd.
1916	148.96	52,717 Tar 35,380 L.H.O. 159,228 L.C.O. 236,827 C.O.	\$221.77	\$0.0252	8	\$0.0065
1915	229.21	114,186 L.C.O. 99,140 Tar	217.37	0.025	10	0.0101
1914	188.06	225,533 C.O. 201,583 Tar	404.36	0.047	18	0.0218
DEPARTMENTAL FORCE ACCOUNT						
1916	47.21	84,294 Tar 7,164 L.C.O.	\$192.84	\$0.022	8	\$0.0039
1915	57.10	23,358 C.O. 17,081 L.C.O.	284.79	0.034	12	0.0113
1914	53.73	54,090 Tar 112,690 Tar	400.32	0.048	18	0.0220
1913	13.49	20,796 C.O. 33,955 Tar	601.12	0.072	28	0.0244

COLD APPLICATION

		CONTRACT WORK				DEPARTMENTAL FORCE ACCOUNT			
HOT APPLICATION	1915	7.37	17,560 Tar	\$521.67	\$0.074	28	\$0.0263	0.29	
	1914	13.87	{ 15,302 Tar 24,720 H.O.	817.80	0.102	61	0.0538	0.36	
DEPARTMENTAL FORCE ACCOUNT									
	1915	4.51	13,131 H.O.	\$ 812.04	\$0.114	39	\$0.0444	0.41	
	1914	1.00	4,693 H.O.	1,413.21	0.150	58	0.0710	0.50	
	1913	8.75	31,119 H.O.	1,222.18	0.138	51	0.0529	0.40	
CONTRACT WORK									
NO COVER	1915	1.06	3,674 L.C.O.	\$112.64	\$0.012			0.20	
	1914	0.50	1,173 C.O.	224.00	0.024			0.25	
	1913	2.26	4,243 C.O.	150.45	0.010			0.20	
COST OF BITUMINOUS MATERIAL PER GALLON									
Year	Tar, Cold Application	Tar, Hot Application	Light Hot Oil Application	Light Cold Oil	Cold Oil	Hot Oil	Year	Labor Cents	Teams Cents
1916	\$0.0592	\$ 0.057	65-75% Asph.	40-55% Asph.	50-65% Asph.	85-95% Asph.	1916	20-30	50-62½
1915	0.038-0.066	0.1025					1915	15-25	50-62½
1914	0.066-0.096	0.093					1914	15-25	50-62½
1913	0.075						1913	15-25	50-62½

MAINTENANCE SCHEDULE

1225

**TABLE SHOWING CHARACTER OF MAINTENANCE AND RENEWAL EXPENDITURE FOR 1914,
OVER 500 MILES OF ROAD**

DIVISION 7

NEW YORK STATE COMMISSION OF HIGHWAYS

Perry, Perkins
Division Engineer

MAINTENANCE DEPARTMENT REPORT 1914

H. G. Hotchkiss, Jr.,
Acting Superintendent of Maintenance

County	Miles	Resurfacing		Oiling		Patrol	Maint. Mat.	Extra Labor	Guard Rail	Miscel.	Eng. and Insp.	Total
		Miles	Cost	Miles	Cost							
Genesee.....	31.00	3.00	\$9470.50	24.74	\$6410.63	\$2574.00	\$310.86	\$910.44	\$451.55	\$161.67	\$2072.13	\$22370.78
Ontario.....	100.99	5.59	40085.03	52.38	19390.66	7311.00	4107.60	7921.50	1713.28	286.96	3930.98	84790.51
Orleans.....	58.14	3.47	13482.82	36.02	15796.64	4679.00	2337.01	1388.86	460.34	94.26	4537.10	42726.03
Livingston.....	82.05			41.19	16392.56	6753.00	2044.05	557.83	1441.77	334.00	3350.66	31073.87
Monroe.....	220.19	4.75	68662.19	100.36	50682.88	14331.00	13317.51	9683.57	3702.02	986.57	9334.42	179300.19
Wyoming.....	21.36			4.00	2423.60	1866.00	811.77	1573.51	581.85	70.73	1338.40	8685.86
Total.....	514.63	16.81	\$131083.54	258.69	\$111114.97	\$37464.00	\$22988.83	\$22035.71	\$3351.31	\$1934.10	\$24983.69	\$359956.24

Average cost per mile oiling..... \$420 52 Engineering and inspection 6.94 %
 Average cost per mile resurfacing..... 7797 95
 The items of maintenance material and extra labor Monroe Co. includes 5 75 Miles calcium chloride average cost
 Average cost per mile patrol..... 73 00 per mile..... \$185.23
 Number feet guard rail painted one coat..... 154763 Average cost per foot..... \$0 0240
 Number feet guard rail painted two coats..... 60845 Average cost per foot..... 0.19
 Number feet wooden guard rail rebuilt..... 1426 Average cost per foot..... 0.85
 Number feet concrete guard rail rebuilt..... 2196 Average cost per foot..... 0.85

CULVERT AND BRIDGE COST DATA

Culverts

The following data will help in estimating the cost of small concrete jobs, such as culverts, walls, etc. This data was collected by Mr. E. E. Kidder during the season of 1908.

COST DATA SMALL CULVERTS

	Per Cu. Yd.
Forms (labor)	\$0.58
Lumber	0.50
¹ Labor, mixing, and placing.....	1.18
¹ Foreman	0.20
¹ Broken stone, at crusher.....	0.90
¹ Hauling stone, one mile	0.30
Sand at pit at 65 cts. per cu. yd.	0.32
Hauling sand six miles	0.75
¹ Taking down forms	0.10
Cement at culverts	2.00
Total	\$6 83

Labor, \$0.15 per hour.

Concrete, hand-mixed.

200 cu. yd., placed in small culverts, averaging 12 to 15 cu. yd. each.

NOTE.—The labor of placing the concrete is customarily sublet to masons for \$2.00 per cu. yd.

Small Culverts

Java Center Road. George A. Wellman, Engineer.

One hundred and sixty-one cu. yd. of concrete in culverts, averaging 12 to 20 cu. yd. each.

Boulders were embedded in the third-class concrete. Water only had to be hauled for 30 cu. yd. of concrete.

Item	Total Quality	Materials		Amt. per Cu. Yd. of concrete	
		Unit Cost	Total Cost	Material	Costs
Cement ..	138 bbl.	\$1.12..	\$154 56	0.86 bbl.	\$0.96
¹ Sand	60 cu. yd.	1.00..	60.00	0.37 cu. yd.	0.37
Crushed stone	130 " "	1.55..	201.50	0.80 " "	1.24
Lumber.....	3 M.....	30.00..	90.00	0.56
Total.....					\$3.13

Costs are f.o.b. unloading point; teaming of material included in the labor cost given below, except for sand, which cost \$1.00 delivered on the job. Concrete mixed and placed by hand.

¹ Items accurate; other items approximately correct.

Cost of Labor and Teaming

Item	Total	Per Cu. Yd. of Con- crete
Foreman	\$93.00	\$0.58
Labor, unloading stone from cars.	20.00	0.12
Mixing, placing concrete, and removing forms	204.00	1.27
Carpenters, building forms	75.00	0.47
Teaming.....	182.00	1.13
	Total Labor. . .	\$3.57
	Total Material . . .	3.13
	Total . . .	\$6.70

Labor.....	\$0.175	per hour
Teams.....	0.50	" "
Carpenters.....	0.25	" "
Foreman.....	0.30	" "

Small Span Concrete Arch.—The following information of cost of 19-ft. span concrete arch was given by Mr. Charles M. Edwards, First Assistant Engineer, New York State Department of Highways. Arch was built at Pembroke, N. Y., by a contractor who was crushing stone at a quarry about one-half mile from the work. Cement was hauled three-quarters of a mile. For the concrete a mixture of one part Portland cement, two parts sand, and four parts stone was used. The old masonry abutments and wings were left in place and faced with 8 inches of concrete held by dowels. The quantities were: Concrete, 120 cu. yd.; steel bars, 4500 lb.; pipe railing, 200 lin. feet. The cost of the work was as follows:

Lumber, including arch centers	\$156.00	on job
Steel	106.00	" "
Cement	137.00	on siding, f.o.b.
Stone	240.00	on job
Dust and sand	90.00	
Railing.	78.00	f.o.b. siding
Labor.	300.00	
	Total	\$1107.00

Omitting the cost of railing this figure gives a cost of \$8.57 per cu. yd. of concrete, including steel. This cost does not include salvage of lumber or overhead expenses of any kind. The contractor received \$1500.00 for the work, including the earth filling, for which he used quarry strippings. This filling cost about \$50.00.

¹ The sand on this job cost practically nothing but we have placed the cost at \$1.00 in order to avoid a misleading item.

COST DATA (1924 COST CONDITIONS) LOCK-JOINT CAST-IRON PIPE

Approximate cost f.o.b. switch North eastern States:

Diameter	Per Foot
12''	\$2.45
14''	2.65
16''	3.26
18''	3.67
20''	4.80
24''	6.52
30''	8.97

Averaging cost hauling and installing exclusive of trench excavation.

Diameter	Per Foot
12''	\$0.10
16''	0.15
18''	0.20
24''	0.25
30''	0.30
36''	0.35

Profit item from 20 to 60 cts. per foot.

Bridge Foundation Excavation

Road 191. Season of 1926 (Hinman)

Common labor rate 50 cts. per hour.

400 cu. yd. foundation pit excavation in gravelly loam soil taken out by hand. rock, pick, shovel, bars and wheeled out of pit with wheelbarrows for \$2.70 per cubic yard exclusive of overhead charges.

Pile Driving

Hinman (1926)

Road 191, New York State.—2000 lin. ft. piles driven by 1800-lb. drop hammer, steam hoist rig. Average penetration 1'' per blow; piles 25' long in leads. Average cutoff 4'. Cost to drive \$1.50 per foot of pile ordered in leads including all overhead charges, 1926 cost conditions. Poorly equipped and poorly managed job.

Average cost of suitable timber piles in this locality delivered on work 40 cts. per linear foot for piles less than 30' total length.

Ordinary bid prices for small bridges in Western New York, 80 cts. to \$1.20 per linear foot of timber piles.

COST DATA ON BRIDGE I R.C. 1493, H-188
(45' span steel I-beam bridge with concrete jack arch floor)

Item No. and unit used	Method and equipment used	Labor cost per unit	Material cost-unit	Wage
Rock excavation No. 3. Cu. yd. Hard shale.....	Steam shovel used for 60% of exc. Bal. by teams and sh scrapers.	\$1.53 per cu. yd.	\$0.20 per cu. yd. dynamite	\$0.45 per hr.
No. 2. Earth exc. cu. yd.....	Steam shovel, teams, wagons, and scrapers used.	\$0.38 per cu. yd.	\$0.45 per hr.
No. 21. 2nd class concrete, cu. yd.....	1 bag mixer, wheelbarrows, chutes, etc. 1/2 bag mixer used on footing	\$0.38 per cu. yd.	Gravel \$0.71 + F $\frac{1}{2}$ H Sand \$0.55 + F $\frac{1}{2}$ H	\$0.45 per hr.
Abutment concrete Forms for above item.....	Local labor used. Hemlock 1/2 in. matched. Whalers 2 ft. centers. Wired 3 ft. vertical	\$1.13 per cu. yd. \$0.13 per sq. ft.	Lumber, wire, nails \$0.77 per cu. yd. \$0.09 per sq. ft.	\$0.50
No. 16. 1st cl. concrete for structures	1 bag mixer used. Concrete wheeled into forms.	\$2.62 per cu. yd.	Sand \$0.42 per cu. yd. Stone \$0.42 per cu. yd. Total \$2.11 per cu. yd.	\$0.60
Floor concrete Forms for above item.....	Imported labor. 1/2 in. matched hemlock	\$2.84 per cu. yd.	Lumber, wire, nails \$5.13 per cu. yd. ^s	\$0.60
No. 32A. Bar reinforcement for structures, unit lb.....	Placed by bars, jacks, and staging.	\$0.021 per lb.	\$0.032 F.O.B.	\$0.60
No. 32B. Structural steel.....	Heated over open fire. Poured from pails and broomed.	\$0.32 per lb.	\$0.032 F.O.B.	\$0.60
No. 60A. Bit. waterproofing, sq. ft....	Poured from pails and broomed.	\$0.23 per sq. ft.		
No. 51D. Cement concrete pavt., cu. yd.	Poured with 1 bag mixer. Wheeled both ways.	\$3.60 per cu. yd.		

COST DATA ON BRIDGE I R.C. 1493 II-188—Continued

Item No. and unit used	Overhead included, equipment per unit	Supt.	Misc.	Total	Source
Rock excavation					
No. 3. Cu. yd. Hard shale	\$0.25 per cu. yd.	\$0.15 per cu. yd.	\$0.10 ¹	\$2.41	
No. 2. Earth exc., cu. yd.	\$0.20 per cu. yd.	\$0.54 per cu. yd.	\$0.20 ²	\$0.843	
No. 21. 2nd class concrete, cu. yd.	\$0.257 per yd.	\$0.025 per cu. yd.	\$4.28 ³	\$9.828	
Abutment concrete				\$1.92 cu. yd.	
Forms for above item				\$0.22 sq. ft.	
No. 16. 1st cl. concrete for structures	\$0.46 per cu. yd.	\$0.83	\$7.17 ⁴	\$7.97 cu. yd.	
Floor concrete					
Forms for above item					
No. 32A. Bar reinforcement for structures, unit lb.	\$0.0008 per lb.	\$0.004	\$0.068 per lb.	\$0.065 per lb.	
No. 32B. Structural steel	\$0.0008 per lb.		\$0.002 ⁶ per lb.	\$0.0378 plus freight	
No. 60A. Bit. waterproofing, sq. ft.					
No. 51D. Cement concrete pavt., cu yd.					

¹ Teams \$0.80 per hr. Shovel \$3.80 per hr. Dynamite \$17.50 per case.

² Trucks \$2.50 per hr. Teams \$0.80 per hr.

³ Includes freight, hauling material, rubbing wall. Cement factor 1.29.

⁴ Includes freight, hauling. Cement factor 1.77.

⁵ Includes arches. 20 gauge corrugated metal.

⁶ Hauling and freight on expansion plates.

Cement factor 2.13.

Cost Data Bridge Maintenance**Steel Bridges.**

Paint every 2 to 4 years depending on moisture and gas conditions.

Cost of painting (1923):

Labor \$2.50 per ton per coat.

Paint 80 cts. to \$1.30 per ton of steel per coat.

(See also p. 1235 for more detail data.)

Life of Steel Bridges.

Well maintained, 50 years or more.

Poorly maintained, 20 years or less.

Floors.

Life of plank 5 years average.

Life of concrete 8 to 15 years.

Life of bituminous concrete 8 to 15 years.

Reflooring Barge Canal Bridges (1925) Western New York

Lumber, \$60 per M ft. b.m.

Carpenter work, \$20 per M ft. b.m.

Total per M ft. new floor, \$80.

Floors last about 5 years.

NOTE.—Where floors are strengthened by adding extra timber stringers, caps and bracing, carpenter work will run from \$30 to \$40 per M ft. B.M.

Dismantling Old Steel Bridge Superstructures, \$10 per ton when sold as junk. \$35 per ton old pin connected trusses to be reerected.

Amount of Paint Required on Flat Surfaces

Large variations in amount due to porosity of surface kind of paint and expertness of painter. For average conditions 1 gallon of paint should cover approximately 200 sq. ft. with two coats of paint.

Pay-roll and Material Accounts

Page 1234 shows largest weekly pay rolls for 2 months' duration, plant values, and speeds of work for fourteen macadam roads in New York State built in 1914. At the present time these pay rolls would be two to three times as much and the equipment approximately as shown on pages 1261 to 1264.

From these data and others such as general contractors' association published data, it is reasonable to assume that a contractor has tied up, outside of money on plant and materials, from \$10,000 to \$25,000 for the full length of time the work is in progress and for short periods as high as \$30,000 to \$60,000 for the ordinary rural pavement job (5-mile length, 1926 cost conditions).

If cost of materials and freight increase, there may be the necessity of banking accommodations up to approximately \$100,000 for a short time on 5-mile concrete pavement jobs and up to \$80,000 on 5-mile macadam jobs.

(text continued on page 1238.)

NEW YORK STATE BARGE CANAL DIVISION 4

Painting bridges, season 1925 (force account) (highway bridges)
steel cleaned bare steel 1 coat of red lead 1 finish coat black paint

<i>Hulberton Lift Bridge</i> 191.					Poor condition
Labor.....	\$ 701 00				25% steel bare
Material.....	118 55				140 tons steel
				\$ 879.55	\$6.30 per ton
<i>Holley Lift Bridge</i> 187.					Bad condition
Labor.....	\$ 903.00				40% steel bare
Material.....	130.63			1033.63	214 tons steel
					\$10 per ton
<i>Middleport Lift Bridge</i> 216.					Bad condition
Labor.....	\$1846.00				60% steel bare
Material.....	255 86			2101.86	102 tons steel
					\$10 per ton
<i>Albion Lift Bridge</i> 199.					Bad condition
Labor.....	\$2,259 44				70% steel bare
Material.....	238 83			2498.27	110 tons steel
					\$22 per ton
<i>Albion Lift Bridge</i> 200.					Bad condition
Labor.....	\$ 903 00				40% steel bare
Material.....	205 45			1108.45	107 tons
					\$23 per ton
<i>Spier's Bridge</i> 170.					Fair condition
Labor.....	\$ 385.00				15% steel bare
Material.....	34.32			419.32	60 tons
					\$7 per ton
<i>Mitchell's Bridge</i> 136.					Bad condition
Labor.....	\$ 242.00				30% steel bare
Material.....	41.25			283.25	52 tons
					\$5.50 per ton
<i>Lyll Road Bridge</i> 166.					Bad condition
Labor.....	\$ 123.00				40% steel bare
Material.....	26.08			149.08	53 tons
					\$2.80 per ton
<i>Buffalo Road Bridge</i> 165.					Bad condition
Labor.....	\$ 383.00				50% steel bare
Material.....	29.22			412.22	58 tons
					\$7.10 per ton
<i>Clinton Ave. Bridge</i> 144.					Poor condition
Labor.....	\$ 584.00				25% steel bare
Material.....	137.24			721.24	75 tons
					\$9.60 per ton
<i>Winton Road Bridge</i> 143.					Poor condition
Labor.....	\$ 344.00				25% bare
Material.....	16 45			360.45	75 tons
					\$4.80 per ton
<i>Lee Road Bridge</i> 169					Bad condition
Labor.....	\$ 422.00				40% steel bare
Material.....	49.42			471.42	85 tons
					\$5.50 per ton

Cost left bridge averages
\$1500 per 1 bridge
\$10.00 per ton
Engineer's estimate \$7.00 per ton
with 1 finish coat
\$10.00 per ton with 2 finish coats

Cost fixed-truss bridges
\$770 per bridge
\$7.70 per ton
Engineer's estimate \$7.30 per ton
1 finish coat
\$10.50 per ton 2 finish coats

PAINTING BRIDGES

1233

<p><i>Pine Street Bridge, Lockport,</i> 232. Labor..... \$3051.50 Material..... 451.52</p>		<p>Bad condition 65% steel bare 400 tons \$8.80 per ton</p>
	3503.02	
<p><i>Lake Avenue Bridge, Lockport,</i> 228. Labor..... \$ 1161.00 Material.... 184.26</p>		<p>Poor condition 30% steel bare 80 tons \$16.70 per ton</p>
	1345.26	
<p><i>Brooks Avenue Bridge, 161.</i> Labor..... \$ 72.50</p>		<p>Fair condition 10% steel bare 100 tons 70 cts. per ton</p>
	72.50	
<p><i>Bushnells Basin Guard Gate.</i> Labor..... \$ 395.50 Material..... 117.64</p>		<p>Bad condition 50% steel bare 110 tons \$5 per ton</p>
	513.14	
<p><i>Cartersville Guard Gate.</i> Labor..... \$ 403.00 Material..... 83.55</p>		<p>Bad condition 50% steel bare 110 tons \$4.70 per ton</p>
	486.55	
<p><i>East Guard Lock.</i> Labor..... \$ 585.25 Material..... 157.67</p>		<p>Bad condition 50% bare 110 tons \$7.30 per ton</p>
	742.92	
<p><i>West Guard Lock.</i> Labor..... \$ 558.00 Material..... 169.87</p>		<p>Bad condition 50% bare 110 tons \$7.20 per ton</p>
	727.87	
<p><i>Spencerport Guard Gate.</i> Labor..... \$ 499.00 Material..... 56.91</p>		
	555.91	
<p><i>Holley Guard Gate.</i> Labor..... \$ 264.00 Material..... 65.16</p>		
	329.16	
<p><i>Gantry Crane, Pittsford.</i> Labor..... \$ 155.00 Material... 8.25</p>		
	163.25	
<p>Total amount labor and material</p>	<p><u>\$18,878.32</u></p>	

Guard gate averages
 \$5.50 per gate
 \$5.00 per ton
 Engineer's estimate \$7.00 per ton
 with 1 finish coat

COST DATA

TABLE 222.—SPEED OF WORK, VALUE OF PLANT, FORCE ACCOUNT. SUMMARY OF PLANTS AND FORCE ACCOUNTS

Road No.	Style of Road	Local or Imported Stone	Kind of Hauling	Weekly Force Account	Value of Plant	Speed of Work Miles per Month
1	16-ft. Bit. Mac.	Imported	Mechanical and teams	\$1,000	\$13,500	0.7
2	16 " " "	"	Mechanical	800	13,000	0.7
3	16 " " "	"	Teams	900	8,000	0.5
4	16 " " "	"	"	1,000	8,000	0.6
5	16 " " "	"	"	—	4,500	0.4
6	16 " " "	" top (local bot.)	"	1,900	14,500	1.3
7	16 " " "	Local	Teams and Mechanical	600	12,000	0.5
8	16 " " "	"	Teams	1,000	9,000	0.5
9	16 " " "	"	"	600	9,000	0.6
10	16 " Water Mac	"	"	1,600	10,000	1.2
11	16 " " "	"	"	1,000	10,500	0.8
12	16 " " "	Imported	"	1,000	6,000	0.7
13	14 " " "	"	"	1,200	12,600	0.7
14	16 Resurfacing	"	"	500	5,000	1.5

Labor, 16 to 20 cts. per hour. Average 17.5 cts. Teams, 40 to 50 cts. per hour. Average 45 cts.

Note.—To accompany text page 1231.

DIVISION 4.—BARGE CANAL STRUCTURES PAINTING SUMMARY
Recommended 1924 work. Force account work

Structure	Condi- tion	Total num- ber	Total tons	Estimate total cost	Estimate cost per ton	Labor and materials							
						Clean- ing		Red-lead coat on exposed metal		First finish coat, gray		Second finish coat, black	
						Labor, man- days	Paint, man- gallons	Labor, man- days	Paint, man- gallons	Labor, man- days	Paint, man- gallons	Labor, man- days	Paint, man- gallons
Fixed bridges....	Bad	24	1,600	\$10,000	\$11.80	750	410	400	750	640	690	480	
Fixed bridges....	Poor	13	850	8,000	9.40	250	140	140	390	330	360	250	
Lift bridges....	Bad	4	500	5,000	10.00	200	90	100	200	200	180	150	
Lift bridges....	Poor	3	450	4,000	9.00	100	50	50	180	180	160	130	
Guard gates....	Bad	8	900	9,000	10.00	320	200	200	400	300	330	270	
Totals.....	4,300	\$45,000	\$10.50 Av.	1,620	890	890	1,920	1,710	1,720	1,280	

REQUISITION SUMMARY—1924 WORK

Total labor..... 6200 man-days
Total red-lead paint..... 900 gal.
Total graphite paint (2 coats)..... 3000 gal

NOTE.—Cost estimate based on labor at \$6 per day.

Red-lead paint..... \$2.70 per gallon { 14 lb. red lead
Graphite bridge paint..... 2.00 per gallon { 9.7 gal. linseed oil.

Quantity estimate: 0.5 gal. red lead per ton actually painted.
0.4 gal. per ton first coat graphite paint.
0.3 gal. per ton second coat graphite paint.
2 to 3 tons painted or scraped per man-day.

DIVISION 4.—Continued
Recommended 1925 work. Force account work

Structure	Condition	Total number	Total tons	Estimate total cost	Estimate cost per ton
Fixed bridges.....	Fair	21	1,400	\$12,100	\$9
Lift bridges.....	Fair	1	100	900	9
Totals.....	22	1,500	\$13,000	

PAINTING BRIDGES

1237

DIVISION 4.—Continued

The following bridges (indicated by number) and guard gates are included in the painting estimate which accompanies. Structures marked "Bad" have 35 to 60% of steel surface exposed to weather and should be painted in 1924. Structures marked "Poor" have 20 to 35% of steel surface exposed to weather, and also should be painted in 1924 because their deterioration is manifestly progressive. Structures marked "Fair" have 0 to 20% of steel surface exposed and likewise should be painted but may go over until 1925.

Fixed bridges				Lift bridges			Guard gates
Bad 1924	Poor 1924	Fair 1925	Bad 1924	Poor 1924	Fair 1925	Bad 1924	
130	126	124	187	191	206	Cartersville	
131	129	127	199	203		Bushnell's Basin	
133	143	141	200	211		South Greece	
134	144	142	216			West River	
136	185	159				East River	
137	186	161				Middleport	
138	189	163				Medina	
140	198	170				Albion	
165	217	172					
166	219	173					
169	224	183					
171	226	193					
175	228	196					
176		197					
177		201					
179		202					
180		205					
184		209					
212		218					
213		223					
214		225					
215							
220							
221							

For the purposes of engineering estimates of cost, interest on banking accommodations can be figured for the prevailing interest rate for this kind of accommodation on the basis of \$50,000 for 6 months for 18' width of concrete pavement jobs 5 miles long and \$40,000 for 18' width of macadams, pavement 5 miles long which amounts to approximately \$300 to \$400 per mile for interest on pay roll, freight, and materials.

Bonds and Liability Insurance.—There is considerable fluctuation in the rates for these items of cost, and the engineer should use the prevailing rates for his territory and class of work being done. The different types of bond and liability insurance are described briefly. The prevailing rates for rural pavement work in New York in 1926 are as follows:

Performance bond	0.5% to 2.0% of contract price
Compensation-insurance (labor)	4 to 5% of pay roll
Public liability	1%± of pay roll
Automobile liability on trucks	\$40 per Ford truck per year

The cost estimates in this chapter are based on allowing 10% of pay-roll cost for bonds, insurance, etc.

BONDS

Bonds are divided into three general classes: fidelity, judicial and surety.

A fidelity bond guarantees the honesty of persons.

A judicial bond guarantees the honesty and performance of legal obligations.

A surety bond guarantees the performance of an agreement or contract.

Each of the above divisions covers a number of subdivisions and classifications.

If all highway work, either construction or maintenance, touched upon from other viewpoints in this book, were performed by contract, there would be no need of mentioning any form of bond but the surety, but because in the past few years certain political subdivisions, such as counties and towns, have developed their own construction and maintenance forces, thereby performing the work directly and under the supervision of elected or appointed officers, a short description of all types of bonds with their approximate costs is included.

Fidelity Bonds

Fidelity. Individuals.—This type of bond covers the executive officers of corporations, assistant executive officers, managers and superintendent of stores, buildings and industrial operations, bookkeepers, cashiers, clerks, salesmen, officers and members of organizations, associations (fraternal, beneficial, labor, etc.), building loan associations, cooperative companies.

Schedule.—Where six or more persons are to be covered, and where the surety amounts to \$20,000 or over, a schedule bond may be issued. This form may be used in connection with banks,

large mercantile establishments, industrial operations, associations of all kinds (fraternal, beneficial, or otherwise). Special rates cover each classification.

Position Form.—This bond is a form that covers the position and does not name the person.

Bankers' Blanket.—This is a special form for banks, investment houses, stock brokers, etc. and is issued in lump sum. It protects the bank not only from dishonesty but from other hazards such as holdup, robbery, burglary, mysterious disappearance, etc. The rates are based upon the amount of insurance, number of employees, form of bond etc., and the cost of such a bond is purely individual and based on all circumstances connected with its issue.

Judicial Bonds

All court bonds such as administrators, guardians, committees, receivers in bankruptcy, trustees and also release of attachment, replevin, stay of execution or any bond given to court to guarantee payment before undertaking penalty or obligation in connection with court action, indemnity to sheriff, or other public officers.

Surety Bonds

Construction, supply, maintenance, proposal or bid bonds, etc.

Miscellaneous Bonds

Freight charges, indemnity bonds, lease bonds, lien bonds, replacement bonds, lost securities, etc.

Depository Bonds

Banks, government, state, county, city, and other municipalities.

License Bonds

Government, state, city, town, and village. Bonds required by various cities, towns, and villages for use of streets, construction of vaults, employment agencies, detective agencies, explosives, gasoline tanks, boxing clubs, etc.

Federal Bonds

Various forms required by the United States Government such as prohibition, use of intoxicating liquors, manufacturing of non-alcoholic beverages, warehouse bonds, custom house bonds covering foreign shipments, immigrant bonds, etc.

Except for surety bonds covering construction contracts in Class *A* and Class *B* hereinafter defined in New York State and also for New York City, the other types of bonds mentioned above are subject to a considerable variation in cost, and therefore general statements as to rates and premiums are confined to the surety bonds to Class *A* and Class *B* types, commonly known as contract bonds and defined as follows.

Contract Bond Rates.—Contract bonds may be divided into general classes of construction *A* and *B*; supply; proposal; maintenance; construction and maintenance; supply and maintenance; paving; bridge building; dredging; indemnity bonds; lease bonds;

lien bonds; replacement bonds; city contract bonds; timber cutting bonds; U. S. Mail bonds; printing and engraving bonds.

Construction Class *A* covers all contracts wherein the material, machinery, or device is to be installed, and the work on the premises covers merely the installation of the plant or machinery, such as automatic telephone exchange equipment, coal storage and coal handling machinery, furnishing and installing building elevators, machinery made to special order or design; refrigeration plants on land; signal towers on railroads, standpipes and water towers; quarrying and furnishing of stone for buildings, breakwaters, etc. or for the incorporation of stone in buildings.

The rate for Class *A* construction contracts as above outlined, covering all public contracts in New York City which may be let by all departments of the state government including the state architect, the department of public works, the conservation commission, the various state park commissions and to include public work for counties, cities, towns, villages, school districts and boards of education where the form of contract and bond does *not* make the surety liable to a direct action for the contractor's indebtedness for labor and material is one-half of 1% per annum on the contract price.

Construction Class *B* covers general contracts such as filtration plants; buildings; dams; water works; sewage-disposal plants; barge canals; breakwaters; foundations; locks; masonry; piers; highway construction, etc.

The rate for Class *B* construction contracts as above outlined for above contracts under the supervision of the same political and departmental subdivisions given above is 1% of the contract price for any period up to 24 months. Annual renewal thereafter is one-half of 1% of the contract price.

As an exception to above, the New York State architect's form of bond takes a rate of \$20 per thousand on amount of contract for term of 2 years which includes 1 year's maintenance. Renewal premium at the rate of \$10 per thousand per annum.

New York State Barge Canal contracts take a rate of \$15 per thousand on the amount of contract for term of 2 years. The labor bond is included without extra charge.

Paving contracts for incorporated villages and cities take a rate of \$10 per thousand per annum on the amount of contract.

Maintenance on same is \$2 per thousand per annum on the value of work guaranteed.

In New York City contracts, all departments of the New York City government including all boroughs, boards, and commissions, except the Board of Transportation, take the following rates: Construction contracts Class *A* one-half of 1% per annum on the contract price. Construction contracts Class *B* 1% of the contract price for any period up to 24 months, and annual renewal thereafter one-half of 1% of the contract price.

Bridge contracts take the same rate as Class *B* construction, but separate contracts for steel and iron tonnage only, for reflooring and repairing superstructure only, and for including assembly or erection take the rate of \$7.50 per thousand on contract price.

Separate contracts for furnishing and delivering metal superstructure only, without assembly or erection, are at the rate of \$2.50 per thousand on contract price.

Dredging contracts, for river and harbor work for the United States Government, tidewater dredging, and dredging on the Great Lakes carry a flat premium of \$7.50 per thousand on amount of contract.

Drainage ditches and all inland dredging or ditching done with a floating or power dredge carry a flat premium of $1\frac{1}{2}\%$ on the contract price.

In bid or proposal bonds, the rate for construction contracts not exceeding \$2500 is 20 cts. per hundred on price bid; minimum premium \$1. For construction contracts of \$2500 or more, rate of bid or proposal bond is \$5 each.

Where no corporate surety bond has been required for either supply or construction contract, maintenance bonds covering material already supplied or work already completed carry a rate of three-fourths of 1% per annum for the amount of penalty on bond. Minimum premium is \$7.50 for term.

The regular construction rate is charged for performance and maintenance. Rate begins immediately upon completion.

Indemnity Bonds

For bonds to indemnify public officials for payment of retaining percentages on completed construction work, where payment is otherwise delayed, the rate is 1% on amount of bond for its full term.

Lien Bonds

Separate bond not guaranteeing completion but guaranteeing owner, lender, mortgagee, or lessee against any liens being filed on building or improvement, where bond is given before the commencement of construction or improvement, or near the commencement of such work, and where at the date of bond no liens have been filed, carry a rate of \$10 per thousand on amount of bond for its term.

Where bond is given at or after completion of work, or when work is so advanced that only final payment remains to be paid and at date of bond no liens have been filed, the rate is \$5 per thousand on amount of bond.

Bonds given to release mechanics or material men's liens, lien of judgment, or any other liens which have been filed against building or other improvement are classified as court bonds, and the rate is \$10 per thousand per annum on amount of bond.

SIDEWALK BONDS

Classified as Construction

Sidewalk bonds are for performance of contract, either to municipality or private parties. The rates are as follows:

Performance \$7.50 per thousand on contract price.

Maintenance 1.50 per thousand on contract price per annum.

One year maintenance only, no charge.

Over 1 year maintenance, premium covers every year of maintenance including the first year.

WORKMEN'S COMPENSATION INSURANCE

Coverage.—Workmen's Compensation Insurance covers the obligation imposed by law upon the employer for compensation or damages for personal injuries to an employee arising out of and in the course of his employment; also the obligation assumed by an employer to pay to injured employees or their dependents the benefits provided under the Workmen's Compensation Law.

The Workmen's Compensation policy also covers liability imposed upon an employer for injuries sustained by employees by reason of the negligence of the employer when such injuries are not compensatory under any workmen's compensation law. This also includes payment of medical, doctor, and hospital bills.

Rates.—Rates for different classes of operation may be found in the Workmen's Compensation manual, which gives a complete general classification of all labor. Each class has a different rate per hundred of pay roll, and a policy covering such insurance is issued for 1 year. Pay rolls are submitted to the insurance Company's auditor, classification talked over with the contractor, and the rates for each applied, and the premium is based upon the entire pay roll.

PUBLIC LIABILITY INSURANCE

Coverage.—This form of insurance provides indemnity for the assured, against loss by reason of his legal liability to persons, other than employees, on account of construction operations performed by independent contractors or subcontractors for the owner or contractor. Employees are protected under Workmen's Compensation Insurance.

This insurance is ordinarily written at a \$5000 limit for one person and \$10,000 for more than one person. If protection is desired for an additional number of persons, the rates increase by a sliding percentage scale.

The minimum premium for a contractor's protective public liability insurance policy is \$20 per year.

Rates.—In contractors' protective or contingent public liability insurance, the rates are based on a total cost of all work let or sublet in connection with each specific contract including costs of all labor, materials and equipment furnished, used, or delivered for use in the execution of such work, whether furnished by the owner, contractor, or subcontractor, as well as allowances, bonuses or commissions, made, paid, or due, at the following rates:

Total cost up to and including \$500,000, 10 cts. per hundred.

Total cost \$500,001 up to and including \$1,000,000, 6 cts. per hundred.

Total cost in excess of \$1,000,000, 4 cts. per hundred.

HIGHWAY EQUIPMENT¹

General Introduction.—Just by way of contrasting a 1926 plant, the writer wishes to enumerate the equipment used on the first contract with which he was connected during the summer of 1900.

This particular piece of highway improvement was a water-bound macadam, 16' wide 6" thick, built in two courses of 3" each in depth after consolidation. It included practically all of the preliminary work which has to be done on a present-day contract. The alignment was stacked out to tangents and regular curves as in present-day methods, except that curves were not banked, the ditches were dug to line a grade, the drainage structure placed as called for by the plans and, in short, except for the equipment used and the thickness and depth of road metal, there was no difference between present-day construction, except in the amount of mechanical equipment.

The list is given herewith:

1 steam roller at an approximate cost of.....	\$2500.00
1 horse-drawn water tank for roller.....	150.00
10 doz. picks.....	120.00
10 doz. shovels.....	120.00
1 doz. sledges.....	15.00
2 knapping hammers.....	2 00
2 doz. iron pins for grade lines.....	2.50
2 600-gal. sprinkling wagons at \$300 each.....	600.00

The above equipment plus the necessary pails, trowels, grading string, and small incidentals were the only preliminary investments which the contractor had to make inasmuch as the commissary houses were built and paid for by the padrone who furnished the labor.

Labor was cheap and plentiful. As the author remembers it, the wages paid ran from 13½ cts. per hour for common labor to 30 cts. per hour to foremen. Carpenters were paid about 25 cts. per hour and inasmuch as teams could be hired at 35 cts. per hour including the driver, and flat dump wagons furnished by the owner, the contractor had no hauling equipment to buy.

It is not to be wondered at that, with so small an initial investment and with labor so cheap, the use of machinery to reduce costs was considered highly theoretical and scarcely to the liking of experienced contractors.

The excavation of cuts and the placing of the material in fills with a three-haul limit of 2000' was done slowly and methodically by hand shovels, the dumped material spread with either shovels or rakes into 6" layers. There was not even a slip scraper, wheeled scraper, or a road machine utilized on the entire 4-mile contract.

The first break away from these old-fashioned ideas, within the writer's experience which was largely confined to western New

¹ E. A. Bonney has supplied the general discussion of this item and the detailed description of the common units of equipment. W. G. Harger has compiled the rental schedules and the approximate overhead equipment charges for unit price estimates.

York, came in 1910 in the substitution of bottom dump wagons for flat wagons, and he well remembers the stock arguments which contractors and owners of teams would give the salesmen for dump wagons; that the team was too far from the load that they drew, that the horses could not stand the extra strain, that the team would be thrown by the sudden dropping of the load, etc.

It was not until the war conditions of 1916 to 1921, when labor was scarce, ineffective, and highly paid, that serious consideration was given to the creation of portable mechanical units to take the place of hand labor. Steam shovels had been used for years on heavy work but were generally mounted on railroad wheels and built in sizes which precluded their passage over highway bridges of ordinary strength.

The development of the gas engine, both for motor trucks and in an industrial way for power units, kept pace with the scarcity of labor; and within the last 10 years the development of mechanical equipment has been so rapid that present-day contracts are carried on with a much smaller labor cost than ever before.

A list is herewith given of equipment which can be considered as entirely normal to any modern contractor building a road several miles long under present-day methods.

1 10-ton three-wheeled motor roller with scarifier, approximate cost.....	\$ 5,500
1 5-ton three-wheeled motor roller with planer and scarifier, approximate cost.....	2,500
1 motor-driven concrete mixer, caterpillar tread.....	7,500
1 motor-driven shovel, $\frac{3}{4}$ -yd. bucket.....	12,000
8 2-yd. motor trucks with dump bodies at \$3000 each...	24,000
2 miles of 2" water pipe with necessary unions, tees, and valves at 20 cts. per foot.....	2,000
1 motor-driven crane for unloading and storing materials	4,500
3000 lin. ft. of steel interlocking forms at 80 cts. per foot	2,400
1 motor grader.....	2,400
1 high-pressure water pump with gasoline engine.....	1,200
Necessary small tools, hammers, shovels, rakes etc....

If the contract in question is to be constructed from local stone, the items in the above plant would be reduced by eliminating the loading crane, but increased by the addition of a crusher, elevator, screen, and bins. In all probability an additional elevator and screen would be needed for the sand bank, with power to drive both units. It is obvious that with a reduction of 50% in the labor charge, an increase of several hundred per cent has occurred in the quantity of equipment needed.

In the modern method of handling highway work, however, there are additional viewpoints which must be considered and which are made possible by the use of equipment. The present-day contractor wishes to average 2½ to 3 miles of road per month, whereas the old-time contractors, even the best of them, were satisfied with 6 or 7 miles per season. The traveling public

demands speed, and without mechanical equipment this speed could not be accomplished. It not only hastens the delivery and placing of materials, but in these very acts a modern plant functioning properly seems to speed up and maintain at a higher average the remaining labor element.

As an example, take the item of earth excavation. Present-day practice puts a steam or gas shovel through all cuts from 18" up, the shovel feeding the motor trucks on which within the last 2 years the use of pneumatic tires is rapidly increasing. The dumping for the fill is taken at the point nearest the shovel so that the loaded trucks are running over the new fill as the work progresses, giving a consolidation which cannot be equaled by any roller. The dump bodies are designed to spread the load as the truck moves forward, thus eliminating almost entirely the necessity for labor on the fill. A motor grader, either on rubber tires or with a crawler tread, works continuously on the new grade as it is built up or cut down. The 10-ton gasoline-driven roller is put into operation within 2 or 3 min and follows the rough grading operation of the trucks and motor grader for the proper consolidation. When the rough grading is complete, the heavier roller is laid aside and the fine grade largely finished with the use of a motor grader or a 5-ton gasoline-driven roller equipped with a planer and scarifier.

When sufficient fine grading has been performed and the concrete pavement started, partitions are installed in the dump trucks so that measured batches of stone and sand can be dumped directly into the hopper of the mixer. Portable turntables are provided so that the trucks will not have to turn around a long distance from the mixer and back up to it; the cement can be loaded directly to the mixer. The surface of the concrete pavement is oftentimes finished by mechanical and power-driven screeds. Water is provided at the mixer by a high-pressure pump and pipe line, and the work progresses at an average speed which was not even thought of 10 years ago.

If the pavement has been covered with a coating of earth for protection and curing, this is later removed without hand labor by the use of a power grader or a light road machine drawn by a small tractor. In many instances the shoulders are built in the same manner and rolled with the small 5-ton roller.

The present-day methods practically exclude hand labor except on the fine grade, the placing of forms, the distribution of concrete at the mixer, and the covering of the finished concrete after the initial set together with the installation of culverts and the erection of guard rails and signs.

This tendency toward the use of equipment in a much larger way than in the earlier days has proved its value to the public who use and pay for the highways and to that percentage of the contracting fraternity who have proved its value to themselves. This same percentage of contractors who have brought the use of mechanical means to its present-day development are of the type of men who would have succeeded to approximately the same degree of success in any other line which they might have elected to make a life work.

In other words the building of highways by contract has become a specialty business, and the contrast between the fit and the unfit is even more plainly marked than similar contrasts in medicine, law, and general business. The requirements of present-day contracts should and do exclude the men working with little or no capital, the inexperienced and the proven failure. The initial investment is such that a man without capital never has an even chance, except under very unusual circumstances. He cannot obtain a contract award and buy the necessary equipment from the earnings of the job as he could years ago. He should be fitted with tools at the start which will allow him to perform the work at item prices as cheaply as his neighbor and competitor. It is perfectly obvious that the plant investment outlined above, properly to equip a road contract on which the contract price may be \$250,000, is all out of proportion to the cost of plant needed for the erection of a \$250,000 reinforced-concrete building or the laying of a \$250,000 concrete-pipe sewer. We have heard this complaint more than once, but it really has no bearing on the situation. The work is there to be done and it should be done in the cheapest known way. We do not state that it is up to a contractor to buy all of the equipment mentioned; we simply say that he needs it. If he can rent any or all of the equipment at a price which will be cheaper for him at the end of his fiscal year or at the end of the contract than the outright purchase would be, and said outright purchase price to include depreciation and interest on investment, then let him rent what he needs and be rid of it at the end of his contract. This is a question where business training and experience enter. We have known contractors who by disregarding the initial investment could show a good profit upon their work but went broke at the end of 2 or 3 years simply because of depreciation of plant and continued interest charges on their plant investment. In other words their jobs were overplanted. In closing these general remarks and before going further into itemized descriptions on costs and types of plant, we would like to remark that it takes a brilliant mind in addition to all other human contracting qualities to enable a man or a corporation actively following highway contracting to produce in the 6 or 8 months of good working weather what the same type of man in another line of work would be content to accumulate in a business year of 12 months.

Rollers.—For many years the steam roller was the standard self-propelled machine common to all highway work, and at first its purpose was simply compression of finished subgrade and the rolling of macadam. About 10 years ago, a pressure scarifier, to be attached to the rear of the machine for the purpose of tearing up the roadbed, was perfected, and since that time the greater per cent of rollers have been scarifier equipped. The steam roller is gradually being retired in favor of the motor roller whose advantages are obvious, namely, elimination of hauling of coal and water and saving of time in stopping and starting the machine morning and night. A steam roller needs from 40 min. to an hour's work before sufficient steam pressure can be obtained to run and the fire has to be drawn or hanked at night.

The motor roller carries sufficient gasoline to operate for a day and a half and water for cooling purposes for a week's operation; it can be started within a very few minutes, and when it stops, the expense ceases.

The so-called 10-ton three-wheeled motor rollers without scarifier cost approximately \$4350 delivered, and with scarifier \$5500. The machines are made in single-cylinder, double-cylinder, and four-cylinder motors. The heavy-duty single-cylinder and double-cylinder machines will probably last longer, as far as the motor is concerned, than the four-cylinder units; the motor speed is much less with the resulting longer life. There is however, more vibration in the slow-moving engine. One of the reasons for the rapid growth in the past few years in the use of four-cylinder machines is that the four-cylinder motor is better known to users of other motor equipment. More mechanics are familiar with the four-cylinder motor, as the construction of these motors is practically standard.

The use of a three-wheeled motor roller lighter than the 10-ton size is somewhat of an innovation, but has been adopted by a large number of states as standard specification for completion of subgrade. The machine is so much smaller than the 10-ton size that its advantages in using between the forms ahead of the concrete mixer are self-evident. Its use has been increased to a large extent by the addition of a planer blade on the front and a small scarifier on the rear, either and both of which are of great help in the final trimming up of subgrade just ahead of the laying of concrete.

A 5-ton three-wheeled motor roller with planer and scarifier costs approximately \$2500 delivered.

Concrete Mixers.—The tendency of the past few years has been toward larger and more powerful mixers; a gasoline machine of crawler type, six-bag capacity, is the machine most popular with the present-day contractors. On the present models the stone, sand, and cement are generally dumped direct from the truck into a loading skip. As the skip is raised, water is automatically discharged into the mixing drum, the amount of water to be varied to use the material. The machines are steered by power operated by one man. The engine is generally a four-cylinder gasoline motor, radiator cooled; all gears are enclosed; it is equipped with roller bearings and lubricated in the automatic way in general use on automobile trucks. The price of a machine of this size is \$7700 delivered.

Steam or Motor Shovels.—A few years ago before the rapid development of the gasoline motor, the use of a power shovel by highway contractors was not considered unless the excavation quantities ran above 8000 to 10,000 cubic yards per mile of highway. At that time it was thought that a face of 4 or 5' in any given cut was needed for the economical use of a power shovel, and with the old system of hauling material away from the shovel by means of horses and wagons, the contractors were probably correct in their contention. The development of the high-speed smaller truck with pneumatic tires with a capacity of from 2 to 2½ yd. has changed the situation to such an extent that power shovels are

now used on any type of excavation where the cut will average 8". There never has been any difficulty with getting a power shovel to dig, the main difficulty being getting the material away from the machine. The use of the fast-moving light trucks has solved the problem, and the further development of the shovels themselves by equipping with gasoline motors has brought about a tremendous impetus in the use of this type machine.

The shovels are generally equipped with crawler treads, which eliminate the necessity for planking ahead of the wheels and enable them to work on soft ground. The size bucket varies from $\frac{1}{2}$ to $\frac{7}{8}$ yd.

The price of a gasoline shovel of this capacity equipped with crawler treads is approximately \$12,000 delivered, steam shovels running about two-thirds as much.

Motor Trucks.—Except where their use is confined to city pavements, the 5-ton truck and larger sizes are being superseded to a large extent by the smaller, quicker, and less costly units of 2 to $2\frac{1}{2}$ tons. The latter trucks have the same equipment as to automatic dump bodies as the heavier machines, but where they are used for concrete operations, they handle only two batches instead of five or more. They are generally equipped with pneumatic tires and are capable of speeds of 25 to 30 miles per hour. They are more easily handled on turntables, do not cut up the subgrade as much as the large trucks, and in general are easier to operate and to keep in running condition. The pneumatic tires save repair bills on both the motor and hoisting apparatus. The bodies are made in a large number of types but generally are rear dump. A fair average cost for trucks of this kind is \$3,000 delivered.

Crane.—The use of a portable crane is one of the recent developments brought about by the necessity for transfer of materials for short distances, such as unloading from storage cars to storage piles, and reloading from storage piles to trucks or measuring bins. No contractor at the present time wishes to depend upon daily shipments of stone and sand. He needs a storage pile of each as a factor of safety against the possibility of non-delivery by the railroad, and while this means an extra handling of the material, the cost is saved by the guarantee of no interruptions.

One of the most elastic units is shown herewith in the crane mounted on a chassis of a 5-ton truck. The crane itself is driven by a separate engine, the truck motor furnishing only the power for traveling. The machine can be utilized in many other ways, namely, the pulling of stumps, the handling of heavy timbers, unloading and laying cast-iron pipe, digging trenches for culverts, etc. The price of the crane complete with all attachments ready for mounting on the chassis of the truck is approximately \$4650 delivered.

Graders.—The item of earth excavation in highway contracts is one that for many years has been a source of trouble and loss to the contractor rather than showing a possibility of profit. Of course, where the excavation ran sufficiently high so that most of the material could be handled with power shovels and taken away by motor trucks, there was less complaint, but on a lighter excava-

tion running 3000 or 4000 yds. per mile, the work if done by hand was almost certain to be a losing item.

The development of the motor grader has done much to change these conditions. The machine weighs from 6000 to 12,000 lb. according to size and power; for construction on rough ground it is equipped with crawler treads; and it is used continuously in leveling the newly dumped material or in combination with a scarifier handles light excavating work. Except in the case of the elevating grader, it is not intended to pick up the material but rather to push it ahead or to one side, and there are cases where because the excavation in general average thickness was too small for economical use of a power shovel, a motor grader was used to windrow the excavated material so that the power shovel could pick it up more easily.

Motor graders with rubber-tired equipment run from \$1800 to \$3300 according to power plant and weight. In the crawler type they run from \$2100 up to \$4300. The choice of machine depends entirely on the amount and character of work to be done.

For maintenance work the rubber-tired equipment works to advantage. It can travel faster than the crawler tread, but of course its use is pretty well restricted to shoulder work on hard-surface roads before scarifying and reshaping on gravel roads. No wheeled machine will work satisfactory in sand and it will bury itself by its own tractive efforts in mud.

Road Graders.—A type of machine seldom seen in the eastern part of this country, which, however, has widespread use in the middle and far west, is the elevating grader. The chief reason for its scarcity in the eastern territory is the lack of sufficient width of the highways for economical handling of the machine. It consists of a plow, either of the moldboard or disc type, and the act of cutting a furrow throws the material on a moving belt which casts it to one side, either directly into an embankment or into trucks, wagons, or cars. The machine travels ordinarily at the rate of $1\frac{1}{2}$ miles per hour, and figuring from the length, width, and depth of the furrow, theoretically the machine will deliver approximately 1500 cu. yd. of earth in a 10-hr. day.

Of course not all theories measure up in actual work performed, but bonafide estimates and reports from contractors using the machine show an average of 1000 cu. yd. per day in material which can be easily plowed. The elevating grader will do this work from one-fourth to one-third cheaper than the cost of other methods.

Blade Graders.—These machines are intended to supplement the use of elevating graders, steam shovels, and all other means of handling earth, by cutting off the high spots in the grade and pushing the material either forward or to one side into low spots. That is a condensed statement of the work which graders perform. It is true that they are utilized particularly with a back sloper attachment for digging ditches, but the main work of the grader will always be the reshaping of subgrade, either in cut or fill.

The graders run through all weights from 1000 to 11,000 lb., pulled by one team or a 10-ton tractor as limits. They run in

price from \$150 to \$2500 according to equipment. More modern machines have leaning wheels, Timken roller bearings, and sometimes attached scarifiers. When used for maintenance work, they are often equipped with rubber tires.

Water Pumps.—There is no single unit in the contractors' plant on the construction of concrete roads which is more worthy of quality in choice and performance than the pump. This point has been emphasized to such an extent as to have two pumps on the job, one to cut in as an extra in case anything should happen to the one in use. If the water stops, the concrete stops, and the whole job is disorganized. (a) Duplex pump and engine mounted on one truck with a capacity of 40 gal. per minute, 175 pounds pressure, maximum head 407 feet, costs approximately \$620.00; a single unit with a capacity of 80 gallons per minute, working under a pressure of 500 pounds maximum head of 1125 feet, would cost \$1630.00. Both prices f.o.b. destination.

The above-listed equipment covers what might be called the average list of units which the highway contractor needs continuously. There are a large number of special tools which he needs only occasionally, and it is not necessary in a book of this kind to go into specialized equipment such as air compressors, pile drivers, pavement-cutting tools, etc. When a unit of this kind is needed, the contractor generally figures it for one job only and charges the entire cost and depreciation for the one job which it is to perform. This procedure puts this type of equipment in a different classification from the list given above, which can be utilized on practically every job at sometime or other.

WATER SUPPLY DATA FOR CONCRETE PAVING*

The State Highway Department of Pennsylvania has compiled the following information for use in determining the sizes of pipe line to be used for the water supply on concrete paving projects. The information is based upon 50% of the water being required for curing and 50% being required for the mixer and sub-grade curing. The department states that if calcium chloride is used for curing the amount of water required for the lengths paved per hour can be reduced one-half.

The tables given under the sizes of pipe lines are figured without modifications for head, and the table at the bottom of the tabulation gives the information for the correction for the head.

The tables are based on a requirement of 3000 gal. of water for 100 ft. of paving apportioned as follows: $\frac{1}{2}$ for curing, $\frac{1}{4}$ for sub-grade, $\frac{1}{4}$ for mixer. The pavement is assumed to be 18 ft. wide. The head given is based on friction loss only. To this must be added the height of the outlet of the pipe above the source of supply.

* Roads and streets, May, 1927.

EQUIPMENT

1251

WATER SUPPLY DATA

Loss of head due to friction in steel pipes for water used in paving

Length paved per hr. ft.	Gal. water required per hr.	V feet per sec.	Length of pipe					
			$\frac{1}{4}$ mi.	1 mi.	$1\frac{1}{2}$ mi.	2 mi.	$2\frac{1}{2}$ mi.	3 mi.
2-inch pipe								
...	2000	3 188	79	158	237	316	395	474
...	2400	3 825	111	222	333	444	556	667
...	2800	4 463	148	296	445	593	741	880
...	3200	5 100	190	381	571	761	952	1142
...	3600	5 738	237	474	711	948	1186	1423
50	4000	6 37	288	577	866	1155	1444	1732
60	4800	7 65	406	812	1218	1624	2030	2436
70	5600	8 92	542	1083	1625	2167	2798	3250
80	6400	10 20	695	1391	2086	2781	3477	4172
90	7200	11 47	867	1733	2600	3466	4333	5200
100	8000	12 75	1055	2111	3166	4221	5277	6332
$2\frac{1}{2}$ -inch pipe								
...	2000	2 233	33	65	98	130	163	195
...	2400	2 679	46	91	137	183	229	274
...	2800	3 126	61	122	183	244	305	366
...	3200	3 572	78	157	235	313	392	470
...	3600	4 019	98	195	293	390	488	586
50	4000	4 47	119	238	357	476	595	714
60	4800	5 36	167	335	502	669	836	1004
70	5600	6 25	223	446	669	893	1116	1339
80	6400	7 15	286	573	850	1146	1432	1719
90	7200	8 04	357	714	1071	1428	1785	2142
100	8000	8 93	435	870	1304	1739	2174	2609
3-inch pipe								
...	2000	1 448	11	22	33	44	55	66
...	2400	1 737	16	31	47	62	78	93
...	2800	2 027	21	41	62	83	104	124
...	3200	2 316	27	53	80	106	133	159
...	3600	2 606	33	66	99	132	166	199
50	4000	2 89	40	80	121	161	201	241
60	4800	3 47	57	113	170	226	283	339
70	5600	4 05	75	151	226	302	377	453
80	6400	4 63	97	194	291	388	485	581
90	7200	5 21	121	242	362	483	604	725
100	8000	5 79	147	294	441	588	736	882
Head, ft.	Pressure per sq. in.	Head, ft.	Pressure per sq. in.	Pressure per sq. in.	Head, ft.	Pressure per sq. in.	Head, ft.	
10	4	200	87	4	0 2	50	115	
20	9	300	110	5	11 5	60	138	
30	13	400	174	6	13 8	70	161	
40	17	500	217	7	16 1	80	184	
50	22	600	260	8	18 4	90	207	
60	26	700	304	9	20 7	100	230	
70	30	800	347	10	23	200	461	
80	35	900	391	20	46	300	691	
90	39	1000	434	30	69	400	922	
100	43	2000	868	40	92	500	1152	

The formula used is the Hazen-Williams Formula:

$$H = K \frac{lv^{1.87}}{d^{4.75}} \text{ in which}$$

H = loss of head due to friction

K = .00038

l = length of pipe in feet

v = velocity of water in feet per second

d = diameter of pipe in feet

A 2-in. pipe = 2.067 internal diameter.

A 2½-in. pipe = 2.469 internal diameter.

A 3-in. pipe = 3.068 internal diameter.

How the Tables Are Used.—Example (1):

Estimated progress of paving 70 ft. per hour. Water required—5600 gal. per hour.

Maximum water pressure in pump—150 lbs. per square inch.

Pipe 2-in. diameter, pump 12 ft. above level of supply. Outlet 40 ft. above pump.

How far from the pump can the work be supplied?

150 lb. pressure = 345 ft. head as per conversion table 345 - 12 - 40 = 293 ft. net head.

The head required for 1 mile of pipe is 1083 ft. Distance water

can be supplied = $\frac{293}{1083} = \frac{1}{4}$ mile.

Example (2):

Estimated progress of paving—70 ft. per hour.

Maximum water pressure in pump—500 lb. per sq. in.

Maximum distance water must be forced = 2½ miles.

What size pipe is required?

500 lb. = total water pressure available, which corresponds to 1152 ft. head.

2-in. pipe under these conditions requires 2706 ft. head or 1175 lb pressure and is too small.

2½-in. pipe is necessary and requires 1116 ft. head; which corresponds to 484 lb. pressure.

A 3-inch pipe requires 337 ft. head which corresponds to 163 lb. pump pressure.

Example (3):

Estimated progress per hour = 90 ft.

Distance water must be forced = 2½ miles. What horsepower and pressure are required?

2-in. pipe requires 4333 ft. head by table or 1880 lb. pressure.

Water required = 7200 gal. per hr. = 2 gal. per sec. = 16.7 lb. per sec.

16.7 by 4333 = 72,360 ft. lb. per sec. ÷ 550 = 132 horsepower.

2½-in. pipe would require 1785 ft. head by table or 775 lb. pressure.

16.7 by 1785 ÷ 550 = 54 horsepower.

3-in. pipe would require 604 ft. head by table or 250 lb. pressure.

16.7 by 604 ÷ 550 = 18 horsepower.

RENTAL SCHEDULE FOR ESTIMATING CONSTRUCTION EQUIPMENT EXPENSE¹

A schedule, evolved from the records and experiences of contractors, manufacturers, and rebuilders of equipment, and designed to furnish contractors with a practical means for estimating equipment expense and determining adequate rental charges has been approved by the Executive Board of the Associated General Contractors. The schedule, which was prepared by the Research Division under the direction of the Committee of Methods of the Association, is printed in the November *Bulletin* of the Associated General Contractors. The schedule and discussion of its application follow.

To use the schedule with safety, it is essential to understand how the amounts were obtained, how they are to be applied, and how they are limited for determining rental charges. Knowing these things, no great difficulty should be found in establishing the charges within the bounds of practical accuracy.

For the reason that arithmetical averages, as obtained from available records, gave few rational values for depreciation and repairs, such averages were given less weight in establishing the tabular amounts than the practical experience of contractors. In fact, the strongest evidence that these amounts are reasonably safe and accurate lies in the endorsement given them by experienced general contractors.

A tentative draft of the schedule was submitted to members in the *Weekly Bulletin* of July 31. They were asked to criticize the amounts and offer suggestions. In accordance with the criticism received, which evinced considerable study upon the subject, some of the tabular amounts were changed. As it now stands, the schedule represents the consensus of opinion of many contractors, and with the proper understanding of what the percentage amounts mean, it should offer a safe means of estimating rental charges.

What the Values Mean.—The endless variation of job conditions, such as topography, ground formation, and climate, indicate how great may be the error of any fixed equipment charge when applied to the exceptional job. But having figures which represent the mean of many projects, a starting point exists for ascertaining reasonable charges for the exceptional circumstances. Figures given in the standard schedule may be said to show equipment expense when machines are not required to operate continuously under either the worst or the best of operation strain. When no especially favorable or unfavorable circumstances attend a project, the tabular values probably give the expense within a permissible error.

To eliminate error as far as possible by permitting consideration and comparison of the individual items that make up equipment expense, the gross amounts are reduced to their component parts. Thus any item of the expense which is known to be unusually high in specific cases may be adjusted in the schedule to obtain a more appropriate rental rate.

¹ General Contractors' Association.

Components of Expense.—Seven items of equipment expense constitute the total rental charge and require consideration in estimating a lump-sum contract or in determining fixed-rate rentals. An average value for each of these items which represent the expense of a general contractor's outfit as a whole has been approved by the Executive Board. The items referred to and their annual proportions of the initial cost of the equipment are as follows:

Schedule of Typical Rental Charge.—Items of expense are expressed as per cents of original capital investment for equipment having a useful life of 6 years and a salvage value of 25% of the original cost.

	%
1. Average depreciation	12 $\frac{1}{2}$
2. Equivalent annual interest at 6 $\frac{1}{2}$ %	4
3. Shop repairs.	6
4. Field repairs	4
5. Storage and incidentals	3 $\frac{1}{2}$
6. Insurance.....	1
7. Taxes.....	1
Total annual expense	32
Equivalent expense on basis of 8 months working time per year.	48
Rental rate per month	4

How to Obtain Proper Percentage.—These percentages and those given in the detailed schedule were determined according to the following principles:

The economical life of a machine is considered to end when its value has depreciated to 25% of the original cost. The average annual depreciation then amounts to 75% of the initial cost divided by the number of years it may be expected to give service. The initial cost of a machine is represented by the cost of that machine delivered at the contractor's yard.

Interest should naturally be charged at the prevailing rate. This may be computed in three ways:

1. By charging the prevailing rate each year on the depreciated value of the machine.

2. By charging the prevailing rate each year on the average value of the machine during economical life. For example, when the salvage rate value is 25% the average value equals (100% + 25%) divided by 2 = 62 $\frac{1}{2}$ %.

3. By finding the proportion which the average value is of the initial cost and charging this proportion of the prevailing rate each year. This proportion is called the equivalent annual interest and shows what interest rate on original cost will yield the same interest as the prevailing rate when applied to the depreciating value of the machine. This is the method used in the above schedule. The average value is 62 $\frac{1}{2}$ % of the original; therefore, the equivalent annual rate is 62 $\frac{1}{2}$ % of the prevailing rate, or 62 $\frac{1}{2}$ % of 6 $\frac{1}{2}$ % = 4%.

Shop and field repairs are separated by reason of a previous recommendation of the Committee on Methods that field repairs

TABLE 223A.—RENTAL SCHEDULE FOR CONSTRUCTION EQUIPMENT

Items of equipment	Economical length of life, years	Annual depreciation, %	Annual shop repairs, %	Annual field repairs, %	Storage and incidentals, %	Insurance, %	Taxes, %	Total annual charge % initial investment
Asphalt mixing plant	40
Auto crane	5	15	6	5	3 $\frac{1}{2}$	I	I	31 $\frac{1}{2}$
Auto truck	5	25	20	20	3 $\frac{1}{2}$	I	I	70 $\frac{1}{2}$
Auto trailer	5	15	6	5	3 $\frac{1}{2}$	I	I	31 $\frac{1}{2}$
Backfiller, power	4	18 $\frac{3}{4}$	6	7	3 $\frac{1}{2}$	I	I	37 $\frac{1}{4}$
Ballast spreader	8	9 $\frac{1}{2}$	6	4	3 $\frac{1}{2}$	I	I	25
Boiler, upright	8	9 $\frac{1}{2}$	20	5	3 $\frac{1}{2}$	I	I	40
Boiler, locomotive	8	9 $\frac{1}{2}$	15	5	3 $\frac{1}{2}$	I	I	35
Bucket, clam shell	4	18 $\frac{3}{4}$	15	6	3 $\frac{1}{2}$	I	I	45 $\frac{1}{4}$
Bucket, orange peel	4	18 $\frac{3}{4}$	25	6	3 $\frac{1}{2}$	I	I	55 $\frac{1}{4}$
Bucket, dragline	4	18 $\frac{3}{4}$	12	3	3 $\frac{1}{2}$	I	I	39 $\frac{1}{4}$
Cars, steel dump	6	12 $\frac{1}{2}$	8	4	3 $\frac{1}{2}$	I	I	30
Cars, wood dump	5	15	7	3	3 $\frac{1}{2}$	I	I	30 $\frac{1}{2}$
Cars, flat	8	9 $\frac{1}{2}$	4	3	3 $\frac{1}{2}$	I	I	22
Cars, hopper	5	15	8	3	3 $\frac{1}{2}$	I	I	31 $\frac{1}{2}$
Compressor, steam	7	10 $\frac{3}{4}$	6	3	3 $\frac{1}{2}$	I	I	25 $\frac{1}{4}$
Compressor, gasoline	4	18 $\frac{3}{4}$	6	7	3 $\frac{1}{2}$	I	I	37 $\frac{1}{4}$
Compressor, electric	6	12 $\frac{1}{2}$	3	3	3 $\frac{1}{2}$	I	I	24
Concrete chutes	2	37 $\frac{1}{2}$	15	15	3 $\frac{1}{2}$	I	I	73
Conveyor, belt	2	37 $\frac{1}{2}$	7	6	3 $\frac{1}{2}$	I	I	56
Conveyor, bucket	2	37 $\frac{1}{2}$	10	6	3 $\frac{1}{2}$	I	I	59
Crusher, rock	6	12 $\frac{1}{2}$	5	3	3 $\frac{1}{2}$	I	I	26
Derrick, wood	5	15	4	4	3 $\frac{1}{2}$	I	I	28 $\frac{1}{2}$
Derrick, steel	10	7 $\frac{1}{2}$	4	3	3 $\frac{1}{2}$	I	I	20
Dragline, steam	6	12 $\frac{1}{2}$	9	8	3 $\frac{1}{2}$	I	I	35
Dragline, gasoline	4	18 $\frac{3}{4}$	10	10	3 $\frac{1}{2}$	I	I	44 $\frac{1}{4}$
Dragline, electric	8	9 $\frac{1}{2}$	7	7	3 $\frac{1}{2}$	I	I	29
Drill, tunnel carriage	5	15	8	8	3 $\frac{1}{2}$	I	I	36 $\frac{1}{2}$
Drill, traction well	6	12 $\frac{1}{2}$	7	10	3 $\frac{1}{2}$	I	I	35
Drill, tripod	4	18 $\frac{3}{4}$	7	10	3 $\frac{1}{2}$	I	I	41 $\frac{1}{4}$
Drill, jack hammer	4	18 $\frac{3}{4}$	7	6	3 $\frac{1}{2}$	I	I	37 $\frac{1}{4}$
Engine, gas	6	12 $\frac{1}{2}$	8	8	3 $\frac{1}{2}$	I	I	34
Engine, steam	10	7 $\frac{1}{2}$	5	5	3 $\frac{1}{2}$	I	I	23
Excavator, cableway	6	12 $\frac{1}{2}$	4	12	3 $\frac{1}{2}$	I	I	34
Excavator, Keystone	5	15	8	4	3 $\frac{1}{2}$	I	I	32 $\frac{1}{2}$
Excavator, trench	5	15	8	6	3 $\frac{1}{2}$	I	I	34 $\frac{1}{2}$
Forms, steel concrete	2	37 $\frac{1}{2}$	20	20	3 $\frac{1}{2}$	I	I	83
Graders, common road	4	18 $\frac{3}{4}$	12	6	3 $\frac{1}{2}$	I	I	42 $\frac{1}{4}$
Grader, elevating	4	18 $\frac{3}{4}$	15	7	3 $\frac{1}{2}$	I	I	46 $\frac{1}{2}$
Hoist, steam	10	7 $\frac{1}{2}$	6	4	3 $\frac{1}{2}$	I	I	23
Hoist, gasoline	6	12 $\frac{1}{2}$	7	8	3 $\frac{1}{2}$	I	I	33
Hoist, electric	8	9 $\frac{1}{2}$	5	3	3 $\frac{1}{2}$	I	I	23
Locomotive:								
Industrial steam	6	8 $\frac{1}{2}$	6	4	3 $\frac{1}{2}$	I	I	24
Industrial gas	4	18 $\frac{3}{4}$	13	10	3 $\frac{1}{2}$	I	I	47 $\frac{1}{4}$
Industrial battery	4	18 $\frac{3}{4}$	15	4	3 $\frac{1}{2}$	I	I	43 $\frac{1}{4}$
Standard gage	10	7 $\frac{1}{2}$	6	4	3 $\frac{1}{2}$	I	I	23
Crane, steam	8	9 $\frac{1}{2}$	7	8	3 $\frac{1}{2}$	I	I	30
Crane, electric	8	9 $\frac{1}{2}$	6	4	3 $\frac{1}{2}$	I	I	25

TABLE 223A.—Continued

Items of equipment	Economical length of life, years	Annual depreciation, %	Annual shop repairs, %	Annual field repairs, %	Storage and incidentals, %	Insurance, %	Taxes, %	Total annual charge % initial investment
Mixer, steam.....	5	15	12	4	3 1/2	1	1	36 3/4
Mixer, gasoline.....	4	18 3/4	13	8	3 1/2	1	1	45 3/4
Mixer, electric.....	6	12 1/2	12	4	3 1/2	1	1	34
Mixer, paving steam.....	5	15	13	4	3 1/2	1	1	37 1/2
Mixer, paving gas.....	3	25	16	0	3 1/2	1	1	55 1/2
Motors.....	6	12 1/2	6	4	3 1/2	1	1	28
Pile driver, steam.....	8	9 1/2	7	5	3 1/2	1	1	27
Pile driver, track.....	10	7 1/2	5	3	3 1/2	1	1	21
Pile hammer, steam.....	7	10 3/4	7	3	3 1/2	1	1	26 1/4
Pipe, galvanized.....	3	25	5	6	3 1/2	1	1	41 3/4
Plows.....	3	25	15	10	3 1/2	1	1	55 1/2
Pneumatic concrete machine.....	4	18 3/4	20	8	3 1/2	1	1	52 3/4
Pump, centrifugal.....	8	9 1/2	6	4	3 1/2	1	1	25
Pump, piston.....	6	12 1/2	7	5	3 1/2	1	1	30
Pump, pulsometer.....	8	9 1/2	2	4	3 1/2	1	1	21
Pump, Emerson.....	8	9 1/2	2	4	3 1/2	1	1	21
Rails.....	8	9 1/2	5	3	3 1/2	1	1	23
Riveter, air.....	5	15	8	4	3 1/2	1	1	32 1/2
Rock channeller.....	6	12 1/2	7	8	3 1/2	1	1	33
Roller, steam road.....	10	7 1/2	5	3	3 1/2	1	1	21
Saw rigs.....	4	18 3/4	10	15	3 1/2	1	1	40 1/4
Scraper, wheel.....	3	25	8	4	3 1/2	1	1	42 1/2
Scraper, slip.....	1	75	25	10	3 1/2	1	1	115 3/4
Scraper, Fresno.....	2	37 1/2	25	15	3 1/2	1	1	83
Shovel, steam.....	6	12 1/2	7	6	3 1/2	1	1	31
Shovel, gasoline.....	4	18 3/4	9	7	3 1/2	1	1	40 1/4
Shovel, electric.....	7	10 3/4	6	5	3 1/2	1	1	27 3/4
Switches, fabricated.....	3	25	3	3	3 1/2	1	1	36 3/4
Tower, steel hoist.....	7	10 3/4	3	4	3 1/2	1	1	23 1/4
Tractor, wheel gas.....	6	12 1/2	9	5	3 1/2	1	1	32
Tractor, caterpillar.....	5	15	15	10	3 1/2	1	1	45 1/2
Wagons, dump.....	4	18 3/4	17	3	3 1/2	1	1	44 1/4
Wagons, hauling.....	4	18 3/4	12	3	3 1/2	1	1	39 1/4
Wagon loaders, power.....	5	15	10	6	3 1/2	1	1	36 1/2

be considered a part of the cost under cost plus contracts and shop repairs be borne by the contractor and covered by the fixed-rate rental charge. This recommendation was made on the ground that an owner should not be made to pay the total cost, for example, of re-fluing a boiler which may have been burned out principally on another owner's work.

The other items of cost require no special explanation.

Three Types of Charges.—Owners of equipment find occasion to establish rental rates as follows:

1. For a lump sum or unit price estimate.
2. To owners on cost plus work.
3. To others than client owners.

In these instances charges should be made as follows:

1. The rental charge or equipment expense for lump sum work includes all the items mentioned above.

2. The fixed rate to owners on cost plus work will include all but field repairs, if this item is paid as a cost of the work. To the amount thus determined may be added a service charge depending upon the policy of the contractor, *i.e.*, whether the service of equipment is included in the profit fee or carried in the rental charge.

3. The charge to persons other than client owners includes all of the items of expense and an additional amount for profit or payment for the machine's earning power.

A further consideration in each of these cases is the rate for double-shift work, where the percentages for depreciation and repairs should be doubled, or nearly so.

Individual Judgment Essential.—The committee desires to emphasize the fact that the values presented in the table should not be considered absolute in determining a rental charge. A real danger presents itself in using any tabular percentage without investigating the conditions under which the equipment is to work. To illustrate: If the values here given for a standard-gage shovel outfit were applied to such an outfit engaged constantly in excavating hard rock, the probability is that the charges allowed would not cover more than half the expense. The frequent dokey shots and the dropping of heavy boulders into cars entails a higher rate of depreciation and repairs than is given in the schedule. On the other hand, if this shovel outfit were steadily engaged in digging sandy loam, the values given in the table would probably cause the equipment charge to contain a fair per cent of profit.

It is with the understanding that individual judgment and experience should adjust the tabular values to meet unusual conditions that this schedule is offered to contractors.

Individual Equipment Rental Schedule.—The component expenses incurred by the ownership and maintenance of construction plant are expressed in this table as percentages of the initial cost for individual items of equipment. They indicate the probable annual expense without profit under ordinary job conditions and should be included in any lump-sum estimate or in determining time-rate rental charges. The salvage value in all cases is considered to be 25 per cent of the initial cost.

Total percentage amounts in the extreme right-hand column should be applied to the total cost of a machine, including charges for transportation from the factory. This gives the total annual charge which for a lump-sum contract covering a full season, is the total equipment expense. For determining a monthly, weekly, or daily rental rate the annual amount is divided by the number of such periods in the year during which construction work may be carried on.

Table 223B giving rental rates for grading equipment has been compiled by F. J. Herlihy, of Minneapolis, Minn. The table, which is reprinted below, shows the original capital cost of his equipment, depreciation charges, average earning days per year, daily charge for interest, depreciation, insurance and storage, and total daily rental charge:

TABLE 223B.—RENTAL RATES FOR GRADING CONTRACTORS EQUIPMENT

Class of equipment	Original capital cost (1920)	Equivalent annual interest rate on original cost, per cent	Annual rate of depreciation on original cost, per cent	Annual insurance and storage rate on original cost, per cent	Total annual rate of accrued charge on original cost, per cent	Total annual charge	Average earning days per year	Daily charge for int., dep., ins. and storage	General shop repairs daily	Daily rental	Estimated cost field repairs daily	Total rental charge daily, including field repairs
Steam shovel.....	\$12,000	3.4	12.2	3.4	20	\$2,400.00	200	\$12.00	\$3.00	\$91.00	\$4.00	\$20.00
Steam shovel.....	20,000	3.4	12.2	3.4	20	4,000.00	200	20.00	6.00	26.00	6.00	32.00
Steam shovel.....	30,000	3.4	12.2	3.4	20	6,000.00	200	30.00	9.00	39.00	9.00	48.00
Steam shovel.....	50,000	3.4	12.2	3.4	20	10,000.00	200	50.00	25.00	115.00	25.00	140.00
Drainage excavator.....	20,000	3.4	12.2	3.4	20	4,000.00	200	20.00	10.00	30.00	10.00	40.00
Drainage excavator.....	30,000	3.4	12.2	3.4	20	6,000.00	200	30.00	15.00	45.00	15.00	60.00
Standard-gage locomotive.....	12,000	3.4	12.2	3.4	20	2,400.00	200	12.00	5.00	17.00	5.00	22.00
Standard-gage locomotive.....	16,000	3.4	12.2	3.4	15	2,400.00	200	12.00	6.00	18.00	6.00	24.00
Standard-gage locomotive.....	24,000	3.4	12.2	3.4	15	3,600.00	200	18.00	8.00	26.00	8.00	34.00
Dinky locomotive.....	4,000	3.4	12.2	3.4	20	800.00	200	4.00	1.50	5.50	1.50	7.00
Dinky locomotive.....	6,000	3.4	12.2	3.4	20	1,200.00	200	6.00	2.50	8.50	2.50	11.00
Locomotive crane.....	20,000	3.4	12.2	3.4	20	4,000.00	200	20.00	6.00	26.00	6.00	32.00
Jordan spreader.....	9,000	3.4	12.2	3.4	15	1,800.00	200	9.00	3.00	12.00	1.00	13.00
Rail per ton.....	48	3.4	12.2	3.4	15	7.20	200	0.01	0.01	0.02	0.00	0.05
Track-throwing machine.....	6,000	3.4	12.2	3.4	20	1,200.00	200	6.00	2.00	8.00	1.00	9.00
20-yd. air dump cars.....	3,750	3.4	12.2	3.4	20	750.00	200	3.75	0.25	4.00	0.25	4.25
16-yd. air dump cars.....	2,800	3.4	12.2	3.4	20	560.00	200	2.80	0.20	3.00	0.25	3.25
12-yd. air dump cars.....	2,000	3.4	12.2	3.4	20	400.00	200	2.00	0.15	2.15	0.15	2.30
4-yd. dump cars.....	430	3.4	12.2	3.4	20	86.00	200	0.43	0.07	0.50	0.10	0.60
1½-yd. dump cars.....	110	3.4	12.2	3.4	20	22.00	200	0.11	0.00	0.20	0.10	0.30
1-yd. dump cars.....	90	3.4	12.2	3.4	20	18.00	200	0.09	0.00	0.15	0.10	0.25
Flat cars.....	1,000	3.4	12.2	3.4	15	150.00	200	0.75	0.15	0.90	0.10	1.00
Gasoline locomotive.....	3,200	3.4	12.2	3.4	20	640.00	200	3.20	1.05	4.25	1.25	5.50
1-yd. Koppel cars, V-shape.....	110	3.4	12.2	3.4	20	22.00	200	0.11	0.04	0.15	0.05	0.20
Motor truck, 5 ton.....	6,000	3.4	22.2	15	30	1,800.00	200	9.00	7.50	16.50	5.00	21.50
Automobile.....	2,000	3.4	31.4	15	50	1,000.00	200	5.00	2.50	7.50	2.50	10.00
Caterpillar tractor, gas.....	5,000	3.4	12.2	3.4	20	1,000.00	150	6.66	8.34	15.00	5.00	20.00
Vertical boiler.....	900	3.4	7.2	3.4	15	135.00	100	1.35	0.65	2.00	0.65	2.65

RENTAL SCHEDULES

Locomotive boiler.....	1,500	3½	7½	3½	15	225.00	100	2 25	1 00	3 25	0 00	3 25
Steam pump.....	500	3½	7½	3½	15	75.00	100	0 75	0 50	1 25	0 00	1 25
Centrifugal pump, d.c.....	1,500	3½	7½	3½	15	225.00	100	2 25	1 25	3 50	0 50	4 00
Belted pump.....	300	3½	7½	3½	15	45.00	100	0 45	0 30	0 75	0 00	0 75
Deep-well pump.....	600	3½	7½	3½	15	90.00	100	0 90	0 60	1 50	0 00	1 50
Gasoline engine.....	1,200	3½	7½	3½	15	180.00	100	1 80	0 60	2 40	0 15	3 50
Steam engine.....	1,800	3½	7½	3½	15	270.00	100	2 70	0 90	3 00	0 15	3 75
Hoisting engine.....	4,250	3½	7½	3½	15	637.50	100	6 38	2 12	8 50	0 50	9 00
Horse pile driver.....	800	3½	12½	3½	20	160.00	100	1 60	0 40	2 00	0 00	2 00
Steam pile driver.....	2,000	3½	12½	3½	20	400.00	100	4 00	0 75	4 75	0 75	5 50
Track pile driver.....	10,000	3½	12½	3½	15	1,500.00	100	15 00	3 00	18 00	2 00	20 00
Steam pile hammer.....	2,500	3½	7½	3½	15	375.00	100	3 75	0 75	4 50	0 50	5 00
Air compressor.....	3,000	3½	7½	3½	15	450.00	100	4 50	1 50	6 00	0 50	6 50
Electric motor.....	500	3½	12½	3½	20	100.00	100	1 00	0 35	1 35	0 15	1 50
Deep-well drill.....	400	3½	12½	3½	20	80.00	100	0 80	0 20	1 00	0 25	1 25
Jack-hammer drill.....	140	3½	12½	3½	20	28.00	100	0 28	0 22	0 50	0 25	0 75
Air steel sharpener.....	2,000	3½	12½	3½	20	400.00	100	4 00	0 25	4 25	0 25	4 50
Stiff-leg derrick.....	2,000	3½	12½	3½	20	400.00	100	4 00	0 50	4 50	0 50	5 00
Porrest log loader.....	400	3½	12½	3½	20	80.00	100	0 80	0 20	1 00	0 25	1 25
Lee wagon loader.....	225	3½	12½	3½	20	45.00	100	0 45	0 15	0 60	0 15	0 75
Clam-shell bucket.....	1,500	3½	12½	3½	20	300.00	100	3 00	0 25	3 25	0 25	3 50
Rock-channeler machine.....	3,000	3½	12½	3½	20	600.00	100	6 00	2 00	8 00	1 00	9 00
Grading machine.....	1,350	3	23½	3½	30	405.00	150	2 70	1 30	4 00	1 00	5 00
Pony road grader.....	200	3	23½	3½	30	60.00	150	0 40	0 20	0 60	0 15	0 75
Grading plow.....	30	3	23½	3½	30	0.00	150	0 06	0 04	0 10	0 00	0 10
Dump wagon.....	180	3	23½	3½	30	54.00	150	0 36	0 34	0 70	0 15	0 85
Hauling wagons.....	120	3	23½	3½	30	36.00	150	0 24	0 24	0 45	0 15	0 60
Wheel scrapers.....	50	3	33½	3½	40	20.00	150	0 13	0 12	0 25	0 00	0 25
Slip scrapers.....	8	3	43½	3½	50	4.00	150	0 03	0 02	0 05	0 00	0 05
Fresno.....	22	3	43½	3½	50	11.00	150	0 07	0 08	0 15	0 00	0 15
Switches, complete.....	150	3½	7½	3½	15	22.50	200	0 11	0 02	0 13	0 00	0 13
100.....	22	3½	7½	3½	15	3 30	200	0 02	0 01	0 03	0 00	0 03
2½-in. galvanized pipe, per 100.....	34	3½	7½	3½	15	5 10	200	0 03	0 01	0 04	0 00	0 04
3-in. galvanized pipe, per 100.....	45	3½	7½	3½	15	6 75	200	0 04	0 01	0 05	0 00	0 05

RENTAL CHARGES FOR CONSTRUCTION EQUIPMENT¹

In connection with the preparation of a standard list of rental charges for construction equipment, a committee of the Associated General Contractors of America has been collecting information as to the practice of various contractors in this matter. In the January 10, 1920 *News Letter* of the association the following schedule of rental charges, submitted by an eastern contractor, is given

TABLE 223C

Equipment	Weekly Rental
Boiler, only, 30 hp. and smaller	\$12.00
Boiler only, 30 to 60 hp.	16.00
Bucket, clam shell, $\frac{3}{4}$ yd.	15.00
Cars, skip, $1\frac{1}{2}$ yd.	2.00
Cars, steel, 1 yd. and smaller	1.50
Crusher only, Acme No. 9 $\frac{1}{2}$	22.00
Cutter, bar portable, with motor	9.50
Derrick, 30 to 50', wooden, homemade	3.00
Drill, small air	3.00
Drill, steam	4.50
Elevator, platform or bucket, 1 yd.	2.00
Engine, skeleton, 2-drum, 20 hp.	8.00
Engine, gasoline, to 8 hp.	3.00
Engine, gasoline, 10 hp.	5.00
Leveling instrument, engineers'	1.50
Mixers, with gasoline engine, 11 to 15' cap.	15.00
Motors, 2 hp.	1.50
Motors, 5 hp.	2.50
Motors, 10 hp.	3.50
Motors, 25 hp.	5.00
Motors, 50 hp.	9.00
Pumps, centrifugal, 10 in., belt driven, with engine	7.00
Pumps, pulsometer, to 4 in.	6.00
Pumps, 3-in., with gasoline engine	3.50
Pumps, diaphragm, with gasoline engine	3.5
Saw benches, plain	3.00
Saw benches, plain, with motor or gas engine attached	5.50
Saw swing cutoff, no power	1.00
Steam shovels, revolving, traction, per day	24.00 ¹
Transit	2.00

¹ Per day.

In submitting the list, the contractor wrote as follows concerning his firm's policy on equipment rental:

The plant rental sheet was revised the first of this year and will be revised again for another year, probably upwards. *Our rental basis for our own work is entirely that of replacement cost.* All plant costing \$150 or more whose life extends over a period of years or over several jobs is shown on our detailed list, which is compiled from our experience of the probable life of each tool. There are three classes:

Class A—Tools which will last through 50 weeks of continuous work.

Class B—Tools which will last through 75 weeks of continuous work.

¹ *Engineering Contracting*, Jan. 21, 1920.

Class C—Tools which will last through 100 weeks of continuous work.

Our rental is sufficient to produce enough revenue to make extraordinary repairs and to replace the plant at the end of this length of time.

You will find that these rentals are uniformly low because they are at cost to ourselves and apply on jobs where we are operating the plant. These plant rentals go into a cost plus or fixed fee contract as a part of the job cost on which profit is figured.

If we rented the plant to outsiders we would charge about half as much again for it.

Our method of handling small tools such as shovels, picks, hammers, etc., is to charge their entire cost to the job. If they are worn out they become part of the job cost. At the completion of the work an inventory is taken and each tool is appraised in cooperation with a representative of the owner. We have five grades: (1) New, 100% of first cost; (2) good, 75%; (3) fair, 50%; (4) poor, 25%; (5) worthless, 0%. We take them back as per inventory.

TABLE 224A.—TYPICAL EQUIPMENT WATER-BOUND MACADAM ROADS

Local stone. 5 miles per season

Equipment item	Approximate first cost 1920	Yearly depreciation, interest, repair, taxes, etc.
Grading equipment (p. 1126) ..	\$ 8,000 to \$30,000	\$ 2,000 to \$11,000
Air compressor and drill outfit	to 3,000	to 1,200
Crushing outfit.....	5,000 to 6,000	1,200 to 1,500
Pumping outfit.....	800 to 1,500	200 to 500
Pipe line, 4 miles ±	3,000 to 5,000	1,500 to 2,000
Roller (included in grading equip.).....		
Wagons or trucks ¹	1,500 to 10,000	1,000 to 5,000
Small tools.....	500 to 1,000	500 to 1,000
Totals.....	\$18,800 to \$56,500	\$6,400 to \$22,200
Moving plant on job.....		1,000 to 2,000
Total yearly.....		\$ 7,500 to \$24,000
Approximate per mile.....		1,500 to 5,000
Approximate per cubic yard macadam ²		0.50 to 1.20

¹ Hauling often sublet.

² Based on 18' road 12" deep (grading overhead not included).

NOTE.—Quarry outfit not needed if boulder stone is used.

TABLE 224B.—TYPICAL EQUIPMENT WATER-BOUND MACADAM
Imported stone. 5 miles per season

Equipment item	Approximate first cost 1926	Approximate yearly depreciation, repairs, interest, taxes, etc.
Grading equipment (p. 1126)...	\$ 8,000 to \$30,000	\$2,000 to \$11,000
Elevator or crane unloader and storage bin.....	2,000 to 10,000	500 to 2,500
Pumping outfit.....	800 to 1,500	200 to 500
Pipe line.....	3,000 to 5,000	1,500 to 2,000
Wagons or trucks ¹	1,500 to 10,000	1,000 to 5,000
Small tools.....	400 to 800	400 to 800
Totals.....	\$16,000 to \$57,000	\$5,600 to \$21,800
Moving plant on job.....		500 to 1,000
Total yearly.....		\$6,100 to \$23,000
Approximate per mile.....		1,200 to 4,600
Approximate per cubic yard macadam ²		0.40 to 1.00

¹ Hauling often sublet.

² Based on 3500 cu. yd. per mile (grading overhead not included).

TABLE 224C.—TYPICAL EQUIPMENT BITUMINOUS MACADAM
Local stone. 5 miles per season

Equipment item	Approximate first cost 1926	Approximate yearly depreciation, repairs, interest, etc.
Grading equipment (p. 1126)...	\$ 8,000 to \$30,000	\$2,000 to \$11,000
Air compressor and drill outfit...	to 3,000	to 1,200
Crushing outfit.....	5,000 to 6,000	1,200 to 1,500
Wagons or trucks ¹	1,500 to 10,000	1,000 to 5,000
Pressure distributor ²	to 9,000	to 4,000
Small tools.....	500 to 1,000	500 to 1,000
Totals.....	\$15,000 to \$59,000	\$4,700 to 23,700
Moving plant on job.....		1,000 to 2,000
Yearly total.....		\$6,000 to \$26,000
Approximate per mile.....		1,200 to 5,000
Approximate per cubic yard macadam ³		0.35 to 1.20

¹ Often sublet.

² Generally sublet.

³ Based on 3500 cu. yd. per mile (grading overhead not included).

TABLE 224D.—TYPICAL EQUIPMENT BITUMINOUS MACADAM
Imported stone. 5 miles per season

Equipment item	Approximate first cost 1926	Approximate yearly depreciation, repairs, interest, etc.
Grading equipment (p. 1126)...	\$ 8,000 to \$30,000	\$2,000 to \$11,000
Unloading outfit	2,000 to 10,000	500 to 2,500
Wagons or trucks ¹	1,500 to 10,000	1,000 to 5,000
Pressure distributor ²	to 9,000	to 4,000
Small tools.....	500 to 1,000	500 to 1,000
Totals.....	\$12,000 to \$60,000	\$4,000 to \$23,500
Moving plant on job	800 to 1,500
Yearly total.....	\$5,000 to 25,000
Approximate per mile	1,000 to 5,000
Approximate per cubic yard macadam ³	0.30 to 1.10

¹ Often sublet.² Generally sublet.³ Based on 17,000 cu. yd. per season (grading overhead not included).TABLE 224E.—TYPICAL EQUIPMENT CEMENT-CONCRETE PAVEMENTS AND BASES
Imported materials

Equipment item	Approximate first cost 1926	Yearly depreciation, interest, repairs, etc.
Grading equipment (p. 1126)...	\$ 8,000 to \$30,000	\$ 2,000 to \$11,000
Concrete equipment (p. 1144) ..	21,000 to 38,000	11,000 to 20,000
Totals.....	\$29,000 to \$68,000	\$13,000 to 31,000
Moving plant on job.....	1,000 to 2,000
Yearly total.....	\$14,000 to \$33,000
Approximate overhead per cubic yard concrete based on 15,000 cu. yd. per year. Grading overhead not included.....	0.90 to 2.00

NOTE.—Where local materials are required, use items from Table 224A for production of local material product and eliminate special car unloading equipment.

TABLE 224F.—TYPICAL EQUIPMENT BITUMINOUS CONCRETE SURFACE COATS

Topeka and sheet asphalt. 100 to 150 tons daily output

Equipment item	Approximate first cost 1926	Yearly depreciation, interest, repair, etc.
Portable car plant.....	\$20,000 to \$30,000	\$ 8,000 to \$12,000
Elevator or crane unloader and bin.....	3,000 to 10,000	800 to 2,500
Trucks ¹	to 30,000	to 15,000
Tandem roller.....	3,000 to 4,000	600 to 800
Small tools.....	500 to 1,000	500 to 1,000
Total.....	\$27,000 to \$75,000	\$10,000 to \$31,000
Moving.....		500 to 1,000
Total yearly.....		\$10,500 to \$32,000
Approximate per ton of mix ²		0.70 to 2.10

¹ Hauling often sublet which materially reduces initial investment.² Based on 15,000 tons seasons output.

TABLE 224G.—TYPICAL EQUIPMENT SMALL-SPAN BRIDGE CONTRACTS

Equipment item	Approximate first cost 1926	Yearly depreciation, interest, repair, etc.
Truck clam-shell crane for unloading materials, steel, stone, sand, etc., and for foundation excavation.....	\$ — to \$ 9,000	— to \$2,500
Pile-driving outfit, drop hammer or steam hammer.....	1,500 to 3,000	400 to 800
Pumping outfit.....	200 to 1,000	50 to 250
Small tractor.....	to 1,000	to 300
One-bag batch concrete mixer.....	700 to 1,000	350 to 500
Trucks or wagons ¹	to 3,000	to 2,000
Air compressor, drill, and riveting outfit.....	to 3,000	to 1,200
Small tools.....	300 to 500	300 to 500
Totals.....	\$3,000 to \$22,000	\$1,100 to \$8,000 ²
Moving plant on job.....		200 to 500

¹ Distributed over season's work which generally amounts to about 6 to 10% of the contract amount.² Hauling generally sublet on small jobs.

NEW YORK STATE (CEMENT CONCRETE PAVEMENT)

Length, miles	Width, feet	Thick-ness, inches	Mix	Reinforcement	Cubic yard price ¹
Herkimer County, Highway 8239, Cold Brook—Nobleboro					
8.23	18	7-6-7	1:1½:3	Marginal bars	\$7.00
Alleghany County, Road 8236, Cuba—Black Creek, Route 2					
2.30	18	7-6-7	1:1½:3	Marginal bars	\$8.50
Broome County, Repair Contract 3126, Kirkwood					
2	18	7-6-7	1:1½:3	40 mesh and area bars	\$9.00
Cattaragus County, Road 1713, Pennsylvania State Line—Portville					
1.91	18	8-7-8	1:½:3	Marginal bars	\$7.50
Chenango County, Road 8216, Coventryville—Bambridge					
6.78	18	7-6-7	1:1½:3	Marginal bars	\$8.00
Columbia County, Road 1753, Stuyvesant—Castleton					
5.42	18	8-7-8	1:1½:3	Marginal bars	\$7.80

¹ Cement and reinforcement not included.

NEW JERSEY STATE

Length, miles	Width, feet	Thick- ness, inches	Mix	Reinforce- ment	Square yard price
Atlantic County—Absecon, Route 3, Section 14					
1.78	20	8	1:1 $\frac{3}{4}$:3 $\frac{1}{2}$	Single line	\$2.75 including cement and re- inforcement
Henderson County, State Route 9, White House--Lebanon					
4	20-30	8	1:1 $\frac{3}{4}$:3 $\frac{1}{2}$	121 lb.	\$3.20
Middlesex County, St. George Ave., State Route 4, Section 32					
4.01	29-50	9	1:1 $\frac{3}{4}$:3 $\frac{1}{2}$	121 lb.	\$3.20
Middlesex County, State Route 4, Section 25, South Amboy					
2.81	29-40	9	1:1 $\frac{3}{4}$:3 $\frac{1}{2}$	121 lb.	\$3.10
Monmouth County, Route 4, Section 4, Keyport Cutoff					
1.31	29	9	1:1 $\frac{3}{4}$:3 $\frac{1}{2}$	121 lb.	\$3.05
Morris County, Dover, Route 5, McFarland St.					
1.25	20-40	8	1:1 $\frac{3}{4}$:3 $\frac{1}{2}$	121 lb.	\$3.00

BID PRICES

1267

CONNECTICUT STATE

Length, feet	Width, feet	Thick- ness, inches	Mix	Reinforcement	Cubic yard price ¹
Hartford County—E. Windsor					
1,650	18	8	1: 2: 3½	17.23 cu. yd.	\$10.00
New Haven County, Middletown—Durham					
28,720	20	8	1: 2: 3½	15.74 cu. yd.	\$8.20
Windham County, Willimantic—Putnam Road					
19,320	18	8	1: 2: 3½	17.23 cu. yd.	\$8.43
Litchfield County, Torrington—Goshen Road					
7,492	20	8	1: 2: 3	Rods	\$9.08
Middlesex County, East Hampton					
14,790	20	8	1: 2: 3	Rods	\$10.00
New Haven County, Waterbury Turnpike					
21,975	20	8	1: 2: 3	Rods	7.43

¹ Cement and reinforcement not included.

PRICE BID TABULATION, NEW YORK, 1926

Item	Item	Unit	Num-ber of bids	Maxi-mum price bid	Mini-mum price bid	Average price bid
2	Earth excavation (roadway)	Cubic yard	30	\$ 1.65	\$ 0.25	\$ 0.62
3	Rock excavation (roadway)	Cubic yard	30	4.40	0.30	2.49
4	Unclassified excavation (roadway)	Cubic yard	30	2.50	0.25	0.82
5	Overhaul	Station yard	30	0.005	0.001	0.0048
6	Sewer pipe:					
	16" pipe (exclusive of excavation)	Lineal foot	30	1.00	0.60	0.85
	12" pipe (exclusive of excavation)	Lineal foot	30	1.25	0.60	0.87
	15" pipe	Lineal foot	21	1.50	0.96	1.31
	18" pipe	Lineal foot	30	2.25	1.00	1.63
	20" pipe	Lineal foot	21	2.75	1.70	2.23
	24" pipe	Lineal foot	22	3.75	2.05	2.95
7	Pipe underdrain:					
	3" drain	Lineal foot	11	0.20	0.07	0.18
	4" drain	Lineal foot	30	0.30	0.15	0.24
	6" drain	Lineal foot	30	0.40	0.18	0.30
13	Cast-iron pipe:					
	12" pipe	Lineal foot	30	3.75	2.50	3.67
	16" pipe	Lineal foot	30	4.00	1.00	3.71
	18" pipe	Lineal foot	30	5.00	4.00	4.86
	20" pipe	Lineal foot	30	6.25	5.00	5.67
	24" pipe	Lineal foot	30	8.00	6.25	7.89
14	Reinforced-concrete pipe:					
	12" pipe	Lineal foot	30	1.95	1.00	1.77
	15" pipe	Lineal foot	30	2.50	1.50	2.06
	18" pipe	Lineal foot	30	3.00	1.85	2.26
	24" pipe	Lineal foot	30	4.00	2.75	3.56
	36" pipe	Lineal foot	10	4.00	4.00	4.73
	36" pipe (exclusive of excavation)	Lineal foot	16	6.50	6.00	6.03
15 ¹	Portland cement	Barrels	30	4.00	2.00	2.85
16 ¹	Cement concrete for structures, 1:2:3½ mix	Cubic yard	222	20.50	9.65	19.25

BID PRICES

1269

171	Cement concrete for parapets, 1: 2: 3½ mix	Cubic yard	186	44.00	13.00
181	Cement concrete for balustrades, 1: 1½: 3 mix	Cubic yard			25.28
191	First-class concrete, 1: 2: 4 mix	Cubic yard	458	27.50	18.60
201	Second-class concrete, 1: 2½: 5 mix	Cubic yard	211	23.00	14.83
211	Medina sandstone or granite curb	Lineal foot			
24	Sandstone or bluestone curb	Lineal foot			
25	Resetting old curbing	Lineal foot	5	0.90	0.50
26	Concrete curbing Type A	Lineal foot	30	1.00	0.70
27a	Concrete curbing Type B	Lineal foot	11	1.25	1.10
27b	Concrete gutters	Square yard	30	2.50	1.00
28	Cobble gutters, cement joints	Square yard	30	1.25	0.80
29	Metal reinforcement for concrete pavement	Square yard	724	0.45	0.20
30	Bar reinforcement for concrete pavement	Pound	312	0.95	0.03
31	Steel fabric reinforcement for culverts	Square foot	888	0.30	0.10
32	Bar reinforcement for structures	Pound	840	0.10	0.04
32A	Structural steel	Pound	260	0.08	0.04
32B	Miscellaneous iron and steel	Pound	30	0.10	0.06
33	Wooden guide railing	Lineal foot			
34	Cable guide railing	Lineal foot	30	1.50	0.70
35	Concrete guide posts	Each	30	3.25	2.00
36	Pipe railing	Lineal foot			
37	Field or quarry stone, bottom course	Cubic yard	30	4.73	1.00
41	Run of bank gravel, bottom course	Cubic yard	30	2.50	1.20
42	Screened gravel, bottom course	Cubic yard			
43	Screened gravel, loose measure, bottom course	Cubic yard			
43A	Broken slag, bottom course	Cubic yard			
43B	Broken slag, loose measure, bottom course	Cubic yard			
44	Broken stone, bottom course	Cubic yard	14	6.25	4.25
44A	Broken stone, loose measure, bottom course	Cubic yard			
45	Concrete foundation for pavement	Cubic yard	6	5.85	5.00
45A	Bituminous-macadam penetration method	Cubic yard	30	4.20	3.00
461	Asphaltic concrete	Cubic yard	19	10.25	6.95
473	Bituminous-macadam mixing method, Type 2	Cubic yard	6	7.50	6.00
483	Binder course, bituminous-macadam mixing method	Square yard	19	1.23	0.70
493	Cement-concrete pavement	Ton	4	10.00	1.00
51A1	Cement-concrete pavement	Cubic yard			
51B1	Cement-concrete pavement	Cubic yard	30	10.55	7.00
51C1	Cement-concrete pavement	Cubic yard	30	9.75	6.00
51D1	Wood-block pavement	Square yard	30	20.00	6.00
52					

PRICE BID TABULATION, NEW YORK, 1926—Continued

Item	Item	Unit	Num- ber of lots	Maxi- mum price bid	Mini- mum price bid	Average price bid
53	Asphaltic-block pavement, approved trap rock.	Square yard	30	\$ 0 70	\$ 0 05	\$ 0.11
53A	Asphaltic-block pavement, approved limestone.	Square yard	30	0 12	0 00	0.10
54	Brick pavement, Type 1.	Square yard	30	4 00	2 40	3.50
54A	Brick pavement, Type 2.	Square yard				
55	Stone-block pavement, Type 1	Square yard	30			
55A	Stone-block pavement, Type 2	Square foot	30	80.00	1 00	39 60
56	Trimming shoulders	Square foot	30	1 00	0 23	0.90
60	Treatment with bituminous material	Square foot				
60A	Bituminous material waterproofing	Square foot				
80	Rip-rap	Cubic yard				
81	Timber and lumber	M ft B. M. board measure				
84	Timber piles	Lineal foot				
85	Cast-in-place concrete piles.	Lineal foot				
87	Test piles	Each				
88	Loading piles	Each		100 00	50.00	82.33

1 Cement not included.

* Bitumen not included.

CHAPTER XVI

NOTES ON CONSTRUCTION

No matter how well a road is designed, unless the construction engineer uses good judgment, and the inspection is conscientious and intelligent, the results will not be satisfactory. This chapter emphasizes the importance of the different stages of the work and gives a few suggestions as to the manner of meeting common difficulties.

DUTIES AND AUTHORITY OF DIFFERENT UNITS OF THE USUAL ORGANIZATION

Inspectors.—Inspectors are responsible for the detail work of construction. They must be thoroughly familiar with the plans and specifications. They pass on the quality of materials delivered, correctness of grades, dimensions of work, and the quality of the workmanship as stipulated in the specifications.

Inspectors have no authority to change plans or specifications. They have authority to reject materials and to stop work which is not being properly done pending the decision of the field engineer. They report directly to the engineer in charge of field construction. Inspectors are really the most important men in the organization, if good work is desired. Good inspectors are hard to get, as the work is tedious and confining.

Field Engineers.—The field engineer is responsible for staking out the construction work, for monthly and final estimates, and for the efficiency of the inspectors. He must keep track of the amount of work done and materials used to see that the contract amounts are not exceeded. He checks all plans and quantities and notifies the chief engineer if changes are desirable.

The field engineer has no authority to change plans or specifications with the exception of minor corrections of mistakes or slight changes in grade and location to fit unexpected conditions, provided such changes do not increase quantities beyond the contract provisions. The field engineer reports directly to the division or chief engineer.

Executive Engineers.—The division or chief engineer is largely an executive. He makes the necessary assignments and has the power to make any necessary changes in the plans to meet unexpected conditions provided these changes do not exceed the contingent allowances of the contract. If required changes call for new items in the contract or for an increase in quantities beyond contingent allowances, he prepares the necessary supplementary contract agreements which must be approved by the contractor

and the financial control officer of the highway department before any such work is done.

Final acceptance of work lies with the head of the department or the civil boards authorizing the work.

Staking for Construction.—The construction survey picks up the center line shown on the plans and by means of offset stakes driven to a certain elevation marks the position and elevation of the road conveniently for building. Any arrangement of stakes that shows the position of the proposed center line and the elevation of the proposed grade is satisfactory. These stakes may be set on one or both sides of the road at intervals of 50 or 100'. The offsets to the center line may be marked to the nearest one-tenth foot,

Staking Out							Notes				
Sta.	Offsets		Cut or Fill		Levels		H. I.	Grade Elev.	Grade Rod Reading	Rod Reading on Stakes	
	L.	R.	L.	R.	B. S.	I. S.				L.	R.
B.M.'s											
											526.42
10	25	23	F05	F10	4.17		530.59	524.2	6.4	6.9	7.4
+50	25	22	F05	F15			"	524.6	6.0	6.5	7.5
11	24	25	F05	F15			"	525.0	5.6	6.1	7.1
+50	21	26	C05	F10			"	525.4	5.2	4.7	6.2
12	22	25	C05	F15			"	525.8	4.8	4.3	6.3
+50	23	24	C10	F20			"	526.2	4.4	3.4	6.4
13	24	24	Gr	Gr			"	526.6	4.0	4.0	4.0
+50	25	23	Gr	F05			"	527.0	3.6	3.6	4.1
14	30	17	Gr	C05		3.20	527.33	527.8	2.8	2.8	2.3
+50	25	23	Gr	C10	7.41		534.80	528.6	6.2	6.2	5.2
15	25	23	C05	F15			"	529.4	5.4	4.9	6.9
+50	25	23	F10	F10			"	530.2	4.6	5.6	5.6
16	25	23	Gr	C10			"	531.0	3.8	3.8	2.8
+50	25	23	F15	Gr			"	531.8	3.0	4.5	2.0
17	24	24	F15	Gr			"	532.6	2.2	3.7	2.2
+50	18	26	F10	F50			"	533.4	1.4	2.4	6.4
							"				

FIG. 329.—Staking out notes.

or the stakes may be set that the offset is an even foot and driven so that the elevation of the proposed grade is above or below them an even foot, half foot, or an odd tenth. A satisfactory method in general use in western New York is to set the construction stakes on both sides every 50', with an even foot or half foot above or below grade.

Such stakes can be readily explained to the ordinary grading foreman so that he has no difficulty in working from them without the assistance of an inspector. The 50' interval is convenient for fine grading, as the lines can be stretched this distance with no apparent sag, while if a 100' interval is used, the sag is objectionable. With stakes on both sides of the road, the elevation of the proposed grade can be readily transferred to the center by stretching a line between them and measuring down or up the required amount. This is a much simpler and more accurate method than transferring by straight-edge where two or three lengths of straight-edge must be used from the stake to the center.

The left stake marked C 4.0' offset 28.0' means that the crown grade of the finished road is 4.0' below the top of this stake and the proposed center line of macadam is 28.0' from the face of the stake (see Fig. 330).

To transfer the proposed grade to the center line by the string method: Fasten chalk line to top of left stake; measure up 3.0' above top of right stake and draw line taut at this elevation. The string is level and 4.0' above crown grade. Pull as tight as possible, allow about $\frac{1}{2}$ " for sag, and measure down 3' 11 $\frac{1}{2}$ " for finished grade.

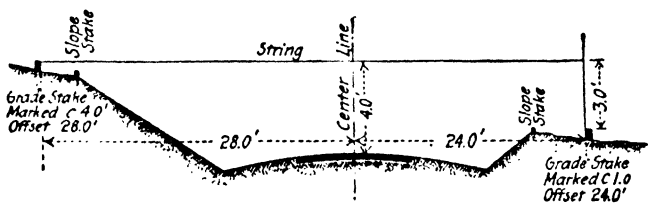

FIG. 330.—Showing suggested method of staking out.

Cost of Staking Out.—The speed and cost of staking at 50' intervals will, of course, vary with the experience of the men and the character of the road. A party of four men should pick up the proposed center line and set offset stakes on both sides at a speed of 1.5 to 2 miles a day; a party of three men should grade these stakes at a speed of 1.0 to 2.0 miles a day, and the cost of staking out for construction, including livery and board, would be from \$40 to \$80 per mile 1925 cost conditions (livery \$4 per day; board \$3 per man per day and engineers \$10 and assistants \$4 to \$6).

It is common for new men to spend an unnecessary amount of time in setting the grade stakes. They will often attempt to have the elevation of the grade stakes correct to within 0.01'. For all practical purposes, for work of this character, stakes correct to within 0.1' in elevation and 0.1' in alignment are satisfactory. Curb stakes for village work, however, should be carefully set to within 0.01' in elevation and line. For such work line is marked by tacks in top of stake.

Culverts.—Culverts are usually constructed before the road is graded. They should be completed well in advance of the pavement, because even though the backfill is carefully tamped, there is bound to be some additional settlement under traffic action, and if the pavement is laid over a fresh backfill, depressions or cracks are sure to develop which, if not repaired, make "thank-you-marms" in the road or introduce areas of no soil support under rigid slabs which often produce cracks unless the pavement is thickened enough to bridge the trench. For extra depth of pavement bases over trenches, see page 417.

Cast-iron Pipe.—Trenches for pipe are dug the required depth, the bottom being made wide enough to allow the joints to be

properly calked. This requires a trench 18 to 24" wider than the pipe diameter; *i.e.*, for a 12" pipe the trench is 30 to 36". Bell holes are dug as shown in Fig. 331, so that the pipe will have a uniform bearing its entire length. At no point should it rest directly on boulders or ledge rocks. If the foundation is soft, the pipe should be laid on a concrete or gravel base. For ordinary soils the only precaution the inspector need take is to prevent backfill under the pipe.

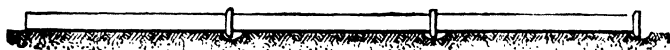

FIG. 331.—Bell holes for pipe trench.

Unless the foreman is alert, the trench is often excavated too much in some places, which are then back filled. This is bad practice except where boulders are encountered which must be removed and the cavities backfilled with good material.

Pipe.—The pipe is inspected for flaws; it is then placed in the trench with the bell end upstream. At each joint the spigot end is placed in the bell and forced against the shoulder, making a tight joint. The pipe is then lined correctly and a gasket of jute

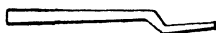

FIG. 332.—Steel joint caulking tool.

or oakum driven into the joint with an iron caulking tool having a 2 to 3" offset, as shown in Fig. 332. The balance of the joint is then filled with a 1:1 cement mortar.

The trench is then backfilled, care being taken not to throw the pipe out of line; the backfill must be well tamped in layers not exceeding 6", heavy paver's rammers being used. A good working rule is to use two of the best men on the job tamping and the laziest man on the force throwing dirt to them.

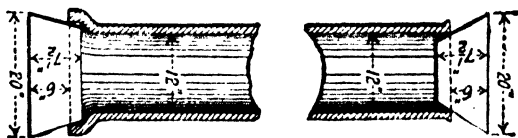

FIG. 333.—Headwall plug extension forms.

Headwalls for Culverts.—The face of the headwall should extend beyond the end of the pipe, as it is difficult to get a good-looking connection if it is flush with the end.

Figure 333 shows a convenient plug form for this extension. This plug is set into the end of the pipe and can be readily removed, the resulting headwall being pleasing in appearance. The headwall

form can, also, be readily skewed (set at an angle with the pipe) if required.

Reinforced-concrete Pipe.—Pipe of this character is laid in the same general manner as cast-iron pipe with the following minor changes. It is desirable to dig the trench 2 or 3" lower than necessary and backfill with gravel well tamped to give a slightly flexible bed for the pipe. It is essential that concrete pipe be handled with care, as most of the damage to this pipe occurs by careless handling. Pipe up to 18" in diameter can be easily handled by rope slings held by hand. For 24" or larger pipe a tripod with chain hoist is desirable to prevent breakage in lowering into the trench and to avoid needless disturbance of the bed by dropping heavy pipe at an angle. The backfill for this kind of pipe must be very carefully done up to half height. In loam, clay, and quicksand soils, it is desirable to cradle the lower half of the pipe with concrete 1:3:6 mix (see Chap. IV p. 217).

CONCRETE CULVERTS

Excavation.—The trench is dug to the required depth; if the material will stand vertically, no back forms are necessary, and the width of the trench is made the width of the out-to-out dimensions of the culverts. If back forms are needed, the trench is usually made 2' wider. If running water is encountered which cannot be temporarily dammed or diverted, the trench is made wide enough to flume the stream through on one side of the back forms for small culverts, or between the abutments for larger-span structures.

Backfill.—The backfill is made as for cast-iron pipe except that it should not be deposited on the fresh top of a culvert within 24 hr. of laying the concrete.

Forms.—Forms should be true to shape and constructed of planed tongue and groove or carefully sized lumber, for the exposed surfaces. Face form lumber should never be less than 1 $\frac{1}{4}$ " and preferably 2" thick and should be well ribbed (see pp. 1346 to 1353 for typical forms). They should be water tight, as otherwise the fine material will run out of the face of the concrete and leave a rough "pop-corn" surface. They must be well braced to prevent bulging. Triangular or feather-edged grooved moldings are placed in the angles of the forms to shape them satisfactorily. The bottom boards of high thin side walls should be left loose until concrete is ready to pour to permit cleaning the foundation concrete of chips or dirt which always collect.

Removal of Forms.—The length of time that the forms should remain in place is a matter of judgment; it depends upon the cement and weather conditions.

The author's practice is as follows:

Headwalls or parapet forms are removed within 36 hr. in dry weather or within 48 hr. in damp, cold weather, in order to rub down the surfaces.

Low side-wall forms for spans of 2 to 3', where the deck is constructed later, may be removed in 36 to 48 hr.

Trunk forms for small culverts 2 to 3' span may be removed in from 3 to 7 days.

Trunk forms for medium culverts up to 10' span, 7 to 14 days.

Deck forms for spans above 10' may be removed in from 14 to 28 days.

Any unusual load, such as a roller, should not be allowed over a new culvert of even a small span in less than 7 days, unless precautions are taken to distribute the pressure by planking the back-fill or otherwise; on the larger structures a time limit of 3 to 4 weeks is advisable.

MIXING AND PLACING CONCRETE

The strength of the concrete depends largely upon the thoroughness of the mixing and the water content.

The author's practice has been as follows:

Hand Mixing Cement and Sand.

3 turns dry for third-class concrete (foundations and side walls)

4 turns dry for second-class concrete (decks and parapets)

Add water and mix mortar.

Drench stone and turn stone and mortar:

3 times for third-class concrete.

4 times for second-class concrete.

Machine Mix.—Minimum 1 min. (15 revolutions).

Deposit in forms by dropping. Do not cast, as this separates the coarse and fine material. Use enough water to give a mixture that quakes like liver under the rammer (about 5 to 6 gal. per sack of cement).

Deposit in layers not over 6" deep and ram each layer thoroughly; spade the concrete thoroughly, and work an excess of the fine stuff to the face of the forms by prying the larger fragments back from the form with a narrow spade or broad-tined fork.

Machine Mixing.—Culverts generally contain such a small quantity of concrete that machine mixing is often not used, although a small mixer is very convenient and the one-bag batch size is in very common use for work of this character. In case a batch mixer is employed, the inspection is simplified to checking the quantities of cement, sand, and stone in each charge, regulating the water content, and insisting on complete mix. Give at least a minute in the drum. If a continuous mixer is used, it is well to keep watch of the cement hopper, as the cement is liable to run low, feeding only a portion of the work, or a large lump of cement may ride on top of the worm and hinder the feed; or the worm may become coated with damp cement which reduces the capacity. If the inspector watches the cement hopper, the contractor will tend to the sand and stone hoppers. Continuous mixers are usually prohibited on account of the uncertainty of the resulting product.

Capacity of Concrete Mixers.—Using a minute mix, different-size mixers will turn out approximately the following amounts of 1:2:4 structural concrete: (20 to 30 batches per hour).

1-bag batch.....	3 to 4 cu. yd. per hour
1½-bag batch.....	5 to 7 cu. yd. per hour
2-bag batch.....	7 to 10 cu. yd. per hour

Finishing Concrete.—If a smooth, marble-like surface is desired, it can be obtained by rubbing down the surface before it has fully set with a cement-sand brick moistened with water. If a rough sandpaper-like finish is wanted, it can be secured by rubbing with a wooden float moistened with water. This finish is not so apt to hair check as the smooth finish. For a high-grade rub finish for more pretentious ornamental structures such as concrete arch bridges, parapets, etc., see specifications on page 1522.

Freshly laid concrete should be protected from a hot sun by covering it with canvas, or blankets, and wetting it down frequently for 4 or 5 days. No plastering of surfaces should be allowed after the cement has set. If, however, it has been badly hair checked from heat, the defect can usually be remedied by rubbing with a carborundum brick. Freshly laid concrete must be protected from frost. A satisfactory method is to cover with canvas and a thick layer of manure or straw. If the concrete has been frost pitted on the surface only, bush hammering will give a rough stone finish, pleasing in appearance. No culvert work should be allowed in continued cold weather, as it is difficult to get a good finish, and in roadwork there is no necessity of doing this work in the winter. *Concrete-culvert inspection must be continuous.*

Amounts of Material Required.—For the amounts of material required per cu. yd. of concrete, see page 1092.

Tables similar to 225 given below and computed for the standard designs in use in any locality are very convenient in placing materials for culvert construction. Table 225 is computed for culverts shown in Fig. 65, Chap. IV, page 221. 3rd class concrete sidewalls and bottom and wings—2nd class slabs and parapets.

NOTE.—Amount of cement shown in Table 225 is based on 1.3 bbls. per c. y. 2nd class and 1.1 bbls. per c. y. 3rd class concrete. If culverts are constructed entirely of 1:2:4 mix take total c. y. of concrete shown for structure and multiply by 1.6 bbls. to get approx. amount of cement.

TABLE 225.—CONCRETE CULVERTS

1.5' high × 2.0' wide							
Length Feet	Concrete Cubic Yards		Paving Square Yards	Ex. Met Square Feet	Cement Barrels ^a	Sand Cubic Yards	Crushed Stone Cubic Yards
	Second	Third					
20	2.2	5.6	6.4	80	8.4	3.6	7.2
21	2.2	5.8	6.4	84	8.6	3.7	7.4
22	2.3	6.1	6.4	88	9.0	3.9	7.8
23	2.4	6.3	6.4	92	9.3	4.1	8.1
24	2.5	6.5	6.4	96	9.7	4.2	8.3
25	2.5	6.7	6.4	100	9.9	4.3	8.5
26	2.6	6.9	6.4	104	10.2	4.4	8.8
27	2.7	7.2	6.4	108	10.6	4.6	9.2
28	2.8	7.4	6.4	112	10.9	4.8	9.5
29	2.8	7.6	6.4	116	11.1	4.9	9.6
30	2.9	7.8	6.4	120	11.5	5.0	9.9
31	3.0	8.1	6.4	124	11.9	5.2	10.3
32	3.1	8.3	6.4	128	12.2	5.3	10.6
33	3.1	8.5	6.4	132	12.4	5.4	10.8
34	3.2	8.7	6.4	136	12.7	5.6	11.0
35	3.3	8.9	6.4	140	13.1	5.7	11.3
36	3.4	9.2	6.4	144	13.5	5.9	11.7
37	3.4	9.4	6.4	148	13.7	6.0	11.9
38	3.5	9.6	6.4	152	14.0	6.1	12.1
39	3.6	9.8	6.4	156	14.5	6.3	12.4
40	3.6	10.1	6.4	160	14.8	6.4	12.7
41	3.7	10.3	6.4	164	15.1	6.5	13.0
42	3.8	10.5	6.4	168	15.4	6.7	13.3
43	3.9	10.7	6.4	172	15.7	6.8	13.5
44	3.9	10.9	6.4	176	15.9	6.9	13.7
45	4.0	11.2	6.4	180	16.4	7.1	14.1
46	4.1	11.4	6.4	184	16.7	7.2	14.4
47	4.2	11.6	6.4	188	17.0	7.4	14.7
48	4.2	11.8	6.4	192	17.2	7.5	14.8
49	4.3	12.1	6.4	196	17.6	7.7	15.2
50	4.4	12.3	6.4	200	18.0	7.8	15.5

^a See note page 1277.

TABLE 225.—Continued

2' high X 2' wide							
Length Feet	Concrete Cubic Yards		Expanded Metal Square Feet	Paving Square Yards	Portland Cement Barrels*	Sand Cubic Yards	Crushed Stone Cubic Yards
	Second	Third					
20	2.4	7.1	80	9.8	10.1	4.4	8.8
21	2.4	7.3	84	9.8	10.4	4.5	9.0
22	2.5	7.6	88	9.8	10.8	4.7	9.4
23	2.6	7.9	92	9.8	11.2	4.9	9.7
24	2.7	8.1	96	9.8	11.5	5.0	10.0
25	2.7	8.4	100	9.8	11.8	5.2	10.3
26	2.8	8.6	104	9.8	12.2	5.3	10.6
27	2.9	8.9	108	9.8	12.6	5.5	10.9
28	3.0	9.2	112	9.8	13.0	5.7	11.3
29	3.0	9.4	116	9.8	13.2	5.8	11.5
30	3.1	9.7	120	9.8	13.6	6.0	11.9
31	3.2	9.9	124	9.8	14.0	6.1	12.1
32	3.3	10.2	128	9.8	14.4	6.3	12.5
33	3.3	10.5	132	9.8	14.7	6.4	12.8
34	3.4	10.7	136	9.8	15.0	6.6	13.0
35	3.5	11.0	140	9.8	15.4	6.8	13.4
36	3.6	11.2	144	9.8	15.8	6.9	13.7
37	3.6	11.5	148	9.8	16.1	7.1	14.0
38	3.7	11.8	152	9.8	16.5	7.2	14.4
39	3.8	12.0	156	9.8	16.8	7.4	14.7
40	3.9	12.3	160	9.8	17.3	7.6	15.0
41	3.9	12.5	164	9.8	17.5	7.7	15.2
42	4.0	12.8	168	9.8	17.9	7.9	15.6
43	4.1	13.1	172	9.8	18.3	8.0	16.0
44	4.2	13.3	176	9.8	18.6	8.2	16.2
45	4.2	13.6	180	9.8	18.9	8.3	16.5
46	4.3	13.9	184	9.8	19.4	8.5	16.9
47	4.4	14.1	188	9.8	19.7	8.6	17.2
48	4.4	14.4	192	9.8	20.0	8.8	17.4
49	4.5	14.6	196	9.8	20.4	8.9	17.7
50	4.6	14.9	200	9.8	20.8	9.1	18.1

* See note page 1277.

TABLE 225.—Continued

2' high x 3' wide							
Length Feet	Concrete Cubic Yards		Expended Metal Square Feet	Steel Pounds	Portland Cement Barrels*	Sand Cubic Yards	Crushed Stone Cubic Yards
	Second	Third					
20	2.3	7.6	100	78	10.5	4.6	9.2
21	2.4	7.9	105	81	11.0	4.8	9.6
22	2.5	8.2	110	85	11.4	5.0	9.9
23	2.6	8.5	115	88	11.8	5.2	10.3
24	2.6	8.8	120	91	12.1	5.3	10.6
25	2.7	9.1	125	95	12.5	5.5	10.9
26	2.8	9.4	130	98	13.0	5.7	11.3
27	2.9	9.7	135	101	13.4	5.9	11.7
28	3.0	9.9	140	105	13.7	6.0	12.0
29	3.1	10.2	145	108	14.1	6.2	12.3
30	3.2	10.5	150	112	14.6	6.4	12.7
31	3.3	10.8	155	115	15.0	6.6	13.1
32	3.4	11.1	160	118	15.4	6.8	13.4
33	3.5	11.4	165	122	15.9	7.0	13.8
34	3.6	11.7	170	125	16.3	7.2	14.2
35	3.7	12.0	175	128	16.7	7.3	14.6
36	3.8	12.2	180	132	17.0	7.5	14.8
37	3.9	12.5	185	135	17.5	7.7	15.2
38	3.9	12.8	190	139	17.8	7.8	15.5
39	4.0	13.1	195	142	18.2	8.0	15.9
40	4.1	13.4	200	145	18.6	8.2	16.2
41	4.2	13.7	205	149	19.0	8.4	16.6
42	4.3	14.0	210	152	19.5	8.6	17.0
43	4.4	14.3	215	156	19.9	8.7	17.3
44	4.5	14.5	220	159	20.2	8.9	17.6
45	4.6	14.8	225	162	20.7	9.1	18.0
46	4.7	15.1	230	166	21.1	9.2	18.4
47	4.8	15.4	235	169	21.5	9.4	18.7
48	4.9	15.7	240	172	21.9	9.6	19.1
49	5.0	16.0	245	176	22.4	9.8	19.5
50	5.1	16.3	250	179	22.8	10.0	19.8

* See note page 1277.

CONCRETE CULVERTS

1281

TABLE 225.—Continued

2' high x 4' wide							
Length Feet	Concrete Cubic Yards		Expanded Metal Square Feet	Steel Pounds	Portland Cement Barrels*	Sand Cubic Yards	Crushed Stone Cubic Yards
	Second	Third					
20	2.7	8.4	120	78	11.8	5.2	10.3
21	2.8	8.7	126	81	12.3	5.3	10.7
22	2.9	9.0	132	85	12.7	5.6	11.0
23	3.1	9.3	138	88	13.2	5.8	11.5
24	3.2	9.7	144	91	13.8	6.0	12.0
25	3.3	10.0	150	95	14.2	6.2	12.3
26	3.4	10.3	156	98	14.6	6.4	12.7
27	3.5	10.6	162	101	15.0	6.6	13.1
28	3.6	10.9	168	105	15.5	6.8	13.4
29	3.7	11.2	174	108	15.9	6.9	13.8
30	3.8	11.5	180	112	16.3	7.1	14.2
31	3.9	11.9	186	115	16.8	7.4	14.6
32	4.0	12.2	192	118	17.3	7.6	15.0
33	4.2	12.5	198	122	17.8	7.8	15.5
34	4.3	12.8	204	125	18.3	8.0	15.9
35	4.4	13.1	210	128	18.7	8.2	16.2
36	4.5	13.4	216	132	19.1	8.4	16.6
37	4.6	13.8	222	135	19.6	8.6	17.1
38	4.7	14.1	228	139	20.1	8.7	17.4
39	4.8	14.4	234	142	20.5	9.0	17.8
40	4.9	14.7	240	145	20.9	9.1	18.2
41	5.0	15.0	246	149	21.4	9.4	18.6
42	5.2	15.3	252	152	21.9	9.6	19.1
43	5.3	15.6	258	156	22.3	9.8	19.4
44	5.4	16.0	264	159	22.9	10.0	19.9
45	5.5	16.3	270	162	23.3	10.2	20.2
46	5.6	16.6	276	166	23.7	10.4	20.6
47	5.7	16.9	282	169	24.1	10.6	21.0
48	5.8	17.2	288	172	24.6	10.8	21.3
49	5.9	17.5	294	176	25.0	10.9	21.7
50	6.0	17.8	300	179	25.4	11.1	22.1

* See note page 1277.

TABLE 225.—Continued

3' high × 3' wide							
Length Feet	Concrete Cubic Yards		Expanded Metal Square Feet	Steel Pounds	Portland Cement Barrels*	Sand Cubic Yards	Crushed Stone Cubic Yards
	Second	Third					
20	2.3	10.4	100	82	13.4	5.9	11.8
21	2.4	10.8	105	85	13.9	6.2	12.3
22	2.5	11.2	110	88	14.4	6.4	12.7
23	2.6	11.5	115	92	14.9	6.6	13.1
24	2.6	11.9	120	95	15.3	6.8	13.5
25	2.7	12.2	125	99	15.7	7.0	13.8
26	2.8	12.6	130	102	16.2	7.2	14.3
27	2.9	13.0	135	105	16.8	7.4	14.8
28	3.0	13.3	140	109	17.2	7.6	15.1
29	3.1	13.7	145	112	17.7	7.9	15.6
30	3.2	14.0	150	116	18.2	8.1	16.0
31	3.3	14.4	155	119	18.7	8.3	16.4
32	3.4	14.8	160	122	19.2	8.5	16.9
33	3.5	15.1	165	126	19.6	8.7	17.3
34	3.6	15.5	170	129	20.2	8.9	17.6
35	3.7	15.8	175	133	20.6	9.1	18.1
36	3.8	16.2	180	136	21.1	9.4	18.6
37	3.9	16.6	185	139	21.6	9.6	19.0
38	3.9	16.9	190	143	22.0	9.7	19.3
39	4.0	17.3	195	146	22.5	10.0	19.8
40	4.1	17.6	200	150	22.9	10.2	20.1
41	4.2	18.0	205	153	23.4	10.4	20.6
42	4.3	18.4	210	156	24.0	10.6	21.1
43	4.4	18.7	215	160	24.4	10.8	21.4
44	4.5	19.1	220	163	24.9	11.0	21.9
45	4.6	19.4	225	167	25.4	11.2	22.3
46	4.7	19.8	230	170	25.9	11.4	22.7
47	4.8	20.2	235	173	26.4	11.7	23.2
48	4.9	20.5	240	177	26.8	11.9	23.6
49	5.0	20.9	245	180	27.4	12.1	24.0
50	5.1	21.2	250	184	27.8	12.3	24.4

* See note page 1277.

TABLE 225.—Continued

3' high × 4' wide							
Length feet	Concrete Cubic Yards		Expanded Metal Square Feet	Steel Pounds	Portland Cement Barrels*	Sand Cubic Yards	Crushed Stone Cubic Yards
	Second	Third					
20	2.7	11.3	120	82	14.8	6.5	13.0
21	2.8	11.7	126	85	15.3	6.8	13.5
22	2.9	12.1	132	88	15.8	7.0	13.9
23	3.1	12.5	138	92	16.5	7.3	14.5
24	3.2	12.9	144	95	17.0	7.5	14.9
25	3.3	13.2	150	99	17.4	7.7	15.3
26	3.4	13.6	156	102	18.0	7.9	15.8
27	3.5	14.0	162	105	18.5	8.2	16.3
28	3.6	14.4	168	109	19.0	8.4	16.7
29	3.7	14.8	174	112	19.6	8.7	17.2
30	3.8	15.2	180	116	20.1	8.9	17.6
31	3.9	15.6	186	119	20.6	9.1	18.1
32	4.0	16.0	192	122	21.1	9.4	18.6
33	4.2	16.4	198	126	21.8	9.6	19.1
34	4.3	16.8	204	129	22.3	9.8	19.6
35	4.4	17.1	210	133	22.8	10.1	20.0
36	4.5	17.5	216	136	23.3	10.3	20.4
37	4.6	17.9	222	139	23.8	10.5	20.9
38	4.7	18.3	228	143	24.3	10.8	21.3
39	4.8	18.7	234	146	24.9	11.0	21.8
40	4.9	19.1	240	150	25.4	11.2	22.3
41	5.0	19.5	246	153	25.9	11.4	22.7
42	5.1	19.9	252	156	26.5	11.7	23.2
43	5.3	20.3	258	160	27.1	12.0	23.7
44	5.4	20.7	264	163	27.7	12.2	24.2
45	5.5	21.0	270	167	28.1	12.4	24.6
46	5.6	21.4	276	170	28.6	12.6	25.0
47	5.7	21.8	282	173	29.1	12.9	25.5
48	5.8	22.2	288	177	29.7	13.1	26.0
49	5.9	22.6	294	180	30.2	13.3	26.4
50	6.0	23.0	300	184	30.7	13.6	26.9

* See note page 1277.

TABLE 225.—Continued

4' high × 4' wide							
Length Feet	Concrete Cubic Yards		Expanded Metal Square Feet	Steel Pounds	Portland Cement Barrels*	Sand Cubic Yards	Crushed Stone Cubic Yards
	Second	Third					
20	2.7	14.5	120	87	18.1	8.1	15.9
21	2.8	15.0	126	90	18.7	8.3	16.5
22	2.9	15.4	132	94	19.2	8.6	17.0
23	3.1	15.9	138	97	20.0	8.9	17.6
24	3.2	16.4	144	100	20.6	9.2	18.2
25	3.3	16.8	150	104	21.1	9.4	18.7
26	3.4	17.3	156	107	21.8	9.7	19.2
27	3.5	17.7	162	111	22.3	9.9	19.7
28	3.6	18.2	168	114	22.9	10.2	20.2
29	3.7	18.7	174	117	23.5	10.5	20.8
30	3.8	19.1	180	121	24.1	10.7	21.2
31	3.9	19.6	186	124	24.7	11.0	21.8
32	4.0	20.1	192	128	25.3	11.3	22.4
33	4.2	20.5	198	131	26.0	11.6	22.9
34	4.3	21.0	204	134	26.6	11.9	23.5
35	4.4	21.4	210	138	27.1	12.1	24.0
36	4.5	21.9	216	141	27.8	12.4	24.5
37	4.6	22.4	222	145	28.4	12.6	25.1
38	4.7	22.8	228	148	28.9	12.9	25.5
39	4.8	23.3	234	151	29.6	13.1	26.1
40	4.9	23.8	240	155	30.2	13.4	26.6
41	5.0	24.2	246	158	30.7	13.7	27.1
42	5.1	24.7	252	162	31.4	14.0	27.7
43	5.3	25.2	258	165	32.1	14.3	28.3
44	5.4	25.6	264	168	32.6	14.5	28.8
45	5.5	26.1	270	172	33.3	14.8	29.3
46	5.6	26.5	276	175	33.8	15.0	29.8
47	5.7	27.0	282	179	34.4	15.3	30.3
48	5.8	27.5	288	182	35.1	15.6	30.9
49	5.9	27.9	294	185	35.6	15.8	31.4
50	6.0	28.4	300	189	36.2	16.1	31.9

* See note page 1277.

TABLE 225.—Continued

3' high × 5' wide							
Length Feet	Concrete Cubic Yards		Expanded Metal Square Feet	Steel Pounds	Portland Cement Barrels*	Sand Cubic Yards	Crushed Stone Cubic Yards
	Second	Third					
20	4.0	12.4	140	83	17.5	7.7	15.2
21	4.2	12.8	147	86	18.1	7.9	15.7
22	4.4	13.3	154	90	18.9	8.3	16.4
23	4.6	13.7	161	93	19.5	8.6	17.0
24	4.7	14.1	168	96	20.1	8.8	17.4
25	4.9	14.5	175	100	20.7	9.1	18.0
26	5.1	14.9	182	103	21.4	9.3	18.5
27	5.3	15.4	189	106	22.1	9.6	19.2
28	5.4	15.8	196	110	22.6	9.9	19.7
29	5.6	16.2	203	113	23.3	10.2	20.2
30	5.8	16.6	210	117	23.9	10.5	20.8
31	5.9	17.0	217	120	24.5	10.7	21.2
32	6.1	17.4	224	123	25.1	11.0	21.8
33	6.3	17.9	231	127	25.9	11.3	22.4
34	6.5	18.3	238	130	26.5	11.6	23.0
35	6.6	18.7	245	134	27.1	11.8	23.5
36	6.8	19.1	252	137	27.7	12.1	24.0
37	7.0	19.5	259	140	28.4	12.4	24.6
38	7.2	19.9	266	144	29.0	12.7	25.1
39	7.3	20.4	273	147	29.6	12.9	25.7
40	7.5	20.8	280	150	30.3	13.2	26.2
41	7.7	21.2	287	154	30.9	13.5	26.8
42	7.8	21.6	294	157	31.5	13.7	27.3
43	8.0	22.0	301	161	32.1	14.0	27.8
44	8.2	22.4	308	164	32.8	14.3	28.4
45	8.4	22.9	315	167	33.4	14.6	29.0
46	8.5	23.3	322	171	34.1	14.8	29.5
47	8.7	23.7	329	174	34.7	15.1	30.0
48	8.9	24.1	336	177	35.3	15.3	30.6
49	9.1	24.5	343	181	36.0	15.6	31.2
50	9.2	24.9	350	184	36.5	15.9	31.6

* See note page 1277.

TABLE 225.—Continued

4' high × 5' wide							
Length Feet	Concrete Cubic Yards		Expanded Metal Square Feet	Steel Pounds	Portland Cement Barrels*	Sand Cubic Yards	Crushed Stone Cubic Yards
	Second	Third					
20	4.0	15.8	140	88	21.0	9.2	18.4
21	4.2	16.3	147	92	21.7	9.6	19.0
22	4.4	16.8	154	95	22.5	9.9	19.7
23	4.6	17.2	161	99	23.1	10.2	20.2
24	4.7	17.7	168	102	23.7	10.5	20.8
25	4.9	18.2	175	105	24.5	10.8	21.4
26	5.1	18.7	182	109	25.2	11.1	22.1
27	5.3	19.2	189	112	26.0	11.5	22.7
28	5.4	19.7	196	116	26.6	11.7	23.3
29	5.6	20.2	203	119	27.4	12.1	23.9
30	5.8	20.7	210	122	28.1	12.4	24.6
31	5.9	21.2	217	126	28.8	12.7	25.1
32	6.1	21.7	224	129	29.5	13.0	25.8
33	6.3	22.1	231	133	30.2	13.3	26.3
34	6.5	22.6	238	136	30.9	13.6	27.0
35	6.6	23.1	245	139	31.5	13.9	27.6
36	6.8	23.6	252	143	32.3	14.2	28.2
37	7.0	24.1	259	146	33.0	14.5	28.8
38	7.2	24.6	266	150	33.8	14.9	29.5
39	7.3	25.1	273	153	34.4	15.1	30.1
40	7.5	25.6	280	156	35.2	15.5	30.7
41	7.7	26.1	287	160	35.9	15.8	31.3
42	7.8	26.6	294	163	36.6	16.1	31.9
43	8.0	27.0	301	167	37.2	16.4	32.5
44	8.2	27.5	308	170	38.0	16.7	33.1
45	8.4	28.0	315	173	38.7	17.0	33.8
46	8.5	28.5	322	177	39.3	17.3	34.3
47	8.7	29.0	329	180	40.1	17.6	35.0
48	8.9	29.5	336	184	40.9	18.0	35.6
49	9.1	30.0	343	187	41.6	18.3	36.3
50	9.2	30.5	350	190	42.2	18.6	36.8

* See note page 1277.

TABLE 225.—*Concluded*

5' high × 5' wide							
Length Feet	Concrete Cubic Yards		Expanded Metal Square Feet	Steel Pounds	Portland Cement Barrels*	Sand Cubic Yards	Crushed Stone Cubic Yards
	Second	Third					
20	4.0	19.5	140	93	24.7	11.0	21.8
21	4.2	20.0	147	96	25.5	11.3	22.5
22	4.4	20.6	154	100	26.3	11.7	23.2
23	4.6	21.2	161	103	27.2	12.1	24.2
24	4.7	21.7	168	106	27.8	12.4	24.8
25	4.9	22.3	175	110	28.7	12.7	25.4
26	5.1	22.9	182	113	29.5	13.1	26.2
27	5.3	23.4	189	117	30.3	13.4	26.8
28	5.4	24.0	196	120	31.0	13.8	27.6
29	5.6	24.6	203	123	31.9	14.1	28.2
30	5.8	25.1	210	127	32.6	14.5	29.0
31	5.9	25.7	217	130	33.4	14.8	29.6
32	6.1	26.2	224	134	34.1	15.1	30.2
33	6.3	26.8	231	137	35.0	15.5	31.0
34	6.5	27.4	238	140	35.8	15.9	31.8
35	6.6	27.9	245	144	36.4	16.2	32.4
36	6.8	28.5	252	147	37.3	16.5	33.0
37	7.0	29.1	259	150	38.2	16.9	33.8
38	7.2	29.6	266	154	38.9	17.2	34.4
39	7.3	30.2	273	157	39.6	17.6	35.1
40	7.5	30.8	280	161	40.5	17.9	35.8
41	7.7	31.3	287	164	41.2	18.3	36.5
42	7.8	31.9	294	167	42.0	18.6	37.2
43	8.0	32.5	301	171	42.8	19.0	37.9
44	8.2	33.0	308	174	43.6	19.3	38.6
45	8.4	33.6	315	178	44.4	19.7	39.3
46	8.5	34.2	322	181	45.2	20.0	40.0
47	8.7	34.7	329	184	45.9	20.3	40.6
48	8.9	35.2	336	188	46.7	20.6	41.2
49	9.1	35.9	343	191	47.6	21.0	42.0
50	9.2	36.4	350	195	48.3	21.4	42.8

* See note page 1277.

GRADING INSPECTION

Rough Grading.—Rough grading means all of the work preliminary to the finished shaping, and includes moving practically all the dirt that is to be handled. It is particularly important to supervise this stage of construction, as it is here that the constructing engineer regulates the placing of the best material in the center (under the metalling) and the poorest material on the sides.

In order to grade economically, the contractor and inspector should each be furnished with lists similar to those given below (Fig. 334), showing, in a convenient form, the amount of excavation

Excavation Summary					Lists
Sta. to Sta.	Exc.	Emb.	Waste	Borrow	
123	134	476	375		Remarks
134	140	206	240		
140	157	642	662		
157	178	766	629	185	
178	179	231		231	
179	186	298	244		
Detail Quantities					Remarks
Sta. to Sta.	Exc.	Emb.			
123	123+50	575	725		
123+50	124	150	900		
124	124+50	—	1450		
124+50	125	150	900		
125	125+50	320	200		
125+50	126	170	500		
126	126+50	30	925		
126+50	127	30	450		
127	127+50	260	410		
127+50	128	350	250		
128	128+50	635	160		
128+50	129	635	75		

FIG. 334.—Grading quantities.

station by station and within what bounds it is to be placed, or a mass diagram can be prepared as explained on page 997.

Cuts.—For cuts over 3' deep, slope stakes are placed and care taken that the slopes are properly carried down. If excavated beyond the finished lines, it is practically impossible to make a back-fill that will hold, and the resulting irregularities are unsightly. This is impossible where a steam shovel is used, in which case the slope is cut to the half-slope line and the upper earth plowed down to complete the lower portion in fill.

Fills.—For fill slope, stakes are set in the same manner as for cuts.¹ The earth should be deposited in thin layers, 6 to 8" deep, extending from slope to slope, and each layer well compacted

¹ Slope stakes can be located directly from the templet cross-section which is a much easier method than the railroad practice of rod and level computation.

either with a roller or by driving over it with wagons in the process of building. Where the old surface has a steep slope, it must be plowed to give a good bond with the new fill and prevent slide.

It is bad practice to build the center of the fill and then shovel loose material off of the edge to widen the slopes, as this loose side-fill is not compacted and under the action of frost will nearly always slough away from the harder central portion.

To get the full benefit of the teaming in compacting the dirt, a deep fill should be started at a point nearest the cut from which the material is hauled and each load driven over the loose layer. In this way nearly every fill can be better compacted than by the use



FIG. 335.—Fills laid in layers.

of a roller alone. For long fills where there is considerable teaming over each layer, a roller is not usually needed.

Wet clay or heavy loam should never be placed in the bottom of a fill, as it dries slowly when not in contact with the air and keeps the fill "spongy." The writer has seen cases where fills not over 3' deep have remained soft for 2 months where wet material had been used, and it was finally necessary to remove it.

For shallow fills 6" or less in depth, the underlying hard roadbed must be plowed or scarified in order to bond the new thin fill with the old surface. This applies only to the area under the pavement proper.

Transferring Grade from Stakes.—A handy level for transferring the grade from stakes to the center of the road is shown below.



FIG. 336.—String level.

If well made and properly used it will transfer the grade elevation 50' with an error of less than 2", which is close enough for this stage of the construction: Its proper use depends on its being located midway between stake and hand. If held close to the hand the grade transfer will always be low due to sag of the string.

Ditches.—The ditches must always be dug out enough to protect the center grading before the fine grading (stone trench) is completed, and it is usually cheaper for the contractor, as well as better for the road, to dig them out before the fine grading begins.

Regulation of Materials in Fills.—In fills, particularly shallow ones, the road can be greatly improved by a judicious selection of available materials. Material taken from two nearby cuts, or at different depths in the same cut, will often vary in character and the most experienced man on the job should indicate which materials to use in the center of the fill, under the metalling, and

which on the sides. The soils in the order of value for fills are gravel, coarse sand, loam, and clay. For shallow fills on a good foundation, clay should not be used under the stone, and a good material must be overhauled or borrowed. It is better to avoid overhaul if possible, as it is an item liable to be disputed as to the amount. Where it is necessary, a good practical method of determining the amount of the small quantities of earth usually needed is to keep track of the number of wagonloads overhauled from station to station.

Sod may be used in the sides of the fill but should be kept at least 3' outside of the pavement edge. It should never be used as a shoulder close to the stone or in the center of the fill under the metalling.

The author wishes to emphasize the importance of this regulation of material. At present the inspection of rough grading is often confined to keeping the sod from the center fill, and the center fill is made of dirt just as it happens along. As a result, the subgrade will vary greatly in character and if a uniform depth of stone is used over this "spotty" fill, the results are often not satisfactory, while if the depth of stone is varied to meet the subgrade conditions, an unnecessary amount of stone is used. In cases where there is no choice of earth materials, the stone depth must be made thick enough to meet the requirements of the grade. See Table 153, page 959 for macadam depths on different soils.

FINE GRADING FOR STONE TRENCH (MACADAM ROADS)

The fine grading includes the shaping and consolidation of the stone trench.

The construction shoulder must be at least 2.5' wide and well consolidated in order to hold the macadam solidly during rolling. This must be watched continually by the inspector, as it is a point often slighted.

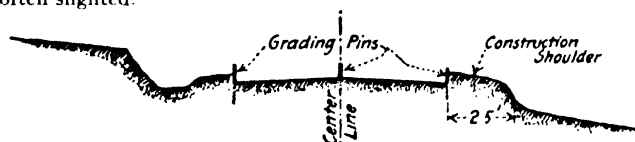

FIG. 337.

Shaping the Grade.—A simple guide for shaping the grade is shown in the accompanying sketch (Fig. 337) and consists of three strings (center and sides) stretched between pins driven at least every 50' and preferably every 25'. The pins should not be placed at intervals of more than 50', as this will cause objectionable sag in the lines and the grade will be undulating. On vertical curves at summits, the pins should be placed at from 12 to 25' intervals. The grade elevation is transferred and the lines carefully set at their proper elevation by means of a straight-edge, level and rod, or by stretching a line between grade stakes on opposite sides of the road as previously described. The string level recommended for rough grading cannot be used, as it is not sufficiently accurate.

The general level of the finished consolidated fine grade should be correct to within 1". This leeway of 1" from the figured grade makes it possible to get satisfactory results without wasting time on finical work and does not appreciably affect the total amount of excavation, as the errors tend to balance. There should, however, be no short, small irregularities of grade noticeable to the eye. Continuous inspection on shaping the grade is not necessary.

Consolidating the Grade.—Most soils when slightly moist will consolidate readily if thoroughly rolled. Clay, heavy loams or excessively fine sandy loams (quicksand) will not pack when wet. Continued rolling is injurious for these soils in this condition, as they will "work" under the roller. If they occur only in small pockets, they can be removed and replaced with good material; if in stretches of any length the grade must dry out before placing the stone. Underdrains are constructed at this time, where necessary, and the surface ditches are cleaned out and made effective. Where a hard shower has softened the surface only of a previously consolidated grade of this kind and the contractor wishes to lay stone, the surface can be hardened by spreading a thin layer of gravel or waste $\frac{3}{4}$ " stone and rolling into the earth. This will help in preventing the stone teams from cutting up the grade.

Gravels and finely pulverized clay, or clay loams (deep dust), will not consolidate when dry; such material must be thoroughly sprinkled to get a compact grade. It is not, however, customary to sprinkle coarse gravels, even if slightly loose, as no objectionable results follow from placing stone on such a grade; deep clay or loam dust is objectionable and must be sprinkled.

Coarse sand makes an ideal foundation but is hard to keep in shape while placing the first layer of stone. In some cases sprinkling will harden it sufficiently; in others a layer of fine loam has been spread over the sand and flushed in with satisfactory results. Sometimes where loam is not available, a cheap cheesecloth has been spread over the top of shifting sand to prevent the stone from punching in too much under the roller. The author has never encountered any coarse sand that could not be satisfactorily treated by sprinkling and covering with 1 or 2" of $\frac{3}{4}$ " stone; the blanket of $\frac{3}{4}$ " stone prevents the sand from squeezing up into the loose bottom stone and spreading the fragments.

While coarse sand makes a good foundation, a fine sand or sandy loam approaching quicksand is very treacherous; it is difficult to judge the degree of fineness at which a sand becomes treacherous, particularly when it is dry. A sieve test can be made (not over 30% should pass a 100 sieve), but a good practical method in the field is to saturate the material thoroughly with water; a satisfactory sand becomes more compact while an exceedingly fine sand gets "quaky."

SUBBASE MACADAM ROADS

Determination of Stone Depths and Construction of Subbase. Practically the only engineering problem that the constructing engineer has to solve is that of foundations. It is recognized by most designers and estimators that it is impossible from even a

careful preliminary examination of the soil to specify exactly the amounts and depths of foundation stone. To meet this an extra quantity of subbase or bottom stone is allowed the constructor, to be used as he sees fit. During the progress of the rough and fine grading the exact limits of the different kinds of subgrade soil are determined and the stone depths varied according to his judgment (see p. 437). Men that really understand this part of the work are hard to get, as it is only from extended experience and intelligent study of their own failures and successes that a sound judgment is developed. An examination of Table 153 (p. 959), will help a beginner. A good constructing engineer is much more difficult to find at present than a good technical designer.

Where subbase is used, the subgrade is dug out to the required extra depth and rolled if it is in such shape that it will not "work." Peat, muck, wet fine sand or wet clay cannot be rolled until the subbase is placed and filled. Where it is possible, such soils should be drained and allowed to dry before placing the base, but it is often not feasible to dry them enough to allow rolling, even though underdrainage is put in, which partially hardens them and successfully protects the road after the stone has been placed. This is particularly true on flats where it is hard to get an outlet for a drain or in the fine sands on which an underdrain has little effect on account of the capillary action of the material. Where a soft subgrade of this kind is encountered, a stony gravel makes the best subbase, as it contains no voids between the larger fragments and when rolled the soft underlying material cannot squeeze up through the course. In case boulder or quarry-stone base is used on a soft grade, it is necessary to lay them in close contact by hand and then fill the voids completely with gravel or stone before rolling; otherwise the subgrade material would squeeze up between the stones, separating them and partially destroying the efficiency of the base.

In the spring and fall of the year it is common to find good material so saturated from long-continued rains that it acts badly under the roller, and instead of waiting for the grade to dry out, when the normal thickness of stone would be sufficient, subbase is often put in either to help the contractor so that he will not be delayed or because the engineer is misled as to the character of the material. This results in a waste of money. On the other hand, clay, when thoroughly dry, is hard and firm, which often influences a new man to omit subbase where it will surely be needed.

The use of subbase should not depend too much on the action of the grade under the roller unless the degree of saturation of the material is considered, although it serves as a guide in locating doubtful spots. The final determination should depend on test pits or bar and core soundings, which develop the character of the underlying material. See Table 153, page 959, for macadam depths on different soils.

The subbase is constructed, as explained under Foundations, page 430, either of gravel, boulder or quarry stone. The depth is gaged by lines. The ratio of loose to rolled depth is given on page 1132.

Continuous inspection is not needed on subbase; the depth of grading is checked before the stone is placed and the width, depth, and workmanship can be readily determined after the base is completed, and by an occasional inspection during the progress of the work.

Bottom Stone.—The earth subgrade must be firm and compact before the stone is spread. Bottom stone must never be laid on a soft grade. One of the most common slips of inspection is to allow this to be done, and the result is a "punky" bottom course that is never up to standard. The distributing power of this course depends largely on the stone fragments being firmly interlocked; if the stone is placed on a soft grade and rolled, the earth will squeeze up between the fragments and separate them.

The depth of the loose stone is gaged by the lines or cubical wooden blocks placed on the subgrade. Blocks are more convenient than lines except over subbase of stone fills, where lines must be used to get a spread true to shape and grade. The ratio of loose to rolled depths is given on page 1168. It is impossible properly to consolidate more than $6\frac{1}{2}$ " of loose stone. If the depth of bottom course is greater than 5" consolidated thickness, it must be laid, compacted, and filled in two or more layers.

The loose stone is rolled until the stones are solidly interlocked and there is no movement under the roller. *A single 10 ton, 3 wheel roller can properly consolidate and fill about 100 to 125 consolidated cu. yd. per day of 10 hours.* A thin layer of satisfactory filler (see Materials, p. 715) is spread over the top, rolled, and broomed in; the process is repeated until the stone is thoroughly filled. Continuous inspection on bottom course is not necessary. The widths and depths can be readily checked by occasional inspection. The three points to be carefully watched during construction are: (1) that the grade is firm, (2) that the loose fragments are thoroughly rolled before the filler is applied, and (3) that the finished surface is true to shape and grade, as a permanently smooth top course cannot be constructed over a humpy bottom; the top course must be uniform in thickness. A great many inspectors believe the contractor when he tells them that he can smooth up the job with the top course. He can temporarily, but the second-season result is hell.

It is desirable to complete the bottom course well in advance of the top, in which case the contractor can work to advantage after rains, and the course will be better compacted by subjecting it to some traffic action.

Where local stone is crushed on the job and the stone used ranges in size from 1" to tailings, care must be used in spreading that the sizes are well mixed, as pockets of fine or coarse stone are objectionable. The simplest method of mixing is to run the different sizes into one bin at the crusher; if they are separated they can be well mixed by loading one end of the wagons with the $1\frac{1}{4}$ to $2\frac{1}{2}$ " and the other end with $2\frac{1}{2}$ to $3\frac{1}{2}$ ", and when dumped on the grade they will run together. When difficulty is experienced with these methods in obtaining a well-mixed stone spread, the loose stone can be harrowed. Many specifications call for harrowing thor-

oughly where a large range of crushed-stone size are allowed in one course. If possible, tailings should be used as subbase. When used in the bottom course having a rolled depth of 4 or 5", they should be placed in the lower part of the course, but for a 3" depth they should be placed on top and broken with a knapping hammer into fragments of less than 3½".

The filler should not be dumped directly on the stone unless absolutely necessary. Drawing the loads onto the unfilled stone loosens the course, and, also, at each pile of filler there is apt to be left an excess which is hard to clean off.

The approximate amount of filler required per 100', and the spacing of 1½-yd. loads are given below. The amount varies for the different materials used.

TABLE 226.—GIVING THE APPROXIMATE AMOUNT OF FILLER REQUIRED PER 100' OF ROAD FOR CRUSHED STONE MACADAM BOTTOM COURSES OF DIFFERENT WIDTHS AND DEPTHS, USING 0.35 CU. YD. OF FILLER PER CUBIC YARD OF ROLLED BOTTOM (In cubic yards)

Width of macadam, feet	Rolled depth of bottom course, inches			
	3	4	5	6
10	3.2	4.3	5.4	6.6
12	3.8	5.1	6.5	7.6
14	4.5	6.0	7.5	9.0
15	4.9	6.4	8.0	9.9
16	5.2	6.9	8.6	10.4
18	5.9	7.9	9.7	11.8
20	6.4	8.6	10.8	12.8
22	7.0	9.4	11.8	14.2

TABLE 227.—GIVING THE APPROXIMATE SPACING OF 1.5-CU. YD. LOADS OF FILLER FOR THE WIDTHS AND DEPTHS SHOWN IN THE PRECEDING TABLE (In feet)

Width of macadam, feet	Rolled depth of bottom course, inches			
	3	4	5	6
10	46	34	27	23
12	40	30	23	20
14	33	25	20	17
15	31	23	19	15
16	29	22	17	13
18	25	19	16	12
20	23	18	13	11
22	21	16	12	10

Grading and foundations have been treated at some length, as they are the most difficult parts of the construction.

Pit-gravel Bottom or Subbase Bottom.—A stony gravel containing not over 15% of loam makes a satisfactory course; the depths vary from 4 to 18"; pit or creek gravel even when unusually coarse has from 40 to 60% of fine material; a suitable gravel for pit-run bottom should not contain more fine material passing a $\frac{1}{4}$ " screen than coarse material retained on a $\frac{1}{4}$ " screen. If there is a large excess of fine, the gravel should be screened and remixed at the bin in proper proportions.

The great difficulty in this construction is to get proper consolidation without too much delay. It is advisable to lay a course of this kind at least 2 weeks ahead of the top stone in order to give traffic and rains a chance to help consolidate the course. The addition of 10% of loam to clean gravel will quicken the consolidation. This can be done either at the pit by leaving a thin layer of loam, when stripping, which runs down with the gravel in loading or by placing from $\frac{1}{2}$ to 1" of loam on top of the gravel as spread on the road. The author has succeeded in getting rapid consolidation by snatching loaded teams over the loose course with the road roller; the roller continually smooths out the gravel and eases the haul for the teams; the horses' hoofs and wagon wheels punch into the gravel and pack it down rapidly. Sprinkling helps. A gravel bottom consolidates unevenly and it is always necessary to reshape it somewhat after consolidation; about 10 cts. per cubic yard should be allowed for this reshaping of crown and elimination of humps and hollows. A properly consolidated gravel bottom will permit a 4-ton load on 3 $\frac{1}{2}$ " tires passing over it without making a wheel mark over $\frac{1}{8}$ " deep; this is a simple available construction test. We have gone into some detail covering this construction as it is the most economical type of bottom in a large number of cases but is not generally favored because it is harder to consolidate than the other types of bottom. With a 3" or preferably a 4" macadam top it has proved perfectly satisfactory on Class III and IV traffic roads.

The depth of gravel is gaged by blocks or lines and the ratio of loose to rolled depth is approximately 1.20.

Water-bound Top.—Water-bound top is constructed in the same way as the bottom course except that stone dust is used for a filler and the course is puddled as has been described (see Specifications, p. 1454).

If the stone used is a local stone crushed on the job, the output of the crusher must be carefully controlled, especially when selected boulders are used, as it is very important that the size and quality of such stone shall be uniform.

Materials Required.

For amount of limestone screenings, see page 1168.

For amount of stone required, see page 1168.

For ratio of loose to rolled depths, see page 1168.

For suitability of materials, see page 440.

For amount of water, see page 1172.

Imported stone can be inspected on the cars. Aside from this, comparatively little inspection is required except at the stage when the loose stone has been rolled and before the screenings are spread. At this time the inspector should examine the rolled course very carefully to see that it is true to shape and has no short depressions or humps. The smooth-riding quality of the road depends on this inspection and too much care cannot be taken. This point is particularly emphasized, as many stone roads have been criticized as rough for automobile traffic. Any depressions are filled with stone of the same size as the body of the course and rolled, after which the course is again inspected and corrected until it is made true. The screenings are then spread, broomed in dry, and puddled. In puddling use plenty of water and roll rapidly. If a pipe line and hose are used, a pressure of 100 to 125 lb. at delivery should be maintained. The road can be conveniently puddled in stretches of 100 to 200'.

After the road has dried out and been open to traffic, if raveling occurs, it can usually be remedied by light sprinkling and rolling.

Where the top course is granite, gneiss, or trap, it is often necessary to use a certain percentage of limestone dust with the normal screenings. The limestone is more effective when spread last, filling the top voids of the course.

Bituminous Macadam: Penetration Method.

Amounts of material, see pages 446 and 1141.

The main points to be controlled in bituminous-macadam top are:

1. Proper size of stone.
2. Uniformity of spread.
3. Proper depth of spread.
4. Proper preliminary rolling and truing up of stone spread.
5. Proper heating and spread of bitumen.
6. Insistence on thorough final rolling.
7. Construction inspection records.
8. See also Specifications (p. 1458).

Under careful inspection, a top course of this type is smooth riding and should not develop inequalities of surface over $\frac{3}{8}$ " in 10'.

Practically all the inspection items have been discussed, but for convenience of readers who merely refer to this paragraph without following through the discussion in Chap. VI the essentials will be repeated.

A uniform-sized clean grade of coarse stone is important; $1\frac{1}{4}$ to $2\frac{1}{2}$ " is usually specified and the inspector must examine all rail shipments during unloading and as delivered on the road to see that not over 15% of the stone as spread is less than $1\frac{1}{4}$ " in size. Undersized or non-uniform stone should be rejected. In spreading the stone, small pockets of fine stone which always occur at intervals even with the best grade of aggregate must be dug out and replaced with well-graded aggregate. The depth of the loose spread must be checked. The depth of spread is usually regulated by cubical blocks of wood resting on the subgrade. The amount of stone used can be checked by railroad weights if imported stone

is used. For the proper amount of coarse aggregate, see page 447. After the preliminary rolling, a careful inspection of the course should be made for humps or hollows. This is the proper time to eliminate such defects, and all inequalities in the surface must be corrected by removing a small amount of the stone or adding additional $1\frac{1}{4}$ to $2\frac{1}{2}$ " size and rerolling. Inequalities never can be fixed by the addition of small-sized stone. Stone spread does not require continuous inspection, as all faults can be detected by examination at any time before the bitumen is applied.

A careful check must be kept on the temperature of the bitumen, as overheating is very injurious and underheating spoils a free-flowing spread. Temperature should be tested with a thermometer at short intervals, but after a little practice the inspector can tell by visual inspection whether the temperature is proper. If too hot, a heavy white smoke develops on pouring. If too cold, the bitumen pour is a rubbery-like sheet. Maximum and minimum temperatures are given in all specifications and vary for the material used. The inspector must reject all overheated material as too many failures have resulted from carelessness in overheating.

In applying by whatever method, care must be exercised to prevent frequent cases of overlap, as waves or humps develop at these points. These defects do not appear for some time after the road is opened for traffic and the inexperienced inspector fails to realize the necessity for care in this particular. As soon as the bitumen is spread, the inspector must examine the spread carefully, and where pools of bitumen occur (a few cases will always occur even with the greatest care), the entire top course (stone and all) must be removed and replaced with new stone, tamped or rolled, and repoured. Lean spots should be given a little extra bitumen. The inspection of bituminous application must be continuous and is vitally important in the success of the pavement. Specifications generally state that the stone must be clean and dry. Bitumen should not be spread if the stone is dirty, but practically a slight dampness is not injurious. It should not be wet but a slight dampness does no harm; a practical test is that there must be no pools of water in the bottom of the course and the stones must not be so damp that a hissing sound is produced when the bitumen is applied at a temperature of 300 to 340°F. In the writer's opinion, the air temperature should not be less than 50°F., as bitumen applied in cold weather is so chilled when it strikes the stone that an excessive amount is retained on the surface. As soon as the bitumen is applied, a thin layer of $\frac{3}{4}$ " stone is spread over the surface and rolled lightly; continued rolling at this point is injurious, as freshly laid bituminous tops tend to shove under the roller and form waves. The road can be thoroughly rolled and shaped to advantage only after the bitumen has had some time to harden. Good results have been obtained by rolling thoroughly the succeeding day after the binder is applied unless in the meantime rain has saturated the course, in which case it must be allowed to dry before rolling. In the author's opinion, the best method of rolling is to roll twice over lightly each morning for 10 days and gradually bring the road down to a hard firm surface

giving it a very thorough final rolling at the end of a week or 10 days. The roller must not be reversed suddenly. It must run easily to rest and start gradually. Before rolling is started the $\frac{3}{4}$ " stone should be spread evenly and any excess broomed off.

One roller can handle an average of approx. 80-100 cu. yd. consolidated top per day. If the rate of spread exceeds this amount additional rollers will be required. Rollers should be the 3 wheel type of at least 10 tons weight.

The amount of bitumen spread per square yard is usually controlled by spreading a given number of pots or hods or tanks in a given length of the road. These units of length can readily be marked off by the inspector with a stick or tape. This method will be satisfactory if checked up twice a day by the number of barrels used. When the binder is heated in small kettles, it will sometimes catch fire, but this is usually due to scale which has collected in the tank, and if cleaned out, it generally remedies the trouble. Bitumen has different volumes at different temperatures (see following table). The inspector should bear this in mind; the rate of application generally applies to 60°F., so that a correction is necessary if tanks are rated by volume capacity at spreading temperatures of 250 to 350°F. The simplest method of measurement and payment is by the pound or ton weight unit bases. A volume-correction table follows.

TABLE 228

To 400°F. is approximately 12% volume increase
To 350°F. is approximately 10% volume increase
To 300°F. is approximately 8% volume increase
To 250°F. is approximately 6% volume increase
To 200°F. is approximately 4% volume increase
To 150°F. is approximately 2% volume increase
To 60°F. is approximately 0% volume increase

Where bituminous materials are heated by steam it is often convenient to know the temperature of steam at different pressures; the following table is inserted for this purpose.

TABLE 229

Pressure gage, pounds per square inch	Temperature of steam, degrees Fahrenheit	Pressure gage, pounds per square inch	Temperature of steam, degrees Fahrenheit	Pressure gage, pounds per square inch	Temperature of steam, degrees Fahrenheit
15 ¹	213	100	328	200	382
20	228	120	341	220	390
40	267	140	353	240	397
60	293	160	363	260	404
80	312	180	373	280	411
100	328	200	382	300	417

¹ Normal air pressure, 15 lb.; to get ordinary steam gage reading subtract 15 lb. from the values given in this table.

INSPECTION RECORD FORM

Name of Road: Pittsford-NaplesDate: July 21, 1922Inspector: John DoeEngineer: Richard RoeContractor: John Smith

Record of Inspection

Bottom course: Examined and approved Sta. 125 + 50 to 140 + 00.
Two depressions Sta. 135 + 20 and 137 + 30 filled in
with No. 3 stone rolled and filled.

Top course, stone spread: Sta. 125 + 50 to 131 + 25 examined and
approved; no corrections necessary for depth
or uniformity.

Binder coat (asphalt): Sta. 119 to 124 + 10.

Official acceptance, dated July 1, 1922.

Method, hand spread.

No. sq. yd. covered, 910.

No. gal. used, 1,650 ±.

Rate of application, 1.8 gal. per sq. yd.

Temperature, Max. 340°, Min. 290°

Air temperature, 60° to 80°.

Seal coat:

None used on this road.

Finish rolling:

Sta. 85 to 90.

Routine rolling 90 to 126.

Remarks: 40 gal. bitumen rejected on account of overheating small amount
left in one kettle.

Signed,
JOHN DOE

CEMENT-CONCRETE PAVEMENTS

Amounts of material, see pages 461 and 1145.

"Manipulation of Concrete. Inspection Details.—The following quotation from New York Instructions (1923) outlines the main points to be considered in connection with concrete pavement construction:

ONE COURSE PLAIN AND REINFORCED CONCRETE

"The fundamental requirements to be followed in building a plain or reinforced-concrete pavement according to our Standard Specifications are:

1. Properly prepared subgrade.
2. Thorough and complete drainage system.
3. Full depth of pavement.
4. Full cement content.
5. Clean and well-graded aggregates.
6. Proper proportioning of aggregates.
7. Accurate water measurement.
8. Mixing interval to be at least 1 minute.
9. Placing reinforcing material as specified.
10. Proper compaction of concrete.
11. Staking joints securely and placing them exactly perpendicular.
12. Finishing at the proper time and according to specifications.
13. Curing for the full period called for in the specifications.

"The surface of this type of pavement can be made even and true and free from waves, irregularities, and uneven joints. When defects are found, they are the result of lax inspection and poor workmanship.

"**Preliminary Preparation.**—Before starting to lay the concrete pavement, the inspector must see that the contractor has his concrete mixer, subgrade tester, roller and belt or finishing machine, split float and bridge for finishing at joints, straight-edge, template for reinforcement, edging tools, stone forks, charging conveyances (of uniform size), measuring boxes, steel bulkheads, forms, pins for staking, striking template, reinforcing fabric in flat sheets, expansion-joint material in straight full or half lengths,

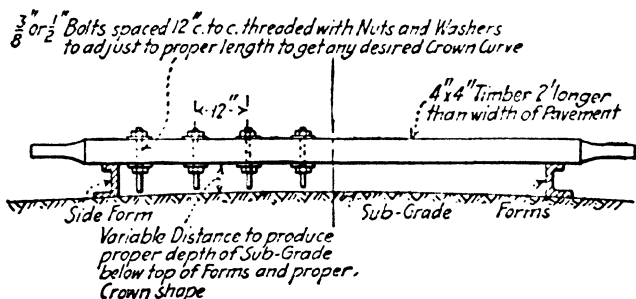

Sub-grade tester.

FIG. 338.—Sub-grade tester.

covering canvases and forms for same. The mixer must be equipped with timing and water-measuring devices, as well as satisfactory charging skip and discharging chute or bucket as specified. It is necessary that all this equipment, tools, and material be first class and approved by the division engineer before the work of placing concrete wearing surface may be started and that they be kept in first-class condition during the progress of the work.

"**Aggregate.**—The fine and coarse aggregate shall be well-graded, clean products which have been tested and approved by the engineer of tests before being used in the work.¹ Field tests must be made daily for sizing, loam content, and organic impurities. The inspector must watch carefully the materials as they are delivered to the work and in case of rail shipments must have an understanding with the contractor that he must be notified in order that the cars can be inspected for acceptance or rejection before unloading.²

"Each material must be kept clean and not allowed to become mixed with dirt and other materials. Fine aggregates must be

¹ See Chapter II for test methods.

² Central batching from large stock is generally specified to prevent dirty aggregate.

shoveled and coarse aggregates forked from the tops of the piles in order to minimize the chances of picking up dirt. Aggregates that cannot be forked or shoveled clean must be rejected.

"Frequent visits should be paid to the sand pits and quarries, especially those in which there are questionable materials. In stone quarries, consideration must be given to stripping and the disposal of unsatisfactory waste. Screen openings must be checked and the proper facilities adopted that will insure a thorough mixture of sizes.

"Cement must be carefully stored and kept dry. Under no conditions shall it be placed on the ground. Samples of each car, when not tested at the plant in accordance with instructions, must be sent to the laboratory. Pending a report the cement cannot be used.

"Forms.—Forms shall be erected only after the subgrade has been properly prepared. The subgrade tester shall be operated from these forms in accordance with the specifications to insure the proper depth for the pavement at all points. The subgrade tester must remain at the mixer at all times and must be used at each move of the mixer. *[This stipulation is not always feasible. It is better to check the grade with the tester for a hundred feet ahead of the mixer and then correct any small rutting due the teaming or moving the mixer by eye. A tester under the mixer boom is an abomination.]* It always must be used in a vertical position and when being moved shall not be raised from the side forms. A string level should never be used in setting side form. A suitable true straight-edge and 3' carpenter's level must be used and the level must be checked for accuracy by reversing it.

"Only straight, substantial, and clean forms shall be used. Wood forms should only be used for curves of less than 150' radius. All unsatisfactory or rejected forms shall be removed from the work.

"Wooden forms must be used on curves of 150' radius and less. Sawcuts shall be made at frequent intervals to obtain the necessary true curvature.

"All forms must be oiled or greased each time before use. Straightening must be done whenever necessary.

TABLE 230.—MIDDLE ORDINATES FOR STRING LINING CURVES, IN INCHES

Length of chord in feet along gage.....	100	98	93	87	82	76	69	62	58
Middle ordinate for 1° curve	2 $\frac{5}{8}$	2 $\frac{1}{2}$	2 $\frac{1}{4}$	2	1 $\frac{3}{4}$	1 $\frac{1}{2}$	1 $\frac{1}{4}$	1	$\frac{3}{8}$
Length of chord in feet along gage.....	53	49	44	38	35	30	25	20	15
Middle ordinate for 1° curve	$\frac{3}{4}$	$\frac{3}{8}$	$\frac{3}{8}$	$\frac{3}{8}$	$\frac{3}{8}$	$\frac{3}{8}$	$\frac{3}{8}$	$\frac{3}{8}$	$\frac{3}{8}$

To get middle ordinate for any curve multiply the value given by the degree of curvature of the curve in question.

"Forms must be set accurately and substantially. Poor line and grade are not only annoying in appearance but result in uneven surfaces and indicate careless work. Forms shall be protected against any disturbances such as dumping materials.

"The subgrade must be brought to a true elevation and rolled to a width of at least 18" outside of the form line. The practice of blocking up forms on stones where the subgrade is low and afterwards tamping a loose dirt fill inside and along the form must never be allowed. If the subgrade is found to be too low after forms are placed, they must be removed, the subgrade brought to the proper elevation and rolled for the required width before the forms are finally reset to a full and even bearing on the subgrade.

"Two hundred feet on both sides must be set at all times in advance of the mixer. There shall be string line stretches on one side, then checked by eye in order to detect any irregularities. Special attention should be given to joints in forms, and when tops of forms do not coincide at these points, the forms should be rejected. Short curves and parts of the tangents should be laid out at the same time in order to get an intelligent check. Middle ordinates for various lengths of chords for the different curves should be at command, in order to eliminate kinks and uneven curves.¹ A line of forms shall be securely staked to this string line and then the opposite side is placed. Care must be used to get the proper width and elevation for opposite forms.

"Curves shall be widened and superelevated in accordance with standards when indicated on the plans.

"Grades as shown on plan shall be on the normal center line of the roadway on superelevated curves. No concreting shall start on a widened curve until forms are erected and checked on both sides.

"All forms must be removed within 24 hr. after concreting.

"The inspector should carefully examine the edges of the pavement immediately after the removal of the side forms and, if concrete is honeycombed, have it sealed with cement-sand mortar, afterward insisting on a more adequate spading of the concrete adjacent to side forms.

"Measuring Devices, Checking Quantities and Composition.—Proportions shall not be varied for any reason without approval of the division engineer. The correct measuring of all materials is essential in securing satisfactory work.

"The contents of all proportioning boxes and batch boxes must be determined by accurate measurements and such changes as are necessary in regulating the proportioning must be made prior to beginning operations.

"The inspector must keep accurate check on the amount of cement used and maintain a daily record of the length of pavement laid and the quantities of cement required and used.

"The inspector shall arrange for the weighing of an occasional bag of cement to see that they contain 94 lb. net (with an allowed variation of 5%) and must be sure that the man dumping cement shakes the bag well in order to get the entire amount out of the sack.

¹ See page 1301.

"The number of empty bags must be counted about every 2 hr. and then placed in separate piles or removed from the work. This method will relieve accumulation of any shortage or excess.

"The use of industrial systems will require one inspector at the material yards. Cars on which the aggregates are measured direct must have separate and vertical compartments for each kind of aggregate and must be of the exact size of the batch in order to insure correct proportions.

"Combined aggregates shall not be permitted to be measured in vertical containers of one opening. In this case especially arranged measuring devices must be used for each aggregate from which the container can be filled.

"Care must be used in protecting the cement against wind during the loading process. If necessary, erect a canopy. In cars when the cement will be exposed, lids or covers must be used at all times. Under no conditions permit cement that cannot be used immediately to be loaded on industrial cars.

"Some jobs will require different methods from these, depending on the contractor's equipment. Consideration must be given and if there are any unusual features, the division engineer should be called to the work for final decisions as to the method to be used by the inspector.

"**Consistency.**—The consistency of concrete is very important because the strength is greatly reduced by the use of excess water. Only sufficient water shall be used that will form a concrete similar in consistency to moist (not wet) earth when a finishing machine is used and quaking wet for hand finishing.¹ The inspector must note the moisture of the sand in order to vary, whenever necessary, the amount of water. (See also pp. 461 and 744 for consistency and slump tests.)

"The contractor shall be required to have a glass gage on the mixer in order visually to determine the quantity of water for each batch. Examination must be made of all valves and pipes in the mixer to detect leaks which cause non-uniform amounts of water per batch.

"The concrete shall be particularly dry for finishing-machine work. A wet concrete will not only be low in strength but a scale of mortar may be formed which will peel off in course of time under traffic. Frequent examinations throughout the day's work should be made in the recently finished concrete by inserting vertically a blunt end of a pencil in the surface in order to detect excess mortar. There should be only sufficient mortar completely to cover the coarse aggregate.

"Non-uniformity in the consistency of the concrete results in uneven surfaces; therefore, the inspector must correct at once faults in the water-supply system of the mixer and not allow the work to proceed until these faults have been found and corrected.

"After the pavement is finished and before it hardens, be sure that no stones project above the surface or that the surface appears

¹ Avoid extremely dry concrete, as under the usual inspection better results are obtained with a fairly easy-flowing consistency.

honeycombed. Have these faults corrected by using a hand float or the reapplication of the finishing machine.

"Mixing."¹—The concrete mixer must be equipped with approved timing and water-measuring devices and an approved device for discharging the concrete, all of which must be kept in workable

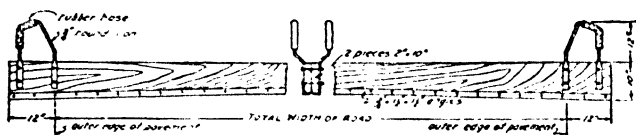

FIG. 339.—Screed strike board.

condition at all times. The time, as noted in the specification, must be strictly adhered to. The concrete must not be discharged until the full time has expired. At frequent intervals the inspector should check the time of mixing. The time of mixing shall be measured from the time the last material enters the drum from the loading skip until the first material is discharged into the bucket.

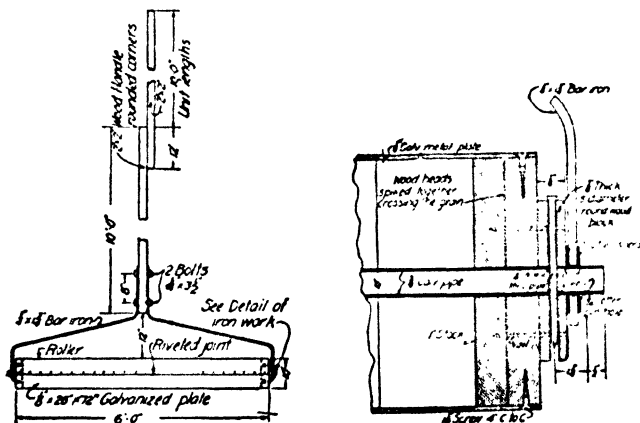

FIG. 340.—Detail of roller.

"The skip shall not be dumped into the mixer until the previous batch has been entirely discharged; otherwise non-uniform mixes will result.

"Placing."—Concrete shall be placed only on a subgrade which has been tested by means of a subgrade tester placed at the discharge end of the mixer. The subgrade must be firm and smooth and all

¹ For effect of time of mixing on strength, see Chapter VI, page 475.

loose material removed. Loose material along the forms must be removed by means of a square-point shovel or spade.

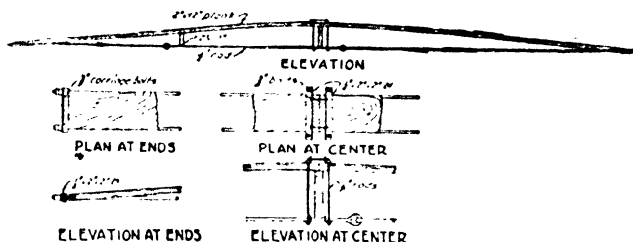

FIG. 341.—Finishing bridge.

“The first layer of concrete shall be deposited to the depth of fabric reinforcing, 2” below the surface of the pavement and struck

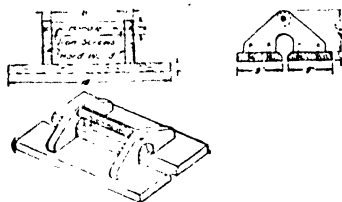

FIG. 342.—Split float.

off with an approved template. Rod reinforcement shall be placed 3” from all transverse expansion and construction joints and at a depth equal to 2”.

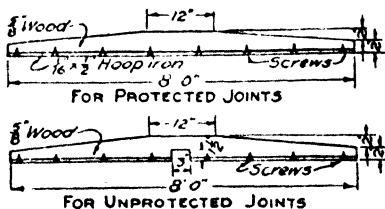

FIG. 343.—Testing straight edge.

“The fabric reinforcement must be perfectly flat when placed in the work. If furnished in rolls, it must be flattened by the use of a machine. The fabric must extend to within 2” of all sides and must be lapped as specified. It must be protected before use from

the weather except as required from day to day. Under no condition shall it be stored in the open, especially during the winter months.

"The fabric reinforcement is placed 2" below the surface. A striking template insuring a 2" depth must be used.

"After the placement of fabric reinforcement, the remaining 2" of concrete is placed. It must be placed of sufficient depth to have a slight excess ahead of the strike board for finishing. Do not permit the workmen to walk on this concrete after the initial spreading.

"Evenness of finished pavement surface is insured by the proper even spreading and distribution from the drop bucket of the mixer. Uneven distribution and attempts to fill in low places with mortar results in a wavy surface which is detected only after the mortar has hardened.

"**Finishing.**—As soon as the full depth of concrete has been spread, it shall be struck off, either by a hand template or approved finishing machine. A slight excess of concrete must be maintained ahead of the strikeboard. Depressions and holes must be filled with concrete, not mortar, and must be retamped.

"A hand template must be of specified length and weight. It shall be first worked in a crosswise movement and then followed by tamping, to insure a proper cross-section and the imbedding of coarse aggregate. The template shall be operated until within 2' of an expansion joint, and then lifted to the joint and worked back from the joint. Excess mortar and concrete must be carefully removed and in no case be permitted to remain. Templates (both hand and finishing machine) must be checked frequently for crown.

"Immediately after tamping, the sides must be spaded continuously in order to prevent honeycombed sections and to insure satisfactory edging. Any excess mortar or concrete must be removed. The sides along the bulkhead and filler must be spaded to insure dense surfaces and to ease the lifting of the bulkhead against raising the filler.

"Hand tamping shall be followed by a roller of standard dimensions and weight. The use of roller must not be delayed until the surface is partially set; otherwise the concrete will be lifted. Too early rolling will remove too much mortar and not water. The roller must be moved slowly, not to exceed 16' in 40 sec., and must be passed over and back, the roller then being lifted and advanced one-half its length, the rolling operation then being repeated. The first rolling must proceed from the end of the slab first laid, and free water must be allowed to come to the surface between each rolling. The roller must be wetted after each operation and kept clean and true in form.

"Belting of the surface shall follow. The belt shall be kept moist or oiled and cleaned at all times, in order that the full width can rest on the pavement. The belt must not be so heavy as to mark the finished surface. The belt shall be operated in a crosswise movement, so that any part for the total and breadth rests on the pavement.

"There should be two beltings. The first must be slow to take out irregularities, remove excess water and smooth out the surface. The second shall be a little faster in the forward motion to give the finish and prevent markings. Never permit a belt to remain on fresh concrete.

"Approved finishing machines may be used in place of hand work. When such is the case, it is necessary for the contractor to have equipment for hand work which can be resorted to in the case of a breakdown in the finishing machine.

"In the use of a finishing machine there is a tendency of the operator to perform too many operations with the result that excess mortar accumulates. The operator should be so instructed and trained as to finish the pavement with one or two strikings, one or two tampings, and two beltings. The parts of the machine for all operations must at all times be regulated to insure contact with the surface at all points. The belt must be kept moist.

"On grades exceeding 3%, the surface of the pavement must be rolled with a hand roller following the passage of the finishing machine in the manner prescribed for finishing by hand.

"One of the most frequent defects in finishing-machine work is that of irregular wavy surface. This is frequently caused by the machine moving too fast, the use of the machine for spreading by carrying an excess of material in front of the blade, failure to feed properly sufficient material by hand to the tamper and most often by running the tamper while the machine is not moving. The finishing machine should move forward at a uniform rate of speed. The blade should not be used for moving any considerable amount of material, only sufficient material being kept in front of the blade to produce a full section. After the finishing machine has come to a stop, before the tamping is resumed, the machine should be moved back a few feet and then started forward, and the tamping not resumed until the machine has moved forward for at least 1'.

"Edging shall not be done too early after the belting.

"Curves shall be widened and superelevated where necessary. On transitions, intermediate pins must be set exactly at grade at beginnings and endings, together with one or two between sections.

"The finished crown should be checked frequently by using a string and small blocks the height of the crown, the blocks being placed on the side forms and a string stretched from top to top of blocks. To insure a proper crown it is frequently necessary to have the template shaped to an arc $\frac{1}{4}$ " greater than the required crown to offset the slump of the concrete during hardening.

"**Joints.**—All expansion and construction transverse and longitudinal joints must be vertical, level, and free from irregularity. Irregularities caused by improper and careless work produce defects in the pavement such as one slab rising higher than the other and additional cracks.

"Before using joint filler, it must be checked for all dimensions and quality. Many poor results are obtained by joints that are too short and of insufficient depth. Shearing of the edges and sides of concrete under expansion ruptures the concrete and causes spalling.

"Joint filler must be furnished in flat sections. No brand of filler shall be used unless approved by the engineer of tests.

"Only when indicated in the specifications may minimum lengths be connected as one continuous length. These short lengths must be joined by lacing, staples or other suitable means before being installed.

"The steel bulkhead shall be of exact dimensions and oiled or greased at all times. The workman shall be required to lay it on a flat area when not in use, in order to keep it perfectly straight. Any kinks must be straightened immediately after being noticed. It shall be firmly staked on the side towards the mixer with iron pins, the number and length depending on the subgrade conditions and methods of finishing. The joint filler shall be set on the side of the bulkhead away from the mixer.

"A steel bulkhead against which the expansion joint filler is placed must be firmly supported by at least 10 iron pins, 12 to 18" in length depending on the subgrade; 5 pins along both sides of the bulkhead and filler with 2" below the surface.

"These pins must be long enough and are to remain in place in order to insure straight joints in all directions. When joint filler is placed directly against hardened concrete, 5 pins shall be used on the side away from the concrete.

"The joint filler shall be set just flush with the pavement.

"A small amount of spading shall be done along the oiled or greased bulkhead in order to ease removal. The bulkhead shall not be removed until at least 10' of concrete has been placed ahead and the striking and tamping has been done on either side or immediately over it. No striking or tamping shall be permitted after the bulkhead is removed, other than just enough tamping with a rod to fill the cavity left by the bulkhead. The bulkhead shall be removed by raising opposite ends at the same time through holes in either end, into which hooks are inserted.

"After the removal of the bulkhead on hand-finished work when the filler is higher than the surface, a split float or straight-edge in accordance with the standards shall be used, after which the edging tool of $\frac{1}{8}$ " radius is operated on either side.

"For finishing machine work, where the filler is slightly raised or flush, the edges shall be rounded with the above radius tool. All joint finishing shall be done by a skilled workman from a finishing bridge. On no work shall connected concrete be permitted to remain over the filler, as this condition causes serious spalling under traffic. Edging is to be done along construction joints with the $\frac{1}{8}$ " radius tool.

"The belt should be operated immediately on each side of the joint so as to give a uniform appearance to the entire surface.

"The surface of pavement adjacent to joints must be finished with the utmost care by an experienced workman in order to obviate uneven joints which induce an uneven, bumpy riding surface. The 6' straight-edge must be used in testing all surfaces adjacent to joints prior to the last belting of the surface, and when the surface is uneven it must be corrected.

"As soon as the forms are removed, investigation must be made to determine if any fillers do not extend entirely through from one side to the other. If not, the contractor shall open the connected sides by means of a chisel. Under no condition permit shoulder material to be deposited along the sides until there is positive assurance that the joints are open.

"Protection.—The surface shall be protected with canvas as specified. The canvas shall never be dragged over the surface of the green concrete. In warm weather when the temperature is above 70°F., the surface of the concrete shall be thoroughly wetted as soon after it is finished as it is possible to do so without injuring the surface, the canvas carried over the concrete and lowered vertically onto the surface, and the canvas kept wet. A set of frames to support canvas covering shall be kept on hand at all times near the concreting work to be used in the event of warm or rainy weather, as the canvas must not be laid on fresh concrete. In cool weather the canvas may be dispensed with. Hair checking or cracking can sometimes be eliminated by spraying fresh concrete, using a nozzle that will produce a fine spray or fog, but care must be taken not to use a nozzle that will cause pits in the surface. If this does not prevent hair checking and the materials are dry, they should be thoroughly wet down before they are placed in the mixer. As soon as the surface has hardened sufficiently so that it will not be injured, the canvas shall be removed. It must be thoroughly wetted and covered with earth or other approved material at least 2" deep, which must be kept wet at least 8 days by sprinkling with water, except in cold, late fall weather. When straw is used in place of earth for covering, the straw should be spread to a minimum depth of 4" and kept wet for a period of at least 8 days during warm weather. Straw shall remain in place for a period of at least 18 days under the most favorable conditions. All persons must be kept off the concrete surface for 3 days. All traffic must be kept off the surface for the full time specified and in the late fall, the time of curing must be extended 1 week. After the specified time has elapsed, the covering material shall be removed and the pavement swept clean. If found necessary, owing to local conditions, the contractor must furnish a watchman at all times to secure the required protection. In some instances it may be necessary for the contractor to construct temporary foot bridges over the surface of the concrete to permit the necessary passage of pedestrians or cattle from one side of the road to the other."

Concreting during Rain Storms.—Inexperienced inspectors are sometimes puzzled to make a reasonable interpretation in regard to stopping work on account of rain and they worry their heads off if they see a cloud the size of a hand in the sky. From a practical standpoint it is safe to instruct them not to worry; in case of rain the men will quit before it rains hard enough to do any serious damage; as a matter of fact a light rain gives an excellent spray surface finish much superior to any hand manipulation and I have never had any concrete seriously damaged even by hard showers; if the men quit in the midst of a block and leave the work without

heading up it is necessary to reject and dig out a few feet of the pavement to get a good vertical connection.

Protection of Concrete in Warm Weather.—Hot sun and drying winds damage the surface-wearing power of concrete pavements and also often produce so-called temperature and wind checks which are unsightly to say the least. Concrete should be protected in hot weather in order to get the best results; the methods usually adopted are burlap or canvas covers on frames, pending, earth cover sprinkled or continuous spray sprinkling. Special protection of this kind is not necessary when the temperature in the spring or fall of the year gets below 50 or 60°F. Surface checks (short hair cracks) are difficult to prevent under a hot sun and strong dry wind, as they develop before the finishing is complete and before it is possible to protect the concrete by canvas covers. Under these conditions a light spray applied continuously after the surface is belted seems to help reduce these checks. If they do form, a fairly satisfactory repair is to omit the earth cover till the next day, and after the surface is fairly dry, fill the checks with dry cement; this is done by sprinkling it along the checks and pushing it in with a small broom.

Concreting in Cold Weather.—Cold-weather work in connection with concrete paving is a rare emergency and should be permitted only to finish a short piece of incomplete work. With the utmost care results are rarely good, as concrete in pavements cannot be as well protected as building concrete under unfavorable weather conditions. Concrete should never be placed on a frozen subgrade.

The simplest solution where an unexpected cold snap develops is to heat the aggregates and protect the concrete by covering with canvas, straw, hay or earth. The addition of calcium chloride ($3\frac{1}{2}\%$ by weight) to the mixing water will prevent damage if the temperature does not fall below 28°. A simple method of using this chemical which has the property of reducing the freezing point of water and hastening the set of concrete is described as follows in "Recommended Practice" of the Portland Cement Association: "It can best be added to the mix by making a concentrated solution $1\frac{1}{2}$ lb. per gal. of water; this concentrated solution is added to the mixing water at the rate of a gallon per sack of cement used." This treatment adds about 15 cts. per cu. yd. to the cost of the concrete. Chemical means alone should not be relied on to prevent damage; heating and cover should also be used.

Inspection and Engineering Records.—Inspectors should be required to turn in daily signed records of the essentials in connection with the pavement work. These records are very useful in case of dispute or lawsuits.

The following forms have been used by the author. They can be easily and quickly filled in. They are prepared in book form of pocket size. Two inspectors are usually required: a batch inspector who is responsible for the measurement and quality of the materials and an inspector at the mixer responsible for the grade, forms and manipulation.

CONCRETE PAVEMENTS

1311

MATERIAL INSPECTOR'S REPORT

Name of Road: _____

Date: Sept. 21, 1922

Inspector's Signature: John Doe

Materials Received on Job:

Car Nos.	Amount	Cement	Brand	Acceptance No.
L. & N. 21435	231 bbl.		Atlas	B. R. 2645

Car Nos.	Amount	Sand	Source	Test No.
L. V. 25462	110,500 lb.		Continental	B. R. 1750
Penna. 175133	104,700 lb.		Oaks	Field No. 7

Car Nos.	Amount	Stone	Source	Test No.
L. V. 10546	103,400 lb.		LeRoy	B. R. 1120

Materials Delivered to Mixer

Cement	304 5 bbl.
Sand, approximately	115 tons
Stone, approximately	170 tons

PAVEMENT INSPECTOR'S REPORT

Name of Road: _____

Date: Sept. 21, 1922

Inspector's Signature: Richard Roe

Approval of Grade and Forms

Sta. to Sta.	Time of Approval
25 + 30 - 28 + 20	7 a.m.
28 + 20 - 30 + 50	1 p.m.

Tests of Mixer (twice daily)

Time of Mix per Seconds, Batch	Number of Revolutions per Batch	Time Test Made
58	15	8 a.m.
59	15½	3 p.m.

Concrete Data (4 times daily)

Sta. to Sta.	Cu. Yd.	Cement	Cement Factor	Time
25 + 30 - 26 + 80	60.0	117.50	1.96	10 a.m.
25 + 30 - 27 + 35	82.0	158.25	1.93	1 p.m.
25 + 30 - 28 + 05	110.0	210.00	1.91	3 p.m.
25 + 30 - 29 + 23	157.2	302.00	1.92	6 p.m.

Remarks

Previous day's run covered with earth and sprinkled.

Previous day's run shows satisfactory edge.

Cement tally by batchmaker disagrees with material inspector by 2.5 bbl.

SAMPLE ENGINEER'S DIARY

The diary of the engineer in charge shows all essentials of the work for purposes of record and possible lawsuits.

Name of Road: _____

Date: Sept. 21, 1922

Engineer: John Smith

Engineering Force:

John Smith, General Supervision

John Doe, Materials

Richard Roe, Pavement Inspection

Headquarters Inspector visited work

Contractor's Work:

Force: 70 men

8 teams

8 Ford trucks.

Work: Steam Shovel Station 200 to 201

Fine Grade Sta. 80 to 90

Concrete Pavement Sta. 25 + 30 - 29 + 23

Cement Factor 1.92

Materials Delivered:

Cement L. & N. 21435..... 231 bbl.

Sand L. V. 25462..... 110,500 lb.

Penn. 175133..... 104,700 lb.

Stone L. V. 10546..... 103,400 lb.

Correspondence: See letter attached giving ruling on maximum cement factor.

Sept. 21, 1922.

Mr. John Brown

Contractor

City

Dear Sir:

The following letter (a copy of which has been sent to the division engineer) states definitely my attitude and ruling as Engineer in charge of Road _____, in regard to the amount of cement that I can properly certify for payment as used in the concrete pavement work. If you are dissatisfied with this ruling, you can appeal to the division engineer. The following ruling will apply for all estimates unless I receive definite written instructions from the division engineer to modify this ruling. This letter is sent to you at this time in order to give you ample time to make any necessary changes in your batching procedure so that there will be no loss to you on the cement item on completion of the road. This formal action is necessary as your cement factor has been excessively high.

I will certify for payment all cement actually used in pavement work up to an amount which produces an average cement factor for the entire job of not to exceed 2.02 bbl. per cubic yard of concrete pavement. I will not certify to any total final excess of cement used over and above this limit on the ground that it is due to careless batching of the sand and stone. In order to give you ample opportunity to avoid final loss, I will certify the pavement as satisfactory where the daily cement factor does not fall below 1.80 but will not accept any pavement concrete having a lower factor than 1.80 as reported by my inspector four times daily. You are to continue using three whole bags of cement per batch, and any variations in your procedure are to be made in connection with the sand and stone.

This ruling is based on the following data:

The amount of cement provided in your contract is based on 1.90 bbl. per cu. yd. of concrete pavement 1:1½:3 mix. Based on previous construction experience with this mix I instructed you to use for a three-bag batch 4.50 cu. ft. of sand and 9.00 cu. ft. of stone. Under this basis of proportioning properly and accurately batched it has been my experience that the 1.90 factor could have been easily maintained and there would have been no overrun of cement on the contract.

My original instructions to you in this matter of batching were officially overruled by the department on the ground that they did not exactly comply with the Specifications and we were both instructed to batch three bags of cement, 4.28 cu. ft. of sand, and 8.56 cu. ft. of stone. This ruling raises the cement factor about 5% and under this ruling I am willing and justified in certifying a maximum of 2.02 bbl. per cu. yd. where this amount

is actually used. This will involve a possible overrun on the contract of about 750 bbl. of cement (Item 17) and there is no question in my mind but what this overrun should be approved under the batching instructions we have received.

Up to date however you have used 2.10 bbl. per cu. yd. of pavement and this amount is excessive and not warranted. It is apparently due to a shortage of stone and sand in the mix. Between Sta. 157-86 and 121-68 you used 2,110,000 lb. of stone (railroad weights) and 2,246.50 bbl. of cement. On the basis of batching three bags of cement, 4.28 cu. ft. of sand, and 8.56 cu. ft. of stone you should use at least 990 lb. of stone per bbl. of cement. (Inequality of grade has no effect on this basis of figuring.) Between these stations you should have used at least 2,224,000 lb. of stone, showing a shortage of 114,000 lb. or 5% of the total. Stone amounts to be about 80% of the compacted concrete and a shortage of 5% would raise the cement factor about 4%. The average cement factor between these stations was 2.09 or 3 $\frac{1}{2}$ % above the amount I am willing to certify.

In a similar manner between Sta. 157-86 and 128-15 you used 979,800 lb. of sand and 1,800 bbl. of cement. You should have used at least 1,000,000 lb. of sand showing a shortage of approximately 10%. Sand amount to about 40% of the pavement volume and a 10% shortage would account for a 4% increase in the cement factor which checks the stone results given above.

Your batching apparatus consisting of steel sand hoppers and a steel double-gate blow-stone batcher has been rated by me and found to be correct. The exactness of your routine batching, however, depends on the care of your men and I have personally noted a number of cases where under stress of time they were not completely filled. As a further evidence of carelessness in batching, your daily cement factor has ranged from 1.02 to 2.20. The grade work has been excellent, and while minor inequalities in grade which it is impossible to prevent might account for a small variation, they would not account for such a big range.

The outstanding facts are that you have not used enough sand and stone and that it is evident that more care is necessary to prevent underrun in measuring your sand and stone. It is not the function of the engineer or inspectors to act as foreman for your men and prevent careless work. Our duty lies in calling your attention to conditions and in stating the maximum limits of variations that we are willing to accept. We shall be pleased to give you a daily statement of the cement factor but will hold you responsible for variations which exceed the ruling given in the first of this letter.

Sincerely yours,

Engineer in Charge.

BITUMINOUS CONCRETES

Amounts of material, see pages 495 and 1143.

Inspection Details.—Two inspectors are required to handle the plant work and the road work.

Plant Inspection.—Plant inspection covers testing materials and proportions of mix, checking temperatures, uniform feed of aggregates to drying drum, time of mixing, and certification of load weights as the mix leaves the plant for the road.

Plant Testing Equipment.—Plant testing can be carried out with the following equipment:

- 1 set of standard screens and sieves as may be called for in specifications requirements.
- 1 stiff brush for cleaning sieves.
- 1 laboratory stone balance (pan capacity 10 lb.).
- 1 laboratory sand balance (pan capacity 100 g.).
- 1 penetration machine with needles, glass dish, large pan for holding water and thermometer.
- 1 paddle and roll of manilla paper for pat test (for sheet-asphalt surface mixtures).
- 2 armored thermometers of suitable range for recording temperatures of the hot aggregates and mixtures.

A supply of report forms.

All apparatus should be properly housed in a separate building or room not less than 10 by 10' and provided with a stool and work bench.

Sampling should follow the proposed methods of the American Society.

Samples.¹—Samples should be put in clean, dry containers, preferably tin boxes or cans. The following amounts of the different materials are required for test:

	Pounds
Stone, slag and gravel.....	5
Filler.....	½
Sand.....	1
Refined asphalt.....	1
Asphalt cement.....	1
Flux.....	1

Method of Sampling.—Extreme care should be taken in every case to obtain a sample which is truly representative of the material to be examined. These samples are for the use of the testing laboratory only and should not be used for testing at the plant before submitting them to the laboratory. The particular precautions to be observed in each case are given below.

Stone, Slag, or Gravel.—A sufficient number of 5-lb. samples to be taken from different parts of the pile. These should be thoroughly mixed together and reduced by quartering to the desired size.

Filler.—Samples should be taken from several bags and mixed.

Sand.—Samples should be taken from the interior of the pile where the sand is damp. A sufficient number of 1-lb. samples to be taken from different parts of the pile. These should be thoroughly mixed together and reduced by quartering to the desired size.

Refined Asphalt and Asphalt Cement.—(a) In barrels: At least one sample should be taken from each batch. It should be taken at sufficient depth below the surface to insure obtaining representative material free from all dirt or other extraneous matter, and at a point not less than 4" distant from the top and sides of the barrel. (b) In tank cars: The contents of the tank should be heated until completely liquid throughout. It should then be agitated and thoroughly mixed by means of air or steam, after which the sample shall be taken from the dome in such a manner as to obtain the asphalt from a point at least 3' below the surface. (c) In kettles: The contents of the kettles must be completely liquid and thoroughly agitated previous to and during sampling. The sample may be taken from the pipe through which the material is delivered to the mixer by means of a clean dipper.

Flux.—The directions given for sampling refined asphalt and asphalt cement apply to this material except that under ordinary conditions it is not necessary to agitate the contents of the tank car.

Surface and Binder Mixtures.—Samples should preferably be taken on the street after the mixture has been shoveled and raked. Samples taken from the plant shall be obtained from the wagons, special care being observed to avoid material from top of the load or which appears to vary from the average. Samples should be pressed between a sheet of paper and trimmed while hot to a convenient size. This is known as the pat test. The impression left on the paper is a fair guide as to the proper grading of the mix (see Figs. 344A to 344D).

¹Adapted from proposed specifications for sheet-asphalt pavements, A. S. M. E., 1922.



FIG. 344A.—About right amount of asphalt.



FIG. 344*B*.—Strong excess of asphalt.

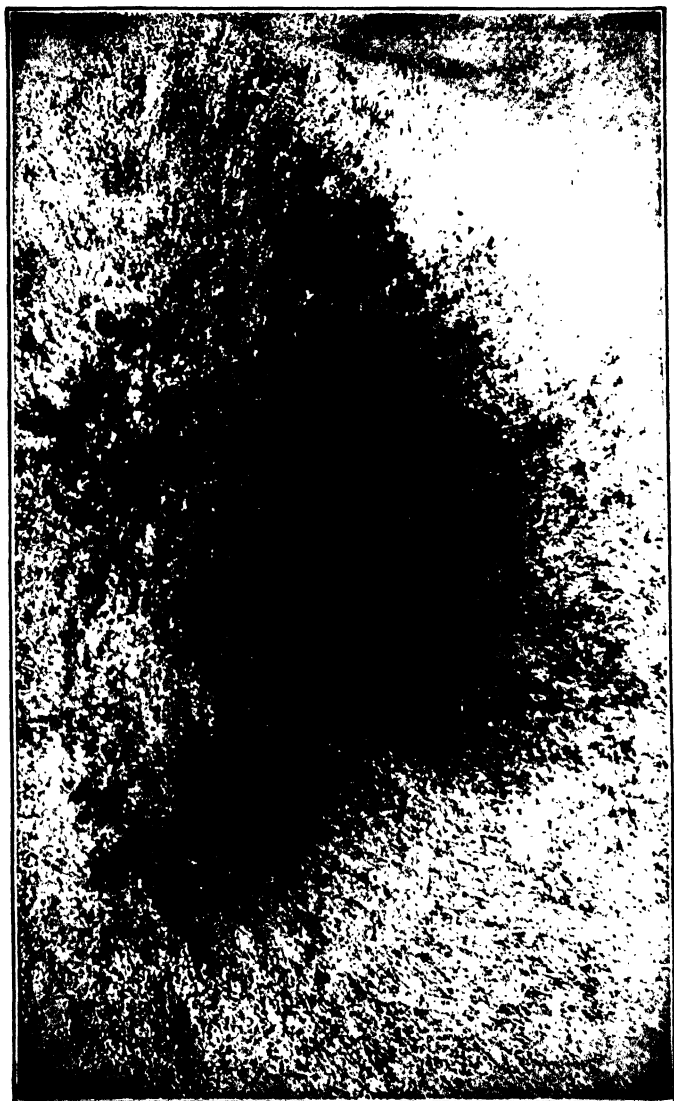

FIG. 344C.—Slight excess of asphalt.



FIG. 344D.—Slightly deficient in asphalt.
FIGS. 344A, B, C and D.—Pat test illustrations. (From Richard-
son's "Asphalt Construction for Pavements and Highways.")

The pat paper test which is referred to above is thus described in Richardson's book "The Modern Asphalt Pavement."

"A small wooden paddle with a blade 3 to 4" wide, 5 or 6" long, and $\frac{1}{2}$ " thick, tapered to an edge at one end and with a convenient handle at the other, is used to take as much of the hot mixture from the wagon as it will hold, being careful to avoid any of the last droppings from the mixer which may not be entirely representative of the average mixture. Samples of mixture should never be taken from the mixer itself, but only from the wagon after mixing is completed.

"In the meantime a piece of brown manilla paper with a fairly smooth surface, 10 or 12" wide, and torn off at the same length from a roll of this paper, which can be had at any paper warehouse, is creased down the middle and opened out of some very firm and smooth surface of wood, not stone or metal, which would conduct heat too rapidly. The hot mixture is dropped into the paper sideways from the paddle and half of the paper doubled over on it. The mixture is then pressed down flat with a block of wood of convenient size until the surface is flat. It is then struck five or six sharp blows with the block until the pat is about $\frac{1}{2}$ " thick."

The paper will be found to be stained to a different degree depending upon whether there is a deficiency, a proper amount, or an excess, present. Examples of such stains are illustrated in the accompanying Figs. 334A to 334D

Plant Analysis.—The proper proportions of aggregate are determined by analyzing the sizing of the different materials separately and then determining the proper proportion of each for the mix desired. A sample record of such work follows:

Proportions of Mix.—The proportions of mix should be determined by the engineer by screen analysis of the different materials that the contractor proposes to use.

As an example, assume that a mixture of cement, fine sand, coarse sand, and buckwheat stone is proposed and it is desired to determine the relative amounts of the different materials to use in order to get the correct proportion of sizes specified.

For all ordinary purposes a size analysis can be safely made using the following screens: 200, 80, 40, 10, $\frac{1}{4}$ " and $\frac{1}{2}$ ".

The materials are thoroughly dried and the percentages expressed by weight.

Pine sand (feeder pit) road 63	%
Passing 200	5
Passing 80 retained on 200	70
Passing 40 retained on 80	25
Good Quality	
Coarse sand (Bauerman pit) road 63	%
Passing 200	1
Passing 80 retained on 200	2
Passing 40 retained on 80	20
Passing 10 retained on 40	68
Buckwheat stone (commercial plant) road 63	%
Passing 200	1
Passing 40 retained on 200	2
Passing 10 retained on 40	7
Passing $\frac{1}{4}$ retained on 10	60
Passing $\frac{1}{2}$ retained on $\frac{1}{4}$	30
The proportions can now be varied to produce practically any required mix.	

TABULATION SHOWING METHOD OF DETERMINING THE NUMBER OF POUNDS OF EACH MATERIAL TO BE USED IN A 100-LB. BATCH TO PRODUCE A REQUIRED MIX

Material	Number pounds	Bitu- men	Mineral aggregate					
			200	80	40	10	¼ in.	½ in.
Bitumen	9.5	9.5						
Cement	8.5	...	8.5					
Fine sand	33.0	...	1.5	23.1	8.4			
Coarse sand	33.0	...	0.3	0.7	9.6	22.4		
Buckwheat stone	16.0	...	0.1	0.1	0.2	1.1	9.7	4.8
Totals	100.0	9.5	10.4	23.9	18.2	23.5	9.7	4.8

NOTE.—The above mix used on Road 63 has served well for 12 years under Class 11.4 traffic.

In this way the effect of varying any of the component parts of the mix can be readily seen and determined.

The total size of the batch is of course varied to suit the capacity of the plant.

The laboratory analysis of the daily sample taken on the road furnishes a check on the plant inspector.

The usual daily plant analysis consists of a mechanical sieve analysis of the hot aggregate as it runs into the batch box. If it varies much from the desired amount, the method of feeding the various sizes to the drum should be changed. The proportioning of the different sands and stones to the drying drum is often very crudely done and results in a non-uniform aggregate. This does not generally occur in large stationary plants but it is a frequent source of trouble in small semiportable road plants.

Checking Temperatures.—Probably the most important duty of the plant inspector on road jobs is to prevent overheating of the bitumen or stone aggregates, as most of our failures are directly traceable to overheating. In small semiportable plants, the storage bin for the aggregate is generally small and it is difficult to regulate the heat of aggregate running directly from drum to batch with small storage. The plant inspector must under no circumstances permit overheating which is generally set at 350°F.

Time of Mix.—Minimum time of mix recommended by Asphalt Association:

Binder course 30 sec.
Modified Topeka or sheet-asphalt surface 60 sec.

Record of Output.—A record of the weight and temperature of each load is made, see page 1323.

Field Inspection.—The inspection of grading, culverts, and macadam bases are the same as discussed under Macadam, pages 1272 to 1294.

The essentials of inspection of concrete paving base are the same as for concrete pavement (see pp. 1300 to 1313) in regard to subgrade, form setting, mixing, and placing except that the finishing requires different procedure and while the curing must not be neglected and requires earth cover and sprinkling, it does not require burlap or canvas covers immediately following the placing.

The surface of the concrete base must not show porosity or voids of any kind and the coarse aggregate must be imbedded, but a smooth, glassy surface is undesirable, as the binder coat does not get a good grip and tends to shove more rapidly into waves. The same care must be exercised to get a uniform crown and longitudinal profile, as depressions or humps in the foundation eventually produce an uneven surface due to the impossibility of laying unequal-depth surface mix with the same degree of compaction. The surface mix must be uniform in thickness. City of Rochester, N. Y., Specifications limit the variation in depth of surface mix as follows: "The surface thickness shall not be less than 2". Not more than 10% excess thickness will be permitted at any one spot."

Inspection of Laying Asphaltic Surface.—The inspection of laying and compacting the binder and surface layers of asphaltic concrete includes: approval of the condition of the concrete or macadam base, checking the depth of spread, temperature of mix as delivered, amount of rolling, and true shape of finished surface.

Condition of Base.—The base must have set a sufficient time and be well hardened. Specifications for the time of curing of cement concrete bases range from 7 to 21 days. Fourteen days is a reasonable length of time in warm weather, but should be increased to 21 days in the fall when the temperature falls below 50° on the average.

The base must be clean and free from dust, mud, organic deposits, or leaves. It should be broomed just prior to laying the asphaltic mix.

The base must not be wet. Slight dampness does no harm, but no asphaltic mix should be laid during rain or when the base has any pools of water or any snow on its surface.

Binder Course.—Binder should be laid only as far ahead of the surface as needed for keeping the work moving and should never be more than a day in advance of the surface mix. If such binder develops flaws such as poor bond or becomes broken up under traffic, it must be removed and replaced with fresh material.

Temperature of Mix.—The plant inspector is supposed to prevent overheating so that the usual point for the field inspector to watch is minimum temperature. This is generally set at 200°F. Once in a while a hot load gets by the plant inspector, which can easily be detected at the road, as the load will develop a heavy white smoke when dumped. Maximum temperature is usually set at 325°F. at the street or 350°F. at the plant.

Thickness of Spread.—Thickness of spread is regulated by weight. Each driver is furnished by the plant inspector with a card certifying weight of load. This card is given to the field

inspector who regulates the distance (number of square yards) that each load should cover. For all practical purposes, the ordinary surface mix (Topeka) weighs about 105 lb. per square yard per inch thickness of consolidated finished depth. The weight of binder depends on the mix used; it is usually paid for by the ton and put on under a specification of a certain number of pounds per square yard. The record of weight and surface area is illustrated on page 1323.

The mix must be dumped ahead of the spread and entirely rehandled by spreading by hot shovels and raked to final shape with hot rakes.

Joints.—All joints where work is stopped at noon or night must be cut back square vertical edges to full depth and painted with hot asphalt or a rope joint can be used. A lap joint ironed in is not advised.

Rolling and Finish.—As soon as practicable, the surface should be rolled with a light (3-ton) tandem roller and the final compression obtained with a 7- or 8-ton tandem. Rolling is important. It requires not only the ordinary straight roll but also cross-rolling to produce a smooth result. The maximum speed of rolling is usually set at from 100 to 200 sq. yds. per hour for roller. The finished surface should show no depressions or humps of over $\frac{3}{8}$ " as measured by a 10' straight-edge placed longitudinally to the road.

The use of two rollers of different weights is desirable particularly in cool weather or on macadam bases. The light roller can get on the hot mix quicker which prevents cracking likely to develop in cool weather due to the surface cooling much more rapidly than the body of the mix. Recent tendency in rolling calls for the use of 3 wheel, 10 ton road rollers for compaction due to many cases of poor compaction with the use of tandem rollers with a consequent rough uneven surface after heavy trucking traffic produced final compaction.

The following quotation gives rolling specifications in detail:

Compacting Surface Course.—"While still hot, the surface course shall be thoroughly and uniformly compressed by a power-driven tandem roller weighing not less than 7 tons, except that initial compression may be obtained by a power-driven tandem roller weighing not less than 4 tons. Rolling shall start longitudinally at the sides and proceed toward the center of the pavement, overlapping on successive trips by at least one-half the width of the roller. The pavement shall then be subjected to diagonal rolling in two directions, the second diagonal rolling crossing the lines of the first. If the width of the pavement permits, it shall in addition be rolled at right angles to the center line. Rolling shall be continued until all roller marks are eliminated. The motion of the roller shall at all times be slow enough to avoid displacement of the hot mixture, and any displacements occurring as a result of reversing the direction of the roller, or by any other cause, shall at once be corrected by the use of rakes and of fresh mixture when required. Rolling shall proceed at an average rate of not to exceed 200 sq. yds. per hour per roller, and shall continue until no further compression is possible. To prevent adhesion of the surface mixture to the roller, the wheels shall be kept properly moistened, but excess of either water or oil will not be permitted. Before final compression a light uniform coating of limestone dust or Portland cement shall be swept over the surface of the pavement and the rolling then continued."

PLANT RECORD, SEPT. 29, 1914

Load record				Bitumen record	
Load	Time	Temperature of mix, degrees Fahrenheit	Weight of load, pounds	Time	Temperature, degrees, Fahrenheit
1	7:30	320	5000	7:00	310
2	7:45	310	5000	8:00	345
3	7:55	300	6000	9:00	340
4	8:15	300	6000	10:00	310
5	8:25	290	5000	11:00	305
6, etc.	8:45	310	5000	12:00	320

ROAD RECORD, TEST SAMPLE 7, SEPT. 29, 1915

Load No.	Time	Temperature of mix, degrees Fahrenheit	Weight as per ticket, pounds	Number yards covered	Location on road
1	8:00	310	5000	25	Sta. 10 + 30 to 10 + 42
2	8:20	300	5000	25	Sta. 10 + 42 to 10 + 54
3	8:30	295	6000	30	Sta. 10 + 54 to 10 + 69
4	8:45	295	6000	30	Sta. 10 + 69 to 10 + 84
5, etc.	9:00	280	5000	25	Sta. 10 + 84 to 10 + 90

The following report on a Topeka mix resurfacing job in New York State illustrates a specific case where part of the work was satisfactory and part unsatisfactory.

REPORT FOR DIVISION ENGINEER ON REPAIR CONTRACT —

July 9, 1925

Mr. _____

Dear Sir:

In accordance with your instructions of July 1 I have made a thorough field inspection of the contractor's equipment, construction operations, and completed work on Repair Contract — with special reference to complaints made in regard to this job. The inspections were made July 2 and 4, at which time the pavement had been completed from Sta. 101 to 288, Road —. The surface roughness of the pavement was tested by means of a 10' straight-edge, by riding over the pavement in a Ford car, Essex Coach (balloon tires), and Cadillac car at speeds from 20 to 40 miles per hour. Local people were interviewed as to how they liked the pavement, and it was examined after a hard rain for pools of water. The stability of the edge of the black base was tested by driving loaded trucks (24,000 lb.) along the side of the base 6" from the edge. Cross rolling was checked up by inspection of the rolling. All plant and laying equipment was checked over and all operations checked for temperatures, time studies, etc. Materials were inspected and check sieve analysis made.

Complaints were evidently based on the first 1500' of pavement which is somewhat rougher than desirable. It took the inspectors and contractors' men this distance to solve the special difficulties of manipulation due to inequalities of the old pavement. From Sta. 206 to 288, the pavement now being laid shows a smooth-riding surface. I would class this job as

a whole including equipment and manipulation as a good average job, and while it cannot be classed as of the highest grade, there is no basis for any fear that either the department or this type of pavement will be discredited on account of poor workmanship. As a matter of fact, the local people are enthusiastic over the type of pavement and the job as a whole.

It is, however, probably desirable to make a few minor changes listed below and it is certainly desirable at this time to consider future changes and additions to the existing specifications to bring them up to a first-class standard. Most of the following recommendations cannot be enforced under the existing specifications if the contractor objects.

RECOMMENDED CHANGES REPAIR CONTRACT —

Design changes.

1. Construct a bituminous (binder) flush edging $1\frac{1}{2}$ " deep 6" wide on both sides of the top course to prevent crumbling of edge. This has already been recommended by the engineer in charge and is essential for the success of the pavement. The contractors have agreed to do this at binder prices, but they consider it a favor at this price and they will probably want some return favors amounting to about double what a reasonable supplementary agreement price would be.

2. Bridge over small pipe culvert trenches with cement-concrete base slabs to prevent settlement and disagreeable bumps developing. This is common city practice and will tend to prevent a general criticism of the type from the ordinary road user.

Contractors' Equipment and Manipulation.

1. Side forms to be solidly pinned down with top of pins flush with top of form to permit proper cross-rolling. At present the wooden side forms are loosely held by long pins on the outside edge which stick up above the form and prevent good cross-rolling. Quite frequently the roller hits these pins, loosens the form, shoves it out of line, and causes bad hair cracks along the edge (see specification discussion). This recommendation cannot be enforced under existing specification if the contractor objects without a supplementary agreement. It may be desirable to construct the bituminous flush edging ahead of the surface mix, which would simplify the form problem and dispense with special forms when laying top course. This may be worth trying but will require a special price supplementary agreement.

2. A three-wheeled 10-ton standard roller should be used to consolidate the first spread of black base in pot holes and along the edge of the old macadam. At present a tandem roller is being used and there is no possibility of its being really effective for this first layer (see specification discussion). This recommendation cannot be enforced under present specification.

3. Three rakers should be used to spread top. At present only two are used, and while it may be possible for these men to produce a surface which meets our minimum requirements, it is certain that a much better surface would be obtained with an additional raker (see specification discussion). This recommendation cannot be enforced under present specification.

4. Roller man should be required to keep moving at least 8 hr. out of 10 and to roll for at least 30 minutes, after the rakers stop at night (see specification discussion). This recommendation cannot be enforced under present specification.

5. Overflow pipes should be provided for both sand and stone storage compartments on mixing plant to prevent mixing of sizes. At present the sieve analyses show that at times the stone hopper discharge contains 40% of sand; 15% is the usual maximum limit (see specification discussion). This recommendation cannot be enforced under present specification.

6. Correctness of plant scales should be tested and certified by sealer of weights and measures.

There is no reason to doubt these scales but a large amount of binder is paid for by weight, and it is just as well to have a certificate of correctness.

7. Insist on a minimum time of mixing for top course of 60 sec. per batch. Present time varies from 35 to 50 sec. (see specification discussion). This recommendation cannot be enforced under present specification.

8. At least 50 lb. of commercial mineral filler should be used per 1000-lb. batch of top mix and the amount of asphalt increased from 85 to about 90 lb. per batch. At present no filler is used. The present mix used for top shows an excellent grading except for fine stuff. The desirability of this

recommendation can be easily checked by referring the matter to the Asphalt Association or to the city testing engineer, Mr. ———. This recommendation can be enforced, but the contractors will probably ask you to forgo it to balance up their favor to you in constructing the new edging at binder prices. They never will be really willing to use the proper amount of filler until it is paid for as a separate item.

9. Fill pot holes and place edge-widening strip for at least 1 mile ahead of regular binder and surface spread to permit better compaction of this layer.

Engineering Recommendations.—1. Have an inspector on the scale platform to check weights for binder paid for by the ton.

2. Provide necessary screens, drying outfit, and scales to permit engineer to make daily check analyses of mineral aggregate.

RECOMMENDED CHANGES IN SPECIFICATIONS

Certain changes are recommended in the 1925 specifications. Our present specifications are a distinct improvement over the 1923 specifications in the matter of grading of the mineral aggregate and use of mineral filler but they are still weak and indefinite on a number of points of equipment, and manipulation details which are necessary to insure thorough and uniform mixing, spreading, and rolling. To illustrate these points, the following table compares the best prevailing practice with our 1925 specifications and also shows how Repair Contract ——— compares with both the best practice and Local Specifications.

I have looked over most of the hot-mix jobs in this locality during construction for the last 15 years and in my opinion there has never yet been first-class work done on a state road in this vicinity. The contractors always insist on taking advantage of the weakness of these specifications, and while they do a moderately good job, the tendency has always been to cut down on needed mineral filler, to mix the batches too short a time, to rake carelessly, to underroll, and to cut quite fine on the weight per sq. yd. of surface mix.

Considering that this type of pavement is a logical and economical solution for a considerable mileage of reconstruction, it is certainly desirable to use a specification which will permit the engineers to force a first-class job in case of dispute.

COMPARISON OF SPECIFICATIONS AND PRACTICE ON REPAIR CONTRACT
 Compiled by W. G. Harger, July 7, 1925

Item	Best specification practice, 1925	Local 1925 specifications	Practice on Repair Contract	Recommended changes Repair Contract
Mixing Plant Items				
Minimum capacity of mixer.....	10 tons per hr. surface mix	No mention	10 ton normal capacity 12 to 14 tons per hr. surface mix	Plant is being crowded
Minimum size of batch.....	1000 pounds	No mention	1000 pounds	O. K.
Type of kiln dryer.....	Rotary	Rotary	Rotary	O. K.
Temperature measurement of hot aggregate.....	Pyrometer	No mention	Pyrometer	O. K.
Screen for separation of hot aggregate.	At least 2 sizes Passing No. 10 Retained No. 10 Reject retained $\frac{3}{4}$ "	2 sizes Passing No. 10 Retained No. 10 Rejects	O. K.
Minimum number separate storage compartments, hot aggregate.....	2	No mention	2	O. K.
Overflow pipes from separate bins.....	Required	No mention	None	Should be provided
Maximum carry over of sizes in storage bins.....	15%	No mention	10% to 45%	Excessive at times
Type of scales to weigh aggregate.....	Standard lever scales with 2 bar control	No mention	Standard	O. K.
Certificate of scale accuracy.....	Sealer of weights and measures	No mention	Have not been tested	Should be tested
Type of mixer.....	Twin Pug	Revolving blade	Twin Pug	O. K.
Maximum clearance end of mixer blades to lining of drum.	Surface mix $\frac{3}{8}$ " Binder 1"	No mention	1 $\frac{3}{4}$ "	Rather excessive but seems satisfactory
Minimum time of mix per batch:	Surface and binder combined $\frac{3}{4}$ to $\frac{5}{8}$ "	No mention		Not mixed long enough. Recommend
Open binder.....	30 sec.	No mention	25-40 sec.	50 sec. minimum
Close binder.....	50 sec.	No mention	35-50 sec.	60 sec. minimum
Surface.....	60 sec.	No mention		

COMPARISON OF SPECIFICATIONS AND PRACTICE ON REPAIR CONTRACT (Continued)

Item	Best specification practice, 1925	Local 1925 specifications	Practice on Repair Contract	Recommended changes Repair Contract
Number asphalt kettles..... Method of heating asphalt..... Asphalt temperature measurement..... Range in temperatures of hot-mix aggregate..... Range in temperature (asphalt)..... Daily sieve analyses of mineral aggregate firm Hopper shoots..... Proportions of mix.....	2 Steam Thermometers 275 to 350°F. 250 to 350°F. Required	No mention No mention Thermometers 225 to 300°F. 275 to 325°F. No mention	2 Steam Thermometers 225 to 330°F. 200 to 320°F. None	O. K. O. K. O. K. O. K. O. K. Should be made by engineer
See special discussion at end of report				
Hauling and laying items				
Covers on loads..... Maximum amount dumped ahead of racker..... Spreading equipment..... Maximum rate of spreading per racker.....	Required in cool weather or long hauls 6 tons Heater, smoothing iron tamping irons, shovels and racks 33 sq. yd. per hr.	Required Not mentioned Necessary Not mentioned	Not used for short hauls warm weather 5.5 tons O. K. 2 racker used 60 to 90 sq. yds. per hr. per racker Tamped Timber strips poorly fastened by long pins which prevent proper cross-rolling	O. K. O. K. O. K. Needs three racker for good work O. K. Improve existing side forms
Tamping along edge..... Temporary edge forms.....	Required Timber strips firmly spiked with top of fastener pins flush with top of form to permit cross-rolling	Required Not mentioned		

COMPARISON OF SPECIFICATIONS AND PRACTICE ON REPAIR CONTRACT ——— (Continued)

Item	Best specification practice, 1925	Local 1925 specifications	Practice on Repair Contract ———	Recommended changes Repair Contract ———
Type of roller binder course.....	10 ton 3 wheel or 8 ton tandem as ordered	8-ton tandem	Three-wheel 10-ton available but not used. 8-ton tandem used all rolling	Use three-wheel 10-ton roller for first course of binder. 8-ton tandem O. K. for balance of work O. K.
Surface course.....	7-8 ton tandem for finishing; 5-ton tandem for initial compression	8-ton tandem	8-ton tandem	Roller should be kept moving continually and should roll for at least $\frac{1}{4}$ hr. after rakers stop O. K. O. K.
Maximum permissible amount of rolling per hr. per roller surface max.	100 to 150 sq. yd. per roller per hr.	Not mentioned	170 to 200 sq. yd. per hr.	O. K. O. K.
Testing surface with 10' straight-edge.....	Required	Required	Tested by inspector	O. K. O. K.
Repair of depressions.....	Immediately after initial compression	Not mentioned	Repaired at once	O. K. O. K.
Cement coat.....	Required	Required	O. K.	O. K. O. K.
Minimum weight surface mix per sq. yd. for $1\frac{1}{4}$ " finished depth.....	155 to 160 lb. per sq. yd.	Not mentioned	157 lb. per sq. yd. according to batch weights	O. K. O. K.

DISCUSSION OF SURFACE MIX GRADING AND SIGNIFICANCE OF LABORATORY TESTS

Laboratory analyses of the finished mixture are not a very reliable basis for determining the actual composition of the pavement except for the percentage of bitumen which is quite reliable considering the average of a number of samples.

The safest means for designing the mix and determining the best batch proportions is by the use of daily sieve analyses of both the raw products before they enter the drying drum and sieve analyses of the sand and stone products as they are discharged from storage bins into the mixing hopper. The first analysis determines the approximate proportion of sand and stone to be fed to the drying drum and the second analysis determines the final batching proportions and the amount of mineral filler required for a good mix.

On repair contract — the sand used is supplied by George Amish. It is a good uniform product. The stone used is a mixture of Dustless screening and stone dust. This product is furnished by the Le Roy Limestone Company. It is a good product but fluctuates considerably in composition. The analysis of these two materials is attached. An examination of these sieve analyses taken July 2, 1925, indicates that they should be fed to the drying drum in the proportion of about 1 part stone to 2 parts sand. This is the proportion being used and is satisfactory.

Sieve analyses of the Hopper feed of hot sand and stone are attached (July 2, 1925).

The batch proportions being used are 265 lb. of Hopper feed stone, 650 lb. of Hopper feed sand and 85 lb. of asphalt. Using these proportions and the Hopper analyses of sand and stone of July 2, we get the following grading for the final mix. This tabulation also shows the ideal mix for conditions similar to this road (see Chapter VI, page 501). It can be readily seen that the mix used is unusually good except for a shortage of fine material (pass 200 mesh) which can be easily added as bagged mineral filler.

	Mix in use Repair Con- tract — July 2, 1925. %	Ideal mix, %
Bitumen.....	8.5	9.0
Passing 200 mesh.....	4.6	9.0
Passing 80 mesh.....	14.1	14.0
Passing 40 mesh.....	37.8	25.0
Passing 10 mesh.....	13.6	21.0
Passing 1/2 sieve.....	14.8	15.0
Passing 3/8 sieve.....	6.6	7.0
Total.....	100.0	100.0

On the basis of this analysis I recommend that at least 50 lb. of commercial mineral filler be used per batch and that the asphalt be increased to about 8 to 90 lb. as determined by trial.

The laboratory analyses of the finished product consistently show from 9.0 to 9.8 % of bitumen, while the scale proportions indicate 8.5 %. As the determination of bitumen is quite accurate, this indicates the possibility that the plant scales are incorrect or that there is a consistent shortage of 50 to 100 lb. per batch in weighing the mineral aggregate. This is not a severe discrepancy, but it indicates that it is desirable for the plant inspector to keep some track on the weighing operations, particularly for binder where it is paid for by weight.

HOPPER FEED ANALYSIS

	Sand, %	Stone, %
Retained on $\frac{1}{4}$ "	26
Retained on 10	56
Retained on 40	15	14
Retained on 80	58	1
Retained on 200	21	1
Pass 200	6	2

RAW PRODUCTS

	Sand, %	Stone, %
Retained on $\frac{1}{4}$ "	1	7
Retained on 10	7	43
Retained on 40	15	32
Retained on 80	42	7
Retained on 200	26	5
Pass 200	9	6

BINDER COURSE

Grading of Aggregate.—The binder is batched 250 lb. of sand, 650 lb. of stone, and 45 lb. of asphalt. This is a satisfactory mix which works well in the pavement.

The binder (black base) is spread and compacted in two or three layers depending on the inequalities to be taken out.

At present each layer is being compacted by the 8-ton tandem roller. This roller is not suitable for compacting the first layer which fills in pot holes and widens the old macadam by a narrow side strip of varying depth. I recommend that a standard 10-ton three-wheel roller be used in compacting this first layer. The tandem roller is satisfactory for the top layer of binder.

Criticism has been made that the binder was not properly compacted nor was it protected from side shore by a firm earth shoulder. The base as now laid shows no evidence of either side shove or rutting when 24,000-lb. truck loads are run along the edge. It is probable that continued heavy traffic may compact this edge in the future somewhat and increase the crown slightly, but I have no hesitation in saying that an earth shoulder of the light soil available would have no effect in improving the stability of this edge. The stability of the edge must depend on the stiffness of the black base itself. We have recommended the use of a three-wheel roller to minimize future settlement, under continued heavy traffic.

It is desirable to fill all pot holes and place the side-widening stop for at least 1 mile ahead of the regular binder and surface spread to get a better compaction by rolling and traffic. This evener layer should be well pounded.

Signed

W. G. Harger.

BRICK PAVEMENT

Amounts of material, see pages 511 and 1146.

"Inspection Details.—The success of a brick pavement depends largely on the care in construction and rigid inspection. Inspection covers careful control of grading, culvert backfills, concrete base, and brick surface. Inspection methods for all operations up to the brick surface have been previously discussed.

"Brick surface inspection includes control of handling brick, cushion, laying, culling, rolling, grouting, and protection until set.

Suggestions published by the Dunn Wire Cut Lug Brick Company are definite and reliable as any source. They are quoted as follows:

“Expansion Joints.—Expansion joints shall be placed parallel with and at each curb line and extend across each street and alley intersections. It should be $\frac{1}{2}$ ” in width for streets less than 20’ wide; $\frac{3}{4}$ ” for streets from 20 to 30’ wide, and 1” in width for streets wider than 30’. This joint must extend to the depth of the brick.

“A premolded or prepared bituminous strip which will be unaffected by the action of water and will remain pliable at all temperatures to which it may be subjected shall be used for this purpose. The material should be made into strips of suitable length and of the required depth and thickness and shall be placed in the pavement with the ends closely joined as the bricks are being laid.

“Delivery of Brick.—Before the grading is finished, the brick shall be hauled and neatly piled outside the curb line in sufficient quantities to complete the brick surface. Clamps or conveyors may be used in connection with this work, but the brick shall not be dumped from wagons to piles, or from cars to wagons, nor shall they be piled in any location where they are likely to become bespattered or covered with mud or otherwise injured, unless thoroughly protected.

“In delivering the brick from the piles for placement in the street, no wheeling in barrows will be allowed on the brick surface. The brick shall be so arranged and carried on a pallet, or conveyor, that when delivered to the dropper, each brick, in the regular operation of placing upon the cement-sand bed as prepared, will naturally lie with the projections in the same direction and with the best edge uppermost.

“Cement-sand Bed.—Upon the foundation as prepared there shall be spread a bed of cement and sand of uniform density to the depth of 1” and in the proportion of 1 cement and 4 sand. The cement and sand shall be thoroughly mixed dry in a mixer until a uniform color is obtained.

“The cement-sand bed shall be carefully shaped to a true cross-section, parallel with the finished pavement, by means of a template covering at least one-half of the width of the brick work, and so made as to be easily drawn over the curb or guide rails set to the proper elevation. The operation of shaping the cement-sand bed for the brick is considered of prime importance in securing the desired evenness in the surface of the finished pavement.

“Brick Laying.—Upon the cement-sand bed as prepared, the brick shall be immediately laid with the best edge up, the projections in one direction, and with the courses straight and at right angles to the center line of the pavement, except in the case of hillside brick which are to be laid parallel thereto. All joints must be broken at least 3”, and the courses straightened by tapping lightly with a sledge on a 4 by 4” timber 3’ in length, provided for that purpose. Nothing but the whole brick shall be used except in starting and finishing courses, or in such cases as may be directed by the engineer. The cutting and trimming of the brick shall be done by

experienced men. For closures, nothing less than 3" bats shall be used, and the fractured ends laid toward the center of the pavement. Broken and chipped brick suitable for batting shall be used so far as practical in obtaining the necessary half brick for breaking course and making closures, instead of breaking otherwise whole and sound brick. All brick when laid shall be clean and kept clean and entirely free from dirt or other foreign matter until the pavement is completed. All the work of brick laying shall be done over the brick already laid. The disturbing of the prepared cement-sand bed is prohibited. As soon as any surplus of delivery of brick is ascertained, they shall promptly be moved forward for use.

"After the brick have been laid, the chips shall be swept from the street, all soft brick removed, and those badly broken, badly spawled, or misshapen shall be turned over or removed by the contractor. Brick slightly chipped for batting in shall be carried forward and used for that purpose; the remainder shall be placed in separate piles along the street. The inspector shall keep the brick culled, and the contractor shall make the necessary changes and replacements so that the work at all times shall be ready for the grouting within 50' of the brick laying.

"After the brick are laid the contractor will start culling. Then you and your inspectors should carefully go over them, marking all soft¹ bricks to be taken out and rejected; all kilnmarked bricks to be turned over, and if not satisfactory to be taken out and used for pinning in; all overburned bricks,² which are burned to a cinder to be rejected. All underburned bricks, which, in your opinion, will not make a satisfactory pavement, to be rejected. All bronzed bricks (which have the appearance of overburned brick but this on one side only) to be turned over, and if satisfactory allowed to remain in the pavement.

"Be sure that you have culled all of the bricks before the pavement is rolled, for after the pavement is rolled if much culling is done you are liable to have a rough pavement. After the pavement is rolled go over same and mark all broken and spalled bricks, to be taken out or turned over.

"Be careful of all high and low bricks in the pavement, for same will wear badly when the road is finished.

"Be sure that your bricks are laid at right angles to the curb and are not wavy as to line.

"In no case allow any 'Dutchman'³ in your pavement except on curves where absolutely necessary.

"**Rolling.**—Immediately after the brick in the pavement have been inspected and the surface of the pavement swept clean, it shall be rolled with a self-propelling tandem roller, weighing approximately 3 tons, in the following manner: The rolling will

¹ Soft brick are found by sprinkling the pavement lightly; the soft or under-burned brick will absorb the moisture, rapidly becoming dull, while the good brick still glisten with the water.

² Over-burned brick are known by their color, which is much darker than the average.

³ "Dutchman." Brick chipped to wedge shape to fill in between radial courses on curves.

commence near the curb or edging line, at a slow pace and continue back and forth until the center of the pavement is reached, then pass to the opposite curb or edging line and repeat in the same manner to the center of the street. After the first passage of the roller the pace may be quickened. The pavement shall then be rolled transversely at an angle of 45° ; repeat the rolling in like manner in the opposite direction, then roll parallel with the curb or edging line until the surface is smooth.

"Before this last rolling takes place, all broken or injured brick must be taken up and replaced with acceptable ones. Portions of the pavement inaccessible to the roller shall be tamped to grade by the use of a hand tamper applied upon a 2" plank.

"After the final rolling, the surface shall be tested with a 10' straight-edge laid parallel with the center line of the pavement and any depressions exceeding $\frac{1}{4}$ " shall be taken out.

"All brick laid shall be rolled ready for grouting at the end of the working day.

"Cement Grout Filler.—The cement grout used in filling the joints in the brick shall consist of 1 part of cement and $1\frac{1}{2}$ parts of sand.

"The cement shall meet the requirements of the Standard Specifications for Portland Cement of the American Society for Testing Materials, adopted Aug. 16, 1909, with amendments and additions thereto adopted by the said society.

"The sand for the cement-sand bed and the grout filler shall be composed of clean, sharp, well-graded quartz grains and shall not contain more than 5% of clay or silt. The grains shall be such size that all will pass a No. 12 sieve and that not more than 40% will pass a No. 50 sieve.

"As soon as the pavement is rolled and before the filler is applied, the pavement shall be thoroughly saturated with water so as to insure the hardening of the cement-sand bed. The brick must be wet when the grouting starts.

"The cement and sand for grouting in correct proportions shall be thoroughly mixed dry until the mass assumes a uniform color. From this mixture a small batch not exceeding 2 cu. ft. shall be placed in a suitable box or a machine especially adapted for that purpose. Slowly add water and thoroughly mix until the mixture is of such a consistency that it will readily flow into the joints without separation. Ample time must be taken in preparing this liquid mixture, first making a plastic mortar, then gradually thinning by mixing and slowly adding water; continue the mixing until all is removed and applied to the surface in small quantities. The application should be continued until the joints appear to be filled. Any surplus material remaining on the bricks shall then be swept into the joints. Extreme care must be taken that the joints are not cemented over and that the filler extends down to the bottom of the brick.

"After the first coat has had a chance to settle and before the initial set develops, a second coat shall be applied in a similar manner with a somewhat thicker grout. After this application has had time to settle and before the initial set takes place, the pavement shall be finished to a smooth surface with a squeegee

having a rubber edge which shall be worked over the brick at an angle with the joints, thus leaving them entirely filled.

"The contractor shall provide thin metal strips $1\frac{1}{16}$ " by 6" by 3' long and insert same in the brick joints across the street when closing up a stretch of grouting at work intervals, so that the grouting will end in a vertical joint. These strips must be taken out when the grout becomes stiff and before the initial set.

Protection of Filler.—After the surface has been thoroughly inspected and if approved, and sufficient time for setting has taken place so that a coating of sand or earth will not absorb any moisture from the cement mixture, the surface shall be covered with 1" or more of sand or earth to prevent too rapid drying of the filler. This shall be kept moist for at least 4 days, and no traffic shall be allowed on the street for a period of at least 15 days.

Hillside Brick.—On grades, when ordered by the engineer, standard hillside brick shall be used. These brick shall in quality and test conform to the requirements of these specifications.

The general method of constructing a wire-cut lug hillside pavement shall conform to the standard specifications, except that the bricks shall be laid longitudinally instead of transversely. They shall be grouted in the manner specified for brick pavements except that all grout in the surface grooves of the wire-cut lug hillside brick shall be broomed out before it shall have time to set up (care being taken not to disturb the grout in the longitudinal joints). This brooming shall be done transversely with a rattan broom.

NOTE.—We strongly advise the use of a small mixer properly equipped for applying the grout. This mixer should be used for the first application, and a suitable box for the second application. When boxes are used the grout shall be removed from the same with scoop shovels.

Bituminous Filler.—Where bituminous filler is used, the brick must be clean and dry when the filler is applied. It must be heated to the proper temperature between 300 to 380°F. and applied by either conical pouring cans the nose of which rests on the joint and is drawn along the joint, or by the squeegee method. The squeegee method is recommended by the brick people. In this method the hot filler is poured on the pavement and rapidly worked into the joints by hot iron squeegees operated slowly backward and forward at an angle with the joints. The operation is continued until the joints remain full and a thin film of bitumen remains on the surface of the brick. A thin sand or screening coat is spread over the surface and the pavement opened for traffic.

BRIDGES

Staking Out Bridges.—Bridge abutment and superstructure plans are usually quite thoroughly dimensioned and these dimensions refer to the center line of the finished bridge and to the clear span between faces of abutments or between bearing centers.

Abutments are usually staked out for construction by means of two or more firmly driven center-line stakes placed outside of the limits of excavation and at a known distance from the face

of the wings are shown by special wing stakes. Figure 345 shows the usual method which is modified to fit special conditions. The

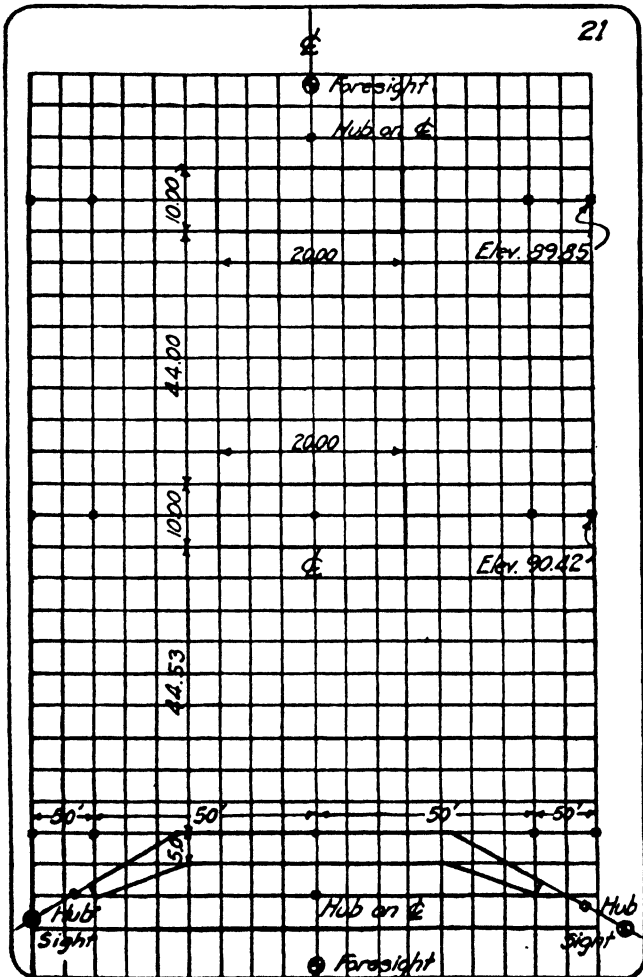

FIG. 345.—(Continued).

elevation of the top of all these stakes is determined from which the grade of the foundations, bridge seats, camber blocks, etc. can

be readily determined. A permanent bench mark is established in the immediate vicinity.

Bearing Power of Foundation Soils.—The foundation pit is excavated to the lines and grade shown on the plan and the character of the soil determined not only for the bottom of the pit but also for at least 10' below the bottom by bar and gas-pipe core samples to be certain that the underlying strata does not materially change the safe bearing of the soil encountered at the grade depth. All bridge abutment plans should show and generally do show the base-pressure diagram which gives the maximum toe and heel pressure for the completed structure (see Fig. A, p. 1047). The safe bearing power of soils is a very indefinite proposition and all assumptions should be conservative. While actual test loads can be applied, this is rarely necessary for the usual highway bridge and the final decision as to the width of spread, footing, or the use of piles is based on the allowable pressures, discussed on pages 207 to 209 and repeated at this point in tabular form. Table 232 shows the result of actual tests for settlement on common soils.

TABLE 231.—RECOMMENDED MAXIMUM PRESSURE ON BRIDGE FOUNDATION SOILS

Clean dry sand.....	2 ton per sq. ft.
Confined sand and fine gravel.....	3 ton per sq. ft.
Coarse gravel.....	4 to 5 ton per sq. ft.
Ordinary mixture sand and clay.....	2 ton per sq. ft.
Soft damp clay.....	1 ton per sq. ft.
Dry clay thick layers.....	3 to 4 ton per sq. ft.
Cemented gravel and hard pan.....	6 to 7 ton per sq. ft.
Soft rock.....	8 ton per sq. ft.
Hard rock.....	20 ton per sq. ft.

NOTE.—Arch bridges require piles unless the foundation soil is rock or hardpan.

Actual Test Loads.—Safe load is generally considered as 50 % of actual load producing a settlement of $\frac{1}{8}$ " in 48 hr.

TABLE 232.—ACTUAL PRESSURES ON DEEP FOUNDATIONS
(E. S. Corthell)

Actual pressures which showed no settlement				
Material	Number of examples	Pressure in tons per square feet		
		Maximum	Minimum	Average
Fine sand.....	10	5.4	2.25	4.5
Coarse sand and gravel.....	33	7.75	2.4	5.1
Sand and clay.....	10	8.5	2.5	4.9
Alluvium and silt.....	7	6.2	1.5	2.9
Hard clay.....	16	8.0	2.0	5.08
Hardpan.....	5	12.0	3.0	8.7
Actual pressures which showed settlement				
Fine clay.....	3	7.0	1.8	5.2
Clay.....	5	5.6	4.5	5.2
Alluvium and silt.....	2	7.6	1.6	
Sand and clay.....	3	7.4	1.6	3.3

The method of reducing toe pressure by increasing the width of the footer course is explained on pages 1047 to 1049. If there is any uncertainty as to objectionable settlement, piles should be used, as it never pays to take a chance on foundation stability. Piles should also be used if there is danger of excessive scour, even if the soil is safe from the standpoint of bearing value.

Test Piles.—If piles are shown on the plan or become necessary on account of unexpected foundation soil conditions, test piles are driven to determine the length, number, and spacing of piles to be ordered driven.

At least six test piles should be driven located at the center of each abutment and at the ends of the wings to determine variation in conditions which are likely to occur.

These piles are driven to a satisfactory resistance. There are two general conditions; first where the pile is driven to rock or a hardpan strata and where the top material is semifluid and very soft; in which case it is figured as a long column and for which blunt-end or blunt-point piles are required (see long column table, p. 1078); second, where the pile develops a safe load by skin friction between pile and soil, in which case the length size and taper control the safe load which is increased by length and size.

The safe load in friction piles can be closely determined only by actual test loads and is usually specified as 50% of the actual load causing a settlement of $\frac{1}{8}$ " in 48 hr., but as a general rule the so-called *Engineering News* formulas which are based on extended experience and tests will serve as a safe criterion of safe load. These formulae are given below and are supposed to give a factor of safety of 6 although Table 233 comparing actual observed and computed loads shows considerable range of results.

TABLE 233.—COMPARISON OF ACTUAL AND COMPUTED SAFE LOADS ON PILES¹
(*Engineering News* formulas—drop hammer)

Length of pile, feet	Weight of hammer, W lb.	Height of fall, h ft.	Last penetration per blow, S" inches	Load		Character of soil
				Observed	Computed	
53	2,000	4.0	8.5	13,300	1,690	Almost fluid mud
25	1,600	25.0	3.0	22,400	19,750	Soft muddy bottom
35	1,700	25.0	2.0	44,800	28,300	Mud 30' deep
35	910	5.0	0.35	62,500	6,740	Mud, sand and clay
..	1,900	20.0	1.5	75,000	44,100	Stiff clay
91	2,300	22.0	1.75	75,000	36,800	Mud 60'. Sand 6'
73	2,300	33.5	3.75	34,000	32,500	Water 12'. Mud 61'
30	2,300	22.0	2.0	38,000	33,700	Sand
33	2,300	22.0	1.0	110,000	50,600	Sand

¹ American Civil Engineer's Pocket Book, John Wiley & Son, Publishers.

In order to utilize the *Engineering News* formulas with reasonable assurance of accuracy, the piles must drive with fairly uniform or

gradually increasing resistance; the hammer must not have a noticeable rebound and must fall on solid uninjured pile top; that is, when test penetration is taken, broomed tops must be cut off square down to solid wood. Also the formula for drop hammers assumes free fall. For a restrained fall where cable and drum remain attached to hammer use 80% of computed safe load as given by the formula. In driving test piles the safe load should be computed at 10', 15', 20', etc. depths to determine the relation of length and

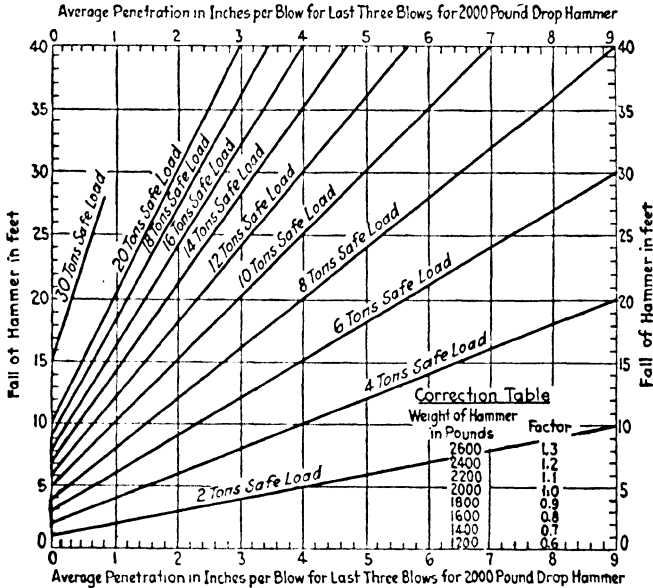

FIG. 346A.—Safe pile loads drop hammer test with free fall. (Shear release.) Use 80% of safe loads for drop hammer with usual cable and drum rig.

safe load in order to work out a reasonable length spacing layout and individual pile load. Piles are usually spaced $2\frac{1}{2}$ to 3', never less than $2\frac{1}{2}$ ' and rarely over 4'. Tops should be cut off at staggered elevations to prevent a cleavage plane. Final top elevations are usually 12 to 18" above bottom of concrete.

Practical refusal in driving piles is generally assumed when the resistance to driving indicates the pile safe for 30 tons. This occurs when the penetration per blow is from $\frac{1}{8}$ to $\frac{1}{5}$ " for ordinary drop hammers falling 15 to 20' (see Figs. 346A and 346B). The usual drop hammer should weigh at least 2000 lbs. for timber piles and the drop should not exceed 20 ft. In driving concrete piles the hammer should weigh at least as much as the pile and the drop

should not exceed 6 ft. In driving concrete piles steam hammers striking a blow of at least 12,000 ft. lbs. are usually specified with the added requirement of water jets in hard driving. No effort should be made to drive piles beyond the depth at which practical refusal is reached, unless pile penetration is less than minimum stipulated and it is possible to get further penetration by water-jet methods.

Leads must be used even with double-acting steam hammers to permit steam hammers to rest entire weight on top of pile.

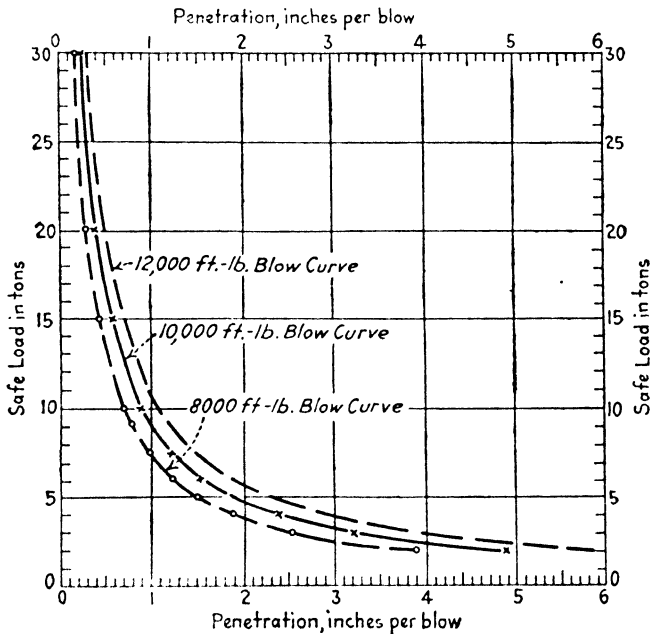

FIG. 346B.—Safe pile loads. Double acting steam hammer test penetrations.

ENGINEERING NEWS FORMULAS

Drop hammers	$P = \frac{2WH}{S + 1}$
Single-action steam hammers	$P = \frac{2Wh}{S + 0.1}$
Double-action steam hammers	$P = \frac{2E}{S + 0.1}$

P = safe load in pounds per pile.

W = weight of hammer in pounds.

h = fall of hammer in feet.

S = penetration per blow last 5 blows in inches.

E = energy of blow in feet, pounds. (Get from maker's catalogue.)

TABLE 234.—TYPICAL DOUBLE-ACTING STEAM-HAMMER SIZES
Specifications of McKiernan-Terry pile hammers

Size of hammer.....	1	2	3	5	6	7	9-B-2	11-B
Net weight, pounds.....	145	343	675	1,500	2,900	5,000	6,760	13,185
Shipping weight, pounds.....	185	380	735	1,560	2,970	5,075	6,800	13,285
Cubic measurements, inches.....	9 X 11 X 47	11 X 10 X 37	14 X 13 X 62	19 X 14 X 57	24 X 19 X 63	27 X 21 X 73	24 X 20 X 92	30 X 26 X 110
Weight of ram, pounds.....	21	48	68	200	400	800	1,500	3,625
Bore, inches.....	2 1/4	4 1/8	3 1/4	7	9 3/4	12 1/2	8 1/2	12 3/8
Stroke, 1 inches.....	3 3/4	5 1/4	5 3/4	7	8 3/4	9 1/2	16	20
Strokes per minute.....	500	500	400	300	275	225	140	120
Foot-pounds energy per blow.....	100	140	350	1,000	2,500	4,150	8,200	22,080
Boiler horsepower required.....	10	10	15	20	25	35	40	60
Compressed air, actual cubic feet.....	75	85	90	200	275	350	400	600
Size of hose, inches.....	3/4	3/4	1	1 1/4	1 1/4	1 1/2	1 1/2	2
Size wood sheeting, square or round piling, inches.....	2 X 10	3 X 8	3 X 12	4 X 12	6 X 12	10 X 14	17	21
Penetration in average material, feet.....	4-6	6-10	6-10	10-15	15-20	Largest	30-40	60-80
Size steel sheet piling, inches.....	9	9	12	12	12	Largest	Largest	Largest
Penetration in average material, feet.....	6-10	10-15	10-15	15-20	20-30	30-40	50-60	70-100
Code word for hammer.....	GAPUP	GODME	IBALA	SOZBY	SUDDO	SUDOF	UBMIM	SUZEX

The strokes per minute given above should not be exceeded. See Table 234A for full details.

NOTE.—When ordering hammer sizes 9-B-2 or 11-B, be sure to specify whether flat or bell-bottom anvil block is wanted.

NOTE.—To get safe bearing power of piles for these hammers, use formula $L = \frac{2E}{S + 0.1}$ where

L = bearing power in pounds.

E = energy per blow in foot-pounds.

S = final penetration per blow in inches.

NOTE.—For effect of variation in number of blows per minute on force of blow (E) see maker's catalogue. This is illustrated by Table 234A for McKiernan-Terry Hammers.

TABLE 234A

Size of hammer	Weight of ram, pounds	Lifting area of piston, square inches	Striking area of piston, square inches	Length of stroke, inches	Foot pounds blow at given stroke per minute	
					Strokes per minute	Foot pounds per blow
No. 1	21	1.932	3 976	3 $\frac{3}{4}$	500	100
No. 2	43	3.487	3 187	5 $\frac{1}{4}$	500	140
No. 3	68	3.139	8 296	5 $\frac{1}{4}$	400	350
No. 5	200	18 85	18 85	7	300	1,000
					275	800
					250	650
No. 6	400	36 18	36 18	8 $\frac{3}{4}$	275	2,500
					230	2,160
					200	1,680
No. 7	800	55.6	55.6	9 $\frac{1}{2}$	225	4,150
					195	3,720
					170	3,280
No. 9-B-2	1,500	44 177	56 745	16	140	8,200
					130	7,000
					120	5,940
No. 11-B	3,625	100.645	120.28	20	120	22,080
					110	18,920
					100	15,640

Attention is called to the fact that our hammers at the speeds indicated above must develop the foot pounds per blow as specified. Calculations based on steam pressure are misleading because no two set-ups are identical and it is impossible to determine the mean effective pressure in the working cylinder from the boiler pressure as shown by gauge.

Figure 346A shows safe load 2000 lb. drop hammer for different falls and penetrations with load factors for other hammer weights. *This diagram assumes free fall. For restrained fall (cable and drum attached to hammer) use 80% of loads given.*

Figure 346B shows safe loads for different penetrations per blow for double acting steam hammers striking a 10,000 ft. lb. blow with load factors for other forces of blow.

Table 234 gives typical double-acting steam-hammer specifications.

As a check on the *Engineering News* formulas, Trautwine states that friction on piles will support following total loads per sq. ft. of pile surface in contact with earth.

Soil	Total load per sq. ft. pile surface, pounds	Safe load per sq. ft. pile surface, pounds
Dense moist sand.....	2000	400
Loamy gravel.....	2000	400
Common soils and clays.....	1000 to 1500	200 to 300
Silt and mud.....	200 to 400	50 to 100

Horizontal Stability of Piles.—For the ordinary bridge foundation conditions there is rarely any doubt of horizontal stability but where piles are driven through a very soft upper layer with only a short penetration into an underlying hard layer and where after driving the tops of the piles can be easily moved horizontally it is necessary to insure against horizontal movement of the abutments by means of batter piles. Where a condition of this kind is unexpectedly encountered the inspector should get in touch with the bridge engineer for specific instructions as to the number, length, location and batter of the piles to be used to insure stability.

Inspectors Records.—Sample records for bridge work are given below from the California Manual.

Forms.—The following figures illustrate typical forming for concrete which is strong enough to prevent objectionable deflection.

The practice of the Illinois Highway Commission in designing forms for reinforced-concrete girder bridges is as follows:

"1. Rail and Girder Forms.—Forms for side rails of reinforced-concrete slab bridges may be constructed of 1" sheeting with vertical studs placed not farther apart than 2'. Forms for the girders of reinforced girder bridges should preferably be constructed of commercial 2" sheeting with studs not farther apart than $2\frac{1}{2}'$. All sheeting should be surfaced on the side adjacent to the concrete.

"2. Bracing Rail Forms.—Rail or girder forms are best kept in line by extending the caps of each bent a sufficient distance, bracing them to the falsework posts and then running a heavy stringpiece along the ends of the extended caps, bracing from this stringpiece to each stud of the rail or girder forms.

"3. Setting Panel and Coping Forms.—The panels and coping of rail and girder forms should, whenever practicable, be omitted until the floor of the span has been concreted. The weight of the floor is usually the greater part of the total weight of the superstructure, and if any settlement of the falsework occurs, it is usually when the floor is placed. If the panel and coping forms are completed before any concrete is placed, settlement of the falsework will show in the panels and coping. It is not safe to trust to a camber to take care of the settlement, as the settlement is almost sure to be uneven at the different supports. The side forms of the rails or girders should preferably be left 3 or 4' higher than the finished girder, and just before the last concrete is placed, a triangular molding should be nailed on the inside of the forms at the exact elevation required and used as a guide for a template in striking off the top of the girder. If these precautions are taken, the portions of the work visible from the roadway may show perfect lines, although a settlement of the concrete may have occurred which shows as a sag in the bottom of the girders when viewed from the side. A small settlement of falsework which occurs before the concrete has set does not injure the strength of the bridge.

"4. Construction of Girder Forms.—Girder forms should be so built as to permit of ready removal without injury to the concrete. The underside of copings should be given a pitch towards the girder for this purpose. Great care should be taken to secure perfect alignment of rail and girder forms. Local kinks should be taken out before the concrete is placed.

"5. Alignment of Forms.—Correct alignment of girder and rail forms cannot be too strongly emphasized. Irregular lines are exceedingly unsightly and as the bridge will be judged for all time to come from the appearance of the portion visible from the roadway, if this appearance is unsightly, the bridge will be condemned by the public regardless of the possible excellence of the concrete."

The following instructions for constructing concrete highway bridges forms were prepared by M. W. Torkelson, bridge engineer, Wisconsin Highway Commission.

"1. Never place the bents for any kind of falsework more than 5' apart.

"2. If you can possibly get a pile driver, use driven piling to support your falsework.

			STANDARD	PILE	RECORDED
<i>Specification Notes:</i>					
<i>Material</i>	<i>Fir or Pine</i>				
<i>Load Required</i>	<i>20 Tons each</i>				
<i>Min. Tip</i>	<i>8"</i>				
<i>Min. Butt</i>	<i>20"</i>				
<i>Pay Length = Length below Cutoff</i>					
<i>Load = $P = \frac{2Wh}{5+1}$ where W = weight</i>					
<i>of hammer in lbs, S = Average Penetration</i>					
<i>in inches last 3 blows, h = height of drop</i>					
<i>in feet. P in pounds.</i>					
<i>North Abutment</i>					
<i>No</i>	<i>Total Length</i>	<i>Cutoff</i>	<i>Pay L.</i>	<i>Last 3 blows Pen</i>	<i>h</i>
<i>1</i>	<i>24</i>	<i>4</i>	<i>20</i>	<i>1"</i>	<i>15</i>
<i>2</i>	<i>24</i>	<i>4</i>	<i>20</i>	<i>1½</i>	<i>15</i>
<i>3</i>	<i>25</i>	<i>5</i>	<i>20</i>	<i>2</i>	<i>15</i>
<i>4</i>	<i>26</i>	<i>6</i>	<i>20</i>	<i>1</i>	<i>15</i>
<i>5</i>	<i>23</i>	<i>3</i>	<i>20</i>	<i>2</i>	<i>15</i>
<i>6</i>	<i>22</i>	<i>2</i>	<i>20</i>	<i>2</i>	<i>15</i>
<i>Totals</i>	<i>144</i>	<i>24</i>	<i>120</i>		
<i>South Abutment</i>					
<i>1</i>	<i>25</i>	<i>5</i>	<i>20</i>	<i>2</i>	<i>25</i>

FIG. 347.—Sample construction pile records.

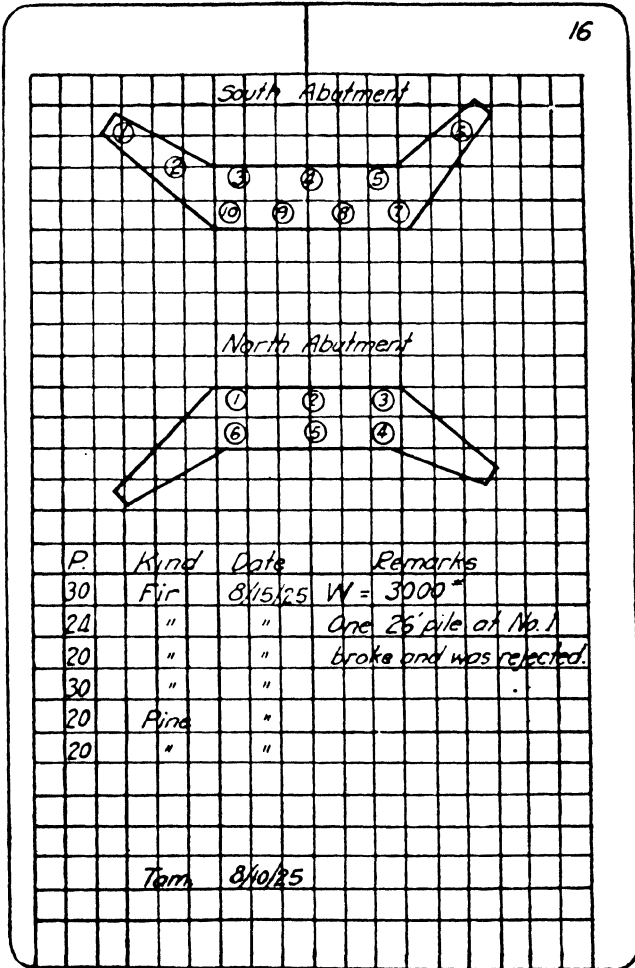

FIG. 347.—(Continued.)

"3. If you cannot get a pile driver, good bottom can be obtained by laying planks or timbers on the stream bed to get a good wide footing for each bent, then placing the mud sill upon the planks to support the posts. Before the planks or timbers are laid upon the stream bed, this should be leveled and all soft mud or easily removed sand should be removed. Sometimes temporary concrete sills can be used to advantage, but the principle is the same as for wooden sills.

"4. The posts for the bents should be 8" thick and of good sound timber. Always use eight posts in each bent where the road is 20' wide, and arrange the posts so that two will come under each railing.

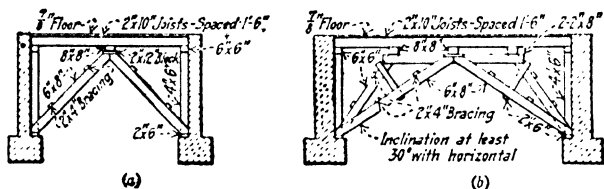

FIG. 348A.

"5. Use a heavy cap on top of the posts fastening either with dowels or by means of very heavy spiking, and let this cap extend about 4' beyond the railing.

"6. The floor can best be directly supported by 2 by 10 joists spaced 18". Under railings double this up.

"7. With the joists spaced as in (6), the floor can be 1 or 7/8" material. It should be nailed to the joists with 8-penny nails and should extend about 4' beyond the outside of the railing. This extra width is needed to brace the railing and for walking across the bridge.

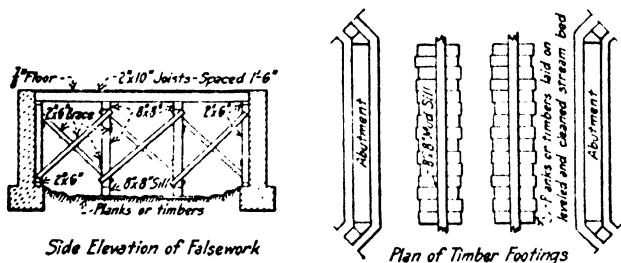

FIG. 348B.—Falsework for small concrete bridges.*

"8. Be sure to cross-brace the falsework both ways so that it will be held rigid against pressure from any direction. Unless this is looked after, the falsework is likely to wobble when the placing of the concrete begins.

"9. Always use good planed and sized lumber on the railing, as this is the part of the work which shows up. Have all panel work and three-cornered chamfer strips made at the same planing mill. Send your bridge plan to the mill and have strips cut to the proper dimensions. Wet railing forms thoroughly before pouring concrete.

"10. Always keep a man tamping the concrete next to the forms. This will give a good smooth surface when they are removed and diminish the work of finish. A wooden tamper will give better results than a steel spade.

* NOTE.—Specifications mud sills, page 1521.

"11. Removal of Forms.—In order to make possible the obtaining of a satisfactory surface finish, forms, on ornamental work, railings, parapets, and vertical surfaces that do not carry loads and that will be exposed in the finished work shall be removed in not less than 12 nor more than 48 hr., depending upon weather conditions. Forms under slabs, beams, girders, and arches* shall remain in place at least 21 days in warm weather, and in cold weather at the discretion of the engineer. Forms shall always be removed from columns before removing shoring from beneath beams and girders, in order to determine the conditions of column concrete.

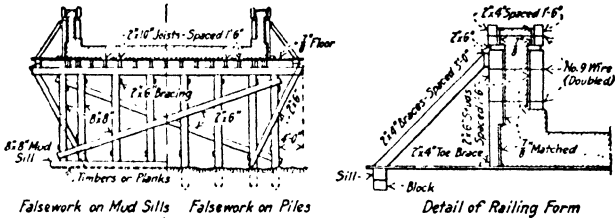

FIG. 349.

"No forms whatever shall be removed at any time without the consent of the engineer. Such consent shall not relieve the contractor of responsibility for the safety of the work. As soon as the forms are removed all rough places, holes, and porous spots shall be filled, and all bolts, wires, or other appliances used to hold the forms and passing through the concrete shall be cut off or pushed back with nail set $\frac{1}{2}$ " below the surface and the ends covered with cement mortar of the same mix as used in the body of the work."

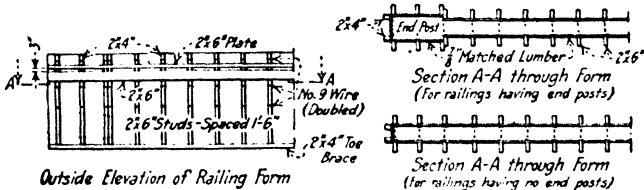

FIG. 350.

The falsework and form plans given in Figs. 348A to 350 were prepared by M. W. Torkelson, bridge engineer for the Wisconsin Highway Commission.

The plans shown in (a) Fig. 348A are for spans up to and including 14'; while the plans shown in (b) Fig. 348A are for spans of 16 to 24' inclusive. The bents should be spaced 5' centers. Use four 2 by 10" joists under the railing. Use hardwood wedges for camber and to facilitate removal of forms.

The falsework in Fig. 348B should be used where it is impossible to drive piles. Bents should be spaced not more than 5' centers, and two posts should be spaced under the railing. Use four 2 by

* **AUTHOR'S NOTE.**—A good rough and ready rule for minimum time in days for removing forms under arches is to divide the span in feet by 4. This assumes warm weather. No backfill should be made in less than 28 days.

10" joists under the railing. Use 2 by 6" joists on top of footing under each joist. Use hardwood wedges for camber and to facilitate erection. Details of an elevation of a bent are shown in Fig. 349.

The falsework bent shown in Fig. 349 may be a framed bent supported on a mudsill as is shown on the left, or may be a pile bent as shown on the right. Eight posts or eight piles should be used in a bent for a 20' roadway. Two posts or piles should be spaced close together under the railing. Bents should be spaced not more than 5' centers. Use four 2 by 10" joists under the railing. Use hardwood wedges for camber and to facilitate erection. Pour

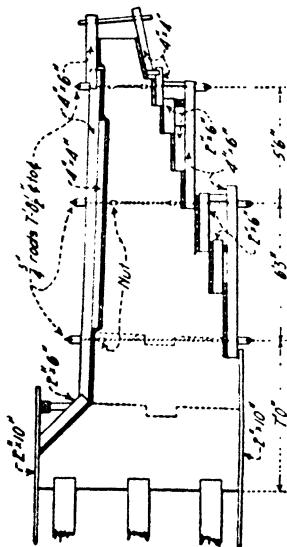

FIG. 351.

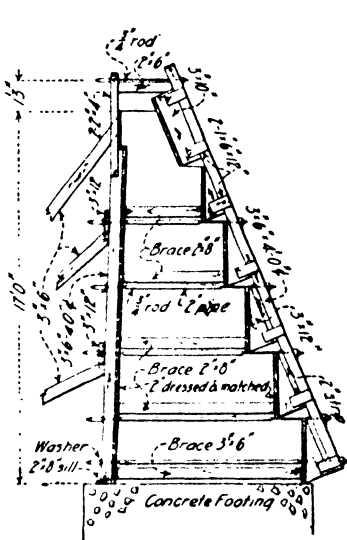

FIG. 352.

floor to top of curb, then build inside railing form to top of 2 by 6" plate, or under side of coping, and pour rail to this point. Let concrete set while pouring other rail to this height. Return to first rail and see if any settlement has occurred, and if so wedge up 2 by 6" plate level before building form for coping. Always provide camber in forms $\frac{1}{4}$ " for each 10' of span. Have three-cornered strip made at planing mill. For elevation and section of railing forms, see Fig. 350.

Details of forms for retaining walls as constructed by the Illinois Central Railroad are shown in Fig. 351. The forms were constructed in sections 54' long. These forms were cross-braced by $\frac{3}{4}$ " rods spaced 7' 8 $\frac{1}{2}$ " centers as shown. When the forms were taken down, the ends of these rods were unscrewed, the main

portions of the rod being left in the wall. The forms were made of 2" plank surfaced on the inside.

Forms used by the Chicago and Northwestern Railway are shown in Fig. 352. The forms were built in sections 35' long. The 2 by 8" braces were used to hold the sides of the forms apart and were removed as the concrete was put in place. The 2" pipe used to cover the rod bracing was old boiler flues and rejected pipe.

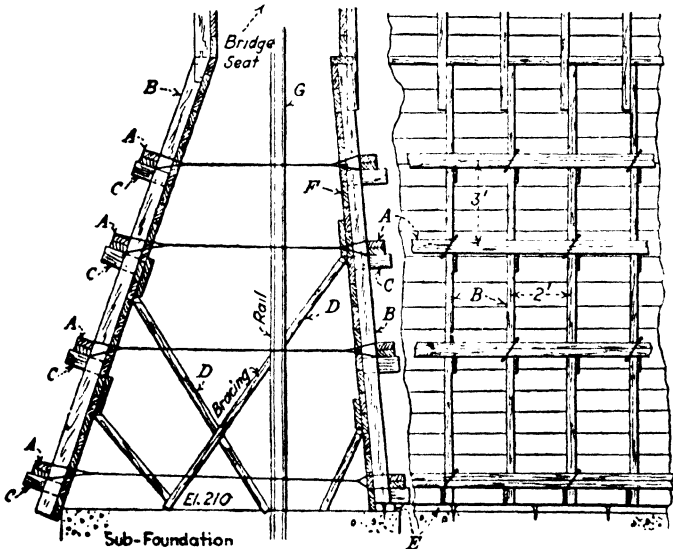

FIG. 353.—Typical form. High abutment Ry. elimination project. New York State.

Description

- A. Whalers. Two 2 by 6" boards nailed together.
 - B. Braces. 2 by 6"—spaced 2' apart.
 - C. Braces to hold whaler in place.
 - D. Inside braces after forms were set. Notice pressure against wires.
 - E. This board held in place and form started from here.
 - F. Boarding 2 by 8".
 - G. Rails.
- Wire is No. 9 form wire tied to whalers, twisted and also doubled.
Wires are staggered on different braces and whalers.

Typical abutment form New York State elimination abutment
Fig. 353.

Typical section arch form shown in Fig. 354.

Detail design data for forms given in Chap. XIV, page 1052.

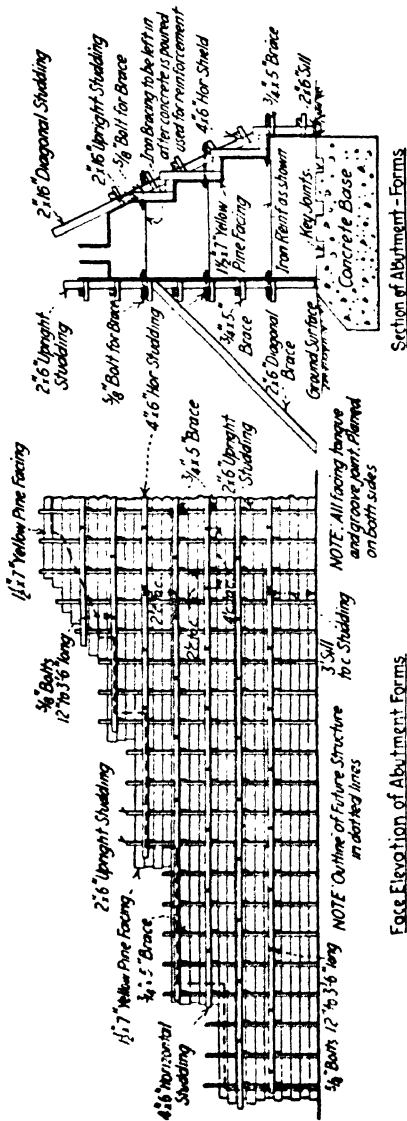

FIG. 354.—Typical abutment form. N. Y. Central railroad bridge.

NOTE.—If 1" facing is used the vertical studing is spaced. 16" c to c.

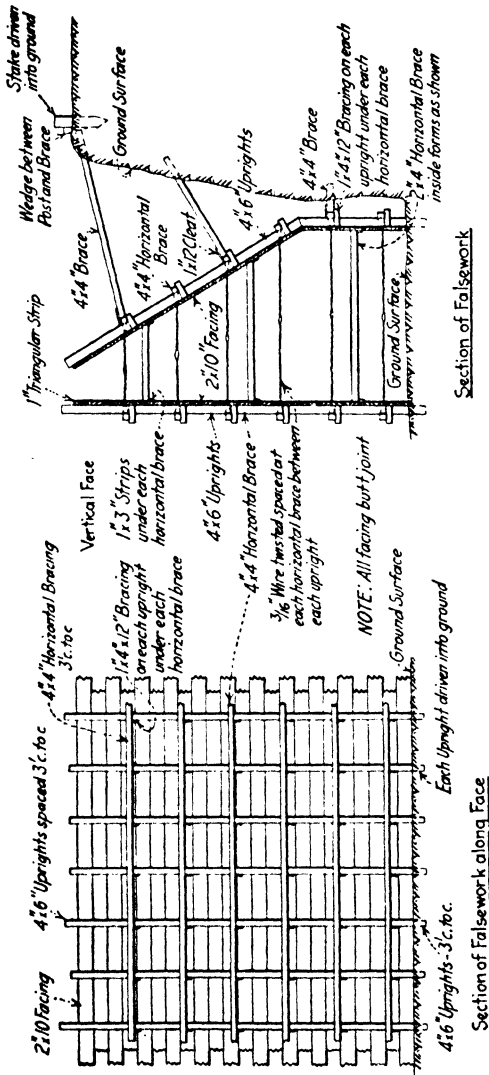

FIG. 354.—Typical high retaining wall form.

Bridge Inspection.—The following extracts from the California Highway Commission Manual of Instructions cover most points not specifically explained in the ordinary specification. These extracts are supplemented by a short statement in regard to foundation soils, test piles, and staking out on pages 1334 to 1354, which the author has found to be convenient data for inspectors (see also Specifications, pp. 1492 to 1572).

CONSTRUCTION DETAILS¹

“Resident engineers shall be guided by the following instructions concerning the various types of work:

“**Section 1. Excavation.**—Safe and proper foundations for bridge structures are of the utmost importance. The life and safety of the structure depends on the stability of its foundations.

“At the time a structure is designed, the type of footing and the allowable soil pressures are determined from the most available data, but upon opening the excavation pits the conditions may be found to be different from those assumed in design. This may make it desirable to alter the footings either by changing their size, raising them, lowering them, by driving piles, or by other means.

“The bridge engineer shall always be notified sufficiently in advance of the date upon which it will be possible to inspect the footings or foundation materials, so that he or his assistant may inspect them to determine their suitability and pass upon any desired changes.

“In case excavation is wet or the material is of such nature that it has to be cribbed or shored, the cofferdam or crib shall be of sufficient size so that there will be ample room between the forms and the cofferdam to permit bracing, to provide pumps for pumping, and to permit inspection of the concrete after the forms have been removed.

“The cofferdams, cribs, and shoring shall be sufficiently strong to withstand the pressures caused by dewatering the pit. The contractor shall be required to submit sketches of the method of constructing cofferdams or cribs. Braces shall not be permitted to extend into or through the concrete, but should be so arranged that they can be removed as the concrete is placed.

“Before placing concrete, all loose material shall be removed from the bottom of excavations and from the walls where excavation is made to neat lines. Care shall be taken not to allow material which has been loosened by blasting, etc., to remain in footing or abutment excavations (see specifications for details of excavation).

“**Section 2. Backfilling** (see specifications for details).—Backfilling around piers and abutments shall be carried up uniformly around the entire structure. In case of approach fills against abutments, the filling shall not be done until the concrete has set sufficiently to withstand the earth pressure.

“Backfilling that is to become an integral part of the roadway embankment shall be compacted by spreading in thin layers

¹ California Manual.

rolled, tamped, puddled, or compacted by other methods approved by the bridge engineer. The class of material will determine the method to be used.

"No rubbish, timbers, or other foreign materials shall be used for backfilling. Boulders shall not be permitted to drop against the fresh concrete.

"Forms shall be removed to the ground line.

"Section 3. Falsework.—For important structures the contractor shall submit a plan for approval showing the proposed method of constructing the falsework (see specifications).

"Driven falsework is preferable, but framed falsework may be approved when soils are suitable, and when sufficient bearing is provided under the sills to prevent settlement. Especial care shall be taken to get sufficient bearing area in the case of adobe or clay soils because of the liability of the soil becoming wet and soft when concrete is placed. Falsework shall be so constructed that in the event of settlement it can be taken up with wedges. In case of supports being placed where excavation has been made, the supporting timbers shall be set upon the original firm ground or where possible upon the concrete footings.

"It shall be constructed with braces and fastened together in such a manner as to act as a unit so that the settlement will be practically uniform.

"The use of bolts in fastening falsework is preferable to spiking, as it will be much more rigid and removal will be facilitated.

"Plans for arch centering, trussed falsework, and falsework for structures over railway tracks must be submitted to the bridge engineer for approval before their use will be permitted. In the case of supports over railway tracks, it is necessary that the plans be approved by the railway officials. The resident engineer will see that these plans are submitted sufficiently in advance of their use, so that there will be ample time for approval.

"In setting grades for falsework, an allowance shall be made not only for settlement occurring from the soil, but for closing of horizontal joints in vertical framing. This allowance shall be determined as far as possible by data obtained from previous work. The resident engineer shall take careful levels before and after placing of concrete, and before removal of forms, submitting the settlement data so obtained together with a sketch of the falsework used, and a description of conditions, in the final report of the work.

"Section 4. Forms.—The plan submitted by the contractor for the falsework shall include the forming plan.

"In constructing forms, the grade, alignment, surface appearance, and rigidity shall always be kept in mind.

"Forms shall be constructed of lumber surfaced one side and two edges. Joints in sheeting shall be permitted only at studs. Studs shall be spaced so that the lines will be straight and true, with no bulging and tipping out of line. Where 1" lumber is used for sheeting, studs shall be held by means of walings of sufficient size to insure rigidity of the forms. The use of 2" T and G lumber on the exposed surfaces will give a much better finished appearance and will facilitate finishing the concrete surface.

"If green lumber is used, the sheeting shall be nailed as tight as possible. If thoroughly seasoned lumber is used, the forms shall be oiled before the concrete is placed, or a space from $\frac{1}{16}$ to $\frac{1}{8}$ " in width, depending upon the condition of the lumber, shall be left to take care of swell. These cracks shall be closed by thoroughly soaking the forms with water prior to placing concrete, in order to prevent loss of cement and an unsightly surface finish. Ship-lap may be used but it shall be thoroughly seasoned to prevent shrinkage of the forms.

"Knot holes and other apertures in forms shall be closed in an acceptable manner before placing the concrete. Sheeting of a width greater than 8" will not be permitted unless special precautions are taken to prevent warping.

"The amount of camber to be used in placing falsework depends upon the bearing power of the soil, type of forms, number of joints in the falsework and length of span. The camber shown on the plans is the amount that should exist after the forms have been removed. A reasonably safe rule to follow is to double this amount to allow the settlement, but local conditions must be considered in determining this amount. The thickness of the floor slab shall be the same at all points regardless of the amount of camber used.

"The use of bolts as tie rods in forms where practicable, such as, piers, abutments, or other mass concrete, is desirable because of the rigidity obtained. When wire is used, it shall be of sufficient strength and elasticity to permit thorough tightening.

"Oiled or other treated forms are desirable, but oiling must be done before the reinforcing steel is placed.

"If steel forms are used, they must be made of metal of sufficient gage to withstand knocks, so as not to become dented. If of large size they shall be constructed with stiffeners to prevent bending. When reused they must be thoroughly cleaned and oiled before concrete shall again be placed against them.

"If railing forms are constructed of lumber, the best results will be obtained by using tongue and groove flooring for sheeting and other lumber cut to size with a minimum of joints and treated with white shellac. Bolts are preferable, as wired forms are too flexible and difficult to tighten in the thin section. The railing forms shall be set true to line and grade by using transit and level.

"**Section 5. Reinforcing Steel.**—The placing of the reinforcement is a very important detail of the concrete structure. The success of the structure depends upon the reinforced members. The resident engineer shall see that the steel is furnished according to specifications, that none is placed unless absolutely clean, that the spacing in all cases is correct, that all bars are tied at intersections (with figure-eight ties), adequately supported by concrete blocks or other acceptable means and that there is sufficient space between the steel and surface of concrete to give full protection to the steel.

"Laps are to be made only where shown on the plans unless authorized by the bridge engineer or his assistant and when made shall be not less than 40 diameters. At laps the steel shall be so located that there will be at least 2" of concrete around each bar.

"Extreme care shall be exercised during placing of concrete to see that the steel does not become misplaced. The bars should be joggled to insure a good bond.

"If for any reason concrete becomes dried on the bars before they are covered, it shall be removed by scraping and not by hammering the bars.

"Section 6. Concrete. (a) *Mixing* (see specifications and item 7 on page 39 of the Construction Department Manual).—When starting the placement of concrete the rock may be reduced in the first few batches until the mixer has become thoroughly coated with cement in order to insure the workability of the concrete.

"(b) *Placing* (see specifications).—It is of the utmost importance that concrete be properly placed and, in order to secure the required results, the resident engineers must give this close and minute attention.

"The plans will contain a diagram showing the successive locations of concrete placement. The contractor shall equip the work in such a way that this can be followed. If it is necessary to make joints in the concrete, they shall be horizontal in piers and abutments, except in abutments for arch spans when they shall be made at right angles to the resultant line of thrusts. If joints are made, they shall be securely bonded by stepping, notching or by use of dowels or other acceptable means. Joints will not be permitted in girder spans except as shown on the plans, unless authorized by the bridge engineer (see plates 355 and 356).

CONSTRUCTION JOINTS

Mass Concrete.—Construction joints in mass concrete abutments, wings and walls are often necessary and there is no objection to their use. The concrete is brought up in horizontal layers 6" to 8" thick to permit proper placing and spading. At the end of the days' work a key or dowel joint is provided. Dowel joints by means of vertical steel beams or rails as shown in Fig. 353 are the most convenient method and are usually adopted utilizing old steel from the old bridge but key joints similar to Fig. 354, page 1352, are entirely satisfactory. These key joints should be approximately 9" to 12" deep and have a top area of approximately 30% of the total area to be bonded.

Slab decks should be constructed full depth for the entire span at one operation and if there is any doubt of being able to accomplish this they should be laid in strips parallel to the span and each strip completed. There is no objection to laying in a series of strips. If a breakdown makes it necessary to stop work and it is impossible to finish by hand mixing methods put in a header perpendicular to the axis of the slab and provide corrugated key projections of at least 30% of the section area as shown in Fig. 356. These joints should be located at points of least shear (near center of span).

Arch rings are handled in the same manner as slabs except that work is started at both abutments working towards the crown to

keep a symmetrical load on the center and prevent distortion. It is common practice to lay arch rings in strips but intermediate joints

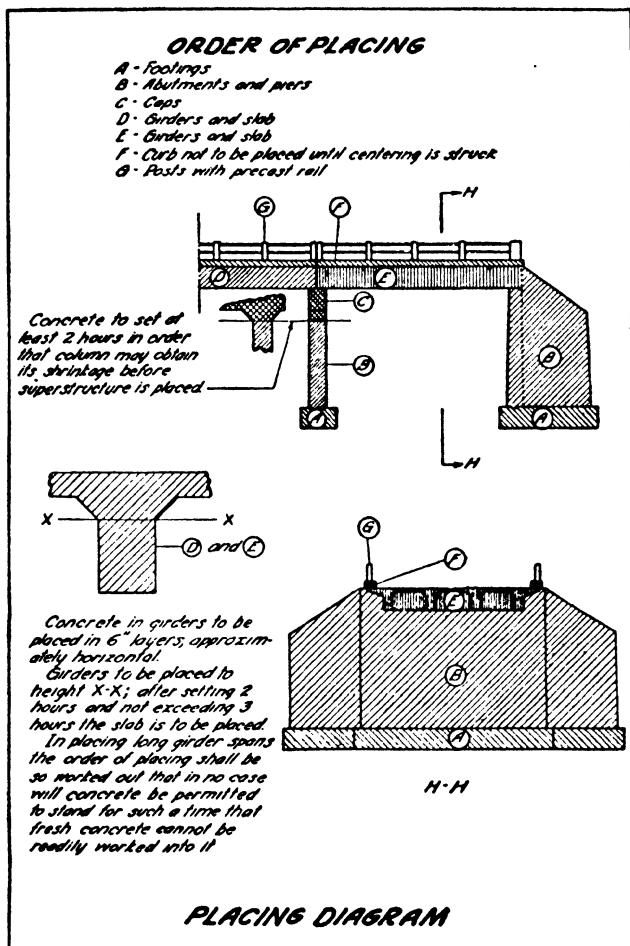

FIG. 355.—Order of placing concrete.

are to be avoided if possible; when necessary they should be perpendicular to the arch ring radius and can be placed at any location without much danger of weakness.

Girders are handled in the same manner as slabs except that they must not be constructed in strips.

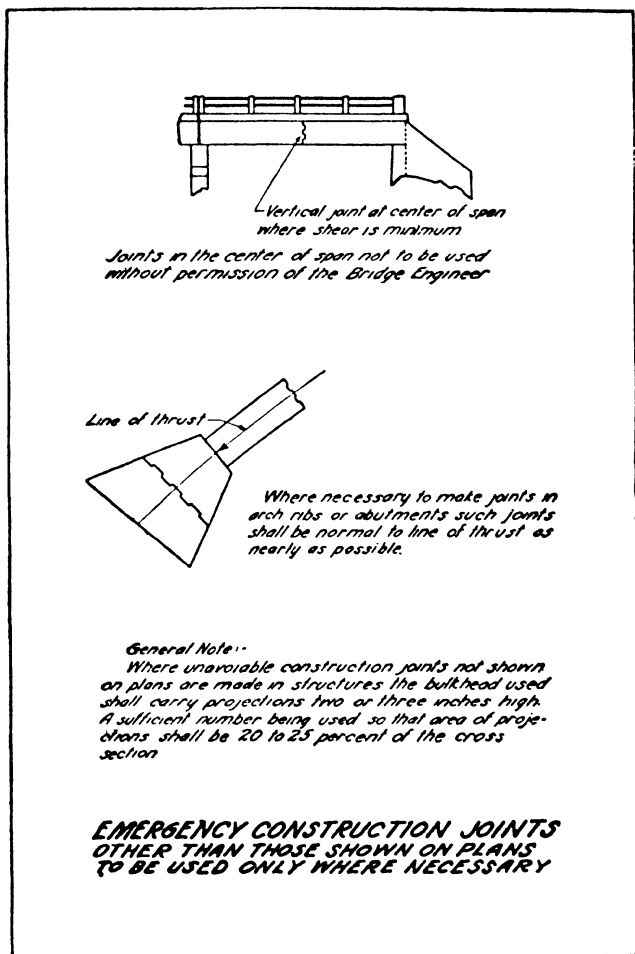

FIG. 356.—Emergency construction joints.

T-beams are the most difficult deck to pour properly and a strong effort should be made to complete the superstructure in one con-

tinuous pour even if double shifts are required. The inspector should have in mind that for T-beam construction, Fig. 73, page 252, the floor slab is part of the beam and concrete must be poured full depth, both beam and slab being carried forward in one operation. The best method of pouring a T-beam structure is to start at one side of the bridge, pour one beam and slab complete and then work across the bridge completing each beam and slab one at a time. In case a break down forces a joint the best location is in the floor slab parallel and midway between two beams.

"Concrete shall not be placed in the curb and railing until the falsework has been removed, except in the case of through girder spans when the girder and curb shall be placed monolithically. The curb and railing shall be constructed separately. The utmost care shall be exercised to keep the forms in good alignment.

"Except in cases of necessity, no concrete shall be placed under water and at no time will it be permissible to place concrete in running water. When concrete is placed under water, it shall be by means of a tremie, bottom-dump bucket or other method equally as good, and acceptable to the bridge engineer. The concrete shall be of such consistency that it will flow and not separate when deposited under the water; if it is too dry or too wet it will separate with a resulting poor concrete.

"Concrete shall be placed in successive layers in all portions of the work except the deck. As each layer is placed, it shall be thoroughly rodded and worked into a compact mass. In high forms care shall be exercised to see that the placing is not so rapid as to permit sufficient pressure to accumulate as to cause bulging of the forms. Care shall be exercised to see that all bolts or wires are tight at all times.

"In piers, abutments, or other large masses the concrete can be spaded very satisfactorily with a square-point shovel, but in smaller sections it will be necessary to have special tools.

"When boulders (plum rocks) are placed in mass concrete, they shall be placed in such a manner as to insure their being thoroughly imbedded with no air pockets around them and not less than 6" of concrete on all sides (see specifications).

"When placing concrete in girders or beams, the first layer shall be just sufficient to cover the steel and shall start at one end and be carried continuously along the full length of the girders before the second layer is started. The succeeding layers shall be of proper thickness to permit proper working of the concrete. While placing of concrete is in progress and before it has taken the initial set, the forms shall be hammered on the outside with a wooden mallet or hammer to insure the mortar being brought to the surface.

"When placing concrete in the deck, it shall be started at one end, brought up to grade, and carried forward in one operation. The surface and grade shall be obtained either by using screeds set to grade or by means of a template cut to the proper crown and operated on the side forms. The surface shall then be smoothed longitudinally with a wooden float, operated with a combined longitudinal and transverse motion to plane off the high places and bring the low places up to grade. After this has been accomplished,

a smooth surface shall be obtained by finishing with a belt, hose, float or other acceptable method. It is essential that a smooth-riding surface be obtained so that impact will be reduced to a minimum.

"Where angle irons are placed at points, extreme care shall be exercised to see that they fit true to grade, are not tipped, and are securely fastened before the placement of concrete is commenced. During the placing of concrete they shall be carefully watched to see that they are not knocked out of position. It is preferable to have angles $\frac{1}{8}$ " below grade.

"The placing of concrete in the curbs and railing shall be carried up in layers, and after a layer has been spaded and worked sufficiently, it shall not be disturbed in spading the succeeding layers, for in doing so air pockets will be formed on the surface with a resulting poor finish.

"(c) *Finishing* (see specifications).—A good finished appearance is essential at all times. Good finish depends upon good formwork, care in placing, removal of forms as soon as possible, and care in finishing by experienced labor.

"At all corners where possible, such as at construction joints and open tops of forms, an edging tool of proper radius shall be used to round the corners. Corners that cannot be treated in this manner shall be chamfered, either by nailing a fillet of the required dimensions, to the forms, or by beveling the corners of the forms

"Excellent results will be obtained by finishing in two operations, namely, "first rub" and "second rub."

"The "first rub" is a surface treatment of imperfections that are present upon removal of forms, such as form marks, bolt holes, protruding tie wires, etc., and must be made immediately upon removal of forms—usually done within 24 to 48 hr. after concrete is placed, on vertical surfaces that are not supporting members. A mortar composed of 1 part cement to 3 parts sand (screened through a 14- or 16-mesh screen) is applied to the entire surface, after removing any fins or projections, while the concrete is green so that it will become an integral part of the surface. Care shall be exercised that the mixture is not too rich so that checking of the surface will be prevented.

"The "second rub" can best be done as the last operation when all other work on the structure is completed, the workman to start at the top and work down, the treatment to consist of the application of water and very thorough rubbing with carborundum stones.

"The quality of the finish obtained depends upon the skill of the workmen, as in both "first" and "second" rub, hard work, proper supervision, and particular care must be exercised to leave the surface without showing lines where work started and stopped.

"Mechanical means of surfacing may be employed if the results obtained are of the same quality as the foregoing.

"If dark cement is used in the railings, a small amount of hydrated lime should be added to the mixture to make a lighter color in this portion of the structure.

"(d) *Curing* (see specifications).—Where possible the curing of concrete shall be done by covering the surface with earth and

dyking or flooding with water. In places where this method is not possible, the concrete shall be kept wet by sprinkling or covering with burlap that is kept well dampened the required length of time. The resident engineer shall insist upon proper curing. The strength of structures will be greatly affected by the curing and may be reduced as much as 30% if this work is not properly done. With this in view steps shall be taken to cure the concrete as soon as possible after it is in place.

"Section 7. Waterproofing and Repair of Concrete Structures.

(a) *Necessity for Waterproofing.*—Where structures are subjected to action from salt air and salt water or alkali, it is important that the concrete be as impervious as possible. If there is any porosity, the salt water and alkali will attack the concrete, and if there is steel within reach, it will corrode. When steel corrodes, it expands, destroying the bond and cracking the covering concrete.

(b) *Waterproofing New Structures.*—The best method of preventing this destructive action is by obtaining a dense concrete when the structure is constructed. In order to obtain a dense concrete, the utmost care and attention must be exercised.

"There are certain rules and practice to be followed as given below:

1. Use of dense, rich concrete, not less than 6 sacks of cement per cu. yd.
2. From 2' below low water to 2' above high water 7 sacks of cement per cu. yd. shall preferably be used.
3. Concrete to be deposited in dry when possible.
4. Avoid contact of salt water with the concrete for at least 4 days after placing (see p. 1530).
5. Use of strong, sound aggregates.
6. Avoidance of beach sands.
7. Fresh water to be used in mixing concrete. A minimum of water to be used at all times.
8. Only concrete block chairs to be used for supporting reinforcing steel.
9. Reinforcing steel to be well imbedded in the concrete.
10. Construction joints to be reduced to a minimum number.
11. Concrete to be spaded and tamped thoroughly to produce a uniform skin surface.
12. Oiled or treated forms.
13. Concrete to be mixed not less than 2 min.

(c) *Repairing Old Structures.*—The best method of repairing a reinforced-concrete structure that has been affected by the action of salt water or alkali is to remove loose concrete and recover the reinforcing steel with concrete. Small repairs can be made by hand methods but where any quantity of repairing is to be done one of the best methods is to apply gunnite.

"Section 8. Pile Driving. (a) *Materials.*—For details of materials for all classes of piling, see specifications.

(b) *Limitation of Use.*—In general, the penetration for any pile shall be not less than 10' in hard material and not less than one-third the length of the pile nor less than 20' in soft material.

"For foundation work, no piling shall be used to penetrate a very soft upper stratum overlying a hard stratum unless the piles penetrate the hard material a sufficient distance rigidly to fix the ends.

(c) *Caps.*—The heads of all concrete piles, and the heads of timber piles when the nature of the driving is such as unduly to injure them, shall be protected by caps of approved design, prefer-

ably having a rope or other suitable cushion next to the pile head and fitting into a casting which in turn supports a timber shock block. When the area of the head of any timber pile is greater than that of the face of the hammer, a suitable cap shall be provided to distribute the blow of the hammer throughout the cross-

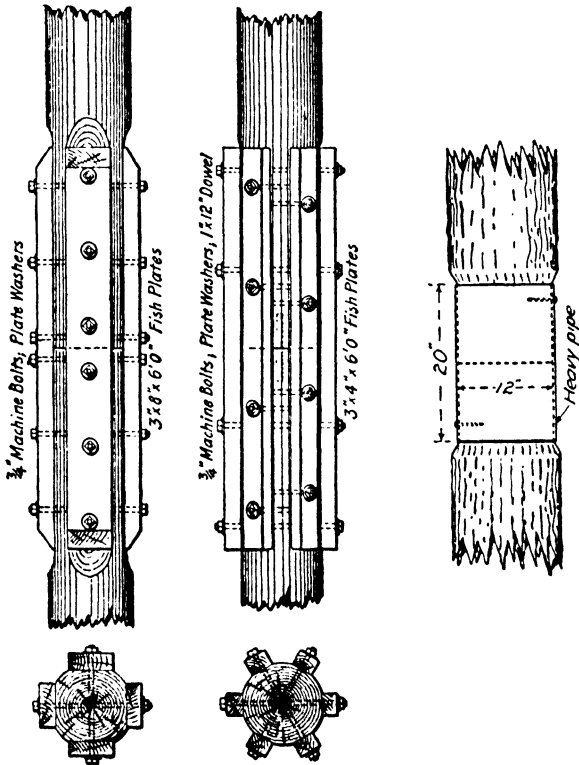

FIG. 357.—Pile splices.

section of the pile and thus avoid, as far as possible, the tendency to split or shatter the pile.

“(d) *Splicing Timber Piles.*—Piles shall not be spliced except by the permission of the bridge engineer.

“(e) *Methods of Driving.*—Timber piles shall be driven with a drop hammer, steam hammer, water jets, or a combination of water jet and hammer. Concrete piles shall not be driven without the combination of steam hammer and jet except by permission of the bridge engineer. Two jets shall preferably be used to eliminate

the possibility of the pile crawling. If satisfactory to the bridge engineer, concrete piles may be used, cast with a pipe through the center. The final penetration shall be secured without the aid of the jet.

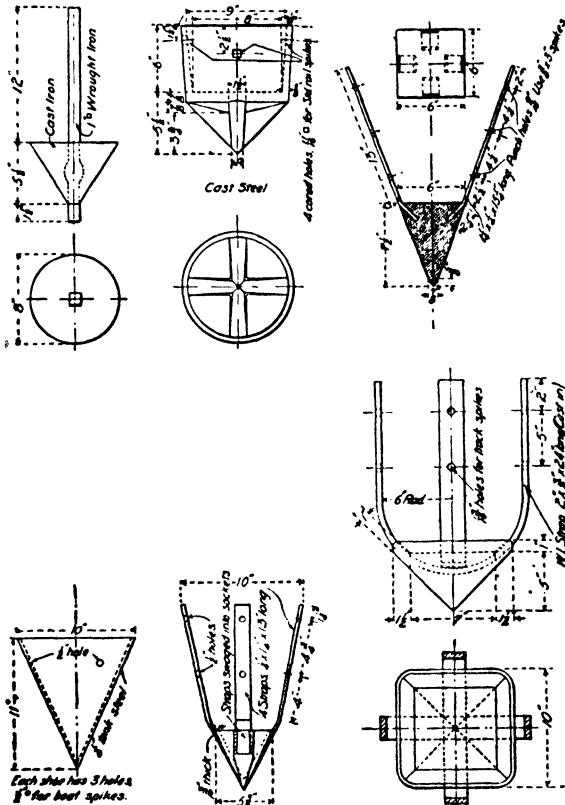

FIGS. 13d, e and f.—Shoes for Timber Piles.

FIG. 358.—Pile shoes.

"When gravity hammers are used, they shall weigh not less than 3000 lb. and the fall shall be so regulated as to avoid injury to the pile and in no case shall exceed 15'.

"When the penetration is $\frac{1}{8}$ " or less per blow, driving shall be stopped, as such penetration shall be considered refusal

"Steam hammers shall develop an energy per blow of not less than 12,000 ft.-lb.

"The leads shall be so guyed or braced as to hold the pile in position during the entire process of driving. Extension leads are preferred, but the use of a follower will be permitted when necessary. A submarine hammer may be used where piles are driven under water, but they must be of such length that when cut off there will be a sound, clean head.

"There shall be a variation of not more than $\frac{1}{4}$ " per foot from the vertical or batter line indicated.

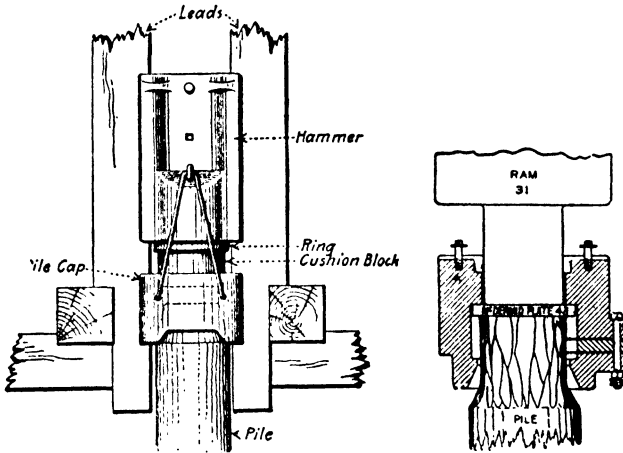

FIG. 359.—Pile caps.

"In some instances loading tests may be necessary to determine the bearing value of piles. More generally, however, the following formulas shall be used to determine bearing values:

$$P = \frac{2WH}{s + 1.0} \text{ for drop hammers}$$

$$P = \frac{2WH}{s + 0.1} \text{ for single-acting steam hammers}$$

$$P^1 = \frac{2H(W + Ap)}{s + 0.1} \text{ for double-acting steam hammers}$$

where P = safe bearing power in pounds.

W = weight in pounds of striking parts of hammer

H = height of fall in feet or length of stroke.

A = area of piston in square inches.

p = steam pressure in pounds per square inch.

s = The average penetration in inches per blow for the last 5 to 10 blows for gravity hammers and the last 10 to 20 blows for steam hammers.

¹ AUTHOR'S NOTE.—Formula page 1340 using maker's speed of blow in determining E is more reliable than the use of steam pressure area and stroke.

"The above formulas are applicable only when

"a. The hammer has a free fall.

"b. The head of the pile is free from broomed or crushed wood fiber.

"c. The penetration is at a reasonably quick and uniform rate.

"d. There is no perceptible bounce after the blow. Twice the height of the bounce shall be deducted from H to determine its true value in the formula.

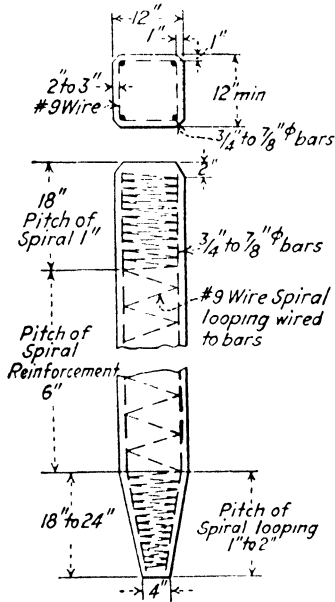

Typical precast concrete pile
Ordinary strength up to 30'.

"In case water jets are used in connection with the driving, the bearing power shall be determined by the above formulas from the results of driving after the jets have been withdrawn, or a load test may be applied.

"When required, by the bridge engineer, test piles shall be driven of a length and at the location designated. These piles shall be of greater length than the length assumed in the design in order to provide for any variation in soil conditions.

"After proper penetration is determined by driving test piles, the resident engineer shall furnish the contractor with an itemized list showing the number and length of all piles, and the contractor shall furnish piles in accordance with such itemized list.

"The storage of piles in all cases shall be such as to avoid injury to the pile. If the surface of treated piles is bruised, it shall be retreated in an acceptable manner.

"The tops of all piling shall be sawed to a true plane as shown on the plans and at the elevation so indicated. Piles which support timber caps or grillage work shall be sawed to the exact plane of the superimposed structure and shall exactly fit it. Foundation piles shall be cut off at staggered elevations so that cleavage planes shall be avoided. Broken, split or misplaced piles shall be withdrawn and properly replaced. Also, those driven below cut-off grade fixed by the engineer shall be withdrawn and replaced by new and if necessary, longer piles at the expense of the contractor. All piles raised during the process of driving the adjacent piles shall be driven down again.

"(f) *Concrete Piles.*¹—In general the same rules that apply to other concrete shall govern the mixing and placing of precast concrete piles. The casting platform shall be so constructed that it is absolutely level and so there shall be no settlement when the load of concrete is applied.

"The forms shall be of the same standard as required for other classes of concrete work and of sufficient stability to prevent warping, tipping out of line, or bending. They shall be so constructed that removal can be made within 48 hr. without moving the pile. As soon as the forms are removed, the surface shall be treated in the same manner as specified for other concrete surface treatment. They shall also be cured in the same manner. They shall not be moved until the 28 days have elapsed and in case of piles to be driven in salt water preferably not before 60 days.

"In handling piles, care shall be taken not to bruise the surface or break the corners. Piles shall be handled by means of a sling or other acceptable method to prevent undue stresses with resulting rupture of the pile. If they are cracked or damaged in handling so as to be unfit for use, it will be cause for rejection and all such piles shall be replaced by the contractor at his expense.

"It is preferred that piles be cast full length of the reinforcement and cut off to the required height, but if this is not done, the contractor shall protect the projecting steel during driving.

"The reinforcing steel shall have a cover of not less than 2" and where piles are subject to the action of salt air and water a minimum cover of 3" shall be obtained.

"In driving piles for concrete bents, a good method to follow is first to drive the vertical piles and to provide a guide for the batter piles by bolting two large timbers alongside the vertical piles. This will help to keep all the piles in line.

"(g) *Sheet Piling.*—These rules apply only to such sheet piling as may be specified in the contract and not to methods which the contractor may employ in the prosecution of the work.

¹ **AUTHOR'S NOTE.**—Figure of typical concrete pile based on 1% to 1½% longitudinal reinforcement with looping as shown. This pile is a safe design for 20 to 30 ton load up to about 30 ft. total length. For special heavy loads and extreme lengths see Jacoby and Davis Foundations for Design of Precast Piles.

"The type and quality of piles used shall be as specified and shall be driven to the required elevation.

"They shall be driven in approximately the same manner as specified for other piles but shall be drift sharpened so that adjacent piles shall be wedged tightly together. They shall be braced securely by means of waling strips either on the inside or on the outside as conditions require. The wales shall be of one length where possible. If splices are necessary they shall be made with timber of the same section as the wale itself and securely bolted. The sheet piles shall be bolted to the wales sufficiently to give stability.

STEEL STRUCTURES¹

"**Section 1. Shop Inspection.**—All important steel structures are usually inspected at the shops, but whether shop inspection has been made or not, work which does not conform to the specifications and to recognized good practice shall be rejected by the resident engineer.

"**Section 2. Unloading and Storage.**—When the steel arrives at the site of the work, the resident engineer shall see that it is unloaded in such a way as to avoid bending of plates or members or unduly marring the shop paint. The steel shall be placed in a protected place upon a substantial raised platform. It shall be piled in such a way that it will not topple over or the steel be bent by an excess weight upon it.

"Any material bent in shipping shall be straightened cold. If it is so badly bent that this cannot be done, it shall be rejected.

"**Section 3. Falsework.**—Before any steel is erected, the falsework shall be carefully inspected by the resident engineer. He shall see that camber blocks are set to the proper grades and alignment and that they are maintained until the span is swung

"**Section 4. Anchor Bolts.**—The resident engineer shall see that the anchor-bolt holes are drilled in the correct location and perpendicular to the plane of the bridge seat. Great care shall be exercised to see that anchor bolts are set in exact position and securely grouted into place. Expansion ends of trusses must be free to move longitudinally under change of temperature but they should be anchored against lifting or moving sidewise. To accomplish this, the nuts on the anchor bolts should be brought down to allow a slight clearance between the nut and the shoe. Masonry plates should be grouted in such a manner as to insure perfect bearing over the entire surface of the plate and they must be level and to exact elevation.

"**Section 5. Erection.**—Segmental rollers should be set to the exact angle shown on the plans. When the span is swung and the floor is completed, the rollers will stand vertical at the average temperature. If the angle of inclination is not shown, the attention of the bridge engineer should be called to the fact. In assembling steel, the resident engineer shall see that proper care is observed to avoid injury or damage to the various parts. Excessive hammering

¹ See also pp. 1533 to 1566.

which may distort the metal shall not be permitted. All parts shall be placed in accordance with the erection diagram of working drawings. Reamed connections which have been match marked in the shop should be erected in accordance with those marks.

"Drifting which would distort the metal shall not be permitted. Should holes be poorly matched, they should be reamed to such size as will give a true hole throughout and larger rivets driven. In all cases, the resident engineer shall see that the proper sequence is observed in riveting in order that all rivets may be driven. Before permitting riveting, all members shall be accurately and firmly bolted up and all burred edges should be removed so that all parts are in close contact. At least 25% of the holes shall be bolted.

"The resident engineer shall check the sizes of all members, see that all joints, shown on the plans as milled, are brought to perfect bearing, that all loose fillers and pin packing or ring fillers are placed as shown.

"Section 6. Riveting.—All field riveting shall be done with pneumatic hammers. The resident engineer shall check rivets as to length as per standard specifications. Rivets shall be heated uniformly to a light cherry-red color and be at that color when inserted in the holes for driving. The heating of the points of rivets more than the remainder shall not be permitted. When ready for driving they should be free from slag, scale, and other adhering matter and when driven they should completely fill the holes. Burned, burred or otherwise defective rivets and rivets which throw off sparks when taken from the forge shall not be driven. Rivets whose heads are pitted from burning shall be rejected.

"There have been times when as many as 25% of rivets that have been placed on the job have had to be removed. To prevent this, the resident engineer shall inform the contractor in advance that only such riveting as is of the best quality and workmanship will be accepted and that other than perfect rivets will have to be removed and replaced. No recupping or calking will be allowed. Loose, burned, badly formed or otherwise defective rivets shall be cut out. All rivets shall be required to have full heads and line up with rows in which they are driven.

"In cutting out defective rivets, care shall be taken not to injure the adjacent metal and if necessary the resident engineer shall require the rivet shanks to be removed by drilling. Should injury be evident, the contractor shall be required to ream the holes until the injured metal is removed and drive larger rivets. Should the injury be of such extent that removing up to $\frac{1}{4}$ " larger than original diameter of the holes will not remove the injured metal, a new member or part of member will be required.

"Section 7. Concrete Floors.—Concrete floors on steel trusses shall not be placed until after the falsework has been removed and the span swung into place. In placing the concrete in the slab, the order as shown on the plans should be followed. If there is no order of concrete placement shown on the plans, the attention of

the bridge engineer shall be called to the fact and he will give instructions.

"It is always safe to begin at the center of the span and work in both directions.

"The resident engineer shall see that counters are properly adjusted, that the turnbuckles are so adjusted that they have the same number of turns in the barrel of the turnbuckles. Counters should be left loose until the span is swung. They should then be tightened sufficiently to take out any slack which exists in the member but only tightened to the point where they will take stress.

PART III

SPECIFICATIONS

The following clauses quoted from various sources are examples of current practice. They are not ideal but serve to show the points to be considered, and have been included to give condensed authoritative descriptions of construction operations. If the reader is preparing specifications he can obtain the most up-to-date ideas from the U. S. Bureau of Roads and the American Association of Highway Officials, who have prepared standard specifications covering all clauses of road and bridge work.

A specification should be complete, concise, and clear as to the materials, manipulation, and basis of measurement and payment. In preparing a specification it is convenient to have a general outline of points to be covered. Such an outline has been prepared by the U. S. Office of Public Roads to serve as a uniform basis for specifications for federal aid and is reproduced below. It is in the author's opinion a very good reminder of necessary requirements.

The usual size of page used for highway specifications is approximately $8\frac{1}{2}$ by 11"; this is an unwieldy size for field use; a size of 6 by 9" is much handier and is about the smallest dimension feasible on account of space required on the proposal bidding blanks. Where much work is being done, the specifications proper can be printed in pocket form $4\frac{1}{4}$ by $6\frac{1}{2}$ " and the proposal, contract, and bond separately on the usual $8\frac{1}{2}$ by 11" size. This makes a convenient combination for both the field men and for office filing of contract records.

Repetitions should be avoided. Segregating the requirements for materials in one part of the specification will prevent repetitions. Blanks to be filled out by hand are undesirable and should be reduced to a minimum. Loose-leaf specifications are poor practice. Printed bidding sheets containing the estimate quantities of work reduce possible complications in connection with comparing bids.

No attempt is made in this book to discuss methods of bidding or the legal forms of contract, as they must conform to local statutes.

STANDARD OUTLINE OF ROAD AND BRIDGE SPECIFICATIONS

Proposed as Standards of Practice U. S. Bureau of Public Roads (1925)

NOTE.—General headings and subheadings appear in the outline in the order and form in which, it is proposed, they should be used in Standard Specifications; each of these subheadings should cover pertinent subject matter, treated in the form and arrangement indicated. Subject matter to

be dealt with under each item and subheading is briefed, where not otherwise clear and self-evident. To promote succinctness, as well as uniformity, the selected typical phraseology appearing in this outline is suggested as standard. It is not the intent that all subjects here outlined be covered in a state Standard Specification, if not involved in the work contemplated by a state, or required by law, but such headings, items, subheadings, and subject matter as are involved in a specification should appear in the order and form indicated in this outline. Such additional items, or general subjects with suitable headings, as are desired should be inserted in their logical position in the outline. Such additional clauses or incidental paragraphs as are desired should be placed following those shown in the item or article to which they pertain.

Title Page or Cover for Specifications, Etc.

NOTE.—The name of the state should appear at the top of the title page in bold-faced caps.

Definitions and Terms

Definition of State, State Highway Department, or Commission, Engineer, Contractor, and all words or terms used in a special sense.

Proposal Requirements and Conditions

Contents of Proposal Forms.—Location and description of project, approximate estimate with schedule of items for which bid prices are invited, special provisions, date, time, and place of opening.

Interpretation of Estimates.—Basis for comparing bids; statement regarding right of engineer to increase or decrease quantities shown in proposal. Actual quantities to be paid for at unit prices.

Examination of Plans, Specifications, Special Provisions, and Site of Work.

Preparation of Proposal.—Requirement that proposal must be filled out completely. Specific requirements as to signatures.

Rejection of Proposals Containing Alterations, Erasures, or Irregularities.

Proposal Guaranty.—Form and amount required—if certified check, to whom payable.

Delivery of Proposals.

Withdrawal of Proposals.

Public Opening of Proposals.

Disqualification of Bidders.—Because of submission of more than one proposal, collusion, unbalanced proposals, lack of competency.

Competency of Bidders.—Criteria as desired by state.

Material Guaranty.—Showing by bidder of material sources and manufacture, and samples for approval may be required previous to award of contract.

Any Additional Clauses Desired.

Award and Execution of Contract

Consideration of Bids.—Comparison of bids based on correct summation of items at prices bid. Right to reject any and all proposals and to waive technicalities.

Award of Contract.—By whom, place, to whom, and when made.

Return of Proposal Guaranties.—How and when returned.

Requirement of Contract Bond.—Reference to form furnished by state and to the amount, or to percentage of amount of contract required.

Execution of Contract.—Time and place.

Approval of Contract.—Reference to such formal approval as state or local laws require.

Failure to Execute Contract.—After certain period, cause for annulment; guaranty becomes property of state. Statement as to procedure with work.

Any Additional Clauses Desired.

Scope of Work

Intent of Plans and Specifications.—Statement that the intent is to prescribe a complete work or improvement which the contractor undertakes to do, in full compliance with the plans, these specifications, the special provisions, proposal and contract, including all earthwork, base and surface courses, structures, and incidental construction. Contractor to furnish all required materials, equipment, tools, labor, and incidentals unless in certain cases otherwise provided in these specifications, the special provisions, proposal, or contract.

Special Work.—Statement that proposed construction or requirements not covered by these specifications to be covered by special provisions, and performed by contractor.

Increased or Decreased Quantities of Work.—Engineer reserves right to alter quantities of work as found necessary or desirable without waiving or invalidating any condition or provision of contract. Contractor to perform work as increased or decreased, and no allowance to be made for anticipated profits.

Extra Work.—Unforeseen work made necessary by alteration of plans or of work or by other reason, involving increased or decreased unit cost to contractor, or work necessary to complete improvement for which no price is provided in contract, all to be performed in accordance with specifications and as directed.

Maintenance of Detours.—Statement indicating party responsible for, and charged with, roadway upkeep along detours during construction period.

Removal and Disposal of Structures and Obstructions.—All obstructions, structures not designated for use, obstructing fences, telephone poles, etc., to be disposed of by the contractor as directed.

Rights in and Use of Materials Found on the Work.—Upon approval, contractor may make use of any material found in earthwork operations, for any purpose for which it is suitable; when material so made use of was intended for use in embankment or otherwise, contractor to replace with equivalent quantity of material suitable for embankment.

Final Clearing Up.

Any Additional Clauses Desired.

Control of the Work

Authority of Engineer.—All work to be done under direct supervision of the engineer, who shall decide all questions as to interpretation, materials, work, progress, disputes, and mutual rights between contractors, acceptable fulfillment, and compensation.

Plans and Working Drawings.—Statement that plans will show in detail structures up to and including 20' spans, lines, grades, typical cross-section of improvement, and general cross-sections; plans also will show general features of bridges (over 20' span). Supplementary bridge plans, shop details, etc., as necessary to be furnished by contractor but not to be used prior to approval. Authorized alterations will be indorsed on approved plans or shown on supplementary sheets. Additional details relative to working drawings.

Conformity with Plans and Allowable Deviations.—Statement that finished work in all cases must conform with approved lines, grades, typical cross-section, and general cross-sections, except minor deviations authorized by engineer in writing.

Coordination of Specifications, Plans, and Special Provisions.—Statement that a requirement in any one of the three is binding. In case of discrepancy, figures to govern over scaled dimensions, plans over specifications, special provisions over plans.

Cooperation by Contractor.—Two sets of approved plans, specifications and special provisions, and authorized alterations supplied to contractor; one set must be kept available on work. English-speaking contractor's representative to be available to receive and execute orders. Contractor to avoid interference with other contractors.

Construction Stakes.—Furnished and set up by engineer to give line and grade; contractor to furnish all additional stakes, templets, and other materials and work necessary for marking and maintaining points and lines. Finished surfaces to conform in all respects to lines, grades, and plans.

Authority and Duties of Inspectors.—Inspectors employed by state to inspect all work and material and report to engineer; and to note and suspend, if necessary, unsatisfactory work and reject work containing unsatisfactory materials, all pending final decision by engineer. Not authorized to alter specifications, nor accept any portion of work, nor act as foreman for contractor, nor interfere with management of work, nor to bind engineer in any way.

Inspection.—Contractors to furnish engineer and inspector with every facility for complete inspection of work and of the preparation and manufacture of the materials, also to uncover questioned work if ordered; detailed procedure in such cases.

Removal of Defective and Unauthorized Work.—Defective work to be remedied or removed and replaced forthwith as directed, at contractor's

expense. Unauthorized work to be removed if so ordered. Or engineer may replace and charge against contractor.

Final Inspection.—To be made within certain period subsequent to final cleaning up following completion of project.

Any Additional Clauses Desired.

Control of Material

Source of Supply and Quality.—Statement that only approved materials conforming to requirements shall be used. Approved source of supply to stand approved only so long as the material conforms to requirements.

Samples and Tests.—Prescribed samples to be submitted by contractor or producer for testing. Tests to be made in accordance with U. S. Department of Agriculture *Bulletin* 1216 (or other recognized methods if desired). Contractor to furnish facilities for verification of his scales and measures.

Storage.—Preservation and fitness to be assured.

Defective Materials.—Materials not conforming to requirements shall be rejected and removed from work, and replaced in an acceptable manner by contractor at his expense. Engineer may remove and charge against contractor.

Any Additional Clauses Desired.

Legal Relations and Responsibility to Public

Laws to Be Observed.—Federal, state, and local; to save the state harmless against all claims from violations.

Permits and Licenses.—Contractor to procure.

Patented Devices, Materials and Processes.

Restoration of Surfaces Opened by Permit.—Contractor not to allow openings except on authorized permit. Repair work involved to be performed by contractor at expense of party making opening.

Federal Participation.—Contractor placed on notice that the work is to be subject to inspection by the federal government, which is not, however, a party to the contract.

Sanitary Provisions.—Contractor to comply with Board of Health requirements.

Public Convenience and Safety.—Comprehensive regulations and instructions relative to handling the work to assure uninterrupted convenience and safety to traffic and the public along or near the work. If desired, detail here maintenance of half the roadway for traffic during construction. No road to be closed to public except by express permission of the engineer.

Barricades and Warning Signs.—Contractor to provide; to be illuminated at night.

Use of Explosives.

Protection and Restoration of Property.—Contractor not to trespass upon, damage, or neglect the rights of public or private property; to take precautions to protect same, also underground structures, monuments, and trees; to restore at own expense where, directly or indirectly, is responsible for injury occurring; or upon notice engineer may cause such restoration and charge against moneys due or to become due contractor.

Responsibility for Damage Claims.—Contractor to assume when brought in suits for any damage, injury, or infringement resulting from his work or neglect; engineer may retain, sufficient to cover, moneys due, or to become due, contractor.

Opening of Section of Highway to Traffic.—At option of engineer; but such opening not an acceptance, and maintenance to be at contractor's expense unless otherwise specifically provided.

Contractor's Responsibility for Work.—Does not cease until final acceptance by engineer in writing. Responsibility covers all injury to work from elements and traffic unless otherwise provided. Contractor to repair same, also to care for materials and unfinished work during suspension.

Personal Liability of Public Officials.

No Waiver of Legal Rights.

Any Additional Clauses Desired.

Prosecution and Progress

Subletting or Assignment of Contract.

Prosecution of Work.—Notice of beginning. Place of starting determined by engineer. Prosecuted at points as ordered. When resuming work subsequent to suspension, contractor to give due notice to engineer to afford opportunity to reestablish inspection.

Limitations of Operation.—Contractor not to open up work to the prejudice of work already started or to inconvenience traffic more than is necessary as determined by the engineer.

Character of Workmen and Equipment.

Temporary Suspension of Work.—Wholly or in part, at order of engineer, because of unfavorable weather, or other essential conditions; or because of failure on the part of the contractor to prosecute the work properly in accordance with the contract, to carry out orders, to remove defective material or work; but the contractor shall not suspend the work without authority.

Determination and Extension of Contract Time for Completion.

Failure to Complete Work on Time.

Annulment of Contract.—Detailed causes, procedure, and retent.

Termination of Contractor's Responsibility.—Contract to be considered complete when all work has been completed and accepted by engineer and final estimate paid; contractor to be then released from further obligation except as set forth in his bond.

Any Additional Clauses Desired.

Measurement and Payment

Measurement of Quantities.—All work acceptably completed under the contract to be measured by U. S. Standard Measures and quantities of work performed to be computed based on such measurements. Linear base course, surface course, or pavement measurements to be along actual surfaces, not horizontally. Structures to be measured according to neat line shown on plan or ordered.

Scope of Payment.—Compensation provided, at bid prices, to be accepted as full payment for materials, labor, tools, and equipment necessary to perform and complete the work, also loss, damage, unforeseen difficulties, all risks and patent infringements. Before payment contractor to satisfy engineer as to liquidation of bills.

Increased or Decreased Quantities.—Increased or decreased quantities of work for which there are contract unit prices to be paid at such prices for the quantities actually done with no allowance for anticipated profits. Such restrictive provisions as desired.

Extra and Force Account Work.—Extra work to be paid either under a Supplemental Agreement or by Force Account as agreed before starting such work. Supplemental agreement to be signed by both parties. Force account to be done only upon written order. Detailed procedure relative to force account payment.

Omitted Items.—Provision that engineer may order items omitted from contract, found unnecessary to the improvement without vitiating contract with such restrictive provisions as desired.

Partial Payments.

Acceptance and Final Payment.

Any Additional Clauses Desired.

CONSTRUCTION DETAILS

Earthwork

Description.—Earthwork to consist of all clearing and grubbing, roadway and drainage excavation, excavation for structures, embankment, borrow, overhaul, subgrade, shoulder, and subbase construction, all to be done by contractor and paid for in accordance with these specifications.

CLEARING AND GRUBBING

Description.—Specific requirements.

Measurement and Payment.

ROADWAY AND DRAINAGE EXCAVATION

Description.—This work shall consist of . . . , giving specific list of all types and features of work desired to be included—"all in conformity with the lines, grades and cross-sections shown on plans."

Classification.

Construction Methods.

Method of Measurement.—In original position by average end area method; measurement of overbreak as desired.

Basis of Payment.

EXCAVATION FOR STRUCTURES

Description.—Statement of work included. (Not to overlap roadway and drainage excavation.)

Construction Methods.—Depth, back fill, layers, compaction, etc.

Method of Measurement.—Allowance outside of neat structure lines.

Basis of Payment.

EMBANKMENT

Construction Methods.—Of suitable material; depth of layers, compaction; hillside embankment; responsibility.

Compensation.—Not to be paid for directly but to be considered part of work included in prices bid for excavation and borrow.

DISPOSAL OF SURPLUS MATERIAL

Statement of requirements. Not to be compensated for directly but to be considered part of work included in prices bid for excavation and borrow.

BORROW

Description.—To consist of excavation, and disposal as directed, of satisfactory material obtained from borrow pits when material not available from excavation to complete embankments.

Construction Methods.—No work prior to staking out; pits to be trimmed to permit measurement; to drain where practicable.

Method of Measurement and Basis of Payment.—In original position by average end areas or equivalent method.

OVERHAUL

Method of determination and basis of payment.

SUBGRADE

Description.—After earthwork substantially completed and all drains laid, subgrade to be brought to lines, grades, and typical cross-section shown on plans.

Construction Methods.—Soft and unstable material, also rock to be removed; to be refilled with suitable material from excavation and borrow. Rolling clauses as desired; superficial scarifying of old stone or gravel roadways where reconstructed base course not ordered; highway and railway intersections.

Protection of Subgrade.—For surface courses; for pavements; no storage or stock piling of material; no surfacing material to be placed or pavement laid on frozen or muddy subgrade; nor on any subgrade prior to checking and approval.

Compensation.—As desired.

SHOULDERS

Description.—After earthwork substantially completed and all drains laid, shoulders to be constructed of approved material, to elevation, width, and shape shown on plans, and dressed as directed after surface course or pavement is completed.

Materials and Construction Methods.

Method of Measurement and Compensation.—As desired.

SUBBASE

Description.—Item to consist of special approved material, placed and compacted in excavations made by removal of soft, unstable, or other unsuitable subgrade materials; to be constructed where specifically ordered.

Materials.—Field or quarry stone, etc.; filler, slag, gravel, etc.

Construction Methods.—As desired (usually by cubic yard).

FINISHING EARTH-GRADED ROADS

Description.—Where road to be finished as an earth-graded road without surfacing other than earth, after all other earthwork and all structures completed, roadway to be finished for travel, to lines, grades, and typical cross-section shown on plans.

Construction Methods.

Method of Measurement and Basis of Payment.

FINE GRADING SUBGRADE AND SHOULDERS

Description.—This work to consist of preparing a previously graded road for immediate placement of surface courses or pavements.

Construction Methods.

Method of Measurement and Basis of Payment.—As desired; or may be stipulated as included under some other suitable item.

Base Courses

Repeat the following outline for each kind of course desired.

SUBGRADE TREATMENT

Description.—Item to consist of granular or other stabilizing courses constructed on the subgrade in accordance with these specifications and conforming in all respects with the lines, grades, and typical cross-section shown on plans.

Materials.

Construction Methods.

Method of Measurement and Basis of Payment.

—————BASE COURSE
(Insert name)

Description.—Item to consist of a foundation course of etc. . . . constructed on the subgrade or other completed base course in accordance with these specifications, conforming in all respects, etc. (similar to above).

Materials.—Stone, sand, screenings, binder, etc.

Construction Methods.—Placing, rolling, etc.

Method of Measurement and Basis of Payment.

Surface Courses or Pavements

SURFACE TREATMENT

Description.—Indicate number of treatments and gallons to each treatment if paid by square yard; or prescribe "item to consist of consecutive treatments or amount and type of material noted on typical cross-section on plans."

Materials.

Construction Methods.

Method of Measurement and Basis of Payment.—Preferably by square yard.

—————SURFACE COURSE (OR PAVEMENT)
(Insert name)

Repeat the following outline for each kind of surfacing or pavement. Arrange in order from lower types to higher. Each item should prescribe a tamplet and straight-edge test of finished surface.

Description.

Materials.

Construction Methods.

Method of Measurement and Basis of Payment.—Details of measurement; the accepted quantities of this item thus measured shall be paid for at the contract unit prices bid per square yard for (insert exact name), which price, except as otherwise expressly provided, shall be full compensation for furnishing, hauling, and placing all materials, and for all labor, equipment, tools, and incidentals necessary to complete the item.

Concrete Bridges

Description.—Concrete bridges to be built as indicated on plans, conforming to line, grade, and dimensions shown, and in accordance with the specifications for piling, concrete, reinforcing steel, and other items which constitute the complete structure.

Materials.—Statement that materials shall be those prescribed for the several items which constitute the structure, with supplementary requirements pertaining to bridges only, as desired.

Construction Methods.—Prescribe foundation preparation and construction, falsework, sequence and method of casting, and details peculiar to bridge construction. Manipulation and mixing of materials, concrete finish protection, etc., should be prescribed under concrete, except such requirements peculiar to bridges as are desired here.

Design.—May be detailed as desired here, or reference made to independent Bridge Design section.

Method of Measurement and Basis of Payment.—Statement that the bridge will be paid for by the actual quantities of the various items incorporated—piling, concrete of the various classes, reinforcing steel, and wearing floor surface complete in place at the unit prices bid for the several items

enumerated, which prices, except as otherwise expressly provided, shall be full compensation for all work, materials, labor, and incidental work necessary to complete the bridge ready for use.

Steel Bridges

Description.

Materials.

Construction Methods.

Design.—May be detailed as desired here, or reference made to independent Bridge Design section.

Method of Measurement and Basis of Payment.—Statement that the bridge will be paid for by the actual quantities of the various items incorporated—piling, concrete, reinforcing steel, structural steel, and wearing floors as desired, all complete in place at the unit price bid for the several items enumerated, which prices, except as otherwise expressly provided, shall be full compensation for all work, materials, labor, and incidental work necessary to complete the bridge ready for use.

Timber Bridges

Description.

Materials.

Construction Methods.

Design.—May be detailed as desired here or reference made to independent Bridge Design section.

Method of Measurement and Basis of Payment.

Culverts and Retaining Walls

Description.—All concrete and masonry culverts, all pipe culverts, end walls, retaining walls to be built as indicated on plans conforming to line, grade, and dimensions shown and in accordance with the specifications for concrete, reinforcing steel, masonry, culvert pipe of the several varieties, and other items which constitute the complete structure.

Materials.—Statement that materials shall be those prescribed for the several items which constitute the structure.

Construction Methods.—Foundation conditions and involved preparation and construction. Pipe culverts to be constructed of the kind of pipe indicated, suitably connected and laid. General requirements for mortar joints, also for back filling.

Method of Measurement.—Quantities of various items for payment to be actual amounts completed and accepted. Concrete and masonry to be computed from neat dimensions shown on plans or ordered in writing, pipe to be measured in place.

Basis of Payment.—Culverts, including pipe culverts and retaining walls, to be paid for at contract unit prices bid for the several items which constitute the completed structure, which prices, except as otherwise expressly provided, shall be full compensation for all material, labor, equipment, tools, and incidentals necessary to complete the structure ready for use.

Concrete

Description.—Classification and classified uses, proportions.

Materials.—Specify composition and materials for each class. Strength and quality requirements.

Construction Methods.

Method of Measurement and Basis of Payment.

Reinforcing Steel

Description.

Materials.

Construction Methods.—Bending and placing.

Method of Measurement and Basis of Payment.

Structural Steel

Description.

Materials.

Construction Methods.

Method of Measurement and Basis of Payment.

Masonry

(Insert name)

Repeat for each type.

Description.

Materials.
Construction Methods.
Method of Measurement and Basis of Payment.

Concrete Pipe

Repeat for each kind of pipe.

Description.—Under this item concrete pipe conforming to these specifications, of the sizes and dimensions shown on the plans, shall be furnished and placed as directed.

Materials.
Manufacture.
Method of Measurement and Basis of Payment.

Cast-iron Pipe, Corrugated Galvanized Metal Pipe, Vitrified Pipe

Incidental Construction

Description, material, construction methods, method of measurement, and basis of payment to be included under each of the following items.

Piling, Rip-rap, Cribbing, Underdrains, Gutters, Curbing, Guard Rails, Additional Items As Desired

Bridge Design

If desired, design and design details of bridges may be grouped below, and mentioned in Construction Details division by reference only. Such cross-reference must be expressly made.

General Design.—Loads, stresses, substructures and retaining-wall assumptions, etc.

Concrete Design.
Structural Steel Design.
Timber Structure Design.

Material Details

NOTE.—If it be desired to group all materials in an independent division, properties, tests, and requirements for all materials should be detailed here. In such case the materials must be classified and defined as shown below and appropriate cross-reference expressly made to them under the subcaption materials appearing in each item of Construction Details.

Cementing Materials.—Portland cement, lime, etc.

Water.

Fine Aggregate.—Filler dust, sand, grit, etc., for all purposes, including all non-bituminous fillers.

Coarse Aggregate.—Stone, gravel, slag, etc., for all purposes.

Telford and Quarry Stone, etc.

Masonry Stone, etc.

Paving Brick and Blocks.

Bituminous Materials.

Culvert Pipes, Drain Tiles, etc.—Concrete, cast iron, corrugated metal, vitrified clay, etc.

Metal Reinforcement.—Bars, mesh, expanded metal, etc.

Structural Steel.—Structural shapes, fabricated steel, etc.

Miscellaneous Iron and Steel.—Castings, special wrought work, etc.

Treated Timbers.

Untreated Timbers.

Paints, Oils, etc.

Monuments.

Miscellaneous Materials.—Fencing wire, cables, pipe rail, etc.

Forms

NOTE.—Documents which pertain to the individual project and which from their nature require filing out, completion or execution should be arranged in the following order. If desired they may be bound in a separate pamphlet.

Notice to Contractors

Time and place of receiving and opening proposals.

Brief description of proposed work.

Place where plans and specifications may be examined or secured, and from whom information may be obtained.

Rights reserved to reject any or all proposals.

SPECIFICATIONS

Any additional information desired, such as competency of bidders.

NOTE.—The above information should be shown in the advertisement for bids, and on the notice to contractors, which may be sent out to prospective bidders.

Special Provisions

Supplementing the specifications for the construction of
(give the identification of proposed work.

such as road name, number, job number, etc.).

NOTE.—Under this section should be placed all supplemental specifications and exceptions, as pertain only to the particular project and contract proposed and are not covered satisfactorily in the general specification divisions and are not standard or common to all work for which the general specifications may have been prepared such as:

Materials, etc., furnished by the state. All materials, equipment, or other facilities for prosecuting the work, furnished by the state to the contractor, should be here listed, with conditions governing delivery, use, and return.

Statement relative to disposal of specific materials or structures found on the work and not to be used in the construction thereof.

Special stipulations and requirements intended to apply to the one project only and to supersede corresponding stipulations and requirements as prescribed in the general specifications.

Specifications for special structures, such as lift bridges, etc.

Materials Investigated on State Highway No. 8264

The following data concerning materials has been compiled by the New York State Bureau of Highways. The information is as reliable as it is possible to obtain without actual development of pits or ledges but neither the quantity nor the continuance of quality is guaranteed. In all cases prospective bidders are required to satisfy themselves as to the available supply of materials and their relative location.

Materials similar to those designated and of acceptable quality from any source will be accepted. Acceptable materials must be furnished from other sources whenever the sources here indicated fail in quality or quantity. The bidders' attention is called to the General Specifications concerning Materials of Construction.

TABLE OF MATERIALS, AUGUST 30, 1926*Location*

0.1 mile from Station 143 + 70
.....

Kind

Sand
Sand
Stone

Source

Local commercial
Approved commercial
Approved commercial

For Items Numbered

All items
All items
All items

Test No.

G-6315
.....
.....

Attention of Bidders

All concrete pavement will be tested for thickness and quality of pavement. Sections of pavement which are found to be more than one-quarter inch short of the specified thickness shall be removed and replaced at the Contractor's expense.

All Portland Cement furnished on this contract must be bin-tested.

Proposal

Spaces for name and address of bidder.

Detailed description of location of roadway or structure, length and width of surfacing or pavement, or length and type of structure, referring to the plans, drawings, specifications, special provisions, etc., by their titles and markings for identification. If the proposal bond form is used, it should be attached to or furnished with the proposal form.

Address (as "To the State Highway Department").

Declaration of the bidder that the only persons or parties interested in the proposal as principals are those named therein; that the proposal is made without collusion with any other person, firm, or corporation; that he has carefully examined the specifications, including special provisions, if any, and that he has made a personal examination of the site of the work; that he is to furnish all the necessary machinery, tools, apparatus, and other means of construction, and do all the work and furnish all the materials specified in the manner and time prescribed; that he understands that the quantities are approximate only and subject to increase or decrease, and the declaration of his willingness to perform increased or decreased quantities of work at unit prices bid in accordance with the specifications at the unit prices bid in the following proposal schedule.

Itemized proposal showing the approximate quantities with spaces for unit prices bid, as:

PROPOSAL SCHEDULE

Time for completing project working days

Item No.	Approximate quantities	Items with unit bid price written in words	Unit bid price	Amount bid
1		Cubic yards excavation for per cubic yard..		
	Total.....			

NOTE.—Spaces should be left for filling in the unit prices both in words and figures, as indicated. The items of work should be numbered in the order and with the same titles and units of measure shown in the specifications. The units of measure used should be as follows:

The cubic yard for all volumes except the gallon for bituminous materials when not weighed and the barrel for cement.

The square yard for all surface measurements except the square foot for wire mesh or expanded metal. Acre may be used for clearing and grubbing.

The foot or mile for linear measurements.

The ton of 2000 pounds for weights except the pound for steel and casting.

A unit price each for any item desired.

Proposal to perform "extra work," or "force account."

Proposal to execute contract agreement and to begin work as prescribed and to complete work as bid in schedule (or as stated in proposal).

Proposal stating the amount of contract bond.

Proposal for guaranty of work until final completion and acceptance.

Statement of enclosure of proposal guaranty, naming form, amount, and conditions of forfeiture.

Spaced for signatures, titles, and individual addresses.

Proposal Bond

In case a proposal bond is used in lieu of a certified check, the form therefor should be attached to or furnished with the proposal form.

Contract

The form of contract should be as short as consistent with legal requirements.

The notice to contractors, specifications, special provisions, proposal, and plans should be referred to and made a part of this agreement, and such reference should identify the specifications, plans, drawing, etc., by their specific markings. When standard specifications approved by the Bureau

of Public Roads are to govern, identification must be made by date of formal approval.

The federal government is not to appear as party to this agreement.

Contract Bond

Estimates

Estimates shall be made up in accordance with the order and units of measure indicated in the proposal form.

Index

Itemized index to be placed at the end of the specifications instead of at this point if the foregoing documents are issued as separate pamphlets.

General Clauses

For the best examples of general clauses the reader is referred to Standard Specifications of the American Association of Highway Officials.

Examples are not included in this book as they are rarely needed by field or office men and can be readily obtained from local state or government bureaus free of charge.

MATERIALS¹

NEW JERSEY SPECIFICATIONS

91. Requirements Governing Materials

91A. General Conditions Governing Their Use.—No materials shall be used which do not conform with the requirements therefor as herein defined. All materials used in the construction of any of the items of work given in the estimate of quantities or in any additional or extra work that may be performed by the contractor, as herein provided, shall be furnished by the contractor. The materials required for the different items of construction are given under said items. The requirements governing the use of patented materials, products or processes are given in Article 14. Samples of acceptable materials are on file at the laboratory of the department, Taylor and Quarry Place, Trenton, N. J., and will be shown to prospective bidders upon request. No materials shall be used until tested and released by the testing engineer.

Railroad cars or barges, used for transporting such road materials as stone, gravel, slag, sand, bituminous filler, Portland cement, bituminous cement, oils, tars, etc., must be clean when any of these road materials are deposited therein. Materials shipped in cars, the sides or bottoms of which are coated with coal dust, manure, ashes, clay, loam, earth, hay, straw, etc., will be rejected regardless of the quality of said materials. Railroad cars containing broken sides or bottoms must be repaired before any materials are deposited therein.

Trucks, wagons or other vehicles used in hauling or transporting road materials must be kept clean, in proper working condition, have strong, substantial bodies which will prevent materials from escaping therefrom during transit, and be approved by the Engineer before being used.

Materials which have been approved before shipment and are injured in transit, during unloading or handling at the site of the work, shall not be used until reapproved. During handling of all stone, sand or other materials which are to be used in concrete extra care must be taken that no earth or subgrade gets mixed therewith.

All bituminous cements shall be shipped ready for use without further fluxing at the mixing plant or roadside. Each carload of bituminous or Portland cement must be sampled and released before being used. Such samples may be taken before shipment under special arrangement in each case with the department, or, in default thereof, must be taken by the engineer or inspector on arrival at the terminal nearest the work, or at any other convenient point. Carloads of stone, sand, gravel and bituminous paving mixtures shall be carefully examined by the inspector, but shall not be unloaded until released by him. Materials appearing defective shall be sampled and held until the sample taken has been tested by the testing engineer. Any material condemned by the engineer shall be removed at once from the roadway.

Cement and other materials liable to damage from the elements by exposure must be stored in proper structures which will prevent them from

¹ State of New Jersey.

becoming damaged. The method of storing and handling explosives and highly inflammable materials will be governed by the local regulations therefor.

The quantities of materials required shall be determined by weight unless otherwise specified. The railroad shipping weights shall govern in deciding the actual amount furnished or used. The contractor, when requested, shall furnish the department with the freight bills of all materials received.

91B. Conditions Governing Approval of Materials.—No materials will be approved for use which do not comply with the requirements given therefor. The approval of a given material is in effect only as long as the material supplied is of the same character and composition as the sample approved. The approval of a material for a particular purpose or for use in a specified manner does not approve its use for any other purpose or manner.

91C. Methods Used in Testing Materials.—The methods to be used in testing the materials given herein are those on file at the office of the department at Trenton, and will be furnished to producers or manufacturers upon application.

92. Broken Stone

All broken stone, regardless of type, must not contain more than five (5) per cent of weathered or partly decomposed rock. When used in concrete or to be coated with a bituminous material it must be free from pieces coated or partly coated with mud, clay, loam or other foreign material, and must not contain any other type of stone having a higher per cent of wear than that specified for the stone itself. All such stone must be shipped in clean cars. Stone shipped in dirty cars will be rejected. Any one given type of broken stone, as shipped, must not contain over ten (10) per cent of any other type of stone. Approved stone of different types cannot be mixed during use, nor used intermittently for any one given item of construction. All orders for crushed or broken stone must state purpose for which it is to be used.

All stone must not contain more than five (5) per cent of slabs, flat or elongated pieces, the width of which is less than five (5) per cent of the length. The various stone fragments composing any particular size shall be uniformly distributed throughout the mass of stone, as shipped. When two (2) or more sizes of stone are mixed to secure any particular specified size, the mixing must be done before the stone is loaded into the shipping vehicle. The following methods are suggested:

Simultaneously feeding on belt conveyor proper proportions of the different sizes.

Feeding proper proportions of the different sizes through converging chutes into the bin or stock pile from which the material is to be shipped.

Reversing screen plates or other arrangement of screens, which will insure a properly graded material of the sizes desired.

Shipments containing piles or layers of broken stone that are not uniform will be rejected.

Stone intended for use in any Portland cement concrete or to be coated with a bitumen, in addition to meeting the above requirements, must not contain more than ten (10) per cent of stone coated or partly coated with stone dust. Stone which has become coated with mud, loam, clay or other foreign material, either during transit or after receipt on site of work, must not be used and shall be removed from the highway or storage site.

92A. Sizes.—Permissible variations as to size of stone are shown in the table below for each size and grade of stone. This table shows the minimum and maximum allowable percentages passing the different screens and sieves. The screens and sieves designated in the table are those used in the laboratory of the department.

Whenever the words Trap, Granite, Dolomite, Limestone Gneiss, Sandstone or Quartzite are used in these specifications, the rocks designated thereby shall comply with the following additional requirements respectively.

Trap Rock.—A basic, igneous rock consisting principally of augite and plagioclase. It must be of medium or fine grain texture, show an even distribution of the constituent minerals, be of uniform quality and structure throughout, and have a per cent wear not greater than three (3).

Granite.—An igneous rock consisting principally of quartz and feldspar. It shall be of medium or fine grain texture, show an even distribution of the constituent minerals, be of uniform quality and texture throughout, and have a per cent wear not greater than four and one-half (4.5).

Dolomite.—A rock consisting principally of the carbonates of lime and magnesia. It must contain not less than thirty (30) per cent of magnesium carbonate, nor less than eighty (80) per cent of the combined carbonates of

TOTAL PER CENT PASSING

Grades and sizes	Laboratory screens, inches								Sieves		
	3 1/2	3	2 1/4	1 3/4	1 1/4	3/4	1/2	1/4	10	30	200
2 1/2-in. "ballast"	100	90-100	0-25	0-5							
Concrete stone	100	95-100	25-60	0-5							
1 1/2-in. stone	100	95-100	0-15	0-5							
3/4-in. stone		100	95-100	0-25	0-5						
Screenings—Grade A. ¹				100	95-100	50-85	35-70			10-30	0-5
Screenings—Grade B.				100	95-100	40-80	25-65	5-20			
Dustless screenings				100	95-100	25-75	0-25	0-5			
Stone dust—Grade A. ²						100	95-100	70-90			
Stone dust—Grade B.						100	95-100	90-100			

¹ Screenings Grade A shall be made from recrushed stone only.

² Stone dust Grade A shall be made from recrushed stone only.

It is suggested that stone-crushing plants be equipped with the following screens: 3 1/2, 3, 2 1/4, 1 1/4, 3/4 in., and a dust jacket with 1/8-in. openings if round, or 1/4-in. if square. If any special sizes of stone are required, additional screens will be needed. The type and size of broken stone required for the different items of construction are specified under said items.

lime and magnesia. It must be of uniform quality and texture throughout, have a per cent wear not greater than 3.5 and be of such density that it will not be noticeably affected by five (5) immersions in a saturated solution of sodium sulphate with proper dehydration after each immersion.

Limestone.—A rock consisting principally of the carbonates of lime and magnesia. It must contain not less than fifty-five (55) per cent of calcium carbonates, nor less than eighty (80) per cent of the combined carbonates of lime and magnesia, have a per cent wear not greater than six (6), and be of such a density that it will not be noticeably affected by five (5) immersions in a saturated solution of sodium sulphate with proper dehydration after each immersion.

Gneiss.—A rock containing practically the same minerals as granite, but having these minerals arranged in strata. It must have a dense structure with the lines of stratification not so distinctly formed that the stone breaks in thin pieces or slabs. It must have a per cent wear not greater than four and one-half (4.5).

Sandstone or Quartzite.—A rock belonging to either of these two types shall contain not less than ninety (90) per cent of quartz, be of uniform quality and texture, free from seams, lines of clay, distinct cleavage planes, or lines of stratification which will cause the stone to break into three slabs or pieces. It must have a per cent wear not greater than four and one-half (4.5).

93. Slag

All slag must be air cooled, have a fresh, clean surface, free from mud, dirt, clay or loam. It must not be brittle nor glassy nor have an apparent specific gravity greater than 3.0 at 15.5°C. When used for concrete it must produce a concrete which will have an average compressive strength of not less than 4000 lb. per square inch when twenty-eight (28) days old, having the same composition and consistency, and tested in the same manner given here under Broken Stone. It must weigh not less than seventy (70) pounds per cubic foot loose measure, and be free from decomposed products. The requirements governing the different sizes will be the same as for broken stone. Slag containing more than one and one-half (1½) per cent of sulphur shall not be used in reinforcement concrete.

94. Gravel

Gravel shall be divided into two general classes: Washed gravel and road gravel.

94A. Washed Gravel.—Washed gravel may be composed partially or totally of crushed pebbles, but must be free from soft, thin, elongated pieces, organic matter, loam, clay, or pebbles coated therewith. It shall contain only pebbles of a sound, hard, durable character, and must be uniform in composition, free from weathered, decomposed pebbles, pieces of coal or other foreign materials. It shall not contain more than 5 per cent of slate, shale or soft sandstone particles, having a per cent wear greater than.

When tested by means of laboratory screens and sieves the various sizes of washed gravel shall conform to the following requirements:

TOTAL PER CENT PASSING

Sizes	Laboratory screens, inches					Sieves
	2¼	1½	1¼	½	¼	10-mesh
1½ in.	100	...	0-25	0-5		
¾ in.	100	75-100	0-25	0-5	
Concrete gravel ¹	100	...	25-50	0-12	0-2	
Pea gravel.....	100	95-100	0-25	0-5

¹ Concrete gravel size may be prepared by mixing two (2) parts of one and one-half (1½) inch gravel with one (1) part of three-quarter (¾) inch gravel by volume; however, when thus prepared, these two sizes must be mixed in such a manner that will insure a uniformly graded product, conforming to the screen requirements given below. The method employed in mixing in each case must be approved by the department before using.

94B. Road Gravel.—Road gravel shall be composed of sand and hard, durable pebbles of quartz, mixed with clay in such proportions that the gravel will comply with the grading and other requirements specified herein below, and also compact under travel into a hard, dense pavement. It shall contain not less than eight (8) nor more than twenty (20) per cent by weight of material removed by the elutriation test, and the gravel having the fine material thus removed shall, when tested by means of laboratory screens and sieves, comply with the requirements given below:

TOTAL PER CENT PASSING

Grades	Screens, inches					Sieves
	2	1½	1	½	¼	
A	100	95-100	85-100	55-90	45-80	35-70
B	...	100	95-100	90-100	75-95	60-85

95. Sands

Sands shall consist of grains or particles of quartz or other hard and durable rocks, the surfaces of which are not coated with any foreign material nor worn smooth. The grains shall be moderately sharp, free from soft, decomposed or partly decomposed sand grains, lumps of clay, or ferruginous cemented sand, mica, loam, sea salts, organic matter, or other materials.

Sands shall be divided into two general classes, bituminous sands and concrete sands.

95A. Bituminous Sands.—Bituminous sands are those intended for use in the construction of bituminous pavements, bituminous mortars, bituminous filters, or mastics, and when tested by means of laboratory screens and sieves shall conform to the following requirements:

Passing	Retained on	Minimum, %	Maximum, %
¼-in. screen	10-mesh sieve	0.0	2.0
10-mesh sieve	30-mesh sieve	10.0	30.0
30-mesh sieve	50-mesh sieve	15.0	42.0
50-mesh sieve	80-mesh sieve	20.0	35.0
80-mesh sieve	200-mesh sieve	15.0	35.0
200-mesh sieve	5.0

95B. Concrete Sands.—Concrete sands are those intended for use with Portland cement either in a Portland cement concrete or mortar, and when tested by means of laboratory screens and sieves should conform to the following requirements:

Passing	Retained on	Minimum, %	Maximum, %
¼-in. screen	¼-in. screen	...	1.0
¼-in. screen	10-mesh sieve	5.0	25.0
10-mesh sieve	30-mesh sieve	30.0	60.0
30-mesh sieve	50-mesh sieve	20.0	40.0
50-mesh sieve	200-mesh sieve	5.0	15.0
200-mesh sieve	5.0

Concrete sands must not contain more than four (4) per cent of material removed by the elutriation test and must produce a Portland cement mortar which will have at the end of seven (7) and twenty-eight (28) days a crushing and tensile strength equal to or greater than that of a mortar prepared in the same manner, of the same proportions and consistency, using the same cement, and Standard Ottawa sand.¹ The ratio of cement to sand is to be the same as that specified for the concrete in which said sand is to be used. The approval of a sand for use in concrete of a given composition does not approve its use in concrete having a different composition.

95C. Stone Dust.—Stone dust, Grade A, may be used as a concrete sand, but only after being approved by the engineer for this purpose, said approval shall apply only to the material that is actually represented by the sample. It must produce a mortar having not less than one hundred and twenty-five (125) per cent of the strength of a similar mortar prepared from Ottawa sand and tested in the same manner as Concrete Sands.

95D. Grout Sand.—Sands intended for use in a Portland cement grout must, in addition to meeting the other general requirements given above, all pass a 10-mesh sieve and produce a Portland cement mortar which will have at least seventy-five (75) per cent of the strength of a similar mortar prepared with Standard Ottawa sand, and tested in the same manner as Concrete Sands.

95E. Cushion Sand.—Sands for use in the cushion course placed under paving blocks shall comply with the requirements for a concrete sand except the mortar produced therefrom need only 75 per cent of the strength of a similar mortar prepared from Standard Ottawa sand and tested in the same manner as specified under Concrete Sand.

96. Portland Cement

This cement shall comply with the requirements and be tested in the manner specified by the A. S. T. M. standards, Serial Designation C9-21, with all subsequent changes or corrections.

All Portland cement required for use will be shipped from bins previously approved by the State Highway Department. Copies of all Portland cement orders, placed by the contractor with cement companies, direct or through brokers or local dealers, shall be forwarded to the department. When an order is placed through a broker or local dealer, said broker or local dealer shall furnish the department with a copy of this order to the cement company for the cement required. In all cases, regardless of whether the cement is ordered by the contractors direct or through brokers, the order must be placed with the cement company at least ten (10) days previous to the date of the initial shipment. The extra cost, if any, required for shipment from previously approved bins shall be borne by the contractor and will not be paid for by the department.

All Portland cement shall be shipped in cloth bags, which are plainly stamped with the manufacturer's name and brand of cement contained therein. Each bag shall contain ninety-four (94) pounds of cement net weight and be considered as containing one (1) cubic foot of cement.

Bags of cement which for any reason have become partially set on the outside or which contain lumps or partly set cement shall be rejected.

Different brands, makes, or grades of cement, must be piled by themselves. Approved cements cannot be mixed during use, or used intermittently in any one given item of construction.

All cement must be stored in bins prepared for this purpose and shipment made only from these bins. All cars shall be loaded under the supervision of and sealed by a representative of the State Highway Commission. Cars received at their point of destination with seals broken or destroyed may be unloaded, but should not be used until resampled and approved.

Producers are requested not to permit shipments to be made of any cement that does not comply with the requirements given. It is assumed that all cement shipped complies with the requirements given herein. All shipments made containing cement that does not comply with the requirements given herein shall be replaced with cement that does comply with said requirements.

Water used with Portland cement shall be clean, free from oil, acid, alkali, sea salts, or vegetable matter.

¹ Ottawa Sand is furnished by the Ottawa Silica Co. of Ottawa, Ill. One hundred per cent passes a No. 20 sieve and 100 per cent is retained on a No. 30 sieve. It has about 37 per cent of voids and a fineness modulus of 3.0.

Item 19A. Special Cement (Quick Hardening)¹

Under this item the contractor shall furnish and place cement meeting the following requirements:

A pat of neat cement shall remain firm and hard, and show no signs of distortion, cracking, checking, or disintegration in the steam test for soundness.

The cement shall not develop initial set in less than 45 min. when the Vicat needle is used or 60 min. when the Gillmore needle is used. Final check shall be attained within 10 hr.

The average tensile strength in pounds per square inch of not less than three standard mortar briquettes composed of 1 part cement and 3 parts standard sand, by weight, shall be equal to or higher than the following:

Age at Test, Days	Storage of Briquettes	Tensile Strength, Pounds, per Square Inch
1	1 day in moist air.	300
7	1 day in moist air, 6 days in water.	350
28	1 day in moist air, 27 days in water.	400

The average tensile strength of standard mortar at 7 days shall be higher than the strength at 1 day and the average tensile strength of standard mortar at 28 days shall be higher than the strength at 7 days.

The cement shall be tested in accordance with the methods of tests as given in the Standard Specifications of the American Society for Testing Materials, Serial Designation C-9-21.

All cement shall be sampled as directed by the Bureau.

Measurement and Payment.—The quantity to be paid for shall be the number of barrels, of 376 lb. net weight, incorporated in the work in accordance with the specifications and to the satisfaction of the engineer.

97. Mineral Fillers

Fillers for use in a bituminous mortar, bituminous concrete, or sheet asphalt shall be Portland cement, ground limestone, or pulverized lime not less than eighty-five (85) per cent of which must pass a one hundred (100) mesh sieve and sixty-five (65) per cent a two hundred (200) mesh sieve. It shall be free from lumps or balls or any foreign material that may injure it for the purpose intended.

98. Bituminous Cement

Must be uniform, homogeneous, and free from water. They must pass the requirements designated below for the respective type of pavement for which they are intended to be used. They must have the consistency required herein before shipping, for fluxing will not be allowed at the mixing plant.

99. Asphaltic Cements and Oils

Asphaltic cements may be made from petroleum or from fluxed or unfluxed natural asphalts, and must be free from tar or tar products.

¹ To get quick-hardening concrete by other methods, see p. 485.

99A. Prepared from Natural Asphalts.

Grades	NA-1		NA-2		NA-3		NA-4		NA-5	
	Min.	Max.	Min.	Max.	Min.	Max.	Min.	Max.	Min.	Max.
Tests										
1. Specific gravity at 15.5°C.....	1.045									
2. Penetration at 25°C., 100 g.—5 sec.....	40	50	1.045		1.04		1.04	150	10	20
3. Penetration at 48°C., 50 g.—5 sec.....				60	75		90			80
4. Evaporation loss at 163°C., 20 g.—5 hour, per cent.....										
(a) Penetration on residue at 25°C., 100 g.—5 sec.....	1.50	3.0	1.50	3.00	1.50	3.50	1.50	4.0		3.0
5. Solubility in benzol, C ₆ H ₆ , per cent.....	20		25		35		45		5	
6. Bitumen soluble in ether (C ₂ H ₅) ₂ O, per cent.....	95.00	98.00	95.00	98.00	95.00	98.00	95.00	98.00		
7. Bitumen soluble in carbon tetrachloride, CCl ₄ , per cent.....	85.00		85.00		85.00		85.00			
8. Flash point in °C.....	99.00		99.00		99.00		99.00			
9. Ductility at 50 penetration (cm.).....	175		175		175		105			
10. Paraffin scale.....	50.0		50.0		50.0		50.0		25.0 ¹	

¹ Taken at 20 penetration.

99B. Petroleum Residua Prepared from Heavy Mexican Petroleum.

Grades	H.M.1		H.M.2		H.M.3		H.M.4	
	Min.	Max.	Min.	Max.	Min.	Max.	Min.	Max.
1. Specific gravity at 15.5°C.....	1.04		1.035		1.035		1.03	
2. Penetration at 25°C., 100 g.—5 sec.	45	55	55	65	75	95	90	150
3. Penetration at 40°C., 50 g.—5 sec.		300		300				
4. Evaporation loss at 103°C., 20 g.—for 5 hour, per cent.		1.00		1.00		1.50		1.50
(a) Penetration on residue at 25°C., 100 g.—5 sec.	30		35		45		50	
5. Solubility in benzol, C ₆ H ₆ , per cent.	99.80		99.80		99.80		99.80	
6. Solubility in ether, (C ₂ H ₅) ₂ O, per cent.	75.00		75.00		75.00		75.00	
7. Solubility in carbon tetrachloride, CCl ₄ , per cent.	99.00		99.00		99.00		99.00	
8. Flash point in °C.	225		215		210		200	
9. Ductility at 50 penetration (cm.)	100		90		80		70	
10. Paraffin scale, per cent.		1.25		1.25		1.50		1.75

99C. Petroleum Residua Prepared from Light Mexican Petroleum.

Grades	L.M. ¹		L.M. ²		L.M. ³		L.M. ⁴		L.M. ⁴	
	Min.	Max.	Min.	Max.	Min.	Max.	Min.	Max.	Min.	Max.
1. Specific gravity at 15.5°C.....	1.035	1.030	1.030	1.030	1.030	1.025
2. Penetration at 25°C., 100 g.—5 sec.	45	55	55	65	65	95	75	95	90	150
3. Penetration at 46°C., 50 g.—5 sec	300	300
4. Evaporation loss at 163°C., 20 g.—for 5 hour. per cent.	1.00	1.00	1.50	1.50
(a) Penetration on residue at 25°C., 100 g.— 5 sec.....	30	35	35	45	50	50
5. Solubility in benzol, C ₆ H ₆ , per cent	99.80	99.80	99.80	99.80	99.80	99.80
6. Solubility in ether, (C ₂ H ₅) ₂ O, per cent	75.00	75.00	75.00	75.00	75.00	75.00
7. Solubility in carbon tetrachloride, CCl ₄ , per cent.....	99.00	99.00	99.00	99.00	99.00	99.00
8. Flash point in °C.....	225	215	215	210	200	200
9. Ductility at 50 penetration (cm.).....	100	90	90	80	70	70
10. Paraffin scale, per cent.....	3.50	3.75	4.00	4.00	4.50

99E. Petroleum Residua Prepared by Blending California and Mexican Residua.

Grades	C.M. ¹		C.M. ²		C.M. ³		C.M. ⁴	
	Min.	Max.	Min.	Max.	Min.	Max.	Min.	Max.
Tests								
1. Specific gravity at 15.5°C.....	1.03	1.025	1.02	1.02
2. Penetration at 25°C., 100 g.—5 sec.....	45	55	55	65	75	95	90	150
3. Penetration at 40°C., 50 g.—5 sec.....								
4. Evaporation loss at 103°C., 20 g.—for 5 hour, per cent.....		1.00		1.00		1.50		1.50
(a) Penetration on residue at 25°C., 100 g.— 5 sec.....	25	30	40	45
5. Solubility in benzol, C ₆ H ₆ , per cent.....	99.80	99.80	99.80	99.80
6. Solubility in ether, (C ₂ H ₅) ₂ O, per cent.....	80.0	80.0	82.0	83.0
7. Solubility in carbon tetrachloride, CCl ₄ , per cent.....	99.00	99.00	99.00	99.00
8. Flash point in °C.....	220	215	205	190
9. Ductility at 50 penetration (cm.).....	125.0	125.0	100.0	100.0
10. Paraffin scale, per cent.....		2.25		2.25		2.50		2.75

99G. Asphalt Cement Emulsion.—*General:* The emulsion shall be homogeneous, of such character that it will mix with water in all proportions and of such stability that it will remain constant and uniform while being combined and mixed with clean, wet, crushed stone. Its consistency shall be such as uniformly to coat the stone and remain constant while being handled.

Stone Test: One (1) pound of dry, clean, trap rock screenings, Grade A, shall be washed until clean and surplus water allowed to drain off for a period of five (5) minutes.

To this clean, washed, crushed stone screenings shall be added one and one-quarter (1¼) ounces of the emulsion. The mixture will then be constantly agitated by stirring, turning and mixing for a period of three (3) minutes.

Any material that will not retain its emulsified characteristics without appreciable separation during such agitation will be rejected as being unsuited for the purpose for which it is intended.

Analysis of Emulsion: When distilled up to a temperature of 260°C. the total loss shall not exceed thirty-two (32) per cent and not more than two (2) per cent of this distillate shall be other than water. The residue from the foregoing distillation shall comply with the following requirements:

Grade	A.E.					
	Min.	Max.	Min.	Max.	Min.	Max.
1. Specific gravity at 25°C..	1.01					
2. Penetration at 25°C., 100 g.—5 sec.	150	250				
3. Solubility in CS ₂ , per cent	98.5					
4. Fixed carbon, per cent...	0.0	15.0				
5. Ash, per cent.	0.0	1.0				
6. Ductility at 25°C. (cm.)...	40.0					
7. Paraffin scale, per cent...	4.7				

99H. Asphaltic Oils.

Nature of oils	Dust oil		Slow curing oil		Rapid curing oil		Cut back light		Cut back heavy		Hot oil light		Hot oil heavy	
	Min.	Max.	Min.	Max.	Min.	Max.	Min.	Max.	Min.	Max.	Min.	Max.	Min.	Max.
Grades	D.O.		S.C.O.		R.C.O.		L.K.		H.K.		L.H.O.		H.H.O.	
Tests	Min.	Max.	Min.	Max.	Min.	Max.	Min.	Max.	Min.	Max.	Min.	Max.	Min.	Max.
1. Specific gravity at 15.5°C.....	0.92	0.93	0.90	0.95	1.00
2. Evaporation loss on 20 g. at 103°C. —for 5 hours, per cent.....	8.0	25.0	12.0	20.0	35.0	30.0	5.0	12.0	5.0
(a) Penetration on residue at —25°C., 100 gm.—5 sec.....	10	30	20	75	45	90	45	90
(b) Float test at 50°C. (seconds) —for 5 hours, per cent.....	3.0	4.0	15.0	10.0	25.0	20.0
	25°C.	46°C.	40°C.	25°C.	25°C.	90°C.	90°C.
4. Viscosity—temperature (first 50 c.c., Engler)—seconds.....	225	450	175	300	275	450	180	325	600	1200	300	600	600	1200
5. Solubility in benzol, C ₆ H ₆ , per cent.....	99.5	99.5	99.5	99.5	99.5	99.5	99.5
6. Ductility, at 50 penetration (cm.).....	20.0	70.0	70.0	20.0	20.0
7. Asphaltic content at 100 penetra- tion, per cent.....	40.0	50.0	50.0	65.0	60.0	75.0	55.0	65.0	60.0	70.0	75.0	85.0	85.0	95.0
8. Flash point in °C.....	140	160

100. Tars

Tar may be either coal tar or petroleum water gas tar. They must comply with the following requirements:

Grades	A		B		X		KP	
	Min.	Max.	Min.	Max.	Min.	Max.	Min.	Max.
1. Water content, per cent.....	0.00	2.0	0.00	2.0
2. Specific gravity at 15°C.....	1.20	1.28	1.12	1.18	1.22	1.30	1.15	1.20
3. Float test at 50°C. in seconds.....	35	75	30	36
4. Melting point (B. & R.), °C.....
5. Viscosity Engler at 40°C., first 50 c.c. (seconds).....	100	150
6. Viscosity Engler at 80°C., first 50 c.c. (seconds).....	40	60
7. Free carbon, per cent.....	12.0	20.0	4.0	12.0	12.0	25.0	12.0	25.0
8. Distillation °C.-170°C., per cent.....	0.1	7.0	0.1	10.0
9. Distillation °C.-235°C., per cent.....	10.0	18.0	3.0	23.0
10. Distillation °C.-270°C., per cent.....	18.0	30.0	12.0	27.0
11. Distillation °C.-300°C., per cent.....	28.0	35.0	15.0	32.0
12. Specific gravity of entire distillate.....	1.02	1.01	1.03	0.98
13. Melting point of distillation residue.....

100A. Coal Tars.

SPECIFICATIONS

100B. Water-gas Tars.

Grades ¹	UA		UB		UC		UD		U ²		U ³		U ⁴	
	Min.	Max.	Min.	Max.	Min.	Max.	Min.	Max.	Min.	Max.	Min.	Max.	Min.	Max.
1. Specific gravity at 25°C.....	1.09	1.13	1.10	1.14	1.09	1.145	1.110	1.155	1.14	1.18	1.15	1.185	1.16	1.19
2. Float test at 50°C. (sec.).....									50	75	80	110	115	145
3. Viscosity at 40°C., 1st 50 c.c.— Engler (sec.).....	80	120	250	350	400	500	700	800						
4. Free carbon (using CS ₂ cold), per cent.....		5.0		5.0		5.0		5.0		5.0		5.0		5.0
5. Distillation—total up to 170°C., per cent.....		3.0		2.0		3.0		2.0		Nil.		Nil.		Nil.
6. Distillation—total up to 235°C., per cent.....		18.0		15.0		20.0		18.0		4.0		3.0		2.0
7. Distillation—total up to 270°C., per cent.....		35.0		30.0		30.0		28.0		13.0		11.0		9.0
8. Distillation—total up to 300°C., per cent.....		45.0		40.0		40.0		38.0		26.0		22.0		18.0
9. Melting point of distillation resi- due (B. & R.), °C.....		60		60		60		60		65		65		65

¹ Grades UA, UB, UC and UD are to be prepared by cutting back U³ with a suitable distillate.

LEGEND OF ASPHALTIC CEMENTS, ASPHALTIC OILS AND TARS

Intended use	Grades that may be specified
Sheet asphalt, type S. A.....	N. A. ⁻¹ , H. M. ⁻¹ , L. M. ⁻¹ , C. ⁻¹ , C. M. ⁻¹ , or T. ⁻¹
Bituminous concrete surfaces, mixed hot, Type F. A.-B. C. ⁻¹ , F. A.-B. C. ⁻² , or W-B.	N. A. ⁻² , H. M. ⁻² , L. M. ⁻² , C. ⁻² , C. M. ⁻² , or T. ⁻²
Bituminous concrete surfaces, mixed cold, type A.....	N. A. ⁻³ , H. M. ⁻³ , L. M. ⁻³ , C. ⁻³ , C. M. ⁻³ , or T. ⁻³
Bituminous macadam surfaces, penetration method.....	N. A. ⁻⁴ , H. M. ⁻⁴ , L. M. ⁻⁴ , C. ⁻⁴ , C. M. ⁻⁴ , T. ⁻⁴ , X., or U. ⁻⁴
Patch work, hot-mixing method..	H. H. O., X., or U. ⁻⁴
Patch work, cold-mixing method..	L. K., H. K., P., or U. C
Surface treatments, cold applica- tion—macadam.....	S. C. O., R. C. O., B., U. B., or U. C
Bituminous concrete.....	L. K., or H. K
Surface treatment, hot applica- tion—macadam.....	L. H. O., H. H. O., A., or U. ⁻²

101. Bituminous Waterproofing Compounds

All bituminous waterproofing paints shall be prepared ready for use before shipment and shall be shipped in strong, substantial containers, plainly marked with the name and weight of content and name and address of the manufacturer. When so requested, the analysis of all paints furnished must be supplied by the manufacturer within ten (10) days after request is made.

101A. Tar Paints.—Tar paints shall be prepared from a refined coal tar or water-gas tar and a tar distillate. They shall be free from water or petroleum distillates, and must comply with the following requirements:

Grades	T P ⁻¹		T P ⁻²		T P ⁻³	
	Min.	Max.	Min.	Max.	Min.	Max.
1. Viscosity at 25°C., first 50 c.c Engler (seconds)	325	400	275	350	275	350
2. Free carbon (using hot benzol, C ₆ H ₆), per cent	8.0	14.0	12.0	18.0	4.0	10.0
3. Distillation:						
0°-170°C., per cent....	20.0	28.0	12.0	20.0	12.0	20.0
0°-235°C., per cent....	0.0	37.0	15.0	35.0	15.0	35.0
0°-270°C., per cent....	0.0	39.5	0.0	39.5	0.0	41.0
0°-300°C., per cent....	0.0	41.5	0.0	43.5	0.0	46.0
4. Melting point of distilla- tion residue (Ball & Ring) °C	60	70	55	70	55	70

101B. Asphaltic Paints.—Asphalt paints shall be prepared from petroleum residue or natural asphalts, and a petroleum or tar distillate. They shall be free from water, animal or vegetable oils, fats or greases, and shall comply with the following requirements:

	A P-1					
	Min.	Max.	Min.	Max.	Min.	Max.
1. Evaporation loss at 163°C. on 20 g. for 5 hours, per cent.	45.0					
(a) Penetration on residue at 25°C. (100 g.-5 sec.)	10	20				
2. Evaporation loss at 100°C. on 20 g. for 5 hours, per cent.	35.0					
3. Solubility in benzol, C ₆ H ₆ (Prepared from petroleum asphalt), per cent.	99.5					
(Prepared from natural asphalt), per cent.	95.0					
4. Ductility at 50 penetration at 25°C., centimeters	20.0					
5. Viscosity at 25°C. (Engler, first 50 c.c.), seconds.	200	300				
6. Asphaltic content at 100 penetration, per cent.	50.0	60.0				

102. Wood Preservatives

Wood preservatives used in the pressure treatment of wooden blocks, piling, etc., shall be either an oil distillate from coal-gas tar coke-oven tar, or a product of which at least sixty-five (65) per cent shall be a distillate of coal-gas tar or coke-oven tar, and the remainder shall be refined or filtered coal-gas tar or coke-oven tar. Only one type of preservative shall be used on any one contract. They must comply with the following requirements as given under W P-1 and W P-2.

Wood preservatives used in the open-tank treatment of guard rail posts or other timbers shall be an oil obtained by distillation from coal tar or coke-oven tar, and shall be free from any admixture of undistilled tar, water-gas tar, or tars or oils obtained from any other sources. The oil shall conform to the following specifications given under W P-1.

Grades	W P-1		W P-2		W P-3	
	Min.	Max.	Min.	Max.	Min.	Max.
1. Water content, per cent.	3.0	3.0	1.0
2. Solubility in benzol, C ₆ H ₆ , per cent.	99.5	...	97.0	...	99.75	...
3. Specific gravity at 38°C./38°C., per cent.	1.06	...	1.07	1.14
4. Specific gravity at 38°C./15°C.	1.09	1.13
5. Distillates (based on water-free oil), 0°C.-210°C., per cent.	5.0	5.0
6. Distillates (based on water-free oil), 0°C.-235°C., per cent.	15.0	25.0	25.0
7. Distillates (based on water-free oil), 235°C.-300°C., per cent.	20.0
8. Float test at 70°C. on distillation residue above 355°C., if over 10 per cent, inches.	50
9. Float test at 70°C., on distillation residue above 355°C., if over 35 per cent, inches.	80	25
10. Per cent of residue above 355°C.	50.0
11. Specific viscosity, Engler at 20°C. on 200 c.c.	10
12. Specific gravity at 38°C./15.5°C. of fraction between 235° and 315°C.	1.03	...	1.02
13. Specific gravity at 38°C./15.5°C. of fraction between 315°C. and 355°C.	1.09	...	1.09
14. Coke residue, per cent.	2.0	10.0	2.0
15. Tar acids (per cent of total distillates), per cent.	15.0
16. Flash point (Cleveland open cup), °C.	120
17. Fire point (Cleveland open cup), °C.	165
18. All to be liquid (no solid), °C.	21

103. Joint Fillers

The material used in filling joints in pavements, curbs, gutters, etc., shall be divided into two grades, Grade P, poured joint fillers, and Grade M, molded joint fillers.

The poured joint fillers shall be prepared from either a coal tar or an asphalt cement, complying with the requirements given below.

Molded joint fillers shall be prepared by impregnating such inert materials as felt, woolen or cotton fiber, paper pulp, sawdust, etc., with a bituminous cement complying with the requirements given below. The inert material may be applied as a layer on the outside of a bituminous sheet, or may be uniformly distributed through the bituminous material. In either case sufficient inert material must be used to prevent the joint from chipping during cold weather.

Molded joint fillers shall be cast in sheets, the thickness of which shall be the same as the joint width specified, but in no case shall molded joint fillers be cast in sheets less than one-half ($\frac{1}{2}$) inch nor more than three-quarters ($\frac{3}{4}$) inch thick. When no special width is specified the joints shall be cast in sheets from one-half ($\frac{1}{2}$) inch to five-eighths ($\frac{5}{8}$) inch thick.

All molded joint fillers to be used in transverse joints in a concrete pavement shall be cast in lengths equal to one-half the width of the pavement, have a width of one-half ($\frac{1}{2}$) inch greater than the thickness of the pave-

SPECIFICATIONS

ment, have one edge cut to the curvature specified for the crown of the pavement, and have a thickness equal to the width of the joint as above specified. When for use in longitudinal joints in concrete pavements adjacent to curbs, gutters, headers, etc., molded joints shall be made in the lengths and widths ordered.

The various grades of bitumen used for the fabrication of expansion joint fillers shall comply with the requirements given below.

Grades	M. A.		P. A.		P. T.	
	Min.	Max.	Min.	Max.	Min.	Max.
1. Specific gravity at 25°C.....	1.00	...	1.00	...	1.22	1.30
2. Penetration at 25°C.-100 g. for 5 sec.....	25	35	30	40		
3. Penetration at 46°C.-100 g. for 5 sec.....	...	55	...	70		
4. Melting point (ball and ring)°C.....	65	95	36	50
5. Evaporation loss on 20 g. at 163°C. for 5 hours, per cent.....	...	1.0	...	1.0		
6. Solubility in benzol. C ₆ H ₆ , per cent.....	99.0	...	99.5	...	65.0	80.0
7. Solubility in carbon tetrachloride, CCl ₄ , per cent.....	99.0	...		
8. Flash point in °C.....	200	...		
9. Ductility at 25°C., centimeters.....	4.0	...	4.0	...		
10. Float Test at 100°C.....	55	75
11. Distillation 0°-170°C., per cent.....	1.0
Distillation 0°-300°C., per cent.....	5.0
12. Free carbon, per cent.....	20.0	35.0

104. Lignin Binders

They must be concentrated liquid extracts from organic matter, uniform in composition; homogeneous, free from mineral oils, asphalts or tars. During concentration the liquors must not be heated above 212°F. They must conform to the following requirements:

Grades	G. N.	
	Min.	Max.
1. Specific gravity at 60°F.....	1.25	
2. Solubility in cold water, per cent.....	99.5	
3. Solubility in hot water, per cent.....	99.5	
4. Evaporation loss at 100°C. to constant weight, per cent.....	...	55.0
5. Ash content, per cent.....	...	9.5
6. Free acids, per cent.....	...	0.5
7. SO ₂ content as sulphite, per cent.....	...	1.0
8. CaO content.....	...	2.5
9. MgO content, per cent.....	1.25	
10. Ferric oxide content, per cent.....	...	0.25

105. Inorganic Binders

This class of binder shall consist of concentrated solutions of soluble alkaline silicates and may contain soluble organic compounds. They shall fulfill the following requirements:

Grades	S. S.		R. M.			
	Min.	Max.	Min.	Max.	Min.	Max.
1. Solubility in hot water, per cent	99.0	99.5			
2. Specific gravity at 60°F.	1.35	1.40	1.20	1.30		
3. Residue on evaporation at 110°C. to constant weight, per cent	60.0	70.0	30.0	40.0		
4. Silica content of residue, per cent	70.0	80.0	36.0	40.0		

106. Telford Base Stone

This stone shall be prepared from a hard, durable rock, such as trap, granite, gneiss, limestone, etc. In the selection of these stones no decomposed, weathered, shattered or soft stone shall be included. The stone shall be broken nearly rectangular in shape, and of such a width that, after knapping, they will produce a foundation of the required thickness. When no special size is specified the stone shall be so broken that, after knapping and trimming up, they will be approximately eight (8) inches in depth, not less than two (2) or more than (5) inches in width, and from six (6) to twelve (12) inches in length.

107. Cobble Stones

Cobble stones shall be composed of only good, hard, durable stone which are nearly uniform in size. They shall not exceed five (5) inches in their largest diameter, except for the center line and side lines of gutters where 8-inch stones may be used. They must have fairly smooth, even faces that will permit the construction of a gutter surface with a uniform contour.

108. Rubble Stones

Rubble stones shall be prepared from a hard, durable, tough stone, such as trap, granite, gneiss, etc., that has a fairly uniform fine grain, is sound, free from weathered or decomposed stone, shattered ends or structural defects, marked laminations, seams or cracks, and must be approved by the engineer for the use intended.

When for use in a rubble gutter stone shall be not less than six (6) nor more than eight (8) inches in depth, not less than two (2) nor more than five (5) inches in width, and from six (6) to ten (10) inches in length. The top surface must be approximately flat, and so cut as to permit the construction of a gutter surface of the proper contour. When for use in rubble masonry unless otherwise specified the stone for the faces of the wall shall be not less than six (6) inches thick nor less than twelve (12) inches long. The width shall not be less than the thickness and the length shall not exceed three (3) times the thickness. Selected stones, rough squared, cut to the required pitch, shall be prepared for use at all angles and ends of walls.

109. Stone Block for Gutters

Stone block for gutters shall be prepared from a hard, tough rock such as trap, granite, gneiss, etc. In the selection of the stone all decomposed, weathered, soft, brittle or laminated stone will be excluded. The blocks should be of nearly the same degree of hardness and toughness. They shall be so cut that they will be practically rectangular in shape, be not less than six (6) nor more than eight (8) inches square on top, and from six (6) to eight (8) inches in depth. The blocks shall be so split and dressed as to form, when laid, close joints not exceeding one-half ($\frac{1}{2}$) inch in width on the top, and have a fairly smooth top and bottom surface.

110. Construction Brick

Brick for use in constructing manholes, catch basins, etc., shall be new, whole building brick of a standard brand or make. They must be of a uniform commercial size.

The physical properties of construction brick shall comply with the requirements for Hard Brick, as defined in A. S. T. M. standards, Serial Designation C21-20.

111. Masonry Stone

The stone used in the construction of stone masonry, such as retaining walls, headers, etc., shall be a hard, durable stone, that will easily permit of its being cut, chipped or chiseled into the required shape or form. Stone shall be of two grades, rough dressed and hand dressed. Rough-dressed stone shall be fairly rectangular in shape, have at least one smooth, even face, be not less than three (3) inches in thickness, nor less than eight (8) inches in width, and have a length greater than one-half the thickness of the wall in which the stone will be used. Hand-dressed stone will be hand dressed to nearly rectangular shape. The front face shall be smooth and even, free from objectionable depressions or projections, be rectangular in shape, have straight edges with square corners, and the other faces dressed nearly perpendicular to this face.

Hand-dressed stone shall be not less than eighteen (18) inches in length, six (6) inches in thickness, nor less than one (1) foot in width, and must be approved by the engineer before being used.

Header stone shall be equal in length to the thickness of the wall in which it will be used.

112. Stone Curbing

Straight curbing shall be made from either granite or bluestone; circular curbing from granite only.

The granite used shall be a good grade of medium fine grain granite which has a uniform texture and distribution of its constituent minerals, is neither stratified nor laminated, and is free from seams, evidence of weathering, or disintegration.

The bluestone shall be a hard, durable stone that is free from such imperfections as soft or weathered spots, shattered layers, weathered bedding planes, or distinct lines of stratification. It must be of sufficient hardness as to be serviceable, but not so hard as to be brittle or glassy.

All curbing shall be cut in lengths of not less than four (4) nor more than eight (8) feet, and be twenty (20) inches in depth unless a concrete footing is specified to be used, when the depth shall be sixteen (16) inches.

The top of all curbing shall be dressed to an even, smooth surface for full length, have straight, even edges, and a one-quarter ($\frac{1}{4}$) inch bevel. The front faces shall be hand dressed full length for a depth of twelve (12) inches, and have a batter of one (1) inch from the top of the curb to the finished line of the gutter and be straight from this line to the bottom. The back face shall be hand dressed for a depth of three (3) inches. All dressed faces shall be free from depressions, projections or other defects, and hand dressed in a manner equal to four (4) cut stone finish. All curbing shall have square ends that will permit joints being made not more than one-quarter ($\frac{1}{4}$) inch in width for full depth.

112A. Five-inch Curbing.—Five-inch curbing shall be five (5) inches in thickness on the top and not less than six (6) nor more than eight (8) inches in thickness on the bottom; other dimensions to be as above specified.

112B. Six-inch Curbing.—Six-inch curbing shall be six (6) inches in thickness on the top and less than seven (7) nor more than eight (8) inches in thickness on the bottom; other dimensions to be as above specified.

112C. Eight-inch Curbing.—Eight-inch curbing shall be not less than eight (8) inches in thickness on the top nor less than nine (9) nor more than eleven (11) inches on the bottom; other dimensions to be as above specified.

112D. Circular Curbing.—Circular curbing shall be similarly cut and dressed in the same manner as straight curbing. It must be so cut as to conform accurately to the required radius. The ends shall be so cut as to permit of joints being made of not more than one-quarter ($\frac{1}{4}$) inch in width for full depth.

113. Paving Blocks

113A. New Granite Paving Blocks.—New granite paving blocks shall be prepared from a granite of medium or fine-grained structure, showing an

even distribution of the constituent minerals of uniform quality, structure and texture.

Physical Properties.—The granite shall have a French coefficient of wear of not less than nine (9). The average of three determinations shall be used in reporting this test.

Dimensions.—The blocks shall meet the following requirements:

Length on top.....	8 to 12 in.
Width on top.....	3½ to 4½ in.
Depth.....	4¾ to 5¾ in.

Dressing.—The blocks shall be so dressed that the faces will be approximately rectangular in shape and the ends and sides sufficiently smooth to permit the blocks to be laid with joints not exceeding one-half (½) inch in width at the top and for a distance of one (1) inch down therefrom, and not exceed one (1) inch in width at any other part of the joint. The top surface of the block shall be so cut that there will be no depressions measuring more than three-eighths (¾) inch in depth from a straightedge laid in any direction on the top of said block and parallel to the general surface there of.

Care shall be exercised in handling the blocks so that the edges and corners shall not be chipped or broken. Blocks otherwise acceptable may be rejected on account of spalling.

Inspection.—The engineer or his authorized representative shall select at the work not less than three (3) blocks which fairly represent the actual shipment. These blocks shall be tested for the French coefficient of wear.

No samples shall include blocks that would be rejected by visual examination. The bedding plane shall be marked on at least two (2) of the blocks selected. All deliveries shall be subject to further inspection at the work prior to and during paving. Blocks received at the work that are manufactured at a quarry other than the quarry or quarries stated in the certificate submitted by the contractor at the time of bidding shall be rejected.

113B. Recut Granite Paving Blocks.—The recut granite paving blocks shall be made from the blocks in the street or roadway which is to be paved. Additional blocks required shall be either new granite blocks or made from other used granite blocks of the proper size and equal in quality to those in the pavement to be repaved.

Physical Properties.—All recut blocks must show a French coefficient of wear equal to that specified herein for new granite paving blocks.

Dimensions.—The blocks shall meet the following requirements:

Length on top.....	Not less than 6 in.
Width.....	3½ to 4½ in.
Depth.....	4¾ to 5¾ in.

Dressing.—The blocks shall be so dressed that the faces will be approximately rectangular in shape and the ends and sides sufficiently smooth to permit the blocks to be laid with joints not exceeding one-half (½) inch in width at any part of the joint. Blocks less than six and one-half (6½) inches in length shall be reclipped. The head of the blocks shall be so cut that they shall have not more than three-eighths (¾) inch depression across the head measured from a straightedge held parallel to the general surface of the blocks.

Inspection.—After the blocks have been recut they shall be carefully inspected. Undersized or irregular-shaped blocks or those not complying with the above requirements shall be rejected and must be removed from the roadway.

113C. New Sandstone Paving Blocks.—Sandstone paving blocks shall consist of the best quality sandstone, free from quarry checks or cracks, and shall be quarried from fine grain live rock, showing a straight and even fracture. The material shall be of uniform quality and texture, free from seams, lines or clay, or other substances which, in the opinion of the engineer, will be injurious to its use as paving blocks.

Physical Properties.—All sandstone blocks must have a French coefficient of wear of not less than nine (9). The average of three (3) determinations shall be made in reporting this test.

Dimensions.—The blocks shall meet the following requirements:

Length on top.....	8 to 12 in.
Width on top.....	3½ to 4½ in.
Depth.....	4¾ to 5¾ in.

Dressing.—The blocks shall be dressed in the same manner as that specified for new granite paving block.

Inspection.—The same method of inspection shall be used as that specified for the new granite paving blocks.

113D. Durax Paving Blocks.—Durax paving blocks shall be cut from a granite that complies with the requirements specified herein for new granite paving blocks.

Dimensions.—Durax blocks shall have six (6) irregular, approximately square surfaces, the edges of which shall measure not less than two and three-quarter ($2\frac{3}{4}$) inches, nor more than four (4) inches.

Dressing.—The blocks shall be dressed so as to conform with the requirements specified for new granite blocks, except that the faces shall be square instead of rectangular.

Inspection.—The same method of inspection shall be used for Durax blocks as that specified for new granite blocks.

113E. Vitrified Paving Brick.—All brick used for pavement or gutter surfaces shall be vitrified and prepared especially for paving purposes. They shall be pressed brick with lugs or wire-cut lug brick when the pavement is to be Portland cement grout filled, and wire cut without lugs when the pavement is to be filled with a bituminous cement or bituminous mortar. Special forms shall be furnished when so ordered or required without extra compensation.

All brick shall be thoroughly annealed, tough, and durable, regular in size and shape, and evenly burned. When broken, the brick shall show a dense, stonelike body free from lime, air pockets, cracks, or marked laminations. Kiln marks shall not exceed three-sixteenth ($\frac{3}{16}$) inch, and the wearing surface shall show but slight kiln marks.

Representative samples of the brick shall meet the following requirements when subjected to the rattler test:

Average loss by abrasion on 3-in. wire-cut brick twenty-five (25) per cent.; maximum, twenty-seven (27) per cent.

Average loss by abrasion on $3\frac{1}{2}$ -in. wire-cut brick, twenty-three (23) per cent.; maximum, twenty-five (25) per cent.

An abrasion loss of one (1) per cent lower than that specified above will be required for repressed paving brick.

A maximum of three tests may be used as a basis for rejection.

The brick shall meet the following dimensions;

Either $8\frac{1}{2} \times 3 \times 4$ in., or $8\frac{1}{2} \times 3\frac{1}{2} \times 4$ in.

Variations among brick from a single plant shall not exceed the following limits:

Variation in length.....	$\frac{1}{2}$ inch
Variation in width.....	$\frac{3}{8}$ inch
Variation in depth.....	$\frac{3}{8}$ inch

If the edges of the brick are rounded, the radius shall not exceed three-sixteenth ($\frac{3}{16}$) inch.

The name or trade-mark of the manufacturer, if shown on the brick, shall be recessed and not raised.

The brick shall be subjected to inspection subsequent to delivery and during laying in order to cull out and reject upon variations from the general and dimensions clauses and upon the following grounds:

All brick which are broken through or chipped in such manner that neither wearing surface remains substantially intact, or in such manner that the lower or bearing surface is reduced in area by more than one-eighth ($\frac{1}{8}$).

All brick which are cracked to a depth greater than one-eighth ($\frac{1}{8}$) inch on any surface, or which are cracked on the wearing surface.

All brick which are so offized or misshaped, bent, twisted, or kiln marked that they will not form a proper surface or align properly with other brick.

All brick which are obviously too soft and too poorly vitrified to endure street wear.

113F. Asphalt Blocks.—These blocks shall be prepared from trap rock and a mineral filler of ground limestone or Portland cement bound together with an asphaltic cement. The trap rock shall be prepared by recrushing clean $\frac{3}{4}$ -in. to $1\frac{1}{2}$ -in. stone which is free from all weathered or decomposed material and quarry screenings. The product thus produced must all pass through a screen having circular openings one-quarter ($\frac{1}{4}$) inch in diameter, the stone therein shall be as near cubical as possible, and be so graded as to

produce in the finished block, the mesh composition specified below. The mineral filler must fulfill the requirements given in Article 97; the asphalt cement, those for Grade NA., as defined in Article 99A.

All blocks shall be uniform in texture and composition, straight, true to form, free from warp, wind, and broken corners or edges. The planes of the opposite faces and edges must be parallel. Each block shall be five (5) inches in width, twelve (12) inches in length, and two (2) inches in depth and any variation therefrom of over one-quarter ($\frac{1}{4}$) inch in length or one-eighth ($\frac{1}{8}$) inch in width or depth from these dimensions will cause the rejection of such blocks.

Anchor blocks shall, in addition to meeting the requirements specified hereinabove, have a strip of sheet iron one (1) inch wide so embedded in the block that it is firmly held in place, does not project less than three-eighths ($\frac{3}{8}$) inch or over one-half ($\frac{1}{2}$) inch below the surface of the face of the block, is elliptical in shape, the major axis of which is not less than nine (9) inches or over ten (10) inches and the minor axis not less than two and one-half ($2\frac{1}{2}$) inches or over three (3) inches.

All blocks must have a specific gravity at 15.5°C., of not less than 2.40 and be so prepared that they will comply in all respects to the following additional requirements:

COMPOSITION

Size of screen and sieves		Minimum, %	Maximum, %
Passing	Retained on		
.....	$\frac{1}{4}$ -in. screen		0 0
$\frac{1}{4}$ -in. screen	20-mesh	35 0	50 0
20-mesh	100-mesh	15 0	30 0
100-mesh	26 0	36 0
Bitumen content	6 5	8.0

After having been dried for twenty-four (24) hours at a temperature of 150°F., the blocks shall not absorb more than one (1) per cent of water based on the weight after drying, when immersed in water for seven (7) days.

The average penetration of the block under the punch test shall not exceed 0.25 in. at 100°F., and 1.00 in. at 115°F.

Blocks which have the corners or edges broken off of one end only and will pass the other requirements giving hereinabove, may be used for half blocks adjacent to curb, for breaking courses, and in making closures.

In addition to the above requirements, the block must be prepared by a manufacturer or producer who is experienced in the preparation of such blocks. Before approval by the engineer of any blocks of this type, the manufacturer or producer thereof must submit a statement giving the locations of two or more pavements that are five (5) years or more old, have given good service during this time, do not show evidence of an unnatural wear or deterioration, and were constructed of paving blocks of the type herein specified.

Each consignment or carload shall be sampled in such a manner that each sample represents about ten thousand (10,000) blocks. The blocks selected for the samples shall be taken at random from the shipment and shall represent the average quality of blocks contained in the consignment. In case the blocks fail to pass the tests herein specified, a check analysis shall be made on another sample similarly selected. If the check sample passes the requirements above specified, the shipment or consignment shall be accepted, otherwise rejected, unless the engineer shall agree to resample the consignment.

113G. Wooden Blocks.—All wooden blocks used for paving purposes shall be creosoted in the manner designed below, and comply with the other requirements given.

Quality of Wood for Blocks.—The lumber to be used in manufacturing blocks shall be Southern yellow pine, Norway pine, Douglas fir, tamarack, black gum, or hemlock, but only one kind shall be used on any one section of pavement.

The blocks shall be sound and shall be well manufactured, square butted, square edged, free from unsound, loose, or hollow knots, knot holes, worm holes, and other defects such as shakes, checks, etc., which would be injurious to the blocks.

The number of annual rings in the one (1) inch measured radially, which begins two (2) inches from the pith of the block, shall not be less than six (6), provided, however, that blocks containing between five (5) and six (6) rings in this inch will be accepted if they contain thirty-three and one-third ($33\frac{1}{3}$) per cent or more of summer wood. In case the block does not contain the pith, the one (1) inch to be used shall begin one (1) inch from the ring which has the shortest radius. When being treated the blocks in each charge shall contain an average of at least seventy (70) per cent of heart wood. No one block shall be accepted that contains less than fifty (50) per cent of heart wood.

Size of Block.—Blocks shall be from five (5) to ten (10) inches in length, but shall have an average length of twice the depth; they may be from three (3) to four (4) inches in width, and three (3), three and one-half ($3\frac{1}{2}$) or four (4) inches in depth, as specified. Only block of a single width shall be used in a section of pavement. A variation of one-sixteenth ($\frac{1}{16}$) of an inch shall be allowed in the depth, and one-eighth ($\frac{1}{8}$) inch in the width of the block.

Properties of Preservatives.—The preservative to be used in manufacturing of block shall be a coal-tar distillate or a coal-tar paving oil, complying with the requirements given therefor. The preservatives used shall be designated by the engineer, but only one preservative shall be used on any one contract.

Inspection of Preservative.—The manufacturer of the blocks shall permit complete sampling at all times and places, and shall furnish, if required, satisfactory proof of the origin of the preservative. Samples of the preservative, taken from the treating tank during treatment, at no time shall show an accumulation of more than two (2) per cent of sawdust, dirt, or other foreign materials. Due allowance shall be made for such accumulation of foreign materials by injecting an additional quantity of preservative into the blocks.

Treatment of Blocks.—The blocks shall be treated with the preservative under pressure so that they shall contain not less than sixteen (16) pounds per cubic foot, and at no time shall be subjected to a temperature of more than two hundred and forty (240) degrees Fahrenheit. They shall show satisfactory penetration of the preservative after treatment. All blocks which have become warped, checked or otherwise injured in the process of treatment will be rejected.

Inspection of Blocks.—The blocks will be subjected to inspection before, during and after treatment and may be reinspected at any time. The plant shall be equipped with gages and appliances necessary for suitable inspection and every facility for this inspection shall be afforded.

Handling of Blocks.—The blocks at all times shall be kept clean, piled neatly and shall be handled carefully, as blocks otherwise acceptable may be rejected if they become coated with dirt.

114. Pipes

All pipe of any given type, grade, or size must be uniform in appearance, composition, and texture. The smallest inside diameter shall be the governing size. Unless otherwise specified, all lengths must be straight, true to form, with circular cross-sections, and free from cracks, holes, ragged chips, or broken ends. No cross, second grade, used or second-hand, injured or defective pipe shall be used, or other grades or sizes substituted for those specified. No pipe shall be used until approved by the engineer. Whenever possible, the manufacturer should have consignments inspected and approved before shipment.

114A. Drain Tile.—The pipe used for drain tile shall be either vitrified tile or machine-made concrete pipe, unless otherwise shown on plans.

Vitrified pipe shall be of the best-grade, first-quality, salt-glazed pipe of the hub-and-spigot type. The glazing shall extend uniformly over both the exterior and interior surfaces. It shall be uniformly and thoroughly burned, free from blisters, cracks, or other defects that will injure it for the purpose intended. The dry pipe must give a clear, metallic ring when tapped. It shall be furnished in lengths of not less than twenty-four (24) inches. The inside diameter shall be the determining size. Unless otherwise specified, all lengths must be straight. When required, curved or special forms of pipe shall be furnished.

Concrete drain pipe shall be made of the same materials and in the manner specified for machine-made reinforced concrete pipe, given below, with the exception that no reinforcing metal is required and the ultimate strength of pipe shall be 1000 D. The dimensions for this kind of pipe shall conform to the A. S. T. M. requirements, Serial Designation C14-21.

114B. Cast-iron Pipe.—All cast-iron pipe shall be of the hub-and-spigot style. It shall be manufactured in the lengths specified. When no length is designated, it shall be manufactured, in lengths not less than three (3) feet nor more than twelve (12) feet. Unless otherwise specified, each length shall have square ends, be straight in the direction of the cylinder and the inner and outer surfaces shall be concentric and true circles in cross-section. All pipe shall be smooth, free from scales, lumps, blisters, cracks, broken ends, or other defects considered injurious for the use intended. Small sand- or blow-holes will not be considered defects. Each joint shall have the maker's initials cast upon it in raised letters.

All cast-iron pipe shall be made from first quality cast iron which is free from clinker iron or other inferior iron. It must produce a sound, tough, durable casting, having a uniform, even grain that is soft enough to admit satisfactorily of drilling and cutting.

Either cast-iron water pipe, Grade A, or cast-iron culvert pipe will be accepted provided it complies with the requirements given above and its weight per lineal foot is not less than that given below for the different sizes.

Nominal inside diameter, inches	Thickness, inches	Weight per lineal foot, pound
4	0.42	20.0
6	0.44	30.8
8	0.46	42.9
10	0.50	57.1
12	0.54	72.5
14	0.57	89.6
16	0.60	108.3
18	0.64	129.2
20	0.67	150.0
24	0.76	204.2
30	0.88	291.7
36	0.99	391.7

No pipe will be accepted, the weight of which shall be five (5) per cent less than the weights herein specified.

Each section of cast-iron pipe shall be coated inside and outside with coal-tar pitch varnish to which sufficient linseed oil has been added to make a smooth coat, tough and tenacious when cold, with no tendency to scale off.

114C. Corrugated Sheet Iron or Steel. Size and Shape.—Each joint shall have square ends, be circular in form and of the size and length indicated on plans. When no particular length of joint is indicated, the pipe shall be shipped in standard lengths of the required size. The inlet and outlet ends shall be reinforced by a round rod not less than one-half ($\frac{1}{2}$) inch in diameter. Sufficient metal shall be lapped over this rod to cover it completely. Each joint shall be firmly and neatly riveted together, the rivets being spaced not over three (3) inches apart in longitudinal seams, nor more than eight (8) inches apart in circumferential seams. The metal shall be lapped not less than one and one-half ($1\frac{1}{2}$) inches in longitudinal seams nor less than one (1) corrugation in circumferential seams.

Composition of Materials Used.—All corrugated pipe shall be manufactured from galvanized sheets of iron or steel that were prepared from either a pure-iron or a copper-bearing pure-iron steel. These sheets must be uniform in thickness, and free from blisters, scales, or other defects which will injure them for galvanizing. All rivets, reinforcing rods, and couplings or connecting bands shall be made from the same grade metal as the body of the pipe.

Pure iron shall be so refined that it shall have an iron content of not less than ninety-nine and seventy-nine hundredths (99.79) per cent, copper-bearing pure iron, not less than 99.75 per cent and not less than 0.20 per

cent of copper. Copper steel shall be so prepared that it shall contain not less than three-tenths (0.3) of one (1) per cent of copper nor more than fifteen hundredths (0.15) per cent of carbon, five hundredths (0.05) per cent of sulphur, four hundredths (0.04) per cent phosphorus, and from thirty hundredths (0.30) to forty-five hundredths (0.45) per cent manganese.

Galvanizing.—All sheet metal used in the manufacture of corrugated pipe shall be galvanized on both sides by the hot-dipping process. Each square foot of uncorrugated sheet shall contain not less than two (2) ounces of spelter, evenly distributed over both surfaces. The zinc coating must be uniform in thickness, completely cover both sides, firmly adhere thereto, and be free from imperfections of any kind, and show no signs of cracking or blistering. All rivets, reinforcing rods, and couplings or connecting bands shall be galvanized in the same manner as the sheets.

Corrugation.—The corrugations of any one given size of pipe shall be uniform but must not be less than three-eighths ($\frac{3}{8}$) inch in depth, nor more than three (3) inches from center to center.

Gages of Sheets Required.—Corrugated metal pipe shall be made of sheets of the following thickness (U. S. Standard Gage Measure):

Diameter	Gage
Pipe from 12 to 20 in.	shall not be lighter than 16
Pipe from 24 to 30 in.	shall not be lighter than 15
Pipe from 36 to 42 in.	shall not be lighter than 14
Pipe from 48 to 60 in.	shall not be lighter than 12

114D. Reinforced Concrete Pipe. Type of Pipe.—Reinforced concrete pipe may be either cast or machine made. Each type shall conform in size, shape and reinforcement to the standards as shown in the table forming a part in these specifications. The letter C or M shall be plainly impressed upon the outside surface of each length of pipe to designate whether it is cast or machine-made respectively. Each length of pipe shall also be clearly marked with the date of manufacture and the name or trade-mark of the manufacturer.

Shape.—All concrete pipe 12 in. or over in diameter shall be reinforced as herein specified and be of the bell-and-spigot type unless some other type is specified or shown on the plan. Each section shall have square ends, be circular or elliptical in cross-section, unless otherwise specified, and have walls of uniform thickness throughout except the bell end, which shall have a thickness of not less than three-fourths ($\frac{3}{4}$) of the wall thickness at a point $\frac{1}{4}$ in. from the end of the bell.

Size.—It shall be cast in sections, the length of which shall be as herein specified or shown on plans. When no particular length is specified, the pipes shall be manufactured in standard lengths of not less than four (4) feet, nor more than six (6) feet. The smallest inside diameter shall govern in deciding the sizes of any given pipe.

Joints.—The bell end shall be so constructed that the spigot end will enter to full depth. The distance the spigot end must enter freely shall be as follows: 12- to 18-in. pipes not less than two and one-half ($2\frac{1}{2}$) inches; 18- to 30-in. pipe, not less than three (3) inches; and 30- to 72-in. pipe, not less than three and one-half ($3\frac{1}{2}$) inches.

Finish.—The surface of all pipe, both interior and exterior shall be smooth and even, of uniform texture, free from surface checks, cracks, blisters, fractures, laminations, lean and porous spots. The pipe shall be true to dimensions intended in the design with a permissible variation from the true form of not more than $1\frac{1}{2}$ per cent. The shell of the pipe may be thicker than called for in the designs, but it shall not be less than the designated shell thickness by more than 5 per cent.

Composition.—Concrete pipe shall be prepared from a concrete mortar having the following composition:

Portland cement	1 part by volume
Fine aggregate	1 to 2 parts by volume
Coarse aggregate	3 parts by volume

and sufficient reinforcing metal to meet the requirements given below.

Materials.—The Portland cement shall comply with the requirements give in Article 96. The fine aggregate shall be concrete sand, complying with the requirements given in Article 95-B. The coarse aggregate shall be dustless screenings prepared from trap rock, dolomite or pea gravel as defined in Articles 92 and 94 respectively.

The reinforcing metal shall be woven wire mesh, expanded metal, rods, hoops, or spirals manufactured from billet steel which complies with the requirements specified therefor by the A. S. T. M. Standards, Serial Designation A 15-14. It must be free from grease, dirt, rust, or any foreign material that will prevent the concrete from properly adhering thereto.

Preparation.—Concrete pipe shall be prepared from the materials above specified. Each length shall be cast in a single operation. The molds must be properly assembled, cleaned, and oiled when so ordered before any concrete mortar is placed therein. The reinforcing metal must be so held in the required position that it will not be displaced during manufacture of the pipe. For cast pipe the forms shall not be removed until the concrete is at least twelve (12) hours old, and after removal unless steam cured, the pipe must be covered and be kept wet at least ten (10) days. Pipe manufactured when the atmospheric temperature may drop below 35°F. must be so protected that the concrete therein will not at any time have a temperature below 35°F., until the concrete is at least seven (7) days old. Pipe shall not be shipped for use that is less than fourteen (14) days old.

Reinforcement.—All pipe shall be reinforced as herein specified. Pipe under thirty (30) inches in diameter shall have a single line of reinforcement, thirty (30) inches and above, two lines of reinforcements as shown in the table below or an approved method of reinforcement developing equivalent strength.

Single lines of reinforcement shall be placed at equal distances from the inside and outside surfaces of the pipe.

Double lines of reinforcement shall be placed parallel to each other and one (1) inch from the inside and outside surface walls of the pipe, other requirements to be as above defined for single-line reinforcements.

Longitudinal reinforcement shall extend full length of each section and into the bell, and shall be wired or otherwise securely fastened to the body and bell reinforcement.

Circular reinforcement shall extend completely around the pipe and have adjacent lap not less than forty (40) diameters of the circular reinforcement and be firmly fastened together.

The thickness of the pipe walls and total cross-sectional area of circular and longitudinal reinforcement for the different sizes of the pipe shall be not less than those shown in the table given below:

Diameter of pipe, inches	Cast pipe		Machine-made pipe		Longitudinal reinforcing	
	Shell thickness, inches	Minimum area of circular reinforcing per foot of pipe	Shell thickness, inches	Minimum area of circular reinforcing per foot of pipe	Minimum number of long	Minimum total area long
12	2	0.070	1½	0.003	4	0.196
15	2¼	0.096	1¾	0.123	4	0.196
18	2½	0.123	2	0.160	4	0.16
24	3	0.180	2½	0.220	4	0.196
30	3½	2 × 0.167	3	2 × 0.210	8	0.92
36	4	2 × 0.200	3	2 × 0.300	8	0.614
42	4½	2 × 0.230	3½	2 × 0.320	8	0.614
48	5	2 × 0.265	4	2 × 0.350	8	1.200
54	5½	2 × 0.300	4½	2 × 0.390	12	1.326
60	6	2 × 0.330	5	2 × 0.410	12	1.326

Strength.—When supported at the bottom upon a knife edge one (1) inch in width, or upon two rounded bearings centered two (2) inches apart, in such manner than an even bearing is provided throughout the whole length, exclusive of the bell, and load is applied at the crown through a similar knife edge, all pipe twenty-four (24) inches in diameter and greater shall withstand, without the appearance of a visible crack extending through the entire length of the pipe, a load of 1000 D lb. per lineal foot of laying length;

all pipe of a diameter less than 24 in. when tested in a similar manner shall withstand a load of 1330 lb., as specified for larger size pipe. When tested to destruction, all pipe of twenty-four (24) inches diameter and greater shall show an ultimate strength of not less than 1500 D lb. per lineal foot of laying length; all pipe of a diameter less than twenty-four (24) inches shall, in a similar manner, show an ultimate strength of not less than 2000 D lb. per lineal foot of laying length. In the above expression of load D is the inside diameter of the pipe in feet.

Absorption.—The maximum average absorption as obtained by the A. S. T. M. standard boiling test shall not exceed eight (8) per cent by weight.

Testing.—Each manufacturer furnishing pipe under these specifications shall be fully equipped to carry out the tests herein designated. Upon the demand of the department and under its supervision, the manufacturer shall perform such number of tests as the department may deem necessary to establish the quality of the pipe offered for its use. Failure of any size of pipe to meet the test requirements shall be sufficient cause for rejection of all pipes of that size, which the test specimen represents.

Inspection.—All pipes shall be subject to inspection at the factory, or point of delivery, by a competent inspector employed by the department. The purposes of the inspection shall be to cull and reject pipes which, independent of the physical tests herein specified, fail to meet the requirements of these specifications and rejection through inspection may be made on account of any of the following:

(a) Porous spots on either inside or outside surface of pipe having an area of more than ten (10) square inches and a depth of more than one-half inch.

(b) Pipes which have been patched to repair porous spots, cracks or other defects.

(c) Variations in any dimension exceeding the permissible variations.

(d) Fractures or cracks passing through the body or bell, except that a single crack at either end of pipe not exceeding three inches in length or a single fracture in the bell not exceeding two inches in depth nor extending more than 10 per cent around the circumference of the bell will not be considered cause for rejection.

(e) Failure to give a clear ringing sound when tapped with a light hammer.

(f) Exposure of the reinforcement when such exposure would indicate that the reinforcement was misplaced.

(g) In machine-made pipe the entire absence from the exterior surface of a pipe of the characteristic water marks due to suction, caused by the removal of the outer form, shall be considered proof of an insufficient quantity of mixing water and shall be sufficient cause for rejection of such pipe.

Vitrified Pipe

Vitrified pipe shall be double-strength, salt-glazed, vitrified, stoneware sewer pipe of the first quality (for dimensions and weights, see p. 1084). The item will include the furnishing delivering, handling, laying, and cementing of joints; also the operations of excavating the trench, bracing, sheeting, or otherwise supporting the sides, grading and preparing the bottom, back-filling and compacting to the original surface, and the removal of all surplus material.

115. Reinforcing Metal

All reinforcing metal shall be made from open-hearth or Bessemer steel, complying with the A. S. T. M. standard requirements of tentative standards for the type of steel from which the reinforcing metal is required to be made.

When any special design, shape, or form of reinforcing metal is specified to be used, the same shall be used in the manner and in the quantity required. All reinforcement shall be placed as shown or as otherwise ordered by the engineer. It must be free from rust, paints, oils, grease, or other foreign materials that will prevent the proper bond being secured between the concrete and the metal. All reinforcement must be straight unless curved or special shapes are required. When so required, they must have the designated shape when used.

When reinforcing bars or rods have to be spliced, the lap shall be not less than forty (40) diameters for deformed rods, or fifty (50) diameters for plain rods. The lapped ends shall be firmly clamped together or otherwise securely fastened in a manner satisfactory to the engineer. All bars or rods shall be firmly and securely fastened together in a satisfactory man-

ner at all intersections. At intersections the members in reinforcing fabric shall be welded or otherwise securely fastened.

116. Structural Steel

Structural steel shall be prepared from a steel that complies with the requirements given in Volume 16, Part 1 of the A. S. T. M., pages 99 and 111 to 113. A coupon giving the analysis of the Melt Number from which the steel forms or structures were made shall be furnished with each shipment.

Whenever any special forms or shapes are specified to be used, the steel shall be made to conform to such shapes and dimensions. The methods used in manufacturing the steel into the forms required shall be such that the steel is not injured thereby. All shearing and chipping shall be neatly and accurately done, and all portions of the steel which will be exposed to view must be neatly finished. All holes must be neatly punched and riveting and bolting performed in a workmanlike manner. Undersized holes shall be reamed to size. All pins and rivets must be full size and fit accurately at normal temperature.

All structural steel must be protected from the weather and have clean surfaces before being worked into the proper shapes or forms. When structures are required to be painted before shipment, the surfaces must be cleaned and given a coat of an approved paint.

117. Miscellaneous Iron and Steel

All cast-iron, malleable-iron, or cast-steel castings shall be prepared in the manner and from a metal which complies with the A. S. T. M. requirements as defined in the 1918 Year Book, pages 406, 403, and 220 respectively.

When any special size, shape, or form is specified to be used, the casting must comply with these dimensions. All castings must have the weight and thickness of metal as specified or shown on plans. They must be neatly finished, free from fins, broken edges, blow-holes, cracked sections, or warped surfaces. They must be properly protected during shipment and painted when so specified.

118. Guard Rails

Guard rails shall be made either of wood or galvanized pipe as specified. The dimensions or sizes of materials to be used therefor shall be as specified. When no definite size or character of material as specified for a given type of guard rail, the material furnished shall comply with the requirements given below for such materials.

118A. Wooden Guard Rails.—The lumber used in all wooden guard rails shall be well seasoned, straight grained, sound, surfaced on all sides and be free from shattered or cracked ends, barked edges, loose or unsound knots, and reasonably free from other knots.

The wooden rails shall be made from long-leaf yellow pine, chestnut, or oak. The top rails or caps shall be two-inch plank, eight (8) inches wide, sixteen (16) feet long. The bottom rail shall be two-inch plank ten (10) inches wide, and sixteen (16) feet long. All rail plank must have square ends for the full width of the plank. Rails and caps shall have their joints on alternate posts.

Posts shall be made from chestnut, oak, locust, white or red cedar. They shall not be less than seven (7) feet in length, six (6) inches square, have the top ends cut to the bevel required, the lower end off square, and the lower four (4) feet treated. The treatment shall consist of immersing the posts in a bath of hot tar. The tar used for this purpose shall be Grade A or U¹, as defined in Articles 100A and 100B. The tar shall be heated between 225 and 275°F., and kept at this temperature during the treatment of the posts.

The posts shall be placed in a vertical position in the hot tar for not less than thirty (30) minutes, or as much longer as is needed to heat the lower four (4) feet of the posts to the same temperature as the tar. Immediately upon removing from the hot tar, it shall be immersed in a bath of cold tar of the same grade until cooled to normal temperature. The portion of the posts treated shall be slightly in excess of the depth that the posts will be placed in the ground, but in no case shall the treatment extend more than six (6) inches above the ground.

118B. Galvanized Pipe Rails.—All pipe shall be made from the best grade of galvanized wrought-iron pipe that is equal in every respect to the best grade of "Byers' wrought-iron galvanized pipe." All such pipe must have an even, smooth surface, be full weight and thickness, well threaded,

and free from rust or cracks. All fittings used in pipe guard railing, shall be galvanized and made from malleable iron that is free from flaws, cracks, etc. They shall be neatly threaded or bored to the required size needed for the proper installation of the pipe.

Steel Cable

Cable shall be three-strand, seven wire to the strand, double-galvanized, steel-wire cable of $\frac{3}{4}$ " diameter. Individual wires shall be not less than 0.120" diameter.

The minimum tensile strength of the rope shall be 15,000 lb.

Each wire of the cable and all fittings and fastenings, except threaded portions, shall be galvanized by the "hot dip method" and shall have a continuous coating of pure zinc of a uniform thickness, so applied that it will adhere firmly to the surface of the wire, and it shall be capable of withstanding four immersions in a standard testing solution of copper sulphate without showing any trace of metallic copper on the steel. The first three immersions shall be for a period of 1 min. each and the fourth immersion for a period of $\frac{1}{2}$ min.

The threaded portions of all fittings and fastenings shall have a continuous coating of pure zinc of a uniform thickness, so applied that it will adhere firmly to the surface of the thread, and it shall be capable of withstanding two immersions, of 1 min. each, in a standard testing solution of copper sulphate without showing any trace of metallic copper on the steel.

These threaded portions shall receive, after erection, two coats of aluminum paint meeting the requirements under Materials of Construction.

119. Timber and Lumber

General.—All timber or lumber shall be well seasoned, straight grained, sound, free from loose knots, shattered, worm holes, cracked ends, barked edges, or other defects that impair its strength or durability for the use intended. It must be cut or sawed to the specified size and dimensions, and when painting is required, must be surfaced on all faces to be painted. It must be of sufficient length to give square ends for full width of the length specified.

When a special kind or grade of timber or lumber is specified, this kind or grade must be furnished. When no kind or grade is specified, the wood may be white oak, chestnut, long leaf yellow pine. Timber for use as piling must withstand the specified driving without spreading or excess brooming of the head. It must be not less than six (6) inches in diameter at the point or ten (10) inches at the butt. It must have a uniform taper from butt to tip, have the bark removed, be free from short bends, and a straight line from the center of the butt to the center of the tip shall lie wholly within the body of the pile. All knots or blemishes must be trimmed off close and even with the body of the pile. The lower ends shall be cut square or tapered as may be directed by the engineer.

Timber or lumber to be creosoted, unless otherwise specified, shall comply with the requirements given above and shall be long-leaf yellow pine. It must be treated with the creosote oil described in paragraph 102, and the treatment so performed that the wood will absorb not less than twelve (12) pounds of oil per cubic foot for lumber having a minimum cross-section not over four (4) inches, or eight (8) pounds per cubic foot for lumber having a minimum cross-section of not less than six (6) inches.

Log Cribbing (U. S. Forest Road Specifications)

Log cribbing shall be built to the lines and grades given by the engineer and constructed in conformity with the plans or as directed by the engineer.

Materials.—The contractor shall secure and prepare or shall furnish at his own expense all necessary logs, timber, hardware, etc., under the conditions and as called for under the heading "Material" for "Log Bridges."

Construction.—The cribbing shall be supported on mudsills with flattened lower surfaces placed as shown on the plans.

All logs, including face logs, tie logs, mudsills and anchor logs, shall be properly notched together and drift bolted as shown on the plans.

The minimum lengths and sizes of logs shall be as shown on the plans. Each course of logs shall break joint with the adjacent courses. The lengths of tie logs required for the proper support and anchorage of the cribbing shall be as determined by the engineer.

The face and tie logs are to be so notched together, and hewn if necessary, that the face logs will be in contact with each other throughout their entire

length, except that in case a satisfactory rock backfill is placed against the face logs the engineer may permit open spaces not exceeding 4 inches in width between the face logs. When permission to use such spaces is given, the rock backfill shall be carefully placed, using the larger rocks adjacent to the logs and backing up with the smaller rocks in such manner that earth and finer material will not escape or be washed out.

Payment.—Payment will be made by the linear foot of face logs in place complete at the unit bid price, which price shall include the furnishing and placing of transverse mudsills, tie logs, anchor logs and drift bolts. Such unit bid price shall be payment in full for all materials, labor, excavation, backfilling and incidental work required for the construction of the cribbing complete. The measurement of log cribbing shall include only the linear feet of face logs, or longitudinal mudsills when such are used, and will not include transverse mudsills, tie logs or anchor logs.

120. Paints

120A. General.—All paints shall be shipped in strong, substantial containers, plainly marked with the name and weight of paint content, and name and address of the manufacturer. When so requested, samples and analysis of all pigments, oils, thinners, or driers used, or paints furnished shall be supplied by the manufacturer within ten (10) days after request is made therefor.

Paints shall consist of pigments of the required fineness and composition, ground to the desired consistency in raw or boiled linseed oil, to which shall be added additional oil, and a thinner, or a drier, or both. All pigments, oils, thinners, and driers used shall be of the best quality, free from adulterants of any kind, and shall comply with the requirements given below for these materials.

120B. Paint Paste.—All paint paste shall consist of the specified pigment or pigments ground in linseed oil to the required consistency. The paste must be so prepared that it is uniform in composition and consistency, will not cake or segregate in the retainers, and will easily break up in oil to form a smooth, uniform paint of brushing consistency which will not run nor sag. The color, hiding power, and weight per gallon when specified shall be the same or equal to the approved sample.

120C. Ready Mixed Paints.—To prepare a paint so that it will have the required consistency and curing properties for the use intended, the paste shall be mixed with sufficient linseed oil, turpentine, and drier to produce a paint having these properties. Unless otherwise specified, the exact quantity of linseed oil, turpentine, and drier required for this purpose shall be determined by the engineer.

120D. Raw and Boiled Linseed Oil.—Raw linseed oil must be strictly pure, well-settled linseed oil, perfectly clear and not show any sediment or loss of more than two-tenths (0.2) per cent when heated for one-half (½) hour at temperature between 105 and 130°C.

Boiled linseed oil shall be made by heating the raw linseed oil to at least 350°F., with oxides of lead and manganese for a sufficient length of time to secure the proper combination of the constituents. After this it shall be properly clarified by settling or other suitable treatment.

The oil shall be rejected if it shows the presence of any foreign matter, other than lead or manganese or compounds of these metals.

Raw and boiled linseed oil shall conform to the following requirements:

Material Tests	Raw linseed oil		Boiled linseed oil	
	Mini- mum	Maxi- mum	Mini- mum	Maxi- mum
1. Specific gravity at 15.5°C./15.5°C.	0.932	0.936	0.937	0.945
2. Acid number.....	6.00	8.00
3. Saponification number.....	189	195	189	195
4. Unsaponifiable matter, per cent.....	1.50	1.50
5. Refractive index at 25°C.....	1.479	1.4805	1.479	1.484
6. Iodine number (Hanus).....	180	178
7. Ash, per cent.....	0.2	0.7
8. Manganese, per cent.....	0.03
9. Calcium, per cent.....	0.3
10. Lead, per cent.....	0.1

120E. Turpentine or Thinner.—Turpentine shall be the distillate commonly known as Gum Turpentine or Spirits of Turpentine which is distilled from pine oleoresins or the product secured from resinous wood by extraction with volatile solvents, by steam or by destructive distillation. Either or both of these two products; gum spirits or wood turpentine, shall be furnished for use when so specified.

The turpentine shall be clear and free from suspended matter and water.

The color shall be Standard or better.

The specific gravity shall not be less than 0.862 nor more than 0.872 at 15.5°C.

The refractive index at 15.5°C. shall not be less than 1.468 nor more than 1.478.

The initial boiling point shall not be less than 150 nor more than 160°C.

Ninety (90) per cent of the turpentine shall distil below 170°C.

The polymerization residue shall not exceed two (2) per cent, and its refractive index at 15.5°C. shall not be less than 1.500.

120F. Drier.—The drier shall be composed of lead and manganese oxides in combination with pure linseed oil and solvent. It must be free from adulterants, sediment and suspended matter. It shall not flash below 95°F. in an open tester or 72°F. in a closed Abel tester.

120G. Pure White Lead. Dry Pigments.—The pigment shall be a pure basic carbonate of lead of the formula $2\text{PbCO}_3\cdot\text{PbOH}_2$, containing sixty-five (65) to seventy-five (75) per cent of lead carbonate, and not more than two (2) per cent of total impurities, including moisture. It shall be ground to such fineness that it will all pass a 200-mesh sieve and contain no more than two (2) per cent material retained on a 325-mesh sieve.

Paste.—The paste shall be the dry pigment ground in oil in the manner specified above. It shall consist of:

	Percentages	
	Minimum	Maximum
Pigment.....	90	92.0
Linseed oil.....	8	10.0
Moisture and other volatile matter.....	..	0.7
Coarse particles and "skins" (total residue retained on a 325-mesh sieve based on pigment).....	..	2.0

Ready-mixed Paint.—The ready-mixed paint shall be prepared from the paste in the manner specified above.

120H. Pure Zinc-oxide Paint. Dry Pigment.—The dry pigment shall consist of pure oxide of zinc which shall contain not less than ninety-eight (98) per cent of zinc oxide nor more than two-tenths (0.2) per cent of sulphur or two (2) per cent of total impurities including moisture. The pigment shall be so ground that it will all pass a 200-mesh sieve.

Paste.—The paste shall be the dry pigment ground in oil as above specified. It shall consist of:

	Percentages	
	Minimum	Maximum
Pigment.....	82	86.0
Linseed oil.....	14	18.0
Coarse particles and "skins" (total residue left on a 200-mesh sieve, based on pigment).....	..	0.5
Moisture and other volatile matter.....	..	0.5

Ready-mixed Paint.—The ready-mixed paint shall be prepared from the paste in the manner specified above.

120I. Red Lead. Dry Pigment.—The dry pigment shall consist entirely of the oxides of lead which shall contain from eighty-five (85) to ninety-five (95) per cent of PB_2O_4 , not more than one (1) per cent of total impurities and shall be so ground that not more than three-tenths (0.3) per cent is retained on a 200-mesh sieve.

Paste.—The paste shall be the pigment ground in oil as above specified. It shall consist of:

	Percentages	
	Minimum	Maximum
Pigment.....	92	94.0
Linseed oil	6	8.0
Moisture and other volatile matter.....	..	0.5
Coarse particles and "skins" (total residue left on a 200-mesh sieve).....	..	0.5

Ready-mixed Paint.—The ready-mixed paint shall be prepared from the paste in the manner specified above.

The resulting paint, when mixed in the proportions given below and brushed on a smooth, vertical, iron surface, shall dry hard and elastic without running, streaking, or sagging.

Red-lead paste.....	20 lb.
Raw linseed oil.....	4½ pt.
Turpentine.....	2 gills
Liquid drier.....	2 gills

120J. Leaded Zinc Oxide. Dry Pigment.—The dry pigment shall be a pure zinc oxide and a normal or basic lead sulphate. The pigment shall be so ground that it will all pass a 200-mesh sieve and the zinc oxide shall not contain more than one (1) per cent of soluble salts nor more than one and five-tenths (1.5) per cent of total impurities including moisture.

This type of paint shall be divided into two brands, High Leaded and Low Leaded. The high-leaded paint shall contain not less than sixty (60) per cent of zinc oxide and the low-leaded paint not less than ninety-three (93) per cent of zinc oxide, the remaining pigment in each case to be a normal or basic lead sulphate.

Paste.—The paste shall be the dry pigment ground in oil as above specified. It shall consist of:

	Percentages	
	Minimum	Maximum
Pigment.....	88.0
Linseed oil.....	12.0
Moisture and other volatile matter.....	0.5
Coarse particles and "skins" (total residue left on a 200-mesh sieve based on pigment).....	..	0.5

Ready-mixed Paint.—The ready-mixed paint shall be prepared from the paste in the manner specified above.

120K. White Basic Sulphide. Dry Pigment.—The pigment shall be the sublimated product prepared from lead sulphide ores. The pigment shall be so ground that it will all pass a 200-mesh sieve, contain not more than five-tenths (0.5) per cent of material retained on a 325-mesh sieve and have the following composition:

Lead oxide..... eleven (11) to eighteen (18) per cent
 Zinc oxide..... not more than nine (9) per cent
 Total impurities, including moisture..... not more than one (1) per cent

The remainder shall be lead sulphide.

Paste.—The paste shall be the pigment ground in oil as above specified. It shall consist of:

	Percentages	
	Minimum	Maximum
Pigment.....	89	91.0
Linseed oil.....	9	11.0
Moisture and other volatile matter.....	..	0.7
Coarse particles and "skins" (total residue retained on a 325-mesh sieve, based on pigment).....	..	0.5

Ready-mixed Paint—The ready-mixed paint shall be prepared from the paste in the manner specified above.

120L. Tinted Paint with White Base. Dry Pigment.—The ingredients used in preparing this pigment shall comply with the requirements given above for said ingredients. The pigments shall be composed of:

	Percentages	
	Minimum	Maximum
White lead (basic carbonate, basic sulphate, or a mixture thereof).....	45	70
Zinc oxide (ZnO).....	30	55
Silica, magnesium silicate, aluminum silicate, barium sulphate, pure tinting colors, or any mixture thereof.....	0	15

In no case shall the sum of the basic lead carbonate, basic lead sulphate, and zinc oxide be less than eighty-five (85) per cent of the mixture. The lead and zinc pigments may be introduced in the form of any mixture prepared from basic carbonate white lead, basic sulphate white lead, zinc oxide, or leaded zinc, provided the above requirements as to composition are met.

Liquid.—The liquid in semipaste paint shall be entirely pure, raw or refined linseed oil; in ready-mixed paint it shall contain not less than ninety (90) per cent pure raw linseed oil, the balance to be combined drier and thinner. The thinner shall be turpentine, volatile mineral spirits, or a mixture thereof.

Semipaste.—The paste shall be the pigment ground in oil as above specified. It shall mix readily in all proportions without curdling with linseed oil, turpentine, or volatile mineral spirits, or any combination of these substances. The color, hiding power, and weight per gallon when specified, shall be not less than that of the approved sample. The paste shall consist of:

	Percentages	
	Minimum	Maximum
Pigment.....	73	77.0
Linseed oil.....	23	27.0
Moisture and other volatile matter.....	..	0.7
Coarse particles and "skins" (total residue on a 200-mesh sieve based on pigment)....	..	0.5

Ready-mixed Paint.—The ready-mixed paint shall be prepared from the paste in the manner specified above. The weight per gallon shall be not less than fifteen and three-quarter (15¾) pounds. The paint shall consist of:

	Percentages	
	Minimum	Maximum
Pigment.....	62	66.0
Liquid (containing at least 90 per cent linseed oil).....	34	38.0
Water	0.5
Coarse particles and "skins" (total residue retained on a 200-mesh sieve, based on pigment).....	..	0.5

120M. Graphite. Dry Pigment.—The dry pigment shall be a pure, natural flake graphite and silicate rock to which may be added a small percentage of carbon black, iron oxide, or other oxides needed to secure a desired tint or color. The pigment shall be so ground that it will all pass a 200-mesh sieve and contain not more than ten (10) per cent of material retained on a 325-mesh sieve. The prepared pigment must contain not less than forty-five (45) per cent of natural graphite.

Paste.—The paste shall be the pigment ground in oil as above specified. It shall consist of:

	Percentages	
	Minimum	Maximum
Pigment.....	62	66.0
Linseed oil.....	34	38.0
Moisture and other volatile matter.....	..	0.80
Coarse particles and "skins" (total per cent on a 325-mesh sieve, based on the pigment)	3	6.0

Ready-mixed Paint.—The ready-mixed paint shall be prepared from the paste in the manner specified above.

The resulting paint when mixed in the proportions given below, and brushed on a smooth, vertical, iron surface shall dry hard and elastic without running, streaking, or sagging. It shall consist of:

	Percentages	
	Minimum	Maximum
Pigment.....	30	35
Boiled linseed oil.....	65	70
Japan drier.....	5	6
Turpentine and volatile matter.....	3	6

CLEARING AND GRUBBING (WASHINGTON STATE SPECIFICATIONS)

Clearing.—The right-of-way must be cleared to the width of — feet on each side of the center line, or as shall be designated by the engineer; all trees, brush, and other vegetable matter within the space designated to be cut down, and the same, together with all other logs, brushwood, and fences already down, shall be burned or removed from the grounds, as the engineer may direct, so as not to injure the adjoining lands or to obstruct the line of the fences along the boundaries of the said right-of-way. When the embankments exceed two feet in height it will be required to cut the trees, brush, and stumps close to the ground.

Light clearing shall include the removal of all standing trees of a size up to one foot in diameter, together with all other logs, brush, and other vegetable matter already down or lying loose on the ground.

Heavy clearing shall include the removal of all standing trees over one foot in diameter, together with all other logs, brush, and other vegetable matter already down or lying loose on the ground.

Grubbing.—From the space required for the roadbed and necessary slopes and side drains, and whatever additional space may be required by the engineer, except where the excavations are three feet or more in depth, vegetable matter embedded in the ground shall be grubbed up, and removed or disposed of as the engineer may direct, and only the area so grubbed shall be estimated.

Clearing and Grubbing (U. S. Forest and Road Specifications).—This item shall include all clearing, grubbing, and disposal of timber.

The right-of-way must be cleared on each side of the center line of the road to the full width indicated by the plans, or as the engineer may require. All trees, brush and other vegetable matter within the space designated shall be cut down and all tree branches extending into the right-of-way which hang within 20 feet of the ground shall be cut off. The edge of the clearing shall present a fairly regular and uniform alignment, except that fine specimens of trees shall be left standing when in the judgment of the engineer they will not be injurious to the road. All stumps and all trees, the stumps of which are not to be grubbed, shall be cut not more than two feet above the ground.

From the space required for the roadbed and necessary slopes and side drains except where the embankments at the point in question are three feet or more in height, all stumps, large roots, and other imbedded wood or vegetable matter shall be grubbed or blasted from the ground.

The contractor will be required to use merchantable timber cut from the right-of-way for the drainage or other structures for which it may be suitable and for which he would otherwise be compelled to cut merchantable timber from adjacent government land. All clear and sound logs or poles having a top diameter of four inches or more and a length of four feet or more will be considered as merchantable timber in the operations under these specifications. The merchantable timber in excess of that needed in the construction of the road which must be cut in the clearing of the right-of-way shall be felled in the right-of-way, cleared of limbs and brush, sawed into such standard lengths as may be designated by the engineer and skidded into workmanlike piles at the edge of the right-of-way, before grading is undertaken. The title to all such timber cut from National Forest lands shall remain with the United States subject to disposal by the Forest Service, U. S. Department of Agriculture, under its regular procedure.

All other than merchantable trees, together with all brush, stumps, roots, and other débris, must be placed in neat conical piles with the small material at the bottom and the large limbs and other materials stacked on the outside of the pile in such a manner as to be completely consumed when the pile is burned. In case the burning is to precede the construction operations, the piles may be placed in the center of the right-of-way, otherwise, the piles should be placed in the most convenient place to the side of the right-of-way where they may be burned without damage to the surrounding forest cover. In no case will it be permissible to merely throw the refuse outside of the right-of-way or to place it in windrows at the side of the right-of-way.

The material placed in piles shall be burned by the contractor at such time and in such manner as absolutely to prevent the fire from spreading to areas adjoining the right-of-way.

Particular care must be exercised to avoid producing an unsightly appearance by burning or scorching green trees standing along the edge of the right-of-way. Any trees permanently defaced in this manner shall be cut down and disposed of as the engineer may direct.

When upon the advice of the Forest Supervisor of the National Forest concerned the engineer determines that the proper protection of the National Forest from fire demands that burning operation shall be discontinued, the contractor shall make such disposal on the ground of the material as the engineer may indicate.

EXCAVATION (WASHINGTON STATE SPECIFICATIONS)

Under the head of excavation shall be included all excavations required for the formation of the roadbed, the digging of all ditches, cutting new channels for streams, preparing foundations, the altering of all highway or private roads and all excavations in any way connected with or incidental to the construction of the road, and the expense of hauling and depositing same in embankments wherever required.

Embankments.—Under the head of embankments shall be included all embankments for any of the purposes mentioned not formed from excavations taken from the prism of the road or other necessary excavations.

All grading shall be done and estimated by the cubic yard, measured in the excavation, except material borrowed for embankment, which shall be measured in embankment, and shall be comprised under heads, viz.:

Earth, Hard-pan, Loose Rock, Solid Rock, Shell Rock, and Solid Rock Borrow.

Earth.—Earth will include clay, sand, loam, gravel, and all hard material that can, in the opinion of the chief engineer, be reasonably plowed, and all earthy matter or earth containing loose stones or boulders intermixed, and all other material that does not come under the classification of hard-pan, loose rock, solid rock, shell rock, and solid rock borrow.

Hard-pan.—Hard-pan will include material, not loose or solid rock, that cannot, in the opinion of the chief engineer, be reasonably plowed on account of its own inherent hardness.

Loose Rock.—Loose rock will include all stone and detached rock, found in separate masses, containing not less than one cubic foot, nor more than one-half cubic yard, and all slate or other rock, soft or loose enough to be removed without blasting, although blasting may occasionally be resorted to.

Solid Rock.—Solid rock will include all rock in place, and boulders measuring one-half cubic yard and upwards, in removing which it is necessary to resort to drilling and blasting.

Shell-rock Excavation.—Shell-rock excavation will include all deposits composed entirely of rock in masses of less than one cubic foot which have broken off from the cliffs above the roadbed, but will only be estimated when in large deposits.

Solid Rock Borrow.—Solid rock borrow shall consist of solid rock, according to above classification, excavated outside of the regular cross-sections of the cuts for the roadbed, and placed and measured in embankment.

EXCAVATION (NEW YORK STATE SPECIFICATIONS, ITEMS NO. 2 TO 46)

Item 2—Earth Excavation

Item 3—Rock Excavation

2.1. Under these items the Contractor shall grade the entire length of roadway, ditches and side slopes to the required lines and grades; shall make all excavations for culverts, underdrains, catch basins, leaching basins, and

other structures except posts; shall grade connecting public highways as directed and remove spongy material from the subgrade to the depths required—all as shown on the plans or as directed by the engineer.

This item includes the excavation, filling, and rolling necessary to complete the road and all structures connected therewith except as noted above, and includes the removal of all objectionable material for the full width of the improvement except as noted under section 1.1, and the filling to the required grade with acceptable material of all areas originally below the required grade, or excavated below grade under orders of the engineer.

Backfill for structures, old macadam excavated, and sod ordered removed from the site of a new embankment, shall be paid for as Earth Excavation.

2.2. All suitable materials from the excavation shall be used so far as practicable in making embankments, building up low places on the subgrade or shoulders, and such other places as directed.

2.3. Surplus material shall be placed in embankments, shall be used for extending the shoulders or shall be deposited in spoil banks, as directed by the engineer. All surplus materials shall be removed and disposed of as directed by the engineer before the subgrade or shoulder rolling is completed and before any stone is placed on the roadway.

2.4. If there is not sufficient suitable material to complete the grading and to bring the subgrade to the required height, the contractor shall borrow additional material from the sides of the roadway or from other borrow pits as directed by the engineer so that the established grade for the road, embankments, etc., will be secured. All borrow pits outside the highway shall be acquired by the contractor at his own expense, and any borrow pits in or adjacent to the highway shall be left in a neat and satisfactory condition and shall be thoroughly drained.

2.5. The contractor shall remove boulders and all muck, quicksand, soft clay, and spongy material which will not consolidate under the roller, from the subgrade to a depth to be determined by the engineer, and refill the space with acceptable materials from the excavations, or with stone or gravel, as directed. If stone or gravel is used, the same will be paid for at the contract price bid for item Foundation Course. After all drains have been laid and the surface of the subgrade has been properly shaped, it shall be thoroughly rolled and compacted with an approved self-propelled roller weighing not less than 10 tons. Water puddling shall be resorted to in case the soil requires it. Care shall be taken not to roll clay foundations too much, thus developing a plastic condition. All hollows and depressions which develop shall be filled with acceptable material, and the subgrade shall again be rolled. This process of filling and rolling shall be repeated until no depressions develop. In places where the character of the material makes the use of such a roller impracticable, a lighter one may be permitted. The subgrade shall not be muddy, or otherwise unsatisfactory when the foundation course is placed upon it. All culverts, ditches, and drains shall be satisfactorily completed to drain effectively the highway before the placing of any pavement will be permitted. The shoulders shall be rolled and left in a compact and satisfactory condition at the completion of the pavement.

2.6. Embankment shall be formed of suitable materials. If formed of stone, all reasonable precautions must be taken to insure a solid embankment. The upper surface of the embankment shall be rolled and left in a satisfactory condition and approximately true to line and grades. Large stone shall not project within 6 inches of the finished subgrade, and all hollows, and depressions shall be filled with the smaller stone from the excavation, with gravel or with other acceptable material. Stone in embankments shall not be used nearer than 6 inches to the surface of shoulder.

Where the filling is less than 2 feet in depth all vegetable matter shall be removed from the original surface. Where necessitated by the existing slope, the original surface shall be trenched or otherwise broken up before placing new embankment thereon.

Where the depth of fill is less than 6" the underlying surface must be plowed or scarified to get a good bond. The price for such work is included in the price bid for excavation.

Embankment shall be constructed in successive horizontal layers not exceeding 12 inches in thickness; when concrete is to be placed thereon, these layers shall not exceed 6 inches in thickness. Each layer shall extend across the entire fill and shall be thoroughly rolled and compacted by approved methods. If impracticable to use a heavy roller for this work a grooved roller shall be used.

2.7. At all intersecting public highways the contractor shall grade back to a sufficient distance with acceptable materials, as directed by the engineer so that a smooth riding and satisfactory junction will be produced.

2.8. The quantity of excavation to be paid for under Items 2 and 3 shall be the number of cubic yards of material, measured in its original position, excavated and disposed of as directed by the engineer, and the limits shall not exceed those shown upon the plans or fixed by the engineer.

The price bid for Earth Excavation shall include the removal of all materials, as specified under section 2.1—except as provided below for Rock Excavation,—the placing of same in embankment or spoil, the rolling, compacting, grading, and all other work incidental thereto.

No direct payment shall be made under Items 2 or 3 for work in connection with contractor's plant, nor for his other requirements in carrying out the provisions of this contract, but compensation therefor shall be considered as having been included in the prices stipulated for the various items of the contract.

The price bid for Item 3 shall include the removal of all boulders of more than 13 cubic feet and all hard ledge rock and the placing of same in embankment or spoil if not used under other items of the contract, and rolling, compacting, grading, and all other work incidental thereto. Boulders of less than 13 cubic feet, and all soft or disintegrated rock which can be removed with pick and shovel, shall not be paid for under Rock Excavation, but under Earth Excavation. The price bid for the items shall include all labor, materials, supplies, and plant and incidentals necessary to complete the work.

Item 4—Overhaul

4.1. If the haul on any material either from cuts or borrow pits made in accordance with directions from the engineer exceeds 2000 feet it shall be classified as overhaul.

For each 100 feet of haul greater than 2000 feet the contractor shall receive the price bid for Overhaul per cubic yard of all material so moved, measured in its original position.¹

The price bid shall include all labor, appliances, and incidentals necessary to complete the work.

CONSTRUCTION METHODS

Preparing Fine Grade²

Under this item the contractor shall prepare the fine grade to receive payment in conformity with the lines and grades as shown on the plans or as ordered by the engineer.

Before any paving material is placed upon the fine grade it shall be shaped to line and grade and compacted with an approved self-propelling roller weighing not less than 5 tons. All hollows and depressions which develop under rolling shall be filled with acceptable material and shall again be rolled. This process of shaping, rolling, and filling shall be repeated until no depressions develop. The subgrade shall not be muddy or otherwise unsatisfactory when the pavement is placed upon it. If the fine grade becomes rutted or displaced due to any cause whatsoever, the contractor shall regrade same without additional payment.

The quantity to be paid for under this item shall be the number of square yards of the fine grade prepared in accordance with the plans or the orders of the engineer, on which pavement is placed.

The price bid per square yard shall cover all labor and incidental work (scarifying if necessary), to form, trim, and compact the fine grade underneath the pavement to the lines and grades as shown on the plans or as ordered by the engineer, and the furnishing and placing of the necessary filler on any scarified area.

STATE HIGHWAY DEPARTMENT OF TEXAS

Item 32. Subgrade Treatment

32.1. Description.—This item shall consist of treating a gumbo, adobe, or other faulty subgrade with a stabilizing course of granular material to perfect a foundation for base courses, surface courses, or pavements. It shall be

¹ Specifications should stipulate that the amount of overhaul will be computed by the Mass Diagram Method.

² New York.

constructed in accordance with the specifications and in conformity with the line, grade, and typical cross-section shown on plans.

32.2. Materials.—The materials for this course will be noted on the plans. In general, they will be coarse sand, fine gravel, cinders, or other local material of a granular nature, of such quality and properties as the engineer may approve in writing. Unless otherwise prescribed, the material shall be such that all will pass the $\frac{1}{2}$ " screen, and 40 % will be retained on the 10-mesh screen.

32.3. Construction Methods.—The subgrade to be treated shall have been completed to line, grade, and typical cross-section. The granular material shall then be delivered and evenly spread on the subgrade in such quantity that when the work is completed the requirements of the typical cross-section will have been fulfilled. It shall be the charge of the contractor that the required amount of material shall be delivered in each 100' station and uniformly distributed throughout each station.

32.4. The material shall then be incorporated with the material of the subgrade as required on the plans and rolled and sprinkled as directed. The contractor shall work and dress the surface as directed until the treated subgrade is set up hard and smooth in accordance with the grade and typical cross-section required, and so maintained until the proposed base course or surface course or pavement is in place.

32.5. Method of Measurement.—Work and acceptable material furnished shall be measured by the cubic yard of material, loose measurement.

32.6. Basis of Payment.—The material furnished as prescribed by this item shall be paid for at the contract unit price per cubic yard for Subgrade Treatment Material. The work performed as prescribed for this item, measured as provided above, shall be paid for at the contract unit price bid per cubic yard for Subgrade Treatment, which price shall be full compensation for loading all material, hauling not over $\frac{1}{4}$ mile, delivered on the road, spreading and finishing, all labor, equipment, tools, and incidentals necessary to complete the work except screening material, rolling, and sprinkling. Hauling material into each quarter mile beyond the first quarter mile shall be paid for at the contract unit price per cubic yard bid for Material Hauled Additional Quarter Mile. Screening will be paid for at the contract unit price bid per cubic yard for Screening.

Item 39. Foundation Course, Run-of-bank Gravel¹

a. Work.—Under this item the contractor shall furnish and place a foundation course of run-of-bank gravel of the depth and in the places called for on the plans and ordered by the engineer.

b. Material and Placing.—All gravel shall be of hard, durable stone and well graded. The proportions of coarse and fine particles shall be satisfactory to the engineer. Before using run-of-bank gravel in the work the same shall be tested to determine its suitability. Should at any time during the work and for any reason the gravel fail to maintain suitable proportions of the coarse and fine particles, the contractor shall, by the addition of selected material and satisfactory manipulation, produce a material meeting the above requirements.

No segregation of large or fine particles will be allowed, but the gravel as spread shall be well graded with no pockets of fine material.

In cases where the finished thickness of the course is to be more than 9", the gravel shall be spread, rolled, and filled in separate layers as directed by the engineer.

After laying, this course shall be thoroughly rolled with an approved roller weighing not less than 10 tons, and shall then be filled as directed and again rolled and the filler broomed until the stones are bound together and thoroughly compacted. All holes or depressions found in rolling shall be filled with gravel and the surface shall be rerolled until it conforms to the lines and grades as shown on the plans. In all cases a sufficient but not excessive amount of fine material (coarse sand or screenings) shall be used to fill all voids. In limited areas where the use of a roller is impracticable heavy tampers may be used to consolidate the material. In all cases the foundation course must be so thoroughly compacted that it will not wave under the roller. This course shall not be laid in excess of 500 lin. ft. without being rolled and thoroughly filled so as to render it waterproof, and thereby prevent the softening of the subgrade.

¹ New York.

c. Measurement and Payment.—The quantity of foundation course to be paid for under this item shall be the number of cubic yards of compacted material in place as shown on the plans or ordered by the engineer.

The price bid shall cover the furnishing, placing, filling, and rolling of the material and all labor and incidental expenses necessary to complete the work.

Item 39A. Foundation Course, Run-of-bank Gravel, Loose Measure

The general specifications for Item 39 shall apply, except that the quantity to be paid for will be the number of cubic yards, loose measure, incorporated in the work, as directed by the engineer.

Item 40. Foundation Course, Screened Gravel¹

a. Work.—Under this item the contractor shall furnish and place a foundation course of screened gravel of the depth and in the places called for by the plans or as ordered by the engineer in accordance with Sec. *f* of item Excavation.

b. Drainage.—No gravel shall be placed on the road until the culverts are completed and proper drainage provided and subgrade shaped and rolled to the satisfaction of the engineer.

c. Material and Placing.—All gravel shall be hard, durable stone satisfactory to the engineer. The particles shall be of such size as will pass through a 3 $\frac{3}{4}$ " circular hole and will be retained on a 1 $\frac{1}{2}$ " circular hole and shall be well graded. In cases where the finished thickness of the course is to be more than 6" the gravel for it shall be spread, rolled, and filled in two separate courses.

After the subgrade has been properly prepared a course of 1" of approved sand or cinders shall be evenly spread upon the grade, after which the screened gravel shall be spread evenly, so that it will have after rolling the proper thickness. No segregation of large or fine particles will be permitted, but the gravel shall be well graded with no pockets of fine material.

d. Rolling and Filling.—After the gravel has been spread loose it shall be thoroughly rolled with an approved self-propelling roller weighing not less than 10 tons.

The rolling must begin at the sides and continue toward the center until there is no movement of the stone ahead of the roller. After the gravel is thoroughly compacted No. 1 size gravel and sand shall be thoroughly spread upon the surface and kept in with rattan or steel brooms and rolled.

This course shall not be laid in excess of 500 lin. ft. without being rolled and thoroughly filled so as to render it waterproof and thereby prevent the softening up of the subgrade. Should the subgrade material become churned up into or mixed with the foundation course through the contractor's hauling over it or working on it when the subgrade is in a wet condition, the contractor shall, at his own expense, remove such mixture of subgrade material and gravel and replace the foundation course.

e. In Case of Two Courses.—When two courses of screened gravel are laid each course shall be treated separately by rolling and filling as described above.

f. Measurement and Payment.—The quantity to be paid for under this item shall be the number of cubic yards of compacted material in place and shall be computed by multiplying the finished cross-section of the foundation course as shown upon the plans or ordered by the engineer, by the length measured along the axis of the pavement.

The price bid shall cover the furnishing, placing, filling, rolling of the material, and all labor and incidental expenses necessary to complete the work satisfactorily.

Item 41. Foundation Course, Field or Quarry Stone¹

a. Work.—Under this item the contractor shall furnish and place a foundation course of stone of the depth and in the places called for by the plans, or as ordered by the engineer in accordance with Sec. *f* of item Excavation.

b. Drainage.—No stone shall be placed on the road until the culverts are complete and proper drainage provided and subgrade shaped and rolled to the satisfaction of the engineer.

c. Material and Placing.—After the subgrade has been properly prepared a course of 1" of approved sand, gravel, or cinders shall be evenly spread upon the grade. This 1" course of sand, gravel, or cinders shall not be

¹ New York.

estimated as a part of the depth of the foundation course, but payment for same shall be included in the price bid for this item.

Stone used in the foundation course shall be of hard, sound, and durable quality, acceptable to the engineer.

The depth of the stone shall in no case be greater than the depth specified for the course, the width shall not be greater than the depth, or more than 9"; and the length shall not be greater than one and one-third times the depth, or more than 12". The distribution of the stone shall be of a uniformity satisfactory to the engineer. In cases where the finished thickness of the course is more than 9" the foundation course shall be laid in two courses and the first course completely filled and rolled before constructing the second. Stone of greater than permissible dimension shall be broken to proper size before placing. All flat stone and fragments having an average dimension over 6" shall be roughly placed by hand on their broadest edge with their longest dimension crosswise of the road and in as close contact as possible. The smaller stone shall then be shoveled or forked upon the surface of the course.

After laying, this course shall be thoroughly rolled with an approved self-propelling roller weighing not less than 10 tons. After rolling, the course shall be tested with a line 25' in length and any depressions over 1" in depth shall be eliminated by the use of broken stone. The course shall then be rerolled and filled with broken stone uniformly distributed and thoroughly rolled, after which coarse sand or screenings shall be used to fill the voids and rolled. In all cases the foundation course shall be so thoroughly compacted that it will not weave under the roller. Gravel or selected shale may be substituted for the broken-stone filler if so designated on the plans or in the itemized proposal. This course shall not be laid in excess of 500 lin. ft. without being rolled and thoroughly filled so as to render it waterproof and thereby preventing the softening of the subgrade. Should the subgrade material become churned up into or mixed with the foundation course through any reason whatsoever, the contractor shall, at his own expense, remove such mixture of subgrade material and stone and replace the foundation course.

d. Measurement and Payment.—The quantity to be paid for under this item shall be the number of cubic yards of compacted material in place and shall be computed by multiplying the finished cross-section of the foundation course as shown upon the plans or ordered by the engineer by the length measured along the axis of the pavement.

The price bid shall cover the furnishing, placing, filling, and rolling of all materials, and all labor and incidental expense necessary to complete the work.

Item 33. Reconstructed Base Course¹

33.1. Description.—This item shall consist of the reshaping of the existing surface and the addition of the required amount of new material, all of which shall be compacted to form a foundation course for other base courses or for surface courses or pavements. The additional material shall conform to the requirements for material of the type of the original course as prescribed in these specifications, and the item shall be constructed in accordance with these specifications and in conformity with the lines, grades, and typical cross-section shown on the plans. The item name corresponding to the original course shall be given on the plans.

33.2. Construction Methods.—The existing surface shall be scarified for the full width of the proposed base course and to such uniform depth below the proposed finished surface as will eliminate all existing depressions and irregularities and permit of uniform reshaping. Any existing bituminous mat of more than $\frac{1}{2}$ " thickness shall be removed from the work.

33.3. After scarifying, the material shall be shaped to conform to the required section, the required material added in a uniform course of such depth that when compacted the finished surface will conform to the line, grade, and typical cross-section. The course shall then be rolled and sprinkled if directed, and finished and maintained as required in the specifications for the base course corresponding to the original construction as noted on the plans.

33.4. Methods of Measurement and Basis of Payment.—The work of scarifying, loosening, and shaping the original construction shall be measured by the square yard and paid for at the contract unit price per square yard bid for Reconstructed Base Course.

¹ Texas.

33.5. All other work performed as prescribed, and all accepted material shall be measured by the cubic yard, loose measurement. The material furnished as prescribed shall be paid for at the contract unit price per cubic yard for the base-course material corresponding to the original constructed as noted on the plans when such price is requested and tendered in the proposal. When such price is not so requested, right-of-way and royalty charges on the material in the pit will not be a charge to the contractor.

33.6. The work performed as prescribed shall be paid for at the contract price per cubic yard bid for the item named on the plans as the type of original construction, which price shall be full compensation for loading all material, hauling not over $\frac{1}{4}$ mile, delivering on the road, spreading and finishing, all labor, equipment, tools, and incidentals necessary to complete the work except rolling, and sprinkling. Hauling material into each quarter mile beyond the first quarter mile shall be paid for at the contract unit price per cubic yard bid for Material Hauled Additional Quarter Mile.

Item 34. Shell Base Course¹

34.1. Description.—This item shall consist of a foundation course for surface courses, or other base courses, shall be composed of shell, and shall be constructed on the prepared subgrade in accordance with these specifications and in conformity with the lines, grades, compacted thickness, number of component courses, and typical cross-section shown on the plans.

34.2. Material.—The shell shall consist of sound particles of oyster, clay, or other shells equally acceptable to the engineer, and shall not contain more than 15% of mud, clay marl, or loam.

34.3. Construction Methods.—The material shall be delivered and spread by hand on the prepared subgrade or completed base course to such depth that, when compacted, the thickness shown on the plans will be secured and shaped to conform to the typical cross-section. Side forms and either cubical blocks or center guide forms of proper size shall be used to fix the depth of the loose material. It shall be the charge of the contractor that the required amount of material shall be delivered in each 100' station and uniformly distributed throughout each station.

34.4. The work shall be rolled and sprinkled or opened to traffic as directed. The contractor, as often as directed, shall work and dress the surface so that the cross-section shall continue uniform and true to line and grade until accepted. When the typical cross-section requires that this item be constructed in more than one course, each additional course shall be constructed independently after the previous one has been completed and accepted, all as prescribed above.

34.5. Method of Measurement.—Work and accepted material hauled to the road shall be measured by the cubic yard of material, loose measurement, as delivered on the road.

34.6. Basis of Payment.—The material furnished as prescribed by this item shall be paid for at the contract unit price per cubic yard bid for Shell. The work performed as prescribed by this item and measured as provided above shall be paid for at the contract unit price per cubic yard bid for Shell Base Course, which price shall be full compensation for loading all material, hauling not over $\frac{1}{4}$ mile, delivering on the road, and finishing, all labor, equipment, tools, and incidentals necessary to complete the work except rolling, and sprinkling. Hauling material into each quarter mile beyond the first quarter mile shall be paid for at the contract unit price bid per cubic yard for Material Hauled Additional Quarter Mile.

Item 35. Caliche Base Course¹

35.1. Description.—This item shall consist of a foundation course for surface courses, or other base courses, shall be composed of caliche, and shall be constructed on the prepared subgrade in accordance with these specifications and in conformity with the lines, grades, compacted thickness, number of component courses, and typical cross-section shown on the plans.

35.2. Material.—Caliche shall consist of a natural mixture of approximately equal proportions of calcareous dust and quartz sand with or without the presence of gravel or small stones, all of which, when tested, shall pass a $3\frac{1}{2}$ " screen, and shall not contain more than 10% clay.

35.3. Construction Methods.—The material shall be delivered and spread by hand on the prepared subgrade to such depth that when compacted the

¹ Texas.

thickness shown on the plans will be secured and shaped to conform to the typical cross-section. Side forms and either cubical blocks or center guide forms of proper size shall be used. It shall be the charge of the contractor that the required amount of material shall be delivered in each 100' station and uniformly distributed throughout each station.

35.4. If, in the opinion of the engineer, it be practicable to do so, the caliche shall be puddled with water before being finally shaped and compacted. This puddling may be done either in the pit before the material is hauled onto the road or it may be done by sprinkling with water after the material has been spread upon the subgrade. In case puddling is done in the material pit, the caliche shall at once be hauled onto the road, spread by means of hoes, rakes, or shovels, shaped, and rolled before it has dried out. In case puddling is to be done after it has been spread upon the subgrade, the surface shall be thoroughly harrowed, plowed, or otherwise opened up, during the process of sprinkling, in order to insure the proper puddling of the caliche. After being thoroughly puddled, to the satisfaction of the engineer, the surface shall be shaped to a uniform thickness and cross-section and the succeeding course of material shall be added and puddled in the same manner. Each succeeding course shall be placed and puddled as soon after the preceding one as practicable.

35.5. The work shall be rolled or opened to traffic as directed. The contractor, as often as directed, shall work and dress the surface so that the cross-section shall continue uniform and true to line and grade until accepted.

35.6. The work shall be rolled or opened to traffic as directed. The contractor, as often as directed, shall work and dress the surface so that the cross-section shall continue uniform and true to line and grade until accepted.

35.6. Method of Measurement.—Work and accepted material shall be measured by the cubic yard of material, loose measurement, as delivered on the road.

35.7. Basis of Payment.—When a unit price for Caliche is requested and tendered in the proposal, the material furnished as prescribed by this item shall be paid for at the contract unit price so bid per cubic yard. When such price is not so requested, right-of-way charges and royalties on the material in the pit will not be a charge to the contractor. The work performed as prescribed for this item, measured as provided above, shall be paid for at the contract unit price bid per cubic yard for Caliche Base Course, which price shall be full compensation for loading all material, hauling not over $\frac{1}{4}$ mile, delivering on the road, puddling and finishing, all labor, equipment, tools and incidentals necessary to complete the work except rolling, and sprinkling. Hauling material into each quarter mile beyond the first quarter mile shall be paid for at the contract unit price per cubic yard bid for Material Hauled Additional Quarter Mile.

Item 36. Disintegrated Limestone Base Course¹

36.1. Description.—This item shall consist of a foundation course for surface courses or other base courses, shall be composed of disintegrated limestone, and shall be constructed on the prepared subgrade in accordance with these specifications and in conformity with the lines, grades, compacted thickness, number of component courses, and typical cross-section shown on plans.

36.2. Materials.—The material shall consist of a good quality of disintegrated limestone, reasonably free from soil and clay, and when loaded from the material pit shall not contain more than 25% of material which will pass a $\frac{1}{4}$ " mesh screen. The disintegrated limestone shall be such as can be loosened up in the pit by the use of plows or picks and without the use of explosives. Material containing gravel or hard flint pebbles will be admitted, although all hard stones over $3\frac{1}{2}$ " in their largest dimension, which will not be broken up by traffic or rolling, must be thrown out at the pit by the contractor at his own expense.

36.3. Construction Methods.—The material shall be delivered and spread by hand on the prepared subgrade to such depth that when compacted the thickness shown on the plans will be secured, and shaped to conform to the typical cross-section. Side forms and either cubical blocks or center guide forms of proper size shall be used to fix the depth of the loose material. It shall be the charge of the contractor that the required amount of material shall be delivered in each 100' station and uniformly distributed throughout each station.

¹ Texas.

36.4. After the material has been spread and shaped, the surface shall be thoroughly sprinkled with water and rolled as soon as sufficiently dried off. The contractor, as often as directed, shall work and dress the surface so that the cross-section shall continue uniform and true to line and grade until accepted. When the typical cross-section requires that this item be constructed in more than one course, each additional course shall be constructed independently after the previous one has been completed and accepted, all as prescribed above.

36.5. Method of Measurement.—Work and accepted material hauled to the road shall be measured by the cubic yard of material, loose measurement, as delivered on the road.

36.6. Basis of Payment.—When a unit price for Disintegrated Limestone is requested and tendered in the proposal, the material furnished as prescribed by this item shall be paid for at the contract unit price so bid per cubic yard. When such price is not so requested, right-of-way charges and royalties on the material in the pit will not be a charge to the contractor. The work performed as prescribed for this item, measured as provided above, shall be paid for at the contract unit price bid per cubic yard for Disintegrated Base Course, which price shall be full compensation for loosening and loading all material at the pit, hauling not over $\frac{1}{4}$ mile, delivering on the road, puddling and finishing, all labor, equipment, tools, and incidentals necessary to complete the work except rolling, and sprinkling. Hauling material into each quarter mile beyond the first quarter mile shall be paid for at the contract unit price bid per cubic yard for Material Hauled Additional Quarter Mile.

Item 37. Iron-ore Topsoil Base Course¹

37.1. Description.—This item shall consist of a foundation course for surface courses or other base courses, shall be composed of iron-ore topsoil, and shall be constructed on the prepared subgrade in accordance with these specifications and in conformity with the lines, grades, compacted thickness, number of component courses, and typical cross-section shown on plans.

37.2. Materials.—Iron-ore topsoil shall consist of hematite, hydrated hematite, or limonite ore as found at the surface but of a quality free from vegetable matter which, when loaded from the material pit, shall not contain more than 15% of clay. The material shall be such as can be loosened up in the pit by the use of plows or picks and without the use of explosives. Material containing gravel or hard pieces of ore will be admitted, although all pieces over $3\frac{1}{2}$ " in their largest dimension, which will not be broken up during construction, must be thrown out at the pit by the contractor at his own expense. The material shall have a cementing value of not less than 50 and be so graded that 40 to 75% is retained on a 10-mesh screen when tested by laboratory methods.

37.3. Construction Methods.—The material shall be delivered and spread by hand on the prepared subgrade to such depth that when compacted the thickness shown on the plans will be secured and shaped to conform to the typical cross-section, and rolled if required. Side forms and either cubical blocks or center guide forms of proper size shall be used to fix the depth of the loose material. It shall be the charge of the contractor that the required amount of material shall be delivered in each 100' station and uniformly distributed throughout each station.

37.4. After the material has been spread and shaped, the work shall be rolled or opened to traffic as directed. If the material is of such a quality that it adheres to the wheels of the roller after sprinkling, the surface shall be sanded, the necessary material being measured as surfacing material. The contractor, as often as directed, shall work and dress the surface so that the cross-section shall continue uniform and true to line and grade until accepted. When the typical cross-section requires that this item be constructed in more than one course, each additional course shall be constructed independently after the previous one has been completed and accepted, all as prescribed above.

37.5. Method of Measurement.—Work and accepted material hauled to the road shall be measured by the cubic yard, loose measurement, as delivered on the road.

37.6. Basis of Payment.—When a unit price for Iron-ore Topsoil is requested and tendered in the proposal, the material furnished as prescribed by this item shall be paid for at the contract unit price so bid per cubic yard. When such price is not so requested, right-of-way charges and royalties on

¹ Texas.

the material in the pit will not be a charge to the contractor. The work performed as prescribed for this item, measured as provided above, shall be paid for at the contract unit price bid per cubic yard for Iron-ore Topsoil Base Course, which price shall be full compensation for loosening and loading all material at the pit, hauling not over $\frac{1}{4}$ mile, delivering on the road, finishing, all labor, equipment, tools, and incidentals necessary to complete the work except rolling, and sprinkling. Hauling material into each quarter mile beyond the first quarter mile shall be paid for at the contract unit price bid per cubic yard for Material Hauled Additional Quarter Mile.

Item 38. Gravel Base Course¹

38.1. Description.—This item shall consist of a foundation course for surface courses or for other base courses, shall be composed of gravel, and shall be constructed on the prepared subgrade in accordance with these specifications, and in conformity with the lines, grades, compacted thickness, number of component courses, and typical cross-section shown on the plans.

38.2. Materials.—The gravel shall consist of hard durable particles of stone mixed with sand or clay or other similar binding material and when tested by laboratory methods shall fulfil the following requirements:

Retained on $3\frac{1}{2}$ " screen.....	0-5%
Retained on $\frac{1}{4}$ " screen.....	50-75%

38.3. Of the material retained on the $\frac{1}{4}$ " screen, 50 to 75% shall be retained on the $\frac{1}{8}$ " screen.

38.4. The material passing the $\frac{1}{4}$ " screen shall be known as "binder," and of this material 15 to 35 % shall pass the 200-mesh sieve. The cementing value of the binder shall be not less than 50.

38.5. The gravel may be crushed or uncrushed, and may be bank run, or the binder may be added and incorporated by approved methods as herein-after specified.

38.6. Construction Methods.—The material shall be delivered in flat-bottom wagons or approved trucks and uniformly dumped on the subgrade or completed course, spread to such depth that, when compacted, the thickness shown on the plans will be secured, harrowed if necessary, and shaped to conform to the typical cross-section. Each day's hauling shall be spread the same day. When the width of the course is more than 12' the material shall be dumped in two equal rows. The thickness of the course as well as the material shall be strictly uniform. Side forms, and either center forms or cubical blocks, shall be used to fix the depth of loose material. All areas and "nests" of segregated coarse or fine material shall be removed and replaced with well-graded material and compacted.

38.7. If the gravel is deficient in binder as prescribed under Materials above, after it is spread and shaped, additional binder shall be furnished and applied in the amount directed by the engineer so as to comply with the grading requirements. Such binder shall be measured and paid for as provided for the normal gravel, and shall be carefully and evenly incorporated with the material in place as directed by the engineer.

38.8. The work shall be rolled and sprinkled, or opened to traffic as directed. Ruts shall be kept filled twice a day or more as directed. When irregularities, depressions, or weak spots develop during the process of shaping and setting up, the affected areas shall be corrected immediately by scarifying, adding material as needed, reshaping, and compacting. This process shall be continued, and the course maintained with grading machines or other equipment as required, to the required line, grade, and typical cross-section until the surface is smooth and hard, free from ruts and undulations, well bonded to the width shown on plans, and the work is accepted.

38.9. When the typical cross-section requires that this item be constructed in more than one course, each course shall be constructed independently after the previous one is completed and accepted, all as prescribed above.

38.10. Method of Measurement.—Work and accepted material shall be measured by the cubic yard of material, loose measurement, as delivered on the road.

38.11. Basis of Payment.—When a unit price for Gravel for Base Course is requested and tendered in the proposal, the material furnished as prescribed for this item shall be paid for at the contract unit price so bid; which price shall include all pit charges, crushing, screening, and freight f.o.b.

¹ Texas.

delivery points. When such price is not requested the material will be furnished free of royalty and right-of-way charges, and the contractor will be paid for all Crushing and Screening or Screening as ordered, at the prices bid per cubic yard for Crushing and Screening or for Screening.

38.12. The work performed as prescribed for this item, measured as provided under Measurement, shall be paid for at the contract unit price bid per cubic yard for Gravel Base Course, which price shall be full compensation for loading all material, hauling not over $\frac{1}{4}$ mile, delivering on the road, spreading and finishing, all labor, equipment, tools, and incidentals necessary to complete the work except crushing, screening, rolling, and sprinkling. Hauling into each quarter mile beyond the first quarter mile shall be paid for at the contract unit price bid per cubic yard for Material Hauled Additional Quarter Mile.

Item 39. Soft Limestone Base Course¹

39.1. Description.—This item shall consist of a foundation course for surface courses, or for other base courses, shall be composed of large fragments of soft local limestone wedged in place with small stones and spalls and leveled up with smaller stone and binder, and shall be constructed on the prepared subgrade in accordance with these specifications, and in conformity with the lines, grades, and typical cross-sections shown on the plans.

39.2. Material.—The limestone shall be the best obtainable in the local pits, free from soapstone or similar material and with a per cent of wear of not more than 12. The stones shall be no larger than 12" in their largest dimension. The broken stone shall be of a size to pass the $3\frac{1}{2}$ " screen. The binder shall be screenings, gravel, caliche, or other approved material which shall pass the $\frac{3}{4}$ " screen.

39.3. Construction Methods.—The large stone shall be dumped and spread upon the prepared subgrade, and broken with sledges until there are no stones near the top of the course larger than 6". When the sledging has been finished, the surface shall be rearranged to insure uniform distribution of the material, the larger voids filled with spalls, and the course rolled. The surface shall then be bonded with sufficient crushed stone and binder to fill the superficial voids, and the course finished to conform to the line, grade, and typical cross-section.

39.4. The rolling shall be as prescribed under Extra Rolling and Sprinkling for Base Courses, and the surface shall be sprinkled if ordered by the engineer. Any irregularities that develop during or after rolling shall be remedied by loosening, adding or removing material and rebonding. The surface shall be maintained in its finished condition until accepted.

39.5. Method of Measurement.—Work and accepted material shall be measured by the cubic yard of material, loose measurement, as delivered on the road.

39.6. Basis of Payment.—When a unit price for Local Base Course Limestone is requested and tendered in the proposal, the material furnished as prescribed for this item shall be paid for at the contract unit price so bid. When such price is not so requested, right-of-way charges and royalties on the material in the pit will not be a charge to the contractor.

39.7. The work performed as prescribed for this item, measured as provided under Measurement, shall be paid for at the contract unit price bid per cubic yard for Soft Limestone Base Course, which price shall be full compensation for loading all material, hauling not over $\frac{1}{4}$ mile, delivering on the road, spreading, and finishing, all labor, equipment, tools, and incidentals necessary to complete the work, except rolling and sprinkling. Hauling into each quarter mile beyond the first quarter mile shall be paid for at the contract unit price bid per cubic yard for Material Hauled Additional Quarter Mile.

Item 40. Sledged-stone Base Course¹

40.1. Description.—This item shall consist of a foundation course for surface courses, or for other base courses, shall be composed of large stones wedged in place by small stones and spalls and leveled up with broken stone and binder, and shall be constructed on the prepared subgrade in accordance with these specifications, and in conformity with the lines, grades, and typical cross-section shown on plans.

40.2. Material.—The stone shall be a good grade of limestone or sandstone, free from excess of shell, soapstone, or other similar material with a per cent of wear of not over 8. Thin stones which break into slabs shall not be used.

¹ Texas.

The stones shall not be over 12" in their largest dimension. The broken stone shall be of a size to pass the 3½" screen. The binder shall be screenings, gravel, caliche, or other approved material which shall pass the ¼"-screen.

40.3. Construction Methods.—The large stone shall be dumped and spread upon the prepared subgrade, and broken with sledges until there are no stones near the top of the course larger than 6". When the sledging has been finished, the surface shall be rearranged to insure uniform distribution of the material, the larger voids filled with the spalls, and the course rolled. The surface shall then be bonded with sufficient crushed stone and binder to fill the superficial voids, and the course finished to conform to the line, grade, and typical cross-section.

40.4. The rolling shall be as prescribed under Extra Rolling and Sprinkling for Base Courses, and the surface shall be sprinkled if ordered by the engineer. Any irregularities that develop during or after rolling shall be remedied by loosening, adding or removing material, and rebonding. The surface shall be maintained in its finished condition until accepted.

40.5. Method of Measurement.—Work and accepted material shall be measured by the cubic yard of material, loose measurement, as delivered on the road.

40.6. Basis of Payment.—When a unit price for Sledging Stone is requested and tendered in the proposal, the material furnished as prescribed for this item shall be paid for at the contract unit price so bid. When such price is not so requested, right-of-way charges and royalties on the material in the pit will not be a charge to the contractor.

40.7. The work performed as prescribed for this item, measured as provided under Measurement, shall be paid for at the contract unit price bid per cubic yard for Sledged-stone Base Course, which price shall be full compensation for loading all material, hauling not over ¼ mile, delivering on the road, spreading and finishing, all labor, equipment, tools, and incidentals necessary to complete the work except rolling, and sprinkling. Hauling into each quarter mile beyond the first quarter mile shall be paid for at the contract unit price bid per cubic yard for Material Hauled Additional Quarter Mile.

Item 41. Crusher-run Broken-stone Base Course¹

41.1 Description.—This item shall consist of a foundation course for surface courses, or other base courses, shall be composed of crushed stone and screenings as the material comes from the crusher, and shall be constructed on the prepared subgrade, or other completed base course, in accordance with these specifications, and in conformity with the lines, grades, compacted thickness, number of component courses, and typical cross-section shown on the plans.

41.2. Material.—The stone shall not contain more than 5 % of partially decomposed particles, and not more than 5 % of flat or elongated pieces, the width of which is less than half the length. The material may be unscreened or partially screened, but when tested by laboratory methods the stone shall meet the following requirements:

Retained on the 3½" screen.....	0 to 5 %
Retained on the 2" screen.....	25 to 60 %
Retained on the ¼" screen.....	95 to 100 %

41.3. Screenings for additional binder shall be the product from similar stone which shall meet the following requirements:

Retained on the 1" screen.....	0 to 5 %
Retained on the 14" screen.....	20 to 60 %

41.4. Construction Methods.—The subgrade shall be rolled. The stone shall be delivered in flat-bottom wagons or approved trucks, and uniformly dumped on the subgrade, spread to such a depth that when compacted the thickness shown on the plans will be secured, shaped to conform to the typical cross-section, and rolled. The subgrade shall be thoroughly dry when the material is delivered; each day's hauling shall be spread the same day. When the width of base course is more than 12' the material shall be dumped in two equal rows. The thickness of the course as well as the material shall be strictly uniform. Side forms, and either center forms or cubical blocks, shall be used to fix the depth of loose material. All areas and "nests" of

¹ Texas.

segregated coarse or fine material shall be removed and replaced with well-graded material and rerolled if necessary.

41.5. The rolling shall be as prescribed under Extra Rolling and Sprinkling Base and Surface Courses. After thorough rolling, and if found necessary, screenings shall be spread with shovels in a uniform layer. The screenings shall not be dumped directly on the surface of the coarse stone. The course shall be further rolled and sprinkled if ordered by the engineer, the surface shall be thoroughly bonded to his satisfaction, and finished to conform to the line, grade, and typical cross-section.

41.6. If any irregularities develop in the surface during or after rolling, they shall be remedied by loosening, adding or removing material, and rebonding. The surface shall be maintained in its finished condition until accepted.

41.7. If at any time the subgrade material should become churned up or mixed with the base course, the contractor, without additional compensation, shall dig out and remove such mixture, reshape and compact the subgrade, and reconstruct the base course with new material.

41.8. When the typical cross-section requires that this item be built in more than one course, each course shall be constructed independently after the previous one is completed and accepted, all as prescribed above.

41.9. Method of Measurement.—Work and accepted material shall be measured by the cubic yard of material loose measurement, as delivered on the road.

41.10. Basis of Payment.—The material furnished as prescribed by this item shall be paid for at the contract unit price per cubic yard for Crusher-run Broken Stone, which price shall also be full compensation for quarrying, crushing, and screening, and freight involved. The work performed as prescribed for this item, measured as provided above, shall be paid for at the contract unit price per cubic yard bid for Crusher-run Broken-stone Base Course, which price shall be full compensation for loading all material, hauling not over ¼ mile, delivering on the road, spreading and finishing, all labor, equipment, tools, and incidentals necessary to complete the work except rolling, and sprinkling. Hauling material into each additional quarter mile beyond the first quarter mile shall be paid for at the contract unit price per cubic yard bid for Material Hauled Additional Quarter Mile.

Item 42. Water-bound Gravel or Broken-stone Macadam Base Course¹

42.1. Description.—This item shall consist of a foundation course for surface courses or pavements, shall be composed of washed gravel or broken stone and binder, and shall be constructed on the prepared subgrade or other completed base course in accordance with these specifications, and in conformity with the lines, grades, compacted thickness, and typical cross-section shown on the plans.

42.2. Material.—The broken stone shall consist of angular fragments of rock (excluding schist shale or slate) of uniform quality throughout, with not more than 5 % of soft friable material, not more than 5 % of flat or elongated pieces the width of which is less than half the length, and with a per cent of wear of not more than 8. When tested by laboratory methods the stone shall meet the following requirements:

Retained on 3½" screen	0- 5%
Retained on 2" screen	25-60%
Retained on ¾" screen	100%

42.3. The washed gravel shall consist of rounded or angular fragments of rock with not more than 5 % of slate, shale, or soft sandstone particles, and shall be free from organic matter, clay, loam, or pebbles coated therewith. It may be crushed or uncrushed, and shall have a per cent of wear (abrasion test for gravel) of not more than 18. When tested by laboratory methods it shall meet the following requirements:

Retained on 3½" screen	9- 5%
Retained on 1½" screen	25- 60%
Retained on ½" screen	95-100%

42.4. Screenings shall consist of material equal in quality to that specified for Broken Stone above, and shall be that product of the crusher, including the dust of fracture, which will meet the following requirements:

Retained on ¾" screen	0- 5%
Retained on ¼" screen	20-60%
Passing 200-mesh sieve.....	5-20%

¹ Texas.

42.5. Construction Methods.—The subgrade shall be rolled and shall be dry and clean of all foreign substances. The stone or gravel shall be furnished, spread upon it to such loose depth that when completed the compacted depth shown on plans will be obtained, harrowed if necessary, sloped to the typical cross-section, and dry rolled. The stone shall be spread with shovels from storage piles along the side of the roadway or from dumping boards or may be spread directly from approved vehicles. The gravel may be dumped in two equal rows and shaped by grading machine or road drag, provided it is shaped the same day it is dumped. The thickness of the course, as well as the material, shall be strictly uniform. Side forms, and either center forms or cubical blocks, shall be used to fix the depth of loose material. The shoulders shall be built up to support the edges of the course as directed. All areas and "nests" of segregated coarse or fine material shall be removed and replaced with well-graded material.

42.6. The dry rolling shall be done with a self-propelled roller weighing not less than 8 tons. The rolling shall be longitudinal, shall begin at the sides, overlapping the earth shoulders at least 6", and progress gradually to the center. At any low places that develop the material shall be loosened and the necessary additional material placed and rerolled. The entire surface shall be thoroughly rolled until all settlement has ceased.

42.7. Screenings shall be applied gradually over the surface during the dry rolling in such an amount as will completely fill the interstices. The screenings shall not be dumped on the surface of the stone or gravel, but shall be cast thinly with a spreading motion of the shovel and broomed into the voids. The rolling shall continue while the screenings are being spread, so as to aid by jarring the fine material into the interstices. The screenings shall not be allowed to cake or "bridge" on the surface so as to prevent the filling of the voids or the direct bearing of the roller on the surface of the stone or gravel. The spreading and rolling shall continue until no more screenings will go in dry and the whole surface conforms to the line, grade, and typical cross-section. No excess screenings shall be used.

42.8. Dumping of ashes and cinders from the firebox on the course must not be allowed and any litter must be removed from the stone or gravel before the roller passes over it.

42.9. After the dry rolling and filling is complete, the surface of the course shall be sprinkled with water until thoroughly saturated and more screenings added and rolled. The sprinkling and rolling shall continue until a grout forms in front of the roller that will fill all voids. The work shall then be permitted partially to dry out, and the rolling shall be continued on successive days until the bond is complete and the surface does not creep or wave under the roller. The surface of the course shall be maintained in its finished condition until accepted.

42.10. Method of Measurement.—The work completed and accepted shall be measured by the square yard.

42.11. Basis of Payment.—All work performed under this item and measured as provided above shall be paid for at the contract unit price per square yard bid for Water-bound Gravel or Broken-stone Macadam Base Course, which price shall be full compensation for purchasing, furnishing, quarrying, screening, hauling and delivering on the road, and rolling all materials, for all labor, equipment, tools, and incidentals necessary to complete the work. No overhaul will be allowed.

BOTTOM COURSE

Item 43. Bottom Course, Screened Gravel; Item 44. Bottom Course, Broken Slag; Item 45. Bottom Course, Broken Stone¹

a. Work.—Under these items the contractor shall furnish and place stone, slag, or gravel, conforming to the general requirements for same, either upon the properly prepared subgrade or upon the foundation course. This stone, slag, or gravel shall be of sizes specified below.

b. Material.—After the subgrade or foundation course shall have been properly prepared and proper drainage provided, a course of broken stone, broken slag, or gravel of graded No. 4 or a uniform mixture of Nos. 3 and 4 shall be spread evenly so that it will have, after rolling, the required thickness.

In cases where the finished thickness of the bottom course is of more than 5" the broken stone, broken slag, or gravel for it shall be spread, rolled,

¹ New York.

and filled in two separate layers, neither of which shall be of a greater depth than 6" measured loose.

c. Gaging Blocks.—The depth of loose stone, slag, or gravel in all cases shall be gaged by the use of cubical blocks of suitable size.

d. Dumping on Roadway.—The spreading of any layer or course of broken stone, broken slag, gravel, or filler, whether in foundation, bottom, or top courses, shall be done from suitable spreader wagons or from piles dumped along the road as directed by the engineer.

No segregation of large or fine particles will be allowed, but the stone, slag, or gravel as spread shall be well graded with no pockets of fine material.

e. Rolling and Filling.—After the bottom course of stone, slag, or gravel has been laid loose it shall be thoroughly rolled with an approved roller weighing not less than 10 tons.

This rolling must begin at the sides and continue toward the center and shall continue until there is no movement of the course ahead of the roller. After the course is thoroughly compacted, No. 1 stone, slag, or gravel, and screenings or sand, or a mixture of these, shall be uniformly spread upon the surface and swept in with rattan or steel brooms and rolled dry. After the completion of the rolling no teaming other than that necessary for bringing material for the next course shall be allowed over the rolled material. It is the intention to bind this course with the small stone or slag, but no surplus of filler will be allowed on this course. This course shall not be laid in excess of 500 lin. ft. without being rolled and thoroughly filed so as to render it waterproof and thereby prevent the softening up of the subgrade.

f. In Case of Two Courses.—When two courses are laid each course shall be treated by rolling and adding fine material as described above.

g. Replacing.—If the subgrade material shall become churned up into or mixed with the bottom or subbottom courses through the contractor's hauling over it or working on it when the subgrade is in a wet condition, the contractor shall at his own expense remove such mixture of subgrade material and broken stone, broken slag, or gravel and replace it with clean broken stone, broken slag, or gravel of the proper size, and shall roll or otherwise compact the material so as to produce a uniform, firm, and even bottom course.

If the above condition occurs through no fault of the contractor, the contractor shall be paid both for excavating and replacing under the items Excavation and Bottom Course respectively.

h. Piles of Filler.—All filler shall be delivered and piled alongside the road before the course in which it is to be used is placed.

i. Measurement and Payment.—The quantity to be paid for under these items respectively shall be the number of cubic yards of compacted material in place in the completed course. The amount to be estimated shall be computed by multiplying the finished cross-section of bottom course, as shown upon the plans or ordered by the engineer, by the length of the bottom course measured along the axis of the pavement.

The price bid for the respective items shall cover the furnishing, placing, filling, rolling of the material, and all labor and incidental expenses necessary to complete the work.

Item 50. Binder Course, Bituminous Macadam, Mixing Method¹

a. Work.—Under this item the contractor shall construct a bituminous binder course of the thickness shown on the plans, consisting of compact broken stone and bituminous material upon a previously prepared foundation. It shall be laid in conformity with the lines and grades shown upon the plans or ordered by the engineer. A smooth finish will be insisted upon, free from irregularities and waviness.

b. Material and Method.—The broken stone used in this course shall be of accepted material of No. 1 size.

c. The mineral aggregate for the binder course shall be heated in revolving drivers to between 225 and 300°F. The mineral aggregate shall be continuously agitated during the heating.

d. The bituminous material to be used in this course shall conform to the specifications for bituminous material A, type 2.

e. The bituminous material A shall be heated in kettles so designed as to admit of an even heating of the entire mass, with an efficient control of the heat at all times. The bituminous material shall be heated to a temperature between 275 and 325°F. All material heated above 325°F. either before or

¹ New York.

during mixing with the broken stone, or which has been damaged by long-continued heating, shall be rejected. No asphalt cement shall be heated in kettles containing tar.

f. When thoroughly heated to the proper temperatures, the bituminous material and the mineral aggregate for the binder course shall be mixed in such proportions as to give from 5 to 8 % by weight of bitumen in the completed mixture. The contractor shall provide means for accurately proportioning the mixture. The mixer shall be of satisfactory design, having revolving blades and efficient means for keeping the temperature at the desired point without burning the bitumen. The mixing shall continue until every particle of the mineral aggregate is thoroughly coated with the bituminous material and a uniform mixture has been obtained, which when discharged shall have a temperature between 225 and 300°F.

g. The use of batteries of small batch mixers will not be allowed.

h. The bituminous mixture, heated and prepared as specified above, shall be delivered from the mixer to the point of deposition in the pavement, if at a considerable distance, in suitable trucks or wagons, provided with canvas covers for retaining the heat. To prevent undue compacting on long hauls, partitions may be required for large truck loads. As delivered, the mixture shall have a temperature of at least 200°F. Material having a lower temperature than this shall not be laid in the pavement. Before the mixture is placed, all contact surfaces of curbs, edging manholes, etc., shall be well painted with hot bituminous material. The mixture shall be immediately spread over the foundation course by men experienced in such work, so that when rolled it shall have the required thickness and shall be free from surface depressions and irregularities. The hot paving mixture shall not be dumped in large masses upon the foundation. It shall be dumped upon platforms and shoveled with hot shovels into position in the pavement.

i. The binder course, placed as above specified, shall be compressed with hot hand tamps along the curbs, around manholes, and other edgings. It shall be rolled at once while the material is still warm and pliable, beginning at the edges and working toward the center. The roller wheels shall be swabbed with crude oil to prevent the asphalt from sticking to the roller. Rolling shall continue without interruption until all roller marks disappear and the surface shows no further compressibility. All places which the roller cannot effectively reach shall be compressed with hot tamps.

j. The finished surface of the binder course shall be tested with a 10' straight-edge laid parallel with the center line of the pavement, upon any portion of the surface, and any depressions exceeding $\frac{1}{2}$ " shall be satisfactorily eliminated or the course relaid.

k. No more binder course shall be laid at any one time than can be covered by 2 days' run of the paving plant on surface mixture.

l. Roller.—Rollers used for the binder course shall be well-balanced, self-propelled tandem rollers of satisfactory design, weighing between 7 and 8 tons. They shall give a compression under the rear roller of between 200 and 300 lb. per lineal inch of roll, and shall be provided with an ash pan which shall prevent ashes from dropping upon the pavement.

m. The contractor shall provide a sufficient number of accurate efficient thermometers for determining the temperatures of the bituminous material and mineral aggregate at all stages of the work.

n. Measurement and Payment.—The quantity to be paid for under this item shall be the number of tons of material incorporated in the pavement, exclusive of the bituminous material, as shown on the plans or directed by the engineer.

The price bid shall cover the furnishing (bituminous material excepted), heating, placing, rolling, and compacting of all materials, together with all other labor and incidental expenses necessary to complete the work satisfactorily.

The furnishing of the bituminous material will be paid for under the appropriate item, therefore, as shown on the proposal sheet.

Item 43. Bituminous-concrete Base Course¹

43.1. Description.—This item shall consist of a bituminous-concrete foundation course for bituminous surface courses or pavements, shall be composed of coarse and fine mineral aggregate and bituminous cement, and shall be constructed on the prepared subgrade or completed base course in accordance with these specifications and in conformity with the lines, grades, compacted thickness, and typical cross-section shown on the plans.

¹ Texas.

43.2. Material.—The mineral aggregate for the mixture shall consist of a coarse aggregate of crushed stone or gravel, and a fine aggregate. Samples of the coarse and fine aggregate shall be submitted in accordance with standard prescribed methods, and approval both of the material and of the source of supply shall be obtained from the engineer, prior to delivery of material. Material shipped in dirty cars or vehicles will be rejected. The coarse aggregate shall consist of clean, tough, durable fragments of rock (excluding schist, shale, or slate) of uniform quality throughout, shall be free from an excess of thin or elongated pieces, and free from soft or disintegrated stone, dirt, organic, or other injurious matter occurring either free or as a coating on the stone. The aggregate shall have a per cent of wear of not more than 7 for stone and not more than 15 for gravel (abrasion test for gravel) and when tested by laboratory methods shall meet the following requirements:

Passing 2 1/4" screen.....	100 %
Passing 1 1/4" screen.....	25-75 %

43.3. The fine aggregate shall consist of sand or a combination of sand and screenings, composed of hard durable grains free from clay organic matter or any soft or injurious material. When tested by laboratory methods, it shall meet the following requirements:

Passing	Retained on	%
1/4" screen		100
3/4" screen	10-mesh sieve	0-20
10	40	15-50
40	80	25-65
80	200	7-40
200		9-6

43.4. The bituminous material shall meet the requirements given below for OA-7, NA-7, or NA-9. The material shall be homogeneous, free from water, and the asphalt material shall not foam when heated to 175°C. (347°F.). Oil asphalt for any one contract shall not vary more than 0.020 in specific gravity nor more than 10°C. in melting point within the test limits above specified.

43.5. OA-7. Oil asphalt.

Specific gravity 25°/25°C. (77°/77°F.)..... Not less than 1.020
 Flash point..... Not less than 175°C. (347°F.)
 Melting point..... 45°C. (113°F.)-65°C. (149°F.)
 Penetration at 25°C. (77°F.), 100 g., 5 sec..... 40-50
 Loss at 163°C. (325°F.), 5 hr..... Not more than 1.0 %

- a. Penetration of residue at 25°C. (77°F.), 100 g., 5 sec.... Not less than 25
 Total bitumen (soluble in carbon disulphide), not less than 99.5 %.
- b. Organic matter insoluble..... Not more than 0.2 %

43.6. NA-7. Fluxed Bermudez asphalt.

Specific gravity 25°/25°C. (77°/77°F.)..... 1.055-1.075
 Flash point..... Not less than 175°C. (347°F.)
 Melting point..... 45°C. (113°F.)-55°C. (131°F.)
 Penetration at 25°C. (77°F.), 100 g., 5 sec..... 40-50
 Loss at 163°C. (325°F.), 5 hr..... Not more than 3.0 %

- a. Penetration of residue at 25°C. (77°F.), 100 g., 5 sec.... Not less than 20
 Total bitumen (soluble in carbon disulphide), not less than 94.0 %.
- b. Inorganic matter insoluble..... 2.5-4.0 %

43.7. NA-9. Fluxed Trinidad asphalt.

Specific gravity 25°/25°C. (77°/77°F.)..... 1.210-1.270
 Flash point..... Not less than 175°C. (347°F.)
 Melting point..... 50°C. (122°F.)-60°C. (140°F.)
 Penetration at 25°C. (77°F.), 100 g., 5 sec..... 40-50
 Loss at 163°C. (325°F.), 5 hr..... Not more than 3.0 %

- a. Penetration of residue at 25°C. (77°F.), 100 g., 5 sec.... Not less than 20
 Total bitumen (soluble in carbon disulphide), not less than 65.0 %.
- b. Inorganic matter insoluble..... 22.0-32.0 %

43.8. Proportions of Materials in Total Mixture.—In addition to the previous requirements, the coarse aggregate, fine aggregate, and bituminous

material shall be so graded and proportioned by weight that when combined a total mixture of the following proportions will be secured:

Passing	Retained on	% by Weight
2 3/4" screen	1 1/4" screen	20-45
1 1/2" screen	3/4" screen	15-45
3/4" screen	10-mesh sieve	10-25
10-mesh		15-35
200		3- 5

Bitumen (soluble in carbon disulphide), 4-7 %.

43.9. The proportions shall be varied within the limits designated as directed by the engineer, but neither the type nor proportions of material shall be varied without the consent of the engineer. The percentage of bitumen in the finished base course shall not vary more than one-half of 1 % from the proportion established by the engineer. Unvarying uniformity is of prime importance and both the proportioning and treatment of all materials must be maintained consistently satisfactory to the engineer throughout the construction period, and, whenever required by him, samples of the hot mixture may be taken several times daily, and the mixture, to be acceptable, must invariably conform to all requirements.

43.10. **Preparation of Mineral Aggregate.**—The coarse and fine aggregate shall be heated as directed to between 250 to 350°F. in suitable apparatus in which the aggregate shall be continuously agitated during the heating and in which the temperature can be efficiently and positively controlled.

43.11. The bituminous material shall be separately heated, with effective control of the temperature at all times, to between 250 and 350°F. All material heated above 350°F. either before or during the mixing with the mineral aggregate shall be rejected.

43.12. **Mixing.**—The constituent proportions of the mineral aggregate shall be measured separately and accurately by weight or volume by accurate plant methods which meet the engineer's specific written approval. The required quantity of hot bituminous material for each batch shall be measured by actual weighing with accurate scales attached to the bucket. The measuring and proportioning shall be such as to secure accurately and consistently the graded mixture prescribed by these specifications. Batches shall be uniform and shall not be varied except by direction of the engineer. The mixing shall be done in an approved batch mixer, which shall be designed and operated as to produce and discharge a uniform mixture of thoroughly coated mineral aggregate and bituminous material as prescribed. The heated bituminous material shall be introduced in the mixing chamber after the mineral aggregate has been previously mixed therein. The mixture as discharged shall be at a temperature between 250 and 350°F., and shall not vary more than 30° from the temperature set by the engineer within those limits. The plant must be provided with separate heating and mixing chambers, no direct heat except steam shall be applied to the exterior surface of the mixing chamber, and no flame shall be allowed to pass through the mixing chamber.

43.13. **Placing.**—The prepared mixture shall be transported from the mixing plant to the road in tight vehicles previously cleaned of all foreign materials, and shall be delivered on the road at a temperature between 250 and 350°F. If required by engineer, the loads shall be protected from the weather by canvas, or other suitable material. No loads shall be sent out so late in the day as to prevent spreading and rolling the mixture during daylight, unless artificial light satisfactory to the engineer is provided. The work shall be done only when weather conditions, in the opinion of the engineer, are suitable.

43.14. Prior to the arrival of the hot mixture upon the work, the subgrade, having been rolled, shall be thoroughly bonded with no loose or foreign particles on its surface, and shall be dry, or in any case free from standing water. Contact surfaces of curbs, gutters, manholes, etc., shall be painted with a thin uniform coat of hot asphaltic cement, or asphaltic cement dissolved in naphtha, just before the surface mixture is placed against them. Upon arrival at the work, the hot mixture shall be dumped on approved steel "dump boards" outside of the area upon which it is to be spread, and immediately distributed into place by means of hot shovels and spread with hot rakes in a uniformly loose layer of such depth that when compacted the depth shown on the typical cross-section will be obtained. Adjacent to flush curbs, gutters, etc., the mixture shall be raked uniformly high, so that

it will be slightly above the edge of the curb or flush structure. The mixture shall be rolled at once while it is still warm and pliable, beginning at the edges and working toward the center. The rolling shall be done by tandem rollers weighing not less than 8 tons, or by a similar tandem roller and a three-wheeled roller weighing not less than 10 tons. Means for preventing the bituminous material from adhering to the roller shall be provided as directed by the engineer. The rolling shall progress continuously at the rate of not more than 200 sq. yd. per hour per roller and shall include longitudinal rolling and two diagonal rollings approximately at right angles to each other. The motion of the rollers shall be at all times slow enough to avoid displacement of the hot mixture or any tendency to the creation of waves, and shall be continued until all roller marks disappear and the course has a density of not less than 95 % of its maximum calculated density. For a radial distance of 8" around all structures and all places inaccessible to the rollers, compression shall be effected by hot iron tampers of bearing area of 14 sq. in. or more, and weight of not less than 25 lb.

43.15. Joints.—Placing of the base course shall be as nearly continuous as possible, and the roller shall pass over the unprotected end of the freshly laid mixture only when the laying of the course is discontinued for such length of time as to permit the mixture to become chilled. In all such cases when the work is resumed the material laid shall be cut back so as to produce a slightly beveled edge for the full thickness of the course. The old material which has been cut away shall be removed from the work and new mix laid against the fresh cut. If desired, a stout rope may be stretched across the pavement where the joint is to be made. When the work is resumed, the material laid shall be cut back to the rope, which will be removed together with the surplus material and the fresh mix laid against the joint thus formed. Hot smoothing irons may be used for sealing joints, but in such case extreme care shall be exercised to avoid burning the surface.

43.16. Surface Finish and Tests.—The surface of the mixture after rolling shall be smooth, dense, and true to the established crown and grade. Before the completion of the rolling the surface shall be tested as follows, and corrected as necessary by properly adding or removing hot mixture, retesting, and rerolling until the finished surface complies with the test requirements.

43.17. Surface Tests.—The finished course shall show no deviation from the general surface in excess of $\frac{1}{4}$ " as shown by deviation from a 10' straight-edge laid parallel to the center line of the road so as to bridge any depressions and touch all high spots.

43.18. Such portions of the course as are defective in finish, density, or composition or become loose, broken, or mixed with dirt prior to the application of the wearing surface shall be removed and replaced with fresh hot mixture and rebuilt in accordance with these specifications at the expense of the contractor. The base course shall be protected from traffic until cold.

43.19. The surface shall be maintained in its finished condition until accepted.

43.20. Method of Measurement.—This item shall be measured by the square yard complete in place.

43.21. Basis of Payment.—The yardage of completed and accepted work measured as provided above shall be paid for at the contract unit price bid per square yard, for Bituminous Concrete Base Course, which price shall be full compensation for quarrying, furnishing, hauling, and placing all material, for preparation of all material, for all labor, equipment, tools, and incidentals necessary to complete the work.

FOUNDATION TYPE C

74A. PORTLAND CEMENT CONCRETE

1. COMPOSITION.

This foundation shall be prepared from concrete having the following composition: Portland cement one (1) bag, fine aggregate three (3) cubic feet, coarse aggregate five (5) cubic feet by volume, unless the character of the aggregate is such that the specified quantity of cement required per cubic yard is not secured. In such cases, the ratio of cement to fine aggregate or of fine aggregate to coarse aggregate, shall be changed as herein provided so that the specified quantity of cement will be secured per cubic yard of concrete. The Contractor will receive no additional compensation for making such changes.

Concrete headers, when integral with the foundation, shall be constructed of the same aggregate used in the foundation, but shall have the following

composition: Portland cement, one (1) bag; fine aggregate, two (2) cubic feet; coarse aggregate, four (4) cubic feet.

2. MATERIALS REQUIRED.

Cement—The cement shall meet the requirements given in Article 96.

Fine Aggregate—The fine aggregate shall be concrete sand as defined in Article 95b.

Coarse Aggregate—The coarse aggregate shall be trap rock, dolomite or concrete size or grade as specified in Articles 92 to 94 inclusive.

Cement and Aggregate—Before any orders are placed or deliveries made, the Contractor shall obtain the Engineer's written approval of the cement, fine and coarse aggregates he intends to use. In making requests for said approval, the Contractor will give the name, producer, location, and method of shipment of these materials.

Water—All water used in concrete shall be clean, free from oil, acids, alkalis, sea salts, vegetable matter, or ingredients that are injurious to concrete.

Joint Filler—All joint fillers used shall comply with the requirements given therefor in Article 103 for Grade M. A. Joint Fillers.

3. GENERAL.

The completed foundation shall have the width, thickness and surface contour shown on plans.

A cubic yard of concrete shall contain not less than four and sixty-four hundredths (4.64) bags of cement.

The Engineer shall compare the calculated amount of cement required according to these specifications, with the amount actually used, as determined by actual count of the number of bags of cement used per day. If the amount of cement used during any three (3) consecutive days is less by more than five (5) per cent, or if the amount of cement used during any one day is less by more than ten (10) per cent of the amount hereinbefore required, the Contractor shall, at his own expense, remove all such concrete and replace the same with new concrete, constructed according to these specifications.

The subgrade must comply with the requirements specified in Articles 67, 68 and 73. In addition it must be kept constantly wet at least fifty (50) feet in front of the mixer. To secure the desired depth of saturation, the subgrade shall be sprinkled at frequent intervals. The rapidity with which the water shall be applied and the quantity used shall vary with the character of the subgrade. The depth of saturation for sand and gravel subgrades shall not be less than four (4) inches, for clay and clay loam subgrades not less than three (3) inches. The rate the water is applied and method of sprinkling employed, shall be such as not to form pools of water on the surface of the subgrade yet all parts of the subgrade must be saturated to the depth required before any concrete is applied thereon.

After the subgrade has been properly wet it must be protected in the manner ordered by the Engineer so that ruts are not formed during the hauling of the aggregate or paving mixtures.

All materials used in a concrete foundation must be kept clean during transportation and hauling. Neither the coarse or fine aggregate shall be deposited upon the subgrade shoulders or adjacent gutters unless permission is given therefor in the "Proposal." When deposited in piles adjacent to the work the ground upon which the material is deposited must be hard, firm, well drained and free from all vegetable matter. All devices used in measuring these aggregates shall be so constructed that they will hold the exact volume of material required, and meet the approval of the Engineer.

No concrete shall be prepared or laid until the condition of the equipment that will be used in the preparation thereof has been approved in writing by the Engineer. This approval will be required for each contract and shall be requested by the Contractor sufficiently in advance of starting work to permit of any required changes being made without delaying the work.

The Contractor shall provide such measuring devices as will insure the required quantity of each ingredient being used in each batch. All such devices and the method of measuring the materials must be approved by the Engineer. A bag of portland cement ninety-four (94) pounds net, shall be considered as one (1) cubic foot.

The proportions of fine and coarse aggregate required to be used to secure the specified cement content, also the consistency required and the crushing strength of the concrete thus prepared, shall be determined by the Engineer. These factors must be determined for each contract during the preparation of the initial concrete. No concrete shall be laid until they have been thus

determined. When so determined they shall only be changed when the required cement content is not being secured. The Construction Inspector shall notify the Engineer when the initial concrete will be prepared, said notice to be given at least five (5) days previous to its preparation, also whenever the required cement content is not being secured.

Concrete shall not be mixed or laid when the atmospheric temperature in the shade or the temperature of the aggregate is at or below 32 deg. F. When written permission is secured from the Engineer to construct pavement when the temperature drops below 32 deg. F. at night, the concrete must be protected from freezing by one of the following methods. Any concrete that has been frozen before it is five days old shall be replaced.

1. After the strips of canvas or burlap have been removed, the concrete shall be covered with a six (6) to eight (8) inch layer of straw or salt hay over which a canvas cover shall be spread and firmly fastened in place. This cover shall be at least four (4) feet longer than the pavement is wide, laid across the pavement with edges overlapping, and the edges of each layer firmly fastened in place by straps or weights. Upon this canvas there is then placed another layer of straw if the weather is fairly severe.

2. Boards are placed across the center of the concrete at frequent intervals upon which a steam pipe is laid. The entire pavement is then covered with wooden trestles slightly longer than the pavement is wide and which are of sufficient height to leave an air space of not less than six (6) inches above the pavement surface. These boards are then covered with canvas or strips of tarred paper which must be firmly fastened in place. Steam is then passed through the pipe until the weather has moderated or the pavement is at least five days old.

During very severe weather this method of protection should always be used and it may be found necessary in extreme cases to cover the canvas with a layer of salt hay or straw.

4. SURFACE FINISH.

The finished surface of the concrete shall be uniform in appearance, free from all loose or partly imbedded stone, lean or porous spots, depressions or projections that are over three-eighths ($\frac{3}{8}$) inch above or below the specified surface of the concrete as determined by a straight edge, not less than ten (10) feet long laid parallel to the center line of the pavement. It must also be at the required grade and parallel to the finished surface at all points.

5. CONSISTENCY.

The consistency of the concrete shall be determined by the slump method. When the slump has been determined for concrete containing a given aggregate, no subsequent concrete prepared from these aggregates shall have any greater slump. All concrete that has a greater slump shall be removed from the roadway before any initial set has developed. Said slump shall be determined with a truncated cone twelve (12) inches high, eight (8) inches diameter at the base, and four (4) inches diameter at the top.

When the required consistency of the concrete has been established by the method defined above, the crushing strength of this concrete shall be determined by six (6) inch cubes. These cubes, and all subsequent cubes taken and tested, shall be moulded and cured in the field in the same manner, and tested when twenty-eight (28) days old. In determining the average crushing strength of this concrete, not less than three (3) nor more than five (5) cubes shall be taken at irregular intervals from different batches of concrete.

When the average strength of this concrete has been thus determined, all subsequent concrete prepared from the same aggregates shall have a crushing strength of not less than seventy-five (75) per cent of this average, and not more than ten (10) per cent of the individual samples shall have a crushing strength less than ninety (90) per cent of this average.

6. MIXING CONCRETE.

The materials shall be mixed in a concrete mixer of the batch type, having a capacity of not less than three (3) bags of cement per batch of concrete of the composition herein specified. Said mixer shall be equipped with an automatic locking device that will prevent materials being discharged before they have been in the mixer the required length of time, a water tank containing an adjustable overflow with the necessary valves to prevent water flowing into the tank while the tank is discharging into the mixer, and a speed regulator that will prevent the drum from revolving slower than twelve (12) or faster than twenty (20) revolutions per minute. Each batch must be in motion in the mixing drum at least one and one-quarter ($1\frac{1}{4}$) minutes or as much longer as may be necessary to insure a uniform and homogeneous concrete that has the required consistency. If the timing device should be out of

order, the concrete must be mixed not less than two and one-half (2½) minutes until such time as said device is repaired. The drum must be completely emptied before mixing successive batches. The concrete shall be mixed only in such quantity as will be required for immediate use. Any concrete that has developed initial set or has been mixed longer than thirty (30) minutes before being deposited in place, shall not be used.

The different ingredients used must be perfectly clean, kept free from foreign materials during the operation of handling, mixing, and placing. The Contractor must prevent any segregation of the coarse or fine particles of the aggregate taking place during hauling or the handling, or the inclusion therewith of any foreign material when these materials are loaded into the measuring bins or mixer.

The Contractor shall notify the Engineer, in writing, at least three (3) days in advance when he is ready to prepare the initial concrete.

7. PLACING CONCRETE.

After mixing, the concrete shall be deposited at once in successive batches upon the subgrade to the required depth and for the entire width of the pavement. Immediately after being thus deposited, the piles or batches of concrete shall be uniformly distributed over the subgrade so that the resulting surface is fairly uniform in character, and sufficiently above the grade of the finished surface that, after being struck off the surface thereof will not be compressed below the grade specified therefor.

When concrete is to be placed adjacent to railroad tracks, or around such structures as catch basins, manhole tops, or other objects that project through the pavement, no concrete shall be placed within eighteen (18) inches of said tracks or structures until they have been set to the required grade and alignment.

8. FINISHING CONCRETE.

The concrete shall be brought to the required grade and curvature by the use of a hand strike board. This board must be at least eighteen (18) inches longer than the pavement is wide. A hand template shall be used to consolidate the concrete and produce the required finish. Both the strike board and template shall have the same curvature as that specified for the crown of the pavement.

After being properly placed the concrete shall be struck off and the whole surface thereof tamped until thoroughly consolidated and of a uniform consistency and density. Additional concrete shall be added to all low places and porous spots, and retamped to the required grade and density. The concrete should not be tamped to the required grade and solidity later than thirty (30) minutes after placing, but must be properly struck off and tamped before any initial set has developed.

9. CURING AND PROTECTING.

After the concrete has been properly struck off, tamped and tested, it shall be covered at once with strips of burlap or canvas laid perpendicular to the center line of the pavement. The edge of each strip shall overlap the adjacent strips about one (1) inch. The different strips of burlap shall be at least two (2) feet longer than the width of the pavement.

When properly placed this covering shall be sprinkled at once with sufficient water to saturate it and kept wet until removed. As soon as the concrete has hardened sufficiently to prevent pitting, these strips shall be removed and the concrete protected by covering it immediately with salt hay or straw. This covering shall be spread in a layer not less than six (6) inches thick, loose, and must be added in sufficient quantity to completely cover the concrete. During the spreading, care must be exercised that the surface of the concrete is not marred or injured. As soon as spread, it shall be wet at once and kept constantly saturated for at least ten (10) days. The pavement must be kept closed to traveling public, contractor, engineers and officials, for at least fourteen (14) days, and as much longer as the Engineer may order.

The water pipe, which supplies the water for the concrete must not be removed before the time required for the curing of the adjacent concrete. This pipe line must be provided with tees and stop cocks at intervals of not over two hundred (200) feet and must be of sufficient size to permit of the proper sprinkling of the concrete and the operation of the concrete mixer at the same time.

The Contractor shall erect and maintain suitable barricades to protect the concrete from traffic, domestic animals, etc. Any part of the concrete damaged from traffic or any other cause occurring prior to its final acceptance, shall be repaired or replaced by the Contractor at his own expense in a

manner satisfactory to the Engineer. Before any surface pavement materials are deposited on the foundation, the covering shall be removed and disposed of as directed by the Engineer.

If permission is given to lay concrete when the temperature may drop below thirty-two (32) degrees Fahrenheit before the concrete is five (5) days old, the concrete shall be protected in the manner specified above.

10. SIDE FORMS.

The thickness of the pavement foundation and its alignment shall be determined by side forms. These shall be set to the established line and grade of the pavement foundation with their upper faces at the grade established for the adjacent edge. They must be equal in width to the thickness of the pavement foundation at the edge, shall be firmly held in place by lock nuts, clamps, and steel pins, and supported at all joints or elsewhere as needed to prevent the forms from springing out of alignment. All forms shall have square ends with clamping devices which will lock adjacent ends firmly together. The anchoring pins must be not less than twenty-four (24) inches long, and of sufficient size to firmly hold the forms in place. No pins, nuts or clamps shall project above the top of the form or be so placed as to interfere with the free movement of the strike board or tamper. All forms must be straight, free from warp, clean when used, and oiled if so ordered. Forms shall not be removed sooner than fifteen (15) hours after the adjacent concrete has been placed.

11. JOINTS.

Expansion joints shall be constructed at the end of each day's work, or when work is suspended for over thirty (30) minutes, and at all other places designated on plans.

Expansion joints shall be of either the poured or premoulded type. When the type to be used is not designated on plans, the Contractor may construct either. The bitumen used to form the joints and the method of manufacturing premoulded joints must comply with the requirements given therefor in Article 103.

The forms used to cast a poured joint must be so designed and used that the concrete will not be injured by its removal, the opening will have the specified dimensions, be perpendicular to the pavement surface and axis must be approved by the Engineer. They shall be so set that the top edge is at the same elevation as the surface of the concrete and firmly held in place by iron rods or pins driven into the subgrade.

The bitumen used for pour joints shall be Grade P. A. and shall be applied at a temperature between 300 and 400 deg. F. Sufficient bitumen shall be used to fill the joint flush full. The joint must be opened to full depth and both faces clean and dry when the bitumen is applied.

Premoulded joints shall be formed by inserting during construction, sheets of bituminized felt or prepared semi-solid bitumen complying with the requirements given therefor in Article 103. These sheets shall be inserted perpendicular to the axis of the pavement and its surface. They shall be equal in length to the width of the foundation, have the same width as the thickness specified for said foundation, and the top edges cut to the required curvature before installation. When two sheets are used for one joint, the abutting ends must be cut square and held firmly together during installation, placing and finishing of the concrete. After side-forms are removed, the ends of the joints shall be cleaned of all concrete to the full depth.

The device used to hold the joint filler in position until the adjacent concrete has been placed, shall be a metal plate equal in length to the width of the foundation, have one edge cut to the crown specified for the surface of the foundation, be of sufficient thickness, and so designed that it can easily be fastened and held in place without springing out of shape or alignment.

12. REINFORCEMENT.

The concrete shall be reinforced at all points shown on plans with the size and type of metal designated, also at all places where trenches or other openings are made in the subgrade for the installation of drains or structures not shown on plans. When no method of reinforcing the concrete over openings made in the subgrade is shown on plans, it shall be reinforced as follows:

One-half ($\frac{1}{2}$) inch deformed bars shall be placed perpendicular to the trench, two (2) inches above the bottom of the concrete foundation, spaced twelve (12) inches to centers and shall extend for a distance at least twelve (12) inches beyond each edge of the opening. Payment will be made for all such reinforcement installed, not shown on plans, at the contract unit price per pound in place.

Series of 1917

IOWA STATE HIGHWAY COMMISSION

AMES, IOWA

Standard Specifications For Earth and Gravel Road Construction

Revised series of 1917 distributed by the State Highway Commission under Chapter I-A, Title VIII, Supplement to the Code 1913 as amended by Acts of the Thirty-Sixth General Assembly

Section Three

EARTH ROADS

1. **Alignment.**—The center of the finished roadway shall conform in alignment to the center stakes. These stakes shall follow, as nearly as possible, the center line of the right-of-way.

2. **Grade Lines.**—The grade line shown on the profiles shall denote the crown of the finished roadway at its center line.

3. **Cross-section.**—Unless otherwise provided the cross-section to be used is the standard cross-section of the Highway Commission for the road system on which the work is located.

NOTE.—The Commission will approve changes in the standard cross-section to meet local conditions, on specific improvements, but a change approved for one road shall not be construed to apply to other roads. In each case the proposed change should be submitted to the district engineer who will make a field examination to determine the feasibility of the changes proposed.

4. **Grading.**—Under this head will be included all excavation and embankments required for the formation of the earth roadway, cutting all ditches along or contiguous to the road, forming the approaches to all side roads and farm entrances, changing of stream channels, and all other excavations and embankments connected with or incident to the construction of the road. Grading will be estimated under the following heads, viz.:

Solid rock excavation.

Loose rock excavation.

Earth excavation.

Solid rock excavation will include all rock in masses which can not be removed without blasting, also all detached rock or boulders measuring not less than one cubic yard each.

Loose rock excavation will include all slate or other rock which can be quarried or removed without blasting, also all detached rock or boulders measuring not less than one-fourth nor more than one cubic yard each.

Earth excavation will include all loose stones, boulders, and other material of every description as found, which are not included in the above specifications as solid and loose rock.

5. **Excavation.**—Excavation shall be made in all cases to the required alignment and cross-section. Any roots, stumps, or other timber encountered in the excavation shall be removed and burned or otherwise disposed of as directed by the engineer, but shall not be placed in the embankments. All materials taken from excavations shall be deposited in the embankments unless otherwise specified or directed by the engineer. The cost of moving the same when the average length of haul does not exceed five hundred (500) feet will be considered as included in the price per cubic yard for excavation.

6. **Provision for Drainage.**—If it is necessary in the prosecution of the work to interrupt or obstruct the natural drainage of the surface, or the flow of artificial drains, the contractor shall provide for the same during the progress of the work in such a way that no damage shall result to either public or private interests. He shall then be held liable for all damages which may result from any neglect to provide for either natural or artificial drainage which he may have interrupted.

7. **Intercepting Ditch.**—In cuts along sidehills where there is a possibility of surface water causing damage by flowing down the side slope of the cut, a ditch shall be constructed to intercept the surface water and prevent it from flowing into the cut. The contractor will be paid for this work as an extra.

8. **Borrow Pits.**—When sufficient material for the embankments is not obtainable within the side ditches and excavations as staked out, the contractor shall make up the deficiency from borrow pits laid out by the engineer. Borrowing must be done from regular shaped borrow pits in order to admit of ready and accurate measurements, care being taken not to unnecessarily injure or disfigure the land. The banks must be sloped, the pits so constructed that surface water will drain out and the premises left in a condition satisfactory to the engineer. The right-of-way for borrow pits will be furnished by the county.

9. **Berms.**—Wherever it becomes necessary to make an excavation along the side of the road as in the construction of borrow pits, ditches, etc., a berm not less than four feet in width shall be left between the toe of slope of the roadway embankment and the top of the excavation bank.

10. **Waste.**—When the amount of cut exceeds the amount of fill the excess material shall be deposited as directed by the engineer. Such material shall preferably be used in widening the adjacent fills so as to reduce the side slopes thereon.

11. **Embankments.**—Embankments shall be carried up in horizontal layers, each of which shall be carried out to its proper width in the cross-section of the roadway. Sod obtained in the cuts may be deposited in the embankments provided it is so placed as to be not closer than twelve (12) inches to the finished roadway or subgrade. Stones obtained from cuts shall be so distributed in the embankments as to not form pockets or cavities. All existing slopes and surfaces of embankment shall be plowed where additional fill is to be made, so that the new material will bond with the old.

12. **Guard Rail.**—Where the height of an embankment is over six feet, substantial guard rails shall be constructed along the shoulders. Such guard rail will be paid for at the price bid per lineal foot of rail. Where the height of the embankment is six feet or less, the side slopes shall be flattened to a slope not steeper than three to one (3 : 1) unless otherwise shown on the plans.

13. **Sod in Blade Grader Work and Shallow Fills.**—In blade grader work and in fills so shallow that the sod cannot be kept at least twelve (12") inches below the finished roadway, such sod, after being cut loose with blade grade or plows, shall be disked and harrowed until it is reduced to small pieces which will not interfere with traffic. These small pieces of sod shall not be deposited in the middle of the road but shall be deposited near the shoulders and shall be covered with earth. The middle portion of the road shall be formed of earth free from sod. The diskings and harrowing of sod is included in the price bid for excavation.

14. **Side Ditches.**—The side ditches shall be excavated to the depth, alignment, and cross-section shown on the drawings. Care shall be taken to secure a uniform grade on the ditches so that the water will readily drain out, and to secure smooth, uniform slopes on the ditch banks in strict conformance with the drawings.

15. Clearing and Grubbing.—The ground included in the highway must be cleared of trees, stumps, brush, weeds and grass to the full width of right-of-way, unless otherwise directed. All timber, stumps, brush, and other vegetable matter must be burned unless otherwise directed by the engineer. Such material shall not be placed in the embankments.

Where embankments are to be more than two and one-half feet in height, it will be sufficient to cut all trees, stumps, and brush close to the ground. Where embankments are to be less than two and one-half feet in height, and in all excavations, all stumps and large roots must be grubbed out and burned or removed.

Unless otherwise specified, clearing and grubbing will be paid for as extra work, as provided in Section Two, paragraph 22. Allowance will be made for all grubbing in excavations for the roadbed, all grubbing in borrow pits ordered and staked out by the engineer to supply material for the embankments, and all grubbing in embankments less than two and one-half feet high, but will not be allowed for embankments over two and one-half feet high, or in borrow pits made by the contractor without having been so ordered by the engineer.

16. Hedge rows.—Hedges, under these specifications, are rows of trees or bushes, used for fence purposes or wind breaks, containing at least three bushes or trees per rod. For removing such hedges the contractor will be paid the price bid per rod.

17. Measurements.—Grading shall be estimated and paid for by the cubic yard at the prices specified in the tender. Measurements of grading quantities will, in all cases, be made from the cuts or pits from which the material is taken, by cross-sectioning before and after excavation, and the volumes determined by the average end area method.

18. Haul and Overhaul.—The average length of haul shall be determined by locating the center of gravity of the cut and the center of gravity of the corresponding fill. If the center of gravity of the cut is more than five hundred (500) feet from the center of gravity of the corresponding fill, overhaul at the rate of one cent per cubic yard per 100 feet will be allowed for the entire amount of material in the cut for the distance between the centers of gravity in excess of five hundred (500) feet.

NOTE.—Should the engineer desire to eliminate any payment for overhaul, a stipulation to that effect may be inserted in the instructions to bidders, as provided in Section Two, paragraph 25.

19. Tile Sub-drains.—Tile sub-drains shall be put in wherever shown on the plans. The tile used shall meet the requirements of the standard specifications for farm drain tile adopted in 1916 by the American Society for Testing Materials. The tile shall be laid true to grade and alignment established by the engineer. For furnishing and laying tile drains, the contractor will be paid at the price bid for such work.

NOTE.—The first requirement of road construction is to get a well-drained roadbed. For this reason, county engineers are instructed to require tile drainage on all portions of the highways where there is any question regarding the adequacy of the surface drainage or the stability of the soil.

If possible, the flow line of the tile shall be placed a minimum depth of five feet below the elevation of the roadway shoulders. No tile less than six inches in diameter shall be specified.

Where the grade of the side ditch is less than one per cent., inlets to the tile shall be provided at intervals of about five hundred feet. These inlets shall be constructed by filling the trench for a length of about three feet with coarse gravel, broken stone, or other suitable porous material. The top of the porous material shall be raised about eight inches above the top of the trench.

20. Finishing Stakes.—The engineer shall set suitable finishing stakes to guide the contractor in finishing the road.

NOTE.—One of the most common defects in earth road construction is the failure to bring the earth shoulders up to the proper grade and alignment. The shoulders are often left low and irregular, thus resulting in an unsightly road having too much crown in the center. This defect can be obviated only by setting stakes, giving the grade and alignment of the shoulders. In finishing, the contractor should use a templet to fit the crown of the road, and in this case stakes need be set only along one shoulder or along the center line. If no templet is used, finishing stakes should be set along each shoulder and on the center line.

Finishing stakes on fills should be set above the established grade so as to allow the proper amount of shrinkage. Under average conditions the following percentages of shrinkage should give satisfactory results.

Depth of Fill	Percentage of Shrinkage
Up to 5.0 feet.....	15%
5.0 feet to 12.0 feet.....	12%
12.0 feet to 18.0 feet.....	10%

21. Finishing.—If the road is not to be surfaced with gravel, the contractor shall, after having brought it substantially to grade, complete the work in such a manner that the finished road will be smooth and true to cross-section, grade and alignment. No extra compensation will be allowed for finishing as this work must be included in the price bid for excavation.

If the road is to be surfaced with gravel, the earthwork necessary for forming the sub-grade shall be executed in the manner specified for the class of gravel surfacing to be used. The preparation of the sub-grade for the gravel surfacing is not included in the price bid for earthwork.

22. Installing Temporary Culverts.—Temporary culverts will be construed to mean corrugated culverts, boiler pipe culverts, concrete tile culverts, or cast iron culverts not over thirty-six inches in diameter, and placed without permanent bulkheads. The county will furnish and deliver temporary culverts at the railroad station. The contractor will be required to haul, properly place, and fill over such culverts. For this he will be paid at the price bid per lineal foot.

Item 51. Sand-clay Surface Course¹

51.1. Description.—This item shall consist of a wearing course composed of an intimate mixture, either natural or artificial, of properly proportioned sand and clay, and shall be constructed on the prepared subgrade in accordance with these specifications and in conformity with the lines, grades, compacted thickness, number of component courses, and typical cross-section shown on the plans.

51.2. Material.—Natural sand clay shall consist of sand and clay, or top-soil, occurring properly proportioned, and obtained from pits designated by the engineer. After the pit has been stripped, the engineer shall inspect and approve the material before it is placed on the subgrade. All material used shall be free from weeds, vegetable, or other injurious matter, and all stones of more than 1" in diameter shall be removed by the contractor at the pit.

51.3. Sand for an artificial mixture or to supplement a natural mixture shall be sharp, clean, free from dirt or loam, and not too fine. It shall not be used until approved by the engineer.

51.4. Clay for an artificial mixture or to supplement a natural mixture shall show resistance to slaking and be satisfactory to the engineer, shall have good binding qualities, and shall not be used until approved by the engineer.

51.5. Construction Methods.—Where it is necessary to bring the sand and clay on the subgrade separately, and mix them in place, a trench shall be formed in the subgrade with the grading machine to receive the bottom layer, which may be either sand or clay. No trenching of the subgrade will be required where the subsoil is of sand or clay that is to be mixed with the clay or sand, as the case may be.

51.6. a. Clay on Sand Subgrade.—The clay shall be spread over the prepared subgrade in such quantities and to such depth that when mixed with the sand a compacted surfacing of the width and depth shown on the plans will be obtained. After the clay has been spread the contractor shall plow up sand from beneath and add sand from the sides, but only in such amount that the net proportion of sand and clay is about 2:1 or in sufficient quantity so that the clay will slightly more than fill the voids of the sand.

51.7. b. Sand on Clay Subgrade.—This process is exactly similar to that in paragraph above, except that the subgrade shall be plowed to a depth of 4", after which it shall be harrowed until completely pulverized; the sand shall be spread over the subgrade in such quantities and to such a depth that, when mixed with clay, a compacted surfacing of the width and depth, shown on the plans, will be obtained. The depth to which the sand should be

¹ Texas.

spread will depend upon the amount of sand contained originally in the clay of the roadbed. As near as practicable, only enough clay shall be plowed up from beneath just to fill the voids of the sand, and no surplus of clay will be allowed. Where the subgrade material consists of clay which, in the opinion of the engineer, is not considered suitable for use in the surface, the sand layer shall be spread first, and of a depth more than is sufficient for use in surfacing, and as directed by the engineer. The surplus sand shall remain under the completed surface to serve to improve the drainage of the road. The proper proportion of suitable clay shall then be hauled and spread on the sand, as in case *c* following.

51.8. c. Sand and Clay on a Different Subgrade Soil.—Where it is necessary to bring the sand and clay on the road separately, the trench should be filled with the bottom layer of material (which may be either sand or clay) to such a depth, and then have the top layer spread upon it to such a depth that when mixed together the sand and clay will show a properly proportioned and uniformly mixed compacted surfacing of the width and depth shown on plans.

51.9. d. Natural Sand Clay.—The surfacing material shall be spread on the prepared subgrade to such a depth that, when compacted, it will be of the width and depth shown on the plans.

51.10. In all cases, only sufficient clay to fill the voids of the sand shall be used, the clay serving as a binder for the sand. On sections of road that are not exposed to the sun and wind, as in dense woods, deep cuts, or on low boggy sections, a smaller percentage of clay will be required, in proportion to the smaller percentage of voids in the sand. On heavy grades, especially when exposed to the sun and wind, a greater percentage of clay will be required. It shall be the charge of the contractor that the required amount of material shall be delivered in each 100' station and uniformly distributed throughout each station.

51.11. After the material has been spread as prescribed in the several cases above, the material shall be thoroughly mixed with a disc harrow. The operations of plowing and harrowing shall be repeated until the sand and clay are mixed thoroughly and uniformly in the proper proportions. After the mixing is completed, the contractor shall shape the roadway with a road machine or road drag and permit traffic upon it. After the first soaking rain, the contractor shall plow and harrow the surfacing material until it practically becomes mud, after which he shall shape the surface and keep it in shape by repeated dragging until it has dried out and is thoroughly compacted.

51.12. When the typical cross-section requires that this item be constructed in more than one course, the additional courses shall be constructed independently on the previously completed course in accordance with clauses *c* or *d* of these specifications, and maintained and finished as provided above.

51.13. Method of Measurement.—Work and accepted material hauled from prescribed pits to the road shall be measured by the cubic yard of material, loose measurement, as delivered on the road.

51.14. Basis of Payment.—The material will be furnished by the county, unless otherwise provided in special provisions. The work performed as prescribed in this item and measured, as provided above, shall be paid for at the contract unit price per cubic yard bid for Sand-clay Surface Course, which price shall be full compensation for loading all material, hauling not over $\frac{1}{4}$ mile, delivering on the road and finishing, all labor, equipment, tools, and incidentals necessary to complete the work, except rolling, and sprinkling. Hauling material into each quarter mile beyond the first quarter mile shall be paid for at the contract unit price per cubic yard bid for Material Hauled Additional Quarter Mile.

Item 52. Shell Surface Course¹

52.1. Description.—This item shall consist of a wearing course composed of shell, and shall be constructed on the prepared subgrade, or completed base course, in accordance with these specifications and in conformity with the lines, grades, compacted thickness, number of component courses, and typical cross-section shown on the plans.

52.2. Material.—The shell shall consist of sound particles of oyster, clay, or other shells equally acceptable to the engineer, and shall not contain more than 15 % of mud, clay marl, or loam. No shells which will not be broken up during construction to pieces not larger than 2" shall be allowed

¹ Texas.

in the material delivered, and all such oversize shell shall be removed at the contractor's expense.

52.3. Construction Methods.—The material shall be delivered, and spread by hand on the prepared subgrade, or completed course, to such depth that when compacted the thickness shown on the plans will be secured and shaped to conform to the typical cross-section. Side forms and either cubical blocks or center guide forms of proper size shall be used to fix the depth of the loose material. It shall be the charge of the contractor that the required amount of material shall be delivered in each 100' station and uniformly distributed throughout each station.

52.4. The work shall be rolled and sprinkled or opened to traffic as directed. The contractor, as often as directed, shall work and dress the surface so that the cross-section shall continue uniform and true to line and grade, and until the surface is smooth, hard, free from ruts and undulations and well bonded to the width shown on plans, and the work is accepted. When the typical cross-section requires that this item be constructed in more than one course, each additional course shall be constructed independently after the previous one has been completed and accepted, all as prescribed above.

52.5. Methods of Measurement.—Work and accepted material hauled to the road shall be measured by the cubic yard of material, loose measurement, as delivered on the road.

52.6. Basis of Payment.—When a unit price for Shell is requested and tendered in the proposal, the material furnished as prescribed by this item shall be paid for at the contract unit price so bid per cubic yard. The work performed as prescribed by this item and measured as provided above shall be paid for at the contract unit price bid per cubic yard for Shell Surface Course, which price shall be full compensation for loading all materials, hauling not over $\frac{1}{4}$ mile, delivering on the road and finishing, all labor, equipment, tools, and incidentals necessary to complete the work, except rolling, and sprinkling. Hauling material into each quarter mile beyond the first quarter mile shall be paid for at the contract unit price bid per cubic yard for Material Hauled Additional Quarter Mile.

Item 53. Caliche Surface Course¹

53.1. Description.—This item shall consist of a wearing course composed of caliche, and shall be constructed on the prepared subgrade or completed base course in accordance with these specifications, and in conformity with the lines, grades, compacted thickness, number of component courses, and typical cross-section shown on the plans.

53.2. Material.—Caliche shall consist of a natural mixture of approximately equal proportions of calcareous dust and quartz sand with or without the presence of gravel or small stones, all of which, when tested, shall pass a 2" screen. Oversize material shall be removed at the contractor's expense.

53.3. Construction Methods.—The material shall be delivered, and spread by hand on the prepared subgrade to such depth that when compacted the thickness shown on the plans will be secured, and shaped to conform to the typical cross-section. Side forms and either cubical blocks or center guide forms of proper size shall be used. It shall be the charge of the contractor that the required amount of material shall be delivered in each 100' station and uniformly distributed throughout each station.

53.4. If, in the opinion of the engineer, it be practicable to do so, the caliche shall be puddled with water before being finally shaped and compacted. This puddling may be done either in the pit before the material is hauled on the road, or it may be done by sprinkling with water after the material has been spread upon the subgrade. In case puddling is done in the material pit, the caliche shall at once be hauled onto the road, spread by means of hoes, rakes, or shovels, shaped, and rolled before it has dried out. In case puddling is to be done after it has been spread upon the subgrade, the surface shall be thoroughly harrowed, plowed, or otherwise opened up during the process of sprinkling, in order to insure the proper puddling of the caliche. After thoroughly puddled, to the satisfaction of the engineer, the surface shall be shaped to a uniform thickness and cross-section, and the succeeding course of material shall be added and puddled in the same manner. Each succeeding course shall be placed and puddled as soon after the proceeding one as practicable.

53.5. The work shall be rolled or opened to traffic as directed. The contractor, as often as directed, shall work and dress the surface so that the

¹ Texas.

cross-section shall continue uniform and true to line and grade, and until the surface is smooth, hard, free from ruts and undulations and well bonded to the width shown on plans, and the work is accepted.

53.6. Methods of Measurement.—Work and accepted material hauled to the road shall be measured by the cubic yard, loose measurement, as delivered on the road.

53.7. Basis of Payment.—When a unit price for Caliche is requested and tendered in the proposal, the material furnished as prescribed by this item shall be paid for at the contract unit price so bid per cubic yard. When such price is not so requested, right-of-way charges and royalties on the material in the pit will be borne by the county. The work performed as prescribed for this item, measured as provided above, shall be paid for at the contract unit price bid per cubic yard for Caliche Surface Course, which price, shall be full compensation for loosening and loading all material at the pit, hauling not over $\frac{1}{4}$ mile, delivering on the road, puddling, and finishing, all labor, equipment, tools, and incidentals necessary to complete the work, except rolling, and sprinkling. Hauling material into each quarter mile beyond the first quarter mile shall be paid for at the contract unit price bid per cubic yard for Material Hauled Additional Quarter Mile.

Item 54. Disintegrated Limestone Surface Course¹

54.1. Description.—This item shall consist of a wearing course composed of disintegrated limestone, and shall be constructed on the prepared subgrade or completed base course in accordance with these specifications, and in conformity with the lines, grades, compacted thickness, number of component courses, and typical cross-section shown on the plans.

54.2. Material.—The material shall consist of a good quality of disintegrated limestone, reasonably free from soil and clay, and when loaded from the material pit shall not contain more than 25% of material which will pass a $\frac{1}{4}$ " mesh screen. The disintegrated limestone shall be such as can be loosened up in the pit by the use of plows or picks and without the use of explosives. Material containing gravel or hard flint pebbles will be admitted, although all hard stones over $1\frac{1}{2}$ " in their largest dimension, which will not be broken up during construction, must be thrown out at the pit by the contractor at his own expense.

54.3. Construction Methods.—The material shall be delivered, and spread by hand on the prepared subgrade, or completed course, to such depth that when compacted the thickness shown on the plans will be secured and shaped to conform to the typical cross-section. Side forms and either cubical blocks or center guide forms of proper size shall be used to fix the depth of the loose material. It shall be the charge of the contractor that the required amount of material shall be delivered in each 100' station and uniformly distributed throughout each station.

54.4. After the material has been spread and shaped, the surface shall be thoroughly sprinkled with water and rolled as soon as it has sufficiently dried off. The contractor, as often as directed, shall work and dress the surface so that the cross-section shall continue uniform and true to line and grade, and until the surface is smooth, hard, free from ruts and undulations, and well bonded to the width shown on plans, and the work is accepted. When the typical cross-section requires that this item be constructed in more than one course, each additional course shall be constructed independently after the previous one has been completed and accepted, all as prescribed above.

54.5. Method of Measurement.—Work and accepted material hauled to the road shall be measured by the cubic yard of material, loose measurement, as delivered on the road.

54.6. Basis of Payment.—When a unit price for Disintegrated Limestone is requested and tendered in the proposal, the material furnished as prescribed by this item shall be paid for at the contract unit price so bid per cubic yard; when such price is not so requested, right-of-way charges and royalties on the material in the pit will be borne by the county. The work performed as prescribed for this item, measured as provided above, shall be paid for at the contract unit price bid per cubic yard for Disintegrated Limestone Surface Course, which price shall be full compensation for loosening and loading all material at the pit, hauling not over $\frac{1}{4}$ mile, delivering on the road, puddling and finishing, all labor, equipment, tools, and incidentals

¹ Texas.

necessary to complete the work, except rolling, and sprinkling. Hauling material into each quarter mile beyond the first quarter mile shall be paid for at the contract unit price bid per cubic yard for Material Hauled Additional Quarter Mile.

Item 55. Iron-ore Topsoil Surface Course¹

55.1. Description.—This item shall consist of a wearing course composed of iron-ore topsoil, and shall be constructed on the prepared subgrade in accordance with these specifications and in conformity with the lines, grades, compacted thickness, number of component courses, and typical cross-section shown on plans.

55.2. Material.—Iron-ore topsoil shall consist of hematite, hydrated hematite, or limonite ore as found at the surface but of a quality free from vegetable matter, which when loaded from the material pit shall not contain more than 15 % of clay. The material shall be such as can be loosened up in the pit by the use of plows or picks and without the use of explosives. Material containing gravel or hard pieces of ore will be admitted, although all pieces over 1½" in their largest dimensions, which will not be broken up during construction, must be thrown out at the pit by the contractor at his own expense. The material shall have a cementing value of not less than 50 and be so graded that 40 to 75 % is retained on a 10-mesh screen when tested by laboratory methods.

55.3. Construction Methods.—The material shall be delivered and spread by hand on the prepared subgrade to such depth that when compacted the thickness shown on the plans will be secured and shaped to conform to the typical cross-section, and rolled if required. Side forms and either cubical blocks or center guide forms of proper size shall be used to fix the depth of the loose material. It shall be the charge of the contractor that the required amount of material shall be delivered in each 100' station and uniformly distributed throughout each station.

55.4. After the material has been spread and shaped, the work shall be rolled or opened to traffic as directed. If the material is of such a quality that it adheres to the wheels of the roller after sprinkling, the surface shall be sanded, the necessary material being measured as surfacing material. The contractor, as often as directed, shall work and dress the surface so that the cross-section shall continue uniform and true to line and grade and until the surface is smooth, hard, free from ruts and undulations and well bonded to the width shown on plans, and the work is accepted. When the typical cross-section requires that this item be constructed in more than one course, each additional course shall be constructed independently after the previous one has been completed and accepted, all as prescribed above.

55.5. Method of Measurement.—Work and accepted material hauled to the road shall be measured by the cubic yard, loose measurement, as delivered on the road.

55.6. Basis of Payment.—When a unit price for Iron-ore Topsoil is requested and tendered in the proposal, the material furnished as prescribed by this item shall be paid for at the contract unit price so bid per cubic yard. When such price is not so requested, right-of-way charges and royalties on the material in the pit will be borne by the county. The work performed as prescribed for this item, measured as provided above, shall be paid for at the contract unit price bid per cubic yard for Iron-ore Topsoil Surface Course, which price shall be full compensation for loosening and loading all material at the pit, hauling not over ¼ mile, delivering on the road, finishing, all labor, equipment, tools, and incidentals necessary to complete the work, except rolling, and sprinkling. Hauling material into each quarter mile beyond the first quarter mile shall be paid for at the contract unit price bid per cubic yard for Material Hauled Additional Quarter Mile.

Item 56. Pea-gravel Surface Course¹

56.1. Description.—This item shall consist of a wearing course composed of fine or pea gravel, and shall be constructed on the prepared subgrade, or completed base course, in accordance with these specifications and in conformity with the lines, grades, compacted thickness, number of component courses, and typical cross-section shown on the plans.

56.2. Material.—The gravel shall consist of hard, durable particles of stone mixed with sand or clay or similar binding material and when tested by laboratory methods shall fulfil the following requirements:

¹ Texas.

Passing the 1" screen.....	95-100 %
Retained on $\frac{1}{4}$ " screen.....	10- 35 %
Retained on 10-mesh sieve.....	35- 70 %

Of the material passing the 10-mesh sieve, 25 to 40 shall pass the 200-mesh sieve. The cementing value of the material passing the 10-mesh sieve shall not be less than 50.

56.3. Construction Methods.—The material shall be delivered in slab-bottom wagons or approved trucks, and uniformly dumped on the subgrade or completed course, spread to such depth that, when compacted, the thickness shown on the plans will be secured, harrowed if necessary, and shaped to conform to the typical cross-section. Each day's hauling shall be spread the same day. When the width of the base course is more than 12', the material shall be dumped in two equal rows. The thickness of the course as well as the material shall be strictly uniform. Side forms, and either center forms or cubical blocks, shall be used to fix the depth of loose material. All areas and "nests" of segregated coarse or fine material shall be removed and replaced with well-graded material and compacted.

56.4. The work shall be rolled and sprinkled, or opened to traffic as directed. Ruts shall be kept filled twice a day or more as directed. When irregularities, depressions, or weak spots develop during the process of shaping and setting up, the affected areas shall be corrected immediately by scarifying, adding material as needed, reshaping, and compacting. This process shall be continued, and the course maintained with grading machines or other equipment as required, to the required line, grade, and typical cross-section until the surface is smooth and hard, free from ruts and undulations, well bonded to the width shown on plans, and the work is accepted.

56.5. When the typical cross-section requires that this item be constructed in more than one course, each course shall be constructed independently after the previous one is completed and accepted. All as prescribed above.

56.6. Method of Measurement.—Work and accepted material shall be measured by the cubic yard of material, loose measurement, as delivered on the road.

56.7. Basis of Payment.—When a unit price for Pea Gravel is requested and tendered in the proposal, the material furnished as prescribed for this item shall be paid for at the contract unit price so bid, which price shall include all pit charges, screening, and freight f. o. b. delivery points. When such price is not requested the material will be furnished by the county free of royalty and right-of-way charges, and the contractor will be paid for Screening, as ordered, at the prices bid per cubic yard for Screening.

56.8. The work performed as prescribed for this item, measured as provided under Measurement, shall be paid for at the contract unit price bid per cubic yard for Pea-gravel Surface Course, which price shall be full compensation for loading all material, hauling not over $\frac{1}{4}$ mile, delivering on the road, spreading and finishing, all labor, equipment, tools, and incidentals necessary to complete the work, except screening, rolling, and sprinkling. Hauling into each quarter mile beyond the first quarter mile shall be paid for at the contract unit price bid per cubic yard for Material Hauled Additional Quarter Mile.

Item 57. Standard Gravel Surface Course¹

57.1. Description.—This item shall consist of a wearing course composed of gravel, and shall be constructed on the prepared subgrade, or completed base course, in accordance with these specifications and in conformity with the lines, grades, compacted thickness, number of component courses, and typical cross-section shown on the plans.

57.2. Materials.—The gravel shall consist of hard, durable particles of stone mixed with sand or clay or similar binding material, and when tested by laboratory methods shall fulfil the following requirements:

Passing 1" screen.....	95-100 %
Retained on $\frac{1}{4}$ " screen.....	50- 75 %

Of the material retained on the $\frac{1}{4}$ " screen, 35 to 75 % shall be retained on the $\frac{3}{8}$ " screen.

57.3. The material passing the $\frac{1}{4}$ " screen shall be known as "binder," and of this material 15 to 35 % shall pass the 200-mesh sieve. The cementing value of the binder shall be not less than 50.

¹ Texas.

57.4. The gravel may be crushed, and may be bank run, or the binder may be added and incorporated by approved methods as hereinafter specified.

57.5. **Construction Methods.**—The material shall be delivered in flat-bottom wagons or approved trucks and uniformly dumped on the subgrade or completed course, spread to such depth that, when compacted, the thickness shown on the plans will be secured, harrowed if necessary, and shaped to conform to the typical cross-section. Each day's hauling shall be spread the same day. When the width of the course is more than 12' the material shall be dumped in two equal rows. The thickness of the course as well as the material shall be strictly uniform. Side forms, and either center forms or cubical blocks, shall be used to fix the depth of loose material. All areas and "nests" of segregated coarse or fine material shall be removed and replaced with well-graded material and compacted.

57.6. If the gravel is deficient in binder as prescribed under Materials above, after it is spread and shaped, additional binder shall be furnished and applied in the amount directed by the engineer so as to comply with the grading requirements. Such binder shall be measured and paid for as provided for the normal gravel, and shall be carefully and evenly incorporated with the material in place as directed by the engineer.

57.7. The work shall be rolled and sprinkled, or opened to traffic as directed. Ruts shall be kept filled twice a day or more as directed. When irregularities, depressions, or weak spots develop during the process of shaping and setting up, the affected areas shall be corrected immediately by scarifying, adding material as needed, reshaping, and compacting. This process shall be continued, and the course maintained with grading machines or other equipment as required, to the required line, grade, and typical cross-section until the surface is smooth and hard, free from ruts and undulations, well bonded to the width shown on plans, and the work is accepted.

57.8. When the typical cross-section requires that this item be constructed in more than one course, each course shall be constructed independently after the previous one is completed and accepted, all as prescribed above.

57.9. **Method of Measurement.**—Work and accepted material shall be measured by the cubic yard of material loose measurement, as delivered on the road.

57.10. **Basis of Payment.**—When a unit price for Gravel for Surface Course is requested and tendered in the proposal, the materials furnished as prescribed for this item shall be paid for at the contract unit price so bid, which price shall include all pit charges, crushing, screening, and freight f. o. b. delivery points. When such price is not requested the material will be furnished by the county free of royalty and right-of-way charges, and the contractor will be paid for all Crushing and Screening or Screening, as ordered, at the prices bid per cubic yard for Crushing and Screening or for Screening.

57.11. The work performed as prescribed for this item, measured as provided under Measurement, shall be paid for at the contract unit price bid per cubic yard for Standard Gravel Surface Course, which price shall be full compensation for loading all material, hauling not over $\frac{1}{4}$ mile, delivering on the road, spreading and finishing, all labor, equipment, tools, and incidentals necessary to complete the work, except crushing, screening, rolling, and sprinkling. Hauling into each quarter mile beyond the first quarter mile shall be paid for at the contract unit price bid per cubic yard for Material Hauled Additional Quarter Mile.

TOP COURSE (NEW YORK STATE SPECIFICATIONS, ITEMS 47 to 55)

Item 47—Top Course—Water Bound Macadam—Gravel

47.1. Under this item the Contractor shall furnish and place upon the bottom course, gravel of an approved character to form the top course.

47.2. The top course shall consist of approved gravel of the character hereinbefore specified and of the thickness shown on the plans, together with the binder necessary to properly fill and bind the course. For this purpose gravel of No. 3 size with, when approved by the Engineer, a certain amount of No. 2 size, may be used. (See page 720 for meaning of these numbers as to size.) Run of bank gravel shall not be used except by written permission of the Division Engineer; this permit must be given in advance, shall specify the locality from which it is to be taken, and contain a proviso that if the material should at any time become unsatisfactory its use shall at once

cease and proper material be furnished without additional recompense even if it has to be imported. A copy of any such permit must be filed with the State Highway Commission, and on this permit must be the written and signed acceptance of all the conditions by the Contractor.

47.3. The gravel shall be spread evenly upon the bottom course, using cubical blocks for gauging, to such a depth as to insure the required thickness after it shall have been thoroughly rolled and compacted with an approved roller weighing 10 to 12 tons. Care shall be exercised to prevent any depressions or surface irregularities after rolling the gravel and binder.

47.4. When the gravel consists of screened material the binder shall consist of a mixture of the sand screened out and the No. 1 size, with enough clay added when necessary to make a percentage of 12 to 17, but not to exceed 17 per cent. The binder shall be added as directed by the Engineer and thoroughly swept into interstices thereof until they are filled. After sprinkling the surface it shall be thoroughly rolled. The adding of binder where necessary and the sweeping, sprinkling and rolling shall continue until the course is compacted. The pavement shall then be opened to traffic and shall be in a first-class and satisfactory condition at the time of its acceptance.

47.5. When the gravel consists of run of the bank the binder shall be the fine particles contained in the material in its natural state except that when so ordered in writing by the division Engineer a small percentage of clay or loam may be added, when necessary to properly bind the course.

The particles shall be of such size as will pass through a 3 $\frac{1}{2}$ -inch circular hole, and shall be well graded. Gravel shall be of such nature that the material passing a $\frac{1}{4}$ -inch screen shall not be more than five per centum (not feasible, see page 138) in excess of the voids in the remaining material after its separation therefrom. Should at any time during the work and for any reason the gravel fail to maintain suitable proportions of the coarse and fine particles, the Contractor shall by the addition of selected material and satisfactory manipulation produce a top course meeting the above requirements.

Care shall be taken to keep the large stone away from the surface.

After sprinkling the surface it shall be thoroughly rolled. Additional material for binder shall be added where necessary and the sprinkling and rolling shall continue until the course is compacted. The pavement shall then be opened to traffic and shall be in a first-class and satisfactory condition at the time of its acceptance.

47.6. The quantity to be paid for under this item shall be the number of cubic yards of compacted material in place in the completed course. The amount will be computed by multiplying the finished cross-section of the top course as shown on the plans or ordered by the Engineer, by the length of the top course measured along the axis of the pavement.

The price bid under this item shall include the furnishing, placing, rolling, filling, and puddling of the material, and all labor, material and incidental expenses necessary to complete the work.

Gravel or screenings remaining loose on the surface after the work is completed shall not be estimated as a part of the depth of the top course, but payment therefor shall be included in the price bid for this item.

Item 48—Top Course—Water Bound Macadam—Broken Stone

48.1. Under this item the Contractor shall furnish and place upon the bottom course broken stone to form the top course.

48.2. The top course shall, except as noted below, consist of No. 3 broken stone as shown on the plans and of the thickness shown thereon, together with the binder necessary to properly fill and bind the course. The binder shall consist of screenings and No. 1 stone mixed.

48.3. The No. 3 stone shall be spread evenly upon the bottom course, using cubical blocks for gauging, to such a depth as to insure the required thickness after it shall have been thoroughly rolled and compacted. Care shall be used in the spreading of the stone that no irregularities in the contour shall develop in the rolling; every such irregularity that does occur the Contractor shall remove before adding the smaller material. The rolling shall be done with a 10 to 12 ton self-propelled roller of approved pattern, and shall be continued until the layer of stone does not creep or wave ahead of the roller.

After the stone has been compacted to the satisfaction of the Engineer, a light coating of binder shall be spread on dry by shoveling from piles

previously placed alongside the pavement, and immediately swept in and thoroughly rolled. Care must be taken throughout to add the binder only in light coatings and to thoroughly sweep each coating in order that the maximum amount of binder may be worked in to fill the voids. The spreading and sweeping and rolling shall be continued until no more binder will go in dry, after which the macadam shall be sprinkled until saturated, the sprinkler being followed by the roller. If the sub-grade should become wet to such an extent that the pavement becomes unstable and waves under the roller, the roller shall be taken off and this portion left to dry out before puddling is resumed.

More screenings shall be added where necessary, and the sweeping, sprinkling, and rolling shall continue until a grout has been formed that shall fill all the voids and be pushed into a wave by the wheels of the roller. After the wave of grout has been produced over the whole section of the macadam this portion shall be left to dry out, after which it shall be opened to traffic. The macadam shall be repuddled and back-rolled on succeeding days as much as may be necessary to secure satisfactory results. The macadam shall then be covered with a wearing carpet of screenings at least three-eighths of an inch thick; this wearing carpet shall be maintained and renewed until the whole road is accepted. During all the working hours when the roller is not needed for rolling the fills, sub-grade, shoulders and unfinished courses of the pavement, it shall be employed in back-rolling the earlier portions of the macadam.

48.4. The quantity to be paid for under this item shall be the number of cubic yards of compacted material in place in the completed course. The amount to be estimated shall be computed by multiplying the finished cross-section of the top course as shown on the plans or ordered by the Engineer, by the length of the top course measured along the axis of the pavement.

The price bid shall include the furnishing, placing, rolling, filling and puddling of the material, and all labor, material and incidental expenses, necessary to complete the work.

No. 1 stone or gravel chips or screenings remaining loose on the surface after the work is completed shall not be estimated as a part of the depth of the top course, but payment therefor shall be included in the price bid for this item.

Item 49—Cleaning Old Pavement

49.1. The purpose of the work called for under this item is to prepare an old macadam or old concrete surface for the application of a new top course or a wearing carpet.

49.2. Under this item the Contractor shall clean the old macadam or concrete surface by the use of seal hand brooms or by the use of mechanical sweepers of approved type, as directed by the Engineer, so as to completely uncover but not dislodge the embedded stones of the pavement.

All mud, dust, and other dirt so swept off shall then be removed and deposited in such places and in such manner as the Engineer may direct.

49.3. Ruts and depressions of a greater depth than one inch below the general surface of the pavement shall be completely swept out by hand brooms until all loose material has been removed and the embedded stones are fully uncovered.

This operation of cleaning out the ruts and depressions and filling them with thoroughly compacted stone and binder to the general level of the surface, shall precede the general operation of cleaning the macadam surface.

49.4. The amount to be paid for under this item shall be the actual number of square yards of old macadam or concrete, including ruts and depressions, cleaned in accordance with the above sections and to the satisfaction of the Engineer.

The price bid shall include all labor, tools, appliances, the removal of material cleaned from the surface, and all other expenses incidental thereto.

Item 50—Scarifying and Reshaping Old Macadam

50.1. The purpose of the work under this item is to prepare old macadam pavement for the application of a top course.

50.2. Under this item the Contractor shall thoroughly scarify the old macadam by hand picking or by means of a mechanical scarifier of approved type. Unless specifically authorized by the Engineer, the use of a roller with spiked wheels will not be permitted.

The loosened stones shall then be forked or raked over as directed by the Engineer, after which the macadam shall be compacted by rolling with a self-propelled roller weighing not less than 10 tons until an even and firm surface is produced. If necessary in order to satisfactorily compact the stones, the macadam shall be sprinkled during the process of rolling.

50.3. The quantity to be paid for under this item shall be the actual number of square yards, scarified, reshaped, rolled and compacted to the satisfaction of the Engineer, and the price stipulated shall include all labor appliances and expenses incidental thereto.

Item 51—Surface Treatments with Bituminous Material

51.1. Under this item the Contractor shall apply bituminous material and shall apply broken stone or gravel of specified sizes as a wearing carpet to a new or old pavement of macadam, concrete, or any other substance or type, as shown on the plans or ordered by the Engineer.

51.2. If the pavement to be treated is a newly built macadam or concrete, after it shall have become thoroughly dried and hardened, it shall be swept clean of all dust, dirt or other loose material; if ordered by the Engineer, the sweeping of the macadam shall be continued until the voids are exposed in the surface to a satisfactory depth, not exceeding one-half inch. The price bid, under this item, shall include the aforesaid cleaning of the pavements.

If the pavement to be treated is an old macadam or old concrete, the cleaning shall be paid for under item "Cleaning Old Pavement."

51.3. After the pavement shall have been cleaned to the satisfaction of the Engineer, and when dry, the bituminous material shall be uniformly sprayed over the surface by means of an approved pressure distributor. The bituminous material for hot application shall be heated to a temperature between 250 degrees and 350 degrees F. as required, and when tar is used, it shall be heated to a temperature between 200 degrees and 250 degrees F. as required.

The amount of bituminous material to be used in any one application shall not be less than one-sixth nor more than one-half gallon per square yard, the precise quantity depending upon the character of the pavement, the materials and the local conditions. The Contractor shall, therefore, be subject entirely to the direction of the Engineer in this respect.

51.4. The bituminous material applied as above specified shall then be immediately covered, while soft, with a uniform layer of approved broken stone of No. 2 or No. 1 size, after which the stone shall be rolled with a self-propelled roller of approved weight. If ordered by the Engineer another application of bituminous material shall then be made to be followed by an application of approved No. 2 stone or approved No. 1 stone, and again rolled to the satisfaction of the Engineer.

The quantity of No. 2 stone and of No. 1 stone to be used shall be sufficient to completely cover the bituminous material and shall be spread in two or more thin applications, the roller being used after each spreading. The total amount of stone to be used after each application of the bituminous material being that which will become imbedded under the pressure of the roller. The final application of the stone shall be of No. 1 size.

51.5. Gravel, which has been tested and approved for use, may be substituted for broken stone if screened to produce particles corresponding with No. 2 and No. 1 sizes.

51.6. No bituminous material for surface treatment shall be placed between October 15th and May 15th, except by written permission of the Engineer, nor when the air temperature on the work is below 50 degrees F., nor when the pavement is damp or in an otherwise unsatisfactory condition.

51.7. Under this item the Contractor shall be paid for the number of gallons of bituminous material furnished in and incorporated in the work in accordance with these specifications and the orders of the Engineer. Bituminous material, that has been wasted or that has been rendered unfit for use by over-heating or by long-continued heating, shall not be paid for. For purposes of measurement, a gallon shall be a volume of

231 cubic inches and measurement shall be based on the volume of the bituminous material at a temperature of 60 degrees F.

The price bid shall include the furnishing, hauling, heating and applying the bituminous material, and shall also include the spreading, rolling and incorporation of the stone into the wearing carpet.

This item shall not include the furnishing of the No. 1 and No. 2 stone or gravel, nor the delivery of same along the side of the road; these will be paid for under Items Screened Gravel or Broken Stone Loose Measure, respectively.

Item 52—Top Course Bituminous Macadam—Penetration Method

52.1. Under this item the Contractor shall furnish and lay a broken stone top course composed of fragments of the specified sizes, and incorporate therewith bituminous material introduced from the surface by means of an approved pressure distributor.¹

¹ Hand spreading from pots or hods is more satisfactory for the first coat but not for the flush coat.

52.2. After the bottom course shall have been completed to the satisfaction of the Engineer, a course of approved No. 3 broken stone shall be evenly spread thereon in such quantity that after the application of the bituminous material and broken stone of smaller sizes, hereafter specified, the final compacted thickness of the top course shall be as called for on the plans or ordered by the Engineer.

The No. 3 stone shall then be smoothed out by passing over it a few times a self-propelled roller weighing approximately 10 tons, after which bituminous material of the kind specified in the proposal, heated to a temperature between 250 degrees and 350 degrees Fahrenheit if asphalt is used, and between 200 degrees and 250 degrees if tar is used, shall be evenly spreading over the surface. The quantity of bituminous material to be used in the first application shall be the amount ordered by the Engineer, which will approximate 1 $\frac{3}{4}$ gallons per square yard for a top course 3 inches thick, with a proportional reduction in the quantity for thinner courses.

The surface shall then be immediately covered with a layer of approved No. 2 broken stone, after which it shall be compacted with a self-propelled roller weighing approximately 10 tons; during the rolling process, additional No. 2 broken stone shall be applied and broomed about until the voids in the No. 3 stone are entirely filled.* The rolling shall be continued until the course of stone is thoroughly compacted and its surface is true and even to the established grade and conforms in all respects to the requirements specified for finishing and testing the surface of "Top Course Bituminous Macadam, Mixing Method—Type 1."

52.3. After this portion of the work shall have been completed to the satisfaction of the Engineer, all loose stone shall be swept from the surface and a sealing coat of one-half gallon of bituminous material per square yard shall be applied by means of an approved pressure distributor. After this it shall be immediately covered with approved No. 1 broken stone, spread and broomed about by experienced workmen, and again rolled; the rolling shall be continued and additional No. 1 stone shall be applied until a smooth, uniform surface is produced.

52.4. Before being opened to traffic a layer of No. 1 broken stone approximately one-half inch thick shall be spread loose on the surface for wearing course.

52.5. The quantity to be paid for under this item shall be the number of cubic yards of compacted material in place in the completed course. The amount to be estimated shall be computed by multiplying the finished cross-section of the top course, as shown upon the plans or ordered by the Engineer, by the length of the top course measured along the axis of the pavement.

The price bid shall include the heating and placing of the bituminous material, the furnishing, placing, rolling and filling of the broken stone, and all labor, materials, and incidental expenses necessary to complete the top course.

This item shall not include the furnishing and delivery of the bituminous

* Too much rolling is injurious while the oil is hot; better results are obtained by waiting till the next day to compact; the course should be rolled early in the morning for 10 days and gradually hardened down.

material; such furnishing and delivering will be paid for under the item covering such material.

No. 1 broken stone or gravel, chips or screenings remaining loose on the surface after the work is completed shall not be estimated as a part of the depth of the top course, but payment for these shall be included in the price bid for item 52.

Item 47. Top Course. Bituminous Macadam, Penetration Method

a. **Work.**—Under this item the contractor shall furnish and lay a broken stone or broken-slag top course composed of fragments of the specified sizes, and incorporate therewith bituminous material applied by means of a pressure distributor of an approved type. The laying of this course will not be allowed after Oct. 15 except under the written permission of the engineer and the approval of the Deputy Commissioner.

b. **Method.**—After the bottom course shall have been completed to the satisfaction of the engineer, a course of clean approved No. 3 broken stone or broken slag shall be evenly spread thereon in such quantity that before the application of the bituminous material and broken stone or broken slag of small sizes, hereafter specified, the compacted thickness of the top course shall be as called for on the plans.

No stone with dust coating will be permitted for use in this course. If any stone spread for this course becomes wet or dirty, it must be allowed to dry to the full depth of the course, and dirty stones removed and replaced with clean stone before the pouring of bituminous material proceeds.

All filler for the top course shall be delivered and piled alongside the road before the top course is placed.

The No. 3 stone or slag shall then be compacted by passing over it a self-propelled roller weighing approximately 10 tons, after which bituminous material of the kind specified in the proposal (heated to a temperature between 200 and 300°F. when tar is used and between 250 and 325°F. when asphalt is used) shall be evenly spread over the surface by the use of an approved pressure distributor, operating under a pressure of 50 lb. per square inch or more as the engineer may direct. The quantity of bituminous material to be used in the first application shall be the amount ordered by the engineer, which will approximate 2 gal. per square yard for a compacted top course 3" thick, with a proportional reduction in the quantity for thinner courses.

In order to insure uniformity at the junction point of two applications, it will be required that the distributor should in starting lap back on the previous application, covering the lap with building paper, to avoid either an excess or an insufficient quantity at the junction point. The paper shall then be removed and destroyed.

The surface shall then be immediately filled with clean No. 1 broken stone or broken slag, after which it shall be compacted with a self-propelled roller weighing approximately 10 tons; during the rolling process, additional broken stone as specified above or broken slag shall be applied and broomed about until the voids in the No. 3 stone or slag are entirely filled. The rolling shall be continued until the course of stone or slag is thoroughly compacted and its surface is true and even to the established grade.

c. **Testing Surface.**—Before placing the sealing coat, the pavement shall be tested with a 10' straight-edge laid parallel with the center line of the pavement, and any depressions exceeding $\frac{1}{4}$ " shall be satisfactorily eliminated or the pavement relaid.

d. **Sealing Coat.**—After this portion of the work shall have been completed to the satisfaction of the engineer, all loose stone or slag shall be swept from the surface and a sealing coat of approximately $\frac{3}{4}$ gal. of bituminous material per square yard shall be applied by means of an approved pressure distributor. After this it shall be immediately covered with approved No. 1 broken stone or slag, spread and broomed about by experienced workmen, and again rolled; the rolling shall be continued and additional No. 1 stone or slag shall be applied until a smooth, uniform surface is produced.

e. **Wearing Carpet.**—Before being opened to traffic a layer of No. 1 broken stone or slag approximately $\frac{1}{4}$ " thick shall be spread loose on the surface for wearing course. After the road has been open to traffic for 10 days, or as the engineer may direct, this wearing carpet shall be again spread by sweeping the surplus from the sides to the center of the pavement.

f. **Measurement and Payment.**—The quantity to be paid for under this item shall be the number of cubic yards of compacted No. 3 stone or slag

which shall be computed by multiplying the finished cross-section of the top course, as shown upon the plans or ordered by the engineer, by the length of the top course measured along the axis of pavement, making no deduction for catch basins and manholes.

The price bid shall cover the heating and placing of the bituminous material, the furnishing, placing, rolling, and filling of the broken stone or broken slag, and all labor, materials, and incidental expenses necessary to complete the top course.

This item shall not cover the furnishing and delivery of the bituminous material; such furnishing and delivering will be paid for under the item covering such material.

No. 1 broken stone or slag shall not be estimated as a part of the depth of the top course, but payment for same shall be included in the price bid for

SURFACE TYPE FA-BC-2

75J. FINE AGGREGATE. BITUMINOUS CONCRETE

Two Course

1. DEFINITION.

A bituminous concrete pavement is defined as one which is composed of clean stone, bituminous sand and a mineral filler, bound together with bituminous cement.

2. THICKNESS AND WEIGHT.

This pavement shall be laid in two courses—the top or wearing course and the bottom or binder course. The top course must have an average thickness, after ultimate compression, of not less than one and one-half (1½) inches, shall not be less than one and one-quarter (1¼) inches nor more than two (2) inches thick at any point, and have an average weight of not less than one hundred eighty-five (185) pounds per square yard, exclusive of the squeegee coat. The bottom course shall have an average thickness, after ultimate compression, of not less than one and one-half (1½) inches and shall not be less than one and one-quarter (1¼) inches nor more than two and one-half (2½) inches thick at any point, and have an average weight of not less than one hundred seventy (170) pounds per square yard of surface.

3. MATERIALS REQUIRED.

The binder course shall be prepared from ¾-in. trap rock, dolomite or . . . bituminous sand, mineral filler, and asphaltic cement Grades NA², LM², CM¹ or

The surface course shall be prepared from dustless screenings made from trap rock, dolomite or bituminous sand, mineral filler and asphaltic cement Grades NA², LM², CM², or

These materials shall comply with the requirements given therefor in Articles 92, 95-A and 99.

4. COMPOSITION.

The finished pavement, exclusive of any bituminous sealing mixture applied, shall not vary in composition more than the limits given below:

Screens and sieves		Type of openings	Bottom course		Top course	
Passing	Retained on		Minimum, %	Maximum, %	Minimum, %	Maximum, %
1½-in.	1-in.	Circular	0.0	25.0		
1-in.	¾-in.	Circular	40.0	70.0	0.0	15.0
¾-in.	½-in.	Circular	5.0	20.0	20.0	45.0
½-in.	10-mesh	Square	0.0	15.0	10.0	25.0
10-mesh	30-mesh	Square	3.0	10.0	6.0	18.0
30-mesh	50-mesh	Square	4.0	8.0	6.0	12.0
50-mesh	80-mesh	Square	4.0	8.0	6.0	12.0
80-mesh	200-mesh	Square	3.0	12.0	5.0	11.0
200-mesh	Square	2.0	8.0	5.0	8.0
Total stone content ret. on 10-mesh.			75.0	90.0	50.0	70.0
Bitumen content			4.0	5.5	6.0	8.0

5. ESTIMATING INGREDIENTS.

The proportions of the different ingredients required to prepare the pavement shall be determined by weight. The pavement must not vary in composition more than the specified limits given.

The bitumen content is based upon the finished pavement, exclusive of any mineral or bituminous surface coating applied. The exact amount of mineral filler and asphaltic cement to use between the limits defined herein shall be determined by the Testing Engineer. In calculating the percentages of the various sizes of ingredients of which the mineral aggregate is composed, the bitumen is included. The actual amount of paving mixture used shall be estimated from the railroad shipping weights of the ingredients used, batches of paving mixtures prepared and used, or loads delivered and laid.

6. PREPARATION.

The quantity of ingredients used per batch in the preparation of both the top and bottom courses must be accurately determined by either weight or measurement, depending upon the type of plant and kind of material being used. In either case the devices used in measuring these ingredients must be standardized whenever so requested, also the manner in which these devices are used shall be demonstrated and the quantity of material thus secured verified, whenever so ordered by the Inspector or Engineer. The plant used in preparing the paving mixtures shall comply with the requirements given below.

The mineral filler should be so cast into the mixing chamber that it is evenly distributed over the surface of the aggregate and not dumped in one end of the mixing chamber. The asphaltic cement should also be added slowly in a thin sheet the full width of the mixing chamber. If the filler and asphaltic cement are not added in this manner, the time required to produce a uniform paving mixture will be two (2) or more minutes per batch, otherwise, from one (1) to one and one-half (1½) minutes will be sufficient.

(a) Wearing Surface. The aggregate for the wearing surface must have a temperature of not less than 275°F. nor more than 350°F. when ready to be coated with the asphaltic cement. The asphaltic cement, when applied to the aggregate, must have a temperature of not less than 250°F. and not more than 350°F., and must be free from unmelted lumps. The mineral filler may be added cold and must be thoroughly dry.

In the preparation of this mixture the aggregate is first added to the mixing chamber, then the mineral filler. After the mineral filler has become uniformly distributed through the aggregate the asphaltic cement is added and the mixing continued until a bituminous mixture is secured that is uniform and homogeneous in composition and all the particles of the aggregate are uniformly and completely coated with the hot asphaltic cement.

(b) Binder Course. The aggregate for the binder course must have a temperature of not less than 250°F. nor more than 350°F. when ready to be coated with the asphaltic cement. The asphaltic cement shall have the same temperature when applied as specified for the wearing surface. No mineral filler is required in the binder.

In preparing the binder course, the stone and sand are run into the mixing chamber and the asphaltic cement added as soon as the sand is thoroughly incorporated with the stone. The mixing is continued until all particles of the aggregate are completely coated with hot asphaltic cement and the mixture is uniform and homogeneous in composition. Care must be exercised in the preparation of this binder that the aggregate does not get too hot, that excess fine material or asphaltic cement are not used if rich spots in the binder are to be avoided.

7. HAULING AND HANDLING.

The paving mixtures must be kept clean during hauling and handling and covered during transit with canvas or other materials which will retain their temperature. These mixtures must not be hauled such a distance that segregation of the ingredients takes place or that a crust is formed on the surface, bottom or sides of said mixture which has a temperature lower than that required. These mixtures must not be dumped any faster than they can be properly handled by the shovelers nor at such a rate that over six (6) tons of paving mixture are upon the platforms at the same time. They must be spread immediately after being dumped and must be kept perfectly clean until spread. Any part of the paving mixture which becomes dirty or chilled below the required temperature must be rejected. All paving mixture must be carefully removed from the spot upon which it was placed before any additional paving mixture is placed thereon.

The mixture for the wearing surface, when dumped on the platforms, must have a temperature between 272°F. and 350°F.; for the binder course, between 250°F. and 325°F. Any portions of the wearing surface mixture that become chilled below 250°F. or of the binder below 225°F. before being spread shall be discarded.

These paving mixtures may be dumped direct on a concrete foundation, but when the foundation is macadam or telford they shall be dumped on metal or wooden platforms which must be of such size that the paving mixture will not fall off when dumped thereon or work off during spreading. The wearing surface mixture may be dumped on the binder. However, each load of paving mixture must be dumped outside of the area over which it will be spread.

All vehicles used in transporting paving mixtures must have tight-fitting bottoms which will hold hot, thin mixtures without leaking. When motor trucks are used the bodies should be insulated for long hauls during cold weather so that the paving mixtures adjacent the ends and sides will not become chilled during transit. All motor trucks used for this purpose must have dump bodies that will permit the rapid unloading of these mixtures. The inside surface of these bodies should be oiled just before loading. However, only sufficient of this oil shall be used to coat the surface. No pools of oil must appear on the bottom of the truck.

8. SPREADING AND RAKING.

Immediately after the paving mixture has been dumped upon the platform, it shall be deposited at once upon the foundation or binder with hot shovels in such a manner that any segregation of the ingredients or irregularities in composition will be eliminated as much as possible. After being thus deposited it shall be so spread with hot iron rakes that after being thoroughly compacted by tamping and rolling each course shall have the average thickness, surface finish and contour specified.

During spreading and raking the workmen must not walk over or stand on the paving mixture except when necessary to correct irregularities in the initial raking. The paving mixture shall not be spread any faster than it can be properly handled by the rakers.

(a) Binder. The binder course shall only be rolled sufficient to properly compact and bind together the ingredients of the aggregate; also to disclose any open spots or low places. When any depressions are discovered they shall be filled with additional binder and rerolled so that the surface of this binder course shall be of a uniform character, at the required grade and have the specified crown.

The surface of the binder course after compression shall not show in any place an excess of asphaltic cement or fine matrix, and any area of one square foot or more showing an excess of asphaltic cement shall be cut out and replaced with proper binder. Smaller spots may be dried by the use of stone dust and smoothing irons.

After being spread and rolled as above specified the binder course must be protected from all travel and be kept perfectly clean until the top course has been applied. If any part of the binder course shows a lack of bond, becomes loose or broken or gets covered with dirt it must be replaced with proper material, laid in accordance with the requirements given.

The binder course after being properly constructed should be covered immediately with the top course. In no case shall more binder be laid during any one day than can be covered by the top course during the same day. No binder course should be left uncovered during the night. If it becomes coated with dust or dirt when left so uncovered it must be swept clean or replaced with proper material as the Engineer may direct, before any surface course is applied thereto.

(b) Surface.—Special care must be used in spreading and raking the wearing surface if porous spots, depression or projections are to be eliminated. For this purpose the Contractor shall employ not less than (3) rakers for each one hundred (100) square yards of surface pavement laid per hour. Additional rakers must be employed when a greater quantity of pavement is being laid per hour.

The rolling of the wearing surface mixture must be so executed that porous spots will be eliminated, the formation of waves and depressions prevented and the required density and surface finish secured.

Whenever the pavement is laid along side of brick or concrete gutters, street car tracks, man-hole heads or liners, the finished surface adjacent to them shall be left one-quarter ($\frac{1}{4}$) of an inch higher in order to provide for

subsequent compression by traffic and to avoid depressions which would otherwise be liable to occur at these points.

9. ROLLING.

After the paving mixtures have been properly spread and raked they shall be rolled as soon as they will bear the roller without undue displacement or hair cracking. Delays in the initial rolling of the freshly raked mixtures will not be permitted. In all places inaccessible to a roller, such as adjacent to curbs, gutters, headers, man-holes, etc., the required compression shall be secured with hot tampers.

The initial and final rolling of the binder course shall be done with a six (6) to eight (8) ton tandem roller or a ten (10) to twelve (12) ton three-wheel power roller. The initial rolling of the top course or wearing surface shall be done with a five (5) ton tandem roller, but final compression shall always be secured with an eight (8) to ten (10) ton tandem roller or a ten (10) to twelve (12) ton three-wheel power roller when the Engineer permits or requires the use of this type of roller.

When more than one hundred (100) square yards of wearing surface are laid per hour, two (2) rollers shall be kept in use, one of which shall be of the finishing size. An additional finishing roller will be required for each additional one hundred (100) square yards of wearing surface laid per hour. All rollers used shall be kept in good condition and shall weigh not less than two hundred (200) pounds to the inch width of tread. Each roller shall be in the charge of a competent experienced roller Engineer and must be kept in continuous operation as nearly as practicable. During an 8-hour day each roller must be engaged in actual rolling for not less than six and one-half (6½) hours, not more than one and one-half (1½) hours being allowed for cleaning fires, watering, etc. The ashes from the roller must not be dumped upon the binder or wearing surface courses.

The surface of the wheels of the roller must be kept clean at all times and either oiled or wet with water as ordered by the Engineer. When the use of water is permitted, it shall not be applied in such quantity that surplus water will run off of the wheels of the roller onto the pavement.

During the initial rolling of both the top and bottom courses, the roller shall travel parallel to the axis of the pavement, beginning at each edge and working towards the center. Each trip of the roller shall overlap the preceding one about one-half (½) the width of the roller. Alternate trips of the roller should be of slightly different lengths. Subsequent rolling shall be both diagonal and parallel to the axis of the pavement. The rolling shall be continued at the rate of not more than one hundred fifty (150) square yards of wearing surface per hour for each roller of the finishing size. The roller must not pass off the pavement during rolling, nor stand on the completed pavement which has not cooled to normal temperature.

The rolling should be so executed that all parts of the pavement will receive equal compression; also develop any low or high spots caused by improper spreading and raking. The surface of low spots or depressions shall be roughened with a hot rake, additional material added thereto and rerolled immediately. Excess material shall be removed from the high spots. Such repairs should be made as soon after the initial rolling as possible while the pavement is yet fairly soft.

10. SEAL COAT.

As soon as possible after the rolling of the mixture is finished and while the surface is yet fresh, clean and hot, a seal coat of bituminous cement shall be spread thereon. The cement used for this purpose shall be the same as used in preparing the pavement mixture. It shall be applied at a temperature between 250°F. and 350°F. from a squeegee distributor, and then evenly spread with rubber squeegees. Only sufficient cement shall be used to coat the surface and fill the surface voids without leaving an excess on the surface. Immediately over this a top dressing of dustless screenings or pea gravel, or a mixture thereof, shall be uniformly spread and rolled into the surface. Some surplus of this dressing shall be left on the surface.

11. SURFACE FINISH.

The surface of the finished pavement must substantially conform to the grade and contour specified and shall be free from depressions or projections which are one-quarter (¼) of an inch above or below the established grade as determined by a straight edge, five (5) feet in length, laid parallel to the axis of the road. It must be uniform in density and composition, thoroughly bonded together and water tight, and be free from porous or rough spots that will remain wet after the balance of the surface is dry. Such portions

of the completed pavement as are defective in finish, or that do not comply in all respects with the requirements of these specifications, shall be taken up, removed and replaced with suitable material, properly made and laid in accordance with the requirements of these specifications at the expense of the Contractor.

12. JOINTS.

The paving shall be so done that the number of joints required shall be reduced to a minimum. When a rope joint is not used the edges of the previously laid pavement shall be cut off in a straight line far enough back from the edge to insure that the wearing surface has the required thickness. The cut shall be made at a slight angle to the pavement surface and present a smooth unbroken edge. The face of the joint shall be painted with bituminous cement, after which the hot bituminous mixture shall be raked over it to the proper depth. Hot smoothers or tampers shall be carefully employed in such manner as to insure the proper bond between the two (2) paving mixtures without burning or injuring either. The finished joint must be on the same plane as the adjacent finished pavement surface. Joints which are above or below the general plane of the pavement surface must be brought to the proper grade or remade.

The faces of all curbs and gutters, iron castings or other objects projecting through the pavement shall be painted with hot bituminous cement before the adjoining paving mixture is laid. The adjacent paving mixture shall be compressed by ramming with hot tampers when the required compression cannot be secured with the roller.

13. FOUNDATION, CONDITION OF.

The foundation, when a bituminous pavement is applied thereon, must be dry, clean, free from all frost, and have a temperature above 32°F. at the point where the paving mixture is being laid. It must substantially conform to the grade and crown specified, and comply with the requirements given for the type of foundation being used. When a foundation is in the proper condition to receive a paving mixture it must be protected from all travel that will injure, deface or carry foreign material upon it.

14. EDGE PROTECTORS.

When the edges of pavements are not protected by a concrete or stone curb or header, four (4) to six (6) inch planks of the same thickness as the finished pavement must be used for this purpose, which shall be firmly secured and left in place until the pavement has been properly rolled and thoroughly set.

15. CONSTRUCTION SEASON.

The pavement shall be laid between the first day of May and the first day of December, unless written permission is secured from the Department to lay pavement at any other time. No pavement shall be laid when it is raining or when the atmospheric temperature is below 32°F., or when the weather is such as to make it very difficult to lay the paving mixture in a manner which will permit the proper density and surface finish being secured.

16. WORKMEN.

The workmen employed by the Contractor must have had sufficient experience in the preparation of bituminous paving mixtures and the construction of bituminous pavements to be able to operate the equipment in such a manner that the pavement produced will have the required composition, density and surface finish. The men operating the mixing plant, the spreaders, rakers and roller men must show by the work completed that they have had the necessary experience and are making the proper effort to execute the work in the manner required by these specifications. Otherwise, their services will have to be dispensed with by the Contractor.

17. PLANT AND EQUIPMENT.

The plant used in preparing all bituminous paving mixtures must be of the batch type, capable of mixing in the manner herein specified not less than ten (10) tons of the paving mixture for each mixer per hour, and must be provided with separate chambers for heating and mixing the ingredients. No direct heat except steam shall be applied to the exterior surface of the mixing chamber or flame through the same. The aggregate shall be heated in a revolving kiln. The heat must be so regulated that the aggregate can easily be heated to and maintained to the required temperature. The temperature of the uncoated heated aggregate shall be determined by an electric pyrometer, so placed at the discharge chute of the dryer as to register automatically the temperature thereof.

All mixing plants which do not dry and heat the aggregate in unit batches must be equipped with a twin-pug mixer, rotary screen, storage bins, hopper and scales.

The rotary screen must separate the aggregate into two or more sizes, exclusive of tailings. This screen must be not less than five (5) feet in length and contain the size openings necessary to produce a paving mixture of the composition herein specified.

The main bin into which the hot screened aggregate falls must be divided to correspond to the different sized openings in the rotary screen, and be so arranged that the aggregate from each size screen will pass into its respective bin without getting into the adjacent sub-bins. Each sub-bin must be provided with an overflow that will prevent excess material being accumulated in any one sub-bin. An overflow must also be provided to prevent all material larger than that permitted to be used in the pavement under construction from falling into any of the bins.

Each sub-bin must have a separate outlet with a gate at the bottom, and so arranged that any definite quantity of aggregate can be drawn therefrom. The hopper into which the hot aggregate is drawn must rest upon a set of scales so arranged that any definite weight of material can be weighed out of each sub-bin.

The mixer must be capable of holding and properly mixing at least a one thousand (1000) pound batch of paving mixture. Each plant, regardless of the type of mixer used, must have at least two asphalt kettles holding not less than six hundred (600) gallons each, and an asphalt thermometer for use therewith. The heat must be applied to these kettles in such a manner that the asphalt cement will be uniformly heated without being burned or decomposed.

The asphalt carrier used to measure and apply the asphalt cement must be balanced upon a set of scales. It shall be so arranged that the asphalt cement can be easily and quickly weighed and poured in a thin sheet between the two lines of paddles the full width of the mixer.

When a squeegee distributor is required to be used, it must be designed for this particular purpose. All equipment and methods used in the preparation and construction of the pavement must be approved by the Engineer before being used on this contract.

18. FIELD LABORATORY.

The Contractor shall provide and keep in good order at the plant the following testing equipment which may be used by the Engineer or Inspector.

1 Penetration Machine Complete with Dishes, Thermometer, Needles, Stop Watch, etc.

1 Laboratory Sand Scale, 500-gr. capacity.

1 Set 6- to 8-in. Sieves, containing the following: Sizes 10, 20, 30, 40, 50, 80 and 200 meshes, with bottom pan and cover.

1 Set 6- to 8-in. Screens, $1\frac{1}{4}$, 1, $\frac{3}{4}$, $\frac{1}{2}$ and $\frac{1}{4}$ in.

2 6-in. Pointed Trowels.

2 6- to 8-in. Steel Spatulas.

2 Brushes.

2 Or more Inspectors' Armor Asphalt Thermometers.

1 Roll Pat Test Paper.

The above equipment must be standard type and approved by the Testing Engineer. The Contractor shall also provide a field laboratory in which to house and use the above equipment, said laboratory to be not less than ten (10) feet wide, twelve (12) feet long and seven (7) feet high, floored, contain not less than two windows and work bench with the necessary drawers; this laboratory to be used exclusively for testing purposes by the Contractor, Engineer or Inspector.

SURFACE TYPE S. A.

75C. SHEET ASPHALT

Two Course

1. DEFINITION.

A sheet asphalt pavement is one in which the wearing surface is composed of bituminous sand and mineral filler, bound together with an asphaltic cement. It is usually laid in two courses—the top or wearing surface and the bottom or binder course.

2. THICKNESS AND WEIGHT.

The top course must have an average thickness after ultimate compression of not less than one and one-half inches ($1\frac{1}{2}$ "), shall not be less than one

and one-quarter inches ($1\frac{1}{4}$ ") nor more than two inches (2") thick at any one point, and shall have an average weight of not less than one hundred fifty (150) pounds per square yard.

The bottom course shall have an average thickness after ultimate compression of not less than one and one-half inches ($1\frac{1}{2}$ "), shall not be less than one and one-quarter inches ($1\frac{1}{4}$ ") nor more than two and one-half inches ($2\frac{1}{2}$ ") thick at any one point, and shall have an average weight of not less than one hundred seventy (170) pounds per square yard.

3. MATERIALS REQUIRED.

The top or wearing surface shall be prepared from bituminous sand, mineral filler and asphaltic cement, Grade LM¹, CM¹, NA¹ or.....

The bottom or binder course shall be prepared from $\frac{3}{4}$ -in. trap rock, dolomite or..... bituminous sand and asphaltic cement, Grades LM¹, CM¹, NA¹ or.....

These materials shall comply with the requirements given in Articles 92, 95A, 97 and 99.

4. COMPOSITION.

The finished pavement must not vary in composition more than the limits given below:

Screens and sieves		Type of opening	Bottom course		Top course	
Passing	Retained on		Minimum, %	Maximum, %	Minimum, %	Maximum, %
$1\frac{1}{2}$ -in.	1-in.	Circular	0 0	25.0		
1-in.	$\frac{1}{2}$ -in.	Circular	40 0	70.0		
$\frac{1}{2}$ -in.	$\frac{1}{4}$ -in.	Circular	5 0	20 0		
$\frac{1}{4}$ -in.	10-mesh	Square	00 0	15.0	2.0
10-mesh	30-mesh	Square	3 0	10 0	10 0	30.0
30-mesh	50-mesh	Square	4 0	8.0	15.0	30.0
50-mesh	80-mesh	Square	4.0	8.0	15.0	30.0
80-mesh	200-mesh	Square	3.0	12.0	12.0	28.0
200-mesh filler	..	Square	0.0	5.0	12 0	20.0
Total stone content—retained on 10-mesh.....			75 0	90.0	0.0	2.0
Bitumen content.....			4.0	5.5	10.5	12.5

5. ESTIMATING INGREDIENTS.

The proportions of the different ingredients required to prepare the pavement shall be determined by weight. The pavement must not vary in composition more than the specified limits given.

The bitumen content is based upon the finished pavement, exclusive of any mineral or bituminous surface coating applied. The exact amount of mineral filler and asphaltic cement to use between the limits defined herein shall be determined by the Testing Engineer. In calculating the percentages of the various sizes of ingredients of which the mineral aggregate is composed, the bitumen is included. The actual amount of paving mixture used shall be estimated from the railroad shipping weights of the ingredients used, batches of paving mixtures prepared and used, or loads delivered and laid.

SURFACE TYPE A 75L. AMIESITE BITUMINOUS CONCRETE

Two Course

1. DEFINITION.

A bituminous concrete pavement is defined as one which is composed of clean stone, bituminous sand and a mineral filler, bound together with bituminous cement.

2. THICKNESS AND WEIGHT.

This pavement shall be laid in two (2) courses; the bottom, or binder course, and the top, or wearing course, in the ratio of not less than two (2) nor more than three (3) parts of bottom course as one (1) part of top, by weight. The finished pavement must be not less than two (2) nor more than three (3) inches thick at any point after ultimate compression, and weigh not less than two hundred and fifty (250) pounds per square yard of surface. The thickness of the top course must be sufficient to completely cover the bottom course, and also to eliminate any inequalities in the binder surface. However, in no case shall it be laid over one (1) inch thick after compression.

3. MATERIALS REQUIRED.

The pavement shall be prepared from the following ingredients: trap rock, dolomite or and stone dust, Grade A, hydrated lime, and bituminous cement, Grade NA³, LM³, T³, CM³, or

These materials shall comply with the requirements therefor as defined in Articles 92 and 99.

4. COMPOSITION.

The finished pavement must not vary in composition more than the limits given below:

Screens and sieves			Bottom course		Top course	
Passing	Retained on	Type of opening	Minimum, %	Maximum, %	Minimum, %	Maximum, %
2-in.	1-in.	Circular	40 0	70 0		
1-in.	½-in.	Circular	25 0	35 0		20 0
½-in.	¼-in.	Circular	0 0	10 0	40 0	55 0
¼-in.	10-mesh	Square	3 0	8 0	15 0	30 0
10	30-mesh	Square	4 0	8 0	8 0	15 0
30	80-mesh	Square	3 0	6 0	3 0	8 0
80	200-mesh	Square	2 0	7 0	2 0	6 0
200-mesh	Filler	Square	2 0	6 0	4 0	8 0
Total stone content—retained on						
10-mesh			70 0	95 0	65 0	85 0
Bitumen content			3 0	5 0	5 5	8 0

5. ESTIMATING INGREDIENTS.

The proportions of the different ingredients required to prepare the pavement shall be determined by weight. The pavement must not vary in composition more than the specified limits given.

The bitumen content is based upon the finished pavement, exclusive of any mineral or bituminous surface coating applied. The exact amount of mineral filler and asphaltic cement to use between the limits defined herein shall be determined by the Testing Engineer. In calculating the percentages of the various sizes of ingredients of which the mineral aggregate is composed, the bitumen is included. The actual amount of paving mixture used shall be estimated from the railroad shipping weights of the ingredients used, batches of paving mixture prepared and used, or loads delivered and laid.

6. PREPARATION.

The quantity of ingredients used per batch in the preparation of the paving mixture must be accurately determined by either weight or measurement depending upon the type of plant and kind of material being used. In either case the devices used in measuring these ingredients must be standardized whenever so requested, also the manner in which these devices are used shall be demonstrated and the quantity of material thus secured verified, whenever so ordered by the Inspector or Engineer. The plant used in preparing the paving mixtures shall comply with the requirements given below.

The mineral filler should be so cast into the mixing chamber that it is evenly distributed over the surface of the aggregate and not dumped in one

end of the mixing chamber. The asphaltic cement should also be added slowly in a thin sheet the full width of the mixing chamber. If the filler and asphaltic cement are not added in this manner, the time required to produce a uniform paving mixture will be two (2) or more minutes per batch, otherwise, from one (1) to one and one-half (1½) minutes will be sufficient.

The mineral aggregate must be perfectly dry when coated and have a temperature of not less than 60°F. nor more than 125°F. The bitumen, when applied to the aggregate must have a temperature of not less than 250°F. nor more than 350°F., and must be free from unmelted lumps. From three (3) to five (5) pounds of hydrated lime shall be used for each ton of paving mixture prepared.

In preparing the paving mixture for both the top and bottom courses, the stone and sand shall first be placed in the mixing chamber, after which some liquefier shall be added, and as soon as the aggregate is coated therewith the asphaltic cement shall be added. More liquefier shall then be added and the mixing continued until the aggregate is completely coated with the asphaltic cement. The hydrated lime shall then be added, and more liquefier, if necessary, to secure the proper distribution of the asphaltic cement. The mixing shall continue until all particles of the aggregate are completely and uniformly coated with the asphaltic cement.

The paving mixture, when properly prepared, must be uniform in composition, free from lumps or balls containing an excessive quantity of bitumen, from material containing less bitumen than that required, and not show evidence of the improper application of the liquefier. The above mixture shall not be laid sooner than twenty-four (24) hours nor later than fourteen (14) days after preparation, unless written permission is secured from the Engineer to lay the same before or after these intervals.

7. HAULING AND HANDLING.

The paving mixtures must be kept clean during hauling and handling. These mixtures must not be dumped any faster than they can be properly handled by the shovelers, nor at such a rate that over six (6) tons of paving mixture are upon the platforms at the same time. They must be spread immediately after being dumped, and must be kept perfectly clean until spread. Any part of the paving mixture which becomes dirty must be rejected. All paving mixture must be carefully removed from the spot upon which it was placed before any additional paving mixture is placed thereon.

These paving mixtures may be dumped direct on a concrete foundation, but when the foundation is macadam or telford they shall be dumped on metal or wooden platforms, which must be of such size that the paving mixture will not fall off when dumped thereon or work off during spreading. The wearing surface mixture may be dumped on the binder. However, each load of paving mixture must be dumped outside of the area over which it will be spread.

All vehicles used in transporting paving mixtures must have tight-fitting bottoms which will hold hot, thin mixtures without leaking. When motor trucks are used the bodies should be insulated for long hauls during cold weather so that the paving mixtures adjacent the ends and sides will not become chilled during transit. All motor trucks used for this purpose must have dump bodies that will permit the rapid unloading of the mixture. The inside surface of these bodies should be oiled just before loading. However, only sufficient of this oil shall be used to coat the surface. No pools of oil must appear in the bottom of the truck.

8. SPREADING.

(a) Bottom Course.

The paving mixture for both courses must have a temperature of not less than 50°F. nor more than 125°F., when dumped on the platforms or when spread, unless written permission is secured from the Engineer to lay the paving mixture when it has a lower or higher temperature than that specified above.

The bottom course shall be so spread upon the foundation that after being rolled as herein specified, it will be uniform in density and its upper surface will have the proper crown and be parallel to the grade established for the surface of the finished pavement.

The time and manner of rolling shall be governed by the condition of the paving mixture. If the paving mixture contains enough liquefier to be soft and plastic it shall not be rolled until the bitumen has hardened sufficiently to give the pavement the necessary stability when properly consolidated by

rolling. During rainy or cold weather it may require twenty-four (24) hours or more for the bitumen to cure after the paving mixture has been spread, but during hot, dry weather it may cure sufficiently in from six (6) to eight (8) hours.

When properly cured the paving mixture shall be rolled. The initial rolling shall be continued until the desired bond between the ingredients of the aggregate is secured and any porous or low spots disclosed. Depressions made by rolling shall be filled with additional material and rolled so that the surface of this bottom course will be of a uniform character and have the required grade and crown.

After being spread and rolled as above specified, the bottom course must be protected from all travel and kept perfectly clean until the top course has been applied. If any part of this course shows a lack of bond, becomes loose or broken up, or covered with mud, it must be replaced with proper material laid in accordance with the requirements given herein. If, before the surface course is applied, it becomes coated or partly coated with dust, the part thus coated must be swept and then given a light application of bituminous cement Grade K, or replaced with proper material as the Engineer may direct. When this bituminous cement is used it must be allowed to cure before any surface course is applied to the bottom course thus coated. If the bottom course becomes wet before it can be covered, it must be allowed to dry before the surface pavement is laid.

(b) *Top Course.*

After the bottom course has been spread and rolled as above specified it shall be covered at once with the top course. This course shall be spread in a uniform layer and immediately rolled until it shows no further evidence of compressibility.

9. **ROLLING.**

The initial and final rolling shall always be done with 10- to 12-ton three-wheel power-driven roller, or a 12- to 15-ton tandem roller. During the initial rolling the roller shall travel parallel to the axis of the pavement, beginning at each edge and working towards the center.

Subsequent rolling shall be both diagonal and parallel to the axis of the pavement. The rolling shall be continuous at the rate of not more than one hundred fifty (150) square yards of surface per hour for each roller. The roller must not pass off the paving mixture during rolling and the wheels of the same must be kept clean and oiled at all times. No water shall be applied to the wheels of the roller. Ashes, coal, dirty water or grease must not be allowed to drop from the roller onto the pavement.

If porous spots or spots showing compression remain after rolling, more of the top course must be added at such points and firmly rolled into place. After rolling has been finished the surface of the top course must have the required crown, density and thickness and be at the grade established for the surface of the finished pavement. The surface shall then be covered with a thin coating of clean, coarse sand or stone dust, using about five (5) pounds per square yard. After this coating has been applied, the part of the pavement thus covered must be open to travel.

The faces of the curbs, gutters, iron castings and other objects in the pavement shall be painted with bituminous cement Grade K before the above mixture is placed against them. The adjacent paving mixture shall be compressed by tamping when it is impossible to properly compress it by rolling.

10. **SURFACE FINISH.**

The surface of the finished pavement must be even, uniform, free from bumps, waves or depressions that are more than one-quarter ($\frac{1}{4}$) of an inch below or above the general surface of the pavement as determined by a straight edge not less than five (5) feet in length, laid parallel to the axis of the pavement. It must be uniform in density and composition, thoroughly bonded together, water-tight and have the grade and crown specified or shown on plans. The paving mixture must be so spread, raked and rolled that the pavement surface will be free from porous or rough spots. When such spots appear in the surface they must be repaired in a manner satisfactory to the Engineer or cut out and replaced with material prepared and laid as herein specified.

Portions of the completed pavement which are defective in finish, compression or composition, or which do not comply in all respects with the requirements of these specifications, at the Contractor's expense shall be removed, and replaced with material prepared and laid in accordance with the requirements therefor as given herein.

11. FOUNDATION, CONDITION OF.

The foundation, when a bituminous pavement is applied thereon, must be dry, clean, free from all frost, and have a temperature above 32°F. at the point where the paving mixture is being laid. It must substantially conform to the grade and crown specified, and comply with the requirements given for the type of foundation being used. When a foundation is in the proper condition to receive a paving mixture it must be protected from all travel that will injure, deface or carry foreign material upon it.

12. EDGE PROTECTORS.

When the edges of pavements are not protected by a concrete or stone curb or header, four (4) to six (6) inch planks of the same thickness as the finished pavement must be used for this purpose, which shall be firmly secured and left in place until the pavement has been properly rolled and thoroughly set.

13. CONSTRUCTION SEASON.

The pavement shall be laid between the first day of May and the first day of December, unless written permission is secured from the Department to lay pavement at any other time. No pavement shall be laid when it is raining or when the atmospheric temperature is below 32°F., or when the weather is such as to make it very difficult to lay the paving mixture in a manner which will permit the proper density and surface finish being secured.

14. WORKMEN.

The workmen employed by the Contractor must have sufficient experience in the preparation of bituminous paving mixtures and the construction of bituminous pavements to be able to operate the equipment in such a manner that the pavement produced will have the required composition, density and surface finish. The men operating the mixing plant, the spreaders, rakers, and roller men must show by the work completed that they have had the necessary experience and are making the proper effort to execute the work in the manner required by these specifications. Otherwise, their services will have to be dispensed with by the Contractor.

15. PLANT AND EQUIPMENT.

The plant used in preparing the bituminous paving mixtures must be of the batch type, capable of mixing in the manner herein specified, not less than ten (10) tons of the paving mixture each mixer per hour, and must be provided with separate chambers for drying and mixing the ingredients. No direct heat except steam shall be applied to the exterior surface of the mixing chamber. The aggregate, when drying is required, shall be heated in revolving kilns. The heat must be so regulated that the aggregate can easily be heated to, and maintained at, the required temperature.

All mixing plants must be equipped with a twin-pug mixer, rotary screen, storage bins, hopper and scales. The screen must contain the size opening necessary to produce a paving mixture of the composition specified.

The mixer must be capable of holding and properly mixing at least a 1000-lb. batch of paving mixture. Each plant, regardless of the type of mixer used, must have at least two asphalt kettles holding not less than six hundred (600) gallons each, and an asphalt thermometer for use therewith. The heat must be applied to these kettles in such a manner that the asphaltic cement will be uniformly heated without being burnt or decomposed.

The asphalt carrier used to measure and apply the asphaltic cement must be balanced upon a set of scales. It shall be so arranged that the asphaltic cement can be easily and quickly weighed and poured in a thin sheet between the two lines of paddles and for the full width of the mixer.

When a squeegee distributor is required to be used it must be designed for this particular purpose. All equipment and methods used in the preparation and construction of the pavement must be approved by the Engineer before being used on this contract.

16. FIELD LABORATORY.

The Contractor shall provide and keep in good order at the plant the following testing equipment which may be used by the Engineer or Inspector.

1 Penetration Machine complete with Dishes, Thermometer, Needles, Stop Watch, etc.

1 Laboratory Sand Scale 500-gr. capacity.

1 Set 6- to 8-in. Sieves, containing the following: Sizes 10, 20, 30, 40, 50, 80, and 200 meshes, with bottom pan and cover.

1 Set 6- to 8-in Screens, 1¼, 1, ¾, ½ and ¼ in.

2 6-in. Pointed Trowels.

- 2 6- to 8-in. Steel Spatulas.
- 2 Brushes.
- 2 Or more Inspectors' Armor Asphalt Thermometers.
- 1 Roll Pat Test Paper.

The above equipment must be of standard type and approved by the Testing Engineer. The Contractor shall also provide a field laboratory in which to house and use the above equipment, said laboratory to be not less than ten (10) feet wide, twelve (12) feet long and seven (7) feet high, floored, contain not less than two windows and work bench with the necessary drawers; this laboratory to be used exclusively for testing purposes by the Contractor, Engineer or Inspector.

**Item¹ 51A. Cement-concrete Pavement (1:2:4); Item 51B
Cement concrete Pavement (1:2:3¹/₂ Mix); Item 51C
Cement-concrete Pavement (1:1¹/₂:3 Mix)**

Item 51A, 51B, 51C and 51D. Cement Concrete Pavement

The general specifications are hereby modified in that

Page 114-115. Forms shall be rounded on the top face to not more than $\frac{3}{4}$ of an inch radius.

Page 118. Where screeding is dispensed with, the reinforcement shall be supported on approved metal supports.

Page 118. Channel for protecting joints shall be constructed of metal $\frac{1}{8}$ inch in thickness.

Page 121. Straw will not be permitted for cover.

Page 121. Sprinkling shall be done with an approved nozzle.

Page 121. When the pipe line necessary for concreting and curing operations is two miles or less in length, a pipe at least 2 $\frac{1}{2}$ inches in diameter shall be used. When the pipe line is more than two miles in length, the additional pipe shall be at least three inches in diameter and shall be placed adjacent to the source of water supply.

Page 121, Paragraph C. The combined weight of vehicle and load shall not exceed 10 tons. The total weight of any combined hauling truck, semi-trailer and load shall not exceed 14 $\frac{1}{2}$ tons. The load on any one trailer wheel shall not exceed 2 $\frac{1}{2}$ tons. All such vehicles and trailers shall be fully equipped with approved pneumatic or cushion tires. Solid rubber tires will not be permitted. Only cushion tires having a hollow section or air core running throughout their entire length will be considered.

Work.—Under this item the contractor shall construct a concrete pavement upon a properly prepared fine grade conforming to the lines, grades, and typical sections shown on the plans or ordered by the engineer.

Material.—The concrete pavement shall consist of a mixture of Portland cement, fine and coarse aggregate, measured separately (however, screened gravel or broken slag cannot be used as coarse aggregate unless it is so noted on the plans or in the itemized proposal).

All material used under this item, such as Portland cement, fine and coarse aggregate, water, joint fillers, etc., shall meet the requirements given in the Detail Specifications—Materials of Construction.

Forms.—The forms for this work shall be made of metal of a minimum length for 10' for tangents and for curves of a radius of 150' and more; for curves of radius less than 150' wooden side forms of 2" well-seasoned surface planks or steel side forms 5' in length shall be used. These forms shall be of a depth equal to the depth of the concrete and steel forms shall have a minimum width of 4" on the base. The material used in manufacturing metal side forms shall be at least No. 10 gage and a 6" side form shall weigh at least 6 $\frac{1}{2}$ lb. per linear foot, including the fastening.

All forms shall be of approved section with a vertical face rounded on the upper corner to not more than $\frac{3}{4}$ " radius. Forms shall have a joint connection to insure unbroken lines across the joint.

All forms must be straight, free from bends and warps at all times, and shall be cleaned thoroughly and oiled before concrete is placed against them, this cleaning and oiling being repeated daily as the forms are moved ahead. The forms shall rest firmly upon the thoroughly compacted subgrade throughout their entire length, shall be joined neatly and tightly and staked securely to line and grade at least 300' in advance of the point of placing concrete by using at least three bracing pins or stakes to each 10' length of side form, so

¹ New York.

that they will resist the pressure of the concrete and the impact of the tamper without springing.

Handling Material.—At no times shall aggregates be piled upon the subgrade except that stock piles may be located at central point on planks or sheet plates on the subgrade not less than 1200' apart. At all times at least 500' of subgrade in advance of the mixer shall be prepared and kept free from all aggregates. When stock piles are located at loading plants or at other distributing points, the materials shall be piled on space that has been properly prepared and the piles shall be of such shape and size that materials may be stored and handled without becoming dirty or mixed with foreign substances. Cement shall be emptied directly from the shipping package into the charging skip of the mixer, or it may be transported to the mixer, emptied from bags if covered by the sand or stone required for each separate batch, provided the aggregates are sufficiently dry to prevent any setting action of the cement during transportation to the mixer, and provided further that the truck body used to transport the batches is equipped with a waterproof tarpaulin for protection from sudden rain.

Measuring Devices.—Wheelbarrows will not be permitted for measuring aggregates, when the aggregates are transported by industrial railway or delivered to the mixer in trucks, wagon, or carts, they shall be contained in batch boxes of the volumes required by the engineer. Subdivided batch boxes shall be approved by the engineer before they may be used. All materials measured in batch boxes, cars, trucks, carts, or other containers are to be struck off at the point of loading. If batch boxes are used, which are not subdivided to give the exact volumes of each of the aggregates, the materials shall be measured, separately and accurately, by approved means before being placed in these batch boxes. Forks shall be used when handling coarse aggregates from the ground. The mixer shall be equipped with a timing device which will automatically lock the discharge lever during the full time of mixing and release it at the end of the mixing period. During the progress of the work, should the timing device become broken, or out of order, the contractor will be permitted to operate while same is being prepared, provided each batch is mixed 1½ min. and provided repairs are made promptly. The mixer shall be equipped with an accurate automatic water-measuring device. No mixing will be permitted when valves are leaking or otherwise out of order. When bulk cement is used, the cement must be proportioned by weight. No volumetric proportioning of cement will be permitted.

Composition.—Under Item 51A the concrete shall be composed of 1 part of Portland cement, 2 parts of fine, and 4 parts of coarse aggregate measured separately.

Under Item 51B the concrete shall be composed of 1 part of Portland cement, 2 parts of fine, and 3½ parts of coarse aggregate measured separately.

Under Item 51C the concrete shall be composed of 1 part of Portland cement, 1½ parts of fine, and 3 parts of coarse aggregate measured separately.

The proportions of coarse aggregate, only, may be varied by the engineer, but the total amount of coarse aggregate shall not be varied by more than 10% from the amount indicated.

Consistency.—When the pavement is finished by hand, sufficient water shall be used in mixing to produce a concrete which will quake when deposited in place, but not enough to cause it to flow.

When the pavement is machine finished only sufficient water shall be used so that when the concrete is dumped on the subgrade it will cone up and quake. The quantity of the water shall be determined by the engineer and shall not be varied without his consent.

Mixing Conditions.—No concrete shall be mixed while the air temperature is at or lower than 40°F. and no materials containing frost shall be used. Cement or fine aggregates containing lumps or crusts of hardened materials shall not be used. The concrete shall be mixed only in such quantity as is required for immediate use, and any which has developed initial set or has been mixed longer than 45 min. shall not be used. No concrete is to be placed on a frozen subgrade.

Mixing Concrete.—All equipment necessary for the laying of pavement must be on hand and must be inspected and approved before concreting operations are begun by the contractor. Concrete shall be mixed thoroughly in a batch mixer of an approved type and capacity for a period of not less than 1 min. after all material is in the drum, and during this period the drum shall make not less than 12 nor more than 18 r.p.m.

The entire contents shall be removed from the drum before materials are placed therein for the succeeding batch. The mixer shall be equipped with an approved boom and bucket discharging device.

Placing Concrete.—Before any concrete may be placed, each section of the subgrade must be checked with a standard "subgrade tester" and approved, this operation being continued as the work progresses, a standard "subgrade tester" being kept in place on the forms at the discharge end of the mixer at all times. Loose, dry material shall be thoroughly tamped into the subgrade and all soft or objectionable material be removed from the subgrade before any concrete is placed. Concrete shall be placed only on a moist subgrade. If the subgrade is dry it shall be sprinkled with as much water as will be absorbed readily. Where the pavement is to be laid adjacent to railway tracks or around structures, concrete shall not be placed until the tracks and structures have been set to the required grade and alignment in advance, and all structures which project through the pavement shall be cleaned thoroughly to permit adhesion of the concrete.

During placing of the concrete pavement, a roller, weighing not less than 5 tons, shall be maintained in readiness to reroll the fine grade if the surface for any reason has become uneven or defective.

The concrete shall be laid on not more than one-half of the width of pavement at one time. An interval of at least 7 days shall elapse between placing parallel adjacent slabs of pavement. All edges shall be protected by planking or other approved method where traffic is permitted prior to completion of the full pavement width.

The concrete shall be deposited on the subgrade in successive batches, directly from the mixer, by means of an approved boom and bucket discharging device. Concrete shall be distributed to the required depth and for the entire width of the slab by shoveling or any approved method which will preserve the integrity of the mixture. However, in no case shall rakes be used for distributing concrete. Concrete shall be thoroughly spaded along all joints and on the inside of forms.

Where the pavement is reinforced, the reinforcement shall be securely held in place to insure its being in the prescribed position after the concrete has been poured. The concrete shall be struck off by means of a template, to the required depth below the surface of the finished pavement before the reinforcement is placed, except that screeding may be dispensed with provided the reinforcement is held in its prescribed position by any other method acceptable to the Deputy Commissioner.

Forming Joints.—Joints shall be formed where shown on plans or as directed by the engineer. They shall be perpendicular to the surface of the pavement for the full depth of the section and extend in a straight line.

Expansion joints may be of either the permolded or poured type, meeting requirements of the Detail Specifications—Materials of Construction.

Pins for staking joints and bulkheads shall be $\frac{1}{4}$ " steel 12" long and shall be left in place in the pavement.

Bulkheads shall conform to the section of the pavement, shall be $\frac{3}{8}$ " steel, shall be cleaned each time used, and shall be straight and smooth.

Premolded transverse joints shall be $\frac{1}{2}$ " in thickness and shall extend $\frac{1}{2}$ " above the surface of the pavement.

Premolded longitudinal joints shall be flush with the true surface of the pavement and shall be the thickness shown on the plans.

Transverse expansion joints shall be $\frac{1}{2}$ " in thickness, normal to the center line of pavement, and in a straight line across the full width of the pavement. These joints shall be spaced 40' apart, unless otherwise shown on the plans, and shall also be formed whenever it is necessary to stop concreting. If, due to any emergency, concreting must be stopped within 10' after forming a transverse joint, the contractor shall remove the concrete to the joint previously formed and no payment will be made for placing or removing.

The concrete along all joints shall be carefully compacted and finished to a true surface, a split float being used for transverse joints. All joints shall be tested with a 10' straight-edge or template immediately after forming and any variation from the true surface shall be immediately corrected. Joints shall be open on the edges for their entire depth upon the removal of the forms.

Where the pavement is constructed continuously across a bridge or culvert whose floor is below grade, transverse joints shall be formed at such distance from the abutment as to insure a bearing at the ends of the slab of not less than five feet beyond the limits of the backfill area.

Where the pavement joins a bridge or culvert, whose floor is at grade, transverse joints shall be formed at the back of each abutment and also at such distance from the abutment as to give a bearing at the end of the slab of not less than five feet beyond the limit of the backfill area.

Premolded transverse joints shall be formed by staking a bulkhead securely in place by means of a row of pins driven on each side, 2' apart and 2" below the surface of the pavement alongside of which the premolded joint shall be placed and securely staked by one row of pins driven 2' apart and 2" below the surface of the pavement. When the concrete has been placed on both sides of the bulkhead and struck off true to the surface, the bulkhead shall be carefully removed.

Poured joints shall be formed by staking a temporary joint, of a type approved by the Deputy Commissioner, securely in place by means of a row of pins driven on each side 2' apart and 2" below the surface of the pavement. These temporary joints shall be left in place until ready to pour the joint.

Finishing Concrete.—Competent concrete finishers shall be employed at all times. The surface of the concrete shall be struck off by means of two screeds (i.e., a steel template or steel-shod wooden template) at least 6" in width weighing no less than 15 lb. per linear foot. The templates shall be at least 2' longer than the width of the pavement slab, shall be shaped to the surface of the pavement and have sufficient strength to retain their shape under all working conditions. The first screed shall be used as a combination tamp and screed, sufficient tamping to be done to thoroughly compact the entire mass of the concrete and the screed carried back and moved forward with a longitudinal and crosswise movement. The screed shall not be lifted from the form during the screeding process. Concrete shall pile up in front of each screed, during the screeding process, for its full length at all times.

The second screeding shall follow in close succession to the first, care being taken to keep the screed bearing directly on the side forms at all times and to secure a smooth and even surface.

After the screeding has been completed the concrete shall be finished by using a belt of wood or canvas not less than 10 nor more than 12" in width. These belts shall not be less than 2' longer than the width of the pavement. The belts shall be worked with a longitudinal and crosswise motion, care being taken not to permit the edges to dig in the surface of the concrete or to work the crown out of the pavement.

Belting shall be repeated until all surplus water is removed from the surface.

When an approved finishing machine is used, an experienced operator, satisfactory to the engineer, must, at all times, be in charge of the machine and a complete hand-finishing outfit must be provided in case of breakdown.

Necessary hand finishing of joints and surface irregularities shall be done, with a wooden float, from a bridge which shall not rest on the concrete at any point. All ends and edges of the concrete slab shall be rounded with an approved edging tool, to a radius of approximately $\frac{1}{2}$ ".

The surface of the pavement shall be tested, immediately after finishing, with the standard 10' straight-edge laid parallel with the center line of the pavement and any irregularity exceeding $\frac{1}{4}$ " shall be immediately corrected to the satisfaction of the engineer.

After the pavement has been completed the surface shall be given a broom finish, the broom being drawn across the surface in not more than one stroke per width of broom.

Premolded transverse joints shall be trimmed, with an approved tool, before cover coat is applied and any irregularity in the adjacent pavement shall be immediately corrected in a manner satisfactory to the engineer.

Forms shall not be removed until the day after the concrete is placed.

Protection of Concrete.—Vehicular traffic shall be excluded from the concrete by the erection and maintenance of substantial barricades, for a period of at least 21 days after laying, or longer if so desired.

When ordered by the engineer, temporary crossovers, consisting of a 4" layer of suitable soil free from stone and a 3" plank roadway 16' wide securely held in place, shall be constructed at all street and road intersections to accommodate traffic. The concrete shall be protected as follows:

a. During threatening weather the concrete shall be protected with canvas as soon as it is finished. Sufficient canvas to cover 200 lin. ft. of pavement, slab shall be provided and available for immediate use.

b. The concrete shall be protected with two layers of burlap laid directly on the pavement as soon as it has hardened sufficiently so that the burlap

will not adhere. The strips shall overlap not less than 6" and burlap must be thoroughly wet when placed, and kept wet by spraying until covering can be placed. Sufficient burlap to cover at least the pavement laid in a single day must be provided. The burlap shall be kept wet until removed.

Immediately after the burlap is removed the entire surface of the pavement including edges and sides, shall be wetted thoroughly and covered with hay, straw, or other approved material of a like nature to a depth of not less than 6", which covering shall be kept wet by sprinkling with water for at least 10 days. The covering material shall remain on the pavement for a period of 18 days or, under favorable conditions, for a shorter period as directed by the engineer, after which the covering shall be removed, the pavement swept clean, and the concrete allowed to cure for 3 days more before the roadway may be opened to traffic.

The ponding method may be used, in which case the contractor must keep the surface flooded by at least 2" of water for a period of 10 days.

c. The general specifications, par. C, are hereby modified in that the combined weight of vehicle and load shall not be more than 10 tons and that the total weight of any combined hauling truck, semitrailer, and load shall not exceed $14\frac{1}{2}$ tons and the load on any one trailer wheel shall not exceed $2\frac{1}{2}$ tons.

All such vehicles and trailers shall be fully equipped with approved pneumatic or cushion tires. Solid rubber tires will not be permitted. Only cushion tires having a hollow section or air core running throughout their entire length will be considered.

d. During cold weather, concrete shall be protected with a canvas cover, supported above the surface of the pavement on approved frames, so that the canvas will not rest upon the surface of the concrete. When the concrete has hardened sufficiently, the canvas cover and frame shall be removed and the surface of the pavement shall be covered with straw or other approved material to a depth of not less than 6". It shall remain in place not less than 3 days, after which it may be removed and other cover material applied.

In cold weather or when required or approved, other methods of curing and protection may be used. Any concrete laid during cold weather is done at the contractor's risk and damaged sections of concrete must be removed and replaced by him at his own expense.

Sealing Joints and Maintenance of Cracks.—All expansion and construction joints and all cracks shall be sealed before the pavement is open to traffic and just prior to discontinuing operation when the work is suspended during the winter and just previous to acceptance. The joints and cracks shall be cleaned thoroughly, and, when they are dry, hot, bituminous material shall be poured into them, care being exercised to prevent the bituminous material from spreading over the surface of the pavement for a width of more than 1" on either side of the joint. The bituminous material shall then be covered with coarse, dry sand. This bituminous material shall meet the requirements of the specifications for Bituminous Material, A, penetration method.

Measurement and Payment.—The quantity to be paid for under this item shall be computed by multiplying the cross-section of concrete pavement, as shown on the plans or ordered by the engineer, by the total length of pavement measured along the axis of the pavement, making no deductions for catch basins and manholes.

The Bureau may take cores from the finished concrete pavement previous to acceptance in order to determine its quality and thickness.

This work will be paid for at the contract unit price per cubic yard for cement-concrete pavement under which the contractor shall furnish and place all materials (except Portland cement and metal reinforcement) necessary to complete the concrete pavement. The price bid shall cover the mixing, placing, screeding, finishing, and curing of the concrete, furnishing and placing of forms, expansion joints, crossovers, material for filling cracks, etc., and all other labor, material, and appliances necessary to secure a perfect concrete pavement.

NEW YORK STATE SPECIFICATIONS

ITEM 60—ASPHALT BLOCK PAVEMENT.—APPROVED TRAP ROCK

ITEM 60A—ASPHALT BLOCK PAVEMENT.—APPROVED LIMESTONE

60.1. **Work.**—Under this item the Contractor shall furnish and place upon a properly prepared foundation asphalt block of the quality specified where shown upon the plans or ordered by the Engineer. This pavement

shall be placed upon the old macadam, old concrete pavement, new concrete foundation or on other foundations as ordered by the Engineer and shown upon the plans.

60.2. **Material.**—The blocks shall be 5" in width, by 12" in length, by 2" in depth, and a variation of more than $\frac{1}{4}$ " in length or $\frac{3}{8}$ " in width or depth from these dimensions will be sufficient ground for rejecting any block.

60.3 The blocks shall consist of the following materials:

Asphaltic cement.

Approved crushed trap rock [item 60], or approved crushed limestone [item 60A].

Inorganic dust.

The asphaltic cement shall have the following characteristics:

1. It shall be free from water.
2. The various hydrocarbons composing it shall be present in a homogeneous solution.
3. It shall have a specific gravity at 77°F. of not less than 0.99.
4. It shall have a penetration (77°F., 100 g., 5 sec.) of not less than 15 nor more than 25.
5. It shall have an evaporation loss of less than 2 per cent. The penetration (77°F., 100 g., 5 sec.) of this residue shall be at least 50% of the original penetration.
6. Its solubility at air temperature in carbon disulphide, for the following named products, shall be at least 99.5% for pure bitumen products, 95.0% for Bermudez products, 81.0% for Cuban products and 66.0% for Trinidad products.
7. The solubility of the bitumen, at air temperature, in 76°B. paraffin petroleum naphtha distilling between 140°F. and 190°F. shall be between 65 and 80 %.

8. The bitumen, shall show between 8 and 18% fixed carbon.

9. It shall show an open flash not less than 375°F.

10. It shall not contain more than 4.7% paraffin scale.

11. It shall show a toughness at 32°F. not less than 10 cm. Toughness is determined by breaking a cylinder of the material $1\frac{3}{4}$ " in diameter by $1\frac{3}{4}$ " in height in a Page impact machine (A. S. T. M., 1908). The first drop of the hammer being from a height of 5 cm. and each succeeding blow increased by 5 cm.

12. It shall have a ductility at 77°F., of not less than 8 cm. (Dow mold).

13. All asphaltic cement will be sampled by an Engineer of the Department of Highways and samples sent to the Bureau of Tests, Albany, N. Y.

The crushed rock for coarse aggregate used in the blocks shall be crushed from clean hard rock and shall not contain any soft ingredients. It must be crushed so that every particle will pass a screen of $\frac{1}{4}$ -in. mesh.

The inorganic dust, or filler, shall be produced from sound limestone, and shall be powdered to such a fineness that all of it shall pass a 30-mesh sieve and not less than 50% of it shall pass a 200-mesh sieve. Sufficient inorganic dust shall be used to give a minimum percentage of voids in the block, and provide a sufficient medium for absorbing the asphalt cement.

60.4. **Block Composition.**—The block composition shall yield not less than 8, nor more than 11% of bitumen, when extracted with carbon disulphide.

The mineral aggregate of the blocks shall meet the following mesh analyses:

Passing No. 200 sieve at least, %	18.0
Passing No. 80 sieve, retained on No. 200 sieve, %	12 to 18
Passing No. 40 sieve, retained on No. 80 sieve, %	8 to 14
Passing No. 20 sieve, retained on No. 40 sieve, %	8 to 16
Passing No. 10 sieve, retained on No. 20 sieve, %	15 to 20
Passing $\frac{1}{4}$ -in. sieve, %	100

The use of dust coated screenings will be cause for rejection. The blocks shall receive a compression in the moulds of not less than 200 tons.

The blocks shall have a specific gravity of not less than 2.45 for trap blocks, [Item 60]; or not less than 2.30 for approved limestone blocks, [Item 60A].

After having been dried for 24 hours at a temperature of 150°F., the blocks shall not absorb more than 0.75% of moisture when immersed in water for 7 days.

The average penetration of a block shall not exceed $\frac{1}{4}$ " when tested for 1 min. at a temperature of 100°F. with a cylinder $\frac{1}{4}$ " in diameter loaded with 147 lb

60.5. Method.—Upon the foundation shall be spread a bed of the thickness shown upon the plans, composed of 1 part portland cement and 4 parts sand, thoroughly mixed with sufficient water to make a stiff paste.

This mortar bed shall be struck with a template to a true surface, exactly parallel to the top of the proposed pavement surface and 2" below it.

The blocks shall be laid while the mortar is fresh and before it has begun to harden. All depressions and other irregularities in the surface shall be corrected by the Contractor immediately.

The blocks shall be laid by the pavers standing upon the blocks already laid and not upon the bed of mortar.

The blocks shall be laid at right angles with the line of the street, and in such a manner that all longitudinal joints shall be broken by a lap of approximately four inches. The blocks shall be so laid as to make the lateral joints as tight as possible, consistent with keeping a good alignment of the courses across the street. When thus laid the blocks shall be immediately covered with clean, fine sand, perfectly dry, and screened through a $\frac{3}{8}$ -in. screen. This sand shall be spread over the surface and swept into the joints and be allowed to remain on the pavement not less than 30 days, or until the action of the traffic on the street shall have thoroughly ground the sand into all the joints.

On grades, curves or elsewhere as shown on the plans or as ordered by the Engineer, blocks containing an imbedded anchor of iron or steel of an approved shape shall be furnished. Steel strips, $1\frac{1}{2}$ " wide, $\frac{3}{4}$ " thick and from 2 to 4' long may be set on edge between courses as a substitute for anchor blocks. These anchor blocks or steel strips are to be laid in such courses and at such intervals as shown on plans or as directed by the Engineer. Payment for imbedded metal in anchor blocks or for steel strips will be made under the item "MISCELLANEOUS IRON AND STEEL."

60.6. The materials incorporated into blocks shall be approved by the Engineer, and samples of all materials shall be sent to the Bureau of Tests and they shall pass the tests required by this Bureau for these materials.

60.7. The methods of work and materials used shall at all times be subject to the inspection and supervision of the Engineer or his representative upon the work.

60.8. Measurement and Payment.—The quantity to be paid for under this item shall be the number of square yards of asphalt block laid in accordance with the plans or as directed by the Engineer. The price bid shall cover the furnishing and placing of all materials, (except PORTLAND CEMENT), mortar bed, and all labor and incidental expenses necessary to complete the work. Where placed upon old concrete foundation or upon old macadam the preparation of the foundation to receive the mortar bed will be paid for under item "CLEANING EXISTING PAVEMENT" or item "SCARIFYING AND RESHAPING OLD MACADAM."

47.14. Measurement and Payment.—The quantity to be paid for under this item shall be the number of cubic yards of concrete foundation and edging for pavement incorporated in the work in accordance with the plans or as directed by the Engineer.

The price bid shall cover the furnishing and placing of all forms and materials, (except Portland cement) all mixing, tamping, finishing and all labor, appliances, and incidental expenses necessary to complete the work. The amount to be estimated shall be computed by multiplying the cross-section of concrete foundation and edging as shown upon the plans or ordered by the Engineer by the total length of concrete foundation and edging measured along the axis of the pavement, making no deductions for catch basins and manholes.

ITEM 61—BRICK PAVEMENT.—TYPE 1

ITEM 61A—BRICK PAVEMENT.—TYPE 2

61.1. Work.—Under this item the Contractor shall furnish and place the number of square yards of brick pavement required in accordance with the plans or as ordered by the Engineer. The item will cover the furnishing and placing of all the brick, cushion, grout, expansion joints and all material, labor and other expenses incidental thereto but will not cover the concrete foundation, edging, curbing, manholes, catch basins, etc., which will be paid for under the especially designated items thereof.

61.2. Material.—All bricks or blocks used must be annealed and especially burned for street paving and of the very best quality as regards hardness, dimensions, toughness, straight lines and non-absorption of water.

All brick must be neatly piled outside of the neat lines of pavement and the dumping of brick will not be allowed.

61.3. The paving bricks shall be subjected to abrasion tests conducted by the Commission in the manner and with rattlers of the type adopted February 7, 1911, by the National Paving Brick Manufacturers Association. One sample of bricks shall be taken and tested for every two hundred thousand (200,000) bricks and less than this when conditions warrant. An average loss in weight in a rattler test exceeding twenty-four (24) per centum, or an average absorption of three and one-half ($3\frac{1}{2}$) per centum of water shall cause the rejection of the total quantity that the test represents, provided, however, that if permitted the bricks may be carefully reculled, and new samples taken and tested. If this second test passes the requirements, the bricks represented by it may be used. If this second test fails, no further test shall be permitted but the entire lot shall be rejected. To insure the furnishing of bricks of uniformly acceptable quality, if any "brand" of brick of which three lots, each of ten thousand (10,000) bricks or more, offered consecutively for acceptance tests, fail to meet the requirements for this section without reculling them, then this brand shall be rejected.

All the above tests will be made by the Bureau of Tests of the State Commission of Highways.

61.4. On grades of 5 per cent or over an approved special form of block suitable for steep grades shall be used.

61.5. The size of the brick shall be $3\frac{1}{2}$ " in width by 4" in depth by $8\frac{3}{4}$ " in length, unless otherwise shown on plans, and shall not vary from the dimensions specified more than $\frac{1}{4}$ " in width or more than $\frac{1}{4}$ " in depth nor more than $\frac{1}{2}$ " in length. Bricks of a given brand shall not vary among themselves more than $\frac{1}{4}$ " in depth nor more than $\frac{1}{4}$ " in width nor more than $\frac{1}{2}$ " in length in any one shipment. If the edges are rounded the radius shall not be greater than $\frac{3}{16}$ of an inch. One side shall contain lugs of such dimensions that transverse joints will not be less than $\frac{3}{16}$ of an inch nor more than $\frac{1}{4}$ " in width. Each end shall contain a semi-circular groove of $\frac{1}{4}$ - to $\frac{1}{4}$ " radius, or a bulge of at least $\frac{1}{4}$ ". The grooves shall be horizontal, and shall match perfectly when the bricks are laid in the finished pavement. Bricks in any course shall not vary in width by more than $\frac{1}{4}$ ".

61.6. Not less than 10 days after the concrete foundation has been completed, there shall be laid a bed of clean Cushion Sand as described under "Materials of Construction," which shall be 1" thick after being rolled with a roller weighing 150 lb. per foot of width. Before being rolled this bed of sand shall be brought to the proper elevation and crown as shown on the plans by a template of a shape and size satisfactory to the Engineer. After being rolled all irregularities of the surface shall be eliminated and the sand cushion shall be brought to the exact form and section by the use of lutes or hand templates.

61.7. Premoulded longitudinal expansion joints shall be placed alongside each curb or edging, and shall conform strictly to the requirements given under "MATERIALS OF CONSTRUCTION."

These joints must extend to the depth of the brick. No transverse joints shall be allowed. The material should be made into strips of suitable length and of the required depth and thickness as shown on plans and should be laid in the pavement with the ends closely joined as the brick are being laid.

61.8. On the sand cushion prepared as in section 61.6 the bricks shall be carefully set on edge with the best edge up, shall be laid straight and at right angles to the edging line, except at road intersections, where they shall be laid at such angles as directed by the Engineer. All brick shall be laid with the lugs in the same direction, joints shall be close and at right angles to the tops and sides. Each alternate course shall be commenced with a half brick.

No half bricks or bats shall be used except at the ends of courses, and no bats shall be less than 3" in length and at right angles to the courses. All joints shall be broken with a lap of not less than three (3) inches.

When laying brick on a street or road used in conjunction with a traction company the courses shall be started at the rails and laid down toward the curbs or edgings.

All brick shall be clean when placed in the pavement. Brick which in the opinion of the Engineer are not satisfactorily clean, shall be washed before being placed.

In no case shall the sand cushion in front of the pavement be disturbed or walked on during the laying of the bricks.

61.9. After a sufficient number of bricks have been laid, all soft, broken or badly misshapen bricks shall be marked by the inspector and removed by the

Contractor. Any bricks slightly spalled or kiln-marked shall be turned over, and should the opposite face be acceptable, it may be replaced in the pavements otherwise, it must be removed.

In laying brick pavement, the inspector shall keep the bricks culled, and the Contractor shall make the necessary changes and replacements so that the work shall at all times be ready for grouting within 300 ft. from the brick-laying.

61.10. After all objectionable bricks have been removed from the pavement and all replacements have been made the pavement shall be swept clean and thoroughly rolled with a self-propelled tandem roller weighing not over 5 tons and not less than 3 tons. Horse rolling shall not be permitted. This rolling shall start along the outside edges and progress toward the center. It shall then be rerolled diagonally both ways until the surface is even. After final rolling the pavement shall be tested with a 10' straight edge laid parallel with the curb, and any depression exceeding $\frac{1}{4}$ " shall be corrected and brought to the proper grade. All bricks disturbed in making replacements or correcting depressions shall be settled into place by ramming or by rerolling. All gutter bricks must be brought to grade by ramming.

This rolling shall start along the outside edges and progress toward the center as slowly as possible. After the first passage of the roller, the pace may be quickened. Portions of the pavement inaccessible to roller shall be tamped to grade by the use of hand tamper applied upon a 2" board.

If during or after the rolling of the pavement the sand cushion shall work up between the brick more than $\frac{1}{4}$ their depth, the brick shall be taken up and the sand cushion again rolled until firm enough to support the weight of the brick and roller. After final rolling all broken brick must be replaced.

Each section of pavement must be acceptable to the Engineer before the grouting on that section may be commenced.

61.11. Grout.—Grout for filling the joints of brick or block pavements shall be composed of 1 part Portland cement and 1 part group sand, if hand mixed, and 1 part Portland cement and 2 parts group sand if machine mixed.

61.12. The box for hand mixing this grout shall be about 4' 8" long, 2' 6" wide and 1' 2" deep, supported on legs of different lengths in order that the mixture shall readily flow to the lowest corner, which shall not be more than 6" above the pavement. Any approved mechanical grout mixer may be used.

61.13. If hand mixed, the material, not exceeding 1 sack of cement together with a like amount of sand, shall be placed in the box and mixed dry, until the mass assumes a uniform color. Water shall then be added, forming a liquid mixture of the consistency of thin cream for the first coat and slightly thicker for each succeeding coat. From the time the water is applied until the last drop is removed and floated into the joints of the pavement the mixture must be constantly agitated.

61.14. Spreading Grout.—The brick shall be wet to the satisfaction of the Engineer before any grout is placed. The grout shall be removed from the box to the street surface with a scoop shovel and immediately swept into the joints, the mixture in the box being constantly agitated while this is being done.

If a mixer is used, as soon as the grout is deposited upon the surface it must be swept into the joints. The work of grouting shall proceed for the entire width of the pavement, working from the sides toward the center. When sufficient time has elapsed for the grout to thoroughly penetrate all the joints, but before the grout has begun to harden, the section treated shall be gone over a second time in the same manner, care being taken to thoroughly fill all joints to the bottom and flush with the top of the brick. If necessary to secure flush joints, a third, fourth or fifth coat of the grout shall be swept in and smoothed off with a suitable squeegee. The squeegee must in all cases be worked at an angle of 45° with the joints.

Care shall be taken to so conduct the grouting that no part of any joint will receive an application of the second grout until the first is satisfactorily completed, nor of the third until the second is completed, etc. To insure this result metal strips $\frac{1}{8}$ " by 6" by 3" must be inserted, for the full length of the joint, at work intervals; all of the several applications of grout must be completed up to this joint before any grouting is begun on the other side of it.

61.15. Covering.—After the joints are thus filled flush with the top of the bricks and sufficient time for hardening has taken place, the pavement must then be sprinkled, shortly after which 1" of suitable material shall be spread evenly over the entire surface, and be kept moist for a period of at least 10 days and until the grout has thoroughly hardened.

During this period the section grouted must remain absolutely free from disturbance or traffic of any kind. Before opening for traffic this cover coat shall be completely removed.

61.17. Plastering Rail.—Wherever railway track is encountered in the area to be paved, the rails shall be plastered with a stiff mortar mixed, 1 part of Portland cement to 3 parts of concrete masonry sand. This shall be used to completely fill under the head of the rail on both sides of the web. When this is done no deduction will be made from the paved area for the area of the rails for purposes of payment.

61.18. Measurement and Payment.—The quantity of pavement to be paid for under this item shall be the number of square yards placed in accordance with the plans or directions of the Engineer, and shall be computed by multiplying the actual width of pavement, including expansion joints, by the total length of pavement measured along the axis of the road and parallel to the surface, except that the area of manhole covers and catch basins, where encountered, shall be omitted. The price bid per square yard shall cover the sand cushion, paving brick, grout, (except Portland Cement), material for expansion joint, sand covering, sprinkling, and all other labor, materials and incidentals necessary to satisfactorily complete the work.

ITEM 61—A

The specifications for this item will be the same as those given under Item 61 and entitled "BRICK PAVEMENT, TYPE 1," except in the following details: **CEMENT-SAND BED.**—Not less than 10 days after the concrete foundation has been completed, there shall be spread upon this foundation a bed of cement and concrete masonry sand, consisting of 1 part cement and 4 parts of concrete masonry sand of which the depth shall not be greater than 1" after rolling. The sand and cement must be thoroughly mixed dry before placing either by an approved type of mixer, or by hand, on a mixing board or pan. The materials shall be thoroughly mixed until a uniform color is obtained and should be spread on the foundation in this condition. The cement-sand bed shall be struck off with a template and be brought to the exact form and section shown on plans to the required depth below the finished grade. After the bed has been leveled off it shall be rolled with a hand roller weighing about 300 lb. If any depressions develop they shall be filled in and the bed again leveled and the rolling shall be repeated as many times as are necessary to compress the sand bed. Tramping upon the cement-sand bed is prohibited. The inspector must keep the brick culled and the Contractor shall make the necessary changes and replacements so that the work at all times shall be ready for the grouting within 100 ft. of the brick line.

All brick laid must be rolled ready for grouting at the end of the working period and each day's work must be completed in full.

Before the grouting is applied the rolled bricks shall be thoroughly wet by sprinkling. It is important that the bricks be well wet so as to set up the cement-sand bed. An excess of water over that required and taken up by the cement-sand cushion must not be used. The operation of grouting will be followed as for "Type 1."

Payment will be made as for "Type 1" except that it will also cover the cement-sand bed (except PORTLAND CEMENT).

ITEM 59—WOOD BLOCK PAVEMENT

(NEW YORK STATE 1922)

59.1. Work.—Under this item the Contractor shall furnish and place upon a properly prepared foundation wood block of the quality specified where shown upon the plans or ordered by the Engineer.

This pavement shall be placed upon the old macadam, old concrete pavement, new concrete foundation or on other foundation as shown on the plans and ordered by the Engineer.

59.2. Material.—The blocks shall be from 6 to 9" long and shall average 8"; they shall be 3" in depth and from 3 to 4" in width; but all blocks in one piece of pavement shall be of uniform width. No variation greater than $\frac{1}{8}$ " shall be allowed in the depth and $\frac{1}{8}$ " in the width of the blocks.

59.3. Blocks shall be made from Southern yellow pine, North Carolina pine, Norway pine, black gum or tamarack; only one kind of wood however shall be used in one piece of pavement.

Yellow pine block shall be made from what is known as Southern yellow pine, well manufactured, full size, saw butted, all square edges, and shall be free from the following defects:

Unsound, loose and hollow knots, worm holes and knot holes, through shakes and round shakes that show on the surface. In yellow pine timber the annular rings shall average not less than six to the inch and shall be in no case less than four to the inch, measured radially.

Norway pine, gum, North Carolina pine and tamarack block shall be cut from timber that is first-class in every respect, and shall be of the same grade as that defined for the Southern yellow pine.

59.4. The creosote oil with which the blocks shall be treated shall conform to either of the following specifications, designated as "A" and "B."

The preservative to be used under this specification shall be a product of coal gas, water gas or coke oven tar, which shall be free from adulterations and contain no raw or unfiltered tars, petroleum compounds, or tar products obtained from processes other than those stated.

SPECIFICATION "A"

The specific gravity shall not be less than one and eight-hundredths (1.08) nor more than one and fourteen hundredths (1.14) at a temperature of thirty-eight (38) degrees centigrade.

Not more than three and one-half (3½) per centum shall be insoluble by continuous hot extraction with benzol and chloroform.

On distillation, which shall be made exactly as described in Bulletin 65 of the Railway Engineering and Maintenance of Way Association, the distillate, based on water free oil, shall not exceed one-half (½) of one (1) per centum at one hundred and fifty (150) degrees centigrade, and shall be not less than thirty (30) nor more than forty (40) per centum at three hundred and fifteen (315) degrees centigrade.

The oil shall contain not more than three (3) per centum of water.

SPECIFICATION "B"

It shall be completely liquid at thirty-eight (38) degrees centigrade, and shall have a specific gravity at that temperature of not less than one and three hundredths (1.03) nor more than one and eight hundredths (1.08).

It shall contain not more than two (2) per centum of matter insoluble by hot extraction with benzol and chloroform.

On distillation, which shall be made exactly as described in Bulletin No. 65 of the American Railways Engineering and Maintenance of Way Association, the distillate based on water free oil shall be within the following limits:

At 210°C. not more than 5%.

At 235°C., not more than 35%.

At 315°C., not more than 85%.

The oil shall yield a coke residue not exceeding three (3) per cent.

The distillate, between 210°C. and 235°C., shall yield solids on cooling to 15°C. The preservative shall contain not more than 3% of water.

59.5. **Sampling of Oil.**—The manufacturer of the oil shall permit full and complete inspection and sampling at the factory at which the oil is produced, of all materials either crude or refined, entering into the manufacture of the finished product itself, in order that the materials used can be determined to be in accordance with the foregoing requirements. He shall also submit satisfactory proof of the origin of all materials entering into the composition of the finished product.

Samples of the preservative taken by the inspector from the treating tank during the progress of the work shall at no time show an accumulation of more than 2% of foreign matter, such as sawdust or dirt.

59.6. The blocks shall be treated with the preservative above described, so that they shall contain at least 16 lb. of the same per cubic foot of timber.

The manufacturer of the block shall equip his plant with all necessary gauges, appliances and facilities to enable the inspector to satisfy himself that the requirements of the specifications are fulfilled.

59.7. **Method.**—Upon the foundation shall be spread a bed of cement mortar at no place less than ½" in thickness, composed of one part Portland cement and four parts sand thoroughly mixed dry. This mortar bed shall be struck with a template to a true surface exactly parallel to the top of the proposed pavement surface and 3" below it. The bed shall be sprinkled, immediately in advance of the block laying, with clean water by hand sprinklers.

59.8. On the mortar surface prepared as described, the blocks shall be laid with grain vertical and at such angles with the curb as the Engineer may direct. The block shall be laid in straight and parallel courses and set loosely together but the joints shall not exceed $\frac{1}{8}$ " and the blocks shall not be driven together. Each course of blocks shall be of uniform width and depth, with end joints broken by a lap of not less than $2\frac{1}{2}$ ". Only whole blocks shall be used except in starting courses, cutting closures, or where specially permitted by the Engineer. Expansion joints of the same character as is specified for "Brick Pavements" shall be used as shown on the plans or as ordered by the Engineer. On steep grades or elsewhere as shown on the plans or as ordered by the Engineer, iron or steel plates shall be furnished, inserted and secured in the transverse joints. Such plates shall conform exactly to the surface of the paving. Payment for them will be made under item "MISCELLANEOUS IRON AND STEEL."

Closures shall be carefully cut and trimmed by experienced men, the portion of the blocks used shall be free from defects and the cut end shall have a surface perpendicular to the top of the block and cut at a proper angle to give a close joint. In laying block the pavers must stand on the block previously laid.

After the laying is completed, defective blocks shall be carefully culled out, low blocks raised, the courses carefully aligned and the blocks spaced up. The pavement shall then be rolled by a self-propelled tandem roller weighing not less than $2\frac{1}{2}$ tons nor more than 5 tons; the pavement being at the same time lightly sprinkled and the rolling continued until a uniform surface is obtained. Upon the completion of the rolling any defective blocks shall be removed and be replaced with sound blocks, and displaced blocks shall be realigned. The joints in the pavement shall then be immediately filled in the manner hereinafter described. If deemed advisable by the Engineer, portions of pavement laid with blocks which have become "dried out" shall be sprinkled with water at frequent intervals before joints of same are filled.

59.9 After rolling, the blocks shall be flushed with an approved bituminous filler heated to at least 300°F ., which shall be poured over the whole surface and well forced into the joints by rubber squeegees. While the bituminous filler is still hot it shall be immediately followed with a thin coating of clean dry sand. Before turning traffic onto the pavement a coating of $\frac{1}{2}$ " in thickness of dry screened sand shall be spread over the entire surface.

59.10. **Measurement and Payment.**—The quantity to be paid for under this item shall be the number of square yards, including expansion joints, of pavement laid in accordance with the plans and as directed by the Engineer.

The price bid shall cover the furnishing and placing of the mortar bed, (except PORTLAND CEMENT), wood block, bituminous filler and sand surfacing and all other labor and incidental expenses necessary to complete the work.

ITEM 62—STONE BLOCK PAVEMENT.—TYPE I

ITEM 62A—STONE BLOCK PAVEMENT.—TYPE 2

62.1. **Work.**—Under this item the Contractor shall furnish and place upon a properly prepared foundation Stone Block pavement of the quality specified below, as shown upon the plans or directed by the Engineer.

The item will include the furnishing and placing of all the block, sand cushion, grout, expansion joints and all material, labor and other expenses incidental thereto, but will not include the concrete foundation, edging, curbing, manholes, catch basins, etc., which will be paid for under the especially designated items therefor.

62.2. **Material.**—The dimensions of granite or other blocks except of Medina sandstone shall be as follows: Not less than 8" nor more than $12\frac{1}{2}$ " long on top, not less than $3\frac{1}{4}$ " nor more than $4\frac{1}{2}$ " wide on top, and not less than $4\frac{3}{4}$ " nor more than $5\frac{1}{2}$ " deep. They shall be dressed so that after laying no measurement of any joint shall show a width of more than $\frac{1}{2}$ " for a depth of 1", or a width of more than 1" in any part of the joint. The head of the block shall be so cut that it shall not have a depression in it more than $\frac{3}{8}$ " deep, and the edges and corners must be full unchipped and unbroken. All blocks shall be sorted and laid in straight course of uniform width and depth.

The dimensions of the Medina sandstone blocks shall be as follows: Not less than 8" nor more than $13\frac{1}{2}$ " long on top; not less than 3" nor more than $5\frac{1}{4}$ " wide on top and not less than 6" nor more than 7" deep. They shall be dressed so that after laying no measurement of any joint shall show a width of more than $\frac{1}{4}$ " for a depth of $2\frac{1}{2}$ " or a width of more than 1" in any part

of the joint. The head of the block shall be so cut that it shall not have a depression in it more than $\frac{3}{8}$ " deep and the edges and corners must be full unchipped and unbroken. All blocks shall be sorted and laid in straight courses of uniform width and depth.

62.3. The blocks shall be of stone of medium sized grain showing an even distribution of constituent material. They shall be of uniform quality and texture, without seams scales or disintegration. They shall be made from rock which when tested in the Deval Rattler will show a "coefficient of wear" of more than 7 and less than 14. All blocks for any one contract shall be from the same quarry unless otherwise directed.

62.4. Method.—On the prepared foundation, sufficient clean Cushion Sand as described under "Materials of Construction" shall be spread to such a thickness that after the pavement has been thoroughly rammed or settled the sand under the block shall be nowhere less than 1" thick.

Premoulded longitudinal expansion joints shall be placed along side each curb or edging and shall conform strictly to the requirements given under "MATERIALS OF CONSTRUCTION."

These joints must extend to the depth of the block. No transverse joints shall be allowed. The material should be made into strips of suitable length and of the required depth and thickness as shown on plans and should be laid in the pavement with the ends loosely joined as the block are being laid.

On the sand cushion above specified the blocks shall be set vertically on edge in close contact with each other, and in straight rows across the road at right angles to the curb, except at intersections or curves, where the angle of the rows with the curb shall be varied to meet the conditions. Blocks in adjoining rows shall be set to break joints not less than 3". All blocks shall be set so that when thoroughly rolled or settled to a firm, unyielding bearing, they will then be true to lines, grades and cross-sections, and have no joints greater than the maximum allowable. All depressions or irregularities in the surface shall be corrected to the satisfaction of the Engineer. Only practiced and competent pavers shall be employed in laying the blocks.

After the blocks are laid, sufficient approved clean gravel shall be spread over the surface and swept into the joints so as to fill the latter to a depth of about 2" from the bottom. The blocks shall then be thoroughly rolled until firm, with a roller weighing not less than 6 tons, even and true to the lines, grades and cross-sections. Blocks not brought to true surface by rolling shall be rammed.

Portland cement grout mixed in proportions of 1 part cement and 2 parts sand shall then be poured into the joints until the grout flushes to the surface of the pavement. The grout shall be broomed when required, and the pouring and brooming shall be continued until all the joints are thoroughly filled, and the grout is even with the highest part of any and all blocks. Before grouting the blocks shall be wet by sprinkling or otherwise. Grout shall be mixed as specified under Item 61.

62.5. Covering.—After grouting shall have been completed and the grout shall have sufficiently hardened, a coating of suitable material about 1" deep shall be spread over the whole surface of the grouted pavement, and the road shall then be sprinkled with water. This covering shall be kept wet, and no travel of any kind shall be allowed on the completed pavement for at least 10 days thereafter, nor until the grout shall have thoroughly set, when the covering shall be completely removed.

62.6. Measurement and Payment.—The quantity to be paid for under this item shall be the number of square yards of pavement within the edging or curbing laid in accordance with the plans and as directed by the Engineer.

The price bid shall cover the furnishing and placing of all materials, (except PORTLAND CEMENT), the spreading of sand cushion, the laying, rolling, grouting, surfacing and all labor and incidental expenses necessary to complete the work.

ITEM 62—A

The specifications for this item will be the same as those given under Item 62 and entitled "STONE BLOCK PAVEMENT, TYPE I," except in the following details:

CEMENT-SAND BED.—Not less than 10 days after the concrete foundation has been completed, there shall be spread upon this foundation a bed of cement and concrete masonry sand, consisting of 1 part cement and 4 parts of concrete masonry sand of which the depth shall not be greater than 1" after rolling. The sand and cement must be thoroughly mixed dry before

placing either by an approved type of mixer, or by hand, on a mixing board or pan. The materials shall be thoroughly mixed until a uniform color is obtained and should be spread on the foundation in this condition. The cement-sand bed shall be struck off with a template and be brought to the exact form and section shown on plans to the required depth below the finished grade. After the bed has been leveled off it shall be rolled with a hand roller weighing about 300 lb. If any depressions develop they shall be filled in and the bed again leveled and the rolling shall be repeated as many times as are necessary to compress the sand bed. Tramping upon the cement-sand bed is prohibited. The inspector must keep the block culled and the Contractor shall make the necessary changes and replacements so that the work at all times shall be ready for the grouting within 100 ft. of the block line.

All block laid must be rolled ready for grouting at the end of the working period and each day's work must be completed in full.

Before the grouting is applied the rolled block shall be thoroughly wet by sprinkling. It is important that the blocks be well wet so as to set up the cement-sand bed. An excess of water over that required and taken up by the cement-sand cushion must not be used. The operation of grouting will be followed as for "Type 1."

Payment will be made as for "Type 1" except that it will also cover the cement-sand bed (except PORTLAND CEMENT).

Item 56. Trimming Shoulders New York

a. Work.—Under this item the contractor shall form and trim shoulders, ditches, and slopes in a workman-like manner to the lines and grades of the typical sections shown on plans and as the engineer may direct. The shoulders should be rolled with a roller weighing not less than 3 tons and left in a compact and satisfactory condition at the completion of the contract.

b. Measurement and Payment.—The quantity to be paid for shall be the number of linear feet measured along the axis of the roadway where the work is actually performed.

The price bid per linear foot of road shall cover all labor and incidental work necessary to trim, form, and compact shoulders, ditches, and slopes to the line and grade shown on the plans or as ordered by the engineer.

STANDARD SPECIFICATIONS FOR LOCAL IMPROVEMENTS

City of Rochester, N. Y.

Division E. Sidewalk Construction

(1920 Edition)

Table of Contents

	Page
E-1. Subgrade and Drainage.....	1484
<i>a.</i> Preparation of Subgrade	1484
1. Excavating, Rolling, etc.	
2. Trees to be Removed	
3. Roots and Trees Not Removed	
<i>b.</i> Surface Drainage	1484
1. Walk Grades	
<i>c.</i> Provision of Underdrainage.....	1484
1. When Required	
2. Drainage Course	
3. Connections with Sewers	
4. Subgrade, etc., to be Wet	
5. Prices to Cover	
E-2. Foundation and Wearing Surface of Concrete Walks.....	1485
<i>a.</i> Forms, Dimensions, etc.....	1485
1. Forms	
2. Dimensions of Slabs	
3. Joints	
4. Thickness	
5. Expansion Joints	
6. Edges to be Rounded	

	Page
b. Two-course Walks.....	1485
1. Foundation Course	
2. Reinforcement	
3. Wearing Surface	
4. Thickness, etc.	
5. Method of Finishing	
6. Excessive Moisture	
7. Prices to Cover	
c. One-course Walks.....	1486
1. Quality of Concrete	
2. One-course Walks on Residence Streets	
3. Thickness	
4. Method of Construction	
5. Reinforcement	
6. Prices to Cover	
d. Protection of Walks	
1. To be Kept Moist, etc.	
2. Extreme Weather Conditions	

E-1. Subgrade and Drainage

a. **Preparation of Subgrade.**—1. The ground to be occupied by the sidewalk shall be excavated or filled to a subgrade, which, after being compacted, shall be such a depth below the finished surface of the sidewalk as may be shown on the plans. The subgrade shall immediately be dressed to a plain surface containing no large stones, roots, sod, or rubbish and shall slope downward toward the street $\frac{1}{2}$ " in 1', horizontally, and to such longitudinal grade as may be shown on the plans. The completed subgrade shall project 4" in excavation and 18" in embankment on each side beyond the edges of the completed walk. After the grading is completed, the surface shall be compacted by rolling or ramming. All soft and spongy places shall be removed and all depressions filled with material as nearly as possible conforming to that in the remainder of the subgrade. All filling shall be compacted in layers not exceeding 6" in thickness.

2. Trees shall not be cut down or otherwise disturbed except by order of the engineer as shown on the plan. Any tree to be removed must be grubbed out or excavated with all of its principal roots and in case of cement walks for the entire width of the sidewalk. Trees having a diameter of 6" or over will be paid for, the measurement to be taken 3" above the ground. Payment for the removal of such trees will be made in accordance with the contract price for the removal of trees.

Stumps will be removed when encountered in the work. They must be grubbed out or excavated as in the case of trees. Stumps having a diameter of 6" or over at the place where they were cut will be paid for at the contract price bid for removing stumps.

3. Roots and trees which are not removed, but which are contiguous to the line of the sidewalks, and in any manner interfere therewith, must be trimmed and cut away as the engineer shall direct. Where the engineer may direct, the sidewalks shall be fitted to such trees.

b. **Surface Drainage.**—1. In establishing the grade for the walk, 1" shall be added to the grade resulting from the $\frac{1}{2}$ " rise per foot from the curb grade, so that the earth slope from the curb to the walk shall be left 1" below the walk surface, to insure proper drainage of all water from the sidewalk. The grade established will be the side nearest the curb.

c. **Provision of Underdrainage.**—1. When shown on the plans or required by the engineer, a suitable drainage system shall be installed and connected with sewers or other drains as indicated.

2. On the subgrade prepared as specified, the drainage course, when required, shall be thoroughly rolled or tamped to a surface at least 5" below the finished grade of the walk. The drainage course shall be composed of broken stone, gravel, or boiler-plant cinders 4" in thickness when compacted. The broken stone for this purpose may be any durable stone, crushed to such size that all will pass through a screen with 2" openings and be retained on a $\frac{1}{2}$ " screen. Gravel for the purpose may be any sound, durable gravel, all of which shall pass through a 2" screen and be retained on a $\frac{1}{4}$ " screen. If cinders are used they must be good boiler-plant cinders from which the ashes have been screened out. The cinders must be thoroughly drenched with water before they are placed on the sidewalk.

3. The bottom of the drainage course shall be connected with street drains, or sewer inlets, by 3" hard farm tile drain pipe at such points, not more than 200' apart, as will drain all the standing water out of the drainage course.

4. While compacting the subgrade and drainage course, the material shall be kept thoroughly wet and shall be in that condition when the concrete is deposited; unless the subgrade is composed of damp clay, in which case extra care must be taken to prevent it becoming too soft.

5. *Prices to Coter.*—The cost of preparing the subgrade as specified above in Subdivision a, except as otherwise provided, shall be included in the contract price for subgrade. Where underdrainage is required by the plans or by order of the engineer, the cost of providing the materials and constructing the drainage course complete, as specified above in Subdivision b, Pars. 1 to 4, inclusive, shall be included in the contract price for drain tile for underdrainage.

Where contracts are for walks only, the items for extra earth excavation shall include all excavation above the finished grade line, as shown on the standard plans, and shall be for such width as indicated by a special section.

E-2. Foundation and Wearing Surface

a. *Forms, Dimensions, and Joints.*—1. Forms shall be free from warp and have sufficient strength to resist springing out of shape. The forms shall be well staked or otherwise held to the established lines and grades and their upper edges shall conform to the established grade of the walk. All wood forms shall be thoroughly wetted and metal forms oiled before depositing any material against them. All mortar and dirt shall be removed from forms that have been previously used.

2. The slabs or independently divided blocks, when not reinforced, shall have an area of not more than 36 sq. ft. and shall not have any dimensions greater than 6'. The large slabs shall be reinforced as hereinafter specified. In general, no walk shall be less than 5' in width.

3. Each slab shall be separate from the adjoining one by a straight joint filled with tar paper. All joints shall be made with a jointing tool not less than $\frac{1}{2}$ " thick, and so made as to slightly round the corners of the flags.

4. The thickness of the walks shall be generally 1" in thickness for each foot in width, but in no case less than 5" for a two-course walk, or 4" for a one-course walk, for residence streets, and not less than 6" for a two-course walk on business streets. The maximum thickness will be shown on the plans.

5. A $\frac{3}{8}$ " thick expansion joint of asphaltic felt the same depth as the concrete shall be provided at least once in every 50'. Wherever the walk extends directly against the curb or building, a $\frac{1}{2}$ " expansion joint of asphaltic felt shall be provided.

6. Unless protected by metal, the upper edges of the concrete shall be rounded to a radius of $\frac{1}{2}$ ".

7. Where steel dividers are used between each slab, tar paper and asphaltic felt joints may be omitted.

b. *Two-course Walks.*—1. Where the sidewalk extends from the curb to a building a two-course walk may be laid, otherwise a one-course walk shall be laid.

2. The foundation course of a two-course walk shall be composed of Portland cement concrete designated as Class B concrete in these specifications. The proportioning, mixing, and placing of concrete shall be done in accordance with the specifications for Class B Portland cement concrete. (See Division B-1 of these specifications.)

3. Slabs having an area of more than 36 sq. ft. or having any dimension greater than 6' shall be reinforced with wire fabric or with plain or deformed bars. The cross-sectional area of metal shall amount to at least 0.041 sq. in. per lineal foot. The reinforcement shall be placed upon and slightly pressed into the concrete base immediately after the base is placed. Reinforcement shall not cross an expansion joint. Where joined it shall be lapped sufficiently to develop the full strength of the metal.

4. The wearing-surface course shall be mixed in the manner specified for mixing Portland cement concrete (see Division B-1) and shall be composed of Class B Portland cement mortar. Both the Portland cement and the fine aggregate used shall conform to the requirements of these specifications, Division B-1. The mortar shall be of a consistency that will not require tamping, but which can easily be spread into position.

5. The wearing-surface course shall have a minimum thickness of 1" and shall be placed immediately after mixing. In no case shall more than 40 min. elapse between the time the concrete for base is mixed and the time the wearing course is placed.

6. After the wearing course has been brought to the established grade, it shall be worked with a wooden float in a manner that will thoroughly compact it. When required, the surface shall be troweled smooth, but excessive working with a steel trowel shall be avoided. The slab marking shall be made in the wearing course, directly over the joints in the base, with a tool which will completely separate the wearing courses of adjacent slabs.

7. If excessive moisture occurs on the surface, it must be taken up with a rag or mop, and in no case shall dry cement or a mixture of dry cement and sand be used to absorb this moisture, or to hasten the hardening.

8. *Prices to Cover.*—The cost of furnishing and preparing the material and constructing the foundations and wearing surface, as specified above in subdivisions *a* and *b*, shall be included in the contract price for foundation and wearing surface of two-course sidewalks, except that where reinforcement is required additional payment shall be made, at the contract price for reinforcement, for such quantities as are shown on the plans or required by written order of the engineer.

c. One-course Walks.—The general requirements of the specifications covering two-course walks will apply to one-course walks with the following exceptions:

1. The concrete shall be Class A concrete, as specified in these specifications, Division B-1, Subdivision *d*.

2. In general, one-course walks shall be laid on all residential streets.

3. The thickness of one-course walks shall be not less than 4" at any section.

4. The forms shall be filled, the concrete struck off, coarse particles forced back from the surface, and the work finished as specified under two-course walk, Subdivision *b*.

5. When a one-course walk is to be reinforced the metal shall be placed 2" from the finished surface. The minimum amount of metal shall be as specified under two-course walk.

6. *Prices to Cover.*—The cost of furnishing and preparing the material and constructing the sidewalk, as specified above in Subdivisions *a* and *c*, shall be included with contract price for one-course sidewalks, except that where reinforcement is required additional payment shall be made, at the contract price for reinforcement, for such quantities as are required by written order of the engineer, or shown on the plans.

d. Protection of Walks.—1. When completed, all walks shall be kept moist and covered with canvas or boards and protected from traffic and the elements for at least 3 days, and shall not be opened to traffic until the engineer so directs. The cost of such protection shall be included in the contract price for sidewalk construction.

2. If, at any time during the progress of the work the temperature is, or in the opinion of the engineer will within 24 hrs. drop to 35°F., the water and aggregate used in preparing the concrete shall be heated, and precautions shall be taken to protect the work from freezing for at least 3 days. In no case shall concrete be deposited upon a frozen subgrade or subbase. No concrete shall be laid in freezing weather.

Item 12.—Changing Elevation of Manholes and Catch Basins¹

a. Work.—Under this item the contractor shall raise or lower, to the grades given, all existing covers of catch basins or manholes.

b. Material.—All changes shall be made with acceptable brick laid in Portland cement mortar of 1 part cement and 2 parts concrete sand.

c. Method.—All work shall be done in a workman-like manner by competent masons.

d. Measurement and Payment.—For each manhole or catch basin raised or lowered as directed by the engineer, the contractor shall receive the unit price bid.

The price bid shall cover all labor, materials (except Portland cement), and incidentals necessary to complete the work. If any manhole or catch-basin heads or covers are broken through carelessness on the part of the contractor, they shall be replaced at his expense.

¹ New York.

Item 7. Pipe Underdrain¹

a. Work.—Under this item the contractor shall furnish and lay, at his option, porous tile, vitrified clay, or concrete pipe wherever required for drainage, of the size indicated on the plans or in the itemized proposal.

b. Material.—1. Porous tile shall be whole and free from cracks and other defects and must be satisfactory to the engineer.

2. Vitrified clay pipe shall be first-quality, double-strength, salt-glazed, sound, vitrified, stoneware pipe.

3. Concrete pipe shall be first quality and free from cracks and other defects, and must be satisfactory to the engineer. The concrete shall consist of a mixture of 1 part Portland cement, 2 parts concrete sand, and 3 parts of broken stone or screened gravel of No. 1 size.

c. Method.—The pipe shall be laid true to line and grade on a 2" bed of No. 2 size stone, gravel, or slag and shall be covered as laid with broken stone, screened gravel, or broken slag, placed around and above it to a height and in a manner as directed by the engineer. The joints shall be wrapped with a strip of burlap or tar paper not less than 6" wide and lapped at least 6" on top of the pipe.

d. Measurement and Payment.—The amount to be paid for under this item shall be the number of linear feet of pipe furnished and incorporated in the work.

The price bid shall cover all labor, materials, and incidentals necessary to complete the work, except that the necessary excavation will be paid for under the item Excavation, and the necessary broken stone, broken slag, or screened gravel will be paid for under the items Broken Stone, Loose Measurement, Broken Slag, Loose Measurement, or Screened Gravel, Loose Measurement.

Item 10. Relaying Old Pipe¹

a. Work.—Under this item the contractor shall, as directed, carefully remove, preserve, haul, and relay old pipe found in existing culverts.

The old pipe when relaid shall be true to line and grade and have a full, firm, even bearing, and the work shall be in every way the same as if new pipe were being laid.

Existing pipe in good condition which is damaged in removing, due to the carelessness of the contractor, shall be replaced with new pipe at the contractor's expense.

Existing pipe which is, in the engineer's judgment, unfit for relaying may be destroyed before removing.

b. Measurement and Payment.—The amount to be paid for under this item shall be the number of linear feet incorporated in the work. New pipe furnished to replace old pipe which is destroyed through the carelessness of the contractor shall be paid for as if the old pipe had been preserved and relaid.

The price bid shall cover the labor, materials, and incidentals necessary to complete the work, except that the excavation necessary will be paid for under the item Excavation.

Drop Inlets¹

Drop inlets shall be constructed where shown upon the plans, or directed by the engineer. The details of construction shall be such as he may direct.

Payment for drop inlets will be made under appropriate items at the contract price for the materials entering into their construction; that is, payment will be made for the various amounts of excavation, concrete, miscellaneous iron and steel, cast-iron pipe, Portland cement, etc. Payment under these items shall cover all labor and materials necessary to complete the work.

Item 15. Stone Filling¹

a. Work.—Under this item the contractor shall furnish and place acceptable stone or either quarry, field, or cobblestone on slopes, in fills, in crib work, and similar work as required. The larger stones shall be properly embedded at the bottom of the fill; all stones shall be so placed as to make a fill of maximum capacity.

b. Measurement and Payment.—The quantity to be paid for under this item shall be the number of cubic yards measured in its final position and incorporated in the work as directed by the engineer. The price stipulated shall cover the cost of obtaining the stone, placing and all materials and expenses incidental thereto, except that the excavation necessary will be paid for under the item Excavation.

¹ New York.

Item 16. Rip-Rap¹

a. Work.—Under this item the contractor shall furnish and place rip-rap for slope protection where shown upon the plans or ordered by the engineer.

b. Material.—Rip-rap shall consist of field stone or rough, unhewn quarry stones as nearly cubical in form as is practicable, placed upon a slope not steeper than the angle of repose, and so laid that the weight of the large stones is carried by the soil and not by the stones adjacent. Fifty per cent of the mass shall be large stones of 2 cu. ft. or more.

The largest stones shall be placed first, roughly arranged and in close contact; the stones shall rest upon a 6" bed of stone chips or gravel or other acceptable porous material, where ordered by the engineer. The spaces between the larger stones shall be filled with spalls of suitable size.

c. Measurement and Payment.—The quantity of rip-rap to be paid for under this item shall be the number of cubic yards placed in accordance with the plans or as directed by the engineer. When a porous bed is placed in accordance with the directions of the engineer, the quantity of the same shall be included in the quantity of rip-rap and paid for as such.

The price bid shall cover all labor, materials, and incidental expenses necessary to complete the work satisfactorily, except that the excavation necessary will be paid for under the item Excavation.

Item 18. Timber and Lumber¹

a. Work.—Under this item the contractor shall furnish and place all timber and lumber of various sizes as may be ordered for sills or platforms beneath the road, for culverts, bridges, reinforcing existing structures, and for other similar purposes as ordered by the engineer.

b. Material.—Timber and lumber shall be of shortleaf yellow pine or spruce or other acceptable kind, sound, square-edged, free from shakes, loose knots, or decay, and shall be planed and framed if required.

c. Work Not Included.—No payments will be made under this item for timber or lumber for forms, molds, or centers, for sheeting or bracing, scaffolds, fences, guide rails, or any part of the contractor's temporary bridges, roads, or plant; but payment for timber and lumber used in the above cases shall be included under the appropriate items covering the same.

d. Measurement and Payment.—The quantity of timber and lumber to be paid for shall be the number of thousand feet, board measure, actually placed in accordance with orders of the engineer. If any round timber is used it shall be estimated as square timber of the largest size, omitting fractions of an inch, which can be inscribed in the small end of the log.

No second-hand timber shall be used except with the approval of the engineer. The price bid shall cover all bolts, spikes, and other fastenings and all other material and expenses incidental of furnishing, framing, and placing the timber and lumber satisfactorily.

Item 27. Concrete Curbing¹

a. Work.—Under this item the contractor shall place concrete curbing, of the type shown on the plans, where shown on the plans or ordered by the engineer.

b. Material.—The concrete shall consist of a mixture of 1 part Portland cement, 2 parts of concrete sand, and 3 parts of broken stone or screened gravel measured separately, and shall be mixed in accordance with the general requirements of Concrete Masonry.

The aggregates for concrete curbing shall meet the requirements given in the detailed specifications, Materials of Construction.

c. Method and Forms.—Curbing shall be molded in place in sections 6' long and provision made at each joint for expansion of $\frac{1}{8}$ ".

All forms shall be set true to line and grade and held rigidly in position. They shall be either of metal or of acceptable planed and matched lumber, and of such construction that a smooth surface will be provided.

The forms shall be left in place until the concrete has set sufficiently so that, in the opinion of the engineer, they can be removed without injury to the curbing. The curbing shall immediately upon the removal of the forms be rubbed down to a smooth and uniform surface, but no plastering will be allowed. For this work a competent and skilful finisher shall be employed.

The curbing shall be covered, immediately after finishing, with burlap, or other material acceptable to the engineer, which shall be kept wet for a period of 3 days.

¹ New York.

d. Protection.—The contractor shall protect the curbing and keep it in first-class condition until the completion of the contract. Any curbing which is damaged at any time previous to the final acceptance of the work shall be removed and replaced with satisfactory curbing at the contractor's expense.

e. Measurement and Payment.—The quantity to be paid for under this item shall be the number of linear feet placed in accordance with the plans or the directions of the engineer.

The price bid for concrete curbing shall cover the furnishing and placing of all concrete, tile, porous filling, forms, and all materials (except Portland cement), labor, and incidental expenses necessary to complete the work, except that the excavation necessary will be paid for under the item Excavation.

Item 34. Wooden Guide Railing¹

a. Work.—Under this item the contractor shall furnish and erect wooden guide railing of the type indicated, where shown on the plans or ordered by the engineer.

b. Material.—The posts shall be of seasoned white oak, cedar, locust, tamarack, or chestnut. Posts and rails shall be sound, clear, and cut from live timber. The posts shall be round, at least 6" in diameter at the smaller end after the bark is removed. Posts shall be shaved to even surfaces free from bark or skin. The lower part of the posts to a point 3' from the top shall be dipped while dry in suitable bituminous material heated to a temperature of 300°F., or shall be charred as directed. The posts if dipped shall be thoroughly dry before being set in the ground.

Rails shall be of seasoned, planed spruce or yellow pine and be properly secured to the posts, all in a workman-like manner.

White paint used under this item shall conform to the specifications under Materials of Construction.

c. Painting.—The joints of the rails and posts shall be given one coat of white paint before being put together; the beveled tops of posts shall receive two heavy coats of the same. The entire surface exposed above the ground shall receive three coats of white paint. No paint shall be applied in wet or freezing weather.

d. Measurement and Payment.—The quantity of wooden guide railing to be paid for under this item shall be the number of linear feet completed in place.

The price bid shall cover the furnishing and erecting of all posts and rail, the excavation, painting, dipping, hardware, and all expenses and incidentals necessary to complete the work.

Item 35. Cable Guide Railing¹

a. Work.—Under this item the contractor shall furnish and erect guide railing as shown on the standard structure sheet at such places as indicated on the plan or as otherwise directed by the engineer.

Stretches of guide railing more than 500' in length shall have two intermediate anchors for each 500' stretch or fraction thereof.

b. Material.—The posts shall be made of concrete consisting of 1 part of Portland cement, 2 parts of concrete sand, and 3 parts of crushed stone or screened gravel, all measured loose bulk in boxes or forms of known capacity.

All posts shall be reinforced as shown on the standard structure sheet with fabricated steel bars meeting all the requirements of the Standard Specifications of the A.S.T.M. Serial Designation A-15-14 or, at the contractor's option, with steel fabric meeting all requirements of the Standard Specifications of the A.S.T.M. Serial Designation A-82-21T.

All exposed surfaces shall be finished true to line. No plastering of any surface will be permitted.

After erection, all exposed surfaces of the post shall receive a uniform application of a solution consisting of 8 lb. of zinc sulphate to 1 gal. of water. The application shall be permitted to set for at least 48 hr., after which the posts, when perfectly dry, shall receive two coats of white paint meeting the requirements under Materials of Construction.

Cable shall be three-strand, seven-wire-to-the-strand, double-galvanized steel wire cable of $\frac{3}{4}$ " diameter. Individual wires shall be not less than 0.120" diameter.

The minimum tensile strength of the rope shall be 15,000 lb.

¹ New York.

Each wire of the cable and all fittings and fastenings, except threaded portions, shall be galvanized by the hot-dip method and shall have a continuous coating of pure zinc of a uniform thickness, so applied that it will adhere firmly to the surface of the wire, and it shall be capable of withstanding four immersions in a standard testing solution of copper sulphate without showing any trace of metallic copper on the steel. The first three immersions shall be for a period of 1 min. each and the fourth immersion for a period of $\frac{1}{4}$ min.

The threaded portions of all fittings and fastenings shall have a continuous coating of pure zinc of a uniform thickness, so applied that it will adhere firmly to the surface of the thread, and it shall be capable of withstanding two immersions, of 1 min. each, in a standard testing solution of copper sulphate without showing any trace of metallic copper on the steel.

These threaded portions shall receive, after erection, two coats of aluminum paint meeting the requirements under Materials of Construction.

c. Measurement and Payment.—The quantity of guide railing to be paid for under this item shall be the number of linear feet outside to outside of posts, completed in place, as shown on the plans or as directed by the engineer.

The price bid shall cover the furnishing and placing of all material, the excavation, backfilling, and all other labor and incidental expenses necessary to complete the work satisfactorily.

Item 36. Concrete Guide Posts¹

a. Work and Material.—Under this item the contractor shall furnish and erect concrete posts conforming to the requirements of Item 35.

After erecting, all exposed surfaces of the posts shall receive a uniform application of a solution consisting of 8 lb. of zinc sulphate to 1 gal. of water. This application shall be permitted to set for at least 48 hr., after which the posts, when perfectly dry, shall receive two coats of white paint, meeting the requirements under Materials of Construction.

These posts shall be erected and spread as directed by the engineer.

b. Measurement and Payment.—The number of concrete guide posts to be paid for under this item shall be the number erected in accordance with the plans and orders of the engineer.

The price bid shall cover furnishing and placing of all material, the excavation, backfilling, and all labor and incidental expenses necessary to complete the work satisfactorily.

Item 57. Removing Old Bituminous Carpet¹

a. Work.—Under this item the contractor shall remove the old bituminous carpet as shown on the plans or as directed by the engineer.

b. The loosened bituminous material shall be immediately removed from the payment and deposited as directed by the engineer.

c. Measurement and Payment.—The quantity to be paid for under this item shall be the number of square yards of bituminous carpet removed in accordance with the plans or as directed by the engineer.

d. The price bid shall cover all labor, appliances, and incidental expenses necessary thereto.

Item 58M. Cleaning Existing Pavement (Per Mile); Item 58Y. Cleaning Existing Pavement (Per Mile)¹

a. Work.—The purpose of the work called for under this item is to prepare the existing pavement for the application of a new top course or a wearing carpet.

b. Method.—Under this item the contractor shall clean the existing pavement by the use of hand brooms or by the use of mechanical sweepers of approved type, as directed by the engineer, so as to uncover but not dislodge the embedded stones of the pavement.

All mud, dust, and other dirt so swept off shall then be removed and deposited in such places and in such manner as the engineer may direct.

c. Ruts.—Ruts and depressions of a greater depth than 1" below the general surface of the pavement shall be swept out by hand brooms until all loose material has been removed and the embedded stones are uncovered.

The operation of cleaning out the ruts and depressions and filling them with thoroughly compacted stone or slag and binder to the general level of the surface shall immediately follow the general operation of cleaning the surface.

¹ New York.

d. Measurement and Payment.—The price bid shall include all labor, tools, appliances, the removal of material cleaned from the surface, and all other expenses incidental thereto.

The amount to be paid for under this item shall be the actual quantity of existing pavement, cleaned in accordance with the above and to the satisfaction of the engineer.

Item 59. Scarifying and Reshaping Old Macadam¹

a. Purpose.—The purpose of the work under this item is to prepare old macadam pavement for the application of a top course.

b. Work.—Under this item the contractor shall thoroughly scarify the old macadam, by hand picking or by means of a mechanical scarifier of approved type. When a roller with spiked wheels is used the macadam must be further broken by hand picking, or plowing and harrowing.

The loosened stones shall then be forked or raked over as directed by the engineer, after which the macadam shall be compacted by rolling with a self-propelled roller weighing not less than 10 tons until an even and firm surface is produced, after which coarse gravel or screenings shall be used to fill all voids. If necessary in order to compact the stones satisfactorily, the macadam shall be sprinkled during the process of rolling and filling.

c. Measurement and Payment.—The quantity to be paid for under this item shall be the actual number of square yards scarified, reshaped, rolled, refilled, and compacted to the satisfaction of the engineer, and the price bid shall cover the furnishing of the necessary filler and all labor, appliances, and expenses incidental thereto.

Item 34—Guide Signs

34.1. Under this item the Contractor shall furnish and erect guide signs of the type indicated where shown upon the plans or ordered by the Engineer.

34.2. Permanent guide signs shall be for the purpose of furnishing permanent directions to traffic after the completion of the contract. Permanent guide signs shall be constructed of kiln dried white pine and of the dimensions shown on the plans. They shall first be given four coats of white lead mixed with linseed oil. After the last coat has become thoroughly dried the letters shall be painted with black enamel paint, and when this is thoroughly dry they shall be given one coat of the finest white shellac.

34.3. Temporary guide signs shall be for the purpose of guiding traffic along a detour during construction. Temporary guide signs shall be constructed of kiln dried white pine and of the dimensions shown on the plans. They shall first be given three coats of white lead mixed with linseed oil. After the last coat has become thoroughly dried the letters shall be painted with black enamel paint.

34.4. The number of guide signs to be paid for under this item shall be the number of signs placed in accordance with the plans and ordered by the Engineer. All signs become the property of the State upon payment for this item.

The price bid shall include the furnishing of all labor and materials necessary to satisfactorily erect permanent guide signs on sign posts and temporary guide signs including sign posts, each guide sign complete in place.

Item 35—Highway Number Signs

35.1. Under this item the Contractor shall paint on the concrete sign post highway number signs of the type indicated where shown upon the plans or ordered by the Engineer.

35.2. Highway number signs shall be painted on all concrete sign posts with letters which shall first be formed of two coats of flat black mixed in oil and afterward retraced with black enamel.

35.3. The number of highway number signs to be paid for under this item shall be the number placed in accordance with the plans and ordered by the Engineer.

The price bid shall include the furnishing of all labor and materials to satisfactorily complete the work.

¹ New York.

SPECIFICATIONS

Item 36—Danger Signs

36.1. Under this item the Contractor shall furnish and erect danger signs where shown upon the plans or ordered by the Engineer. These shall be of the type called for by the plans.

36.2. Danger signs shall be constructed of a material and painted similar to that specified for guide signs and shall be of the dimensions and lettered as shown on the standard plans. These signs shall be placed on the standard concrete sign posts and set at an angle of forty-five degrees to the center line. When the standard sign is used the arrow shall point in the direction of the danger.

36.3. The number of completed danger signs for which the Contractor will receive payment will be the number placed in accordance with the plans and ordered by the Engineer.

The price bid shall include the furnishing of all labor and materials necessary to complete each danger sign in a satisfactory manner.

Item 37—Concrete Sign Posts

37.1. Under this item the Contractor shall furnish and erect concrete sign posts of the type indicated, where shown upon the plans or ordered by the Engineer.

37.2. Concrete sign posts shall be made of first-class concrete and of the dimensions and materials shown on the standard plans. To these posts shall be securely fastened guide boards and signs.

37.3. The number of completed concrete sign posts to be paid for under this item shall be the number erected in accordance with the plans and ordered by the Engineer.

The price bid shall include all concrete, reinforcement, forms, excavation and backfill, and the furnishing of all other labor and materials necessary to complete each concrete sign post in a satisfactory manner.

LOOSE STONE

Item 38—Screened Gravel—Loose Measure

Item 39—Broken Stone—Loose Measure

38.1. Under these items the Contractor shall furnish and place upon the road, as directed by the Engineer, broken stone and gravel of the sizes designated on the Itemized Proposal. This stone and gravel will be used for general repair work and for miscellaneous work.

38.2. The stone or gravel delivered shall be of approved quality and shall conform to the general requirements for broken stone and gravel, and they shall be of the sizes ordered.

38.3. The quantity to be paid for under Items 38 and 39 respectively shall be the quantity of broken stone or gravel furnished and delivered on the work at the places and in the condition specified by the Engineer. When the material is produced by the contractor on the work, it shall be measured in cubic yards; it shall be measured in tons of 2000 lbs. when the material is imported and the weight is obtainable from reliable sources such as certified quarry or railroad figures.

The price bid shall include furnishing and delivering the stone or gravel as directed by the Engineer and all labor, appliances and expenses incidental thereto; also the spreading, rolling or incorporating of the stone or gravel in the work, when required by the Engineer.

BRIDGES AND CULVERTS

Item 83. Timber Structures

83.1. Description.—All timber structures shall be built as indicated on the plans, conforming to line, grade, dimensions, and design shown and in accordance with the specifications for piling, concrete, untreated timber, treated timber, and other pay items which are to constitute the complete structure.

83.2. Material.—(1) All timber shall be sound, sawed standard size, straight, out of wind, and shall be free from defects, such as decay, worm holes, injurious shakes, checks, and crooked, cross, or spiral grain, large, loose, or unsound knots, knots in groups, large pitch pockets, or other defects

that might impair its strength and durability. Unless otherwise specified, wane may show on only one corner of a piece. Wane shall not exceed one-half the length of the piece nor measure more than 1" across the face of the wane. Not more than 10% of the pieces of one size may show any wane.

83.3. (2) Standard size and dressing. Rough timbers sawed to "standard size" shall be interpreted to mean that sawn rough timber shall not be over $\frac{1}{4}$ " scant from actual size specified. For instance, a 12 by 12" timber shall measure not less than $11\frac{3}{4}$ by $11\frac{3}{4}$ ". "Standard dressing" shall be interpreted to mean that not more than $\frac{1}{4}$ " shall be allowed for dressing each surface. For instance, a standard 12 by 12" timber, dressed four sides, shall measure not less than $11\frac{1}{2}$ by $11\frac{1}{2}$ ".

83.4. (3) All timber shall be classified as "dense," or "sound," and as "treated" or "untreated."

83.5. (4) "Sound timber" shall meet all the requirements set forth above and may be used for columns, sills, wheel guards, bulkhead sheeting, and bracing.

83.6. (5) "Dense timber" shall be required for truss members, floor beams, stringers, caps, and flooring. Dense timber shall meet all the requirements set forth above and shall be classified as follows: (a) Dense timber of longleaf pine, shortleaf pine, and Cuban pine; (b) dense timber of coast region Douglas fir; and (c) dense timber of other species.

83.7. a. Dense timber of longleaf pine, shortleaf pine and Cuban pine shall show at one end or the other an average of at least six annual rings per inch and at least one-third summerwood, all measured over the third, fourth, and fifth inches on a radial line from the pith. Wide-ringed material excluded by this rule shall be acceptable, provided the amount of summerwood as above measured shall be at least one-half. The contrast in color between summerwood and springwood shall be sharp, and the summerwood shall be dark in color except in pieces having more than one-half summerwood.

83.8. In cases where timbers do not contain pith and it is impossible to locate it with any degree of accuracy, the above inspection shall be made over 3" in an approximate radial line beginning at the edge nearest the pith in timbers over 3" in thickness, and in the second inch of the piece nearest to the pith in timbers 3" or less in thickness.

83.9. In dimension material containing the pith but not a 5" radial line, which is less than 2 by 8" in section, or less than 8" in width, that does not show over 16 sq. in. on the cross-section, the inspection shall apply to the second inch from the pith. In larger material that does not show a 5" radial line, the inspection shall apply to the third inch farthest from pith.

83.10. b. Dense timber of coast region Douglas fir shall be strong timber of medium rate of growth and show on one end or the other an average of at least six annual rings per inch, and at least one-third summerwood measured over 3" on a line located as hereinafter described. Wide-ringed material, excluded by this rule, shall be acceptable, provided the amount of summerwood as above measured shall be at least one-half. Material in which the proportion of summerwood is not clearly discernible shall not be used.

83.11. When the least dimension is 5" or more, the pith being present, the line over which the rate of growth and percentage of summerwood measurements shall be made shall run from the pith to the corner farthest from the pith. The 3" line shall begin at a distance from the pith equal to 2" less than one-half the least dimensions of the piece.

83.12. For all pieces not having the pith present, the center of the 3" line shall be at the center of the end of the piece, and the direction of the 3" line shall be at right angles to the annual rings.

83.13. If a radial line of 3" cannot be obtained, the measurement shall be made over the entire radial line that is available.

83.14. c. Dense timber of other species. Other species of timber for truss members, floor beams, caps, and flooring shall be strictly first quality.

83.15. (6) **Untreated Timber.**—For designs based on a fiber stress in bending of 1500 to 1600 lb. per square inch, one of the following species of timber shall be used:

Douglas fir from Pacific coast region.
Longleaf pine.
Cuban pine.
White oak.

83.16. Heart Requirement.—All untreated timber shall show at least 85% heartwood on any girth.

83.17. (7) Treated Timber.—Timber treated by a pressure method to retain 8 to 12 lb. of oil per cubic foot, as hereinafter specified, and so treated that all sapwood is entirely impregnated with creosote oil, shall fulfil the requirements for untreated timber except that there shall be no heartwood requirement.

83.18. For designs based on a fiber stress in bending of 1500 to 1600 lb. per square inch, one of the following species of timber shall be used:

- Douglas fir from Pacific coast region.
- Longleaf pine.
- Cuban pine.
- Shortleaf pine.
- White oak.

83.19. Preservation Treatment.—Timber to be treated for preservation shall be cut and framed prior to treatment. After treatment no unnecessary cutting of treated piles or timber will be allowed.

83.20. The range of pressure, temperature, and time duration shall be controlled so as to result in maximum penetration by the quantity of preservative injected, which shall permeate all of the sapwood and as much of the heartwood as practicable.

83.21. The amount of preservative and manner of treatment shall be as indicated on the plans and shall fulfil the following requirements:

Timber shall be treated with the preservative specified by any standard full-cell process to retain not less than 12 lb. of the preservative per cubic foot or by any standard empty-cell process to retain not less than 8 lb. of the preservative per cubic foot, except Douglas fir, which shall be treated to retain not less than 10 lb. by any standard full-cell process or 6 lb. by any standard empty-cell process.

83.22. The preservative shall be one of the following grades of creosote oil or creosote coal-tar solution as directed by the engineer, or indicated on the plans, and shall meet the following requirements:

	Creosote oil			Creosote coal-tar solution
	Grade 1	Grade 2	Grade 3	
It shall not contain water in excess of	3%	3%	3%	3%
It shall not contain matter insoluble in benzol in excess of	0.5%	0.5%	0.5%	2%
Specific gravity of oil at 38/15.5°C. shall not be less than	1.03	1.03	1.03	1.05 1.12
The distillate based on water-free oil shall be within the following limits up to 210°C., not more than	5%	8%	10%	5%
Up to 235°C., not more than	25%	35%	40%	25%
The float test of residue above 355°C. shall not exceed 50 sec. at 70°C. if the distillation residue above 355° exceeds	5%	5%	5%	26%
Coke residue of oil not more than ...	2%	2%	2%	6%

The foregoing tests shall be made in accordance with Standard Methods of A.S.T.M. Designation D38-18.

83.23. Method of Construction.—Treated timber shall be carefully handled without sudden dropping, breaking of outer fibers, bruising, or penetrating the surface with tools. It shall be handled with rope slings. Cant dogs, hooks, or pike poles shall not be used.

83.24. All places where the surface of treated timber is broken by cutting, boring, or otherwise shall be thoroughly coated with hot creosote oil and then with a coating of hot tar pitch.

83.25. Pile caps shall be level and have full even bearing on all piles in the bent and be secured to each pile a $\frac{3}{4}$ " diameter drift bolt extending at least 9" into the pile.

83.26. Truss and bent timbers shall be accurately cut, and framed to a close fit in such manner that they will have even bearing over the entire contact surface of the joint. No blocking or shimming of any kind will be allowed in making joints, nor will open joints be accepted. Mortises shall be true to size for their full depth and tenons shall make snug fit therein.

83.27. All bolt holes shall be bored with an augur $\frac{1}{16}$ " smaller in diameter than the bolt. Mortises and tenons shall be "draw bored."

83.28. Stringers shall be sized at bearings. Outside stringers may have butt joints but interior stringers shall be framed to bear over the full width of floor beam or cap at each end. The ends shall be separated at least $\frac{1}{2}$ " for the circulation of air and shall be securely fastened to the timber on which they rest.

Where width of stringers is less than one-third of the depth, then two lines of 2 by 4 bracing placed at quarter points of span shall be used.

83.29. Roadway floor plank shall have a nominal thickness of either 4 or 3" as specified, and an actual width of not less than $9\frac{1}{2}$ ". Sidewalk floor plank shall be surfaced to uniform thickness. It shall have an actual minimum width of $5\frac{1}{2}$ " and thickness of $1\frac{3}{8}$ ".

83.30. All floor plank shall be laid heart side down with $\frac{1}{4}$ " openings and be spiked to each stringer or nailing strip with at least two 7" spikes for 4" plank and two 6" spikes for 3" plank. Rough plank shall be carefully graded as to thickness before laying, and be laid so that no two adjacent planks vary in thickness more than $\frac{1}{16}$ ". All floors shall be cut to a straight line along the sides of the roadway and walkway.

83.31. Wheel guards, as shown on the plans, shall be constructed on each side of the road. They shall be raised from the floor by blocks 3" thick by 1' long, spaced about 5' apart, center to center, and shall be fastened in place by a $\frac{3}{8}$ " bolt passing through the wheel guard, each block and floor plank.

83.32. Railings shall be built in accordance with the designs shown on the plans, and shall be constructed in a workman-like and substantial manner. Unless otherwise noted, all railing material shall be dressed on four sides.

83.33. Pins may be turned, or split and drawn, from clear sound wood of the kind specified on the plans. They shall be made 6" longer than the required finished length, and when driven into place shall have their ends sawed off flush with the surface of the member.

83.34. Turned pins shall be made from square stock sawed parallel to the grain. One end shall be left square for about 1" and the other shall have a dull point. The body of the pin shall be uniform in diameter and $\frac{1}{16}$ " larger than the diameter of the hole. The finished pins shall be free from knots, knot holes, pockets, splits, or flaws which might impair their strength.

83.35. Split and drawn pins shall be made from straight-grained green lumber and be allowed to season. One end shall be hardened and pointed by charring. They shall be octagonal in shape, and when seasoned, the diameter between parallel faces shall be the same as the diameter of the holes in which they are to be driven.

83.36. Bolts shall be of the sizes specified and must be perfect in every respect. They shall have square heads and nuts, and screw threads shall make close fits in the nuts. All bolts shall be effectually checked after the nuts are adjusted.

83.37. Washers shall be used between all bolt heads and nuts, and the wood. Cast washers shall have a thickness equal to the diameter of the bolt and a diameter of four times the thickness. For plate washers, the size of the square shall be equal to four times, and the thickness equal to one-half the diameter of the bolt.

83.38. Painting Treated Timbers.—Hot creosote oil shall be poured into the bolt hole before the insertion of the bolts, in such a manner that the entire surface of the holes shall receive a coating of the oil. After the necessary cutting has been done to receive the cap, the heads of piles shall be given three coats of hot creosote oil. They shall then be covered with a coat of hot tar pitch over which shall be placed a sheet of three-ply roofing felt or galvanized iron, or a covering may be built up of alternate layers of hot tar pitch and loose woven fabric similar to membrane waterproofing, using four layers of pitch and three of the fabric. The cover shall measure at least 6" more in each dimension than the diameter of the pile, and shall be bent down over the pile and the edges fastened with large-headed nails, or secured by binding with galvanized wire. After the cover is in place the cap shall be placed and drift bolted as prescribed above.

83.39. Painting Untreated Timbers.—In structures of untreated timber the following surfaces shall be thoroughly coated with a thick coat of

red lead paint, hot tar, hot asphaltum, or hot coal-tar creosote before assembling: Heads of piles, end, tops, and all contact surfaces of pile caps, floor beams, and stringer ends, joints and all contact surfaces of truss members, laterals, and braces. The back face of bulkheads and all other timber in contact with earth shall be thoroughly coated with one of the materials specified above, or a carbolineum.

83.40. Unless otherwise specified, railings shall be made of untreated dressed lumber and shall be painted with three coats of paint composed of 75 % pure lead and 25 % zinc white by weight, mixed in pure, raw linseed oil. Turpentine drier shall be added to the paint in the average proportions of $\frac{1}{2}$ pt. of drier to 1 gal. of paint.

83.41. All bolts passing through non-resinous wood shall be painted with two coats of red lead paint at least 85 % pure.

83.42. **Design Details.**—Features of loading are prescribed under design details for steel structures. Unit stresses shall be as shown on plans.

83.43. **Method of Measurement.**—"Treated timber" and "untreated timber" complete in place according to the plans and these specifications shall be measured separately by the thousand feet board measure. Measurements shall be computed from the dimensions shown on plans, unless changes in such dimensions have been authorized by the engineer. "Standard" timber sizes shall be used in computations. This measurement shall include only such timber as is a part of the completed and accepted work, and shall not include timber used for erection purposes, such as falsework, forms, bracing, sheeting, etc. Any piling, concrete, masonry, or any supplementary floor wearing tops shown on plans will be measured as provided in pertinent specifications.

83.44. **Basis of Payment.**—Timber structures complete in place shall be paid for by the quantities as above measured at the contract unit price per thousand feet board measure bid for "untreated bridge timber" or "treated bridge timber," as the case may be, complete in place according to the plans or as directed by the engineer, which prices shall be full compensation for all materials, hardware, equipment, tools, labor, painting, preservative treatment, and all incidentals necessary to complete the structure ready for use; provided, however, that piling, concrete, masonry, and supplementary floor wearing tops shown on plans shall be paid for as provided in pertinent specifications.

MAINE STATE HIGHWAY COMMISSION, BRIDGE DIVISION

Soils

1. **Soils.**—*a.* The soils constituting the foundation materials upon which bridge abutments, piers, retaining walls, etc., are commonly placed are, for the purpose of these specifications, divided as follows:

1. Solid rock.
2. Loose rock.
3. Earth.

2. **Solid Rock.**—*a.* All hard-rock material existing in generally solid masses, which from the nature of its structure cannot be removed from its location without being drilled and blasted or otherwise broken into fragments, shall constitute solid rock.

3. **Loose Rock.**—*a.* All rock material existing in generally broken fragments by reason of having been separated by natural means into fragments which are removable from their locations by the use of pickaxe and crowbars shall constitute loose rock. The drilling and blasting of loose rock to facilitate its removal shall not be construed as giving to it the classification of solid rock.

4. **Earth.**—*a.* All soil material other than solid and loose rock occurring within the body of material to be removed from excavations for abutments, piers, retaining walls, etc. shall be classified as "earth." This classification shall include soils intermixed with boulders, loose and cemented sands and gravels, hardpan, clay, gumbo, muck, etc. It shall also include wood which has become embedded within the soil by natural processes of time.

b. Whenever boulders are encountered within the excavations having in each boulder a volume of 1 cu. yd. or more, the contract unit price for loose-rock excavation shall apply.

5. **Leveling Ledge Rock.**—*a.* Ledge rock, whether exposed by nature or within excavated areas shall be leveled to secure satisfactory foundation conditions for either concrete or stone masonry, as the engineer may direct.

The preparation of ledge rock surfaces to receive stone masonry shall be such as to secure a uniform, even bedding of the imposed stones. "Stilting" of stones will not be permitted. In all cases the leveling shall be such as to render the substructure secure against sliding. Surfaces worn smooth by glacial, water, or other action shall be roughened and if rounded or tilted at an angle with the horizontal shall be leveled horizontally as a whole or in steps. All "shelly" areas shall be removed and cracks and fissures through which water flows shall be caulked or otherwise satisfactorily treated to remove the flowing water from the foundation area. All ledge areas shall be thoroughly cleaned to secure a proper bond with the stone or the concrete masonry placed upon them.

Bridge Excavation

6. Excavation.—*a.* Foundation pits and trenches shall, in general, be excavated to the depths shown upon the plans and to such additional depths as the engineer may direct in order to secure firm, practically incompressible foundations having satisfactory safe load resistance, and to a satisfactory depth below possible frost action. All pits and trenches in which piles are to be driven shall be completed before driving is commenced, and following its completion, all loose soil and chips, bark or other foreign material shall be removed from the excavations before concrete or other substructure material is placed therein.

b. The contractor shall be prepared to sheet the sides of excavations, and to put in proper walings, struts, shorings, and braces to protect the same from caving.

c. To provide a working space for the construction of forms for concrete or for the laying and pointing of stone masonry an allowance will be made for material excavated outside of the base dimensions shown upon the plans, on the basis of actual material removed, provided, however, that the maximum allowance outside of the base dimensions of abutments, piers, columns, etc., shall not be greater than the following:

For concrete work.....	1' 6"
For stone masonry work.....	2' 6"

No allowance shall be made on account of slope of sides of excavations.

d. In the removal of the approach embankment of an existing bridge structure or of a previous structure the foregoing conditions governing excavations shall apply. Unless otherwise provided in the contract, the depth of an approach embankment shall be considered as the distance measured from its top surface vertically downward to the top of the original ground surface which existed prior to the construction of the embankment if the latter can be determined by the existence of vegetable mold or other satisfactory evidence. In the absence of satisfactory evidence the probable original ground surface shall be assumed from such evidence as the engineer may consider reliable and satisfactory.

7. Excavated Material.—*a.* All soil material taken from existing approach embankments and excavations except such as is acceptable and is required and used for backfill around abutments, piers, retaining walls, etc., for the filling of approaches, and for construction of embankments, shall be disposed of as the engineer may direct. Excavated material shall not be disposed of at locations obstructing the stream flow or otherwise impairing the efficiency or the appearance of the bridge structure.

b. Excavated material accepted and used in backfill, in the filling of approaches, and in the construction of embankments shall be paid for as excavation only when the entire work is performed at one and the same time.

c. Excavated material acceptable for use in the construction of embankments, in backfill, and in the filling of approaches, permissible, under the conditions involved, of being placed therein without intermediate storage and rehandling but used by the contractor in the construction of cofferdams, protection embankments, or other temporary structures incident to the performance and completion of any part of the work shall be regarded as fill material and shall be replaced at his own expense. Furthermore, such material when wasted by reason of the methods and operations adopted by the contractor in the excavation of the work shall likewise be replaced at his expense.

8. Unwatering.—*a.* The contractor shall at his own expense do all unwatering required in connection with the excavation of pits and trenches. Pumping shall not be permitted from the inside of forms for abutments,

piers, retaining walls, etc., while concrete is being placed therein. Sumps may be used within the space between cofferdams and the form work, provided moving water is not permitted to come into contact with fresh concrete or concrete that has attained only a "green" set.

9. Approval of Foundation.—*a.* Especial care shall be taken not to loosen or disturb the soil forming the bottom of an excavation and the final removal of material just above the finished foundation elevation shall not be made until immediately before the construction of the substructure is commenced. Foundation excavations shall be examined and approved by the engineer.

10. Removal of Cofferdams.—*a.* All cofferdams, dams, protection embankments, etc. used as a means for making excavations shall be removed unless otherwise provided, leaving the stream bed clear of obstruction thereby. Stream bed or other areas excavated or eroded, incident to or resulting from such temporary excavation protections shall be carefully backfilled to the satisfaction of the engineer.

11. Measurement of Excavation.—*a.* All volumes of excavated material shall, unless otherwise provided, be measured in the excavation. However, volumes below the depths provided in the contract shall be subject to special adjustment, in as far as payment therefor is concerned.

b. Clearing and grubbing and the removing of existing obstructions from the area to be excavated will be considered as included in the contract price for excavation.

Fill

12. Backfill, Fill, and Embankment.—*a.* All materials used for backfill around abutments, piers, etc.; for fill in the rear of abutments; and for construction of approach embankments, protection embankments, etc., shall be of a quality acceptable to the engineer as such. When the material contains insufficient moisture to permit thorough compacting, additional water for this purpose shall be added. Material excavated from foundation pits and trenches shall be used for these works, unless otherwise provided in the contract or directed by the engineer. However, all material so used shall be paid for as "Excavation" except in cases where the excavation and fill work are not executed simultaneously.

b. Material excavated from foundation pits and trenches and stored at or near the bridge site will, when rehandled and deposited in fill or embankment work, be paid for at the contract unit price or prices per cubic yard for "Fill" but will not be again paid for as "Excavation."

c. Material taken from the adjacent roadway for use in the construction of fill or embankment will be paid for at the contract unit price or prices per cubic yard for "Fill" but will not be paid for as "Excavation." Whenever considered practicable by the engineer, improvements in the roadway alignment and grade shall be secured by this means. However, such improvements shall not involve a maximum haul of the material, greater than two thousand feet (2000' 0") nor shall they include the removal of either loose or solid ledge rock except when specially provided in the contract or in a subsequent agreement.

d. All spaces excavated and not occupied by abutments, piers, or other permanent work shall be refilled with earth up to the surface of the surrounding ground or to such height as the engineer may direct. All backfill shall be thoroughly compacted and, in general, its top surfaces shall be neatly graded.

e. Fill material used in the rear of simple span and arch abutments shall be deposited in successive layers not exceeding 12" in thickness extending the full width of the cross-section and shall wherever possible, except in freezing weather, be compacted by thoroughly saturating or flooding with water. In all cases where fill cannot be compacted by the use of water, it shall be rammed or otherwise compacted as the engineer may direct.

f. Fill placed adjacent to culvert and other small structures shall be deposited on both sides at the same time and to the same elevation.

g. Fill shall not be deposited against "green" set concrete; nor shall wedge-shaped sections of earth be placed against abutments, wing walls, arch spandrels, and retaining walls.

h. Approach embankments shall consist of filling the approaches to bridges, over arches, and around the ends of abutment wing walls to elevations above the surface of the surrounding natural ground area.

i. Protection embankments shall consist of earth embankments, usually rip-rapped, constructed to secure protection for bridge approaches, stream diversions, etc.

j. Embankment material shall be deposited in successive layers not exceeding 12" in thickness extending the full width of the cross-section, and except in unimportant locations each layer shall be thoroughly compacted by rolling, ramming, or other satisfactory means.

k. When embankment material is to be deposited upon a hillside, the surface of the hillside area shall be cut into steps, ploughed, or otherwise satisfactorily prepared to secure a bond with the new material to be imposed upon it.

l. Material placed behind and over arches shall be deposited in layers as described for embankment work and will be deposited symmetrically from the haunches upward until the crown is covered.

m. Material subject to free erosion, such as loose sand, shall not be deposited upon embankment slopes.

n. The sides of embankments shall, unless otherwise provided by the contract plans or required by the engineer, be graded to uniform even slopes having a batter of one and one-half horizontal to one vertical ($1\frac{1}{2}$: 1).

o. The sides of all embankments unless protected by rip-rap, brush mattress, or other approved means against stream scour or other erosive action shall be seeded to produce a future grass sod protection. The kinds of grass seed to be used shall be approved by the engineer. However, the following mixture of seed will be used unless otherwise provided:

- 45 lb. timothy.
- 14 lb. red top.
- 8 lb. clover.
- 6 lb. Japanese millet.

The seeding of slopes shall be done at periods of the year generally recognized as satisfactory for the development of the sod protection. Whenever necessary, in the opinion of the engineer, the development of the seeding shall be protected by a "cover crop" of oats, buckwheat, or other cereal.

p. The contractor shall be responsible for the stability of all constructed embankments and shall, until the work is finally accepted, replace any portions which, in the opinion of the engineer, have become displaced as a result of improper workmanship, carelessness, or neglect on his part; or of damage resulting from storms, cloudbursts, or other natural causes, not attributable to unavoidable slides, distortions, or other movements of the original ground underlying the embankment.

13. Borrow Excavation.—*a.* When material removed from excavation pits and trenches is unsatisfactory for use in fill and embankment work or is insufficient in quantity for the work to be done, the contractor shall obtain the necessary additional material by excavating from the adjacent roadway or from borrow pits as the engineer may direct.

b. Wherever the natural contour of the ground surface renders it possible, borrow pits shall be so constructed as to provide effective drainage of the excavated area.

c. No "borrow" excavation shall be developed as a "borrow pit" until the entire area has been carefully cross-sectioned. Material removed prior to the securing of cross-sections will not be paid for.

14. Ditches.—*a.* In the construction of approach embankments and roadway cuts, special care shall be exercised in locating and constructing ditches for the drainage of embankment and cut slopes and the slopes of the adjoining areas. In general, ditches shall be located in natural rather than in filled ground, and shall divert the water away from the ends of abutment wing walls or other locations likely to become injuriously affected by scour. When necessary, in the opinion of the engineer, ditches shall be paved with hand-laid cobblestones of satisfactory size and quality.

15. Measurement of Fill.—*a.* In the measurement of fill, three general divisions shall be recognized, *viz.*:

1. Backfill shall include all fill material placed in front and rear of abutments and retaining walls and around piers required to fill the foundation pits and trenches up to the elevation of bed of stream or to the original ground surface or to such other lower elevation or elevations as may be required by the contract or determined by the engineer.

2. Approach fill shall include all fill material placed in the rear of abutments and retaining walls, or upon the roadway embankments adjacent to the bridge structure required to replace the formerly existing approach embankment material removed by the foundation excavation operations, together with all material required to increase the width or the height of such approach embankments or to construct new approach embankments.

3. Protection fill shall include all fill material required for the construction of protection embankments.

b. Rip-rap protection placed upon the slopes of embankments and in front of abutments and retaining walls and around piers shall not be considered as fill.

c. Backfill will be paid for at the contract unit price per cubic yard only within the limits for which "excavation" is allowed.

d. All volumes of backfill, fill, and embankment not secured from excavation pits and trenches as provided in Secs. 7a, 7b, and 12b shall, in general, be obtained from roadway or borrow-pit excavations. Whenever, by the cross-section method, such measurement is impracticable the method of measuring shall be such as the engineer may determine.

Rip-rap

16. **Material.**—(a) The material to be used for rip-rap protection around abutments and piers or at other locations where protection from stream scour is required shall consist of clean, sound, and durable rock which will not become disintegrated by the action of water or by exposure to the atmospheric elements. Either boulders or quarried rock may be used. The size and quality of the stones shall be subject to the approval of the engineer.

(b) In general, rip-rap deposited in the stream bed as protection around abutments and piers shall be composed of 50 to 75% "two-man stone" or larger. The remaining portion shall be graded from the "two-man" size down to sizes weighing 10 to 15 lb. Stones placed upon the lower portions of embankment slopes to protect them against stream scour shall generally be composed of stones of sizes varying from a "one-man" to a "two-man" size with a comparatively small percentage of stones of smaller sizes.

17. **Placing.**—a. Stones deposited in the stream bed shall be well mixed as to sizes and when in position shall provide a comparatively uniform protective covering, having the desired depth and area.

b. Stones placed upon embankment slopes shall, if conditions will permit, have the bed course placed in a trench at the toe of the slope. The face or outer course shall be random rubble, hand laid to secure an efficient interlocking of all face stones and stones placed as backing. The dimension of outer-courses stones normal to the surface of the embankment slope shall be not less than 6" and the stones shall be laid with close joints roughly perpendicular to the slope which shall be filled with spalls and gravel or crushed rock. The thickness of the rip-rap layers shall be greater at the bottom than at the top. The base course shall be protected by depositing rip-rap in front of it, if considered necessary by the engineer.

18. **Measurement.**—a. All volumes of rip-rap shall, in general, be determined from measurements of material in place. Whenever such measurement is impracticable by reason of stream-bed conditions, the method of measuring shall be such as the engineer may determine.

Brush Mattress¹

19. **Material.**—a. The material to be used in the construction of brush mattress for the protection of embankments against stream scour shall generally be composed of willow limbs and saplings of sizes adapted to the construction of well-compacted masses of intertwined elements.

20. **Construction.**—a. The general dimensions and details of construction shall be in accord with the contract plans.

21. **Placing.**—a. Sections of mattress shall generally be constructed and put in place at such periods of the year as will permit the willow to take root and thereby become a more perfect protection at a later date. The mattress shall be covered with a layer of topsoil and shall be stayed in position by driving anchor stakes or anchor staples and weighting the mattress with stones as the engineer may direct.

22. **Measurement.**—a. Brush mattress shall be measured in place, complete, in square yards of top surface area.

Item 103. Untreated Timber Piling²

103.1. **Description.**—This item shall consist of round or square timber piles of the kind and dimensions specified, and in conformity with the pertinent designated plans. They shall be driven in accordance with these specifications in the location and to the elevation shown on plans or as directed by the engineer.

¹ State of Maine.

² Texas.

103.2. Except for trestle work, timber piles shall be used only below permanent ground-water level. Untreated timber piles shall not be used in water which is infested by marine borers. In general, the penetration for any pile shall not be less than 10' in hard material and not less than one-third the length of the pile nor less than 20' in soft material. For foundation work, no piling shall be used to penetrate a very soft upper stratum overlying a hard stratum unless the piles penetrate the hard material a sufficient distance to fix the ends rigidly.

103.3. Material for Foundation Piles.—These piles may be of any species which will satisfactorily stand driving. They shall be cut from live, sound trees, shall be solid and free from defects, such as injurious ring shakes, large unsound, or loose knots, decay, or other defects which might impair their strength or durability. They shall be cut from above the ground swell and have a uniform taper and shall be free from short bends. A straight line drawn from the center of the butt to the center of the tip shall lie wholly within the body of the pile. Piles shall be peeled soon after cutting. All knots shall be trimmed closed to the body of the pile. For round piles, the minimum diameter at the tip shall be 8", and at the butt shall be 12". The maximum diameter at the butt shall be 20". Square piles shall be uniform in cross-section, not less than 10 by 12" for lengths over 30'.

103.4. If possible, piles shall be full length. Where the length required is greater than is practical to obtain, they may, upon written approval of the engineer, be spliced. All splices shall be made in accordance with detail plans, prepared to meet the special conditions encountered and which shall be approved before the piles are driven.

103.5. Material for Trestle Piles and Foundation Piles for Trestle Bents. These piles shall meet the requirements for timber Foundation Piles and in addition shall be durable timber. The species required will be post oak, white oak, red or black cypress, or Southern yellow pine (80 % heart).

103.6. Construction Methods.—Piles shall not be driven until after the excavation is complete. Any material forced up between the piles shall be removed to correct elevation before masonry for the foundation is placed. Timber piles shall be driven with a gravity hammer, steam hammer, water jets, or a combination of water jets and hammer. The driving of piling with followers shall be avoided if practicable, and shall be done under written permission of the engineer only. When followers are used, one pile from every group of ten shall be a long pile driven without a follower and shall be used as a test pile to determine the average bearing power of the group. Collars or bands to protect timber piles against splitting and brooming shall be provided where necessary. Timber piles shall be pointed where soil conditions require it. When necessary, the piles shall be shod with metal shoes of a design satisfactory to the engineer, the points of the piles being carefully shaped to secure an even and uniform bearing on the shoes.

103.7. Gravity hammers for driving timber piles shall weigh not less than 2000 lb. and the fall shall be so regulated as to avoid injury to the pile, and in no case shall exceed 20'. Piles shall be driven with a variation of not more than $\frac{1}{4}$ " per foot from the vertical or from the batter line indicated. All piles raised during the process of driving adjacent piles shall be driven down again if required by the engineer.

103.8. When required, the size and the number of piles shall be determined by actual loading tests. In general, these tests shall consist of the application of a test load placed upon a suitable platform supported by the pile, together with suitable apparatus for accurately determining the superimposed weight and the settlement under each increment of load. The safe allowable load shall be considered as 50 % of that load which, after 48 hr. application, causes a permanent settlement, measured at the top of the pile, of not more than $\frac{1}{4}$ ". At least, one pile of each group of 100 piles shall be thus tested.

103.9. Timber Piles.—In the absence of loading tests, the safe bearing values for timber piles shall be determined by the following formulas:

$$P = \frac{2WH}{S + 1.0} \text{ for gravity hammers}$$

$$P = \frac{2WH}{S + 0.1} \text{ for single-acting steam hammers}$$

$$P_1 = \frac{2H(W + A\phi)}{S + 0.1} \text{ for double-acting steam hammers}$$

¹ NOTE.—Better formula given on page 1340.

- where P = safe bearing power, in pounds.
 W = weight, in pounds, of striking parts of hammer.
 H = height of fall, in feet.
 A = area of piston, in square inches.
 p = steam pressure, in pounds per square inch.
 S = the average penetration, in inches per blow, for the last 5 to 10 blows for gravity hammers and the last 10 to 20 blows for steam hammer.

103.10. The above formulas are applicable only when:

- (a) The hammer has a free fall.
- (b) The head of the pile is free from broomed or crushed wood fiber.
- (c) The penetration is at a reasonably quick and uniform rate.
- (d) There is no sensible bounce after the blow. Twice the height of the bounce shall be deducted from H to determine its true value in the formula.

103.11. The bearing powers of timber piles, as determined by the foregoing formulas, shall be considered effective only when they are less than the crushing strengths of the piles. In general, piles shall be required to develop a bearing capacity of not less than 15 nor more than 25 tons. However, the character of the soil penetrated, conditions of driving, distribution, sizes and lengths of the piles involved, and the computed load per pile shall be given due consideration in determining the reliability of driven pile.

103.12. In case water jets are used in connection with the driving, the bearing power shall be determined by the above formulas, from the results of driving after the jets have been withdrawn, or a load test may be applied.

103.13. The tops of foundation piles shall be embedded in the concrete footing at least 1', and where seals of concrete deposited in water are used with piles, the piles shall project at least 1' above the top of the seal concrete. They shall be cut off level at such elevation that the tops of the piles will be always wet.

103.14. Foundation piles for framed bents shall be cut off level approximately 3' above the surface of the ground and the cap rigidly secured to each pile by drift bolts extending at least 9" into the pile.

103.15. Trestle piles shall be cut off level at the elevation on the plans and the caps secured as described above. If the cut-off is 10' or more above the ground line, timber piles shall be braced by diagonal cross-bracing composed of 3 by 10" timbers, secured to the lines by $\frac{3}{4}$ " diameter through bolts.

103.16. In bents of untreated piles the heads of the piles shall be thoroughly coated with a thick protective coat of red-lead paint, hot tar, tar asphaltum, or hot coal-tar creosote before the caps are placed.

103.17. The tops of all piling shall be sawed to a true plane as shown on the plans, and at the elevation fixed by the engineer. Piles which support timber caps or grillage work shall be sawed to the exact plane of the superimposed structure and shall exactly fit it. Broken, split, or misplaced piles shall be drawn and properly replaced. Piles driven below the cut-off grade fixed by the engineer shall be withdrawn and replaced by new and, if necessary, longer piles, at the expense of the contractor.

103.18. **Basis of Payment.**—All piling left in place in the structure will be paid for at the contract unit price bid per linear foot for Untreated Timber Piling complete in place, which price shall be full compensation for furnishing all piling, all materials, equipment, tools, labor, and incidentals necessary to complete the work. No allowance will be made for falsework piling. Payment will be made at this price for only the actual number of feet of piles left in place in the completed work, and no allowance will be made for any piles which are not driven in accordance with the specifications, or as ordered by and made acceptable to the engineer.

Item 104. Treated Timber Piling¹

104.1. **Description.**—This item shall consist of round or square treated timber piles of the kind and dimensions specified and in conformity with the pertinent designated plans. They shall be driven in accordance with these specifications in the location and to the elevation shown on the plans or as directed by the engineer.

104.2. **Materials.**—Requirements for treated foundation piles, treated trestle piles, and treated foundation piles for trestle bents shall be identical with the corresponding requirements for untreated timber piles with the additional requirements following:

¹ Texas.

104.3. Piles shall be treated with the creosote oil or creosote coal-tar solutions prescribed in the specifications for Timber Structures. The ranges of pressure, temperature, and time duration of treatment shall be controlled so as to result in maximum penetration of the quantity of preservative injected, which shall permeate all of the sapwood and as much of the heartwood as practicable. For general construction, not in sea water, piles shall be treated to retain not less than 12 lb. of the preservative per cubic foot of wood by any full-cell process, or not less than 8 lb. by any standard empty-cell process.

104.4. Construction methods for treated timber piling shall be identical with those prescribed for untreated timber piling. The following additional requirements apply to treated timber piling:

104.5. Treated piles and timbers shall be carefully handled without sudden dropping, breaking of outer fibres, bruising, or penetrating the surface with tools. They shall be handled with rope slings. Cant dogs, hooks, or pike poles shall not be used where such tools will penetrate into the untreated wood.

104.6. After the necessary cutting has been done to receive the cap, the heads of piles shall be given three coats of hot creosote oil. They shall then be covered with a coat of hot tar pitch, over which shall be placed a sheet of three-ply roofing felt or galvanized iron, or a covering may be built of alternate layers of hot tar pitch and loose woven fabric, similar to membrane waterproofing, using four layers of pitch and three of the fabric. The cover shall measure at least 6" more in each direction than the diameter of the pile, and shall be bent down over the pile and the edges fastened with large-headed nails, or secured by binding with galvanized wire. After the cover is in place the cap shall be placed and drift bolted as prescribed.

104.7. All places where the surface of treated piles or timbers is broken by cutting, boring, or otherwise shall be thoroughly coated with hot creosote oil and then with a coating of hot tar pitch. Hot creosote oil shall be poured into the bolt holes before the insertion of the bolts in such manner that the entire surface of the holes shall receive a coating of the oil.

104.8. Basis of Payment.—All piling left in place in the structure will be paid for at the contract unit price bid per linear foot for Treated Timber Piling complete in place, which price shall be full compensation for furnishing all piling, all treating, all materials, equipment, tools, labor, and incidentals necessary to complete the work. No allowance will be made for falsework piling. Payment will be made at this price for only the actual number of feet of piles left in place in the completed work, and no allowance will be made for any piles which are not driven in accordance with the specifications, or as ordered by and made acceptable to the engineer.

Item 105. Precast Concrete Piling¹

105.1. Description.—This item shall consist of piles precast of Portland cement concrete made and reinforced in accordance with these specifications and in conformity with the pertinent designated plans. They shall be driven in accordance with these specifications in the location and to the elevation shown on the plans or as directed by the engineer.

105.2. Materials and Design.—All concrete materials and their preparation and placing shall be in accordance with the requirements for Class D concrete. (All coarse aggregate to pass a $\frac{3}{4}$ " ring.) It shall be the charge of the contractor to order materials for and cast and manufacture the requisite lengths and amount of piling to complete the required structure or work.

105.3. Precast concrete piles may be square, circular, or octagonal in section. If a square section is employed, the corners shall be chamfered at least 1". Piles shall preferably be cast with a driving point and for hard driving shall preferably be shod with a metal shoe of approved pattern. Piling may be either of uniform section or tapered as desired. Tapered piling shall not, in general, be used for trestle construction except for that portion of the pile which lies below the ground line; nor shall tapered piles be used in any location where the piles are to act as columns. In general, concrete piles shall have a cross-sectional area, measured above the taper, of not less than 140 sq. in. and, when they are to be used in salt water, they shall have a cross-sectional area of not less than 220 sq. in.

105.4. The length shall not exceed 30 times the average diameter for piles driven through firm soil, and shall not exceed 15 times the average diameter for piles driven to rock through loose, wet soil, or filled ground.

¹ Texas.

When lateral support is deficient so that the piles act as columns, they shall be designed as columns.

105.5. Reinforcement shall conform to the requirements for reinforcing steel of these specifications, and the weight and dimensions shall be as shown on plans.

105.6. Reinforcement for precast concrete piling shall consist of longitudinal bars in combination with lateral reinforcement in the form of hoops or spirals. The longitudinal reinforcement shall be not less than 1% and preferably not less than $1\frac{1}{2}$ % of the total cross-section of the pile. The reinforcement shall be placed at a clear distance from the face of the pile of not less than 2" and, when the piles are for use in salt water or alkali soils, this clear distance shall be not less than 3". The driving point and also the top of the pile shall be protected against impact by means of special spiral winding or bands designed for this purpose. The reinforcing system shall preferably be of the "unit" type, rigidly wired or fastened at all intersections and held to true position in the forms by means of concrete blocks or other suitable device. Where piles exceed 55' in length, additional longitudinal reinforcement shall be added throughout the central one-third of the length. Piling under retaining walls, abutments, etc., shall be designed to withstand the lateral stress induced.

105.7. Where waterproofing is to be used, special specifications will be given and the work shall be in accordance therewith.

105.8. Forms shall be accessible for tamping and consolidation of the concrete. Under good weather-curing conditions, side forms may be removed at any time not less than 24 hr. subsequent to placing concrete, but the entire pile shall remain supported for at least 7 days, and shall not be subjected to any handling stress until the concrete has set for at least 21 days, and for a longer period in cold weather, the additional time to be determined by the engineer.

105.9. Casting.—Piling may be cast in either a vertical or a horizontal position. When vertical forms are used, special care shall be exercised to puddle and tamp the concrete around the reinforcing and to avoid the formation of stone pockets. When horizontal forms are used, the piles shall not be cast in tiers.

105.10. During the placing of concrete, the forms shall be vibrated by tapping with a hammer or wooden maul. Concrete shall be placed continuously in each pile and shall be carefully spaded, puddled, and tamped, duly marked, special care being exercised to avoid horizontal or diagonal cleavage planes, and to see that the reinforcement is properly embedded in the concrete.

105.11. Finish.—As soon as the forms are removed, concrete piles shall be carefully pointed with 1:2 mortar, filling up all cavities or irregularities.

105.12. Trestle piling exposed to view shall be finished above the ground line in accordance with the provisions governing the finishing of concrete columns. Foundation piling, that portion of trestle piling which will be below the ground surface, and piles for use in sea water or alkali soils, shall not be finished except by pointing as above set forth.

105.13. Curing.—Concrete piles shall be cured in accordance with the general provisions governing the curing of concrete as elsewhere provided. As soon as the piles have set sufficiently to permit, they shall be removed from the forms and piled in a curing pile separated from each other by wood spacing blocks. No pile shall be driven until it has set for at least 30 days, and in cold weather for a longer period, as determined by the engineer. Concrete piles for use in sea water or alkali soils shall be cured for not less than 60 days before being used.

105.14. Storage and Handling of Precast Concrete Piling.—For precast piles, the method of storing and handling shall be such as to eliminate the danger of fracture by impact or undue bending stresses, in curing or transporting the piles from the molds and into the leads. In general, concrete piles shall be lifted by means of a suitable bridle or sling attached to the pile at points not over 20' apart. In no case shall the methods of handling be such as to induce stresses in the concrete of more than 650 lb. compression per square inch or in the reinforcing steel in excess of 12,000 lb. per square inch, allowing 100% of the calculated load for impact and shock effects.

105.15. In handling piles for use in sea water or alkali soils, special care shall be exercised to avoid injury to the surface of the pile.

105.16. Concrete piles when properly designed, constructed, and placed may be subjected to loads as determined by tests or formula, but not to exceed 300 lb. per square inch of total cross-section at the smallest effective

point and generally not to exceed 25 tons per pile with a maximum limit of 30 tons per pile.

105.17. Construction Methods.—Requirements for equipment and driving large concrete piles will be covered by special specifications.

105.18. Hammers for Concrete Piles.—Concrete piles preferably shall be driven with steam hammers. Double-acting steam hammers for this purpose shall develop an energy per blow at each full stroke of the piston of not less than 12,000 ft.-lb., except that in sandy material when used in combination with a suitable water jet having a pressure of 125 lb. per square inch at end of nozzle the above requirements may be modified.

105.19. Gravity hammers, when their use is permitted, shall weigh not less than the weight of the pile and the maximum drop shall not exceed 8'.

105.20. Water Jets.—Water jets may be used, either alone or in combination with a hammer. The volume and pressure of the water at the jet nozzles, and the number of jets used, shall be sufficient freely to erode the material adjacent to the pile.

105.21. If water jets and a hammer are used for driving, the jets shall be withdrawn and the piles shall be driven by the hammer to secure the final penetration. This procedure may be varied if the desired results are not obtained.

105.22. Piles shall be driven with a variation of not more than $\frac{1}{4}$ " per foot from the vertical or from the batter line indicated.

105.23. Loading Tests.—When required, the size and the number of piles shall be determined by actual loading tests. In general, these tests shall consist of the application of a test load placed upon a suitable platform supported by the pile, together with suitable apparatus for accurately determining the superimposed weight and the settlement of the pile under each increment of load. The safe allowable load shall be considered as 50% of that load which, after 48 hr. application, causes a permanent settlement, measured at the top of the pile, of not more than $\frac{1}{4}$ ". At least one pile for each group of 100 piles shall be thus tested.

105.24. Concrete Piles.—In the absence of the loading tests, the safe bearing values for piles shall be determined by the formulas given for timber piling (p. 1340).

105.26. In case water jets are used in connection with the driving, the bearing power shall be determined by the above formulas from the results of driving after the jets have been withdrawn, or a load test may be applied.

105.27. Concrete Piles.—The bearing values for concrete piles shall be determined by means of the loading tests above specified. The formulas specified above for timber piling may be used as a rough approximation for precast concrete piles.

105.28. When required, the contractor shall drive test piles of a length and at the location designated by the engineer. These piles shall be of greater length than the length assumed in the design in order to provide for any variation in soil conditions.

105.29. Jetting piles shall extend to a good solid stratum. Their carrying capacity shall be determined by actual tests or, if driven with the aid of a jet and for the last five blows of the gravity hammer or last twenty blows of the steam hammer, driven without any jet, the same formula may be applied as in the case of driven piles.

105.30. Extensions, splices, or "build-ups" on concrete piles generally shall be avoided but when necessary they shall be made as follows:

105.31. After the driving is completed, the concrete at the end of the pile shall be cut away, leaving the reinforcing steel exposed for a length of 40 diameters; the final cut of the concrete shall be perpendicular to the axis of the pile. Reinforcement similar to that used in the pile shall be securely fastened to the projecting steel and the necessary form work shall be placed, care being taken to prevent leakage along the pile. The concrete shall be of the same quality as that used originally in the pile. Just prior to placing concrete, the top of the pile shall be thoroughly wetted and covered with a thin coating of neat cement. The forms shall remain in place not less than 7 days and shall then be carefully removed and the entire exposed surface of the pile finished as above specified.

105.32. Methods of Measurement.—Only the actual number of linear feet of accepted piles left in place of the completed work shall be measured. No allowance will be made for cut-offs or any unaccepted footage. "Build-ups" constructed as required shall be measured as piling, provided that no allowance shall be made for "build-ups" which are necessary by damage to the piles during driving.

105.33. Basis of Payment.—The piling measured as provided above will be paid for at the contract unit price bid per linear foot of Precast Concrete Piling, which price will be full compensation for furnishing all materials, equipment, labor, and incidentals necessary to complete the work, except that test piles ordered but not used in the work be paid for as extra work.

Item 106. Cast-in-place Concrete Piling¹

106.1. Description.—These piles shall consist of a metal shell driven in the location and to the elevation shown on the plans, which shall remain in place, and concrete cast in place in the shell, all as prescribed in these specifications.

106.2. Materials and requirements for concrete and reinforcing steel shall be the same as prescribed for Precast Concrete Piling, with the additional requirement that in all cases the reinforcement shall be of the unit system, rigidly fastened together and lowered into the shell. No loose bars will be permitted.

106.3. Metal Shells.—The metal shall be of a sufficient thickness and reinforced to such an extent that it will hold its original form and show no signs of distortion after the core has been withdrawn. The design of the shell shall be submitted to and approved by the engineer before any driving is done. After the shell has been driven and the core withdrawn, it shall be inspected and approved before any concrete is placed. No payment will be made for any shell which has been improperly driven, is broken, or otherwise defective, and, if necessary, any such shell shall be removed and replaced.

106.4. Construction Methods.—No concrete shall be placed until all driving within a radius of 15' has been completed, or until all the shells for any one bent have been completely driven. If this cannot be done, all driving within the above limits shall be discontinued until the concrete in the last pile cast has set at least 7 days, and no load shall be allowed on any pile cast less than 7 days.

106.5. Concrete shall be placed continuously in each pile, care being used to fill every part of the shell and to work concrete around the reinforcement without displacing it. No concrete shall be placed in shells containing an accumulation of water.

106.6. Method of Measurement.—Only the actual number of linear feet of accepted piles left in place in the completed work shall be measured. No allowance will be made for cut-offs or any unaccepted footage.

106.7. Basis of Payment.—The piling measured as provided above will be paid for at the contract unit price bid per linear foot for Cast-in-place Concrete Piling, which price will be full compensation for furnishing and driving the shells, for all materials, equipment, labor, and incidentals necessary to complete the work, except that test piles ordered but not used in the work will be paid for as extra work.

Item 107. Plain Rip-rap¹

107.1. Description.—This item shall consist of a protective course or layer of "one-man" stone laid on slopes and at such places as shown on the plans or as designated by the engineer, and filled with spalls, and shall be constructed in accordance with these specifications and in conformity with the depth of course and other details shown on the pertinent cross-sections.

107.2. Material.—The "one-man stone" shall be free from structural defects, of approved quality, not less than $\frac{1}{2}$ cu. ft. in volume, and not less than 3" thick. The width of the stones shall not be less than twice the thickness. The spalls shall be of material of similar quality.

107.3. Construction Methods.—Slopes, where rip-rap is used, shall be no steeper than the angle of repose, unless otherwise indicated or directed. The stone shall be bedded, one against the other, with the ends in contact. The spaces between the larger stone shall be filled with spalls of suitable size, and all spalls shall be rammed thoroughly into place. The finished surface of the rip-rap shall present an even, tight surface true to the lines, grades, and sections given.

107.4. Method of Measurement.—This item shall be measured by the square yard complete in place. The measurement shall be made parallel to the face and not necessarily horizontally.

107.5. Basis of Payment.—The yardage of completed and accepted work measured as provided above shall be paid for at the contract unit price

¹ Texas

bid per square yard for Plain Rip-rap, which price shall be full compensation for furnishing and hauling all material, for all quarrying involved, for all labor, equipment, tools, and incidentals necessary to complete the work.

Item 108. Grouted Rip-rap¹

108.1. Description.—This item shall consist of a protective course or layer of "one-man" stone laid on slopes and at such places as shown on the plans or as designated by the engineer, and grouted, and shall be constructed in accordance with these specifications, and in conformity with the depth of course and other details shown on the pertinent cross-sections.

108.2. Material.—The "one-man stone" shall be free from structural defects, of approved quality, not less than $\frac{1}{2}$ cu. ft. in volume, and not less than 4" thick and 5" wide.

108.3. Construction Methods.—Slopes, where rip-rap is used, shall be no steeper than the angle of repose, unless indicated or directed. The stone shall be bedded, one against the other, with the ends in contact.

108.4. Application of Grout Filler.—After the stones have been tamped, inspected, and approved, the spaces between the stones shall be filled with cement grout consisting of 1 part Portland cement and 2 parts approved sand.

108.5. Method of Measurement.—This item shall be measured by the square yard complete in place. The measurement shall be made parallel to the face and not necessarily horizontally.

108.6. Basis of Payment.—The yardage of completed and accepted work measured as provided above shall be paid for at the contract unit price bid per square yard for Grouted Rip-rap, which price shall be full compensation for furnishing and hauling all material, for all quarrying involved, for all labor, equipment, tools, and incidentals necessary to complete the work.

Item B-6 (L. & U.).—Loaded and Unloaded Test Piles²

1. Description.—(a) Loaded test piles shall consist of loading any type of pile with twice the loading specified on the plans. Loaded test piles will be driven where directed by the engineer and in accordance with these specifications.

(b) Unloaded test piles shall be of timber and of the same cross-section as the piling called for on the plans. It shall be of such length and shall be driven as directed by the engineer.

Both types of test piles shall be driven with the same equipment that is to be used by the Contractor in driving the piles called for on the plans.

2. Excavation.—All excavation of the foundation, if any, shall be completed before driving is commenced in accordance with the specifications for the particular type of piling used.

3. Method of Testing. (a) *Loaded Test Piles.*—After the pile of the type specified by the engineer has been driven in accordance with the requirements of the specifications for that type, it shall be loaded. The loading material shall be of any kind approved by the engineer. The loading platform or box shall be so constructed that readings may be taken directly on the pile. This platform or box shall be so built as to carry safely, in the opinion of the engineer, an amount of the approved material equal in weight to twice the loading shown on the plans. Before the platform or box is constructed, any split or broomed portion of the pile shall be cut off, leaving a sound surface to support the box.

The loading material shall be applied gradually, as directed by the engineer, and shall be so placed that at all times the load will be concentric with the pile. The loading material shall be placed within, usually, 24 hr. after the pile is driven, unless otherwise directed by the engineer.

The capacity of any pile so tested shall be considered equal to one-half the load carried by the pile without exceeding a total permanent settlement of $\frac{1}{4}$ " in 48 hr., unless otherwise specified by the engineer.

(b) *Unloaded Test Piles.*—Piles of this type shall be driven in accordance with the specifications for the particular type of piling shown on the plans. The piles shall be driven until the capacity as determined by formula is equal to that shown on the plans, or until the required penetration is obtained, unless otherwise directed by the engineer. The length of piles driven shall be as determined by the engineer. In case it is necessary, as determined by the engineer, to jet any piles, it shall be done as specified under Untreated and Treated Timber Piling.

¹ Texas.

² North Carolina.

4. Basis of Payment. (a) *Loaded Test Piles.*—This work shall be paid for at the contract unit price for Loaded Test Piles. This price will include all materials, equipment, tools, labor, and work incidental to constructing the platform or box, procuring and placing the loading material, removing both the platform or box and material, and disposing of same as directed by the engineer. The piling test will be paid for in accordance with the Basis of Payment for the particular type of piling used. No payment will be made for test loadings made or test piles driven that are not in accordance with these specifications or as directed by the engineer and accepted by him.

(b) *Unloaded Test Piles.*—This work will be paid for at the contract unit price for Unloaded Test Piles complete in place. This price will include all materials, equipment, tools, jetting, labor, and work incidental thereto. No payment will be made for test piles driven that are not in accordance with these specifications or as directed by the engineer and accepted by him.

Item B-7. Sheet Piling¹

1. Description.—This specification covers only such sheet piling as is shown on the plans or is ordered by the engineer to be left in place so that it becomes a part of the finished structure.

2. Material.—The timber, unless otherwise definitely noted upon the plans or specified, may consist of any species which will satisfactorily stand driving. It shall be sawn or hewn with square corners and shall be free from worm holes, loose knots, wind shakes, decayed or unsound portions, or other defects which might impair its strength or tightness.

The piles shall be of the thickness specified or directed and shall be provided with tongues and grooves of ample proportions, either cut from the solid material or made by building up the piles of three planks securely fastened together. The piling shall be drift sharpened at their lower ends so as to wedge the adjacent piles together tightly.

3. Construction.—The tops of the piles shall be cut off to a straight line at the elevation indicated and shall be braced with a waling strip, properly lapped and joined at all splices and corners. The wales shall preferably be in one length between corners and shall be bolted near the top of each pile. When in contact with a concrete footing, the waling strip shall be placed upon the outside of the piles at such an elevation that it can be braced with steel tie rods embedded in the concrete footing.

4. Driving.—Sheet piling shall be driven with either a maul, sledge, gravity, or steam hammer, as approved by the engineer. In case it is necessary, in order to obtain the penetration required, the piling shall be jetted.

5. Basis of Payment.—Payment will be made at the contract price per thousand feet, board measure, for Sheet Piling, which price will include the cost of furnishing, driving, and cutting off such piles as are required. Payment will be made only for that portion remaining in place and no allowance will be made for material cut off, or for any piling that is not driven in accordance with these specifications, or as directed by the engineer and accepted by him.

Concrete Materials and Construction²

1. Composition.—(a) Concrete for culvert and bridge structures shall be composed of Portland cement, water, sand aggregate, and stone aggregate mixed and placed by such means and in such manner as to produce in the finished structures a conglomerate mass having uniform texture and strength.

Materials

2. Cement.—(a) All Portland cement used shall fulfil the physical and chemical requirements of the U. S. Bureau of Standards, *Circular 33*, and the A.S.T.M. Standard Specifications and Tests for Portland Cement (Serial Designation C-17), with any subsequent amendments and additions thereto adopted by the Society.

(b) All cement shall be delivered in suitable packages with the brand and the name of the manufacturer plainly marked thereon. All cement shall be dry and free from lumps. Except when otherwise provided, the cement for any given structure shall be of only one brand and produced by a single mill. All cement shall be sampled after delivery.

(c) All cement shall be stored in weatherproof buildings having the floors properly blocked or raised from the ground to prevent absorption of moisture. Provision for storage shall be ample, and the shipments of cement as received

¹ North Carolina.

² State of Maine.

shall be separately stored in such a manner as to provide easy access for identification and inspection of each shipment. The use of cement damaged by weather shall not be permitted, and all damaged cement from whatever cause shall be removed immediately from the work.

3. Sand Aggregate.—(a) The sand aggregate for concrete shall consist of hard, tough, preferably silicious material; clean, free from mineral or other coatings, lumps, soft particles, clayey dust, "clay balls," loam or other deleterious vegetable or mineral matter. The particles shall be well graded from a size that will pass a "standard" sieve having four meshes per linear inch to a size retained upon a "standard" sieve having 100 meshes per linear inch. Not more than 25% and not less than 15% shall pass a "standard" sieve having 50 meshes per linear inch, or a "Tyler" sieve having 48 meshes per linear inch.

(b) Sand shall not contain more than 5% by weight, of sandy dust (material passing a 100-mesh sieve), and not more than 3%, by weight, shall be removable by the elutriation test.

(c) Mechanical analysis of the grading shall be made from carefully prepared samples taken by the method of quartering.

(d) The presence of deleterious organic impurities in sand shall be tested and determined by the "Abrams-Harder" field test.

(e) Stone screenings may, at the option of the engineer, be used as sand aggregate either alone or in combination with sand.

(f) The particles of stone shall be generally angular and shall be uniformly graded from a size that will pass through a revolving screen having circular openings $\frac{3}{8}$ " in diameter to a size that will be retained upon a "standard" sieve having 100 meshes per linear inch. Stone screening shall not contain more than 5% of fine crusher dust (material passing a 100-mesh sieve). Screenings shall have been produced from strong, tough, and durable rock having a French coefficient of wear of not less than 6, and shall be free from thin, elongated, or laminated particles, disintegrated rock, fine clayey dust, loam, or other deleterious vegetable or mineral matter.

4. Stone Aggregate.—(a) The stone aggregate for concrete shall consist of particles of broken stone or of gravel originating from uniformly strong, tough, and durable rock having a French coefficient of wear of not less than 6 and shall be free from elongated and laminated particles, disintegrated rock, fine clayey dust, loam, or other deleterious vegetable or mineral matter. The grading of the particles from coarse to fine shall be approximately uniform, the maximum size depending upon the character and details of the work to be constructed. The volume of the concrete mass, location and spacing of reinforcing steel, height of forms, etc., shall be considered in determining the maximum size or sizes of the stone aggregate. However, the following sizes passing screens having circular openings are generally applicable:

Structure	Size of Screen
Mass concrete 2' and over in thickness or depth.....	2 $\frac{1}{2}$ "-3"
Mass concrete under 2' in thickness or depth.....	1 $\frac{1}{2}$ "-2 $\frac{1}{2}$ "
Reinforced-concrete walls 2' or more in thickness with reinforcing metal 6" or more apart.....	2 $\frac{1}{2}$ "
Reinforced-concrete walls 10" to 2' in thickness with reinforcing metal 3 to 6" apart.....	2"
Reinforced-concrete walls under 10" in thickness.....	1 $\frac{1}{2}$ "
Reinforced-concrete beams, girders, and spandrel arch ribs with reinforcing steel spaced 2" in clear between bars.....	1 $\frac{1}{2}$ "
Reinforced-concrete beams, girders, and spandrel arch ribs with reinforcing steel spaced under 2" in clear between bars.....	$\frac{3}{4}$ "-1"
Reinforced-concrete bridge floors and bridge sidewalk slabs.....	$\frac{3}{4}$ "-1 $\frac{1}{2}$ "
Reinforced-concrete columns, plain.....	1 $\frac{1}{2}$ "-2"
Reinforced-concrete columns, hooped.....	$\frac{3}{4}$ "-1 $\frac{1}{2}$ "
Bridge hand rails and balustrades.....	$\frac{3}{4}$ "-1"
Concrete placed under water.....	$\frac{3}{4}$ "-1"

(b) The minimum size of particles shall be that retained upon a sieve having four meshes per linear inch.

(c) Broken stone shall contain not over 5%, by weight, of clean crusher dust. Gravel shall contain not over 5%, by weight, of sand aggregate (material passing a sieve having four meshes per linear inch), and shall be free from mineral or other coating.

5. Premixed Aggregate.—(a) Premixed aggregate in the form of pit or bank-run gravel shall be used instead of separate sand and stone aggregates

only when permitted by the engineer, in writing. Its granulometric composition and other physical properties shall conform to the requirements for its sand and stone contents when considered independently. Frequent tests shall be made to determine the relative proportions of sand and stone aggregates and the granulometric composition of each. Irregularities may, at the option of the engineer, be corrected by the addition of sand or of stone aggregates, as conditions may require to secure a satisfactory material. Irregularities rendering it impracticable to secure a satisfactory combined aggregate shall be considered ample reason for discontinuing the use of premixed aggregates and for requiring that such material be screened and used as separate sand and stone aggregate.

(b) Premixed aggregate containing an inadequate proportion of stone aggregate may, at the option of the engineer, be used in concrete, provided the contractor will undertake, in writing, to provide at his own expense the additional quantity of cement required to produce concrete having the strength of the grade contemplated in comparison with the quality required for a 1:2 relation of sand and stone aggregates. The contractor shall also bear the expense involved in making the laboratory tests required for the determination of the premixed aggregate relation.

6. One-man Stones.—(a) One-man stones to be used in rubble or Cyclopean concrete and as bond or dowel stones in construction joints shall consist of angular fragments of tough, dense, and durable rock, having a French coefficient of wear of not less than 6. They shall be free from seams or other structural defects, foreign substances, and coating of any character. In general, the maximum size of the stones shall not exceed that which one man can lift and readily move about, while the minimum shall not include stones measuring less than 6" in their shortest dimension.

7. Water.—(a) All water used in concrete or used for curing concrete shall be subject to the approval of the engineer. It shall be fresh, reasonably clear and free from oil, acid, alkali, and vegetable matter, or other deleterious substances.

(b) An effective means shall be provided for the gaging of the mixing water for concrete. The device used for gaging shall be controllable to the extent of varying the quantity of water to be used per batch within a permissible range of 1 pt. per bag of cement used in the concrete mix.

Field Tests

8. Test Specimen Molds.—(a) Molds for field and laboratory use shall be produced from steel piping so fabricated as to be adapted to the production of concrete cylinders 6" in diameter by 12" long.

(b) To provide for the easy removal of the cylinders from the molds a longitudinal element of the original pipe shall be machined out and the open space so produced shall be closed by forcing the metal edges into close contact with clips and bolts or by ring clamps surrounding the molds.

(c) The inside of the molds shall be smooth and the sharp edges shall have all burrs and roughness removed. The ends shall be cut true and parallel. Each mold shall be provided with a steel base plate measuring (10 by 10 by $\frac{3}{8}$ ").

9. Preparation of Specimens.—(a) For the purpose of determining the quality of concrete being produced, test specimens shall be taken at such intervals as the engineer may direct.

(b) In general, the concrete used for specimens shall be taken from the middle of the batches while being discharged from the mixer drum. However, the engineer may for specific reasons require that the test sample be taken from the first or the last concrete discharged from the mixer or from the mass of concrete after it has been subjected to the operations of placing.

(c) The concrete shall be carefully compacted in the molds by the use of a slicing tool prepared from a piece of $\frac{3}{8}$ " diameter rod flattened for a length of 5 to 6" to a thickness of $\frac{3}{32}$ to $\frac{1}{8}$ " to form a blade-like tool, the full length of which shall be approximately 15" exclusive of the handle produced by bending the rod to form a hand grip of convenient shape.

(d) It is important that the test cylinders be free from honeycomb and "pockets" of stone aggregate. It is especially important that, so far as possible, all the mixing water be retained by the molds within the concrete mass.

(e) Special care shall be exercised in finishing the top ends of the cylinders true and even to permit a uniform bearing in the testing machine. Finishing may be executed in either of two ways:

1. By filling the specimen molds up to within $\frac{1}{4}$ to $\frac{3}{8}$ " of their tops, then, after a period of 15 to 20 min. has elapsed, completing the cylinders by

capping with neat cement paste and using a cover plate of heavy plate glass or of metal to shape the top surface, the plate being adjusted to perfect contact with the top edge of the molds. Plate glass or metal plates shall generally be 8 by 8" in size and shall be oiled on under side to permit their ready removal when the concrete has taken a "green set."

To prevent excess shrinkage the cement paste must be mixed to form approximately a "normal consistency" mass and should be prepared several minutes in advance of its application to the cylinder ends.

2. By the use of a plaster mason's trowel to remove excess concrete material from the top surfaces of the specimens and to dress these surfaces true and even by carefully troweling them flush with the top edge of the specimen molds.

To prevent evaporation of the moisture the specimens shall be covered with wet cloths as soon as troweled. These cloths are to be kept moist.

10. **Stripping, Marking, and Curing Specimens.**—(a) Cylinders shall remain in the molds 24 hr. before being removed. Immediately upon removal they shall be carefully marked for identification, preferably with black paint, and shall be cured by burying in wet sand until the expiration of the test period.

(b) Identification marks, if placed upon the top ends of the cylinders while the concrete is green, shall be so executed as to not impair or injure the surface bearing while testing.

Proportioning

11. **Grades and Strengths.**—(a) Concrete for culvert and bridge structures shall be divided into four grades, viz.: A, B, C, and D.

(b) Concrete of each grade when mixed in accordance with the specified requirements for mobility and time of mixing and molded into test cylinders 6" in diameter by 12" long shall develop not less than the following compressive strengths in pounds per square inch at the ages of 7 and 28 days respectively:

Grade	7 Days	28 Days
A	2100	3000
B	1500	2300
C	1000	1700
D	700	1200

Compressive strength shall be determined from an average of five cylinders tested at each age.

(c) If the test specimens fail to fulfil the strength requirements for 7-day tests and the 28-day tests show the strength desired for the grade specified, the concrete shall be considered acceptable.

12. **Proportions of Aggregates.**—(a) In general, the relation of sand to stone aggregate shall be 1 part sand to 2 parts stone measured by weight or by the corresponding volumes. Preference will be given to the former. Variations from this ratio will be subject to the approval of the engineer. The quantity of sand contained in the stone aggregate shall be taken account of in its relation to the total sand content of the mix. The accurate measurement of the aggregates used per batch of concrete is essential.

13. **Relation of Cement to Aggregates.**—(a) The quantity of cement to be used per batch of concrete shall be determined by the engineer and shall, in general, be dependent upon the quantity necessary to produce from the aggregates to be used a workable mix which will secure, in the finished structure, concrete having strength equal or greater than that assumed by the conditions of the design. The concrete shall also possess the density, toughness, and other physical properties necessary for durability. Consistent with these conditions the contractor may be required to change the cement content of the mix to conform with variations in the gradings of the aggregates.

(b) Whenever considered advisable, in the opinion of the engineer, the quantity of cement to be incorporated in the mix shall be determined by laboratory tests, which shall be made by and at the expense of the Commission. However, the contractor shall supply and ship f.o.b. cars the quantities of materials required for such tests. If test specimens are prepared at the bridge site he may be called upon to provide the labor necessary for their preparation.

14. **Mobility.**—(a) The mobility (consistency or workability) of the concrete is mainly dependent upon the thoroughness of the mixing and the quantity of water contained in the mix. The mobility of the concrete mix

shall be at all times as the engineer may direct. However, in general, the quantity of water used shall be sufficient to produce concrete, the mortar component of which is of a saturated, sticky, semiplastic consistency, showing no free water when removed from the mixer, and when transported in barrows, buckets, chutes, etc., it shall show no appreciable segregation of the component materials. When deposited in forms it shall settle in place and become thoroughly compacted with a comparatively small amount of spading, slicing, or other manipulating. When transported in metal chutes placed at an angle of 30° with the horizontal it will slide (not flow) to its place of placing.

(b) The top surface of concrete having the mobility described above will show a cement film upon the set concrete. Accumulations of inert, clay-like material commonly known as "laitance" result from the use of an excessive quantity of water in the concrete mix and are indicative of low-strength concrete.

15. Mixing.—(a) The concrete shall be mixed in the quantities required for immediate use and any which has developed initial set, or which does not reach the forms within 30 min. after the water has been added, shall not be used.

(b) Unless hand mixing is especially permitted by the engineer, the mixing shall be done in a batch mixer of approved size and type which will insure the uniform distribution of the materials throughout the mass so that the mixture is uniform in color and semiplastic in appearance. The mixing shall continue for a minimum time of 1½ min. after all the materials are assembled in the drum, during which time the drum shall revolve at the speed for which it was designed, but shall make not less than 14 nor more than 20 r.p.m. The mixer shall be equipped with an attachment for automatically locking the discharging device so as to prevent the emptying of the mixer until all the materials have been mixed together for the minimum time required. The entire content of the drum shall be discharged before any materials are placed therein for the succeeding batch.

(c) The mixer shall have a capacity of not less than a "one-bag batch" of concrete.

(d) The first batch of concrete material's placed in the mixer shall contain an additional quantity of sand, cement, and water sufficient to coat the inside surface of the drum without diminishing the mortar content of the mix. Upon the cessation of mixing for any considerable length of time, the mixer shall be thoroughly cleaned by flushing it with a stream of water from a hose or by the use of some other satisfactory method.

16. Hand Mixing.—(a) When hand mixing is permitted, the sand aggregate shall be spread evenly upon the platform and the cement spread upon it. The sand aggregate and cement shall then be mixed dry with shovels or spades (mixing with hoes shall not be permitted) until a uniform color is attained, after which the mixture shall be formed into a "crater" and the quantity of water necessary to produce a mortar of desired mobility poured thereon. The material upon the outer portion of the "crater" ring shall then be shoveled to the center and the entire mass sliced and turned until a uniformly wet mortar is produced. The stone aggregate which shall have been previously wetted shall then be deposited upon the mortar and the entire mass turned and returned with shovels or spades until all the stone particles have become thoroughly coated with mortar. Hand-mixed batches shall not exceed ½ cu. yd. in volume. Mixing platforms shall be water-tight and shall be of ample size readily to accommodate the work involved. Hand mixing will not be permitted for concrete placed under water.

17. Retempering.—(a) All mortar and concrete shall be used while fresh before the initial set has begun. No retempering of mortar or concrete shall be allowed.

Placing and Curing

18. Handling and Placing.—(a) Concrete, after the completion of the mixing, shall be handled rapidly to the place of final deposit. When chutes are used they shall be so designed as to transport the concrete at or near the place of depositing so as to avoid rehandling. Transportation by successive shoveling within the forms shall, in general, not be permitted. Chutes shall be of metal, or, if of wood, shall be metal lined.

(b) The concrete shall be deposited in such a manner as will prevent the separation of the ingredient materials and permit its thorough compacting without jarring, deforming, or displacing the forms or the metal reinforcement. Dropping the concrete from too great a height, throwing it too great

a distance, depositing large quantities at one point and running or working it along the forms, or other practices tending to cause segregation shall not be permitted. In general, concrete shall not be dropped from a height greater than 5'. It shall be compacted and worked into contact with all parts of the forms by agitating it with a straight spade or a slicing tool kept moving up and down until the mass has settled into place and all surplus water has been forced to the surface. Especial care shall be taken to break down any arching action and to prevent the formation of "pockets of stone." The concrete shall be thoroughly compacted around all reinforcing metal to secure maximum bond therewith. Care shall be taken not to jar the form work or the reinforcement metal after the concrete has taken its initial set.

(c) Wherever practicable, concrete shall be deposited continuously for each monolithic section of the work. All floor slabs, sidewalk slabs, and similar thin sections of the work shall be placed full thickness.

(d) In general, all concrete in piers, abutments, and retaining walls shall be deposited in horizontal layers of uniform thickness throughout. The thickness of layers shall not exceed 8 to 10". An incomplete layer shall be left with a vertical construction joint.

(e) In general, no concrete shall be placed in pier, abutment, or other excavations without forms. When placing without forms is permitted by the engineer, especial care shall be taken that lumps of earth or other foreign matter falling from the sides of the excavation do not become buried in the concrete.

(f) Horizontal layers so located as to produce a construction joint at a location wherein a "feather edge" will nominally be produced in the succeeding layer shall be so formed by inset form work that the succeeding layer will end in a body of concrete having a thickness of not less than 6".

(g) Each layer of concrete shall generally be left somewhat rough to secure an efficient bonding with the next layer above. A succeeding layer placed before the underlying layer has become set shall be compacted in a manner that will entirely break up and obliterate the tendency to produce a construction joint between the layers.

(h) Wooden spacer struts and braces within the forms shall be removed when the placing of concrete has reached their height. These pieces of form material must not be buried within the concrete mass.

(i) Layers completing a day's work or placed just prior to discontinuing temporarily concrete operations shall generally be cleaned of all "laitance" or other objectionable material as soon as the concrete has become sufficiently firm to retain its form. To avoid visible joints so far as possible upon face surface, the top surface of the concrete adjacent to the forms shall be finished by being smoothed with a plaster mason's trowel.

(j) In all cases where face surfaces are to have a mortar surface, whether rubbed or not, a spade or slicing tool shall be worked between the concrete and the form to force back the stone aggregate and to produce a dense mortar face.

(k) In all cases where, on account of the obstructions produced by reinforcing metal, shape of forms, or any other uncontrollable condition, difficulty is encountered in puddling the concrete adjacent to the forms, the mortar content of the mix shall be brought into proper contact with interior surfaces by vibrating the forms. The vibrations shall be produced by striking their outside surfaces with wooden mallets or by any other means satisfactory to the engineer.

(l) Top surfaces of bridge seats, backwalls, parapet walls, curbs and hand-rail bases, retaining walls, roadway slabs, etc., shall generally be "struck" with a straight-edge or "floated" after the stone aggregate has been forced below the finished elevation of the concrete. The use of a layer of mortar to produce the final finished surface shall not be permitted. Surfaces which will ultimately support the pedestals of girders, trusses, columns, or other metal superstructure parts shall be finished smooth, true, and even. To assure the production of roadway and sidewalk slabs having the thickness indicated upon the plans, their top surfaces shall be screeded to correct contours by the use of strike boards supported upon firm guides or screeding strips. It is important that the top surface of roadway and sidewalk slabs be accurately finished to true elevation and grade.

(m) Care must be taken that face surfaces of forms and the surface of reinforcement do not become splashed with concrete which will take its initial set before becoming covered by the concrete being placed in the work. Splashes that have taken such initial set shall be carefully removed and the surface of the form again wetted or oiled.

(n) In no case shall the work on any section or layer be stopped or temporarily discontinued within 18" below the top of any face, unless the details of the work provide for a coping having a thickness less than 18", in which case, at the option of the engineer, the construction joint may be made at the under side of the coping.

(o) In placing concrete in columns the work shall be discontinued at the elevation of the bottom of the girders, beams, or slabs taking bearing upon them for a period of not less than 2 hr. before continuing the placing of concrete in the girders, beams, or slabs. Each column shall be examined for accumulations of "laitance" or other foreign matter which, if present, shall be removed in preparation for resuming the placing of concrete. The placing of concrete in column forms shall not be discontinued at an intermediate point between base and top.

(p) All concrete in through girder spans shall be placed complete in a single operation. All concrete in slab spans shall be placed complete in a single operation up to the tops of wheel guards or hand-rail bases. All T-beam spans shall, unless otherwise permitted by the engineer, be constructed in a single operation. When the concrete of the T-stem is permitted to be placed independent of the slab section, the construction joint shall be located at the under side of the slab and the bond between stem and slab shall be a mechanical one produced by embedding 2 by 4" wooden blocks having a length approximately 4" less than the width of the stem in the top surface of the concrete when placed. To provide for the uniform spacing of the blocks and their ready removal when the concrete has taken a set sufficient to hold its form, the blocks shall be beveled $\frac{1}{4}$ " on the sides and ends and shall be firmly nailed upon a board at a distance of 1' center to center. The blocks shall be thoroughly oiled to facilitate their ready removal from the concrete.

(q) When new concrete is placed upon the top of a preceding day's work or upon the top of concrete that has become fully set especial care shall be taken that the outer edge of the new layer of concrete shows at all times a fringe of mortar to assure perfect contact with the surface of the existing concrete.

(r) The placing of concrete in solid and open spandrel arches involving volumes too great for monolithic construction shall be subdivided as the engineer may direct. In general, the order of construction or sequence of the work shall be shown upon the plans and shall include details of keyed construction joints in arch rings and their locations together with the details for the attachment of spandrel walls to the outer edge of arch rings. Sections shall be so arranged that initial stresses will not be created in the metal reinforcement.

(s) The placing of concrete in solid and open spandrel arches shall preferably be a single continuous operation and to secure a proper loading of the centering shall involve symmetrical placing about the crown of the arch. The extrados of the arch ring shall be, unless shaped by an extrados form, screeded to correct contour and finished with a wooden float to secure an even, uniform surface.

(t) Spandrel wall concrete shall not be placed until after the arch centering has been released. The placing of concrete in the copings of spandrel walls and in hand rails shall not be commenced until all spandrel wall concrete is in place and a sufficient length of time has elapsed to permit the arch to adjust itself to the loads produced by the latter.

(u) Construction joints in abutments, piers, and retaining walls and in portions of superstructures wherein the conditions involved may result in the seepage of water through the joints and the future discoloration of exposed surfaces shall contain water baffles consisting of a sheet of zinc or galvanized iron 6" in width set vertically at a distance of not less than 3" from the exposed face surface and embedded one-half its width in the concrete below the joint and the remaining width in the concrete above. The sections or strips of metal shall overlap not less than 6" at their ends.

19. **Placing in Cold Weather.**—(a) In general, no concrete shall be mixed and placed when the air temperature is at or below 35°F. When the mixing and placing of concrete are permitted, in writing, by the engineer, special precautions shall be taken to avoid the use of materials containing frost, and efficient and adequate means shall be provided to prevent the chilling or freezing of the concrete. At the time it is placed in the forms, the concrete shall have a temperature not lower than 50°F. The protection afforded shall conform to the requirements of Sec. 27, Curing Concrete. The method of heating the concrete materials shall be approved by the engineer, but the

work shall be done entirely at the risk of the contractor. The use of salt or any other chemical to prevent freezing or to procure quick setting of the concrete shall not be permitted.

20. Placing under Water.—(a) Placing of concrete in water shall be permitted only (a) when contemplated by the contract plans and (b) when authorized by the engineer in writing. A description of the method and equipment to be used shall be submitted by the contractor and approved by the engineer before the work is started.

(b) Cofferdams shall be sufficiently tight to prevent any current through the space in which the concrete is to be deposited. Pumping will not be permitted while the concrete is being placed nor until it has become fully set.

(c) The method used shall be such as will not permit the washing of the cement from the concrete mix. In no case shall concrete be dumped from barrows or shoveled into the water or allowed to fall through the water in either open or closed metal chutes.

(d) The tremie, when used, shall consist of a tube 12 to 16" in diameter, constructed in sections with flanged couplings fitted with gaskets. It shall be so constructed as to permit its initial charging without dropping the concrete through the water. In operating the tremie it shall be kept filled at all times and the discharge end shall be raised only sufficiently to permit the concrete to move uniformly down the tube. Special care shall be exercised in moving the tremie to secure a practically uniform and level surface upon the concrete in place, and to prevent the loss of the charge. In the event of losing the charge the tremie shall be refilled as described for its initial filling. The means supporting the tremie shall be such as to permit the free movement of the discharge end over the entire top surface of the work and shall permit its being rapidly lowered, when necessary to prevent a too rapid flow or a loss of the entire charge.

(e) The bucket, when used, shall be so constructed that it cannot be dumped until it rests upon the surface upon which its charge is to be placed. In general, this construction shall consist of a base frame extending below the doors forming the bottom of the bucket a sufficient distance to permit them to open downward and outward when tripped or unlatched. The portions of the frame opposite the ends of the doors shall be of solid sheet metal to prevent the initial movement of the concrete in these directions when the bucket is being dumped. The sides of the bucket below the elevation of the under side of the doors shall be of open construction, permitting the free displacement of the water. The portion of the frame coming in contact with previously placed concrete shall have a bearing area which will prevent the loaded bucket from slumping into the concrete a distance sufficient to produce a movement of water tending to dislocate its cement content. The top of the bucket shall not be closed.

(f) In operating the bucket it shall be completely filled and when lowered into the water its descent shall be sufficiently slow to prevent all unnecessary movement of the water. In the operation of discharging and lifting the bucket it shall be raised slowly to avoid, so far as possible, a movement of the water above the concrete. The concrete shall be placed in layers having top surfaces as uniform and even as possible.

(g) The bags, when used, shall be of jute or other coarse cloth. They shall be about two-thirds filled with concrete, and shall be carefully hand placed in header and stretcher order to secure an efficient interlocking of the whole mass.

(h) When possible, the concrete shall be placed continuously from start to finish in so far as that portion of the work to be placed under water is concerned. In order to assure a thorough bonding between the layers, the equipment for mixing, transporting, and placing the concrete shall be adequate to produce a rate of progress which will permit the placing of each succeeding layer before the preceding layer has taken its initial set. The use of "plums" shall not be permitted in concrete placed under water. To prevent the formation of "laitance," the concrete shall be agitated as little as possible while being placed. All laitance or other foreign matter shall be removed from the surface of a complete portion of the work before the placing of concrete by the usual methods is commenced thereon.

21. Placing on or against Set Concrete.—(a) Whenever new concrete is to be placed on or against concrete which has fully set, the surface of the set concrete shall, unless thoroughly cleaned of all "laitance" and objectionable material before becoming set, be roughened and carefully cleaned of "laitance" and foreign matter and be drenched with water until saturated. The forms, if they are not in close contact with the set concrete, shall be

tightened against its faces, and the new concrete placed therein shall, be compacted in a manner assuring maximum bond between the new and the old material. If necessary, in the opinion of the engineer, the new concrete shall contain an excess mortar content.

22. Bonding Construction Joints.—(a) The construction joints produced between layers of concrete placed intermittently in piers, abutments, and retaining walls shall be bonded to prevent displacement by sliding or by overturning. Approved hard, sound, and durable stones of "one-man" size may be used in structures having a width of 4' or more, while in narrower structures metal dowels or a mechanical bond secured by producing a "mortise and tenon" interlock shall be used. When the concreting of the lower layer is complete, its surface shall be prepared for bonding the layer to be superimposed upon it before the concrete has taken its set.

(b) When "bond" or "dowel" stones are to be used they shall be hand placed as specified for the placing of stones in rubble or Cyclopean concrete (see Sec. 23 (b), Rubble or Cyclopean Concrete), except that stones having a distinct stratified structure shall be set with the "grain" vertical to the construction joint.

(c) Metal dowels shall consist, in general, of rods having a diameter of not less than $\frac{1}{2}$ " and a length of not less than 1'. However, when approved by the engineer, metal secured from scrap bar, pipe, castings, etc., may be used, provided such metal has ample cross-section and is free from rust scale. In general, dowels shall be staggered and their distance center to center shall not exceed 3'.

(d) When a "mortise and tenon" bond is to be used the "mortise" shall be produced by forcing the ends of 6 by 6" timbers into the unset concrete to a depth of 3 to 4". The holes so produced shall be staggered and shall not exceed 2' center to center. To facilitate their ready removal from the concrete after it has taken its set the ends of the scantlings shall be slightly beveled and thoroughly oiled.

23. Rubble or Cyclopean Concrete.—(a) Whenever provision is made upon the plans for the use of rubble concrete in abutments, piers, and retaining walls, its use shall be permitted in portions of these constructions having a width of 4' or more. The stones or "plums" used shall consist of angular fragments of tough, dense, and durable rock of the size commonly known as "one-man stone," i.e., stones not larger than one man can readily lift. They shall be free from seams or other structural defects, foreign substances, and coatings of any character.

(b) The stones shall be hand placed (not cast or thrown into the concrete) in "rack and pinion" order, not less than the width of a man's foot apart nor nearer than 1' to the inside of the forms and shall be forced down into the fresh concrete a depth equal to one-half their size. When stratified stones are used, they shall generally be laid upon their natural bed. Each layer of stones shall be covered with concrete to a depth equal to the size of the stones, before a succeeding layer shall be placed. The concrete surrounding the stones shall be thoroughly compacted so as to fill all irregularities and cavities in their surfaces. Under no circumstances shall a course of stones extend higher than 2' below the top surfaces of abutments and piers upon which the bridge superstructure is to be placed. When the tops of abutments and piers are finished with copings, the uppermost course of stones shall be located at least 1' below the under side of copings.

24. Joints.—(a) The locations and details for expansion joints in retaining walls, abutments, etc., shall be strictly adhered to.

(b) Where sliding joints are to be provided at the ends of slab, T-beam, and girder spans having a length less than 30' the bridge seat or other bearing areas shall be screeded true to grade and carefully finished by the use of a plaster mason's trowel and when the concrete has become thoroughly set, the bearing areas shall, unless otherwise provided upon the plans, be covered with a layer of asphalt-treated roofing felt before the superstructure concrete is put in place. To insure free movement consistent with the lengths of superstructure spans, the thickness of the layer of felt shall vary correspondingly and shall, in general, be made of sheets of heavy roofing felt swabbed with liquid asphalt between each sheet. Thickness of layers shall vary as follows:

Span Lengths
10' and less
11-20'
21-30'

Layer Thickness
 $\frac{1}{2}$ "
 $\frac{3}{4}$ "
1"

Reinforced-concrete T-beam and girder spans of lengths over 30' shall, in general, be provided with bronze expansion plates or other approved devices for permitting free expansion and contraction movements. Unless especially provided otherwise upon the plans, no reinforcement shall extend across an expansion joint.

(c) In general, the locations of construction joints shall be planned in advance of the placing of concrete. These joints shall be located and constructed so as to impair the strength and appearance of the structure the least possible. Diagonal or otherwise deformed construction joints in abutments, piers, retaining walls, slabs, beams, and girders shall not be permitted.

(d) In general, every structural element of a bridge structure shall be completed without discontinuing the placing of concrete, if practicable. So-called "construction joints" produced by discontinuing the work at the end of a day or at other times shall be predetermined as to location, if possible. These joints shall be located perpendicular to the principal lines of stress and generally at points of minimum shear.

(e) Construction joints shall be produced as specified in Sec. 18, Handling and Placing, and Sec. 22, Bonding Construction Joints.

25. Cleaning Mixers, Tools, Etc.—(a) All mixers, chutes, barrows, spades, slicing tools, etc., shall be cleaned from all adhering mortar at the end of each day's work or at other times whenever the mixing and placing of concrete is temporarily discontinued for any considerable length of time. It is also advisable that splashes and spatters of mortar adhering to the interior surfaces of forms and to metal reinforcement be removed at the time of discontinuing placing, since they can be most readily removed at that time. They must be removed before the placing of concrete is resumed. If not removed, these accumulations of inert material produce two unsatisfactory conditions, viz.: they either cleave from the surfaces of the forms and remain temporarily embedded in the face surface of the concrete to become disintegrated at a later period, or they remain firm upon the forms and cleave from the surfaces of the new concrete when the forms are removed, leaving these surfaces rough and irregular.

26. Protection of Work.—(a) Concrete in place shall not be subjected to vibrating, jarring, or other movement tending to produce incipient fractures during the period of "green" set. Form carpenters, carpenters' helpers, and other laborers shall not be permitted to walk or work upon the concrete when it has become sufficiently set to break or crumble under their feet, but has not yet attained a hard set. Carpenters and their helpers engaged upon the construction of forms above green-set concrete shall work upon properly constructed scaffoldings and walkways.

27. Curing Concrete.—(a) In order to develop the desired strength, careful attention shall be given to the proper curing of the concrete. In hot weather all concrete surfaces exposed to premature drying shall be protected from the direct rays of the sun by means of canvas, straw, sand, or other satisfactory covering, and shall be kept continually moist by sprinkling or otherwise for a period of at least 10 days after placing. Other precautions to insure proper curing of concrete shall be taken by the contractor as directed by the engineer.

(b) Concrete placed in cold weather shall be amply protected to retain its initial temperature (not lower than 50°F.) for at least 72 hr. after the placing is complete and until the concrete has become set. The temperature shall then be maintained above freezing, 32°F., for an additional 7 days and the concrete shall be kept moist throughout the entire 10-day period. Concrete showing injury by frost shall be removed and replaced at the contractor's expense.

Reinforcement

28. Metal Reinforcement.—(a) Reinforcement metal used shall be manufactured in accordance with and shall in all respects fulfil the physical and chemical requirements of the A.S.T.M. Standard Specifications for Billet-steel Concrete Reinforcement Bars (Serial Designation A15-14) with any subsequent amendments and additions thereto adopted by the Society, except that it shall be produced only by the open-hearth process and that deformed bars shall not be machined to obtain a uniform cross-section before testing. Unless otherwise provided, only steel of "structural-steel grade" shall be used. Wherever structural-steel shapes are to be used, they shall fulfil the physical and chemical requirements of the A.S.T.M. Standard Specifications for Structural Steel for Bridges (Serial Designation A17-16) with

any subsequent amendments and additions thereto adopted by the Society. Preference shall be given to bars and shapes manufactured by the open-hearth process. No enrolled material will be accepted.

(b) Unless otherwise provided upon the plans, all reinforcement shall be plain round bars. It shall be free from mill and rust scales, dirt, oil, paint, or other foreign matter and, if ordered by the engineer, shall be scraped and cleaned by the use of scrapers, wire brushes, or other satisfactory means. Steel shall be stored on skids or other supports at a satisfactory height above the ground.

(c) The bending of reinforcement to conform to the dimensions shown on the plans shall be accurately done. In general, the radii of bends shall be equal or greater than twice the diameter of the bar measured from the inside of the curved metal; however, the radii for stirrups shall be equal to or less than the diameter of the bar. All bending shall be done cold.

(d) All reinforcement shall be accurately placed in the locations shown on the plans and adequate means provided for securely holding it in correct position during the placing of concrete in the forms. Whenever the reinforcement is to be held out of contact with the forms by supporting it upon blocks, precast mortar blocks of approved dimensions shall be used. Likewise tiers of bars in girders, T-beam stems, etc., shall be separated by the use of precast blocks. The use of pebbles, flat pieces of broken stone, bricks, metal pipe, or wooden blocks shall not be permitted.

(e) The locations of the reinforcement are, with few exceptions, mathematically determined to conform with the loadings assumed in the design and variations therefrom, produced by "foot and spade" placing of the metal, radically affect the strength. The placing of the reinforcement as the concreting progresses without definite means for holding it in its correct location shall not be permitted.

(f) Reinforcement shall be placed well in advance of the concreting, and shall be inspected and approved by the engineer before any concrete is placed in contact with it.

(g) No deviation in sizes shown on the plans, or in the spacing or the arrangement of the bars will be allowed except by special permission of the engineer, in writing. An application for permission to substitute other sizes for those shown on the plans or for permission to splice reinforcement bars shall be accompanied by sketches showing the complete layout proposed. Splices shall be avoided at points of maximum stress and shall be staggered where possible. The number of splices shall be minimum. No splices will be permitted in the main reinforcement of beams and girders. Splices in adjacent bars shall be staggered. Splices shall be designed to develop the strength of the bar without exceeding the allowable bond stress, but in the absence of an actual design a minimum lap of 40 diameters shall be used. All splices shall be firmly seized with not less than four turns of wire at intervals of 6 to 10", depending upon the size of bars, the shorter spacing being used upon the larger sizes of bars. When required by the engineer, cable clamps shall be used to fasten reinforcing bars. Such clamps shall develop the full strength of the bar. Splicing by means of welds shall not be permitted.

(h) Reinforcement showing splashes of dried mortar shall be cleaned before being imbedded in the concrete.

Forms

29. Forms.—(a) All forms shall be well built, substantial, and unyielding, securely braced, strutted, and tied to prevent motion and distortion while concrete is being placed in them and amply strong to safely support, in addition to the weight of the concrete, all superimposed loads (runways, barrow loads, workmen, scaffolding, etc.), placed upon them. In proportioning forms, falsework and centering concrete shall be treated as a liquid weighing 144 lb. per cubic foot for vertical loads and 72 lb. for horizontal pressure.

(b) Concrete surfaces as related to form construction shall be divided into two classes, *viz.*:

1. Forms for unexposed surfaces, such as the back surfaces of abutment breast walls and wing walls; the back surfaces of retaining walls, and surfaces of abutments, piers, etc., located below the beds of streams and the finished surfaces of backfill around abutments, piers, and retaining walls.

2. Forms for exposed surfaces which include all surfaces not considered as unexposed.

(c) All back surfaces of retaining walls to a depth of 18" below the tops of these walls and all front or face surfaces of abutments and piers to a depth

of 2' below the finished ground surface or to a greater depth, if, in the opinion of the engineer, there is a possibility of a deepening of the waterway due to scour, shall be treated as exposed and shall be constructed accordingly.

(d) All lumber used for exposed surface forms shall, unless otherwise provided, consist of sized and dressed tongue and groove lumber, free from loose knots, knot holes, cracks, and other defects affecting the strength of the lumber or the accuracy of the finished concrete surfaces. When other than tongue and groove lumber is to be used it shall be dressed on one side and both edges (d3s) to a uniform thickness and width and of the quality described for tongue and groove material. The thickness of tongue and groove lumber shall be not less than 1¼" and of plain dressed lumber not less than 1½". To provide for reusing the lumber a greater number of times it may be dressed on both sides.

(e) Lumber used for unexposed surface forms shall be of uniform width, straight-edged, and dressed on one side (d1s) to a uniform thickness of not less than 1½". It shall be free from loose knots, knot holes, cracks, wane, or other defects rendering it unsuitable for form work. When permitted by the engineer, undressed lumber of uniform thickness and width, otherwise fulfilling the requirements for lumber dressed on one side, may be used for unexposed surface forms.

(f) Lumber for studding, walings, struts, braces, etc., shall be free from winds, crack, and other structural defects rendering it unsatisfactory for the purpose for which it is to be used.

(g) Forms shall be built to conform accurately to the dimensions, location, contours, and details shown on the plans. The faces of forms against which the concrete is to be placed shall be dressed smooth and uniform and shall be free from winds, twists, buckles, and other irregularities. They shall be constructed by experienced and capable workmen and shall be sufficiently tight to prevent the leakage of cement and mortar through the joints. In general, forms shall be constructed so that they can be removed from the bottom upward and shall be designed so that they may be removed without damage to the concrete. In general, forms shall be provided for all work. The placing of concrete in excavated pits and trenches without forms shall be permitted only in exceptional cases and at the discretion of the engineer (see Sec. 18 (e), Handling and Placing).

(h) Except in the construction of forms for round-ended piers, the lagging or sheeting shall be placed horizontal. For long abutment, pier, and retaining-wall forms requiring two or more lengths of lagging, the joints in adjacent pieces shall be staggered to secure additional rigidity. Forms built to be erected and removed in sections shall be provided with an ample means for holding the sections rigidly to correct alignment and grade.

(i) All corners within the forms shall be fitted with chamfer strips, mitered at their intersections, to prevent spalling of the concrete during the removal of the forms. In general, chamfer strips shall not have a greater width than 1" nor a less width than ½". The size to be adopted for a given portion of the work shall depend somewhat upon the general dimensions involved. Provision shall be made for the chamfering of the top edges of abutment bridge seats and wing walls, tops of piers, and retaining walls, tops of side (through) girders, roadway curbs, etc., by nailing chamfer strips inside the forms. These strips serve as screeding strips for the finishing of the top surface of the concrete when it is placed. They are usually made ¾ to 1" in width. Unless otherwise provided, all chamfer strips shall produce in the concrete plain, flat surfaces.

(j) Form material or form sections used more than once shall be carefully cleaned from adhering mortar and other accumulations of foreign matter, if any.

(k) The forms for beams, girders, columns, and spandrel arches shall be so constructed as to permit the sides to be removed without disturbing the supports.

(l) All sawdust, chips, blocks, shavings, and other foreign matter within the forms shall be removed before depositing concrete in them. Forms, more especially column and thin reinforced wall forms shall, wherever necessary, be built with removable pieces of sheeting to permit thorough clearing.

(m) All forms shall be held rigidly to correct alignment and location by ample supports and braces. In all cases where metal anchorages or ties within or through the face forms are required to hold the forms in their correct position, such anchorages or ties shall be of ample strength and shall be so constructed that the metal work can be removed to a depth of 2" from

the face surface of the concrete without injury or damage to such surfaces by spalling or otherwise. The cavities produced by the removal of the metal shall be carefully filled with a mortar mix similar to that contained in the concrete in which the cavities occur.

(n) Forms shall be inspected and approved before placing concrete within them.

30. Unwatering Forms.—(a) Unless otherwise provided, all forms shall be unwatered before concrete is placed in them. Pumping will not be permitted from the inside of forms for abutments, piers, and retaining walls while concrete is being placed. Moving water shall not be permitted to come in contact with fresh concrete. In general, cofferdams, caissons, cribs, or other devices used to exclude water from foundation excavations shall be constructed to provide free access to all exterior portions of the substructure forms, both for their construction and their inspection.

31. Preparing Form Surfaces.—(a) In order to insure the non-adhesion of the mortar to the forms the inside surfaces shall be uniformly coated with raw paraffin or other non-staining mineral oil, soaped, or thoroughly wetted with water (except in freezing weather). If soap is used it shall be mixed with sufficient water to produce a thin jelly-like substance. When forms are used more than once they shall be carefully cleaned at each setting and recoated with oil or soap.

(b) Whenever forms are constructed several days in advance of filling them with concrete they shall be kept moist or otherwise protected against warping of the lagging and other defects produced by the drying out of the lumber.

(c) Forms used for producing openings in hand rails or other portions of the work shall be thoroughly saturated by immersing in water or otherwise to prevent swelling by absorption of water from the concrete.

32. Removal of Forms.—(a) Location, weather conditions, materials used, and the character of the structure involved shall be considered in determining the time for the removal of forms.

(b) In general, forms shall not be removed until sufficient time has elapsed subsequent to the complete placing of the concrete to permit the development of a set which will give forth a distinct "stoney ring" when the concrete is struck with a small hammer. (Frozen concrete shall not be so tested.)

(c) Forms shall be removed from columns before removing the falsework or shoring from beneath the adjacent beams and girders so that the condition of the column concrete may be determined.

(d) The falsework or shoring originally placed under the forms shall remain in place until its final removal. The supports must be removed in a manner which will permit the concrete to assume uniformly and gradually the stresses due to its own weight.

(e) Methods of removal tending to produce shocks, jars, and fracturing of the concrete shall not be permitted. In general, the removal of forms shall be from the bottom upwards.

(f) Forms shall not be removed at any time without the consent of the engineer. However, such consent shall not in any way relieve the contractor of his responsibility for the work.

Arch Centering and Falsework

33. Arch Centering.—(a) Foundations for the falsework and centering of arches when not consisting of solid rock or other unyielding soil material shall be reinforced by the use of piles, grillage, or other means to support without appreciable settlement the loads to be superimposed thereon.

(b) The timbering of the falsework and centering shall be securely and rigidly constructed and shall, for all spans having a length greater than 20', be supported upon adjustable wedges or other approved devices to facilitate lowering of the centering or other supports under full control, evenly and gradually, without subjecting the concrete of the arch span to shock or an uneven distribution of pressure.

(c) The lagging or sheeting of the arch centering shall be narrow and shall otherwise fulfil the requirements for exposed surface forms. All uneven joints or other irregularities due to the curvature of the centering shall be planed off.

(d) All lagging and timbering shall be thoroughly saturated with water prior to commencing the construction of the arches, and shall be kept so saturated until the concreting of the arch ring or of the main arches is complete and a satisfactory length of time, in the opinion of the engineer, has

elapsed to render the concrete not only self-supporting but also of sufficient strength safely to support the structure loads to be imposed thereon. When this strength has been secured the centering and falsework shall be permitted to dry out gradually as a means of slowly relaxing their support. As soon as the arch ring has or the main arches have, in the opinion of the engineer, assumed a permanent set the placing of the concrete in spandrel walls or in other deck construction may proceed.

(e) The contractor shall provide upon the main arch forms or centering, as the engineer may direct, suitable check blocks for the purpose of observing the deflections produced as the work progresses.

(f) Detail plans of falsework and centering for concrete arch spans shall be supplied by the contractor for the approval of the engineer whenever required by a general note on the contract plans or requested so to do by the engineer in writing. Detail plans shall show in addition to elevation, plan, and section views, the mathematical development of the design and the kind and sizes of material to be used. All details shall be shown upon drawings of standard size (see Proposal and Contract Requirements—Size of Plans) and when the work is complete the original plan, on tracing cloth, shall be supplied to the Commission for its Bridge Division file.

34. Falsework.—(a) All falsework used for supporting reinforced-concrete superstructures shall be composed of timbers having ample cross-sectional areas to resist without deformation or appreciable settlement the loads imposed upon them. It shall be well built, rigid and unyielding, securely braced, strutted, and tied to prevent distortion and motion tending to produce vibration and deformation of the superstructure forms.

(b) When the vertical members of falsework consist of piles or when framed or other falsework is supported upon piles, the piles shall be driven to secure a safe load resistance of at least 15 tons per pile (see Piles and Pile Driving).

(c) When falsework is supported upon mud sills the sills shall consist of at least two layers of timbers, the upper layer being laid transversely with the under or bottom one. The foundation pressures resulting from the imposed loads upon mud sills (falsework, forms, fresh concrete, scaffolding, tramways, etc.) shall, in general, not exceed the following:

- | | |
|--|------------------------|
| 1. For firm sand, gravel, rotten rock, very firm clay, and other similar soils in confined thick beds..... | 2 tons per square foot |
| 2. For loose sand and gravel and ordinary clay soils in confined thick beds..... | 1 ton per square foot |
| 3. For soft clay and firm alluvial soils..... | ½ ton per square foot |

All arch centering and falsework shall be subject to the approval of the engineer, but the work shall be done entirely at the risk of the contractor, the engineer's approval in no way relieving him of his responsibility.

(d) Forms supported upon falsework shall be provided with a satisfactory means for their adjustment in the event of settlement or deformation of the falsework due to overloading or other causes.

Surface Finish

35. Surface Finish.—(a) In general, all face surfaces of concrete, whether produced by contact with the forms or by screeding, floating, troweling, or other means, shall be true and even, free from depressions or projections not shown on the plans, and from "honeycomb," stone pockets, and other defects resulting from defective forms and improper placing; nor shall these surfaces show layers of accumulated "laitance" or other foreign materials. Furthermore, these surfaces shall be free from injurious seams, flaws, cracks, broken edges, or other defects.

(b) As soon as the forms are removed, all stone pockets, "laitance" layers, chips, shavings, or other foreign matter shall be removed by the use of chisels or by other means satisfactory to the engineer, and the cavities so produced shall be filled as he may direct. The cavities shall be freed from loose dust and the surrounding concrete shall, if dried, be thoroughly saturated with water before the cavities are filled.

(c) Small "water cavities," air voids, pits, and other defects not detrimental to the strength of the structure shall be filled with mortar of the same mix as that used in the concrete containing the defects. This mortar shall be applied with a wooden float and shall be thoroughly forced into the holes to fill them completely. All excess mortar shall be removed by "cutting"

it away with the edge of the float. Cavities, pits, and other defects upon vertical surfaces shall be filled by floating upward to force the mortar into contact with the uppermost surfaces of the holes.

(d) Bolt or other holes resulting from form ties shall be carefully filled. Mortar shall not be applied to dried-out concrete surfaces.

(e) Under no circumstances shall mortar be used for the purpose of producing a plaster coating to cover irregularities of surface resulting from warps, buckles, mismatches of lagging, or other defects in forms.

(f) Concrete surfaces as related to their final finish shall be divided into three classes, viz.:

1. Surfaces permanently covered with water, backfill, and approach fill after the completion of the work or intended to be so covered (top surface of roadway slabs, back surfaces of the breast and wing walls of abutments, back surfaces of retaining walls, and surfaces of abutments, piers, etc., located 2' below the elevation of extreme low water, or an equal depth below the finished surfaces of backfill around abutments, piers, and retaining walls shall be so considered) shall be subject to the general conditions noted above.

2. Surfaces not exposed to general view (sides and bottoms of interior girders and stringers, bottom surfaces of floor slab or of slab spans, and other surfaces as the engineer may decide shall be considered as so exposed) shall be subject to the general conditions described above. Furthermore, these surfaces shall, when finally finished, show no depressions or projections beyond the general surface. Form marks shall not be removed, but all surfaces which, in the opinion of the engineer, are of this class shall present a clean-cut, workman-like appearance.

3. Surfaces exposed to general view (sides and bottoms of exterior girders and stringers, spandrel arches, roadway curbs, hand rails, cantilevered brackets under sidewalks, girders at tops of substructure bents, and all exposed surfaces of abutment breast and wing walls, piers and retaining walls down to a depth of 2' below extreme low water or an equal depth below the finished ground surface, or to a greater depth, if, in the opinion of the engineer, there is a possibility of a deepening of the waterway, and any other surfaces as the engineer may decide shall be so considered) shall be "rubbed mortar" finished.

(g) A "rubbed-mortar" finish shall be produced as follows:

As soon as the mortar used in filling surface defects has taken a firm set, the surface to be finished shall be moistened and thoroughly rubbed or ground with a carborundum brick or similar tool to remove from such surfaces all inert sand and cement materials and to eradicate all impressions of form work. When the surface under treatment has been rubbed to a smooth and even surface, the pasty material adhering to the surface shall be entirely washed off and the surface shall be again wet rubbed until a small accumulation of fine-grained paste is produced. This paste shall not be removed, but shall be carefully spread with a moist whitewash brush to form a uniform, very thin coating upon the surface of the concrete. This coating shall remain undisturbed until it has attained a firm set.

(h) Final surface finishing shall not be done in freezing weather or when the concrete contains frost. In cold weather the preliminary rubbing necessary to remove the inert sand and cement materials and surface inequalities may be done without the application of water to the concrete surfaces.

36. Sidewalk Finish.—(a) Unless otherwise provided, the finishing of sidewalk areas upon bridge structures shall consist essentially of the following treatment, following the general screeding of the surface as specified in Sec. 18 (k), Handling and Placing. A margin 4" in width shall be outlined adjacent to the base of the sidewalk hand rail by tautly stretching a cord having a diameter of $\frac{3}{16}$ to $\frac{1}{4}$ " upon the freshly screeded surface, following which this margin or strip shall be finished smooth by the use of a plaster mason's trowel, and in this operation the cord shall be pressed firmly into the concrete to produce a clearly defined margin. Similarly, a margin 6" in width shall be defined smooth upon the curb side or edge of the sidewalk. When the sidewalk upon the bridge does not connect with a concrete sidewalk upon the approaches to the bridge, the ends of the sidewalk shall be finished with a margin 4" in width to conform with the finish along the curb; otherwise the finish at the ends shall be such as to match the margins used upon the slab of the approach sidewalk. Following the finishing of the margins as above specified the entire midarea of the sidewalk slab shall be finished with a short wooden float which shall be moved in small circles to produce a shell-like pattern upon the surface of the concrete. Care shall be exercised not to "float" beyond the cord marks upon either margin. Unless otherwise

provided upon the plans, the sidewalk area shall not be divided into longitudinal sections by transverse grooves cut with the tool used for that purpose upon ordinary sidewalk work. Transverse grooves produce lines of weakness in the sidewalk slab which tend to develop cracks at these locations.

Precast Sections

37. Forms or Molds.—(a) Forms or molds for precasting hand rail or other sections shall fulfill all specified requirements for form materials and construction. Metal or metal-lined forms shall be used only when the smooth surfaces they produce harmonize with other face surfaces of the structure.

38. Casting.—(a) The metal reinforcement shall be placed and rigidly held in the position shown upon the detail plans.

(b) The methods used for depositing and placing the concrete shall fulfill the specified requirements for this work. See Sec. 18, Handling and Placing. The surface of the concrete corresponding to the open side of the form or mold shall be floated, troweled, or otherwise finished to produce a uniform, even surface texture comparable to the "formed" surfaces of the section or member. Proper curing conditions shall be provided.

39. Stripping and Finishing.—(a) Precast sections shall not be removed from the forms until the concrete has attained ample set to permit the work to be done without danger of spalling, cracking, or other injury.

(b) The finishing of the concrete surfaces shall not be undertaken until the concrete has attained a "hard" set. The finishing of surfaces by breaking up the "green" set shall not be permitted.

40. Assembling.—(a) In the assembling of precast sections the methods of lifting, transporting, and otherwise handling the sections shall be such as not to subject them to stresses producing fractures, incipient cracks, or other defects.

(b) Assembled sections shall be held rigidly in position by braces, struts or other supports until incorporated in the finished structure.

Floor Slabs on Metal Structures

41. Floor Slabs on Metal Structures.—(a) The materials, methods of construction, etc., used in placing reinforced-concrete floor slabs upon metal bridge structures shall, in general, conform to the specified requirements for the construction of bridge superstructures composed entirely of reinforced concrete.

(b) Especial care shall be taken during construction operations to protect the metal portions of the structure against disfigurement by spatters, splashing, and smirches of mortar and concrete. Following the placing of the concrete, the metal surfaces shall be thoroughly cleaned without injuring the paint upon them. This work shall be done at the contractor's expense.

Miscellaneous

42. Foundation under Concrete.—(a) Where concrete is to be placed on an excavated earth surface other than rock, especial care shall be taken not to loosen or disturb the bottom of the excavation and the final removal of material to the finished foundation elevation shall not be made, except in the case of concrete roadway slabs on bridge approaches, until immediately before the concrete is to be placed. The excavation elevations shown on the plans for abutments, piers, and retaining walls shall be considered only as approximate and may be changed to elevations securing satisfactory foundation conditions. Placing of concrete in excavations shall not be commenced until the depth and character of the foundations have been examined and approved by the engineer. All rock or "near-rock" foundation surfaces shall be free from loose pieces, cut to firm surfaces, leveled, or stepped, if necessary, and thoroughly cleaned to secure a proper bond with the concrete.

43. Drainage.—(a) Scappers, grating, down pipes, or other openings or fixtures intended to provide a means of drainage for the roadway or sidewalks shall be provided as shown on the plans or as required by the engineer. Special attention shall be given to the matter of providing discharge clear of all steel or other parts of the structure subject to injury therefrom.

STATE HIGHWAY DEPARTMENT OF TEXAS

Item 85. Concrete

85.1. Description.—Concrete shall be composed of Portland cement, fine and coarse aggregate, each measured separately and accurately by volume, and water, mixed as provided in these specifications, and shall be constructed

where, and of the form, dimensions, and design shown on the plans. Concrete shall be classified and proportioned by volume as follows, and in no event shall the number of bags of cement of 94 lb. each used per cubic yard of concrete in place be less than the number required below:

Class	Parts Aggregate to 1 Cement	Bags Cement to Cubic Yard
A	6	6.0
B	7½	5.0
C	9	4.5
D	5	7.0

85.2. The engineer shall regulate the proportion of fine to coarse aggregate to secure the maximum density and, in general, the proportions in terms of the three ingredients shall approximate the following normal ratios for the several classes of concrete:

Class A	1-2	-4
Class B	1-2½	-5
Class C	1-3	-6
Class D	1-2	-3

85.3. When the class of concrete required is not expressly indicated on the plans, the following requirements shall govern:

1. For superstructure, arch rings, walls, or other parts of a structure having a least dimension less than 1', and for all heavily reinforced concrete except where Class D is used, and for concrete deposited under water, Class A concrete shall be used.

2. For substructures having a minimum thickness of at least 1', and in which all steel is embedded at least 3" (5" where below low water), and does not carry calculated stress, Class B concrete shall be used.

3. For unreinforced footings, not deposited under water, Class C concrete shall be used.

4. For railing, rail posts, and other very thin sections Class D concrete shall be used.

85.4. **Materials.**—The coarse aggregate shall consist of broken stone or gravel conforming to the following requirements:

Broken stone shall consist of clean, tough, durable fragments of rock (excluding schist, shale, or slate) of uniform quality throughout, shall be free from an excess of thin or elongated pieces, soft or disintegrated stone, dirt, organic, or other injurious matter occurring either free or as a coating on the stone. All stone shall have a per cent of wear of not more than 6. All limestone shall meet the requirements of the soundness test.

85.5. Gravel shall consist of clean, hard, durable, uncoated pebbles having a per cent of wear of not more than 15 (abrasion test for gravel) and shall be free from soft, thin, or laminated pieces, disintegrated stone, dirt, organic, or other injurious matter occurring either free or as a coating on the stone. Where reinforcing steel is to be used, gravel shall be free from salt and alkali. Pit or bank-run gravel shall not be used.

85.6. **Grading.**—Coarse aggregate shall be well graded, and when tested by laboratory methods, 95 to 100 % shall be retained on the ¾" screen for all classes.

85.7. For Class A, 95 to 100 % shall pass the 1½", and 40 to 75 % shall pass the ¾" screen. For massive sections of a concrete Class B grading may be used when expressly permitted.

85.8. For Class B, 95 to 100 % shall pass the 2½", and 40 to 75 % shall pass the 1½" and be retained on the ¾" screen.

85.9. For Class C, 95 to 100 % shall pass the 3", and 40 to 75 % shall pass the 1½" and be retained on the 1" screen.

85.10. For Class D, all shall pass the ¾", and 30 to 75 % shall pass the ½" screen.

85.11. When A concrete is required in thin sections less than 8" in thickness, the material shall all pass the ¾" screen.

85.12. Coarse aggregate conforming in all respects to the above requirements except grading may be used, provided that concrete made from such material meets the requirements of the strength test hereinafter specified.

85.13. Fine aggregate shall consist of sand, or a combination of sand and not more than 50% of stone screenings, conforming to the following requirements:

85.14. Sand shall be composed of clean, hard, durable, uncoated grains, free from lumps, silt or flaky particles, loam, organic or other injurious

matter. Where reinforcing steel is to be used, sand shall be free from sal or alkali.

85.15. Stone screenings shall consist of the clean, dustless product resulting from the crushing of stone, meeting all the requirements for coarse aggregate except for grading, and free from lumps.

85.16. Fine aggregate shall be well graded from coarse to fine and shall meet the following requirements:

Passing the $\frac{1}{4}$ " screen.....	95-100%
Passing 20-mesh sieve.....	35- 70%
Passing 50-mesh sieve.....	5- 30%
Passing 100-mesh sieve.....	0- 5%

Weight removed by elutriation test not more than 3%.

85.17. When subjected to the color test for organic impurities, the fine aggregate shall not show a color darker than the standard color.

85.18. Fine aggregate conforming to all requirements except grading and color, and mortar strength hereinafter specified, may be used, provided that concrete made from such material shall meet the requirements of the concrete strength test hereinafter specified.

85.19. Cement shall conform to the requirements for Portland cement prescribed in U. S. Department of Agriculture *Bulletin* 1216. The cement shall be stored in such a manner as to permit easy access for proper inspection and identification of each shipment, and in a suitable weather-tight building which will protect the cement from dampness.

85.20. Water shall be clean, clear, free from oil, acid, alkali, or vegetable matter and shall not be used until the source of supply has been approved. If at any time the water from this source shall become of unsatisfactory quality or insufficient quantity the contractor may be required to provide satisfactory water from some other source. Water of doubtful quality shall be tested in briquettes as provided under Mortar Strength of this specification and the test results shall be equal to those made from water of known satisfactory quality.

85.21. Mortar Strength.—When the fine aggregate is mixed with Portland cement in the proportion of 1: 3, the tensile or compressive-strength ratio compared to Ottawa-sand mortar briquettes of the same proportions and consistency shall be not less than 100% at 7 and 28 days.

85.22. Concrete Strength Test.—Concrete materials may be submitted to the following test and shall be considered to pass the concrete strength test when the following strength requirements are fulfilled. In no case, however, shall aggregate be used which contains more than 3% of material removable by the elutriation test, nor shall coarse aggregate contain more than 1½% of clay or dust.

85.23. The coarse aggregate, fine aggregate, cement, and water proposed for use shall be mixed in the same proportions and to the same consistency that they are to be used in the work, and tested as prescribed in U. S. Department of Agriculture *Bulletin* 1216, and at least the following compression strengths shall be obtained, for the several classes:

Class	7-day Test	28-day Test
A	1300	2000
B	1000	1700
C	900	1500
D	1700	2500

85.24.—The seven-day requirements may be waived. The exact proportions may be varied, with the approval of the engineer, to obtain the strength desired and the new proportions used in the work, but the proportions of cement to total aggregate shall not be less than hereinafter prescribed, only such proportions shall be used as will produce a workable mixture, and no allowance shall be made the contractor for altered or additional work or material involved in the reportioning.

85.25. Hydrated Lime.—This material delivered to the work in the original packages may be used to an amount not exceeding 10% by volume of the Portland cement. Each package shall be clearly marked to show the brand, the net weight, the name of the manufacturer, and place of manufacture. It shall comply with the current specifications of the A.S.T.M.

85.26. For hand-mixed concrete the lime shall be well mixed while dry. It shall be considered as an additional material, not as replacing any cement.

The use of hydrated lime, unless otherwise specified, is optional with the contractor except that it shall not be used in concrete deposited under water, and no compensation for it will be allowed the contractor.

85.27. All sampling of materials shall be as required in U. S. Department of Agriculture *Bulletin* 1216. Cement shall be packed, shipped, stored, and inspected as prescribed in *Bulletin* 1216.

85.28. The method of storing and handling aggregate on the work shall be such as to avoid segregation of sizes, and mixture of the material with mud, dust, or trash. When deemed necessary, the engineer may order the use of platforms for the storage of coarse aggregate. Aggregate shipped in dirty cars or containers, or that becomes mixed with weeds, dirt, or foreign material or that is not uniform, or the component parts of which have become segregated, shall be rejected. Preferably, no aggregate shall be stored or dumped on the roadbed.

85.29. Construction Methods.—All equipment, tools, and machinery used for hauling materials and performing any part of the work must be approved by the engineer and must be maintained in satisfactory working condition.

85.30. Falsework for supporting concrete work shall be built on foundations of sufficient strength to carry the load without appreciable deformation. Falsework which cannot be founded on solid footings must be supported by ample falsework piling. Falsework shall be designed to carry the full loads coming upon it. For single-span bridges falsework shall be given a permanent camber equal to $\frac{1}{200}$ " per foot of clear span. Multiple-span bridges shall be given the amount of camber specified on the plans. In general, double wedges or other suitable means shall be provided for constructing falsework and forms to correct lines. On important structures, when requested by the engineer, the contractor shall submit plans for falsework and forms for checking and approving before the falsework is constructed. No extra compensation will be allowed for falsework.

85.31. Wood or metal forms shall be constructed of materials sufficient in strength to hold the concrete without bulging between supports. The material to be used in wood forms for exposed surfaces shall be sized and dressed lumber, free from knot holes, loose knots, cracks, splits, or other defects affecting its strength, the accuracy, or the appearance of the finished concrete surfaces, and in general shall be at least $1\frac{1}{2}$ " thick. Tongue and grooved material may be required by the engineer. If metal forms are used, all bolt and rivet holes shall be countersunk so that a plane, smooth surface will be obtained.

85.32. In designing forms and centering, the concrete shall be treated as a liquid weighing 150 lb. per cubic foot for vertical loads, and 85 lb. per cubic foot for horizontal pressure. The unsupported length of the wooden columns and compression members shall not exceed thirty times the diameter or least side.

85.33. Forms shall be so designed and constructed that they may be removed without injury to the concrete. Blocks and bracing shall be removed with the forms and in no case shall any portion of the wood forms be left in the concrete. Special attention shall be paid to the ties and bracing, and where the forms appear to be insufficiently braced, or unsatisfactorily built, either before or during construction, the engineer shall order the work to be stopped until the defects have been corrected to his satisfaction. If the forms bulge or sag at any point when the concrete is placed in them, the portion of concrete causing the distortion shall be immediately removed and the forms properly repaired and strengthened before continuing the work. The forms shall be so constructed that the finished concrete shall be of the form and dimensions as shown on the plans and true to line and grade.

85.34. Forms shall be filleted at all sharp corners and shall be given a bevel in the case of all projections, such as girders, copings, etc., sufficient to insure their easy removal.

85.35. To insure a first-class surface finish on the concrete, the forms shall be painted with a colorless oil, or some other satisfactory means taken to prevent the concrete adhering to them. The forms shall be thoroughly drenched with water immediately before the concrete is placed in them. They shall be inspected immediately preceding the placing of concrete, any bulging or warping shall be remedied, and all dirt, sawdust, shavings, or other débris within the forms shall be removed.

85.36. For narrow walls where access to the bottom of the forms is not readily attainable otherwise, the lower form boards shall be left loose so that they may be removed for cleaning out all chips, dirt, sawdust or other extraneous material immediately prior to placing concrete.

85.37. Form lumber which is used a second time shall be thoroughly cleaned and shall be free from bulge, splits, or warps.

85.38. Measuring Materials.—All materials shall be separately and accurately measured by volume, unless otherwise specified, and each batch shall be uniform. The coarse and fine aggregate shall be measured loose and separately. No computed change in volume for moisture content shall be considered. A bag of cement (American) as packed by the manufacturers and weighing 94 lb. shall be considered 1 cu. ft. The contractor shall furnish and use approved measuring boxes, pans, or mechanical devices, which in operation will give the exact volumes of coarse and fine aggregate required for the several classes of concrete required, and so designed and plainly marked that the inspector can accurately and conveniently check the quantities of each aggregate actually being used.

85.39. Consistency.—The quantity of water to be used shall be determined by the engineer, and not varied without his consent. The contractor shall furnish and use with the mixer an approved adjustable water-measuring device which will prevent excess water flowing into the mixer in order that the consistency may be under positive control, and all batches may be of the same consistency.

85.40. In general, the minimum amount of water shall be used which will produce the required workability. The mortar shall cling to the coarse aggregate, and shall show no free water when removed from the mixer. The concrete when being transported in a clean metal chute at an angle of 30° to the horizontal shall slide, and not flow, and when dropped directly from the discharge chute of the mixer, shall flatten out at the center of the pile, but shall stand up and not flow at the edges. The upper surface of the set concrete shall show a cement film upon the surface, but shall be free from laitance. In no case shall an amount of water be used sufficient to cause the collection of a surplus on the surface.

85.41. Mixing Conditions.—The concrete shall be mixed in the quantities required for immediate use and any which has developed initial set, or which is not in place within 30 min. after the water has been added, shall not be used. No concrete shall be mixed while the air temperature is at or below 35°F. without the approval of the engineer. Retempering of concrete or mortar will not be allowed.

85.42. Mixing.—The mixing shall be done in a batch-mixer of approved type which will insure the uniform distribution of the material throughout the mass so that the mixture is uniform in color and smooth in appearance. The mixing shall continue for a minimum time of 1½ min. after all the ingredients are assembled in the drum, during which time the drum shall revolve at the speed for which it was designed but shall make not less than 14 nor more than 20 r.p.m. The mixer shall be equipped with an attachment for satisfactorily locking the discharging device so as to prevent the emptying of the mixer until all the materials have been mixed together for the minimum time required. The entire contents of the drum shall be discharged before any materials are placed therein for the succeeding batch. The mixer shall be equipped with bucket and boom delivery unless otherwise permitted by the engineer, have a capacity of not less than three bags of cement per batch of concrete of the composition herein specified, and a speed regulator to hold the mixer to its normal speed of revolution.

85.43. Hand Mixing.—Hand mixing will not be allowed except with the specific permission of the engineer on very small jobs or in case of an emergency. When hand mixing is permitted it shall be done on a water-tight platform. The fine aggregate and cement, shall first be mixed until a uniform color is attained and then spread over the mixing board in a thin layer.

85.44. The coarse aggregate, which shall have been previously drenched, shall then be spread over the fine aggregate and cement in a uniform layer and the whole mass turned as the water is added.

85.45. After the water has been added, the mass shall be turned at least six times, and more if necessary, to make the mixture uniform in color and smooth in appearance. Hand-mixed batches shall not exceed ½ cu. yd. in volume.

85.46. Placing.—No concrete shall be poured in foundation until the engineer has approved the depth and character of the foundation, nor shall any concrete be poured in forms until the engineer has approved the placing of the steel.

85.47. The concrete shall be placed in the forms immediately after mixing and in such manner as to avoid the separation or segregation of the aggregate. The mixing plant shall be equipped and arranged so as to permit the mixing and placing of the concrete quickly and uniformly.

85.48. In depositing the concrete, care shall be taken to fill the form entirely, and to compact the concrete by continuous tamping, slicing, and spading, but not to bulge or distort the forms or to disturb their alignment. Any porous section shall be removed at the expense of the contractor.

85.49. When concrete is deposited through chutes, the angle of the same with the horizontal shall be such as will allow the concrete to slide slowly and without separation of the aggregate. The delivery from the spout shall be as close as possible to the point of deposit. Chutes shall preferably be of metal, but if of wood, metal lined, they shall be kept clean and free from material adhering to their sides and shall be thoroughly flushed with water before and after each run.

85.50. The use of long chutes will be allowed only with written permission of the engineer, and such permission will not be given for work which will be exposed to salt or brackish water.

85.51. Pipes when used shall be kept full of concrete, and the discharge end shall be kept buried in fresh concrete, and shall meet the requirements prescribed for tremies.

85.52. Depositing large quantities at one point in the forms, and running and working it along the forms, will not be permitted. Special care shall be taken, in filling the forms, to work the coarser aggregate away from the face of the forms and to force the concrete under and around the reinforcement. The concrete shall be worked with a steel slicing rod, or other satisfactory implement, in such a manner as to bring a thick layer of mortar in contact with the forms and reinforcement, and to prevent the formation of pockets of stone.

85.53. All faces shall be spaded. Portions inaccessible to slicing rod or spade shall be worked by vibrating the forms by wooden mallets or as directed by the engineer. After the concrete has taken its initial set, care shall be exercised to prevent walking on the concrete, to avoid jarring the forms or knocking or straining projecting reinforcement.

85.54. Concrete shall be placed in continuous horizontal layers, in general not over 1' in thickness. When a monolithic layer cannot be completed in one operation, it shall be terminated with a vertical bulkhead. No feathering out will be tolerated. The batches of concrete shall follow the preceding batch closely before any initial set can take place in order to prevent lines of demarcation between batches. Successive horizontal layers shall be bonded to each other. The surface of each layer shall be left rough or other provision for bonding made as required.

85.55. Joints.—Joints may be constructed joints or expansion joints of either the sliding or filled type.

85.56. Construction Joints.—Wherever the work of placing concrete is delayed until the concrete shall have taken its initial set, the point of stopping shall be deemed a construction joint. So far as possible the location of construction joints shall be planned in advance and the placing of concrete carried continuously from joint to joint. These joints shall be perpendicular to the principal lines of stress and, in general, shall be located at points of minimum shear.

85.57. Where dowels, reinforcing bars, or other adequate ties are not shown on the plans or required by the engineer, keys shall be made by imbedding water-soaked beveled timbers of a size shown on the details, or as directed by the engineer, in the soft concrete, which shall be removed when the concrete has set. In resuming work, the surface of the concrete previously placed shall be thoroughly cleaned of dirt, scum, laitance, or other soft material, with stiff wire brushes, and if deemed necessary by the engineer, shall be roughened with a steel tool. The surface shall then be thoroughly washed with clean water and painted with a thick coat of neat cement mortar, after which the placing of concrete may proceed.

85.58. No concrete work shall be stopped or temporarily discontinued within 18" of the top of any finished surface, unless such work is finished with a coping having a thickness less than 18", in which case the joint shall be made at the under line of the coping.

85.59. In construction joints exposed to view where seepage of water is particularly objectionable, a metal baffle strip, preferably of copper, zinc, or sheet lead, shall be inserted. The strip shall be placed not less than 3" from the face of the concrete and shall extend into each section of the concrete a distance of not less than 2".

85.60. Sliding joints shall be constructed as provided at ends of slabs, girders, or beams or between walls, etc. The surface of the supporting concrete shall be given a smooth finish and covered with two layers of three-

ply roofing felt or other material as prescribed to separate the concrete. All metal sliding surfaces shall be coated with graphite and grease just before being placed in position, and care shall be exercised to prevent any deposit of concrete which will interfere with the sliding action.

85.61. Concreting in Cold Weather.—No concrete shall be placed when the atmospheric temperature is below 35°F. unless permission to do so is granted in writing by the engineer. When such permission is given, the following requirements shall govern:

85.62. The contractor shall furnish sufficient canvas and framework, or other type of housing to enclose and protect the structure in such a way that the air surrounding the fresh concrete can be kept at a temperature of not less than 45°F. for a period of 5 days after the concrete is placed.

85.63. Sufficient heating apparatus, such as stoves, salamanders, or steam equipment, and fuel to furnish all required heat, shall be supplied. All water used for mixing concrete shall be heated to a temperature of at least 70, but not over 150°F. Aggregates shall be heated either by steam or by dry heat to a temperature of at least 70, but not over 150°F. The heating apparatus shall be such as to heat the mass uniformly and preclude the possibility of the occurrence of hot spots which will burn the material. The temperature of the mixed concrete shall not be less than 60°F. at the time of placing in the forms.

85.64. The contractor shall assume all risk connected with the placing of concrete during freezing weather, and permission given by the engineer to place concrete during such time will in no way relieve the contractor of responsibility for satisfactory results. Should concrete placed under such conditions prove unsatisfactory, it shall be rejected. It is understood that the contractor is responsible for the quality and strength of concrete placed under any and all weather conditions.

85.65. Depositing in Water.—Concrete shall be deposited in water only with the permission of the engineer and under his supervision. It shall be Class A concrete with 10% of excess cement. The cofferdams shall be sufficiently tight to prevent any current passing through the space in which the concrete is to be deposited. Pumping will not be permitted in the cofferdams while the concrete is being placed, nor until it has reached its initial set.

85.66. When depositing in water is allowed, the concrete shall be carefully placed in the space in which it is to remain in a compact mass by means of a tremie, closed-bottom dumping bucket, or other approved method that does not permit the concrete to fall through the water without adequate protection. The concrete shall not be disturbed after being deposited. No concrete shall be placed in running water, and forms which are not reasonably water-tight shall not be used for holding concrete deposited under water. Depositing shall be regulated to produce approximately horizontal surfaces.

85.67. When a tremie is used, it shall consist of a tube having a diameter of not less than 10", constructed in sections having flanged couplings fitted with gaskets. The means of supporting the tremie shall be such as to permit the free movement of the discharge end over the entire top surface of the work and shall be such as to permit it to be rapidly lowered when necessary to choke off or retard the flow. The discharge end shall be entirely sealed at all times and the tremie tube kept full to the bottom of the hopper. When a batch is dumped into the hopper the tremie shall be slightly raised, but not out of the concrete at the bottom, until the batch discharges to the bottom of the hopper. The flow is then stopped by lowering the tremie. The flow shall be continuous and in no case shall be interrupted until the work is complete.

85.68. When concrete is placed by means of a bottom-dump bucket, the bucket shall have a capacity of not less than $\frac{1}{4}$ cu. yd. The bucket shall be lowered gradually and carefully until it rests upon the concrete already placed. It shall then be raised very slowly during the discharge travel, the intent being to maintain, as nearly as possible, still water at the point of discharge and to avoid agitating the mixture.

85.69. Rubble or Cyclopean Concrete.—Rubble or cyclopean concrete shall consist of either Class B or Class C concrete, in which is imbedded large individual stones in accordance with the following requirements:

85.70. This class of concrete shall be used only in massive piers, gravity abutments, and heavy footings and only with the approval of the engineer.

85.71. The stone for this class of work shall be of the quality required for coarse aggregate, and may be one-man stone or derrick stone as specified hereinbelow.

85.72. The stone shall be carefully placed (not dropped or cast) and the method of placing shall be such as to avoid injury to the forms or to the partially set adjacent masonry. Stratified stone shall be placed upon its natural bed. All stone shall be thoroughly saturated with water before being placed.

85.73. The total volume of the stone used shall not be greater than one-third of the total volume of the portion of the work in which it is placed.

85.74. For walls or piers greater than 2' in thickness, one-man stone may be used. Each stone shall be completely surrounded by a layer of concrete not less than 6" in thickness. No stone shall extend above a point 1' below the top surface of any wall or pier nor shall it extend within less than 8" of any coping.

85.75. For walls or piers greater than 4' in thickness derrick stone may be used. Each stone shall be completely surrounded by a layer of concrete not less than 1' in thickness. No stone shall extend above a point of 2' below the top surface of any wall or pier nor shall it extend within less than 8" of any coping.

85.76. Concrete Exposed to Sea Water.—For concrete exposed to the action of sea water, the following requirements shall govern:

85.77. Concrete for walls 2 feet or less in thickness shall be mixed in the proportions specified for Class A concrete with 10% additional cement. For mass walls, that portion of the surface exposed to the action of salt water and for a distance of at least 2' inward from the exterior of the mass shall be constructed as above specified, while the interior of the mass may be constructed of concrete as specified on the plans and mixed in the ordinary manner. The original surface as the concrete comes from the forms shall be left undisturbed. In order to secure a thick and dense surface film, the form surfaces shall be heavily coated with shellac or an approved form oil. No construction joints shall be located between points 2' below extreme low water and 4' above extreme high water.

85.78. In general, reinforced concrete shall not be used in sea water. However, when it is used, the reinforcement shall be placed as far from the surface as is consistent with the design and shall be proportioned to withstand a stress of not more than three-fourths of the allowable stress. The minimum clear distance from the face of the concrete to the nearest face of any reinforcing bar shall in no case be less than 5" except in precast concrete piles, where a 3" minimum may be used.

85.79. Concrete exposed to the action of drift or to impact and abrasion from any cause shall be protected by encasing that portion of the surface, extending from an elevation at least 4' above high tide to an elevation 4' below low tide, with a special sheathing or protective armor as shown on the plans or noted in the supplemental specifications, and provision shall be made in the size of the original cofferdam for sufficient clearance to permit access to the masonry surface for the installation and effective anchorage of this sheathing.

85.80. The protective armor above noted may be of metal plates, a vitrified brick, or dense stone facing, a dense mortar facing placed simultaneously with the interior of the wall by means of baffle plates, treated timber sheathing, or other approved construction.

85.81. When so specified, the cofferdam may be constructed above the mud line with treated material and left permanently in place. In this case, the space between the neat masonry lines and the interior of the cofferdam shall be filled with waterproof material.

85.82. Concrete between the tide limits above specified shall not, in any case, be deposited in sea water. In no case shall fresh concrete within those limits be exposed to the action of sea water nor shall salt water be allowed to come in contact with the concrete until it shall have been allowed to set for at least 30 days and preferably for a longer period.

85.83. Concrete piles when used in alkali soils shall, unless otherwise specified, be subject to the same requirements as are provided hereinabove for concrete piles in sea water.

85.84. Concrete Exposed to Alkali Soils or Water.—In general, the same requirements as above specified for concrete in sea water shall govern the construction of concrete in alkali soils or water. When so specified, the forms below the ground line may be constructed of treated timber, waterproofed with a brush coating of a suitable bituminous material, and left permanently in place. In lieu of the above, the surface of the concrete below ground may be treated with an approved system of membrane waterproofing or may be protected by a sheathing of suitable design. Concrete shall not be allowed to come in contact with alkali soil or water until it

shall have been allowed to set for at least 30 days and for a longer period if possible. No construction joints shall be permitted below an elevation of 2' above the ground line. The surface film shall be left intact as it comes from the forms. To secure a heavy and dense surface film, the form surfaces shall be heavily coated with shellac or an approved form oil. The soil around footings placed in alkali soil shall be thoroughly and effectively drained to avoid a concentration of salts at or around the footings.

85.85. Removal of Forms.—In order to make possible the obtaining of a satisfactory surface finish, forms on ornamental work, railings, parapets, and exposed vertical surfaces shall be removed in not less than 12 nor more than 48 hr., depending upon weather conditions. Forms shall always be removed from columns before removing shoring from beneath beams or girders, in order to determine the condition of concrete in the columns.

85.86. The following table shall serve as a guide for the minimum time required before the removal of forms, not counting the days in which the temperature is below 40°F.:

Centering under beams.....	28 days
Floor slabs.....	14 to 28 days
Walls.....	7 days
Columns.....	10 days
The sides of beams, and all other parts.....	7 days

85.87. No forms whatever shall be removed at any time without the consent of the engineer. Such consent shall not relieve the contractor of responsibility for the safety of the work. As soon as the forms are removed all bolts, wires, or other appliances which hold the forms and which pass through the concrete shall be cut off or set back 1" below the surface. All rough places, holes, and porous spots shall be filled with mortar composed of 1 part Portland cement to 2 parts sand.

85.88. Defective Work.—Any defective work discovered, after the forms have been removed, shall be removed immediately and renewed. If the surface of the concrete is bulged, uneven, or shows excess honeycombing or form marks, which in the opinion of the engineer cannot be repaired satisfactorily, the entire section shall be removed and renewed, and no compensation will be allowed for the work or material.

85.89. Curing Concrete.—Careful attention shall be given by the contractor to the proper curing of concrete hand rails, floors, and finished surfaces. Such surfaces shall be protected from the sun and the whole structure shall be kept wet for a period of at least 7 days. All concrete floors shall be covered as soon as possible with sand, earth, or other suitable material and kept thoroughly moistened for a period of at least 10 days by sprinkling each morning and evening, or more frequently if deemed necessary by the engineer. The covering material shall not be cleared from the surface of the concrete floor for a period of at least 28 days.

85.90. Unless otherwise permitted by the engineer, concrete bridge floors shall be closed to traffic for a period of at least 21 days after placing, and for such additional time as it may be deemed advisable.

85.91. Finish.—The external surface of concrete shall be given one of the following finishes as required on plans:

85.92. Class 1. Surface Finish.—As soon as the pointing has set sufficiently to permit it, the entire surface shall be thoroughly wet with a brush and rubbed with a No. 16 carborundum stone or an abrasive of equal quality, bringing the surface to a paste. The rubbing shall be continued sufficiently to remove all form marks and projections, producing a smooth, dense surface without pits or irregularities.

85.93. The material which, in the above process, has been ground to a paste shall be carefully spread or brushed uniformly over the entire surface and allowed to take a "reset." The final finish shall be obtained by a thorough rubbing with a No. 30 carborundum stone or an abrasive of equal quality. This rubbing shall continue until the entire surface is of a smooth texture and uniform in color.

85.94. After the final rubbing is completed, the surface shall be thoroughly drenched and kept wet for a period of 7 days, unless otherwise directed.

85.95. Railing balusters and other precast members which have been disfigured by the drip from the abrasive shall be thoroughly cleaned by means of a dilute solution of muriatic acid.

85.96. Class 2. Surface Finish.—After the pointing has set sufficiently to permit it, the entire surface shall be thoroughly wetted and rubbed with

a No. 16 carborundum stone or an abrasive of equal quality to bring the surface to a smooth texture and remove all form marks. The paste formed by the rubbing as above described may be finished by carefully stripping with a clean brush, or it may be spread uniformly over the surface and allowed to take a "reset," after which it may be finished by floating with a canvas, carpet-faced, or cork float or rubbed down with dry burlap.

85.97. Treatment and Finish for Horizontal Surfaces Not Subjected to Wear.—All upper horizontal surfaces such as the tops of hand-rail posts and caps and the tops of parapets, copings, and bridge seats shall be formed by placing an excess of material in the forms and removing or striking off such excess with a wooden templet, forcing the coarse aggregate below the mortar surface. The use of mortar topping for concrete railing caps and other surfaces falling under this classification shall in no case be permitted.

85.98. The final finish for caps and railings shall be obtained in one of the following ways:

85.99. a. Brush Finish.—After the concrete has been struck off, as above described, the surface shall be thoroughly worked and floated with a wooden, canvas, or cork float, the operation to be performed by skilled and experienced concrete finishers. Before this last finish has set, the surface shall be lightly striped with a fine brush to remove the surface cement film, leaving a fine-grained, smooth, but sanded texture.

85.100. b. Float Finish.—In lieu of the above, the surface may be finished with a rough carpet float or other suitable device, leaving the surface even, but distinctly sandy or pebbled in texture.

85.101. c. Ground or Terrazzo Finish.—When specified, the upper surface or rail caps, parapets, etc., may be finished by grinding with a carborundum stone, or equally good abrasive, to a smooth, dense, terrazzo finish. Finish of this character shall be done as follows:

85.102. Using a No. 16 carborundum stone or an abrasive of equal quality, the surface shall be ground dry or in water until it is smooth and the individual pebbles and aggregate particles are cut and polished. The surface shall then be completely cleansed with water, and the final rubbing done by means of a No. 30 stone. The finished surface shall present the texture of polished marble and shall show the various aggregate particles in polished outline.

85.103. d. Other Types.—Special types of rail cap finish, such as "tooled finish," "sand-blasted finish," etc., shall be done in accordance with the general requirements governing Special Surface Finishes, as hereinafter provided.

85.104. Special Surface Finishes.—When so specified, special surface finishes may be employed for ornamental panels, coping, and like construction. In general, the method and manner of performing this work will be fully provided for in the special provisions for the particular work in question.

85.105. In each case the contractor shall be required to prepare test or sample panels under the direction of the engineer, and the method and manner of finish, the choice and selection of the aggregate, and other features affecting the work shall be approved before any further work is done.

85.106. Following are typical general requirements for the principal types of special surface finishes:

85.107. Tooled Finish.—Finish of this character for panels and other like work may be secured by the use of a bush hammer, pick, crandall, or other approved tool. Air tools shall preferably be employed. No tooling shall be done until the concrete has set for at least 14 days and as much longer as may be necessary to prevent the aggregate particles from being "picked" out of the surface. The finished surface shall show a grouping of broken aggregate particles in a matrix of mortar, each aggregate particle being in slight relief.

85.108. Sand-blast Finish.—The type of finish required in this method shall be similar to that above described for tooled finish, but finer grained in texture. The sand blasting must be done by means of approved equipment and in such manner as to produce an even, fine-grained surface in which the mortar has been cut away, leaving the aggregate particles exposed.

85.109. Wire-brush or Scrubbed Finish.—This type of finish shall be produced by scrubbing the surface of a green concrete with stiff wire or fiber brushes, using a solution of muriatic acid in the proportion of 1 part acid to 4 parts water. As soon as the forms are removed and while the concrete is yet comparatively green, the surface shall be thoroughly and evenly scrubbed as above described until the cement film or surface is completely removed and the aggregate particles are exposed, leaving an even-pebbled texture

presenting an appearance grading from that of fine granite to coarse conglomerate, depending upon the size and grading of aggregate used. Granite chips or colored aggregates may be used in this connection if desired. As soon as the scrubbing has progressed sufficiently to produce the texture desired, the entire surface shall be thoroughly washed with water, to which a small amount of ammonia has been added, to remove all traces of the acid.

85.110. Methods of Measurement.—All concrete conforming to the specification and plans and placed as directed shall be measured by the cubic yard in place. In computing the concrete yardage for payment, the dimensions used shall be those shown on plans or ordered in writing by the engineer. No measurements or other allowances shall be made for work or material for forms, falsework, cofferdams, pumping, bracing, etc. No deductions in measurement shall be made for paneling less than 6" in width.

85.111. Basis of Payment.—Payment shall be made for the yardage of accepted concrete measured as prescribed above at the contract unit price bid per cubic yard for Class A, Class B, Class C, or Class D concrete, as the case may be. Such payment shall be full compensation for all materials, forms, falsework, placing, and finishing, all equipment, tools, labor, and incidentals necessary to complete the item, except that steel reinforcement shall be paid for as a separate item.

Item 82. Steel Structures¹

82.1. Description.—All steel structures shall be built as indicated on the plans, conforming to line, grade, dimensions, and design shown, and in accordance with the specifications for piling, concrete, masonry, structural steel, and other pay items which are to constitute the complete structure, and in conformity with such specifications prescribed under concrete bridges as are involved.

82.2. Materials and construction methods used shall be those prescribed for the several items which are to constitute the structure and in addition shall conform to the following requirements:

FABRICATION

82.3. All deformed structural material shall be properly straightened by methods which are non-injurious, prior to being laid off, punched, or otherwise worked in the shop. Sharp kinks and bends shall be cause for rejection.

82.4. The workmanship and finish shall be first class and equal to the best practice in modern bridge shops. Shearing and chipping shall be neatly and accurately done, and all portions of the work exposed to view shall be neatly finished. No changes shall be made in any drawing after it has been approved except by the consent or direction of the engineer in writing. Substitutions of sections having different dimensions from those shown on the plans shall be made only when approved in writing by the engineer.

82.5. Rivet Holes.—When general reaming is not required, holes in material $\frac{3}{4}$ " or less in thickness may be punched full size. Holes in material more than $\frac{3}{4}$ " in thickness shall be subpunched and reamed, or drilled from the solid.

82.6. Punched Holes.—Full-size punched holes shall be $\frac{1}{16}$ " larger than the nominal diameter of the rivet. The diameter of the die shall not exceed the diameter of the punch by more than $\frac{1}{32}$ ". Holes must be clean cut, without torn or ragged edges. If any holes must be enlarged to admit the rivets, they shall be reamed.

82.7. Accuracy of Punched Holes.—The punching of holes shall be so accurately done that after assembling the component parts of a member, a cylindrical pin $\frac{1}{8}$ " smaller than the nominal diameter of the punched hole may be passed through at least 75 of any group of 100 contiguous holes in the same surface or in like proportions for any group of holes. If this requirement is not fulfilled, the badly punched pieces shall be rejected. If any holes will not pass a pin $\frac{1}{16}$ " smaller than the nominal diameter of the punched hole, this shall be cause for rejection.

82.8. Drilled Holes.—Drilled holes shall be $\frac{1}{16}$ " larger than the nominal diameter of the rivet. Burrs on the outside surfaces shall be removed with a tool producing a $\frac{1}{16}$ " fillet around the edge of the hole.

82.9. Subpunched and Reamed Holes.—Subpunched and reamed holes shall be punched $\frac{1}{16}$ " smaller than the nominal diameter of the rivet and shall then be reamed to a diameter $\frac{1}{16}$ " larger than the nominal diameter of

¹ Texas.

the rivet. The punch and die shall have the same relative sizes as specified for full-size punched holes. Burrs produced by reaming shall be removed with a tool producing a $\frac{1}{16}$ " fillet around the edge of the hole.

82.10. Reaming of rivet holes shall be done with twist drills or with short taper reamers. Reamers preferably shall not be directed by hand. No oil or grease shall be used as a lubricant.

82.11. Accuracy of Reamed and Drilled Holes.—Reamed or drilled holes shall be cylindrical and perpendicular to the member and their accuracy shall be the same as specified for punched holes except that after reaming or drilling 85 of any group of 100 contiguous holes in the same surface, or in like proportion for any group of holes, shall not show an offset greater than $\frac{1}{32}$ " between adjacent thicknesses of metal.

82.12. Drifting of Holes.—The drifting done during assembling shall be only such as to bring the parts into position and not sufficient to enlarge the holes or distort the metal.

82.13. General Reaming.—General reaming may be required, in which case a definite provision to this effect shall be included elsewhere in the contract.

82.14. When general reaming is required, all rivet holes in main members shall be subpunched and reamed or drilled from the solid. This requirement shall not apply to rivet holes in top and bottom chord lateral members, lateral hangers, truss and girder sway bracings, and to the lateral plates, connection angles, etc., connecting these members to the main member of the structure. Connection plates or other parts acting both as main member material and secondary (lateral sway bracing, etc.) member material shall generally have subpunched and reamed holes in locations engaging similar holes in main members.

82.15. Reaming shall be done after the pieces forming a built member are assembled and firmly bolted together. No interchange of reamed parts will be permitted.

82.16. Field Connections.—When general reaming is required, or in punched work when specifically required by the engineer, holes for field connections, except those in lateral, longitudinal and sway bracing, shall be reamed or drilled. Riveted trusses shall be assembled in the shop, the parts adjusted to line and fit, and the holes for field connections reamed or drilled while so assembled. Holes for other field connections shall be reamed or drilled with the connecting parts assembled, or else reamed or drilled to a metal template not less than 1" thick.

82.17. Shop Assembling.—All surfaces of metal to be in contact when assembled shall be carefully painted with one coat of the paint specified for the shop coat. The paint shall be applied upon surfaces free from dirt, loose mill scale, or other foreign matter and the parts shall be assembled while the paint is plastic.

82.18. The component parts of a built member shall be assembled, drift pinned to prevent lateral movement, and firmly bolted to draw the parts into close contact before reaming, drilling, or riveting is begun. Assembled parts shall be taken apart, if necessary, for the removal of burrs and shavings produced by the reaming operation.

82.19. The member shall be free from twists, bends, or other deformations.

82.20. Preparatory to shop riveting full-size punched material, the rivet holes shall be cleared for the admission of the rivets by reaming.

82.21. End connection angles, stiffener angles, etc. shall be carefully adjusted to correct locations and rigidly bolted, clamped or otherwise firmly held in place until riveted.

82.22. Match Marking.—Connecting parts assembled in the shop for the purpose of reaming or drilling holes in field connections shall be match marked, and a diagram showing such marks shall be furnished to the engineer.

82.23. Rivets.—The diameter of rivets indicated upon the plans shall be understood to mean their diameter before heating.

82.24. Heads of driven rivets shall be of approved shape, concentric with the shanks, true to size, full, neatly formed, free from fins, and in full contact with the surface of the member.

82.25. Field Rivets.—Field rivets, for each size and length, shall be supplied in excess of the actual number to be driven to provide for losses due to misuse, improper driving, or other contingencies. Rivets shall be free from furnace scale on their shanks, and from fins on the under side of the machine-formed heads.

82.26. Bolts and Bolted Connections.—Bolted connections shall not be used unless specifically authorized. Where bolted connections are permitted,

the bolts furnished shall be unfinished bolts (ordinary rough or machine bolts), or turned bolts, as specified or directed by the engineer.

82.27. Unfinished Bolts.—Unfinished bolts shall be standard bolts with hexagonal heads and nuts. The use of "button-head" bolts will not be permitted. Bolts transmitting shear shall be threaded to such a length that not more than one thread will be within the grip of the metal. The bolts will be of lengths which will extend entirely through their nuts but not more than $\frac{1}{4}$ " beyond. The diameter of the bolt holes shall be $\frac{1}{16}$ " greater than the diameter of the bolts used.

82.28. Turned Bolts.—Holes for turned bolts shall be carefully reamed or drilled and the bolts turned to a driving fit by being given a finishing cut. The threads shall be entirely outside of the holes and the heads and nuts shall be hexagonal. Approved nut locks shall be used on all bolts unless permission to the contrary is secured from the engineer. When nut locks are not used, round washers having a thickness of $\frac{1}{8}$ " shall be placed under the nuts.

82.29. Riveting.—Rivets shall be heated uniformly to a light cherry red color and shall be driven while hot. The heating of the points of rivets more than the remainder will not be permitted. When ready for driving, they shall be free from slag, scale, and other adhering matter, and when driven, they shall completely fill the holes. Burned, burred, or otherwise defective rivets, or rivets which throw off sparks when taken from the furnace or forge, shall not be driven.

82.30. Loose, burned, badly formed or otherwise defective rivets shall be cut out. Calking and recupping of rivets heads will not be allowed. In cutting out defective rivets, care shall be taken not to injure the adjacent metal, and if necessary, the rivet shank shall be removed by drilling.

82.31. Countersinking shall be neatly done and countersunk rivets shall completely fill the holes.

82.32. Shop rivets shall be driven by direct-acting riveters where practicable. The riveting machine shall retain the pressure for a short time after the upsetting is complete.

82.33. Pneumatic hammers shall be used for field riveting except when the use of other hand tools for riveting is permitted by the engineer.

82.34. Edge Planing.—Sheared edges of material more than $\frac{5}{8}$ " in thickness shall, when required by the engineer, be planed to a depth of not less than $\frac{1}{8}$ ". Reentrant cuts shall be filleted before cutting.

82.35. Planing of Bearing Surfaces.—Ends of columns taking bearing upon base and cap plates shall be milled to true surfaces and correct bevels after the main section of these members and the end connection angles have been fully riveted.

82.36. Caps and base plates of columns and the sole plates of girders and trusses shall have full contact when assembled. The plates, if warped or deformed, shall be hot-straightened, planed, and otherwise treated to secure an accurate, uniform contact. After being riveted in place, the excess metal of countersunk rivet heads shall be chipped smooth and flush with the surrounding metal and the surfaces which are to come in contact with other metal surfaces shall be planed or milled, if necessary, to secure proper contact. Correspondingly, the surfaces of base and sole plates which are to come in contact with masonry shall be rough finished, if not free from warps or other deformations.

82.37. Surfaces of cast pedestals and shoes which are to come in contact with metal surfaces shall be planed and those which are to take bearing upon the masonry shall be rough finished.

82.38. In planing the surfaces of expansion bearings, the cut of the tool shall be in the direction of expansion.

82.39. Surfaces of bronze bearing plates intended for sliding contact shall be carefully milled and polish finished.

82.40. Abutting Joints.—Abutting ends of compression members shall, after being riveted, be accurately faced to secure an even bearing when assembled in the structure.

82.41. Ends of tension members at splices shall be rough finished to secure close and neat but not contact-fitting joints.

82.42. End Connection Angles.—End connection angles of floor beams and stringers shall be flush with each other and accurately set as to position and length of member. In general, end connection angles shall not be finished unless required by the terms of the contract. However, faulty assembling and riveting may be cause for requiring them to be milled, in which case their thickness shall be reduced not to exceed $\frac{1}{4}$ " nor shall their rivet-bearing value be reduced below design requirements.

82.43. Built Members.—The several pieces forming one built member shall be straight and close fitting. Such members shall be true to detailed dimensions and free from twists, bends, open joints, or other defects resulting from faulty fabrication and workmanship.

82.44. Lacing Bars.—The ends of lacing bars shall be neatly rounded unless otherwise indicated.

82.45. Web Plates.—Web plates of girders having no cover plates may be detailed with the top edge of the web flush with the backs of the flange angles. Any portion of the plate projecting beyond the angles shall be chipped flush with the backs of the angles. Web plates of girders having cover plates may be $\frac{1}{2}$ " less in width than the distance back to back of flange angles.

82.46. When web plates are spliced not more than $\frac{3}{8}$ " clearance between ends of plates will be allowed.

82.47. Web Stiffeners.—End stiffener angles of girders and stiffener angles intended as supports for concentrated loads shall be milled or ground to secure a uniform even bearing against the flange angles. Intermediate stiffener angles shall fit sufficiently tight to exclude water after being painted.

82.48. Web Splices and Fillers.—Web splice plates and fillers under stiffeners shall fit within $\frac{1}{8}$ " at each end.

82.49. Eyebars.—Eyebars shall be straight and true to size, and shall be free from twists, folds in the neck or head, or any other defect affecting their service strength. Heads shall be made by upsetting, rolling, or forging. Welds in the body portions or in the heads of bars will not be permitted. The form of the heads may be determined by the dies in use at the works where the eyebars are to be made, if satisfactory to the engineer. The thickness of head and neck shall not overrun more than $\frac{1}{16}$ ".

82.50. Boring.—Before boring, each eyebar shall be properly annealed and carefully straightened. Pin holes shall be located on the center line of the bar and in the centers of the heads. The holes in the ends of the bars shall be bored simultaneously and shall be so accurately located that when the bars of the same truss panels are placed in a pile, the pins may be completely inserted in the pin holes without driving. All eyebars intended for the same location in the trusses shall be interchangeable.

82.51. Annealing.—All eyebars shall be annealed by heating uniformly to the proper temperature followed by slow and uniform cooling in the furnace. The temperature of the bars shall be under full control at all stages.

82.52. Forged pins and other steel parts requiring their full strength which have been partially heated shall be subsequently annealed. Slight bends in pieces of secondary importance may be made without heating the metal. Crimped web stiffeners need not be annealed.

82.53. Pins and Rollers.—Pins and rollers shall be accurately turned to detailed dimensions and shall be smooth, straight, and free from flaws. The final surface shall be produced by a finishing cut.

82.54. Forged Pins.—Pins having a diameter greater than 6" shall be forged and annealed.

82.55. Border Pins.—Pins larger than 8" in diameter shall have a hole not less than 2" in diameter bored longitudinally through their centers. Pins showing defective interior conditions shall be rejected.

82.56. Boring Pin Holes.—Pin holes shall be bored true to detailed dimensions, smooth, and straight; at right angles with the axis of the member and parallel with each other unless otherwise required. A finishing cut shall always be made.

82.57. The length outside to outside of holes in tension members and inside to inside of holes in compression members shall not vary from detailed dimensions more than $\frac{1}{32}$ ". Boring of holes in built-up members shall be done after the riveting is completed.

82.58. Pin Clearances.—The difference in diameter between the pin and the pin hole shall be not more than $\frac{1}{32}$ ".

82.59. Welds.—Welding of steel shall not be permitted except to remedy minor defects, and then only with the approval of the engineer.

82.60. Screw Threads.—Screw threads shall make close fits in the nuts and shall be U. S. Standard except that for diameters greater than $1\frac{1}{2}$ ", they shall be made with six threads to the inch.

82.61. Pilot and Driving Nuts.—Two pilot nuts and two driving nuts shall be furnished for each size of pin, unless otherwise specified.

MILL AND SHOP INSPECTION

82.62. Notice of Rolling and Fabrication.—The contractor shall give ample notice to the engineer of the beginning of work at the mill and shop.

so that inspection may be provided. No material shall be rolled or fabricated before the engineer has been notified where the orders have been placed.

82.63. Facilities for Inspection.—The contractor shall furnish all facilities for the inspection of material and workmanship in the mill and shop and inspectors shall be allowed free access to the necessary parts of the premises.

82.64. Inspector's Authority.—The inspector shall have the power to reject materials or workmanship which do not fulfil the requirements of these specifications; but in cases of dispute the contractor may appeal to the engineer, whose decision shall be final.

82.65. Inspection at the mill and shop is intended as a means of facilitating the work and avoiding errors, and it is expressly understood that it will not relieve the contractor from any responsibility in regard to imperfect material or workmanship and the necessity for replacing same.

82.66. Mill Orders and Shipping Statements.—The contractor shall furnish the engineer with as many copies of mill orders and shipping statements as the engineer may direct. The weights of the individual members shall be shown.

82.67. Cost of Testing.—Unless otherwise provided, the contractor shall furnish, without charge, test specimens as specified herein, and all labor, testing machines, and tools necessary to prepare the specimens and to make the full-sized tests.

82.68. Rejections.—The acceptance of any material or finished members by the inspector shall not be a bar to their subsequent rejection, if found defective. Rejected material and workmanship shall be replaced promptly or made good by the contractor.

82.69. Marking and Shipping.—Members weighing more than 3 tons shall have the weight marked thereon. Bolts and rivets of one length and diameter and loose nuts or washers of each size shall be packed separately. Pins, small parts, and small packages of bolts, rivets, washers, and nuts shall be shipped in boxes, crates, kegs, or barrels, but the gross weight of any package shall not exceed 300 lb. A list and description of the contained material shall be plainly marked on the outside of each shipping container.

82.70. The weight of all tools and erection material shall be kept separate.

82.71. Anchor bolts, washers, and other anchorage or grillage materials shall be shipped to suit the requirements of the masonry construction.

82.72. Loading and Unloading.—The loading, transportation, unloading, and piling of structural material shall be so conducted that the metal will be kept clean and free from injury by rough handling.

ERECTION

82.73. Field Inspection.—All work of erection shall be subject to the inspection of the engineer who shall be given all facilities required for a thorough inspection of workmanship.

82.74. Material and workmanship not previously inspected will be inspected after its delivery to the site of the work.

82.75. Storage.—All material shall be stored in such manner as to prevent deterioration by rust or loss of minor parts. No material shall be piled so as to rest upon the ground or in water, but must be placed on suitable skids or platforms.

82.76. Preparation of Bearing Area.—Column bases, truss and girder pedestals, and shoes shall have a full and uniform bearing upon the substructure masonry. Masonry bearing plates shall not be placed upon the bridge-seat areas of piers or abutments which are improperly formed or irregular.

82.77. The shoes and pedestals of truss and girder spans, the bases of columns, and the center and end bearings of swing spans shall be rigidly and permanently located to correct alignments and elevations. Unless otherwise provided, they shall be placed on a layer of canvas and red lead applied as follows:

82.78. Thoroughly swab the top surface of the bridge-seat bearing area with red lead paint and place upon it three layers of 12- to 14-oz. duck, each layer being thoroughly swabbed on its top surface with red-lead paint. Place the superstructure shoes or pedestals in position while the paint is plastic.

82.79. Handling Members.—The field assembling of the component parts of a structure shall involve the use of methods and appliances not likely to produce injury by twisting, bending, or otherwise deforming the metal. No member slightly bent or twisted shall be put in place until its defects are corrected, and members seriously damaged in handling shall be rejected.

82.80. Alignment.—Before beginning the field riveting, the structure shall be adjusted to correct grade and alignment and the elevation of panel points

(ends of floorbeams) properly regulated. For truss spans a slight excess camber will be permitted while the bottom chords are being riveted, but the correct camber and relative elevations of panel points shall be secured before riveting the top chord joints, top lateral system and sway bracing.

82.81. Straightening Bent Materials.—The straightening of bent edges of plates, angles, and other shapes shall be done by methods not likely to produce fracture or other injury. The metal shall not be heated unless permitted by the engineer, in which case the heating shall not be to a higher temperature than that producing a dark cherry-red color. After heating, the metal shall be cooled as slowly as possible.

82.82. Following the completion of the straightening of a bend or buckle, the surface of the metal shall be carefully inspected for evidence of incipient or other fractures.

82.83. Assembling and Riveting.—All field connections and splices shall be securely drift pinned and bolted before riveting. Important connections in trusses, girders, floor system, etc. shall have at least 50% of the holes filled. An ample number of drift pins shall be used to prevent slipping at joints and splices.

82.84. The results obtained in the field assembling and riveting of the members of a structure shall conform to the requirements for shop assembling and riveting. Field-driven rivets shall be inspected and accepted before being painted.

82.85. Field riveting shall be done before the falsework is removed unless special permission to the contrary is given by the engineer.

82.86. Railings shall not be riveted until the falsework has been removed.

82.87. Adjustment of Pin Nuts.—All nuts on pins shall be thoroughly tightened and the pins so located in the holes that the members shall take full and even bearing upon them.

82.88. Setting Anchor Bolts.—Anchor-bolt holes shall be drilled in correct locations perpendicularly to the plane of the bridge seat, and the anchor bolts shall be set in Portland-cement mortar therein. The mortar shall consist of one part cement to one part clean, fine-grained sand mixed sufficiently wet to flow freely.

82.89. Anchor bolts shall first be dropped into dry holes to assure their proper fit after setting. They shall then be set as follows: Fill the hole about two-thirds full of mortar and by a uniform, even pressure or by light blows with a hammer (flogging and ramming will not be permitted), force the bolt down until the mortar rises to the top of the hole and the anchor-bolt nut rests firmly against the metal shoe or pedestal. Remove all excess mortar which may have flushed out of the hole to permit proper field painting of the metal surfaces.

82.90. The location of the anchor bolts in relation to the slotted holes in expansion shoes shall be varied with the prevailing temperature. The nuts on anchor bolts at the expansion end of spans shall permit the free movement of the span.

82.91. The holes may be drilled in accordance with the provisions of the above-mentioned article or, if in concrete masonry, may be formed by the insertion in the fresh concrete of oiled wooden plugs or metal pipe sleeves which are subsequently withdrawn after the concrete has partially set. When the holes are formed by the latter method, they shall be not less than 4" in diameter to allow for horizontal adjustment of the bolts.

82.92. In lieu of the above methods of placing, anchor bolts in concrete masonry may be set to exact location in the concrete when it is placed. In this case great care shall be exercised to insure the proper setting of the bolts, and any inaccuracies which will be detrimental to the structures shall be corrected by suitable means.

82.93. Setting Bedplates.—Bedplates preferably shall be set on a layer of canvas and red lead as specified in these specifications. When bedplates are set in Portland-cement mortar, no superstructure or other load shall be placed thereon until this mortar has been allowed to set for a period of at least 96 hr.

82.94. Placing Superstructure.—No superstructure load shall be placed upon finished piers or abutments until the engineer directs. In general a minimum time of 21 days shall be allowed for the hardening of the concrete before any superstructure load is placed thereon.

82.95. Tubular Steel Piers.—The general requirements governing the depths of foundations as above set forth shall govern in the case of tubular steel piers except that steel tubes resting upon gravel foundation without piling shall in no case be carried to a depth less than 8' below the permanent

bed of the stream and to such additional depth as may be necessary to eliminate all danger of undermining.

82.96. Tubular piers shall, in general, be sunk by the open-dredging process, or by means of compressed air. The cross-sectional area of each tube shall be sufficient to provide the requisite bearing area and to provide spacing room for the requisite number of piles, in case piles are used. After the tubes are sunk to the desired elevation, the bottom shall be sealed by means of concrete deposited under water. After the seal has set sufficiently to permit, the tubes shall be unwatered and the rest of the concrete deposited in the dry. If the seal is to act in flexure against the hydrostatic head, the tubes must be weighed sufficiently to develop the necessary downward reaction and sufficient shear anchorage provided around the interior circumference of the tube to transfer this weight into the seal concrete.

82.97. Metal tubes shall be painted two coats of an approved structural paint before being sunk, and the exposed portions shall be given an additional coat after erection.

82.98. Piles used in connection with tubular steel piers shall be driven after tubes are sunk unless otherwise permitted by the engineer. When driven after the tubes are in place, the piles may be driven by means of a follower, provided that one pile out of every group of ten or one for every tube shall be a long pile driven without a follower, such pile to be used as a test pile to determine the necessary length for the rest of the group. After the long pile is driven to the required penetration as determined by the bearing power formula, it shall be cut off to the required elevation.

82.99. If desired (and under written permission from the engineer), tubular steel piers may be sunk in large holes which previously have been dredged for the purpose. In this case, piles may be driven in the dredged hole before the tubes are placed, cut off to the desired elevation, bound in cluster form if desired, and the tubes placed over them. If this procedure is followed, the excavated hole around the piers shall be carefully backfilled.

82.100. Filling material for tubular piers shall be either Class A or Class B concrete as specified, except the bottom seal which shall be as specified for concrete deposited under water.

PAINING—MATERIALS AND COMPOSITION

82.101. a. Paints shall consist of pigments of the required fineness and composition, ground to the desired consistency in raw or boiled linseed oil, to which shall be added additional oil, and a thinner, or drier, or both. All pigments, oils, thinners, and driers used shall be of the best quality, free from adulterants of any kind, and shall comply with the requirements given below for these materials.

82.102. b. All paint paste shall consist of the specified pigment or pigments ground in linseed oil to the required consistency. The paste must be so prepared that it is uniform in composition and consistency, will not cake or segregate in the retainers, and will easily break up in oil to form a smooth, uniform paint of proper brushing consistency. The color, hiding power, and weight per gallon when specified shall be the same or equal to the approved sample.

82.103. c. To prepare a paint so that it will have the required consistency and drying properties for the use intended, the paste shall be mixed with sufficient linseed oil, turpentine, and drier to produce a paint having these properties. Unless otherwise specified, the exact quantity of linseed oil, turpentine, and drier required for this purpose shall be determined by the engineer.

82.104. d. Raw linseed oil used shall conform to the requirements of the A. S. T. M. Standard Specifications for Purity of Raw Linseed Oil from North American Seed D1-15, with subsequent amendments and additions thereto.

82.105. The boiled linseed oil used shall conform to the requirements of the A.S.T.M. Standard Specifications for Purity of Boiled Linseed Oil from North American Seed, D11-15, with subsequent amendments and additions thereto.

82.106. Furthermore, if permitted, raw and boiled linseed oil of South American seed shall meet the requirements of tentative specifications of A.S.T.M. DN-21T and D-78-21T.

82.107. e. Drier shall be composed of turpentine, lead, and manganese oxides cooked in linseed oil. The proportion of lead shall be not less than three times that of manganese. It shall contain no resin or varnish gums, and not more than 70 % shall volatilize at 450°F. When flowed on metal

and allowed to dry, it shall produce an elastic film. The flash point shall not be lower than 95°F. when tested in an open cup-tester. When a mixture of 10 % of drier with 90 % pure raw linseed oil is flowed on a glass slab, which is then held nearly vertical, and is kept at a temperature of 70°F., with free access of air, the coating shall dry throughout, neither sticky nor brittle, in not over 10 hr.

82.108. f. Turpentine shall be the distillate commonly known as "gum turpentine," or "spirits turpentine," which is distilled from pine oleoresins or the product secured from resinous wood by extraction with volatile solvents, by steam or by destructive distillation. Either or both of these two products—gum spirits or wood turpentine—shall be furnished for use when so specified.

82.109. The turpentine shall be clear and free from suspended matter and water.

The color shall be "Standard" or better.

The specific gravity shall be not less than 0.862 nor more than 0.872 at 15.5°C.

The refractive index at 15.5°C. shall be not less than 1.468 nor more than 1.478.

The initial boiling point shall be not less than 150 nor more than 160°C.

Ninety per cent of the turpentine shall distill below 170°C.

The polymerization residue shall not exceed 2 %, and its refractive index at 15.5°C. shall be not less than 1.500.

82.110. g. Pure White Lead. Dry Pigment.—The pigment shall be a pure basic carbonate of lead of the formula $2\text{PbCO}_3\cdot\text{PbOH}_2$, containing 65 to 75 % of lead carbonate, and shall conform to the requirements of tentative specifications A.S.T.M. D81-21T and subsequent revisions, and not more than 2 % of total impurities, including moisture. It shall be ground to such fineness that it will all pass a 200-mesh sieve and contain not more than 2 % material retained on a 325-mesh sieve.

82.111. Paste.—The paste shall be the dry pigment ground in pure raw linseed oil in the manner specified above. It shall consist of:

	Percentages	
	Minimum	Maximum
Pigment.....	90	92
Linseed oil.....	8	10
Moisture and other volatile matter.....		0.7
Coarse particles and "skins" (total residue retained on a 200-mesh sieve, based on pigment).....		2.0

82.112. Ready-mixed Paint.—The ready-mixed paint shall be prepared from the paste in the manner specified above.

82.113. h. Pure Zinc oxide Paint. Dry Pigment.—The dry pigment shall consist of pure oxide of zinc which shall contain not less than 98% of zinc oxide, nor more than two-tenths of 1% of sulphur or 2% of total impurities including moisture. The pigment shall be so ground that it will all pass a 200-mesh sieve.

82.114. Paste.—The paste shall be the dry pigment ground in oil as above specified. It shall consist of:

	Percentages	
	Minimum	Maximum
Pigment.....	82	86
Linseed.....	14	18
Coarse particles and "skins" (total residue left on a 200-mesh sieve, based on pigment).....		0.5
Moisture and other volatile matter.....		0.5

82.115. Ready-mixed Paint.—The ready-mixed paint shall be prepared from the paste in the manner specified above, in accordance with tentative specifications of A.S.T.M. 79-21S.

82.116. i. Red Lead. Dry Pigment.—The dry pigment shall consist entirely of the oxides of lead which shall conform to the requirements of A.S.T.M. Specifications D-83-21T 95% grade.

82.117. Paste.—The paste shall be the pigment ground in oil as above specified. It shall consist of:

Pigment.....	Percentages	
	Minimum	Maximum
Linseed oil.....	92	95 or more
Moisture and other volatile matter.....	6	8
Coarse particles and "skins" (total residue left on a 200-mesh sieve).....		0.5
		7.5

82.118. Ready-mixed Paint.—The ready-mixed paint shall be prepared from the paste in the manner specified above.

82.119. The resulting paint, when mixed in the proportions given below and brushed on a smooth vertical metal surface, shall dry hard and elastic without running, streaking or sagging.

82.120. For Shop Coat.

Red-lead paste.....	20 lb.
Raw linseed oil.....	4½ pints (0.43 lb.)
Turpentine.....	2 gills (7.3 oz.)
Liquid drier.....	2 gills (12.0 oz.)

82.121. The formula given above will produce 1 gal. of paint and should weigh 25 lb. and 10 oz.

82.122. j. Leaded Zinc Oxide. Dry Pigment.—The dry pigment shall be a pure zinc oxide and a normal or basic lead sulphate. The pigment shall be so ground that it will all pass a 200-mesh sieve and the zinc oxide shall not contain more than 1 % of soluble salts nor more than 1.5 % of total impurities including moisture.

82.123. This type of paint shall be divided into two brands, "high leaded" and "low leaded." The high-leaded paint shall contain not less than 60% of zinc oxide and the low-leaded paint not less than 93% of zinc oxide, the remaining pigment in each case to be a normal or basic lead sulphate.

82.124. Paste.—The paste shall be the dry pigment ground in oil as above specified. It shall consist of:

Pigment.....	Percentages	
	Minimum	Maximum
Linseed oil.....		88.0
Moisture and other volatile matter.....	12.0	
Coarse particles and "skins" (total residue left on a 200-mesh sieve, based on pigment).....		0.5
		0.5

82.125. Ready-mixed Paint.—The ready-mixed paint shall be prepared from the paste in the manner specified above.

82.126. k. Sublimed Blue Lead.—The sublimed blue lead pigment shall consist of sublimed blue lead fume, free from all adulterants and shall meet the following requirements:

	%
Lead sulphate (PbSO ₄).....	45-55
Lead oxide (PbO).....	30-40
Lead sulphide (PbS).....	Not over 12
Lead sulphite (PbSO ₃).....	Not over 5
Zinc oxide (ZnO).....	Not over 5
Carbon and undetermined.....	Not over 5

82.127. Sublimed blue lead paint shall consist of either:

1. Sublimed blue lead in oil paste (90% sublimed blue lead ground in 10% raw linseed oil) mixed as follows:

100 lb. sublimed blue lead in oil paste	} For field coat.
4 gal. pure raw linseed oil	
2 pt. turpentine	
2 pt. drier	

82.128. 2. A ready-mixed paint made by grinding pure dry sublimed blue lead in pure raw linseed oil in the following proportions:

90 lb. dry sublimed blue lead	} For field coat.
5½ gal. raw linseed oil	
2 pt. turpentine	
2 pt. drier	

82.129. 1. Graphite. Dry Pigment.—The dry pigment shall be a pure amorphous and silicate rock to which may be added a small percentage of carbon black, iron oxide, or other oxides needed to secure a desired tint or color. The pigment shall be so ground that it will all pass a 200-mesh sieve, and contain not more than 3 % of material retained on a 325-mesh sieve. The prepared pigment must contain not less than 35 % nor more than 50 % of graphite in the form of graphitic carbon.

82.130. Paste.—The paste shall be the pigment ground in oil as above specified. It shall consist of:

	Percentages	
	Minimum	Maximum
Pigment.....	62	66
Linseed oil.....	34	38
Moisture and other volatile matter.....		80
Coarse particles and "skins" (total per cent on a 325-mesh sieve, based on the pigment).....	3	6

82.131. Ready-mixed Paint.—The ready-mixed paint shall be prepared from the paste in the manner above.

82.132. The resulting paint when mixed in the proportions given below, and brushed on a smooth vertical metal surface shall dry hard and elastic without running, streaking, or sagging. It shall consist of:

	Percentages	
	Minimum	Maximum
Pigment.....	39	35
Boiled linseed oil.....	65	70
Drier.....	5	6
Turpentine and volatile matter.....	3	6

82.133. All paints or paint materials shall be shipped in strong, substantial containers, plainly marked with the name, color, and weight of paint content, and name and address of the manufacturer.

82.134. n. Manufacturer's Guarantee.—The manufacturer of each brand of paint submitted for acceptance under these specifications shall file with the commission a certificate of analysis and manufacturer's guarantee, setting forth the trade name or brand of paint to be furnished together with a facsimile copy thereof and a typical analysis showing the percentage of each of the chemical elements in the pigment vehicle. The manufacturers shall provide that all paint furnished under these specifications shall conform to the certified analysis as filed and to the statement of the various percentages of the ingredients on the receptacle or container. The manufacturer's guarantee shall be of the form furnished by the purchaser, and shall be sworn to by a person having legal authority to bind the company by his acts.

82.135. o. Sampling and Testing.—Samples when required for testing purposes shall not be less than 1 qt. in amount. The paint shall be thoroughly stirred before selecting the sample.

82.136. In testing paint used under these specifications, the following:

1. Per cent of water in paint vehicle. Determination of water with amyl reagent.

2. Raw linseed oil. Methods of testing prescribed in A.S.T.M. Standard Specification for Purity of Raw Linseed Oil from North American Seed D1-15, and for South American Seed A.S.T.M. D-77-21T D78-21T.

3. Boiled linseed oil. Methods of testing prescribed in A.S.T.M. Standard Specification for Purity of Boiled Linseed Oil from North American Seed D-11-15, and for South American Seed A.S.T.M. D-77-21T D78-21T.

4. Determination of volatile oils in vehicle. Bureau of Standards *Misc. Pub.* 15, p. 40.

5. Paint vehicle. Methods in Bureau of Standards, *Circular* 89.

6. Red lead. A.S.T.M. Standard Methods Routine Analysis Dry Lead D-49-18.

7. White lead. A.S.T.M. Standard Methods Routine Analysis of White Pigments D34-17.

8. Sublimed blue lead. Shall be made in accordance with method of analysis of paint materials, subcommittee viii, A.S.T.M., Vol. 22, Part 1, and subsequent revisions thereto adopted by the society.

9. Zinc oxide. A.S.T.M. Standard Method of Routine Analysis of White Pigments D34-17.

10. Graphite pigment. Methods of tests prescribed in *Bulletin* 1216 (U. S. Dept. of Agr.).

82.137. p. No sieve is to be used in the determination of the fineness of the pigments for these paints which on examination under a 150 magnification lens in a microscope shows any irregularity of wire spacings in the mesh or shows any noticeable amount of wear on the sides of the wires.

82.138. Standard 325-mesh Sieve.—The 325-mesh sieve referred to in this specification is a woven rectangular-mesh wire sieve having not less than 322 nor more than 327 meshes per linear inch in either direction. The nominal size of opening shall be 0.0017" square and the size of wire shall be 0.0014" in diameter.

82.139. q. Inspection.—The contractor for these paints shall allow the state inspector free access to all parts of his shops while work on these paints is being carried out; also the contractor shall give the inspector every reasonable facility to enable him to insure that these paints are being made in accordance with this specification.

82.140. r. Samples.—Before work is commenced on the manufacture of these paints, the contractor shall furnish the state inspector with separate samples of all pigments and vehicles to be used in such paints; each such sample to be clearly labeled and marked to show the name of the material and the name and number of the paint in which it is to be used. When so requested, samples and analyses of all pigments, oils, thinners, or driers used, or paints furnished shall be supplied by the manufacturer within 10 days after request is made therefor. Before paint is shipped, the inspector shall take individual samples from one barrel in each five for each kind of paint. Tests may be made on individual samples or on one composite sample for each 25 barrels of paint.

82.141. s. Paints which on analysis show more than a 3% variation in the proportion of any pigments or vehicle from that called for will be rejected.

PAINTING—APPLICATION

82.142. a. The painting of metal structures shall include, unless otherwise provided in the contract, the proper preparation of the metal surfaces, the application, protecting, and drying of the paint coatings, the protection of pedestrian, vehicular, or other traffic upon or underneath the bridge structure, the protection of all positions of the structure (superstructure and substructure) against disfigurement by spatters, splashes and smirches of paint or of paint materials, and the supplying of all tools, tackle, scaffolding, labor, workmanship, and materials necessary for the entire work.

82.143. b. Number of Coats.—All new structural steel work shall, unless otherwise especially provided upon the plans or in the contract, be painted three coats of paint. The first coat is to be applied immediately after the shop fabrication is complete except that all surfaces coming into contact are to be painted before being assembled. The second and third coats are to be applied after all erection is complete, except that immediately following the field riveting of the members, the heads of field rivets, and all abrasions of the shop coat due to handling at the shop, shipment, erection, etc., and all field erection marks shall be thoroughly covered with one coat of shop paint and permitted to become thoroughly dry before the first field coat is applied.

82.144. c. The color of each succeeding coat shall be sufficiently different from that previously applied to permit readily the discovery of an incomplete application of the paint coat. The colors of the coats shall be determined by the engineer.

82.145. d. Weather Conditions.—Paint shall be applied only when the air temperature is at or above 40°F. It shall not be applied upon damp surfaces or upon metal containing frost, nor shall it be applied when the air is misty, or otherwise, in the opinion of the engineer, unsatisfactory for the work.

82.146. Material painted under cover in damp or cold weather shall remain under cover until dry or until weather conditions permit its exposure in the open. Painting in open yards or upon erected structures shall not be done when the metal has absorbed sufficient heat to cause the paint to blister and produce a porous paint film.

82.147. e. Application.—No wide brushes shall be used. All brushes shall be oval in shape.

82.148. The paint when applied shall be so manipulated under the brush as to produce a uniform, even coating in close contact with the metal or with previously applied paint. In general, the primary movement of the brush shall describe a series of small circles thoroughly to fill all irregularities

in the surface, after which the coating shall be smoothed and thinned by a series of parallel strokes.

82.149. To secure a maximum thickness of paint film upon rivet heads, edges of plates, angles, or other rolled shapes, these areas shall be "striped" in advance of the general painting, and shortly afterward shall be given a second or "wash" coat when the general coat is applied. The paint shall be well worked into all joints and open spaces.

82.150. Paint shall be thoroughly stirred, preferably by means of mechanical mixers, before being removed from the containers, and to keep the pigments in suspension shall be kept stirred while being applied.

82.151. All painting must be done in a neat and workmanlike manner. On all surfaces which are inaccessible for paint brushes, the paint shall be applied with sheep-skin daubers specially constructed for the purpose.

82.152. f. Removal of Improper Paint.—All metal coated with impure or unauthorized paint shall be thoroughly cleaned and repainted to the satisfaction of the engineer, at the expense of the contractor.

82.153. g. Thinning.—If it is necessary in cool weather to thin the paint in order that it shall spread more freely, this shall be done only by heating in hot water or on steam radiators.

82.154. h. Shop Cleaning.—All surfaces of metal to be painted shall be thoroughly cleaned from rust, loose mill scale, dirt, oil or grease, and all other foreign substances. The removal of rust, scale, and dirt shall generally be done by the use of sand blast, metal brushes, scrapers, chisels, hammers, or other effective means. Oil and grease may be removed by the use of gasoline or benzine. Bristle or wood fiber brushes shall be used for removing loose dust.

82.155. i. Shop Painting.—In shop-riveted work, all surfaces coming into contact when shop assembled shall each be painted a good shop coat thoroughly and evenly applied before assembling. These pieces may be assembled while the paint is still wet.

82.156. When all fabrication work is complete and has been accepted as such, all surfaces not painted before assembling shall be painted a good shop coat. Shipping pieces shall not be loaded for shipment until thoroughly dry. No painting shall be done after loading material on cars.

82.157. j. Erection marks for the field identification of members shall be painted upon previously painted surfaces.

82.158. k. With the exception of abutting chord and column splices, column and truss shoe bases, machine-finished surfaces shall be coated as soon as practicable after being accepted, with a hot mixture of white lead and tallow before removed from the shop. Surfaces of iron and steel castings milled for the purpose of removing scales, scabs, fins, blisters, or other surface deformations shall generally be given the shop coat of paint.

82.159. The composition used for coating machine-finished surfaces shall be mixed in the following proportions:

- 4 lb. pure tallow.
- 2 lb. pure white lead.
- 1 qt. pure linseed oil.

82.160. l. Field Cleaning.—When the erection work is complete, including all riveting, straightening of bent metal, etc., all adhering rust, scale, dirt, grease, or other foreign matter shall be removed as specified under shop cleaning.

82.161. m. Field Painting.—As soon as the field cleaning is done to the satisfaction of the engineer, the heads of field rivets and any surfaces from which the shop coat of paint has become worn off or has otherwise become defective and all shipping and erection marks shall be thoroughly covered with one coat of the same paint as used in the shop and permitted to become thoroughly dry before the first field coat is applied.

82.162. When the paint applied for "touching up" rivet heads and abraded surfaces has become thoroughly dry, the first and second field coats may be applied. In no case shall a succeeding coat be applied until the previous coat has dried throughout the full thickness of the paint film.

82.163. All small cracks and cavities which have not become sealed in a water-tight manner by the first field coat shall be filled with a pasty mixture of red lead and linseed oil before the second field coat is applied.

82.164. n. Scope of Work.—Unless otherwise provided, maintenance painting shall consist of the removal of the rust, scale, dead paint, dirt, grease, or other foreign matter from the metal parts or portions of existing bridge structures and the application of paint thereon.

82.165. All metal surfaces not in close contact with other metal surfaces or with wooden floor or truss members, concrete, stone masonry, etc. shall be considered as exposed to deterioration by rusting and shall be thoroughly cleaned and painted the number of coats indicated in and made a part of the contract.

82.166. o. Number of Coats.—Unless otherwise provided, metal after being cleaned to the satisfaction of the engineer, shall be painted with at least two coats of paint.

82.167. p. Cleaning and Painting.—The requirements and methods of procedure for maintenance, cleaning, and painting shall be the same as specified for shop and field painting.

82.168. Whenever roadway or sidewalk planking is laid too closely in contact with the metal to permit free access for proper cleaning and painting, the planks shall either be removed or shall be cut to provide at least a 1" clearance for that purpose. The removal or the cutting of planks shall be done as directed by the engineer. All planks removed shall be satisfactorily replaced and if broken or otherwise injured to an extent rendering them unfit for use, they shall be renewed at the expense of the contractor.

DESIGN DETAILS

82.169. In general, plans for steel bridges will not be approved except for structures spanning navigable channels, and for locations where the cost of concrete structures would be prohibitive.

82.170. Drawings.—The state highway engineer will furnish designs, showing details preferred with usual conditions.

82.171. Alternate Designs.—Bidders may submit alternate designs when agreeable to the state highway engineer, and when so provided for in the notice to contractors. Alternate designs shall have as great strength and general merits as the designs furnished by the state highway engineer. Bidders submitting alternate designs shall furnish stress sheets and general plans which shall show all dimensions and sectional area.

82.172. Size of Drawings.—All drawings shall be 22 by 36" over all, with a margin of 2" on the left-hand edge and $\frac{1}{2}$ " margins on the other edges.

82.173. Approval of Drawings.—Upon the acceptance and execution of the contract, the contractor shall prepare and furnish standard-size working drawings showing complete details of all parts of the structure. Blueprints, in triplicate, of these drawings shall be submitted to the state highway engineer for his approval before any material is ordered or work begun in the shop. All details shall be subject to his modifications or approval.

82.174. The contractor alone shall be responsible for the correctness of the drawing, although the drawing may have been approved by the engineer.

82.175. Prints for the State Highway Department.—After drawings have been approved, the contractor shall furnish the state highway department, without cost, five complete sets of prints and four sets of all shipping bills.

82.176. Name Plates.—When specified one or more cast-iron name plates of an approved design, giving the date of construction, the names of the state highway engineer, state bridge engineer, consulting bridge engineer, county engineer, county commissioners court, and the contractor for the superstructure, shall be securely bolted to the superstructure at the point or points specified.

82.177. Width of Roadway and Sidewalk.—The width of roadway shall be the clear width measured at right angles to the longitudinal center line of the bridge between the tops of curbs or guard timbers, if these exist; otherwise, it shall be the clear width inside to inside of the handrails or other fence-like protections paralleling the sides of the structure.

82.178. Upon structures having a sidewalk, the clear width of sidewalk shall be measured at right angles to the curb or guard timber and from the face thereof to the extreme inside portion of the handrail. For structures having trusses, girders, or parapet walls adjacent to the curbs, the width of sidewalk shall be measured from their extreme outside portions to the inside of the handrail.

82.179. Curbs.—The width of curbs shall be not less than 6" and preferably shall be not less than 9". Their heights shall be not less than 9".

82.180. Clearances.—The clearance width shall be the clear width available, and the clearance height shall be the clear height available for the passage of vehicular traffic as shown on the clearance diagrams.

82.181. Unless otherwise provided, the several parts of the structure shall be constructed to secure the following limiting dimensions or clearances for traffic.

82.182. Bridges constructed for the use of one-way highway traffic shall have a roadway clearance not less than that shown in the diagram, Fig. 1. The roadway clearance for the use of two-way traffic shall be not less than that shown in Fig. 2. The roadway width shall be increased at least 9' for each additional line of traffic.

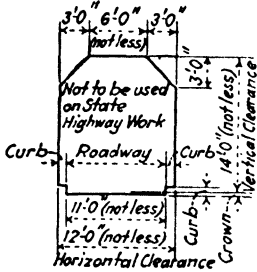

ONE WAY HIGHWAY TRAFFIC

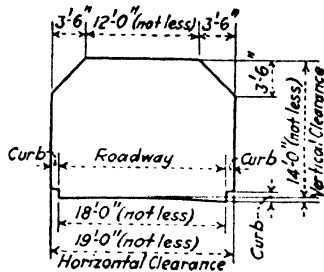

TWO WAY HIGHWAY TRAFFIC

FIG. 1.

FIG. 2.

Clearance diagrams.

82.183. Bridges constructed for the combined use of highway and electric-railway traffic shall have roadway clearances not less than those shown in Figs. 3 and 4.

82.184. In all cases involving curved tracks, the lateral clearances shall be increased an amount corresponding to that required to maintain the

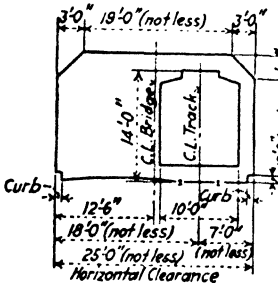

SINGLE TRACK RAILWAY AND ONE WAY HIGHWAY TRAFFIC

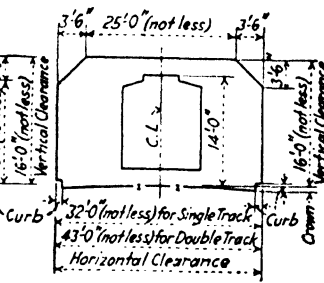

ELECTRIC RAILWAY AND TWO WAY HIGHWAY TRAFFIC

FIG. 3.

FIG. 4.

Clearance diagrams.

standard clearances. When the outer rail is superelevated, the clearances shall be correspondingly increased.

82.185. Spacing of Trusses and Girders.—Main trusses and girders shall be spaced a sufficient distance apart center to center to be secure against overturning by the assumed lateral and other forces.

82.186. Types of Bridges.—The type of bridge to be used for various span lengths may be as follows:

- Rolled beams up to 40'.
- Plate girders from 30 to 100'.
- Low riveted trusses from 45 to 100'.
- Riveted trusses from 90 to 150'.
- Riveted or pin-connected trusses above 150'.

82.187. b. Loads.—Unless otherwise provided, the component parts of a structure shall be proportioned for the stresses produced by the following loads with the assumed load distribution herein elsewhere prescribed. The stresses due to each shall be shown separately upon stress sheets.

82.188. Dead Load.—The dead load shall consist of the weight of the structure complete, including the weight of the roadway floor, conduits, cables, or other public-utility services supported thereon.

82.189. The following weights are to be used in computing the dead load:

Substance	Weight per Cubic Foot, Pounds
Steel.....	490
Iron, cast.....	450
Bronze.....	524
Timber (treated or untreated).....	60
Concrete.....	144
Loose sand and earth.....	100
Rammed sand or gravel.....	120
Macadam or gravel rolled.....	140
Cinder filling.....	60
Asphalt wearing surface.....	150
Granite-block paving.....	160
Vitrified brick paving.....	150
Granolithic pavement.....	150

82.190. Live Load.—The integral parts of bridge floor systems, including their direct connections to trusses, girders, and viaduct towers and bents, shall be designed for the maximum stresses produced by truck concentrations

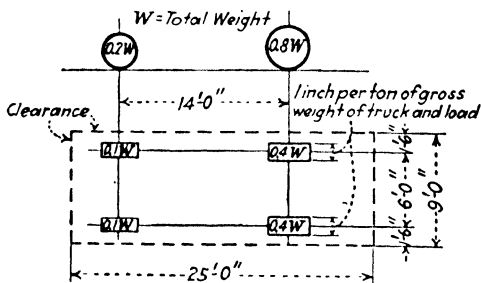

TYPICAL TRUCK

FIG. 5.—Typical truck loading.

Floor beams, hangers, and all integral members or parts of trusses and girders subjected to the direct action of floor loads and impacts shall correspondingly be designed for truck concentrations. The truck dimensions and weight distributions used for design purposes shall be those of the typical or standard trucks shown in Fig. 5. These standard trucks are designated by the letter H, followed by a numeral indicating for each class its gross or total weight in tons.

82.191. The class of loading used shall be one of the following:

Loading H15.....	15-ton trucks.
Loading H10.....	10-ton trucks.

Live Load for Trusses and Girders.—The trusses and girders of bridge spans and the columns of viaduct towers and bents shall be designed for the stresses produced by a load on each traffic lane composed of a uniform load per linear foot of lane with a concentrated load so located longitudinally therein as to produce maximum stresses. The concentrated load shall be considered

as uniformly distributed transversely on a line having a length equal to the width of the lane. The standard truck clearance width of 9' shall be assumed as constituting the width of one traffic lane.

82.192. The class of loading used shall be one of the following:

Loading H15. A total load on each traffic lane composed of a uniform load of 450 lb. per linear foot and a single concentrated load of 21,000 lb.

Loading H10. A total load on each traffic lane composed of a uniform load of 300 lb. per linear foot and a single concentrated load of 14,000 lb.

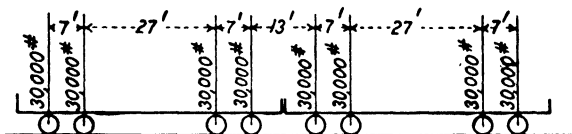

FIG. 6.—Electric car loading.

82.193. **Load Classification of Bridges.**—Bridges shall be classified or rated in relation to their capacities for safely supporting highway loads. In general, the division into classes and the corresponding loadings shall be as follows:

Class A. Bridges supporting normally heavy highway-traffic units with occasional specially heavy loads. Class A bridges shall be designed for loading H15.

Class B. Bridges of a temporary or semitemporary nature supporting light highway-traffic units. Class B bridges shall be designed for loading H10.

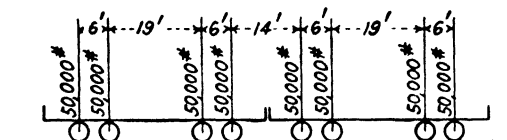

FIG. 7.—Freight car loading.

82.194. **Application of Loads to Girders and Trusses.**—Girders and trusses shall be designed to support as many traffic lanes as the width of roadway will permit, assuming them to be placed symmetrically with regard to the roadway center lines.

82.195. To provide for an increase in truss and girder stresses resulting from the passage of eccentrically placed loads and for a decrease in traffic-lane intensity for increasing widths of roadway, the stresses obtained by the application of the above loading shall be multiplied by the coefficient C given by the following formulas:

Case I. When W is less than 18',

$$C = \frac{W}{9}$$

Case II. When W is equal to or greater than 18',

$$C = \frac{18 + W}{18n}$$

where W = the width of roadway for bridges with two main girders or trusses; or the distance center to center of girders or trusses for bridges with more than two main girders or trusses.

n = number of lanes of traffic.

82.196. Application of Loads to Floor System.—Bridge floor systems shall be designed to support as many trucks, not exceeding four, as the width of roadway will permit.

82.197. When the design of the floor system involves the placing of trucks adjacent to curbs, the extreme position of a truck shall be assumed as that in which the center of the outside wheel is 1' 6" from the inside edge of the curb.

82.198. Sidewalk Loads.—All sidewalk stringers and brackets shall be designed to support a live load of not less than 100 lb. per square foot of sidewalk area.

82.199. Girders or trusses supporting sidewalks shall be designed to support a sidewalk live load as determined by the following formula, provided that in no case shall the live load be less than 20 lb. per square foot of sidewalk area:

$$P = (80 - 0.125L)(1 - 0.025W)$$

where P = live load, in pounds per square foot of sidewalk area.

L = loaded length of sidewalk, in feet.

W = clear width of sidewalk, in feet.

No impact increment shall be added to sidewalk load.

82.200. In general, provision shall be made to prevent the encroachment of roadway loads upon the sidewalk area. Whenever the details of the structure permit such encroachment, the sidewalks shall be designed for the roadway loads and impacts so involved.

82.201. All live-load stresses, except those due to sidewalk loads and centrifugal tractive and wind forces, shall be increased by an allowance for dynamic, vibratory, and impact effects.

82.202. For end floorbeams, floorbeam hangers, columns supporting floorbeam concentrations and all floorbeam connections, the impact allowance shall be 60% of the live-load stress.

82.203. For all other portions of structures, the impact allowance or increment is expressed as a coefficient of the live-load stress varying with the loaded length of the structure and the width of the roadway area. Its intensity is determined by the following formulas in which

I = impact coefficient.

L = loaded length in feet producing the maximum static stress in the member considered.

W = the width of roadway for bridges with two main girders or trusses; or the distance center to center of girders or trusses for bridges with more than two main girders or trusses.

For electric railway loads:

$$I = \frac{L + 900}{12L + 1200}$$

82.204. For Highway Loads.

When W is equal to or less than 18'.

$$I = \frac{L + 250}{10L + 250}$$

When W is greater than 18'.

$$I = \frac{36}{W + 18} \times \frac{(L + 250)}{(10L + 500)}$$

82.205. For highway loads, the maximum value of I , as given by the above formulas, shall not exceed 0.30. The impact allowance for intermediate floor beams and stringers shall be 0.30.

82.205a. Wind Load.—The force due to wind and lateral vibrations shall be taken as horizontal and shall be treated as a uniformly moving load acting only on the lateral and sway bracing. This lateral force shall be taken at 30 lb. per square foot on one and one-half times the side area of all trusses or girders plus the area of the railings and the vertical projection of the floor. In the case of truss spans it shall be considered as divided between the loaded and the unloaded chords in the proportion of two-thirds to the former and one-third to the latter. In addition to the foregoing, a moving load of 150 lb. per linear foot shall be considered as acting in the plane of the bridge floor on highway bridges and 300 lb. per linear foot upon bridges for combined highway and electric-railway service. However, in the case of structures having a reinforced-concrete floor slab engaging the flanges of the steel floor members this additional loaded chord load need not be considered.

82.206. c. Distribution of Truck Wheel Loads to Stringers and Floorbeams.—In calculating end shears and end reactions of stringers and floorbeams, no lateral or longitudinal distribution of wheel loads shall be assumed.

82.207. Bending Moments.—In determining bending moments in stringers, each wheel load shall be assumed as concentrated at a point. When the floor system is designed for one truck, each interior stringer shall be proportioned to support that part of one rear wheel load, or those parts of one front wheel load and one rear wheel load, represented by a fraction whose numerator is the stringer spacing in feet and whose denominator is:

4' 0" for plank floors.

5' 0" for strip floors 4" or more in thickness and for wood blocks on a 4" plank subfloor.

6' 0" for reinforced-concrete floors.

82.208. When the floor system is designed for two trucks, each interior stringer shall be proportioned to support that part of one rear wheel load, or these parts of one front wheel load and one rear wheel load, represented by a fraction whose numerator is the stringer spacing in feet and whose denominator is:

3' 6" for plank floors.

4' 0" for strip floors 4" or more in thickness and for wood blocks on a 4" plank subfloor.

4' 6" for reinforced-concrete floors.

82.209. The live load supported by the outside stringers shall be the reaction of the truck wheels in the most unfavorable position, assuming the flooring to act as a simple beam, but this live load shall in no case be less than would be required for interior stringers under the above requirements.

82.210. The above distribution rules govern only when the stringer spacing is not greater than the denominator which applies to the particular case under consideration. When the stringer spacing is greater than this distance, the stringer loads shall be determined by the reactions of the truck wheels placed in the most unfavorable position, assuming the flooring between stringers to act as simple beams.

82.211. The combined load capacity of the stringers in a panel shall be not less than the total live and dead load in the panel.

82.212. Bending Moments in Floorbeams.—In determining bending moments in floorbeams, each wheel load shall be assumed as concentrated at a point.

82.213. When stringers are omitted and the floor is supported directly on the floorbeams, the latter shall be proportioned to carry that fraction of one axle load, when the floor system is designed for one truck, or of two axle loads, when the floor system is designed for two trucks, whose numerator is the floorbeam spacing in feet and whose denominator is:

4' 0" for plank floors.

5' 0" for strip floors 4" or more in thickness and for wood blocks on 4" plank subfloor.

6' 0" for reinforced-concrete floors.

82.214. When the spacing of floorbeams exceeds the denominator given but is less than the axle spacing (14' 0"), each beam shall be proportioned to carry the full axle load or loads.

82.215. When the floorbeam spacing exceeds the spacing of axles the load supported on each floorbeam shall be the maximum reaction due to the axle loads, assuming the flooring between floorbeams to act as a simple beam.

82.216. d. Unit Stresses—Steel Structures.—Unless otherwise provided, the several parts of a structure shall be so proportioned that the unit stresses will not exceed the following, except as provided for structural-steel design, under combined stresses, secondary stresses and allowances for overload. Unless otherwise noted, all unit stresses are given in pounds per square inch.

82.217. Structural Grade and Rivet Steel—Tensions.

Axial tension, structural members, net section 16,000

Rivets in tension, where permitted, .50% of single shear values

Bolts, area at root of thread. 10,000

82.218. Structural Grade and Rivet Steel—Compression.

Axial compression, gross section 15,000–50 l/r

but not to exceed 13,500

l = length of member, in inches

r = least radius of gyration, in inches.

82.219. Structural Grade and Rivet Steel—Bending on Extreme Fiber.

Rolled shapes, built sections and girders, net section . . . 16,000

Pins 24,000

82.220. Structural Grade and Rivet Steel—Shear.	
Girder webs, gross section.....	10,000
Pins and shop-driven rivets.....	12,000
Power-driven field rivets and turned bolts.....	10,000
Hand-driven rivets and unfinished bolts.....	7,500

82.221. Structural Grade and Rivet Steel—Bearings.	
Pins, steel parts in contact and shop-driven rivets.....	24,000
Power-driven field rivets and turned bolts.....	20,000
Hand-driven rivets and unfinished bolts.....	15,000
Expansion rollers, pounds per linear inch.....	600 <i>d</i>
where <i>d</i> = diameter of roller in inches.	

82.222 Structural Grade and Rivet Steel—Countersunk Rivets.	
In metal $\frac{3}{4}$ " thick and over, half the depth of countersink shall be omitted in calculating bearing area.	
In metal less than $\frac{3}{4}$ " thick, countersunk rivets shall not be assumed to carry stress.	

82.223 Structural Grade and Rivet Steel—Diagonal Tension.

In webs of girders and rolled beams, at sections where maximum shear and bending occur simultaneously.....	16,000
Wrought iron—axial tension.....	12,000
Cast steel—bending on extreme fiber.....	12,000
Cast iron—bending on extreme fiber.....	3,000
Cast steel—shear.....	10,000
Cast iron—shear.....	3,000
Cast steel—bearing.....	14,000
Cast iron—bearing.....	10,000
Bronze sliding expansion bearings.....	3,000
Bearing on concrete masonry and limestone masonry and better.....	500

82.224. Dimensions for Stress Calculation.—For the calculation of stresses, effective span lengths shall be assumed as follows:

Beams and girders, distance between centers of bearings. Trusses, distance between centers of end pins or of bearings. Floor beams, distance between centers of trusses or girders. Stringers, distance between centers of floorbeams.

82.225. For the calculation of stresses, effective depths shall be assumed as follows:

Riveted trusses, distance between centers of gravity of the chords.

Pin-connected trusses, distance between centers of chord pins.

Plate girders, distance between centers of gravity of the flanges but not to exceed the distance back to back of flange angles.

82.226. Reversal of Stress.—Members subject to reversal of stress during the passage of live load shall be proportioned as follows: Determine the tensile and the compressive stresses and increase each by 50% of the smaller; then proportion the member so that it will be capable of resisting each increased stress. The connections shall be proportioned for the sum of the original stresses.

82.227. No pin-connected member shall be subjected to reversal of stress.

82.228. When the live-load and dead-load stresses are of opposite sign, only 70% of the dead load stress shall be considered as effective in counteracting the live load stress.

82.229. Combined Stresses.—Members subject to both axial and bending stresses shall be proportioned so that the combined fiber stresses will not exceed the allowable axial stress. Members continuous over panel points shall be proportioned for live- and dead-load bending moments equivalent to those computed for a simple beam having a span equal to one panel length.

82.230. Stresses Due to Lateral and Longitudinal Forces and Temperature.—In proportioning the various parts of the structure, provision shall be made for the following stress combinations:

Group A—Dead load; live load; impact; centrifugal force.

Group B—Lateral force; longitudinal force; temperature.

82.231. Members subject to the stresses of Group A in combination with the stresses of Group B, either direct or flexural or both, shall be designed for any of the following combinations at unit stresses 25% greater than those specified, but the resulting sections shall be not less than would be required if the stresses of Group A were considered alone.

1. The combined stresses of Group B in combination with dead load only.
2. The combined stresses of Group A in combination with 50% of the combined stresses of Group B.
3. The combined stresses of Group A in combination with temperature only.

82.232. Secondary Stresses.—Members and their details shall be proportioned to reduce secondary stresses to a minimum. In simple trusses without subdivided panels the secondary stresses due to deformation in any member whose width measured in the place of flexure is less than one-tenth of its length need not be considered. When this ratio is exceeded, or where subdivided panels are used, the secondary stresses shall be computed. In members designed for secondary stresses in combination with other stresses the specified allowable unit stresses may be increased 30%, but the sections shall be not less than required for primary stresses.

82.233. Allowance for Overload.—For the calculation of stress reversal or counterstresses, the specified live loads, either uniform or concentrated, shall be increased 100% and for this loading condition the specified unit stresses shall be increased not more than 50%. The resulting sections shall be not less than would have been required had the allowance for overload not been considered.

82.234. Compression Flanges of Beams and Girders.—The gross area of the compression flanges of beams and plate girders shall be not less than the gross area of the tension flanges.

82.235. The laterally unsupported length of the compression flanges of beams and girders shall not exceed forty times the flange width. When the unsupported length of flange exceeds twelve times the flange width, the compressive stress in pounds per square inch shall not exceed:

$$19,000 - 250 \frac{L}{b} \text{ (maximum value, 16,000 lb.)}$$

where

L = length, in inches, of unsupported flange, between lateral connections or knee braces.

b = flange width in inches.

82.236. Rolled beams shall be proportioned by the moments of inertia of their sections. Proper allowances shall be made for any reduction in strength due to rivet holes in the tension flange or to any reduction in allowable stress due to the length of unsupported compression flange.

82.237. Limiting Lengths of Members.—The ratio of unsupported length to the least radius of gyration shall not exceed 120 for main compression and stiffening members nor 140 for laterals and sway bracing. In proportioning the top chords of low trusses the unsupported length shall be assumed as the length between the rigid verticals.

82.238. For main riveted tension members the ratio of length to least radius of gyration shall not exceed 200.

82.239. Effective Bearing Area.—The effective bearing area of a pin, bolt, or rivet shall be its nominal diameter multiplied by the thickness of the metal on which it bears.

82.240. Effective Diameter of Rivets.—In proportioning rivets, the nominal diameter of the rivet shall be used.

82.241. Size of Rivets.—Rivets shall be of the size specified but generally shall be $\frac{3}{4}$ " or $\frac{1}{2}$ " in diameter; $\frac{5}{16}$ " rivets shall not be used in members carrying calculated stress except in $2\frac{1}{2}$ " legs of angles and in flanges of 6 and 7" beams and channels.

82.242. The diameter of rivets in angles carrying calculated stress shall not exceed one-fourth of the width of the leg in which they are driven. In angles whose size is not so determined $\frac{5}{16}$ " rivets may be used in 2" legs, $\frac{3}{8}$ " rivets in $2\frac{1}{2}$ " legs and $\frac{1}{2}$ " rivets in 3" legs.

82.243. In no case, except in handrails, shall structural shapes be used which do not admit the use of $\frac{5}{16}$ " diameter rivets.

82.244. Pitch of Rivets.—The minimum allowable distance between centers of rivets shall be three times the diameter of the rivet, but preferably shall be not less than the following:

For $\frac{1}{4}$ " diameter rivets.....	3"
For $\frac{3}{8}$ " diameter rivets.....	$2\frac{1}{2}$ "
For $\frac{1}{2}$ " diameter rivets.....	$2\frac{3}{4}$ "

82.245. The maximum allowable pitch in the line of stress shall not exceed 6" or sixteen times the thickness of the thinnest outside plate or angle

connected, except in angles having two gage lines with rivets staggered where the pitch in each line may be twice the above with a maximum of 10".

82.246. In webs of members composed of two or more plates in contact, the rivets shall be spaced not more than 10" between centers in gage and pitch, provided such rivets serve no other purpose than to hold the plates in close contact. Tension members composed of two angles in contact shall be stitch riveted, using a pitch not greater than 12".

82.247. Pitch in Ends of Compression Members.—Panel points shall be considered as ends of compression members. In the ends of built compression members the pitch of rivets connecting the component parts of the member shall not exceed four times the diameter of the rivet for a length equal to one and one-half times the maximum width of member. Beyond this point the rivet pitch shall be gradually increased for a length equal to one and one-half times the maximum width of the member until the maximum spacing is reached. In angles having two lines of staggered rivets, in one leg, the pitch on each line may be twice that specified above but not greater than that allowed for the body of the member.

82.248. Edge Distance of Rivets.—The minimum distance from the center of any rivet to a sheared edge shall be:

For $\frac{7}{8}$ " diameter rivets.....	1 $\frac{1}{2}$ "
For $\frac{3}{4}$ " diameter rivets.....	1 $\frac{3}{4}$ "
For $\frac{5}{8}$ " diameter rivets.....	1 $\frac{3}{8}$ "

82.249. The minimum distance from rolled or planned edges, except flanges of beams and channels, shall be:

For $\frac{7}{8}$ " diameter rivets.....	1 $\frac{1}{2}$ "
For $\frac{3}{4}$ " diameter rivets.....	1 $\frac{1}{8}$ "
For $\frac{5}{8}$ " diameter rivets.....	1"

82.250. The maximum distance from any edge shall be eight times the thickness of the thinnest outside plate, but shall not exceed 5".

82.251. Long Rivets.—Long rivets subject to calculated stress and having a grip in excess of $4\frac{1}{2}$ diameters shall be increased at least 1% for each additional $\frac{1}{16}$ " of grip. If the grip exceeds six times the diameter of the rivet, specially designed rivets shall be used.

82.252. Rivets in direct tension shall, in general, not be used. However, where so used their value shall be one-half that permitted for rivets in shear. Countersunk rivets shall not be used in tension.

82.253. Depth Ratios.—Trusses preferably shall have a depth not less than $\frac{1}{10}$ of the span, plate girders a depth not less than $\frac{1}{12}$ of the span, and rolled beams a depth not less than $\frac{1}{20}$ of the span. If less depths than these are used, the sections shall be increased so that the maximum deflection will not be greater than if these limiting ratios had not been exceeded.

82.254. Parts Accessible.—The accessibility of all parts of a structure for inspection, cleaning, and painting shall be insured by the proper proportioning of members and the design of their details.

82.255. Open Sections and Pockets.—Closed sections shall in general be avoided. Pockets or depressions which will retain water shall be avoided as far as possible and those which are unavoidable shall be provided with effective drain holes or shall be effectively filled with waterproof material.

82.256. Details shall be arranged so that the retention of dirt, leaves, or other foreign matter will be reduced to a minimum. Wherever angles are used, either singly or in pairs, they preferably shall be placed with the vertical legs extending downward.

82.257. Symmetrical Sections.—Main members shall be proportioned so that their neutral axes shall be as nearly as practicable in the center of the section.

82.258. In general, the gravity axes of main truss and other important members, meeting to form a joint, shall intersect in a common point so as to avoid eccentricity of stress. In cases of unavoidable eccentricity the members affected thereby shall be proportioned and the connection details designed to resist the stresses produced.

82.259. Effective Area of Angles in Tension.—The effective area of single angles in tension shall be assumed as the net area of the connected leg plus 50% of the area of the unconnected leg.

82.260. The effective area of a double-angle tension member shall be assumed as 80% of the net area of the member unless the end details and

connections are such that the individual angles are held against bending in both directions, in which case the full net area may be used. When the angles connect to separate gusset plates, as in the case of a double-webbed truss, the gusset plates shall be stiffened by diaphragms in the line of the connected angles or by tie plates extending to the ends of the angles if they are to be considered as offering such resistance to bending that the full net area can be used. When the angles are connected back to back on the opposite sides of a single gusset plate, the support may be assumed to be sufficient to allow the use of the full net section.

82.261. Lug angles shall not be considered as effective in transmitting stress.

82.262. Strength of Connections.—Unless otherwise provided, all connections shall be proportioned to develop not less than the full strength of the members connected.

82.263. No connection, except for lacing bars and handrails, shall contain less than three rivets.

82.264. Splices.—Continuous compression members in riveted structures, such as chords and trestle posts, shall have milled ends and full contact bearing at the splices.

82.265. All splices, whether in tension or compression, shall be proportioned to develop the full strength of the members spliced and no allowance shall be made for milled ends of compression members.

82.266. Splices shall be located as close to panel points as possible and, in general, shall be on that side of the panel point which is subjected to the smaller stress and outside of gusset plates.

82.267. The arrangement of the plates, angles or other splice elements shall be such as to make proper provision for the stresses in the component parts of the members spliced.

82.268. Indirect Splices.—In all splice plates not in direct contact with the parts they connect, the number of rivets on each side of the joint shall be in excess of the number which would otherwise be required for a contact splice to the extent of two extra transverse lines for each intervening plate.

82.269. Fillers.—Where indirect splices involve rivets carrying stress and passing through fillers, the fillers shall be extended beyond the splicing material and the extension secured by additional rivets sufficient in number to develop the section of the filler.

82.270. When the filler is less than $\frac{1}{4}$ " thick, the splicing materials shall also be extended.

82.271. Gusset Plates.—Gusset or connecting plates shall be used for connecting all main members, except in pin-connected structures. In proportioning and detailing these plates, the rivets connecting each member shall be located, as nearly as practicable, symmetrically with the axis of the member. However, the full development of the elements of the member shall be given due consideration. The gusset plates shall be of ample thickness to resist shear, direct stress and flexure acting on the weakest or critical section of maximum stress. Reentrant cuts shall be avoided as far as possible.

82.272. Minimum Thickness of Metal.—The minimum thickness of structural steel shall be $\frac{3}{16}$ " except for fillers and railings. However, gusset plates shall not be less than $\frac{3}{8}$ " in thickness.

82.273. Metal subjected to marked corrosive influence shall be increased in thickness.

82.274. Cast steel shall not be less than 1" and cast iron not less than $1\frac{1}{4}$ " thick, except for filler blocks.

82.275. Compression Members.—In built compression members the metal shall be concentrated as much as possible in the webs and flanges, so that the center of gravity of the section may be near the center line of the member as practicable.

82.276. Plates in Compression.—Cover plates of built compression members and cover plates on the compression flanges of plate girders shall have a minimum thickness of one-fortieth, and the web plates of compression members a minimum thickness of one-thirtieth, of the transverse distance between the lines of rivets connecting them to the flanges. However, failing to meet this requirement, the width of plate between the connecting lines of rivets in excess of forty times the thickness for cover plates and thirty times the thickness for web plates, shall not be considered as effective in resisting stress.

82.277. Outstanding Flanges.—Outstanding compression flanges of girders and main compression members shall have a minimum thickness of

one-twelfth of the width of outstanding flange. For lateral bracing and other secondary members this minimum thickness may be one-fourteenth of the width of the outstanding flange.

82.278. Tie Plates.—The open sides of compression members shall be provided with lacing bars and shall have tie plates as near each end as practicable and at intermediate points where the lacing is interrupted. Compression members composed of two angles and cover plates shall have, on their open sides, ties composed of short lengths of channel section with the flanges riveted to the vertical legs of the angles.

82.279. Tension members composed of shapes shall have their separate segments connected by tie plates or by tie plates and lacing bars.

82.280. The thickness of the tie plates shall be not less than one-fiftieth of the distance between the connecting lines of rivets. The tie plates shall be connected by not less than three rivets on each side, and in members having lacing bars the last rivet in the tie plate shall preferably also pass through the end of the adjacent bar.

82.281. For main compression members, the end tie plates shall have a length not less than one and one-half times the perpendicular distance between the lines of rivets connecting them to the member and with a rivet spacing of the preferred minimum and the intermediate tie plates a length not less than that distance. For main tension members the end tie plates shall have the length above specified for end tie plates on main compression members and the length of the intermediate tie plates shall not be less than three-fourths the length specified for intermediate tie plates on compression members. In tension members whose elements are connected by tie plates only, the distance center to center of plates shall not exceed 3'.

82.282. For lateral struts and other secondary members, the length of end and intermediate tie plates shall be not less than three-fourths the perpendicular distance between the lines of rivets connecting them to the member.

82.283. Lacing Bars.—The lacing of compression members shall be proportioned to resist a transverse shear not less than that calculated by the formula:

$$S = 300A.$$

where S = transverse shear, in pounds.

A = gross area of member, in square inches.

82.284. This shear shall be considered as divided equally among all stiffening parts in parallel planes, whether made up of continuous plates or lattice. The stress in the individual lacing bar shall be taken as the component of the shear, in the direction of the bar, in case single lacing is used and half that amount if double lacing is used. The size of the bar shall be determined by the column formula in which L shall be taken as the distance between the connections to the main sections.

82.285. The minimum width of lacing bars shall be:

For $\frac{7}{8}$ " diameter rivets.....	2 $\frac{1}{2}$ "
For $\frac{3}{4}$ " diameter rivets.....	2 $\frac{1}{4}$ "
For $\frac{5}{8}$ " diameter rivets.....	2 $\frac{1}{8}$ "

82.286. Lacing bars having two rivets in each end shall be used for flanges 5" or more in width.

82.287. The minimum thickness of bars shall be one-fortieth of the distance between end rivets in the case of single lacing and one-sixtieth of this distance for double lacing.

82.288. Double lacing, riveted at the intersections, shall be used when the perpendicular distance between rivet lines exceeds 15".

82.289. The inclination of single lacing shall generally be about 60° and for double lacing it shall be about 45° to the axis of the member. Furthermore, the maximum spacing of lacing bars shall be such that the ratio of length to radius of gyration $\left(\frac{L}{r}\right)$ for the portion of single flange between consecutive connections will be smaller than this ratio for the member as a whole.

82.290. Shapes of equivalent strength may be used instead of flats.

82.291. Net Section at Pins.—Pin-connected riveted tension members shall have a net section, both through the pin hole and back of the pin hole, at least 25% in excess of the net section of the body of the member.

82.292. Net Section of Riveted Tension Members.—In calculating the required area of riveted tension members, net sections shall be used in all

cases, and in deducting rivet holes they shall be taken as $\frac{1}{8}$ " larger than the nominal diameter of the rivet.

82.293. The net section shall be the least area which can be obtained by deducting from the gross sectional area, the area of holes cut by any straight or zigzag section across the member, counting the full area of the first hole and a fractional part of each succeeding hole, the fractional part being determined by the formula:

$$x = 1 - \frac{S^2}{4gh}$$

where x = fraction of rivet hole to be deducted.

S = stagger or longitudinal spacing of rivets with respect to rivet on last gage line.

g = distance between gage lines, or transverse spacing.

h = diameter of rivet holes, or nominal diameter of rivet plus $\frac{1}{8}$ ".

82.294. Location of Pins.—Pins shall be located, with respect to the neutral axis of the members, so as to reduce to a minimum secondary stresses due to bending.

82.295. Pin Plates.—Pin plates shall be of sufficient thickness to provide the required bearing area upon the pin; they shall be as wide as the dimensions of the member will allow; and their length, measured from pin center to end, shall be at least equal to the width. Pin plates shall contain sufficient rivets to distribute their due proportion of the pin pressure to the full cross-section of the members; only the rivets located within two lines drawn from the pin center toward the body of the member and inclined at 45° to the axis of the member shall be considered effective for this purpose. In the case of members composed of web plates and flange angles (with or without a cover plate), there shall be at least one outside pin plate covering the vertical legs of the flange angles.

82.296. At the ends of compression members at least one pair of pin plates shall extend not less than 6" beyond the near edge of the tie plate.

82.297. All pin-connected compression members shall be provided with hange plates having a minimum thickness of $\frac{3}{8}$ ".

82.298. Forked Ends.—Forked ends on compression members will be permitted only when unavoidable. When used, a sufficient number of pin plates shall be provided to give each jaw the full strength of the compression member. At least one pair of these plates shall extend to the far edge of the tie plates, and the others not less than 6" beyond the near edge of the tie plates.

82.299. Pins and Pin Nuts.—Pins shall be proportioned for the maximum shears and bending moments by the stresses in the members connected. If there are eyebars among the parts connected, the diameter of the pin shall be not less than two-thirds of the width of the widest bar attached. Pins shall be of sufficient length to secure a full bearing of all parts connected upon the turned body of the pin. They shall be secured in position by hexagonal chambered nuts or by hexagonal solid nuts with washers. Where the pins are bored, through rods with cap washers may be used. In general, malleable castings conforming to the requirements of Material Details, Item 100.28, shall be used for pin nuts. Pin nuts shall be secured by cotters in the screw ends.

82.300. Bolts.—Unless specifically authorized, bolted connections will not be permitted. Bolts, when used, shall be unfinished or turned as specified and shall meet the requirements of Item 50.31.

82.301. Bolts in tension shall have double nuts.

82.302. Upset Ends.—Bars and rods with screw ends shall be upset to provide a cross-sectional area at the root of the thread which shall exceed the net section of the body of the member by at least 15%.

82.303. Sleeve Nuts.—Sleeve nuts shall not be used.

82.304. Expansion.—Provision for expansion and contraction, to the extent of $\frac{1}{8}$ " for each 10' of span, shall be made for all bridges. Expansion ends shall be firmly secured against lifting or lateral movement.

82.305. Expansion Bearings.—Spans of less than 70' may be arranged to slide upon metal plates with smooth surfaces. Spans of 70' and over shall be provided with rollers or rockers or with the special sliding bearings described below. Neither rollers nor rockers shall be used for expansion bearings at the top of trestle posts.

82.306. Fixed Bearings.—Fixed bearings shall be firmly anchored.

82.307. Hinged or Pin Bearings.—Spans of 70' and over shall have hinged or pin bearings at both ends. The pedestals or shoes shall be so designed

that all loads will act through the end pins which will be located directly over the geometrical center of the bearings.

82.308. Rollers.—Expansion rollers shall be not less than 4" in diameter for span lengths of 100' or less and this minimum shall be increased not less than 1" for each additional 100' of span, and proportionally for intermediate lengths. They shall be connected together by substantial side bars and shall be effectually guided so as to prevent lateral movement, skewing, or creeping. The rollers and bearing plates shall be protected from dirt and water as far as possible, and the construction shall be such that water will not be retained and that the roller nests may be inspected and cleaned with the minimum difficulty.

82.309. Rockers.—Pin-bearing expansion rockers shall be of cast steel or cast iron.

82.310. Special Sliding Expansion Bearings.—Sliding plates for the expansion bearings of spans of 70' and over shall be of Class A bronze, as prescribed under item Structural Steel. These plates shall be chamfered at the ends and shall be held securely in position, usually by being inset into the metal of the pedestals and sole plates. Provision shall be made against any accumulation of dirt which will obstruct their movement.

82.311. Pedestals and Shoes.—Pedestals and shoes shall be designed to secure rigidity and stability and to distribute the reaction uniformly over the entire bearing area. Preferably, they shall be made of cast steel or structural steel. The bottom bearing widths shall not exceed the top bearing widths by more than twice the depth of pedestal and, when involving pin bearings, this depth shall be measured from the center of pin.

82.312. Where built pedestals and shoes are used, the web plates and the angles connecting them to the base plates shall be not less than $\frac{1}{2}$ " thick. If the size of the pedestal permits, the webs shall be rigidly connected transversely.

82.313. Inclined Bearings.—For spans on an inclined grade and without pin or hinged bearings, the sole plates shall be beveled so that the substructure bridge seats will be level.

82.314. Anchor Bolts.—Trusses, girders, and I-beam spans shall be securely anchored to their substructures. Anchor bolts shall be roughened by being screw threaded or swedged to secure a satisfactory grip upon the material used to embed them in the holes.

82.315. The following are the minimum requirements for each bearing:

For I-beams spans, the outer beam shall be anchored at each end with two bolts

1" in diameter, set 10" in the masonry.

For girder and truss spans, 50' in length or less, 2 bolts

1" in diameter, set 10" in masonry,

51 to 100' in length, 2 bolts, $1\frac{1}{4}$ " in diameter, set 1' 0" in masonry.

101 to 150' in length, 2 bolts, $1\frac{1}{2}$ " in diameter, set 15" in masonry.

151 to 250' in length, 4 bolts, $1\frac{3}{4}$ " in diameter, set 1' 6" in masonry.

82.316. Anchor bolts subject to tension, as in the column bases of trestle bents and towers, shall be designed to engage a mass of masonry which will secure a resistance equal to one and one-half times the calculated uplift.

FLOOR SYSTEM

82.317. Floorbeams.—Floorbeams preferably shall be at right angles to the trusses or main girders and shall be rigidly connected thereto. In general, floorbeam connections shall be located above the bottom chord, and in riveted work the bottom-chord lateral system shall engage both the bottom chord and the floorbeam. Floorbeam connections to pin-connected trusses preferably shall be above the bottom-chord pins, but, if located below, the vertical posts shall be extended below the pins to secure rigid connections to the floorbeams.

82.318. End Floorbeams.—Except in skew bridges, end floorbeams shall be provided in all truss and girder spans. End floorbeams preferably shall be designed to permit the use of jacks for the future lifting of the superstructure, under which condition the specified unit stresses shall not be exceeded by more than 50%.

82.319. End floorbeams shall be arranged to permit future painting of the sides of the beams adjacent to the abutment backwalls.

82.320. Stringers.—Steel stringers preferably shall be riveted between the floorbeams, with end connections to the floorbeam webs.

82.321. End Struts.—When end floorbeams are not used, the end-panel stringers shall be secured in correct locations by end struts securely connected to the stringers and to the main trusses or girders. The end-panel lateral bracing shall be rigidly attached to the main trusses or girders and shall also be attached to the end struts. Adequate provision shall be made for the expansion movement of stringers.

82.322. End Connections for Floorbeams and Stringers.—The end-connection angles of floorbeams and stringers shall be not less than $\frac{3}{8}$ " in thickness. When milled ends are required, the thickness of connection angles shall be $\frac{1}{16}$ " greater than for connection angles not required to be milled. Except in cases of special end floorbeam details, end connections for floorbeams and stringers shall be made with two angles at each end. Bracket or shelf angles which may be used to furnish support during erection shall not be considered in determining the number of rivets required to transmit end shears.

82.323. End-connection angles shall develop the full depth of the webs by having a length as great as the flanges will permit.

82.324. In the preparation of end-connection details, special care shall be exercised to provide ample clearance for the driving of field connection rivets.

82.325. The use of any type of floorbeam hanger which does not prevent all rotation or longitudinal motion of the floorbeam will not be permitted.

82.326. Expansion Joints.—To provide for expansion and contraction movement, suitable floor expansion joints shall be provided at the expansion ends of all spans and at other points where they may be required.

82.327. Apron plates, when used, shall be designed properly to bridge the joint and to prevent, as far as possible, the deposit of roadway debris upon the bridge seat.

BRACING

82.328. Design of Bracing.—Lateral, longitudinal, and transverse bracing shall be composed of angles or other shapes offering resistance to deformation when subjected to compressive stress, and shall have riveted connections.

82.329. In general, bracing shall consist of a double system of diagonal tension members with transverse compression members. The diagonals in each system shall be proportioned to carry the total lateral stress in tension, the transverse struts (or floorbeams) acting as compression members of both systems.

82.330. All intersections of lateral and sway bracing shall be riveted to add rigidity and prevent deformations.

82.331. Lateral Bracing.—Bottom lateral bracing shall be provided in all bridges except I-beam spans, from which it may be omitted. Bottom laterals preferably shall be supported by rigid hangers at the intersections.

82.332. Top lateral bracing shall be provided in deck spans and in through spans having sufficient headroom.

82.333. Lateral bracing for compression chords shall preferably consist of either two or four angle latticed sections; and so designed as to effectively engage both flanges of the chords.

82.334. Lateral bracing shall have concentric connections to chords at end joints, and preferably throughout. The connections between the lateral bracing and the chords shall be designed to avoid, as far as possible, any bending stress in the truss members.

82.335. Portal and Sway Bracing.—Through truss spans shall have portal bracing, preferably of the two-plane or box type, rigidly connected to the end post and top chord flanges, and constructed as deep as the minimum clearance will allow. When a single-plane portal is used, it preferably shall be located in the central transverse plane of the end posts, with diaphragms between the webs of the posts to provide for a proper distribution of the portal stresses. The portal bracing shall be designed to take the full end reaction of the top-chord lateral system and the end posts shall be designed to transfer this reaction to the truss bearings.

82.336. Deck truss spans shall have adequate sway bracing at the ends and at all intermediate panel points. This bracing shall occupy the full depth of the trusses below the floor system. The bracing shall be proportioned to transfer the end reaction of the top lateral system to the substructure.

82.337. Through truss spans shall have sway bracing at each intermediate panel point if the height of the trusses is such as to permit a depth of 5' or

more for the bracing. When the height of the trusses will not permit of such depth, the top lateral struts shall be provided with knee braces. Top lateral struts shall be at least as deep as the top chord. Sway bracing shall be of ample strength to transfer one-half of the wind pressure to the leeward truss.

82.338. Cross-frames.—Deck plate-girder spans shall be provided with cross-frames at each end proportioned to resist all lateral forces and shall have intermediate cross-frames at intervals not exceeding 15'. These frames shall be connected to the outstanding lags of the stiffener angles and to the girder flanges.

82.339. Low Truss Spans.—The vertical truss members and the floorbeam connections of low truss spans shall be proportioned to resist a lateral force, applied at the top-chord panel points of the truss determined by the following equation:

$$R = 150 (A + P)$$

where R = lateral force in pounds.

A = area of cross-section of chord in square inches.

P = panel length in feet.

82.340. This rigidity may be secured in part by extending one or both of the floorbeam connection angles upward along the inside of the post. Preferably outrigger brackets attached to the vertical posts on the outside of the trusses shall not be used.

82.341. Through Girder Spans.—Through plate-girder spans shall be stiffened against lateral deformations by means of gusset plates, or knee braces with solid webs, attached to the stiffener angles and floorbeams. If the unsupported length of the inclined edge of the gusset plate exceeds sixty times its thickness, the gusset plate shall have stiffener angles riveted along its edge.

82.342. These braces generally shall extend to the clearance line and preferably shall be spaced not farther apart than 15'.

82.343. Railings.—Substantial railings shall be provided along each side of the bridge for the protection of traffic. In general, the railings shall be two classes, viz.:

1. Railings suitable for use on country bridges which are not subject to general pedestrian traffic.

2. Railings for the protection of pedestrians on bridge in cities or villages.

82.344. The top rail of all railings shall be located approximately 3' 6" above the bridge floor and shall be capable of resisting a horizontal force of 100 lb. per linear foot.

82.345. Railings of the first class may consist of not less than two lines of horizontal rails of approved section.

82.346. Railings of the second class shall consist of an upper and lower horizontal rail connected by a suitable web. The clear distance between the floor and the lower rail shall not exceed 6".

82.347. Preferably the unsupported length of any rail section shall not exceed 8' and all connections to posts, truss members, etc. shall contain not less than two rivets each. Ample provision shall be made for movement due to temperature.

PLATE GIRDERS

82.348. Proportioning.—Plate girders shall be proportioned either by assuming the flanges to be concentrated at their centers of gravity or by the moment of inertia of the net section. In the former case one-eighth of the gross area of the web is available as net flange area, but the effective depth shall not be assumed to be greater than the distance back to back of flange angles. For girders having unusual cross-sections, the moment-of-inertia method shall be used.

82.349. Flange Sections.—The gross section of the compression flange shall be not less than the gross section of the tension flange. The compression flange preferably shall be stayed against lateral deflection at intervals not exceeding twelve times its width.

82.350. The flange angles shall form as large a portion of the gross area of the flange as practicable.

82.351. When flange cover plates are used, at least one plate on the top flange shall extend the full length of the girder. Any additional flange cover plates shall be of such length as to allow two rows of rivets to be placed at each end of the plate beyond its theoretical end, and there shall be a sufficient number of rivets at the ends of each plate to develop its full stress value before the theoretical end of the next outside plate is reached.

82.352. Flange cover plates shall be equal in thickness, or shall diminish in thickness from the flange angles outward. No plate shall have a thickness greater than that of the flange angles.

82.353. Web Plates.—Web plates shall be proportioned for both the vertical and horizontal shearing stresses. Splices in web plates shall be avoided as far as possible, but, when used, they shall be designed to develop the full value of the web plate for both bending and shearing stresses.

82.354. Flange Rivets.—The number of rivets connecting the flange angles to the web plates shall be sufficient to develop the increment of flange stress transmitted to the flange angles, combined with any load that is applied directly to the flange. For electric railways, one-wheel load, when applied directly to the flange, shall be assumed to be distributed uniformly over a length of 3'.

82.355. Flange Splices.—Splices in flange members shall not be used except by special permission of the engineer. Two members shall not be spliced at the same cross-section, and if practicable, splices shall be located at points where there is an excess of section. The net section of the splice shall exceed by 10% the net section of the member spliced. Flange angle splices shall consist of two angles, one on each side. Splice angles shall be fitted to secure close contact with the material spliced.

82.356. Web Splices.—Web plates shall be symmetrically spliced by plates on each side. The splice shall be equal in strength to the web in both shear and moment. There shall be at least two rows of rivets on each side of the joint.

82.357. End Stiffeners.—Plate girders shall have stiffener angles over end bearings, the outstanding legs of which shall be as wide as the flange angles will allow and shall fit tightly against them. These end stiffeners shall be proportioned for bearing on the outstanding legs of the flange angles, no allowance being made for the legs fitted to the fillets of the flange angles. End stiffeners shall be arranged to transmit the total end reaction and to distribute it over the bearings. They shall not be crimped and the connection to the web shall contain a sufficient number of rivets to transmit the entire reaction.

82.358. Intermediate Stiffeners.—Intermediate-stiffener angles shall be riveted in pairs to the web of the girder. The outstanding leg of each angle shall have a width of not more than sixteen times its thickness and not less than 2" plus one-thirtieth of the depth of the girder.

82.359. Intermediate stiffeners shall be spaced at intervals not exceeding:

- a. Six feet.
- b. The depth of the web.
- c. The distance given by the formula.

$$d = \frac{t}{40} (12,000 - S)$$

where d = distance between rivet lines of stiffeners in inches.

t = thickness of web in inches.

s = web shear in pounds per square inch at the point considered.

82.360. When the depth of the web between the flange angles or side plates is less than sixty times the web thickness, intermediate stiffeners may be omitted.

82.361. Intermediate-stiffener angles shall be placed at points of concentrated loading and shall be designed to transmit the reactions to the girder web. Such stiffeners shall not be crimped. Other intermediate stiffeners may be crimped.

82.362. Ends of Through Girders.—The upper corners of through plate girders, where exposed, shall be neatly rounded to a radius consistent with the size of the flange angles and the vertical height of the girder above the roadway. The first flange plate or a plate of the same width will be bent around the curve and continued to the bottom of the girder. In a bridge consisting of two or more spans, only the corners on the extreme ends need to be rounded, unless the spans have girders of varying heights, in which case the higher girders shall have their top flanges neatly curved down at the ends to meet the top corners of the girders in the adjacent spans.

82.363. End Bearings.—End bearings of girders on masonry shall be raised above the bridge seat by metal pedestals or plates a height of at least 2".

82.364. Sole and Masonry Plates.—Sole and masonry plates shall each be not less than $\frac{3}{4}$ " thick.

82.365. Camber.—In general, camber will not be required in plate girders except for long spans or special conditions. When used, it shall be sufficient in amount to meet the requirements of the engineer.

TRUSSES

82.366. Main Features.—Preference will be given to trusses with single intersecting web members or other forms of trusses possessing the least ambiguity in computed stresses and the greatest elements of serviceability. Adjustable members in any part of the structure preferably shall be avoided. Members shall be symmetrical about the central plates of trusses and all parts shall be so designed that they can be inspected, cleaned and painted.

82.367. Through riveted and pin-connected spans will generally have inclined end posts. Low truss spans shall be of the riveted type. In low truss spans, laterally unsupported hip joints or "flying hips" shall be avoided.

82.368. Top Chords and End Posts.—Top chords and end posts of low and through truss spans shall be made usually of two side segments with one cover plate and with tie plates and lacing on the open side. In chords of light section, tie plates and lacing may be used in place of a cover plate.

82.369. Top chords of deck trusses subjected to direct loading shall be designed for the cross-bending occasioned by the dead, live, and impact loads of the floor system, in addition to the direct chord stresses, and all top-chord splices shall be proportioned for those stresses and any shearing stresses they may receive. Where the shape of the truss permits, compression chords shall be built continuous, with splices located as near the panel points as possible and preferably on the side subjected to the smaller stress.

82.370. The top-chord sections of low truss spans shall be so proportioned that the radius of gyration about the vertical axis of the member shall be at least one and one-half times the radius of gyration about the horizontal axis.

82.371. Bottom Chords.—The bottom chords of riveted trusses generally shall be spliced outside of gusset plates near panel points and on the side farthest away from the center of the span.

82.372. Bottom chords composed of angles preferably shall be detailed with the vertical legs of the angles extending downward.

82.373. Working Lines and Gravity Axes.—For compression members formed of side segments and a cover plate, the working line shall coincide as nearly as practicable with the gravity axis of the section. For symmetrical sections the working line shall coincide with the gravity axis. For two angle bottom chord or diagonal members, the working line may be taken as the gage line nearest the back of the angle.

82.374. Camber.—Trusses shall in general be given a camber by increasing the length of the top chords an amount in each panel length equal to $\frac{1}{4}$ " for each 10' of their horizontal projection.

82.375. Rigid Members in Pin-connected Trusses.—Pin-connected trusses shall have stiff riveted members in the bottom chords of the first two main panels at each end of the span and all web members performing the function of suspenders shall be of stiff riveted construction.

82.376. Counters and Adjustable Members.—Rigid counters are preferred. Adjustable counters, when used, shall have open turnbuckles and in the design of these members an allowance of 10,000 lb. shall be made for initial stress. Only one set of diagonals in any panel shall be adjustable. Sleeve nuts and loop bars shall not be used.

82.377. Eyebars.—Eyebars shall have a cross-sectional area through the center of the pin hole exceeding that of the body of the bar by at least 40%. The net section adjacent to the head shall be not less than that of the main body of the bar. The thickness of the bar shall be not less than one-eighth of the width and greater than 2". The forms of the head shall be submitted to the engineer for approval before the bars are made. The diameter of the pin shall be not less than two-thirds of the width of the widest bar connected.

82.378. Packing Eyebars.—The eyebars of a set shall be packed symmetrically about the central plane of the truss and as nearly parallel as practicable, but in no case shall the inclination of any bar to the plane of the truss exceed $\frac{1}{8}$ " per foot. Bars shall be packed as closely as practicable and held against lateral movement, but they shall be arranged so that adjacent bars in the same panel will be separated by at least $\frac{1}{4}$ ".

82.379. All intersecting diagonal bars not far enough apart to clear each other at all times shall be well clamped together at intersections.

82.380. Steel filling rings shall be provided, when required, to prevent lateral movements of eyebars or other members connected upon pins.

82.381. Diaphragms.—Diaphragms shall be provided in the trusses at the end connections of all floorbeams. In general, such diaphragms shall extend down to the bottom flange of the floorbeam and for at least two rivet spaces above the top flange.

82.382. The gusset plates engaging the pedestal pin at the end of a truss shall be rigidly connected by a diaphragm which shall, in general, take direct bearing on the pin. Similarly, the pedestal webs shall, where practicable, be connected by diaphragms which shall in general take bearing on the beam.

82.383. A diaphragm shall be provided between gusset plates engaging main members whenever the end tie plate is located at a distance of 4' or more from the point of intersection of the members. In general, the web of this diaphragm shall be located in the plane of the latticed flange.

82.384. Sole and Masonry Plates.—Sole and masonry plates supporting trusses and columns shall each have a thickness of not less than $\frac{3}{4}$ ". The bottom chords of trusses shall be raised above the bridge seat at least 2" by the use of metal plates or pedestals.

VIADUCTS

82.385. Type.—Viaducts shall consist usually of alternate tower spans and free spans of plate girders or riveted trusses supported on trestle towers. However, in viaducts having a column height less than 35', trestle bents may alternate with the towers.

82.386. In viaducts requiring freedom of waterway and in structures having a less total column height than 20', the number of intermediate trestle bents may be increased over that specified above but, in general, shall not exceed four in number. Ample rigidity shall be secured in the attachment of the superimposed spans to the column caps of the bents.

82.387. Bents and Towers.—Each trestle bent shall be composed preferably of two main supporting columns. Towers shall be composed of two bents rigidly braced and strutted both longitudinally and transversely.

82.388. Single Bents.—Where viaduct spans are supported on single bents, such bents, if less than 20' in height, shall be pin connected to their base sections or shall be designed to resist bending.

82.389. Batter.—Columns preferably shall have a transverse batter of not less than 1 horizontal to 12 vertical.

82.390. Depth of Girders.—The depth of plate girders in viaducts preferably shall be uniform.

82.391. Girder Connections.—Girders of tower spans shall be fastened at each end to the tops of the columns or to the cross-girders. Girders between towers shall have one end riveted, and shall be provided with an effective expansion joint at the other end. No bracing or sway frame shall be common to abutting spans.

82.392. Bracing.—Towers shall be thoroughly braced, both transversely and longitudinally, with a double system of stiff tension diagonals with riveted connections. Longitudinal and transverse struts shall be placed at caps and bases and at all intermediate panel points. All bracing connections are to be made by gusset plates.

82.393. Column splices generally shall be located close to and above the panel points of the bracing.

82.394. Horizontal diagonal bracing shall be provided at the tops and bases of towers and at least at all intermediate panel points of the lateral bracing where the tower columns are spliced.

82.395. Provision shall be made in column bearings for expansion of tower bracing. The struts at the base of towers shall be strong enough to slide the movable shoes with the structure unloaded. The coefficient of friction shall be taken at 0.3.

82.396. Sole and Masonry Plates.—Sole and masonry plates shall each be not less than $\frac{3}{4}$ " thick.

82.397. Anchorage.—Viaduct bents preferably shall have a sufficient spread at the base to prevent tension in any windward leg. When this is impracticable, the column anchorages shall be designed safely to resist not less than one and one-half times the calculated uplift.

82.398. Method of Measurement.—The quantities of the various pay items which constitute the structure constructed and completed in accordance with this specification and accepted, shall be measured for payment according to the plans and specifications for the several items, and in terms of the corresponding units prescribed for the several pay items.

82.399. Basis of Payment.—These measured quantities shall be paid for at the contract unit prices bid for the several pay items, which payment and

prices shall be full compensation for furnishing, fabricating, transporting and erecting all materials, for all shop work, painting and field work, for all labor, equipment, tools and incidentals necessary to complete the structures ready for use.

**STANDARD SPECIFICATIONS
FOR
HIGHWAY BRIDGES AND INCIDENTAL STRUCTURES
AMERICAN ASSOCIATION OF STATE HIGHWAY OFFICIALS**

June 1, 1925

Introduction

These standard bridge specifications have been prepared for the purpose of encouraging and promoting a more uniform practice in the design and construction of highway bridges.

The intent has been to put forth specifications susceptible of the widest possible application and in their preparation the existing range of conditions and practices has been carefully studied, and coordinated in all essential elements to the greatest extent practicable.

The specifications have been written primarily to meet the needs of the state bridge engineers for a complete working specification. The requirements, therefore, have been made consistently definite, but it is recognized that, in individual cases, local or sectional limitations may make some modifications necessary.

In scope, the specifications are limited to the field of ordinary highway bridges and do not provide for unusual span lengths and types of construction, for which provision must be made by special or supplemental specifications.

The engineers who, as members of the subcommittee on Bridges and Structures of the American Association of State Highway Officials, have been responsible for their production are as follows:

- E. F. Kelley, U. S. Bureau of Public Roads, Washington, D. C., Chairman.
- E. E. Brandow, State Department of Highways, Pennsylvania, Secretary.
- J. H. Ames, State Highway Commission, Iowa.
- Charles E. Andrew, State Highway Department, Washington.
- W. C. Buetow, Resigned, formerly with State Highway Commission, Wisconsin.
- G. F. Burch, Department of Public Works and Buildings, Illinois.
- W. C. Burnham, State Highway Commission, Oklahoma.
- William L. Craven, State Highway Commission, North Carolina.
- L. N. Edwards, State Highway Commission, Maine.
- J. T. Ellison, State Highway Department, Minnesota.
- William R. Glidden, State Highway Commission, Virginia.
- C. L. Hussey, State Board of Public Roads, Rhode Island.
- C. B. McCullough, State Highway Commission, Oregon.
- Charles A. Mead, State Board of Public Utility Commissioners, New Jersey.
- H. E. Sargent, State Highway Board, Montpelier, Vt.
- S. B. Slack, State Highway Department, Georgia.
- L. G. Smith, State Highway Department, Alabama.
- William J. Titus, State Highway Commission, Indiana.
- M. W. Torkelson, State Highway Commission, Wisconsin.
- H. E. Warrington, Resigned, formerly with State Highway Commission, California.
- G. G. Wickline, State Highway Department, Texas.
- R. B. Wright, U. S. Bureau of Public Roads, Portland, Ore.

SECTION 18

PAVING BLOCKS

Asphalt Blocks

1. **General.**—Asphalt blocks shall be composed of asphaltic cement, mineral aggregate and inorganic dust, as herein specified, thoroughly mixed while hot in such proportions, depending on their character, that the finished blocks shall conform to the specified requirements.

The ingredients of the blocks shall be tested in accordance with the methods provided in the tentative Standard Methods of Sampling and Testing of the American Association of State Highway Officials.

Each bidder shall submit with his bid a specimen block of the size and quality described in these specifications, labeled with the name of the bidder, the name of the manufacturer, and the place of manufacture. Bids not accompanied by specimen blocks will not be accepted.

2. Asphaltic Cement.—The asphaltic cement shall conform to the following requirements:

1. It shall be homogeneous and free from water.
2. Specific gravity $25^{\circ}/25^{\circ}\text{C}$. ($77^{\circ}/77^{\circ}\text{F}$.), not less than 1.00.
3. Flash point: Not less than 190°C . (374°F .).
4. The penetration at 25°C . (77°F .), 100 g., 5 sec. shall be varied to suit climatic and traffic conditions in accordance with the following table:

Traffic	Temperature		
	Low	Moderate	High
Light	15-25	15-25	10-15
Moderate	15-25	15-20	10-15
Heavy	15-20	10-20	5-15

5. Loss on heating: At 163°C . (325°F .), 50 g., 5 hr., not more than 2%.
6. Penetration of residue after heating: At 25°C . (77°F .), 100 g., 5 sec., as compared to penetration before heating, not less than 50%.
7. Ductility: At 25°C . (77°F .), not less than 5.
8. Proportion of bitumen soluble in carbon tetrachloride: not less than 99%.

3. Mineral Aggregate.—The mineral aggregate shall be clean, hard, unweathered trap rock, dolomite, limestone, copper conglomerate, or other suitable material which shall show a percentage of wear of not more than 5%. Its grading shall be such as to produce, with the inorganic dust, the mesh composition hereinafter specified.

4. Inorganic Dust.—The inorganic dust, or filler, shall be produced from sound limestone or other approved material and shall be powdered to such a fineness that 95% shall pass a 30-mesh sieve and not less than 50% shall pass a 200-mesh sieve. Sufficient inorganic dust shall be used to give the mesh composition hereinafter specified.

5. Manufacture of Blocks.—Before being mixed, the asphaltic cement and crushed mineral aggregate shall be heated separately. In no case shall either be heated to a higher temperature than 350°F ., but the temperature of each shall be so regulated that the temperature of the block mixture as delivered to the press molds shall be not less than 225°F .

The mineral aggregate, inorganic dust, and asphaltic cement in the proper proportions shall be thoroughly mixed to produce a homogeneous mass in which all particles are thoroughly coated with asphaltic cement.

The blocks shall receive a compression in the molds of not less than 4000 lb. per square inch, applied on the 5 by 12" surface. After pressing they shall be cooled by passing through water or by other suitable means.

6. Characteristics of Finished Blocks. Size and Shape.—The blocks shall be 5" in width by 12" in lengths unless the depth required is less than 2", in which case they shall be 4" in width by 8" in length. The depth shall be as shown on the plans. A variation either way from these dimensions of $\frac{1}{4}$ " in length or $\frac{1}{8}$ " in width or depth will be sufficient cause for rejection of any block.

Composition.—The composition of the blocks, as delivered on the work, shall conform to the following requirements:

Retained by $\frac{1}{4}$ " screen (circular openings)	not more than 10%
Passing $\frac{1}{4}$ " screen and retained by 20-mesh sieve	30 to 60%
Passing 20-mesh sieve and retained by 100-mesh sieve	15 to 35%
Passing 100-mesh sieve (including all fines)	20 to 40%
Passing 200-mesh sieve	not less than 15%
Bitumen content	6½ to 9%

Specific Gravity.—The blocks shall have a specific gravity of not less than 2.35 at 77°F .

Absorption Test.—The blocks to be tested shall be cleaned of loose particles, carefully weighed, placed in a pressure vessel and subjected to a vacuum

of 23" for 1 hr. at room temperature. While still maintaining the vacuum, water shall then be admitted to the vessel until the blocks are completely immersed, after which the vacuum shall be relieved and water pressure carried up to 100 lb. per square inch and there maintained for 1 hr. The blocks shall then be removed from the vessel and, after mopping off all surface water, shall be carefully weighed. The average of a set of four blocks tested in this manner shall show absorption not exceeding one-half of 1 per cent by weight.

Asphalt-block Wearing Surface

15. General Requirement.—Asphalt-block wearing surfaces for concrete floors shall be placed only after the concrete floor has been thoroughly cured.

16. Materials.—All materials used in the construction of asphalt-block wearing surfaces shall conform to the requirements of Division II. Sand for the mortar bed shall conform to the requirements for Grade B fine aggregate.

17. Preparation of Subfloor.—After the concrete floor slab has been properly cured, and immediately before the mortar bed is placed, the surface of the slab shall be thoroughly hand broomed with stiff-wire or fiber brooms to remove all dust or foreign materials adhering to the surface.

18. Mortar Bed.—The mortar bed shall consist of sand and Portland cement, in the proportion of 1 part cement to 4 parts sand, mixed with sufficient water to moisten the ingredients thoroughly and to make a mortar of such consistency that it can easily be spread upon the foundation and struck with a template to a smooth and even surface. It must not, however, be so soft as to allow the blocks to sink into the mortar when they are placed thereon.

The mortar bed shall be spread on the foundation slab and evenly distributed thereon in a uniform layer $1\frac{1}{2}$ " in thickness. The bed shall be struck to a true surface exactly parallel to the top of the finished pavement in the following manner:

Wooden strips 4" wide by $1\frac{1}{4}$ " thick, or strips of steel 4" wide by $\frac{3}{8}$ to $\frac{3}{16}$ " thick, of a convenient length for handling, shall be carefully set from curb to curb to the exact crown of the pavement and imbedded throughout their length in the mortar, so that the top surface of the strips shall be below the grade of the finished pavement by an amount equal to the thickness of the blocks and not less, on the average, than $\frac{1}{2}$ " above the concrete. An iron-shod straight-edge or striker shall be drawn on two sets of these strips, set as above described, to strike the mortar bed to a true and even surface. The mortar bed shall be showered with fresh mortar and struck off as many times as is necessary to produce a uniformly dense bed, free from depressions or porous spots. Special care shall be exercised to produce a bed of uniform density. As soon as the mortar bed has been struck off, one set of strips shall be taken up and the trench carefully filled with mortar so that it will have the same height and density as the adjacent mortar.

In the case of car tracks, a template to run on the rails shall be used to strike the mortar bed to the required grade between the rails.

19. Laying the Blocks.—Upon the mortar cushion prepared as described above, the blocks shall be immediately laid with close joints and uniform top surface.

The blocks shall be laid by the pavers standing upon the blocks already laid and not upon the bed of mortar, and shall be laid at right angles to the axis of the pavement with such crown as is shown on the plans, and in such a manner that all longitudinal joints shall be broken by a lap of approximately 4". The blocks shall be laid so as to make the lateral joints as tight as possible, consistent with keeping a good alignment across the pavement, and where possible the longitudinal joints shall be immediately closed by pressing each course in the direction of its length with a lever.

After the blocks are laid, any irregularities in the surface of the pavement shall be corrected and the pavement immediately covered with clean, dry sand, all of which shall pass a 10-mesh sieve. The sand shall be spread over the surface and swept into the joints and shall be allowed to remain on the pavement not less than 30 days, or until such time as the action of the traffic on the pavement shall have thoroughly ground the sand into all the joints.

20. Opening to Traffic.—After the pavement is laid and sanded, it shall be protected from all vehicle traffic for a period of at least 7 days and for a longer period if directed by the engineer.

21. Measurement and Payment.—Payment for asphalt-block wearing surfaces shall include the cost of furnishing all materials, equipment, tools, and labor necessary for the satisfactory completion of the work. Payment will be made on the basis of the number of square yards of wearing surface complete in place.

STATE HIGHWAY DEPARTMENT OF TEXAS

Item 84. Culverts and Retaining Walls

84.1. Description.—All concrete and masonry culverts, all pipe culverts, headwalls, and retaining walls shall be built as indicated on the plans, conforming to line, grade, dimensions, and design shown, and in accordance with the specifications for Concrete, Masonry, and Pipe of the several varieties, and other pay items which are to constitute the complete structures.

84.2. Materials and material requirements shall be as prescribed for the several pay items involved.

84.3. Construction Methods.—All foundations shall be inspected and approved by the engineer previous to placing any masonry of footing. All excavations shall be carried to depth of foundation materials satisfactory to the engineer regardless of the elevations shown on the plans, and unsuitable material shall be replaced with approved material if required. If rock bottom is secured, the excavation shall be done in such a manner as to allow the solid rock to be exposed and prepared in horizontal beds for receiving the masonry. All loose and disintegrated rock shall be removed.

84.4. Pipe culverts under the roadbed shall be so placed that the minimum distance from finished grade of roadway to the top of pipe shall be as provided in the following table:

TABLE OF MINIMUM DEPTHS OF GOOD FILL OR BALLAST OVER PIPE
CULVERTS

(On center line of roadway C, and outer edge of shoulder S)

Inside diameter	Cast iron		Vitrified clay and corrugated galvanized metal		Concrete		Inside diameter
	C	S	C	S	C	S	
12"	1' 0"	8"	1' 6"	1' 0"	1' 0"	8"	12"
14"	1' 0"	14"
15"	1' 6"	1' 0"	1' 0"	...	15"
16"	1' 0"	8"	16"
18"	1' 0"	8"	1' 6"	1' 0"	1' 0"	8"	18"
24"	1' 0"	8"	2' 0"	1' 0"	1' 0"	8"	24"
30"	1' 3"	8"	2' 6"	1' 0"	1' 3"	8"	30"
36"	1' 6"	8"	3' 0"	1' 0"	1' 6"	8"	36"
42"	1' 9"	8"	42"
48"	2' 0"	8"	48"

NOTE.—If the material in the fill contains much clay, silt, or loam, increase the above minimum by 4".

84.5. When pipe is of the bell-and-spigot type, the bell end of the pipe shall be laid up grade and all joints shall be made water tight with 1 to 2 Portland-cement mortar. Before succeeding sections of pipe are laid, the lower portion of the hub of the preceding pipe shall be plastered on the inside with cement mortar of sufficient thickness to bring the inner surfaces of the abutting pipes even. After the pipe is laid, the remainder of the joint shall be filled with similar material, and sufficient additional material shall be used to form a bead around the joint. The inside of the joint shall be wiped and finished smooth. After initial set, the cement on the outside shall be protected from the air and sun with an earth covering. The bottom of the trench shall be so shaped as to support each section of the pipe the full length of the body and shall have depressions cut to take

the bell of the pipe. Wherever solid rock occurs in a culvert trench, it shall be excavated to a depth of at least 6" below the pipe and the space thus made refilled with selected fine material. In like manner, earthy material that is not sufficiently firm to support the pipe uniformly shall be excavated and replaced by selected fine material. In refilling the pipe trench the material for backfill shall be free from large stones for a depth of 9" around the pipe, and shall be placed carefully under and around the pipe and tamped to give the pipe a uniform bearing throughout. The ends of all pipe culverts shall be protected by concrete or masonry headwalls unless otherwise ordered by the engineer.

84.6. Method of Measurement.—The quantities of the various pay items which constitute the completed and accepted structures shall be measured for payment according to the plans and specifications for the several items. Only accepted work shall be included and the dimensions used shall be the neat dimensions shown on the plans or ordered in writing.

84.7. Basis of Payment.—The measured quantities, as provided above, shall be paid for at the contract unit prices bid for the several items, which prices shall be full compensation for furnishing, hauling, and placing all material, all labor, equipment, tools, and necessary incidentals. Such payment shall constitute full payment for the completed structure ready for use. Whenever the construction of the new structures involves the removal or demolition of an existing structure, unless otherwise expressly provided, such removal or demolition shall not be paid for directly, but shall be considered a subsidiary work pertaining to excavation or to prescribed pay items involved in the work.

Item 91. Cast-iron Pipe

91.1. Description.—Under this item cast-iron pipe conforming to these specifications, of the sizes and dimensions shown on the plans, shall be furnished and placed as directed.

91.2. Materials.—Cast-iron pipe shall be of good quality, of the bell-and-spigot type, and all pipe shall be made of cast iron of such character as to be strong, tough, of even grain, and soft enough to admit of satisfactory drilling and cutting; the metal shall be made without any admixture of cinder iron and other inferior metal, and the surface of the pipe shall be free from scales, lumps, blisters and holes, and other defects impairing its strength or utility; it shall be solid, round and cast vertical. It shall be in sections not less than 3' in length and with the inner and outer surfaces true concentric cylinders. It may be plain, smooth, and straight cast-iron water pipe or it may be approved corrugated cast-iron or approved rib cast-iron culvert pipe. Corrugations, when present, shall have a pitch of not more than 3" and a depth of not less than 1/2". The pipe shall be heated to 300°F. and coated inside and outside by dipping in coal-tar pitch or varnish.

91.3. The pipe shall have a minimum thickness and weight as shown in the following tables, and no pipe shall be accepted the weight of which is more than 5% less than the weights given:

Inside Diameter, Inches	Plain Cast-iron Pipe	Weight per Foot, Pounds
	Minimum Thickness, Inches	
12	5/8	50
16	7/8	75
18	1 1/8	85
24	1 3/8	145
30	1 5/8	180
36	1 7/8	250

Corrugated or Ribbed Cast-iron Pipe

Inside Diameter, Inches	Minimum Thickness, Inches	Weight per Foot, Pounds
16	1 1/4	60
18	1 1/2	65
24	1 5/8	90
30	1 7/8	115
36	2	135

91.4. The pipe shall have sufficient strength so that when tested with the three-point standard crushing test, as prescribed in the *Bulletin* 1216, it will show a load-supporting capacity in pounds per linear foot of at least 1500*D*, where *D* equals the inside diameter of the pipe in feet.

91.5. Pipe weighing 5% or more less than the required standard weight shall be rejected.

91.6. Each section of cast-iron pipe shall be coated inside and outside with coal-tar pitch varnish, to which sufficient linseed oil has been added to make a smooth coat, tough and tenacious when cold, and with no tendency to scale off.

91.7. Method of Measurement and Basis of Payment.—This item shall be paid for at the contract prices bid per linear foot of Cast-iron Pipe of the several sizes measured complete in place, which prices shall be full compensation for furnishing, hauling, and installing the pipe, for preparation of bed and backfilling, and for all material, equipment, tools, labor, and incidentals necessary to complete the work, but shall not be payment for excavation nor for concrete or masonry headwalls.

Item 92. Corrugated Galvanized Metal Pipe

92.1. Description.—This item shall consist of furnishing and placing corrugated galvanized metal pipe conforming to these specifications. The pipe shall be furnished of the sizes and dimensions required and shall be installed at such places as shown on the plans or as designated by the engineer in accordance with these specifications, and in conformity with the lines and grades given.

92.2. Materials.—Corrugated metal pipe shall be fabricated from corrugated sheets, the base metal of which shall be made by the open-hearth process. The base metal in the finished sheets shall conform to the following chemical requirements:

The total amount of carbon, phosphorus, sulphur, manganese and silicon shall not exceed 0.7%. If the total of these five elements equals or exceeds 0.20%, the metal shall contain not less than 0.17% of copper and not more than 0.06% of sulphur. If the total of these five elements is less than 0.20%, the presence of copper is optional and sulphur shall not exceed 0.04%.

NOTE.—A permissible variation of 0.04% will be allowed for total impurities and 0.01% for sulphur in analysis of finished sheet.

92.3. Rivets.—All rivets shall be of the same material as the base metal specified for the corrugated sheets. They shall be thoroughly galvanized or sherardized.

92.4. Weight Tolerance.—The average weight per square foot of the culvert sheets, as determined by weighing in lots not exceeding 6000 lb., shall not vary from the theoretical weight by more than 5% either way for each lot of one gage or size.

92.5. Spelter.—The base metal sheets shall be uniformly galvanized on both sides by the hot process. A uniform coating of Prime Western Spelter shall be applied at the rate of not less than 2 oz. per square foot of metal. If the average spelter coating as determined from samples shows less than 2 oz. of spelter per square foot of metal, or if any one sample shows less than 1.8 oz. of spelter per square foot of metal, the shipment shall be rejected. Sheets having blister spots, holes, or other imperfections in the galvanizing after corrugating shall be rejected.

92.6. Bidders shall state in the proposal the typical chemical composition, brand of metal, trade name, and name of manufacturer of the material to be furnished.

92.7. No metal shall be accepted under these specifications and no bids shall be considered for the materials above described until after the sheet manufacturer's certified analysis and manufacturer's guarantee shall have been passed upon by the engineer and accepted.

92.8. Misbranding, or other misrepresentation, and non-uniformity of product shall each be considered a sufficient reason to discontinue the acceptance of any brand under these specifications, and the notice of discontinuance of any brand sent to the sheet manufacturer shall be considered to be notice to any culvert companies which handle that particular brand.

92.9. The manufacturer of each brand shall file with the engineer a certificate setting forth the name or brand of metal to be furnished and a typical analysis showing the percentage of each of the five above-mentioned chemical elements. The certificate shall be sworn to for the manufacturing company by a person having legal authority to bind the company.

92.10. The manufacturer of the sheets shall submit with the certified analysis a guarantee providing that all metal furnished shall conform to the certified analysis filed, shall bear a suitable identification brand or mark, and shall be replaced without cost to the purchaser when not in conformity with the specified analysis, gage, or spelter coating, and the guarantee shall

be so worded as to remain in effect as long as the manufacturer continues to furnish material.

92.11. No culverts shall be accepted unless the metal is identified by a stamp on each section showing:

1. Name of sheet manufacturer.
2. Name of brand.
3. The gage.

92.12. The identification brands shall be placed on the sheets by the manufacturers of the sheets, in such a way that when rolled into culverts such identification shall appear on the outside of each section of each pipe. Pipe having any section not so stamped shall be promptly rejected.

92.13. Laboratory tests shall follow the methods of the U. S. Department of Agriculture *Bulletin* 1216. The analysis made by the chemists or inspection bureau designated or approved by the engineer shall be taken as final, but before any considerable shipment is rejected, a check analysis shall be made.

92.14. If the engineer so elects, he may have the material inspected at the rolling mill or the culverts inspected in the shop where they are fabricated. He may require a chemical analysis from the mill for any heat and also a physical test of the properties of the metal taken from any heat, to be made by the mill. The inspection both at the mill and at the shop shall be made under the direction of the engineer. The engineer, or his representative, shall have free access to the mill or shop for inspection purposes, and every facility shall be extended to him for this purpose. Any material or pipe included in any shipment which has been rejected at the mill or shop will be considered sufficient cause for the rejection of the entire shipment.

92.15. All rivets shall be driven cold in such a manner that the plates shall be drawn tightly together throughout the entire lap. No rivet shall be closer than twice its diameter from the edge of the metal. All rivets shall have neat, workmanlike, and full hemispherical heads or heads of a form acceptable to the engineer, shall be driven without bending, and shall completely fill the hole. Longitudinal seams of 30 and 36" pipe shall be double riveted. Circumferential shop-riveted seams shall have a maximum rivet spacing of 6" and shall lap at least one full corrugation, except that six rivets will be sufficient in 12" pipe.

92.16. If a band is used for end finish, it shall be riveted around the end of the culvert with rivets at intervals of 10" or less. This band shall be of galvanized metal equivalent in cross-section to $\frac{3}{8}$ by 1" for 16-gage metal, $\frac{3}{8}$ by $1\frac{1}{2}$ " for 14-gage and 12-gage metal.

SPECIAL CONSTRUCTION

92.17. **Shape.**—Pipe furnished under these specifications shall be of the full-circle riveted type, with lap-joint construction.

92.18. **Minimum Sizes Admitted.**—For farm-entrance crossings, the minimum diameter of pipe shall be 12". For roadway culverts, the minimum diameter permitted shall be 15".

92.19. **Dimensions and Weights.**—The length of sheets and widths of lap shall be as shown in the following table. The dimension given in diameter for pipe is nominal.

The gage of the uncoated metal and weight per foot of the finished culvert shall not be less than specified in the table. All gages given are United States Standard Gage (U. S. S. G.) and the maximum variation allowable in any sheet is 5% either way from the theoretical weight. The total weight of any shipment of 100 sheets or more shall not underrun the theoretical weight by more than 2%.

Nominal diameter, inches	Minimum gage U. S. Standard, uncoated metal	Weight per foot, finished culvert, pounds
12	16	10.8
15	16	13.1
18	16	15.7
21	14	22.6
24	14	25.4
30	14	31.9
36	12	52.0

92.20. Net Length of Culvert Pipe.—The length of culvert specified shall be the net length of the finished culvert, which does not include any material used to procure an end finish on the pipe. If the average deficiency in length of any shipment of pipe is greater than 1%, the shipment shall be rejected.

92.21. Lengths of Sections.—All pipe shall be furnished in the lengths ordered, except that pipe for culverts 26' or more in length may be furnished in sections not less than 12' in length. Where bands or couplings are required, a separate unit price shall be submitted for each size necessary; such price to cover material and installation. For small shipments involving less than carload lots, the above requirements may be modified by written authorization from the engineer.

92.22. Corrugations.—Corrugations shall be not less than $2\frac{1}{4}$ " nor more than $2\frac{3}{4}$ " center to center. The corrugations shall have a depth of not less than $\frac{1}{4}$ ".

92.23. Field joints shall be made with bands of the same material as the culvert, and shall be not less than $7\frac{1}{2}$ " wide, so constructed as to lap an equal portion of each of the culvert sections to be connected. Such bands shall be connected at the ends by angles having minimum dimensions of $1\frac{1}{2}$ by $1\frac{1}{2}$ by $\frac{3}{8}$ ", and of length equal to full width of band, or by other approved connections of suitable strength. Each connection shall be fastened by at least two bolts not less than $\frac{1}{2}$ " in diameter. All such connections shall be made of galvanized metal of the same quality as the base metal in the culvert.

92.24. It is the essence of these specifications that, in addition to compliance with the details of construction, the completed pipe shall show careful, finished workmanship in all particulars.

92.25. Culvert pipe on which the spelter coating has been bruised or broken either in the shop or in shipping, or which shows defective workmanship, shall be rejected. This requirement shall apply not only to the individual pipe but to the shipment on any contract as a whole. Among others, the following defects are specified as constituting poor workmanship, and the presence of any or all of them in any individual culvert pipe or, in general, in any shipment, shall constitute sufficient cause for rejection:

- Uneven laps.
- Elliptical shaping.
- Variation from a straight center line.
- Ragged or diagonal sheared edges.
- Loose, unevenly lined or spaced rivets.
- Poorly formed rivet heads.
- Unfinished ends.
- Illegible brands.
- Lack of rigidity.
- Bruised, scaled or broken spelter coating.
- Dents or bends in the metal itself.

92.26. The field inspection shall be made by the engineer, who shall be furnished by the contractor with an itemized statement of the sizes and lengths of culvert pipe in each shipment. This inspection shall include an examination of the culvert pipe for deficiencies in lengths of sheets used, nominal specified diameter, net length of finished culvert pipe, and any evidence of poor workmanship as outlined above. The inspection may include the taking of samples for chemical analysis and determination of weight of spelter coating. The inspection shall be made promptly upon notification by the contractor of the arrival of the material.

92.27. The pipe making up the shipment shall fully meet the requirements of these specifications, and if 50 % of the pipe in any shipment fails to meet these requirements, the entire shipment may be rejected.

92.28. When samples are taken for chemical analysis and determination of weight of spelter coating, at least one sample from which a specimen $2\frac{1}{4}$ " square may be prepared shall be selected from each ten culverts of a shipment, and not less than three samples shall represent any one shipment.

92.29. The pipe shall be laid in the trench with the separate sections firmly joined together and with outside laps of circumferential joints pointing up stream and with longitudinal laps on the sides. Any metal in joints which is not thoroughly protected by galvanizing shall be coated with a suitable asphaltum paint.

92.30. Method of Measurement and Basis of Payment.—This item shall be paid for at the contract prices bid per linear foot of Corrugated Galvanized

Metal Pipe of the several sizes measured complete in place, which price shall be full compensation for furnishing, hauling, and installing the pipe, for preparation of bed and backfilling, and for all material, equipment, tools, labor, and incidentals, but shall not be payment for excavation nor for concrete or masonry headwall.

Item 93. Vitrified Clay Pipe

93.1. Description.—Under this item vitrified clay pipe conforming to these specifications, of the sizes and dimensions shown on the plans, shall be furnished and placed as directed.

93.2. Materials and Manufacture.—Vitrified clay pipe shall be of the hub-and spigot type, of first quality, sound, thoroughly and perfectly burned, without warps, cracks, or other imperfections, and shall be fully and smoothly glazed over the entire inner and outer surfaces, except that the inside of the hub and the outside of the spigot may be unglazed for two-thirds of the depth of the hub. On all other portions of the pipe, the glazing shall completely cover and form an integral part of the pipe body. If glazed, the inside of the hub and the outside of the spigot shall be scored in three parallel lines extending completely around the circumference. This pipe shall be manufactured of a suitable temperature to secure a tough, vitreous material which, when broken, shall show a tense and solid body, without detrimental cracks or laminations. It shall be of such toughness that it may be cut with a chisel and hammer, and when struck with a hammer shall give a metallic ring.

93.3. The pipe shall have sufficient strength so that when tested with the three-point standard crushing test, as prescribed in the U. S. Department of Agriculture *Bulletin* 1216, it will show a load-supporting capacity in pounds per linear foot of at least $1500D$, where D equals the inside diameter of the pipe in feet.

93.4. The minimum length of sections, thickness, and the depth of hub shall be as follows:

Size, inches	Minimum length, feet	Thickness, inches	Depth of hub, inches
12	2	1	3
15	2	1 1/4	3
18	2	1 1/2	3 1/4
20	2	1 3/8	3 1/2
22	2	1 5/8	3 3/4
24	2	2	4
27	2 1/2	2 1/4	4
30	2 1/2	2 1/2	4
33	2 1/2	2 3/4	5
36	2 1/2	2 3/4	5
42	2 1/2	3 1/2	5

93.5. Method of Measurement and Basis of Payment.—This item shall be paid for at the contract prices bid per linear foot of Vitrified Clay Pipe of the several sizes measured complete in place, which prices shall be full compensation for furnishing, hauling, and installing the pipe, for preparation of bed and backfilling, and for all material, equipment, tools, labor, and incidentals necessary to complete the work, but shall not be payment for excavation or for concrete or masonry headwalls.

Item 94. Relaying Culvert Pipe

94.1. Description.—This item shall consist of the careful removal and preserving of pipe from existing pipe culverts as ordered and relaying the same as shown on the plans or as designated by the engineer in accordance with these specifications for the type of pipe involved and in conformity with the lines and grades given.

94.2. Method of Measurement.—This item shall be measured by the actual number of linear feet of pipe complete in place as required.

94.3. Basis of Payment.—This item measured as provided above shall be paid for at the contract unit price bid per linear foot for Relaying Culvert

Pipe 18" diameter and under or Relaying Culvert Pipe over 18" diameter, as the case may be, which price shall be full compensation for the removal, preservation, and relaying of the pipe, all new material necessary except pipe, all labor, equipment, tools, and incidentals necessary to complete the work, but shall not be payment for excavation, nor for concrete or masonry headwalls.

Item 101. Sodding

101.1. Description.—This item shall consist of providing and planting approved live sod on earth slopes or shoulders, when and as directed for protection against erosion.

101.2. The sods shall be of suitable size, variety, and character for the purpose selected and for the soil upon which they are to be planted, for vigorous and hardy growth, and approved by the engineer.

101.3. On embankments constructed on soil which is easily eroded or on sections subject to overflow, and where climatic conditions are favorable to the easy rooting of Bermuda Grass, Rescue Grass, Bur Clover, or Japanese Clover and if in the opinion of the engineer it is necessary, the contractor shall provide and plant as directed, such sods, or tufts of some suitable grass.

101.4. Where sodding is to be done, tufts of suitable grass shall be placed on slope just underneath the shoulder line so as to form one continuous strip of turf 3" wide and on remainder of slope and upon shoulders similar tufts of grass about 3" in diameter shall be spaced approximately 12" center to center in rows. Sodding shall be done at such times as the engineer may direct and in such manner that the grass will at once take root.

101.5. Basis of Payment.—Sodding completed and accepted by the engineer will be paid for at the contract unit price bid per 100 lin. ft. of roadway sodded on both sides to the width required by the engineer, which price shall be full compensation for furnishing and planting the sod, all labor, equipment, tools, and incidentals necessary to complete the work. The average width of sodding for the unit price bid shall be construed to mean an average width of not over 30'.

PART IV

GENERAL TABLES AND FORMULÆ

CONVERSION TABLE

Linear Units

Old Surveyors' Units

1 link	= 7.92 in.
100 links	= 1 chain = 66 ft.
25 links	= 1 rod = 16.5 ft.

Ordinary Measure

12 in.	= 1 ft.
3 ft.	= 1 yd.
5280 ft.	= 1 mile

Square Units

1 sq. ft.	= 144 sq. in.
1 sq. yd.	= 9 sq. ft.
	= 1296 sq. in.
1 acre	= 43,560 sq. ft.
	= 4840 sq. yds.
1 sq. mile	= 27,878,400 sq. ft.
	= 3,097,600 sq. yds.
	= 640 acres

Volume Units

1 cu. ft.	= 1728 cu. in.
	= 7.4805 ordinary gal.
	= 6.32 Imperial gal.
1 cu. yd.	= 27 cu. ft.
	= 46,656 cu. in.
1 ordinary gal.	= 231 cu. in.
1 Imperial gal.	= 277 cu. in.
1 barrel	= 31.5 gal.
	= 4.21 cu. ft.

Weight Units

1 pound	= 16 ounces
1 ordinary ton	= 2000 pounds
1 long ton	= 2240 pounds

Temperature Units

Freezing point of water	= 32° Fahrenheit
	= 0° Centigrade
Boiling point of water at normal air pressure	= 212° Fahrenheit
	= 100° Centigrade
1 degree Fahrenheit	= 0.5556 degree Centigrade
1 degree Centigrade	= 1.8 degrees Fahrenheit

TABLE OF EQUIVALENTS OF INCHES AND FRACTIONS OF INCHES IN DECIMALS OF A FOOT

In.	0 In.	1 In.	2 In.	3 In.	4 In.	5 In.
		.0833	.1667	.2500	.3333	.4167
$\frac{1}{32}$.0026	.0859	.1693	.2526	.3359	.4193
$\frac{1}{16}$.0052	.0885	.1719	.2552	.3385	.4219
$\frac{3}{32}$.0078	.0911	.1745	.2578	.3411	.4245
$\frac{1}{8}$.0104	.0938	.1771	.2604	.3438	.4271
$\frac{3}{32}$.0130	.0964	.1797	.2630	.3464	.4297
$\frac{1}{6}$.0156	.0990	.1823	.2656	.3490	.4323
$\frac{5}{32}$.0182	.1016	.1849	.2682	.3516	.4349
$\frac{1}{4}$.0208	.1042	.1875	.2708	.3542	.4375
$\frac{3}{32}$.0234	.1068	.1901	.2734	.3568	.4401
$\frac{1}{6}$.0260	.1094	.1927	.2760	.3594	.4427
$\frac{5}{32}$.0286	.1120	.1953	.2786	.3620	.4453
$\frac{3}{8}$.0313	.1146	.1979	.2813	.3646	.4479
$\frac{1}{2}$.0339	.1172	.2005	.2839	.3672	.4505
$\frac{5}{16}$.0365	.1198	.2031	.2865	.3698	.4531
$\frac{3}{8}$.0391	.1224	.2057	.2891	.3724	.4557
$\frac{1}{2}$.0417	.1253	.2083	.2917	.3750	.4583
$\frac{5}{16}$.0443	.1276	.2091	.2943	.3776	.4609
$\frac{3}{8}$.0469	.1302	.2135	.2969	.3802	.4635
$\frac{7}{16}$.0495	.1328	.2161	.2995	.3828	.4661
$\frac{5}{8}$.0521	.1354	.2188	.3021	.3854	.4688
$\frac{3}{4}$.0547	.1380	.2214	.3047	.3880	.4714
$\frac{7}{8}$.0573	.1406	.2240	.3073	.3906	.4740
$\frac{15}{16}$.0599	.1432	.2266	.3099	.3932	.4766
$\frac{3}{4}$.0625	.1458	.2292	.3125	.3958	.4792
$\frac{7}{8}$.0651	.1484	.2318	.3151	.3984	.4818
$\frac{15}{16}$.0677	.1510	.2344	.3177	.4010	.4844
$\frac{15}{16}$.0703	.1536	.2370	.3203	.4036	.4870
$\frac{7}{8}$.0729	.1563	.2396	.3229	.4063	.4896
$\frac{15}{16}$.0755	.1589	.2422	.3255	.4089	.4922
$\frac{15}{16}$.0781	.1615	.2448	.3281	.4115	.4948
$\frac{15}{16}$.0807	.1641	.2474	.3307	.4141	.4974

ONVERSION TABLE

1575

EQUIVALENTS OF INCHES AND FRACTIONS OF INCHES IN DECIMALS OF A FOOT

In.	6 In.	7 In.	8 In.	9 In.	10 In.	11 In.
	.5000	.5833	.6667	.7500	.8333	.9167
$\frac{1}{12}$.5026	.5859	.6693	.7526	.8359	.9193
$\frac{1}{16}$.5052	.5885	.6719	.7552	.8385	.9219
$\frac{1}{8}$.5078	.5911	.6745	.7578	.8411	.9245
$\frac{1}{4}$.5104	.5938	.6771	.7604	.8438	.9271
$\frac{3}{16}$.5130	.5964	.6797	.7630	.8464	.9297
$\frac{1}{2}$.5156	.5990	.6823	.7656	.8490	.9323
$\frac{5}{8}$.5182	.6016	.6849	.7682	.8516	.9349
$\frac{3}{4}$.5208	.6042	.6875	.7708	.8542	.9375
$\frac{7}{8}$.5234	.6068	.6901	.7734	.8568	.9401
$\frac{15}{16}$.5260	.6094	.6927	.7760	.8594	.9427
$\frac{1}{1}$.5286	.6120	.6953	.7786	.8620	.9453
$\frac{1}{2}$.5313	.6146	.6979	.7813	.8646	.9479
$\frac{3}{4}$.5339	.6172	.7005	.7839	.8672	.9505
$\frac{5}{8}$.5365	.6198	.7031	.7865	.8698	.9531
$\frac{7}{8}$.5391	.6224	.7057	.7891	.8724	.9557
$\frac{1}{2}$.5417	.6250	.7083	.7917	.8750	.9583
$\frac{3}{4}$.5443	.6276	.7109	.7943	.8776	.9609
$\frac{5}{8}$.5469	.6302	.7135	.7969	.8802	.9635
$\frac{7}{8}$.5495	.6328	.7161	.7995	.8828	.9661
$\frac{1}{2}$.5521	.6354	.7188	.8021	.8854	.9688
$\frac{3}{4}$.5547	.6380	.7214	.8047	.8880	.9714
$\frac{5}{8}$.5573	.6406	.7240	.8073	.8906	.9740
$\frac{7}{8}$.5599	.6432	.7266	.8099	.8932	.9766
$\frac{1}{2}$.5625	.6458	.7292	.8125	.8958	.9792
$\frac{3}{4}$.5651	.6484	.7318	.8151	.8984	.9818
$\frac{5}{8}$.5677	.6510	.7344	.8177	.9010	.9844
$\frac{7}{8}$.5703	.6536	.7370	.8203	.9036	.9870
$\frac{1}{2}$.5729	.6563	.7396	.8229	.9063	.9896
$\frac{3}{4}$.5755	.6589	.7422	.8255	.9089	.9922
$\frac{5}{8}$.5781	.6615	.7448	.8281	.9115	.9948
$\frac{7}{8}$.5807	.6641	.7474	.8307	.9141	.9974

TABLE OF AREAS AND VOLUMES

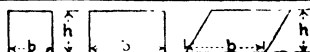

Squares, Rectangles, and Parallelograms. Area = bh

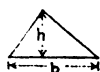

Triangles



Area = $\frac{1}{2}bh$

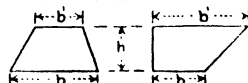

Trapezoids

Area = $\frac{b + b'}{2}h$

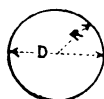

Circles

$$\text{Area} = \pi R^2 = \frac{\pi D^2}{4}$$

Circumference of Circle = $2\pi R = \pi D$

Commonly used value of $\pi = 3.1416$

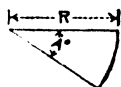

Sector of Circle

$$\text{Area} = \pi R^2 \frac{A^\circ}{360^\circ}$$

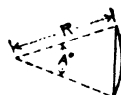

Segment of a Circle

$$\text{Area} = \left(\pi R^2 \frac{A^\circ}{360^\circ} \right) - \left(R \sin \frac{A}{2} \right) \left(R \cos \frac{A}{2} \right)$$

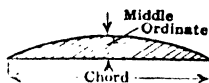

Area of Parabolic Segment

Area = $\frac{2}{3}$ Middle Ordinate \times Chord.

Volumes

Cubes, Rectangular Prisms, Parallelepipeds, Cylinders, etc. All solids having parallel bases and a constant cross-section.

Volume = area of base \times perpendicular height between the planes of the bases.

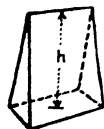
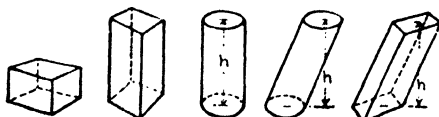

Wedges. Having parallel ends.

Volume = area of base $\times \frac{1}{3}$ the height perpendicular to the plane of the base.

Cones and Pyramids, whether right or oblique, regular or irregular.

Volume = $\frac{1}{3}$ area of the base \times height perpendicular to the plane of the base

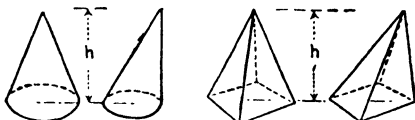

Frustums of Pyramids or Cones, whether right or oblique, regular or irregular provided the base and top are parallel.



Volume = $\frac{1}{3}$ perpendicular height between base and top \times (area_{top} + area_{base} + $\sqrt{\text{area}_{\text{top}} \times \text{area}_{\text{base}}}$)
or by the prismoidal formula

Volume = $\frac{1}{6}$ perpendicular height \times (area_{top} + area_{base} + $\frac{4 \times \text{area of section parallel to and midway between base and top}}$)

Prismoidal Formula

Trautwine defines a prismoid as a solid having for its ends two parallel plane figures connected by other plane figures on which and through every point of which a straight line may be drawn from one of the two parallel ends to the other. These connecting planes may be parallelograms or not and parallel to each other or not. This includes cubes, all parallelpipeds, prisms, cylinders, pyramids, cones, and their frustums, provided the top and base are parallel and wedges.

The prismoidal formula applies to all these solids either alone or to any form that can be separated into units of the above forms.

Prismoidal formula

$$\text{Volume} = h \times \frac{A + a + 4M}{6}$$

h = perpendicular distance between the parallel ends

A = area of one of the parallel ends

a = area of the other parallel end

M = area of a cross-section midway between and parallel to the two parallel ends

Sphere

$$\text{Volume} = \frac{4}{3} \pi R^3 = 4.1888 R^3$$

$$= \frac{1}{6} \pi D^3 = 0.5236 D^3$$

In which R = radius of sphere

D = diameter of sphere

TABLE OF TRIGONOMETRIC FUNCTIONS AND THE SOLUTION OF TRIANGLES

In the accompanying figure the trigonometric functions of the angle A between the lines BA and AC are as follows;

$$\begin{aligned}\sin A &= \frac{BC}{AB} \\ \cos A &= \frac{AC}{AB} \\ \tan A &= \frac{BC}{AC} \\ \cot A &= \frac{AC}{BC} \\ \sec A &= \frac{AB}{AC} \\ \operatorname{cosec} A &= \frac{AB}{BC} \\ \operatorname{ex-sec} A &= \frac{BE}{BC}\end{aligned}$$

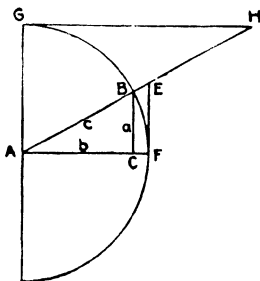

In the right-angled triangle ABC let a equal the side BC opposite the angle A ; let b equal the side AC opposite the angle B ; let c equal AB , the side opposite the angle C .

Let $C = 90^\circ$

The following formulæ apply to right-angled triangles:

<i>Angles.</i>	$A + B + C = 180^\circ$	<i>Sides.</i>	$a = c \sin A = b \tan A$
	$A + B = 90^\circ$		$a = \sqrt{(c+b)(c-b)}$
	$A = 90^\circ - B$		$b = c \cos A = \frac{a}{\tan A}$
	$B = 90^\circ - A$		

$$\begin{aligned}\sin A &= \frac{a}{c} \\ \cos A &= \frac{b}{c} \\ \tan A &= \frac{a}{b}\end{aligned}$$

Area

$$\text{area} = \frac{a b}{2}$$

$$\begin{aligned}b &= \sqrt{(c+a)(c-a)} \\ c &= \frac{a}{\sin A} = \frac{b}{\cos A} \\ c &= \sqrt{a^2 + b^2}\end{aligned}$$

Oblique Triangles.

Note. Where an angle is more than 90° its sine, cosine, and tangent are equal to that of the angle ($180^\circ -$ the angle in question); that is, if the sine of 120° is desired take the sine of ($180^\circ - 120^\circ$) = 60° .

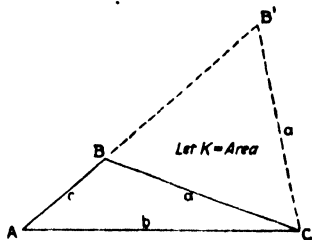

Given	Desired	Formulae
A, B, a	C, b	$C = 180 - (A + B); b = \frac{a}{\sin A} \cdot \sin B$
	c, K	$c = \frac{a}{\sin A} \sin (A + B); K = \frac{a^2 \sin B \sin C}{2 \sin A}$
A, a, b	B, C	$\sin B = \frac{\sin A}{a} b; C = 180^\circ - (A + B)$
	c	$c = \frac{a}{\sin A} \sin C$ Two solutions are possible with B' as an acute angle and B as an obtuse angle
C, a, b	$\frac{1}{2} (A+B)$	$\frac{1}{2} (A+B) = 90^\circ - \frac{1}{2} C$
	$\frac{1}{2} (A-B)$	$\tan \frac{1}{2} (A-B) = \frac{a-b}{a+b} \tan \frac{1}{2} (A+B)$
	A, B	$A = \frac{1}{2} (A+B) + \frac{1}{2} (A-B)$ $B = \frac{1}{2} (A+B) - \frac{1}{2} (A-B)$
	c	$c = (a-b) \frac{\sin \frac{1}{2} (A+B)}{\sin \frac{1}{2} (A-B)}$
	K	$K = \frac{1}{2} ab \sin C$
a, b, c	B	In the following formula $s = \frac{1}{2} (a + b + c)$ $\sin \frac{1}{2} B = \sqrt{\frac{(s-a)(s-c)}{ac}}$ $\sin B = \frac{2 \sqrt{s(s-a)(s-b)(s-c)}}{ac}$
	K	$K = \sqrt{s(s-a)(s-b)(s-c)}$

TABLE OF SQUARES, CUBES, SQUARE ROOTS, CUBE ROOTS, CIRCUMFERENCES AND CIRCULAR AREAS OF NOS. FROM 1 TO 520

No.	Square	Cube	Sq. Root	Cube Root	CIRCLE	
					Circum.	Area
1	1	1	1.0000	1.0000	3.142	0.7854
2	4	8	1.4142	1.2599	6.283	3.1416
3	9	27	1.7321	1.4422	9.425	7.0686
4	16	64	2.0000	1.5874	12.566	12.5664
5	25	125	2.2361	1.7100	15.708	19.6350
6	36	216	2.4495	1.8171	18.850	28.2743
7	49	343	2.6458	1.9129	21.991	38.4845
8	64	512	2.8284	2.0000	25.133	50.2655
9	81	729	3.0000	2.0801	28.274	63.6173
10	100	1000	3.1623	2.1544	31.416	78.5398
11	121	1331	3.3166	2.2240	34.558	95.033
12	144	1728	3.4641	2.2894	37.699	113.097
13	169	2197	3.6056	2.3513	40.841	132.732
14	196	2744	3.7417	2.4101	43.982	153.938
15	225	3375	3.8730	2.4662	47.124	176.715
16	256	4096	4.0000	2.5198	50.265	201.062
17	289	4913	4.1231	2.5713	53.407	226.980
18	324	5832	4.2426	2.6207	56.549	254.469
19	361	6859	4.3589	2.6684	59.690	283.529
20	400	8000	4.4721	2.7144	62.832	314.159
21	441	9261	4.5826	2.7589	65.973	346.361
22	484	10648	4.6904	2.8020	69.115	380.133
23	529	12167	4.7958	2.8439	72.257	415.476
24	576	13824	4.8990	2.8845	75.398	452.389
25	625	15625	5.0000	2.9240	78.540	490.874
26	676	17576	5.0990	2.9625	81.681	530.929
27	729	19683	5.1962	3.0000	84.823	572.555
28	784	21952	5.2915	3.0366	87.965	615.752
29	841	24389	5.3852	3.0723	91.106	660.520
30	900	27000	5.4772	3.1072	94.248	706.858
31	961	29791	5.5678	3.1414	97.389	754.768
32	1024	32768	5.6569	3.1748	100.531	804.248
33	1089	35937	5.7446	3.2075	103.673	855.299
34	1156	39304	5.8310	3.2396	106.814	907.920
35	1225	42875	5.9161	3.2711	109.956	962.113
36	1296	46656	6.0000	3.3019	113.097	1017.88
37	1369	50653	6.0828	3.3322	116.239	1075.21
38	1444	54872	6.1644	3.3620	119.381	1134.11
39	1521	59319	6.2450	3.3912	122.522	1194.59
40	1600	64000	6.3246	3.4200	125.660	1256.64

SQUARES, CUBES, SQUARE ROOTS, CUBE ROOTS, CIRCUMFERENCES
AND CIRCULAR AREAS OF NOS. FROM 1 TO 520

No.	Square	Cube	Sq. Root	Cube Root	CIRCLE	
					Circum.	Area
41	1681	68921	6.4031	3.4482	128.81	1320.25
42	1764	74088	6.4807	3.4760	131.95	1385.44
43	1849	79507	6.5574	3.5034	135.09	1452.20
44	1936	85184	6.6332	3.5303	138.23	1520.53
45	2025	91125	6.7082	3.5569	141.37	1590.43
46	2116	97336	6.7823	3.5830	144.51	1661.90
47	2209	103823	6.8557	3.6088	147.65	1734.94
48	2304	110592	6.9282	3.6342	150.80	1809.56
49	2401	117649	7.0000	3.6593	153.94	1885.74
50	2500	125000	7.0711	3.6840	157.08	1963.50
51	2601	132651	7.1414	3.7084	160.22	2042.82
52	2704	140608	7.2111	3.7325	163.36	2123.72
53	2809	148877	7.2801	3.7563	166.50	2206.18
54	2916	157464	7.3485	3.7798	169.65	2290.22
55	3025	166375	7.4162	3.8030	172.79	2375.83
56	3136	175616	7.4833	3.8259	175.93	2463.01
57	3249	185193	7.5498	3.8485	179.07	2551.76
58	3364	195112	7.6158	3.8709	182.21	2642.08
59	3481	205379	7.6811	3.8930	185.35	2733.97
60	3600	216000	7.7460	3.9149	188.50	2827.43
61	3721	226981	7.8102	3.9365	191.64	2922.47
62	3844	238328	7.8740	3.9579	194.78	3019.07
63	3969	250047	7.9373	3.9791	197.92	3117.25
64	4096	262144	8.0000	4.0000	201.06	3216.99
65	4225	274625	8.0623	4.0207	204.20	3318.31
66	4356	287496	8.1240	4.0412	207.35	3421.19
67	4489	300763	8.1854	4.0615	210.49	3525.65
68	4624	314432	8.2462	4.0817	213.63	3631.68
69	4761	328509	8.3066	4.1016	216.77	3739.28
70	4900	343000	8.3666	4.1213	219.91	3848.45
71	5041	357911	8.4261	4.1408	223.05	3959.19
72	5184	373248	8.4853	4.1602	226.19	4071.50
73	5329	389017	8.5440	4.1793	229.34	4185.39
74	5476	405224	8.6023	4.1983	232.48	4300.84
75	5625	421875	8.6603	4.2172	235.62	4417.86
76	5776	438976	8.7178	4.2358	238.76	4536.46
77	5929	456533	8.7750	4.2543	241.90	4656.63
78	6084	474552	8.8318	4.2727	245.04	4778.36
79	6241	493039	8.8882	4.2908	248.19	4901.67
80	6400	512000	8.9443	4.3089	251.33	5026.55

SQUARES, CUBES, SQUARE ROOTS, CUBE ROOTS, CIRCUMFERENCES
AND CIRCULAR AREAS OF NOS. FROM 1 TO 520

No.	Square	Cube	Sq. Root	Cube Root	CIRCLE	
					Circum.	Area
81	6561	531441	9.0000	4.3267	254.47	5153.00
82	6724	551368	9.0554	4.3445	257.61	5281.02
83	6889	571787	9.1104	4.3621	260.75	5410.61
84	7056	592704	9.1652	4.3795	263.89	5541.77
85	7225	614125	9.2195	4.3968	267.04	5674.50
86	7396	636056	9.2736	4.4140	270.18	5808.80
87	7569	658503	9.3274	4.4310	273.32	5944.68
88	7744	681472	9.3808	4.4480	276.46	6082.12
89	7921	704969	9.4340	4.4647	279.60	6221.14
90	8100	729000	9.4868	4.4814	282.74	6361.73
91	8281	753571	9.5394	4.4979	285.88	6503.88
92	8464	778688	9.5917	4.5144	289.03	6647.61
93	8649	804357	9.6437	4.5307	292.17	6792.91
94	8836	830584	9.6954	4.5468	295.31	6939.78
95	9025	857375	9.7468	4.5629	298.45	7088.22
96	9216	884736	9.7980	4.5789	301.59	7238.23
97	9409	912673	9.8489	4.5947	304.73	7389.81
98	9604	941192	9.8995	4.6104	307.88	7542.96
99	9801	970299	9.9499	4.6261	311.02	7697.69
100	10000	1000000	10.0000	4.6416	314.16	7853.98
101	10201	1030301	10.0499	4.6570	317.30	8011.85
102	10404	1061208	10.0995	4.6723	320.44	8171.28
103	10609	1092727	10.1489	4.6875	323.58	8332.29
104	10816	1124864	10.1980	4.7027	326.73	8494.87
105	11025	1157625	10.2470	4.7177	329.87	8659.01
106	11236	1191016	10.2956	4.7326	333.01	8824.73
107	11449	1225043	10.3441	4.7475	336.15	8992.02
108	11664	1259712	10.3923	4.7622	339.29	9160.88
109	11881	1295029	10.4403	4.7769	342.43	9331.32
110	12100	1331000	10.4881	4.7914	345.58	9503.32
111	12321	1367631	10.5357	4.8059	348.72	9676.89
112	12544	1404928	10.5830	4.8203	351.86	9852.03
113	12769	1442897	10.6301	4.8346	355.00	10028.7
114	12996	1481544	10.6771	4.8488	358.14	10207.0
115	13225	1520875	10.7238	4.8629	361.28	10386.9
116	13456	1560896	10.7703	4.8770	364.42	10568.3
117	13689	1601613	10.8167	4.8910	367.57	10751.3
118	13924	1643032	10.8628	4.9049	370.71	10935.9
119	14161	1685159	10.9087	4.9187	373.85	11122.0
120	14400	1728000	10.9545	4.9324	376.99	11309.7

SQUARES, CUBES, SQUARE ROOTS, CUBE ROOTS, CIRCUMFERENCES
AND CIRCULAR AREAS OF NOS. FROM 1 TO 520

No.	Square	Cube	Sq. Root	Cube Root	CIRCLE	
					Circum.	Area
121	14641	1771561	11.0000	4.9461	380.13	11499.0
122	14884	1815848	11.0454	4.9597	383.27	11689.9
123	15129	1860867	11.0905	4.9732	386.42	11882.3
124	15376	1906624	11.1355	4.9866	389.56	12076.3
125	15625	1953125	11.1803	5.0000	392.70	12271.8
126	15876	2000376	11.2250	5.0133	395.84	12469.0
127	16129	2048383	11.2694	5.0265	398.98	12667.7
128	16384	2097152	11.3137	5.0397	402.12	12868.0
129	16641	2146689	11.3578	5.0528	405.27	13069.8
130	16900	2197000	11.4018	5.0658	408.41	13273.2
131	17161	2248091	11.4455	5.0788	411.55	13478.2
132	17424	2299968	11.4891	5.0916	414.69	13684.8
133	17689	2352637	11.5326	5.1045	417.83	13892.9
134	17956	2406104	11.5758	5.1172	420.97	14102.6
135	18225	2460375	11.6190	5.1299	424.12	14313.9
136	18496	2515456	11.6619	5.1426	427.26	14526.7
137	18769	2571353	11.7047	5.1551	430.40	14741.1
138	19044	2628072	11.7473	5.1676	433.54	14957.1
139	19321	2685619	11.7898	5.1801	436.68	15174.7
140	19600	2744000	11.8322	5.1925	439.82	15393.8
141	19881	2803221	11.8743	5.2048	442.96	15614.5
142	20164	2863288	11.9164	5.2171	446.11	15836.8
143	20449	2924207	11.9583	5.2293	449.25	16060.6
144	20736	2985984	12.0000	5.2415	452.39	16286.0
145	21025	3048625	12.0416	5.2536	455.53	16513.0
146	21316	3112136	12.0830	5.2656	458.67	16741.5
147	21609	3176523	12.1244	5.2776	461.81	16971.7
148	21904	3241792	12.1655	5.2896	464.96	17203.4
149	22201	3307949	12.2066	5.3015	468.10	17436.6
150	22500	3375000	12.2474	5.3133	471.24	17671.5
151	22801	3442951	12.2882	5.3251	474.38	17907.9
152	23104	3511808	12.3288	5.3368	477.52	18145.8
153	23409	3581577	12.3693	5.3485	480.66	18385.4
154	23716	3652264	12.4097	5.3601	483.81	18626.5
155	24025	3723875	12.4499	5.3717	486.95	18869.2
156	24336	3796416	12.4900	5.3832	490.09	19113.4
157	24649	3869893	12.5300	5.3947	493.23	19359.3
158	24964	3944312	12.5698	5.4061	496.37	19606.7
159	25281	4019679	12.6095	5.4175	499.51	19855.7
160	25600	4096000	12.6491	5.4288	502.65	20106.2

SQUARES, CUBES, SQUARE ROOTS, CUBE ROOTS, CIRCUMFERENCES
AND CIRCULAR AREAS OF NOS. FROM 1 TO 520

No.	Square	Cube	Sq. Root	Cube Root	CIRCLE	
					Circum.	Area
161	25921	4173281	12.6886	5.4401	505.80	20358.3
162	26244	4251528	12.7279	5.4514	508.04	20612.0
163	26569	4330747	12.7671	5.4626	512.08	20867.2
164	26896	4410944	12.8062	5.4737	515.22	21124.1
165	27225	4492125	12.8452	5.4848	518.36	21382.5
166	27556	4574296	12.8841	5.4959	521.50	21642.4
167	27889	4657463	12.9228	5.5069	524.65	21904.0
168	28224	4741632	12.9615	5.5178	527.79	22167.1
169	28561	4826809	13.0000	5.5288	530.93	22431.8
170	28900	4913000	13.0384	5.5397	534.07	22698.0
171	29241	5000211	13.0767	5.5505	537.21	22965.8
172	29584	5088448	13.1149	5.5613	540.35	23235.2
173	29929	5177717	13.1529	5.5721	543.50	23506.2
174	30276	5268024	13.1909	5.5828	546.64	23778.7
175	30625	5359375	13.2288	5.5934	549.78	24052.8
176	30976	5451776	13.2665	5.6041	552.92	24328.5
177	31329	5545233	13.3041	5.6147	556.06	24605.7
178	31684	5639752	13.3417	5.6252	559.20	24884.6
179	32041	5735339	13.3791	5.6357	562.35	25164.9
180	32400	5832000	13.4164	5.6462	565.49	25446.9
181	32761	5929741	13.4536	5.6567	568.63	25730.4
182	33124	6028568	13.4907	5.6671	571.77	26015.5
183	33489	6128487	13.5277	5.6774	574.91	26302.2
184	33856	6229504	13.5647	5.6877	578.05	26590.4
185	34225	6331625	13.6015	5.6980	581.19	26880.3
186	34596	6434856	13.6382	5.7083	584.34	27171.6
187	34969	6539203	13.6748	5.7185	587.48	27464.6
188	35344	6644672	13.7113	5.7287	590.62	27759.1
189	35721	6751269	13.7477	5.7388	593.76	28055.2
190	36100	6859000	13.7840	5.7489	596.90	28352.9
191	36481	6967871	13.8203	5.7590	600.04	28652.1
192	36864	7077888	13.8564	5.7690	603.19	28952.9
193	37249	7189057	13.8924	5.7790	606.33	29255.3
194	37636	7301384	13.9284	5.7890	609.47	29559.2
195	38025	7414875	13.9642	5.7989	612.61	29864.8
196	38416	7529536	14.0000	5.8088	615.75	30171.9
197	38809	7645373	14.0357	5.8186	618.89	30480.5
198	39204	7762392	14.0712	5.8285	622.04	30790.7
199	39601	7880599	14.1067	5.8383	625.18	31102.6
200	40000	8000000	14.1421	5.8480	628.32	31415.9

SQUARES, CUBES, SQUARE ROOTS, CUBE ROOTS, CIRCUMFERENCES
AND CIRCULAR AREAS OF NOS. FROM 1 TO 520

No.	Square	Cube	Sq. Root	Cube Root	CIRCLE	
					Circum.	Area
201	40401	8120601	14.1774	5.8578	631.46	31730.9
202	40804	8242408	14.2127	5.8675	634.60	32047.4
203	41209	8365427	14.2478	5.8771	637.74	32365.5
204	41616	8489664	14.2829	5.8868	640.89	32685.1
205	42025	8615125	14.3178	5.8964	644.03	33006.4
206	42436	8741816	14.3527	5.9059	647.17	33329.2
207	42849	8869743	14.3875	5.9155	650.31	33653.5
208	43264	8998912	14.4222	5.9250	653.45	33979.5
209	43681	9129329	14.4568	5.9345	656.59	34307.0
210	44100	9261000	14.4914	5.9439	659.73	34636.1
211	44521	9393931	14.5258	5.9533	662.88	34966.7
212	44944	9528128	14.5602	5.9627	666.02	35298.9
213	45369	9663597	14.5945	5.9721	669.16	35632.7
214	45796	9800344	14.6287	5.9814	672.30	35968.1
215	46225	9938375	14.6629	5.9907	675.44	36305.0
216	46656	10077696	14.6969	6.0000	678.58	36643.5
217	47089	10218313	14.7309	6.0092	681.73	36983.6
218	47524	10360232	14.7648	6.0185	684.87	37325.3
219	47961	10503459	14.7986	6.0277	688.01	37668.5
220	48400	10648000	14.8324	6.0368	691.15	38013.3
221	48841	10793861	14.8661	6.0459	694.29	38359.6
222	49284	10941048	14.8997	6.0550	697.43	38707.6
223	49729	11089567	14.9332	6.0641	700.58	39057.1
224	50176	11239424	14.9666	6.0732	703.72	39408.1
225	50625	11390625	15.0000	6.0822	706.86	39760.8
226	51076	11543176	15.0333	6.0912	710.00	40115.0
227	51529	11697083	15.0665	6.1002	713.14	40470.8
228	51984	11852352	15.0997	6.1091	716.28	40828.1
229	52441	12008989	15.1327	6.1180	719.42	41187.1
230	52900	12167000	15.1658	6.1269	722.57	41547.6
231	53361	12326391	15.1987	6.1358	725.71	41909.6
232	53824	12487168	15.2315	6.1446	728.85	42273.3
233	54289	12649337	15.2643	6.1534	731.99	42638.5
234	54756	12812904	15.2971	6.1622	735.13	43005.3
235	55225	12977875	15.3297	6.1710	738.27	43373.6
236	55696	13144256	15.3623	6.1797	741.42	43743.5
237	56169	13312053	15.3948	6.1885	744.56	44115.0
238	56644	13481272	15.4272	6.1972	747.70	44488.1
239	57121	13651919	15.4596	6.2058	750.84	44862.7
240	57600	13824000	15.4919	6.2145	753.98	45238.9

SQUARES, CUBES, SQUARE ROOTS, CUBE ROOTS, CIRCUMFERENCES
AND CIRCULAR AREAS OF NOS. FROM 1 TO 520

No.	Square	Cube	Sq. Root	Cube Root	CIRCLE	
					Circum.	Area
241	58081	13997521	15.5242	6.2231	757.12	45616.7
242	58564	14172488	15.5563	6.2317	760.27	45996.1
243	59049	14348907	15.5885	6.2403	763.41	46377.0
244	59536	14526784	15.6205	6.2488	766.55	46759.5
245	60025	14706125	15.6525	6.2573	769.69	47143.5
246	60516	14886936	15.6844	6.2658	772.83	47529.2
247	61009	15069223	15.7162	6.2743	775.97	47916.4
248	61504	15252992	15.7480	6.2828	779.12	48305.1
249	62001	15438249	15.7797	6.2912	782.26	48695.5
250	62500	15625000	15.8114	6.2996	785.40	49087.4
251	63001	15813251	15.8430	6.3080	788.54	49480.9
252	63504	16003008	15.8745	6.3164	791.68	49875.9
253	64009	16194277	15.9060	6.3247	794.82	50272.6
254	64516	16387064	15.9374	6.3330	797.96	50670.7
255	65025	16581375	15.9687	6.3413	801.11	51070.5
256	65536	16777216	16.0000	6.3496	804.25	51471.9
257	66049	16974593	16.0312	6.3579	807.39	51874.8
258	66564	17173512	16.0624	6.3661	810.53	52279.2
259	67081	17373979	16.0935	6.3743	813.67	52685.3
260	67600	17576000	16.1245	6.3825	816.81	53092.9
261	68121	17779581	16.1555	6.3907	819.96	53502.1
262	68644	17984728	16.1864	6.3988	823.10	53912.4
263	69169	18191447	16.2173	6.4070	826.24	54325.2
264	69696	18399744	16.2481	6.4151	829.38	54739.1
265	70225	18609625	16.2788	6.4232	832.52	55154.6
266	70756	18821096	16.3095	6.4312	835.66	55571.6
267	71289	19034163	16.3401	6.4393	838.81	55990.3
268	71824	19248832	16.3707	6.4473	841.95	56410.4
269	72361	19465109	16.4012	6.4553	845.09	56832.2
270	72900	19683000	16.4317	6.4633	848.23	57255.5
271	73441	19902511	16.4621	6.4713	851.37	57680.4
272	73984	20123648	16.4924	6.4792	854.51	58106.9
273	74529	20346417	16.5227	6.4872	857.66	58534.9
274	75076	20570824	16.5529	6.4951	860.80	58964.6
275	75625	20796875	16.5831	6.5030	863.94	59395.7
276	76176	21024576	16.6132	6.5108	867.08	59828.5
277	76729	21253933	16.6433	6.5187	870.22	60262.8
278	77284	21484952	16.6733	6.5265	873.36	60698.7
279	77841	21717639	16.7033	6.5343	876.50	61136.2
280	78400	21952000	16.7332	6.5421	879.65	61575.2

SQUARES, CUBES, SQUARE ROOTS, CUBE ROOTS, CIRCUMFERENCES
AND CIRCULAR AREAS OF NOS. FROM 1 TO 520

No.	Square	Cube	Sq. Root	Cube Root	CIRCLE	
					Circum.	Area
281	78961	22188041	16.7631	6.5499	882.79	62015.8
282	79524	22425768	16.7929	6.5577	885.93	62458.0
283	80089	22665187	16.8226	6.5654	889.07	62901.8
284	80656	22906304	16.8523	6.5731	892.21	63347.1
285	81225	23149125	16.8819	6.5808	895.35	63794.0
286	81706	23393656	16.9115	6.5885	898.50	64242.4
287	82369	23639903	16.9411	6.5962	901.64	64692.5
288	82944	23887872	16.9706	6.6039	904.78	65144.1
289	83521	24137569	17.0000	6.6115	907.92	65597.2
290	84100	24389000	17.0294	6.6191	911.06	66052.0
291	84681	24642171	17.0587	6.6267	914.20	66508.3
292	85264	24897088	17.0880	6.6343	917.35	66966.2
293	85849	25153757	17.1172	6.6419	920.49	67425.6
294	86436	25412184	17.1464	6.6494	923.63	67886.7
295	87025	25672375	17.1756	6.6569	926.77	68349.3
296	87616	25934336	17.2047	6.6644	929.91	68813.5
297	88209	26198073	17.2337	6.6719	933.05	69279.2
298	88804	26463592	17.2627	6.6794	936.19	69746.5
299	89401	26730809	17.2916	6.6869	939.34	70215.4
300	90000	27000000	17.3205	6.6943	942.48	70685.8
301	90601	27270901	17.3494	6.7018	945.62	71157.9
302	91204	27543608	17.3781	6.7092	948.76	71631.5
303	91809	27818127	17.4069	6.7166	951.90	72106.6
304	92416	28094464	17.4356	6.7240	955.04	72583.4
305	93025	28372625	17.4642	6.7313	958.19	73061.7
306	93636	28652616	17.4929	6.7387	961.33	73541.5
307	94249	28934443	17.5214	6.7460	964.47	74023.0
308	94864	29218112	17.5499	6.7533	967.61	74506.0
309	95481	29503629	17.5784	6.7606	970.75	74990.6
310	96100	29791000	17.6068	6.7679	973.89	75476.8
311	96721	30080231	17.6352	6.7752	977.04	75964.5
312	97344	30371328	17.6635	6.7824	980.18	76453.8
313	97969	30664297	17.6918	6.7897	983.32	76944.7
314	98596	30959144	17.7200	6.7969	986.46	77437.1
315	99225	31255875	17.7482	6.8041	989.60	77931.1
316	99856	31554496	17.7764	6.8113	992.74	78426.7
317	100489	31855013	17.8045	6.8185	995.88	78923.9
318	101124	32157432	17.8326	6.8256	999.03	79422.6
319	101761	32461759	17.8606	6.8328	1002.20	79922.9
320	102400	32768000	17.8885	6.8399	1005.30	80424.8

SQUARES, CUBES, SQUARE ROOTS, CUBE ROOTS, CIRCUMFERENCES
AND CIRCULAR AREAS OF NOS. FROM 1 TO 520

No.	Square	Cube	Sq. Root	Cube Root	CIRCLE	
					Circum.	Area
321	103041	33076161	17.9165	6.8470	1008.5	80928.2
322	103684	33386248	17.9444	6.8541	1011.6	81433.2
323	104329	33698267	17.9722	6.8612	1014.7	81939.8
324	104976	34012224	18.0000	6.8683	1017.9	82448.0
325	105625	34328125	18.0278	6.8753	1021.0	82957.7
326	106276	34645976	18.0555	6.8824	1024.2	83469.0
327	106929	34965783	18.0831	6.8894	1027.3	83981.8
328	107584	35287552	18.1108	6.8964	1030.4	84496.3
329	108241	35611289	18.1384	6.9034	1033.6	85012.3
330	108900	35937000	18.1659	6.9104	1036.7	85529.9
331	109561	36264691	18.1934	6.9174	1039.9	86049.0
332	110224	36594368	18.2209	6.9244	1043.0	86569.7
333	110889	36926037	18.2483	6.9313	1046.2	87092.0
334	111556	37259704	18.2757	6.9382	1049.3	87615.9
335	112225	37595375	18.3030	6.9451	1052.4	88141.3
336	112896	37933056	18.3303	6.9521	1055.6	88668.3
337	113569	38272753	18.3576	6.9589	1058.7	89196.9
338	114244	38614472	18.3848	6.9658	1061.9	89727.0
339	114921	38958219	18.4120	6.9727	1065.0	90258.7
340	115600	39304000	18.4391	6.9795	1068.1	90792.0
341	116281	39651821	18.4662	6.9864	1071.3	91326.9
342	116964	40001688	18.4932	6.9932	1074.4	91863.3
343	117649	40353607	18.5203	7.0000	1077.6	92401.3
344	118336	40707584	18.5472	7.0068	1080.7	92940.9
345	119025	41063625	18.5742	7.0136	1083.8	93482.0
346	119716	41421736	18.6011	7.0203	1087.0	94024.7
347	120409	41781923	18.6279	7.0271	1090.1	94569.0
348	121104	42144192	18.6548	7.0338	1093.3	95114.9
349	121801	42508549	18.6815	7.0406	1096.4	95662.3
350	122500	42875000	18.7083	7.0473	1099.6	96211.3
351	123201	43243551	18.7350	7.0540	1102.7	96761.8
352	123904	43614208	18.7617	7.0607	1105.8	97314.0
353	124609	43986977	18.7883	7.0674	1109.0	97867.7
354	125316	44361864	18.8149	7.0740	1112.1	98423.0
355	126025	44738875	18.8414	7.0807	1115.3	98979.8
356	126736	45118016	18.8680	7.0873	1118.4	99538.2
357	127449	45499293	18.8944	7.0940	1121.5	100098
358	128164	45882712	18.9209	7.1006	1124.7	100660
359	128881	46268279	18.9473	7.1072	1127.8	101223
360	129600	46656000	18.9737	7.1138	1131.0	101788

SQUARES, CUBES, SQUARE ROOTS, CUBE ROOTS, CIRCUMFERENCES
AND CIRCULAR AREAS OF NOS. FROM 1 TO 520

No.	Square	Cube	Sq. Root	Cube Root	CIRCLE	
					Circum.	Area
361	130321	47045881	19.0000	7.1204	1134.1	102354
362	131044	47437928	19.0263	7.1269	1137.3	102922
363	131769	47832147	19.0526	7.1335	1140.4	103491
364	132496	48228544	19.0788	7.1400	1143.5	104062
365	133225	48627125	19.1050	7.1466	1146.7	104635
366	133956	49027896	19.1311	7.1531	1149.8	105209
367	134689	49430863	19.1572	7.1596	1153.0	105785
368	135424	49836032	19.1833	7.1661	1156.1	106362
369	136161	50243409	19.2094	7.1726	1159.2	106941
370	136900	50653000	19.2354	7.1791	1162.4	107521
371	137641	51064811	19.2614	7.1855	1165.5	108103
372	138384	51478848	19.2873	7.1920	1168.7	108687
373	139129	51895117	19.3132	7.1984	1171.8	109272
374	139876	52313624	19.3391	7.2048	1175.0	109858
375	140625	52734375	19.3649	7.2112	1178.1	110447
376	141376	53157376	19.3907	7.2177	1181.2	111036
377	142129	53582633	19.4165	7.2240	1184.4	111628
378	142884	54010152	19.4422	7.2304	1187.5	112221
379	143641	54439939	19.4679	7.2368	1190.7	112815
380	144400	54872000	19.4936	7.2432	1193.8	113411
381	145161	55306341	19.5192	7.2495	1196.9	114009
382	145924	55742968	19.5448	7.2558	1200.1	114608
383	146689	56181887	19.5704	7.2622	1203.2	115209
384	147456	56623104	19.5959	7.2685	1206.4	115812
385	148225	57066625	19.6214	7.2748	1209.5	116416
386	148996	57512456	19.6469	7.2811	1212.7	117021
387	149769	57960603	19.6723	7.2874	1215.8	117628
388	150544	58411072	19.6977	7.2936	1218.9	118237
389	151321	58863869	19.7231	7.2999	1222.1	118847
390	152100	59319000	19.7484	7.3061	1225.2	119459
391	152881	59776471	19.7737	7.3124	1228.4	120072
392	153664	60236288	19.7990	7.3186	1231.5	120687
393	154449	60698457	19.8242	7.3248	1234.6	121304
394	155236	61162984	19.8494	7.3310	1237.8	121922
395	156025	61629875	19.8746	7.3372	1240.9	122542
396	156816	62099136	19.8997	7.3434	1244.1	123163
397	157609	62570773	19.9249	7.3496	1247.2	123786
398	158404	63044792	19.9499	7.3558	1250.4	124410
399	159201	63521199	19.9750	7.3619	1253.5	125036
400	160000	64000000	20.0000	7.3684	1256.6	125664

SQUARES, CUBES, SQUARE ROOTS, CUBE ROOTS, CIRCUMFERENCES,
AND CIRCULAR AREAS OF NOS. FROM 1 TO 520

No.	Square	Cube	Sq. Root	Cube Root	CIRCLE	
					Circum.	Area
401	160801	64481201	20.0250	7.3742	1259.8	126293
402	161604	64964808	20.0499	7.3803	1262.9	126923
403	162409	65450827	20.0749	7.3864	1266.1	127556
404	163216	65939264	20.0998	7.3925	1269.2	128190
405	164025	66430125	20.1246	7.3986	1272.3	128825
406	164836	66923416	20.1494	7.4047	1275.5	129462
407	165649	67419143	20.1742	7.4108	1278.6	130100
408	166464	67917312	20.1990	7.4169	1281.8	130741
409	167281	68417929	20.2237	7.4229	1284.9	131382
410	168100	68921000	20.2485	7.4290	1288.1	132025
411	168921	69426531	20.2731	7.4350	1291.2	132670
412	169744	69934528	20.2978	7.4410	1294.3	133317
413	170569	70444997	20.3224	7.4470	1297.5	133965
414	171396	70957944	20.3470	7.4530	1300.6	134614
415	172225	71473375	20.3715	7.4590	1303.8	135265
416	173056	71991296	20.3961	7.4650	1306.9	135918
417	173889	72511713	20.4206	7.4710	1310.0	136572
418	174724	73034632	20.4450	7.4770	1313.2	137228
419	175561	73560059	20.4695	7.4829	1316.3	137885
420	176400	74088000	20.4939	7.4889	1319.5	138544
421	177241	74618461	20.5183	7.4948	1322.6	139205
422	178084	75151448	20.5426	7.5007	1325.8	139867
423	178929	75686967	20.5670	7.5067	1328.9	140531
424	179776	76225024	20.5913	7.5126	1332.0	141196
425	180625	76765625	20.6155	7.5185	1335.2	141863
426	181476	77308776	20.6398	7.5244	1338.3	142531
427	182329	77854483	20.6640	7.5302	1341.5	143201
428	183184	78402752	20.6882	7.5361	1344.6	143872
429	184041	78953589	20.7123	7.5420	1347.7	144545
430	184900	79507000	20.7364	7.5478	1350.9	145220
431	185761	80062991	20.7605	7.5537	1354.0	145896
432	186624	80621568	20.7846	7.5595	1357.2	146574
433	187489	81182737	20.8087	7.5654	1360.3	147254
434	188356	81746504	20.8327	7.5712	1363.5	147934
435	189225	82312875	20.8567	7.5770	1366.6	148617
436	190096	82881856	20.8806	7.5828	1369.7	149301
437	190969	83453453	20.9045	7.5886	1372.9	149987
438	191844	84027672	20.9284	7.5944	1376.0	150674
439	192721	84604519	20.9523	7.6001	1379.2	151363
440	193600	85184000	20.9762	7.6059	1382.3	152053

SQUARES, CUBES, SQUARE ROOTS, CUBE ROOTS, CIRCUMFERENCES
AND CIRCULAR AREAS OF NOS. FROM 1 TO 520

No.	Square	Cube	Sq. Root	Cube Root	CIRCLE	
					Circum.	Area
441	194481	85766121	21.0000	7.6117	1385.4	152745
442	195364	86350888	21.0238	7.6174	1388.6	153439
443	196249	86938307	21.0476	7.6232	1391.7	154134
444	197136	87528384	21.0713	7.6289	1394.9	154830
445	198025	88121125	21.0950	7.6346	1398.0	155528
446	198916	88716536	21.1187	7.6403	1401.2	156228
447	199809	89314623	21.1424	7.6460	1404.3	156930
448	200704	89915392	21.1660	7.6517	1407.4	157633
449	201601	90518849	21.1896	7.6574	1410.6	158337
450	202500	91125000	21.2132	7.6631	1413.7	159043
451	203401	91733851	21.2368	7.6688	1416.9	159751
452	204304	92345408	21.2603	7.6744	1420.0	160460
453	205209	92959677	21.2838	7.6801	1423.1	161171
454	206116	93576664	21.3073	7.6857	1426.3	161883
455	207025	94196375	21.3307	7.6914	1429.4	162597
456	207936	94818816	21.3542	7.6970	1432.6	163313
457	208849	95443993	21.3776	7.7026	1435.7	164030
458	209764	96071912	21.4009	7.7082	1438.9	164748
459	210681	96702579	21.4243	7.7138	1442.0	165468
460	211600	97336000	21.4476	7.7194	1445.1	166190
461	212521	97972181	21.4709	7.7250	1448.3	166914
462	213444	98611128	21.4942	7.7306	1451.4	167639
463	214369	99252847	21.5174	7.7362	1454.6	168365
464	215296	99897344	21.5407	7.7418	1457.7	169093
465	216225	100544625	21.5639	7.7473	1460.8	169823
466	217156	101194696	21.5870	7.7529	1464.0	170554
467	218089	101847563	21.6102	7.7584	1467.1	171287
468	219024	102503232	21.6333	7.7639	1470.3	172021
469	219961	103161709	21.6564	7.7695	1473.4	172757
470	220900	103823000	21.6795	7.7750	1476.5	173494
471	221841	104487111	21.7025	7.7805	1479.7	174234
472	222784	105154048	21.7256	7.7860	1482.8	174974
473	223729	105823817	21.7486	7.7915	1486.0	175716
474	224676	106496424	21.7715	7.7970	1489.1	176460
475	225625	107171875	21.7945	7.8025	1492.3	177205
476	226576	107850176	21.8174	7.8079	1495.4	177952
477	227529	108531333	21.8403	7.8134	1498.5	178701
478	228484	109215352	21.8632	7.8188	1501.7	179451
479	229441	109902239	21.8861	7.8243	1504.8	180203
480	230400	110592000	21.9089	7.8297	1508.0	180956

SQUARES, CUBES, SQUARE ROOTS, CUBE ROOTS, CIRCUMFERENCES
AND CIRCULAR AREAS OF NOS. FROM 1 TO 520

No.	Square	Cube	Sq. Root	Cube Root	CIRCLE	
					Circum.	Area
481	231361	111284641	21.9317	7.8352	1511.1	181711
482	232324	111980168	21.9545	7.8406	1514.3	182467
483	233280	112678587	21.9773	7.8460	1517.4	183225
484	234256	113379904	22.0000	7.8514	1520.5	183984
485	235225	114084125	22.0227	7.8568	1523.7	184745
486	236196	114791256	22.0454	7.8622	1526.8	185508
487	237169	115501303	22.0681	7.8676	1530.0	186272
488	238144	116214272	22.0907	7.8730	1533.1	187038
489	239121	116930169	22.1133	7.8784	1536.2	187805
490	240100	117649000	22.1359	7.8837	1539.4	188574
491	241081	118370771	22.1585	7.8891	1542.5	189345
492	242064	119095488	22.1811	7.8944	1545.7	190117
493	243049	119823157	22.2036	7.8998	1548.8	190890
494	244036	120553784	22.2261	7.9051	1551.9	191665
495	245025	121287375	22.2486	7.9105	1555.1	192442
496	246016	122023936	22.2711	7.9158	1558.2	193221
497	247009	122763473	22.2935	7.9211	1561.4	194000
498	248004	123505992	22.3159	7.9264	1564.5	194782
499	249001	124251499	22.3383	7.9317	1567.7	195565
500	250000	125000000	22.3607	7.9370	1570.8	196350
501	251001	125751501	22.3830	7.9423	1573.9	197136
502	252004	126506008	22.4054	7.9476	1577.1	197923
503	253009	127263527	22.4277	7.9528	1580.2	198713
504	254016	128024064	22.4499	7.9581	1583.4	199504
505	255025	128787625	22.4722	7.9634	1586.5	200296
506	256036	129554216	22.4944	7.9686	1589.7	201090
507	257049	130323843	22.5167	7.9739	1592.8	201886
508	258064	131096512	22.5389	7.9791	1595.9	202683
509	259081	131872229	22.5610	7.9843	1599.1	203482
510	260100	132651000	22.5832	7.9896	1602.2	204282
511	261121	133432831	22.6053	7.9948	1605.4	205084
512	262144	134217728	22.6274	8.0000	1608.5	205887
513	263169	135005697	22.6495	8.0052	1611.6	206692
514	264196	135796744	22.6716	8.0104	1614.8	207499
515	265225	136590875	22.6936	8.0156	1617.9	208307
516	266256	137388096	22.7156	8.0208	1621.1	209117
517	267289	138188413	22.7376	8.0260	1624.2	209928
518	268324	138991832	22.7596	8.0311	1627.3	210741
519	269361	139798359	22.7816	8.0363	1630.5	211556
520	270400	140608000	22.8035	8.0415	1633.6	212372

TABLE OF TANGENTS AND CO-TANGENTS

'	0°		1°		2°		3°		'
	TAN.	CO-TAN.	TAN.	CO-TAN.	TAN.	CO-TAN.	TAN.	CO-TAN.	
0	.00000	Infinite.	.01746	57.2900	.03402	28.6363	.05241	19.0811	60
1	.00029	3437.750	.01775	56.3506	.03521	28.3994	.05270	18.9755	59
2	.00058	1718.870	.01804	55.4415	.03550	28.1664	.05299	18.8711	58
3	.00087	1145.920	.01833	54.5613	.03579	27.9372	.05328	18.7678	57
4	.00116	859.436	.01862	53.7086	.03609	27.7117	.05357	18.6656	56
5	.00145	687.549	.01891	52.8821	.03638	27.4899	.05387	18.5645	55
6	.00175	572.957	.01920	52.0807	.03667	27.2715	.05416	18.4645	54
7	.00204	491.106	.01949	51.3032	.03696	27.0566	.05445	18.3653	53
8	.00233	429.718	.01978	50.5485	.03725	26.8450	.05474	18.2677	52
9	.00262	381.971	.02007	49.8157	.03754	26.6367	.05503	18.1708	51
10	.00291	343.774	.02036	49.1039	.03783	26.4316	.05532	18.0750	50
11	.00320	312.521	.02066	48.4121	.03812	26.2296	.05562	17.9802	49
12	.00349	286.478	.02095	47.7395	.03842	26.0307	.05591	17.8863	48
13	.00378	264.441	.02124	47.0853	.03871	25.8348	.05620	17.7934	47
14	.00407	245.552	.02153	46.4489	.03900	25.6418	.05649	17.7015	46
15	.00436	229.182	.02182	45.8204	.03929	25.4517	.05678	17.6106	45
16	.00465	214.858	.02211	45.2261	.03958	25.2644	.05708	17.5205	44
17	.00495	202.219	.02240	44.6386	.03987	25.0798	.05737	17.4314	43
18	.00524	190.984	.02269	44.0661	.04016	24.8978	.05766	17.3432	42
19	.00553	180.932	.02298	43.5081	.04046	24.7185	.05795	17.2558	41
20	.00582	171.885	.02328	42.9641	.04075	24.5418	.05824	17.1693	40
21	.00611	163.700	.02357	42.4335	.04104	24.3675	.05854	17.0837	39
22	.00640	156.259	.02386	41.9158	.04133	24.1957	.05883	16.9990	38
23	.00669	149.405	.02415	41.4106	.04162	24.0263	.05912	16.9150	37
24	.00698	143.237	.02444	40.9174	.04191	23.8593	.05941	16.8319	36
25	.00727	137.507	.02473	40.4358	.04220	23.6945	.05970	16.7496	35
26	.00756	132.219	.02502	39.9655	.04250	23.5321	.05999	16.6681	34
27	.00785	127.321	.02531	39.5050	.04279	23.3718	.06029	16.5874	33
28	.00814	122.774	.02560	39.0568	.04308	23.2137	.06058	16.5075	32
29	.00844	118.540	.02589	38.6177	.04337	23.0577	.06087	16.4283	31
30	.00873	114.589	.02619	38.1885	.04366	22.9038	.06116	16.3499	30
31	.00902	110.892	.02648	37.7686	.04395	22.7519	.06145	16.2722	29
32	.00931	107.426	.02677	37.3579	.04424	22.6020	.06175	16.1952	28
33	.00960	104.171	.02706	36.9560	.04454	22.4541	.06204	16.1190	27
34	.00989	101.107	.02735	36.5627	.04483	22.3081	.06233	16.0435	26
35	.01018	98.2179	.02764	36.1776	.04512	22.1640	.06262	15.9687	25
36	.01047	95.4895	.02793	35.8006	.04541	22.0217	.06291	15.8945	24
37	.01076	92.9085	.02822	35.4313	.04570	21.8813	.06321	15.8211	23
38	.01105	90.4633	.02851	35.0695	.04599	21.7426	.06350	15.7483	22
39	.01135	88.1436	.02881	34.7151	.04628	21.6056	.06379	15.6762	21
40	.01164	85.9398	.02910	34.3678	.04658	21.4704	.06408	15.6048	20
41	.01193	83.8435	.02939	34.0273	.04687	21.3360	.06437	15.5340	19
42	.01222	81.8470	.02968	33.6935	.04716	21.2039	.06467	15.4638	18
43	.01251	79.9434	.02997	33.3662	.04745	21.0747	.06496	15.3943	17
44	.01280	78.1263	.03026	33.0452	.04774	20.9460	.06525	15.3254	16
45	.01309	76.3900	.03055	32.7303	.04803	20.8188	.06554	15.2571	15
46	.01338	74.7292	.03084	32.4213	.04832	20.6932	.06584	15.1893	14
47	.01367	73.1390	.03114	32.1181	.04862	20.5691	.06613	15.1222	13
48	.01396	71.6151	.03143	31.8205	.04891	20.4465	.06642	15.0557	12
49	.01425	70.1533	.03172	31.5284	.04920	20.3253	.06671	14.9898	11
50	.01455	68.7501	.03201	31.2416	.04949	20.2056	.06700	14.9244	10
51	.01484	67.4019	.03230	30.9599	.04978	20.0872	.06730	14.8596	9
52	.01513	66.1055	.03259	30.6833	.05007	19.9702	.06759	14.7954	8
53	.01542	64.8580	.03288	30.4116	.05037	19.8546	.06788	14.7317	7
54	.01571	63.6567	.03317	30.1446	.05066	19.7403	.06817	14.6685	6
55	.01600	62.4992	.03346	29.8823	.05095	19.6273	.06847	14.6059	5
56	.01629	61.3829	.03376	29.6245	.05124	19.5156	.06876	14.5438	4
57	.01658	60.3058	.03405	29.3711	.05153	19.4051	.06905	14.4823	3
58	.01687	59.2659	.03434	29.1220	.05182	19.2959	.06934	14.4212	2
59	.01716	58.2612	.03463	28.8771	.05212	19.1879	.06963	14.3607	1
60	.01746	57.2900	.03492	28.6363	.05241	19.0811	.06993	14.3007	0
	CO-TAN.	TAN.	CO-TAN.	TAN.	CO-TAN.	TAN.	CO-TAN.	TAN.	
		89°		88°		87°		86°	

'	4°		5°		6°		7°		'
	TAN.	CO-TAN.	TAN.	CO-TAN.	TAN.	CO-TAN.	TAN.	CO-TAN.	
0	.06993	14.3007	.08749	11.4301	.10510	9.51436	.12278	8.14435	60
1	.07022	14.2411	.08778	11.3919	.10540	9.45781	.12308	8.12481	59
2	.07051	14.1821	.08807	11.3540	.10569	9.40141	.12338	8.10536	58
3	.07080	14.1235	.08837	11.3163	.10599	9.43515	.12367	8.08600	57
4	.07110	14.0655	.08866	11.2789	.10628	9.40904	.12397	8.06674	56
5	.07139	14.0079	.08895	11.2417	.10657	9.38377	.12426	8.04756	55
6	.07168	13.9507	.08925	11.2048	.10687	9.35724	.12456	8.02848	54
7	.07197	13.8940	.08954	11.1681	.10716	9.33154	.12485	8.00948	53
8	.07227	13.8378	.08983	11.1316	.10746	9.30599	.12515	7.99058	52
9	.07256	13.7821	.09013	11.0954	.10775	9.28058	.12544	7.97176	51
10	.07285	13.7267	.09042	11.0594	.10805	9.25530	.12574	7.95302	50
11	.07314	13.6710	.09071	11.0237	.10834	9.23016	.12603	7.93438	49
12	.07344	13.6174	.09101	10.9882	.10863	9.20516	.12633	7.91582	48
13	.07373	13.5634	.09130	10.9529	.10893	9.18028	.12662	7.89734	47
14	.07402	13.5098	.09159	10.9178	.10922	9.15554	.12692	7.87895	46
15	.07431	13.4566	.09189	10.8829	.10952	9.13093	.12722	7.86064	45
16	.07461	13.4039	.09218	10.8483	.10981	9.10646	.12751	7.84242	44
17	.07490	13.3515	.09247	10.8139	.11011	9.08211	.12781	7.82428	43
18	.07519	13.2996	.09277	10.7797	.11040	9.05789	.12810	7.80622	42
19	.07548	13.2480	.09306	10.7457	.11070	9.03379	.12840	7.78825	41
20	.07578	13.1969	.09335	10.7119	.11099	9.00983	.12869	7.77035	40
21	.07607	13.1461	.09365	10.6783	.11128	8.98598	.12899	7.75254	39
22	.07636	13.0958	.09394	10.6450	.11158	8.96227	.12929	7.73480	38
23	.07665	13.0458	.09423	10.6118	.11187	8.93867	.12958	7.71715	37
24	.07695	12.9962	.09453	10.5789	.11217	8.91520	.12988	7.69957	36
25	.07724	12.9469	.09482	10.5462	.11246	8.89185	.13017	7.68208	35
26	.07753	12.8981	.09511	10.5136	.11276	8.86862	.13047	7.66466	34
27	.07782	12.8496	.09541	10.4813	.11305	8.84551	.13076	7.64732	33
28	.07812	12.8014	.09570	10.4491	.11335	8.82252	.13106	7.63005	32
29	.07841	12.7536	.09600	10.4172	.11364	8.79964	.13136	7.61287	31
30	.07870	12.7062	.09629	10.3854	.11394	8.77689	.13165	7.59575	30
31	.07899	12.6591	.09658	10.3538	.11423	8.75425	.13195	7.57872	29
32	.07929	12.6124	.09688	10.3224	.11452	8.73172	.13224	7.56176	28
33	.07958	12.5660	.09717	10.2913	.11482	8.70931	.13254	7.54487	27
34	.07987	12.5199	.09746	10.2602	.11511	8.68711	.13284	7.52806	26
35	.08017	12.4742	.09776	10.2294	.11541	8.66482	.13313	7.51132	25
36	.08046	12.4288	.09805	10.1988	.11570	8.64275	.13343	7.49465	24
37	.08075	12.3838	.09834	10.1683	.11600	8.62078	.13372	7.47806	23
38	.08104	12.3390	.09864	10.1381	.11629	8.59893	.13402	7.46154	22
39	.08134	12.2946	.09893	10.1080	.11659	8.57718	.13432	7.44509	21
40	.08163	12.2505	.09923	10.0780	.11688	8.55555	.13461	7.42871	20
41	.08192	12.2067	.09952	10.0483	.11718	8.53402	.13491	7.41240	19
42	.08221	12.1632	.09981	10.0187	.11747	8.51259	.13521	7.39616	18
43	.08251	12.1201	.10011	9.98931	.11777	8.49128	.13550	7.37999	17
44	.08280	12.0772	.10040	9.96007	.11806	8.47007	.13580	7.36389	16
45	.08309	12.0346	.10069	9.93101	.11836	8.44896	.13609	7.34786	15
46	.08339	11.9923	.10099	9.90211	.11865	8.42795	.13639	7.33190	14
47	.08368	11.9504	.10128	9.87338	.11895	8.40705	.13669	7.31600	13
48	.08397	11.9087	.10158	9.84482	.11924	8.38625	.13698	7.30018	12
49	.08427	11.8673	.10187	9.81641	.11954	8.36555	.13728	7.28442	11
50	.08456	11.8262	.10216	9.78817	.11983	8.34496	.13758	7.26873	10
51	.08485	11.7853	.10246	9.76009	.12013	8.32446	.13787	7.25310	9
52	.08514	11.7448	.10275	9.73217	.12042	8.30406	.13817	7.23754	8
53	.08544	11.7045	.10305	9.70441	.12072	8.28376	.13846	7.22204	7
54	.08573	11.6645	.10334	9.67680	.12101	8.26355	.13876	7.20661	6
55	.08602	11.6248	.10363	9.64935	.12131	8.24345	.13906	7.19125	5
56	.08632	11.5853	.10393	9.62205	.12160	8.22344	.13935	7.17594	4
57	.08661	11.5461	.10422	9.59490	.12190	8.20352	.13965	7.16071	3
58	.08690	11.5072	.10452	9.56791	.12219	8.18379	.13995	7.14553	2
59	.08720	11.4685	.10481	9.54106	.12249	8.16398	.14024	7.13042	1
60	.08749	11.4301	.10510	9.51436	.12278	8.14435	.14054	7.11537	0
'	CO-TAN.	TAN.	CO-TAN.	TAN.	CO-TAN.	TAN.	CO-TAN.	TAN.	'
		85°		84°		83°		82°	

NATURAL TANGENTS

1595

'	8°		9°		10°		11°		'
	TAN.	CO-TAN.	TAN.	CO-TAN.	TAN.	CO-TAN.	TAN.	CO-TAN.	
0	.14054	7.11537	.15838	6.31375	.17633	5.67128	.19438	5.14455	60
1	.14084	7.10038	.15868	6.30189	.17663	5.66165	.19468	5.13658	59
2	.14113	7.08546	.15898	6.29007	.17693	5.65205	.19498	5.12862	58
3	.14143	7.07050	.15928	6.27829	.17723	5.64248	.19529	5.12069	57
4	.14173	7.05579	.15958	6.26655	.17753	5.63295	.19559	5.11270	56
5	.14202	7.04105	.15988	6.25486	.17783	5.62344	.19589	5.10490	55
6	.14232	7.02637	.16017	6.24321	.17813	5.61397	.19619	5.09704	54
7	.14262	7.01174	.16047	6.23160	.17843	5.60452	.19649	5.08921	53
8	.14291	6.99718	.16077	6.22003	.17873	5.59511	.19680	5.08139	52
9	.14321	6.98268	.16107	6.20851	.17903	5.58573	.19710	5.07360	51
10	.14351	6.96823	.16137	6.19703	.17933	5.57638	.19740	5.06584	50
11	.14381	6.95385	.16167	6.18559	.17963	5.56706	.19770	5.05809	49
12	.14410	6.93952	.16196	6.17419	.17993	5.55777	.19801	5.05037	48
13	.14440	6.92525	.16226	6.16283	.18023	5.54851	.19831	5.04267	47
14	.14470	6.91104	.16256	6.15151	.18053	5.53927	.19861	5.03499	46
15	.14499	6.89688	.16286	6.14023	.18083	5.53007	.19891	5.02734	45
16	.14529	6.88278	.16316	6.12899	.18113	5.52090	.19921	5.01971	44
17	.14559	6.86874	.16346	6.11779	.18143	5.51176	.19952	5.01210	43
18	.14588	6.85475	.16376	6.10664	.18173	5.50264	.19982	5.00451	42
19	.14618	6.84082	.16405	6.09552	.18203	5.49356	.20012	4.99695	41
20	.14648	6.82694	.16435	6.08444	.18233	5.48451	.20042	4.98940	40
21	.14678	6.81312	.16465	6.07340	.18263	5.47548	.20073	4.98188	39
22	.14707	6.79936	.16495	6.06240	.18293	5.46648	.20103	4.97438	38
23	.14737	6.78566	.16525	6.05143	.18323	5.45751	.20133	4.96690	37
24	.14767	6.77199	.16555	6.04051	.18353	5.44857	.20164	4.95945	36
25	.14796	6.75838	.16585	6.02962	.18383	5.43966	.20194	4.95201	35
26	.14826	6.74483	.16615	6.01878	.18414	5.43077	.20224	4.94460	34
27	.14856	6.73133	.16645	6.00797	.18444	5.42192	.20254	4.93721	33
28	.14886	6.71789	.16674	5.99720	.18474	5.41309	.20285	4.92984	32
29	.14915	6.70450	.16704	5.98646	.18504	5.40429	.20315	4.92249	31
30	.14945	6.69116	.16734	5.97576	.18534	5.39552	.20345	4.91516	30
31	.14975	6.67787	.16764	5.96510	.18564	5.38677	.20376	4.90785	29
32	.15005	6.66463	.16794	5.95448	.18594	5.37805	.20406	4.90056	28
33	.15034	6.65144	.16824	5.94390	.18624	5.36936	.20436	4.89330	27
34	.15064	6.63831	.16854	5.93335	.18654	5.36070	.20466	4.88605	26
35	.15094	6.62523	.16884	5.92283	.18684	5.35206	.20497	4.87882	25
36	.15124	6.61219	.16914	5.91235	.18714	5.34345	.20527	4.87162	24
37	.15153	6.59921	.16944	5.90191	.18745	5.33487	.20557	4.86444	23
38	.15183	6.58627	.16974	5.89151	.18775	5.32631	.20588	4.85727	22
39	.15213	6.57339	.17004	5.88114	.18805	5.31778	.20618	4.85013	21
40	.15243	6.56055	.17033	5.87080	.18835	5.30928	.20648	4.84300	20
41	.15272	6.54777	.17063	5.86051	.18865	5.30080	.20679	4.83590	19
42	.15302	6.53503	.17093	5.85024	.18895	5.29235	.20709	4.82882	18
43	.15332	6.52234	.17123	5.84001	.18925	5.28393	.20739	4.82175	17
44	.15362	6.50970	.17153	5.82982	.18955	5.27553	.20770	4.81471	16
45	.15391	6.49710	.17183	5.81966	.18986	5.26715	.20800	4.80769	15
46	.15421	6.48456	.17213	5.80953	.19016	5.25880	.20830	4.80068	14
47	.15451	6.47206	.17243	5.79944	.19046	5.25048	.20861	4.79370	13
48	.15481	6.45961	.17273	5.78938	.19076	5.24218	.20891	4.78673	12
49	.15511	6.44720	.17303	5.77936	.19106	5.23391	.20921	4.77978	11
50	.15540	6.43484	.17333	5.76937	.19136	5.22566	.20952	4.77286	10
51	.15570	6.42253	.17363	5.75941	.19166	5.21744	.20982	4.76595	9
52	.15600	6.41026	.17393	5.74949	.19197	5.20925	.21013	4.75906	8
53	.15630	6.39804	.17423	5.73960	.19227	5.20107	.21043	4.75219	7
54	.15660	6.38587	.17453	5.72974	.19257	5.19293	.21073	4.74534	6
55	.15689	6.37374	.17483	5.71992	.19287	5.18480	.21104	4.73851	5
56	.15719	6.36165	.17513	5.71013	.19317	5.17671	.21134	4.73170	4
57	.15749	6.34961	.17543	5.70037	.19347	5.16863	.21164	4.72490	3
58	.15779	6.33761	.17573	5.69064	.19378	5.16058	.21195	4.71813	2
59	.15809	6.32566	.17603	5.68094	.19408	5.15256	.21225	4.71137	1
60	.15838	6.31375	.17633	5.67128	.19438	5.14455	.21256	4.70463	0

CO-TAN. TAN. CO-TAN. TAN. CO-TAN. TAN. CO-TAN. TAN. 81° 80° 79° 78°

°	12°		13°		14°		15°		°
	TAN.	CO-TAN.	TAN.	CO-TAN.	TAN.	CO-TAN.	TAN.	CO-TAN.	
0	.21256	4.70463	.23087	4.33148	.24933	4.01078	.26795	3.73205	60
1	.21286	4.69791	.23117	4.32573	.24964	4.00582	.26826	3.72771	59
2	.21316	4.69121	.23148	4.32001	.24995	4.00086	.26857	3.72337	58
3	.21347	4.68452	.23179	4.31430	.25026	3.99592	.26888	3.71903	57
4	.21377	4.67786	.23209	4.30860	.25056	3.99099	.26920	3.71476	56
5	.21408	4.67121	.23240	4.30291	.25087	3.98607	.26951	3.71046	55
6	.21438	4.66458	.23271	4.29724	.25118	3.98117	.26982	3.70616	54
7	.21469	4.65797	.23301	4.29159	.25149	3.97627	.27013	3.70188	53
8	.21499	4.65138	.23332	4.28595	.25180	3.97139	.27044	3.69761	52
9	.21529	4.64480	.23363	4.28032	.25211	3.96651	.27076	3.69335	51
10	.21560	4.63825	.23393	4.27471	.25242	3.96165	.27107	3.68909	50
11	.21590	4.63171	.23424	4.26911	.25273	3.95680	.27138	3.68485	49
12	.21621	4.62518	.23455	4.26352	.25304	3.95196	.27169	3.68061	48
13	.21651	4.61868	.23485	4.25795	.25335	3.94713	.27201	3.67638	47
14	.21682	4.61219	.23516	4.25239	.25366	3.94232	.27232	3.67217	46
15	.21712	4.60572	.23547	4.24685	.25397	3.93751	.27263	3.66796	45
16	.21743	4.59927	.23578	4.24132	.25428	3.93271	.27294	3.66376	44
17	.21773	4.59283	.23608	4.23580	.25459	3.92793	.27326	3.65957	43
18	.21804	4.58641	.23639	4.23030	.25490	3.92316	.27357	3.65538	42
19	.21834	4.58001	.23670	4.22481	.25521	3.91839	.27388	3.65121	41
20	.21864	4.57363	.23700	4.21933	.25552	3.91364	.27419	3.64705	40
21	.21895	4.56726	.23731	4.21387	.25583	3.90890	.27451	3.64289	39
22	.21925	4.56091	.23762	4.20842	.25614	3.90417	.27482	3.63874	38
23	.21956	4.55458	.23793	4.20298	.25645	3.89945	.27513	3.63461	37
24	.21986	4.54826	.23823	4.19756	.25676	3.89474	.27545	3.63048	36
25	.22017	4.54196	.23854	4.19215	.25707	3.89004	.27576	3.62636	35
26	.22047	4.53568	.23885	4.18675	.25738	3.88536	.27607	3.62224	34
27	.22078	4.52941	.23916	4.18137	.25769	3.88068	.27638	3.61814	33
28	.22108	4.52316	.23946	4.17600	.25800	3.87601	.27670	3.61405	32
29	.22139	4.51693	.23977	4.17064	.25831	3.87136	.27701	3.60996	31
30	.22169	4.51071	.24008	4.16530	.25862	3.86671	.27732	3.60588	30
31	.22200	4.50451	.24039	4.15997	.25893	3.86208	.27764	3.60181	29
32	.22231	4.49832	.24069	4.15465	.25924	3.85745	.27795	3.59775	28
33	.22261	4.49215	.24100	4.14934	.25955	3.85284	.27826	3.59370	27
34	.22292	4.48600	.24131	4.14405	.25986	3.84824	.27858	3.58966	26
35	.22322	4.47986	.24162	4.13877	.26017	3.84364	.27889	3.58562	25
36	.22353	4.47374	.24193	4.13350	.26048	3.83906	.27920	3.58160	24
37	.22383	4.46764	.24223	4.12825	.26079	3.83449	.27952	3.57758	23
38	.22414	4.46155	.24254	4.12301	.26110	3.82992	.27983	3.57357	22
39	.22444	4.45548	.24285	4.11778	.26141	3.82537	.28015	3.56957	21
40	.22475	4.44942	.24316	4.11256	.26172	3.82083	.28046	3.56557	20
41	.22505	4.44338	.24347	4.10736	.26203	3.81630	.28077	3.56159	19
42	.22536	4.43735	.24377	4.10216	.26235	3.81177	.28109	3.55761	18
43	.22567	4.43134	.24408	4.09699	.26266	3.80726	.28140	3.55364	17
44	.22597	4.42534	.24439	4.09182	.26297	3.80276	.28172	3.54968	16
45	.22628	4.41936	.24470	4.08666	.26328	3.79827	.28203	3.54573	15
46	.22658	4.41340	.24501	4.08152	.26359	3.79378	.28234	3.54179	14
47	.22689	4.40745	.24532	4.07639	.26390	3.78931	.28266	3.53785	13
48	.22719	4.40152	.24562	4.07127	.26421	3.78485	.28297	3.53393	12
49	.22750	4.39560	.24593	4.06616	.26452	3.78040	.28329	3.53001	11
50	.22781	4.38969	.24624	4.06107	.26483	3.77595	.28360	3.52609	10
51	.22811	4.38381	.24655	4.05599	.26515	3.77152	.28391	3.52219	9
52	.22842	4.37793	.24686	4.05092	.26546	3.76709	.28423	3.51829	8
53	.22872	4.37207	.24717	4.04586	.26577	3.76268	.28454	3.51441	7
54	.22903	4.36623	.24747	4.04081	.26608	3.75828	.28486	3.51053	6
55	.22934	4.36040	.24778	4.03578	.26639	3.75388	.28517	3.50666	5
56	.22964	4.35459	.24809	4.03075	.26670	3.74949	.28549	3.50279	4
57	.22995	4.34879	.24840	4.02574	.26701	3.74512	.28580	3.49894	3
58	.23026	4.34300	.24871	4.02074	.26733	3.74075	.28612	3.49509	2
59	.23056	4.33723	.24902	4.01576	.26764	3.73640	.28643	3.49125	1
60	.23087	4.33148	.24933	4.01078	.26795	3.73205	.28675	3.48741	0
	CO-TAN.	TAN.	CO-TAN.	TAN.	CO-TAN.	TAN.	CO-TAN.	TAN.	
		77°		76°		75°		74°	

NATURAL TANGENTS

1597

'	16°		17°		18°		19°		'
	TAN.	CO-TAN.	TAN.	CO-TAN.	TAN.	CO-TAN.	TAN.	CO-TAN.	
0	.28675	3.48741	.30573	3.27085	.32492	3.07768	.34433	2.90421	60
1	.28706	3.48359	.30605	3.26745	.32524	3.07464	.34405	2.90147	59
2	.28738	3.47977	.30637	3.26406	.32556	3.07160	.34378	2.89873	58
3	.28769	3.47596	.30669	3.26067	.32588	3.06857	.34350	2.89600	57
4	.28800	3.47216	.30700	3.25729	.32621	3.06554	.34322	2.89327	56
5	.28832	3.46837	.30732	3.25392	.32653	3.06252	.34295	2.89055	55
6	.28864	3.46458	.30764	3.25055	.32685	3.05950	.34268	2.88783	54
7	.28895	3.46080	.30796	3.24719	.32717	3.05649	.34241	2.88511	53
8	.28927	3.45703	.30828	3.24383	.32749	3.05349	.34214	2.88240	52
9	.28958	3.45327	.30860	3.24049	.32782	3.05049	.34187	2.87970	51
10	.28990	3.44951	.30891	3.23714	.32814	3.04749	.34160	2.87700	50
11	.29021	3.44576	.30923	3.23381	.32846	3.04450	.34133	2.87430	49
12	.29053	3.44202	.30955	3.23048	.32878	3.04152	.34106	2.87161	48
13	.29084	3.43829	.30987	3.22715	.32911	3.03854	.34079	2.86892	47
14	.29116	3.43456	.31019	3.22384	.32943	3.03556	.34052	2.86624	46
15	.29147	3.43084	.31051	3.22053	.32975	3.03260	.34025	2.86356	45
16	.29179	3.42713	.31083	3.21722	.33007	3.02966	.33998	2.86089	44
17	.29210	3.42343	.31115	3.21392	.33040	3.02672	.33971	2.85822	43
18	.29242	3.41973	.31147	3.21063	.33072	3.02377	.33944	2.85555	42
19	.29274	3.41604	.31178	3.20734	.33104	3.02077	.33917	2.85289	41
20	.29305	3.41236	.31210	3.20406	.33136	3.01783	.33890	2.85023	40
21	.29337	3.40869	.31242	3.20079	.33169	3.01489	.33863	2.84758	39
22	.29368	3.40502	.31274	3.19752	.33201	3.01196	.33836	2.84494	38
23	.29400	3.40136	.31306	3.19426	.33233	3.00903	.33809	2.84229	37
24	.29432	3.39771	.31338	3.19100	.33266	3.00611	.33782	2.83965	36
25	.29463	3.39406	.31370	3.18775	.33298	3.00318	.33755	2.83702	35
26	.29495	3.39042	.31402	3.18451	.33330	3.00026	.33728	2.83439	34
27	.29526	3.38679	.31434	3.18127	.33363	2.99738	.33701	2.83176	33
28	.29558	3.38317	.31466	3.17804	.33395	2.99447	.33674	2.82914	32
29	.29590	3.37955	.31498	3.17481	.33427	2.99158	.33647	2.82653	31
30	.29621	3.37594	.31530	3.17159	.33460	2.98868	.33620	2.82391	30
31	.29653	3.37234	.31562	3.16838	.33492	2.98580	.33593	2.82130	29
32	.29685	3.36875	.31594	3.16517	.33524	2.98292	.33566	2.81870	28
33	.29716	3.36516	.31626	3.16197	.33557	2.98004	.33539	2.81610	27
34	.29748	3.36158	.31658	3.15877	.33589	2.97717	.33512	2.81350	26
35	.29780	3.35800	.31690	3.15558	.33621	2.97430	.33485	2.81091	25
36	.29811	3.35443	.31722	3.15240	.33654	2.97144	.33458	2.80833	24
37	.29843	3.35087	.31754	3.14922	.33686	2.96858	.33431	2.80574	23
38	.29875	3.34732	.31786	3.14605	.33718	2.96573	.33404	2.80316	22
39	.29906	3.34377	.31818	3.14288	.33751	2.96288	.33377	2.80059	21
40	.29938	3.34023	.31850	3.13972	.33783	2.96004	.33350	2.79802	20
41	.29970	3.33670	.31882	3.13656	.33816	2.95721	.33323	2.79545	19
42	.30001	3.33317	.31914	3.13341	.33848	2.95438	.33296	2.79289	18
43	.30033	3.32965	.31946	3.13027	.33881	2.95155	.33269	2.79033	17
44	.30065	3.32614	.31978	3.12713	.33913	2.94872	.33242	2.78778	16
45	.30097	3.32264	.32010	3.12400	.33945	2.94590	.33215	2.78523	15
46	.30128	3.31914	.32042	3.12087	.33978	2.94309	.33188	2.78269	14
47	.30160	3.31565	.32074	3.11775	.34010	2.94028	.33161	2.78014	13
48	.30192	3.31216	.32106	3.11464	.34043	2.93748	.33134	2.77761	12
49	.30224	3.30868	.32139	3.11153	.34075	2.93468	.33107	2.77507	11
50	.30255	3.30521	.32171	3.10842	.34108	2.93189	.33080	2.77254	10
51	.30287	3.30174	.32203	3.10532	.34140	2.92910	.33053	2.77002	9
52	.30319	3.29829	.32235	3.10223	.34173	2.92632	.33026	2.76750	8
53	.30351	3.29483	.32267	3.09914	.34205	2.92354	.32999	2.76498	7
54	.30382	3.29139	.32299	3.09606	.34238	2.92076	.32972	2.76247	6
55	.30414	3.28795	.32331	3.09298	.34270	2.91799	.32945	2.75996	5
56	.30446	3.28452	.32363	3.08991	.34303	2.91523	.32918	2.75746	4
57	.30478	3.28109	.32396	3.08685	.34335	2.91246	.32891	2.75496	3
58	.30509	3.27767	.32428	3.08379	.34368	2.90971	.32864	2.75246	2
59	.30541	3.27426	.32460	3.08073	.34400	2.90696	.32837	2.74997	1
60	.30573	3.27085	.32492	3.07768	.34433	2.90421	.32810	2.74748	0
'	CO-TAN.	TAN.	CO-TAN.	TAN.	CO-TAN.	TAN.	CO-TAN.	TAN.	'
		73°		72°		71°		70°	

'	20°		21°		22°		23°		'
	TAN.	CO-TAN.	TAN.	CO-TAN.	TAN.	CO-TAN.	TAN.	CO-TAN.	
0	.36397	2.74748	.38386	2.60509	.40403	2.47509	.42447	2.35585	60
1	.36430	2.74499	.38420	2.60283	.40436	2.47302	.42482	2.35395	59
2	.36463	2.74251	.38453	2.60057	.40470	2.47095	.42516	2.35205	58
3	.36496	2.74004	.38487	2.59831	.40504	2.46888	.42551	2.35015	57
4	.36529	2.73756	.38520	2.59606	.40538	2.46682	.42585	2.34825	56
5	.36562	2.73509	.38553	2.59381	.40572	2.46476	.42619	2.34636	55
6	.36595	2.73263	.38587	2.59156	.40606	2.46270	.42654	2.34447	54
7	.36628	2.73017	.38620	2.58932	.40640	2.46065	.42688	2.34258	53
8	.36661	2.72771	.38654	2.58708	.40674	2.45860	.42722	2.34069	52
9	.36694	2.72526	.38687	2.58484	.40707	2.45655	.42757	2.33881	51
10	.36727	2.72281	.38721	2.58261	.40741	2.45451	.42791	2.33693	50
11	.36760	2.72036	.38754	2.58038	.40775	2.45246	.42826	2.33505	49
12	.36793	2.71792	.38787	2.57815	.40809	2.45043	.42860	2.33317	48
13	.36826	2.71548	.38821	2.57593	.40843	2.44840	.42894	2.33130	47
14	.36859	2.71305	.38854	2.57371	.40877	2.44636	.42929	2.32943	46
15	.36892	2.71062	.38888	2.57150	.40911	2.44433	.42963	2.32756	45
16	.36925	2.70819	.38921	2.56928	.40945	2.44230	.42998	2.32570	44
17	.36958	2.70577	.38955	2.56707	.40979	2.44027	.43032	2.32383	43
18	.36991	2.70335	.38988	2.56487	.41013	2.43825	.43067	2.32197	42
19	.37024	2.70094	.39022	2.56266	.41047	2.43623	.43101	2.32012	41
20	.37057	2.69853	.39055	2.56046	.41081	2.43422	.43136	2.31826	40
21	.37090	2.69612	.39089	2.55827	.41115	2.43220	.43170	2.31641	39
22	.37124	2.69371	.39122	2.55608	.41149	2.43019	.43205	2.31456	38
23	.37157	2.69131	.39156	2.55389	.41183	2.42819	.43239	2.31271	37
24	.37190	2.68892	.39190	2.55170	.41217	2.42618	.43274	2.31086	36
25	.37223	2.68653	.39223	2.54952	.41251	2.42418	.43308	2.30902	35
26	.37256	2.68414	.39257	2.54734	.41285	2.42218	.43343	2.30718	34
27	.37289	2.68175	.39290	2.54516	.41319	2.42019	.43378	2.30534	33
28	.37322	2.67937	.39324	2.54299	.41353	2.41819	.43412	2.30351	32
29	.37355	2.67700	.39357	2.54082	.41387	2.41620	.43447	2.30167	31
30	.37388	2.67462	.39391	2.53865	.41421	2.41421	.43481	2.29984	30
31	.37422	2.67225	.39425	2.53648	.41455	2.41223	.43516	2.29801	29
32	.37455	2.66989	.39458	2.53432	.41490	2.41025	.43550	2.29618	28
33	.37488	2.66752	.39492	2.53217	.41524	2.40827	.43585	2.29437	27
34	.37521	2.66516	.39526	2.53001	.41558	2.40629	.43620	2.29254	26
35	.37554	2.66281	.39559	2.52786	.41592	2.40432	.43654	2.29073	25
36	.37588	2.66046	.39593	2.52571	.41626	2.40235	.43689	2.28891	24
37	.37621	2.65811	.39626	2.52357	.41660	2.40038	.43724	2.28710	23
38	.37654	2.65576	.39660	2.52142	.41694	2.39841	.43758	2.28528	22
39	.37687	2.65342	.39694	2.51929	.41728	2.39645	.43793	2.28348	21
40	.37720	2.65109	.39727	2.51715	.41763	2.39449	.43828	2.28167	20
41	.37754	2.64875	.39761	2.51502	.41797	2.39253	.43862	2.27987	19
42	.37787	2.64642	.39795	2.51289	.41831	2.39058	.43897	2.27806	18
43	.37820	2.64410	.39829	2.51076	.41865	2.38862	.43932	2.27626	17
44	.37853	2.64177	.39862	2.50864	.41899	2.38668	.43966	2.27447	16
45	.37887	2.63945	.39896	2.50652	.41933	2.38473	.44001	2.27267	15
46	.37920	2.63714	.39930	2.50440	.41968	2.38279	.44036	2.27088	14
47	.37953	2.63483	.39963	2.50229	.42002	2.38084	.44071	2.26909	13
48	.37986	2.63252	.39997	2.50018	.42036	2.37891	.44105	2.26730	12
49	.38020	2.63021	.40031	2.49807	.42070	2.37697	.44140	2.26552	11
50	.38053	2.62791	.40065	2.49597	.42105	2.37504	.44175	2.26374	10
51	.38086	2.62561	.40098	2.49386	.42139	2.37311	.44210	2.26196	9
52	.38120	2.62332	.40132	2.49177	.42173	2.37118	.44244	2.26018	8
53	.38153	2.62103	.40166	2.48967	.42207	2.36925	.44279	2.25840	7
54	.38186	2.61874	.40200	2.48758	.42242	2.36733	.44314	2.25663	6
55	.38220	2.61646	.40234	2.48549	.42276	2.36541	.44349	2.25486	5
56	.38253	2.61418	.40267	2.48340	.42310	2.36349	.44384	2.25309	4
57	.38286	2.61190	.40301	2.48132	.42345	2.36158	.44418	2.25132	3
58	.38320	2.60963	.40335	2.47924	.42379	2.35967	.44453	2.24956	2
59	.38353	2.60736	.40369	2.47716	.42413	2.35776	.44488	2.24780	1
60	.38386	2.60509	.40403	2.47509	.42447	2.35585	.44523	2.24604	0
'	CO-TAN.	TAN.	CO-TAN.	TAN.	CO-TAN.	TAN.	CO-TAN.	TAN.	'
	60°		68°		67°		66°		

NATURAL TANGENTS

1599

	24°		25°		26°		27°		
	TAN.	CO-TAN.	TAN.	CO-TAN.	TAN.	CO-TAN.	TAN.	CO-TAN.	
0	.44523	2.24604	.46631	2.14451	.48773	2.05030	.50953	1.96261	60
1	.44558	2.24428	.46666	2.14288	.48809	2.04879	.50980	1.96120	59
2	.44593	2.24252	.46702	2.14125	.48845	2.04728	.51026	1.95979	58
3	.44627	2.24077	.46737	2.13963	.48881	2.04577	.51066	1.95838	57
4	.44662	2.23902	.46772	2.13801	.48917	2.04426	.51099	1.95698	56
5	.44697	2.23727	.46808	2.13639	.48953	2.04276	.51136	1.95557	55
6	.44732	2.23553	.46843	2.13477	.48989	2.04125	.51173	1.95417	54
7	.44767	2.23378	.46879	2.13316	.49026	2.03975	.51209	1.95277	53
8	.44802	2.23204	.46914	2.13154	.49062	2.03825	.51246	1.95137	52
9	.44837	2.23030	.46950	2.12993	.49098	2.03675	.51283	1.94997	51
10	.44872	2.22857	.46985	2.12832	.49134	2.03526	.51319	1.94858	50
11	.44907	2.22683	.47021	2.12671	.49170	2.03376	.51356	1.94718	49
12	.44942	2.22510	.47056	2.12511	.49206	2.03227	.51393	1.94579	48
13	.44977	2.22337	.47092	2.12350	.49242	2.03078	.51430	1.94440	47
14	.45012	2.22164	.47128	2.12190	.49278	2.02929	.51467	1.94301	46
15	.45047	2.21992	.47163	2.12030	.49315	2.02780	.51503	1.94162	45
16	.45082	2.21819	.47199	2.11871	.49351	2.02631	.51540	1.94023	44
17	.45117	2.21647	.47234	2.11711	.49387	2.02483	.51577	1.93885	43
18	.45152	2.21475	.47270	2.11552	.49423	2.02335	.51614	1.93746	42
19	.45187	2.21304	.47305	2.11392	.49459	2.02187	.51651	1.93608	41
20	.45222	2.21132	.47341	2.11233	.49495	2.02039	.51688	1.93470	40
21	.45257	2.20961	.47377	2.11075	.49532	2.01891	.51724	1.93332	39
22	.45292	2.20790	.47412	2.10916	.49568	2.01743	.51761	1.93195	38
23	.45327	2.20619	.47448	2.10758	.49604	2.01596	.51798	1.93057	37
24	.45362	2.20449	.47483	2.10600	.49640	2.01449	.51835	1.92920	36
25	.45397	2.20278	.47519	2.10442	.49677	2.01302	.51872	1.92782	35
26	.45432	2.20108	.47555	2.10284	.49713	2.01155	.51909	1.92645	34
27	.45467	2.19938	.47590	2.10126	.49749	2.01008	.51946	1.92508	33
28	.45502	2.19769	.47626	2.09969	.49786	2.00862	.51983	1.92371	32
29	.45537	2.19599	.47662	2.09811	.49822	2.00715	.52020	1.92235	31
30	.45573	2.19430	.47698	2.09654	.49858	2.00569	.52057	1.92098	30
31	.45608	2.19261	.47733	2.09498	.49894	2.00423	.52094	1.91962	29
32	.45643	2.19092	.47769	2.09341	.49931	2.00277	.52131	1.91826	28
33	.45678	2.18923	.47805	2.09184	.49967	2.00131	.52168	1.91690	27
34	.45713	2.18755	.47840	2.09028	.50004	1.99986	.52205	1.91554	26
35	.45748	2.18587	.47876	2.08872	.50040	1.99841	.52242	1.91418	25
36	.45784	2.18419	.47912	2.08716	.50076	1.99695	.52279	1.91282	24
37	.45819	2.18251	.47948	2.08560	.50113	1.99550	.52316	1.91147	23
38	.45854	2.18084	.47984	2.08405	.50149	1.99404	.52353	1.91012	22
39	.45889	2.17916	.48019	2.08250	.50185	1.99261	.52390	1.90876	21
40	.45924	2.17749	.48055	2.08094	.50222	1.99116	.52427	1.90741	20
41	.45960	2.17582	.48091	2.07939	.50258	1.98972	.52464	1.90607	19
42	.45995	2.17416	.48127	2.07785	.50295	1.98828	.52501	1.90472	18
43	.46030	2.17249	.48163	2.07630	.50331	1.98684	.52538	1.90337	17
44	.46065	2.17083	.48198	2.07476	.50368	1.98540	.52575	1.90203	16
45	.46101	2.16917	.48234	2.07321	.50404	1.98396	.52613	1.90069	15
46	.46136	2.16751	.48270	2.07167	.50441	1.98253	.52650	1.89935	14
47	.46171	2.16585	.48306	2.07014	.50477	1.98110	.52687	1.89801	13
48	.46206	2.16420	.48342	2.06860	.50514	1.97966	.52724	1.89667	12
49	.46242	2.16255	.48378	2.06706	.50550	1.97823	.52761	1.89533	11
50	.46277	2.16090	.48414	2.06553	.50587	1.97680	.52798	1.89400	10
51	.46312	2.15925	.48450	2.06400	.50623	1.97538	.52836	1.89266	9
52	.46348	2.15760	.48486	2.06247	.50660	1.97395	.52873	1.89133	8
53	.46383	2.15596	.48521	2.06094	.50696	1.97253	.52910	1.89000	7
54	.46418	2.15432	.48557	2.05942	.50733	1.97111	.52947	1.88867	6
55	.46454	2.15268	.48593	2.05790	.50769	1.96969	.52984	1.88734	5
56	.46489	2.15104	.48629	2.05637	.50806	1.96827	.53022	1.88602	4
57	.46525	2.14940	.48665	2.05485	.50843	1.96685	.53059	1.88469	3
58	.46560	2.14777	.48701	2.05333	.50879	1.96544	.53096	1.88337	2
59	.46595	2.14614	.48737	2.05182	.50916	1.96402	.53134	1.88205	1
60	.46631	2.14451	.48773	2.05030	.50953	1.96261	.53171	1.88073	0
	CO-TAN.	TAN.	CO-TAN.	TAN.	CO-TAN.	TAN.	CO-TAN.	TAN.	
	65°		64°		63°		62°		

	28°		29°		30°		31°		
	TAN.	CO-TAN.	TAN.	CO-TAN.	TAN.	CO-TAN.	TAN.	CO-TAN.	
0	.53171	1.88073	.55431	1.80405	.57735	1.73205	.60086	1.66428	60
1	.53208	1.87941	.55409	1.80281	.57774	1.73089	.60126	1.66318	59
2	.53246	1.87809	.55507	1.80158	.57813	1.72973	.60165	1.66209	58
3	.53283	1.87677	.55545	1.80034	.57851	1.72857	.60205	1.66099	57
4	.53320	1.87546	.55583	1.79911	.57890	1.72741	.60245	1.65990	56
5	.53358	1.87415	.55621	1.79788	.57929	1.72625	.60284	1.65881	55
6	.53395	1.87283	.55659	1.79665	.57968	1.72509	.60324	1.65772	54
7	.53432	1.87152	.55697	1.79542	.58007	1.72393	.60364	1.65663	53
8	.53470	1.87021	.55736	1.79419	.58046	1.72278	.60403	1.65554	52
9	.53507	1.86891	.55774	1.79296	.58085	1.72163	.60443	1.65445	51
10	.53545	1.86760	.55812	1.79174	.58124	1.72047	.60483	1.65337	50
11	.53582	1.86630	.55850	1.79051	.58162	1.71932	.60522	1.65228	49
12	.53620	1.86499	.55888	1.78929	.58201	1.71817	.60562	1.65120	48
13	.53657	1.86369	.55926	1.78807	.58240	1.71702	.60602	1.65011	47
14	.53694	1.86239	.55964	1.78685	.58279	1.71588	.60642	1.64903	46
15	.53732	1.86109	.56003	1.78563	.58318	1.71473	.60681	1.64795	45
16	.53769	1.85979	.56041	1.78441	.58357	1.71358	.60721	1.64687	44
17	.53807	1.85850	.56079	1.78319	.58396	1.71244	.60761	1.64579	43
18	.53844	1.85720	.56117	1.78198	.58435	1.71129	.60801	1.64471	42
19	.53882	1.85591	.56156	1.78077	.58474	1.71015	.60841	1.64363	41
20	.53920	1.85462	.56194	1.77955	.58513	1.70901	.60881	1.64256	40
21	.53957	1.85333	.56232	1.77834	.58552	1.70787	.60921	1.64148	39
22	.53995	1.85204	.56270	1.77713	.58591	1.70673	.60960	1.64041	38
23	.54032	1.85075	.56309	1.77592	.58631	1.70560	.61000	1.63934	37
24	.54070	1.84946	.56347	1.77471	.58670	1.70446	.61040	1.63826	36
25	.54107	1.84818	.56385	1.77351	.58709	1.70332	.61080	1.63719	35
26	.54145	1.84689	.56424	1.77230	.58748	1.70219	.61120	1.63612	34
27	.54183	1.84561	.56462	1.77110	.58787	1.70106	.61160	1.63505	33
28	.54220	1.84433	.56500	1.76990	.58826	1.69992	.61200	1.63398	32
29	.54258	1.84305	.56539	1.76869	.58865	1.69879	.61240	1.63292	31
30	.54296	1.84177	.56577	1.76749	.58904	1.69766	.61280	1.63185	30
31	.54333	1.84049	.56616	1.76630	.58944	1.69653	.61320	1.63079	29
32	.54371	1.83922	.56654	1.76510	.58983	1.69541	.61360	1.62972	28
33	.54409	1.83794	.56693	1.76390	.59022	1.69428	.61400	1.62866	27
34	.54446	1.83667	.56731	1.76271	.59061	1.69316	.61440	1.62760	26
35	.54484	1.83540	.56769	1.76151	.59101	1.69203	.61480	1.62654	25
35	.54522	1.83413	.56808	1.76032	.59140	1.69091	.61520	1.62548	24
37	.54560	1.83286	.56846	1.75913	.59179	1.68979	.61561	1.62442	23
38	.54597	1.83159	.56885	1.75794	.59218	1.68866	.61601	1.62336	22
39	.54635	1.83033	.56923	1.75675	.59258	1.68754	.61641	1.62230	21
40	.54673	1.82906	.56962	1.75556	.59297	1.68643	.61681	1.62125	20
41	.54711	1.82780	.57000	1.75437	.59336	1.68531	.61721	1.62019	19
42	.54748	1.82654	.57039	1.75319	.59376	1.68419	.61761	1.61914	18
43	.54786	1.82528	.57078	1.75200	.59415	1.68308	.61801	1.61808	17
44	.54824	1.82402	.57116	1.75082	.59454	1.68196	.61842	1.61703	16
45	.54862	1.82276	.57155	1.74964	.59494	1.68085	.61882	1.61598	15
46	.54900	1.82150	.57193	1.74846	.59533	1.67974	.61922	1.61493	14
47	.54938	1.82025	.57232	1.74728	.59573	1.67863	.61962	1.61388	13
48	.54975	1.81899	.57271	1.74610	.59612	1.67752	.62003	1.61283	12
49	.55013	1.81774	.57309	1.74492	.59651	1.67641	.62043	1.61179	11
50	.55051	1.81649	.57348	1.74375	.59691	1.67530	.62083	1.61074	10
51	.55089	1.81524	.57386	1.74257	.59730	1.67419	.62124	1.60970	9
52	.55127	1.81399	.57425	1.74140	.59770	1.67309	.62164	1.60865	8
53	.55165	1.81274	.57464	1.74022	.59809	1.67198	.62204	1.60761	7
54	.55203	1.81150	.57503	1.73905	.59849	1.67088	.62245	1.60657	6
55	.55241	1.81025	.57541	1.73788	.59888	1.66978	.62285	1.60553	5
56	.55279	1.80901	.57580	1.73671	.59928	1.66867	.62325	1.60449	4
57	.55317	1.80777	.57619	1.73555	.59967	1.66757	.62366	1.60345	3
58	.55355	1.80653	.57657	1.73438	.60007	1.66647	.62406	1.60241	2
59	.55393	1.80529	.57696	1.73321	.60046	1.66538	.62446	1.60137	1
60	.55431	1.80405	.57735	1.73205	.60086	1.66428	.62487	1.60033	0
	CO-TAN.	TAN.	CO-TAN.	TAN.	CO-TAN.	TAN.	CO-TAN.	TAN.	
	61°		60°		59°		58°		

NATURAL TANGENTS

1601

'	32°		33°		34°		35°		'
	TAN.	CO-TAN.	TAN.	CO-TAN.	TAN.	CO-TAN.	TAN.	CO-TAN.	
0	.62487	1.60033	.64941	1.53086	.67451	1.48256	.70021	1.42815	60
1	.62527	1.59930	.64982	1.53888	.67493	1.48163	.70064	1.42726	59
2	.62568	1.59826	.65023	1.53701	.67536	1.48070	.70107	1.42638	58
3	.62608	1.59723	.65065	1.53593	.67578	1.47977	.70151	1.42550	57
4	.62649	1.59620	.65106	1.53595	.67620	1.47885	.70194	1.42462	56
5	.62689	1.59517	.65148	1.53497	.67663	1.47792	.70238	1.42374	55
6	.62730	1.59414	.65189	1.53400	.67705	1.47709	.70281	1.42286	54
7	.62771	1.59311	.65231	1.53302	.67748	1.47607	.70325	1.42198	53
8	.62811	1.59208	.65272	1.53205	.67790	1.47514	.70368	1.42110	52
9	.62852	1.59105	.65314	1.53107	.67832	1.47422	.70412	1.42022	51
10	.62892	1.59002	.65355	1.53010	.67875	1.47330	.70455	1.41934	50
11	.62933	1.58900	.65397	1.52913	.67917	1.47238	.70499	1.41847	49
12	.62973	1.58797	.65438	1.52816	.67960	1.47146	.70542	1.41759	48
13	.63014	1.58695	.65480	1.52719	.68002	1.47053	.70586	1.41672	47
14	.63055	1.58593	.65521	1.52622	.68045	1.46962	.70629	1.41584	46
15	.63095	1.58490	.65563	1.52525	.68088	1.46870	.70673	1.41497	45
16	.63136	1.58388	.65604	1.52429	.68130	1.46778	.70717	1.41409	44
17	.63177	1.58286	.65646	1.52332	.68173	1.46686	.70760	1.41322	43
18	.63217	1.58184	.65688	1.52235	.68215	1.46595	.70804	1.41235	42
19	.63258	1.58083	.65729	1.52139	.68258	1.46503	.70848	1.41148	41
20	.63299	1.57981	.65771	1.52043	.68301	1.46411	.70891	1.41061	40
21	.63340	1.57879	.65813	1.51946	.68343	1.46320	.70935	1.40974	39
22	.63380	1.57778	.65854	1.51850	.68386	1.46229	.70979	1.40887	38
23	.63421	1.57676	.65896	1.51754	.68429	1.46137	.71023	1.40800	37
24	.63462	1.57575	.65938	1.51658	.68471	1.46046	.71066	1.40714	36
25	.63503	1.57474	.65980	1.51562	.68514	1.45955	.71110	1.40627	35
26	.63544	1.57372	.66021	1.51466	.68557	1.45864	.71154	1.40540	34
27	.63584	1.57271	.66063	1.51370	.68600	1.45773	.71198	1.40454	33
28	.63625	1.57170	.66105	1.51275	.68642	1.45682	.71242	1.40367	32
29	.63666	1.57069	.66147	1.51179	.68685	1.45591	.71285	1.40281	31
30	.63707	1.56969	.66189	1.51084	.68728	1.45501	.71329	1.40195	30
31	.63748	1.56868	.66230	1.50988	.68771	1.45410	.71373	1.40109	29
32	.63789	1.56767	.66272	1.50893	.68814	1.45320	.71417	1.40022	28
33	.63830	1.56667	.66314	1.50797	.68857	1.45229	.71461	1.39936	27
34	.63871	1.56566	.66356	1.50702	.68900	1.45139	.71505	1.39850	26
35	.63912	1.56466	.66398	1.50607	.68942	1.45049	.71549	1.39764	25
36	.63953	1.56366	.66440	1.50512	.68985	1.44958	.71593	1.39679	24
37	.63994	1.56265	.66482	1.50417	.69028	1.44868	.71637	1.39593	23
38	.64035	1.56165	.66524	1.50322	.69071	1.44778	.71681	1.39507	22
39	.64076	1.56065	.66566	1.50228	.69114	1.44688	.71725	1.39421	21
40	.64117	1.55966	.66608	1.50133	.69157	1.44598	.71769	1.39336	20
41	.64158	1.55866	.66650	1.50038	.69200	1.44508	.71813	1.39250	19
42	.64199	1.55766	.66692	1.49944	.69243	1.44418	.71857	1.39165	18
43	.64240	1.55666	.66734	1.49849	.69286	1.44329	.71901	1.39079	17
44	.64281	1.55567	.66776	1.49755	.69329	1.44239	.71946	1.38994	16
45	.64322	1.55467	.66818	1.49661	.69372	1.44149	.71990	1.38909	15
46	.64363	1.55368	.66860	1.49566	.69416	1.44060	.72034	1.38824	14
47	.64404	1.55269	.66902	1.49472	.69459	1.43970	.72078	1.38738	13
48	.64446	1.55170	.66944	1.49378	.69502	1.43881	.72122	1.38653	12
49	.64487	1.55071	.66986	1.49284	.69545	1.43792	.72166	1.38568	11
50	.64528	1.54972	.67028	1.49190	.69588	1.43703	.72211	1.38484	10
51	.64569	1.54873	.67071	1.49097	.69631	1.43614	.72255	1.38399	9
52	.64610	1.54774	.67113	1.49003	.69675	1.43525	.72299	1.38314	8
53	.64652	1.54675	.67155	1.48909	.69718	1.43436	.72344	1.38229	7
54	.64693	1.54576	.67197	1.48816	.69761	1.43347	.72388	1.38145	6
55	.64734	1.54478	.67239	1.48722	.69804	1.43258	.72432	1.38060	5
56	.64775	1.54379	.67282	1.48629	.69847	1.43169	.72477	1.37976	4
57	.64817	1.54281	.67324	1.48536	.69891	1.43080	.72521	1.37891	3
58	.64858	1.54183	.67366	1.48442	.69934	1.42992	.72565	1.37807	2
59	.64899	1.54085	.67409	1.48349	.69977	1.42903	.72610	1.37722	1
60	.64941	1.53986	.67451	1.48256	.70021	1.42815	.72654	1.37638	0

CO-TAN. TAN. CO-TAN. TAN. CO-TAN. TAN. CO-TAN. TAN. 57° 56° 55° 54°

'	36°		37°		38°		39°		'
	TAN.	CO-TAN.	TAN.	CO-TAN.	TAN.	CO-TAN.	TAN.	CO-TAN.	
c	.72654	1.37638	.75355	1.32704	.78129	1.27994	.80978	1.23490	60
1	.72699	1.37554	.75401	1.32624	.78175	1.27917	.81027	1.23416	59
2	.72743	1.37470	.75447	1.32544	.78222	1.27841	.81075	1.23343	58
3	.72788	1.37386	.75492	1.32464	.78266	1.27764	.81123	1.23270	57
4	.72832	1.37302	.75538	1.32384	.78310	1.27688	.81171	1.23196	56
5	.72877	1.37218	.75584	1.32304	.78353	1.27611	.81220	1.23123	55
6	.72921	1.37134	.75629	1.32224	.78410	1.27535	.81268	1.23050	54
7	.72966	1.37050	.75675	1.32144	.78457	1.27458	.81316	1.22977	53
8	.73010	1.36967	.75721	1.32064	.78504	1.27382	.81364	1.22904	52
9	.73055	1.36883	.75767	1.31984	.78551	1.27306	.81413	1.22831	51
10	.73100	1.36800	.75812	1.31904	.78598	1.27230	.81461	1.22758	50
11	.73144	1.36716	.75858	1.31825	.78645	1.27153	.81510	1.22685	49
12	.73189	1.36633	.75904	1.31745	.78692	1.27077	.81558	1.22612	48
13	.73234	1.36549	.75950	1.31666	.78730	1.27001	.81606	1.22539	47
14	.73278	1.36466	.76006	1.31586	.78780	1.26925	.81655	1.22467	46
15	.73323	1.36383	.76042	1.31507	.78834	1.26849	.81703	1.22394	45
16	.73368	1.36300	.76088	1.31427	.78881	1.26774	.81752	1.22321	44
17	.73413	1.36217	.76134	1.31348	.78928	1.26698	.81800	1.22249	43
18	.73457	1.36133	.76180	1.31269	.78975	1.26622	.81849	1.22176	42
19	.73502	1.36051	.76226	1.31190	.79022	1.26546	.81898	1.22104	41
20	.73547	1.35968	.76272	1.31110	.79070	1.26471	.81946	1.22031	40
21	.73592	1.35885	.76318	1.31031	.79117	1.26395	.81995	1.21959	39
22	.73637	1.35802	.76364	1.30952	.79164	1.26319	.82044	1.21886	38
23	.73681	1.35719	.76410	1.30873	.79212	1.26244	.82092	1.21814	37
24	.73726	1.35637	.76456	1.30795	.79259	1.26169	.82141	1.21742	36
25	.73771	1.35554	.76502	1.30716	.79306	1.26093	.82190	1.21670	35
26	.73816	1.35472	.76548	1.30637	.79354	1.26018	.82238	1.21598	34
27	.73861	1.35389	.76594	1.30558	.79401	1.25943	.82287	1.21526	33
28	.73906	1.35307	.76640	1.30480	.79449	1.25867	.82336	1.21454	32
29	.73951	1.35224	.76686	1.30401	.79496	1.25792	.82385	1.21382	31
30	.73996	1.35142	.76733	1.30323	.79544	1.25717	.82434	1.21310	30
31	.74041	1.35060	.76779	1.30244	.79591	1.25642	.82483	1.21238	29
32	.74086	1.34978	.76825	1.30166	.79639	1.25567	.82531	1.21166	28
33	.74131	1.34896	.76871	1.30087	.79686	1.25492	.82580	1.21094	27
34	.74176	1.34814	.76918	1.30009	.79734	1.25417	.82629	1.21022	26
35	.74221	1.34732	.76964	1.29931	.79781	1.25343	.82678	1.20951	25
36	.74267	1.34650	.77010	1.29853	.79829	1.25268	.82727	1.20879	24
37	.74312	1.34568	.77057	1.29775	.79877	1.25193	.82776	1.20808	23
38	.74357	1.34487	.77103	1.29696	.79924	1.25118	.82825	1.20736	22
39	.74402	1.34405	.77149	1.29618	.79972	1.25044	.82874	1.20665	21
40	.74447	1.34323	.77196	1.29541	.80020	1.24969	.82923	1.20593	20
41	.74492	1.34242	.77242	1.29463	.80067	1.24895	.82972	1.20522	19
42	.74538	1.34160	.77289	1.29385	.80115	1.24820	.83022	1.20451	18
43	.74583	1.34079	.77335	1.29307	.80163	1.24746	.83071	1.20379	17
44	.74628	1.33998	.77382	1.29229	.80211	1.24672	.83120	1.20308	16
45	.74674	1.33916	.77428	1.29152	.80258	1.24597	.83169	1.20237	15
46	.74719	1.33835	.77475	1.29074	.80306	1.24523	.83218	1.20166	14
47	.74764	1.33754	.77521	1.28997	.80354	1.24449	.83268	1.20095	13
48	.74810	1.33673	.77568	1.28919	.80402	1.24375	.83317	1.20024	12
49	.74855	1.33592	.77615	1.28842	.80450	1.24301	.83366	1.19953	11
50	.74900	1.33511	.77661	1.28764	.80498	1.24227	.83415	1.19882	10
51	.74946	1.33430	.77708	1.28687	.80546	1.24153	.83465	1.19811	9
52	.74991	1.33349	.77754	1.28610	.80594	1.24079	.83514	1.19740	8
53	.75037	1.33268	.77801	1.28533	.80642	1.24005	.83564	1.19669	7
54	.75082	1.33187	.77848	1.28456	.80690	1.23931	.83613	1.19599	6
55	.75128	1.33106	.77895	1.28379	.80738	1.23858	.83662	1.19528	5
56	.75173	1.33026	.77941	1.28302	.80786	1.23784	.83712	1.19457	4
57	.75219	1.32946	.77988	1.28225	.80834	1.23710	.83761	1.19387	3
58	.75264	1.32865	.78035	1.28148	.80882	1.23637	.83811	1.19316	2
59	.75310	1.32785	.78082	1.28071	.80930	1.23563	.83860	1.19246	1
60	.75355	1.32704	.78129	1.27994	.80978	1.23490	.83910	1.19175	0

CO-TAN. TAN. 53°

CO-TAN. TAN. 52°

CO-TAN. TAN. 51°

CO-TAN. TAN. 50°

NATURAL TANGENTS

1603

'	40°		41°		42°		43°		'
	TAN.	CO-TAN.	TAN.	CO-TAN.	TAN.	CO-TAN.	TAN.	CO-TAN.	
0	.83010	1.19175	.86029	1.15037	.90040	1.11061	-.93252	1.07237	60
1	.83060	1.19105	.86080	1.14969	.90093	1.10996	-.93306	1.07174	59
2	.84009	1.19035	.87031	1.14902	.90146	1.10931	-.93360	1.07112	58
3	.84059	1.18964	.87082	1.14834	.90199	1.10867	-.93415	1.07049	57
4	.84108	1.18894	.87133	1.14767	.90251	1.10802	-.93469	1.06987	56
5	.84158	1.18824	.87184	1.14700	.90304	1.10737	-.93524	1.06925	55
6	.84208	1.18754	.87236	1.14632	.90357	1.10672	-.93578	1.06862	54
7	.84258	1.18684	.87287	1.14565	.90410	1.10607	-.93633	1.06800	53
8	.84307	1.18614	.87338	1.14498	.90463	1.10543	-.93688	1.06738	52
9	.84357	1.18544	.87389	1.14430	.90516	1.10478	-.93742	1.06676	51
10	.84407	1.18474	.87441	1.14363	.90569	1.10414	-.93797	1.06613	50
11	.84457	1.18404	.87492	1.14296	.90621	1.10349	-.93852	1.06551	49
12	.84507	1.18334	.87543	1.14229	.90674	1.10285	-.93906	1.06489	48
13	.84556	1.18264	.87595	1.14162	.90727	1.10220	-.93961	1.06427	47
14	.84606	1.18194	.87646	1.14095	.90781	1.10156	-.94016	1.06365	46
15	.84656	1.18125	.87698	1.14028	.90834	1.10091	-.94071	1.06303	45
16	.84706	1.18055	.87749	1.13961	.90887	1.10027	-.94125	1.06241	44
17	.84756	1.17986	.87801	1.13894	.90940	1.09963	-.94180	1.06179	43
18	.84806	1.17916	.87852	1.13828	.90993	1.09899	-.94235	1.06117	42
19	.84856	1.17846	.87904	1.13761	.91046	1.09834	-.94290	1.06056	41
20	.84906	1.17777	.87955	1.13694	.91099	1.09770	-.94345	1.05994	40
21	.84956	1.17708	.88007	1.13627	.91153	1.09706	-.94400	1.05932	39
22	.85006	1.17638	.88059	1.13561	.91206	1.09642	-.94455	1.05870	38
23	.85057	1.17569	.88110	1.13494	.91259	1.09578	-.94510	1.05809	37
24	.85107	1.17500	.88162	1.13428	.91313	1.09514	-.94565	1.05747	36
25	.85157	1.17430	.88214	1.13361	.91366	1.09450	-.94620	1.05685	35
26	.85207	1.17361	.88265	1.13295	.91419	1.09386	-.94676	1.05624	34
27	.85257	1.17292	.88317	1.13228	.91473	1.09322	-.94731	1.05562	33
28	.85307	1.17223	.88369	1.13162	.91526	1.09258	-.94786	1.05501	32
29	.85358	1.17154	.88421	1.13096	.91580	1.09195	-.94841	1.05439	31
30	.85408	1.17085	.88473	1.13029	.91633	1.09131	-.94896	1.05378	30
31	.85458	1.17016	.88524	1.12963	.91687	1.09067	-.94952	1.05317	29
32	.85509	1.16947	.88576	1.12897	.91740	1.09003	-.95007	1.05255	28
33	.85559	1.16878	.88628	1.12831	.91794	1.08940	-.95062	1.05194	27
34	.85609	1.16809	.88680	1.12765	.91847	1.08876	-.95118	1.05133	26
35	.85660	1.16741	.88732	1.12699	.91901	1.08813	-.95173	1.05072	25
36	.85710	1.16672	.88784	1.12633	.91955	1.08749	-.95229	1.05010	24
37	.85761	1.16603	.88836	1.12567	.92008	1.08686	-.95284	1.04949	23
38	.85811	1.16535	.88888	1.12501	.92062	1.08622	-.95340	1.04888	22
39	.85862	1.16466	.88940	1.12435	.92116	1.08559	-.95395	1.04827	21
40	.85912	1.16398	.88992	1.12369	.92170	1.08496	-.95451	1.04766	20
41	.85963	1.16329	.89045	1.12303	.92224	1.08432	-.95506	1.04705	19
42	.86014	1.16261	.89097	1.12238	.92277	1.08369	-.95562	1.04644	18
43	.86064	1.16192	.89149	1.12172	.92331	1.08306	-.95618	1.04583	17
44	.86115	1.16124	.89201	1.12106	.92385	1.08243	-.95673	1.04522	16
45	.86166	1.16056	.89253	1.12041	.92439	1.08179	-.95729	1.04461	15
46	.86216	1.15987	.89306	1.11975	.92493	1.08116	-.95785	1.04401	14
47	.86267	1.15919	.89358	1.11909	.92547	1.08053	-.95841	1.04340	13
48	.86318	1.15851	.89410	1.11844	.92601	1.07990	-.95897	1.04279	12
49	.86368	1.15783	.89463	1.11778	.92655	1.07927	-.95952	1.04218	11
50	.86419	1.15715	.89515	1.11713	.92709	1.07864	-.96008	1.04158	10
51	.86470	1.15647	.89567	1.11648	.92763	1.07801	-.96064	1.04097	9
52	.86521	1.15579	.89620	1.11582	.92817	1.07738	-.96120	1.04036	8
53	.86572	1.15511	.89672	1.11517	.92872	1.07676	-.96176	1.03976	7
54	.86623	1.15443	.89725	1.11452	.92926	1.07613	-.96232	1.03915	6
55	.86674	1.15375	.89777	1.11387	.92980	1.07550	-.96288	1.03855	5
56	.86725	1.15308	.89830	1.11321	.93034	1.07487	-.96344	1.03794	4
57	.86776	1.15240	.89883	1.11256	.93088	1.07425	-.96400	1.03734	3
58	.86827	1.15172	.89935	1.11191	.93143	1.07362	-.96457	1.03674	2
59	.86878	1.15104	.89988	1.11126	.93197	1.07299	-.96513	1.03613	1
60	.86929	1.15037	.90040	1.11061	.93252	1.07237	-.96569	1.03553	0

CO-TAN. TAN. CO-TAN. TAN. CO-TAN. TAN. CO-TAN. TAN.

49°

48°

47°

46°

44°				44°				44°			
	TAN.	CO-TAN.		TAN.	CO-TAN.			TAN.	CO-TAN.		
0	.96569	1.03553	60	21	.97756	1.02295	39	41	.98901	1.01112	19
1	.96625	1.03403	59	22	.97813	1.02236	38	42	.98958	1.01053	18
2	.96681	1.03343	58	23	.97870	1.02176	37	43	.99016	1.00994	17
3	.96738	1.03272	57	24	.97927	1.02117	36	44	.99073	1.00935	16
4	.96794	1.03212	56	25	.97984	1.02057	35	45	.99131	1.00876	15
5	.96850	1.03152	55	26	.98041	1.01998	34	46	.99189	1.00818	14
6	.96907	1.03192	54	27	.98098	1.01939	33	47	.99247	1.00759	13
7	.96963	1.03132	53	28	.98155	1.01879	32	48	.99304	1.00701	12
8	.97020	1.03072	52	29	.98213	1.01820	31	49	.99362	1.00642	11
9	.97076	1.03012	51	30	.98270	1.01761	30	50	.99420	1.00583	10
10	.97133	1.02952	50	31	.98327	1.01702	29	51	.99478	1.00525	9
11	.97189	1.02892	49	32	.98384	1.01642	28	52	.99536	1.00467	8
12	.97246	1.02832	48	33	.98441	1.01583	27	53	.99594	1.00408	7
13	.97302	1.02772	47	34	.98499	1.01524	26	54	.99652	1.00350	6
14	.97359	1.02713	46	35	.98556	1.01465	25	55	.99710	1.00291	5
15	.97416	1.02653	45	36	.98613	1.01406	24	56	.99768	1.00233	4
16	.97472	1.02593	44	37	.98671	1.01347	23	57	.99826	1.00175	3
17	.97529	1.02533	43	38	.98728	1.01288	22	58	.99884	1.00116	2
18	.97586	1.02474	42	39	.98786	1.01229	21	59	.99942	1.00058	1
19	.97643	1.02414	41	40	.98843	1.01170	20	60	I	I	0
20	.97700	1.02355	40								
	CO-TAN.	TAN.			CO-TAN.	TAN.			CO-TAN.	TAN.	
	45°				45°				45°		

NATURAL SINES AND COSINES

0°				0°				0°			
	SINE	COSINE		SINE	COSINE			SINE	COSINE		
0	.00000	I	60	21	.00611	.99998	39	41	.01193	.99993	19
1	.00020	I	59	22	.00640	.99998	38	42	.01222	.99993	18
2	.00058	I	58	23	.00669	.99998	37	43	.01251	.99992	17
3	.00087	I	57	24	.00698	.99998	36	44	.01280	.99992	16
4	.00116	I	56	25	.00727	.99997	35	45	.01309	.99991	15
5	.00145	I	55	26	.00756	.99997	34	46	.01338	.99991	14
6	.00175	I	54	27	.00785	.99997	33	47	.01367	.99991	13
7	.00204	I	53	28	.00814	.99997	32	48	.01396	.99990	12
8	.00233	I	52	29	.00844	.99996	31	49	.01425	.99990	11
9	.00262	I	51	30	.00873	.99996	30	50	.01454	.99989	10
10	.00291	I	50	31	.00902	.99996	29	51	.01483	.99989	9
11	.00320	.99999	49	32	.00931	.99996	28	52	.01513	.99989	8
12	.00349	.99999	48	33	.00960	.99995	27	53	.01542	.99988	7
13	.00378	.99999	47	34	.00989	.99995	26	54	.01571	.99988	6
14	.00407	.99999	46	35	.01018	.99995	25	55	.01600	.99987	5
15	.00436	.99999	45	36	.01047	.99995	24	56	.01629	.99987	4
16	.00465	.99999	44	37	.01076	.99994	23	57	.01658	.99986	3
17	.00495	.99999	43	38	.01105	.99994	22	58	.01687	.99986	2
18	.00524	.99999	42	39	.01134	.99994	21	59	.01716	.99985	1
19	.00553	.99998	41	40	.01164	.99993	20	60	.01745	.99985	0
20	.00582	.99998	40								
	CO-SINE	SINE			CO-SINE	SINE			CO-SINE	SINE	
	89°				89°				89°		

NATURAL SINES

'	1°		2°		3°		4°		'
	SINE	COSINE	SINE	COSINE	SINE	COSINE	SINE	COSINE	
0	.01745	.99985	.03490	.99939	.05234	.99863	.06976	.99756	60
1	.01774	.99984	.03519	.99938	.05263	.99861	.07005	.99754	59
2	.01803	.99984	.03548	.99937	.05292	.99860	.07034	.99752	58
3	.01832	.99983	.03577	.99936	.05321	.99858	.07063	.99750	57
4	.01860	.99983	.03606	.99935	.05350	.99857	.07092	.99748	56
5	.01889	.99982	.03635	.99934	.05379	.99855	.07121	.99746	55
6	.01920	.99982	.03664	.99933	.05408	.99854	.07150	.99744	54
7	.01949	.99981	.03693	.99932	.05437	.99852	.07179	.99742	53
8	.01978	.99980	.03723	.99931	.05466	.99851	.07208	.99740	52
9	.02007	.99980	.03752	.99930	.05495	.99849	.07237	.99738	51
10	.02036	.99979	.03781	.99929	.05524	.99847	.07266	.99736	50
11	.02065	.99979	.03810	.99927	.05553	.99846	.07295	.99734	49
12	.02094	.99978	.03839	.99926	.05582	.99844	.07324	.99731	48
13	.02123	.99977	.03868	.99925	.05611	.99842	.07353	.99729	47
14	.02152	.99977	.03897	.99924	.05640	.99841	.07382	.99727	46
15	.02181	.99976	.03926	.99923	.05669	.99839	.07411	.99725	45
16	.02211	.99976	.03955	.99922	.05698	.99838	.07440	.99723	44
17	.02240	.99975	.03984	.99921	.05727	.99836	.07469	.99721	43
18	.02269	.99974	.04013	.99919	.05756	.99834	.07498	.99719	42
19	.02298	.99974	.04042	.99918	.05785	.99833	.07527	.99716	41
20	.02327	.99973	.04071	.99917	.05814	.99831	.07556	.99714	40
21	.02356	.99972	.04100	.99916	.05844	.99829	.07585	.99712	39
22	.02385	.99972	.04129	.99915	.05873	.99827	.07614	.99710	38
23	.02414	.99971	.04158	.99913	.05902	.99826	.07643	.99708	37
24	.02443	.99970	.04188	.99912	.05931	.99824	.07672	.99705	36
25	.02472	.99969	.04217	.99911	.05960	.99822	.07701	.99703	35
26	.02501	.99969	.04246	.99910	.05989	.99821	.07730	.99701	34
27	.02530	.99968	.04275	.99909	.06018	.99819	.07759	.99699	33
28	.02559	.99967	.04304	.99907	.06047	.99817	.07788	.99696	32
29	.02588	.99966	.04333	.99906	.06076	.99815	.07817	.99694	31
30	.02618	.99966	.04362	.99905	.06105	.99813	.07846	.99692	30
31	.02647	.99965	.04391	.99904	.06134	.99812	.07875	.99689	29
32	.02676	.99964	.04420	.99902	.06163	.99810	.07904	.99687	28
33	.02705	.99963	.04449	.99901	.06192	.99808	.07933	.99685	27
34	.02734	.99963	.04478	.99900	.06221	.99806	.07962	.99683	26
35	.02763	.99962	.04507	.99898	.06250	.99804	.07991	.99680	25
36	.02792	.99961	.04536	.99897	.06279	.99803	.08020	.99678	24
37	.02821	.99960	.04565	.99896	.06308	.99801	.08049	.99676	23
38	.02850	.99959	.04594	.99894	.06337	.99799	.08078	.99673	22
39	.02879	.99959	.04623	.99893	.06366	.99797	.08107	.99671	21
40	.02908	.99958	.04653	.99892	.06395	.99795	.08136	.99668	20
41	.02938	.99957	.04682	.99890	.06424	.99793	.08165	.99666	19
42	.02967	.99956	.04711	.99889	.06453	.99792	.08194	.99664	18
43	.02996	.99955	.04740	.99888	.06482	.99790	.08223	.99661	17
44	.03025	.99954	.04769	.99886	.06511	.99788	.08252	.99659	16
45	.03054	.99953	.04798	.99885	.06540	.99786	.08281	.99657	15
46	.03083	.99952	.04827	.99883	.06569	.99784	.08310	.99654	14
47	.03112	.99952	.04856	.99882	.06598	.99782	.08339	.99652	13
48	.03141	.99951	.04885	.99881	.06627	.99780	.08368	.99649	12
49	.03170	.99950	.04914	.99879	.06656	.99778	.08397	.99647	11
50	.03199	.99949	.04943	.99878	.06685	.99776	.08426	.99644	10
51	.03228	.99948	.04972	.99876	.06714	.99774	.08455	.99642	9
52	.03257	.99947	.05001	.99875	.06743	.99772	.08484	.99639	8
53	.03286	.99946	.05030	.99873	.06773	.99770	.08513	.99637	7
54	.03316	.99945	.05059	.99872	.06802	.99768	.08542	.99635	6
55	.03345	.99944	.05088	.99870	.06831	.99766	.08571	.99632	5
56	.03374	.99943	.05117	.99869	.06860	.99764	.08600	.99630	4
57	.03403	.99942	.05146	.99867	.06889	.99762	.08629	.99627	3
58	.03432	.99941	.05175	.99866	.06918	.99760	.08658	.99625	2
59	.03461	.99940	.05205	.99864	.06947	.99758	.08687	.99622	1
60	.03490	.99939	.05234	.99863	.06976	.99756	.08716	.99619	0
'	COSINE SINE		COSINE SINE		COSINE SINE		COSINE SINE		'
	88°		87°		86°		85°		

'	5°		6°		7°		8°		'
	SINE	COSINE	SINE	COSINE	SINE	COSINE	SINE	COSINE	
0	.08716	.99619	.10453	.99452	.12187	.99255	.13917	.99027	60
1	.08745	.99617	.10482	.99449	.12216	.99251	.13946	.99023	59
2	.08774	.99614	.10511	.99446	.12245	.99248	.13975	.99019	58
3	.08803	.99612	.10540	.99443	.12274	.99244	.14004	.99015	57
4	.08831	.99609	.10569	.99440	.12302	.99240	.14033	.99011	56
5	.08860	.99607	.10597	.99437	.12331	.99237	.14061	.99006	55
6	.08889	.99604	.10626	.99434	.12360	.99233	.14090	.99002	54
7	.08918	.99602	.10655	.99431	.12389	.99230	.14119	.98998	53
8	.08947	.99599	.10684	.99428	.12418	.99226	.14148	.98994	52
9	.08976	.99596	.10713	.99424	.12447	.99222	.14177	.98990	51
10	.09005	.99594	.10742	.99421	.12476	.99219	.14205	.98986	50
11	.09034	.99591	.10771	.99418	.12504	.99215	.14234	.98982	49
12	.09063	.99588	.10800	.99415	.12533	.99211	.14263	.98978	48
13	.09092	.99586	.10829	.99412	.12562	.99208	.14292	.98973	47
14	.09121	.99583	.10858	.99409	.12591	.99204	.14320	.98969	46
15	.09150	.99580	.10887	.99406	.12620	.99200	.14349	.98965	45
16	.09179	.99578	.10916	.99402	.12649	.99197	.14378	.98961	44
17	.09208	.99575	.10945	.99399	.12678	.99193	.14407	.98957	43
18	.09237	.99572	.10973	.99396	.12706	.99189	.14436	.98953	42
19	.09266	.99570	.11002	.99393	.12735	.99186	.14464	.98948	41
20	.09295	.99567	.11031	.99390	.12764	.99182	.14493	.98944	40
21	.09324	.99564	.11060	.99386	.12793	.99178	.14522	.98940	39
22	.09353	.99562	.11089	.99383	.12822	.99175	.14551	.98936	38
23	.09382	.99559	.11118	.99380	.12851	.99171	.14580	.98931	37
24	.09411	.99556	.11147	.99377	.12880	.99167	.14608	.98927	36
25	.09440	.99553	.11176	.99374	.12908	.99163	.14637	.98923	35
26	.09469	.99551	.11205	.99370	.12937	.99160	.14666	.98919	34
27	.09498	.99548	.11234	.99367	.12966	.99156	.14695	.98914	33
28	.09527	.99545	.11263	.99364	.12995	.99152	.14723	.98910	32
29	.09556	.99542	.11291	.99360	.13024	.99148	.14752	.98906	31
30	.09585	.99540	.11320	.99357	.13053	.99144	.14781	.98902	30
31	.09614	.99537	.11349	.99354	.13081	.99141	.14810	.98897	29
32	.09642	.99534	.11378	.99351	.13110	.99137	.14838	.98893	28
33	.09671	.99531	.11407	.99347	.13139	.99133	.14867	.98889	27
34	.09700	.99528	.11436	.99344	.13168	.99129	.14896	.98884	26
35	.09729	.99526	.11465	.99341	.13197	.99125	.14925	.98880	25
36	.09758	.99523	.11494	.99337	.13226	.99122	.14954	.98876	24
37	.09787	.99520	.11523	.99334	.13254	.99118	.14982	.98871	23
38	.09816	.99517	.11552	.99331	.13283	.99114	.15011	.98867	22
39	.09845	.99514	.11580	.99327	.13312	.99110	.15040	.98863	21
40	.09874	.99511	.11609	.99324	.13341	.99106	.15069	.98858	20
41	.09903	.99508	.11638	.99320	.13370	.99102	.15097	.98854	19
42	.09932	.99506	.11667	.99317	.13399	.99098	.15126	.98849	18
43	.09961	.99503	.11696	.99314	.13427	.99094	.15155	.98845	17
44	.09990	.99500	.11725	.99310	.13456	.99090	.15184	.98841	16
45	.10019	.99497	.11754	.99307	.13485	.99087	.15212	.98836	15
46	.10048	.99494	.11783	.99303	.13514	.99083	.15241	.98832	14
47	.10077	.99491	.11812	.99300	.13543	.99079	.15270	.98827	13
48	.10106	.99488	.11840	.99297	.13572	.99075	.15299	.98823	12
49	.10135	.99485	.11869	.99293	.13600	.99071	.15327	.98818	11
50	.10164	.99482	.11898	.99290	.13629	.99067	.15356	.98814	10
51	.10192	.99479	.11927	.99286	.13658	.99063	.15385	.98809	9
52	.10221	.99476	.11956	.99283	.13687	.99059	.15414	.98805	8
53	.10250	.99473	.11985	.99279	.13716	.99055	.15442	.98800	7
54	.10279	.99470	.12014	.99276	.13744	.99051	.15471	.98796	6
55	.10308	.99467	.12043	.99272	.13773	.99047	.15500	.98791	5
56	.10337	.99464	.12071	.99269	.13802	.99043	.15529	.98787	4
57	.10366	.99461	.12100	.99265	.13831	.99039	.15557	.98782	3
58	.10395	.99458	.12129	.99262	.13860	.99035	.15586	.98778	2
59	.10424	.99455	.12158	.99258	.13889	.99031	.15615	.98773	1
60	.10453	.99452	.12187	.99255	.13917	.99027	.15643	.98769	0
'	84°		83°		82°		81°		'
	COSINE	SINE	COSINE	SINE	COSINE	SINE	COSINE	SINE	

NATURAL SINES

1607

'	9°		10°		11°		12°		'
	SINE	COSINE	SINE	COSINE	SINE	COSINE	SINE	COSINE	
0	.15643	.98769	.17365	.98481	.19081	.98163	.20791	.97815	60
1	.15672	.98764	.17393	.98476	.19109	.98157	.20820	.97809	59
2	.15701	.98760	.17422	.98471	.19138	.98152	.20848	.97803	58
3	.15730	.98755	.17451	.98466	.19167	.98146	.20877	.97797	57
4	.15758	.98751	.17479	.98461	.19195	.98140	.20905	.97791	56
5	.15787	.98746	.17508	.98455	.19224	.98135	.20933	.97784	55
6	.15816	.98741	.17537	.98450	.19252	.98129	.20962	.97778	54
7	.15845	.98737	.17565	.98445	.19281	.98124	.20990	.97772	53
8	.15873	.98732	.17594	.98440	.19309	.98118	.21019	.97766	52
9	.15902	.98728	.17623	.98435	.19338	.98112	.21047	.97760	51
10	.15931	.98723	.17651	.98430	.19366	.98107	.21076	.97754	50
11	.15959	.98718	.17680	.98425	.19395	.98101	.21104	.97748	49
12	.15988	.98714	.17708	.98420	.19423	.98096	.21132	.97742	48
13	.16017	.98709	.17737	.98414	.19452	.98090	.21161	.97735	47
14	.16046	.98704	.17766	.98409	.19481	.98084	.21189	.97729	46
15	.16074	.98700	.17794	.98404	.19509	.98079	.21218	.97723	45
16	.16103	.98695	.17823	.98399	.19538	.98073	.21246	.97717	44
17	.16132	.98690	.17852	.98394	.19566	.98067	.21275	.97711	43
18	.16160	.98689	.17880	.98389	.19595	.98061	.21303	.97705	42
19	.16189	.98681	.17909	.98383	.19623	.98056	.21331	.97698	41
20	.16218	.98676	.17937	.98378	.19652	.98050	.21360	.97692	40
21	.16246	.98671	.17966	.98373	.19680	.98044	.21388	.97686	39
22	.16275	.98667	.17995	.98368	.19709	.98039	.21417	.97680	38
23	.16304	.98662	.18023	.98362	.19737	.98033	.21445	.97673	37
24	.16333	.98657	.18052	.98357	.19766	.98027	.21474	.97667	36
25	.16361	.98652	.18081	.98352	.19794	.98021	.21502	.97661	35
26	.16390	.98648	.18109	.98347	.19823	.98016	.21530	.97655	34
27	.16419	.98643	.18138	.98341	.19851	.98010	.21559	.97648	33
28	.16447	.98638	.18166	.98336	.19880	.98004	.21587	.97642	32
29	.16476	.98633	.18195	.98331	.19908	.97998	.21616	.97636	31
30	.16505	.98629	.18224	.98325	.19937	.97992	.21644	.97630	30
31	.16533	.98624	.18252	.98320	.19965	.97987	.21672	.97623	29
32	.16562	.98619	.18281	.98315	.19994	.97981	.21701	.97617	28
33	.16591	.98614	.18309	.98310	.20022	.97975	.21729	.97611	27
34	.16620	.98609	.18338	.98304	.20051	.97969	.21758	.97604	26
35	.16648	.98604	.18367	.98299	.20079	.97963	.21786	.97598	25
36	.16677	.98600	.18395	.98294	.20108	.97958	.21814	.97592	24
37	.16706	.98595	.18424	.98288	.20136	.97952	.21843	.97585	23
38	.16734	.98590	.18452	.98283	.20165	.97946	.21871*	.97579	22
39	.16763	.98585	.18481	.98277	.20193	.97940	.21899	.97573	21
40	.16792	.98580	.18509	.98272	.20222	.97934	.21928	.97566	20
41	.16820	.98575	.18538	.98267	.20250	.97928	.21956	.97560	19
42	.16849	.98570	.18567	.98261	.20279	.97922	.21985	.97553	18
43	.16878	.98565	.18595	.98256	.20307	.97916	.22013	.97547	17
44	.16906	.98561	.18624	.98250	.20336	.97910	.22041	.97541	16
45	.16935	.98556	.18652	.98245	.20364	.97905	.22070	.97534	15
46	.16964	.98551	.18681	.98240	.20393	.97900	.22098	.97528	14
47	.16992	.98546	.18710	.98234	.20421	.97893	.22126	.97521	13
48	.17021	.98541	.18738	.98229	.20450	.97887	.22155	.97515	12
49	.17050	.98536	.18767	.98223	.20478	.97881	.22183	.97508	11
50	.17078	.98531	.18795	.98218	.20507	.97875	.22212	.97501	10
51	.17107	.98526	.18824	.98212	.20535	.97869	.22240	.97496	9
52	.17136	.98521	.18852	.98207	.20563	.97863	.22268	.97489	8
53	.17164	.98516	.18881	.98201	.20592	.97857	.22297	.97483	7
54	.17193	.98511	.18910	.98196	.20620	.97851	.22325	.97476	6
55	.17222	.98506	.18938	.98190	.20649	.97845	.22353	.97470	5
56	.17250	.98501	.18967	.98185	.20677	.97839	.22382	.97463	4
57	.17279	.98496	.18995	.98179	.20706	.97833	.22410	.97457	3
58	.17308	.98491	.19024	.98174	.20734	.97827	.22438	.97450	2
59	.17336	.98486	.19052	.98168	.20763	.97821	.22467	.97444	1
60	.17365	.98481	.19081	.98163	.20791	.97815	.22495	.97437	0
'	COSINE	SINE	COSINE	SINE	COSINE	SINE	COSINE	SINE	'
	80°		79°		78°		77°		

'	13°		14°		15°		16°		'
	SINE	COSINE	SINE	COSINE	SINE	COSINE	SINE	COSINE	
0	.22495	.97437	.24192	.97030	.25882	.96593	.27564	.96126	60
1	.22523	.97430	.24220	.97023	.25910	.96585	.27592	.96118	59
2	.22552	.97424	.24249	.97015	.25938	.96578	.27620	.96110	58
3	.22580	.97417	.24277	.97008	.25966	.96570	.27648	.96102	57
4	.22608	.97411	.24305	.97001	.25994	.96562	.27676	.96094	56
5	.22637	.97404	.24333	.96994	.26022	.96555	.27704	.96086	55
6	.22665	.97398	.24362	.96987	.26050	.96547	.27731	.96078	54
7	.22693	.97391	.24390	.96980	.26079	.96540	.27759	.96070	53
8	.22722	.97384	.24418	.96973	.26107	.96532	.27787	.96062	52
9	.22750	.97378	.24446	.96966	.26135	.96524	.27815	.96054	51
10	.22778	.97371	.24474	.96959	.26163	.96517	.27843	.96046	50
11	.22807	.97365	.24503	.96952	.26191	.96509	.27871	.96037	49
12	.22835	.97358	.24531	.96945	.26219	.96502	.27899	.96029	48
13	.22863	.97351	.24559	.96937	.26247	.96494	.27927	.96021	47
14	.22892	.97345	.24587	.96930	.26275	.96486	.27955	.96013	46
15	.22920	.97338	.24615	.96923	.26303	.96479	.27983	.96005	45
16	.22948	.97331	.24644	.96916	.26331	.96471	.28011	.95997	44
17	.22977	.97325	.24672	.96909	.26359	.96463	.28039	.95989	43
18	.23005	.97318	.24700	.96902	.26387	.96455	.28067	.95981	42
19	.23033	.97311	.24728	.96894	.26415	.96448	.28095	.95972	41
20	.23062	.97304	.24756	.96887	.26443	.96440	.28123	.95964	40
21	.23090	.97298	.24784	.96880	.26471	.96433	.28151	.95956	39
22	.23118	.97291	.24813	.96873	.26500	.96425	.28178	.95948	38
23	.23146	.97284	.24841	.96866	.26528	.96417	.28206	.95940	37
24	.23175	.97278	.24869	.96858	.26556	.96410	.28234	.95931	36
25	.23203	.97271	.24897	.96851	.26584	.96402	.28262	.95923	35
26	.23231	.97264	.24925	.96844	.26612	.96394	.28290	.95915	34
27	.23260	.97257	.24954	.96837	.26640	.96386	.28318	.95907	33
28	.23288	.97251	.24982	.96829	.26668	.96379	.28346	.95898	32
29	.23316	.97244	.25010	.96822	.26696	.96371	.28374	.95890	31
30	.23345	.97237	.25038	.96815	.26724	.96363	.28402	.95882	30
31	.23373	.97230	.25066	.96807	.26752	.96355	.28429	.95874	29
32	.23401	.97223	.25094	.96800	.26780	.96347	.28457	.95865	28
33	.23429	.97217	.25122	.96793	.26808	.96340	.28485	.95857	27
34	.23458	.97210	.25151	.96786	.26836	.96332	.28513	.95849	26
35	.23486	.97203	.25179	.96778	.26864	.96324	.28541	.95841	25
36	.23514	.97196	.25207	.96771	.26892	.96316	.28569	.95832	24
37	.23542	.97189	.25235	.96764	.26920	.96308	.28597	.95824	23
38	.23571	.97182	.25263	.96756	.26948	.96301	.28625	.95816	22
39	.23599	.97176	.25291	.96749	.26976	.96293	.28652	.95807	21
40	.23627	.97169	.25320	.96742	.27004	.96285	.28680	.95799	20
41	.23656	.97162	.25348	.96734	.27032	.96277	.28708	.95791	19
42	.23684	.97155	.25376	.96727	.27060	.96269	.28736	.95782	18
43	.23712	.97148	.25404	.96719	.27088	.96261	.28764	.95774	17
44	.23740	.97141	.25432	.96712	.27116	.96253	.28792	.95766	16
45	.23769	.97134	.25460	.96705	.27144	.96246	.28820	.95757	15
46	.23797	.97127	.25488	.96697	.27172	.96238	.28847	.95749	14
47	.23825	.97120	.25516	.96690	.27200	.96230	.28875	.95740	13
48	.23853	.97113	.25545	.96682	.27228	.96222	.28903	.95732	12
49	.23882	.97106	.25573	.96675	.27256	.96214	.28931	.95724	11
50	.23910	.97100	.25601	.96667	.27284	.96206	.28959	.95715	10
51	.23938	.97093	.25629	.96660	.27312	.96198	.28987	.95707	9
52	.23966	.97086	.25657	.96653	.27340	.96190	.29015	.95698	8
53	.23995	.97079	.25685	.96645	.27368	.96182	.29042	.95690	7
54	.24023	.97072	.25713	.96638	.27396	.96174	.29070	.95681	6
55	.24051	.97065	.25741	.96630	.27424	.96166	.29098	.95673	5
56	.24079	.97058	.25769	.96623	.27452	.96158	.29126	.95664	4
57	.24108	.97051	.25797	.96615	.27480	.96150	.29154	.95656	3
58	.24136	.97044	.25826	.96608	.27508	.96142	.29182	.95647	2
59	.24164	.97037	.25854	.96600	.27536	.96134	.29209	.95639	1
60	.24192	.97030	.25882	.96593	.27564	.96126	.29237	.95630	0
'	COSINE	SINE	COSINE	SINE	COSINE	SINE	COSINE	SINE	'
	76°		75°		74°		73°		

NATURAL SINES

1609

'	17°		18°		19°		20°		'
	SINE	COSINE	SINE	COSINE	SINE	COSINE	SINE	COSINE	
0	.29237	.95630	.30902	.95106	.32557	.94552	.34202	.93069	60
1	.29265	.95622	.30929	.95097	.32584	.94542	.34229	.93059	59
2	.29293	.95613	.30957	.95088	.32612	.94533	.34257	.93049	58
3	.29321	.95605	.30985	.95079	.32639	.94523	.34284	.93039	57
4	.29348	.95596	.31012	.95070	.32667	.94514	.34311	.93029	56
5	.29376	.95588	.31040	.95061	.32694	.94504	.34339	.93019	55
6	.29404	.95579	.31068	.95052	.32722	.94495	.34366	.93009	54
7	.29432	.95571	.31095	.95043	.32749	.94485	.34393	.93000	53
8	.29460	.95562	.31123	.95033	.32777	.94476	.34421	.93000	52
9	.29487	.95554	.31151	.95024	.32804	.94466	.34448	.93000	51
10	.29515	.95545	.31178	.95015	.32832	.94457	.34475	.93000	50
11	.29543	.95536	.31206	.95006	.32859	.94447	.34503	.93000	49
12	.29571	.95528	.31233	.94997	.32887	.94438	.34530	.93000	48
13	.29599	.95519	.31261	.94988	.32914	.94428	.34557	.93000	47
14	.29626	.95511	.31289	.94979	.32942	.94418	.34584	.93000	46
15	.29654	.95502	.31316	.94970	.32969	.94409	.34612	.93000	45
16	.29682	.95493	.31344	.94961	.32997	.94400	.34639	.93000	44
17	.29710	.95485	.31372	.94952	.33024	.94390	.34666	.93000	43
18	.29737	.95476	.31399	.94943	.33051	.94380	.34694	.93000	42
19	.29765	.95467	.31427	.94933	.33079	.94370	.34721	.93000	41
20	.29793	.95459	.31454	.94924	.33106	.94361	.34748	.93000	40
21	.29821	.95450	.31482	.94915	.33134	.94351	.34775	.93000	39
22	.29849	.95441	.31510	.94906	.33161	.94342	.34803	.93000	38
23	.29876	.95433	.31537	.94897	.33189	.94332	.34830	.93000	37
24	.29904	.95424	.31565	.94888	.33216	.94322	.34857	.93000	36
25	.29932	.95415	.31593	.94878	.33244	.94313	.34884	.93000	35
26	.29960	.95407	.31620	.94869	.33271	.94303	.34912	.93000	34
27	.29987	.95398	.31648	.94860	.33298	.94293	.34939	.93000	33
28	.30015	.95389	.31675	.94851	.33326	.94284	.34966	.93000	32
29	.30043	.95380	.31703	.94842	.33353	.94274	.34993	.93000	31
30	.30071	.95372	.31730	.94832	.33381	.94264	.35021	.93000	30
31	.30098	.95363	.31758	.94823	.33408	.94254	.35048	.93000	29
32	.30126	.95354	.31786	.94814	.33436	.94245	.35075	.93000	28
33	.30154	.95345	.31813	.94805	.33463	.94235	.35102	.93000	27
34	.30182	.95337	.31841	.94795	.33490	.94225	.35130	.93000	26
35	.30209	.95328	.31868	.94786	.33518	.94215	.35157	.93000	25
36	.30237	.95319	.31896	.94777	.33545	.94206	.35184	.93000	24
37	.30265	.95310	.31923	.94768	.33573	.94196	.35211	.93000	23
38	.30292	.95301	.31951	.94758	.33600	.94186	.35239	.93000	22
39	.30320	.95293	.31979	.94749	.33627	.94176	.35266	.93000	21
40	.30348	.95284	.32006	.94740	.33655	.94167	.35293	.93000	20
41	.30376	.95275	.32034	.94730	.33682	.94157	.35320	.93000	19
42	.30403	.95266	.32061	.94721	.33710	.94147	.35347	.93000	18
43	.30431	.95257	.32089	.94712	.33737	.94137	.35375	.93000	17
44	.30459	.95248	.32116	.94702	.33764	.94127	.35402	.93000	16
45	.30486	.95240	.32144	.94693	.33792	.94118	.35429	.93000	15
46	.30514	.95231	.32171	.94684	.33819	.94108	.35456	.93000	14
47	.30542	.95222	.32199	.94674	.33846	.94098	.35484	.93000	13
48	.30570	.95213	.32227	.94665	.33874	.94088	.35511	.93000	12
49	.30597	.95204	.32254	.94656	.33901	.94078	.35538	.93000	11
50	.30625	.95195	.32282	.94646	.33929	.94068	.35565	.93000	10
51	.30653	.95186	.32309	.94637	.33956	.94058	.35592	.93000	9
52	.30680	.95177	.32337	.94627	.33983	.94049	.35619	.93000	8
53	.30708	.95168	.32364	.94618	.34011	.94039	.35647	.93000	7
54	.30736	.95159	.32392	.94609	.34038	.94029	.35674	.93000	6
55	.30763	.95150	.32419	.94599	.34065	.94019	.35701	.93000	5
56	.30791	.95142	.32447	.94590	.34093	.94009	.35728	.93000	4
57	.30819	.95133	.32474	.94580	.34120	.93999	.35755	.93000	3
58	.30846	.95124	.32502	.94571	.34147	.93989	.35782	.93000	2
59	.30874	.95115	.32529	.94561	.34175	.93979	.35810	.93000	1
60	.30902	.95106	.32557	.94552	.34202	.93969	.35837	.93000	0
'	COSINE	SINE	COSINE	SINE	COSINE	SINE	COSINE	SINE	'

72°

71°

70°

69°

	21°		22°		23°		24°		'
	SINE	COSINE	SINE	COSINE	SINE	COSINE	SINE	COSINE	
0	.35837	.93358	.37461	.92718	.39073	.92050	.40674	.91355	60
1	.35904	.93348	.37488	.92707	.39100	.92039	.40700	.91343	59
2	.35981	.93337	.37515	.92697	.39127	.92028	.40727	.91331	58
3	.35918	.93327	.37542	.92686	.39153	.92016	.40753	.91319	57
4	.35945	.93316	.37569	.92675	.39180	.92005	.40780	.91307	56
5	.35973	.93306	.37595	.92664	.39207	.91994	.40806	.91295	55
6	.36000	.93295	.37622	.92653	.39234	.91982	.40833	.91283	54
7	.36027	.93285	.37649	.92642	.39260	.91971	.40860	.91272	53
8	.36054	.93274	.37676	.92631	.39287	.91959	.40886	.91260	52
9	.36081	.93264	.37703	.92620	.39314	.91948	.40913	.91248	51
10	.36108	.93253	.37730	.92609	.39341	.91936	.40939	.91236	50
11	.36135	.93243	.37757	.92598	.39367	.91925	.40966	.91224	49
12	.36162	.93232	.37784	.92587	.39394	.91914	.40992	.91212	48
13	.36190	.93222	.37811	.92576	.39421	.91902	.41019	.91200	47
14	.36217	.93211	.37838	.92565	.39448	.91891	.41045	.91188	46
15	.36244	.93201	.37865	.92554	.39474	.91879	.41072	.91176	45
16	.36271	.93190	.37892	.92543	.39501	.91868	.41098	.91164	44
17	.36298	.93180	.37919	.92532	.39528	.91856	.41125	.91152	43
18	.36325	.93169	.37946	.92521	.39555	.91845	.41151	.91140	42
19	.36352	.93159	.37973	.92510	.39581	.91833	.41178	.91128	41
20	.36379	.93148	.37999	.92499	.39608	.91822	.41204	.91116	40
21	.36406	.93137	.38026	.92488	.39635	.91810	.41231	.91104	39
22	.36434	.93127	.38053	.92477	.39661	.91799	.41257	.91092	38
23	.36461	.93116	.38080	.92466	.39688	.91787	.41284	.91080	37
24	.36488	.93106	.38107	.92455	.39715	.91775	.41310	.91068	36
25	.36515	.93095	.38134	.92444	.39741	.91764	.41337	.91056	35
26	.36542	.93084	.38161	.92432	.39768	.91752	.41363	.91044	34
27	.36569	.93074	.38188	.92421	.39795	.91741	.41390	.91032	33
28	.36596	.93063	.38215	.92410	.39822	.91729	.41416	.91020	32
29	.36623	.93052	.38241	.92399	.39848	.91718	.41443	.91008	31
30	.36650	.93042	.38268	.92388	.39875	.91706	.41469	.90996	30
31	.36677	.93031	.38295	.92377	.39902	.91694	.41496	.90984	29
32	.36704	.93020	.38322	.92366	.39928	.91683	.41522	.90972	28
33	.36731	.93010	.38349	.92355	.39955	.91671	.41549	.90960	27
34	.36758	.93000	.38376	.92343	.39982	.91660	.41575	.90948	26
35	.36785	.92988	.38403	.92332	.40008	.91648	.41602	.90936	25
36	.36812	.92978	.38430	.92321	.40035	.91636	.41628	.90924	24
37	.36839	.92967	.38456	.92310	.40062	.91625	.41655	.90911	23
38	.36866	.92956	.38483	.92299	.40088	.91613	.41681	.90899	22
39	.36894	.92945	.38510	.92287	.40115	.91601	.41707	.90887	21
40	.36921	.92935	.38537	.92276	.40141	.91590	.41734	.90875	20
41	.36948	.92924	.38564	.92265	.40168	.91578	.41760	.90863	19
42	.36975	.92913	.38591	.92254	.40195	.91566	.41787	.90851	18
43	.37002	.92902	.38617	.92243	.40221	.91555	.41813	.90839	17
44	.37029	.92892	.38644	.92231	.40248	.91543	.41840	.90826	16
45	.37056	.92881	.38671	.92220	.40275	.91531	.41866	.90814	15
46	.37083	.92870	.38698	.92209	.40301	.91519	.41892	.90802	14
47	.37110	.92859	.38725	.92198	.40328	.91508	.41919	.90790	13
48	.37137	.92849	.38752	.92186	.40355	.91496	.41945	.90778	12
49	.37164	.92838	.38778	.92175	.40381	.91484	.41972	.90766	11
50	.37191	.92827	.38805	.92164	.40408	.91472	.41998	.90753	10
51	.37218	.92816	.38832	.92152	.40434	.91461	.42024	.90741	9
52	.37245	.92805	.38859	.92141	.40461	.91449	.42051	.90729	8
53	.37272	.92794	.38886	.92130	.40488	.91437	.42077	.90717	7
54	.37299	.92784	.38912	.92119	.40514	.91425	.42104	.90704	6
55	.37326	.92773	.38939	.92107	.40541	.91414	.42130	.90692	5
56	.37353	.92762	.38966	.92096	.40567	.91402	.42156	.90680	4
57	.37380	.92751	.38993	.92085	.40594	.91390	.42183	.90668	3
58	.37407	.92740	.39020	.92073	.40621	.91378	.42209	.90655	2
59	.37434	.92729	.39046	.92062	.40647	.91366	.42235	.90643	1
60	.37461	.92718	.39073	.92050	.40674	.91355	.42262	.90631	0
	COSINE	SINE	COSINE	SINE	COSINE	SINE	COSINE	SINE	

68°

67°

66°

65°

NATURAL SINES

'	25°		26°		27°		28°		'
	SINE	COSINE	SINE	COSINE	SINE	COSINE	SINE	COSINE	
0	.42262	.90631	.43837	.89879	.45399	.89101	.46947	.88295	60
1	.42288	.90618	.43803	.89867	.45425	.89087	.46973	.88281	59
2	.42315	.90606	.43880	.89854	.45451	.89074	.46999	.88267	58
3	.42341	.90594	.43916	.89841	.45477	.89061	.47025	.88254	57
4	.42367	.90582	.43942	.89828	.45503	.89048	.47050	.88240	56
5	.42394	.90569	.43968	.89816	.45529	.89035	.47076	.88226	55
6	.42420	.90557	.43994	.89803	.45554	.89021	.47101	.88213	54
7	.42446	.90545	.44020	.89790	.45580	.89008	.47127	.88199	53
8	.42473	.90532	.44046	.89777	.45606	.88995	.47153	.88185	52
9	.42499	.90520	.44072	.89764	.45632	.88981	.47178	.88172	51
10	.42525	.90507	.44098	.89752	.45658	.88968	.47204	.88158	50
11	.42552	.90495	.44124	.89739	.45684	.88955	.47229	.88144	49
12	.42578	.90483	.44151	.89726	.45710	.88942	.47255	.88130	48
13	.42604	.90470	.44177	.89713	.45736	.88928	.47281	.88117	47
14	.42631	.90458	.44203	.89700	.45762	.88915	.47306	.88103	46
15	.42657	.90446	.44229	.89687	.45787	.88902	.47332	.88089	45
16	.42683	.90433	.44255	.89674	.45813	.88888	.47358	.88075	44
17	.42709	.90421	.44281	.89662	.45839	.88875	.47383	.88062	43
18	.42736	.90408	.44307	.89649	.45865	.88862	.47409	.88048	42
19	.42762	.90396	.44333	.89636	.45891	.88848	.47434	.88034	41
20	.42788	.90383	.44359	.89623	.45917	.88835	.47460	.88020	40
21	.42815	.90371	.44385	.89610	.45942	.88822	.47486	.88006	39
22	.42841	.90358	.44411	.89597	.45968	.88808	.47511	.87993	38
23	.42867	.90346	.44437	.89584	.45994	.88795	.47537	.87979	37
24	.42894	.90334	.44464	.89571	.46020	.88782	.47562	.87965	36
25	.42920	.90321	.44490	.89558	.46046	.88768	.47588	.87951	35
26	.42946	.90309	.44516	.89545	.46072	.88755	.47614	.87937	34
27	.42972	.90296	.44542	.89532	.46097	.88741	.47639	.87923	33
28	.43000	.90284	.44568	.89519	.46123	.88728	.47665	.87909	32
29	.43025	.90271	.44594	.89506	.46149	.88715	.47690	.87896	31
30	.43051	.90259	.44620	.89493	.46175	.88701	.47716	.87882	30
31	.43077	.90246	.44646	.89480	.46201	.88688	.47741	.87868	29
32	.43104	.90233	.44672	.89467	.46226	.88674	.47767	.87854	28
33	.43130	.90221	.44698	.89454	.46252	.88661	.47793	.87840	27
34	.43156	.90208	.44724	.89441	.46278	.88647	.47818	.87826	26
35	.43182	.90196	.44750	.89428	.46304	.88634	.47844	.87812	25
36	.43209	.90183	.44776	.89415	.46330	.88620	.47869	.87798	24
37	.43235	.90171	.44802	.89402	.46355	.88607	.47895	.87784	23
38	.43261	.90158	.44828	.89389	.46381	.88593	.47920	.87770	22
39	.43287	.90146	.44854	.89376	.46407	.88580	.47946	.87756	21
40	.43313	.90133	.44880	.89363	.46433	.88566	.47971	.87742	20
41	.43340	.90120	.44906	.89350	.46458	.88553	.47997	.87729	19
42	.43366	.90108	.44932	.89337	.46484	.88539	.48022	.87715	18
43	.43392	.90095	.44958	.89324	.46510	.88526	.48048	.87701	17
44	.43418	.90082	.44984	.89311	.46536	.88512	.48073	.87687	16
45	.43445	.90070	.45010	.89298	.46561	.88499	.48099	.87673	15
46	.43471	.90057	.45036	.89285	.46587	.88485	.48124	.87659	14
47	.43497	.90045	.45062	.89272	.46613	.88472	.48150	.87645	13
48	.43523	.90032	.45088	.89259	.46639	.88458	.48175	.87631	12
49	.43549	.90019	.45114	.89245	.46664	.88445	.48201	.87617	11
50	.43575	.90007	.45140	.89232	.46690	.88431	.48226	.87603	10
51	.43602	.89994	.45166	.89219	.46716	.88417	.48252	.87589	9
52	.43628	.89981	.45192	.89206	.46742	.88404	.48277	.87575	8
53	.43654	.89968	.45218	.89193	.46767	.88390	.48303	.87561	7
54	.43680	.89956	.45243	.89180	.46793	.88377	.48328	.87546	6
55	.43706	.89943	.45269	.89167	.46819	.88363	.48354	.87532	5
56	.43733	.89930	.45295	.89153	.46844	.88349	.48379	.87518	4
57	.43759	.89918	.45321	.89140	.46870	.88336	.48405	.87504	3
58	.43785	.89905	.45347	.89127	.46896	.88322	.48430	.87490	2
59	.43811	.89892	.45373	.89114	.46921	.88308	.48456	.87476	1
60	.43837	.89879	.45399	.89101	.46947	.88295	.48481	.87462	0
'	COSINE SINE		COSINE SINE		COSINE SINE		COSINE SINE		'
	64°		63°		62°		61°		

	29°		30°		31°		32°		
	SINE	COSINE	SINE	COSINE	SINE	COSINE	SINE	COSINE	
0	.48481	.87462	.50000	.86603	.51504	.85717	.52992	.84805	69
1	.48506	.87448	.50025	.86588	.51529	.85702	.53017	.84780	59
2	.48532	.87434	.50050	.86573	.51554	.85687	.53041	.84754	58
3	.48557	.87420	.50076	.86559	.51579	.85672	.53066	.84729	57
4	.48583	.87406	.50101	.86544	.51604	.85657	.53091	.84703	56
5	.48608	.87391	.50126	.86530	.51628	.85642	.53115	.84678	55
6	.48634	.87377	.50151	.86515	.51653	.85627	.53140	.84652	54
7	.48659	.87363	.50176	.86501	.51678	.85612	.53164	.84627	53
8	.48684	.87349	.50201	.86486	.51703	.85597	.53189	.84601	52
9	.48710	.87335	.50227	.86471	.51728	.85582	.53214	.84576	51
10	.48735	.87321	.50252	.86457	.51753	.85567	.53238	.84550	50
11	.48761	.87306	.50277	.86442	.51778	.85551	.53263	.84525	49
12	.48786	.87292	.50302	.86427	.51803	.85536	.53288	.84500	48
13	.48811	.87278	.50327	.86413	.51828	.85521	.53312	.84474	47
14	.48837	.87264	.50352	.86398	.51852	.85506	.53337	.84448	46
15	.48862	.87250	.50377	.86384	.51877	.85491	.53361	.84423	45
16	.48888	.87235	.50403	.86369	.51902	.85476	.53386	.84397	44
17	.48913	.87221	.50428	.86354	.51927	.85461	.53411	.84372	43
18	.48938	.87207	.50453	.86340	.51952	.85446	.53435	.84346	42
19	.48964	.87193	.50478	.86325	.51977	.85431	.53460	.84321	41
20	.48989	.87178	.50503	.86310	.52002	.85416	.53484	.84295	40
21	.49014	.87164	.50528	.86295	.52026	.85401	.53509	.84270	39
22	.49040	.87150	.50553	.86281	.52051	.85385	.53534	.84244	38
23	.49065	.87136	.50578	.86266	.52076	.85370	.53558	.84218	37
24	.49090	.87121	.50603	.86251	.52101	.85355	.53583	.84193	36
25	.49116	.87107	.50628	.86237	.52126	.85340	.53607	.84167	35
26	.49141	.87093	.50654	.86222	.52151	.85325	.53632	.84141	34
27	.49166	.87079	.50679	.86207	.52175	.85310	.53656	.84115	33
28	.49192	.87064	.50704	.86192	.52200	.85294	.53681	.84090	32
29	.49217	.87050	.50729	.86178	.52225	.85279	.53705	.84064	31
30	.49242	.87036	.50754	.86163	.52250	.85264	.53730	.84038	30
31	.49268	.87021	.50779	.86148	.52275	.85249	.53754	.84012	29
32	.49293	.87007	.50804	.86133	.52299	.85234	.53779	.83987	28
33	.49318	.86993	.50829	.86119	.52324	.85218	.53804	.83961	27
34	.49344	.86978	.50854	.86104	.52349	.85203	.53828	.83936	26
35	.49369	.86964	.50879	.86089	.52374	.85188	.53853	.83910	25
36	.49394	.86949	.50904	.86074	.52399	.85173	.53877	.83885	24
37	.49419	.86935	.50929	.86059	.52423	.85157	.53902	.83860	23
38	.49445	.86921	.50954	.86045	.52448	.85142	.53926	.83834	22
39	.49470	.86906	.50979	.86030	.52473	.85127	.53951	.83809	21
40	.49495	.86892	.51004	.86015	.52498	.85112	.53975	.83783	20
41	.49521	.86878	.51029	.86000	.52522	.85096	.54000	.83758	19
42	.49546	.86863	.51054	.85985	.52547	.85081	.54024	.83732	18
43	.49571	.86849	.51079	.85970	.52572	.85066	.54049	.83707	17
44	.49596	.86834	.51104	.85955	.52597	.85051	.54073	.83681	16
45	.49622	.86820	.51129	.85941	.52621	.85035	.54097	.83656	15
46	.49647	.86805	.51154	.85926	.52646	.85020	.54122	.83630	14
47	.49672	.86791	.51179	.85911	.52671	.85005	.54146	.83605	13
48	.49697	.86777	.51204	.85896	.52696	.84990	.54171	.83579	12
49	.49723	.86762	.51229	.85881	.52720	.84974	.54195	.83554	11
50	.49748	.86748	.51254	.85866	.52745	.84959	.54220	.83528	10
51	.49773	.86733	.51279	.85851	.52770	.84943	.54244	.83503	9
52	.49798	.86719	.51304	.85836	.52794	.84928	.54269	.83477	8
53	.49824	.86704	.51329	.85821	.52819	.84913	.54293	.83452	7
54	.49849	.86690	.51354	.85806	.52844	.84897	.54317	.83426	6
55	.49874	.86675	.51379	.85792	.52869	.84882	.54342	.83401	5
56	.49899	.86661	.51404	.85777	.52893	.84866	.54366	.83375	4
57	.49924	.86646	.51429	.85762	.52918	.84851	.54391	.83350	3
58	.49950	.86632	.51454	.85747	.52943	.84836	.54415	.83324	2
59	.49975	.86617	.51479	.85732	.52967	.84820	.54440	.83299	1
60	.50000	.86603	.51504	.85717	.52992	.84805	.54464	.83273	0
	COSINE		SINE		COSINE		SINE		
	60°		59°		58°		57°		

NATURAL SINES

'	33°		34°		35°		36°		'
	SINE	COSINE	SINE	COSINE	SINE	COSINE	SINE	COSINE	
0	.54464	.83867	.55919	.82904	.57358	.81915	.58779	.80902	60
1	.54488	.83851	.55943	.82887	.57381	.81899	.58802	.80885	59
2	.54513	.83835	.55968	.82871	.57405	.81882	.58826	.80867	58
3	.54537	.83819	.55992	.82855	.57429	.81865	.58849	.80850	57
4	.54561	.83804	.56016	.82839	.57453	.81848	.58873	.80833	56
5	.54586	.83788	.56040	.82822	.57477	.81832	.58896	.80816	55
6	.54610	.83772	.56064	.82806	.57501	.81815	.58920	.80799	54
7	.54635	.83756	.56088	.82790	.57524	.81798	.58943	.80782	53
8	.54659	.83740	.56112	.82773	.57548	.81782	.58967	.80765	52
9	.54683	.83724	.56136	.82757	.57572	.81765	.58990	.80748	51
10	.54708	.83708	.56160	.82741	.57596	.81748	.59014	.80730	50
11	.54732	.83692	.56184	.82724	.57619	.81731	.59037	.80713	49
12	.54756	.83676	.56208	.82708	.57643	.81714	.59061	.80696	48
13	.54781	.83660	.56232	.82692	.57667	.81698	.59084	.80679	47
14	.54805	.83645	.56256	.82675	.57691	.81681	.59108	.80662	46
15	.54829	.83629	.56280	.82659	.57715	.81664	.59131	.80644	45
16	.54854	.83613	.56305	.82643	.57738	.81647	.59154	.80627	44
17	.54878	.83597	.56329	.82626	.57762	.81631	.59178	.80610	43
18	.54902	.83581	.56353	.82610	.57786	.81614	.59201	.80593	42
19	.54927	.83565	.56377	.82593	.57810	.81597	.59225	.80576	41
20	.54951	.83549	.56401	.82577	.57833	.81580	.59248	.80558	40
21	.54975	.83533	.56425	.82561	.57857	.81563	.59272	.80541	39
22	.54999	.83517	.56449	.82544	.57881	.81546	.59295	.80524	38
23	.55024	.83501	.56473	.82528	.57904	.81530	.59318	.80507	37
24	.55048	.83485	.56497	.82511	.57928	.81513	.59342	.80489	36
25	.55072	.83469	.56521	.82495	.57952	.81496	.59365	.80472	35
26	.55097	.83453	.56545	.82478	.57976	.81479	.59389	.80455	34
27	.55121	.83437	.56569	.82462	.57999	.81462	.59412	.80438	33
28	.55145	.83421	.56593	.82446	.58023	.81445	.59436	.80420	32
29	.55169	.83405	.56617	.82429	.58047	.81428	.59459	.80403	31
30	.55194	.83389	.56641	.82413	.58070	.81412	.59482	.80386	30
31	.55218	.83373	.56665	.82396	.58094	.81395	.59506	.80368	29
32	.55242	.83356	.56689	.82380	.58118	.81378	.59529	.80351	28
33	.55266	.83340	.56713	.82363	.58141	.81361	.59552	.80334	27
34	.55291	.83324	.56737	.82347	.58165	.81344	.59576	.80316	26
35	.55315	.83308	.56760	.82330	.58189	.81327	.59599	.80299	25
36	.55339	.83292	.56784	.82314	.58212	.81310	.59622	.80282	24
37	.55363	.83276	.56808	.82297	.58236	.81293	.59646	.80264	23
38	.55388	.83260	.56832	.82281	.58260	.81276	.59669	.80247	22
39	.55412	.83244	.56856	.82264	.58283	.81259	.59693	.80230	21
40	.55436	.83228	.56880	.82248	.58307	.81242	.59716	.80212	20
41	.55460	.83212	.56904	.82231	.58330	.81225	.59739	.80195	19
42	.55484	.83195	.56928	.82214	.58354	.81208	.59763	.80178	18
43	.55509	.83179	.56952	.82198	.58378	.81191	.59786	.80160	17
44	.55533	.83163	.56976	.82181	.58401	.81174	.59809	.80143	16
45	.55557	.83147	.57000	.82165	.58425	.81157	.59832	.80125	15
46	.55581	.83131	.57024	.82148	.58449	.81140	.59856	.80108	14
47	.55605	.83115	.57047	.82132	.58472	.81123	.59879	.80091	13
48	.55630	.83098	.57071	.82115	.58496	.81106	.59902	.80073	12
49	.55654	.83082	.57095	.82098	.58519	.81089	.59926	.80056	11
50	.55678	.83066	.57119	.82082	.58543	.81072	.59949	.80038	10
51	.55702	.83050	.57143	.82065	.58567	.81055	.59972	.80021	9
52	.55726	.83034	.57167	.82048	.58590	.81038	.59995	.80003	8
53	.55750	.83017	.57191	.82032	.58614	.81021	.60019	.79986	7
54	.55775	.83001	.57215	.82015	.58637	.81004	.60042	.79968	6
55	.55799	.82985	.57238	.81999	.58661	.80987	.60065	.79951	5
56	.55823	.82969	.57262	.81982	.58684	.80970	.60089	.79934	4
57	.55847	.82953	.57286	.81965	.58708	.80953	.60112	.79916	3
58	.55871	.82937	.57310	.81949	.58731	.80936	.60135	.79899	2
59	.55895	.82920	.57334	.81932	.58755	.80919	.60158	.79881	1
60	.55919	.82904	.57358	.81915	.58779	.80902	.60182	.79864	0
'	COSINE SINE		COSINE SINE		COSINE SINE		COSINE SINE		'
	56°		55°		54°		53°		

°	37°		38°		39°		40°		'
	SINE	COSINE	SINE	COSINE	SINE	COSINE	SINE	COSINE	
0	.60182	.79864	.61566	.78801	.62932	.77715	.64279	.76604	60
1	.60205	.79846	.61589	.78783	.62955	.77696	.64301	.76586	59
2	.60228	.79829	.61612	.78765	.62977	.77678	.64323	.76567	58
3	.60251	.79811	.61635	.78747	.63000	.77660	.64346	.76548	57
4	.60274	.79793	.61658	.78729	.63022	.77641	.64368	.76530	56
5	.60298	.79776	.61681	.78711	.63045	.77623	.64390	.76511	55
6	.60321	.79758	.61704	.78694	.63068	.77605	.64412	.76492	54
7	.60344	.79741	.61726	.78676	.63090	.77586	.64435	.76473	53
8	.60367	.79723	.61749	.78658	.63113	.77568	.64457	.76455	52
9	.60390	.79706	.61772	.78640	.63135	.77550	.64479	.76436	51
10	.60414	.79688	.61795	.78622	.63158	.77531	.64501	.76417	50
11	.60437	.79671	.61818	.78604	.63180	.77513	.64524	.76398	49
12	.60460	.79653	.61841	.78586	.63203	.77494	.64546	.76380	48
13	.60483	.79635	.61864	.78568	.63225	.77476	.64568	.76361	47
14	.60506	.79618	.61887	.78550	.63248	.77458	.64590	.76342	46
15	.60529	.79600	.61909	.78532	.63271	.77439	.64612	.76323	45
16	.60553	.79583	.61932	.78514	.63293	.77421	.64635	.76304	44
17	.60576	.79565	.61955	.78496	.63316	.77402	.64657	.76286	43
18	.60599	.79547	.61978	.78478	.63338	.77384	.64679	.76267	42
19	.60622	.79530	.62001	.78460	.63361	.77366	.64701	.76248	41
20	.60645	.79512	.62024	.78442	.63383	.77347	.64723	.76229	40
21	.60668	.79494	.62046	.78424	.63406	.77329	.64746	.76210	39
22	.60691	.79477	.62069	.78405	.63428	.77310	.64768	.76192	38
23	.60714	.79459	.62092	.78387	.63451	.77292	.64790	.76173	37
24	.60738	.79441	.62115	.78369	.63473	.77273	.64812	.76154	36
25	.60761	.79424	.62138	.78351	.63496	.77255	.64834	.76135	35
26	.60784	.79406	.62160	.78333	.63518	.77236	.64856	.76116	34
27	.60807	.79388	.62183	.78315	.63540	.77218	.64878	.76097	33
28	.60830	.79371	.62206	.78297	.63563	.77199	.64901	.76078	32
29	.60853	.79353	.62229	.78279	.63585	.77181	.64923	.76059	31
30	.60876	.79335	.62251	.78261	.63608	.77162	.64945	.76041	30
31	.60899	.79318	.62274	.78243	.63630	.77144	.64967	.76022	29
32	.60922	.79300	.62297	.78225	.63653	.77125	.64989	.76003	28
33	.60945	.79282	.62320	.78206	.63675	.77107	.65011	.75984	27
34	.60968	.79264	.62342	.78188	.63698	.77088	.65033	.75965	26
35	.60991	.79247	.62365	.78170	.63720	.77070	.65055	.75946	25
36	.61015	.79229	.62388	.78152	.63742	.77051	.65077	.75927	24
37	.61038	.79211	.62411	.78134	.63765	.77033	.65100	.75908	23
38	.61061	.79193	.62433	.78116	.63787	.77014	.65122	.75889	22
39	.61084	.79176	.62456	.78098	.63810	.76996	.65144	.75870	21
40	.61107	.79158	.62479	.78079	.63832	.76977	.65166	.75851	20
41	.61130	.79140	.62502	.78061	.63854	.76959	.65188	.75832	19
42	.61153	.79122	.62524	.78043	.63877	.76940	.65210	.75813	18
43	.61176	.79105	.62547	.78025	.63899	.76921	.65232	.75794	17
44	.61199	.79087	.62570	.78007	.63922	.76903	.65254	.75775	16
45	.61222	.79069	.62592	.77988	.63944	.76884	.65276	.75756	15
46	.61245	.79051	.62615	.77970	.63966	.76866	.65298	.75738	14
47	.61268	.79033	.62638	.77952	.63989	.76847	.65320	.75719	13
48	.61291	.79016	.62660	.77934	.64011	.76828	.65342	.75700	12
49	.61314	.78998	.62683	.77916	.64033	.76810	.65364	.75680	11
50	.61337	.78980	.62706	.77897	.64056	.76791	.65386	.75661	10
51	.61360	.78962	.62728	.77879	.64078	.76772	.65408	.75642	9
52	.61383	.78944	.62751	.77861	.64100	.76754	.65430	.75623	8
53	.61406	.78926	.62774	.77843	.64123	.76735	.65452	.75604	7
54	.61429	.78908	.62796	.77824	.64145	.76717	.65474	.75585	6
55	.61451	.78891	.62819	.77806	.64167	.76698	.65496	.75566	5
56	.61474	.78873	.62842	.77788	.64190	.76679	.65518	.75547	4
57	.61497	.78855	.62864	.77769	.64212	.76661	.65540	.75528	3
58	.61520	.78837	.62887	.77751	.64234	.76642	.65562	.75509	2
59	.61543	.78819	.62909	.77733	.64256	.76623	.65584	.75490	1
60	.61566	.78801	.62932	.77715	.64279	.76604	.65606	.75471	0
	COSINE	SINE	COSINE	SINE	COSINE	SINE	COSINE	SINE	
		52°		51°		50°		49°	

NATURAL SINES

'	41°		42°		43°		44°		'
	SINE	COSINE	SINE	COSINE	SINE	COSINE	SINE	COSINE	
0	.65606	.75471	.66913	.74314	.68200	.73135	.69466	.71934	60
1	.65628	.75452	.66935	.74295	.68221	.73116	.69487	.71914	59
2	.65650	.75433	.66956	.74276	.68242	.73096	.69508	.71894	58
3	.65672	.75414	.66978	.74256	.68264	.73076	.69529	.71873	57
4	.65694	.75395	.66999	.74237	.68285	.73056	.69549	.71853	56
5	.65716	.75375	.67021	.74217	.68306	.73036	.69570	.71833	55
6	.65738	.75356	.67043	.74198	.68327	.73016	.69591	.71813	54
7	.65759	.75337	.67064	.74178	.68349	.72996	.69612	.71792	53
8	.65781	.75318	.67086	.74159	.68370	.72976	.69633	.71772	52
9	.65803	.75299	.67107	.74139	.68391	.72957	.69654	.71752	51
10	.65825	.75280	.67129	.74120	.68412	.72937	.69675	.71732	50
11	.65847	.75261	.67151	.74100	.68434	.72917	.69696	.71711	49
12	.65869	.75241	.67172	.74080	.68455	.72897	.69717	.71691	48
13	.65891	.75222	.67194	.74061	.68476	.72877	.69737	.71671	47
14	.65913	.75203	.67215	.74041	.68497	.72857	.69758	.71650	46
15	.65935	.75184	.67237	.74022	.68518	.72837	.69779	.71630	45
16	.65957	.75165	.67258	.74002	.68539	.72817	.69800	.71610	44
17	.65978	.75146	.67280	.73983	.68561	.72797	.69821	.71590	43
18	.66000	.75126	.67301	.73963	.68582	.72777	.69842	.71569	42
19	.66022	.75107	.67323	.73944	.68603	.72757	.69862	.71549	41
20	.66044	.75088	.67344	.73924	.68624	.72737	.69883	.71529	40
21	.66066	.75069	.67366	.73904	.68645	.72717	.69904	.71508	39
22	.66088	.75050	.67387	.73885	.68666	.72697	.69925	.71488	38
23	.66109	.75030	.67409	.73865	.68688	.72677	.69946	.71468	37
24	.66131	.75011	.67430	.73846	.68709	.72657	.69966	.71447	36
25	.66153	.74992	.67452	.73826	.68730	.72637	.69987	.71427	35
26	.66175	.74973	.67473	.73806	.68751	.72617	.70008	.71407	34
27	.66197	.74953	.67495	.73787	.68772	.72597	.70029	.71386	33
28	.66218	.74934	.67516	.73767	.68793	.72577	.70049	.71366	32
29	.66240	.74915	.67538	.73747	.68814	.72557	.70070	.71345	31
30	.66262	.74896	.67559	.73728	.68835	.72537	.70091	.71325	30
31	.66284	.74876	.67580	.73708	.68857	.72517	.70112	.71305	29
32	.66306	.74857	.67602	.73688	.68878	.72497	.70132	.71284	28
33	.66327	.74838	.67623	.73669	.68899	.72477	.70153	.71264	27
34	.66349	.74818	.67645	.73649	.68920	.72457	.70174	.71243	26
35	.66371	.74799	.67666	.73629	.68941	.72437	.70195	.71223	25
36	.66393	.74780	.67688	.73610	.68962	.72417	.70215	.71203	24
37	.66414	.74760	.67709	.73590	.68983	.72397	.70236	.71182	23
38	.66436	.74741	.67730	.73570	.69004	.72377	.70257	.71162	22
39	.66458	.74722	.67752	.73551	.69025	.72357	.70277	.71141	21
40	.66480	.74703	.67773	.73531	.69046	.72337	.70298	.71121	20
41	.66501	.74683	.67795	.73511	.69067	.72317	.70319	.71100	19
42	.66523	.74664	.67816	.73491	.69088	.72297	.70339	.71080	18
43	.66545	.74644	.67837	.73472	.69109	.72277	.70360	.71059	17
44	.66566	.74625	.67859	.73452	.69130	.72257	.70381	.71039	16
45	.66588	.74606	.67880	.73432	.69151	.72236	.70401	.71019	15
46	.66610	.74586	.67901	.73413	.69172	.72216	.70422	.70998	14
47	.66632	.74567	.67923	.73393	.69193	.72196	.70443	.70978	13
48	.66653	.74548	.67944	.73373	.69214	.72176	.70463	.70957	12
49	.66675	.74528	.67965	.73353	.69235	.72156	.70484	.70937	11
50	.66697	.74509	.67987	.73333	.69256	.72136	.70505	.70916	10
51	.66718	.74489	.68008	.73314	.69277	.72116	.70525	.70896	9
52	.66740	.74470	.68029	.73294	.69298	.72095	.70546	.70875	8
53	.66762	.74451	.68051	.73274	.69319	.72075	.70567	.70855	7
54	.66783	.74431	.68072	.73254	.69340	.72055	.70587	.70834	6
55	.66805	.74412	.68093	.73234	.69361	.72035	.70608	.70813	5
56	.66827	.74392	.68115	.73215	.69382	.72015	.70628	.70793	4
57	.66848	.74373	.68136	.73195	.69403	.71995	.70649	.70772	3
58	.66870	.74353	.68157	.73175	.69424	.71974	.70670	.70752	2
59	.66891	.74334	.68179	.73155	.69445	.71954	.70690	.70731	1
60	.66913	.74314	.68200	.73135	.69466	.71934	.70711	.70711	0
'	COSINE	SINE	COSINE	SINE	COSINE	SINE	COSINE	SINE	'
	48°		47°		46°		45°		

NATURAL SECANTS AND CO-SECANTS

'	0°		1°		2°		3°		'
	SEC.	CO-SEC.	SEC.	CO-SEC.	SEC.	CO-SEC.	SEC.	CO-SEC.	
0	I	Infinite.	1.0001	57.299	1.0006	28.654	1.0014	19.107	60
1	I	3437.70	1.0001	56.359	1.0006	28.417	1.0014	19.002	59
2	I	1718.90	1.0002	55.450	1.0006	28.184	1.0014	18.897	58
3	I	1145.90	1.0002	54.570	1.0006	27.955	1.0014	18.794	57
4	I	859.44	1.0002	53.718	1.0006	27.730	1.0014	18.692	56
5	I	687.55	1.0002	52.891	1.0007	27.508	1.0014	18.591	55
6	I	574.96	1.0002	52.090	1.0007	27.290	1.0015	18.491	54
7	I	491.11	1.0002	51.313	1.0007	27.075	1.0015	18.393	53
8	I	429.72	1.0002	50.558	1.0007	26.864	1.0015	18.295	52
9	I	381.97	1.0002	49.826	1.0007	26.655	1.0015	18.198	51
10	I	343.77	1.0002	49.114	1.0007	26.450	1.0015	18.103	50
11	I	312.52	1.0002	48.422	1.0007	26.249	1.0015	18.008	49
12	I	286.48	1.0002	47.750	1.0007	26.050	1.0016	17.914	48
13	I	264.44	1.0002	47.096	1.0007	25.854	1.0016	17.821	47
14	I	245.55	1.0002	46.460	1.0008	25.661	1.0016	17.730	46
15	I	229.18	1.0002	45.840	1.0008	25.471	1.0016	17.639	45
16	I	214.86	1.0002	45.237	1.0008	25.284	1.0016	17.549	44
17	I	202.22	1.0002	44.650	1.0008	25.100	1.0016	17.460	43
18	I	190.99	1.0002	44.077	1.0008	24.918	1.0017	17.372	42
19	I	180.73	1.0003	43.520	1.0008	24.739	1.0017	17.285	41
20	I	171.89	1.0003	42.976	1.0008	24.562	1.0017	17.198	40
21	I	163.70	1.0003	42.445	1.0008	24.388	1.0017	17.113	39
22	I	156.26	1.0003	41.928	1.0008	24.216	1.0017	17.028	38
23	I	149.47	1.0003	41.423	1.0009	24.047	1.0017	16.944	37
24	I	143.24	1.0003	40.930	1.0009	23.880	1.0018	16.861	36
25	I	137.51	1.0003	40.448	1.0009	23.716	1.0018	16.779	35
26	I	132.22	1.0003	39.978	1.0009	23.553	1.0018	16.698	34
27	I	127.32	1.0003	39.518	1.0009	23.393	1.0018	16.617	33
28	I	122.78	1.0003	39.069	1.0009	23.235	1.0018	16.538	32
29	I	118.54	1.0003	38.631	1.0009	23.079	1.0018	16.459	31
30	I	114.59	1.0003	38.201	1.0009	22.925	1.0019	16.380	30
31	I	110.90	1.0003	37.782	1.0010	22.774	1.0019	16.303	29
32	I	107.43	1.0003	37.371	1.0010	22.624	1.0019	16.226	28
33	I	104.17	1.0004	36.969	1.0010	22.476	1.0019	16.150	27
34	I	101.11	1.0004	36.576	1.0010	22.330	1.0019	16.075	26
35	I	98.223	1.0004	36.191	1.0010	22.186	1.0019	16.000	25
36	I	95.495	1.0004	35.814	1.0010	22.044	1.0020	15.926	24
37	I	92.914	1.0004	35.445	1.0010	21.904	1.0020	15.853	23
38	I.0001	92.469	1.0004	35.084	1.0010	21.765	1.0020	15.780	22
39	I.0001	88.140	1.0004	34.729	1.0011	21.629	1.0020	15.708	21
40	I.0001	85.946	1.0004	34.382	1.0011	21.494	1.0020	15.637	20
41	I.0001	83.849	1.0004	34.042	1.0011	21.360	1.0021	15.566	19
42	I.0001	81.853	1.0004	33.708	1.0011	21.228	1.0021	15.496	18
43	I.0001	79.950	1.0004	33.381	1.0011	21.098	1.0021	15.427	17
44	I.0001	78.133	1.0004	33.060	1.0011	20.970	1.0021	15.358	16
45	I.0001	76.396	1.0005	32.745	1.0011	20.843	1.0021	15.290	15
46	I.0001	74.736	1.0005	32.437	1.0012	20.717	1.0022	15.222	14
47	I.0001	73.146	1.0005	32.134	1.0012	20.593	1.0022	15.155	13
48	I.0001	71.622	1.0005	31.836	1.0012	20.471	1.0022	15.089	12
49	I.0001	71.160	1.0005	31.544	1.0012	20.350	1.0022	15.023	11
50	I.0001	68.757	1.0005	31.257	1.0012	20.230	1.0022	14.958	10
51	I.0001	67.409	1.0005	30.976	1.0012	20.112	1.0023	14.893	9
52	I.0001	66.113	1.0005	30.699	1.0012	19.995	1.0023	14.829	8
53	I.0001	64.866	1.0005	30.428	1.0013	19.880	1.0023	14.765	7
54	I.0001	63.664	1.0005	30.161	1.0013	19.766	1.0023	14.702	6
55	I.0001	62.507	1.0005	29.899	1.0013	19.653	1.0023	14.640	5
56	I.0001	61.391	1.0006	29.641	1.0013	19.541	1.0024	14.578	4
57	I.0001	61.314	1.0006	29.388	1.0013	19.431	1.0.24	14.517	3
58	I.0001	59.274	1.0006	29.139	1.0013	19.322	1.0024	14.456	2
59	I.0001	58.270	1.0006	28.894	1.0013	19.214	1.0024	14.395	1
60	I.0001	57.299	1.0006	28.654	1.0014	19.107	1.0024	14.333	0
'	Co-sec.	Sec.	Co-sec.	Sec.	Co-sec.	Sec.	Co-sec.	Sec.	
		89°		88°		87°		86°	

NATURAL SECANTS

1617

'	4°		5°		6°		7°		'
	SEC.	CO-SEC.	SEC.	CO-SEC.	SEC.	CO-SEC.	SEC.	CO-SEC.	
0	1.0024	14.335	1.0038	11.474	1.0055	9.5668	1.0075	8.2055	60
1	1.0025	14.276	1.0038	11.436	1.0055	9.5404	1.0075	8.1861	59
2	1.0025	14.217	1.0039	11.398	1.0056	9.5141	1.0076	8.1668	58
3	1.0025	14.159	1.0039	11.360	1.0056	9.4880	1.0076	8.1476	57
4	1.0025	14.101	1.0039	11.323	1.0056	9.4620	1.0076	8.1285	56
5	1.0025	14.043	1.0039	11.286	1.0057	9.4362	1.0077	8.1094	55
6	1.0026	13.986	1.0040	11.249	1.0057	9.4105	1.0077	8.0905	54
7	1.0026	13.930	1.0040	11.213	1.0057	9.3850	1.0078	8.0717	53
8	1.0026	13.874	1.0040	11.176	1.0057	9.3596	1.0078	8.0529	52
9	1.0026	13.818	1.0040	11.140	1.0058	9.3343	1.0078	8.0342	51
10	1.0026	13.763	1.0041	11.104	1.0058	9.3092	1.0079	8.0156	50
11	1.0027	13.708	1.0041	11.069	1.0058	9.2842	1.0079	7.9971	49
12	1.0027	13.654	1.0041	11.033	1.0059	9.2593	1.0079	7.9787	48
13	1.0027	13.600	1.0041	10.998	1.0059	9.2346	1.0080	7.9604	47
14	1.0027	13.547	1.0042	10.963	1.0059	9.2100	1.0080	7.9421	46
15	1.0027	13.494	1.0042	10.929	1.0060	9.1855	1.0080	7.9240	45
16	1.0028	13.441	1.0042	10.894	1.0060	9.1612	1.0081	7.9059	44
17	1.0028	13.389	1.0043	10.860	1.0060	9.1370	1.0081	7.8879	43
18	1.0028	13.337	1.0043	10.826	1.0061	9.1129	1.0082	7.8700	42
19	1.0028	13.286	1.0043	10.792	1.0061	9.0890	1.0082	7.8522	41
20	1.0029	13.235	1.0043	10.758	1.0061	9.0651	1.0082	7.8344	40
21	1.0029	13.184	1.0044	10.725	1.0062	9.0414	1.0083	7.8168	39
22	1.0029	13.134	1.0044	10.692	1.0062	9.0179	1.0083	7.7992	38
23	1.0029	13.084	1.0044	10.659	1.0062	8.9944	1.0084	7.7817	37
24	1.0029	13.034	1.0044	10.626	1.0063	8.9711	1.0084	7.7642	36
25	1.0030	12.985	1.0045	10.593	1.0063	8.9479	1.0084	7.7469	35
26	1.0030	12.937	1.0045	10.561	1.0063	8.9248	1.0085	7.7296	34
27	1.0030	12.888	1.0045	10.529	1.0064	8.9018	1.0085	7.7124	33
28	1.0030	12.840	1.0046	10.497	1.0064	8.8790	1.0085	7.6953	32
29	1.0031	12.793	1.0046	10.465	1.0064	8.8563	1.0086	7.6783	31
30	1.0031	12.745	1.0046	10.433	1.0065	8.8337	1.0086	7.6613	30
31	1.0031	12.698	1.0046	10.402	1.0065	8.8112	1.0087	7.6444	29
32	1.0031	12.652	1.0047	10.371	1.0065	8.7888	1.0087	7.6276	28
33	1.0032	12.606	1.0047	10.340	1.0066	8.7665	1.0087	7.6108	27
34	1.0032	12.560	1.0047	10.309	1.0066	8.7444	1.0088	7.5942	26
35	1.0032	12.514	1.0048	10.278	1.0066	8.7223	1.0088	7.5776	25
36	1.0032	12.469	1.0048	10.248	1.0067	8.7004	1.0089	7.5611	24
37	1.0032	12.424	1.0048	10.217	1.0067	8.6786	1.0089	7.5446	23
38	1.0033	12.379	1.0048	10.187	1.0067	8.6569	1.0089	7.5282	22
39	1.0033	12.335	1.0049	10.157	1.0068	8.6353	1.0090	7.5119	21
40	1.0033	12.291	1.0049	10.127	1.0068	8.6138	1.0090	7.4957	20
41	1.0033	12.248	1.0049	10.098	1.0068	8.5924	1.0090	7.4795	19
42	1.0034	12.204	1.0050	10.068	1.0069	8.5711	1.0091	7.4634	18
43	1.0034	12.161	1.0050	10.039	1.0069	8.5499	1.0091	7.4474	17
44	1.0034	12.118	1.0050	10.010	1.0069	8.5289	1.0092	7.4315	16
45	1.0034	12.076	1.0050	9.9812	1.0070	8.5079	1.0092	7.4156	15
46	1.0035	12.034	1.0051	9.9525	1.0070	8.4871	1.0092	7.3998	14
47	1.0035	11.992	1.0051	9.9239	1.0070	8.4663	1.0093	7.3840	13
48	1.0035	11.950	1.0051	9.8955	1.0071	8.4457	1.0093	7.3683	12
49	1.0035	11.909	1.0052	9.8672	1.0071	8.4251	1.0094	7.3527	11
50	1.0036	11.868	1.0052	9.8391	1.0071	8.4046	1.0094	7.3372	10
51	1.0036	11.828	1.0052	9.8112	1.0072	8.3843	1.0094	7.3217	9
52	1.0036	11.787	1.0053	9.7834	1.0072	8.3640	1.0095	7.3063	8
53	1.0036	11.747	1.0053	9.7558	1.0073	8.3438	1.0095	7.2909	7
54	1.0037	11.707	1.0053	9.7283	1.0073	8.3238	1.0096	7.2757	6
55	1.0037	11.668	1.0053	9.7010	1.0073	8.3039	1.0096	7.2604	5
56	1.0037	11.628	1.0054	9.6739	1.0074	8.2840	1.0097	7.2453	4
57	1.0037	11.589	1.0054	9.6469	1.0074	8.2642	1.0097	7.2302	3
58	1.0038	11.550	1.0054	9.6200	1.0074	8.2446	1.0097	7.2152	2
59	1.0038	11.512	1.0055	9.5933	1.0075	8.2250	1.0098	7.2002	1
60	1.0038	11.474	1.0055	9.5668	1.0075	8.2055	1.0098	7.1853	0
'	CO-SEC.	SEC.	CO-SEC.	SEC.	CO-SEC.	SEC.	CO-SEC.	SEC.	'
	85°		84°		83°		82°		

'	8°		9°		10°		11°		'
	SEC.	CO-SEC.	SEC.	CO-SEC.	SEC.	CO-SEC.	SEC.	CO-SEC.	
0	1.0098	7.1853	1.0125	6.3924	1.0154	5.7588	1.0187	5.2408	60
1	1.0099	7.1704	1.0125	6.3807	1.0155	5.7493	1.0188	5.2330	59
2	1.0099	7.1557	1.0125	6.3690	1.0155	5.7398	1.0188	5.2252	58
3	1.0099	7.1409	1.0126	6.3574	1.0156	5.7304	1.0189	5.2174	57
4	1.0100	7.1263	1.0126	6.3458	1.0156	5.7210	1.0189	5.2097	56
5	1.0100	7.1117	1.0127	6.3343	1.0157	5.7117	1.0190	5.2019	55
6	1.0101	7.0972	1.0127	6.3228	1.0157	5.7023	1.0191	5.1942	54
7	1.0101	7.0827	1.0128	6.3113	1.0158	5.6930	1.0191	5.1865	53
8	1.0102	7.0683	1.0128	6.2999	1.0158	5.6838	1.0192	5.1788	52
9	1.0102	7.0539	1.0129	6.2885	1.0159	5.6745	1.0192	5.1712	51
10	1.0102	7.0396	1.0129	6.2772	1.0159	5.6653	1.0193	5.1636	50
11	1.0103	7.0254	1.0130	6.2659	1.0160	5.6561	1.0193	5.1560	49
12	1.0103	7.0112	1.0130	6.2546	1.0160	5.6470	1.0194	5.1484	48
13	1.0104	6.9971	1.0131	6.2434	1.0161	5.6379	1.0195	5.1409	47
14	1.0104	6.9830	1.0131	6.2322	1.0162	5.6288	1.0195	5.1333	46
15	1.0104	6.9690	1.0132	6.2211	1.0162	5.6197	1.0196	5.1258	45
16	1.0105	6.9550	1.0132	6.2100	1.0163	5.6107	1.0196	5.1183	44
17	1.0105	6.9411	1.0133	6.1990	1.0163	5.6017	1.0197	5.1109	43
18	1.0106	6.9273	1.0133	6.1880	1.0164	5.5928	1.0198	5.1034	42
19	1.0106	6.9135	1.0134	6.1770	1.0164	5.5838	1.0198	5.0960	41
20	1.0107	6.8998	1.0134	6.1661	1.0165	5.5749	1.0199	5.0886	40
21	1.0107	6.8861	1.0135	6.1552	1.0165	5.5660	1.0199	5.0812	39
22	1.0107	6.8725	1.0135	6.1443	1.0166	5.5572	1.0200	5.0739	38
23	1.0108	6.8589	1.0136	6.1335	1.0166	5.5484	1.0201	5.0666	37
24	1.0108	6.8454	1.0136	6.1227	1.0167	5.5396	1.0201	5.0593	36
25	1.0109	6.8320	1.0136	6.1120	1.0167	5.5308	1.0202	5.0520	35
26	1.0109	6.8185	1.0137	6.1013	1.0168	5.5221	1.0202	5.0447	34
27	1.0110	6.8052	1.0137	6.0906	1.0169	5.5134	1.0203	5.0375	33
28	1.0110	6.7919	1.0138	6.0800	1.0169	5.5047	1.0204	5.0302	32
29	1.0111	6.7787	1.0138	6.0694	1.0170	5.4960	1.0204	5.0230	31
30	1.0111	6.7655	1.0139	6.0588	1.0170	5.4874	1.0205	5.0158	30
31	1.0111	6.7523	1.0139	6.0483	1.0171	5.4788	1.0205	5.0087	29
32	1.0112	6.7392	1.0140	6.0379	1.0171	5.4702	1.0206	5.0015	28
33	1.0112	6.7262	1.0140	6.0274	1.0172	5.4617	1.0207	4.9944	27
34	1.0113	6.7132	1.0141	6.0170	1.0172	5.4532	1.0207	4.9873	26
35	1.0113	6.7003	1.0141	6.0066	1.0173	5.4447	1.0208	4.9802	25
36	1.0114	6.6874	1.0142	5.9963	1.0174	5.4362	1.0208	4.9732	24
37	1.0114	6.6745	1.0142	5.9860	1.0174	5.4278	1.0209	4.9661	23
38	1.0115	6.6617	1.0143	5.9758	1.0175	5.4194	1.0210	4.9591	22
39	1.0115	6.6490	1.0143	5.9655	1.0175	5.4110	1.0210	4.9521	21
40	1.0115	6.6363	1.0144	5.9554	1.0176	5.4026	1.0211	4.9452	20
41	1.0116	6.6237	1.0144	5.9452	1.0176	5.3943	1.0211	4.9382	19
42	1.0116	6.6111	1.0145	5.9351	1.0177	5.3860	1.0212	4.9313	18
43	1.0117	6.5985	1.0145	5.9250	1.0177	5.3777	1.0213	4.9243	17
44	1.0117	6.5860	1.0146	5.9150	1.0178	5.3695	1.0213	4.9175	16
45	1.0118	6.5736	1.0146	5.9049	1.0179	5.3612	1.0214	4.9106	15
46	1.0118	6.5612	1.0147	5.8950	1.0179	5.3530	1.0215	4.9037	14
47	1.0119	6.5488	1.0147	5.8850	1.0180	5.3449	1.0215	4.8969	13
48	1.0119	6.5365	1.0148	5.8751	1.0180	5.3367	1.0216	4.8901	12
49	1.0119	6.5243	1.0148	5.8652	1.0181	5.3286	1.0216	4.8833	11
50	1.0120	6.5121	1.0149	5.8554	1.0181	5.3205	1.0217	4.8765	10
51	1.0120	6.4999	1.0150	5.8456	1.0182	5.3124	1.0218	4.8697	9
52	1.0121	6.4878	1.0150	5.8358	1.0182	5.3044	1.0218	4.8630	8
53	1.0121	6.4757	1.0151	5.8261	1.0183	5.2963	1.0219	4.8563	7
54	1.0122	6.4637	1.0151	5.8163	1.0184	5.2883	1.0220	4.8496	6
55	1.0122	6.4517	1.0152	5.8067	1.0184	5.2803	1.0220	4.8429	5
56	1.0123	6.4398	1.0152	5.7970	1.0185	5.2724	1.0221	4.8362	4
57	1.0123	6.4279	1.0153	5.7874	1.0185	5.2645	1.0221	4.8296	3
58	1.0124	6.4160	1.0153	5.7778	1.0186	5.2566	1.0222	4.8229	2
59	1.0124	6.4042	1.0154	5.7683	1.0186	5.2487	1.0223	4.8163	1
60	1.0125	6.3924	1.0154	5.7588	1.0187	5.2408	1.0223	4.8097	0
'	CO-SEC.	SEC.	CO-SEC.	SEC.	CO-SEC.	SEC.	CO-SEC.	SEC.	'
		81°		80°		79°		78°	

NATURAL SECANTS

1619

'	12°		13°		14°		15°		'
	SEC.	CO-SEC.	SEC.	CO-SEC.	SEC.	CO-SEC.	SEC.	CO-SEC.	
0	1.0223	4.8097	1.0263	4.4454	1.0306	4.1336	1.0353	3.8637	60
1	1.0224	4.8032	1.0264	4.4398	1.0307	4.1287	1.0353	3.8595	59
2	1.0225	4.7966	1.0264	4.4342	1.0308	4.1239	1.0354	3.8553	58
3	1.0225	4.7901	1.0265	4.4287	1.0308	4.1191	1.0355	3.8512	57
4	1.0226	4.7835	1.0266	4.4231	1.0309	4.1144	1.0356	3.8470	56
5	1.0226	4.7770	1.0266	4.4176	1.0310	4.1096	1.0357	3.8428	55
6	1.0227	4.7706	1.0267	4.4121	1.0311	4.1048	1.0358	3.8387	54
7	1.0228	4.7641	1.0268	4.4065	1.0311	4.1001	1.0358	3.8346	53
8	1.0228	4.7576	1.0268	4.4011	1.0312	4.0953	1.0359	3.8304	52
9	1.0229	4.7512	1.0269	4.3956	1.0313	4.0906	1.0360	3.8263	51
10	1.0230	4.7448	1.0270	4.3910	1.0314	4.0859	1.0361	3.8222	50
11	1.0230	4.7384	1.0271	4.3847	1.0314	4.0812	1.0362	3.8181	49
12	1.0231	4.7320	1.0271	4.3792	1.0315	4.0765	1.0362	3.8140	48
13	1.0232	4.7257	1.0272	4.3738	1.0316	4.0718	1.0363	3.8100	47
14	1.0232	4.7193	1.0273	4.3684	1.0317	4.0672	1.0364	3.8059	46
15	1.0233	4.7130	1.0273	4.3630	1.0317	4.0625	1.0365	3.8018	45
16	1.0234	4.7067	1.0274	4.3576	1.0318	4.0579	1.0366	3.7978	44
17	1.0234	4.7004	1.0275	4.3522	1.0319	4.0532	1.0367	3.7937	43
18	1.0235	4.6942	1.0276	4.3469	1.0320	4.0486	1.0367	3.7897	42
19	1.0235	4.6879	1.0276	4.3415	1.0320	4.0440	1.0368	3.7857	41
20	1.0236	4.6817	1.0277	4.3362	1.0321	4.0394	1.0369	3.7816	40
21	1.0237	4.6754	1.0278	4.3309	1.0322	4.0348	1.0370	3.7776	39
22	1.0237	4.6692	1.0278	4.3256	1.0323	4.0302	1.0371	3.7736	38
23	1.0238	4.6631	1.0279	4.3203	1.0323	4.0256	1.0371	3.7697	37
24	1.0239	4.6569	1.0280	4.3150	1.0324	4.0211	1.0372	3.7657	36
25	1.0239	4.6507	1.0280	4.3098	1.0325	4.0165	1.0373	3.7617	35
26	1.0240	4.6446	1.0281	4.3045	1.0326	4.0120	1.0374	3.7577	34
27	1.0241	4.6385	1.0282	4.2993	1.0327	4.0074	1.0375	3.7538	33
28	1.0241	4.6324	1.0283	4.2941	1.0327	4.0029	1.0376	3.7498	32
29	1.0242	4.6263	1.0283	4.2888	1.0328	3.9984	1.0376	3.7459	31
30	1.0243	4.6202	1.0284	4.2836	1.0329	3.9939	1.0377	3.7420	30
31	1.0243	4.6142	1.0285	4.2785	1.0330	3.9894	1.0378	3.7380	29
32	1.0244	4.6081	1.0285	4.2733	1.0330	3.9850	1.0379	3.7341	28
33	1.0245	4.6021	1.0286	4.2681	1.0331	3.9805	1.0380	3.7302	27
34	1.0245	4.5961	1.0287	4.2630	1.0332	3.9760	1.0381	3.7263	26
35	1.0246	4.5901	1.0288	4.2579	1.0333	3.9716	1.0382	3.7224	25
36	1.0247	4.5841	1.0288	4.2527	1.0334	3.9672	1.0382	3.7186	24
37	1.0247	4.5782	1.0289	4.2476	1.0334	3.9627	1.0383	3.7147	23
38	1.0248	4.5722	1.0290	4.2425	1.0335	3.9583	1.0384	3.7108	22
39	1.0249	4.5663	1.0291	4.2375	1.0336	3.9539	1.0385	3.7070	21
40	1.0249	4.5604	1.0291	4.2324	1.0337	3.9495	1.0386	3.7031	20
41	1.0250	4.5545	1.0292	4.2273	1.0338	3.9451	1.0387	3.6993	19
42	1.0251	4.5486	1.0293	4.2223	1.0338	3.9408	1.0387	3.6955	18
43	1.0251	4.5428	1.0293	4.2173	1.0339	3.9364	1.0388	3.6917	17
44	1.0252	4.5369	1.0294	4.2122	1.0340	3.9320	1.0389	3.6878	16
45	1.0253	4.5311	1.0295	4.2072	1.0341	3.9277	1.0390	3.6840	15
46	1.0253	4.5253	1.0296	4.2022	1.0341	3.9234	1.0391	3.6802	14
47	1.0254	4.5195	1.0296	4.1972	1.0342	3.9190	1.0392	3.6765	13
48	1.0255	4.5137	1.0297	4.1923	1.0343	3.9147	1.0393	3.6727	12
49	1.0255	4.5079	1.0298	4.1873	1.0344	3.9104	1.0393	3.6689	11
50	1.0256	4.5021	1.0299	4.1824	1.0345	3.9061	1.0394	3.6651	10
51	1.0257	4.4964	1.0299	4.1774	1.0345	3.9018	1.0395	3.6614	9
52	1.0257	4.4907	1.0300	4.1725	1.0346	3.8976	1.0396	3.6576	8
53	1.0258	4.4850	1.0301	4.1676	1.0347	3.8933	1.0397	3.6539	7
54	1.0259	4.4793	1.0302	4.1627	1.0348	3.8890	1.0398	3.6502	6
55	1.0260	4.4736	1.0302	4.1578	1.0349	3.8848	1.0399	3.6464	5
56	1.0260	4.4679	1.0303	4.1529	1.0349	3.8805	1.0399	3.6427	4
57	1.0261	4.4623	1.0304	4.1481	1.0350	3.8763	1.0400	3.6390	3
58	1.0262	4.4566	1.0305	4.1432	1.0351	3.8721	1.0401	3.6353	2
59	1.0262	4.4510	1.0305	4.1384	1.0352	3.8679	1.0402	3.6316	1
60	1.0263	4.4454	1.0306	4.1336	1.0353	3.8637	1.0403	3.6279	0

CO-SEC. SEC. CO-SEC. SEC. CO-SEC. SEC. CO-SEC. SEC.

77°

78°

75°

74°

'	16°		17°		18°		19°		'
	SEC.	CO-SEC.	SEC.	CO-SEC.	SEC.	CO-SEC.	SEC.	CO-SEC.	
0	1.0403	3.6279	1.0457	3.4203	1.0515	3.2361	1.0576	3.0715	60
1	1.0404	3.6243	1.0458	3.4170	1.0516	3.2332	1.0577	3.0690	59
2	1.0405	3.6206	1.0459	3.4138	1.0517	3.2303	1.0578	3.0664	58
3	1.0406	3.6169	1.0460	3.4106	1.0518	3.2274	1.0579	3.0638	57
4	1.0406	3.6133	1.0461	3.4073	1.0519	3.2245	1.0580	3.0612	56
5	1.0407	3.6096	1.0461	3.4041	1.0520	3.2216	1.0581	3.0586	55
6	1.0408	3.6060	1.0462	3.4009	1.0521	3.2188	1.0582	3.0561	54
7	1.0409	3.6024	1.0463	3.3977	1.0522	3.2159	1.0584	3.0535	53
8	1.0410	3.5987	1.0464	3.3945	1.0523	3.2131	1.0585	3.0509	52
9	1.0411	3.5951	1.0465	3.3913	1.0524	3.2102	1.0586	3.0484	51
10	1.0412	3.5915	1.0466	3.3881	1.0525	3.2074	1.0587	3.0458	50
11	1.0413	3.5879	1.0467	3.3849	1.0526	3.2045	1.0588	3.0433	49
12	1.0413	3.5843	1.0468	3.3817	1.0527	3.2017	1.0589	3.0407	48
13	1.0414	3.5807	1.0469	3.3785	1.0528	3.1989	1.0590	3.0382	47
14	1.0415	3.5772	1.0470	3.3754	1.0529	3.1960	1.0591	3.0357	46
15	1.0416	3.5736	1.0471	3.3722	1.0530	3.1932	1.0592	3.0331	45
16	1.0417	3.5700	1.0472	3.3690	1.0531	3.1904	1.0593	3.0306	44
17	1.0418	3.5665	1.0473	3.3659	1.0532	3.1876	1.0594	3.0281	43
18	1.0419	3.5629	1.0474	3.3627	1.0533	3.1848	1.0595	3.0256	42
19	1.0420	3.5594	1.0475	3.3596	1.0534	3.1820	1.0596	3.0231	41
20	1.0420	3.5559	1.0476	3.3565	1.0535	3.1792	1.0598	3.0206	40
21	1.0421	3.5523	1.0477	3.3534	1.0536	3.1764	1.0599	3.0181	39
22	1.0422	3.5488	1.0478	3.3502	1.0537	3.1736	1.0600	3.0156	38
23	1.0423	3.5453	1.0478	3.3471	1.0538	3.1708	1.0601	3.0131	37
24	1.0424	3.5418	1.0479	3.3440	1.0539	3.1681	1.0602	3.0106	36
25	1.0425	3.5383	1.0480	3.3409	1.0540	3.1653	1.0603	3.0081	35
26	1.0426	3.5348	1.0481	3.3378	1.0541	3.1625	1.0604	3.0056	34
27	1.0427	3.5313	1.0482	3.3347	1.0542	3.1598	1.0605	3.0031	33
28	1.0428	3.5277	1.0483	3.3316	1.0543	3.1570	1.0606	3.0007	32
29	1.0428	3.5244	1.0484	3.3285	1.0544	3.1543	1.0607	2.9982	31
30	1.0429	3.5209	1.0485	3.3255	1.0545	3.1515	1.0608	2.9957	30
31	1.0430	3.5175	1.0486	3.3224	1.0546	3.1488	1.0609	2.9932	29
32	1.0431	3.5140	1.0487	3.3194	1.0547	3.1461	1.0611	2.9908	28
33	1.0432	3.5106	1.0488	3.3163	1.0548	3.1433	1.0612	2.9884	27
34	1.0433	3.5072	1.0489	3.3133	1.0549	3.1406	1.0613	2.9859	26
35	1.0434	3.5037	1.0490	3.3102	1.0550	3.1379	1.0614	2.9835	25
36	1.0435	3.5003	1.0491	3.3072	1.0551	3.1352	1.0615	2.9810	24
37	1.0436	3.4969	1.0492	3.3042	1.0552	3.1325	1.0616	2.9786	23
38	1.0437	3.4935	1.0493	3.3011	1.0553	3.1298	1.0617	2.9762	22
39	1.0438	3.4901	1.0494	3.2981	1.0554	3.1271	1.0618	2.9738	21
40	1.0438	3.4867	1.0495	3.2951	1.0555	3.1244	1.0619	2.9713	20
41	1.0439	3.4833	1.0496	3.2921	1.0556	3.1217	1.0620	2.9689	19
42	1.0440	3.4799	1.0497	3.2891	1.0557	3.1190	1.0622	2.9665	18
43	1.0441	3.4766	1.0498	3.2861	1.0558	3.1163	1.0623	2.9641	17
44	1.0442	3.4732	1.0499	3.2831	1.0559	3.1137	1.0624	2.9617	16
45	1.0443	3.4698	1.0500	3.2801	1.0560	3.1110	1.0625	2.9593	15
46	1.0444	3.4665	1.0501	3.2772	1.0561	3.1083	1.0626	2.9569	14
47	1.0445	3.4632	1.0502	3.2742	1.0562	3.1057	1.0627	2.9545	13
48	1.0446	3.4598	1.0503	3.2712	1.0563	3.1030	1.0628	2.9521	12
49	1.0447	3.4565	1.0504	3.2683	1.0565	3.1004	1.0629	2.9497	11
50	1.0448	3.4532	1.0505	3.2653	1.0566	3.0977	1.0630	2.9474	10
51	1.0448	3.4498	1.0506	3.2624	1.0567	3.0951	1.0632	2.9450	9
52	1.0449	3.4465	1.0507	3.2594	1.0568	3.0925	1.0633	2.9426	8
53	1.0450	3.4432	1.0508	3.2565	1.0569	3.0898	1.0634	2.9402	7
54	1.0451	3.4399	1.0509	3.2535	1.0570	3.0872	1.0635	2.9379	6
55	1.0452	3.4366	1.0510	3.2506	1.0571	3.0846	1.0636	2.9355	5
56	1.0453	3.4334	1.0511	3.2477	1.0572	3.0820	1.0637	2.9332	4
57	1.0454	3.4301	1.0512	3.2448	1.0573	3.0793	1.0638	2.9308	3
58	1.0455	3.4268	1.0513	3.2419	1.0574	3.0767	1.0639	2.9285	2
59	1.0456	3.4236	1.0514	3.2390	1.0575	3.0741	1.0641	2.9261	1
60	1.0457	3.4203	1.0515	3.2361	1.0576	3.0715	1.0642	2.9238	0
'	CO-SEC.	SEC.	CO-SEC.	SEC.	CO-SEC.	SEC.	CO-SEC.	SEC.	'

73°

72°

71°

70°

NATURAL SECANTS

1621

'	20°		21°		22°		23°		'
	SEC.	CO-SEC.	SEC.	CO-SEC.	SEC.	CO-SEC.	SEC.	CO-SEC.	
0	1.0642	2.9238	1.0711	2.7904	1.0785	2.6695	1.0864	2.5593	60
1	1.0643	2.9215	1.0713	2.7883	1.0787	2.6675	1.0865	2.5575	59
2	1.0644	2.9191	1.0714	2.7862	1.0788	2.6656	1.0866	2.5558	58
3	1.0645	2.9168	1.0715	2.7841	1.0789	2.6637	1.0868	2.5540	57
4	1.0646	2.9145	1.0716	2.7820	1.0790	2.6618	1.0869	2.5523	56
5	1.0647	2.9122	1.0717	2.7799	1.0792	2.6599	1.0870	2.5506	55
6	1.0648	2.9098	1.0719	2.7778	1.0793	2.6580	1.0872	2.5488	54
7	1.0650	2.9075	1.0720	2.7757	1.0794	2.6561	1.0873	2.5471	53
8	1.0651	2.9052	1.0721	2.7736	1.0795	2.6542	1.0874	2.5453	52
9	1.0652	2.9029	1.0722	2.7715	1.0797	2.6523	1.0876	2.5436	51
10	1.0653	2.9006	1.0723	2.7694	1.0798	2.6504	1.0877	2.5419	50
11	1.0654	2.8983	1.0725	2.7674	1.0799	2.6485	1.0878	2.5402	49
12	1.0655	2.8960	1.0726	2.7653	1.0801	2.6466	1.0880	2.5384	48
13	1.0656	2.8937	1.0727	2.7632	1.0802	2.6447	1.0881	2.5367	47
14	1.0658	2.8915	1.0728	2.7611	1.0803	2.6428	1.0882	2.5350	46
15	1.0659	2.8892	1.0729	2.7591	1.0804	2.6410	1.0884	2.5333	45
16	1.0660	2.8869	1.0731	2.7570	1.0806	2.6391	1.0885	2.5316	44
17	1.0661	2.8846	1.0732	2.7550	1.0807	2.6372	1.0886	2.5299	43
18	1.0662	2.8824	1.0733	2.7529	1.0808	2.6353	1.0888	2.5281	42
19	1.0663	2.8801	1.0734	2.7509	1.0810	2.6335	1.0889	2.5264	41
20	1.0664	2.8778	1.0736	2.7488	1.0811	2.6316	1.0891	2.5247	40
21	1.0666	2.8756	1.0737	2.7468	1.0812	2.6297	1.0892	2.5230	39
22	1.0667	2.8733	1.0738	2.7447	1.0813	2.6279	1.0893	2.5213	38
23	1.0668	2.8711	1.0739	2.7427	1.0815	2.6260	1.0895	2.5196	37
24	1.0669	2.8688	1.0740	2.7406	1.0816	2.6242	1.0896	2.5179	36
25	1.0670	2.8666	1.0742	2.7386	1.0817	2.6223	1.0897	2.5163	35
26	1.0671	2.8644	1.0743	2.7366	1.0819	2.6205	1.0899	2.5146	34
27	1.0673	2.8621	1.0744	2.7346	1.0820	2.6186	1.0900	2.5129	33
28	1.0674	2.8599	1.0745	2.7325	1.0821	2.6168	1.0902	2.5112	32
29	1.0675	2.8577	1.0747	2.7305	1.0823	2.6150	1.0903	2.5095	31
30	1.0676	2.8554	1.0748	2.7285	1.0824	2.6131	1.0904	2.5078	30
31	1.0677	2.8532	1.0749	2.7265	1.0825	2.6113	1.0906	2.5062	29
32	1.0678	2.8510	1.0750	2.7245	1.0826	2.6095	1.0907	2.5045	28
33	1.0679	2.8488	1.0751	2.7225	1.0828	2.6076	1.0908	2.5028	27
34	1.0681	2.8466	1.0753	2.7205	1.0829	2.6058	1.0910	2.5011	26
35	1.0682	2.8444	1.0754	2.7185	1.0830	2.6040	1.0911	2.4995	25
36	1.0683	2.8422	1.0755	2.7165	1.0832	2.6022	1.0913	2.4978	24
37	1.0684	2.8400	1.0756	2.7145	1.0833	2.6003	1.0914	2.4961	23
38	1.0685	2.8378	1.0758	2.7125	1.0834	2.5985	1.0915	2.4945	22
39	1.0686	2.8356	1.0759	2.7105	1.0836	2.5967	1.0917	2.4928	21
40	1.0688	2.8334	1.0760	2.7085	1.0837	2.5949	1.0918	2.4912	20
41	1.0689	2.8312	1.0761	2.7065	1.0838	2.5931	1.0920	2.4895	19
42	1.0690	2.8290	1.0763	2.7045	1.0840	2.5913	1.0921	2.4879	18
43	1.0691	2.8269	1.0764	2.7026	1.0841	2.5895	1.0922	2.4862	17
44	1.0692	2.8247	1.0765	2.7006	1.0842	2.5877	1.0924	2.4846	16
45	1.0694	2.8225	1.0766	2.6986	1.0844	2.5859	1.0925	2.4829	15
46	1.0695	2.8204	1.0768	2.6967	1.0845	2.5841	1.0927	2.4813	14
47	1.0696	2.8182	1.0769	2.6947	1.0846	2.5823	1.0928	2.4797	13
48	1.0697	2.8160	1.0770	2.6927	1.0847	2.5805	1.0929	2.4780	12
49	1.0698	2.8139	1.0771	2.6908	1.0849	2.5787	1.0931	2.4764	11
50	1.0699	2.8117	1.0773	2.6888	1.0850	2.5770	1.0932	2.4748	10
51	1.0701	2.8096	1.0774	2.6869	1.0851	2.5752	1.0934	2.4731	9
52	1.0702	2.8074	1.0775	2.6849	1.0853	2.5734	1.0935	2.4715	8
53	1.0703	2.8053	1.0776	2.6830	1.0854	2.5716	1.0936	2.4699	7
54	1.0704	2.8032	1.0778	2.6810	1.0855	2.5699	1.0938	2.4683	6
55	1.0705	2.8010	1.0779	2.6791	1.0857	2.5681	1.0939	2.4666	5
56	1.0707	2.7989	1.0780	2.6772	1.0858	2.5663	1.0941	2.4650	4
57	1.0708	2.7968	1.0781	2.6752	1.0859	2.5646	1.0942	2.4634	3
58	1.0709	2.7947	1.0783	2.6733	1.0861	2.5628	1.0943	2.4618	2
59	1.0710	2.7925	1.0784	2.6714	1.0862	2.5610	1.0945	2.4602	1
60	1.0711	2.7904	1.0785	2.6695	1.0864	2.5593	1.0946	2.4586	0

69°

68°

67°

66°

'	24°		25°		26°		27°		'
	SEC.	CO-SEC.	SEC.	CO-SEC.	SEC.	CO-SEC.	SEC.	CO-SEC.	
0	1.0046	2.4586	1.1034	2.3662	1.1126	2.2812	1.1223	2.2027	60
1	1.0048	2.4570	1.1035	2.3647	1.1127	2.2798	1.1225	2.2014	59
2	1.0049	2.4554	1.1037	2.3632	1.1129	2.2784	1.1226	2.2002	58
3	1.0051	2.4538	1.1038	2.3618	1.1131	2.2771	1.1228	2.1989	57
4	1.0052	2.4522	1.1040	2.3603	1.1132	2.2757	1.1230	2.1977	56
5	1.0053	2.4506	1.1041	2.3588	1.1134	2.2744	1.1231	2.1964	55
6	1.0055	2.4490	1.1043	2.3574	1.1135	2.2730	1.1233	2.1952	54
7	1.0056	2.4474	1.1044	2.3559	1.1137	2.2717	1.1235	2.1939	53
8	1.0058	2.4458	1.1046	2.3544	1.1139	2.2703	1.1237	2.1927	52
9	1.0059	2.4442	1.1047	2.3530	1.1140	2.2690	1.1238	2.1914	51
10	1.0061	2.4426	1.1049	2.3515	1.1142	2.2676	1.1240	2.1902	50
11	1.0062	2.4411	1.1050	2.3501	1.1143	2.2663	1.1242	2.1889	49
12	1.0063	2.4395	1.1052	2.3486	1.1145	2.2650	1.1243	2.1877	48
13	1.0065	2.4379	1.1053	2.3472	1.1147	2.2636	1.1245	2.1865	47
14	1.0066	2.4363	1.1055	2.3457	1.1148	2.2623	1.1247	2.1852	46
15	1.0068	2.4347	1.1056	2.3443	1.1150	2.2610	1.1248	2.1840	45
16	1.0069	2.4332	1.1058	2.3428	1.1151	2.2596	1.1250	2.1828	44
17	1.0071	2.4316	1.1059	2.3414	1.1153	2.2583	1.1252	2.1815	43
18	1.0072	2.4300	1.1061	2.3399	1.1155	2.2570	1.1253	2.1803	42
19	1.0073	2.4285	1.1062	2.3385	1.1156	2.2556	1.1255	2.1791	41
20	1.0075	2.4269	1.1064	2.3371	1.1158	2.2543	1.1257	2.1778	40
21	1.0076	2.4254	1.1065	2.3356	1.1159	2.2530	1.1258	2.1766	39
22	1.0078	2.4238	1.1067	2.3342	1.1161	2.2517	1.1260	2.1754	38
23	1.0079	2.4222	1.1068	2.3328	1.1163	2.2503	1.1262	2.1742	37
24	1.0081	2.4207	1.1070	2.3313	1.1164	2.2490	1.1264	2.1730	36
25	1.0082	2.4191	1.1072	2.3299	1.1166	2.2477	1.1265	2.1717	35
26	1.0084	2.4176	1.1073	2.3285	1.1167	2.2464	1.1267	2.1705	34
27	1.0085	2.4160	1.1075	2.3271	1.1169	2.2451	1.1269	2.1693	33
28	1.0086	2.4145	1.1076	2.3256	1.1171	2.2438	1.1270	2.1681	32
29	1.0088	2.4130	1.1078	2.3242	1.1172	2.2425	1.1272	2.1669	31
30	1.0089	2.4114	1.1079	2.3228	1.1174	2.2411	1.1274	2.1657	30
31	1.0091	2.4099	1.1081	2.3214	1.1176	2.2398	1.1275	2.1645	29
32	1.0092	2.4083	1.1082	2.3200	1.1177	2.2385	1.1277	2.1633	28
33	1.0094	2.4068	1.1084	2.3186	1.1179	2.2372	1.1279	2.1620	27
34	1.0095	2.4053	1.1085	2.3172	1.1180	2.2359	1.1281	2.1608	26
35	1.0097	2.4037	1.1087	2.3158	1.1182	2.2346	1.1282	2.1596	25
36	1.0098	2.4022	1.1088	2.3143	1.1184	2.2333	1.1284	2.1584	24
37	1.1000	2.4007	1.1090	2.3129	1.1185	2.2320	1.1286	2.1572	23
38	1.1001	2.3992	1.1092	2.3115	1.1187	2.2307	1.1287	2.1560	22
39	1.1003	2.3976	1.1093	2.3101	1.1189	2.2294	1.1289	2.1548	21
40	1.1004	2.3961	1.1095	2.3087	1.1190	2.2282	1.1291	2.1536	20
41	1.1005	2.3946	1.1096	2.3073	1.1192	2.2269	1.1293	2.1525	19
42	1.1007	2.3931	1.1098	2.3059	1.1193	2.2256	1.1294	2.1513	18
43	1.1008	2.3916	1.1099	2.3046	1.1195	2.2243	1.1296	2.1501	17
44	1.1010	2.3901	1.1101	2.3032	1.1197	2.2230	1.1298	2.1489	16
45	1.1011	2.3886	1.1102	2.3018	1.1198	2.2217	1.1299	2.1477	15
46	1.1013	2.3871	1.1104	2.3004	1.1200	2.2204	1.1301	2.1465	14
47	1.1014	2.3856	1.1106	2.2990	1.1202	2.2192	1.1303	2.1453	13
48	1.1016	2.3841	1.1107	2.2976	1.1203	2.2179	1.1305	2.1441	12
49	1.1017	2.3826	1.1109	2.2962	1.1205	2.2166	1.1306	2.1430	11
50	1.1019	2.3811	1.1110	2.2949	1.1207	2.2153	1.1308	2.1418	10
51	1.1020	2.3796	1.1112	2.2935	1.1208	2.2141	1.1310	2.1406	9
52	1.1022	2.3781	1.1113	2.2921	1.1210	2.2128	1.1312	2.1394	8
53	1.1023	2.3766	1.1115	2.2907	1.1212	2.2115	1.1313	2.1382	7
54	1.1025	2.3751	1.1116	2.2894	1.1213	2.2103	1.1315	2.1371	6
55	1.1026	2.3736	1.1118	2.2880	1.1215	2.2090	1.1317	2.1359	5
56	1.1028	2.3721	1.1120	2.2866	1.1217	2.2077	1.1319	2.1347	4
57	1.1029	2.3706	1.1121	2.2853	1.1218	2.2065	1.1320	2.1335	3
58	1.1031	2.3691	1.1123	2.2839	1.1220	2.2052	1.1322	2.1324	2
59	1.1032	2.3677	1.1124	2.2825	1.1222	2.2039	1.1324	2.1312	1
60	1.1034	2.3662	1.1126	2.2812	1.1223	2.2027	1.1326	2.1300	0
'	CO-SEC.	SEC.	CO-SEC.	SEC.	CO-SEC.	SEC.	CO-SEC.	SEC.	'
	65°		64°		63°		62°		

NATURAL SECANTS

1623

'	28°		29°		30°		31°		'
	SEC.	CO-SEC.	SEC.	CO-SEC.	SEC.	CO-SEC.	SEC.	CO-SEC.	
0	1.1326	2.1300	1.1433	2.0627	1.1547	2.0000	1.1666	1.0416	60
1	1.1327	2.1289	1.1435	2.0616	1.1549	1.9990	1.1668	1.0407	59
2	1.1329	2.1277	1.1437	2.0605	1.1551	1.9980	1.1670	1.0397	58
3	1.1331	2.1266	1.1439	2.0594	1.1553	1.9970	1.1672	1.0388	57
4	1.1333	2.1254	1.1441	2.0583	1.1555	1.9960	1.1674	1.0378	56
5	1.1334	2.1242	1.1443	2.0573	1.1557	1.9950	1.1676	1.0369	55
6	1.1336	2.1231	1.1445	2.0562	1.1559	1.9940	1.1678	1.0360	54
7	1.1338	2.1219	1.1446	2.0551	1.1561	1.9930	1.1681	1.0350	53
8	1.1340	2.1208	1.1448	2.0540	1.1562	1.9920	1.1683	1.0341	52
9	1.1341	2.1196	1.1450	2.0530	1.1564	1.9910	1.1685	1.0332	51
10	1.1343	2.1185	1.1452	2.0519	1.1566	1.9900	1.1687	1.0322	50
11	1.1345	2.1173	1.1454	2.0508	1.1568	1.9890	1.1689	1.0313	49
12	1.1347	2.1162	1.1456	2.0498	1.1570	1.9880	1.1691	1.0304	48
13	1.1349	2.1150	1.1458	2.0487	1.1572	1.9870	1.1693	1.0295	47
14	1.1350	2.1139	1.1459	2.0476	1.1574	1.9860	1.1695	1.0285	46
15	1.1352	2.1127	1.1461	2.0466	1.1576	1.9850	1.1697	1.0276	45
16	1.1354	2.1116	1.1463	2.0455	1.1578	1.9840	1.1699	1.0267	44
17	1.1356	2.1104	1.1465	2.0444	1.1580	1.9830	1.1701	1.0258	43
18	1.1357	2.1093	1.1467	2.0434	1.1582	1.9820	1.1703	1.0248	42
19	1.1359	2.1082	1.1469	2.0423	1.1584	1.9811	1.1705	1.0239	41
20	1.1361	2.1070	1.1471	2.0413	1.1586	1.9801	1.1707	1.0230	40
21	1.1363	2.1059	1.1473	2.0402	1.1588	1.9791	1.1709	1.0221	39
22	1.1365	2.1048	1.1474	2.0392	1.1590	1.9781	1.1712	1.0212	38
23	1.1366	2.1036	1.1476	2.0381	1.1592	1.9771	1.1714	1.0203	37
24	1.1368	2.1025	1.1478	2.0370	1.1594	1.9761	1.1716	1.0193	36
25	1.1370	2.1014	1.1480	2.0360	1.1596	1.9752	1.1718	1.0184	35
26	1.1372	2.1002	1.1482	2.0349	1.1598	1.9742	1.1720	1.0175	34
27	1.1373	2.0991	1.1484	2.0339	1.1600	1.9732	1.1722	1.0166	33
28	1.1375	2.0980	1.1486	2.0329	1.1602	1.9722	1.1724	1.0157	32
29	1.1377	2.0969	1.1488	2.0318	1.1604	1.9713	1.1726	1.0148	31
30	1.1379	2.0957	1.1489	2.0308	1.1606	1.9703	1.1728	1.0139	30
31	1.1381	2.0946	1.1491	2.0297	1.1608	1.9693	1.1730	1.0130	29
32	1.1382	2.0935	1.1493	2.0287	1.1610	1.9683	1.1732	1.0121	28
33	1.1384	2.0924	1.1495	2.0276	1.1612	1.9674	1.1734	1.0112	27
34	1.1386	2.0912	1.1497	2.0266	1.1614	1.9664	1.1737	1.0102	26
35	1.1388	2.0901	1.1499	2.0256	1.1616	1.9654	1.1739	1.0093	25
36	1.1390	2.0890	1.1501	2.0245	1.1618	1.9645	1.1741	1.0084	24
37	1.1391	2.0879	1.1503	2.0235	1.1620	1.9635	1.1743	1.0075	23
38	1.1393	2.0868	1.1505	2.0224	1.1622	1.9625	1.1745	1.0066	22
39	1.1395	2.0857	1.1507	2.0214	1.1624	1.9616	1.1747	1.0057	21
40	1.1397	2.0846	1.1508	2.0204	1.1626	1.9606	1.1749	1.0048	20
41	1.1399	2.0835	1.1510	2.0194	1.1628	1.9596	1.1751	1.0039	19
42	1.1401	2.0824	1.1512	2.0183	1.1630	1.9587	1.1753	1.0030	18
43	1.1402	2.0812	1.1514	2.0173	1.1632	1.9577	1.1756	1.0021	17
44	1.1404	2.0801	1.1516	2.0163	1.1634	1.9568	1.1758	1.0013	16
45	1.1406	2.0790	1.1518	2.0152	1.1636	1.9558	1.1760	1.0004	15
46	1.1408	2.0779	1.1520	2.0142	1.1638	1.9549	1.1762	1.9995	14
47	1.1410	2.0768	1.1522	2.0132	1.1640	1.9539	1.1764	1.9986	13
48	1.1411	2.0757	1.1524	2.0122	1.1642	1.9530	1.1766	1.9977	12
49	1.1413	2.0746	1.1526	2.0111	1.1644	1.9520	1.1768	1.9968	11
50	1.1415	2.0735	1.1528	2.0101	1.1646	1.9510	1.1770	1.9959	10
51	1.1417	2.0725	1.1530	2.0091	1.1648	1.9501	1.1772	1.9950	9
52	1.1419	2.0714	1.1531	2.0081	1.1650	1.9491	1.1775	1.9941	8
53	1.1421	2.0703	1.1533	2.0071	1.1652	1.9482	1.1777	1.9932	7
54	1.1422	2.0692	1.1535	2.0061	1.1654	1.9473	1.1779	1.9924	6
55	1.1424	2.0681	1.1537	2.0050	1.1656	1.9463	1.1781	1.9915	5
56	1.1426	2.0670	1.1539	2.0040	1.1658	1.9454	1.1783	1.9906	4
57	1.1428	2.0659	1.1541	2.0030	1.1660	1.9444	1.1785	1.9897	3
58	1.1430	2.0648	1.1543	2.0020	1.1662	1.9435	1.1787	1.9888	2
59	1.1432	2.0637	1.1545	2.0010	1.1664	1.9425	1.1790	1.9879	1
60	1.1433	2.0627	1.1547	2.0000	1.1666	1.9416	1.1792	1.9871	0

Co-SEC. SEC. Co-SEC. SEC. Co-SEC. SEC. Co-SEC. SEC. Co-SEC. SEC.

61°

60°

59°

58°

'	32°		33°		34°		35°		'
	SEC.	CO-SEC.	SEC.	CO-SEC.	SEC.	CO-SEC.	SEC.	CO-SEC.	
0	1.1792	1.8871	1.1924	1.8361	1.2062	1.7883	1.2208	1.7434	60
1	1.1794	1.8862	1.1926	1.8352	1.2064	1.7875	1.2210	1.7427	59
2	1.1796	1.8853	1.1928	1.8344	1.2067	1.7867	1.2213	1.7420	58
3	1.1798	1.8844	1.1930	1.8336	1.2069	1.7860	1.2215	1.7413	57
4	1.1800	1.8836	1.1933	1.8328	1.2072	1.7852	1.2218	1.7405	56
5	1.1802	1.8827	1.1935	1.8320	1.2074	1.7844	1.2220	1.7398	55
6	1.1805	1.8818	1.1937	1.8311	1.2076	1.7837	1.2223	1.7391	54
7	1.1807	1.8809	1.1939	1.8303	1.2079	1.7829	1.2225	1.7384	53
8	1.1809	1.8801	1.1942	1.8295	1.2081	1.7821	1.2228	1.7377	52
9	1.1811	1.8792	1.1944	1.8287	1.2083	1.7814	1.2230	1.7369	51
10	1.1813	1.8783	1.1946	1.8279	1.2086	1.7806	1.2233	1.7362	50
11	1.1815	1.8775	1.1948	1.8271	1.2088	1.7798	1.2235	1.7355	49
12	1.1818	1.8766	1.1951	1.8263	1.2091	1.7791	1.2238	1.7348	48
13	1.1820	1.8757	1.1953	1.8255	1.2093	1.7783	1.2240	1.7341	47
14	1.1822	1.8749	1.1955	1.8246	1.2095	1.7776	1.2243	1.7334	46
15	1.1824	1.8740	1.1958	1.8238	1.2098	1.7768	1.2245	1.7327	45
16	1.1826	1.8731	1.1960	1.8230	1.2100	1.7760	1.2248	1.7319	44
17	1.1828	1.8723	1.1962	1.8222	1.2103	1.7753	1.2250	1.7312	43
18	1.1831	1.8714	1.1964	1.8214	1.2105	1.7745	1.2253	1.7305	42
19	1.1833	1.8706	1.1967	1.8206	1.2107	1.7738	1.2255	1.7298	41
20	1.1835	1.8697	1.1969	1.8198	1.2110	1.7730	1.2258	1.7291	40
21	1.1837	1.8688	1.1971	1.8190	1.2112	1.7722	1.2260	1.7284	39
22	1.1839	1.8680	1.1974	1.8182	1.2115	1.7715	1.2263	1.7277	38
23	1.1841	1.8671	1.1976	1.8174	1.2117	1.7708	1.2265	1.7270	37
24	1.1844	1.8663	1.1978	1.8166	1.2119	1.7700	1.2268	1.7263	36
25	1.1846	1.8654	1.1980	1.8158	1.2122	1.7693	1.2270	1.7256	35
26	1.1848	1.8646	1.1983	1.8150	1.2124	1.7685	1.2273	1.7249	34
27	1.1850	1.8637	1.1985	1.8142	1.2127	1.7678	1.2276	1.7242	33
28	1.1852	1.8629	1.1987	1.8134	1.2129	1.7670	1.2278	1.7234	32
29	1.1855	1.8620	1.1990	1.8126	1.2132	1.7663	1.2281	1.7227	31
30	1.1857	1.8611	1.1992	1.8118	1.2134	1.7655	1.2283	1.7220	30
31	1.1859	1.8603	1.1994	1.8110	1.2136	1.7648	1.2286	1.7213	29
32	1.1861	1.8595	1.1997	1.8102	1.2139	1.7640	1.2288	1.7206	28
33	1.1863	1.8586	1.1999	1.8094	1.2141	1.7633	1.2291	1.7199	27
34	1.1866	1.8578	1.2001	1.8086	1.2144	1.7625	1.2293	1.7192	26
35	1.1868	1.8569	1.2004	1.8078	1.2146	1.7618	1.2296	1.7185	25
36	1.1870	1.8561	1.2006	1.8070	1.2149	1.7610	1.2298	1.7178	24
37	1.1872	1.8552	1.2008	1.8062	1.2151	1.7603	1.2301	1.7171	23
38	1.1874	1.8544	1.2010	1.8054	1.2153	1.7596	1.2304	1.7164	22
39	1.1877	1.8535	1.2013	1.8047	1.2156	1.7588	1.2306	1.7157	21
40	1.1879	1.8527	1.2015	1.8039	1.2158	1.7581	1.2309	1.7151	20
41	1.1881	1.8519	1.2017	1.8031	1.2161	1.7573	1.2311	1.7144	19
42	1.1883	1.8510	1.2020	1.8023	1.2163	1.7566	1.2314	1.7137	18
43	1.1886	1.8502	1.2022	1.8015	1.2166	1.7559	1.2316	1.7130	17
44	1.1888	1.8493	1.2024	1.8007	1.2168	1.7551	1.2319	1.7123	16
45	1.1890	1.8485	1.2027	1.7999	1.2171	1.7544	1.2322	1.7116	15
46	1.1892	1.8477	1.2029	1.7992	1.2173	1.7537	1.2324	1.7109	14
47	1.1894	1.8468	1.2031	1.7984	1.2175	1.7529	1.2327	1.7102	13
48	1.1897	1.8460	1.2034	1.7976	1.2178	1.7522	1.2329	1.7095	12
49	1.1899	1.8452	1.2036	1.7968	1.2180	1.7514	1.2332	1.7088	11
50	1.1901	1.8443	1.2039	1.7960	1.2183	1.7507	1.2335	1.7081	10
51	1.1903	1.8435	1.2041	1.7953	1.2185	1.7500	1.2337	1.7075	9
52	1.1906	1.8427	1.2043	1.7945	1.2188	1.7493	1.2340	1.7068	8
53	1.1908	1.8418	1.2046	1.7937	1.2190	1.7485	1.2342	1.7061	7
54	1.1910	1.8410	1.2048	1.7929	1.2193	1.7478	1.2345	1.7054	6
55	1.1912	1.8402	1.2050	1.7921	1.2195	1.7471	1.2348	1.7047	5
56	1.1915	1.8394	1.2053	1.7914	1.2198	1.7463	1.2350	1.7040	4
57	1.1917	1.8385	1.2055	1.7906	1.2200	1.7456	1.2353	1.7033	3
58	1.1919	1.8377	1.2057	1.7898	1.2203	1.7449	1.2355	1.7027	2
59	1.1921	1.8369	1.2060	1.7891	1.2205	1.7442	1.2358	1.7020	1
60	1.1922	1.8361	1.2062	1.7883	1.2208	1.7434	1.2361	1.7013	0
'	CO-SEC.	SEC.	CO-SEC.	SEC.	CO-SEC.	SEC.	CO-SEC.	SEC.	'
	57°		58°		55°		54°		

NATURAL SECANTS

1625

'	36°		37°		38°		39°		'
	SEC.	CO-SEC.	SEC.	CO-SEC.	SEC.	CO-SEC.	SEC.	CO-SEC.	
0	1.2361	1.7013	1.2521	1.6616	1.2690	1.6243	1.2867	1.5890	60
1	1.2363	1.7006	1.2524	1.6610	1.2693	1.6237	1.2871	1.5884	59
2	1.2366	1.6999	1.2527	1.6603	1.2696	1.6231	1.2874	1.5879	58
3	1.2368	1.6993	1.2530	1.6597	1.2699	1.6224	1.2877	1.5873	57
4	1.2371	1.6986	1.2532	1.6591	1.2702	1.6218	1.2880	1.5867	56
5	1.2374	1.6979	1.2535	1.6584	1.2705	1.6212	1.2883	1.5862	55
6	1.2376	1.6972	1.2538	1.6578	1.2707	1.6206	1.2886	1.5856	54
7	1.2379	1.6965	1.2541	1.6572	1.2710	1.6200	1.2889	1.5850	53
8	1.2382	1.6959	1.2543	1.6565	1.2713	1.6194	1.2892	1.5845	52
9	1.2384	1.6952	1.2546	1.6559	1.2716	1.6188	1.2895	1.5839	51
10	1.2387	1.6945	1.2549	1.6552	1.2719	1.6182	1.2898	1.5833	50
11	1.2380	1.6938	1.2552	1.6546	1.2722	1.6176	1.2901	1.5828	49
12	1.2392	1.6932	1.2554	1.6540	1.2725	1.6170	1.2904	1.5822	48
13	1.2395	1.6925	1.2557	1.6533	1.2728	1.6164	1.2907	1.5816	47
14	1.2397	1.6918	1.2560	1.6527	1.2731	1.6159	1.2910	1.5811	46
15	1.2400	1.6912	1.2563	1.6521	1.2734	1.6153	1.2913	1.5805	45
16	1.2403	1.6905	1.2565	1.6514	1.2737	1.6147	1.2916	1.5799	44
17	1.2405	1.6898	1.2568	1.6508	1.2739	1.6141	1.2919	1.5794	43
18	1.2408	1.6891	1.2571	1.6502	1.2742	1.6135	1.2922	1.5788	42
19	1.2411	1.6885	1.2574	1.6496	1.2745	1.6129	1.2926	1.5783	41
20	1.2413	1.6878	1.2577	1.6489	1.2748	1.6123	1.2929	1.5777	40
21	1.2416	1.6871	1.2579	1.6483	1.2751	1.6117	1.2932	1.5771	39
22	1.2419	1.6865	1.2582	1.6477	1.2754	1.6111	1.2935	1.5766	38
23	1.2421	1.6858	1.2585	1.6470	1.2757	1.6105	1.2938	1.5760	37
24	1.2424	1.6851	1.2588	1.6464	1.2760	1.6099	1.2941	1.5755	36
25	1.2427	1.6845	1.2591	1.6458	1.2763	1.6093	1.2944	1.5749	35
26	1.2429	1.6838	1.2593	1.6452	1.2766	1.6087	1.2947	1.5743	34
27	1.2432	1.6831	1.2596	1.6445	1.2769	1.6081	1.2950	1.5738	33
28	1.2435	1.6825	1.2599	1.6439	1.2772	1.6075	1.2953	1.5732	32
29	1.2437	1.6818	1.2602	1.6433	1.2775	1.6070	1.2956	1.5727	31
30	1.2440	1.6812	1.2605	1.6427	1.2778	1.6064	1.2960	1.5721	30
31	1.2443	1.6805	1.2607	1.6420	1.2781	1.6058	1.2963	1.5716	29
32	1.2445	1.6798	1.2610	1.6414	1.2784	1.6052	1.2966	1.5710	28
33	1.2448	1.6792	1.2613	1.6408	1.2787	1.6046	1.2969	1.5705	27
34	1.2451	1.6785	1.2616	1.6402	1.2790	1.6040	1.2972	1.5699	26
35	1.2453	1.6779	1.2619	1.6396	1.2793	1.6034	1.2975	1.5694	25
36	1.2456	1.6772	1.2622	1.6390	1.2795	1.6029	1.2978	1.5688	24
37	1.2459	1.6766	1.2624	1.6383	1.2798	1.6023	1.2981	1.5683	23
38	1.2461	1.6759	1.2627	1.6377	1.2801	1.6017	1.2985	1.5677	22
39	1.2464	1.6752	1.2630	1.6371	1.2804	1.6011	1.2988	1.5672	21
40	1.2467	1.6746	1.2633	1.6365	1.2807	1.6005	1.2991	1.5666	20
41	1.2470	1.6739	1.2636	1.6359	1.2810	1.6000	1.2994	1.5661	19
42	1.2472	1.6733	1.2639	1.6352	1.2813	1.5994	1.2997	1.5655	18
43	1.2475	1.6726	1.2641	1.6346	1.2816	1.5988	1.3000	1.5650	17
44	1.2478	1.6720	1.2644	1.6340	1.2819	1.5982	1.3003	1.5644	16
45	1.2480	1.6713	1.2647	1.6334	1.2822	1.5976	1.3006	1.5639	15
46	1.2483	1.6707	1.2650	1.6328	1.2825	1.5971	1.3010	1.5633	14
47	1.2486	1.6700	1.2653	1.6322	1.2828	1.5965	1.3013	1.5628	13
48	1.2488	1.6694	1.2656	1.6316	1.2831	1.5959	1.3016	1.5622	12
49	1.2490	1.6687	1.2659	1.6309	1.2834	1.5953	1.3019	1.5617	11
50	1.2494	1.6681	1.2661	1.6303	1.2837	1.5947	1.3022	1.5611	10
51	1.2497	1.6674	1.2664	1.6297	1.2840	1.5942	1.3025	1.5606	9
52	1.2499	1.6668	1.2667	1.6291	1.2843	1.5936	1.3029	1.5600	8
53	1.2502	1.6661	1.2670	1.6285	1.2846	1.5930	1.3032	1.5595	7
54	1.2505	1.6655	1.2673	1.6279	1.2849	1.5924	1.3035	1.5590	6
55	1.2508	1.6648	1.2676	1.6273	1.2852	1.5919	1.3038	1.5584	5
56	1.2510	1.6642	1.2679	1.6267	1.2855	1.5913	1.3041	1.5579	4
57	1.2513	1.6636	1.2681	1.6261	1.2858	1.5907	1.3044	1.5573	3
58	1.2516	1.6629	1.2684	1.6255	1.2861	1.5901	1.3048	1.5568	2
59	1.2519	1.6623	1.2687	1.6249	1.2864	1.5896	1.3051	1.5563	1
60	1.2521	1.6616	1.2690	1.6243	1.2867	1.5890	1.3054	1.5557	0
'	CO-SEC.	SEC.	CO-SEC.	SEC.	CO-SEC.	SEC.	CO-SEC.	SEC.	'
	53°		52°		51°		50°		

'	40°		41°		42°		43°		'
	SEC.	CO-SEC.	SEC.	CO-SEC.	SEC.	CO-SEC.	SEC.	CO-SEC.	
0	1.3054	1.5557	1.3250	1.5242	1.3456	1.4945	1.3673	1.4663	60
1	1.3057	1.5552	1.3253	1.5237	1.3460	1.4940	1.3677	1.4658	59
2	1.3060	1.5546	1.3257	1.5232	1.3463	1.4935	1.3681	1.4654	58
3	1.3064	1.5541	1.3260	1.5227	1.3467	1.4930	1.3684	1.4649	57
4	1.3067	1.5536	1.3263	1.5222	1.3470	1.4925	1.3688	1.4644	56
5	1.3070	1.5530	1.3267	1.5217	1.3474	1.4921	1.3692	1.4640	55
6	1.3073	1.5525	1.3270	1.5212	1.3477	1.4916	1.3695	1.4635	54
7	1.3076	1.5520	1.3274	1.5207	1.3481	1.4911	1.3699	1.4631	53
8	1.3080	1.5514	1.3277	1.5202	1.3485	1.4906	1.3703	1.4626	52
9	1.3083	1.5509	1.3280	1.5197	1.3488	1.4901	1.3707	1.4622	51
10	1.3086	1.5503	1.3284	1.5192	1.3492	1.4897	1.3710	1.4617	50
11	1.3089	1.5498	1.3287	1.5187	1.3495	1.4892	1.3714	1.4613	49
12	1.3092	1.5493	1.3290	1.5182	1.3499	1.4887	1.3718	1.4608	48
13	1.3096	1.5487	1.3294	1.5177	1.3502	1.4882	1.3722	1.4604	47
14	1.3099	1.5482	1.3297	1.5171	1.3506	1.4877	1.3725	1.4599	46
15	1.3102	1.5477	1.3301	1.5166	1.3509	1.4873	1.3729	1.4595	45
16	1.3105	1.5471	1.3304	1.5161	1.3513	1.4868	1.3733	1.4590	44
17	1.3109	1.5466	1.3307	1.5156	1.3517	1.4863	1.3737	1.4586	43
18	1.3112	1.5461	1.3311	1.5151	1.3520	1.4858	1.3740	1.4581	42
19	1.3115	1.5456	1.3314	1.5146	1.3524	1.4854	1.3744	1.4577	41
20	1.3118	1.5450	1.3318	1.5141	1.3527	1.4849	1.3748	1.4572	40
21	1.3121	1.5445	1.3321	1.5136	1.3531	1.4844	1.3752	1.4568	39
22	1.3125	1.5440	1.3324	1.5131	1.3534	1.4839	1.3756	1.4563	38
23	1.3128	1.5434	1.3328	1.5126	1.3538	1.4835	1.3759	1.4559	37
24	1.3131	1.5429	1.3331	1.5121	1.3542	1.4830	1.3763	1.4554	36
25	1.3134	1.5424	1.3335	1.5116	1.3545	1.4825	1.3767	1.4550	35
26	1.3138	1.5419	1.3338	1.5111	1.3549	1.4821	1.3771	1.4545	34
27	1.3141	1.5413	1.3342	1.5106	1.3552	1.4816	1.3774	1.4541	33
28	1.3144	1.5408	1.3345	1.5101	1.3556	1.4811	1.3778	1.4536	32
29	1.3148	1.5403	1.3348	1.5096	1.3560	1.4806	1.3782	1.4532	31
30	1.3151	1.5398	1.3352	1.5092	1.3563	1.4802	1.3786	1.4527	30
31	1.3154	1.5392	1.3355	1.5087	1.3567	1.4797	1.3790	1.4523	29
32	1.3157	1.5387	1.3359	1.5082	1.3571	1.4792	1.3794	1.4518	28
33	1.3161	1.5382	1.3362	1.5077	1.3574	1.4788	1.3797	1.4514	27
34	1.3164	1.5377	1.3366	1.5072	1.3578	1.4783	1.3801	1.4510	26
35	1.3167	1.5371	1.3369	1.5067	1.3581	1.4778	1.3805	1.4505	25
36	1.3170	1.5366	1.3372	1.5062	1.3585	1.4774	1.3809	1.4501	24
37	1.3174	1.5361	1.3376	1.5057	1.3589	1.4769	1.3813	1.4496	23
38	1.3177	1.5356	1.3379	1.5052	1.3592	1.4764	1.3816	1.4492	22
39	1.3180	1.5351	1.3383	1.5047	1.3596	1.4760	1.3820	1.4487	21
40	1.3184	1.5345	1.3386	1.5042	1.3600	1.4755	1.3824	1.4483	20
41	1.3187	1.5340	1.3390	1.5037	1.3603	1.4750	1.3828	1.4479	19
42	1.3190	1.5335	1.3393	1.5032	1.3607	1.4746	1.3832	1.4474	18
43	1.3193	1.5330	1.3397	1.5027	1.3611	1.4741	1.3836	1.4470	17
44	1.3197	1.5325	1.3400	1.5022	1.3614	1.4736	1.3839	1.4465	16
45	1.3200	1.5319	1.3404	1.5018	1.3618	1.4732	1.3843	1.4461	15
46	1.3203	1.5314	1.3407	1.5013	1.3622	1.4727	1.3847	1.4457	14
47	1.3207	1.5309	1.3411	1.5008	1.3625	1.4723	1.3851	1.4452	13
48	1.3210	1.5304	1.3414	1.5003	1.3629	1.4718	1.3855	1.4448	12
49	1.3213	1.5299	1.3418	1.4998	1.3633	1.4713	1.3859	1.4443	11
50	1.3217	1.5294	1.3421	1.4993	1.3636	1.4709	1.3863	1.4439	10
51	1.3220	1.5289	1.3425	1.4988	1.3640	1.4704	1.3867	1.4435	9
52	1.3223	1.5283	1.3428	1.4983	1.3644	1.4699	1.3870	1.4430	8
53	1.3227	1.5278	1.3432	1.4979	1.3647	1.4695	1.3874	1.4426	7
54	1.3230	1.5273	1.3435	1.4974	1.3651	1.4690	1.3878	1.4422	6
55	1.3233	1.5268	1.3439	1.4969	1.3655	1.4686	1.3882	1.4417	5
56	1.3237	1.5263	1.3442	1.4964	1.3658	1.4681	1.3886	1.4413	4
57	1.3240	1.5258	1.3446	1.4959	1.3662	1.4676	1.3890	1.4408	3
58	1.3243	1.5253	1.3449	1.4954	1.3666	1.4672	1.3894	1.4404	2
59	1.3247	1.5248	1.3453	1.4949	1.3669	1.4667	1.3898	1.4400	1
60	1.3250	1.5242	1.3456	1.4945	1.3673	1.4663	1.3902	1.4395	0
'	CO-SEC.	SEC.	CO-SEC.	SEC.	CO-SEC.	SEC.	CO-SEC.	SEC.	'
	49°		48°		47°		46°		

NATURAL SECANTS

1627

44°				44°				44°			
'	SEC.	CO-SEC.	'	'	SEC.	CO-SEC.	'	'	SEC.	CO-SEC.	'
0	1.3902	1.4305	60	21	1.3984	1.4305	39	41	1.4065	1.4221	19
1	1.3905	1.4301	59	22	1.3988	1.4301	38	42	1.4069	1.4217	18
2	1.3909	1.4287	58	23	1.3992	1.4297	37	43	1.4073	1.4212	17
3	1.3913	1.4282	57	24	1.3996	1.4292	36	44	1.4077	1.4208	16
4	1.3917	1.4278	56	25	1.4000	1.4288	35	45	1.4081	1.4204	15
5	1.3921	1.4274	55	26	1.4004	1.4284	34	46	1.4085	1.4200	14
6	1.3925	1.4270	54	27	1.4008	1.4280	33	47	1.4089	1.4196	13
7	1.3929	1.4265	53	28	1.4012	1.4276	32	48	1.4093	1.4192	12
8	1.3933	1.4261	52	29	1.4016	1.4271	31	49	1.4097	1.4188	11
9	1.3937	1.4257	51	30	1.4020	1.4267	30	50	1.4101	1.4183	10
10	1.3941	1.4252	50	31	1.4024	1.4263	29	51	1.4105	1.4179	9
11	1.3945	1.4248	49	32	1.4028	1.4259	28	52	1.4109	1.4175	8
12	1.3949	1.4244	48	33	1.4032	1.4254	27	53	1.4113	1.4171	7
13	1.3953	1.4239	47	34	1.4036	1.4250	26	54	1.4117	1.4167	6
14	1.3957	1.4235	46	35	1.4040	1.4246	25	55	1.4122	1.4163	5
15	1.3960	1.4231	45	36	1.4044	1.4242	24	56	1.4126	1.4159	4
16	1.3964	1.4227	44	37	1.4048	1.4238	23	57	1.4130	1.4154	3
17	1.3968	1.4222	43	38	1.4052	1.4233	22	58	1.4134	1.4150	2
18	1.3972	1.4218	42	39	1.4056	1.4229	21	59	1.4138	1.4146	1
19	1.3976	1.4214	41	40	1.4060	1.4225	20	60	1.4142	1.4142	0
20	1.3980	1.4210	40								
	CO-SEC.	SEC.			CO-SEC.	SEC.			CO-SEC.	SEC.	
	45°				45°				45°		

TABLE OF LOGARITHMIC NUMBERS

N.	0	1	2	3	4	5	6	7	8	9	Diff.
100	000000	0434	0808	1301	1734	2166	2598	3029	3461	3891	432
101	4321	4751	5181	5609	6038	6466	6894	7321	7748	8174	428
102	8600	9026	9451	9876	*0300	*0724	*1147	*1570	*1993	*2415	424
103	012837	3259	3680	4100	4521	4940	5360	5779	6197	6616	420
104	7033	7451	7868	8284	8700	9116	9532	9947	*0361	*0775	416
105	021189	1603	2016	2428	2841	3252	3664	4075	4486	4896	412
106	5306	5715	6125	6533	6942	7350	7757	8164	8571	8978	408
107	9384	9789	*0195	*0600	*1004	*1408	*1812	*2216	*2619	*3021	404
108	033424	3826	4227	4628	5029	5430	5830	6230	6629	7028	400
109	7426	7825	8223	8620	9017	9414	9811	*0207	*0602	*0998	397
N.	Diff.	1	2	3	4	5	6	7	8	9	Diff.
PROPORTIONAL PARTS	434	43	87	130	174	217	260	304	347	391	434
	433	43	87	130	173	217	260	303	346	390	433
	432	43	86	130	173	216	259	302	346	389	432
	431	43	86	129	172	216	259	302	345	388	431
	430	43	86	129	172	215	258	301	344	387	430
	429	43	86	129	172	215	257	300	343	386	429
	428	43	86	128	171	214	257	300	342	385	428
	427	43	85	128	171	214	256	299	342	384	427
	426	43	85	128	170	213	256	298	341	383	426
	425	43	85	128	170	213	255	298	340	383	425
	424	42	85	127	170	212	254	297	339	382	424
	423	42	85	127	169	212	254	296	338	381	423
	422	42	84	127	169	211	253	295	338	380	422
	421	42	84	126	168	211	253	295	337	379	421
	420	42	84	126	168	210	252	294	336	378	420
	419	42	84	126	168	210	251	293	335	377	419
	418	42	84	125	167	209	251	293	334	376	418
	417	42	83	125	167	209	250	292	334	375	417
	416	42	83	125	166	208	250	291	333	374	416
	415	42	83	125	166	208	249	291	332	374	415
	414	41	83	124	166	207	248	290	331	373	414
	413	41	83	124	165	207	248	289	330	372	413
	412	41	82	124	165	206	247	288	330	371	412
	411	41	82	123	164	206	247	287	329	370	411
	410	41	82	123	164	205	246	287	328	369	410
	409	41	82	123	164	205	245	286	327	368	409
	408	41	82	122	163	204	245	286	326	367	408
	407	41	81	122	163	204	244	285	326	366	407
	406	41	81	122	162	203	244	284	325	365	406
	405	41	81	122	162	203	243	284	324	365	405
	404	40	81	121	162	202	242	283	323	364	404
	403	40	81	121	161	202	242	282	322	363	403
	402	40	80	121	161	201	241	281	322	362	402
	401	40	80	120	160	201	241	281	321	361	401
	400	40	80	120	160	200	240	280	320	360	400
	399	40	80	120	160	200	239	279	319	359	399
	398	40	80	119	159	199	239	279	318	358	398
	397	40	79	119	159	199	238	278	318	357	397
	396	40	79	119	158	198	238	277	317	356	396
	395	40	79	119	158	198	237	277	316	356	395
394	39	79	118	158	197	236	276	315	355	394	
393	39	79	118	157	197	236	275	314	354	393	
392	39	78	118	157	196	235	274	314	353	392	
391	39	78	117	156	196	235	274	313	352	391	
390	39	78	117	156	195	234	273	312	351	390	
389	39	78	117	156	195	233	272	311	350	389	
388	39	78	116	155	194	233	272	310	349	388	
	Diff.	1	2	3	4	5	6	7	8	9	Diff.

* From Allen's "Field and Office Tables." Copyright, 1903, 1914, by C. F. Allen.

N.	0	1	2	3	4	5	6	7	8	9	Diff.
110	041393	1787	2182	2576	2969	3362	3755	4148	4540	4932	393
111	5323	5714	6105	6495	6885	7275	7664	8053	8442	8830	390
112	9218	9606	9993	*0380	*0766	*1153	*1538	*1924	*2309	*2694	386
113	053078	3463	3846	4230	4613	4996	5378	5760	6142	6524	383
114	6905	7286	7666	8046	8426	8805	9185	9563	9942	*0320	379
115	060698	1075	1452	1829	2206	2582	2958	3333	3709	4083	376
116	4458	4832	5206	5580	5953	6326	6699	7071	7443	7815	373
117	8186	8557	8928	9298	9668	*0038	*0407	*0776	*1145	*1514	370
118	071882	2250	2617	2985	3352	3718	4085	4451	4816	5182	366
119	5547	5912	6276	6640	7004	7368	7731	8094	8457	8819	363
120	079181	9543	9904	*0266	*0626	*0987	*1347	*1707	*2067	*2426	360
121	082785	3144	3503	3861	4219	4576	4934	5291	5647	6004	357
122	6360	6716	7071	7426	7781	8136	8490	8845	9198	9552	355
123	9905	*0258	*0611	*0963	*1315	*1667	*2018	*2370	*2721	*3071	352
124	093422	3772	4122	4471	4820	5169	5518	5866	6215	6562	349

N.	Diff.	1	2	3	4	5	6	7	8	9	Diff.
PROPORTIONAL PARTS	387	39	77	116	155	194	232	271	310	348	387
	386	39	77	116	154	193	232	270	309	347	386
	385	39	77	116	154	193	231	270	308	347	385
	384	38	77	115	154	192	230	269	307	346	384
	383	38	77	115	153	192	230	268	306	345	383
	382	38	76	115	153	191	229	267	306	344	382
	381	38	76	114	152	191	229	267	305	343	381
	380	38	76	114	152	190	228	266	304	342	380
	379	38	76	114	152	190	227	265	303	341	379
	378	38	76	113	151	189	227	265	302	340	378
	377	38	75	113	151	189	226	264	302	339	377
	376	38	75	113	150	188	226	263	301	338	376
	375	38	75	113	150	188	225	263	300	338	375
	374	37	75	112	150	187	224	262	299	337	374
	373	37	75	112	149	187	224	261	298	336	373
	372	37	74	112	149	186	223	260	298	335	372
	371	37	74	111	148	186	223	260	297	334	371
	370	37	74	111	148	185	222	259	296	333	370
	369	37	74	111	148	185	221	258	295	332	369
	368	37	74	110	147	184	221	258	294	331	368
	367	37	73	110	147	184	220	257	294	330	367
	366	37	73	110	146	183	220	256	293	329	366
	365	37	73	110	146	183	219	256	292	329	365
	364	36	73	109	146	182	218	255	291	328	364
	363	36	73	109	145	182	218	254	290	327	363
	362	36	72	109	145	181	217	253	290	326	362
	361	36	72	108	144	181	217	253	289	325	361
	360	36	72	108	144	180	216	252	288	324	360
	359	36	72	108	144	180	215	251	287	323	359
	358	36	72	107	143	179	215	251	286	322	358
	357	36	71	107	143	179	214	250	286	321	357
	356	36	71	107	142	178	214	249	285	320	356
	355	36	71	107	142	178	213	249	284	320	355
	354	35	71	106	142	177	212	248	283	319	354
	353	35	71	106	141	177	212	247	282	318	353
	352	35	70	106	141	176	211	246	282	317	352
351	35	70	105	140	176	211	246	281	316	351	
350	35	70	105	140	175	210	245	280	315	350	
349	35	70	105	140	175	209	244	279	314	349	
348	35	70	104	139	174	209	244	278	313	348	
347	35	69	104	139	174	208	243	278	312	347	
Diff.		1	2	3	4	5	6	7	8	9	Diff.

N.	0	1	2	3	4	5	6	7	8	9	Diff.
125	066910	7257	7604	7951	8298	8644	8990	9335	9681	*0026	346
126	100371	0715	1059	1403	1747	2091	2434	2777	3119	3462	343
127	3804	4146	4487	4828	5169	5510	5851	6191	6531	6871	341
128	7210	7549	7888	8227	8565	8903	9241	9579	9916	*0253	338
129	110590	0926	1263	1599	1934	2270	2605	2940	3275	3609	335
130	113943	4277	4611	4944	5278	5611	5943	6276	6608	6940	333
131	7271	7603	7934	8265	8595	8926	9256	9586	9915	*0245	330
132	120574	0903	1231	1560	1888	2216	2544	2871	3198	3525	328
133	3852	4178	4504	4830	5156	5481	5806	6131	6456	6781	325
134	7105	7429	7753	8076	8399	8722	9045	9368	9690	*0012	323
135	130334	0655	0977	1298	1619	1939	2260	2580	2900	3219	321
136	3539	3858	4177	4496	4814	5133	5451	5769	6086	6403	318
137	6721	7037	7354	7671	7987	8303	8618	8934	9249	9564	316
138	9879	*0194	*0508	*0822	*1136	*1450	*1763	*2076	*2389	*2702	314
139	143015	3327	3639	3951	4263	4574	4885	5196	5507	5818	311

N.	Diff.	1	2	3	4	5	6	7	8	9	Diff.
	347	35	69	104	139	174	208	243	278	312	347
	346	35	69	104	138	173	208	242	277	311	346
	345	35	69	104	138	173	207	242	276	311	345
	344	34	69	103	138	172	206	241	275	310	344
	343	34	69	103	137	172	206	240	274	309	343
	342	34	68	103	137	171	205	239	274	308	342
	341	34	68	102	136	171	205	239	273	307	341
	340	34	68	102	136	170	204	238	272	306	340
	339	34	68	102	136	170	203	237	271	305	339
	338	34	68	101	135	169	203	237	270	304	338
	337	34	67	101	135	169	202	236	270	303	337
	336	34	67	101	134	168	202	235	269	302	336
	335	34	67	101	134	168	201	235	268	302	335
	334	33	67	100	134	167	200	234	267	301	334
	333	33	67	100	133	167	200	233	266	300	333
	332	33	66	100	133	166	199	232	266	299	332
	331	33	66	99	132	166	199	232	265	298	331
	330	33	66	99	132	165	198	231	264	297	330
	329	33	66	99	132	165	197	230	263	296	329
	328	33	66	98	131	164	197	230	262	295	328
	327	33	65	98	131	164	196	229	262	294	327
	326	33	65	98	130	163	196	229	261	293	326
	325	33	65	98	130	163	195	228	260	293	325
	324	32	65	97	130	162	194	227	259	292	324
	323	32	65	97	129	162	194	226	258	291	323
	322	32	64	97	129	161	193	225	258	290	322
	321	32	64	96	128	161	193	225	257	289	321
	320	32	64	96	128	160	192	224	256	288	320
	319	32	64	96	128	160	191	223	255	287	319
	318	32	64	95	127	159	191	223	254	286	318
	317	32	63	95	127	159	190	222	254	285	317
	316	32	63	95	126	158	190	221	253	284	316
	315	32	63	95	126	158	189	221	252	284	315
	314	31	63	94	126	157	188	220	251	283	314
	313	31	63	94	125	157	188	219	250	282	313
	312	31	62	94	125	156	187	218	250	281	312
	311	31	62	93	124	156	187	218	249	280	311
	310	31	62	93	124	155	186	217	248	279	310
	309	31	62	93	124	155	185	216	247	278	309
	308	31	62	92	123	154	185	216	246	277	308
	307	31	61	92	123	154	184	215	246	276	307

N.	0	1	2	3	4	5	6	7	8	9	Diff.
140	146128	6438	6748	7058	7367	7676	7985	8294	8603	8911	309
141	9219	9527	9835	*0142	*0449	*0756	*1063	*1370	*1676	*1982	307
142	152288	2594	2900	3205	3510	3815	4120	4424	4728	5032	305
143	5336	5640	5943	6246	6549	6852	7154	7457	7759	8061	303
144	8362	8664	8965	9266	9567	9868	*0168	*0469	*0769	*1068	301
145	161368	1667	1967	2266	2564	2863	3161	3460	3758	4055	299
146	4353	4650	4947	5244	5541	5838	6134	6430	6726	7022	297
147	7317	7613	7908	8203	8497	8792	9086	9380	9674	9968	295
148	170262	0555	0848	1141	1434	1726	2019	2311	2603	2895	293
149	3186	3478	3769	4060	4351	4641	4932	5222	5512	5802	291
150	176091	6381	6670	6959	7248	7536	7825	8113	8401	8689	289
151	8977	9264	9552	9839	*0126	*0413	*0699	*0986	*1272	*1558	287
152	181844	2129	2415	2700	2985	3270	3555	3839	4123	4407	285
153	4691	4975	5259	5542	5825	6108	6391	6674	6956	7239	283
154	7521	7803	8084	8366	8647	8928	9209	9490	9771	*0051	281
155	190332	0612	0892	1171	1451	1730	2010	2289	2567	2846	279
156	3125	3403	3681	3959	4237	4514	4792	5069	5346	5623	278
157	5900	6176	6453	6729	7005	7281	7556	7832	8107	8382	276
158	8657	8932	9206	9481	9755	*0029	*0303	*0577	*0850	*1124	274
159	201397	1670	1943	2216	2488	2761	3033	3305	3577	3848	272

N.	Diff.	1	2	3	4	5	6	7	8	9	Diff.
	306	31	61	92	122	153	184	214	245	275	306
	305	31	61	92	122	153	183	214	244	275	305
	304	30	61	91	122	152	182	213	243	274	304
	303	30	61	91	121	152	182	212	242	273	303
	302	30	60	91	121	151	181	211	242	272	302
	301	30	60	90	120	151	181	211	241	271	301
	300	30	60	90	120	150	180	210	240	270	300
	299	30	60	90	120	150	179	209	239	269	299
	298	30	60	89	119	149	179	209	238	268	298
	297	30	59	89	119	149	178	208	238	267	297
	296	30	59	89	118	148	178	207	237	266	296
	295	30	59	89	118	148	177	207	236	266	295
	294	29	59	88	118	147	177	206	235	265	294
	293	29	59	88	117	147	176	205	234	264	293
	292	29	58	88	117	146	175	204	234	263	292
	291	29	58	87	116	146	175	204	233	262	291
	290	29	58	87	116	145	174	203	232	261	290
	289	29	58	87	116	145	173	202	231	260	289
	288	29	58	86	115	144	173	202	230	259	288
	287	29	57	86	115	144	172	201	230	258	287
	286	29	57	86	114	143	172	200	229	257	286
	285	29	57	86	114	143	171	200	228	257	285
	284	28	57	85	114	142	170	199	227	256	284
	283	28	57	85	113	142	170	198	226	255	283
	282	28	56	85	113	141	169	197	226	254	282
	281	28	56	84	112	141	169	197	225	253	281
	280	28	56	84	112	140	168	196	224	252	280
	279	28	56	84	112	140	167	195	223	251	279
	278	28	56	83	111	139	167	195	222	250	278
	277	28	55	83	111	139	166	194	222	249	277
	276	28	55	83	110	138	166	193	221	248	276
	275	28	55	83	110	138	165	193	220	248	275
	274	27	55	82	110	137	164	192	219	247	274
	273	27	55	82	109	137	164	191	218	246	273
	272	27	54	82	109	136	163	190	218	245	272
	271	27	54	81	108	136	163	190	217	244	271
	Diff.	1	2	3	4	5	6	7	8	9	Diff.

PROPORTIONAL PARTS

N.	0	1	2	3	4	5	6	7	8	9	Diff.
160	204120	4391	4663	4934	5204	5475	5746	6016	6286	6556	271
161	6826	7096	7365	7634	7904	8173	8441	8710	8979	9247	269
162	9515	9783	*0051	*0319	*0586	*0853	*1121	*1388	*1654	*1921	267
163	212188	2454	2720	2986	3252	3518	3783	4049	4314	4579	266
164	4844	5109	5373	5638	5902	6166	6430	6694	6957	7221	264
165	217484	7747	8010	8273	8536	8798	9060	9323	9585	9846	262
166	220108	0370	0631	0892	1153	1414	1675	1936	2196	2456	261
167	2716	2976	3236	3496	3755	4015	4274	4533	4792	5051	259
168	5309	5568	5826	6084	6342	6600	6858	7115	7372	7630	258
169	7887	8144	8400	8657	8913	9170	9426	9682	9938	*0193	256
170	230449	0704	0960	1215	1470	1724	1979	2234	2488	2742	255
171	2996	3250	3504	3757	4011	4264	4517	4770	5023	5276	253
172	5528	5781	6033	6285	6537	6789	7041	7292	7544	7795	252
173	8046	8297	8548	8799	9049	9299	9550	9800	*0050	*0300	250
174	240549	0799	1048	1297	1546	1795	2044	2293	2541	2790	249
175	243038	3266	3534	3782	4030	4277	4525	4772	5019	5266	248
176	5513	5759	6006	6252	6499	6745	6991	7237	7482	7728	246
177	7973	8219	8464	8709	8954	9198	9443	9687	9932	*0176	245
178	250420	0684	0928	1171	1415	1658	1901	2145	2388	2630	243
179	2853	3096	3338	3580	3822	4064	4306	4548	4790	5031	242

N.	Diff.	1	2	3	4	5	6	7	8	9	Diff.
	272	77	54	82	109	136	163	190	218	245	272
	271	27	54	81	108	136	163	190	217	244	271
	270	27	54	81	108	135	162	189	216	243	270
	269	27	54	81	108	135	161	188	215	242	269
	268	27	54	80	107	134	161	188	214	241	268
	267	27	53	80	107	134	160	187	214	240	267
	266	27	53	80	106	133	160	186	213	239	266
	265	27	53	80	106	133	159	186	212	239	265
	264	26	53	79	106	132	158	185	211	238	264
	263	26	53	79	105	132	158	184	210	237	263
	262	26	52	79	105	131	157	183	210	236	262
	261	26	52	78	104	131	157	183	209	235	261
	260	26	52	78	104	130	156	182	208	234	260
	259	26	52	78	104	130	155	181	207	233	259
	258	26	52	77	103	129	155	181	206	232	258
	257	26	51	77	103	129	154	180	206	231	257
	256	26	51	77	102	128	154	179	205	230	256
	255	26	51	77	102	128	153	179	204	230	255
	254	25	51	76	102	127	152	178	203	229	254
	253	25	51	76	101	127	152	177	202	228	253
	252	25	50	76	101	126	151	176	202	227	252
	251	25	50	75	100	126	151	176	201	226	251
	250	25	50	75	100	125	150	175	200	225	250
	249	25	50	75	100	125	149	174	199	224	249
	248	25	50	74	99	124	149	174	198	223	248
	247	25	49	74	99	124	148	173	198	222	247
	246	25	49	74	98	123	148	172	197	221	246
	245	25	49	74	98	123	147	172	196	221	245
	244	24	49	73	98	122	146	171	195	220	244
	243	24	49	73	97	122	146	170	194	219	243
	242	24	48	73	97	121	145	169	194	218	242
	241	24	48	72	96	121	145	169	193	217	241
	240	24	48	72	96	120	144	168	192	216	240
	Diff.	1	2	3	4	5	6	7	8	9	Diff.

PROPORTIONAL PARTS

N.	0	1	2	3	4	5	6	7	8	9	Diff.
180	255273	5514	5755	5996	6237	6477	6718	6958	7198	7439	241
181	7679	7918	8158	8398	8637	8877	9116	9355	9594	9833	239
182	260071	0310	0548	0787	1025	1263	1501	1739	1976	2214	238
183	2451	2688	2925	3162	3399	3636	3873	4109	4346	4582	237
184	4818	5054	5290	5525	5761	5996	6232	6467	6702	6937	235
185	267172	7406	7641	7875	8110	8344	8578	8812	9046	9279	234
186	9513	9746	9980	*0213	*0446	*0679	*0912	*1144	*1377	*1609	233
187	271842	2074	2306	2538	2770	3001	3233	3464	3696	3927	232
188	4158	4389	4620	4850	5081	5311	5542	5772	6002	6232	230
189	6462	6692	6921	7151	7380	7609	7838	8067	8296	8525	229
190	278754	8982	9211	9439	9667	9895	*0123	*0351	*0578	*0806	228
191	281033	1261	1488	1715	1942	2169	2396	2622	2849	3075	227
192	3301	3527	3753	3979	4205	4431	4656	4882	5107	5332	226
193	5557	5782	6007	6232	6456	6681	6905	7129	7354	7578	225
194	7802	8026	8249	8473	8696	8920	9143	9366	9589	9812	223
195	290035	0257	0480	0702	0925	1147	1369	1591	1813	2034	222
196	2256	2478	2699	2920	3141	3363	3584	3804	4025	4246	221
197	4466	4687	4907	5127	5347	5567	5787	6007	6226	6446	220
198	6665	6884	7104	7323	7542	7761	7979	8198	8416	8635	219
199	8853	9071	9289	9507	9725	9943	*0161	*0378	*0595	*0813	218
200	301010	1247	1464	1681	1898	2114	2331	2547	2764	2980	217
201	3106	3412	3628	3844	4059	4275	4491	4706	4921	5136	216
202	5351	5566	5781	5996	6211	6425	6639	6853	7068	7282	215
203	7496	7710	7924	8137	8351	8564	8778	8991	9204	9417	213
204	9630	9843	*0056	*0268	*0481	*0693	*0906	*1118	*1330	*1542	212

N.	Diff.	1	2	3	4	5	6	7	8	9	Diff.
239		21	48	72	96	120	143	167	191	215	239
238		24	48	71	95	119	143	167	190	214	238
237		24	47	71	95	119	142	166	190	213	237
236		24	47	71	94	118	142	165	189	212	236
235		24	47	71	94	118	141	165	188	212	235
234		23	47	70	94	117	140	164	187	211	234
233		23	47	70	93	117	140	163	186	210	233
232		23	46	70	93	116	139	162	186	209	232
231		23	46	69	92	116	139	162	185	208	231
230		23	46	69	92	115	138	161	184	207	230
229		23	46	69	92	115	137	160	183	206	229
228		23	46	68	91	114	137	160	182	205	228
227		23	45	68	91	114	136	159	182	204	227
226		23	45	68	90	113	136	158	181	203	226
225		23	45	68	90	113	135	158	180	203	225
224		22	45	67	90	112	134	157	179	202	224
223		22	45	67	89	112	134	156	178	201	223
222		22	44	67	89	111	133	155	178	200	222
221		22	44	66	88	111	133	155	177	199	221
220		22	44	66	88	110	132	154	176	198	220
219		22	44	66	88	110	131	153	175	197	219
218		22	44	65	87	109	131	153	174	196	218
217		22	43	65	87	109	130	152	174	195	217
216		22	43	65	86	108	130	151	173	194	216
215		22	43	65	86	108	129	151	172	194	215
214		21	43	64	86	107	128	150	171	193	214
213		21	43	64	85	107	128	149	170	192	213
212		21	42	64	85	106	127	148	170	191	212
Diff.		1	2	3	4	5	6	7	8	9	Diff.

PROPORTIONAL PARTS

N.	0	1	2	3	4	5	6	7	8	9	Diff.
205	311754	1066	2177	2389	2600	2812	3023	3234	3445	3656	211
206	3307	4078	4289	4499	4710	4920	5130	5340	5551	5760	210
207	5970	6180	6390	6599	6809	7018	7227	7436	7646	7854	209
208	8003	8272	8481	8689	8898	9106	9314	9522	9730	9938	208
209	320146	0354	0562	0769	0977	1184	1391	1598	1805	2012	207
210	322219	2426	2633	2839	3046	3252	3458	3665	3871	4077	206
211	4252	4488	4694	4899	5105	5310	5516	5721	5926	6131	205
212	6336	6541	6745	6950	7155	7359	7563	7767	7972	8176	204
213	8350	8533	8787	8991	9194	9398	9601	9805	*0008	*0211	203
214	330414	0617	0819	1022	1225	1427	1630	1832	2034	2236	202
215	332438	2640	2842	3044	3246	3447	3649	3850	4051	4253	202
216	4454	4655	4856	5057	5257	5458	5658	5859	6059	6260	201
217	6460	6660	6860	7060	7260	7459	7659	7858	8058	8257	200
218	8456	8656	8855	9054	9253	9451	9650	9849	*0047	*0246	199
219	340444	0642	0841	1039	1237	1435	1632	1830	2028	2225	198
220	342423	2620	2817	3014	3212	3409	3606	3802	3999	4196	197
221	4392	4589	4785	4981	5178	5374	5570	5766	5962	6157	196
222	6353	6549	6744	6939	7135	7330	7525	7720	7915	8110	195
223	8305	8500	8694	8889	9083	9278	9472	9666	9860	*0054	194
224	350248	0442	0636	0829	1023	1216	1410	1603	1796	1989	193
225	352183	2375	2568	2761	2954	3147	3339	3532	3724	3916	193
226	4108	4301	4493	4685	4876	5068	5260	5452	5643	5834	192
227	6026	6217	6408	6599	6790	6981	7172	7363	7554	7744	191
228	7935	8125	8316	8506	8696	8886	9076	9266	9456	9646	190
229	9835	*0025	*0215	*0404	*0593	*0783	*0972	*1161	*1350	*1539	189
230	361728	1917	2105	2294	2482	2671	2859	3048	3236	3424	188
231	3612	3800	3988	4176	4363	4551	4739	4926	5113	5301	188
232	5488	5675	5862	6049	6236	6423	6610	6796	6983	7169	187
233	7356	7542	7729	7915	8101	8287	8473	8659	8845	9030	186
234	9216	9401	9587	9772	9958	*0143	*0328	*0513	*0698	*0883	185
N.	Diff.	1	2	3	4	5	6	7	8	9	Diff.
PROPORTIONAL PARTS	212	21	42	64	85	106	127	148	170	191	212
	211	21	42	63	84	106	127	148	169	190	211
	210	21	42	63	84	105	126	147	168	189	210
	209	21	42	63	84	105	125	146	167	188	209
	208	21	42	62	83	104	125	146	166	187	208
	207	21	41	62	83	104	124	145	166	186	207
	206	21	41	62	82	103	124	144	165	185	206
	205	21	41	62	82	103	123	144	164	185	205
	204	20	41	61	82	102	122	143	163	184	204
	203	20	41	61	81	102	122	142	162	183	203
	202	20	40	61	81	101	121	141	162	182	202
	201	20	40	60	80	101	121	141	161	181	201
	200	20	40	60	80	100	120	140	160	180	200
	199	20	40	60	80	100	119	139	159	179	199
	198	20	40	59	79	99	119	139	158	178	198
	197	20	39	59	79	99	118	138	158	177	197
	196	20	39	59	78	98	118	137	157	176	196
	195	20	39	59	78	98	117	137	156	176	195
	194	19	39	58	78	97	116	136	155	175	194
	193	19	39	58	77	97	116	135	154	174	193
192	19	38	58	77	96	115	134	154	173	192	
191	19	38	57	76	96	115	134	153	172	191	
190	19	38	57	76	95	114	133	152	171	190	
189	19	38	57	76	95	113	132	151	170	189	
188	19	38	56	75	94	113	132	150	169	188	
Diff.	1	2	3	4	5	6	7	8	9	Diff.	

N.	0	1	2	3	4	5	6	7	8	9	Diff.
235	371068	1253	1437	1622	1806	1991	2175	2360	2544	2728	184
236	2912	3096	3280	3464	3647	3831	4015	4198	4382	4565	184
237	4748	4932	5115	5298	5481	5664	5846	6029	6212	6394	183
238	6577	6759	6942	7124	7306	7488	7670	7852	8034	8216	182
239	8398	8580	8761	8943	9124	9306	9487	9668	9849	*0030	181
240	380211	0392	0573	0754	0934	1115	1296	1476	1656	1837	181
241	2017	2197	2377	2557	2737	2917	3097	3277	3456	3636	180
242	3815	3995	4174	4353	4533	4712	4891	5070	5249	5428	179
243	5606	5785	5964	6142	6321	6499	6677	6856	7034	7212	178
244	7390	7568	7746	7923	8101	8279	8456	8634	8811	8989	178
245	389166	9343	9520	9698	9875	*0051	*0228	*0405	*0582	*0759	177
246	390935	1112	1288	1464	1641	1817	1993	2169	2345	2521	176
247	2697	2873	3048	3224	3400	3575	3751	3926	4101	4277	176
248	4452	4627	4802	4977	5152	5326	5501	5676	5850	6025	175
249	6199	6374	6548	6722	6896	7071	7245	7419	7592	7766	174
250	397940	8114	8287	8461	8634	8808	8981	9154	9328	9501	173
251	9674	9847	*0020	*0192	*0365	*0538	*0711	*0883	*1056	*1228	173
252	401401	1573	1745	1917	2089	2261	2433	2605	2777	2949	172
253	3121	3292	3464	3635	3807	3978	4149	4320	4492	4663	171
254	4834	5005	5176	5346	5517	5688	5858	6029	6199	6370	171
255	406540	6710	6881	7051	7221	7391	7561	7731	7901	8070	170
256	8240	8410	8579	8749	8918	9087	9257	9426	9595	9764	169
257	9933	*0102	*0271	*0440	*0609	*0777	*0946	*1114	*1283	*1451	169
258	411620	1758	1926	2093	2261	2429	2596	2764	2931	3132	168
259	3300	3467	3635	3803	3970	4137	4305	4472	4639	4806	167
260	414973	5140	5307	5474	5641	5808	5974	6141	6308	6474	167
261	6641	6807	6973	7139	7306	7472	7638	7804	7970	8135	166
262	8301	8467	8633	8798	8964	9129	9295	9460	9625	9791	165
263	9956	*0121	*0286	*0451	*0616	*0781	*0945	*1110	*1275	*1439	165
264	421604	1768	1933	2097	2261	2426	2590	2754	2918	3082	164

N.	Diff.	1	2	3	4	5	6	7	8	9	Diff.
PROPORTIONAL PARTS	187	19	37	56	75	94	112	131	150	168	187
	186	19	37	56	74	93	112	130	149	167	186
	185	19	37	56	74	93	111	130	148	167	185
	184	18	37	55	74	92	110	129	147	166	184
	183	18	37	55	73	92	110	128	146	165	183
	182	18	36	55	73	91	109	127	146	164	182
	181	18	36	54	72	91	109	127	145	163	181
	180	18	36	54	72	90	108	126	144	162	180
	179	18	36	54	72	90	107	125	143	161	179
	178	18	36	53	71	89	107	125	142	160	178
	177	18	35	53	71	89	106	124	142	159	177
	176	18	35	53	70	88	106	123	141	158	176
	175	18	35	53	70	88	105	123	140	158	175
	174	17	35	52	70	87	104	122	139	157	174
	173	17	35	52	69	87	104	121	138	156	173
	172	17	34	52	69	86	103	120	138	155	172
	171	17	34	51	68	86	103	120	137	154	171
	170	17	34	51	68	85	102	119	136	153	170
169	17	34	51	68	85	101	118	135	152	169	
168	17	34	50	67	84	101	118	134	151	168	
167	17	33	50	67	84	100	117	134	150	167	
166	17	33	50	66	83	100	116	133	149	166	
165	17	33	50	66	83	99	116	132	149	165	
164	16	33	49	66	82	98	115	131	148	164	

N.	Diff.	1	2	3	4	5	6	7	8	9	Diff.
----	-------	---	---	---	---	---	---	---	---	---	-------

N.	0	1	2	3	4	5	6	7	8	9	Diff.
265	423246	3410	3574	3737	3901	4065	4228	4392	4555	4718	164
266	4882	5045	5208	5371	5534	5697	5860	6023	6186	6349	163
267	6511	6674	6836	6999	7161	7324	7486	7648	7811	7973	162
268	8135	8297	8459	8621	8783	8944	9106	9268	9429	9591	162
269	9752	9914	*0075	*0236	*0398	*0559	*0720	*0881	*1042	*1203	161
270	431364	1525	1685	1846	2007	2167	2328	2488	2649	2809	161
271	2969	3130	3290	3450	3610	3770	3930	4090	4249	4409	160
272	4569	4729	4888	5048	5207	5367	5526	5685	5844	6004	159
273	6163	6322	6481	6640	6799	6957	7116	7275	7433	7592	159
274	7751	7909	8067	8226	8384	8542	8701	8859	9017	9175	158
275	439333	9491	9648	9806	9964	*0122	*0279	*0437	*0594	*0752	158
276	440909	1066	1224	1381	1538	1695	1852	2009	2166	2323	157
277	2480	2637	2793	2950	3106	3263	3419	3576	3732	3889	157
278	4045	4201	4357	4513	4669	4825	4981	5137	5293	5449	156
279	5604	5760	5915	6071	6226	6382	6537	6692	6848	7003	155
280	447158	7313	7468	7623	7778	7933	8088	8242	8397	8552	155
281	8706	8861	9015	9170	9324	9478	9633	9787	9941	*0095	154
282	450249	0403	0557	0711	0865	1018	1172	1326	1479	1633	154
283	1786	1940	2093	2247	2400	2553	2706	2859	3012	3165	153
284	3318	3471	3624	3777	3930	4082	4235	4387	4540	4692	153
285	454845	4997	5150	5302	5454	5606	5758	5910	6062	6214	152
286	6366	6518	6670	6821	6973	7125	7276	7428	7579	7731	152
287	7882	8033	8184	8336	8487	8638	8789	8940	9091	9242	151
288	9302	9543	9604	9845	9905	*0146	*0296	*0447	*0597	*0748	151
289	460898	1048	1198	1348	1499	1649	1799	1948	2098	2248	150
290	462398	2548	2697	2847	2997	3146	3296	3445	3594	3744	150
291	3893	4042	4191	4340	4490	4639	4788	4936	5085	5234	149
292	5383	5532	5680	5829	5977	6126	6274	6423	6571	6719	149
293	6868	7016	7164	7312	7460	7608	7756	7904	8052	8200	148
294	8347	8495	8643	8790	8938	9085	9233	9380	9527	9675	148
295	469822	9969	*0116	*0263	*0410	*0557	*0704	*0851	*0998	*1145	147
296	471292	1438	1585	1732	1878	2025	2171	2318	2464	2610	146
297	2756	2903	3049	3195	3341	3487	3633	3779	3925	4071	146
298	4216	4362	4508	4653	4799	4944	5090	5235	5381	5526	146
299	5671	5816	5962	6107	6252	6397	6542	6687	6832	6976	145

N.	Diff.	1	2	3	4	5	6	7	8	9	Diff.
164	16	33	49	66	82	98	115	131	148	164	164
163	16	33	49	65	82	98	114	130	147	163	163
162	16	32	49	65	81	97	113	130	146	162	162
161	16	32	48	64	81	97	113	129	145	161	161
160	16	32	48	64	80	96	112	128	144	160	160
159	16	32	48	64	80	95	111	127	143	159	159
158	16	32	47	63	79	95	111	126	142	158	158
157	16	31	47	63	79	94	110	126	141	157	157
156	16	31	47	62	78	94	109	125	140	156	156
155	16	31	47	62	78	93	109	124	140	155	155
154	15	31	46	62	77	92	108	123	139	154	154
153	15	31	46	61	77	92	107	122	138	153	153
152	15	30	46	61	76	91	106	122	137	152	152
151	15	30	45	60	76	91	106	121	136	151	151
150	15	30	45	60	75	90	105	120	135	150	150
149	15	30	45	60	75	89	104	119	134	149	149
148	15	30	44	59	74	89	104	118	133	148	148
147	15	29	44	59	74	88	103	118	132	147	147
146	15	29	44	58	73	88	102	117	131	146	146
145	15	29	44	58	73	87	102	116	131	145	145
144	14	29	43	58	72	86	101	115	130	144	144
143	14	29	43	57	72	86	100	114	129	143	143

Diff.	1	2	3	4	5	6	7	8	9	Diff.
-------	---	---	---	---	---	---	---	---	---	-------

PROPORTIONAL PARTS

N.	0	1	2	3	4	5	6	7	8	9	Diff.
300	477121	7266	7411	7555	7700	7844	7989	8133	8278	8422	145
301	8566	8711	8855	8999	9143	9287	9431	9575	9719	9863	144
302	48007	0151	0294	0438	0582	0725	0869	1012	1156	1299	144
303	1443	1586	1729	1872	2016	2159	2302	2445	2588	2731	143
304	2574	3016	3159	3302	3445	3587	3730	3872	4015	4157	143
305	484300	4442	4585	4727	4869	5011	5153	5295	5437	5579	142
306	5721	5863	6005	6147	6289	6430	6572	6714	6855	6997	142
307	7138	7280	7421	7563	7704	7845	7986	8127	8269	8410	141
308	8551	8692	8833	8974	9114	9255	9396	9537	9677	9818	141
309	9958	*0099	*0239	*0380	*0520	*0661	*0801	*0941	*1081	*1222	140
310	491362	1502	1642	1782	1922	2062	2201	2341	2481	2621	140
311	2700	2900	3040	3179	3319	3458	3597	3737	3876	4015	139
312	4155	4294	4433	4572	4711	4850	4989	5128	5267	5406	139
313	5544	5683	5822	5960	6099	6238	6376	6515	6653	6791	139
314	6930	7068	7206	7344	7483	7621	7759	7897	8035	8173	138
315	498311	8448	8586	8724	8862	8999	9137	9275	9412	9550	138
316	9687	9824	9962	*0099	*0236	*0374	*0511	*0648	*0785	*0922	137
317	501039	1196	1333	1470	1607	1744	1880	2017	2154	2291	137
318	2427	2564	2700	2837	2973	3109	3246	3382	3518	3655	136
319	3791	3927	4063	4199	4335	4471	4607	4743	4878	5014	136
320	505150	5286	5421	5557	5693	5828	5964	6099	6234	6370	136
321	6505	6640	6776	6911	7046	7181	7316	7451	7586	7721	135
322	7856	7991	8126	8260	8395	8530	8664	8799	8934	9068	135
323	9203	9337	9471	9606	9740	9874	*0009	*0143	*0277	*0411	134
324	510545	0679	0813	0947	1081	1215	1349	1482	1616	1750	134
325	511883	2017	2151	2284	2418	2551	2684	2818	2951	3084	133
326	3218	3351	3484	3617	3750	3883	4016	4149	4282	4415	133
327	4548	4681	4813	4946	5079	5211	5344	5476	5609	5741	133
328	5874	6006	6139	6271	6403	6535	6668	6800	6932	7064	132
329	7199	7331	7463	7595	7727	7858	7989	8121	8252	8383	132
330	518514	8646	8777	8909	9040	9171	9303	9434	9566	9697	131
331	9828	9959	*0090	*0221	*0353	*0484	*0615	*0745	*0876	*1007	131
332	521138	1269	1400	1530	1661	1792	1922	2053	2183	2314	131
333	2444	2575	2705	2835	2966	3096	3226	3356	3486	3616	130
334	3746	3876	4006	4136	4266	4396	4526	4656	4785	4915	130
335	525045	5174	5304	5434	5563	5693	5822	5951	6081	6210	129
336	6339	6469	6598	6727	6856	6985	7114	7243	7372	7501	129
337	7630	7759	7888	8016	8145	8274	8402	8531	8660	8788	129
338	8917	9045	9174	9302	9430	9559	9687	9815	9943	*0072	128
339	530200	0328	0456	0584	0712	0840	0968	1096	1223	1351	128

N.	Diff.	1	2	3	4	5	6	7	8	9	Diff.
PROPORTIONAL PARTS	142	14	28	43	57	71	85	99	114	128	142
	141	14	28	42	56	71	85	99	113	127	141
	140	14	28	42	56	70	84	98	112	126	140
	139	14	28	42	56	70	83	97	111	125	139
	138	14	28	41	55	69	83	97	110	124	138
	137	14	27	41	55	69	82	96	110	123	137
	136	14	27	41	54	68	82	95	109	122	136
	135	14	27	41	54	68	81	95	108	122	135
	134	13	27	40	54	67	80	94	107	121	134
	133	13	27	40	53	67	80	93	106	120	133
	132	13	26	40	53	66	79	92	106	119	132
	131	13	26	39	52	66	79	92	105	118	131
	130	13	26	39	52	65	78	91	104	117	130
	129	13	26	39	52	65	77	90	103	116	129
	128	13	26	38	51	64	77	90	102	115	128
	127	13	25	38	51	64	76	89	102	114	127
	Diff.	1	2	3	4	5	6	7	8	9	Diff.

N.	0	1	2	3	4	5	6	7	8	9	Diff.
420	623249	3353	3456	3559	3663	3766	3869	3973	4076	4179	103
421	4282	4385	4488	4591	4695	4798	4901	5004	5107	5210	103
422	5312	5415	5518	5621	5724	5827	5929	6032	6135	6238	103
423	6340	6443	6546	6648	6751	6853	6956	7058	7161	7263	103
424	7366	7468	7571	7673	7775	7878	7980	8082	8185	8287	102
425	628359	8491	8593	8695	8797	8900	9002	9104	9206	9308	102
426	9410	9512	9613	9715	9817	9919	*0021	*0123	*0224	*0326	102
427	630428	0530	0631	0733	0835	0936	1038	1139	1241	1342	102
428	1444	1545	1647	1748	1849	1951	2052	2153	2255	2356	101
429	2457	2559	2660	2761	2862	2963	3064	3165	3266	3367	101
430	633468	3569	3670	3771	3872	3973	4074	4175	4276	4376	101
431	4477	4578	4679	4779	4880	4981	5081	5182	5283	5383	101
432	5484	5584	5685	5785	5886	5986	6087	6187	6287	6388	100
433	6488	6588	6688	6789	6889	6989	7089	7189	7290	7390	100
434	7490	7590	7690	7790	7890	7990	8090	8190	8290	8389	100
435	638459	8589	8689	8789	8888	8988	9088	9188	9287	9387	100
436	9486	9586	9686	9785	9885	9984	*0084	*0183	*0283	*0382	99
437	640481	0581	0680	0779	0879	0978	1077	1177	1276	1375	99
438	1474	1573	1672	1771	1871	1970	2069	2168	2267	2366	99
439	2465	2563	2662	2761	2860	2959	3058	3156	3255	3354	99
440	643453	3551	3650	3749	3847	3946	4044	4143	4242	4340	98
441	4439	4537	4636	4734	4832	4931	5029	5127	5226	5324	98
442	5422	5521	5619	5717	5815	5913	6011	6110	6208	6306	98
443	6404	6502	6600	6698	6796	6894	6992	7089	7187	7285	98
444	7383	7481	7579	7676	7774	7872	7969	8067	8165	8262	98
445	648360	8458	8555	8653	8750	8848	8945	9043	9140	9237	97
446	9335	9432	9530	9627	9724	9821	9919	*0016	*0113	*0210	97
447	650308	0405	0502	0599	0696	0793	0890	0987	1084	1181	97
448	1278	1375	1472	1569	1666	1762	1859	1956	2053	2150	97
449	2246	2343	2440	2536	2633	2730	2826	2923	3019	3116	97
450	653213	3309	3405	3502	3598	3695	3791	3888	3984	4080	96
451	4177	4273	4369	4465	4562	4658	4754	4850	4946	5042	96
452	5138	5235	5331	5427	5523	5619	5715	5810	5906	6002	96
453	6098	6194	6290	6386	6482	6577	6673	6769	6864	6960	96
454	7056	7152	7247	7343	7438	7534	7629	7725	7820	7916	96
455	658011	8107	8202	8298	8393	8488	8584	8679	8774	8870	95
456	8965	9060	9155	9250	9346	9441	9536	9631	9726	9821	95
457	9916	*0011	*0106	*0201	*0296	*0391	*0486	*0581	*0676	*0771	95
458	666865	0960	1055	1150	1245	1339	1434	1529	1623	1718	95
459	1813	1907	2002	2096	2191	2286	2380	2475	2569	2663	95
460	662758	2852	2947	3041	3135	3230	3324	3418	3512	3607	94
461	3701	3795	3889	3983	4078	4172	4266	4360	4454	4548	94
462	4642	4736	4830	4924	5018	5112	5206	5299	5393	5487	94
463	5581	5675	5769	5862	5956	6050	6143	6237	6331	6424	94
464	6518	6612	6705	6799	6892	6986	7079	7173	7266	7360	94
N.	Diff.	1	2	3	4	5	6	7	8	9	Diff.
PROP. PARTS	104	10	21	31	42	52	62	73	83	94	104
	103	10	21	31	41	52	62	72	82	93	103
	102	10	20	31	41	51	61	71	82	92	102
	101	10	20	30	40	51	61	71	81	91	101
	100	10	20	30	40	50	60	70	80	90	100
	99	10	20	30	40	50	59	69	79	89	99
	98	10	20	29	39	49	59	69	78	88	98
	97	10	19	29	39	49	58	68	78	87	97
	96	10	19	29	38	48	58	67	77	86	96
	95	10	19	29	38	48	57	67	76	86	95
Diff.		1	2	3	4	5	6	7	8	9	Diff.

N.	0	1	2	3	4	5	6	7	8	9	Diff.
465	667453	7546	7640	7733	7826	7920	8013	8106	8199	8293	93
466	8386	8479	8572	8665	8759	8852	8945	9038	9131	9224	93
467	9317	9410	9503	9596	9689	9782	9875	9967	*0060	*0153	93
468	670246	0339	0431	0524	0617	0710	0802	0895	0988	1080	93
469	1173	1265	1358	1451	1543	1636	1728	1821	1913	2005	93
470	672098	2190	2283	2375	2467	2560	2652	2744	2836	2929	92
471	3021	3113	3205	3297	3390	3482	3574	3666	3758	3850	92
472	3942	4034	4126	4218	4310	4402	4494	4586	4677	4769	92
473	4861	4953	5045	5137	5228	5320	5412	5503	5595	5687	92
474	5778	5870	5962	6053	6145	6236	6328	6419	6511	6602	92
475	670694	6785	6876	6968	7059	7151	7242	7333	7424	7516	91
476	7607	7698	7789	7881	7972	8063	8154	8245	8336	8427	91
477	8518	8609	8700	8791	8882	8973	9064	9155	9246	9337	91
478	9428	9519	9610	9700	9791	9882	9973	*0063	*0154	*0245	91
479	680336	0426	0517	0607	0698	0789	0879	0970	1060	1151	91
480	681241	1332	1422	1513	1603	1693	1784	1874	1964	2055	90
481	2145	2235	2326	2416	2506	2596	2686	2777	2867	2957	90
482	3047	3137	3227	3317	3407	3497	3587	3677	3767	3857	90
483	3947	4037	4127	4217	4307	4396	4486	4576	4666	4756	90
484	4845	4935	5025	5114	5204	5294	5383	5473	5563	5652	90
485	685742	5831	5921	6010	6100	6189	6279	6368	6458	6547	89
486	6636	6726	6815	6904	6994	7083	7172	7261	7351	7440	89
487	7529	7618	7707	7796	7886	7975	8064	8153	8242	8331	89
488	8420	8509	8598	8687	8776	8865	8953	9042	9131	9220	89
489	9309	9398	9486	9575	9664	9753	9841	9930	*0019	*0107	89
490	690196	0285	0373	0462	0550	0639	0728	0816	0905	0993	89
491	1081	1170	1258	1347	1435	1524	1612	1700	1789	1877	88
492	1965	2053	2142	2230	2318	2406	2494	2583	2671	2759	88
493	2847	2935	3023	3111	3199	3287	3375	3463	3551	3639	88
494	3727	3815	3903	3991	4078	4166	4254	4342	4430	4517	88
495	694605	4693	4781	4868	4956	5044	5131	5219	5307	5394	88
496	5482	5569	5657	5744	5832	5919	6007	6094	6182	6269	87
497	6356	6444	6531	6618	6706	6793	6880	6968	7055	7142	87
498	7229	7317	7404	7491	7578	7665	7752	7839	7926	8014	87
499	8101	8188	8275	8362	8449	8535	8622	8709	8796	8883	87
500	698970	9057	9144	9231	9317	9404	9491	9578	9664	9751	87
501	9838	9924	*0011	*0098	*0184	*0271	*0358	*0444	*0531	*0617	87
502	700704	0790	0877	0963	1050	1136	1222	1309	1395	1482	86
503	1568	1654	1741	1827	1913	1999	2086	2172	2258	2344	86
504	2431	2517	2603	2689	2775	2861	2947	3033	3119	3205	86
505	703291	3377	3463	3549	3635	3721	3807	3893	3979	4065	86
506	4151	4236	4322	4408	4494	4579	4665	4751	4837	4922	86
507	5008	5094	5179	5265	5350	5436	5522	5607	5693	5778	86
508	5864	5949	6035	6120	6206	6291	6376	6462	6547	6632	85
509	6718	6803	6888	6974	7059	7144	7229	7315	7400	7485	85
N.	Diff.	1	2	3	4	5	6	7	8	9	Diff.
PROP. PARTS	94	9	19	28	38	47	56	66	75	85	94
	93	9	19	28	37	47	56	65	74	84	93
	92	9	18	28	37	46	55	64	74	83	92
	91	9	18	27	36	46	55	64	73	82	91
	90	9	18	27	36	45	54	63	72	81	90
	89	9	18	27	36	45	53	62	71	80	89
	88	9	18	26	35	44	53	62	70	79	88
	87	9	17	26	35	44	52	61	70	78	87
	86	9	17	26	34	43	52	60	69	77	86
	85	9	17	26	34	43	51	60	68	77	85
	Diff.	1	2	3	4	5	6	7	8	9	Diff.

N.	0	1	2	3	4	5	6	7	8	9	Diff
510	70750	7655	7740	7826	7911	7996	8081	8166	8251	8336	85
511	8421	8506	8591	8676	8761	8846	8931	9015	9100	9185	85
512	9270	9355	9440	9524	9609	9694	9779	9863	9948	*0033	85
513	710117	0202	0287	0371	0456	0540	0625	0710	0794	0879	85
514	0963	1048	1132	1217	1301	1385	1470	1554	1639	1723	84
515	711807	1892	1976	2060	2144	2229	2313	2397	2481	2566	84
516	2650	2734	2818	2902	2986	3070	3154	3238	3323	3407	84
517	3491	3575	3659	3742	3826	3910	3994	4078	4162	4246	84
518	4330	4414	4497	4581	4665	4749	4833	4916	5000	5084	84
519	5167	5251	5335	5418	5502	5586	5669	5753	5836	5920	84
520	716003	6087	6170	6254	6337	6421	6504	6588	6671	6754	83
521	6838	6921	7004	7088	7171	7254	7338	7421	7504	7587	83
522	7671	7754	7837	7920	8003	8086	8169	8253	8336	8419	83
523	8502	8585	8668	8751	8834	8917	9000	9083	9165	9248	83
524	9331	9414	9497	9580	9663	9745	9828	9911	9994	*0077	83
525	720159	0242	0325	0407	0490	0573	0655	0738	0821	0903	83
526	0986	1068	1151	1233	1316	1398	1481	1563	1646	1728	82
527	1511	1593	1675	2058	2140	2222	2305	2387	2469	2552	82
528	2634	2716	2798	2881	2963	3045	3127	3209	3291	3374	82
529	3456	3538	3620	3702	3784	3866	3948	4030	4112	4194	82
530	724276	4358	4440	4522	4604	4685	4767	4849	4931	5013	82
531	5025	5106	5188	5269	5350	5431	5512	5593	5674	5755	82
532	5912	5993	6075	6156	6237	6318	6400	6481	6562	6643	82
533	6727	6809	6890	6971	7053	7134	7215	7297	7379	7460	81
534	7541	7623	7704	7785	7866	7948	8029	8110	8191	8273	81
535	725354	8435	8516	8597	8678	8759	8841	8922	9003	9084	81
536	9165	9246	9327	9408	9489	9570	9651	9732	9813	9894	81
537	9974	*0055	*0136	*0217	*0298	*0378	*0459	*0540	*0621	*0702	81
538	737922	0563	0944	1024	1105	1186	1266	1347	1428	1508	81
539	1589	1669	1750	1830	1911	1991	2072	2152	2233	2313	81
540	732394	2474	2555	2635	2715	2796	2876	2956	3037	3117	80
541	3197	3278	3358	3438	3518	3598	3679	3759	3839	3919	80
542	3999	4079	4160	4240	4320	4400	4480	4560	4640	4720	80
543	4800	4880	4960	5040	5120	5200	5279	5359	5439	5519	80
544	5599	5679	5759	5838	5918	5998	6078	6157	6237	6317	80
545	736397	6476	6556	6635	6715	6795	6874	6954	7034	7113	80
546	7193	7272	7352	7431	7511	7590	7670	7749	7829	7908	79
547	7987	8067	8146	8225	8305	8384	8463	8543	8622	8701	79
548	8781	8860	8939	9018	9097	9177	9256	9335	9414	9493	79
549	9572	9651	9731	9810	9889	9968	*0047	*0126	*0205	*0284	79
550	740363	0442	0521	0600	0678	0757	0836	0915	0994	1073	79
551	1152	1230	1309	1388	1467	1546	1624	1703	1782	1860	79
552	1939	2018	2096	2175	2254	2332	2411	2489	2568	2647	79
553	2725	2804	2882	2961	3039	3118	3196	3275	3353	3431	78
554	3510	3588	3667	3745	3823	3902	3980	4058	4136	4215	78

N.	Diff.	1	2	3	4	5	6	7	8	9	Diff.
PROP. PARTS	86	9	17	26	34	43	52	60	69	77	86
	85	9	17	26	34	43	51	60	68	77	85
	84	8	17	25	34	42	50	59	67	76	84
	83	8	17	25	33	42	50	58	66	75	83
	82	8	16	25	33	41	49	57	66	74	82
	81	8	16	24	32	41	49	57	65	73	81
	80	8	16	24	32	40	48	56	64	72	80
	79	8	16	24	32	40	47	55	63	71	79
	Diff.	1	2	3	4	5	6	7	8	9	Diff.

N.	0	1	2	3	4	5	6	7	8	9	Diff.
555	744293	4371	4449	4528	4606	4684	4762	4840	4919	4997	78
556	5075	5153	5231	5309	5387	5465	5543	5621	5699	5777	78
557	5855	5933	6011	6089	6167	6245	6323	6401	6479	6556	78
558	6634	6712	6790	6868	6945	7023	7101	7179	7256	7334	78
559	7412	7489	7567	7645	7722	7800	7878	7955	8033	8110	78
560	748188	8266	8343	8421	8498	8576	8653	8731	8808	8885	77
561	8963	9040	9118	9195	9272	9350	9427	9504	9582	9659	77
562	9736	9814	9891	9968	*0045	*0123	*0200	*0277	*0354	*0431	77
563	750508	0586	0663	0740	0817	0894	0971	1048	1125	1202	77
564	1279	1356	1433	1510	1587	1664	1741	1818	1895	1972	77
565	752048	2125	2202	2279	2356	2433	2509	2586	2663	2740	77
566	2816	2893	2970	3047	3123	3200	3277	3353	3430	3506	77
567	3593	3660	3736	3813	3889	3966	4042	4119	4195	4272	77
568	4348	4425	4501	4578	4654	4730	4807	4883	4960	5036	76
569	5112	5189	5265	5341	5417	5494	5570	5646	5722	5799	76
570	755875	5951	6027	6103	6180	6256	6332	6408	6484	6560	76
571	6636	6712	6788	6864	6940	7016	7092	7168	7244	7320	76
572	7396	7472	7548	7624	7700	7775	7851	7927	8003	8079	76
573	8155	8230	8306	8382	8458	8533	8609	8685	8761	8836	76
574	8912	8988	9063	9139	9214	9290	9366	9441	9517	9592	76
575	759668	9743	9819	9894	9970	*0045	*0121	*0196	*0272	*0347	75
576	760422	0498	0573	0649	0724	0799	0875	0950	1025	1101	75
577	1176	1251	1326	1402	1477	1552	1627	1702	1778	1853	75
578	1928	2003	2078	2153	2228	2303	2378	2453	2529	2604	75
579	2679	2754	2829	2904	2978	3053	3128	3203	3278	3353	75
580	763428	3503	3578	3653	3727	3802	3877	3952	4027	4101	75
581	4176	4251	4326	4400	4475	4550	4624	4699	4774	4848	75
582	4923	4998	5072	5147	5221	5296	5370	5445	5520	5594	75
583	5669	5743	5818	5892	5966	6041	6115	6190	6264	6338	74
584	6413	6487	6562	6636	6710	6785	6859	6933	7007	7082	74
585	767156	7230	7304	7379	7453	7527	7601	7675	7749	7823	74
586	7898	7972	8046	8120	8194	8268	8342	8416	8490	8564	74
587	8638	8712	8786	8860	8934	9008	9082	9156	9230	9304	74
588	9377	9451	9525	9599	9673	9746	9820	9894	9968	*0042	74
589	770115	0189	0263	0336	0410	0484	0557	0631	0705	0778	74
590	770852	0926	0999	1073	1146	1220	1293	1367	1440	1514	74
591	1587	1661	1734	1808	1881	1955	2028	2102	2175	2248	73
592	2322	2395	2468	2542	2615	2688	2762	2835	2908	2981	73
593	3055	3128	3201	3274	3348	3421	3494	3567	3640	3713	73
594	3786	3860	3933	4006	4079	4152	4225	4298	4371	4444	73
595	774517	4590	4663	4736	4809	4882	4955	5028	5100	5173	73
596	5246	5319	5392	5465	5538	5610	5683	5756	5829	5902	73
597	5974	6047	6120	6193	6265	6338	6411	6483	6556	6629	73
598	6701	6774	6846	6919	6992	7064	7137	7209	7282	7354	73
599	7427	7499	7572	7644	7717	7789	7862	7934	8006	8079	72
Diff.	Diff.	1	2	3	4	5	6	7	8	9	Diff.
PRO. PARTS	78	8	16	23	31	39	47	55	62	70	78
	77	8	15	23	31	39	46	54	62	69	77
	76	8	15	23	30	38	46	53	61	68	76
	75	8	15	23	30	38	45	53	60	68	75
	74	7	15	22	30	37	44	52	59	67	74
	73	7	15	22	29	37	44	51	58	66	73
	72	7	14	22	29	36	43	50	57	65	72
Diff.	Diff.	1	2	3	4	5	6	7	8	9	Diff.

N.	0	1	2	3	4	5	6	7	8	9	Diff.
600	778151	8224	8296	8368	8441	8513	8585	8658	8730	8802	72
601	8874	8947	9019	9091	9163	9236	9308	9380	9452	9524	72
602	9596	9669	9741	9813	9885	9957	*0029	*0101	*0173	*0245	72
603	780317	0389	0461	0533	0605	0677	0749	0821	0893	0965	72
604	1037	1109	1181	1253	1324	1396	1468	1540	1612	1684	72
605	781755	1827	1899	1971	2042	2114	2186	2258	2329	2401	72
606	2473	2544	2616	2688	2759	2831	2902	2974	3046	3117	72
607	3189	3260	3332	3403	3475	3546	3618	3689	3761	3832	71
608	3904	3975	4046	4118	4189	4261	4332	4403	4475	4546	71
609	4617	4689	4760	4831	4902	4974	5045	5116	5187	5259	71
610	785330	5401	5472	5543	5615	5686	5757	5828	5899	5970	71
611	6041	6112	6183	6254	6325	6396	6467	6538	6609	6680	71
612	6751	6822	6893	6964	7035	7106	7177	7248	7319	7390	71
613	7460	7531	7602	7673	7744	7815	7885	7956	8027	8098	71
614	8168	8239	8310	8381	8451	8522	8593	8663	8734	8804	71
615	788875	8946	9016	9087	9157	9228	9299	9369	9440	9510	71
616	9581	9651	9722	9792	9863	9933	*0004	*0074	*0144	*0215	70
617	790285	0356	0426	0496	0567	0637	0707	0778	0848	0918	70
618	0988	1059	1129	1199	1269	1340	1410	1480	1550	1620	70
619	1691	1761	1831	1901	1971	2041	2111	2181	2252	2322	70
620	792392	2462	2532	2602	2672	2742	2812	2882	2952	3022	70
621	3092	3162	3231	3301	3371	3441	3511	3581	3651	3721	70
622	3790	3860	3930	4000	4070	4139	4209	4279	4349	4418	70
623	4488	4558	4627	4697	4767	4836	4906	4976	5045	5115	70
624	5185	5254	5324	5393	5463	5532	5602	5672	5741	5811	70
625	795880	5949	6019	6088	6158	6227	6297	6366	6436	6505	69
626	6574	6644	6713	6782	6852	6921	6990	7060	7129	7198	69
627	7268	7337	7406	7475	7545	7614	7683	7752	7821	7890	69
628	7960	8029	8098	8167	8236	8305	8374	8443	8513	8582	69
629	8651	8720	8789	8858	8927	8996	9065	9134	9203	9272	69
630	799341	9409	9478	9547	9616	9685	9754	9823	9892	9961	69
631	800029	0098	0167	0236	0305	0373	0442	0511	0580	0648	69
632	0717	0786	0854	0923	0992	1061	1129	1198	1266	1335	69
633	1404	1472	1541	1609	1678	1747	1815	1884	1952	2021	69
634	2089	2158	2226	2295	2363	2432	2500	2568	2637	2705	68
635	802774	2842	2910	2979	3047	3116	3184	3252	3321	3389	68
636	3457	3525	3594	3662	3730	3798	3867	3935	4003	4071	68
637	4139	4208	4276	4344	4412	4480	4548	4616	4685	4753	68
638	4821	4889	4957	5025	5093	5161	5229	5297	5365	5433	68
639	5501	5569	5637	5705	5773	5841	5908	5976	6044	6112	68
640	806180	6248	6316	6384	6451	6519	6587	6655	6723	6790	68
641	6858	6926	6994	7061	7129	7197	7264	7332	7400	7467	68
642	7535	7603	7670	7738	7806	7873	7941	8008	8076	8143	68
643	8211	8279	8346	8414	8481	8549	8616	8684	8751	8818	67
644	8886	8953	9020	9088	9156	9223	9290	9358	9425	9492	67
645	809560	9627	9694	9762	9829	9896	9964	*0031	*0098	*0165	67
646	810233	0300	0367	0434	0501	0569	0636	0703	0770	0837	67
647	0904	0971	1039	1106	1173	1240	1307	1374	1441	1508	67
648	1575	1642	1709	1776	1843	1910	1977	2044	2111	2178	67
649	2245	2312	2379	2445	2512	2579	2646	2713	2780	2847	67
N.	Diff.	1	2	3	4	5	6	7	8	9	Diff.
PRO. P.TS	73	7	15	22	29	37	44	51	58	66	73
	72	7	14	22	29	36	43	50	58	65	72
	71	7	14	21	28	36	43	50	57	64	71
	70	7	14	21	28	35	42	49	56	63	70
	69	7	14	21	28	35	41	48	55	62	69
68	7	14	20	27	34	41	48	54	61	68	
Diff.		1	2	3	4	5	6	7	8	9	Diff.

N.	0	1	2	3	4	5	6	7	8	9	Diff.
650	812913	2980	3047	3114	3181	3247	3314	3381	3448	3514	67
651	3581	3648	3714	3781	3848	3914	3981	4048	4114	4181	67
652	4248	4314	4381	4447	4514	4581	4647	4714	4780	4847	67
653	4913	4980	5046	5113	5179	5246	5312	5378	5445	5511	66
654	5578	5644	5711	5777	5843	5910	5976	6042	6109	6175	66
655	816241	6308	6374	6440	6506	6573	6639	6705	6771	6838	66
656	6904	6970	7036	7102	7169	7235	7301	7367	7433	7499	66
657	7565	7631	7698	7764	7830	7896	7962	8028	8094	8160	66
658	8226	8292	8358	8424	8490	8556	8622	8688	8754	8820	66
659	8885	8951	9017	9083	9149	9215	9281	9346	9412	9478	66
660	819544	9610	9676	9741	9807	9873	9939	*0004	*0070	*0136	66
661	820201	0267	0333	0399	0464	0530	0595	0661	0727	0792	66
662	0858	0924	0989	1055	1120	1186	1251	1317	1382	1448	66
663	1514	1579	1645	1710	1775	1841	1906	1972	2037	2103	65
664	2168	2233	2299	2364	2430	2495	2560	2626	2691	2756	65
665	822122	2887	2952	3018	3083	3148	3213	3279	3344	3409	65
666	3174	3539	3605	3670	3735	3800	3865	3930	3995	4061	65
667	4126	4191	4256	4321	4386	4451	4516	4581	4646	4711	65
668	4776	4841	4906	4971	5036	5101	5166	5231	5296	5361	65
669	5426	5491	5556	5621	5686	5751	5815	5880	5945	6010	65
670	826075	6140	6204	6269	6334	6399	6464	6528	6593	6658	65
671	6723	6787	6852	6917	6981	7046	7111	7175	7240	7305	65
672	7369	7434	7499	7563	7628	7692	7757	7821	7886	7951	65
673	8015	8080	8144	8209	8273	8338	8402	8467	8531	8595	64
674	8660	8724	8789	8853	8918	8982	9046	9111	9175	9239	64
675	829304	9368	9432	9497	9561	9625	9690	9754	9818	9882	64
676	9947	*0011	*0075	*0139	*0204	*0268	*0332	*0396	*0460	*0525	64
677	830539	0653	0717	0781	0845	0909	0973	1037	1101	1166	64
678	1230	1294	1358	1422	1486	1550	1614	1678	1742	1806	64
679	1870	1934	1998	2062	2126	2189	2253	2317	2381	2445	64
680	832509	2573	2637	2700	2764	2828	2892	2956	3020	3083	64
681	3147	3211	3275	3338	3402	3466	3530	3593	3657	3721	64
682	3784	3848	3912	3975	4039	4103	4166	4230	4294	4357	64
683	4421	4484	4548	4611	4675	4739	4802	4866	4929	4993	64
684	5056	5120	5183	5247	5310	5373	5437	5500	5564	5627	63
685	835691	5754	5817	5881	5944	6007	6071	6134	6197	6261	63
686	6324	6387	6451	6514	6577	6641	6704	6767	6830	6894	63
687	6957	7020	7083	7146	7210	7273	7336	7399	7462	7525	63
688	7588	7652	7715	7778	7841	7904	7967	8030	8093	8156	63
689	8219	8282	8345	8408	8471	8534	8597	8660	8723	8786	63
690	838849	8912	8975	9038	9101	9164	9227	9289	9352	9415	63
691	9478	9541	9604	9667	9729	9792	9855	9918	9981	*0043	63
692	840106	0169	0232	0294	0357	0420	0482	0545	0608	0671	63
693	0733	0796	0859	0921	0984	1046	1109	1172	1234	1297	63
694	1359	1422	1485	1547	1610	1672	1735	1797	1860	1922	63
695	841985	2047	2110	2172	2235	2297	2360	2422	2484	2547	62
696	2609	2672	2734	2796	2859	2921	2983	3046	3108	3170	62
697	3233	3295	3357	3420	3482	3544	3606	3669	3731	3793	62
698	3855	3918	3980	4042	4104	4166	4229	4291	4353	4415	62
699	4477	4539	4601	4664	4726	4788	4850	4912	4974	5036	62

N.	Diff.	1	2	3	4	5	6	7	8	9	Diff.
P. P. T'S	67	7	13	20	27	34	40	47	54	60	67
	66	7	13	20	25	33	40	46	53	59	66
	65	7	13	20	26	33	39	46	52	59	65
	64	6	13	19	26	32	38	45	51	58	64
	63	6	13	19	25	32	38	44	50	57	63
	62	6	12	19	25	31	37	43	50	56	62
	Diff.	1	2	3	4	5	6	7	8	9	Diff.

N.	0	1	2	3	4	5	6	7	8	9	Diff.
700	845098	5160	5222	5284	5346	5408	5470	5532	5594	5656	62
701	5718	5780	5842	5904	5966	6028	6090	6151	6213	6275	62
702	6337	6399	6461	6523	6585	6646	6708	6770	6832	6894	62
703	6955	7017	7079	7141	7202	7264	7326	7388	7449	7511	62
704	7573	7634	7696	7758	7819	7881	7943	8004	8066	8128	62
705	848189	8251	8312	8374	8435	8497	8559	8620	8682	8743	62
706	8805	8866	8928	8989	9051	9112	9174	9235	9297	9358	61
707	9419	9481	9542	9604	9665	9726	9788	9849	9911	9972	61
708	850033	0095	0156	0.17	0279	0340	0401	0462	0524	0585	61
709	0646	0707	0769	0830	0891	0952	1014	1075	1136	1197	61
710	851258	1320	1381	1442	1503	1564	1625	1686	1747	1809	61
711	1870	1931	1992	2053	2114	2175	2236	2297	2358	2419	61
712	2480	2541	2602	2663	2724	2785	2846	2907	2968	3029	61
713	3090	3150	3211	3272	3333	3394	3455	3516	3577	3637	61
714	3698	3759	3820	3881	3941	4002	4063	4124	4185	4245	61
715	854306	4367	4428	4488	4549	4610	4670	4731	4792	4852	61
716	4913	4974	5034	5095	5156	5217	5277	5338	5398	5459	61
717	5519	5580	5640	5701	5761	5822	5882	5943	6003	6064	61
718	6124	6185	6245	6306	6366	6427	6487	6548	6608	6668	60
719	6729	6789	6850	6910	6970	7031	7091	7152	7212	7272	60
720	857332	7393	7453	7513	7574	7634	7694	7755	7815	7875	60
721	7935	7995	8056	8116	8176	8236	8297	8357	8417	8477	60
722	8537	8597	8657	8718	8778	8838	8898	8958	9018	9078	60
723	9138	9198	9258	9318	9379	9439	9499	9559	9619	9679	60
724	9739	9799	9859	9918	9978	*0038	*0098	*0158	*0218	*0278	60
725	860338	0398	0458	0518	0578	0637	0697	0757	0817	0877	60
726	0937	0996	1056	1116	1176	1236	1295	1355	1415	1475	60
727	1534	1594	1654	1714	1773	1833	1893	1952	2012	2072	60
728	2131	2191	2251	2310	2370	2430	2489	2549	2608	2668	60
729	2728	2787	2847	2906	2966	3025	3085	3144	3204	3263	60
730	863323	3382	3442	3501	3561	3620	3680	3739	3799	3858	59
731	3917	3977	4036	4096	4155	4214	4274	4333	4392	4452	59
732	4511	4570	4630	4689	4748	4808	4867	4926	4985	5045	59
733	5104	5163	5222	5282	5341	5400	5459	5519	5578	5637	59
734	5696	5755	5814	5874	5933	5992	6051	6110	6169	6228	59
735	866287	6346	6405	6465	6524	6583	6642	6701	6760	6819	59
736	6878	6937	6996	7055	7114	7173	7232	7291	7350	7409	59
737	7467	7526	7585	7644	7703	7762	7821	7880	7939	7998	59
738	8056	8115	8174	8233	8292	8350	8409	8468	8527	8586	59
739	8644	8703	8762	8821	8879	8938	8997	9056	9114	9173	59
740	869232	9290	9349	9408	9466	9525	9584	9642	9701	9760	59
741	9818	9877	9935	9994	*0053	*0111	*0170	*0228	*0287	*0345	59
742	870404	0462	0521	0579	0638	0696	0755	0813	0872	0930	58
743	0989	1047	1106	1164	1223	1281	1339	1398	1456	1515	58
744	1573	1631	1690	1748	1806	1865	1923	1981	2040	2098	58
745	872156	2215	2273	2331	2389	2448	2506	2564	2622	2681	58
746	2739	2797	2855	2913	2972	3030	3088	3146	3204	3262	58
747	3321	3379	3437	3495	3553	3611	3669	3727	3785	3844	58
748	3902	3960	4018	4076	4134	4192	4250	4308	4366	4424	58
749	4482	4540	4598	4656	4714	4772	4830	4888	4945	5003	58
N.	Diff.	1	2	3	4	5	6	7	8	9	Diff.
P. R. P. T. S.	62	6	12	19	25	31	37	43	50	56	62
	61	6	12	18	24	31	37	43	49	55	61
	60	6	12	18	24	30	36	42	48	54	60
	59	6	12	18	24	30	35	41	47	53	59
	58	6	12	17	23	29	35	41	46	52	58
Diff.		1	2	3	4	5	6	7	8	9	Diff.

N.	0	1	2	3	4	5	6	7	8	9	Diff.
750	875061	5119	5177	5235	5293	5351	5409	5466	5524	5582	58
751	5640	5698	5756	5813	5871	5929	5987	6045	6102	6160	58
752	6218	6276	6333	6391	6449	6507	6564	6622	6680	6737	58
753	6795	6853	6910	6968	7026	7083	7141	7199	7256	7314	58
754	7371	7429	7487	7544	7602	7659	7717	7774	7832	7889	58
755	877947	8004	8062	8119	8177	8234	8292	8349	8407	8464	57
756	852	8579	8637	8694	8752	8809	8866	8924	8981	9039	57
757	9096	9153	9211	9268	9325	9383	9440	9497	9555	9612	57
758	9669	9726	9784	9841	9898	9956	*0013	*0070	*0127	*0185	57
759	880242	0299	0356	0413	0471	0528	0585	0642	0699	0756	57
760	880814	0871	0928	0985	1042	1099	1156	1213	1271	1328	57
761	1385	1442	1499	1556	1613	1670	1727	1784	1841	1898	57
762	1955	2012	2069	2126	2183	2240	2297	2354	2411	2468	57
763	2525	2581	2638	2695	2752	2809	2866	2923	2980	3037	57
764	3093	3150	3207	3264	3321	3377	3434	3491	3548	3605	57
765	883661	3718	3775	3832	3888	3945	4002	4059	4115	4172	57
766	4229	4285	4342	4399	4455	4512	4569	4625	4682	4739	57
767	4795	4852	4909	4965	5022	5078	5135	5192	5248	5305	57
768	5361	5418	5474	5531	5587	5644	5700	5757	5813	5870	57
769	5926	5983	6039	6096	6152	6209	6265	6321	6378	6434	56
770	886491	6547	6604	6660	6716	6773	6829	6885	6942	6998	56
771	7054	7111	7167	7223	7280	7336	7392	7449	7505	7561	56
772	7617	7674	7730	7786	7842	7898	7955	8011	8067	8123	56
773	8179	8236	8292	8348	8404	8460	8516	8573	8629	8685	56
774	8741	8797	8853	8909	8965	9021	9077	9134	9190	9246	56
775	889302	9358	9414	9470	9526	9582	9638	9694	9750	9806	56
776	9862	9918	9974	*0030	*0086	*0141	*0197	*0253	*0309	*0365	56
777	890421	0477	0533	0589	0645	0700	0756	0812	0868	0924	56
778	0980	1035	1091	1147	1203	1259	1314	1370	1426	1482	56
779	1537	1593	1649	1705	1760	1816	1872	1928	1983	2039	56
780	892095	2150	2206	2262	2317	2373	2429	2484	2540	2595	56
781	2651	2707	2762	2818	2873	2929	2985	3040	3096	3151	56
782	3207	3262	3318	3373	3429	3484	3540	3595	3651	3706	56
783	3762	3817	3873	3928	3984	4039	4094	4150	4205	4261	55
784	4316	4371	4427	4482	4538	4593	4648	4704	4759	4814	55
785	894870	4925	4980	5036	5091	5146	5201	5257	5312	5367	55
786	5423	5478	5533	5588	5644	5699	5754	5809	5864	5920	55
787	5975	6030	6085	6140	6195	6251	6306	6361	6416	6471	55
788	6526	6581	6636	6692	6747	6802	6857	6912	6967	7022	55
789	7077	7132	7187	7242	7297	7352	7407	7462	7517	7572	55
790	897627	7682	7737	7792	7847	7902	7957	8012	8067	8122	55
791	8176	8231	8286	8341	8396	8451	8506	8561	8615	8670	55
792	8725	8780	8835	8890	8944	8999	9054	9109	9164	9218	55
793	9273	9328	9383	9437	9492	9547	9602	9656	9711	9766	55
794	9821	9875	9930	9985	*0039	*0094	*0149	*0203	*0258	*0312	55
795	900367	0422	0476	0531	0586	0640	0695	0749	0804	0859	55
796	0913	0968	1022	1077	1131	1186	1240	1295	1349	1404	55
797	1453	1513	1567	1622	1676	1731	1785	1840	1894	1948	54
798	2003	2057	2112	2166	2221	2275	2329	2384	2438	2492	54
799	2547	2601	2655	2710	2764	2818	2873	2927	2981	3036	54
N.	Diff.	1	2	3	4	5	6	7	8	9	Diff.
P. R. P. S.	57	6	11	17	23	29	34	40	46	51	57
	56	6	11	17	22	28	34	39	45	50	56
	55	6	11	17	22	28	33	39	44	50	55
	54	5	11	16	22	27	32	38	43	49	54
Diff.	1	2	3	4	5	6	7	8	9	Diff.	

N.	0	1	2	3	4	5	6	7	8	9	Diff.
800	903090	3144	3199	3253	3307	3361	3416	3470	3524	3578	54
801	3633	3687	3741	3795	3849	3904	3958	4012	4066	4120	54
802	4174	4229	4283	4337	4391	4445	4499	4553	4607	4661	54
803	4716	4770	4824	4878	4932	4986	5040	5094	5148	5202	54
804	5256	5310	5364	5418	5472	5526	5580	5634	5688	5742	54
805	905796	5850	5904	5958	6012	6066	6119	6173	6227	6281	54
806	6335	6389	6443	6497	6551	6604	6658	6712	6766	6820	54
807	6874	6927	6981	7035	7089	7143	7196	7250	7304	7358	54
808	7411	7465	7519	7573	7626	7680	7734	7787	7841	7895	54
809	7949	8002	8056	8110	8163	8217	8270	8324	8378	8431	54
810	908455	8539	8592	8646	8699	8753	8807	8860	8914	8967	51
811	9021	9074	9128	9181	9235	9289	9342	9396	9449	9503	54
812	9556	9610	9663	9716	9770	9823	9877	9930	9984	*0037	51
813	910091	0144	0197	0251	0304	0358	0411	0464	0518	0571	53
814	0624	0678	0731	0784	0838	0891	0944	0998	1051	1104	53
815	911158	1211	1264	1317	1371	1424	1477	1530	1584	1637	53
816	1690	1743	1797	1850	1903	1956	2009	2063	2116	2169	53
817	2222	2275	2328	2381	2435	2488	2541	2594	2647	2700	53
818	2753	2806	2859	2913	2966	3019	3072	3125	3178	3231	53
819	3284	3337	3390	3443	3496	3549	3602	3655	3708	3761	53
820	913814	3867	3920	3973	4026	4079	4132	4184	4237	4290	53
821	4343	4396	4449	4502	4555	4608	4660	4713	4766	4819	53
822	4872	4925	4977	5030	5083	5136	5189	5241	5294	5347	53
823	5400	5453	5505	5558	5611	5664	5716	5769	5822	5875	53
824	5927	5980	6033	6085	6138	6191	6243	6296	6349	6401	53
825	916454	6507	6559	6612	6664	6717	6770	6822	6875	6927	53
826	6930	7033	7085	7138	7190	7243	7295	7348	7400	7453	53
827	7506	7558	7611	7663	7716	7768	7820	7873	7925	7978	52
828	8030	8083	8135	8188	8240	8293	8345	8397	8450	8502	52
829	8555	8607	8659	8712	8764	8816	8869	8921	8973	9026	52
830	919078	9130	9183	9235	9287	9340	9392	9444	9496	9549	52
831	9601	9653	9706	9758	9810	9862	9914	9967	*0019	*0071	52
832	920123	0176	0228	0280	0332	0384	0436	0489	0541	0593	52
833	0645	0697	0749	0801	0853	0906	0958	1010	1062	1114	52
834	1166	1218	1270	1322	1374	1426	1478	1530	1582	1634	52
835	921686	1738	1790	1842	1894	1946	1998	2050	2102	2154	52
836	2206	2258	2310	2362	2414	2466	2518	2570	2622	2674	52
837	2725	2777	2829	2881	2933	2985	3037	3089	3140	3192	52
838	3244	3296	3348	3399	3451	3503	3555	3607	3658	3710	52
839	3762	3814	3865	3917	3969	4021	4072	4124	4176	4228	52
840	924279	4331	4383	4434	4486	4538	4589	4641	4693	4744	52
841	4796	4848	4899	4951	5003	5054	5106	5157	5209	5261	52
842	5312	5364	5415	5467	5518	5570	5621	5673	5725	5776	52
843	5828	5879	5931	5982	6034	6085	6137	6188	6240	6291	51
844	6342	6394	6445	6497	6548	6600	6651	6702	6754	6805	51
845	926857	6908	6959	7011	7062	7114	7165	7216	7268	7319	51
846	7370	7422	7473	7524	7576	7627	7678	7730	7781	7832	51
847	7883	7935	7986	8037	8088	8140	8191	8242	8293	8345	51
848	8396	8447	8498	8549	8601	8652	8703	8754	8805	8857	51
849	8908	8959	9010	9061	9112	9163	9215	9266	9317	9368	51
N.	Diff.	1	2	3	4	5	6	7	8	9	Diff.
P. R. P.TS.	55	6	11	17	22	28	33	39	44	50	55
	54	5	11	16	22	27	32	38	43	49	54
	53	5	11	16	21	27	32	37	42	48	53
	52	5	10	16	21	26	31	36	42	47	52
Diff.	1	2	3	4	5	6	7	8	9	Diff.	

N.	0	1	2	3	4	5	6	7	8	9	Diff.
850	929419	9470	9521	9572	9623	9674	9725	9776	9827	9879	51
851	9930	9981	*0032	*0083	*0134	*0185	*0236	*0287	*0338	*0389	51
852	930440	0491	0542	0592	0643	0694	0745	0796	0847	0898	51
853	0949	1000	1051	1102	1153	1204	1254	1305	1356	1407	51
854	1458	1509	1560	1610	1661	1712	1763	1814	1865	1915	51
855	931966	2017	2068	2118	2169	2220	2271	2322	2372	2423	51
856	2474	2524	2575	2626	2677	2727	2778	2829	2879	2930	51
857	2981	3031	3082	3133	3183	3234	3285	3335	3386	3437	51
858	3487	3538	3589	3639	3690	3740	3791	3841	3892	3943	51
859	3993	4044	4094	4145	4195	4246	4296	4347	4397	4448	51
860	934498	4549	4599	4650	4700	4751	4801	4852	4902	4953	50
861	5003	5054	5104	5154	5205	5255	5306	5356	5406	5457	50
862	5507	5558	5608	5658	5709	5759	5809	5860	5910	5960	50
863	6011	6061	6111	6162	6212	6262	6313	6363	6413	6463	50
864	6514	6564	6614	6665	6715	6765	6815	6865	6916	6966	50
865	937016	7066	7117	7167	7217	7267	7317	7367	7418	7468	50
866	7518	7568	7618	7668	7718	7769	7819	7869	7919	7969	50
867	8019	8069	8119	8169	8219	8269	8320	8370	8420	8470	50
868	8520	8570	8620	8670	8720	8770	8820	8870	8920	8970	50
869	9020	9070	9120	9170	9220	9270	9320	9369	9419	9469	50
870	939519	9569	9619	9669	9719	9769	9819	9869	9918	9968	50
871	940018	0068	0118	0168	0218	0267	0317	0367	0417	0467	50
872	0516	0566	0616	0666	0716	0765	0815	0865	0915	0964	50
873	1014	1064	1114	1163	1213	1263	1313	1362	1412	1462	50
874	1511	1561	1611	1660	1710	1760	1809	1859	1909	1958	50
875	942048	2058	2107	2157	2207	2256	2306	2355	2405	2455	50
876	2504	2554	2603	2653	2702	2752	2801	2851	2901	2950	50
877	3000	3049	3099	3148	3198	3247	3297	3346	3396	3445	49
878	3495	3544	3593	3643	3692	3742	3791	3841	3890	3939	49
879	3999	4038	4088	4137	4186	4236	4285	4335	4384	4433	49
880	944483	4532	4581	4631	4680	4729	4779	4828	4877	4927	49
881	4976	5025	5074	5124	5173	5222	5272	5321	5370	5419	49
882	5469	5518	5567	5616	5665	5715	5764	5813	5862	5912	49
883	5961	6010	6059	6108	6157	6207	6256	6305	6354	6403	49
884	6452	6501	6551	6600	6649	6698	6747	6796	6845	6894	49
885	946943	6903	7041	7090	7140	7189	7238	7287	7336	7385	49
886	7434	7483	7532	7581	7630	7679	7728	7777	7826	7875	49
887	7924	7973	8022	8070	8119	8168	8217	8266	8315	8364	49
888	8413	8462	8511	8560	8609	8657	8706	8755	8804	8853	49
889	8902	8951	8999	9048	9097	9146	9195	9244	9292	9341	49
890	949390	9439	9488	9536	9585	9634	9683	9731	9780	9829	49
891	9878	9926	9975	*0024	*0073	*0121	*0170	*0219	*0267	*0316	49
892	950365	0414	0462	0511	0560	0608	0657	0706	0754	0803	49
893	0651	0900	0949	0997	1046	1095	1143	1192	1240	1289	49
894	1338	1386	1435	1483	1532	1580	1629	1677	1726	1775	49
895	951823	1872	1920	1969	2017	2066	2114	2163	2211	2260	48
896	2308	2356	2405	2453	2502	2550	2599	2647	2696	2744	48
897	2792	2841	2890	2938	2986	3034	3083	3131	3180	3228	48
898	3276	3325	3373	3421	3470	3518	3566	3615	3663	3711	48
899	3760	3808	3856	3905	3953	4001	4049	4098	4146	4194	48

N.	Diff.	1	2	3	4	5	6	7	8	9	Diff.
PR. PTS.	51	5	10	15	20	26	31	36	41	46	51
	50	5	10	15	20	25	30	35	40	45	50
	49	5	10	15	20	25	29	34	39	44	49
	48	5	10	14	19	24	29	34	38	43	48
Diff.		1	2	3	4	5	6	7	8	9	Diff.

N.	0	1	2	3	4	5	6	7	8	9	Diff.
900	954243	4291	4339	4387	4435	4484	4532	4580	4628	4677	48
901	4725	4773	4821	4869	4918	4966	5014	5062	5110	5158	48
902	5207	5255	5303	5351	5399	5447	5495	5543	5592	5640	48
903	5688	5736	5784	5832	5880	5928	5976	6024	6072	6120	48
904	6168	6216	6265	6313	6361	6409	6457	6505	6553	6601	48
905	6564	6609	6745	6793	6840	6888	6936	6984	7032	7080	48
906	7128	7176	7224	7272	7320	7368	7416	7464	7512	7559	48
907	7607	7655	7703	7751	7799	7847	7894	7942	7990	8038	48
908	8086	8134	8181	8229	8277	8325	8373	8421	8468	8516	48
909	8564	8612	8659	8707	8755	8803	8850	8898	8946	8994	48
910	959041	9089	9137	9185	9232	9280	9328	9375	9423	9471	48
911	9518	9566	9614	9661	9709	9757	9804	9852	9900	9947	48
912	9995	*0042	*0090	*0138	*0185	*0233	*0280	*0328	*0376	*0423	48
913	960471	0518	0566	0613	0661	0709	0756	0804	0851	0899	48
914	0946	0994	1041	1089	1136	1184	1231	1279	1326	1374	48
915	961421	1469	1516	1563	1611	1658	1706	1753	1801	1848	47
916	1895	1943	1990	2038	2085	2132	2180	2227	2275	2322	47
917	2369	2417	2464	2511	2559	2606	2653	2701	2748	2795	47
918	2843	2890	2937	2985	3032	3079	3126	3174	3221	3268	47
919	3316	3363	3410	3457	3504	3552	3599	3646	3693	3741	47
920	963788	3835	3882	3929	3977	4024	4071	4118	4165	4212	47
921	4200	4307	4354	4401	4448	4495	4542	4590	4637	4684	47
922	4731	4778	4825	4872	4919	4966	5013	5061	5108	5155	47
923	5202	5249	5296	5343	5390	5437	5484	5531	5578	5625	47
924	5672	5719	5766	5813	5860	5907	5954	6001	6048	6095	47
925	966142	6189	6236	6283	6329	6376	6423	6470	6517	6564	47
926	6611	6658	6705	6752	6799	6845	6892	6939	6986	7033	47
927	7080	7127	7173	7220	7267	7314	7361	7408	7454	7501	47
928	7548	7595	7642	7688	7735	7782	7829	7875	7922	7969	47
929	8016	8062	8109	8156	8203	8249	8296	8343	8390	8436	47
930	968483	8530	8576	8623	8670	8716	8763	8810	8856	8903	47
931	8950	8996	9043	9090	9136	9183	9229	9276	9323	9369	47
932	9416	9463	9509	9556	9602	9649	9695	9742	9789	9835	47
933	9882	9928	9975	*0021	*0068	*0114	*0161	*0207	*0254	*0300	47
934	970347	0393	0440	0486	0533	0579	0626	0672	0719	0765	46
935	970812	0858	0904	0951	0997	1044	1090	1137	1183	1229	46
936	1276	1322	1369	1415	1461	1508	1554	1601	1647	1693	46
937	1740	1786	1832	1879	1925	1971	2018	2064	2110	2157	46
938	2203	2249	2295	2342	2388	2434	2481	2527	2573	2619	46
939	2666	2712	2758	2804	2851	2897	2943	2989	3035	3082	46
940	973128	3174	3220	3266	3313	3359	3405	3451	3497	3543	46
941	3590	3636	3682	3728	3774	3820	3866	3913	3959	4005	46
942	4051	4097	4143	4189	4235	4281	4327	4374	4420	4466	46
943	4512	4558	4604	4650	4696	4742	4788	4834	4880	4926	46
944	4972	5018	5064	5110	5156	5202	5248	5294	5340	5386	46
945	975432	5478	5524	5570	5616	5662	5707	5753	5799	5845	46
946	5891	5937	5983	6029	6075	6121	6167	6212	6258	6304	46
947	6350	6396	6442	6488	6533	6579	6625	6671	6717	6763	46
948	6808	6854	6900	6946	6992	7037	7083	7129	7175	7220	46
949	7266	7312	7358	7403	7449	7495	7541	7586	7632	7678	46
N.	Diff.	1	2	3	4	5	6	7	8	9	Diff.
P. R. P.TS.	49	5	10	15	20	25	29	34	39	44	49
	48	5	10	14	19	24	29	34	38	43	48
	47	5	9	14	19	24	28	33	38	42	47
	46	5	9	14	18	23	28	32	37	41	46
	Diff.	1	2	3	4	5	6	7	8	9	Diff.

N.	0	1	2	3	4	5	6	7	8	9	Diff.
950	977724	7769	7815	7861	7906	7952	7998	8043	8089	8135	46
951	8181	8226	8272	8317	8363	8409	8454	8500	8546	8591	46
952	8637	8683	8728	8774	8819	8865	8911	8956	9002	9047	46
953	9093	9138	9184	9230	9275	9321	9366	9412	9457	9503	46
954	9548	9594	9639	9685	9730	9776	9821	9867	9912	9958	46
955	980003	0049	0094	0140	0185	0231	0276	0322	0367	0412	45
956	0458	0503	0549	0594	0640	0685	0730	0776	0821	0867	45
957	0912	0957	1003	1048	1093	1139	1184	1229	1275	1320	45
958	1366	1411	1456	1501	1547	1592	1637	1683	1728	1773	45
959	1819	1864	1909	1954	2000	2045	2090	2135	2181	2226	45
960	982271	2316	2362	2407	2452	2497	2543	2588	2633	2678	45
961	2723	2769	2814	2859	2904	2949	2994	3040	3085	3130	45
962	3175	3220	3265	3310	3356	3401	3446	3491	3536	3581	45
963	3626	3671	3716	3762	3807	3852	3897	3942	3987	4032	45
964	4077	4122	4167	4212	4257	4302	4347	4392	4437	4482	45
965	984527	4572	4617	4662	4707	4752	4797	4842	4887	4932	45
966	4977	5022	5067	5112	5157	5202	5247	5292	5337	5382	45
967	5426	5471	5516	5561	5606	5651	5696	5741	5786	5831	45
968	5875	5920	5965	6010	6055	6100	6144	6189	6234	6279	45
969	6324	6369	6413	6458	6503	6548	6593	6637	6682	6727	45
970	986772	6817	6861	6906	6951	6996	7040	7085	7130	7175	45
971	7219	7264	7309	7353	7398	7443	7488	7532	7577	7622	45
972	7666	7711	7756	7800	7845	7890	7934	7979	8024	8068	45
973	8113	8157	8202	8247	8291	8336	8381	8425	8470	8514	45
974	8559	8604	8648	8693	8737	8782	8826	8871	8916	8960	45
975	989005	9049	9094	9138	9183	9227	9272	9316	9361	9405	45
976	9450	9494	9539	9583	9628	9672	9717	9761	9806	9850	44
977	9895	9939	9983	*0028	*0072	*0117	*0161	*0206	*0250	*0294	44
978	990339	0383	0428	0472	0516	0561	0605	0650	0694	0738	44
979	0783	0827	0871	0916	0960	1004	1049	1093	1137	1182	44
980	991226	1270	1315	1359	1403	1448	1492	1536	1580	1625	44
981	1669	1713	1758	1802	1846	1890	1935	1979	2023	2067	44
982	2111	2156	2200	2244	2288	2333	2377	2421	2465	2509	44
983	2554	2598	2642	2686	2730	2774	2819	2863	2907	2951	44
984	2995	3039	3083	3127	3172	3216	3260	3304	3348	3392	44
985	993436	3480	3524	3568	3613	3657	3701	3745	3789	3833	44
986	3877	3921	3965	4009	4053	4097	4141	4185	4229	4273	44
987	4317	4361	4405	4449	4493	4537	4581	4625	4669	4713	44
988	4757	4801	4845	4889	4933	4977	5021	5065	5108	5152	44
989	5196	5240	5284	5328	5372	5416	5460	5504	5547	5591	44
990	995635	5679	5723	5767	5811	5854	5898	5942	5986	6030	44
991	6074	6117	6161	6205	6249	6293	6337	6380	6424	6468	44
992	6512	6555	6599	6643	6687	6731	6774	6818	6862	6906	44
993	6949	6993	7037	7080	7124	7168	7212	7255	7299	7343	44
994	7386	7430	7474	7517	7561	7605	7648	7692	7736	7779	44
995	997823	7867	7910	7954	7998	8041	8085	8129	8172	8216	44
996	8259	8303	8347	8390	8434	8477	8521	8564	8608	8652	44
997	8695	8739	8782	8826	8869	8913	8956	9000	9043	9087	44
998	9131	9174	9218	9261	9305	9348	9392	9435	9479	9522	44
999	9565	9609	9652	9696	9739	9783	9826	9870	9913	9957	43
N.	Diff.	1	2	3	4	5	6	7	8	9	Diff.
P.R. PTS.	46	5	9	14	18	23	28	32	37	41	46
	45	5	9	14	18	23	27	32	36	41	45
	44	4	9	13	18	22	26	31	35	40	44
	43	4	9	13	17	22	26	30	34	39	43
	Diff.	1	2	3	4	5	6	7	8	9	Diff.

N.	0	1	2	3	4	5	6	7	8	9	Diff.
1000	000000	0043	0087	0130	0174	0217	0260	0304	0347	0391	43
1001	0434	0477	0521	0564	0608	0651	0694	0738	0781	0824	43
1002	0688	0911	0954	0998	1041	1084	1128	1171	1214	1258	43
1003	1301	1344	1388	1431	1474	1517	1561	1604	1647	1690	43
1004	1734	1777	1820	1863	1907	1950	1993	2036	2080	2123	43
1005	002166	2209	2252	2296	2339	2382	2425	2468	2512	2555	43
1006	2598	2641	2684	2727	2771	2814	2857	2900	2943	2986	43
1007	3029	3073	3116	3159	3202	3245	3288	3331	3374	3417	43
1008	3461	3504	3547	3590	3633	3676	3719	3762	3805	3848	43
1009	3891	3934	3977	4020	4063	4106	4149	4192	4235	4278	43
1010	004321	4364	4407	4450	4493	4536	4579	4622	4665	4708	43
1011	4751	4794	4837	4880	4923	4966	5009	5052	5095	5138	43
1012	5181	5223	5266	5309	5352	5395	5438	5481	5524	5567	43
1013	5609	5652	5695	5738	5781	5824	5867	5909	5952	5995	43
1014	6038	6081	6124	6166	6209	6252	6295	6338	6380	6423	43
1015	006466	6509	6552	6594	6637	6680	6723	6765	6808	6851	43
1016	6894	6936	6979	7022	7065	7107	7150	7193	7236	7278	43
1017	7321	7364	7406	7449	7492	7534	7577	7620	7662	7705	43
1018	7748	7790	7833	7876	7918	7961	8004	8046	8089	8132	43
1019	8174	8217	8259	8302	8345	8387	8430	8472	8515	8558	43
1020	008600	8643	8685	8728	8770	8813	8856	8898	8941	8983	43
1021	9026	9068	9111	9153	9196	9238	9281	9323	9366	9408	42
1022	9451	9493	9536	9578	9621	9663	9706	9748	9791	9833	42
1023	9876	9918	9961	*0003	*0045	*0088	*0130	*0173	*0215	*0258	42
1024	010300	0342	0385	0427	0470	0512	0554	0597	0639	0681	42
1025	010724	0766	0809	0851	0893	0936	0978	1020	1063	1105	42
1026	1147	1190	1232	1274	1317	1359	1401	1444	1486	1528	42
1027	1570	1613	1655	1697	1740	1782	1824	1866	1909	1951	42
1028	1993	2035	2078	2120	2162	2204	2247	2289	2331	2373	42
1029	2415	2458	2500	2542	2584	2626	2669	2711	2753	2795	42
1030	012837	2879	2922	2964	3006	3048	3090	3132	3174	3217	42
1031	3259	3301	3343	3385	3427	3469	3511	3553	3596	3638	42
1032	3680	3722	3764	3806	3848	3890	3932	3974	4016	4058	42
1033	4100	4142	4184	4226	4268	4310	4352	4395	4437	4479	42
1034	4521	4563	4605	4647	4689	4730	4772	4814	4856	4898	42
1035	014940	4982	5024	5066	5108	5150	5192	5234	5276	5318	42
1036	5360	5402	5444	5485	5527	5569	5611	5653	5695	5737	42
1037	5779	5821	5863	5904	5946	5988	6030	6072	6114	6156	42
1038	6197	6239	6281	6323	6365	6407	6448	6490	6532	6574	42
1039	6616	6657	6699	6741	6783	6824	6866	6908	6950	6992	42
1040	017033	7075	7117	7159	7200	7242	7284	7326	7367	7409	42
1041	7451	7492	7534	7576	7618	7659	7701	7743	7784	7826	42
1042	7868	7909	7951	7993	8034	8076	8118	8159	8201	8242	42
1043	8284	8326	8368	8409	8451	8492	8534	8576	8617	8659	42
1044	8700	8742	8784	8825	8867	8908	8950	8992	9033	9075	42
1045	019116	9158	9199	9241	9282	9324	9366	9407	9449	9490	42
1046	9532	9573	9615	9656	9698	9739	9781	9822	9864	9905	41
1047	9947	9988	*0030	*0071	*0113	*0154	*0195	*0237	*0278	*0320	41
1048	020361	0403	0444	0486	0527	0568	0610	0651	0693	0734	41
1049	0775	0817	0858	0900	0941	0982	1024	1065	1107	1148	41
1050	021189	1231	1272	1313	1355	1396	1437	1479	1520	1561	41
N.	Diff.	1	2	3	4	5	6	7	8	9	Diff.
P. P. T. S.	44	4	9	13	18	22	26	31	35	40	44
	43	4	9	13	17	22	26	30	34	39	43
	42	4	8	13	17	21	25	29	34	38	42
	41	4	8	12	16	21	25	29	33	37	41
Diff.	1	2	3	4	5	6	7	8	9	Diff.	

TABLE OF LOGARITHMIC SINES—COSINES, ETC. 1653

0°

TABLE OF LOGARITHMIC SINES—COSINES

179°

M.	Sin.	D. 1".	Cos.	D. 1".	Tan.	D. 1".	Cot.	
0	—∞		10.000000		—∞		—∞	60
1	6.463726		.000000	.00	6.463726		3.536274	59
2	.764756	5017.17	.000000	.00	.764756	5017.17	.235244	58
3	.940847	2934.85	.000000	.00	.940847	2934.85	.059153	57
4	7.065786	2082.32	.000000	.00	7.065786	2082.32	2.934214	56
5	7.162696	1615.17	10.000000	.02	7.162696	1615.17	2.837304	55
6	.241877	1319.68	9.999999	.02	.241878	1319.70	.758122	54
7	.308824	1115.78	.999999	.00	.308825	1115.78	.691175	53
8	.366816	966.53	.999999	.00	.366817	966.53	.633183	52
9	.417968	852.53	.999999	.00	.417970	852.55	.582030	51
		762.63		.02		762.62		
10	7.463726	689.87	9.999998	.02	7.463727	689.88	2.536273	50
11	.505118	629.80	.999998	.02	.505120	629.82	.494880	49
12	.542906	579.37	.999997	.02	.542909	579.38	.457091	48
13	.577668	536.42	.999997	.02	.577672	536.42	.422328	47
14	.609853	499.38	.999996	.02	.609857	499.38	.390143	46
15	7.639816	467.15	9.999996	.02	7.639820	467.15	2.360180	45
16	.667845	438.80	.999995	.02	.667849	438.83	.332151	44
17	.694173	413.73	.999995	.02	.694179	413.73	.305821	43
18	.718997	391.35	.999994	.02	.719003	391.35	.280997	42
19	.742478	371.27	.999993	.02	.742484	371.28	.257516	41
				.02				
20	7.764754	353.15	9.999993	.02	7.764761	353.17	2.235239	40
21	.785943	336.72	.999992	.02	.785951	336.73	.210490	39
22	.806146	321.75	.999991	.02	.806155	321.75	.193845	38
23	.825451	308.05	.999990	.02	.825460	308.07	.174540	37
24	.843934	295.47	.999989	.02	.843944	295.50	.156056	36
25	7.861662	283.88	9.999989	.02	7.861674	283.90	2.138326	35
26	.878695	273.17	.999988	.02	.878708	273.18	.121292	34
27	.895085	263.23	.999987	.02	.895099	263.25	.104901	33
28	.910879	254.00	.999986	.02	.910884	254.00	.089106	32
29	.926119	245.38	.999985	.03	.926134	245.40	.073866	31
				.02				
30	7.940842	237.33	9.999983	.02	7.940858	237.37	2.059142	30
31	.955082	229.80	.999982	.02	.955100	229.82	.044900	29
32	.968870	222.72	.999981	.02	.968889	222.72	.031111	28
33	.982233	216.08	.999980	.02	.982253	216.10	.017747	27
34	.995108	209.82	.999979	.03	.995129	209.83	.004781	26
35	8.007787	203.90	9.999977	.02	8.007809	203.92	1.992191	25
36	.020021	198.30	.999976	.02	.020044	198.35	.979956	24
37	.031919	193.03	.999975	.03	.031945	193.03	.968085	23
38	.043501	188.00	.999973	.02	.043527	188.03	.956473	22
39	.054781	183.25	.999972	.02	.054809	183.28	.945191	21
				.02				
40	8.065776	178.73	9.999971	.03	8.065806	178.75	1.931494	20
41	.076500	174.42	.999969	.02	.076531	174.43	.923469	19
42	.086965	170.30	.999968	.03	.086997	170.33	.913003	18
43	.097133	166.40	.999966	.03	.097217	166.43	.902783	17
44	.107167	162.65	.999964	.03	.107203	162.67	.892797	16
45	8.116926	159.08	9.999963	.02	8.116963	159.12	1.883037	15
46	.126471	155.65	.999961	.03	.126510	155.68	.873490	14
47	.135810	152.38	.999959	.02	.135851	152.42	.864149	13
48	.144953	149.23	.999957	.03	.144996	149.27	.855004	12
49	.153907	146.23	.999956	.03	.153952	146.25	.846048	11
				.03				
50	8.162681	143.32	9.999954	.03	8.162727	143.35	1.837273	10
51	.171280	140.55	.999952	.03	.171328	140.58	.828672	9
52	.179713	137.87	.999950	.03	.179763	137.88	.820237	8
53	.187985	135.28	.999948	.03	.188036	135.33	.811064	7
54	.196102	132.80	.999946	.03	.196156	132.83	.803344	6
55	8.204070	130.42	9.999944	.03	8.204126	130.45	1.795874	5
56	.211895	128.10	.999942	.03	.211953	128.13	.788047	4
57	.219581	125.88	.999940	.03	.219641	125.90	.780359	3
58	.227134	123.72	.999938	.03	.227195	123.77	.772805	2
59	.234557	121.63	.999936	.03	.234621	121.67	.765379	1
60	8.241855		9.999934		8.241921		1.758079	0
	Cos.	D. 1".	Sin.	D. 1".	Cot.	D. 1".	Tan.	M.

90°

* From Allen's "Field and Office Tables." Copyright.

89

M.	Sin.	D. 1".	Cos.	D. 1".	Tan.	D. 1".	Cot.	M.
0	8.241855	119.63	9.999934	.03	8.241921	119.68	1.758079	60
1	.249033	117.68	.999932	.05	.249102	117.72	.750838	59
2	.256094	115.80	.999929	.03	.256165	115.83	.743835	58
3	.263042	113.98	.999927	.03	.263115	114.02	.736885	57
4	.269881	112.22	.999925	.03	.269956	112.25	.730044	56
5	8.276014	110.48	9.999922	.05	8.276631	110.53	1.723309	55
6	.283243	108.83	.999920	.03	.283323	108.88	.716677	54
7	.289773	107.23	.999918	.03	.289856	107.27	.710144	53
8	.296207	105.65	.999915	.05	.296292	105.70	.703708	52
9	.302546	104.13	.999913	.03	.302634	104.17	.697366	51
10	8.308794	102.67	9.999910	.05	8.308834	102.70	1.691116	50
11	.314954	101.24	.999907	.03	.315046	101.27	.684954	49
12	.321027	99.82	.999905	.05	.321122	99.87	.678878	48
13	.327016	98.47	.999902	.03	.327114	98.52	.672886	47
14	.332924	97.15	.999899	.05	.333025	97.18	.666975	46
15	8.338753	95.85	9.998997	.03	8.338856	95.90	1.661144	45
16	.344504	94.62	.999894	.05	.344610	94.65	.655390	44
17	.350181	93.37	.999891	.03	.350289	93.43	.649711	43
18	.355783	92.20	.999888	.05	.355895	92.25	.644105	42
19	.361315	91.03	.999885	.03	.361430	91.08	.638570	41
20	8.366777	89.90	9.998882	.05	8.366895	89.95	1.633105	40
21	.372171	88.80	.999879	.03	.372292	88.83	.627708	39
22	.377479	87.72	.999876	.05	.377622	87.78	.622378	38
23	.382762	86.67	.999873	.03	.382889	86.72	.617111	37
24	.387962	85.65	.999870	.05	.388092	85.70	.611908	36
25	8.393101	84.63	9.99867	.03	8.393234	84.68	1.606766	35
26	.398179	83.67	.999864	.05	.398315	83.72	.601685	34
27	.403199	82.70	.999861	.03	.403338	82.77	.596662	33
28	.408161	81.78	.999858	.05	.408304	81.82	.591696	32
29	.413068	80.85	.999854	.03	.413213	80.92	.586787	31
30	8.417919	79.97	9.99851	.05	8.418068	80.02	1.581932	30
31	.422717	79.08	.999848	.03	.422869	79.15	.577131	29
32	.427462	78.23	.999844	.05	.427618	78.28	.572382	28
33	.432156	77.40	.999841	.03	.432315	77.45	.567685	27
34	.436800	76.57	.999838	.05	.436622	76.63	.563038	26
35	8.441394	75.78	9.99834	.03	8.441560	75.83	1.558440	25
36	.445941	75.08	.999831	.05	.446110	75.05	.553890	24
37	.450440	74.22	.999827	.03	.450613	74.28	.549387	23
38	.454893	73.47	.999824	.05	.455070	73.52	.544920	22
39	.459301	72.73	.999820	.03	.459491	72.80	.540519	21
40	8.463665	72.00	9.99816	.05	8.463849	72.05	1.536151	20
41	.467985	71.30	.999813	.03	.468172	71.37	.531828	19
42	.472263	70.58	.999809	.05	.472454	70.65	.527546	18
43	.476498	69.92	.999805	.03	.476693	69.98	.523307	17
44	.480693	69.25	.999801	.05	.480892	69.30	.519108	16
45	8.484848	68.53	9.99797	.03	8.485050	68.67	1.514950	15
46	.488963	67.95	.999794	.05	.489170	68.00	.510830	14
47	.493040	67.30	.999790	.03	.493250	67.38	.506750	13
48	.497078	66.70	.999786	.05	.497293	66.75	.502707	12
49	.501080	66.08	.999782	.03	.501298	66.15	.498702	11
50	8.505045	65.48	9.99778	.05	8.505267	65.55	1.494733	10
51	.508974	64.88	.999774	.03	.509200	64.97	.490800	9
52	.512867	64.32	.999769	.05	.513098	64.38	.486902	8
53	.516726	63.75	.999765	.03	.516961	63.82	.483039	7
54	.520551	63.20	.999761	.05	.520790	63.27	.479210	6
55	8.524343	62.65	9.99757	.03	8.524586	62.72	1.475414	5
56	.528102	62.10	.999753	.05	.528349	62.18	.471651	4
57	.531828	61.58	.999748	.03	.532080	61.65	.467920	3
58	.535523	61.05	.999744	.05	.535779	61.13	.464221	2
59	.539186	60.55	.999740	.03	.539447	60.62	.460553	1
60	8.542819	60.00	9.999735	.05	8.543084	60.00	1.456916	0
	Cos.	D. 1".	Sin.	D. 1".	Cot.	D. 1".	Tan.	M.

TABLE OF LOGARITHMIC SINES—COSINE, ETC. 1655

2°

177°

M.	Sin.	D. 1".	Cos.	D. 1".	Tan.	D. 1".	Cot.	
0	8.542819	60.05	9.999735	.07	8.543084	60.12	1.456916	60
1	.546422	59.55	.999731	.08	.546691	59.62	.453309	59
2	.549995	59.07	.999726	.07	.550268	59.15	.449732	58
3	.553539	58.58	.999722	.08	.553817	58.65	.446183	57
4	.557054	58.10	.999717	.07	.557336	58.20	.442664	56
5	8.560540	57.65	9.999713	.08	8.560828	57.72	1.439172	55
6	.563999	57.20	.999708	.08	.564291	57.27	.435709	54
7	.567431	56.75	.999704	.08	.567727	56.83	.432273	53
8	.570836	56.30	.999699	.08	.571137	56.38	.428863	52
9	.574214	55.87	.999694	.06	.574520	55.95	.425480	51
10	8.577566	55.43	9.999689	.07	8.577877	55.52	1.422123	50
11	.580942	55.02	.999685	.08	.581268	55.10	.418792	49
12	.584193	54.60	.999680	.08	.584514	54.63	.415486	48
13	.587419	54.20	.999675	.08	.587795	54.27	.412205	47
14	.590721	53.78	.999670	.08	.591051	53.87	.408949	46
15	8.593943	53.40	9.999665	.08	8.594283	53.47	1.405717	45
16	.597152	53.00	.999660	.08	.597492	53.08	.402508	44
17	.600332	52.62	.999655	.08	.600677	52.70	.399323	43
18	.603489	52.23	.999650	.08	.603859	52.32	.396161	42
19	.606623	51.85	.999645	.08	.606978	51.93	.393022	41
20	8.609734	51.48	9.999640	.08	8.610094	51.58	1.389906	40
21	.612823	51.13	.999635	.10	.613189	51.22	.386811	39
22	.615891	50.77	.999629	.08	.616262	50.85	.383738	38
23	.618937	50.42	.999624	.08	.619313	50.50	.380687	37
24	.621962	50.05	.999619	.08	.622343	50.15	.377657	36
25	8.624965	49.72	9.999614	.10	8.625352	49.80	1.374648	35
26	.627948	49.38	.999608	.08	.628340	49.47	.371660	34
27	.630911	49.05	.999603	.10	.631308	49.13	.368692	33
28	.633854	48.70	.999597	.08	.634256	48.80	.365744	32
29	.636776	48.40	.999592	.10	.637184	48.48	.362816	31
30	8.639680	48.05	9.999586	.08	8.640093	48.15	1.359907	30
31	.642563	47.75	.999581	.10	.642952	47.85	.357018	29
32	.645428	47.43	.999575	.08	.645853	47.52	.354147	28
33	.648274	47.13	.999570	.10	.648704	47.22	.351296	27
34	.651102	46.82	.999564	.10	.651537	46.92	.348463	26
35	8.653911	46.52	9.999558	.08	8.654352	46.62	1.345643	25
36	.656702	46.22	.999553	.10	.657149	46.32	.342851	24
37	.659475	45.92	.999547	.10	.659928	46.02	.340072	23
38	.662230	45.63	.999541	.10	.662689	45.73	.337311	22
39	.664968	45.35	.999535	.10	.665433	45.45	.334567	21
40	8.667689	45.07	9.999529	.08	8.668160	45.17	1.331840	20
41	.670393	44.78	.999524	.10	.670870	44.88	.329130	19
42	.673080	44.52	.999518	.10	.673563	44.60	.326437	18
43	.675751	44.23	.999512	.10	.676239	44.35	.323761	17
44	.678405	43.97	.999506	.10	.678900	44.10	.321100	16
45	8.681043	43.70	9.999500	.12	8.681544	43.80	1.318456	15
46	.683665	43.45	.999493	.10	.684172	43.53	.315828	14
47	.686272	43.18	.999487	.10	.686784	43.28	.313216	13
48	.688863	42.92	.999481	.10	.689351	43.03	.310619	12
49	.691438	42.67	.999475	.10	.691963	42.77	.308037	11
50	8.693998	42.42	9.999469	.10	8.694529	42.53	1.305471	10
51	.696543	42.17	.999463	.12	.697051	42.27	.302919	9
52	.699073	41.93	.999456	.10	.699617	42.03	.300383	8
53	.701589	41.68	.999450	.12	.702139	41.78	.297861	7
54	.704090	41.45	.999443	.10	.704646	41.57	.295354	6
55	8.706577	41.20	9.999437	.10	8.707140	41.30	1.292860	5
56	.709049	40.97	.999431	.12	.709618	41.08	.290382	4
57	.711507	40.75	.999424	.10	.712083	40.85	.287917	3
58	.713952	40.52	.999418	.12	.714534	40.63	.285466	2
59	.716383	40.28	.999411	.10	.716972	40.40	.283028	1
60	8.718800		9.999404		8.719396		1.280604	0
	Cos.	D. 1".	Sin.	D. 1".	Cot.	D. 1".	Tan.	M.

M.	Sin.	D. 1".	Cos.	D. 1".	Tan.	D. 1".	Cot.	M.
0	8.718800	40.07	9.999404	.10	8.719396	40.17	1.280604	60
1	.721204	39.85	.999398	.12	.721806	39.97	.278194	59
2	.723595	39.62	.999391	.12	.724204	39.73	.275796	58
3	.725972	39.42	.999384	.10	.726588	39.52	.273412	57
4	.728337	39.18	.999378	.12	.728959	39.30	.271041	56
5	8.730688	38.98	9.999371	.12	8.731317	39.10	1.268683	55
6	.733027	38.78	.999364	.12	.733663	38.88	.266337	54
7	.735354	38.55	.999357	.12	.735996	38.68	.264004	53
8	.737667	38.37	.999350	.12	.738317	38.48	.261683	52
9	.739969	38.17	.999343	.12	.740626	38.27	.259374	51
10	8.742259	37.95	9.999336	.12	8.742922	38.08	1.257078	50
11	.744536	37.77	.999329	.12	.745207	37.87	.254793	49
12	.746802	37.55	.999322	.12	.747479	37.68	.252521	48
13	.749055	37.37	.999315	.12	.749740	37.48	.250260	47
14	.751297	37.18	.999308	.12	.751999	37.48	.248011	46
15	8.753528	36.98	9.999301	.12	8.754227	37.30	1.245773	45
16	.755747	36.80	.999294	.12	.756453	37.10	.243534	44
17	.757955	36.60	.999287	.12	.758668	36.92	.241332	43
18	.760151	36.43	.999279	.13	.760872	36.73	.239128	42
19	.762337	36.23	.999272	.12	.763065	36.55	.236935	41
20	8.764511	36.07	9.999265	.13	8.765246	36.38	1.234754	40
21	.766675	35.88	.999257	.12	.767417	36.02	.232583	39
22	.768828	35.70	.999250	.13	.769578	35.82	.230422	38
23	.770970	35.52	.999242	.12	.771727	35.62	.228273	37
24	.773101	35.37	.999235	.13	.773866	35.45	.226134	36
25	8.775223	35.17	9.999227	.12	8.775999	35.28	1.224005	35
26	.777333	35.02	.999220	.12	.778114	35.13	.221886	34
27	.779434	34.83	.999212	.13	.780222	35.00	.219778	33
28	.781524	34.68	.999205	.12	.782320	34.97	.217680	32
29	.783605	34.50	.999197	.13	.784408	34.80	.215592	31
30	8.785675	34.35	9.999189	.13	8.786486	34.63	1.213514	30
31	.787736	34.18	.999181	.12	.788554	34.47	.211446	29
32	.789787	34.02	.999174	.13	.790613	34.32	.209387	28
33	.791828	33.85	.999166	.13	.792662	34.15	.207337	27
34	.793859	33.70	.999158	.13	.794701	33.98	.205299	26
35	8.795881	33.55	9.999150	.13	8.796731	33.83	1.203269	25
36	.797894	33.38	.999142	.13	.798752	33.68	.201248	24
37	.799897	33.25	.999134	.13	.800763	33.52	.199237	23
38	.801892	33.07	.999126	.13	.802765	33.37	.197235	22
39	.803876	32.93	.999118	.13	.804758	33.22	.195242	21
40	8.805852	32.78	9.999110	.13	8.806742	33.07	1.193258	20
41	.807819	32.63	.999102	.13	.808717	32.92	.191283	19
42	.809777	32.48	.999094	.13	.810683	32.77	.189317	18
43	.811726	32.35	.999086	.15	.812641	32.63	.187359	17
44	.813667	32.20	.999077	.13	.814589	32.47	.185411	16
45	8.815599	32.05	9.999069	.13	8.816529	32.33	1.183471	15
46	.817522	31.90	.999061	.13	.818461	32.20	.181539	14
47	.819436	31.78	.999053	.13	.820384	32.05	.179616	13
48	.821343	31.62	.999044	.15	.822298	31.90	.177702	12
49	.823240	31.50	.999036	.15	.824205	31.78	.175795	11
50	8.825130	31.35	9.999027	.13	8.826103	31.63	1.173897	10
51	.827011	31.22	.999019	.15	.827992	31.48	.172008	9
52	.828884	31.08	.999010	.13	.829874	31.37	.170126	8
53	.830749	30.97	.999002	.15	.831748	31.23	.168252	7
54	.832607	30.82	.998993	.15	.833613	31.08	.166387	6
55	8.834456	30.68	9.998984	.13	8.835471	30.97	1.164529	5
56	.836297	30.55	.998976	.13	.837321	30.83	.162679	4
57	.838130	30.43	.998967	.15	.839163	30.70	.160837	3
58	.839956	30.30	.998958	.15	.840998	30.58	.159002	2
59	.841774	30.18	.998950	.13	.842825	30.45	.157175	1
60	8.843585	30.00	9.998941	.15	8.844644	30.32	1.155356	0
	Cos.	D. 1".	Sin.	D. 1".	Cot.	D. 1".	Tan.	M.

TABLE OF LOGARITHMIC SINES—COSINES, ETC. 1657

4°

175°

M.	Sin.	D. 1''.	Cos.	D. 1''.	Tan.	D. 1''.	Cot.	
0	8.843585		9.998941		8.844644		1.155356	60
1	.845387	30.03	.998932	.15	.846455	30.18	.153345	59
2	.847183	29.93	.998923	.15	.848260	30.08	.151740	58
3	.848971	29.80	.998914	.15	.850057	29.95	.149943	57
4	.850751	29.67	.998905	.15	.851845	29.82	.148154	56
5	8.852525	29.57	9.998896	.15	8.853623	29.70	1.146372	55
6	.854291	29.43	.998887	.15	.855403	29.58	.144597	54
7	.856049	29.30	.998878	.15	.857171	29.47	.142829	53
8	.857801	29.20	.998869	.15	.858932	29.35	.141068	52
9	.859546	28.95	.998860	.15	.860686	29.23	.139314	51
10	8.861283	28.85	9.998851		8.862433		1.137567	50
11	.863014	28.73	.998841	.17	.864173	29.00	.135827	49
12	.864738	28.62	.998832	.15	.865906	28.88	.134094	48
13	.866455	28.50	.998823	.17	.867632	28.77	.132368	47
14	.868165	28.38	.998813	.15	.869351	28.65	.130649	46
15	8.869868	28.28	9.998804	.15	8.871064	28.55	1.128936	45
16	.871565	28.17	.998795	.15	.872770	28.43	.127230	44
17	.873255	28.05	.998785	.17	.874469	28.32	.125531	43
18	.874938	27.95	.998776	.15	.876162	28.22	.123838	42
19	.876615	27.83	.998766	.15	.877849	28.12	.122151	41
20	8.878285	27.73	9.998757		8.879529		1.120471	40
21	.879949	27.63	.998747	.17	.881202	27.88	.118793	39
22	.881607	27.52	.998738	.15	.882869	27.78	.117131	38
23	.883258	27.42	.998728	.17	.884530	27.68	.115470	37
24	.884903	27.32	.998718	.17	.886185	27.58	.113815	36
25	8.886542	27.20	9.998708	.15	8.887833	27.47	1.112167	35
26	.888174	27.12	.998699	.15	.889476	27.38	.110524	34
27	.889801	27.00	.998689	.17	.891112	27.27	.108888	33
28	.891421	26.90	.998679	.17	.892742	27.17	.107258	32
29	.893035	26.80	.998669	.17	.894366	27.07	.105634	31
30	8.894643	26.72	9.998659		8.895984		1.104016	30
31	.896246	26.60	.998649	.17	.897596	26.87	.102404	29
32	.897842	26.50	.998639	.17	.899203	26.78	.100797	28
33	.899432	26.42	.998629	.17	.900803	26.67	.999197	27
34	.901017	26.32	.998619	.17	.902398	26.58	.997602	26
35	8.902596	26.22	9.998609	.17	8.903987	26.48	1.096013	25
36	.904169	26.12	.998599	.17	.905570	26.38	.994430	24
37	.905736	26.02	.998589	.17	.907147	26.28	.992853	23
38	.907297	25.93	.998578	.18	.908719	26.20	.991281	22
39	.908853	25.85	.998568	.17	.910285	26.10	.989715	21
40	8.910404	25.75	9.998558		8.911846		1.088154	20
41	.911949	25.65	.998548	.17	.913401	25.92	.986599	19
42	.913488	25.57	.998537	.18	.914951	25.83	.985049	18
43	.915022	25.47	.998527	.18	.916495	25.73	.983505	17
44	.916550	25.38	.998516	.17	.918034	25.65	.981966	16
45	8.918073	25.30	9.998506	.18	8.919568	25.57	1.080432	15
46	.919591	25.20	.998495	.18	.921096	25.47	.978904	14
47	.921103	25.12	.998485	.17	.922619	25.38	.977381	13
48	.922610	25.12	.998474	.18	.924136	25.28	.975864	12
49	.924112	24.95	.998464	.17	.925649	25.22	.974351	11
50	8.925609	24.85	9.998453		8.927156		1.072844	10
51	.927100	24.78	.998442	.18	.928663	25.03	.971342	9
52	.928587	24.68	.998431	.18	.930155	24.95	.969845	8
53	.930068	24.60	.998421	.17	.931647	24.87	.968353	7
54	.931544	24.52	.998410	.18	.933134	24.78	.966866	6
55	8.933015	24.43	9.998399	.18	8.934616	24.70	1.065384	5
56	.934481	24.35	.998388	.18	.936093	24.62	.963907	4
57	.935942	24.27	.998377	.18	.937565	24.53	.962435	3
58	.937398	24.20	.998366	.18	.939031	24.45	.960968	2
59	.938850	24.12	.998355	.18	.940494	24.37	.959506	1
60	8.940296	24.10	9.998344		8.941952	24.30	1.058048	0
	Cos.	D. 1''.	Sin.	D. 1''.	Cot.	D. 1''.	Tan.	M.

94°

85°

5°

174°

M.	Sin.	D. 1".	Cos.	D. 1".	Tan.	D. 1".	Cot.	
0	8.940296	24.03	9.998344	.18	8.941952	24.20	1.058048	60
1	.941738	23.03	.998333	.18	.943404	24.13	.056596	59
2	.943174	23.07	.998322	.18	.944852	24.05	.055148	58
3	.944606	23.10	.998311	.18	.946295	23.98	.053705	57
4	.946034	23.17	.998300	.18	.947734	23.90	.052266	56
5	8.947456	23.20	9.998289	.20	8.949168	23.82	1.050832	55
6	.948874	23.63	.998277	.18	.950597	23.73	.049403	54
7	.950287	23.55	.998266	.18	.952021	23.67	.047979	53
8	.951646	23.43	.998255	.20	.953441	23.53	.046559	52
9	.953100	23.32	.998243	.18	.954856	23.52	.045144	51
10	8.954499	23.25	9.998232	.20	8.956267	23.45	1.043733	50
11	.955894	23.17	.998220	.18	.957674	23.35	.042326	49
12	.957284	23.10	.998209	.20	.959075	23.30	.040925	48
13	.958670	23.03	.998197	.18	.960473	23.22	.039527	47
14	.960052	22.95	.998186	.20	.961866	23.15	.038134	46
15	8.961429	22.87	9.998174	.18	8.963255	23.07	1.036745	45
16	.962801	22.82	.998163	.20	.964639	23.00	.035361	44
17	.964170	22.75	.998151	.20	.966019	22.92	.033981	43
18	.965534	22.65	.998139	.18	.967391	22.87	.032606	42
19	.966893	22.60	.998128	.20	.968766	22.78	.031234	41
20	8.968249	22.52	9.998116	.20	8.970133	22.72	1.029867	40
21	.969600	22.45	.998104	.20	.971496	22.65	.028504	39
22	.970947	22.37	.998092	.20	.972855	22.57	.027145	38
23	.972289	22.32	.998080	.20	.974209	22.52	.025791	37
24	.973628	22.23	.998068	.20	.975560	22.52	.024440	36
25	8.974962	22.15	9.998056	.20	8.976906	22.43	1.023094	35
26	.976293	22.10	.998044	.20	.978249	22.37	.021752	34
27	.977619	22.03	.998032	.20	.979586	22.30	.020414	33
28	.978941	21.97	.998020	.20	.980921	22.25	.019079	32
29	.980259	21.90	.998008	.20	.982251	22.17	.017749	31
30	8.981573	21.83	9.997996	.20	8.983577	22.10	1.016423	30
31	.982883	21.77	.997984	.20	.984899	22.03	.015101	29
32	.984189	21.70	.997972	.22	.986217	21.97	.013783	28
33	.985491	21.63	.997959	.20	.987532	21.92	.012468	27
34	.986789	21.57	.997947	.20	.988842	21.83	.011158	26
35	8.988083	21.52	9.997935	.22	8.990149	21.78	1.019851	25
36	.989374	21.43	.997922	.20	.991451	21.70	.008549	24
37	.990660	21.38	.997910	.20	.992750	21.65	.007250	23
38	.991943	21.32	.997897	.22	.994045	21.58	.005955	22
39	.993222	21.25	.997885	.22	.995337	21.53	.004663	21
40	8.994497	21.18	9.997872	.20	8.996624	21.45	1.003376	20
41	.995768	21.13	.997860	.20	.997918	21.40	.002092	19
42	.997036	21.05	.997847	.22	.999188	21.33	.000812	18
43	.998299	21.02	.997835	.20	9.000465	21.28	0.999535	17
44	.999560	20.93	.997822	.22	.001738	21.22	.998262	16
45	0.000816	20.88	9.997809	.20	9.003007	21.15	0.996993	15
46	.002069	20.82	.997797	.22	.004272	21.08	.995728	14
47	.003318	20.75	.997784	.22	.005534	21.03	.994466	13
48	.004563	20.70	.997771	.22	.006792	20.97	.993208	12
49	.005805	20.65	.997758	.22	.008047	20.92	.991953	11
50	9.007044	20.57	9.997745	.22	9.009298	20.85	0.990702	10
51	.008278	20.53	.997732	.22	.010546	20.80	.989454	9
52	.009510	20.45	.997719	.22	.011790	20.73	.988210	8
53	.010737	20.42	.997706	.22	.013031	20.68	.986969	7
54	.011962	20.33	.997693	.22	.014268	20.62	.985732	6
55	9.013182	20.30	9.997680	.22	9.015502	20.57	0.984498	5
56	.014400	20.22	.997667	.22	.016732	20.50	.983268	4
57	.015613	20.18	.997654	.22	.017959	20.45	.982041	3
58	.016824	20.12	.997641	.22	.019183	20.40	.980817	2
59	.018031	20.07	.997628	.22	.020403	20.33	.979597	1
60	9.019235		9.997614	.23	9.021620	20.28	0.978380	0
	Cos.	D. 1".	Sin.	D. 1".	Cot.	D. 1".	Tan.	M.

95°

84°

TABLE OF LOGARITHMIC SINES—COSINES, ETC. 1659

90°

173°

M.	Sin.	D. 1''.	Cos.	D. 1''.	Tan.	D. 1''.	Cot.	
0	9.019235	20.00	9.997614		9.021620	20.23	0.978380	60
1	.020435	19.95	.997601	.22	.022834	20.17	.977166	59
2	.021632	19.88	.997588	.23	.024044	20.10	.975956	58
3	.022825	19.85	.997574	.22	.025251	20.07	.974749	57
4	.024016	19.78	.997561	.23	.026455	20.00	.973545	56
5	9.025203	19.72	9.997547		9.027655	19.95	0.972345	55
6	.026386	19.68	.997534	.22	.028852	19.95	.971148	54
7	.027567	19.62	.997520	.23	.030046	19.90	.969954	53
8	.028744	19.57	.997507	.22	.031237	19.85	.968763	52
9	.029918	19.52	.997493	.23	.032425	19.80	.967575	51
10	9.031089	19.47	9.997480		9.033609	19.73	0.966391	50
11	.032257	19.40	.997466	.23	.034791	19.70	.965209	49
12	.033421	19.35	.997452	.22	.035969	19.63	.964031	48
13	.034582	19.32	.997439	.23	.037144	19.58	.962856	47
14	.035741	19.25	.997425	.23	.038316	19.48	.961684	46
15	9.036896	19.20	9.997411		9.039485	19.43	0.960515	45
16	.038048	19.15	.997397	.23	.040651	19.43	.959349	44
17	.039197	19.08	.997383	.23	.041813	19.37	.958187	43
18	.040342	19.05	.997369	.23	.042973	19.33	.957027	42
19	.041485	19.00	.997355	.23	.044130	19.28	.955870	41
20	9.042625	18.95	9.997341		9.045284	19.23	0.954716	40
21	.043762	18.95	.997327	.23	.046434	19.17	.953566	39
22	.044895	18.88	.997313	.23	.047582	19.13	.952418	38
23	.046026	18.85	.997299	.23	.048727	19.08	.951273	37
24	.047154	18.75	.997285	.23	.049869	19.03	.950131	36
25	9.048279	18.68	9.997271		9.051003	18.98	0.948992	35
26	.049400	18.65	.997257	.23	.052144	18.93	.947856	34
27	.050519	18.60	.997242	.25	.053277	18.88	.946723	33
28	.051635	18.57	.997228	.23	.054407	18.83	.945593	32
29	.052749	18.50	.997214	.25	.055535	18.80	.944465	31
30	9.053859	18.45	9.997199		9.056659	18.73	0.943341	30
31	.054966	18.42	.997185	.23	.057781	18.70	.942219	29
32	.056071	18.35	.997170	.25	.058900	18.65	.941100	28
33	.057172	18.35	.997156	.23	.060016	18.60	.939984	27
34	.058271	18.32	.997141	.25	.061130	18.57	.938870	26
35	9.059367	18.22	9.997127		9.062240	18.50	0.937760	25
36	.060460	18.18	.997112	.23	.063348	18.47	.936652	24
37	.061551	18.13	.997098	.25	.064453	18.42	.935547	23
38	.062639	18.08	.997083	.25	.065556	18.38	.934444	22
39	.063724	18.03	.997068	.25	.066655	18.32	.933345	21
40	9.064806	17.98	9.997053		9.067752	18.28	0.932248	20
41	.065885	17.95	.997039	.23	.068846	18.23	.931154	19
42	.066962	17.90	.997024	.25	.069938	18.20	.930062	18
43	.068036	17.85	.997009	.25	.071027	18.15	.928973	17
44	.069107	17.82	.996994	.25	.072113	18.10	.927887	16
45	9.070176	17.77	9.996979		9.073197	18.07	0.926803	15
46	.071242	17.73	.996964	.25	.074278	18.02	.925722	14
47	.072306	17.67	.996949	.25	.075356	17.97	.924644	13
48	.073366	17.63	.996934	.25	.076432	17.93	.923563	12
49	.074424	17.60	.996919	.25	.077505	17.88	.922485	11
50	9.075480	17.55	9.996904		9.078576	17.85	0.921424	10
51	.076533	17.50	.996889	.25	.079644	17.80	.920356	9
52	.077583	17.50	.996874	.25	.080710	17.77	.919290	8
53	.078631	17.47	.996858	.27	.081773	17.72	.918227	7
54	.079676	17.42	.996843	.25	.082833	17.67	.917167	6
55	9.080719	17.38	9.996828		9.083891	17.63	0.916109	5
56	.081759	17.33	.996812	.27	.084947	17.60	.915053	4
57	.082797	17.30	.996797	.25	.086000	17.55	.914000	3
58	.083832	17.25	.996782	.25	.087050	17.50	.912950	2
59	.084864	17.20	.996766	.27	.088098	17.47	.911902	1
60	9.085894	17.17	9.996751		9.089144	17.43	0.910856	0
	Cos.	D. 1''.	Sin.	D. 1''.	Cot.	D. 1''.	Tan.	M.

96°

83°

M.	Sin.	D. 1".	Coa.	D. 1".	Tan.	D. 1".	Cot.	
0	9.085894	17.13	9.996751	.27	9.089144	17.38	0.910856	60
1	.086922	17.03	.996735	.27	.090187	17.30	.909813	59
2	.087947	17.05	.996720	.25	.091223	17.35	.908772	58
3	.088970	17.00	.996704	.27	.092266	17.27	.907734	57
4	.089990	16.97	.996688	.27	.093302	17.23	.906693	56
5	9.091008	16.93	9.996673	.27	9.094336	17.13	0.905664	55
6	.092024	16.83	.996657	.27	.095357	17.13	.904633	54
7	.093037	16.83	.996641	.27	.096365	17.13	.903605	53
8	.094047	16.82	.996625	.27	.097422	17.12	.902578	52
9	.095056	16.77	.996610	.27	.098446	17.07	.901554	51
10	9.096062	16.72	9.996594	.27	9.099468	16.98	0.900532	50
11	.097065	16.63	.996578	.27	.100487	16.95	.899513	49
12	.098066	16.65	.996562	.27	.101504	16.92	.898491	48
13	.099065	16.62	.996546	.27	.102519	16.88	.897467	47
14	.100062	16.57	.996530	.27	.103532	16.83	.896446	46
15	9.101056	16.53	9.996514	.27	9.104542	16.80	0.895428	45
16	.102043	16.43	.996498	.27	.105550	16.77	.894450	44
17	.103037	16.47	.996482	.25	.106556	16.72	.893444	43
18	.104025	16.42	.996465	.27	.107559	16.63	.892441	42
19	.105010	16.37	.996449	.27	.108560	16.65	.891440	41
20	9.105992	16.35	9.996433	.27	9.109559	16.62	0.890441	40
21	.106973	16.30	.996417	.28	.110556	16.53	.889444	39
22	.107951	16.27	.996400	.28	.111551	16.53	.888449	38
23	.108927	16.23	.996384	.27	.112543	16.53	.887457	37
24	.109901	16.20	.996368	.27	.113533	16.50	.886467	36
25	9.110873	16.20	9.996351	.23	9.114521	16.47	0.885479	35
26	.111842	16.15	.996335	.27	.115507	16.43	.884493	34
27	.112809	16.08	.996318	.27	.116491	16.35	.883509	33
28	.113774	16.05	.996302	.25	.117472	16.33	.882528	32
29	.114737	16.02	.996285	.27	.118452	16.28	.881548	31
30	9.115698	15.97	9.996269	.28	9.119429	16.25	0.880571	30
31	.116656	15.95	.996252	.28	.120404	16.22	.879596	29
32	.117613	15.90	.996235	.27	.121377	16.18	.878623	28
33	.118567	15.87	.996219	.27	.122348	16.18	.877652	27
34	.119519	15.83	.996202	.28	.123317	16.15	.876683	26
35	9.120469	15.80	9.996185	.28	9.124284	16.12	0.875716	25
36	.121417	15.75	.996168	.28	.125249	16.08	.874751	24
37	.122362	15.70	.996151	.28	.126211	16.03	.873789	23
38	.123306	15.73	.996134	.28	.127172	16.02	.872828	22
39	.124248	15.65	.996117	.28	.128130	15.97	.871870	21
40	9.125187	15.63	9.996100	.28	9.129087	15.90	0.870913	20
41	.126125	15.58	.996083	.28	.130041	15.88	.869959	19
42	.127060	15.55	.996066	.28	.130994	15.83	.869006	18
43	.127993	15.53	.996049	.28	.131944	15.82	.868056	17
44	.128925	15.48	.996032	.28	.132893	15.77	.867107	16
45	9.129854	15.45	9.996015	.28	9.133839	15.75	0.866161	15
46	.130781	15.42	.995998	.28	.134784	15.70	.865216	14
47	.131706	15.40	.995980	.30	.135726	15.70	.864274	13
48	.132630	15.35	.995963	.28	.136667	15.68	.863333	12
49	.133551	15.32	.995946	.30	.137605	15.63	.862395	11
50	9.134470	15.28	9.995928	.28	9.138542	15.62	0.861458	10
51	.135397	15.27	.995911	.28	.139476	15.57	.860524	9
52	.136303	15.22	.995894	.28	.140409	15.55	.859591	8
53	.137216	15.20	.995876	.30	.141340	15.52	.858660	7
54	.138128	15.15	.995859	.30	.142269	15.48	.857731	6
55	9.139037	15.12	9.995841	.30	9.143196	15.45	0.856804	5
56	.139944	15.10	.995823	.30	.144121	15.42	.855879	4
57	.140850	15.07	.995806	.28	.145044	15.38	.854956	3
58	.141754	15.07	.995788	.30	.145966	15.37	.854034	2
59	.142655	15.02	.995771	.28	.146885	15.32	.853115	1
60	9.143555	15.00	9.995753	.30	9.147803	15.30	0.852197	0
	Coa.	D. 1".	Sin.	D. 1".	Cot.	D. 1".	Tan.	M.

TABLE OF LOGARITHMIC SINES—COSINES, ETC. 1661

8°

171°

M.	Sin.	D. 1".	Cos.	D. 1".	Tan.	D. 1".	Cot.	
0	9.143555	14.97	9.995753	.30	9.147803	15.25	0.852197	60
1	.144453	14.93	.995735	.30	.148718	15.23	.851282	59
2	.145349	14.90	.995717	.30	.149632	15.20	.850368	58
3	.146243	14.88	.995699	.30	.150544	15.17	.849456	57
4	.147136	14.83	.995681	.30	.151454	15.15	.848546	56
5	9.148026	14.82	9.995664	.28	9.152363	15.15	0.847637	55
6	.148915	14.78	.995646	.30	.153269	15.10	.846731	54
7	.149802	14.73	.995628	.30	.154174	15.08	.845826	53
8	.150686	14.72	.995610	.30	.155077	15.05	.844923	52
9	.151569	14.70	.995591	.30	.155978	15.02	.844022	51
10	9.152451	14.65	9.995573	.30	9.156877	14.98	0.843123	50
11	.153330	14.63	.995555	.30	.157775	14.97	.842225	49
12	.154208	14.63	.995537	.30	.158671	14.93	.841329	48
13	.155083	14.58	.995519	.30	.159565	14.90	.840435	47
14	.155957	14.57	.995501	.30	.160457	14.87	.839543	46
15	9.156830	14.55	9.995482	.32	9.161347	14.83	0.838653	45
16	.157700	14.50	.995464	.30	.162236	14.82	.837764	44
17	.158569	14.48	.995446	.30	.163123	14.78	.836877	43
18	.159435	14.43	.995427	.32	.164008	14.75	.835992	42
19	.160301	14.43	.995409	.30	.164892	14.73	.835108	41
20	9.161164	14.35	9.995390	.30	9.165774	14.70	0.834226	40
21	.162025	14.33	.995372	.32	.166651	14.67	.833346	39
22	.162885	14.30	.995353	.32	.167532	14.63	.832468	38
23	.163743	14.28	.995334	.30	.168409	14.62	.831591	37
24	.164600	14.23	.995316	.32	.169284	14.58	.830716	36
25	9.165451	14.23	9.995297	.32	9.170157	14.55	0.829843	35
26	.166307	14.22	.995278	.32	.171029	14.53	.828971	34
27	.167159	14.20	.995260	.30	.171899	14.50	.828101	33
28	.168008	14.15	.995241	.32	.172767	14.47	.827233	32
29	.168856	14.13	.995222	.32	.173634	14.45	.826366	31
30	9.169702	14.10	9.995203	.32	9.174499	14.42	0.825501	30
31	.170547	14.08	.995184	.32	.175362	14.38	.824638	29
32	.171389	14.03	.995165	.32	.176224	14.37	.823776	28
33	.172230	14.02	.995146	.32	.177084	14.33	.822916	27
34	.173070	14.00	.995127	.32	.177942	14.30	.822058	26
35	9.173908	13.97	9.995108	.32	9.178799	14.28	0.821201	25
36	.174744	13.93	.995089	.32	.179655	14.27	.820345	24
37	.175578	13.90	.995070	.32	.180508	14.22	.819492	23
38	.176411	13.88	.995051	.32	.181360	14.20	.818640	22
39	.177242	13.85	.995032	.32	.182211	14.18	.817789	21
40	9.178072	13.83	9.995013	.32	9.183059	14.13	0.816941	20
41	.178900	13.80	.994993	.33	.183907	14.13	.816093	19
42	.179726	13.77	.994974	.32	.184752	14.08	.815248	18
43	.180551	13.75	.994955	.33	.185597	14.08	.814403	17
44	.181374	13.70	.994935	.32	.186439	14.03	.813561	16
45	9.182196	13.67	9.994916	.33	9.187280	14.02	0.812720	15
46	.183016	13.67	.994896	.33	.188120	14.00	.811880	14
47	.183834	13.63	.994877	.32	.188958	13.97	.811042	13
48	.184651	13.62	.994857	.33	.189794	13.93	.810206	12
49	.185466	13.58	.994838	.32	.190629	13.92	.809371	11
50	9.186280	13.57	9.994818	.33	9.191462	13.88	0.808538	10
51	.187092	13.53	.994798	.33	.192294	13.87	.807706	9
52	.187903	13.52	.994779	.32	.193124	13.83	.806876	8
53	.188712	13.48	.994759	.33	.193953	13.82	.806047	7
54	.189519	13.45	.994739	.33	.194780	13.78	.805220	6
55	9.190325	13.42	9.994720	.32	9.195606	13.77	0.804394	5
56	.191130	13.42	.994700	.33	.196430	13.73	.803570	4
57	.191933	13.38	.994680	.33	.197253	13.72	.802747	3
58	.192734	13.35	.994660	.33	.198074	13.68	.801926	2
59	.193534	13.33	.994640	.33	.198894	13.67	.801106	1
60	9.194332	13.30	9.994620	.33	9.199713	13.65	0.800287	0
	Cos.	D. 1".	Sin.	D. 1".	Cot.	D. 1".	Tan.	M.

98°

81°

9°

170

M.	Sin.	D. 1".	Cos.	D. 1".	Tan.	D. 1".	Cot.	
0	9.194332	13.28	9.994620		9.199713		0.800287	60
1	.195129	13.27	.994600	.33	.200529	13.60	.799471	59
2	.195925	13.27	.994580	.33	.201345	13.60	.798655	58
3	.196719	13.23	.994560	.33	.202159	13.57	.797841	57
4	.197511	13.20	.994540	.33	.202971	13.53	.797029	56
5	9.198302	13.18	9.994519	.35	9.203782	13.52	0.796218	55
6	.199091	13.15	.994499	.33	.204592	13.50	.795408	54
7	.199879	13.13	.994479	.33	.205400	13.47	.794600	53
8	.200666	13.12	.994459	.33	.206207	13.45	.793793	52
9	.201451	13.08	.994438	.35	.207013	13.43	.792987	51
10	9.202234	13.05	9.994418	.33	9.207817	13.40	0.792183	50
11	.203017	13.00	.994398	.35	.208619	13.37	.791381	49
12	.203797	13.00	.994377	.35	.209420	13.35	.790580	48
13	.204577	13.00	.994357	.33	.210220	13.33	.789780	47
14	.205354	12.95	.994336	.35	.211018	13.30	.788982	46
15	9.206131	12.95	9.994316	.33	9.211815	13.28	0.788185	45
16	.206906	12.92	.994295	.35	.212611	13.27	.787389	44
17	.207679	12.88	.994274	.35	.213405	13.23	.786595	43
18	.208452	12.83	.994254	.33	.214198	13.22	.785802	42
19	.209222	12.83	.994233	.35	.214989	13.18	.785011	41
20	9.209992	12.80	9.994212	.35	9.215780	13.18	0.784220	40
21	.210760	12.77	.994191	.33	.216568	13.13	.783432	39
22	.211526	12.75	.994171	.33	.217356	13.13	.782644	38
23	.212291	12.75	.994150	.35	.218142	13.10	.781858	37
24	.213055	12.73	.994129	.35	.218926	13.07	.781074	36
25	9.213818	12.72	9.994108	.35	9.219710	13.07	0.780290	35
26	.214579	12.68	.994087	.35	.220492	13.03	.779508	34
27	.215338	12.65	.994066	.35	.221272	13.00	.778728	33
28	.216097	12.65	.994045	.35	.222052	13.00	.777948	32
29	.216854	12.62	.994024	.35	.222830	12.97	.777170	31
30	9.217609	12.57	9.994003	.35	9.223607	12.95	0.776393	30
31	.218363	12.55	.993982	.37	.224382	12.92	.775613	29
32	.219116	12.53	.993960	.35	.225156	12.88	.774844	28
33	.219868	12.50	.993939	.35	.225929	12.85	.774071	27
34	.220618	12.48	.993918	.35	.226700	12.85	.773300	26
35	9.221367	12.48	9.993897	.35	9.227471	12.85	0.772529	25
36	.222115	12.47	.993875	.37	.228239	12.80	.771761	24
37	.222861	12.43	.993854	.35	.229007	12.80	.770993	23
38	.223606	12.42	.993832	.37	.229773	12.77	.770227	22
39	.224349	12.33	.993811	.35	.230539	12.77	.769461	21
40	9.225092	12.38	9.993789	.37	9.231302	12.72	0.768698	20
41	.225833	12.35	.993768	.35	.232065	12.72	.767935	19
42	.226573	12.33	.993746	.37	.232826	12.68	.767174	18
43	.227311	12.30	.993725	.35	.233586	12.67	.766414	17
44	.228048	12.28	.993703	.37	.234345	12.65	.765655	16
45	9.228784	12.27	9.993681	.35	9.235103	12.63	0.764897	15
46	.229518	12.23	.993660	.37	.235859	12.60	.764141	14
47	.230252	12.23	.993638	.35	.236614	12.58	.763386	13
48	.230984	12.20	.993616	.37	.237368	12.57	.762632	12
49	.231715	12.18	.993594	.37	.238120	12.53	.761880	11
50	9.232444	12.15	9.993572	.37	9.238872	12.53	0.761128	10
51	.233172	12.13	.993550	.37	.239622	12.50	.760378	9
52	.233899	12.12	.993528	.37	.240371	12.48	.759629	8
53	.234625	12.10	.993506	.37	.241118	12.45	.758882	7
54	.235349	12.07	.993484	.37	.241865	12.45	.758135	6
55	9.236073	12.07	9.993462	.37	9.242610	12.42	0.757390	5
56	.236795	12.03	.993440	.37	.243354	12.40	.756646	4
57	.237515	12.00	.993418	.37	.244097	12.38	.755903	3
58	.238235	12.00	.993396	.37	.244839	12.37	.755161	2
59	.238953	11.97	.993374	.37	.245579	12.33	.754421	1
60	9.239670	11.95	9.993351	.38	9.246319	12.33	0.753681	0
	Cos.	D. 1"	Sin.	D. 1"	Cot.	D. 1"	Tan.	M.

99°

80°

TABLE OF LOGARITHMIC SINES—COSINES, ETC. 1663

10°

169°

M.	Sin.	D. 1".	Cos.	D. 1".	Tan.	D. 1".	Cot.	M.
0	9.239670	11.93	9.993351	.37	9.246319	12.30	0.753681	60
1	.240386	11.92	.993329	.37	.247057	12.28	.753943	59
2	.241101	11.88	.993307	.38	.247794	12.27	.754206	58
3	.241814	11.87	.993284	.37	.248530	12.23	.754470	57
4	.242526	11.85	.993262	.37	.249264	12.23	.754736	56
5	9.243237	11.83	9.993240	.38	9.249998	12.20	0.755002	55
6	.243947	11.82	.993217	.37	.250730	12.18	.749270	54
7	.244656	11.78	.993195	.38	.251461	12.17	.748539	53
8	.245363	11.77	.993172	.38	.252191	12.15	.747809	52
9	.246069	11.77	.993149	.37	.252920	12.13	.747080	51
10	9.246775	11.72	9.993127	.38	9.253648	12.10	0.746352	50
11	.247478	11.72	.993104	.38	.254374	12.10	.745626	49
12	.248181	11.70	.993081	.37	.255100	12.07	.744900	48
13	.248883	11.67	.993059	.37	.255824	12.05	.744176	47
14	.249583	11.65	.993036	.38	.256547	12.03	.743453	46
15	9.250282	11.63	9.993013	.38	9.257269	12.02	0.742731	45
16	.250980	11.62	.992990	.38	.257990	12.00	.742010	44
17	.251677	11.60	.992967	.38	.258710	11.98	.741290	43
18	.252373	11.57	.992944	.38	.259429	11.95	.740571	42
19	.253067	11.57	.992921	.38	.260146	11.95	.739854	41
20	9.253761	11.53	9.992898	.38	9.260863	11.92	0.739137	40
21	.254453	11.52	.992875	.38	.261578	11.90	.738422	39
22	.255144	11.50	.992852	.38	.262292	11.88	.737708	38
23	.255834	11.48	.992829	.38	.263005	11.87	.736995	37
24	.256523	11.48	.992806	.38	.263717	11.85	.736283	36
25	9.257211	11.45	9.992783	.40	9.264428	11.83	0.735572	35
26	.257908	11.42	.992759	.38	.265138	11.82	.734862	34
27	.258598	11.42	.992736	.38	.265847	11.80	.734153	33
28	.259288	11.38	.992713	.38	.266555	11.77	.733445	32
29	.259951	11.37	.992690	.40	.267261	11.77	.732739	31
30	9.260633	11.35	9.992666	.38	9.267967	11.73	0.732033	30
31	.261314	11.33	.992643	.40	.268671	11.73	.731329	29
32	.261994	11.32	.992619	.38	.269375	11.70	.730625	28
33	.262673	11.30	.992596	.40	.270077	11.70	.729923	27
34	.263351	11.27	.992572	.40	.270779	11.67	.729221	26
35	9.264027	11.27	9.992549	.40	9.271479	11.67	0.728521	25
36	.264703	11.23	.992525	.40	.272178	11.65	.727822	24
37	.265377	11.23	.992501	.40	.272876	11.63	.727124	23
38	.266051	11.20	.992478	.38	.273573	11.62	.726427	22
39	.266723	11.20	.992454	.40	.274269	11.58	.725731	21
40	9.267395	11.17	9.992430	.40	9.274964	11.57	0.725036	20
41	.268065	11.15	.992406	.40	.275658	11.55	.724342	19
42	.268734	11.13	.992382	.38	.276351	11.53	.723649	18
43	.269402	11.12	.992359	.40	.277043	11.52	.722957	17
44	.270069	11.10	.992335	.40	.277734	11.50	.722266	16
45	9.270735	11.08	9.992311	.40	9.278424	11.48	0.721576	15
46	.271400	11.07	.992287	.40	.279113	11.47	.720887	14
47	.272064	11.03	.992263	.40	.279801	11.45	.720199	13
48	.272726	11.03	.992239	.42	.280488	11.43	.719512	12
49	.273388	11.02	.992214	.40	.281174	11.40	.718826	11
50	9.274049	10.98	9.992190	.40	9.281858	11.40	0.718142	10
51	.274708	10.98	.992166	.40	.282542	11.38	.717458	9
52	.275367	10.97	.992142	.40	.283225	11.37	.716775	8
53	.276025	10.93	.992118	.42	.283907	11.35	.716093	7
54	.276681	10.93	.992093	.40	.284588	11.33	.715412	6
55	9.277337	10.90	9.992069	.42	9.285268	11.32	0.714732	5
56	.277991	10.90	.992044	.40	.285947	11.28	.714053	4
57	.278645	10.87	.992020	.40	.286624	11.28	.713376	3
58	.279297	10.85	.991996	.42	.287301	11.27	.712699	2
59	.279948	10.85	.991971	.40	.287977	11.25	.712023	1
60	9.280599	10.85	9.991947	.40	9.288652	11.25	0.711348	0

100°

79°

M.	Sin.	D. 1".	Coa.	D. 1".	Tan.	D. 1".	Cot.	
0	9.280599	10.82	9.991947		9.288652		0.711348	60
1	.281248	10.82	.991922	.42	.289326	11.23	.710674	59
2	.281897	10.78	.991897	.42	.289999	11.22	.710001	58
3	.282544	10.77	.991873	.42	.290671	11.20	.709329	57
4	.283190	10.77	.991848	.42	.291342	11.18	.708658	56
5	9.283836	10.77	9.991823	.42	9.292013	11.18	0.707987	55
6	.284480	10.73	.991799	.40	.292682	11.15	.707318	54
7	.285124	10.73	.991774	.42	.293350	11.13	.706650	53
8	.285766	10.70	.991749	.42	.294017	11.12	.705983	52
9	.286408	10.67	.991724	.42	.294684	11.12	.705316	51
10	9.287048	10.67	9.991699	.42	9.295349	11.07	0.704651	50
11	.287688	10.63	.991674	.42	.296013	11.07	.703987	49
12	.288326	10.63	.991649	.42	.296677	11.03	.703323	48
13	.288964	10.60	.991624	.42	.297339	11.03	.702661	47
14	.289600	10.60	.991599	.42	.298001	11.02	.701999	46
15	9.290236	10.57	9.991574	.42	9.298662	11.00	0.701338	45
16	.290870	10.57	.991549	.42	.299322	11.00	.700678	44
17	.291504	10.55	.991524	.42	.299980	10.97	.700020	43
18	.292137	10.52	.991498	.43	.300638	10.97	.699362	42
19	.292768	10.52	.991473	.42	.301295	10.95	.698705	41
20	9.293399	10.50	9.991448	.43	9.301951	10.93	0.698049	40
21	.294029	10.48	.991422	.42	.302607	10.93	.697393	39
22	.294658	10.47	.991397	.42	.303261	10.90	.696739	38
23	.295286	10.45	.991372	.42	.303914	10.88	.696086	37
24	.295913	10.43	.991346	.43	.304567	10.88	.695433	36
25	9.296539	10.43	9.991321	.42	9.305218	10.85	0.694782	35
26	.297164	10.42	.991295	.43	.305869	10.85	.694131	34
27	.297788	10.40	.991270	.42	.306519	10.83	.693481	33
28	.298412	10.40	.991244	.43	.307168	10.82	.692832	32
29	.299034	10.35	.991218	.42	.307816	10.80	.692184	31
30	9.299655	10.35	9.991193	.43	9.308463	10.78	0.691537	30
31	.300276	10.32	.991167	.43	.309109	10.77	.690891	29
32	.300895	10.32	.991141	.43	.309754	10.75	.690246	28
33	.301514	10.30	.991115	.42	.310399	10.72	.689601	27
34	.302132	10.27	.991090	.42	.311042	10.72	.688958	26
35	9.302748	10.27	9.991064	.43	9.311685	10.72	0.688315	25
36	.303364	10.25	.991038	.43	.312327	10.70	.687673	24
37	.303979	10.25	.991012	.43	.312968	10.68	.687032	23
38	.304593	10.23	.990986	.43	.313608	10.67	.686392	22
39	.305207	10.20	.990960	.43	.314247	10.65	.685753	21
40	9.305819	10.18	9.990934	.43	9.314885	10.63	0.685115	20
41	.306430	10.18	.990908	.43	.315523	10.63	.684477	19
42	.307041	10.15	.990882	.45	.316159	10.60	.683841	18
43	.307650	10.15	.990855	.45	.316795	10.58	.683205	17
44	.308259	10.13	.990829	.43	.317430	10.58	.682570	16
45	9.308867	10.12	9.990803	.43	9.318064	10.57	0.681936	15
46	.309474	10.10	.990777	.43	.318697	10.55	.681303	14
47	.310080	10.10	.990750	.45	.319330	10.55	.680670	13
48	.310685	10.08	.990724	.43	.319961	10.52	.680039	12
49	.311289	10.07	.990697	.43	.320592	10.52	.679408	11
50	9.311893	10.03	9.990671	.43	9.321222	10.50	0.678778	10
51	.312495	10.03	.990645	.45	.321851	10.48	.678149	9
52	.313097	10.02	.990618	.45	.322479	10.47	.677521	8
53	.313698	9.98	.990591	.43	.323106	10.45	.676894	7
54	.314297	10.00	.990565	.45	.323733	10.45	.676267	6
55	9.314897	9.97	9.990538	.45	9.324358	10.42	0.675642	5
56	.315495	9.95	.990511	.45	.324983	10.42	.675017	4
57	.316092	9.95	.990485	.43	.325607	10.40	.674393	3
58	.316689	9.92	.990458	.45	.326231	10.40	.673769	2
59	.317284	9.92	.990431	.45	.326853	10.37	.673147	1
60	9.317879		9.990404		9.327475		0.672525	0

TABLE OF LOGARITHMIC SINES—COSINES, ETC. 1665

12°

167°

M.	Sin.	D. 1".	Cos.	D. 1".	Tan.	D. 1".	Cot.	
0	9.317879	9.90	9.990404		9.327475		0.672525	60
1	.318473	9.88	.990378	.43	.328095	10.33	.671905	59
2	.319066	9.87	.990351	.45	.328715	10.33	.671285	58
3	.319658	9.85	.990324	.45	.329334	10.32	.670666	57
4	1.320249	9.85	.990297	.45	.329953	10.32	.670047	56
5	9.320840	9.85	9.990270	.45	9.330570	10.28	0.669430	55
6	.321430	9.83	.990243	.45	.331187	10.28	.668813	54
7	.322019	9.82	.990215	.47	.331803	10.27	.668197	53
8	.322607	9.80	.990188	.45	.332418	10.25	.667582	52
9	.323194	9.78	.990161	.45	.333033	10.25	.666967	51
10	9.323780	9.77	9.990134	.45	9.333646	10.22	0.666354	50
11	.324366	9.73	.990107	.45	.334259	10.20	.665741	49
12	.324950	9.73	.990079	.47	.334871	10.18	.665129	48
13	.325534	9.72	.990052	.45	.335482	10.18	.664518	47
14	.326117	9.72	.990025	.45	.336093	10.18	.663907	46
15	9.326700	9.68	9.989997	.47	9.336702	10.15	0.663298	45
16	.327281	9.68	.989970	.45	.337311	10.15	.662689	44
17	.327862	9.68	.989942	.47	.337919	10.13	.662081	43
18	.328442	9.65	.989915	.45	.338527	10.10	.661473	42
19	.329021	9.63	.989887	.45	.339133	10.10	.660867	41
20	9.329599	9.62	9.989860	.47	9.339739	10.08	0.660261	40
21	.330176	9.62	.989832	.47	.340344	10.07	.659656	39
22	.330753	9.60	.989804	.45	.340948	10.07	.659052	38
23	.331329	9.57	.989777	.45	.341552	10.07	.658448	37
24	.331903	9.57	.989749	.47	.342155	10.05	.657845	36
25	9.332478	9.58	9.989721	.47	9.342757	10.03	0.657243	35
26	.333051	9.55	.989693	.47	.343358	10.02	.656642	34
27	.333624	9.55	.989665	.47	.343958	10.00	.656042	33
28	.334195	9.52	.989637	.45	.344558	9.98	.655442	32
29	.334767	9.50	.989610	.47	.345157	9.97	.654843	31
30	9.335337	9.48	9.989582	.48	9.345755	9.97	0.654245	30
31	.335906	9.48	.989553	.47	.346353	9.93	.653647	29
32	.336475	9.47	.989525	.47	.346949	9.93	.653051	28
33	.337043	9.45	.989497	.47	.347545	9.93	.652455	27
34	.337610	9.45	.989469	.47	.348141	9.93	.651859	26
35	9.338176	9.43	9.989441	.47	9.348735	9.90	0.651265	25
36	.338742	9.43	.989413	.47	.349329	9.90	.650671	24
37	.339307	9.42	.989385	.47	.349922	9.88	.650078	23
38	.339871	9.40	.989356	.48	.350514	9.87	.649486	22
39	.340434	9.38	.989328	.47	.351106	9.87	.648894	21
40	9.340996	9.37	9.989300	.48	9.351697	9.83	0.648303	20
41	.341554	9.35	.989271	.47	.352287	9.82	.647713	19
42	.342119	9.33	.989243	.48	.352876	9.82	.647124	18
43	.342679	9.33	.989214	.48	.353465	9.82	.646535	17
44	.343239	9.33	.989186	.47	.354053	9.80	.645947	16
45	9.343797	9.30	9.989157	.48	9.354640	9.78	0.645360	15
46	.344355	9.30	.989128	.48	.355227	9.78	.644773	14
47	.344912	9.28	.989100	.47	.355813	9.77	.644187	13
48	.345469	9.28	.989071	.48	.356398	9.75	.643602	12
49	.346024	9.25	.989042	.48	.356982	9.73	.643018	11
50	9.346579	9.25	9.989014	.48	9.357566	9.72	0.642434	10
51	.347134	9.22	.988985	.48	.358149	9.70	.641851	9
52	.347687	9.22	.988956	.48	.358731	9.70	.641269	8
53	.348240	9.20	.988927	.48	.359313	9.70	.640687	7
54	.348792	9.20	.988898	.48	.359893	9.67	.640107	6
55	9.349343	9.18	9.988869	.48	9.360474	9.68	0.639526	5
56	.349893	9.17	.988840	.48	.361053	9.65	.638947	4
57	.350443	9.17	.988811	.48	.361632	9.65	.638368	3
58	.350992	9.15	.988782	.48	.362210	9.63	.637790	2
59	.351540	9.13	.988753	.48	.362787	9.62	.637213	1
60	9.352088	9.13	9.988724	.48	9.363364	9.62	0.636636	0
	Cos.	D. 1".	Sin.	D. 1".	Cot.	D. 1".	Tan.	M.

102°

177°

M.	Sin.	D. 1''.	Cos.	D. 1''.	Tan.	D. 1''.	Cot.	
0	9.352088	9.12	9.988724	.48	9.363364	9.60	0.636636	60
1	.352635	9.10	.988695	.48	.363940	9.58	.636060	59
2	.353181	9.08	.988666	.50	.364515	9.58	.635485	58
3	.353726	9.08	.988636	.48	.365090	9.57	.634910	57
4	.354271	9.07	.988607	.48	.365664	9.55	.634336	56
5	9.354815	9.05	9.988578	.50	9.366237	9.55	0.633763	55
6	.355358	9.05	.988548	.48	.366810	9.53	.633190	54
7	.355901	9.03	.988519	.48	.367382	9.53	.632618	53
8	.356443	9.02	.988490	.50	.367953	9.52	.632047	52
9	.356984	9.00	.988460	.48	.368524	9.52	.631476	51
10	9.357524	9.00	9.988430	.48	9.369094	9.48	0.630906	50
11	.358064	8.98	.988401	.50	.369663	9.48	.630337	49
12	.358603	8.97	.988371	.50	.370232	9.45	.629768	48
13	.359141	8.95	.988342	.48	.370799	9.45	.629201	47
14	.359678	8.95	.988312	.50	.371367	9.47	.628633	46
15	9.360215	8.95	9.988282	.50	9.371933	9.43	0.628067	45
16	.360752	8.92	.988252	.48	.372499	9.42	.627501	44
17	.361287	8.92	.988223	.50	.373064	9.42	.626936	43
18	.361822	8.90	.988193	.50	.373629	9.40	.626371	42
19	.362356	8.88	.988163	.50	.374193	9.38	.625807	41
20	9.362889	8.88	9.988133	.50	9.374756	9.38	0.625244	40
21	.363422	8.87	.988103	.50	.375319	9.37	.624681	39
22	.363954	8.85	.988073	.50	.375881	9.35	.624119	38
23	.364485	8.85	.988043	.50	.376442	9.35	.623558	37
24	.365016	8.83	.988013	.50	.377003	9.35	.622997	36
25	9.365546	8.82	9.987983	.50	9.377563	9.33	0.622437	35
26	.366075	8.82	.987953	.50	.378122	9.32	.621878	34
27	.366604	8.78	.987922	.50	.378681	9.32	.621319	33
28	.367131	8.80	.987892	.50	.379239	9.30	.620761	32
29	.367659	8.77	.987862	.50	.379797	9.28	.620203	31
30	9.368185	8.77	9.987832	.52	9.380354	9.27	0.619646	30
31	.368711	8.75	.987801	.50	.380910	9.27	.619090	29
32	.369236	8.75	.987771	.52	.381466	9.23	.618534	28
33	.369761	8.73	.987740	.50	.382020	9.23	.617980	27
34	.370285	8.73	.987710	.52	.382575	9.25	.617425	26
35	9.370808	8.72	9.987679	.50	9.383129	9.23	0.616871	25
36	.371330	8.70	.987649	.50	.383682	9.22	.616318	24
37	.371852	8.70	.987618	.52	.384234	9.20	.615766	23
38	.372373	8.68	.987588	.50	.384786	9.20	.615214	22
39	.372894	8.67	.987557	.52	.385337	9.18	.614663	21
40	9.373414	8.65	9.987526	.50	9.385888	9.17	0.614112	20
41	.373933	8.65	.987496	.52	.386438	9.15	.613562	19
42	.374452	8.63	.987465	.52	.386987	9.15	.613013	18
43	.374970	8.62	.987434	.52	.387536	9.13	.612464	17
44	.375487	8.60	.987403	.52	.388084	9.12	.611916	16
45	9.376003	8.60	9.987372	.52	9.388631	9.12	0.611369	15
46	.376519	8.60	.987341	.52	.389178	9.12	.610822	14
47	.377035	8.60	.987310	.52	.389724	9.10	.610276	13
48	.377549	8.57	.987279	.52	.390270	9.10	.609730	12
49	.378063	8.57	.987248	.52	.390815	9.08	.609185	11
50	9.378577	8.53	9.987217	.52	9.391360	9.08	0.608640	10
51	.379089	8.53	.987186	.52	.391903	9.05	.608097	9
52	.379601	8.53	.987155	.52	.392447	9.07	.607553	8
53	.380113	8.53	.987124	.52	.392989	9.03	.607011	7
54	.380624	8.52	.987092	.53	.393531	9.03	.606469	6
55	9.381134	8.50	9.987061	.52	9.394073	9.02	0.605927	5
56	.381643	8.48	.987030	.52	.394614	9.02	.605386	4
57	.382152	8.48	.986998	.53	.395154	9.00	.604846	3
58	.382661	8.45	.986967	.52	.395694	9.00	.604306	2
59	.383168	8.45	.986936	.52	.396233	8.98	.603767	1
60	9.383675	8.45	9.986904	.53	9.396771	8.97	0.603229	0
	Cos.	D. 1''.	Sin.	D. 1''.	Cot.	D. 1''.	Tan.	M.

TABLE OF LOGARITHMIC SINES—COSINES, ETC. 1667

14°

165°

M.	Sin.	D. 1".	Cos.	D. 1".	Tan.	D. 1".	Cot.	
0	9.383675	8.45	9.986904	.52	9.396771	8.97	0.603229	50
1	.384182	8.42	.986873	.53	.397309	8.95	.602691	60
2	.384687	8.42	.986841	.53	.397846	8.95	.602154	58
3	.385192	8.42	.986809	.53	.398383	8.93	.601617	57
4	.385697	8.40	.986778	.52	.398919	8.93	.601081	56
5	9.386201	8.38	9.986746	.53	9.399455	8.92	0.600545	55
6	.386704	8.38	.986714	.52	.399990	8.90	.600010	54
7	.387207	8.37	.986683	.52	.400524	8.90	.599476	53
8	.387709	8.35	.986651	.53	.401058	8.88	.598942	52
9	.388210	8.35	.986619	.53	.401591	8.88	.598409	51
10	9.388711	8.33	9.986587	.53	9.402124	8.87	0.597876	50
11	.389211	8.33	.986555	.53	.402656	8.85	.597344	49
12	.389711	8.32	.986523	.53	.403187	8.85	.596813	48
13	.390210	8.30	.986491	.53	.403718	8.85	.596282	47
14	.390708	8.30	.986459	.53	.404249	8.82	.595751	46
15	9.391206	8.28	9.986427	.53	9.404778	8.83	0.595222	45
16	.391703	8.27	.986395	.53	.405308	8.80	.594692	44
17	.392199	8.27	.986363	.53	.405836	8.80	.594164	43
18	.392695	8.27	.986331	.53	.406364	8.80	.593636	42
19	.393191	8.23	.986299	.55	.406892	8.78	.593108	41
20	9.393685	8.23	9.986266	.53	9.407419	8.77	0.592581	40
21	.394179	8.23	.986234	.53	.407945	8.75	.592055	39
22	.394673	8.22	.986202	.55	.408471	8.75	.591529	38
23	.395166	8.20	.986169	.55	.408996	8.75	.591004	37
24	.395658	8.20	.986137	.53	.409521	8.75	.590479	36
25	9.396150	8.18	9.986104	.55	9.410045	8.73	0.589955	35
26	.396641	8.18	.986072	.55	.410560	8.72	.589431	34
27	.397132	8.15	.986039	.53	.411092	8.72	.588908	33
28	.397621	8.17	.986007	.55	.411615	8.70	.588385	32
29	.398111	8.15	.985974	.53	.412137	8.68	.587863	31
30	9.398600	8.13	9.985942	.55	9.412658	8.68	0.587342	30
31	.399088	8.12	.985909	.55	.413179	8.67	.586821	29
32	.399575	8.12	.985876	.55	.413699	8.67	.586301	28
33	.400062	8.12	.985843	.55	.414219	8.67	.585781	27
34	.400549	8.12	.985811	.53	.414738	8.65	.585262	26
35	9.401035	8.10	9.985778	.55	9.415257	8.65	0.584743	25
36	.401520	8.08	.985745	.55	.415775	8.63	.584225	24
37	.402005	8.07	.985712	.55	.416293	8.62	.583707	23
38	.402489	8.05	.985679	.55	.416810	8.60	.583190	22
39	.402972	8.05	.985646	.55	.417326	8.60	.582674	21
40	9.403455	8.05	9.985613	.55	9.417842	8.60	0.582158	20
41	.403938	8.03	.985580	.55	.418358	8.58	.581642	19
42	.404420	8.02	.985547	.55	.418873	8.57	.581127	18
43	.404901	8.02	.985514	.55	.419387	8.57	.580613	17
44	.405382	8.00	.985480	.57	.419901	8.57	.580099	16
45	9.405862	7.98	9.985447	.55	9.420415	8.57	0.579585	15
46	.406341	7.98	.985414	.55	.420927	8.53	.579073	14
47	.406820	7.98	.985381	.55	.421440	8.55	.578560	13
48	.407299	7.97	.985347	.57	.421952	8.53	.578048	12
49	.407777	7.95	.985314	.57	.422463	8.52	.577537	11
50	9.408254	7.95	9.985280	.55	9.422974	8.50	0.577026	10
51	.408731	7.93	.985247	.57	.423484	8.48	.576516	9
52	.409207	7.92	.985213	.55	.423993	8.50	.576007	8
53	.409682	7.92	.985180	.55	.424503	8.47	.575497	7
54	.410157	7.92	.985146	.57	.425011	8.47	.574989	6
55	9.410632	7.90	9.985113	.55	9.425519	8.47	0.574481	5
56	.411106	7.88	.985079	.57	.426027	8.47	.573973	4
57	.411579	7.88	.985045	.57	.426534	8.45	.573466	3
58	.412052	7.87	.985011	.55	.427041	8.45	.572959	2
59	.412524	7.87	.984978	.57	.427547	8.42	.572453	1
60	9.412996		9.984944	.57	9.428052		0.571948	0
	Cos.	D. 1".	Sin.	D. 1".	Cot.	D. 1".	Tan.	M.

104°

35°

M.	Sin.	D. 1".	Co.	D. 1".	Tan.	D. 1".	Cot.	
0	9.412996	7.85	9.984944	.57	9.428052	8.43	0.571948	50
1	.413467	7.85	.984910	.57	.428558	8.40	.571442	60
2	.413938	7.83	.984876	.57	.429062	8.40	.570938	58
3	.414408	7.83	.984842	.57	.429566	8.40	.570434	57
4	.414878	7.82	.984808	.57	.430070	8.38	.569930	56
5	9.415347	7.80	9.984774	.57	9.430573	8.37	0.569427	55
6	.415815	7.80	.984740	.57	.431075	8.37	.568925	54
7	.416283	7.80	.984706	.57	.431577	8.37	.568423	53
8	.416751	7.77	.984672	.57	.432079	8.35	.567921	52
9	.417217	7.78	.984638	.58	.432580	8.33	.567420	51
10	9.417684	7.77	9.984603	.57	9.433080	8.33	0.566920	50
11	.418150	7.75	.984569	.57	.433580	8.33	.566420	49
12	.418615	7.75	.984535	.58	.434080	8.32	.565920	48
13	.419079	7.73	.984500	.58	.434579	8.32	.565421	47
14	.419544	7.75	.984466	.57	.435078	8.32	.564922	46
15	9.420007	7.72	9.984432	.58	9.435576	8.28	0.564424	45
16	.420470	7.72	.984397	.57	.436073	8.28	.563927	44
17	.420933	7.70	.984363	.58	.436570	8.28	.563430	43
18	.421395	7.70	.984328	.58	.437067	8.27	.562933	42
19	.421857	7.68	.984294	.57	.437563	8.27	.562437	41
20	9.422318	7.67	9.984259	.58	9.438059	8.25	0.561941	40
21	.422778	7.67	.984224	.57	.438554	8.25	.561446	39
22	.423238	7.65	.984190	.58	.439048	8.25	.560952	38
23	.423697	7.65	.984155	.58	.439543	8.25	.560457	37
24	.424156	7.65	.984120	.58	.440036	8.22	.559964	36
25	9.424615	7.65	9.984085	.58	9.440529	8.22	0.559471	35
26	.425073	7.63	.984050	.58	.441022	8.22	.558978	34
27	.425530	7.62	.984015	.58	.441514	8.20	.558486	33
28	.425987	7.60	.983981	.58	.442006	8.18	.557994	32
29	.426443	7.60	.983946	.58	.442497	8.18	.557503	31
30	9.426899	7.58	9.983911	.60	9.442988	8.18	0.557012	30
31	.427354	7.58	.983875	.58	.443479	8.15	.556521	29
32	.427809	7.57	.983840	.58	.443968	8.17	.556032	28
33	.428263	7.57	.983805	.58	.444458	8.15	.555542	27
34	.428717	7.55	.983770	.58	.444947	8.13	.555053	26
35	9.429170	7.55	9.983735	.58	9.445435	8.13	0.554565	25
36	.429623	7.53	.983700	.60	.445923	8.13	.554077	24
37	.430075	7.53	.983664	.60	.446411	8.13	.553589	23
38	.430527	7.53	.983629	.58	.446898	8.12	.553102	22
39	.430978	7.52	.983594	.60	.447384	8.10	.552616	21
40	9.431429	7.50	9.983558	.58	9.447870	8.10	0.552130	20
41	.431879	7.50	.983523	.60	.448356	8.08	.551644	19
42	.432329	7.48	.983487	.58	.448841	8.08	.551159	18
43	.432778	7.48	.983452	.60	.449326	8.07	.550674	17
44	.433226	7.48	.983416	.58	.449810	8.07	.550190	16
45	9.433675	7.45	9.983381	.60	9.450294	8.05	0.549706	15
46	.434122	7.45	.983345	.60	.450777	8.05	.549223	14
47	.434569	7.45	.983309	.60	.451260	8.05	.548740	13
48	.435016	7.43	.983273	.58	.451743	8.03	.548257	12
49	.435462	7.43	.983238	.60	.452225	8.02	.547775	11
50	9.435908	7.42	9.983202	.60	9.452706	8.02	0.547294	10
51	.436353	7.42	.983166	.60	.453187	8.02	.546813	9
52	.436798	7.40	.983130	.60	.453668	8.00	.546332	8
53	.437242	7.40	.983094	.60	.454148	8.00	.545852	7
54	.437686	7.40	.983058	.60	.454628	8.00	.545372	6
55	9.438129	7.38	9.983022	.60	9.455107	7.98	0.544893	5
56	.438572	7.37	.982986	.60	.455586	7.97	.544414	4
57	.439014	7.37	.982950	.60	.456064	7.97	.543936	3
58	.439456	7.35	.982914	.60	.456542	7.95	.543458	2
59	.439897	7.35	.982878	.60	.457019	7.95	.542981	1
60	9.440338	7.35	9.982842	.60	9.457496	7.95	0.542504	0
	Co.	D. 1".	Sin.	D. 1".	Cot.	D. 1".	Tan.	M.

TABLE OF LOGARITHMIC SINES—COSINES, ETC. 1669

16°

163°

M.	Sin.	D. 1''.	Cos.	D. 1''.	Tan.	D. 1''.	Cot.	
0	9.440338		9.982842		9.457496		0.542504	60
1	.440778	7.33	.982805	.62	.457973	7.95	.542027	59
2	.441218	7.33	.982769	.60	.458449	7.90	.541551	58
3	.441658	7.33	.982733	.60	.458925	7.93	.541075	57
4	.442096	7.30	.982696	.62	.459400	7.92	.540600	56
5	9.442535	7.32	9.982660	.60	9.459875	7.92	0.540125	55
6	.442973	7.30	.982624	.60	.460349	7.90	.539651	54
7	.443410	7.28	.982587	.62	.460823	7.90	.539177	53
8	.443847	7.28	.982551	.60	.461297	7.90	.538703	52
9	.444284	7.27	.982514	.62	.461770	7.88	.538229	51
10	9.444720		9.982477		9.462242		0.537758	50
11	.445155	7.25	.982441	.62	.462715	7.88	.537285	49
12	.445590	7.25	.982404	.62	.463186	7.85	.536814	48
13	.446025	7.23	.982367	.60	.463658	7.87	.536342	47
14	.446459	7.23	.982331	.62	.464128	7.83	.535872	46
15	9.446893		9.982294		9.464599		0.535401	45
16	.447326	7.22	.982257	.62	.465069	7.83	.534931	44
17	.447759	7.22	.982220	.62	.465539	7.83	.534461	43
18	.448191	7.20	.982183	.62	.466008	7.82	.533992	42
19	.448623	7.18	.982146	.62	.466477	7.80	.533523	41
20	9.449054		9.982109		9.466945		0.533055	40
21	.449485	7.17	.982072	.62	.467413	7.80	.532587	39
22	.449915	7.17	.982035	.62	.467880	7.78	.532120	38
23	.450345	7.17	.981998	.62	.468347	7.78	.531653	37
24	.450775	7.15	.981961	.62	.468814	7.78	.531186	36
25	9.451204		9.981924		9.469280		0.530720	35
26	.451632	7.13	.981886	.63	.469746	7.77	.530254	34
27	.452060	7.13	.981849	.62	.470211	7.75	.529789	33
28	.452488	7.13	.981812	.62	.470676	7.75	.529324	32
29	.452915	7.12	.981774	.63	.471141	7.75	.528859	31
30	9.453342		9.981737		9.471605		0.528395	30
31	.453768	7.10	.981700	.62	.472069	7.73	.527931	29
32	.454194	7.10	.981662	.63	.472532	7.72	.527468	28
33	.454619	7.08	.981625	.62	.472995	7.72	.527005	27
34	.455044	7.08	.981587	.63	.473457	7.70	.526543	26
35	9.455469		9.981549		9.473919		0.526081	25
36	.455893	7.07	.981512	.62	.474381	7.70	.525619	24
37	.456316	7.05	.981474	.63	.474842	7.68	.525158	23
38	.456739	7.05	.981436	.63	.475303	7.68	.524697	22
39	.457162	7.05	.981399	.62	.475763	7.67	.524237	21
40	9.457584		9.981361		9.476223		0.523777	20
41	.458006	7.03	.981323	.63	.476683	7.67	.523317	19
42	.458427	7.02	.981285	.63	.477142	7.65	.522858	18
43	.458848	7.00	.981247	.63	.477601	7.63	.522399	17
44	.459268	7.00	.981209	.63	.478059	7.63	.521941	16
45	9.459688		9.981171		9.478517		0.521483	15
46	.460108	7.00	.981133	.63	.478975	7.63	.521025	14
47	.460527	6.98	.981095	.63	.479432	7.62	.520568	13
48	.460946	6.98	.981057	.63	.479889	7.62	.520111	12
49	.461364	6.97	.981019	.63	.480345	7.60	.519655	11
50	9.461782		9.980981		9.480801		0.519199	10
51	.462199	6.95	.980942	.65	.481257	7.60	.518743	9
52	.462616	6.95	.980904	.63	.481712	7.58	.518288	8
53	.463032	6.93	.980866	.63	.482167	7.58	.517833	7
54	.463448	6.93	.980827	.65	.482621	7.57	.517379	6
55	9.463864		9.980789		9.483075		0.516925	5
56	.464279	6.92	.980750	.63	.483529	7.57	.516471	4
57	.464694	6.92	.980712	.65	.483982	7.55	.516018	3
58	.465108	6.90	.980673	.65	.484435	7.55	.515565	2
59	.465522	6.90	.980635	.63	.484887	7.53	.515113	1
60	9.465935		9.980596		9.485339		0.514661	0
	Cos.	D. 1''.	Sin.	D. 1''.	Cot.	D. 1''.	Tan.	M.

106°

73°

M.	Sin.	D. 1".	Cos.	D. 1".	Tan.	D. 1".	Cot.	
0	9.465935	6.88	9.980596	.63	9.485339	7.53	0.514661	60
1	.466340	6.88	.980553	.65	.485791	7.52	.514209	59
2	.466761	6.87	.980519	.65	.486242	7.52	.513758	58
3	.467173	6.87	.980480	.65	.486693	7.50	.513307	57
4	.467585	6.85	.980442	.65	.487143	7.50	.512857	56
5	9.467996	6.85	9.980403	.65	9.487593	7.50	0.512407	55
6	.468407	6.83	.980364	.65	.488042	7.48	.511957	54
7	.468817	6.83	.980325	.65	.488491	7.48	.511508	53
8	.469227	6.83	.980286	.65	.488941	7.48	.511059	52
9	.469637	6.82	.980247	.65	.489390	7.47	.510610	51
10	9.470046	6.82	9.980208	.65	9.489838	7.47	0.510162	50
11	.470455	6.80	.980169	.65	.490286	7.45	.509714	49
12	.470863	6.80	.980130	.65	.490733	7.45	.509267	48
13	.471271	6.80	.980091	.65	.491180	7.45	.508820	47
14	.471679	6.78	.980052	.65	.491627	7.45	.508373	46
15	9.472086	6.77	9.980012	.67	9.492073	7.43	0.507927	45
16	.472492	6.77	.979973	.65	.492519	7.43	.507481	44
17	.472898	6.77	.979934	.65	.492965	7.42	.507035	43
18	.473304	6.77	.979895	.67	.493410	7.40	.506590	42
19	.473710	6.75	.979855	.65	.493854	7.42	.506146	41
20	9.474115	6.73	9.979816	.67	9.494299	7.40	0.505701	40
21	.474519	6.73	.979776	.65	.494743	7.38	.505257	39
22	.474923	6.73	.979737	.67	.495186	7.40	.504814	38
23	.475327	6.72	.979697	.65	.495630	7.38	.504370	37
24	.475730	6.72	.979658	.67	.496073	7.37	.503927	36
25	9.476133	6.72	9.979618	.65	9.496515	7.37	0.503485	35
26	.476536	6.70	.979579	.67	.496957	7.37	.503043	34
27	.476938	6.70	.979539	.65	.497399	7.37	.502601	33
28	.477340	6.68	.979499	.67	.497841	7.35	.502159	32
29	.477741	6.68	.979459	.65	.498282	7.35	.501718	31
30	9.478142	6.67	9.979420	.67	9.498722	7.35	0.501278	30
31	.478542	6.67	.979380	.67	.499163	7.33	.500836	29
32	.478942	6.67	.979340	.67	.499603	7.32	.500397	28
33	.479342	6.65	.979300	.67	.500042	7.32	.499958	27
34	.479741	6.65	.979260	.67	.500481	7.32	.499519	26
35	9.480140	6.65	9.979220	.67	9.500920	7.32	0.499080	25
36	.480539	6.63	.979180	.67	.501359	7.30	.498641	24
37	.480937	6.62	.979140	.67	.501797	7.30	.498203	23
38	.481334	6.62	.979100	.68	.502235	7.28	.497765	22
39	.481731	6.62	.979059	.67	.502672	7.28	.497328	21
40	9.482128	6.62	9.979019	.67	9.503109	7.28	0.496891	20
41	.482525	6.60	.978979	.67	.503546	7.27	.496454	19
42	.482921	6.58	.978939	.68	.503982	7.27	.496018	18
43	.483316	6.60	.978898	.67	.504418	7.27	.495582	17
44	.483712	6.58	.978858	.68	.504854	7.27	.495146	16
45	9.484107	6.57	9.978817	.67	9.505289	7.25	0.494711	15
46	.484501	6.57	.978777	.67	.505724	7.25	.494276	14
47	.484895	6.57	.978737	.67	.506159	7.25	.493841	13
48	.485289	6.55	.978696	.68	.506593	7.23	.493407	12
49	.485682	6.55	.978655	.67	.507027	7.22	.492973	11
50	9.486075	6.53	9.978615	.68	9.507460	7.22	0.492540	10
51	.486467	6.55	.978574	.68	.507893	7.22	.492107	9
52	.486860	6.52	.978533	.67	.508326	7.22	.491674	8
53	.487251	6.53	.978493	.68	.508759	7.20	.491241	7
54	.487643	6.52	.978452	.68	.509191	7.20	.490809	6
55	9.488034	6.50	9.978411	.68	9.509622	7.18	0.490378	5
56	.488424	6.50	.978370	.68	.510054	7.20	.489946	4
57	.488814	6.50	.978329	.68	.510485	7.18	.489515	3
58	.489204	6.48	.978288	.68	.510916	7.18	.489084	2
59	.489593	6.48	.978247	.68	.511346	7.17	.488654	1
60	9.489982	6.48	9.978206	.68	9.511776	7.17	0.488224	0
	Cos.	D. 1".	Sin.	D. 1".	Cot.	D. 1".	Tan.	M.

TABLE OF LOGARITHMIC SINES—COSINES, ETC. 1671

18°

161°

M.	Sin.	D. 1".	Cos.	D. 1".	Tan.	D. 1".	Cot.	
0	9.489982	6.48	9.978206	.68	9.511776	7.17	0.488224	60
1	.490371	6.47	.978165	.68	.512206	7.15	.487794	59
2	.490759	6.47	.978124	.68	.512635	7.15	.487365	58
3	.491147	6.47	.978083	.68	.513064	7.15	.486936	57
4	.491535	6.45	.978042	.68	.513493	7.15	.486507	56
5	9.491922	6.43	9.978001	.70	9.513921	7.13	0.486079	55
6	.492308	6.45	.977959	.68	.514349	7.13	.485651	54
7	.492695	6.43	.977918	.68	.514777	7.12	.485223	53
8	.493081	6.42	.977877	.70	.515204	7.12	.484796	52
9	.493466	6.42	.977835	.68	.515631	7.10	.484369	51
10	9.493851	6.42	9.977794	.70	9.516057	7.12	0.483943	50
11	.494236	6.42	.977752	.68	.516484	7.10	.483516	49
12	.494621	6.40	.977711	.70	.516910	7.08	.483090	48
13	.495005	6.38	.977669	.68	.517335	7.10	.482665	47
14	.495388	6.39	.977628	.68	.517761	7.08	.482239	46
15	9.495772	6.37	9.977586	.70	9.518186	7.08	0.481814	45
16	.496154	6.38	.977544	.68	.518610	7.07	.481390	44
17	.496537	6.37	.977503	.70	.519034	7.07	.480966	43
18	.496919	6.37	.977461	.70	.519458	7.07	.480542	42
19	.497301	6.35	.977419	.70	.519882	7.05	.480118	41
20	9.497682	6.37	9.977377	.70	9.520305	7.05	0.479695	40
21	.498064	6.33	.977335	.70	.520728	7.05	.479272	39
22	.498444	6.35	.977293	.70	.521151	7.03	.478849	38
23	.498825	6.32	.977251	.70	.521573	7.03	.478427	37
24	.499204	6.32	.977209	.70	.521995	7.03	.478005	36
25	9.499584	6.32	9.977167	.70	9.522417	7.02	0.477583	35
26	.499963	6.32	.977125	.70	.522838	7.02	.477162	34
27	.500342	6.32	.977083	.70	.523259	7.02	.476741	33
28	.500721	6.30	.977041	.70	.523680	7.00	.476320	32
29	.501099	6.28	.976999	.70	.524100	7.00	.475900	31
30	9.501476	6.30	9.976957	.72	9.524520	7.00	0.475480	30
31	.501854	6.28	.976914	.70	.524940	6.98	.475060	29
32	.502231	6.27	.976872	.70	.525359	6.98	.474641	28
33	.502607	6.24	.976830	.72	.525778	6.98	.474222	27
34	.502984	6.27	.976787	.70	.526197	6.97	.473803	26
35	9.503360	6.25	9.976745	.72	9.526615	6.97	0.473385	25
36	.503735	6.25	.976702	.70	.527033	6.97	.472967	24
37	.504110	6.25	.976660	.70	.527451	6.97	.472549	23
38	.504485	6.25	.976617	.72	.527868	6.95	.472132	22
39	.504860	6.23	.976574	.70	.528285	6.95	.471715	21
40	9.505234	6.23	9.976532	.72	9.528702	6.95	0.471298	20
41	.505608	6.22	.976489	.72	.529119	6.93	.470881	19
42	.505981	6.22	.976446	.70	.529535	6.93	.470465	18
43	.506354	6.22	.976404	.72	.529951	6.92	.470049	17
44	.506727	6.20	.976361	.72	.530366	6.92	.469634	16
45	9.507099	6.20	9.976318	.72	9.530781	6.92	0.469219	15
46	.507471	6.20	.976275	.72	.531196	6.92	.468804	14
47	.507843	6.18	.976232	.72	.531611	6.90	.468389	13
48	.508214	6.18	.976189	.72	.532025	6.90	.467975	12
49	.508585	6.18	.976146	.72	.532439	6.90	.467561	11
50	9.508956	6.17	9.976103	.72	9.532853	6.88	0.467147	10
51	.509326	6.17	.976060	.72	.533266	6.88	.466734	9
52	.509696	6.15	.976017	.72	.533679	6.88	.466321	8
53	.510065	6.15	.975974	.73	.534092	6.88	.465908	7
54	.510434	6.15	.975930	.72	.534504	6.87	.465496	6
55	9.510803	6.15	9.975887	.72	9.534916	6.87	0.465084	5
56	.511172	6.13	.975844	.73	.535328	6.85	.464672	4
57	.511540	6.12	.975800	.73	.535739	6.85	.464261	3
58	.511907	6.12	.975757	.72	.536150	6.85	.463850	2
59	.512275	6.13	.975714	.72	.536561	6.85	.463439	1
60	9.512642	6.12	9.975670	.73	9.536972	6.85	0.463028	0
	Cos.	D. 1".	Sin.	D. 1".	Cot.	D. 1".	Tan.	M.

108°

71°

M.	Sin.	D. 1".	Cos.	D. 1".	Tan.	D. 1".	Cot.	
0	9.512642	6.12	9.975670	.72	9.536972	6.83	0.463028	60
1	.513009	6.10	.975627	.73	.537352	6.83	.462618	59
2	.513375	6.10	.975583	.73	.537792	6.83	.462208	58
3	.513741	6.10	.975539	.73	.538202	6.82	.461798	57
4	.514107	6.08	.975496	.72	.538611	6.82	.461389	56
5	9.514472	6.08	9.975452	.73	9.539020	6.82	0.460980	55
6	.514837	6.08	.975408	.73	.539429	6.80	.460571	54
7	.515202	6.07	.975365	.73	.539837	6.80	.460163	53
8	.515566	6.07	.975321	.73	.540245	6.80	.459755	52
9	.515930	6.07	.975277	.73	.540653	6.80	.459347	51
10	9.516294	6.05	9.975233	.73	9.541061	6.78	0.458939	50
11	.516657	6.05	.975189	.73	.541468	6.78	.458532	49
12	.517020	6.03	.975145	.73	.541875	6.77	.458125	48
13	.517382	6.03	.975101	.73	.542281	6.78	.457719	47
14	.517745	6.03	.975057	.73	.542688	6.77	.457312	46
15	9.518107	6.02	9.975013	.73	9.543094	6.77	0.456906	45
16	.518463	6.02	.974969	.73	.543499	6.75	.456501	44
17	.518829	6.02	.974925	.73	.543905	6.75	.456095	43
18	.519190	6.02	.974880	.73	.544310	6.75	.455690	42
19	.519551	6.00	.974836	.73	.544715	6.73	.455285	41
20	9.519911	6.00	9.974792	.73	9.545119	6.75	0.454881	40
21	.520271	6.00	.974748	.75	.545524	6.73	.454476	39
22	.520631	5.98	.974703	.73	.545929	6.72	.454072	38
23	.520990	5.98	.974659	.75	.546331	6.73	.453669	37
24	.521349	5.97	.974614	.73	.546735	6.72	.453265	36
25	9.521707	5.98	9.974570	.73	9.547138	6.70	0.452862	35
26	.522066	5.97	.974525	.75	.547540	6.72	.452460	34
27	.522424	5.97	.974481	.73	.547943	6.72	.452057	33
28	.522781	5.95	.974436	.75	.548345	6.70	.451655	32
29	.523138	5.95	.974391	.73	.548747	6.70	.451253	31
30	9.523495	5.95	9.974347	.75	9.549149	6.68	0.450851	30
31	.523852	5.93	.974302	.75	.549550	6.68	.450450	29
32	.524208	5.93	.974257	.75	.549951	6.68	.450049	28
33	.524564	5.93	.974212	.75	.550352	6.67	.449648	27
34	.524920	5.92	.974167	.75	.550752	6.68	.449248	26
35	9.525275	5.92	9.974122	.75	9.551153	6.65	0.448847	25
36	.525630	5.90	.974077	.75	.551552	6.65	.448448	24
37	.525984	5.90	.974032	.75	.551952	6.65	.448048	23
38	.526339	5.92	.973987	.75	.552351	6.65	.447649	22
39	.526693	5.88	.973942	.75	.552750	6.65	.447250	21
40	9.527046	5.90	9.973897	.75	9.553149	6.65	0.446851	20
41	.527400	5.83	.973852	.75	.553543	6.63	.446452	19
42	.527753	5.87	.973807	.77	.553946	6.63	.446054	18
43	.528105	5.88	.973761	.75	.554344	6.62	.445656	17
44	.528458	5.87	.973716	.75	.554741	6.63	.445259	16
45	9.528810	5.85	9.973671	.77	9.555139	6.62	0.444861	15
46	.529161	5.87	.973625	.75	.555536	6.62	.444464	14
47	.529513	5.85	.973580	.75	.555933	6.60	.444067	13
48	.529864	5.85	.973535	.75	.556329	6.60	.443671	12
49	.530215	5.83	.973489	.75	.556725	6.60	.443275	11
50	9.530565	5.83	9.973444	.77	9.557121	6.60	0.442879	10
51	.530915	5.83	.973398	.77	.557517	6.60	.442483	9
52	.531265	5.82	.973352	.77	.557913	6.58	.442087	8
53	.531614	5.82	.973307	.75	.558308	6.58	.441692	7
54	.531963	5.82	.973261	.77	.558703	6.57	.441297	6
55	9.532312	5.82	9.973215	.77	9.559097	6.57	0.440903	5
56	.532661	5.80	.973169	.77	.559491	6.57	.440509	4
57	.533009	5.80	.973124	.75	.559885	6.57	.440115	3
58	.533357	5.78	.973078	.77	.560279	6.57	.439721	2
59	.533704	5.80	.973032	.77	.560673	6.55	.439327	1
60	9.534052		9.972986		9.561066		0.438934	0
	Cos.	D. 1".	Sin.	D. 1".	Cot.	D. 1".	Tan.	M.

TABLE OF LOGARITHMIC SINES—COSINES, ETC. 1673

10°

159°

M.	Sin.	D. 1".	Cos.	D. 1".	Tan.	D. 1".	Cot.	
0	9.534052		9.972986		9.561066		0.438934	60
1	.534399	5.78	.972940	.77	.561459	6.55	.438541	59
2	.534745	5.77	.972894	.77	.561851	6.53	.438149	58
3	.535092	5.78	.972848	.77	.562244	6.55	.437756	57
4	.535438	5.77	.972802	.77	.562636	6.53	.437364	56
5	9.535783	5.75	9.972755	.78	9.563028	6.53	0.436972	55
6	.536129	5.77	.972709	.77	.563419	6.52	.436581	54
7	.536474	5.75	.972663	.77	.563811	6.53	.436189	53
8	.536818	5.73	.972617	.77	.564202	6.52	.435798	52
9	.537163	5.75	.972570	.78	.564593	6.52	.435407	51
10	9.537507		9.972524		9.564983		0.435017	50
11	.537851	5.73	.972478	.77	.565373	6.50	.434627	49
12	.538194	5.72	.972431	.78	.565763	6.50	.434237	48
13	.538538	5.73	.972385	.77	.566153	6.50	.433847	47
14	.538880	5.70	.972338	.78	.566542	6.48	.433456	46
15	9.539223	5.72	9.972291	.78	9.566932	6.50	0.433068	45
16	.539565	5.70	.972245	.77	.567320	6.47	.432680	44
17	.539907	5.70	.972198	.78	.567709	6.48	.432291	43
18	.540249	5.70	.972151	.78	.568098	6.48	.431902	42
19	.540590	5.68	.972105	.77	.568486	6.47	.431514	41
20	9.540931		9.972058		9.568873		0.431127	40
21	.541272	5.68	.972011	.78	.569261	6.47	.430739	39
22	.541613	5.68	.971964	.78	.569648	6.45	.430352	38
23	.541953	5.67	.971917	.78	.570035	6.45	.429965	37
24	.542293	5.67	.971870	.78	.570422	6.45	.429578	36
25	9.542632	5.65	9.971823	.78	9.570809	6.45	0.429191	35
26	.542971	5.65	.971776	.78	.571195	6.43	.428805	34
27	.543310	5.65	.971729	.78	.571581	6.43	.428419	33
28	.543649	5.65	.971682	.78	.571967	6.43	.428033	32
29	.543987	5.63	.971635	.78	.572352	6.42	.427648	31
30	9.544325		9.971588		9.572738		0.427262	30
31	.544663	5.63	.971540	.80	.573123	6.42	.426877	29
32	.545000	5.62	.971493	.78	.573507	6.40	.426493	28
33	.545338	5.63	.971446	.78	.573892	6.42	.426108	27
34	.545674	5.60	.971398	.80	.574276	6.40	.425724	26
35	9.546011	5.62	9.971351	.78	9.574660	6.40	0.425340	25
36	.546347	5.60	.971303	.80	.575044	6.40	.424956	24
37	.546683	5.60	.971256	.78	.575427	6.38	.424573	23
38	.547019	5.60	.971208	.80	.575810	6.38	.424190	22
39	.547354	5.58	.971161	.78	.576193	6.38	.423807	21
40	9.547689		9.971113		9.576576		0.423424	20
41	.548024	5.58	.971066	.78	.576959	6.38	.423041	19
42	.548359	5.58	.971018	.80	.577341	6.37	.422659	18
43	.548693	5.57	.970970	.80	.577723	6.37	.422277	17
44	.549027	5.55	.970922	.80	.578104	6.35	.421896	16
45	9.549360	5.55	9.970874	.78	9.578486	6.37	0.421514	15
46	.549693	5.55	.970827	.80	.578867	6.35	.421133	14
47	.550026	5.55	.970779	.80	.579248	6.35	.420752	13
48	.550359	5.55	.970731	.80	.579629	6.35	.420371	12
49	.550692	5.55	.970683	.80	.580009	6.33	.419991	11
50	9.551024		9.970635		9.580389		0.419611	10
51	.551356	5.53	.970586	.82	.580769	6.33	.419231	9
52	.551687	5.52	.970538	.80	.581149	6.33	.418851	8
53	.552018	5.52	.970490	.80	.581528	6.32	.418472	7
54	.552349	5.52	.970442	.80	.581907	6.32	.418093	6
55	9.552680	5.50	9.970394	.82	9.582286	6.32	0.417714	5
56	.553010	5.50	.970345	.80	.582665	6.32	.417335	4
57	.553341	5.52	.970297	.80	.583044	6.32	.416956	3
58	.553670	5.48	.970249	.82	.583422	6.30	.416578	2
59	.554000	5.50	.970200	.80	.583800	6.30	.416200	1
60	9.554329	5.48	9.970152	.80	9.584177	6.28	0.415823	0
	Cos.	D. 1".	Sin.	D. 1".	Cot.	D. 1".	Tan.	M.

110°

69°

M.	Sin.	D. 1''.	Cos.	D. 1''.	Tan.	D. 1''.	Cot.	
0	9.554329		9.970152	.82	9.584177	6.30	0.415823	60
1	.554658	5.48	.970103	.80	.584555	6.28	.415445	59
2	.554987	5.48	.970055	.82	.584932	6.28	.415068	58
3	.555315	5.47	.970006	.82	.585309	6.28	.414691	57
4	.555643	5.47	.969957	.80	.585686	6.27	.414314	56
5	9.555971	5.47	9.969909	.82	9.586062	6.28	0.413938	55
6	.556299	5.47	.969860	.82	.586439	6.28	.413561	54
7	.556626	5.45	.969811	.82	.586815	6.27	.413185	53
8	.556953	5.45	.969762	.80	.587190	6.25	.412810	52
9	.557280	5.43	.969714	.82	.587566	6.27	.412434	51
10	9.557606	5.43	9.969665	.82	9.587941	6.25	0.412059	50
11	.557932	5.43	.969616	.82	.588316	6.25	.411684	49
12	.558258	5.42	.969567	.82	.588691	6.25	.411309	48
13	.558583	5.42	.969518	.82	.589066	6.25	.410934	47
14	.558909	5.42	.969469	.82	.589440	6.23	.410560	46
15	9.559234	5.40	9.969420	.83	9.589814	6.23	0.410186	45
16	.559558	5.40	.969370	.83	.590188	6.23	.409812	44
17	.559883	5.42	.969321	.82	.590562	6.23	.409438	43
18	.560207	5.40	.969272	.82	.590935	6.22	.409065	42
19	.560531	5.40	.969223	.83	.591308	6.22	.408692	41
20	9.560855	5.38	9.969173	.82	9.591681	6.22	0.408319	40
21	.561178	5.38	.969124	.82	.592054	6.20	.407946	39
22	.561501	5.38	.969075	.83	.592426	6.22	.407574	38
23	.561824	5.37	.969025	.82	.592799	6.20	.407201	37
24	.562146	5.37	.968976	.83	.593171	6.18	.406829	36
25	9.562468	5.37	9.968926	.82	9.593542	6.20	0.406458	35
26	.562790	5.37	.968877	.82	.593914	6.18	.406086	34
27	.563112	5.37	.968827	.83	.594285	6.18	.405715	33
28	.563433	5.35	.968777	.83	.594656	6.18	.405344	32
29	.563755	5.37	.968728	.82	.595027	6.18	.404973	31
30	9.564075	5.33	9.968678	.83	9.595398	6.17	0.404602	30
31	.564396	5.33	.968628	.83	.595768	6.17	.404232	29
32	.564716	5.33	.968578	.83	.596138	6.17	.403862	28
33	.565036	5.33	.968528	.82	.596508	6.17	.403492	27
34	.565356	5.33	.968479	.83	.596878	6.15	.403122	26
35	9.565676	5.32	9.968429	.83	9.597247	6.15	0.402753	25
36	.565995	5.32	.968379	.83	.597616	6.15	.402384	24
37	.566314	5.32	.968329	.83	.597985	6.15	.402015	23
38	.566632	5.30	.968278	.85	.598354	6.15	.401646	22
39	.566951	5.32	.968228	.83	.598722	6.13	.401278	21
40	9.567269	5.30	9.968178	.83	9.599091	6.13	0.400909	20
41	.567587	5.28	.968128	.83	.599459	6.13	.400541	19
42	.567904	5.30	.968078	.85	.599827	6.12	.400173	18
43	.568222	5.28	.968027	.83	.600194	6.13	.399806	17
44	.568539	5.28	.967977	.83	.600562	6.12	.399438	16
45	9.568856	5.27	9.967927	.85	9.600929	6.12	0.399071	15
46	.569172	5.27	.967876	.83	.601296	6.12	.398704	14
47	.569488	5.27	.967826	.83	.601663	6.12	.398337	13
48	.569804	5.27	.967775	.85	.602029	6.10	.397971	12
49	.570120	5.27	.967725	.83	.602395	6.10	.397605	11
50	9.570435	5.25	9.967674	.83	9.602761	6.10	0.397239	10
51	.570751	5.25	.967624	.85	.603127	6.10	.396873	9
52	.571066	5.23	.967573	.85	.603493	6.08	.396507	8
53	.571380	5.25	.967522	.85	.603858	6.08	.396142	7
54	.571695	5.23	.967471	.83	.604223	6.08	.395777	6
55	9.572009	5.23	9.967421	.85	9.604588	6.08	0.395412	5
56	.572323	5.22	.967370	.85	.604953	6.07	.395047	4
57	.572636	5.22	.967319	.85	.605317	6.07	.394683	3
58	.572950	5.23	.967268	.85	.605682	6.07	.394318	2
59	.573263	5.22	.967217	.85	.606046	6.07	.393954	1
60	9.573575	5.20	9.967166	.85	9.606410	6.07	0.393590	0

	Cos.	D. 1''.	Sin.	D. 1''.	Cot.	D. 1''.	Tan.	M.
--	------	---------	------	---------	------	---------	------	----

TABLE OF LOGARITHMIC SINES—COSINES, ETC. 1675

22°

156°

M.	Sin.	D. 1".	Co.	D. 1".	Tan.	D. 1".	Cot.	
0	9.573575		9.967166		9.606410		0.393590	60
1	.573888	5.22	.967115	.85	.606773	6.05	.393227	59
2	.574200	5.20	.967064	.85	.607137	6.07	.392863	58
3	.574512	5.20	.967013	.85	.607500	6.05	.392500	57
4	.574824	5.20	.966961	.87	.607863	6.05	.392137	56
5	9.575136	5.20	9.966910	.85	9.608225	6.03	0.391775	55
6	.575447	5.18	.966859	.85	.608588	6.05	.391412	54
7	.575758	5.18	.966808	.85	.608950	6.03	.391050	53
8	.576069	5.17	.966756	.85	.609312	6.03	.390688	52
9	.576379	5.17	.966705	.87	.609674	6.03	.390326	51
10	9.576689		9.966653		9.610036		0.389964	50
11	.576999	5.17	.966602	.87	.610397	6.02	.389603	49
12	.577309	5.15	.966550	.85	.610759	6.02	.389241	48
13	.577618	5.15	.966499	.87	.611120	6.02	.388880	47
14	.577927	5.15	.966447	.87	.611480	6.00	.388520	46
15	9.578236	5.15	9.966395	.87	9.611841	6.02	0.388159	45
16	.578545	5.15	.966344	.85	.612201	6.00	.387799	44
17	.578853	5.13	.966292	.87	.612561	6.00	.387439	43
18	.579162	5.15	.966240	.87	.612921	6.00	.387079	42
19	.579470	5.12	.966188	.87	.613281	6.00	.386719	41
20	9.579777		9.966136		9.613641		0.386359	40
21	.580085	5.12	.966085	.85	.614000	5.98	.386000	39
22	.580392	5.12	.966033	.87	.614359	5.98	.385641	38
23	.580699	5.12	.965981	.87	.614718	5.98	.385282	37
24	.581005	5.10	.965929	.88	.615077	5.98	.384923	36
25	9.581312	5.12	9.965876	.87	9.615435	5.97	0.384565	35
26	.581618	5.10	.965824	.87	.615793	5.97	.384207	34
27	.581924	5.10	.965772	.87	.616151	5.97	.383849	33
28	.582229	5.08	.965720	.87	.616509	5.97	.383491	32
29	.582535	5.10	.965668	.88	.616867	5.97	.383133	31
30	9.582840		9.965615		9.617224		0.382776	30
31	.583145	5.08	.965563	.87	.617582	5.97	.382418	29
32	.583449	5.07	.965511	.87	.617939	5.95	.382061	28
33	.583754	5.08	.965458	.83	.618295	5.93	.381705	27
34	.584058	5.07	.965406	.88	.618652	5.95	.381348	26
35	9.584361	5.05	9.965353	.87	9.619008	5.93	0.380992	25
36	.584664	5.07	.965301	.87	.619364	5.93	.380636	24
37	.584968	5.05	.965248	.83	.619720	5.93	.380280	23
38	.585272	5.07	.965195	.88	.620076	5.93	.379924	22
39	.585574	5.03	.965143	.88	.620432	5.93	.379568	21
40	9.585877		9.965090		9.620787		0.379213	20
41	.586179	5.03	.965037	.88	.621142	5.92	.378858	19
42	.586482	5.05	.964984	.88	.621497	5.92	.378503	18
43	.586783	5.02	.964931	.87	.621852	5.92	.378148	17
44	.587085	5.03	.964879	.88	.622207	5.90	.377793	16
45	9.587386	5.02	9.964826	.88	9.622561	5.90	0.377439	15
46	.587688	5.03	.964773	.88	.622915	5.90	.377085	14
47	.587989	5.02	.964720	.88	.623269	5.90	.376731	13
48	.588289	5.00	.964666	.90	.623623	5.90	.376377	12
49	.588590	5.02	.964613	.88	.623976	5.88	.376024	11
50	9.588890		9.964560		9.624330		0.375670	10
51	.589190	5.00	.964507	.88	.624683	5.88	.375317	9
52	.589489	4.98	.964454	.88	.625036	5.88	.374964	8
53	.589789	5.00	.964400	.90	.625388	5.87	.374612	7
54	.590088	4.98	.964347	.88	.625741	5.88	.374259	6
55	9.590387	4.98	9.964294	.88	9.626093	5.87	0.373907	5
56	.590686	4.97	.964240	.90	.626445	5.87	.373555	4
57	.590984	4.97	.964187	.88	.626797	5.87	.373203	3
58	.591282	4.97	.964133	.90	.627149	5.87	.372851	2
59	.591580	4.97	.964080	.88	.627501	5.87	.372499	1
60	9.591878		9.964026		9.627852		0.372148	0
	Co.	D. 1".	Sin.	D. 1".	Cot.	D. 1".	Tan.	M.

112°

67°

M.	Sin.	D. 1".	Cos.	D. 1".	Tan.	D. 1".	Cot.	
0	9.591878	4.97	9.964026	.90	9.627852	5.85	0.372148	60
1	.592176	4.95	.963972	.98	.628203	5.85	.371797	59
2	.592473	4.95	.963919	.90	.628554	5.85	.371446	58
3	.592770	4.95	.963865	.90	.628905	5.83	.371095	57
4	.593067	4.93	.963811	.90	.629255	5.85	.370745	56
5	9.593363	4.93	9.963757	.88	9.629606	5.83	0.370394	55
6	.593659	4.93	.963704	.90	.629956	5.83	.370044	54
7	.593955	4.93	.963650	.90	.630306	5.83	.369694	53
8	.594251	4.93	.963596	.90	.630656	5.83	.369344	52
9	.594547	4.92	.963542	.90	.631005	5.82	.368995	51
10	9.594842	4.92	9.963488	.90	9.631355	5.82	0.368645	50
11	.595137	4.92	.963434	.92	.631704	5.82	.368296	49
12	.595432	4.92	.963379	.90	.632053	5.82	.367947	48
13	.595727	4.90	.963325	.90	.632402	5.80	.367598	47
14	.596021	4.90	.963271	.90	.632750	5.80	.367250	46
15	9.596315	4.90	9.963217	.90	9.633099	5.82	0.366901	45
16	.596609	4.90	.963163	.90	.633447	5.80	.366553	44
17	.596903	4.88	.963108	.92	.633795	5.80	.366205	43
18	.597196	4.90	.963054	.90	.634143	5.80	.365857	42
19	.597490	4.88	.962999	.92	.634490	5.78	.365510	41
20	9.597783	4.87	9.962945	.92	9.634838	5.80	0.365162	40
21	.598075	4.88	.962890	.90	.635185	5.78	.364815	39
22	.598368	4.87	.962836	.90	.635532	5.78	.364468	38
23	.598660	4.87	.962781	.92	.635879	5.78	.364121	37
24	.598952	4.87	.962727	.92	.636226	5.77	.363774	36
25	9.599244	4.87	9.962672	.92	9.636572	5.78	0.363428	35
26	.599536	4.85	.962617	.92	.636919	5.77	.363081	34
27	.599827	4.85	.962562	.90	.637265	5.77	.362735	33
28	.600118	4.85	.962508	.90	.637611	5.77	.362389	32
29	.600409	4.85	.962453	.92	.637956	5.75	.362044	31
30	9.600700	4.83	9.962398	.92	9.638302	5.75	0.361698	30
31	.600990	4.83	.962343	.92	.638647	5.75	.361353	29
32	.601280	4.83	.962288	.92	.638992	5.75	.361008	28
33	.601570	4.83	.962233	.92	.639337	5.75	.360663	27
34	.601860	4.83	.962178	.92	.639682	5.75	.360318	26
35	9.602150	4.82	9.962123	.93	9.640027	5.73	0.359973	25
36	.602439	4.82	.962067	.92	.640371	5.75	.359629	24
37	.602728	4.82	.962012	.92	.640716	5.75	.359284	23
38	.603017	4.80	.961957	.92	.641060	5.73	.358940	22
39	.603305	4.82	.961902	.93	.641404	5.72	.358596	21
40	9.603594	4.80	9.961846	.92	9.641747	5.73	0.358253	20
41	.603882	4.80	.961791	.93	.642091	5.72	.357909	19
42	.604170	4.79	.961735	.92	.642434	5.72	.357566	18
43	.604457	4.80	.961680	.92	.642777	5.72	.357223	17
44	.604745	4.78	.961624	.92	.643120	5.72	.356880	16
45	9.605032	4.78	9.961569	.93	9.643463	5.72	0.356537	15
46	.605319	4.78	.961513	.92	.643806	5.70	.356194	14
47	.605606	4.77	.961458	.92	.644148	5.70	.355852	13
48	.605892	4.77	.961402	.93	.644490	5.70	.355510	12
49	.606179	4.77	.961346	.93	.644832	5.70	.355168	11
50	9.606465	4.77	9.961290	.92	9.645174	5.70	0.354826	10
51	.606751	4.75	.961235	.93	.645516	5.68	.354484	9
52	.607036	4.77	.961179	.93	.645857	5.70	.354143	8
53	.607322	4.75	.961123	.93	.646199	5.68	.353801	7
54	.607607	4.75	.961067	.93	.646540	5.68	.353460	6
55	9.607892	4.75	9.961011	.93	9.646881	5.68	0.353119	5
56	.608177	4.73	.960955	.93	.647222	5.67	.352778	4
57	.608461	4.73	.960899	.93	.647562	5.68	.352438	3
58	.608745	4.73	.960843	.95	.647903	5.67	.352097	2
59	.609029	4.73	.960786	.93	.648243	5.67	.351757	1
60	9.609313	4.73	9.960730	.93	9.648583	5.67	0.351417	0
	Cos.	D. 1".	Sin.	D. 1".	Cot.	D. 1".	Tan.	M.

TABLE OF LOGARITHMIC SINES—COSINES, ETC. 1677

24°

155°

M.	Sin.	D. 1".	Cos.	D. 1".	Tan.	D. 1".	Cot.	M.
0	9.609313	4.73	9.960730	.93	9.648583	5.67	0.351417	60
1	.609597	4.72	.960674	.93	.648923	5.67	.351077	59
2	.609880	4.73	.960618	.95	.649263	5.66	.350737	58
3	.610164	4.72	.960561	.93	.649602	5.67	.350398	57
4	.610447	4.70	.960505	.95	.649942	5.67	.350058	56
5	9.610729	4.72	9.960448	.95	9.650281	5.65	0.349719	55
6	.611012	4.70	.960392	.93	.650620	5.65	.349380	54
7	.611294	4.70	.960335	.95	.650959	5.65	.349041	53
8	.611576	4.70	.960279	.93	.651297	5.63	.348703	52
9	.611858	4.70	.960222	.95	.651636	5.65	.348364	51
10	9.612140	4.68	9.960165	.93	9.651974	5.63	0.348026	50
11	.612421	4.68	.960109	.95	.652312	5.63	.347688	49
12	.612702	4.68	.960052	.95	.652650	5.63	.347350	48
13	.612983	4.68	.959995	.95	.652988	5.63	.347012	47
14	.613264	4.68	.959938	.93	.653326	5.62	.346674	46
15	9.613545	4.67	9.959882	.95	9.653663	5.62	0.346337	45
16	.613825	4.67	.959825	.95	.654000	5.62	.346000	44
17	.614105	4.67	.959768	.95	.654337	5.62	.345663	43
18	.614385	4.67	.959711	.95	.654674	5.62	.345326	42
19	.614665	4.65	.959654	.97	.655011	5.62	.344989	41
20	9.614944	4.65	9.959596	.95	9.655348	5.60	0.344652	40
21	.615223	4.65	.959539	.95	.655684	5.60	.344316	39
22	.615502	4.65	.959482	.95	.656020	5.60	.343980	38
23	.615781	4.65	.959425	.95	.656356	5.60	.343644	37
24	.616060	4.63	.959368	.97	.656692	5.60	.343308	36
25	9.616338	4.63	9.959310	.95	9.657028	5.60	0.342972	35
26	.616616	4.63	.959253	.95	.657364	5.60	.342636	34
27	.616894	4.63	.959195	.95	.657709	5.58	.342301	33
28	.617172	4.63	.959138	.95	.658044	5.58	.341966	32
29	.617450	4.62	.959080	.95	.658369	5.58	.341631	31
30	9.617727	4.62	9.959023	.97	9.658704	5.58	0.341296	30
31	.618004	4.62	.958965	.95	.659039	5.57	.340961	29
32	.618281	4.62	.958908	.95	.659373	5.57	.340627	28
33	.618558	4.62	.958850	.97	.659708	5.57	.340292	27
34	.618834	4.60	.958792	.97	.660042	5.57	.339958	26
35	9.619110	4.60	9.958734	.95	9.660376	5.57	0.339624	25
36	.619386	4.60	.958677	.95	.660710	5.57	.339290	24
37	.619662	4.60	.958619	.95	.661043	5.55	.338957	23
38	.619938	4.58	.958561	.97	.661377	5.57	.338623	22
39	.620213	4.58	.958503	.97	.661710	5.55	.338290	21
40	9.620488	4.58	9.958445	.97	9.662043	5.55	0.337957	20
41	.620763	4.58	.958387	.97	.662376	5.55	.337624	19
42	.621038	4.58	.958329	.97	.662709	5.55	.337291	18
43	.621313	4.57	.958271	.97	.663042	5.55	.336958	17
44	.621587	4.57	.958213	.98	.663375	5.53	.336625	16
45	9.621861	4.57	9.958154	.97	9.663707	5.53	0.336293	15
46	.622135	4.57	.958096	.97	.664039	5.53	.335961	14
47	.622409	4.57	.958038	.97	.664371	5.53	.335629	13
48	.622682	4.55	.957979	.98	.664703	5.53	.335297	12
49	.622956	4.55	.957921	.97	.665035	5.52	.334965	11
50	9.623229	4.55	9.957863	.98	9.665366	5.52	0.334634	10
51	.623502	4.53	.957804	.97	.665698	5.52	.334302	9
52	.623774	4.55	.957746	.98	.666029	5.52	.333971	8
53	.624047	4.53	.957687	.98	.666360	5.52	.333640	7
54	.624319	4.53	.957628	.97	.666691	5.50	.333309	6
55	9.624591	4.53	9.957570	.98	9.667021	5.52	0.332979	5
56	.624863	4.53	.957511	.98	.667352	5.50	.332648	4
57	.625135	4.53	.957452	.98	.667682	5.50	.332318	3
58	.625406	4.52	.957393	.98	.668013	5.52	.331987	2
59	.625677	4.52	.957335	.97	.668343	5.50	.331657	1
60	9.625948	4.52	9.957276	.98	9.668673	5.50	0.331327	0
	Cos.	D. 1".	Sin.	D. 1".	Cot.	D. 1".	Tan.	M.

114°

65°

in.	Sin.	D. 1".	Cos.	D. 1".	Tan.	D. 1".	Cot.	M.
0	9.625948	4.52	9.957276	.98	9.668673		0.331327	60
1	.626219	4.52	.957217	.98	.669002	5.48	.330998	59
2	.626490	4.50	.957158	.98	.669332	5.48	.330668	58
3	.626760	4.50	.957099	.98	.669661	5.48	.330339	57
4	.627030	4.50	.957040	.98	.669991	5.50	.330009	56
5	9.627300	4.50	9.956981	1.00	9.670320	5.48	0.329680	55
6	.627570	4.50	.956921	.98	.670649	5.48	.329351	54
7	.627840	4.50	.956862	.98	.670977	5.47	.329023	53
8	.628109	4.48	.956803	.98	.671306	5.48	.328694	52
9	.628378	4.48	.956744	1.00	.671635	5.48	.328365	51
10	9.628647	4.48	9.956684	.98	9.671963	5.47	0.328037	50
11	.628916	4.48	.956625	.98	.672291	5.47	.327709	49
12	.629185	4.47	.956566	1.00	.672619	5.47	.327381	48
13	.629453	4.47	.956506	.98	.672947	5.47	.327053	47
14	.629721	4.47	.956447	1.00	.673274	5.45	.326726	46
15	9.629989	4.47	9.956387	1.00	9.673602	5.47	0.326398	45
16	.630257	4.47	.956327	1.00	.673929	5.45	.326071	44
17	.630524	4.45	.956268	.98	.674257	5.47	.325743	43
18	.630792	4.47	.956208	1.00	.674584	5.45	.325416	42
19	.631059	4.45	.956148	.98	.674911	5.45	.325089	41
20	9.631326	4.45	9.956089	1.00	9.675237	5.45	0.324763	40
21	.631593	4.43	.956029	1.00	.675564	5.45	.324436	39
22	.631859	4.43	.955969	1.00	.675890	5.43	.324110	38
23	.632125	4.43	.955909	1.00	.676217	5.45	.323783	37
24	.632392	4.45	.955849	1.00	.676543	5.43	.323457	36
25	9.632658	4.43	9.955789	1.00	9.676869	5.43	0.323131	35
26	.632923	4.42	.955729	1.00	.677191	5.42	.322806	34
27	.633189	4.43	.955669	1.00	.677520	5.43	.322480	33
28	.633454	4.42	.955609	1.00	.677846	5.43	.322154	32
29	.633719	4.42	.955548	1.00	.678171	5.42	.321829	31
30	9.633984	4.42	9.955488	1.00	9.678496	5.42	0.321504	30
31	.634249	4.42	.955428	1.00	.678821	5.42	.321179	29
32	.634514	4.40	.955368	1.02	.679146	5.42	.320854	28
33	.634778	4.40	.955307	1.00	.679471	5.42	.320529	27
34	.635042	4.40	.955247	1.02	.679795	5.42	.320205	26
35	9.635306	4.40	9.955186	1.00	9.680120	5.40	0.319880	25
36	.635570	4.40	.955126	1.00	.680444	5.40	.319556	24
37	.635834	4.40	.955065	1.02	.680768	5.40	.319232	23
38	.636097	4.38	.955005	1.00	.681092	5.40	.318908	22
39	.636360	4.38	.954944	1.02	.681416	5.40	.318584	21
40	9.636623	4.38	9.954883	1.00	9.681740	5.40	0.318260	20
41	.636886	4.37	.954823	1.02	.682063	5.38	.317937	19
42	.637148	4.38	.954762	1.02	.682387	5.40	.317613	18
43	.637411	4.37	.954701	1.02	.682710	5.38	.317290	17
44	.637673	4.37	.954640	1.02	.683033	5.38	.316967	16
45	9.637935	4.37	9.954579	1.02	9.683356	5.38	0.316644	15
46	.638197	4.35	.954518	1.02	.683679	5.38	.316321	14
47	.638458	4.35	.954457	1.02	.684001	5.37	.315999	13
48	.638720	4.37	.954396	1.02	.684324	5.38	.315676	12
49	.638981	4.35	.954335	1.02	.684646	5.37	.315354	11
50	9.639242	4.35	9.954274	1.02	9.684968	5.37	0.315032	10
51	.639503	4.35	.954213	1.02	.685290	5.37	.314710	9
52	.639764	4.33	.954152	1.03	.685612	5.37	.314388	8
53	.640024	4.33	.954090	1.02	.685934	5.35	.314066	7
54	.640284	4.33	.954029	1.02	.686255	5.35	.313745	6
55	9.640544	4.33	9.953968	1.03	9.686577	5.37	0.313423	5
56	.640804	4.33	.953906	1.03	.686898	5.35	.313102	4
57	.641064	4.33	.953845	1.02	.687219	5.35	.312781	3
58	.641324	4.33	.953783	1.03	.687540	5.35	.312460	2
59	.641583	4.32	.953722	1.02	.687861	5.35	.312139	1
60	9.641842	4.32	9.953660	1.03	9.688182	5.35	0.311818	0
	Cos.	D. 1".	Sin.	D. 1".	Cot.	D. 1".	Tan.	M.

TABLE OF LOGARITHMIC SINES—COSINES, ETC. 1679

26°

153°

M.	Sin.	D. 1".	Cos.	D. 1".	Tan.	D. 1".	Cot.	
0	9.641842	4.32	9.953660	1.02	9.688182	5.33	0.311818	60
1	.642101	4.32	.953599	1.03	.688502	5.35	.311498	59
2	.642360	4.30	.953537	1.03	.688823	5.33	.311177	58
3	.642618	4.32	.953475	1.03	.689143	5.33	.310857	57
4	.642877	4.30	.953413	1.02	.689463	5.33	.310537	56
5	9.643135	4.30	9.953352	1.03	9.689783	5.33	0.310217	55
6	.643393	4.28	.953290	1.03	.690103	5.33	.309897	54
7	.643650	4.30	.953228	1.03	.690423	5.32	.309577	53
8	.643908	4.28	.953166	1.03	.690742	5.33	.309258	52
9	.644165	4.30	.953104	1.03	.691062	5.32	.308938	51
10	9.644423	4.28	9.953042	1.03	9.691381	5.32	0.308619	50
11	.644680	4.27	.952980	1.03	.691700	5.32	.308300	49
12	.644936	4.28	.952918	1.05	.692019	5.32	.307981	48
13	.645193	4.28	.952855	1.03	.692338	5.30	.307662	47
14	.645450	4.27	.952793	1.03	.692656	5.32	.307344	46
15	9.645706	4.27	9.952731	1.03	9.692975	5.30	0.307025	45
16	.645962	4.27	.952669	1.05	.693293	5.32	.306707	44
17	.646218	4.27	.952606	1.03	.693612	5.30	.306388	43
18	.646474	4.25	.952544	1.05	.693930	5.30	.306070	42
19	.646729	4.25	.952481	1.03	.694248	5.30	.305752	41
20	9.646984	4.27	9.952419	1.05	9.694566	5.28	0.305434	40
21	.647240	4.23	.952356	1.03	.694883	5.30	.305117	39
22	.647494	4.25	.952294	1.05	.695201	5.28	.304799	38
23	.647749	4.25	.952231	1.05	.695518	5.30	.304482	37
24	.648004	4.23	.952168	1.03	.695836	5.28	.304164	36
25	9.648258	4.23	9.952106	1.05	9.696153	5.30	0.303847	35
26	.648512	4.23	.952043	1.05	.696470	5.28	.303530	34
27	.648766	4.23	.951980	1.05	.696787	5.28	.303213	33
28	.649020	4.23	.951917	1.05	.697103	5.28	.302897	32
29	.649274	4.22	.951854	1.05	.697420	5.27	.302580	31
30	9.649527	4.23	9.951791	1.05	9.697736	5.28	0.302264	30
31	.649781	4.22	.951728	1.05	.698053	5.27	.301947	29
32	.650034	4.22	.951665	1.05	.698369	5.27	.301631	28
33	.650287	4.20	.951602	1.05	.698685	5.27	.301315	27
34	.650539	4.22	.951539	1.05	.699001	5.25	.300999	26
35	9.650792	4.20	9.951476	1.07	9.699316	5.27	0.300684	25
36	.651044	4.22	.951412	1.05	.699632	5.25	.300368	24
37	.651297	4.22	.951349	1.05	.699947	5.25	.300053	23
38	.651549	4.20	.951286	1.07	.700263	5.27	.299737	22
39	.651800	4.20	.951222	1.05	.700578	5.25	.299422	21
40	9.652052	4.20	9.951159	1.05	9.700893	5.25	0.299107	20
41	.652304	4.18	.951096	1.07	.701208	5.25	.298792	19
42	.652555	4.18	.951032	1.07	.701523	5.25	.298477	18
43	.652806	4.18	.950968	1.05	.701837	5.25	.298163	17
44	.653057	4.18	.950905	1.07	.702152	5.23	.297848	16
45	9.653308	4.17	9.950841	1.05	9.702466	5.25	0.297534	15
46	.653558	4.17	.950778	1.07	.702781	5.25	.297219	14
47	.653808	4.18	.950714	1.07	.703095	5.23	.296905	13
48	.654059	4.17	.950650	1.07	.703409	5.23	.296591	12
49	.654309	4.15	.950586	1.07	.703722	5.23	.296278	11
50	9.654558	4.17	9.950522	1.07	9.704036	5.23	0.295964	10
51	.654808	4.17	.950458	1.07	.704350	5.23	.295650	9
52	.655058	4.15	.950394	1.07	.704663	5.22	.295337	8
53	.655307	4.15	.950330	1.07	.704976	5.23	.295024	7
54	.655556	4.15	.950266	1.07	.705290	5.22	.294710	6
55	9.655805	4.15	9.950202	1.07	9.705603	5.22	0.294397	5
56	.656054	4.13	.950138	1.07	.705916	5.20	.294084	4
57	.656302	4.15	.950074	1.07	.706228	5.22	.293772	3
58	.656551	4.15	.950010	1.05	.706541	5.22	.293459	2
59	.656799	4.13	.949945	1.05	.706854	5.22	.293146	1
60	9.657047	4.13	9.949881	1.07	9.707166	5.20	0.292834	0
	Cos.	D. 1".	Sin.	D. 1".	Cot.	D. 1".	Tan.	M.

M.	Sin.	D. 1".	Cos.	D. 1".	Tan.	D. 1".	Cot.	
0	9.657047	4.13	9.949881	1.08	9.707166		0.292834	60
1	.657295	4.12	.949816	1.07	.707478	5.20	.292522	59
2	.657542	4.13	.949752	1.07	.707790	5.20	.292210	58
3	.657790	4.13	.949688	1.07	.708102	5.20	.291898	57
4	.658037	4.12	.949623	1.08	.708414	5.20	.291586	56
5	9.658284	4.12	9.949558	1.08	9.708726	5.20	0.291274	55
6	.658531	4.12	.949494	1.08	.709037	5.18	.290963	54
7	.658778	4.12	.949429	1.08	.709349	5.20	.290651	53
8	.659025	4.10	.949364	1.07	.709660	5.18	.290340	52
9	.659271	4.10	.949300	1.08	.709971	5.18	.290029	51
10	9.659517	4.10	9.949235	1.08	9.710282	5.18	0.289718	50
11	.659763	4.10	.949170	1.08	.710593	5.18	.289407	49
12	.660009	4.10	.949105	1.08	.710904	5.18	.289096	48
13	.660255	4.10	.949040	1.08	.711215	5.18	.288785	47
14	.660501	4.10	.948975	1.08	.711525	5.17	.288475	46
15	9.660746	4.08	9.948910	1.08	9.711836	5.18	0.288164	45
16	.660991	4.08	.948845	1.08	.712146	5.17	.287854	44
17	.661236	4.08	.948780	1.08	.712456	5.17	.287544	43
18	.661481	4.08	.948715	1.08	.712766	5.17	.287234	42
19	.661726	4.07	.948650	1.10	.713076	5.17	.286924	41
20	9.661970	4.07	9.948584	1.08	9.713386	5.17	0.286614	40
21	.662214	4.08	.948519	1.08	.713696	5.15	.286304	39
22	.662459	4.07	.948454	1.10	.714005	5.15	.285995	38
23	.662703	4.05	.948388	1.08	.714314	5.15	.285686	37
24	.662946	4.05	.948323	1.10	.714624	5.17	.285376	36
25	9.663190	4.07	9.948257	1.08	9.714933	5.15	0.285067	35
26	.663433	4.05	.948192	1.10	.715242	5.15	.284758	34
27	.663677	4.07	.948126	1.10	.715551	5.15	.284449	33
28	.663920	4.05	.948060	1.10	.715860	5.15	.284140	32
29	.664163	4.05	.947995	1.10	.716168	5.13	.283832	31
30	9.664406	4.03	9.947929	1.10	9.716477	5.13	0.283523	30
31	.664648	4.05	.947863	1.10	.716785	5.13	.283215	29
32	.664891	4.03	.947797	1.10	.717093	5.13	.282907	28
33	.665133	4.03	.947731	1.10	.717401	5.13	.282599	27
34	.665375	4.03	.947665	1.08	.717709	5.13	.282291	26
35	9.665617	4.03	9.947600	1.12	9.718017	5.13	0.281983	25
36	.665859	4.03	.947533	1.12	.718325	5.13	.281675	24
37	.666100	4.02	.947467	1.10	.718633	5.13	.281367	23
38	.666342	4.03	.947401	1.10	.718940	5.12	.281060	22
39	.666583	4.02	.947335	1.10	.719248	5.13	.280752	21
40	9.666824	4.02	9.947269	1.10	9.719555	5.12	0.280445	20
41	.667065	4.00	.947203	1.12	.719862	5.12	.280138	19
42	.667305	4.02	.947136	1.10	.720169	5.12	.279831	18
43	.667546	4.00	.947070	1.10	.720476	5.12	.279524	17
44	.667786	4.02	.947004	1.12	.720783	5.10	.279217	16
45	9.668027	4.00	9.946937	1.10	9.721089	5.12	0.278911	15
46	.668267	3.98	.946871	1.12	.721396	5.10	.278604	14
47	.668506	3.98	.946804	1.12	.721702	5.12	.278298	13
48	.668745	4.00	.946738	1.10	.722009	5.12	.277991	12
49	.668986	4.00	.946671	1.12	.722315	5.10	.277685	11
50	9.669225	3.98	9.946604	1.10	9.722621	5.10	0.277379	10
51	.669464	3.98	.946538	1.12	.722927	5.08	.277073	9
52	.669703	3.98	.946471	1.12	.723232	5.10	.276768	8
53	.669942	3.98	.946404	1.12	.723538	5.10	.276462	7
54	.670181	3.97	.946337	1.12	.723844	5.08	.276156	6
55	9.670419	3.97	9.946270	1.12	9.724149	5.08	0.275851	5
56	.670658	3.97	.946203	1.12	.724454	5.10	.275546	4
57	.670896	3.97	.946136	1.12	.724760	5.08	.275240	3
58	.671134	3.97	.946069	1.12	.725065	5.08	.274935	2
59	.671372	3.97	.946002	1.12	.725370	5.08	.274630	1
60	9.671609	3.95	9.945935	1.12	9.725674	5.07	0.274326	0
	Cos.	D. 1".	Sin.	D. 1".	Cot.	D. 1".	Tan.	M.

TABLE OF LOGARITHMIC SINES—COSINES, ETC. 1681

28°

151°

M.	Sin.	D. 1''.	Cos.	D. 1''.	Tan.	D. 1''.	Cot.	
0	9.671609		9.945935	1.12	9.725674	5.08	0.274326	60
1	.671847	3.97	.945868	1.12	.725979	5.08	.274021	59
2	.672084	3.95	.945800	1.13	.726284	5.08	.273716	58
3	.672321	3.95	.945733	1.12	.726588	5.07	.273412	57
4	.672558	3.95	.945666	1.13	.726892	5.07	.273108	56
5	9.672795	3.95	9.945598	1.12	9.727197	5.08	0.272803	55
6	.673032	3.93	.945531	1.12	.727501	5.07	.272499	54
7	.673268	3.95	.945464	1.13	.727805	5.07	.272195	53
8	.673505	3.93	.945396	1.13	.728109	5.05	.271891	52
9	.673741	3.93	.945328	1.12	.728412	5.07	.271588	51
10	9.673977	3.93	9.945261	1.13	9.728716	5.07	0.271284	50
11	.674213	3.92	.945193	1.13	.729020	5.05	.270980	49
12	.674448	3.93	.945125	1.12	.729323	5.05	.270677	48
13	.674684	3.92	.945058	1.13	.729626	5.05	.270374	47
14	.674919	3.92	.944990	1.13	.729929	5.05	.270071	46
15	9.675155	3.93	9.944922	1.13	9.730233	5.07	0.269767	45
16	.675390	3.92	.944854	1.13	.730535	5.03	.269465	44
17	.675624	3.90	.944786	1.13	.730838	5.05	.269162	43
18	.675859	3.92	.944718	1.13	.731141	5.05	.268859	42
19	.676094	3.90	.944650	1.13	.731444	5.03	.268556	41
20	9.676328	3.90	9.944582	1.13	9.731746	5.03	0.268254	40
21	.676562	3.90	.944514	1.13	.732048	5.05	.267952	39
22	.676796	3.90	.944446	1.15	.732351	5.03	.267649	38
23	.677030	3.90	.944377	1.13	.732653	5.03	.267347	37
24	.677264	3.90	.944309	1.13	.732955	5.03	.267045	36
25	9.677498	3.88	9.944241	1.15	9.733257	5.02	0.266743	35
26	.677731	3.88	.944172	1.13	.733558	5.02	.266442	34
27	.677964	3.88	.944104	1.13	.733859	5.03	.266140	33
28	.678197	3.88	.944036	1.15	.734162	5.02	.265838	32
29	.678430	3.88	.943967	1.13	.734463	5.02	.265537	31
30	9.678663	3.87	9.943899	1.15	9.734764	5.03	0.265236	30
31	.678895	3.88	.943830	1.15	.735066	5.02	.264934	29
32	.679128	3.87	.943761	1.13	.735367	5.02	.264633	28
33	.679360	3.87	.943693	1.15	.735668	5.02	.264332	27
34	.679592	3.87	.943624	1.15	.735969	5.02	.264031	26
35	9.679824	3.87	9.943555	1.15	9.736269	5.02	0.263731	25
36	.680056	3.87	.943486	1.15	.736570	5.02	.263430	24
37	.680288	3.87	.943417	1.15	.736870	5.00	.263130	23
38	.680519	3.85	.943348	1.15	.737171	5.02	.262829	22
39	.680750	3.85	.943279	1.15	.737471	5.00	.262529	21
40	9.680982	3.85	9.943210	1.15	9.737771	5.00	0.262229	20
41	.681213	3.83	.943141	1.15	.738071	5.00	.261929	19
42	.681443	3.85	.943072	1.15	.738371	5.00	.261629	18
43	.681674	3.85	.943003	1.15	.738671	5.00	.261329	17
44	.681905	3.83	.942934	1.17	.738971	5.00	.261029	16
45	9.682135	3.83	9.942864	1.15	9.739271	4.98	0.260729	15
46	.682365	3.83	.942795	1.15	.739570	4.98	.260430	14
47	.682595	3.83	.942726	1.17	.739870	5.00	.260130	13
48	.682825	3.83	.942656	1.17	.740169	4.98	.259831	12
49	.683055	3.83	.942587	1.17	.740468	4.98	.259532	11
50	9.683284	3.83	9.942517	1.15	9.740767	4.98	0.259233	10
51	.683514	3.82	.942448	1.17	.741066	4.98	.258934	9
52	.683743	3.82	.942378	1.17	.741365	4.98	.258635	8
53	.683972	3.82	.942308	1.15	.741664	4.97	.258336	7
54	.684201	3.82	.942239	1.17	.741962	4.98	.258038	6
55	9.684430	3.80	9.942169	1.17	9.742261	4.97	0.257739	5
56	.684658	3.82	.942099	1.17	.742559	4.97	.257441	4
57	.684887	3.80	.942029	1.17	.742858	4.98	.257142	3
58	.685115	3.80	.941959	1.17	.743156	4.97	.256844	2
59	.685343	3.80	.941889	1.17	.743454	4.97	.256546	1
60	9.685571	3.80	9.941819		9.743752		0.256248	0
	Cos.	D. 1''.	Sin.	D. 1''.	Cot.	D. 1''.	Tan.	M.

118°

61°

M.	Sin.	D. 1".	Coa.	D. 1".	Tan.	D. 1".	Cot.	
0	9.685571	3.80	9.941819	1.17	9.743752	4.97	0.256248	60
1	.685799	3.80	.941749	1.17	.744050	4.97	.255950	59
2	.686027	3.78	.941679	1.17	.744348	4.97	.255652	58
3	.686254	3.76	.941609	1.17	.744645	4.95	.255355	57
4	.686482	3.74	.941539	1.17	.744943	4.97	.255057	56
5	9.686709	3.72	9.941469	1.17	9.745240	4.95	0.254760	55
6	.686936	3.72	.941398	1.18	.745538	4.97	.254462	54
7	.687163	3.72	.941328	1.17	.745835	4.95	.254165	53
8	.687389	3.72	.941258	1.18	.746132	4.95	.253868	52
9	.687616	3.72	.941187	1.17	.746429	4.95	.253571	51
10	9.687843	3.77	9.941117	1.18	9.746726	4.95	0.253274	50
11	.688069	3.77	.941046	1.18	.747023	4.93	.252977	49
12	.688295	3.77	.940975	1.17	.747319	4.95	.252681	48
13	.688521	3.77	.940905	1.18	.747616	4.95	.252384	47
14	.688747	3.77	.940834	1.18	.747913	4.95	.252087	46
15	9.688972	3.75	9.940763	1.18	9.748209	4.93	0.251791	45
16	.689198	3.77	.940693	1.17	.748505	4.93	.251495	44
17	.689423	3.75	.940622	1.18	.748801	4.93	.251199	43
18	.689648	3.75	.940551	1.18	.749097	4.93	.250903	42
19	.689873	3.75	.940480	1.18	.749393	4.93	.250607	41
20	9.690098	3.75	9.940409	1.18	9.749689	4.93	0.250311	40
21	.690323	3.75	.940338	1.18	.749985	4.93	.250015	39
22	.690548	3.73	.940267	1.18	.750281	4.92	.249719	38
23	.690772	3.73	.940196	1.18	.750576	4.92	.249424	37
24	.690996	3.73	.940125	1.18	.750872	4.92	.249128	36
25	9.691220	3.73	9.940054	1.20	9.751167	4.92	0.248833	35
26	.691444	3.73	.939982	1.20	.751462	4.92	.248538	34
27	.691668	3.73	.939911	1.18	.751757	4.92	.248243	33
28	.691892	3.72	.939840	1.20	.752052	4.92	.247948	32
29	.692115	3.73	.939768	1.18	.752347	4.92	.247653	31
30	9.692339	3.72	9.939697	1.20	9.752642	4.92	0.247358	30
31	.692562	3.72	.939625	1.18	.752937	4.90	.247063	29
32	.692785	3.72	.939554	1.20	.753231	4.92	.246769	28
33	.693008	3.72	.939482	1.20	.753526	4.90	.246474	27
34	.693231	3.70	.939410	1.18	.753820	4.92	.246180	26
35	9.693453	3.72	9.939339	1.20	9.754115	4.92	0.245885	25
36	.693676	3.72	.939267	1.20	.754409	4.90	.245591	24
37	.693898	3.70	.939195	1.20	.754703	4.90	.245297	23
38	.694120	3.70	.939123	1.18	.754997	4.90	.245003	22
39	.694342	3.70	.939052	1.20	.755291	4.90	.244709	21
40	9.694564	3.70	9.938980	1.20	9.755585	4.88	0.244415	20
41	.694786	3.68	.938908	1.20	.755878	4.88	.244122	19
42	.695007	3.70	.938836	1.22	.756172	4.88	.243828	18
43	.695229	3.68	.938763	1.20	.756465	4.90	.243535	17
44	.695450	3.68	.938691	1.20	.756759	4.88	.243241	16
45	9.695671	3.68	9.938619	1.20	9.757052	4.88	0.242948	15
46	.695892	3.68	.938547	1.20	.757345	4.88	.242655	14
47	.696113	3.68	.938475	1.22	.757638	4.88	.242362	13
48	.696334	3.68	.938402	1.22	.757931	4.88	.242069	12
49	.696554	3.68	.938330	1.20	.758224	4.88	.241776	11
50	9.696775	3.67	9.938258	1.22	9.758517	4.88	0.241483	10
51	.696995	3.67	.938185	1.22	.758810	4.87	.241190	9
52	.697215	3.67	.938113	1.22	.759102	4.88	.240898	8
53	.697435	3.65	.938040	1.22	.759395	4.87	.240605	7
54	.697654	3.67	.937967	1.20	.759687	4.87	.240313	6
55	9.697874	3.67	9.937895	1.22	9.759979	4.87	0.240021	5
56	.698094	3.67	.937822	1.22	.760272	4.88	.239728	4
57	.698313	3.65	.937749	1.22	.760564	4.87	.239436	3
58	.698532	3.65	.937676	1.22	.760856	4.87	.239144	2
59	.698751	3.65	.937604	1.22	.761148	4.87	.238852	1
60	9.698970	3.65	9.937531	1.22	9.761439	4.85	0.238561	0
	Coa.	D. 1".	Sin.	D. 1".	Cot.	D. 1".	Tan.	M.

TABLE OF LOGARITHMIC SINES—COSINES, ETC. 1083

30°

TAN

M.	Sin.	D. 1".	Cos.	D. 1".	Tan.	D. 1".	Cot.	M.
0	9.698970	3.65	9.937531	1.22	9.761439	4.87	0.238561	60
1	.699189	3.63	.937458	1.22	.761731	4.87	.238269	59
2	.699407	3.65	.937385	1.22	.762023	4.85	.237977	58
3	.699626	3.63	.937312	1.23	.762314	4.87	.237686	57
4	.699844	3.63	.937238	1.22	.762606	4.85	.237394	56
5	9.700062	3.63	9.937165	1.22	9.762897	4.85	0.237103	55
6	.700280	3.63	.937092	1.22	.763188	4.85	.236812	54
7	.700498	3.63	.937019	1.22	.763479	4.85	.236521	53
8	.700716	3.63	.936946	1.23	.763770	4.85	.236230	52
9	.700933	3.62	.936872	1.22	.764061	4.85	.235939	51
10	9.701151	3.62	9.936799	1.23	9.764352	4.85	0.235648	50
11	.701368	3.62	.936725	1.22	.764643	4.83	.235357	49
12	.701585	3.62	.936652	1.23	.764933	4.85	.235067	48
13	.701802	3.62	.936578	1.22	.765224	4.85	.234776	47
14	.702019	3.62	.936505	1.22	.765514	4.83	.234486	46
15	9.702236	3.60	9.936431	1.23	9.765805	4.83	0.234195	45
16	.702452	3.62	.936357	1.22	.766095	4.83	.233905	44
17	.702669	3.60	.936284	1.23	.766385	4.83	.233615	43
18	.702885	3.60	.936210	1.23	.766675	4.83	.233325	42
19	.703101	3.60	.936136	1.23	.766965	4.83	.233035	41
20	9.703317	3.60	9.936062	1.23	9.767255	4.83	0.232745	40
21	.703533	3.60	.935988	1.23	.767545	4.82	.232455	39
22	.703749	3.58	.935914	1.23	.767834	4.83	.232166	38
23	.703964	3.58	.935840	1.23	.768124	4.83	.231876	37
24	.704179	3.58	.935766	1.23	.768414	4.82	.231586	36
25	9.704395	3.58	9.935692	1.23	9.768703	4.82	0.231297	35
26	.704610	3.58	.935618	1.25	.768992	4.82	.231008	34
27	.704825	3.58	.935543	1.23	.769281	4.83	.230719	33
28	.705040	3.57	.935469	1.23	.769571	4.82	.230429	32
29	.705254	3.58	.935395	1.25	.769860	4.80	.230140	31
30	9.705469	3.57	9.935320	1.23	9.770148	4.82	0.229852	30
31	.705683	3.58	.935246	1.25	.770437	4.82	.229563	29
32	.705898	3.57	.935171	1.23	.770726	4.82	.229274	28
33	.706112	3.57	.935097	1.25	.771015	4.80	.228985	27
34	.706326	3.55	.935022	1.23	.771303	4.82	.228697	26
35	9.706539	3.57	9.934948	1.25	9.771592	4.80	0.228408	25
36	.706753	3.57	.934873	1.25	.771880	4.80	.228120	24
37	.706967	3.57	.934798	1.25	.772168	4.80	.227832	23
38	.707180	3.55	.934723	1.25	.772457	4.82	.227543	22
39	.707393	3.55	.934649	1.25	.772745	4.80	.227255	21
40	9.707606	3.55	9.934574	1.25	9.773033	4.80	0.226967	20
41	.707819	3.55	.934499	1.25	.773321	4.78	.226679	19
42	.708032	3.55	.934424	1.25	.773608	4.80	.226392	18
43	.708245	3.55	.934349	1.25	.773896	4.80	.226104	17
44	.708458	3.53	.934274	1.25	.774184	4.78	.225816	16
45	9.708670	3.53	9.934199	1.27	9.774471	4.80	0.225529	15
46	.708882	3.53	.934123	1.25	.774759	4.78	.225241	14
47	.709094	3.53	.934048	1.25	.775046	4.78	.224954	13
48	.709306	3.53	.933973	1.25	.775333	4.78	.224667	12
49	.709518	3.53	.933898	1.27	.775621	4.78	.224379	11
50	9.709730	3.52	9.933822	1.25	9.775908	4.78	0.224092	10
51	.709941	3.53	.933747	1.27	.776195	4.78	.223805	9
52	.710153	3.52	.933671	1.25	.776482	4.77	.223518	8
53	.710364	3.52	.933596	1.27	.776768	4.77	.223232	7
54	.710575	3.52	.933520	1.25	.777055	4.78	.222945	6
55	9.710786	3.52	9.933445	1.27	9.777342	4.77	0.222658	5
56	.710997	3.52	.933369	1.27	.777628	4.78	.222372	4
57	.711208	3.52	.933293	1.27	.777915	4.77	.222085	3
58	.711419	3.50	.933217	1.27	.778201	4.78	.221799	2
59	.711629	3.50	.933141	1.25	.778488	4.78	.221512	1
60	9.711839	3.50	9.933066	1.25	9.778774	4.77	0.221226	0
	Cos.	D. 1".	Sin.	D. 1".	Cot.	D. 1".	Tan.	M.

120°

59°

M.	Sin.	D. 1".	Cos.	D. 1".	Tan.	D. 1".	Cot.	
0	9.711839	3.52	9.933066	1.27	9.778774	4.77	0.221226	60
1	.712050	3.50	.932990	1.27	.779060	4.77	.220940	59
2	.712260	3.48	.932914	1.27	.779346	4.77	.220654	58
3	.712469	3.48	.932838	1.27	.779632	4.77	.220368	57
4	.712679	3.50	.932762	1.27	.779918	4.77	.220082	56
5	9.712889	3.50	9.932685	1.28	9.780203	4.75	0.219797	55
6	.713098	3.48	.932609	1.27	.780489	4.77	.219511	54
7	.713308	3.50	.932533	1.27	.780775	4.77	.219225	53
8	.713517	3.48	.932457	1.27	.781060	4.75	.218940	52
9	.713726	3.48	.932380	1.27	.781346	4.77	.218654	51
10	9.713935	3.48	9.932304	1.27	9.781631	4.75	0.218369	50
11	.714144	3.47	.932228	1.28	.781916	4.75	.218084	49
12	.714352	3.48	.932151	1.27	.782201	4.75	.217799	48
13	.714561	3.48	.932075	1.27	.782486	4.75	.217514	47
14	.714769	3.47	.931998	1.28	.782771	4.75	.217229	46
15	9.714978	3.48	9.931921	1.28	9.783056	4.75	0.216944	45
16	.715186	3.47	.931845	1.28	.783341	4.75	.216659	44
17	.715394	3.47	.931768	1.28	.783626	4.73	.216374	43
18	.715602	3.45	.931691	1.28	.783910	4.75	.216090	42
19	.715809	3.47	.931614	1.28	.784195	4.73	.215805	41
20	9.716017	3.45	9.931537	1.28	9.784479	4.75	0.215521	40
21	.716224	3.47	.931460	1.28	.784764	4.73	.215236	39
22	.716432	3.45	.931383	1.28	.785048	4.73	.214952	38
23	.716639	3.45	.931306	1.28	.785332	4.73	.214668	37
24	.716846	3.45	.931229	1.28	.785616	4.73	.214384	36
25	9.717053	3.43	9.931152	1.28	9.785900	4.73	0.214100	35
26	.717259	3.45	.931075	1.28	.786184	4.73	.213816	34
27	.717466	3.45	.930998	1.28	.786468	4.73	.213532	33
28	.717673	3.45	.930921	1.30	.786752	4.73	.213248	32
29	.717879	3.43	.930843	1.28	.787036	4.72	.212964	31
30	9.718085	3.43	9.930766	1.30	9.787319	4.73	0.212681	30
31	.718291	3.43	.930688	1.28	.787603	4.72	.212397	29
32	.718497	3.43	.930611	1.30	.787886	4.73	.212114	28
33	.718703	3.43	.930533	1.28	.788170	4.73	.211830	27
34	.718909	3.43	.930456	1.30	.788453	4.72	.211547	26
35	9.719114	3.42	9.930378	1.30	9.788736	4.72	0.211264	25
36	.719320	3.43	.930300	1.30	.789019	4.72	.210981	24
37	.719525	3.42	.930223	1.28	.789302	4.72	.210698	23
38	.719730	3.42	.930145	1.30	.789585	4.72	.210415	22
39	.719935	3.42	.930067	1.30	.789868	4.72	.210132	21
40	9.720140	3.42	9.929989	1.30	9.790151	4.72	0.209849	20
41	.720345	3.40	.929911	1.30	.790434	4.70	.209566	19
42	.720549	3.42	.929833	1.30	.790716	4.72	.209284	18
43	.720754	3.40	.929755	1.30	.790999	4.70	.209001	17
44	.720958	3.40	.929677	1.30	.791281	4.70	.208719	16
45	9.721162	3.40	9.929599	1.30	9.791563	4.70	0.208437	15
46	.721366	3.40	.929521	1.30	.791846	4.72	.208154	14
47	.721570	3.40	.929442	1.32	.792128	4.70	.207872	13
48	.721774	3.40	.929364	1.30	.792410	4.70	.207590	12
49	.721978	3.38	.929286	1.32	.792692	4.70	.207308	11
50	9.722181	3.40	9.929207	1.30	9.792974	4.70	0.207026	10
51	.722385	3.38	.929129	1.32	.793256	4.70	.206744	9
52	.722588	3.38	.929050	1.30	.793538	4.68	.206462	8
53	.722791	3.38	.928972	1.32	.793819	4.70	.206181	7
54	.722994	3.38	.928893	1.30	.794101	4.70	.205900	6
55	9.723197	3.38	9.928815	1.32	9.794383	4.68	0.205617	5
56	.723400	3.38	.928736	1.32	.794664	4.70	.205336	4
57	.723603	3.38	.928657	1.32	.794946	4.68	.205054	3
58	.723805	3.37	.928578	1.32	.795227	4.68	.204773	2
59	.724007	3.37	.928499	1.32	.795508	4.68	.204492	1
60	9.724210	3.38	9.928420	1.32	9.795789	4.68	0.204211	0

	Cos.	D. 1".	Sin.	D. 1".	Cot.	D. 1".	Tan.	M.
--	------	--------	------	--------	------	--------	------	----

TABLE OF LOGARITHMIC SINES—COSINES, ETC. 1685

32°

147°

M.	Sin.	D. 1".	Cos.	D. 1".	Tan.	D. 1".	Cot.	
0	9.724210	3.37	9.928420	1.30	9.795789	4.68	0.204211	60
1	.724412	3.37	.928342	1.32	.796070	4.68	.203930	59
2	.724614	3.37	.928263	1.33	.796351	4.68	.203649	58
3	.724816	3.35	.928183	1.32	.796632	4.68	.203368	57
4	.725017	3.37	.928104	1.32	.796913	4.68	.203087	56
5	9.725219	3.35	9.928025	1.32	9.797194	4.67	0.202806	55
6	.725420	3.37	.927946	1.32	.797474	4.68	.202526	54
7	.725622	3.35	.927867	1.33	.797755	4.68	.202245	53
8	.725823	3.35	.927787	1.32	.798036	4.68	.201964	52
9	.726024	3.35	.927708	1.32	.798316	4.67	.201684	51
10	9.726225	3.35	9.927629	1.33	9.798596	4.68	0.201404	50
11	.726426	3.33	.927549	1.32	.798877	4.67	.201123	49
12	.726626	3.35	.927470	1.33	.799157	4.67	.200843	48
13	.726827	3.33	.927390	1.33	.799437	4.67	.200563	47
14	.727027	3.35	.927310	1.32	.799717	4.67	.200283	46
15	9.727228	3.33	9.927231	1.33	9.799997	4.67	0.200003	45
16	.727428	3.33	.927151	1.33	.800277	4.67	.199723	44
17	.727628	3.33	.927071	1.33	.800557	4.65	.199443	43
18	.727828	3.32	.926991	1.33	.800836	4.67	.199164	42
19	.728027	3.33	.926911	1.33	.801116	4.67	.198884	41
20	9.728227	3.33	9.926831	1.33	9.801396	4.65	0.198604	40
21	.728427	3.32	.926751	1.33	.801675	4.67	.198325	39
22	.728626	3.32	.926671	1.33	.801955	4.65	.198045	38
23	.728825	3.32	.926591	1.33	.802234	4.65	.197766	37
24	.729024	3.32	.926511	1.33	.802513	4.65	.197487	36
25	9.729223	3.32	9.926431	1.33	9.802792	4.67	0.197208	35
26	.729422	3.32	.926351	1.35	.803072	4.65	.196928	34
27	.729621	3.32	.926270	1.33	.803351	4.65	.196649	33
28	.729820	3.30	.926190	1.33	.803630	4.65	.196370	32
29	.730018	3.32	.926110	1.35	.803909	4.63	.196091	31
30	9.730217	3.30	9.926029	1.33	9.804187	4.65	0.195813	30
31	.730415	3.30	.925949	1.35	.804466	4.65	.195534	29
32	.730613	3.30	.925868	1.33	.804745	4.63	.195255	28
33	.730811	3.30	.925788	1.35	.805023	4.65	.194977	27
34	.731009	3.28	.925707	1.35	.805302	4.65	.194698	26
35	9.731206	3.28	9.925626	1.35	9.805580	4.63	0.194420	25
36	.731404	3.30	.925545	1.35	.805859	4.65	.194141	24
37	.731602	3.30	.925465	1.33	.806137	4.63	.193863	23
38	.731799	3.28	.925384	1.35	.806415	4.63	.193585	22
39	.731996	3.28	.925303	1.35	.806693	4.63	.193307	21
40	9.732193	3.28	9.925222	1.35	9.806971	4.63	0.193029	20
41	.732390	3.28	.925141	1.35	.807249	4.63	.192751	19
42	.732587	3.28	.925060	1.35	.807527	4.63	.192473	18
43	.732784	3.27	.924979	1.37	.807805	4.63	.192195	17
44	.732980	3.27	.924897	1.35	.808083	4.63	.191917	16
45	9.733177	3.27	9.924816	1.35	9.808361	4.62	0.191639	15
46	.733373	3.27	.924735	1.35	.808638	4.62	.191362	14
47	.733569	3.27	.924654	1.35	.808916	4.62	.191084	13
48	.733765	3.27	.924572	1.37	.809193	4.62	.190807	12
49	.733961	3.27	.924491	1.37	.809471	4.62	.190529	11
50	9.734157	3.27	9.924409	1.35	9.809748	4.62	0.190252	10
51	.734353	3.27	.924328	1.37	.810025	4.62	.189975	9
52	.734549	3.25	.924246	1.37	.810302	4.62	.189698	8
53	.734744	3.25	.924164	1.35	.810580	4.62	.189420	7
54	.734939	3.27	.924083	1.37	.810857	4.62	.189143	6
55	9.735135	3.25	9.924001	1.37	9.811134	4.60	0.188866	5
56	.735330	3.25	.923919	1.37	.811410	4.62	.188590	4
57	.735525	3.25	.923837	1.37	.811687	4.62	.188313	3
58	.735719	3.23	.923755	1.37	.811964	4.62	.188036	2
59	.735914	3.25	.923673	1.37	.812241	4.62	.187759	1
60	9.736109	3.25	9.923591	1.37	9.812517	4.60	0.187483	0
	Cos.	D. 1".	Sin.	D. 1".	Cot.	D. 1".	Tan.	M.

122°

57°

M.	Sin.	D. 1".	Cos.	D. 1".	Tan.	D. 1".	Cot.	
0	9.736109	3. 23	9.923591	1. 37	9.812517	4. 62	0.187483	60
1	.736303	3. 25	.923509	1. 37	.812794	4. 60	.187206	59
2	.736498	3. 23	.923427	1. 37	.813070	4. 62	.186930	58
3	.736692	3. 23	.923345	1. 37	.813347	4. 60	.186653	57
4	.736886	3. 23	.923263	1. 37	.813623	4. 60	.186377	56
5	9.737080	3. 23	9.923181	1. 37	9.813909	4. 62	0.186101	55
6	.737274	3. 23	.923098	1. 38	.814176	4. 62	.185824	54
7	.737467	3. 22	.923016	1. 37	.814452	4. 60	.185548	53
8	.737661	3. 23	.922933	1. 38	.814728	4. 60	.185272	52
9	.737855	3. 22	.922851	1. 38	.815004	4. 60	.184996	51
10	9.738048	3. 22	9.922768	1. 37	9.815280	4. 58	0.184720	50
11	.738241	3. 22	.922686	1. 38	.815555	4. 60	.184445	49
12	.738434	3. 22	.922603	1. 38	.815831	4. 60	.184169	48
13	.738627	3. 22	.922520	1. 37	.816107	4. 58	.183893	47
14	.738820	3. 22	.922438	1. 38	.816382	4. 60	.183618	46
15	9.739013	3. 22	9.922355	1. 38	9.816658	4. 58	0.183342	45
16	.739206	3. 22	.922272	1. 38	.816933	4. 58	.183067	44
17	.739398	3. 20	.922189	1. 38	.817209	4. 60	.182791	43
18	.739590	3. 20	.922106	1. 38	.817484	4. 58	.182516	42
19	.739783	3. 22	.922023	1. 38	.817759	4. 60	.182241	41
20	9.739975	3. 20	9.921940	1. 38	9.818035	4. 58	0.181965	40
21	.740167	3. 20	.921857	1. 38	.818310	4. 58	.181690	39
22	.740359	3. 18	.921774	1. 38	.818585	4. 58	.181415	38
23	.740550	3. 20	.921691	1. 40	.818860	4. 58	.181140	37
24	.740742	3. 20	.921607	1. 38	.819135	4. 58	.180865	36
25	9.740934	3. 18	9.921524	1. 38	9.819410	4. 57	0.180590	35
26	.741125	3. 18	.921441	1. 38	.819684	4. 58	.180316	34
27	.741316	3. 18	.921357	1. 40	.819959	4. 58	.180041	33
28	.741508	3. 20	.921274	1. 38	.820234	4. 58	.179766	32
29	.741699	3. 18	.921190	1. 40	.820508	4. 57	.179492	31
30	9.741889	3. 17	9.921107	1. 40	9.820783	4. 58	0.179217	30
31	.742080	3. 18	.921023	1. 40	.821057	4. 57	.178943	29
32	.742271	3. 18	.920939	1. 40	.821332	4. 58	.178668	28
33	.742462	3. 18	.920856	1. 38	.821606	4. 57	.178394	27
34	.742652	3. 17	.920772	1. 40	.821880	4. 57	.178120	26
35	9.742842	3. 17	9.920688	1. 40	9.822154	4. 58	0.177846	25
36	.743033	3. 18	.920604	1. 40	.822429	4. 58	.177571	24
37	.743223	3. 17	.920520	1. 40	.822703	4. 57	.177297	23
38	.743413	3. 17	.920436	1. 40	.822977	4. 57	.177023	22
39	.743602	3. 15	.920352	1. 40	.823251	4. 57	.176749	21
40	9.743792	3. 17	9.920268	1. 40	9.823524	4. 55	0.176476	20
41	.743982	3. 15	.920184	1. 42	.823798	4. 57	.176202	19
42	.744171	3. 15	.920099	1. 42	.824072	4. 57	.175928	18
43	.744361	3. 17	.920015	1. 40	.824345	4. 55	.175655	17
44	.744550	3. 15	.919931	1. 42	.824619	4. 57	.175381	16
45	9.744739	3. 15	9.919846	1. 40	9.824893	4. 55	0.175107	15
46	.744928	3. 15	.919762	1. 42	.825166	4. 55	.174834	14
47	.745117	3. 15	.919677	1. 42	.825439	4. 55	.174561	13
48	.745306	3. 15	.919593	1. 40	.825713	4. 57	.174287	12
49	.745494	3. 13	.919508	1. 42	.825986	4. 55	.174014	11
50	9.745683	3. 15	9.919424	1. 42	9.826259	4. 55	0.173741	10
51	.745871	3. 13	.919339	1. 42	.826532	4. 55	.173468	9
52	.746060	3. 15	.919254	1. 42	.826805	4. 55	.173195	8
53	.746248	3. 13	.919169	1. 42	.827078	4. 55	.172922	7
54	.746436	3. 13	.919085	1. 42	.827351	4. 55	.172649	6
55	9.746624	3. 13	9.919000	1. 42	9.827624	4. 55	0.172376	5
56	.746812	3. 12	.918915	1. 42	.827897	4. 55	.172103	4
57	.746999	3. 12	.918830	1. 42	.828170	4. 55	.171830	3
58	.747187	3. 13	.918745	1. 42	.828444	4. 53	.171558	2
59	.747374	3. 12	.918659	1. 43	.828715	4. 55	.171285	1
60	9.747562	3. 13	9.918574	1. 42	9.828987	4. 53	0.171013	0

TABLE OF LOGARITHMIC SINES—COSINES, ETC. 1687

34°

145°

M.	Sin.	D. 1".	Cos.	D. 1".	Tan.	D. 1".	Cot.	
0	9.747562		9.918574		9.828987		0.171013	60
1	.747749	3.12	.918479	1.42	.829260	4.55	.170740	59
2	.747936	3.12	.918404	1.42	.829532	4.55	.170468	58
3	.748123	3.12	.918318	1.43	.829805	4.55	.170195	57
4	.748310	3.12	.918233	1.42	.830077	4.53	.169923	56
5	9.748497	3.12	9.918147	1.43	9.830349	4.53	0.169651	55
6	.748683	3.10	.918062	1.42	.830621	4.53	.169379	54
7	.748870	3.10	.917976	1.42	.830893	4.53	.169107	53
8	.749056	3.12	.917891	1.43	.831165	4.53	.168835	52
9	.749243	3.10	.917805	1.43	.831437	4.53	.168563	51
10	9.749429	3.10	9.917719	1.42	9.831709	4.53	0.168291	50
11	.749615	3.10	.917634	1.43	.831981	4.53	.168019	49
12	.749801	3.10	.917548	1.43	.832253	4.53	.167747	48
13	.749987	3.08	.917462	1.43	.832525	4.53	.167475	47
14	.750172	3.08	.917376	1.43	.832796	4.52	.167204	46
15	9.750358	3.08	9.917290	1.43	9.833068	4.53	0.166932	45
16	.750543	3.10	.917204	1.43	.833339	4.53	.166661	44
17	.750729	3.08	.917118	1.43	.833611	4.52	.166389	43
18	.750914	3.08	.917032	1.43	.833882	4.53	.166118	42
19	.751099	3.08	.916946	1.45	.834154	4.52	.165846	41
20	9.751284	3.08	9.916859	1.43	9.834425	4.52	0.165575	40
21	.751469	3.08	.916773	1.43	.834696	4.52	.165304	39
22	.751654	3.08	.916687	1.45	.834967	4.52	.165033	38
23	.751839	3.07	.916600	1.45	.835238	4.52	.164762	37
24	.752023	3.07	.916514	1.43	.835509	4.52	.164491	36
25	9.752208	3.08	9.916427	1.45	9.835780	4.52	0.164220	35
26	.752392	3.07	.916341	1.43	.836051	4.52	.163949	34
27	.752576	3.07	.916254	1.45	.836322	4.52	.163678	33
28	.752760	3.07	.916167	1.43	.836593	4.52	.163407	32
29	.752944	3.07	.916081	1.45	.836864	4.50	.163136	31
30	9.753128	3.07	9.915994	1.45	9.837134	4.52	0.162866	30
31	.753312	3.05	.915907	1.45	.837405	4.50	.162595	29
32	.753495	3.07	.915820	1.45	.837675	4.52	.162325	28
33	.753679	3.05	.915733	1.45	.837946	4.52	.162054	27
34	.753862	3.05	.915646	1.45	.838216	4.50	.161784	26
35	9.754046	3.07	9.915559	1.45	9.838487	4.52	0.161513	25
36	.754229	3.05	.915472	1.45	.838757	4.50	.161243	24
37	.754412	3.05	.915385	1.45	.839027	4.50	.160973	23
38	.754595	3.05	.915297	1.45	.839297	4.52	.160703	22
39	.754778	3.03	.915210	1.45	.839568	4.50	.160432	21
40	9.754960	3.05	9.915123	1.47	9.839838	4.50	0.160162	20
41	.755143	3.05	.915035	1.45	.840108	4.50	.159892	19
42	.755326	3.03	.914948	1.47	.840378	4.50	.159622	18
43	.755508	3.03	.914860	1.47	.840648	4.50	.159352	17
44	.755690	3.03	.914773	1.45	.840917	4.48	.159083	16
45	9.755872	3.03	9.914685	1.47	9.841187	4.50	0.158813	15
46	.756054	3.03	.914598	1.45	.841457	4.50	.158543	14
47	.756236	3.03	.914510	1.47	.841727	4.48	.158273	13
48	.756418	3.03	.914422	1.47	.841996	4.50	.158004	12
49	.756600	3.03	.914334	1.47	.842266	4.48	.157734	11
50	9.756782	3.02	9.914246	1.47	9.842535	4.50	0.157465	10
51	.756963	3.02	.914158	1.47	.842805	4.48	.157195	9
52	.757144	3.03	.914070	1.47	.843074	4.48	.156926	8
53	.757326	3.02	.913982	1.47	.843343	4.48	.156657	7
54	.757507	3.02	.913894	1.47	.843612	4.48	.156388	6
55	9.757688	3.02	9.913806	1.47	9.843882	4.50	0.156118	5
56	.757869	3.02	.913718	1.47	.844151	4.48	.155849	4
57	.758050	3.02	.913630	1.47	.844420	4.48	.155580	3
58	.758230	3.00	.913541	1.47	.844689	4.48	.155311	2
59	.758411	3.00	.913453	1.47	.844958	4.48	.155042	1
60	9.758591		9.913365		9.845227		0.154773	0
	Cos.	D. 1".	Sin.	D. 1".	Cot.	D. 1".	Tan.	M.

124°

55°

M.	Sin.	D. 1".	Cos.	D. 1".	Tan.	D. 1".	Cot.	
0	9.758591	3.02	9.913365	1.48	9.845227	4.48	0.154773	60
1	.758772	3.00	.913276	1.48	.845496	4.47	.154504	59
2	.758952	3.00	.913187	1.48	.845764	4.47	.154236	58
3	.759132	3.00	.913099	1.47	.846033	4.48	.153967	57
4	.759312	3.00	.913010	1.47	.846302	4.48	.153698	56
5	9.759492	3.00	9.912922	1.48	9.846570	4.47	0.153430	55
6	.759672	3.00	.912833	1.48	.846839	4.48	.153161	54
7	.759852	2.98	.912744	1.48	.847108	4.48	.152892	53
8	.760031	2.98	.912655	1.48	.847376	4.47	.152624	52
9	.760211	2.98	.912566	1.48	.847644	4.47	.152356	51
10	9.760390	2.98	9.912477	1.48	9.847913	4.47	0.152087	50
11	.760569	2.98	.912388	1.48	.848181	4.47	.151819	49
12	.760748	2.98	.912299	1.48	.848449	4.47	.151551	48
13	.760927	2.98	.912210	1.48	.848717	4.47	.151283	47
14	.761106	2.98	.912121	1.48	.848986	4.48	.151014	46
15	9.761285	2.98	9.912031	1.50	9.849254	4.47	0.150746	45
16	.761464	2.97	.911942	1.48	.849522	4.47	.150478	44
17	.761642	2.98	.911853	1.50	.849790	4.47	.150210	43
18	.761821	2.97	.911763	1.48	.850057	4.45	.149943	42
19	.761999	2.97	.911674	1.50	.850325	4.47	.149675	41
20	9.762177	2.98	9.911584	1.48	9.850593	4.47	0.149407	40
21	.762356	2.97	.911495	1.50	.850861	4.47	.149139	39
22	.762534	2.97	.911405	1.50	.851129	4.47	.148871	38
23	.762712	2.97	.911315	1.50	.851396	4.45	.148604	37
24	.762890	2.95	.911226	1.48	.851664	4.47	.148336	36
25	9.763067	2.97	9.911136	1.50	9.851931	4.45	0.148069	35
26	.763245	2.97	.911046	1.50	.852199	4.47	.147801	34
27	.763422	2.95	.910956	1.50	.852466	4.45	.147534	33
28	.763600	2.97	.910866	1.50	.852733	4.47	.147267	32
29	.763777	2.95	.910776	1.50	.853001	4.45	.146999	31
30	9.763954	2.95	9.910686	1.50	9.853268	4.45	0.146732	30
31	.764131	2.95	.910596	1.50	.853535	4.45	.146465	29
32	.764308	2.95	.910506	1.52	.853802	4.45	.146198	28
33	.764485	2.95	.910415	1.50	.854069	4.45	.145931	27
34	.764662	2.95	.910325	1.50	.854336	4.45	.145664	26
35	9.764838	2.93	9.910235	1.52	9.854603	4.45	0.145397	25
36	.765015	2.93	.910144	1.50	.854870	4.45	.145130	24
37	.765191	2.93	.910054	1.52	.855137	4.45	.144863	23
38	.765367	2.95	.909963	1.50	.855404	4.45	.144596	22
39	.765544	2.93	.909873	1.52	.855671	4.45	.144329	21
40	9.765720	2.93	9.909782	1.52	9.855938	4.43	0.144062	20
41	.765896	2.93	.909691	1.50	.856204	4.45	.143796	19
42	.766072	2.92	.909601	1.52	.856471	4.43	.143529	18
43	.766247	2.92	.909510	1.52	.856737	4.43	.143263	17
44	.766423	2.93	.909419	1.52	.857004	4.45	.142996	16
45	9.766598	2.92	9.909328	1.52	9.857270	4.43	0.142730	15
46	.766774	2.93	.909237	1.52	.857537	4.45	.142463	14
47	.766949	2.92	.909146	1.52	.857803	4.43	.142197	13
48	.767124	2.93	.909055	1.52	.858069	4.45	.141931	12
49	.767300	2.92	.908964	1.52	.858336	4.43	.141664	11
50	9.767475	2.90	9.908873	1.53	9.858602	4.43	0.141398	10
51	.767649	2.92	.908781	1.52	.858868	4.43	.141132	9
52	.767824	2.92	.908690	1.52	.859134	4.43	.140866	8
53	.767999	2.90	.908599	1.53	.859400	4.43	.140600	7
54	.768173	2.92	.908507	1.53	.859666	4.43	.140334	6
55	9.768348	2.92	9.908416	1.52	9.859932	4.43	0.140068	5
56	.768522	2.90	.908324	1.53	.860198	4.43	.139802	4
57	.768697	2.92	.908233	1.53	.860464	4.43	.139536	3
58	.768871	2.90	.908141	1.53	.860730	4.43	.139270	2
59	.769045	2.90	.908049	1.52	.860995	4.42	.139005	1
60	9.769219	2.90	9.907958	1.52	9.861261	4.43	0.138739	0
	Cos.	D. 1".	Sin.	D. 1".	Cot.	D. 1".	Tan.	M.

TABLE OF LOGARITHMIC SINES—COSINES, ETC. 1689

36°

143°

M.	Sin.	D. 1".	Cos.	D. 1".	Tan.	D. 1".	Cot.	
0	9.769219	2.90	9.907958	1.53	9.861261	4.43	0.138739	60
1	.769393	2.88	.907866	1.53	.861527	4.43	.138473	59
2	.769566	2.90	.907774	1.53	.861792	4.43	.138208	58
3	.769740	2.88	.907682	1.53	.862058	4.43	.137942	57
4	.769913	2.90	.907590	1.53	.862323	4.43	.137677	56
5	9.770087	2.88	9.907498	1.53	9.862589	4.42	0.137411	55
6	.770260	2.88	.907406	1.53	.862854	4.42	.137146	54
7	.770433	2.88	.907314	1.53	.863119	4.43	.136881	53
8	.770606	2.88	.907222	1.55	.863385	4.42	.136615	52
9	.770779	2.88	.907129	1.53	.863650	4.42	.136350	51
10	9.770952	2.88	9.907037	1.53	9.863915	4.42	0.136085	50
11	.771125	2.88	.906945	1.55	.864180	4.42	.135820	49
12	.771298	2.87	.906852	1.53	.864445	4.42	.135555	48
13	.771470	2.88	.906760	1.55	.864710	4.42	.135290	47
14	.771643	2.87	.906667	1.53	.864975	4.42	.135025	46
15	9.771815	2.87	9.906575	1.55	9.865240	4.42	0.134760	45
16	.771987	2.87	.906482	1.55	.865505	4.42	.134495	44
17	.772159	2.87	.906389	1.55	.865770	4.42	.134230	43
18	.772331	2.87	.906296	1.53	.866035	4.42	.133965	42
19	.772503	2.87	.906204	1.55	.866300	4.40	.133700	41
20	9.772675	2.87	9.906111	1.55	9.866564	4.42	0.133436	40
21	.772847	2.85	.906018	1.55	.866829	4.42	.133171	39
22	.773018	2.87	.905925	1.55	.867094	4.40	.132906	38
23	.773190	2.85	.905832	1.55	.867358	4.40	.132642	37
24	.773361	2.87	.905739	1.57	.867623	4.40	.132377	36
25	9.773533	2.85	9.905645	1.55	9.867887	4.40	0.132113	35
26	.773704	2.85	.905552	1.55	.868152	4.42	.131848	34
27	.773875	2.85	.905459	1.55	.868416	4.40	.131584	33
28	.774046	2.85	.905366	1.57	.868680	4.42	.131320	32
29	.774217	2.85	.905272	1.55	.868945	4.40	.131055	31
30	9.774388	2.83	9.905179	1.57	9.869209	4.40	0.130791	30
31	.774558	2.85	.905085	1.55	.869473	4.40	.130527	29
32	.774729	2.83	.904992	1.57	.869737	4.40	.130263	28
33	.774899	2.85	.904898	1.57	.870001	4.40	.129999	27
34	.775070	2.83	.904804	1.55	.870265	4.40	.129735	26
35	9.775240	2.83	9.904711	1.57	9.870529	4.40	0.129471	25
36	.775410	2.83	.904617	1.57	.870793	4.40	.129207	24
37	.775580	2.83	.904523	1.57	.871057	4.40	.128943	23
38	.775750	2.83	.904429	1.57	.871321	4.40	.128679	22
39	.775920	2.83	.904335	1.57	.871585	4.40	.128415	21
40	9.776090	2.82	9.904241	1.57	9.871849	4.38	0.128151	20
41	.776259	2.83	.904147	1.57	.872112	4.40	.127888	19
42	.776429	2.82	.904053	1.57	.872376	4.40	.127624	18
43	.776598	2.83	.903959	1.58	.872640	4.38	.127360	17
44	.776768	2.82	.903864	1.57	.872903	4.40	.127097	16
45	9.776937	2.82	9.903770	1.57	9.873167	4.38	0.126833	15
46	.777106	2.82	.903676	1.58	.873430	4.40	.126570	14
47	.777275	2.82	.903581	1.58	.873694	4.40	.126306	13
48	.777444	2.82	.903487	1.57	.873957	4.38	.126043	12
49	.777613	2.80	.903392	1.57	.874220	4.40	.125780	11
50	9.777781	2.82	9.903298	1.58	9.874484	4.38	0.125516	10
51	.777950	2.82	.903203	1.58	.874747	4.38	.125253	9
52	.778119	2.80	.903108	1.57	.875010	4.38	.124990	8
53	.778287	2.80	.903014	1.58	.875273	4.40	.124727	7
54	.778455	2.82	.902919	1.58	.875537	4.38	.124463	6
55	9.778624	2.80	9.902824	1.58	9.875800	4.38	0.124200	5
56	.778792	2.80	.902729	1.58	.876063	4.38	.123937	4
57	.778960	2.80	.902634	1.58	.876326	4.38	.123674	3
58	.779128	2.78	.902539	1.58	.876589	4.38	.123411	2
59	.779295	2.80	.902444	1.58	.876852	4.38	.123148	1
60	9.779463	2.80	9.902349	1.58	9.877114	4.37	0.122886	0
	Cos.	D. 1".	Sin.	D. 1".	Cot.	D. 1".	Tan.	M.

126°

53°

M.	Sin.	D. 1".	Cos.	D. 1".	Tan.	D. 1".	Cot.	
0	9.779463	2.80	9.902349	1.60	9.877114	4.38	0.122886	60
1	.779631	2.78	.902253	1.58	.877377	4.38	.122623	59
2	.779798	2.80	.902158	1.58	.877640	4.38	.122360	58
3	.779966	2.78	.902063	1.58	.877903	4.38	.122097	57
4	.780133	2.78	.901967	1.60	.878165	4.37	.121835	56
5	9.780300	2.78	9.901872	1.58	9.878428	4.38	0.121572	55
6	.780467	2.78	.901776	1.60	.878691	4.38	.121309	54
7	.780634	2.78	.901681	1.58	.878953	4.37	.121047	53
8	.780801	2.78	.901585	1.58	.879216	4.38	.120784	52
9	.780968	2.77	.901490	1.60	.879478	4.38	.120522	51
10	9.781134	2.78	9.901394	1.60	9.879741	4.37	0.120259	50
11	.781301	2.78	.901298	1.60	.880003	4.37	.119997	49
12	.781468	2.77	.901202	1.60	.880265	4.38	.119735	48
13	.781634	2.77	.901106	1.60	.880528	4.38	.119472	47
14	.781800	2.77	.901010	1.60	.880790	4.37	.119210	46
15	9.781966	2.77	9.900914	1.60	9.881052	4.37	0.118948	45
16	.782132	2.77	.900818	1.60	.881314	4.37	.118686	44
17	.782298	2.77	.900722	1.60	.881577	4.37	.118423	43
18	.782464	2.77	.900626	1.62	.881839	4.37	.118161	42
19	.782630	2.77	.900529	1.60	.882101	4.37	.117899	41
20	9.782796	2.75	9.900433	1.60	9.882363	4.37	0.117637	40
21	.782961	2.77	.900337	1.62	.882625	4.37	.117375	39
22	.783127	2.75	.900240	1.60	.882887	4.35	.117113	38
23	.783292	2.75	.900144	1.62	.883148	4.37	.116852	37
24	.783458	2.75	.900047	1.60	.883410	4.37	.116590	36
25	9.783623	2.75	9.899951	1.62	9.883672	4.37	0.116328	35
26	.783788	2.75	.899854	1.62	.883934	4.37	.116066	34
27	.783953	2.75	.899757	1.62	.884196	4.37	.115804	33
28	.784118	2.75	.899660	1.62	.884457	4.35	.115543	32
29	.784282	2.73	.899564	1.60	.884719	4.37	.115281	31
30	9.784447	2.75	9.899467	1.62	9.884980	4.35	0.115020	30
31	.784612	2.73	.899370	1.62	.885242	4.37	.114758	29
32	.784776	2.75	.899273	1.62	.885504	4.35	.114496	28
33	.784941	2.73	.899176	1.63	.885765	4.35	.114235	27
34	.785105	2.73	.899078	1.62	.886026	4.35	.113974	26
35	9.785269	2.73	9.898981	1.62	9.886288	4.37	0.113712	25
36	.785433	2.73	.898884	1.62	.886549	4.35	.113451	24
37	.785597	2.73	.898787	1.62	.886811	4.37	.113189	23
38	.785761	2.73	.898689	1.63	.887072	4.35	.112928	22
39	.785925	2.73	.898592	1.62	.887333	4.35	.112667	21
40	9.786089	2.72	9.898494	1.62	9.887594	4.35	0.112406	20
41	.786252	2.73	.898397	1.63	.887855	4.35	.112145	19
42	.786416	2.72	.898299	1.62	.888116	4.37	.111884	18
43	.786579	2.72	.898202	1.63	.888378	4.35	.111622	17
44	.786742	2.72	.898104	1.63	.888639	4.35	.111361	16
45	9.786906	2.73	9.898006	1.63	9.888900	4.35	0.111100	15
46	.787069	2.72	.897908	1.63	.889161	4.35	.110839	14
47	.787232	2.72	.897810	1.63	.889421	4.33	.110579	13
48	.787395	2.72	.897712	1.63	.889682	4.35	.110318	12
49	.787557	2.70	.897614	1.63	.889943	4.35	.110057	11
50	9.787720	2.72	9.897516	1.63	9.890204	4.35	0.109796	10
51	.787883	2.70	.897418	1.63	.890465	4.33	.109535	9
52	.788045	2.72	.897320	1.63	.890725	4.35	.109275	8
53	.788208	2.70	.897222	1.65	.890986	4.35	.109014	7
54	.788370	2.70	.897123	1.63	.891247	4.35	.108753	6
55	9.788532	2.70	9.897025	1.65	9.891507	4.33	0.108493	5
56	.788694	2.70	.896926	1.65	.891768	4.35	.108232	4
57	.788856	2.70	.896828	1.63	.892028	4.33	.107972	3
58	.789018	2.70	.896729	1.65	.892289	4.35	.107711	2
59	.789180	2.70	.896631	1.63	.892549	4.33	.107451	1
60	9.789342	2.70	9.896532	1.65	9.892810	4.35	0.107190	0

TABLE OF LOGARITHMIC SINES—COSINES, ETC. 1691

38°

141°

M.	Sin.	D. 1".	Cos.	D. 1".	Tan.	D. 1".	Cot.	
0	9.789342	2.70	9.896532	1.65	9.892810	4.33	0.107190	60
1	.789504	2.68	.896433	1.63	.893070	4.25	.106930	59
2	.789665	2.70	.896335	1.65	.893331	4.33	.106669	58
3	.789827	2.68	.896236	1.65	.893591	4.33	.106409	57
4	.789988	2.68	.896137	1.65	.893851	4.33	.106149	56
5	9.790149	2.68	9.896038	1.65	9.894111	4.35	0.105889	55
6	.790310	2.68	.895939	1.65	.894372	4.33	.105628	54
7	.790471	2.68	.895840	1.65	.894632	4.33	.105368	53
8	.790632	2.68	.895741	1.67	.894892	4.33	.105108	52
9	.790793	2.68	.895641	1.65	.895152	4.33	.104848	51
10	9.790954	2.68	9.895542	1.65	9.895412	4.33	0.104588	50
11	.791115	2.67	.895443	1.67	.895672	4.33	.104328	49
12	.791275	2.68	.895343	1.65	.895932	4.33	.104068	48
13	.791436	2.67	.895244	1.65	.896192	4.33	.103808	47
14	.791596	2.67	.895145	1.65	.896452	4.33	.103548	46
15	9.791757	2.67	9.895045	1.67	9.896712	4.32	0.103288	45
16	.791917	2.67	.894945	1.65	.896971	4.33	.103029	44
17	.792077	2.67	.894846	1.67	.897231	4.33	.102769	43
18	.792237	2.67	.894746	1.67	.897491	4.33	.102509	42
19	.792397	2.67	.894646	1.67	.897751	4.32	.102249	41
20	9.792557	2.65	9.894546	1.67	9.898010	4.33	0.101990	40
21	.792716	2.67	.894446	1.67	.898270	4.33	.101730	39
22	.792876	2.65	.894346	1.67	.898530	4.32	.101470	38
23	.793035	2.67	.894246	1.67	.898789	4.33	.101211	37
24	.793195	2.65	.894146	1.67	.899049	4.33	.100951	36
25	9.793354	2.67	9.894046	1.67	9.899308	4.32	0.100692	35
26	.793514	2.67	.893946	1.67	.899568	4.33	.100432	34
27	.793673	2.65	.893846	1.67	.899827	4.32	.100173	33
28	.793832	2.65	.893745	1.68	.900087	4.33	.099913	32
29	.793991	2.65	.893645	1.68	.900346	4.32	.099654	31
30	9.794150	2.63	9.893544	1.67	9.900605	4.32	0.099395	30
31	.794308	2.65	.893444	1.68	.900864	4.33	.099136	29
32	.794467	2.65	.893343	1.67	.901124	4.32	.098876	28
33	.794626	2.63	.893243	1.68	.901383	4.32	.098617	27
34	.794784	2.63	.893142	1.68	.901642	4.32	.098358	26
35	9.794942	2.65	9.893041	1.68	9.901901	4.32	0.098099	25
36	.795101	2.65	.892940	1.68	.902160	4.33	.097840	24
37	.795259	2.63	.892839	1.68	.902420	4.32	.097580	23
38	.795417	2.63	.892739	1.67	.902679	4.32	.097321	22
39	.795575	2.63	.892638	1.70	.902938	4.32	.097062	21
40	9.795733	2.63	9.892536	1.68	9.903197	4.32	0.096803	20
41	.795891	2.63	.892435	1.68	.903456	4.30	.096544	19
42	.796049	2.62	.892334	1.68	.903714	4.32	.096286	18
43	.796206	2.63	.892233	1.68	.903973	4.32	.096027	17
44	.796364	2.62	.892132	1.70	.904232	4.32	.095768	16
45	9.796521	2.63	9.892030	1.68	9.904491	4.32	0.095509	15
46	.796679	2.62	.891929	1.70	.904750	4.30	.095250	14
47	.796836	2.62	.891827	1.68	.905008	4.32	.094992	13
48	.796993	2.62	.891726	1.70	.905267	4.32	.094733	12
49	.797150	2.62	.891624	1.68	.905526	4.32	.094474	11
50	9.797307	2.62	9.891523	1.70	9.905785	4.30	0.094215	10
51	.797464	2.62	.891421	1.70	.906043	4.32	.093957	9
52	.797621	2.60	.891319	1.70	.906302	4.30	.093698	8
53	.797777	2.62	.891217	1.70	.906560	4.32	.093440	7
54	.797934	2.62	.891115	1.70	.906819	4.32	.093181	6
55	9.798091	2.60	9.891013	1.70	9.907077	4.30	0.092923	5
56	.798247	2.60	.890911	1.70	.907336	4.32	.092664	4
57	.798403	2.62	.890809	1.70	.907594	4.32	.092406	3
58	.798560	2.60	.890707	1.70	.907853	4.30	.092147	2
59	.798716	2.60	.890605	1.70	.908111	4.30	.091889	1
60	9.798872	2.60	9.890503	1.70	9.908369	4.30	0.091631	0
	Cos.	D. 1".	Sin.	D. 1".	Cot.	D. 1".	Tan.	M

128°

51°

39°

140°

M.	Sin.	D. 1''.	Cos.	D. 1'	Tan.	D. 1''.	Cot.	
0	9.798872	2.60	9.890503	1.72	9.908369	4.32	0.091631	60
1	.799028	2.60	.890400	1.70	.908628	4.30	.091372	59
2	.799184	2.58	.890298	1.72	.908886	4.30	.091114	58
3	.799339	2.60	.890195	1.70	.909144	4.30	.090856	57
4	.799495	2.60	.890093	1.72	.909402	4.30	.090598	56
5	9.799651	2.58	9.889990	1.70	9.909660	4.30	0.090340	55
6	.799806	2.60	.889888	1.72	.909918	4.30	.090082	54
7	.799962	2.58	.889785	1.72	.910177	4.30	.089823	53
8	.800117	2.58	.889682	1.72	.910435	4.30	.089565	52
9	.800272	2.58	.889579	1.70	.910693	4.30	.089307	51
10	9.800427	2.58	9.889477	1.72	9.910951	4.30	0.089049	50
11	.800582	2.58	.889374	1.72	.911209	4.30	.088791	49
12	.800737	2.58	.889271	1.72	.911467	4.30	.088533	48
13	.800892	2.58	.889168	1.72	.911725	4.30	.088275	47
14	.801047	2.58	.889064	1.73	.911982	4.28	.088018	46
15	9.801201	2.57	9.888961	1.72	9.912240	4.30	0.087760	45
16	.801356	2.58	.888858	1.72	.912498	4.30	.087502	44
17	.801511	2.58	.888755	1.73	.912756	4.30	.087244	43
18	.801665	2.57	.888651	1.72	.913014	4.28	.086986	42
19	.801819	2.57	.888548	1.73	.913271	4.30	.086729	41
20	9.801973	2.58	9.888444	1.72	9.913529	4.30	0.086471	40
21	.802128	2.57	.888341	1.73	.913787	4.28	.086213	39
22	.802282	2.57	.888237	1.72	.914044	4.30	.085956	38
23	.802436	2.55	.888134	1.72	.914302	4.30	.085698	37
24	.802589	2.55	.888030	1.73	.914560	4.30	.085440	36
25	9.802743	2.57	9.887926	1.73	9.914817	4.28	0.085183	35
26	.802897	2.57	.887822	1.73	.915075	4.30	.084925	34
27	.803050	2.55	.887718	1.73	.915332	4.28	.084668	33
28	.803204	2.57	.887614	1.73	.915590	4.30	.084410	32
29	.803357	2.55	.887510	1.73	.915847	4.28	.084153	31
30	9.803511	2.55	9.887406	1.73	9.916104	4.30	0.083896	30
31	.803664	2.55	.887302	1.73	.916362	4.28	.083638	29
32	.803817	2.55	.887198	1.75	.916619	4.30	.083381	28
33	.803970	2.55	.887093	1.73	.916877	4.30	.083123	27
34	.804123	2.55	.886989	1.73	.917134	4.28	.082866	26
35	9.804276	2.55	9.886885	1.73	9.917391	4.28	0.082609	25
36	.804428	2.53	.886780	1.75	.917648	4.28	.082352	24
37	.804581	2.55	.886676	1.73	.917906	4.30	.082094	23
38	.804734	2.55	.886571	1.75	.918163	4.28	.081837	22
39	.804886	2.53	.886466	1.73	.918420	4.28	.081580	21
40	9.805039	2.53	9.886362	1.75	9.918677	4.28	0.081323	20
41	.805191	2.53	.886257	1.75	.918934	4.28	.081066	19
42	.805343	2.53	.886152	1.75	.919191	4.28	.080809	18
43	.805495	2.53	.886047	1.75	.919448	4.28	.080552	17
44	.805647	2.53	.885942	1.75	.919705	4.28	.080295	16
45	9.805799	2.53	9.885837	1.75	9.919962	4.28	0.080038	15
46	.805951	2.53	.885732	1.75	.920219	4.28	.079781	14
47	.806103	2.53	.885627	1.75	.920476	4.28	.079524	13
48	.806254	2.52	.885522	1.75	.920733	4.28	.079267	12
49	.806406	2.52	.885416	1.75	.920990	4.28	.079010	11
50	9.806557	2.53	9.885311	1.77	9.921247	4.27	0.078753	10
51	.806709	2.52	.885205	1.75	.921503	4.28	.078497	9
52	.806860	2.52	.885100	1.77	.921760	4.28	.078240	8
53	.807011	2.53	.884994	1.75	.922017	4.28	.077983	7
54	.807163	2.53	.884889	1.77	.922274	4.27	.077726	6
55	9.807314	2.52	9.884783	1.77	9.922530	4.28	0.077470	5
56	.807465	2.50	.884677	1.75	.922787	4.28	.077213	4
57	.807615	2.50	.884572	1.75	.923044	4.28	.076956	3
58	.807766	2.52	.884466	1.77	.923300	4.27	.076700	2
59	.807917	2.52	.884360	1.77	.923557	4.28	.076443	1
60	9.808067	2.50	9.884254	1.77	9.923814	4.28	0.076186	0
	Cos.	D. 1''.	Sin.	D. 1''.	Cot.	D. 1''.	Tan.	M.

120°

50°

TABLE OF LOGARITHMIC SINES—COSINES, ETC. 1693

40°

139°

M.	Sin.	D. r".	Cos.	D. r".	Tan.	D. r".	Cot.	
0	9.808067	2.52	9.884254	1.77	9.923814	4.27	0.076186	60
1	.808218	2.50	.884148	1.77	.924070	4.28	.075930	59
2	.808368	2.52	.884042	1.77	.924327	4.27	.075673	58
3	.808519	2.50	.883936	1.77	.924583	4.28	.075417	57
4	.808669	2.50	.883829	1.78	.924840	4.28	.075160	56
5	9.808819	2.50	9.883723	1.77	9.925096	4.27	0.074904	55
6	.808969	2.50	.883617	1.77	.925352	4.27	.074648	54
7	.809119	2.50	.883510	1.78	.925609	4.28	.074391	53
8	.809269	2.50	.883404	1.77	.925865	4.27	.074135	52
9	.809419	2.50	.883297	1.78	.926122	4.28	.073878	51
10	9.809569	2.48	9.883191	1.78	9.926378	4.27	0.073622	50
11	.809718	2.50	.883084	1.78	.926634	4.27	.073366	49
12	.809868	2.48	.882977	1.77	.926890	4.28	.073110	48
13	.810017	2.50	.882871	1.78	.927147	4.27	.072853	47
14	.810167	2.50	.882764	1.78	.927403	4.27	.072597	46
15	9.810316	2.48	9.882657	1.78	9.927659	4.27	0.072341	45
16	.810465	2.48	.882550	1.78	.927915	4.27	.072085	44
17	.810614	2.48	.882443	1.78	.928171	4.27	.071829	43
18	.810763	2.48	.882336	1.78	.928427	4.28	.071573	42
19	.810912	2.48	.882229	1.80	.928684	4.27	.071316	41
20	9.811061	2.48	9.882121	1.78	9.928840	4.27	0.071060	40
21	.811210	2.47	.882014	1.78	.929196	4.27	.070804	39
22	.811358	2.48	.881907	1.80	.929452	4.27	.070548	38
23	.811507	2.47	.881799	1.78	.929708	4.27	.070292	37
24	.811655	2.47	.881692	1.80	.929964	4.27	.070036	36
25	9.811804	2.47	9.881584	1.78	9.930220	4.27	0.069780	35
26	.811952	2.47	.881477	1.78	.930475	4.25	.069525	34
27	.812100	2.47	.881369	1.80	.930731	4.27	.069269	33
28	.812248	2.47	.881261	1.80	.930987	4.27	.069013	32
29	.812396	2.47	.881153	1.78	.931243	4.27	.068757	31
30	9.812544	2.47	9.881046	1.80	9.931499	4.27	0.068501	30
31	.812692	2.47	.880938	1.80	.931755	4.25	.068245	29
32	.812840	2.47	.880830	1.80	.932010	4.27	.067990	28
33	.812988	2.45	.880722	1.82	.932266	4.27	.067734	27
34	.813135	2.47	.880613	1.80	.932522	4.27	.067478	26
35	9.813283	2.45	9.880505	1.80	9.932778	4.27	0.067222	25
36	.813430	2.45	.880397	1.80	.933033	4.25	.066967	24
37	.813578	2.47	.880289	1.82	.933289	4.27	.066711	23
38	.813725	2.45	.880180	1.82	.933545	4.27	.066455	22
39	.813872	2.45	.880072	1.82	.933800	4.25	.066200	21
40	9.814019	2.45	9.879963	1.80	9.934056	4.25	0.065944	20
41	.814166	2.45	.879855	1.82	.934311	4.25	.065689	19
42	.814313	2.45	.879746	1.82	.934567	4.27	.065433	18
43	.814460	2.45	.879637	1.80	.934822	4.25	.065178	17
44	.814607	2.43	.879529	1.82	.935078	4.25	.064922	16
45	9.814753	2.45	9.879420	1.82	9.935333	4.27	0.064667	15
46	.814900	2.43	.879311	1.82	.935589	4.25	.064411	14
47	.815046	2.43	.879202	1.82	.935844	4.25	.064156	13
48	.815193	2.45	.879093	1.82	.936100	4.27	.063900	12
49	.815339	2.43	.878984	1.82	.936355	4.25	.063645	11
50	9.815485	2.45	9.878875	1.82	9.936611	4.25	0.063389	10
51	.815632	2.43	.878766	1.83	.936866	4.25	.063134	9
52	.815778	2.43	.878656	1.82	.937121	4.27	.062879	8
53	.815924	2.42	.878547	1.82	.937377	4.27	.062623	7
54	9.816069	2.43	9.878438	1.83	9.937632	4.25	.062368	6
55	.816215	2.43	.878328	1.82	.937887	4.25	.062113	5
56	.816361	2.43	.878219	1.83	.938142	4.27	.061858	4
57	.816507	2.42	.878109	1.83	.938398	4.25	.061602	3
58	.816652	2.42	.877999	1.83	.938653	4.25	.061347	2
59	.816798	2.43	.877890	1.82	.938908	4.25	.061092	1
60	9.816943	2.42	9.877780	1.83	9.939163	4.25	0.060837	0
	Cos.	D. r".	Sin.	D. r".	Cot.	D. r".	Tan.	M.

130°

94°

41°

138°

M.	Sin.	D. 1".	Cos.	D. 1".	Tan.	D. 1".	Cot.	
0	9.816943	2.42	9.877780	1.83	9.939163		0.060837	60
1	.817088	2.42	.877670	1.83	.939418	4.25	.060582	59
2	.817233	2.43	.877560	1.83	.939673	4.25	.060327	58
3	.817379	2.42	.877450	1.83	.939928	4.25	.060072	57
4	.817524	2.40	.877340	1.83	.940183	4.25	.059817	56
5	9.817668	2.42	9.877230	1.83	9.940439	4.27	0.059561	55
6	.817813	2.42	.877120	1.83	.940694	4.25	.059306	54
7	.817958	2.42	.877010	1.85	.940949	4.25	.059051	53
8	.818103	2.40	.876899	1.83	.941204	4.25	.058796	52
9	.818247	2.42	.876789	1.85	.941459	4.23	.058541	51
10	9.818392	2.40	9.876678	1.83	9.941713	4.25	0.058287	50
11	.818536	2.42	.876568	1.85	.941968	4.25	.058032	49
12	.818681	2.40	.876457	1.83	.942223	4.25	.057777	48
13	.818825	2.40	.876347	1.85	.942478	4.25	.057522	47
14	.818969	2.40	.876236	1.85	.942733	4.25	.057267	46
15	9.819113	2.40	9.876125	1.85	9.942988	4.25	0.057012	45
16	.819257	2.40	.876014	1.85	.943243	4.25	.056757	44
17	.819401	2.40	.875904	1.83	.943498	4.25	.056502	43
18	.819545	2.40	.875793	1.85	.943752	4.25	.056248	42
19	.819689	2.38	.875682	1.85	.944007	4.25	.055993	41
20	9.819832	2.40	9.875571	1.87	9.944262	4.25	0.055738	40
21	.819976	2.40	.875459	1.85	.944517	4.23	.055483	39
22	.820120	2.38	.875348	1.85	.944771	4.25	.055229	38
23	.820263	2.38	.875237	1.85	.945026	4.25	.054974	37
24	.820406	2.40	.875126	1.87	.945281	4.23	.054719	36
25	9.820550	2.35	9.875014	1.85	9.945535	4.23	0.054465	35
26	.820693	2.35	.874903	1.85	.945790	4.25	.054210	34
27	.820836	2.35	.874791	1.87	.946045	4.25	.053955	33
28	.820979	2.38	.874680	1.85	.946299	4.23	.053701	32
29	.821122	2.38	.874568	1.87	.946554	4.23	.053446	31
30	9.821265	2.37	9.874456	1.87	9.946808	4.25	0.053192	30
31	.821407	2.38	.874344	1.87	.947063	4.25	.052937	29
32	.821550	2.38	.874232	1.85	.947318	4.23	.052682	28
33	.821693	2.37	.874121	1.87	.947572	4.25	.052428	27
34	.821835	2.37	.874009	1.88	.947827	4.23	.052173	26
35	9.821977	2.38	9.873896	1.87	9.948081	4.23	0.051919	25
36	.822120	2.37	.873784	1.87	.948335	4.25	.051665	24
37	.822262	2.37	.873672	1.87	.948590	4.25	.051410	23
38	.822404	2.37	.873560	1.87	.948844	4.23	.051156	22
39	.822546	2.37	.873448	1.88	.949099	4.23	.050901	21
40	9.822688	2.37	9.873335	1.87	9.949353	4.25	0.050647	20
41	.822830	2.37	.873223	1.88	.949608	4.23	.050392	19
42	.822972	2.37	.873110	1.87	.949862	4.23	.050138	18
43	.823114	2.35	.872998	1.88	.950116	4.25	.049884	17
44	.823255	2.37	.872885	1.88	.950371	4.23	.049629	16
45	9.823397	2.37	9.872772	1.88	9.950625	4.23	0.049375	15
46	.823539	2.37	.872659	1.87	.950879	4.23	.049121	14
47	.823680	2.35	.872547	1.88	.951133	4.23	.048867	13
48	.823821	2.35	.872434	1.88	.951388	4.25	.048612	12
49	.823963	2.37	.872321	1.88	.951642	4.23	.048358	11
50	9.824104	2.35	9.872208	1.88	9.951896	4.23	0.048104	10
51	.824245	2.35	.872095	1.90	.952150	4.25	.047850	9
52	.824386	2.35	.871981	1.88	.952405	4.25	.047595	8
53	.824527	2.35	.871868	1.88	.952659	4.23	.047341	7
54	.824668	2.35	.871755	1.88	.952913	4.23	.047087	6
55	9.824808	2.33	9.871641	1.88	9.953167	4.23	0.046833	5
56	.824949	2.35	.871528	1.90	.953421	4.23	.046579	4
57	.825090	2.35	.871414	1.88	.953675	4.23	.046325	3
58	.825230	2.33	.871301	1.88	.953929	4.23	.046071	2
59	.825371	2.35	.871187	1.90	.954183	4.23	.045817	1
60	9.825511	2.33	9.871073	1.90	9.954437	4.23	0.045563	0

131°

48°

TABLE OF LOGARITHMIC SINES—COSINES, ETC. 1695

42°

137°

M.	Sin.	D. 1".	Cos.	D. 1".	Tan.	D. 1".	Cot.	
0	9.825511	2.33	9.871073	1.88	9.954437	4.23	0.045563	60
1	.825651	2.33	.870960	1.90	.954691	4.25	.045309	59
2	.825791	2.33	.870846	1.90	.954946	4.23	.045054	58
3	.825931	2.33	.870732	1.90	.955200	4.23	.044800	57
4	.826071	2.33	.870618	1.90	.955454	4.23	.044546	56
5	9.826211	2.33	9.870504	1.90	9.955708	4.22	0.044292	55
6	.826351	2.33	.870390	1.90	.955961	4.23	.044039	54
7	.826491	2.33	.870276	1.92	.956215	4.23	.043785	53
8	.826631	2.32	.870161	1.90	.956469	4.23	.043531	52
9	.826770	2.33	.870047	1.90	.956723	4.23	.043277	51
10	9.826910	2.32	9.869933	1.92	9.956977	4.23	0.043023	50
11	.827049	2.33	.869818	1.90	.957231	4.23	.042769	49
12	.827189	2.32	.869704	1.92	.957485	4.23	.042515	48
13	.827328	2.32	.869589	1.92	.957739	4.23	.042261	47
14	.827467	2.32	.869474	1.92	.957993	4.23	.042007	46
15	9.827606	2.32	9.869360	1.90	9.958247	4.23	0.041753	45
16	.827745	2.32	.869245	1.92	.958500	4.22	.041500	44
17	.827884	2.32	.869130	1.92	.958754	4.23	.041246	43
18	.828023	2.32	.869015	1.92	.959008	4.23	.040992	42
19	.828162	2.32	.868900	1.92	.959262	4.23	.040738	41
20	9.828301	2.30	9.868785	1.92	9.959516	4.22	0.040484	40
21	.828439	2.32	.868670	1.92	.959769	4.23	.040231	39
22	.828578	2.30	.868555	1.92	.960023	4.23	.039977	38
23	.828716	2.32	.868440	1.92	.960277	4.23	.039723	37
24	.828855	2.32	.868324	1.93	.960530	4.22	.039470	36
25	9.828993	2.30	9.868209	1.92	9.960784	4.23	0.039216	35
26	.829131	2.30	.868093	1.93	.961038	4.23	.038962	34
27	.829269	2.30	.867978	1.92	.961292	4.23	.038708	33
28	.829407	2.30	.867862	1.92	.961545	4.22	.038455	32
29	.829545	2.30	.867747	1.93	.961799	4.22	.038201	31
30	9.829683	2.30	9.867631	1.93	9.962052	4.23	0.037948	30
31	.829821	2.30	.867515	1.93	.962306	4.23	.037694	29
32	.829959	2.30	.867399	1.93	.962560	4.22	.037440	28
33	.830097	2.28	.867283	1.93	.962813	4.23	.037187	27
34	.830234	2.30	.867167	1.93	.963067	4.23	.036933	26
35	9.830372	2.28	9.867051	1.93	9.963320	4.22	0.036680	25
36	.830509	2.28	.866935	1.93	.963574	4.23	.036426	24
37	.830646	2.28	.866819	1.93	.963828	4.23	.036172	23
38	.830784	2.30	.866703	1.93	.964081	4.22	.035919	22
39	.830921	2.28	.866586	1.93	.964335	4.22	.035665	21
40	9.831058	2.28	9.866470	1.95	9.964588	4.23	0.035412	20
41	.831195	2.28	.866353	1.93	.964842	4.22	.035158	19
42	.831332	2.28	.866237	1.95	.965095	4.23	.034905	18
43	.831469	2.28	.866120	1.93	.965349	4.22	.034651	17
44	.831606	2.27	.866004	1.93	.965602	4.22	.034398	16
45	9.831742	2.28	9.865887	1.95	9.965855	4.22	0.034145	15
46	.831879	2.27	.865770	1.95	.966109	4.23	.033891	14
47	.832015	2.27	.865653	1.95	.966362	4.22	.033638	13
48	.832152	2.28	.865536	1.95	.966616	4.23	.033384	12
49	.832288	2.28	.865419	1.95	.966869	4.23	.033131	11
50	9.832425	2.27	9.865302	1.95	9.967123	4.22	0.032877	10
51	.832561	2.27	.865185	1.95	.967376	4.22	.032624	9
52	.832697	2.27	.865068	1.97	.967629	4.23	.032371	8
53	.832833	2.27	.864950	1.95	.967883	4.22	.032117	7
54	.832969	2.27	.864833	1.95	.968136	4.22	.031864	6
55	9.833105	2.27	9.864716	1.95	9.968389	4.22	0.031611	5
56	.833241	2.27	.864598	1.97	.968643	4.23	.031357	4
57	.833377	2.27	.864481	1.95	.968896	4.22	.031104	3
58	.833512	2.25	.864363	1.97	.969149	4.22	.030851	2
59	.833648	2.27	.864245	1.97	.969403	4.22	.030597	1
60	9.833783	2.25	9.864127	1.97	9.969656	4.22	0.030344	0
	Cos.	D. 1".	Sin.	D. 1".	Cot.	D. 1".	Tan.	M.

122°

47°

43°

136°

M.	Sin.	D. 1".	Coa.	D. 1".	Tan.	D. 1".	Cot.	
0	9.833783	2.27	9.864127	1.95	9.966656	4.22	0.030344	60
1	.833919	2.25	.864010	1.97	.969909	4.22	.030091	59
2	.834054	2.25	.863892	1.97	.970162	4.23	.029838	58
3	.834189	2.27	.863774	1.97	.970416	4.22	.029584	57
4	.834325	2.25	.863656	1.97	.970669	4.22	.029331	56
5	9.834460	2.25	9.863538	1.97	9.970922	4.22	0.029078	55
6	.834595	2.25	.863419	1.97	.971175	4.23	.028825	54
7	.834730	2.25	.863301	1.97	.971429	4.22	.028571	53
8	.834865	2.23	.863183	1.98	.971682	4.22	.028318	52
9	.834999	2.25	.863064	1.97	.971935	4.22	.028065	51
10	9.835134	2.25	9.862946	1.98	9.972188	4.22	0.027812	50
11	.835269	2.23	.862827	1.97	.972441	4.23	.027559	49
12	.835403	2.25	.862709	1.98	.972695	4.22	.027305	48
13	.835538	2.25	.862590	1.98	.972948	4.22	.027052	47
14	.835672	2.23	.862471	1.98	.973201	4.22	.026799	46
15	9.835807	2.23	9.862353	1.97	9.973454	4.22	0.026546	45
16	.835941	2.23	.862234	1.98	.973707	4.22	.026293	44
17	.836075	2.23	.862115	1.98	.973960	4.22	.026040	43
18	.836209	2.23	.861996	1.98	.974213	4.22	.025787	42
19	.836343	2.23	.861877	1.98	.974466	4.23	.025534	41
20	9.836477	2.23	9.861758	2.00	9.974720	4.22	0.025280	40
21	.836611	2.23	.861638	1.98	.974973	4.22	.025027	39
22	.836745	2.22	.861519	1.98	.975226	4.22	.024774	38
23	.836878	2.22	.861400	2.00	.975479	4.22	.024521	37
24	.837012	2.23	.861280	1.98	.975732	4.22	.024268	36
25	9.837146	2.23	9.861161	1.98	9.975985	4.22	0.024015	35
26	.837279	2.22	.861041	1.98	.976238	4.22	.023762	34
27	.837412	2.23	.860922	2.00	.976491	4.22	.023509	33
28	.837546	2.22	.860802	2.00	.976744	4.22	.023256	32
29	.837679	2.22	.860682	2.00	.976997	4.22	.023003	31
30	9.837812	2.22	9.860562	2.00	9.977250	4.22	0.022750	30
31	.837945	2.22	.860442	2.00	.977503	4.22	.022497	29
32	.838078	2.22	.860322	2.00	.977756	4.22	.022244	28
33	.838211	2.22	.860202	2.00	.978009	4.22	.021991	27
34	.838344	2.22	.860082	2.00	.978262	4.22	.021738	26
35	9.838477	2.22	9.859962	2.00	9.978515	4.22	0.021485	25
36	.838610	2.22	.859842	2.00	.978768	4.22	.021232	24
37	.838742	2.22	.859721	2.00	.979021	4.22	.020979	23
38	.838875	2.20	.859601	2.02	.979274	4.22	.020726	22
39	.839007	2.22	.859480	2.00	.979527	4.22	.020473	21
40	9.839140	2.20	9.859360	2.02	9.979780	4.22	0.020220	20
41	.839272	2.20	.859239	2.00	.980033	4.22	.019967	19
42	.839404	2.20	.859119	2.02	.980286	4.20	.019714	18
43	.839536	2.20	.858998	2.02	.980538	4.22	.019462	17
44	.839668	2.20	.858877	2.02	.980791	4.22	.019209	16
45	9.839800	2.20	9.858756	2.02	9.981044	4.22	0.018956	15
46	.839932	2.20	.858635	2.02	.981297	4.22	.018703	14
47	.840064	2.20	.858514	2.02	.981550	4.22	.018450	13
48	.840196	2.20	.858393	2.02	.981803	4.22	.018197	12
49	.840328	2.18	.858272	2.02	.982056	4.22	.017944	11
50	9.840459	2.20	9.858151	2.03	9.982309	4.22	0.017691	10
51	.840591	2.18	.858029	2.02	.982562	4.20	.017438	9
52	.840722	2.20	.857908	2.03	.982814	4.22	.017186	8
53	.840854	2.18	.857786	2.02	.983067	4.22	.016933	7
54	.840985	2.18	.857665	2.03	.983320	4.22	.016680	6
55	9.841116	2.18	9.857543	2.02	9.983573	4.22	0.016427	5
56	.841247	2.18	.857422	2.02	.983826	4.22	.016174	4
57	.841378	2.18	.857300	2.03	.984079	4.22	.015921	3
58	.841509	2.18	.857178	2.03	.984332	4.20	.015668	2
59	.841640	2.18	.857056	2.03	.984584	4.22	.015416	1
60	9.841771		9.856934		9.984837		0.015163	0
	Coa.	D. 1".	Sin.	D. 1".	Cot.	D. 1".	Tan.	M.

133°

46°

TABLE OF LOGARITHMIC SINES—COSINES, ETC. 1697

44°

135°

M.	Sin.	D. 1".	Cos.	D. 1".	Tan.	D. 1".	Cot.	
0	9.841771	2.18	9.856934	2.03	9.984837	4.22	0.015163	60
1	.841902	2.18	.856812	2.03	.985090	4.22	.014910	59
2	.842033	2.17	.856690	2.03	.985343	4.22	.014657	58
3	.842103	2.18	.856568	2.03	.985596	4.20	.014404	57
4	.842294	2.17	.856446	2.03	.985848	4.20	.014152	56
5	9.842424	2.18	9.856323	2.03	9.986101	4.22	0.013899	55
6	.842555	2.17	.856201	2.05	.986354	4.22	.013646	54
7	.842685	2.17	.856078	2.03	.986607	4.22	.013393	53
8	.842815	2.18	.855956	2.05	.986860	4.20	.013140	52
9	.842946	2.17	.855833	2.03	.987112	4.22	.012888	51
10	9.843076	2.17	9.855711	2.05	9.987365	4.22	0.012635	50
11	.843206	2.17	.855588	2.05	.987618	4.22	.012382	49
12	.843336	2.17	.855465	2.05	.987871	4.20	.012129	48
13	.843466	2.15	.855342	2.05	.988123	4.22	.011877	47
14	.843595	2.17	.855219	2.05	.988376	4.22	.011624	46
15	9.843725	2.17	9.855096	2.05	9.988629	4.22	0.011371	45
16	.843855	2.15	.854973	2.05	.988882	4.20	.011118	44
17	.843984	2.17	.854850	2.05	.989134	4.22	.010866	43
18	.844114	2.15	.854727	2.07	.989387	4.22	.010613	42
19	.844243	2.15	.854603	2.05	.989640	4.22	.010360	41
20	9.844372	2.17	9.854480	2.07	9.989893	4.20	0.010107	40
21	.844502	2.15	.854356	2.05	.990145	4.22	.009855	39
22	.844631	2.15	.854233	2.07	.990398	4.22	.009602	38
23	.844760	2.15	.854109	2.07	.990651	4.20	.009349	37
24	.844889	2.15	.853986	2.05	.990903	4.22	.009097	36
25	9.845018	2.15	9.853862	2.07	9.991156	4.22	0.008844	35
26	.845147	2.15	.853738	2.07	.991409	4.22	.008591	34
27	.845276	2.15	.853614	2.07	.991662	4.20	.008338	33
28	.845405	2.13	.853490	2.07	.991914	4.22	.008086	32
29	.845533	2.15	.853366	2.07	.992167	4.22	.007833	31
30	9.845662	2.13	9.853242	2.07	9.992420	4.20	0.007580	30
31	.845790	2.15	.853118	2.07	.992672	4.22	.007328	29
32	.845919	2.13	.852994	2.08	.992925	4.22	.007075	28
33	.846047	2.13	.852869	2.08	.993178	4.20	.006822	27
34	.846175	2.15	.852745	2.07	.993431	4.22	.006569	26
35	9.846304	2.13	9.852620	2.07	9.993683	4.22	0.006317	25
36	.846432	2.13	.852496	2.08	.993936	4.22	.006064	24
37	.846560	2.13	.852371	2.07	.994189	4.20	.005811	23
38	.846688	2.13	.852247	2.08	.994441	4.22	.005559	22
39	.846816	2.13	.852122	2.08	.994694	4.22	.005306	21
40	9.846944	2.12	9.851997	2.08	9.994947	4.20	0.005053	20
41	.847071	2.13	.851872	2.08	.995199	4.22	.004801	19
42	.847199	2.13	.851747	2.08	.995452	4.22	.004548	18
43	.847327	2.12	.851622	2.08	.995705	4.22	.004295	17
44	.847454	2.12	.851497	2.08	.995957	4.20	.004043	16
45	9.847582	2.13	9.851372	2.10	9.996210	4.22	0.003790	15
46	.847709	2.12	.851246	2.08	.996463	4.22	.003537	14
47	.847836	2.13	.851121	2.08	.996715	4.22	.003285	13
48	.847964	2.12	.850996	2.10	.996968	4.22	.003032	12
49	.848091	2.12	.850870	2.08	.997221	4.20	.002779	11
50	9.848218	2.12	9.850745	2.10	9.997473	4.22	0.002527	10
51	.848345	2.12	.850619	2.10	.997726	4.22	.002274	9
52	.848472	2.12	.850493	2.08	.997979	4.20	.002021	8
53	.848599	2.12	.850368	2.10	.998231	4.22	.001769	7
54	.848726	2.12	.850242	2.10	.998484	4.22	.001516	6
55	9.848852	2.12	9.850116	2.10	9.998737	4.20	0.001263	5
56	.848979	2.12	.849990	2.10	.998989	4.22	.001011	4
57	.849106	2.10	.849864	2.10	.999242	4.22	.000758	3
58	.849232	2.12	.849738	2.12	.999495	4.20	.000505	2
59	.849359	2.10	.849611	2.10	.999747	4.20	.000253	1
60	9.849485	2.10	9.849485	2.10	0.000000	4.22	0.000000	0
	Cos.	D. 1".	Sin.	D. 1".	Cot.	D. 1".	Tan.	M.

APPENDIX A

FIRST AID IN CASE OF ACCIDENT

All the data on First Aid are quoted from *Bull.* of the U. S. Health Service, by the courtesy of the Department, which was glad to cooperate to make the data available for emergencies.

Condensed Index

	PAGE
Bruises	1699
Sprains	1699
Foreign Matter in Eyes, Ears, etc.	1699
Snake Bites	1701
Bleeding	1702
Burns and Scald	1708
Wounds	1710
Drowning	1713
Electric Shock	1716
Poisons	1718

U. S. HEALTH SERVICE BULL. 17

BY SURGEON R. M. WOODWARD

Rules to Be Observed in Time of Accident

- "1. Give the patient air.
- "2. Lay the patient down, head lower than the body.
- "3. Rip the clothes off the injured part.
- "4. In removing a coat or shirt, first release the good arm, then the injured one.
- "5. Turn the head to one side to allow vomited matters to escape from the mouth.
- "6. Do not give whisky to the patient. If he can swallow, and needs a stimulant, give coffee, tea, hot milk, or hot water.
- "7. Then follow directions given elsewhere in this book.

A List of Dont's

- "Don't fail to send for the doctor. He knows best.
- "Don't leave the patient in order to go for the doctor if there is anyone you can send. He may need your moral encouragement if nothing more.
- "Don't get excited. An appearance of agitation on your part will discourage the patient.
- "Don't hold an injured person on his feet, nor require him to sit in a chair. He will be better off and less apt to faint if he lies down, preferably with the head low.
- "If you have a first-aid chest, and a bottle of medicine is exhausted, don't wait until you need it again before having the bottle filled.
- "Don't put your fingers on a wound. They are covered with germs, and you will almost surely infect the wound.
- "Don't use a spider web or a quid of tobacco on a wound. They are filthy, do no good, and are very apt to infect the wound. The same thing is true to a less extent in regard to salves of various kinds.
- "Don't place cotton next to a wound. Always keep at least one layer of gauze or boiled cloth between the cotton and the raw surface. The cotton sticks to the wound and is very difficult to remove.
- "Don't apply bandages too tightly.

"Don't remove a dressing to see how a wound looks. Let the doctor do that.

"Don't sit down at the bedside and discuss with the callers all of the horrible accidents you ever heard of. Your conversation will not be appreciated by the patient.

Minor Accidents

"Bruises, sprains, foreign matter in eyes, ears, nose, and throat.

Bruises and Contusions

"A bruise or contusion is an injury where the tissues beneath the skin have been torn but the skin itself has not been opened. Blood oozes out of the injured vessels, but cannot escape, as the skin is still intact. The symptoms are swelling, tenderness, and a feeling of soreness or pain. Discoloration of the skin occurs quickly in superficial contusions and in places where loose tissue abounds, but only after days when the injury is deep seated. This discoloration is at first red and then, successively, purple, black, green, and yellow. This play of colors is due to the changes which take place in the blood while undergoing absorption.

"**Treatment.**—A pad of gauze or soft towel should be tightly bandaged over the injured part to stop hemorrhage, after which cold should be applied except in old or feeble persons or where the contusion is extensive. In the latter case heat is best, as cold might cause gangrene. Evaporating solutions, such as witch hazel, a 15% solution of alcohol in water, or a saturated solution of Epsom salt, are often found of great benefit. A contusion should never be opened except in rare cases when it is necessary to stop persistent bleeding. If an opening is made through the skin, germs are liable to enter and cause severe inflammation, resulting in the formation of pus.

"**Sprains.**—A sprain is a stretching or wrenching of a joint. The joints most frequently affected are the ankle, wrist, knee, and shoulder.

"The symptoms and signs are pain, swelling, impairment or loss of motion, and discoloration from effusion of blood. When there is much swelling it may be difficult to determine whether sprain or fracture, or both, are present.

"It is sometimes very difficult to determine whether an injury near a joint is a sprain, a bruise, a broken bone, or all combined; and if there is doubt, the case should be treated as a broken bone. Injuries about the ankle joint are especially confusing, and sometimes the x-ray shows a fracture that could not have been detected in any other way. It should also be understood that a sprain, particularly if some of the soft parts about the joint are torn, may be much longer in being restored to a normal condition than if a simple break of the bone had occurred without other injury.

"**Treatment.**—Either hot or cold applications are good first-aid measures, but they should be distinctly either hot or cold, and not tepid. Soaking the part for half an hour several times a day in water as hot as can be borne, and gently rubbing the skin, are excellent. If it is more convenient to apply a bag of ice, this can be used, but the heat and cold should not alternate. Propping the part up on pillows assists. If there is much pain, great relief is obtained by surrounding the joint with a thick layer of cotton and applying a plaster bandage. The circulation of the lower part of the limb should be watched, and if found to be impaired the bandage should be cut from above downward and the sides spread apart to relieve any constriction that may be present. After the swelling has subsided somewhat, rubbing with any kind of liniment or with alcohol will help, but it is the rubbing more than the liniment that does the good.

"It is popular belief among laymen that a large quantity of liniment, perhaps applied on flannel cloth, is all that is necessary, and that the rubbing is only of secondary importance. This is a decided mistake. Later on the part should be grasped and gently moved in various directions, making what is known as passive motion. In some cases this is inadvisable and the patient appears to do better with the part at rest, which can be obtained by strapping the joint with strips of sticking plaster or placing the limb in a splint. The black and blue condition of the skin that sometimes appears will gradually subside as the part gets better.

Foreign Bodies in the Eye, Ear, Nose, and Throat

"**Foreign Bodies in the Eye.**—When a piece of steel, a cinder, or any foreign body enters the eye, nature at once floods the eye with tears in an

endeavor to wash the offending agent away, and frequently succeeds. Sometimes, however, the foreign body is embedded in the eyeball, the lid, or other part of the eye, or keeps moving about from one part to another without escaping; then assistance is necessary.

"Occasionally drawing the upper lid well down with the fingers, and allowing the lashes of the lower lid to act as a brush, will remove the body if it is not tightly embedded. Usually, however, it is necessary to invert the upper lid; in other words, turn it inside out. This is not difficult with a little practice. The upper eyelid contains a piece of cartilage or gristle along its lower edge which makes it easy to turn. To invert the eyelid face the patient, or stand behind him as seems more convenient; have him look well down toward the floor; take hold of the lashes of the upper lid with the fingers and thumb of one hand; they lay entirely across the middle of the eyelid a wooden toothpick, match, knitting needle, lead pencil, or other thin object (Fig. 1); press it downward, and at the same time gently pull the lashes upward, when the lid will suddenly turn inside out (Fig. 2).

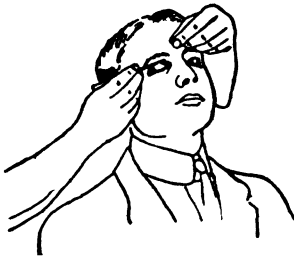

FIG. 1.

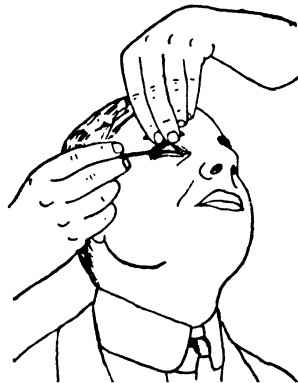

FIG. 2.

Drawing down the lower lid by simply pressing upon it will expose its inside surface. If the foreign body is seen, it should be very gently removed with the corner of a handkerchief. If it is partly embedded in the eyelid, it may be possible to dislodge it gently with a wooden toothpick or other similar object. If the foreign body is on the eyeball, it sometimes requires a good light, good eyesight, and even a magnifying glass to detect it. If found, it should be removed with a handkerchief or other soft material, but if embedded too tightly to be removed in this manner, it is best for the layman not to attempt anything further for fear of greater injury to the eye. Under such circumstances one or both of the eyes should be snugly bandaged with soft lightproof material, such as red flannel and the doctor should be called as soon as possible. The patient should be cautioned not to wink his eyes, as all motion will increase the irritation.

"If you have succeeded in removing the body, and the eye appears very red, a little sweet oil dropped in will be very soothing. It should be remembered that the scratching of the eyeball makes it feel as if the body were still present after its removal. The old household remedy of dropping a flaxseed into the eye in the hope that in slipping about it may dislodge the body is said by specialists to do no good, and may do harm.

"**Foreign Bodies in the Ear.**—Children occasionally place buttons or similar objects in the ear. If near the outlet, they can sometimes be removed (in the absence of suitable instruments) by gently passing along one side a crochet needle or other similar implement. It should be remembered, however, that the drum of the ear, which is extremely delicate, and means so much to the child in the future, is only a short distance inside, and any

effort of this kind made by the layman should be very gentle indeed. A stream of water from a small syringe may wash the object out. If these measures do not succeed, wait for the doctor by all means. Sometimes an insect crawls into the ear. The actual physical danger is less than the mental horror, as the insect soon dies. A little sweet oil dropped into the ear may cause the insect to back out to free itself from the unpleasant predicament if not the oil will kill it.

"Foreign Bodies in the Nose.—If near enough to the nostril to be seen the body may possibly be expelled by compressing the other nostril and having the patient blow his nose hard. A fountain syringe placed 1' above the head, the nozzle of the syringe inserted in the clear nostril, and the patient's face looking somewhat downward will cause the water to flow gently in at one side of the nose and out at the other side, and may dislodge the object. A crochet needle may be gently tried as described for the ear. All these things failing, wait for the doctor.

"Foreign Bodies in the Throat.—If the body can be seen by holding the tongue down with a spoon or by drawing the tongue out with a towel, it can sometimes be hooked out by means of a finger passed well in. If the body is in the windpipe, this will be manifested by violent coughing, which may dislodge it. Inverting the patient and slapping his back may be tried. If these measures do not succeed, then use every effort to quiet the patient, and if practicable send for a physician. If the body is in the gullet on the way to the stomach, vomiting may bring it up, and this can be excited by tickling the throat, or using some of the simple vomiting agents mentioned in the data on poisons (p. 1718) provided the patient can swallow. If it is not dislodged, and is known to be an object without sharp edges, as a coin, for instance, it is best to induce it to go on into the stomach by drinking water, eating bread, mashed potatoes, or other soft food. Once in the stomach the patient, usually a child, should be made to eat all the mashed potatoes he can possibly hold, and a large dose of castor oil should follow. The potatoes form a mass around the foreign body, and the oil usually pushes this mass through the bowels without any trouble whatever. The stools or passages should be carefully watched to determine that the object passes, and if it does not, the doctor should be consulted without delay.

SERIOUS ACCIDENTS—FIRST AID

Bites and Stings of Poisonous Animals or Insects

"Snake Bites.—(Do not give alcohol or ammonia.) Poisonous snake bites must receive instant treatment. Fasten a bandage or handkerchief above the wound and twist it tight to prevent the flow of blood toward the body and heart. Cut the wounded flesh out so that it bleeds freely. If there is anyone with you get him to suck the wound immediately; thoroughly and repeatedly spitting out the blood and washing his mouth with water to eliminate all danger to him. A concentrated solution of potassium permanganate should then be poured into the wound or better injected around and above the wound, using the full charge held by an ordinary hypodermic syringe. When working in a snake country a small pocket case containing a sharp clean lancet, hypodermic syringe, and a bottle of potassium permanganate should always be carried. The tight bandage cutting off the flow of blood must be loosened within 10 min. of its application to permit some circulation, as a long-continued stoppage of blood causes gangrene. Even when the blood is allowed to circulate freely at intervals of 10 to 15 minutes the tight bandage should be removed entirely within a couple of hours. There is great danger in its prolonged use. Snake bites treated promptly in this way are rarely fatal, although they may make the victim very sick. The patient's vitality should be prompted by hot blankets, water bottles, etc.

"Wilson's "Topographic Surveying" states that in addition to this treatment the only sure cure, particularly for the more dangerous tropical snakes, is the hypodermic injection of Antivenene serum. The injection is made in the cellular tissue of the right or left side of the abdomen. Treatment should be immediate for best results, although it may be successful after as much as 3 or 4 hr. If there is time the skin should be carefully cleansed before using the syringe, the needle of which should be inserted deeply closely compressed with the fingers for a couple of minutes and then hastily withdrawn.

"Antivenene serum can be obtained from Les Etablissements Poulenc Freres, 92 Rue Vieille-du-Temple, Paris. The serum will keep for years.

Dose 10 cc. (contents of one flask), or for large snakes, as the cobra, 20 cc. or two full doses at once.

"Bite of Dog or Cat.—This is usually a punctured wound; that is, the teeth enter without tearing the flesh, and the wound almost entirely closes, thereby preventing drainage and increasing the danger. Sucking the wound hard repeatedly and washing out the mouth with hot water may remove some of the poison. Squeezing is less effective. The wound should then be burned either with carbolic acid or a red-hot iron carried to the bottom, and the skin about the wound should be scrubbed with alcohol or other antiseptic. A drain of several strands of boiled sewing silk should be pushed into the bottom of the wound, and an antiseptic dressing or boiled cloth applied over the wound. The patient should then be taken to the nearest place where the Pasteur treatment to prevent hydrophobia or rabies can be secured. The hygienic laboratory of the U. S. Public Health Service in Washington, D. C., administers this treatment without cost.

"If the animal is known to be mad this treatment is imperative, and whether mad or not it is a very wise precaution and relieves the anxiety of the patient.

Bleeding (Hemorrhage)

"Kinds of Blood-vessels.—There are two kinds of blood-vessels. Those that carry the blood from the heart to all parts of the body are called arteries. The blood in them is bright red, and escapes in jets or spurts corresponding

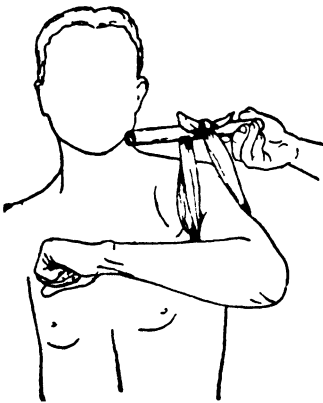

FIG. 3.

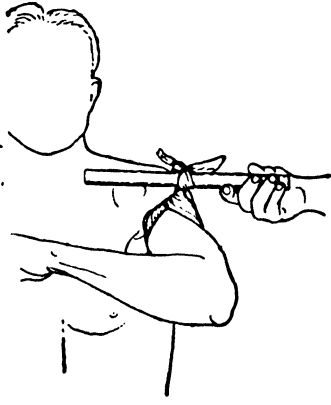

FIG. 4.

to each beat of the heart. Bleeding from these is more dangerous and more difficult to control, as a rule, than bleeding from the vessels that return the blood to the heart. Fortunately, however, the larger arteries in the limbs lie near the bones, and are consequently well protected in most parts by the mass of muscles covering them. The vessels that return the blood to the heart are called veins. They contain a darker blood than the arteries, and when cut the blood escapes in a steady stream, not in spurts. While the largest veins in the limbs are also near the bones, there are some of considerable size just under the skin.

"If we should desire to stop a stream of water flowing past a given point, we would naturally go upstream from that point and not downstream to adopt the necessary measures. When there is bleeding from an artery, the blood coming from the heart, the artery must be compressed at a place between the heart and the bleeding point. On the other hand, if a vein is bleeding, the blood flowing toward the heart pressure must be made on the vein at a place farther from the heart than the bleeding point.

"Bleeding, General Treatment.—Before beginning the treatment of any wound or any bleeding point, if there is time, the operator must carefully cleanse his hands and arms and also the wound and surrounding parts.

The instruments and silk ligature should be boiled, as described under wounds.

"In the aftertreatment of severe bleeding the patient should be kept perfectly quiet in mind and body, his head should be lowered by raising the foot end of his bed or bunk. Give him plenty of fresh air, keep his body warm, and give him hot drinks. After reaction the temperature of the body may rise a degree or two above normal, but if this should continue longer than two or, at most, three days, the dressing should be removed and the wound thoroughly irrigated, first with hot water, then with a solution of bichloride of mercury (1 to 5000) and dressed with aseptic gauze.

"**Bleeding from Arteries.**—There are certain places in the body where the arteries are not covered by much muscle, and can be easily compressed against bone. These places are shown in the illustrations. The bleeding should be controlled first by thumb pressure at the points indicated in the illustrations, and if the services of a doctor can be secured without delay, this will be all that is necessary until he arrives. If there is any doubt as to the exact place at which pressure should be made, a slight shifting of the

thumb from one point to another should be made rapidly, and when the bleeding stops it indicates that the proper location has been reached and pressure should be continuous at this point. If a doctor is not within reach, the bleeding must, of course, be controlled by some other device. When the bleeding is from one of the limbs, and some distance from the body, a bandage or clean handkerchief should be wrapped around the limb

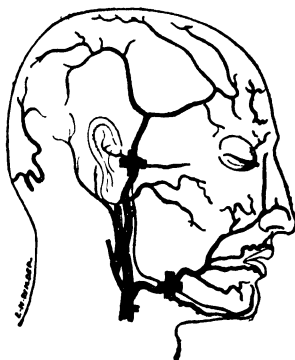

FIG. 5.

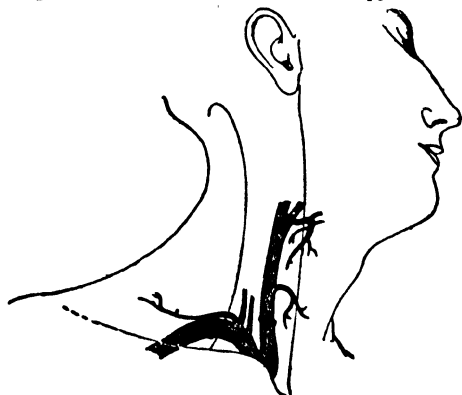

FIG. 6.

at the point indicated by a cross in the illustrations (Figs. 5 to 14) and drawn tight enough to stop the bleeding. The Spanish windlass (Figs. 3 and 4) is made by knotting a handkerchief around the limb loosely, passing a stick through the slack part, and taking up the slack by twisting the handkerchief. To prevent untwisting, the stick is then bound to the limb by one or two other bandages or handkerchiefs. A small round stone, a cork, or other similar object placed in the folds of the handkerchief and

lying directly over the vessel will assist. Only sufficient pressure should be made barely to stop the bleeding. The windlass must be loosened every 20 min. to give a chance for the blood to flow through the part, as there is great danger of gangrene (mortification) if the blood is entirely shut off for longer than this time.

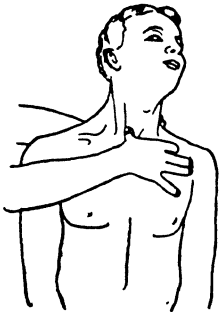

FIG. 7.

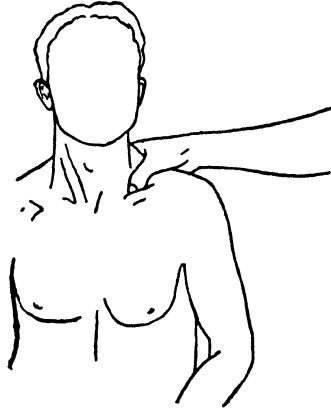

FIG. 8.



FIG. 9.

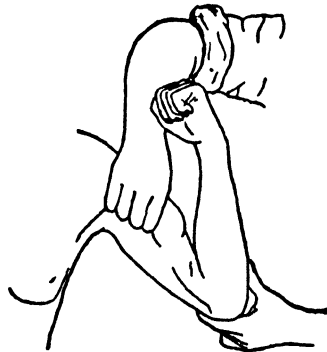

FIG. 10.

"The knot in the windlass should not be untied, and the stick should be left in position for immediate tightening if the blood again begins to flow freely. If the windlass is to be used for several hours, it is best to encircle the limb with a folded towel before applying it, as there is less danger of injuring the skin and soft parts. If the bleeding artery is in or near the body, where a windlass cannot be applied, thumb pressure must be kept up until the doctor arrives, one person relieving another. The second person's thumb

should gradually push the first person's thumb aside, and thus prevent a spurt of blood. In exceptional cases it may be necessary to place the thumb directly in the wound to control the bleeding, but, no matter how clean the thumb may be, this should only be resorted to in desperate cases, as there is

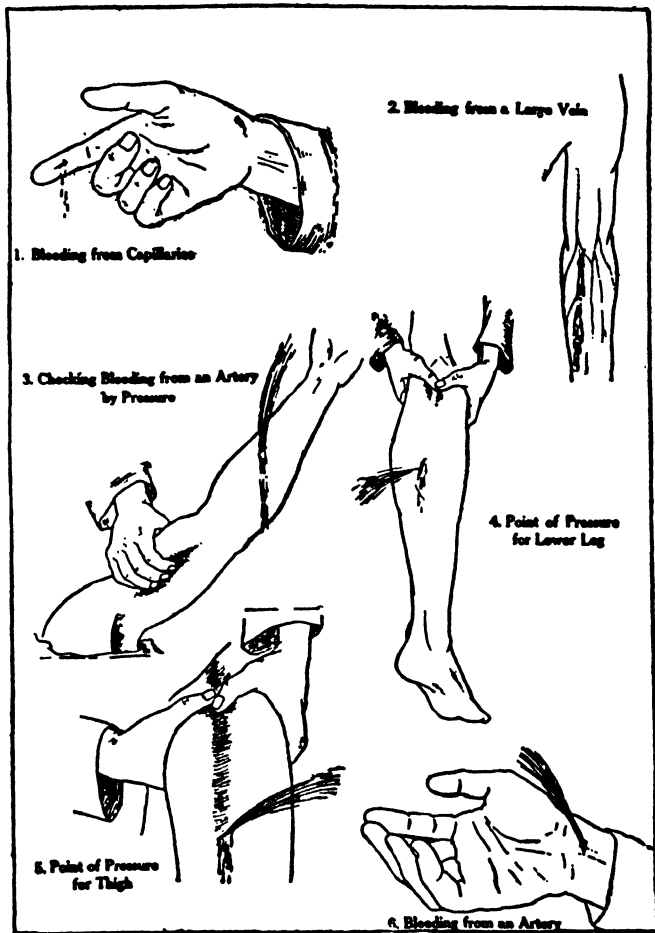

FIG. 11.

great danger of infecting the wound. Reference is made in this connection to the section of Antiseptics.

"In places where the services of a physician cannot be obtained, the wound should be stretched open, the blood-vessel located, seized, and drawn

gently forward with a pair of artery forceps, and the ends tied with heavy thread that has been boiled for 5 min. If artery forceps cannot be obtained, take a needle or a bent pin, pass it through a flame several times, hook onto the vessel, and draw it out; then tie it tightly with the thread described

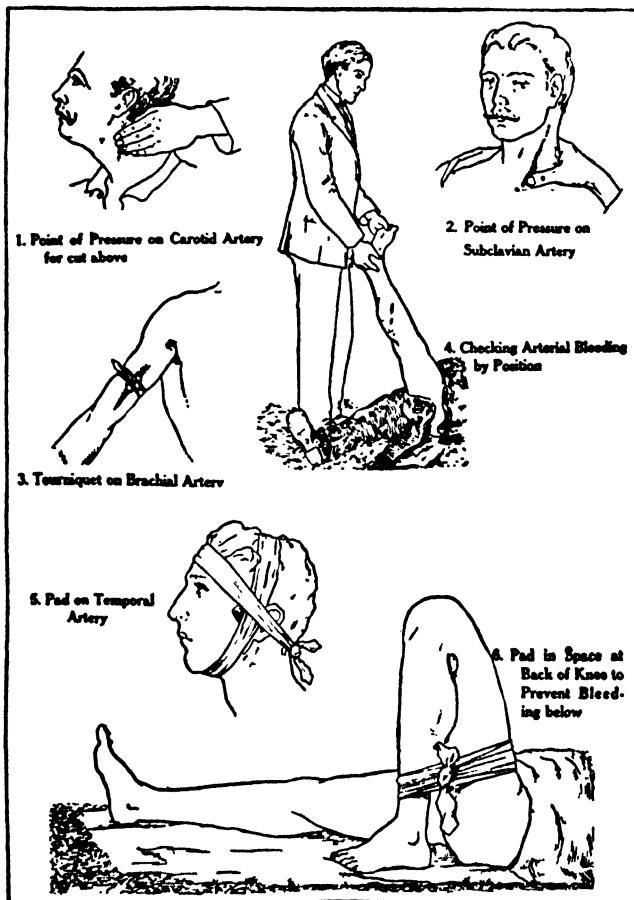

FIG. 12.

above. If a little flesh is tied in the knot with the artery, this will be of no consequence. After the artery has been securely tied the 'Spanish windlass' should be removed, or, if thumb pressure has been employed, this should be discontinued. The wound should then be closed as described under the heading Wounds.

"Bleeding from Veins.—The deep veins, as a rule, follow closely the course of the arteries. If thumb pressure on the far side (the side farthest from the heart) of the bleeding point fails to control the bleeding, a Spanish windlass should be applied on the far side. If the bleeding vein is near the surface, it may be possible in some cases to control it by a windlass with a stone or cork, the windlass not being drawn tight enough to shut off the deeper vessels. In some cases bleeding from veins is best controlled by pressure directly over the bleeding point, but the thumb should be covered by a clean cloth, such as a handkerchief or towel. Elevation of the part and removal of all constricting bands, such as garters, will assist.

"Where there is simply an oozing of blood and it does not appear that any vessel of size has been severed the case can frequently be controlled by steady pressure of the bleeding surface. Sometimes cloths soaked in water as near the boiling point as can be borne and constantly changed will accomplish the result. If peroxide of hydrogen is at hand, it is one of the best-known agents to stop simple oozing.

"Bleeding from Head and Face.—Reference to Fig. 5 will show a point in front of the ear, compression upon which will control bleeding about the

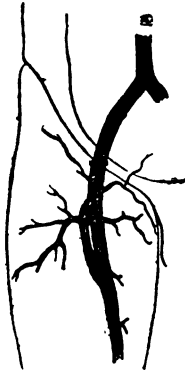

FIG. 13.



FIG. 14.

temple. Another important point for pressure is shown where the artery crosses the edge of the lower jawbone. This controls bleeding in the parts supplied by this artery, as shown in the illustration. If the bleeding is severe and it is evident that a larger and deeper vessel is responsible, it is necessary to compress the large artery in the neck. If you will turn your own head well toward one shoulder, say the right, you will be able to feel on the left side a strong muscle standing out under the skin and extending from a point just back of the ear to the point where the left collar bone joins the breastbone. This is your guide to the deep artery. Pressure should be made deeply between the lower end of this muscle and the windpipe compressing the artery directly against the backbone (Figs. 6 and 7).

"Bleeding from Shoulder.—If the bleeding is in the neighborhood of the shoulder joint, the artery to be controlled is the one lying directly under the collar bone. Pressure is made downward, behind the collar bone, near the point where it joins the breastbone, the artery being compressed against the rib (Figs. 6 and 8).

"Bleeding from Arm, Forearm, and Hand.—If you place your left hand on your right arm between the shoulder and elbow and then bend the right elbow and straighten it out several times you will feel a muscle swell up in the arm and subside again. Extending along the inner edge of this muscle and close to the bone a large artery can be felt beating (Figs. 9

and 10). This is the one to compress when bleeding is from a point in the arm or forearm. If the forearm, the best place to compress this last-mentioned artery is just above the elbow; and is also the best point if there is severe bleeding in the hand.

"Bleeding from Thigh or Leg.—In the groin, halfway between the hip bone and the middle line of the body, the main artery supplying the thigh and leg can be pressed against the bone (Fig. 13). If the bleeding is from the back of the knee, the leg, or foot, the best place to apply pressure is just above the knee at the back of the thigh (Fig. 14).

"Bleeding from Lungs and Stomach.—If the blood is from the lungs, it is generally coughed up and has the bright-red appearance of ordinary blood. If from the stomach, the acid of the stomach juice changes the blood until it has more the appearance of coffee grounds. If, however, the bleeding is severe, the vomited blood may be bright red, as the acid of the stomach may not have had time to act upon it. Sometimes blood brought into the throat from the lungs is swallowed by the patient and later vomited in its changed condition.

"In the treatment of either of these conditions, it is best to keep the patient very quiet in bed, let him suck small pieces of ice in limited quantity, and apply cracked ice in some waterproof covering over the chest or pit of the stomach, as the case may be. Cheerfulness and an encouraging attitude on the part of the attendants are necessary.

"Bleeding from the Nose.—If bleeding of the nose occurs in a full-blooded person, especially if such person is subject to dizziness, we should not be in too much of a hurry to stop it. But if the bleeding is the result of injury or if it occurs in a person suffering from disease of the heart or lungs or from the effects of malarial fever, scurvy, or any disease of the general system, effort should be made to stop it. Nosebleed from a blow, in a healthy individual, usually stops in a short time without any particular treatment. If it does not stop, place a piece of paper folded to the thickness of a quarter of an inch well up between the upper lip and gum, and compress the lip tightly against it. The main blood-vessels supplying the nose pass upward from the corners of the mouth to the sides of the nose, and this paper tends to compress the vessels and shut off the blood supply. The patient should lie on his back with his head on a pillow. If ice is obtainable, it should be cracked into small pieces, wrapped in a thin cloth, and placed over the nose, a sufficient quantity being used to cover the whole surface. Cold applied to the back of the neck will also do good in some cases. If the bleeding is obstinate, a strip of gauze or soft cloth can be pushed gently into the nostrils, the ends being allowed to hang out.

"Bleeding from the Urinary Canal.—This is usually caused by falling astride of a hard object. The bleeding may be profuse, but is usually controlled by pressure with a folded towel. If the bleeding is severe, a stick with a cross-piece at one end should be placed at the foot of the bed, the cross-piece pressing against the towel in the crotch. After the bleeding ceases, the patient should be kept quiet and cold applications should be used.

Burns and Scalds

"Burns.—Burns or scalds are serious and dangerous to life in proportion to the extent and depth of the injury. A burn covering a large area and producing mere reddening and swelling of the skin is as serious as a burn one-half the size in which the skin is destroyed. The danger is from shock, from fever following reaction, from hemorrhage following sloughing, and from congestion and inflammation of internal organs. Burns of slight extent or moderate degree are not so dangerous, and most of the cases commonly met with will recover. But all cases require careful treatment.

"Treatment.—The indications for treatment in these two conditions are virtually the same if the damage is superficial; and this is usually the case, the injuries being only skin deep. Blisters should be pricked with a needle that has been passed through a flame several times. This allows the water to escape from the blisters, but the skin raised by the blisters should not be removed. If the burning agent is pitch or tar, and adheres to the skin, it should not be removed; it will come away later with the blistered skin. Any bland oil, such as sweet oil, linseed oil, or Vaseline, forms a soothing application. Ordinary baking soda or a saturated solution of soda in water can be used. The old 'Carrou' oil made of linseed oil and lime water, half and half, is excellent, but has an unpleasant odor. If lime water is not at hand, it may be obtained as follows: Quicklime is first slaked by adding

to it gradually about 30 times its weight of water. Agitate during $\frac{1}{2}$ hr., allow the lime to settle, and reject the liquid. Add to the residue of lime about 300 times its weight of water, agitate frequently during the next 24 hr., and allow the lime to settle. The clear water standing above the undissolved lime is lime water.

"The parts burned or the entire body, except the head, may be kept immersed in tepid or warm water for days. Cream or white of eggs may be used, but they are apt to become offensive after 24 hr. Kerosene is an old household remedy. One teaspoonful of table salt in a pint of water makes a solution that can be employed. Keep the patient quiet and his bowels active. Pain or restlessness may be relieved by laudanum, 20 drops repeated in 2 hr.

"If the eye is red from contact with the flames or hot fluid, sweet oil is perhaps the best household remedy to drop in. A bandage lightly applied over the eyes to keep out the light will be soothing.

"If the skin or the eye is burned with acid, a solution of baking soda should be used first. If the burning agent is an alkali, such as hartshorn or lye, weak vinegar or lemon juice should be used. Sweet oil should be dropped in the eye after such treatment.

"If the patient has breathed the flame or steam the condition is apt to be a serious one, even though it does not appear so at once. Complete rest and quiet, an ice bag to the chest, the giving of milk and cream, half and half, if swallowing is possible, should be employed. Artificial respiration, as described elsewhere, may be applicable in some cases.

"Speaking generally of burns and scalds, a superficial burn covering a large part of the skin may be more dangerous than a deep burn confined to a small part, for reasons which it is unnecessary to discuss in a book of this kind. No burn or scald should therefore be treated as a trivial matter. Where solutions are used the bandages should be soaked in the same before applying and the solution should be poured over the bandaged part of frequent intervals.

"Paraffin mixtures have been recently used extensively for the treatment of burns. The mixture is melted and then sprayed upon the burned surface. It is then covered with a layer of gauze and more of the mixture is sprayed on. Instead of spraying, the mixture may be painted on the surface with a sterile brush. The mixture becomes hard when it cools, forming a protective coating for the burn. The paraffin should be removed once a day, the wound washed with a weak antiseptic solution, dried with pellets of gauze or cotton, after which another coat of the paraffin mixture is applied. Melted wax may be employed instead of paraffin. In either case a coating of liquid petroleum or kerosene should be applied to the wound before the wax or paraffin is used.

"The scars resulting from burns and scalds always contract, and in severe cases terrible deformities are produced. These may be prevented to some extent by active and passive motion and by splints.

Effects of Cold—Frostbite

"**Frostbite.**—Severe cold depresses the action of the heart, suspends the circulation. These effects are first noticed in the ears, nose, fingers, and toes. Numbness and tingling are the first symptoms, then loss of sensation. If not too long exposed, the circulation may be restored by proper treatment. But if the exposure is long continued or if the cold is very intense the parts are hopelessly frozen and gangrene will be the result. The parts may look all right for a few days after reaction and then become discolored, bluish, and finally black. Another effect of extreme cold is an overpowering sense of drowsiness, but to lie down and go to sleep under such circumstances is almost certain death.

"**Treatment of Frostbites.**—1. Do not bring the patient to the fire until the circulation is restored in the frozen part.

"2. If snow be on the ground or accessible, take a woolen cloth in the hand place a handful of snow upon it, and gently rub the frozen part until the natural color is restored. In case snow is not at hand bathe the part gently with a woolen cloth in the coldest fresh water obtainable, ice water if practicable.

"3. In case the frostbite is old and the skin has turned black or begun to scale off do not attempt to restore its vitality by friction, but use the treatment for burns described on page 1708.

"4. In the case of a person apparently dead from exposure to cold, friction should be applied to the body and the lower extremities and artificial respira-

tion practised as in case of the apparently drowned. As soon as the circulation appears to be restored administer $\frac{1}{40}$ gr. strychnine sulphate. Even if no signs of life appear friction should be kept up for a long period, as instances are on record of recovery after several hours of suspended animation.

Antisepsis, Antiseptics, and the Dressing of Wounds

"We are surrounded at all times by very minute organisms capable of producing various diseases or complications. They are sometimes called 'germs,' and more vulgarly called 'bugs.' The latter name is incorrect, as the germs belong to the vegetable and not the animal kingdom. In first-aid work the germs that particularly interest us are those that get into wounds and infect them, causing pus or 'matter' and sometimes blood poison.

"**Definitions.**—When these complications arise the process is known as 'sepsis.' 'Antisepsis,' therefore, refers to the question of removing or killing the germs, and 'antiseptics' are the medicines or other agents used in accomplishing these purposes. This explanation is made for the reason that it is necessary to use the terms 'antisepsis' and 'antiseptics' in this chapter, there being no common names quite so expressive. There is, another term, 'asepsis,' used by doctors, which refers to the condition where all germs have been removed or killed, but this is a condition that does not often obtain in first-aid work administered by a layman, and therefore will not be further discussed. We frequently hear a person say that he has good blood because when he cuts himself the wound heals quickly. This is apt to give him a false sense of security and cause him to neglect the precautions that should be taken. Some of the worst cases of 'sepsis' and blood poison occur in strong healthy men who have had no previous trouble in the healing of wounds. Germs are always present on the skin and can be demonstrated by laboratory methods. They can only be seen by a microscope of high power. A patient may have taken a hot soap bath before being injured, but his skin is not surgically clean, and antiseptics are therefore employed to destroy the germs that remain.

"**The Dresser's Hands.**—The one who is to make the dressing should see that his own hands are surgically clean before he attempts to clean or 'sterilize' the wound; otherwise he is apt to transfer germs from his hands to the wounds or to the dressings. The hands should be scrubbed with a nailbrush, hot water, and soap. Then the finger nails should be cleansed and the hands scrubbed again. A good way to clean the finger nails is to rake them across a cake of soap, filling the space under each nail with the soap. As this is removed with a pocketknife the dirt comes away with it. Then after the second scrubbing the hands should be soaked and rubbed in some antiseptic solution and not dried. The skin about the wound should now be scrubbed with the nailbrush and soap; and if it is a hairy part, the hair should be shaved for some distance on all sides of the wound before the scrubbing. The wound and the parts about it should then be thoroughly cleansed with the antiseptic solution; and a cloth, preferably one that has been boiled, soaked in the antiseptic solution, laid over the wound, and bound there with a bandage.

"**Alcohol.**—The antiseptic that is most apt to be at hand or most easily obtained is alcohol. It should be diluted with water, making a mixture of 1 part water and 3 parts alcohol. It creates a burning sensation when applied to a wound, but this is a small matter if it prevents infection in the wound. Where alcohol cannot be obtained, whisky or brandy, which contains about 50% of alcohol, may be obtainable. Some experiments have recently been made in the San Francisco Federal Laboratory by officers of the U. S. Public Health Service showing that whisky and brandy are very good antiseptics.

"**Iodine.**—Tincture of iodine, usually known by the layman as simply 'iodine,' is one of the best antiseptics known at the present time. Its power is far greater if applied to a dry surface than to a wet surface. The burning sensation produced in the wound does not last long. A dry sterile dressing over it is preferable to a wet dressing, as the wet dressing lessens its power and is apt to blister the skin. Too much iodine may also blister, and it should therefore be diluted with an equal part of alcohol.

"**Bichloride of Mercury.**—An antiseptic much used in hospitals is bichloride of mercury or corrosive sublimate. It is not apt to be on hand in the ordinary household or camp, but is mentioned as one of the agents to be kept in the first-aid chest. It can be purchased in tablet form, 7.3 grains each and each tablet added to a pint of water makes a solution of 1 part bichloride to 1000 part of water. This strength that is safest for the layman to use is 1

part of bichloride of mercury to 5000 parts of water. This is an excellent antiseptic. It is a deadly poison, however, if taken internally, and should therefore be handled with care.

"Peroxide of Hydrogen.—Peroxide of hydrogen has become a favorite and popular antiseptic. Its power in this regard is weak, but it is a cleansing agent and can be employed as a dressing in the absence of anything better. It tends also to stop oozing of blood in a wound where no large vessels are cut.

"Carbolic Acid.—The pure carbolic acid should be obtained if possible, and as a dressing for wounds should be made into a solution of 1 part of carbolic acid to 100 parts of hot water.

"Compound Cresol Solution.—This is a very serviceable antiseptic solution, as it readily dissolves in cold water and is as powerful as carbolic acid solutions of the same strength. It may be employed in 1% solutions for any purposes for which an antiseptic solution is required. It is especially good for sterilizing instruments, as it does not injure them.

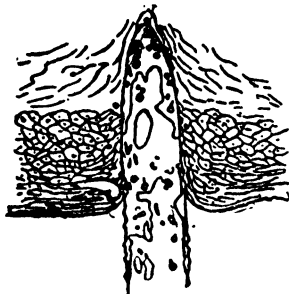

FIG. 15.

"Sterile Dressings.—There can be purchased for the first-aid chest various kinds of sterile dressings; that is, dressings that have had all germs killed by exposure to heat. Sterile gauze comes packed in a box in the form of a roll, and it unrolls as pieces are drawn out and cut off. From a theoretical standpoint the gauze is no longer sterile after the package has once been opened; but for practical first-aid work it answers the purpose if each piece cut off is carefully unfolded with clean hands and the inside of the piece applied next to the wound. It is advisable to buy small packages, so that a new one will be opened from time to time.

"How to Sterilize Dressings.—The one most efficient and always available method of sterilizing dressings is by boiling for 10 min. in plain water, which, from a practical standpoint, kills all germs that can infect a wound. If a dry dressing is desirable, it can be placed in a pan in a hot oven for 15 or 20 min. and removed just as it is beginning to be scorched. If several layers of a sterile dressing are applied directly over a wound and lapped around it at all sides, it is not absolutely necessary that the additional dressing material placed over this be sterile, although it is desirable.

"Sterilizing Instruments, Etc.—If scissors, knitting needles, ordinary needles, or other metal instruments or implements are necessary in dressing a wound, they should be boiled in water for 10 min., or can be passed through a flame several times, or some alcohol can be poured on the instrument and then set on fire with a match. Actual fire is apt to remove the temper from the instrument much more easily than boiling, for which reason boiling is preferable.

"Treatment of Wounds.—Doctors divide wounds into several classes, namely, incised, lacerated, contused, punctured, poisoned, gunshot, and infected. The nature of the first three is sufficiently clear from their names and from a first-aid standpoint may be considered together. The first thing to do is to control severe bleeding by pressure on the wound or upon a distant part of the blood-vessel, as explained in the data on 'Bleeding.' Then, after the dresser has disinfected his own hands, the wound should be thoroughly

cleansed and disinfected; these matters will be explained in 'Antiseptics.' Iodine, if at hand, is the best agent to use. If the wound is on a hairy part, as the scalp, the hair should be shaved for a distance of several inches from the wound. An antiseptic dressing should then be applied, or in the absence of any such agent one may use a clean cloth boiled for 10 min. in clear water or in water to which table salt has been added in the proportion of 1 teaspoonful to the pint. This dressing is retained by a bandage and should not be disturbed for any reason except bleeding if the doctor can be reached within 48 hr.

"If it is impossible to secure the services of a doctor for several days and the wound gapes to such an extent that it cannot be readily closed by bandaging, or is in a part where a scar will mean disfigurement, the layman may attempt to close the wound by stitching, and this can be done by using an ordinary sewing needle with silk or linen thread, both boiled for 10 min., the needle being pushed through the flesh by means of a thimble, also boiled. The stitches should pierce the skin about an eighth or quarter of an inch from the edge of the wound and come out of the fleshy part of the wound about the same distance from the skin. They should be placed about half an inch apart, and each one should be tied and cut off. The stitches should only be drawn tight enough barely to close the wound, because the swelling may make them too tight. No wound should be closed by a layman without leaving drainage; that is, something that will lead off the bloody water that oozes from a wound.

"A piece of boiled sewing silk or linen folded back and forth and then twisted until it makes a skein one-eighth of an inch thick should be laid in the bottom of the wound and allowed to hang out at the lower end for a distance of an inch. This drains by capillary attraction, and there is far less danger of blood poison than if the wound were closed tightly. This drain should be removed after 24 hr. by simply drawing it out without disturbing the stitches. The stitches themselves should be left in place from three to six days, depending principally upon the depth of the wound and its tendency to gape. The stitching of a wound should only be attempted by a layman when a doctor cannot be reached within 48 hr.

"The closure of a wound by sticking plaster is a questionable expedient, because it seals the wound, prevents drainage, and blood poison may follow. If the wound is not large, a strip of boiled cloth may be laid directly over it and the wound then drawn together by strips of sticking plaster applied outside the cloth.

"Whether the wound is closed by stitches or not, the layman should apply an antiseptic dressing, if such is available, and if not, a boiled cloth, as described above, can be used.

"A badly contused or bruised wound should not be stitched by a layman. In a lacerated wound it may be necessary to trim off with boiled scissors a few ragged edges of skin before stitching.

"If a wound has penetrated the belly and the bowel is protruding, it is best not to attempt to push it back if the doctor can be reached within a few hours. It should be gently washed with the salt solution, described at top of page and kept covered with towels frequently wet with the same solution. If a doctor cannot be reached within a few hours, and the person in charge of the patient after a careful examination is sure that the bowel has not been opened or otherwise seriously injured, he should, after carefully washing the bowel with the salt solution mentioned above, return it to the belly. If the bowel is allowed to remain for too great a time outside of the belly, its circulation may be cut off by the pressure of the belly walls and gangrene result. If the bowel has been opened or severely bruised, it should not be returned, as there is danger of forcing fecal matter out of the bowel into the belly cavity, which would cause a dangerous inflammation. If the bowel is not protruding from the wound, simply treat as an ordinary wound.

"Punctured Wounds.—A punctured wound is one made by a piercing agent, such as a nail, tack, knife, or needle. Such a wound is dangerous, because it almost completely closes and does not drain. If germs are introduced at the time of the accident, they cannot escape. A wound of this kind, except of the chest or belly, should be disinfected or burned, and the best agent is pure carbolic acid. In the absence of suitable instruments a knitting needle or other thin blunt implement should be dipped into the carbolic acid and then inserted to the full depth of the wound. This should be repeated several times. The first application causes a burning sensation, but the acid itself soon deadens the part, and the subsequent

applications are less painful. If the knitting needle is then dipped in alcohol or whisky and inserted once or twice and a little is applied to the skin about the wound, it will stop the burning action of the carbolic acid. In the absence of the carbolic acid the alcohol or whisky can be used alone, but are far less efficient. After this treatment an antiseptic dressing or a boiled cloth should be applied to the wound. The frequency with which lockjaw follows punctured wounds, particularly nail wounds, makes it imperative that the doctor be consulted promptly and that the wound be not regarded as trivial because it is small in size. An injection of serum (tetanus antitoxin) will prevent lockjaw.

"Poisoned Wounds.—The principal poisoned wounds met with are those due to bites of animals or bites and stings of insects, and these have been considered under a separate heading (see p. 1701).

"Gunshot Wounds.—A gunshot wound is similar to a punctured wound in that it is small and almost completely closed. If the ball has passed entirely through a part, as the leg, and has not struck an important vessel or broken a bone, the wound is apt to cause less trouble than one in which the ball remains in the flesh. If a portion of clothing is found in the mouth of the wound, it should be removed. The part should be well cleansed with soap and hot water and an antiseptic dressing or a boiled cloth applied. Further than this it is not best for the layman to attempt anything, particularly probing for the bullets. If a bone has been broken by the ball, the case should be treated as described under 'Compound Fracture.'

"Infected Wounds.—A wound should never be permitted to become infected, but it is not always possible to prevent it, as germs may be introduced at the time of the injury by the weapon causing the injury or on pieces of cloth or in dirt carried in with it. Badly contused wounds are also liable to become infected as the devitalized tissue is unable to resist the attack of harmful bacteria. Continuous or frequent irrigation with an antiseptic solution has been found to be the best method of thoroughly cleansing wounds of this kind and to keep them free from bacteria. A very weak bichloride solution (1 to 15,000) may be used for this purpose, or, even sterile water containing one teaspoonful of salt to the quart may be employed if nothing else is available. The Dakin-Carrel solution, is, however, the best for this purpose. Tablets for the preparation of this solution, known under the trade name of Chlorazene tablets, can now be obtained in the drug stores. In order to be effective, the solution should be introduced to the bottom of the wound. A special apparatus is employed for this purpose. Gauze is packed around rubber tubes after they are placed in the wound. Only enough solution to keep the dressing damp should be allowed to flow into the tubes. A modification of this solution has recently been made in which oil is used instead of water. This makes it unnecessary to be continually wetting the gauze as the oil keeps the wound moist for a longer period and the wound need therefore be dressed but once a day.

Resuscitation from Apparent Drowning

"In the act of breathing, the oxygen from the air is absorbed from the lungs into the blood vessels and purifies the blood; at the same time the impure matters picked up by the blood in circulating through the body are filtered out by the lungs and pass off to the atmosphere with the breath. When a person is under water he can hold his breath for a short time, keeping out the water; then he swallows some water into the stomach, and as his strength fails water enters the lungs. The water in the stomach does no particular harm; but that in the lungs is of vital importance because it stops breathing, causes poisoning of the system from lack of purification of the blood, and if allowed to remain for any length of time produces stoppage of the heart and death.

"The indications, therefore, in one apparently drowned are to remove the water from the lungs, to make the patient breathe, and to stimulate the weak heart.

"The old method of rolling a patient over a barrel to remove the water from the lungs is not considered efficient by those who have had most experience. Inverting the patient by grasping his feet and holding him head down for a few moments, at the same time making pressure on his belly inward and toward the chest, may remove part of the water. The chest is separated from the belly by a partition consisting of a thin flat muscle, and pressure inward and upward on the belly forces this partition up against the lungs and may mechanically squeeze some water out of the

tubes in the lungs. Time should not be wasted in prolonged efforts to remove the water, as it is important to proceed as quickly as possible with artificial breathing, which will not only squeeze the water out of the lungs but will renew respiration and revive the patient.

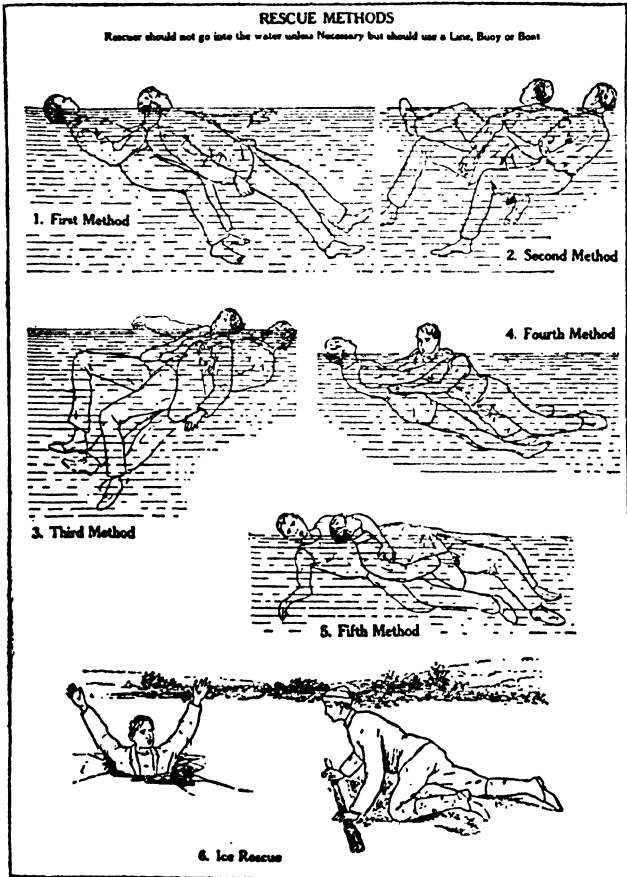

FIG. 16.

"There are several methods that have been suggested and used for inducing artificial breathing, but to save delay in selecting one the layman should have explained to him in a book of this kind one method only, and that one the method that has been accepted as the best, namely, the Schaefer method (see Fig. 17).

"Schafer's description of this method, as quoted by Crile, is as follows, except that the technical words and expressions have been eliminated and ordinary ones that will be understood by a layman substituted:

"The subject, whether a drowned person or not, is allowed to lie prone, i.e., face downward, no preliminary manipulation of the tongue being

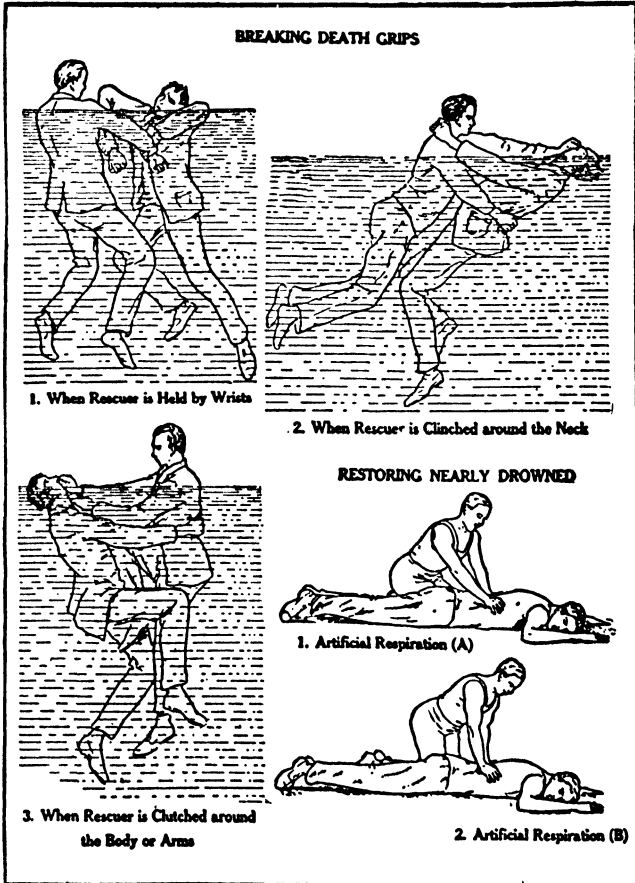

FIG. 17.

required. The operator kneels or squats either across or on one side of the subject, facing the head, and places his hands close together flat upon the back of the subject over the loins, the fingers extending over the lowest ribs. By now leaning forward upon the hands, keeping the elbows extended, the weight of the operator's body is brought to bear upon the sub-

ject, and this not only compresses the lower part of the chest but also the belly upon the ground, the pressure being fairly equally distributed. The result of this is that not only is the chest diminished in extent from before back, but, owing to the pressure which is communicated to the belly, the belly contents are compressed and tend to force the muscle partition between the chest and belly up, so that the chest is diminished in capacity from above down. This is no doubt the reason why the pressure method when applied with the subject lying on his belly is more effective than when applied, as by Howard, with the subject lying on his back. The pressure is applied not violently but gradually during about 3 sec., and is then released by the operator swinging his body back, but without removing his hands. The elasticity of the chest and belly causes these to resume their original dimensions and air passes in through the windpipe. After 2 sec. the process is again commenced, and is continued in the same way, the operator swinging his body forward and backward once every 5 sec., or about 12 times a minute, without any violent effort and with the least possible exertion. This last condition, *viz.*, the absence of muscular exertion, other than that involved in swinging forward and backward, renders it possible to continue the process without fatigue for an indefinite time. It can further be carried out unaided by a woman almost as well as a man, by children upon children; it hardly requires to be taught, a simple demonstration sufficiently teaches it to a large audience. Its advantages in drowning cases over any other method which involves the position on the back are sufficiently obvious, for with it there is no risk of obstruction by water or slime or the contents of the stomach, which can not accumulate in the throat, but must come away by the mouth, and the tongue, in place of falling back, as in the position on the back, falls forward and is unable to produce obstruction.

"Crile says in regard to this method: 'Schafer's method should be used in all cases in the absence of medical assistance or outside of a hospital, and even in a hospital in the absence of immediate surgical aid.' He further says: 'Simple artificial respiration is the only hope in drowning and other accidents occurring when professional help is not at hand.' When the patient is able to swallow, a small cup of black coffee, or hot milk may be given, and repeated a few times at intervals of an hour. If he does not swallow well, and an ordinary syringe is available, the coffee may be injected into the bowel and left there, but the effect is slower.

"It is scarcely necessary to state that the patient should be removed to a warm place, the wet clothing removed, and the lower parts of the body covered and artificially warmed. Pending the arrival of the doctor the patient should be closely watched, and if signs of collapse appear, renewed efforts should be made. Prolonged and systematic rubbing of the skin and kneading of the muscles will assist in promoting the circulation of the blood.

Resuscitation from Electrical Shock¹

"An accidental electric shock usually does not kill at once, but may only stun the victim and for a while stop his breathing.

"The shock is not likely to be immediately fatal because (a) The conductors may make only a brief and imperfect contact with the body. (b) The skin, unless it is wet, offers high resistance to the current.

"Hope of restoring the victim lies in prompt and continued use of artificial respiration. The reasons for this statement are: (a) The fact continuously depends on an exchange of air, as shown by the fact that we must breathe in and out about 18 times a minute. (b) If the body is not thus repeatedly supplied with air, suffocation occurs. (c) Persons whose breathing has been stopped by electric shock have been restored after artificial respiration has been continued for approximately 2 hr.

"INSTRUCTIONS.—Follow these instructions even if the victim appears dead.

"I. Break the circuit immediately.

"1. With a single quick motion separate the victim from the live conductor. In so doing avoid receiving a shock yourself. Many have, by their carelessness, received injury in trying to disconnect victims of shock from live conductors.

"Observe the following precautions: (a) Use a dry coat, a dry rope, a dry stick or board, or any other dry non-conductor to move either the victim or

¹ Taken from "Rules for Resuscitation from Electric Shock." Issued by the National Electric Light Association.

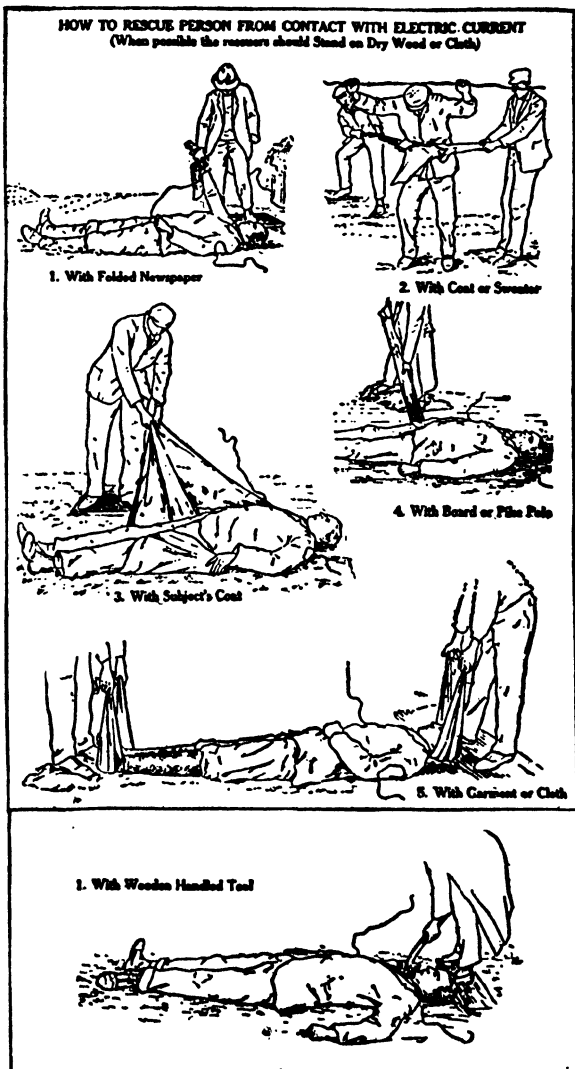

FIG. 18.

the wire, so as to break the electrical contact. Beware of using metal or any moist material. The victim's loose clothing, if dry, may be used to pull him away; do not touch the soles or heels of his shoes while he remains in contact, the nails are dangerous. (b) If the body must be touched by your hands, be sure to cover them with rubber gloves, mackintosh, rubber sheeting, or dry cloth; or stand on a dry board or some other dry insulating surface. If possible, use only one hand. If the victim is conducting the current to ground, and is convulsively clutching the live conductor, it may be easier to shut off the current by lifting him than by leaving him on the ground and trying to break his grasp.

"2. Open the nearest switch, if that is the quickest way to break the circuit.

"3. If necessary to cut a live wire use an ax or a hatchet with a dry wooden handle, or properly insulated pliers.

"II. Attend instantly to the victim's breathing. Use the Schafer method of artificial respiration as described under treatment of the apparently drowned (p. 1713). Burns of the skin should be treated as described for ordinary burns. Warmth to the body, gentle rubbing, and later hot water, milk, or coffee if the subject can swallow, are indicated, but do not give any liquids whatever by mouth until the subject is fully conscious.

DIRECTIONS TO BE FOLLOWED IN CASE OF POISONING

"Send for the doctor immediately, if practicable, and if the nature of the poison is known, have the messenger inform the doctor so that he may come prepared. If the poison is unknown, but the bottle from which it was taken is found, save the bottle, as it may help in case of legal investigation. If the poison has been taken with suicidal intent and the patient survives, the same caution is applicable that was mentioned under Drowning, Gas Poisoning, etc. Warmth to the body, light stimulation, and encouragement are indicated.

"In treating cases of poisoning first give an antidote, if one is available; second, promote early and repeated vomiting to remove the bulk of the poison; third, give something that will help envelope the poison left in the stomach and prevent its further absorption into the system; fourth, remedy the damage that has been done, so far as this is possible.

"The following 'general antidote,' which should be prepared as needed, should be given when poisoning by any of the poisons mentioned in this book occurs or if the poison is unknown: magnesia, 2 teaspoonfuls; charcoal, 2 teaspoonfuls; tannic acid, 1 teaspoonful. These dry powders should be kept thoroughly mixed in the above proportions in an air-tight bottle and when needed 1 heaping tablespoonful should be mixed with a cupful of water. This is one adult dose and should be repeated.

"Should there be no tannic acid on hand, a cupful of very strong tea or tea of oak bark will take the place of the tannic acid and water.

"Vomiting or puking may be induced by tickling the throat with a feather or pushing the finger down the throat, or by the administration of one of the following emetics by mouth:

"*Mustard*.—One tablespoonful stirred to a cream with a cupful of tepid water.

"*Common Salt*.—One tablespoonful to a cupful of tepid water. Not very certain as an emetic.

"*Alum*.—Two teaspoonfuls to a cupful of tepid water. This is a rather feeble emetic.

"*Ipecac*.—Give 1 tablespoonful of the sirup in a cupful of tepid water. Repeat once if necessary.

"The doses recommended throughout this article are for adults; the amount should be proportionately small for children as follows. Divide age of child by 12 more than age. For 6 year old $\frac{6}{6+12} = \frac{6}{18} = \frac{1}{3}$ of adult dose.

Unknown Poison

"Give 'general antidote' following by emetics or raw whites of several eggs; or, in their absence, milk, or flour and water. The white of egg, particularly, is inclined to pick up part of the poison left in the stomach and hold it until the patient can be made to vomit again. If the body is limp and respiration is feeble, tea or coffee can be given as a stimulant, and warmth applied to the body with massage or rubbing will tend to support the circulation.

Opium, Laudanum, Paregoric, Morphine, Codeine, Heroin, Indian Hemp

"Give the 'general antidote,' or potassium permanganate ($\frac{1}{2}$ teaspoonful dissolved in a pint of water, no undissolved crystals should remain in the fluid), or peroxide of hydrogen (2 teaspoonfuls in a pint of water), or borax, or baking soda (about 1 tablespoonful to the pint of water) followed by an emetic. Whites of eggs and considerable quantities of strong tea or strong black coffee should be given, or if unable to swallow, inject the coffee into the bowel with a syringe.

"Give sweet spirits of niter (1 teaspoonful in water three times a day) to aid excretion by kidneys.

"Keep patient awake by shaking, striking with wet towel, applying cold water over face and chest, or forced walking.

"Wines and liquors must not be given.

"When respiration becomes slow and irregular, artificial respiration should be employed, the same as is used to restore the partially drowned.

"After the dangerous symptoms have subsided, the patient should be put in bed, warmth applied, and he should be carefully watched for some time.

Arsenic, Ratsbane, Paris Green, "Rough on Rats," Fowler's Solution

"The best antidote, if the ingredients can be obtained, is prepared by mixing a teaspoonful of magnesia with a cup of water, adding 2 tablespoonfuls of tincture of iron, stirring well, and giving the whole in one dose; or the 'general antidote' may be given, followed by emetics, raw whites of eggs mixed with water, or large drinks of hot greasy water, or salt and water (tablespoonful to pint), or strong tea. Magnesia may be given in tablespoonful doses mixed with water. Lime water in large quantities is of some value, and in its absence lime which may be scraped from the walls or ceiling and mixed with water may be administered.

"Protect stomach with 2 tablespoonfuls of sweet oil, gruel, starch, mucilage, flaxseed tea, or elm-bark tea. Castor oil (2 tablespoonfuls) should be given after vomiting occurs even though the bowel movements are frequent.

"Pain can possibly be lessened by hot bottles to the stomach and bowels.

"Keep patient warm with artificial heat or extra garments, and give strong coffee to avert collapse.

Strychnine, Nux Vomica (Dog Button), Fish Berries, Ignatia Bean

"Give 'general antidote' or charcoal (1 tablespoonful) or strong tea followed by an emetic, then 15-gr. doses of bromide of soda or potash in water repeated every hour until three or four doses have been taken. Several whiffs of ether may be inhaled from a handkerchief at the beginning of a spasm.

"Give sweet spirits of niter (1 teaspoonful in water three times a day).

"Follow by a purge of Epsom salt or any other saline cathartic that is at hand.

"Artificial respiration should be employed the same as is used to restore the partially drowned (p. 1713). Remove the patient to a darkened room and keep as quiet as possible; avoid any sudden noises.

Bichloride of Mercury (Corrosive Sublimate)

"Promote vomiting, if not already present, by giving mustard in water. Do not use salt as an emetic.

"Give raw whites of eggs in water or milk or give milk or mucilage in abundance. In absence of eggs, chop up raw, lean meat finely and diffuse through water or milk and give. It is necessary that vomiting be induced after the eggs, milk, or meat are given, as the mixture formed of these substances will be absorbed if allowed to remain.

"The 'general antidote,' strong tea, and later flour and water, barley water, or flaxseed tea, or elm-bark tea may be given.

"Borax in water, about a tablespoonful to the pint of water, is recommended, but is of doubtful value.

"Stimulate with strong coffee if necessary.

Acid Poison—Acetic, Muriatic, Nitric, Sulphuric, Etc.

"Give no emetic.

"Give 'general antidote,' large drinks of water (or milk) with chalk, whiting, borax, magnesia, or baking soda, or wood ashes, or strong soap-suds; plaster from the wall may be given in emergency; olive oil, raw whites of eggs beaten up with water, and later flaxseed tea, elm-bark tea, gruel, starch, mucilage freely.

"Laudanum (20 drops) may be given if there is much pain.

Carbolic Acid and Cresol and Coal-tar Disinfectants Generally

"Give alcoholic liquors (whisky, brandy, etc.) or equal parts of alcohol and water freely to dissolve the poison. Produce vomiting to get rid of the alcoholic mixture. In the absence of alcoholic liquors, give vinegar, soap-suds, or raw whites of eggs in water. Give solution of Epsom or Glauber salt or sodium phosphate well diluted to hasten elimination of acid that may have entered the circulation.

"Do not give oils or glycerin.

"Milk gruel, flaxseed tea, or elm-bark tea may then be given. Hot applications to extremities. For collapse give strong coffee. Apply artificial respiration if breathings stop.

Alkali Poisons—Lye, Hartshorn, Pearlash, Etc.

"Assist vomiting with large drinks of tepid water.

"Give vinegar, lemon juice or orange juice, hard cider, whites of eggs beaten with water.

"Follow by sweet oil, milk, gruel, barley water, flaxseed tea, or elm-bark tea.

Ptomaine Poisoning from Fish

"The symptoms of ptomaine poisoning are practically the same as those of cholera morbus.

"General antidote, emetics, copious drinks of strong tea, repeat emetic, then castor oil (2 tablespoonfuls) should be given. Continue treatment as given for cholera morbus.

Cholera Morbus (Sporadic Cholera)

"Cholera morbus is an affection of the stomach and intestines, attended by vomiting, purging, and cramps. It comes on suddenly, and may begin by vomiting or purging. It is usually met with during the hot months of summer. It is frequently caused by eating unripe and indigestible fruits and vegetables, decomposed or improperly cooked fish, shellfish, or salad mixtures. Drinking large quantities of iced water and sudden checking of the perspiration, or irritants of any kind, may set up the trouble. The disease usually begins suddenly, often at night, with vomiting, after a feeling of uneasiness, nausea, or a severe cramp. The contents of the stomach are first thrown up, then a bilious matter. The stools are at first solid or semi-solid, but they soon become more watery, lose their color, and sometimes appear not unlike the rice-water stools of genuine Asiatic cholera. The patient soon has a wasted look. His thirst is unquenchable. His skin may become cold and clammy and the pulse very weak. Cramps may occur in the feet and in the calves of the legs. The disease runs a rapid course. The acute symptoms may subside in a few hours. The attack seldom lasts more than 12 hr. Recovery is the rule, but treatment should be promptly applied.

"Treatment.—Apply a large mustard plaster to the abdomen. Give 15 drops of laudanum. If the dose is rejected (immediately vomited), try it again. If it is still not retained, then try two tablets of Sun cholera mixture. If vomiting quickly occurs, then inject into the rectum by means of a glass or rubber syringe about 20 drops of laudanum mixed with a little thin starch or a little water. The rectal injection should be given immediately after an evacuation, and the patient should be instructed to hold it as long as possible. In whatever way the remedy is given, the dose should be repeated in about one hour if the vomiting and purging continue.

"If must not be forgotten, however, that all these remedies contain opium, and that if the patient is inclined to sleep or shows other constitutional effect of the drug the dose must not be repeated.

"The nausea and thirst may be controlled by cracked ice placed in the mouth. Small quantities of carbonated water may be allowed. If the thirst is very urgent a tablespoonful of iced water may be given at short intervals.

Poison Ivy

"Treatment.—Bathe with salt water or a boric acid solution, 1 teaspoonful in a glass of hot water. Open the large blisters and let the water out. Every day bathe the infected areas with warm water, dry without rubbing, and apply the boric acid solution.

Sunstroke

"Cause.—Prolonged exposure to strong rays of the sun or high humid temperature.

"Prevention.—Proper head and spine protection under tropical sun and avoidance of travel under extreme conditions of heat. Drink water sparingly. Oatmeal water in small quantities quenches thirst.

"There are two varieties of trouble:

"1. Heat stroke (heat fever), in which the body temperature is high.

"2. Heat prostration, in which the surface of the body is cool, sometimes below normal.

"*The difference is very important as the treatments are radically different.*

"Symptoms and Treatment. Heat Stroke.—Severe cases the victim may fall unconscious and die instantly. The usual case manifests intense headache, dizziness, nausea, vomiting and hot skin. Temperature may reach 105°F. Pulse full and may be either slow or rapid. Patient sinks into stupor and unconsciousness. They recover under treatment or die within 24 hr.

"Treatment.—Reduce temperature of body at once by cold-water bath. ice pack on head till temperature of body as shown by a thermometer in the rectum is reduced to 100°F. If the temperature rises again repeat the treatment.

"If the patient is exhausted after the reduction in temperature give $\frac{1}{40}$ gr. strychnine sulphate.

"Heat prostration with a cool skin and weak rapid pulse stimulants are required. Wrap patient in blankets, hot-water bottles at feet and around abdomen; give $\frac{1}{40}$ gr. strychnine sulphate. If head is hot, cold-water pack can be applied to head only. If vomiting occurs inject hot salt water solution into rectum (1 tablespoonful of salt to 1 pint of water)."

INDEX

Most used reference shown by **black face** type for page numbers.

The *italic* type for page numbers indicates that the reference is in the second volume where purchaser has the two volume edition. Volume I contains pages 1 to 746; Volume II, pages 747 to 1722.

Abrasion

Allowable values

Bituminous concrete aggregate,

492

Brick paving block, 720

Cement concrete aggregate, 456,
1383

Macadams, 440, 446, 713, 1383

Stone block, 1405, 1482

French coefficient of, 706

Percentage of loss (Ordinary
rocks), 709

Tests for

Brick, 716

Crushed stone, 706

Gravel, 742

Sand, 739

Stone block (Same as crushed
stone)

Absorption (Test for)

Paving brick, 510, 720

Stone, 707, 741

Abutments

Cost

Detail data, 1229

Estimate forms, 1150-1154

Quick estimating diagrams, 310,
648, 758, 762

Design (*see also* Bridges), 207, 1046

Examples of, 241, 246, 258, 265,
284, 293, 294

Forms

Design, 1026, 1052

Examples, 1343-1353

Removal, 1275, 1347, 1531

Finishing, 1531, 1277, 1361

Foundations (*see also* Bridges),
207, 1051

Lengths, 241, 258, 293, 317, 318

Inspection, 1534-1538

Quantities required, 241, 246, 258,
265, 284, 758, 762

Specifications, 245, 261, 289,
1508-1533

Accidents (First aid), 1699-1718

Accidents (Highway)

Causes of

Ordinary highway, 34, 606

Railroad crossing, 606

Location of, 34

Prevention of (*see* Safety provi-
sions), 33, 606

Accuracy (Degree required)

Office work

Alignment, 945

Cross sections, 947

Planimeter areas, 969

Profile, 947

Topography, 946

Surveys

Chaining, 852, 942

Curves, 855, 888, 890

Levels, 833, 906, 909, 942

Meridian determination, 912

Stadia, 852, 932

Topography, 836

Adhesiveness Test, 723, 729

Adjustment of Instruments, 852

Administration

Principles of, 1-73

Cost of highways, 7, 9, 10, 16,
65, 520

Current practice, 1

Economy (Field for), 1, 52, 55,
747

Organization, 49, 552, 1271

Pavements (General suitability),
6, 40, 585, 962

Progressive Improvement, 2,
586

Summarized general principles,
72

Safety of traffic, 33

Tax problem, 17

Traffic requirements, 26

Value of highways

Economic, 1, 3, 10

Intangible, 1, 3, 4

Volume of traffic and road
capacity, 6, 28

Adverse Grades (*see* Grades), 110

Age of Pavements (*see* Life of pave- ments), 531, 535

Alignment (General discussion), 113-121

At bridge approaches, 634

" Hair-pin turns (Switchbacks)

121, 950

" Hills, 117, 120, 634, 950

" Railroad grade crossings, 609,
630, 634

Dangerous alignment, 114, 631,
632

INDEX

- Alignment** (General discussion)
 Effect on construction cost, 119
 " " crown of pavement, 124, 956
 " " grade, 117, 118
 " " location surveys, 82
 " " loads (Horse traffic), 117
 " " motor operation cost, 118
 " " sight distance, 114
 " " width of pavement, 116, 130, 958
 " " " " right of way, 177
 Effect on width of section, 115
 Effect on vehicle clearance, 130
 Encroachment of long wheel base rigs, 116
 Minimum radii (current practice), 116
 " " (recommended practice), 6, 8, 120, 950
 Office methods, 944
 Principles of location, 82
 Sight distance requirements, 7, 9, 114, 177
 Switchback alignment, 121, 950
 Summary of alignment practice, 82, 120, 634, 950
 Survey methods, 831
- Alternate Designs**
 Examples of, 642, 647, 1096
 Value of, 747, 943
- Altitude**
 Barometric determination, 782
 Refraction corrections solar observations, 928
- Amiesite Pavement** (*see also* Bituminous Concrete)
 Amounts of material, 497, 1186
 Cost data, 1185
 Description, 496
 Materials, 497
 Suitability, 6, 8, 47, 491, 598
 Specifications, 1465
- Amounts of Materials**
 Required for. (*See also* type of Pavement or Structure)
Pavements
 Amiesite, 497, 1186
 Bituminous concrete, 496, 1138, 1143
 " " macadam, 446, 1142
 Brick pavements, 511, 1214, 1146
 Concrete (Portland cement), 461, 1092, 1145
 Gravel roads, 356, 433, 1134, 1139
 Macadam foundations, 429-437, 441, 1134, 1138
 Sand clay roads, 347, 1447
 Waterbound macadam, 441, 1140
Structures
 Concrete, 466, 495, 1092, 1181
 Steel, 313, 652, 760-763
- Amounts of Materials, Required for, Structures**
 Timber, 294-307, 798
- Aneroid Barometer, 782, 817**
- Annual Charges** (General)
 Bonds (finance), 23
 Construction (contractor's equipment), 1238-1265
 Maintenance
 Bridges, 210, 1231
 Pavements, 7, 9, 65, 520
 Railroad crossing protection, 600
 Reconstruction of pavements, 65, 520
 Survey and camp equipment, 894, 902
- Apportionment of Funds, 1, 72**
- Arches** (Reinforced Concrete)
 Axis (trial shape of), 1086
 Cost of, 322, 1152, 1154
 Design specifications, 326, 1055
 Examples of, 248, 249
 Forms for, examples, 1350, 1620
 Removal of, 1147
 Foundations for, 207, 1051
 Inspection of, 1337-1368
 Joints (construction), 1357
 Specifications (construction), 1496-1533
 Test of stability (empirical), 1085
 Thickness (trial value), 1087
 Use of (proper economic), 205, 1005
- Areas**
Methods of Computing
 Formulae, 1676
 Planimeter, 969
 Scaling, 970
Rt. of ways (Land Areas)
 Double meridian distance, 1093
 Planimeter, 969, 1093
 Units of measure, 1673
- Arid Region Roads, 365**
- Artillery Loads** (Military), 202
- Asphalt** (*see* Bitumens)
- Asphalt Block Pavement**
 Construction methods, 513
 Cost
 Detailed data, 1208
 General comparative, 513
 Description, 513
 Design
 Current practice, 513
 Recommended practice, 514, 515
 Theoretical design of base, 392, 427, 427, 960
 Durability of pavement surface, 513, 535
 Economic limitations of use, 58, 513, 962
 Failures cause of, 428
 Grade limitation, 425, 962
 Maintenance
 Cost and methods, 569, 542
 Materials
 Amounts required, 515
 Specifications for, 513, 1408

INDEX

- Asphalt Block Pavement, Materials**
 Suitability of, 513, 515, 1406
 Tests and sampling, 766
 Specifications, 1406, 1474
 Suitability of pavement, 58, 513, 969
 Yearly cost, 542
- Asphalt (Kentucky rock)**
 Cost data, 1183
- Asphalt Pavement (Sheet, Topeka mix, etc.), 491-506**
 Aggregates, grading of, 492, 1323, 1438, 1459-1470
 Concrete foundation, 418, 497, 960
 Cost of
 Detail data, 1187
 Estimate forms, 1138, 1142
 General data, 65, 491
 Crowns, 124, 504, 950, 957
 Design of, 492, 497, 1319
 Durability (Life), 520, 535
 Economic limitations of use, 40-48, 58, 491, 579, 585, 962
 Failures (Common causes), 428
 Inspection of construction, 1313
 Limitations of use, 425, 428, 491, 579, 585, 962
 Materials (Amounts), 495, 1138, 1142
 (Suitability), 492, 1336, 1388
 Maintenance
 Cost, 65, 491, 520
 Methods, 564
 Specifications, 1386, 1388, 1435, 1459
 Weight
 Surface mix, 496, 1459
 Black base, 496
 Yearly cost, 65, 491, 520
- Asphaltic Concrete Pavements (see Bituminous concrete), 491-506**
- Authority of Inspectors, 1271**
- Automatic Signals at Railroad Crossings**
 Cost, 600, 602
 Effectiveness, 600, 602
 Financing, 601
 Specifications, 621
 Types of signals, 621
See also Railroad grade crossings
- Automobiles (Their effect on general policy and detail design)**
 Accidents (Causes and locations), 33, 606
Character of Traffic
 Range of travel (local and long distance), 38
 Speed, regulation of, 28, 37, 371
 Types of hauling, 26
 Volume, comparative amount local, 37
 Volume, growth of, 28
 Weight, regulation of, 28, 370
Cost of Operation
 Effect of alignment, 118
 " " grade design, 12, 93
- Automobiles, Cost of Operation**
 Effect of location problems 74-80
 " " pavement surfaces, 11
 Effect on pavement selection, 11
 Inefficient operation, 96
 Cost of maintenance per vehicle mile, 18
 Emergency stops, 114
 Gasoline consumption, 18, 68, 96
 Gasoline tax, 68
 License Fees
 Amount required, 17-22
 Reasonable use of, 17
 Safety of Operation (Requirements of), 33-37
 Crown, one way, 7, 9, 33, 124
 Curves, easy alignment, 6, 8, 120, 950
 " " superelivation, 7, 9, 33, 124, 956
 Ditches, shallow, 142
 Guard rail, 7, 9, 33, 676
 Illumination, 699
 Pavement surfaces, 428, 585, 962
 Pavement widening, 130, 958
 Railroad crossings, elimination of, 599
 Section, shape and width, 130, 951
 Sight distance, 6, 8, 114, 950
 Signs, danger and guide, 599, 609, 687
 Vertical curves, 110, 634, 965
 Tax Burden (General principles), 17
Trucks
 Effect on design, 370
 Effect on general policy, 26
 Operation costs, 11, 96-101, 1163
 Regulation of (Speed, weight, height, length), 28, 371
 Tax burden, 17
 Types suitable for various uses, 26-28
Wheel Loads
 Impact, 202, 372, 1040
 Recommended design loads, 200, 370, 1039
- Backwater Head, 196, 1085**
- Balanced Sections**
 Examples, 162, 786
 Quantities, 786
- Banking Curves**
 Grading shapes, 127, 953
 Layouts at curves, 128-129, 599
 Pavement superelivation, 124, 956
 " width, 132, 958
 Practical rules, 125, 127, 956
 Theoretical discussion, 124
 Use of, 7, 9, 124, 956
- Bar Reinforcement (see Reinforcement)**
 Sizes and weights, 1061
 Specifications, 1418
 Splicing, 1418

INDEX

- Barometer Altitudes**, 782, 817
Base Line (Survey of), 831, 905
Base Pressure (Foundations)
 Distribution of, 1045
 Intensity of (Safe), 208, 1051
 Diagrams of, 1027, 1046
Batter Piles
 Necessity for, 1343
Beams
 Depth ratio (Deflection), 1061
 Formulae for flexure, 1028
 Safe loads concrete beams, 1072-1074
 " " steel beams, 1062-1067
 " " timber beams, 1076
 Deflection
 Formulae, 1028
 Table, 1077
Bearing Power of Soils
 Bridges, 208, 1051
 Pavements, 374
Beautifying the Highway (Tree planting), 177
Bench Levels (see Leveling)
Bench Marks, 853, 906
Bench Sections (Mountain roads)
 Examples, 165, 793
 Quantities, 793
Binder (Asphaltic concrete)
 (See Bituminous concrete)
 Cost, 1138, 1187
 Grading, 499-504, 1330, 1437
 Materials
 Amounts, 495, 1138, 1187
 Suitability, 492, 1386, 1437
 Specifications, 1386, 1436
 Weight, 496, 1138
Bitto Slag (see Bituminous concrete)
Bitulithic Pavement (Warren Bros.)
 (see Bituminous concrete)
Bitumens
 Amounts required
 Bituminous concrete, 495, 1138, 1143, 1438, 1459
 " " macadam, 446, 1142, 1458
 Cold patch repair, 558
 Joints, 511
 Oiling (Surface), 561, 1221
 Cost of applying as binder, 1142, 1169
 Cost of applying as surface treatments, 562, 1221
 Maintenance use, 561, 1221
 Properties of
 Specifications, 1388
 Sampling, 753, 1314
 Suitability and Specifications
 Bituminous concrete, 492, 1399
 Bituminous macadam, 446, 1399
 Cold patch repair, 558, 1399
 Joints, 511, 1401
 Oiling (Surface), 563, 1399
 Tests for
 Adhesiveness, 723
 Ductility, 729
 Evaporation, 729
 Flash, 727
Bitumens, Test for
 Penetration, 728
 Solubility, 730
 Specific gravity, 727
 Use of for
 Binders, 720
 Cracks, 565
 Joints, 511
 Oiling (Surface), 561, 720
 Volume at different temperatures, 754
Bituminous Concrete Pavements, 491-505
 Concrete base for, 418, 426, 497, 960
 Construction methods, 1313
 Cost
 Detail Data, 1187
 Estimate forms, 1138, 1142, 1187
 General comparative, 66, 491
 Design
 Current practice, 491-505, 1436, 1459
 Recommended practice, 418, 426, 492, 960
 Theoretical surface mixtures, 491-505
 Base courses, 491-505
 Durability of pavement surface, 491, 535
 Economic limitations of use, 491, 962
 Equipment for construction, 1264
 Failures (Common causes), 428
 Grade limitations, 425, 962
 Inspection details
 Culverts, 1273
 Grading, 1288
 Pavement, 1313
 Maintenance
 Costs, 491, 520-544
 Methods, 505, 564
 Materials
 Amount required, 495
 Sampling, 1314
 Specifications for, 1436, 1388, 1389
 Suitability of, 492
 Tests for (see Specific material used)
 Reconstruction, 570-598
 Specifications, 1436, 1459
 Suitability of pavement (general conditions), 40, 491, 579, 962
Bituminous Macadam (Mixing method, open mix) (see Bituminous concrete)
Bituminous Macadam Pavement (Penetration method), 443-449
 Construction methods, 1291-1299
 Cost of
 Detail data, 1156-1178
 Estimate forms, 1141
 General data, 65, 443, 662
 Crowns, 124, 443, 950
 Depths recommended (different soils), 391, 959

INDEX

- Bituminous Macadam Pavement**
 (Penetration method)
 Description, 443
 Design
 Current practical, 149, 445
 Recommended practice, 390, 444, 959
 Theoretical, 366-391
 Durability of pavement surface, 444, 531
 Equipment for construction, 1243-1264
 Examples of current practice, 149, 445
 Failures, common causes, 428
 Inspection of construction
 Culverts, 1273
 Grading, 1288
 Pavement, 1291-1299
 Life of pavement, 444, 531
 Limitations of use
 Economic, 40, 58, 443, 586, 962
 Physical, 101, 425-428, 962
 Maintenance
 Costs, 65, 444, 519-544
 Methods, 448, 557
 Materials
 Amounts required, 446, 1132-1143
 Specifications for, 1383
 Suitability of, 446, 1383
 Tests for, 705-745
 Maximum grades, 101, 425, 962
 Proper use of flexible pavements
 Location, 6-9, 40, 443, 962
 Extent (examples), 42
 Reconstruction, 579-598
 Specifications, 1458, 1383
 Suitability of pavement (general condition), 6-9, 40, 428, 962
 Thickness required on different soils, 390, 959
 Thickness of top course, 448
 Typical sections, 149, 160, 445
 Yearly cost of upkeep, 65, 444, 519-544
- Bituminous Surfacing**
 Amounts of materials
 Bitumen, 561, 1221, 1223
 Cover, 561, 1221, 1223
 Cost data, 562, 1221
 Description, 440, 561
 Methods, 561
 Relative value of materials, 440, 562
 Specifications, 1456, 1399
- Black Base** (see Bituminous concrete)
 Cost, 1138, 1187
 Design, 497, 1330
 Inspection, 1313
 Materials
 Amounts required, 495
 Suitability of, 492, 1386, 1388
 Specifications, 1385, 1436
 Weight of, 496
- Blasting** (Small boulders), 1150, 1176
- Bleeding** (First aid), 1708
- Block Pavement**
 (See Type desired)
 Asphalt
 Brick
 Stone
 Wood
- Bolts**
 Weight of, 1070
- Bond Stresses**
 Bar reinforcement, 1036
- Bonds** (Highway finance)
 Cost of
 Serial, 19
 Sinking fund, 19
 Terms of
 Reasonable length, 19, 601
 Yearly retirement budgets, 19
- Bottom Courses** (see also Type of construction desired)
 Cost of, 429-436, 1134-1138
 Depths of (see Pavement depths), 389, 426, 959-960
 Design of
 Flexible Type, 366-391, 959
 Rigid pavements, 392-427, 960
 Inspection of, 1291
 Materials (see Type desired)
 Types (Description and specifications)
 Black base, 501, 1436
 Boulder, 430, 1451, 1426
 Concrete, 497, 1459
 Gravel, 430, 1430
 Macadam, 429, 1433
 Telford, 433, 1431
- Boulders**
 Cost of sledging, 1176
- Boulder Base**
 Construction, 1291, 1425
 Cost, 430, 431, 1132, 1183
 Depth, 389, 390, 430, 959, 1291
 Design, 389, 430
 Examples of, 149-161, 430, 439
 Inspection, 1291
 Materials
 Amounts required, 430, 431, 1132
 Suitability of, 431, 432
 Specifications, 1425
 Suitability, 389, 430, 431
- Box Culverts** (see Culverts)
 Cost, 213, 675, 797, 1150, 1226
 Examples, 220-236
 Inspection, 1273
 Suitable use, 212
 Types of, 212
- Brick Cube Pavement** (McClintock)
 Cost data, 518, 1184
 Description, 516, 585, 592
- Brick Pavement** (Standard)
 Construction data, 1330
 Cost of
 Detail data, 1210
 Estimate forms, 1146, 1214
 General data, 65, 506, 662, 769
 Crowns, 124, 513, 950
 Cushion
 Cement sand, 506-513, 1331
 Sand, 506-513, 1331

INDEX

- Brick Pavement (Standard)**
 Description, general, 506
 Design
 Current practice, 153, 424
 Recommended " , 426, 508, 960
 Theoretical (Base thickness), 421, 426, 960
 Durability of pavement surface, 535
 Economic limitations of use, 40, 46, 428, 506, 585, 962
 Edging, 509
 Equipment for construction, 1243
 Examples of current practice, 153, 424
 Expansion joints, 511
 Failures, common cause, 428
 Inspection of construction
 Culverts, 1273
 Grading, 1288
 Pavement, 1330
 Life of pavement, 535
 Maintenance
 Cost, 519-544
 Methods, 569
 Mastic filler, 1334
 Materials
 Amounts required, 511, 1146, 1214
 Specifications for, 1387, 1406
 Suitability of, 508
 Tests for, 716-745
 Proper use of rigid pavement, 40, 428, 579, 962
 Location, 40, 428, 506, 962
 Extent (example), 44
 Reconstruction, 588
 Specifications
 Cement sand cushion type, 1476
 Standard type, 1476
 Suitability of pavement (General conditions), 40, 46, 428, 506, 585, 962
 Typical sections, 153, 504, 509, 590
 Yearly cost of upkeep, 65, 519-544
- Brick (Paving)**
 Hillside, 513
 Properties, 508, 715
 Sampling, 766
 Specifications, 1408
 Tests, 716
- Bridges (General data), 180-334**
 Economic types, 205-213, 1005, 1546
 Financing (bond terms), 26, 603
 General costs, 310-326, 648-675
 Loadings, 6-9, 200, 1005, 1547, 1039
 Roadway widths, 6-9, 203, 1005, 1546, 633
 Specifications (general design), 6-9, 1005, 1546
- Bridges (Small span) Detail Data**
 Condemnation of, 211, 779
 Construction of, 1334-1370, 1492-1572
- Bridges (Small span) Detail Data**
 Construction of,
 Concrete work
 Amounts of materials, 1092, 1151, 495
 Finish, 1277, 1531, 1521
 Forms, 1343, 1526, 1518, 1026
 Joints (Location), 1557, 1528
 Order of placing, 1358
 Protection of, 1517, 1531
 Speed of mixing, 1276
 Specifications, 1492-1572
 Foundations
 Soil loads, 208, 1051, 1337
 Piles " (Design), 208, 1051
 Test piles, 1338
 Equipment, 1264
 Inspection, 1334
 Records, 1100
 Specifications, 1492-1572
 Staking out, 1334
 Cost of
 Detail cost data, 1226-1231
 Estimate forms, 1150-1156
 Typical cost diagrams (quick estimates), 310-327, 648-675
 Design Data
 Abutments, 207, 241, 258, 284, 293, 1046
 Channel improvements, 181
 Clearances
 Debris, 186, 1025
 Ice, 186, 1025
 Portal, 203, 633, 1546
 Railroad, 633
 Concrete (Mix required)
 Abutments, 245, 261, 289, 1362
 Superstructures, 225, 240, 257, 273, 1511, 1524
 Cost of design, 747, 775, 1004
 Discussion of design (General), 180-213, 1004, 1546
 Flood flow, 186, 1021, 1025
 Floors
 Depth, 206, 1025
 Distribution of loads on, 1042, 1549
 Life of, 1231
 Repair of, 1231
 Surfaces, 210
 Forms
 Examples of, 1543
 Loads (Vertical), 1026, 1052
 Pressures (Fluid), 1026, 1052
 Specifications, 1518, 1526
 Formulae (General design), 1028, 1546
 Foundations
 Depth of, 1051
 Distribution of base pressure, 1046
 Loads (Safe foundation)
 Soils, 208, 1051, 1337
 Piles, 208, 1051
 Loads (Superstructures)
 Dead, 190, 1038
 Live, 6, 8, 200, 1039

INDEX

- Bridges (Small Span) Detail Data, Design Data, Loads (Superstructures)**
 Impact, 202, 1040
 Distribution of, 203, 1043
 Location of structure, 181
 Piers, 207, 1006
 Plans (Typical), 1006
 Roadway widths, 6, 8, 203, 633, 1006, 1546
 Scour, protection from, 211
 Strength of materials, 203, 1033
 " structural units, 203
 Stresses in materials, 203, 1034
 Superstructures (Economic type), 6, 8, 205, 1005, 1546
 Tables of design data, 1026
 Dismantling old steel, 1231
Examples of current practice
Abutments
 Concrete, 241, 258, 284, 293
 Pile, 204, 298, 302, 303, 308
 Timber, 294, 298, 302, 303, 307
Superstructures
Concrete
 " arches, 248-250
 " girders, 251
 " slabs, 237-248
 " tee beams, 252
 " trestles, 308
Steel
 " I beam stringers, 265-283
 " girders, 290
Timber
 " queen post, 302
 " king post, 301
 " stringer, 294, 298
 " trestle, 303, 307
Inspection of construction, 1334
 Maintenance and life of, 210, 1231
 Plans (Typical), 1006
Repair of old bridges
 Cost, 1231-1237
 Painting, 210, 1231
 Strengthening, 779
 Specifications, 1492-1572
 Surveys, 942
Utilization of old structures, 210, 1013
Bruises, 1699
Brush Mattress, 1500
Burke-Ziegler Formulæ for Runoff, 188
Burns and Scalds, 1708
Busses (see Automobiles)
 Effect on bridge widths, 203
 Effect on pavement width, 130
 Operation cost (Relation of items), 99
 " pavement surfaces, 11
 Rear wheel encroachment, 116
 Widths and clearances, 130-141
Cable Guard Rail
 Cost, 602, 769, 1166
 Examples, 679, 680
 Specifications, 1414, 1489
 Use of, 6-9, 37, 676
Calcium Chloride
 Cost data, 1220
 Description, 561
 Use of
 In concrete, 486
 On macadam, 561, 1220
Camber
 Concrete bridges, 240, 257, 1348
 Steel bridges, 1561
Camera (Notes on photography), 818
Camp Equipment
 Depreciation, 902
 Lists of, 894-904
Capacity of Bridges (Volume of traffic), 203, 1005
Capacity of Culverts (Flow of water), 194, 1082
Capacity of Ditches and Streams, 334, 195
Capacity of Highways (Volume of traffic), 6-9, 28, 968, 969
Capillary Rise of Water in Soils, 375
Car Tracks (see Track)
 Examples, 154, 175, 176, 643
 Cost, 662, 769
Cast Iron
 Specifications, 1413
 Weight, 1038
Cast Iron Pipe
 Cost, 213, 661, 675, 797, 1148
 Culverts
 Examples of, 219
 Inspection of, 1273
 Dimensions, 1079
 Flow capacity, 194
 Specifications, 1409, 1567
 Weight, 1079
Catch Basins (see also Manholes)
 Examples of, 689-695
 Grates for, 689-695
 Specifications, 1487
Cattle Guards, 699
Cattle Pass
 Clearances for, 699
Cement (Bituminous) (see Bitumens)
Cement (Portland)
 Amount required in concrete, 466, 485, 495, 1092
 " grouting, 511, 1213
 Cost of handling, 1145, 1161
 Effect on strength of concrete, 485
 Properties, 734
 Sampling, 753
 Specifications, 735, 1387, 1388
 Tests, 735
 Weight, 1038
Cement Concrete (see Concrete)
Cement Concrete Pavements (see Concrete pavements)
Cement Sand Cushion
 Asphalt block pavement, 514, 1474
 Brick pavement, 507, 1331, 1470
 Stone block pavement, 516, 1482
Census (Traffic), 32
Center of Gravity (Plane figures) 1031

INDEX

- Center Line**
 Design (*see* Alignment)
 Mapping, 944
 Survey, 831, 905
- Chaining** (*see also* Base line)
 Accuracy required, 832, 942
- Channel Improvements** (Streams).
 181, 1004, 1500
- Circles, Areas and Circumferences,**
 1580
- Classification of Roads**
 For administration, 6-9, 46
 " design and pavement selection, 6-9, 46
 By location, 46
 By traffic census, 6-9, 33, 959
 Examples of, 33
 For maintenance and renewal, 46, 524
 Examples of, 536
- Clearances**
 Bridge
 Debris and ice, 186, 1025
 Roadway, 203, 1006, 1546
 Portal, 203, 1546
 Vehicle
 Curves, 130
 Tangents, 130
 Vertical, 203
 Railroad
 Horizontal, 633, 542
 Vertical, 633
- Clearing and Grubbing** (Trees and brush)
 Areas, 796
 Cost of, 796
 Objects of, 177
 Specifications, 1420
 Widths of, 177-179
- Cobble Gutters,** 335, 688, 1166, 1217
- Cold Patch**
 Materials
 Amounts, 558
 Suitability, 558
 Methods of using, 558
 Specifications, 558, 1390
 Use of, 557
- Columns**
 Strength of timber long columns, 1078
 " " concrete " 1055
- Compaction of Earth in Fills,** 905
- Compass Variation from True North,** 799-808
- Compensation of Grades at Sharp Curves,** 6-9, 117, 118, 634, 940
- Concrete Beams and Slabs**
 Safe loads, 1072-1075
- Concrete** (Bituminous) (*see* Bituminous concrete)
- Concrete** (Portland cement) (General data)
Aggregates
 Amounts required, 466, 495, 1092, 1146, 1151
 Cement, 734, 456, 1387
 Gravel, 740, 456, 1388
- Concrete** (Portland cement) (General Data) *Aggregates*
 Sand, 735, 456, 1388
 Specifications, 1383-1388
 Stone, 740, 456, 1383
 Suitability, 456, 740, 1383-1388
 Water, 739, 1092
 Amounts of material required, 466, 495, 1092, 1146, 1151
 Cost data (*see also* Cost data index), 661, 766, 1126
 Design of mixes
 Aggregate (Fineness modulus), 479-484, 489
 Cement content (Effect on strength and porosity), 485, 464, 488, 489, 1362, 1511, 1525
 Curing (Effect on strength), 475, 490
 " (Methods), 1309, 1361, 1531
 Mix (Time of), 475, 1276, 1512, 1527
 Water content, 490, 475, 1092, 1527
 Finishing, 1277, 1361, 1531
- Forms**
 Examples of 1343
 Removal of, 1275, 1347, 1531
 Specifications, 1518
 Inspection, 1275, 1299, 1345
 Mixing and placing, 1276, 1304, 1470, 1512
 Protection from sun and frost, 1309, 1470, 1531
 Reinforcement (*see* Reinforcement)
 Sampling for tests, 743, 753
 Specifications, 462, 1470, 1608, 1523
 Weight of, 1038, 1547
 Working stresses, 1033-1036
- Concrete Arches** (*see* Arches), 205, 248, 322-326, 1006, 1085-1087, 1520
- Concrete Bridges** (*see* Bridges)
- Concrete Culverts**
 Design of
 Area of waterway, 186, 1021, 1022, 1004
 Cleaning, 196
 Concrete (Mix used), 225, 1153
 Cost, 675, 797, 1153, 1226
 Cushion over top, 199, 1566
 Discharge capacity, 194
 Inspection of, 1275
 Invert elevation, 197
 " grade, 197
 Length, 203
 Loads, 199, 1039, 1547
 Location layouts, 181
 Roadway width, 203
 Special conditions, 196-198
 Specifications, 1608
 Types in use
 Examples, 212-236
 Selection of economic, 212
- Concrete Foundations** (Pavements)
 Cost, 662, 1138

INDEX

- Concrete Foundations (Pavements)**
 Depth, 426, 960
 Design, 392-427, 960
 Inspection, 1299
 Materials
 Amounts, 495, 1092, 1138
 Suitability of, 492, 1383, 1439
 Specifications, 1439
- Concrete Guard Rail**
 Cost data, 662, 1156, 1216
 Description, 676
 Illustrations of, 681
 Proper use, 37, 676
- Concrete Guide Posts**
 Cost, 662, 1156
 Examples, 680
- Concrete Pavement Hassam** (*see* Hassam concrete)
 Cost of, 1191
- Concrete Pavements**
 Construction methods, 1299, 1470
 Costs (General comparative), 65, 449
 Costs (Detail), 1144, 1194-1210
 Design
 Current practice, 455, 417, 960
 Depth over trenches, 417
 Recommended practice, 450, 960
 Theoretical depths, 392-418, 426, 960
 Durability of pavement surface, 535
 Economic limitations of use, 40, 46, 58, 449, 962
 Equipment for construction, 1243-1269, 1144
 Failures (Common cause), 428
 Inspection details
 Culverts, 1273
 Grading, 1288
 Pavement, 1299
 Maintenance
 Costs, 65, 440, 519-544
 Methods, 552-570
 Materials
 Amounts required, 461, 1092, 1146
 Specifications, 1383
 Suitability of, 456, 1383, 1470
 Tests for, 734-744
 Reconstruction, 570-508
 Sampling for tests, 743, 753
 Specifications, 462, 1470
 Suitability of pavement (General conditions), 40, 46, 58, 428, 449, 962
- Concrete Piles**
 Cost, 766
 Details of, 1366
 Loads
 Design, 208, 1051
 Tests for safe load, 1333
 Specifications, 1503
- Concrete Pipe** (*see* Reinforced concrete pipe)
 Cost, 1148, 1268
- Concrete Pipe** (*see* Reinforced concrete pipe)
 Specifications, 1410
 Weight and dimensions, 218, 1083, 1411
- Concrete Pipe Culverts** (*see also* Culverts)
 Cost, 1148, 1268
 Examples of, 218, 1083
 Weights and dimensions, 218, 1083, 1411
 Specifications, 1410
- Condemnation of Bridges**, 211, 779
- Consistency of Concrete** (Slump test), 461, 744, 1511
- Construction joints**
 Concrete bridge work, 1357, 1516
- Construction of Pavements**
 Equipment (*see* Pavement desired), 1243-1267
 Inspection (*see* Pavement desired), 1271-1334
 Methods (*see* Pavement desired), 1420-1492
- Construction of Roads** (Notes on Inspection)
 Bituminous applications, 1296
 Brick pavement, 1330
 Concrete foundations, 1299
 Concrete pavement (Standard), 1299
 Culverts, 1273
 Grading, 1288
 Macadam foundations, 1291
 Macadam surfaces, 1295
 Topeka mix asphalt (Bituminous concretes), 1313
- Contraction and Expansion**
 Coefficient of
 Concrete, 498, 1053
 Steel, 1053
 Joints
 Cement concrete pavements, 472, 1470
- Contract Bonds**, 1238-1242
- Contractors' Equipment**
 Concrete roads, 1243-1264
 Macadam roads, 1243-1264
- Contracts**
 Estimates for
 Costs, 747, 1119
 Quantities, 747
 Length of, 51
 Policy (General), 51
 Plans for (*see* plans)
 Profit on, 51, 1119
 Relations engineers and contractors, 51
- Conversion Tables**
 Cubic feet to cubic yards, 974
 Feet to miles, 994
 General units (Linear, areas volumes, etc.), 1573
 Minutes to decimals of a degree, 859
 Inches to feet, 1574
 Vertical angles to % of grade, 796
- Corduroy Roads**, 362, 436

INDEX

- Corner Load (Formula), 394-427**
- Corrugated Metal**
 Cost, 767, 797, 213
 Culverts, 216, 1668
 Dimensions, 1080
 Flow capacity, 216
 Specifications, 1668
 Weights and sizes, 1072, 1080
- Corrugated Metal Pipe Culverts (see also Culverts)**
 Costs of, 1148, 767, 797, 213
 Example of, 216
 Use in drive, 338
 Weights and sizes, 1080
- Cosecants natural, 1616**
- Cosines**
 Logarithmic, 1653
 Natural, 1604
- Cost (General comparative)**
 Bridges, 16, 310-326, 661-675
 Culverts, 675, 797, 1148
 General highway costs, 7, 9, 16
 Maintenance, 65, 519-544
 Office work, 747, 1004
 Pavements, 65
 Preliminary investigations, 749
 Railroad crossing protection, 599, 661-675
 Surveys, 747, 749, 840, 893
 Yearly fluctuation of, 1119
- Cost of Bond Financing, 19**
- Cost Data (Labor and materials in detail), 1119-1270**
 Amiesite pavement, 1185
 Asphalt block pavement, 1208
 Asphalt Topeka mix, 1187, 1142, 1158
 Bridges, 1150-1155, 1226-1255
 Brick pavement, 1146
 Edging, 1211
 Expansion joints, 1212, 1146
 Grouting, 1212, 1146
 Hauling, 1128, 1215
 Laying, 1146, 1212
 Materials, amount required, 1210-1214, 1146
 Sand cushion, 1212, 1146
 Unloading brick, 1146, 1213, 1214
- Cobble gutters, 1156, 1217**
- Concrete Culverts, 1150-1155, 1226-1236**
 Forms, 1151, 1228
 Materials required, 1151, 1092
 Mixing and placing, 1152, 1228
- Concrete foundations (Pavement)**
 Materials required, 1092, 1138
 Mixing and placing, 1139
- Concrete pavement (Hassam), 1191**
- Concrete pavement (Standard)**
 Amounts of materials, 1092, 1145
 Expansion joints, 1145
 Finishing and curing, 1145
 Mixing and placing, 1145
 Plant required and overhead, 1144
 Trimming, 1187
 Water supply, 1145
- Cost Data (Labor and materials in detail)**
Guard rail
 Concrete, 1156, 1216
 Wooden, 1166, 1216
 Kentucky rock asphalt pavement, 1183
- Macadam roads**
 Contractor's plant, 1261
 Crushing stone, 1130, 1172
 Excavation, 1126
 Hauling, 1128, 1162
 Loading sand, 1161
 Loading stone, 1161
 Puddling, 1171
 Quantities of materials, 1136, 1168
 Rolling, 1142, 1171
 Spreading bitumen, 1169
 Spreading sand filler, 1137, 1168
 Spreading screenings, 1140, 1168, 1142
 Spreading stone, 1137, 1167
 Stone fill, 1182
 Sub-base (Fieldstone), 1133, 1183
 Unloading stone from cars, 1140, 1159
- Maintenance and repair, 1218-1226**
 Calcium chloride, 1220
 Distribution of maintenance costs, 1225
 Guard rail, resetting, 1156, 1222
 Oiling, 1220
 Recapping macadam, 1218
 Scarfing, 1218
 Painting guard rail, 1216
- Topeka mix (Bituminous concrete)**
 Black Base, 1138, 1137
 Surface mixture, 1143, 1187
- Cost Estimates (Preliminary)**
Bridges and culverts
 Quick estimating data, 310-326, 661-675, 768, -764
- Grade crossing eliminations**
 Quick estimating diagrams, 599, 661-675
- Mountain roads (Pioneer)**
 Quick estimating diagrams, 780-800
- Pavements**
 Construction, 65
 Maintenance, 65
 Renewal, 65
- Cost estimate forms (Detail costs)**
 Bridges and culverts, 1148-1156
 Highways, 1125-1148
- Cost Estimate Forms and Typical Cost Estimates**
 Bridges and culverts, 1148-1156
 Highway construction items, 1125-1148
 Materials (Production of), 1180

INDEX

- Cost of Improved Highway (General comparative)**
 Effect of pavement type, 5, 65
 " of traffic volume, 7, 9, 10, 16, 65
 Permissible economic limits, 16
- Cost of Motor Operation (see also Automobiles)**
 Distribution of items, 98, 1163
 Effect of alignment, 118
 " " grade, 12, 93
 " " pavement surface, 11, 68, 545
- Cotangents**
 Logarithmic, 1653
 Natural, 1593
- Cross Sections (see Sections)**
 Areas by planimeter, 969
 Plotting, 947, 1106
 Survey methods, 833, 909
 Templates for, 962, 969
- Crowns (see also, Individual Pavement desired)**
 "Banked" crowns on curves, 124, 956
 Effect of grade, 160
 Effect of pavement width, 124, 505, 957
 Effect on convenience of travel, 123
 Examples of current practice, 146-174, 580, 955
 " of recommended practice, 146-174, 580, 950
 Maximum and minimum limits, 124, 950
 Normal highway, 124, 950
 "One way" crown, 124, 160
 Ordinates for parabolic, 956
 Streets (City and village), 605, 957
 Superelevation at curves, 124, 956
 Templates for construction, 1304
 Types of crown, 124, 950
- Crushed Stone (see Stone)**
- Crushed Stone Macadam (see Macadam)**
- Crushing Stone**
 Cost data, 1180, 1172-1182
 Proportion of screen sizes of output, 1173-1181
 Weights of, 442, 1180, 1182
- Cube Pavements**
 General description, 516
 See also
 Durax, 516
 Kleinpflaster, 516
 McClintock, 516, 1183
- Cubes and Cube Roots (Table of), 1580**
- Culverts, (180-341)**
 Cost comparative, 213, 675, 797
 Costs (Detail), 1148-1155, 1228
 Design of
 Area of waterway, 186, 1021
 Capacity, 104, 1082
 Cleaning, 196
 Cushion over top, 199, 1668
 Discharge capacity, 104
 Invert elevation, 197
- Culverts, Design of**
 Invert grade, 197
 Length, 6, 8, 203
 Loads, 6, 8, 199, 1038, 1039
 Location layouts, 181
 Roadway width, 6, 8, 203
 Special conditions, 196
 Types in use
 Examples, 212-236, 1033
 Selections of, 6, 8, 212-236
- Driveway culverts**
 Length, 338
 Location, 183, 338
 Size, 338
 Types, 338
 See also cast iron pipe
 " " (concrete culverts)
 " " (concrete pipes)
 " " (corrugated metal pipe)
 " " log culverts
 " " (vitrified tile culverts)
- Curbs**
 Cost of, 661, 1156
 Description, 681
 Examples of, 174, 685, 686
 Specifications, 1404, 1488
 Radii of at intersections, 681
- Curing Concrete (Effect on Strength) 475, 490, 1361, 1309, 1531**
- Curvature (see Alignment)**
- Curves (Survey Data)**
 Functions of 1° curve (table of), 858
 Radii for different degree curves (table of), 855
 Survey problems (solution of), 885-892
- Curves (Alignment)**
 At bridge approaches (minimum radius), 634, 950
 At hairpin (switchbacks), 121, 950
 Banked, 7, 9, 124, 956
 Dangerous alignment, 114, 631, 632
 Effect on construction cost, 119
 " " crown, 124, 956
 " " grade, 117, 118, 949
 " " location surveys, 82
 " " motor operation costs, 118
 " " sight distance, 114
 " " width of pavement, 116, 130, 958
 " " " " right of way, 117 " " " section, 115
- Encroachment of long wheel base rigs, 116**
- Examples of computing notes for staking, 885-892**
- Functions of 1° curve (table), 858**
- Length of (computations), 858**
- Methods of staking out, 885-892, 907**
- Minimum radii (see also Alignment)**
 Current practice, 116
 Recommended practice, 6, 8, 120, 634, 950

INDEX

- Curves**
 Principals of location, 82
 Problems, 885-898
 Radii of (table), 855
 Sight distance, 7, 9, 114, 177
 Switchbacks, 121, 950
 Summary of alignment practice, 82, 120, 634, 950
 Tangent lengths, 859
 Tangent offsets (for staking out), 907
 Vertical curves (*see* Vertical curves), 110, 634, 964
 Widening of pavement or section, 130, 958
- Cuts (First aid) Bleeding, 1702**
Cuts (*see also* Excavation)
 Inspection, 1288
 Staking out, 1272
 Slope stakes, 1272
 Stable slopes, 145
 Ratio cut to fill (shrinkage), 995
- Cut Sections (Excavation)**
 Examples, 146-171, 951
 Quantities, 764, 786-795
- Danger**
 Causes of
 General highway, 33-38
 Railroad Xings, 606
 Prevention of (*see* Safety provisions)
- Danger (Elimination of)**
 Alignment practice, 6-9, 113-121, 634, 950
 Banked curves, 6-9, 124, 956
 Ditches (Shallow), 142
 Grade (Safe descent), 6-9, 86, 101, 982
 Guard rail, 6-9, 676-681
 Illumination at night, 6-9, 699
 "One way" crown, 161
 Pavement widening, 130, 958
 Pedestrian traffic segregation, 6-9, 36, 634, 1008
 Railroad crossings, 599-675
 Sight distance, 6-9, 110, 114, 950
 Traffic clearance (Safe width), 6-9, 130
 Warning signs, 6-9, 687
- Danger Signs**
 Examples, 612, 696
 Location of, 607, 687
 Use of, 7, 9, 687
 Cost, 600
- Debris Clearance (Bridges), 186, 1025**
- Declination**
 Magnetic, 799
 Solar, 827
- Deflection of Beams**
 Formulae for, 1028
 Timber beams, 1077
 Steel beams (Depth ratio), 1081, 1553
- Deformed Bars (*see* Reinforcement)**
- Depreciation**
 Camp equipment, 808
- Depreciation**
 Contractors' equipment, 1243-1284
 Pavements, 26
 Survey equipment, 894
- Depth of Bridge Floors, 206, 634, 1025**
- Depth of Foundations (Small bridges), 209, 1051**
- Depth of Pavements (Thickness)**
 Effect of trenches, 417, 420
 Examples of typical sections, 146-161, 580, 953
 Recommended depths
 Macadam types, 391, 959
 Rigid types, 426, 960
 Theoretical design
 Macadam types, 366-391
 Rigid types, 366-378, 392-427
- Desert Roads, 365**
- Design Details (*see also* Types of pavement or structure desired)**
 Alignment, 113-121, 634, 950
 Bridges, 180-310, 632-660, 1004-1087
 Culverts, 180-310, 1079-1084
 Drainage ditches, 334
 Grades, 83-113, 949
 Location of highways, 74-83
 Minor details, 676-704
 Pavements, 366-518
 Railroad crossings, 599-675
 Sections, 122-179, 951
 Streets, 165-170, 690-695, 957
- Design of Highways (General)**
 Administrative principles, 1-73
 Cost of office work, 747, 943, 1004
 Economic principles, 52-73
 Speed of office work, 1104
 Value of alternate designs, 747, 943
 " " engineering, 50
 Reports (Typical), 1095
- Detours**
 General practice, 2
 Signs, 696
- Deval Rattler (Stone test), 706**
- Dickens Formula for Runoff of Steams, 189, 1021**
- Direction Signs, 687, 1491**
- Distance (Value of saving)**
 Principals of location, 12, 80, 82,
- Distance Units of Measure, 1573**
- Distribution of Loads**
 On bridge floors, 1042, 1548
 " " foundations, 1046-1060
 " pavement " " 378, 410
 at " " joints, 405
- Distribution of Pressure**
 Macadam pavements, 378
 Joints in rigid pavements, 405
- Ditches**
 Capacity of, 334
 Dangerous ditches, 142
 Depth of, 142
 Flow of water in, 334
 Functions of, 334
 Intercepting, 334

INDEX

Ditches

- Protection of (*see* Gutters) 335
- Relief culverts and storm sewers, 182, 337, 669
- Safe ditches, 142
- Value of, 142-143

Ditch Linings (*see* Gutters)

Ditch Protection (Gutters)

Double Meridian Distance Areas, 1095

Dowels (Use of)

- Concrete pavements, 471
- Facing old masonry, 681, 685
- Bridge abutment ties, 241
- Culverts, 221, 222

Drags (Road drags) 571

Drainage

- Bridges (Small span) 180-334, 1004-1088, 1150, 1334, 1492-1678
- Catch basins, 687, 689
- Culverts, 180-334, 1004-1088, 1150-1334
- Curb inlet basins, 600
- Ditch relief culverts, 182
- Ditches, 142, 334
- Driveway culverts, 338
- Low water culverts, 197
- Manholes, 695
- Special conditions, 196
- Storm water sewers, 337, 669, 1149
- Survey notes, 885, 911
- Underdrains, 338

(*see also* Culverts and bridges)

Drains

- Bridge floor, 252, 291
- Under drains, 338, 1156

Drives

- Radii of $\frac{1}{2}$, 121

Driveway Culverts (*see* Culverts) 338

Drop Inlets, 680-690

Drowning (First aid), 1713

Ductility (Test), 729

Durability of Bridges, 1231

Durability of Pavements (*see* Life of pavements)

- Flexible base pavements, 531, 520
 - Rigid Base pavements, 535, 520
- (*see also* Any desired type)

Durax Cube Pavement

- General description, 516

Dust Layers

- (*see* Bitumens)
- (*see* Calcium chloride)

Dustless Screenings

- Use of, 446, 1458
- Size, 446, 1384, 1178
- Weight, 447, 1159

Earth

- Bearing power of bridges, 208, 1051, 1337
- Pavements, 374
- Shrinkage of, 995
- Weight of, 1038
- Pressure against walls, 1043

Earth Excavation

- Computation of, 971-993

Earth Excavation

- Inspection, 1238
- Slopes, different soils, 145
- Specifications, 1481
- Tables of amounts and volumes.

972 " " " mountainroads,

786

- Ratio excavation to fills (Shrinkage), 995

Earth Roads

- Construction, 1288, 1444
- Cost, general comparative, 5, 344
- Crowns, 146, 160, 166, 159, 950, 955
- Description, 344
- Examples of current practice, 146, 159, 160, 166, 345, 955
- Limitations of use, 344
- Maintenance, 347, 571
- Specifications, 1444
- Typical sections, 146, 159, 160, 166, 345, 955
- Yearly cost of upkeep, general, comparative, 347

Economics (General highway)

- Administrative, 1-52
- Engineering design, 52-73
- Alignment, 56, 113-121
- Grades, 56, 83-113, 963
- Pavements, 58-73
- Reconstruction, 579

Financing

- Bond terms, 19

Economic Value of Highways, 3-17

Economy in Design (Details)

- Alignment (Effect on construction cost), 119
- Drainage (Economic types of bridge and culverts), 205-213, 1005
- Grades (Effect on construction cost) Adverse, 110
- Intermediate, 106
- Maximum, 103
- Minimum, 109
- Vertical curves, 110
- Grading widths (Effects on construction cost), 143, 161
- Location (Effects on construction cost), 74
- Materials (Proper use of), 60
- Pavement type, 59
- " width, 59

Economy in Design (General)

- Desirability of, 53, 747
- Field for, 54, 747
- General principles of, 52-73, 747
- Limitations of, 1
- Methods, 52-73, 747, 943
- Necessity for, 53
- Tests of design, 55
- Value of, 50, 943
- Edging, Concrete, 492, 1211
- Elasticity, Modulus of, 1033
- Electric Railroad (*see* Railroad)
- Electric Shock (First aid), 1716
- Electric Trolley Track Practice
- Typical sections, 175, 154

INDEX

- Elimination of Railroad Grade Crossings** (*see* Railroad grade crossings)
- Embankments** (*see* Excavation)
- Consolidation of, 995, 1288
- Effect on pavement depths, 374-377, 391, 959, 960
- Inspection of construction, 1288
- Materials suitable for, 1289
- Ratio cut to fill, 995
- Settlement of (Shrinkage), 995
- Stable slopes, 145
- Specifications, 1421
- Emulsified Bitumen**
- Cold patch, 558, 1395
- Encroachment of Rigs on Sharp Curves**
- Effect of banked curves, 124
- " " length of wheel base, 116
- Engineering** (General)
- Cost of, 747
- Value of, 50, 747, 943
- Engineering Design** (*see* Design)
- Equipment**
- Contractors, 1243-1264
- Office, 1103
- Survey
- Camp, 894-904
- Instruments, 782, 818, 831, 938
- Errors** (Allowable limit of) (*see* Accuracy)
- Estimates**
- Computation and tabulation of, 1087, 1112
- Cost (*see* Costs)
- Forms for (Detail quantities), 1115
- " " " costs, 1128-1158
- General program
- Construction, 20, 65
- Maintenance, 519
- Evaporation Test**, 725, 729
- Excavation** (*see* Earth and rock excavation)
- Amounts required (General comparative), 786
- Cost of, 661, 768, 1126, 1156, 1228
- Cut and fill profile design, 83, 103, 963
- Side hill balanced sections, 104, 162, 787
- Effect of alignment, 119
- " " grading width, 143, 161, 786
- " " intermediate grades, 963
- " " maximum grades, 103
- " " slopes, 145, 787
- Inspection, 1288
- Shrinkage in fill, 995
- Slopes (Stable), 145
- Slope stakes, 1272
- Staking out, 1272
- Expanded Metal**
- Specifications, 1413
- Weights and dimensions, 1080
- Expansion**
- Coefficient of
- Concrete, 498, 1058
- Steel, 498, 1053
- Expansion Joints**
- At curbs, 512
- Brick pavements, 512
- Bridges, 275, 292
- Concrete pavements, 472
- Stone block, 515
- Retaining walls, 677
- Externals**
- Of 1° curve (Table), 858
- Eye Injuries**, 1699
- Failures** (Common causes)
- Asphalt block pavement, 428
- Asphalt pavement, 428
- Bituminous macadam, 428
- Brick pavement, 428
- Concrete pavement (Hassam), 428
- Concrete pavement (Standard), 428
- Stone block pavement, 428
- Waterbound macadam, 428
- Failures** (Pavements)
- Common causes, 428,
- General " " 41, 366-370
- Falsework** (*see* Forms)
- Fees** (Auto license)
- Amounts required, 17-26
- Proper use of, 4, 17, 72
- Tax burden distribution, 17, 72
- Fences**
- Cattle guards, 699
- Guard, 976, 1156, 1216, 1489
- Property line, 700
- Roadway, 700
- Snow, 700
- Fillers**
- Bituminous for block pavements, 506-513, 1334, 1401
- Cost data (*see* Cost data index)
- Grout (*see* Grout)
- Macadam roads (Screenings and sand), 715, 1168
- Fills** (Embankments)
- Consolidation of, 1288, 995, 1421
- Effect on pavement depths, 374-377, 391, 959
- Inspection of construction, 1288
- Materials suitable, 1289, 1421
- Ratio cut to fill, 995
- Settlement of (Shrinkage), 995
- Slope stakes, 1272
- Slopes (Angle of repose), 145
- Specifications, 1421
- Stable slopes, 145
- Widths, 133, 146-159, 164, 951-955
- See also* Excavation
- Fill Sections**
- Examples, 146-161, 166-171, 951
- Financing** (Highway improvements)
- Bonds
- Cost of
- Total, 19-26
- Yearly, 19-26
- Serial bonds, 19

INDEX

- Financing** (Highway improvements),
Bonds
 Sinking fund, 19
 Yearly retirement amounts,
 19-26
 Contractors bonds, 1238
 Construction, 19
 Effects of methods of financing
 on design, 4, 16, 17
 General policy, 19
 Maintenance, 19
 "Pay as you go," 19
 Railroad crossing protection, 601
 Reconstruction, 19
 Tax burden distribution (General),
 17
- Fineness Modulus** (Concrete aggregate), 479-484
- Finishing Concrete**
 Concrete culverts and bridges,
 1277, 1531
 " pavement, 1506
 Cost of, 1152, 1145
 Methods, 1531, 1306
 Specifications, 1631, 1473
- First Aid** (Accidents), 1699-1718
- Flash Point** (Test), 727
- Flexure** (Formulae for), 1028
- Flood Flow in Streams**
 Quantity, 186, 1022
 Velocity, 195
 Scour, 211, 335
- Floors** (Bridge)
 Depth of, 206, 1025
 Distribution of loads on, 1042,
 1549
 Examples of, 237-310, 779
 Loading, 200, 1038-1042, 1547
 Repair of, 779
 Specifications, 1663
 Surfacing, 210, 1663
- Flow of Water**
 Capacity of channels, 195
 " " ditches, 334
 " " pipe culverts, 194
 " " sewers, 337
 Velocity of flow
 Normal in channels, 195, 335
 " " pipes, 194
 Minimum permissible
 culverts, 196
 sewers, 338
 Scour velocities, 335
- Foot** (Decimals of, in inches), 1574
- Footing** (Safe for horses or autos)
See also Each type of pavement
 Limitations of different pavements,
 101, 105, 425, 428, 962
- Fords**, 211
- Forms** (for Concrete)
Concrete Masonry
 Cost of, 1151, 1226
 Design data, 1052, 1026
 Examples of, 1346-1353
 Removal (Time of), 1275, 1347
 Specifications
 Bridges, 1518
 Pavements, 1470
- Forms** (for Concrete)
 Concrete Roads
 Setting (String lining), 1301
 Type of, 1470
- Formulae** (*see also* Operation desired)
 Areas, 1576
 Centers of gravity, 1031
 Centrifugal force (Superelevation),
 124
 Curves
 Encroachment of rear wheels,
 116
 Horizontal, 854
 Vertical, 966
 Design of pavements
 Flexible base pavements, 381-
 387
 Rigid base pavements, 392-427
 Distribution of loads
 Base of abutments, 1045
 Floor loads, 1042
 Flexure of beams (Moments and
 deflections), 1028
 Inertia (Moments of), 1030
 Safe loads on piles, 1340
 Stadia measurements, 932
 Stream runoff, 1021
 Trigonometric, 1578
 Volumes, 1576
 Vertical curves, 966
- Foundations**
 Bridges and culverts (*see* Bridges)
 Pavements (*see* Pavement
 desired)
 Depths required
 Gravel, 390, 959
 Macadam, 390, 959
 Rigid pavements, 426, 960
 Discussion of, 366-426, 407, 506
 Types of, 429-438, 497, 506
- Fracture** (Crushed stone), 707
- French Coefficient of Abrasion**, 706
- Frictional Resistance to Movement**
 Masonry on foundations, 1052
 Wagons, 87
- Frost** (Effect on design), 367
- Functions**
 Trigonometric, logarithmic, 1653
 " , natural, 1595
- Gasoline**
 Consumption per ton mile, 96-
 101, 549
 Tax, 19
 Yearly consumption (Average
 vehicle), 18
- Gauges** (Wire and steel), 1054
- Geological Classification of Rocks**,
 708, 712, 713
- Girder Bridges** (*see also* Bridges)
 Cost, 312, 759-763, 1151
 Examples of, 251, 290
 Quantities, 313, 311, 769-763
 Suitability (Limits), 209, 1005
 Types
 Reinforced concrete, 209, 251
 Steel, 209, 290
 Weights of, 311, 313, 769-763
 Glutrin (Sulphite liquor), 1408

INDEX

- Grade Crossings** (*see* Railroad grade crossing)
- Grades**
Adverse grades, 110
Intermediate grades, 106-109
 Controlling points, 106, 963
 Economic Design
 Effect on construction cost, 106, 963
 " " horse traffic, 106
 " " motor traffic, 106
 Method of laying, 963
 "Rolling" grades, 107, 963
 Examples of, 108, 963
 Limits of use, 56, 107, 963
 Reduction of, 6, 8, 56
 Principles of location, 82
Maximum Grades, 84-106
 Current practice, 102
 Economic design
 Effect on construction cost, 103
 " " horse traffic, 84, 86
 " " motor traffic 84
 Recommended practice, 6, 8, 104, 105, 940
 Effect of alignment (compensation), 6, 8, 117, 118
 " " length of grade, 86-93
 " " safety of traffic, 101, 962
 " " team footing, 101, 962
 " " on type of pavement surface, 101-102, 425, 962
 Principles of location, 82
Minimum Grades, 6, 8, 109
Rolling grades (*see* Intermediate grades)
Street grades, 106
Vertical Curves
 Effect on construction cost, 109, 111
 " " slight distance, 110-112, 634
 Formulae for, 964
 Minimum lengths, 110-112, 634, 964
 Use of (Proper and limits of), 110-112, 634, 964
- Grading**
 Amount required (General comparative), 788
 Cost data, 661, 785-789, 796, 1126, 1158
 Economical design, 54, 963
 Effect on construction cost, 54, 107-109
 Inspection, 1288
 Ratio cut to fill (Shrinkage), 995
 Sections, 146-171, 951
 Slopes (Stable), 145
 Specifications, 1421, 1444
 Width of, 135-171, 951
 (*see also* Excavation)
- Grates** (Catch basin)
 Cost of, 662
 Examples of, 689, 690
- Gravel**
Amounts required
 Concrete, 466, 495, 1098
 Pavements, 431, 356, 1134, 1139
 Production of gravel
 Cost, 1131
 Sizes and weights, 1182
 Sampling, 753
 Sizes
 Concrete, 456, 740, 1385
 Pavements, 355, 432, 1385
Specifications, 1385
Suitability
 Concrete, 456, 740, 1385
 Pavements, 456, 740, 1385
Tests, 740-745
 Abrasion, 742
 Shale content, 742
 Voids, 741
 Weight, 741, 1182
 Use of
 Concrete, 740, 1385
 Pavements (*see* Pavement desired), 353, 430-432, 456, 494
Gravel Bottom Course
 Cost, 354, 430-432, 662, 765-769, 1134
 Depth, 389-391, 959
 Design, 389-391, 430-432
 Inspection, 1291
 Materials
 Amounts, 353-356, 430-433, 1134, 1139
 Suitability, 353-356, 430-433, 1385
 Specifications, 1385, 1430
Gravel Roads
 Cost of, 5, 352, 1134, 1139
 Discussion, 352
 Economic use, 352
 Failures, 355
 Maintenance, 575
 Materials
 Amounts required, 355, 1134, 1139
 Quality, 355, 1385
 Sizes, 355, 1385
 Mileage in use, 42, 353
 Rhythmic corrugations, 358
 Specifications, 1430
 Suitability of (General), 6-9, 353
 Typical sections, 147, 159, 353, 354
Gravity
 Center of, 1081
 Specific (Weights), 709
 Tests, 741
Grout
 Amount required, 511
 Application of, 1338
 Inspection, 1333
 Mix, 511
 Sand suitable for, 511, 1387
 Specifications, 1478
 Grubbing (*see* Clearing)

INDEX

Guard Rail

- Costs, 662, 1216, 1156, 1222
- Description and Specifications
 - Cable, 676-681, 1489
 - Concrete, 676-681
 - Posts, 680, 1489
 - Wall, 682
 - Wooden, 676, 1489
- Examples of, 676-681
- Use of, 7, 9, 676

Guide Signs, 7, 9, 611, 687-696, 1491

Guide Rail (see Guard rail)

Gutters

- Brick, 335, 681-688
- Cobble, 335, 681-688, 1156, 1217
- Concrete, 335, 681-688, 1156, 1217
- Lime stone, 335, 681-688

Hardness

- Test for, 706
- Values (Common rocks), 709-712

Hassam Concrete Pavement

- Amount of materials required, 1191
- Cost data, 1191

Haul

- Computation of length, 1128
- Overhaul
 - Cost of, 661, 768, 1127
 - Mass diagram, 996

Hauling

- Average length computation of, 1128
- Horse traffic
 - Cost of, 1128, 1162
 - Loads on different grades, 90-91
- Motor traffic
 - Cost of, 1128, 1163
 - Effect of alignment, 118
 - " " distance, 80
 - " " grade, 96
 - " " rise and fall, 99-101
 - Suitable conditions for different types of motor, 26, 1163

Hauling Power

- Horses, 86, 117
- Trucks, 94-96

Heel Pressure (Foundations)

- Formulae for, 1045
- Example of computations, 1047

Highway Bonds (see Bonds)

Highways (General)

- Administrative data, 1-73
- Capacity of (Traffic volume), 28, 633, 1008
- Classification of, 6-9, 46
- Costs (General comparative), 5, 7, 9, 10, 16, 65
- Economic design of, 52-73, 747
- Utility requirements, 4-10
- Volume of traffic on (Capacity), 28
- Value of roads, (3-16)
 - Direct, 10
 - Indirect, 4

Holes (Repair of macadam pavements), 557

Horse Traffic

- Effect on design
 - Alignment, 117
 - Grades, 84-93, 101
 - Pavement surface, 101, 102, 425, 962
- Loads drawn, 90-93
- Volume of, 26, 84
- Hydraulic Radius, 195

I Beams (Steel)

- Properties and dimensions, 1062
- Strength of, 1062
- Weights of, 1062

I Beam Stringer Bridges (Steel)

- Cost, 310, 315, 316, 661, 759, 1150, 1229
- Design, 180-211, 1004-1085
- Economic use, 205-209, 1006
- Examples of, 265-289
- Quantities, 265-289, 760
- Suitability, 205-209, 1005

Ice Clearance (Bridges), 186, 1026

Igneous Rocks, 708, 712

Illumination

- Advantages, 699-704
- Cost, 699-704
- Methods, 699-704
- Limitation of use, 7, 9, 699-704

Impact Allowance for

- Bridges, 202, 1040
- Pavements, 370-374, 551

Inches as Decimals of Feet, 1574

Inertia, Moments of

- Plane figures, 1030
- Steel I beams, 1062

Injuries (First aid), 1699

Inlets (Drop), 337, 689-690

Inspection of Construction

- Bridges and culverts, 1273-1287, 1334-1370
- Grading, 1288
- Pavements
 - Asphaltic concretes, 1313
 - Boulder bases, 1291
 - Brick, 1330
 - Cement concrete, 1299
 - Gravel (Consolidation of), 1295
 - Macadam foundations, 1293
 - Penetration bituminous macadam, 1296
 - Waterbound macadam top, 1295
- Value of, 1271

Instruments

- Adjustment, 852
- Equipment list
- Preliminary investigations, 782, 819
- Surveys, 831, 294
- Reconnaissance surveys, 817, 819

Insurance (Contractors), 1238-1242

Intercepting Ditches, 165, 334, 962

Interest

- On pavement investment, 7-9, 65
- On plant and payroll, 1231-1267
- On bonds, 24

INDEX

- Intermediate Grades** (*see* Grades), 106
- Intersecting Roads**
Radii of $\frac{L}{2}$, 121
- Investigations** (Preliminary)
Cost, 749
Equipment, 782, 817, 819
Methods, 747-829
Sample reports, 770-781, 807-816, 642
Sampling materials, 752
Traffic, 750
- Iron** (*see* Cast and wrought iron)
- Joints**
Bridge construction, 276, 291, 292
Contraction (Pavements), 473, 512
Distribution of load at (Pavements), 406.
Expansion (pavements), 472, 512
Key joints, 284, 684
Longitudinal (Pavement), 473
- Joists** (Bridge floors)
Distribution of life loads, 1042
Examples of size and spacing, 265-283, 294-309
Impact, allowance, 202, 1040
Safe loads steel joists, 1061
Safe loads timber stringers, 1076
- Kentucky Rock Asphalt**
Cost data, 1183
- King Post Truss**
Example of, 301
Materials required, 301
- Klienpflaster Cube Pavement**
Description, 516
- Land Taking** (Right of ways)
Areas (Computation of), 1093
Cost (Damages), 1156
Maps, 842
Surveys, 840
See also Right-of-way
- Latitude**, Determination of, 929
- Leaching Basins**, 689
- Level Adjustments of**, 852
- Leveling**
Accuracy required, 833, 906, 909, 942
Methods, 833, 906, 909
Notes, 833, 906, 909
See also Surveys
- Liability Insurance**, 1238-1242
- Life of Bridges**, 1231
- Life of Equipment**
Camp, 902
Contractors, 1243-1264
Survey, 894
- Life of Pavements**
Flexible pavements, 65, 531
Rigid " " 65, 535
- Lighting** (*see* Illumination), 699
- Linear Measure**, Units of, 1573
- Loads or Loading**
Bridge Abutments, 1046
Bridge Superstructures
Dead loads, 199, 1038, 1547
Distribution, 203, 1042, 1548
- Loads or Loading, Bridge Superstructures**
Live loads, 6, 8, 200, 1039, 1042, 1547
Impact " " , 202, 1040
- Foundations**
Piles
Actual safe loads
Formulae for, 1338
Tests for, 1338
Design loads, 208, 1051
Distribution of pressure, 1045
- Soils**
Bridge foundations, 208, 1051, 1337
Pavement " " , 374
Pavements (Design loads), 370-374
- Safe loads**
Beams and slabs, 1072
Columns, 1078, 1035
Steel I beams, 1062
Team loads, 86-93
Wheel loads (Concentrated)
Automobile trucks, 370, 1039
Military loads, 202
Regulation of loads, 28, 370
- Loam** (Test for), 737, 738
- Location of Bridges and Culverts**, 181
- Location of Highways**
Discussion, 74
Summarized principles, 81
Methods, 782
- Location of Signs and Signals**
Automatic signals, 606, 609, 621
Danger signs, 612, 687
- Logarithms**
Numbers (Table of), 1628
Trigometric functions (Table of), 1653
- Log Culverts**
Examples of, 214
Specifications, 1414, 1492
- Logs**
Amount of lumber in, 798
- Lumber**
Specifications, 1414, 1492
- McClintock Cube Pavement**
Cost data, 1184
Description, 516
- Macadam**
See Macadam bottom courses
" Bituminous macadam
" Waterbound "
- Macadam Bottom Course**
Cost, 429-438, 662, 769, 1134, 1167
Depth, 389-391, 969
Design, 389-391, 429-438
Inspection, 1203
Materials
Amounts, 429-438, 441, 1134, 1168
Suitability, 429-438, 441, 1333
Specifications, 1333, 1434
- Machinery** (Contractor's), 1243-1264
- Magnetic Declination**, 799-806

INDEX

- Maintenance of Bridges**
 Cost of
 Floors, 1231
 Painting, 210, 1231-1237
- Maintenance of Highways** (*see also*
 Each type of pavement), 519-
 578)
- Cost
 General, 520-545
 Detail, 520-545, 1218
 Per vehicle mile, 18, 522
- Economic limits, 552, 347
- Equipment, 552-556
- Estimates
 Legislative tax program, 519
 Yearly budget, 540
- Importance of, 519, 48
- Materials and methods
 Bituminous concrete, 564
 Block pavements, 569
 Cement concrete, 565
 Earth, 571
 Gravel, 575
 Macadams, 557-564
 Sand clay, 575
- Organization units, 552-556
- Smoothness (Value of), 545
- Snow removal, 570
- Manholes**, 605
- Maps** (Plans)
 Cost, 747, 845
 Examples of
 Bridges, 1008
 Roads, 1105
 Preparation of, 1105
- Scales, 944
- Masonry**
 Refacing, 677, 685
 Repointing, 677, 685
 Retaining walls, 676, 682
 (*See Concrete*)
 (*See Stone masonry*)
- Mass Diagram**, 997
- Materials** (General data), (705-746)
 Amounts required (*see Respective*
 material)
 Economic use of, 60, 437, 389
 Local, effect on design, 60, 437,
 389
 Location of, 839, 750
 Properties, 705-746
 Reports on location and amount,
 766
 Sampling, 752, 743
 Specifications (*see Specifications*)
 Strength of, 1033
 Tests (*see Tests of materials*), 705-
 746
 Weight of, 709, 1038
- Materials** (Cost of handling),
 1159-1189
- Materials** (Cost of production)
 Crushed stone, 1150
 Gravel, 1151
- Maximum Grades** (*see Grades*)
- Measure** (Units of)
 Area, 1573
 Linear, 1573
 Volumes, 1573
- Measure** (Units of)
 Temperature, 1573
 Weights, 1573
- Medical Notes**
 Accidents (First aid), 1699
 Bleeding, 1702
 Electric shock, 1716
 Drowning, 1713
 Poisoning, 1718
 Sunstroke, 1721
- Melting Point** (Test), 732
- Meridian Determination** (True
 north)
 Magnetic variation, 799-808
 Polaris meridian, 912-927
 Solar meridian, 927-932
- Meridiograph**, 932
- Mesh Reinforcement** (*see Reinforce*
 ment)
 Dimensions and weights, 1056-
 1060
 Specifications, 1412
 Gages of wire, 1054
- Metalling** (Pavements)
 Thickness required, 391, 426, 959,
 969
 Widths of, 6-9, 130, 633, 958
- Military Wheel Loads**, 202
- Minimum Grades** (*see Grades*)
 Bituminous concrete, 1326
 Cement concrete, 462, 1276,
 1471, 1512
 Effect on strength, 475, 486
- Minimum Radii for Curves**
 High type improvements, 120
 634, 950
 Mountain conditions, 121, 950
 Drives, 121, 634
 Intersections, 121, 634, 681
 Curbs, 681
- Mirror Danger Signs**, 698
- Mixing** (Time of)
- Modulus of Elasticity** (Materials)
 1033
- Modulus of Rupture**
 Brick, 423, 510
 Concrete, 397-403
- Moisture Content of Soils**, 375
- Moments** (Beam strength)
 Bending, 1028
 Inertia, 1030
 Resisting, 1029
- Monuments** (Property line), 694
- Mortars**
 Cushion, 506-513, 1476, 1531
 Grout, 506-513, 1476, 1533
- Materials**
 Amounts required, 1093, 1146
 Suitability, 1386
- Motor Busses** (*see also Automob*
 iles)
 Effect on bridge width, 203
 Effect on pavement width, 130
 Cost of operation, 11, 99
- Motor Traffic** (*see Automobiles*)
- Motor Trucks** (*see also Automobiles*)
 Cost of operation, 11, 98, 1163)
 Power on grades, 94, 96
 Regulation of loads, 28, 370

INDEX

- Motor Trucks** (*see also* Automobiles)
 Typical bridge loading, 200, 1039, 1647
 Dimensions, 200, 130, 1039, 1647
- Mountain Roads**
 Alignment, 117-121, 950
 Crowns, 160, 960
 Grades, 105, 949
 Office practice, 1108
 Preliminary investigations, 781
 Right of way, 177
 Sections, 160-171, 786
 Surveys, 898
- Mud Sills** (*see* Forms)
- Natural Cement**, 734
- Natural Trigonometric Functions**
 Cosines, 1604
 Cosecants, 1616
 Cotangents, 1593
 Sines, 1604
 Secants, 1616
 Tangents, 1593
- North, Magnetic** (*see* Magnetic declination)
- North, True** (*see* Meridian)
- Office Work** (Design)
 Accuracy required (*see* Accuracy)
 Cost of, 747, 1104
 Methods, 948-1116
 Speed of, 1104
 Supplies, 1103
 Instructions, 1103
- Oil and Bitumens** (*see also* Bitumens)
 Cost (*see* Pavement desired)
 Quality required (*see* Pavement desired)
 Quantities (*see* Pavement desired)
 Specifications, 1388
 Uses of, 720
 Properties of, 720
- Oiling** (Surface application of)
 Cost
 Detail, 1220
 General, 562
 Materials
 Amounts required, 561, 1220
 Suitability of, 561, 1388
 Specifications, 1388
 Methods
 Discussion, 561
 Specifications, 1456
- Operation of Motor Vehicles** (*see also* Automobiles)
 Cost of
 Effect of alignment, 118
 " " grade, 12, 93
 " " pavement surface, 11, 61-68, 550
- Ordinance Loads** (Military), 202
- Organic Impurities**
 Test for in concrete aggregates, 738
- Organization**
 General, 49
 Construction, 1271
 Duties and authority of engineers, 1271
 Maintenance, 552
- Organization**
 Survey, 831, 893
 Office design, 1105
- Ottawa Sand**, 1387, 460
- Overhaul**
 Computation of, 996
 Cost of, 661, 765-769, 1127
 Specifications, 1423
- Overhead Charges** (Contract)
 Bonds, 1238
 Depreciation, 1243-1264
 Insurance, 1238
 Interest, 1231
 Liability, 1238
- Painting**
 Bridges, 210, 1231
 Guard rail, 1216
- Paints**
 Specifications, 1416
 Amounts required
 Bridge steel, 1231-1237
 Guard Rail, 1216
 Flat surfaces, 1231
- Parabolic Crowns**
 Ordinates for, 173, 504, 956
 Proper use, 175
- Paraffin** (Maximum limit), 722
- Parapets** (Bridge)
 Discussion, 211, 1005
 Examples of, 237-276
- Patrol Maintenance**
 Cost of, 1225
 Equipment, 552-556
 Length of, 552-556
- Pavements** (Detail data)
 (*See* Type of pavement desired)
 Amiesite
 Asphalt, block
 Asphalt, Kentucky Rock
 Asphalt, sheet
 Bituminous macadam
 Brick
 Concrete, standard
 Durax
 Gravel
 Klempflaster
 McClintock cubes
 Sand clay
 Stone block
 Waterbound macadam
 Wood block
- Pavements** (General)
 Cost
 Construction, 65, 16
 Maintenance, 65, 519-544
 Renewal, 65
 Depth of
 Gravel, 391, 959
 Macadam, 391, 959
 Rigid pavements, 426, 960
 Sand-clay, 347
 Design of
 Economic, 1-73, 747
 Engineering principles, 52-73, 366-320
 Failures (Common cause), 428
 Life of (Average), 531-535, 65

INDEX

- Pavements (General)**
 Limitations of use
 Economic, 7, 9, 40-48
 Grades, 101, 425, 969
 Types in use and mileage of, 7, 9, 42
 Suitability of types, 6-9, 40-48, 58, 962
 Widths required, 6, 8, 130, 203, 634, 958
- Pavement Markings**
 Central traffic lane marks, 7, 9, 698
 Railroad crossing warnings, 606-613
- Paving Pitch**
 Expansion joints, 511, 1401
 Mastic filler, 507-512, 1401
- Payroll (Amounts required) 1231-1234**
- Pedestrian Traffic**
 Bridges, 633, 1006
 Highways, 177
 Streets, 174-175
- Penetration (Test), 724, 728**
- Petroleum**
 Properties, 720-734
 Use in road work, 720-734
- Photographic Data, 818**
- Pictures (Notes on photography), 818**
- Piers**
 Design of (*see* Bridges)
 Examples of, 322
 Depth of foundations, 1051
- Piles**
 Actual safe loads (Formulae for), 1338
 " " " Tests, 1338
 Batter piles, 1343
 Caps, 1365
 Concrete (*see* Concrete Piles)
 Cost, 661, 1150, 1228
 Design loads, 208, 1051
 Inspection of, 1338
 Points, 1364
 Refusal of, 208, 1339
 Spacing, 208, 1051
 Specifications, 1501
 Splices, 1363
 Test piles, 1338
 Types of (Proper use), 207
- Pile Trestles (Examples of)**
 Concrete, 308
 Timber, 303
- Pioneer Roads**
 Alignment, 950
 Clearing, 177, 796
 Crowns, 160-171, 960
 Grades, 949
 Office work, 1102
 Pavements, 53, 6
 Preliminary investigations, 781
 Right of way, 177, 796
 Sections, 160-171, 781
 Surveys for, 882
- Pipe Culverts (*see also* Type of culvert desired)**
 Cost of, 1148
- Pipe Culverts (*see also* Type of culvert desired)**
 Design (*see* Culverts), 180-236
 Discharge capacity, 194
 Examples of
 Cast iron pipe, 219, 1079
 Concrete pipe, 218, 1083
 Corrugated metal, 215, 338, 1080
 Vitrified tile, 217, 1084
 Use of
 Economic, 212, 338
 Limitations, 196, 212
 Specifications, 1408, 1566
- Pipe Lines for Concrete Roads**
 Size of, 1250
 Loss of head in, 1250
- Pipe Rail (Bridge), 676**
- Pipes**
 Capacity of, 194, 337
 Cost of, 213, 661, 669, 765-769, 1148, 797
 Dimensions and weights
 Cast iron, 1079
 Corrugated metal, 215, 1080
 Reinforced concrete, 218, 1083
 Vitrified, 217, 1084
 Specifications
 Cast iron, 1409
 Corrugated metal, 1409, 1568
 Reinforced concrete, 1410
 Vitrified, 1412, 1571
- Pipe Underdrains (*see* Underdrains), 338, 1408**
- Pitch (*see* Paving pitch)**
- Planimeter (Use of)**
 Accuracy, 969
 Methods, 969, 1110
- Plans, 943-1115**
 Alternate plans (Value of), 747, 943
 Cost bridge, 747, 775, 1004
 " highway, 747, 1104
 Examples of
 Bridge, 779, 1006
 Highway, 1100
 Office procedure
 Alignment, 944, 1105
 Ditches, 1106
 Grades, 947
 Location, 1105
 Widths
 Grading, 951
 Pavements, 958
 Standardization (Danger of), 747
 Tests of (General), 55
 Record plans, 1100
- Plants (Contractor's), 1243**
- Plates (Steel)**
 Weights, 1068
- Pointing Masonry, 677**
- Poisons (First aid), 1718**
- Polaris Meridian, 912-927**
- Policy (General)**
 Administrative, 1-73
 Economics of, 1-73
 Progressive improvement, 2, 386
 Tax method (Effect on policy), 4, 17

INDEX

- Policy (General)**
 Summary of general principles, 72
- Portal Clearances (Bridges),** 203, 633, 1548
- Portland Cement**
 Amounts required in concrete, 466, 495, 1098
 " grouting, 511, 1146, 1213
 Cost of handling, 1139, 1145, 1161
 Effect on strength of concrete, 485, 489
 Properties, 734
 Specifications, 735, 1387
 Tests, 735
 Weight, 1038
- Posts (see Columns)**
- Posts**
 Guide rail, 676-681, 1156, 1490
 Signs, 696, 1491
- Preliminary Investigations**
 Cost, 749
 Equipment, 782
 Methods, 747-829
- Quick estimating diagrams**
 Bridges, 310-322, 648-675
 Culverts, 213, 675
 Grading, 648, 786
 Pavements, 65, 661
- Sample reports**
 Bridges, 327, 774
 Pavements, 770, 807
 Ry. grade crossings 642, 775
- Sampling material,** 752
- Traffic volume,** 28, 750
- Pressure (General)**
 Concrete against forms, 1026
 Earth against walls, 1043
- Pressure on Bridge Foundations**
 Distribution of, 1045
 Safe loads, 208, 1061
 Diagrams of, 1027, 1046, 1010
- Pressure on Pavements**
 Distribution of
 Macadam, 378
 Joints in rigid pavements, 405
 Soil (Resistance of), 374
 Wheel loads
 Impact, 372
 Static, 370-374
- Profile (Design)**
 Economic principles of, 56, 83, 963
- Grades**
 Adverse, 110
 Intermediate, 106-109, 963
 Maximum, 83-106, 949
 Minimum, 109
 "Rolling," 106-109, 963
- Vertical curves**
 Formulae for, 966
 Minimum length, 110-112, 966
 Sight distance, 110-112, 966
- Reconstruction grade lines,** 964
- Scales,** 944
- Methods**
 Plotting and accuracy, 947, 1108
- Profit (Reasonable contract),** 1119
- Progressive Improvement Highways**
 2, 586
- Property Damage**
 Cost, 1156
- Proportion in Design (see Design),** 52
- Protection of Concrete**
 Freezing, 1310, 1629
 Rain, 1309
 Salt water, 1362, 1530
 Sun heat, 1309, 1531
 Wind, 1309, 1531
- Puddling Macadam Roads**
 Amount of water required, 441, 1172
 Cost data, 1140, 1171
 Specifications, 1454
- Pumping**
 Equipment, 1250
 Size of pipe lines, 1250
 Loss of head, 1250
- Quantities of Materials**
- Pavements**
 Amiesite, 497, 1180
 Bituminous concretes, 495, 1138, 1142
 " macadam, 446, 1142
 Brick, 511
 Cement concrete, 461, 1145, 1138
 Foundation courses
 Boulder base, 430, 441, 1133
 Concrete, 495, 1138
 Gravel, 429-436, 441, 1134
 Macadam, 429-436, 441, 1134
 Gravel pavements, 356, 430, 441, 1134
 Waterbound macadam, 441, 1140
- Structures**
 Concrete aggregates
 " in bridges, 237-327, 1092
 " in culverts, 214-237, 1092
 Reinforcement in bridges, 214-327
 Steel " " , 214-327
 Water in concrete, 461, 1092
- Quantity Estimates (Tables of)**
 Bitumen, 1090
 Sq. yds. pavement, 1089
 Cubic yds. " , 1089
- Radii of Curves**
 (Table for survey purposes), 855
- Radii of Curves (see also Curves and alignment)**
 Effect on cost of construction, 110
 " " " motor operation, 118
 " " crown, 124, 956
 " " encroachment of rear wheels, 116
 " " grade, 117, 118, 634
 " " safety of travel, 114-121, 634

INDEX

- Radii of Curves** (*see also* Curves and alignment)
 Effect on shape of section, 124, 955
 " " sight distance, 114
 " " width of pavement, 130, 958
 " " " " right of way, 177
 " " " " section, 130
 Minimum for safety, 121, 634, 950
 Recommended practice, 121, 634, 950
 Switch back turns, 121, 950
 Table of values for surveys, 855
 Vertical curves for plotting profiles, 110
- Railing** (Guard)
 Bridge, pipe rail, 676, 1158, 1005
 Examples of current practice, 676-681
 Parapets, solid, 211, 682, 1005
 Specifications, 1489
- Railroad** (Stream and electric—general data)
 Clearances, 633-643
 Loads, 634, 1548
 Roadbed sections, 643
 Track (*see* Tracks)
- Railroad Grade Crossings**
Accidents at
 Causes of, 606
 Number of, 34, 601
 Prevention of, 599-641
 Probability of (Danger index), 623
Eliminations of
 Cost estimate diagrams, 600, 648-675
 Financing, 26, 601
 Importance of
 General relative, 599
 Special projects, 625
Methods
 Bridges (Grade separations), 7, 9, 625-675
 Road relocations, 630-632
 Plans (Examples of), 635-642
 Record maps, 1100
 Reports on typical cases, 603, 605, 642, 775
 Specifications (General), 633
Protection at grade Xings
 Cost of, 599
 Economic limits, 602
 Financing, 601
 Importance of, 7, 9, 599
Methods
 Plans, 604
 Reports, 604, 605
 Signs, 610
 Signals, 610-623
 Specifications (General), 609
 Stop orders, 600
 Watchmen and gates, 612
- Railway Track Standard**, 643
Rainfall, 187
Range of Traffic
 Length of trips (Census data), 38
- Rattler Test**
 Brick, 716
 Deval stone test, 706
- Reconstruction of Highways**, (579-598)
 Administrative policy, 579
 Costs (General comparative), 65
 Effect on original design, 369
 Engineering design, 586
 Grade line design, 964
 Legislative estimates, 519
 Typical cases
 Change of type, 587-598
 Resurfacing, 587-598
 Strengthening, 587-598
 Widening, 587-598
 Typical cross sections, 579-598, 955
- Records**
 Construction (Daily reports)
 Bituminous concrete, 1323
 Cement concrete, 1311
 Macadam, 1299
 Maps (General records), 1100
 Office (" "), 1100
- Referencing Transit Hubs**, 852, 905
- Reflectors**, 698
 (Warning signs)
- Refraction** (Effect on observed altitude), 928
- Regulation of Traffic**
 Loads, 28, 370
 Speeds, 28, 37, 371
 Stop orders, 609
 Widths of vehicles, 130
- Reinforced Concrete Pipe**
 Capacity of, 194, 337, 1083
 Cost, 213, 1148
 Culverts, 218
 Dimensions, 218, 1083
 Specifications, 1410
 Weights, 1083
- Reinforcement** (Mesh and bar)
Bars, steel
 Bond stress, 1035
 Corner bars, 450-474
 Dowel connections, 450-474
 In slabs and beams, 221-310, 1072-1074
 Longitudinal ties, 450-474
 Specifications, 1412, 1517
 Value, 450-474
 Weights and sizes, 1061
 Working stresses, 1035
- Mesh*
 In pipe, 218
 In slabs, 221
 Specifications, 1412, 1411
 Weights and sizes, 1056-1060
 Value, 450-474
 Wire gauges and diameters, 1064-1060
- Relocation of Highways** (*see* Location)
- Rental Charges** (Equipment), 1243-1264
- Renewal of Pavements** (*see* Reconstruction)

INDEX

- Repair**
 Bridges (*see* Bridges)
 Pavements (*see* Maintenance)
- Repointing Masonry**
 Cost, 661
- Reports (Typical problems)**
 Bridges, 327, 774, 781, 1095
 Pavements, 770, 1095
 Pioneer roads, 807
 Railroad crossings, 603, 605, 642, 775
 Reconstruction, 583, 594, 598
- Resurfacing Macadam**
See Maintenance
 " Reconstruction
- Retaining Walls**
 Concrete, 682
 Cost, 668, 1150
 Design, 1043, 682
 Examples, 682
 Stone masonry, 683
 Types, 676
- Right of Way**
 Areas of (Computation), 1093
 Cost of (Damages), 1156
 Fences, 700
 Maps and descriptions, 842
 Surveys, 840
 Widths required
 Normal conditions, 6, 8, 177
 Sight distance requirements, 178
 Monuments, 694
- Rip Rap**
 Cost, 661, 1156
 Design, 211
 Grouted, 1507
 Necessity, 211
 Specifications, 1488, 1500, 1506, 1507
- Rivets**
 Driving, 1369
 Weight of, 1070
 Design, 1552
- Road Materials, Economic Use**
(see Materials)
- Road Sections, Typical (Examples)**
 Mountain roads, 161-171
 Ordinary roads, 146-161, 951
 Reconstruction, 579-598, 958
See also Sections
 Streets, 172
- Roads (General types)**
 Earth roads, 344
 Gravel " 352
 Macadam " 429-449
 Pavements, rigid, 449-518
 Sand-clay roads, 347
- Road Systems, 1-73**
 Classification of roads, 6-9, 46
 Financing (Bond method), 19
 Layout and route selection, 74
 Scope of work, 2
 Tax burden distribution, 17
 Traffic requirements, 26
- Roadway—Width of**
 At bridges, 6, 8, 203, 633, 1005
 " culverts, 6, 8, 203
 " pavements, 6, 8, 130, 958, 635
- Roadway—Width of**
 At shoulders, 6, 8, 130, 951, 635
 " traffic capacity, 28, 203, 633, 1005
- Rock Asphalt (Kentucky)**
 Cost data, 1183
 Specifications, 1421, 1497
 Cost of, 661, 765, 1159
 Ratio cut to fill, 996
- Rock Excavation**
Rocks (*see also* Stone)
 Geological classification, 708
 Properties, 705-715
 Sampling, 752
 Tests, 705
 Weights, 709
See also Crushing
- Rollers (*see* Equipment for types of pavement desired)**
- Rolling (*see* Inspection details for type of pavement desired)**
- "Rolling" grades (*see* Grades)**
 Effect on cost, 107
 Example of, 108
 Limits of use, 963
 Methods of designing, 963
- Roots, Square and Cube, 1580**
- Roughness (Pavements)**
 Effect on vehicle operating costs, 61-68, 545
 " " impact loads, 372, 551, 779, 1040
 Vialog records of, 63, 545
- Routes (Location of roads)**
 Discussion, 74
- Ruling Grades (*see* Grades, maximum)**
- Runoff (Flood flow)**
 Quantity, 186, 1021
 Velocities, 195, 335
 Scour, 211, 335
- Rupture (Modulus of)**
 Brick, 423, 510
 Concrete, 397-403
- Rut Roads, 344, 365**
- Safety Provisions**
 Curve banking, 7, 9, 124, 958
 Curve widening, 132, 958
 Curved alignment, 6, 8, 113-121, 634, 950
 Ditches (Shallow), 142
 Grades, 6, 8, 101, 425, 634, 949
 Guard rail, 7, 9, 676
 Illumination, 7, 9, 699
 Railroad Xing protection, 7, 9, 599
 Retaining wall guards, 7, 9, 676
 Shoulders (Solid), 6, 8, 130, 132, 586-596, 952
 Sidewalks, 7, 9, 174, 203, 634, 687, 1005
 Sight distance, 7, 9, 114, 634, 950
 Signals (Automatic), 7, 9, 599
 Signs
 Danger, 6-9, 687
 Guide, 6-9, 687
 Pavement markings, 6-9, 698
 Skidding, 101, 425, 952

INDEX

Safety Provisions

Widths

- Pavement, 6-9, 130, 958
- Shoulders, 6-9, 130, 951

Sampling Materials

- Bituminous, 763
- Brick, 766
- Cement, 763
- Concrete, 763, 743
- Gravel, 763
- Sand, 763
- Stone, 764

Sand

Amounts required

- Concrete (Cement), 466, 495, 1092
- Concrete (Bituminous), 495, 1138, 1142, 1188
- Cover for oiling, 561, 1220
- Filler for bottom courses, 441, 1134, 1168

Sampling, 762

Size

- Concrete (Cement), 460, 1386
- Concrete (Bituminous), 492, 1386

Cushion, 510, 1387

Grout, 511, 1387

Specifications, 1386

Standard Ottawa, 460, 1387

Suitability

Concrete (Cement), 460, 739, 1386

Concrete bituminous, 492, 1386

Cover for oiling, 561

Cushion, 510, 1387

Filler (Macadam), 715

Grout, 511, 1387

Tests

Abrams fineness modulus, 480

Abrasion, 739

Loam content, 737

Organic impurities, 738

Voids, 741

Weight (Specific gravity), 741

Sand Clay Roads

Cost of, 347

Discussion, 347

Economic use, 347

Limitations of use, 48

Maintenance, 575

Materials, 348, 744, 1447

Mileage in use, 42

Reconstruction, 575

Sand-clay mixtures, 347

Sections, 147, 348

Specifications, 351, 1447

Suitability of (General), 48, 347

Tests, 744

Typical sections, 147, 348

Sand Cushion

Block pavements, 507, 1481

Scales

Maps and plans, 944

Profiles, 944

Bridge plans, 1008

Scarifying Macadam

Cost, 1166, 1118

Specifications, 1491

Scour

Ditches, protection of, 335

Rip rap, use of, 211, 1500, 1506

Velocities producing scour, 211, 335

Brush mattress protection, 1500

Specifications, 1506-1507

Scree for Concrete Pavement, 1304

Screenings

Amounts required

Bituminous macadam, 446,

1141, 1168

concrete, 495, 1142

Cover for maintenance oiling,

561, 1221

Waterbound macadam, 441,

1168, 1140

Production of

Percentage of output, 1172-

1181

Sieve analysis of, 1330, 1319

Weight of, 1180, 1159

Suitability

Concrete (Bituminous), 492,

1387

Concrete (Cement), 460, 1387

Cover for oiling, 561, 1383

Macadam construction, 440,

446, 1383

Secants, Table of, 1616

Sections of Roadway (See also

Cross sections, 122-179

Cost of

Effect of grading width, 143

" " pavement " 133

" " soil slopes, 144

Design of

Crowns

Banked, 124, 956

Normal, 124, 950

Street, 173, 957

Cut and fill slopes, 145

Ditches, 142

Shoulders, 6, 8, 130, 951

Widths

Capacity (Tropic volume), 28,

203, 634, 1006

Grading, 6, 8, 130, 634, 951

Pavement, 6, 8, 130, 634, 958

Vehicle clearances, 130

Discussion (General)

High type roads, 122-160, 579-

598

Pioneer roads, 160-171

Streets, 165-177

Examples of

Current practice

Construction, 146-173, 951

Reconstruction, 579-598, 956

Recommended practice, 155,

579-598, 951

Templets for, 962, 969

Serial Bonds (see Bonds), 19, 603

Settlement of Fills

Ratio cut to fill, 995

Under pavements, 369

Methods of laying to prevent,

1888

INDEX

- Sewers**
 Capacity, 337
 Cost, 669, 1149
 Grades (Minimum), 338
 Manholes, 695
 Trenches
 Details, 691-695
 Pavement thickness over, 417, 420
 Storm flow in, 1023
- Shale**
 Tests for in gravel, 742
- Sheet Asphalt** (*see* Bituminous concrete)
- Sheet Piling**, 1508
- Shoulders**
 Slope, 123, 136, 951
 Stone or gravel protection, 130-136, 951
 Width, 6, 8, 130-136, 951
 Concrete Shoulder
 Cost, 1217
- Shrinkage of Earthwork**
 Ratio cut to fill, 995
- Side Culverts** (*see* Culverts)
- Sidehill Sections**
 Amounts of excavation, 162, 786
 Drainage, 182
 Examples of, 161-171
 Quantities, 786-793
 Sections, 161-171, 786-793
 Sight distance, 114, 950
- Sidewalks**
 Cross slope, 175
 Width, 175
 Specifications, 1483
 Use of, 7, 9, 175, 177, 203, 634
- Sieves** (Standard sizes), 736
- Sight Distance**
 Effect on alignment, 114, 945, 950
 " " grades, 82
 " " grading, 82
 " " motor operation cost, 118
 " " right of way widths, 177, 114
 Safe sight distance, 7, 9, 114, 950
 Vertical curves, 110-112, 965, 634
- Signs**
 Danger signs, 6-9, 687-696
 Detour, 696
 Guide " " 6-9, 687-696
 Location of, 687, 607
 Pavement markings, 6-9, 698
 Railroad crossing, 607-613
 Warning, 6-9, 687-696, 607-613
 Specifications, 1491
- Sines**
 Logarithmic, 1653
 Natural, 1604
- Sinking Fund Bonds** (*see* Bonds), 19
- Skidding, Automobiles, Effect on Design**
 Prevention of
 Curve banking, 124, 966
 Grades (Safe), 101, 425, 643, 949
 Pavement surfaces, 425, 428, 962
- Slab Bridges** (*see also* Bridges)
 Costs, 310, 1160
 Construction (Inspection), 1354
 Design
 Ordinary conditions, 180-247
 Loads
 Design, 199, 1038
 Safe (Table of), 1072
 Effect of depth of fill, 1075
 Economic use, 205-210, 1005
 Examples of, 237-247
 Quantities, 237-247, 759
 Suitability, 205-210, 1005
- Slag** (Crushed blast furnace)
 Amount required
 Concrete, 460, 495, 1092
 Macadam, 441, 495
 Specifications, 494, 1385
 Weight, 494, 1385
 Suitability, 441, 494, 715, 456, 1385
- Slides**
 Stable slopes
 Cut, 145
 Fill, 145
 Sliding (Friction resistance), 1052
- Slipperiness of Pavements** (*see also* Each respective pavement)
 Limitations on hills for horse traffic, 101, 962
 Skidding, (Automobiles)
 Effect of curves, 124, 634, 950
 Effect of grade, 101, 425
 Pavement surfaces, 428, 962
- Slopes (Stable cut and fill)**
 Angle of repose of different soils, 145
 Slope Stakes, 1272
 Slump Test (Concrete), 461, 744
- Smoothness of Pavements**
 Value of, 61-68, 545
 Vialog records, 63, 546
- Snake Bites**, 1701
 Treatment of
- Snow**
 Effect on location mountain roads, 904
 Fences, 700
 Removal from highway, 570
- Sodding**, 1499, 1672
- Soils**
 Classification of, 377, 911, 1289, 1421
 Consolidation of, 995, 1291
 Effect on depth of pavement
 Macadam, 385-391, 959
 Rigid, 410-427, 960
 Effect on type of underdrain, 338
 " " slopes, 145
 Regulation in fills, 1289
- Safe loads on**
 Bridge foundations, 208, 1051
 Pavement " " 377
 Shrinkage (Ratio cut to fill), 995
 Weight, 1038
- Solar Meridian**, 927-932
- Solubility (Test)**, 730

INDEX

- Specifications**
 Bridge, 1492-1572
 General clauses, 1371-1376
 Materials (see also Each material), 1382-1420
 Methods (see Type of pavement desired), 1420-1491
 See also Respective item desired
 Road design (General comparative), 6-9
 Ry. grade crossings (" ") 609, 633
- Specific Gravity** (Tests for)
 Rock, 741
 Bitumen, 727
- Specific Gravity** (Weights of materials)
 Miscellaneous substances, 1038
 Rocks, 709-712
- Speed and Distance** (Table of), 616
- Speed of Trucks** (Regulation), 28 371
- Speed of Traffic**
 Discussion of, 37
 Effect on curve banking, 124
- Speed of Work**
 Construction operations
 General road speeds, 1234
 Mixing and placing bridge concrete, 1276
 Office design, 1104, 1113
 Survey work
 Road surveys, 840, 893
 Stadia, 1105
- Spiral Curves**
 Practical method, 129
- Splicing**
 Bars (reinforcement), 281
 Piles, 1363
- Sprains, 1699**
 (Treatment of)
- Sprinkling**
 Fresh concrete, 1309, 1531
 Puddling macadam roads, 1171, 1296
- Square Roots**, Table of, 1580
- Square Units of Measure** (Conversion), 1573
- Square Yards**, Table of, 1089
- Squares and Square Roots**, Table of, 1580
- Stadia Measurements, 844, 932-939, 1105**
- Stage Improvement** (see Progressive improvement)
- Stakes**
 Grade, 1272
 Slope, 1272
 Survey (Number required), 831
- Staking Out** (Construction)
 Bridges, 1334
 Road work, 1272
- Steel** (Structural)
 Erection of, 1368
 Specifications, 1533
 Properties of rolled I beams, 1068
 Weight of, 1038, 760
- Steel Bar Reinforcement** (see Reinforcement)
- Steel Plates**
 Gauges, 1064
 Weights, 1068
- Stone** (see also Rocks)
 Geological classifications, 708
 Suitability for macadam, 714, 715, 440, 1383
 " concrete, 456, 740, 1383
 Weight, 709
- Stone** (Crushed)
Amounts required
 Bituminous concrete, 495, 1138, 1142, 1188
 Bituminous macadam, 446, 1142
 Concrete (Cement), 466, 495, 1092, 1145
 Macadam foundations, 429-437, 442, 1134
 Waterbound macadam top, 441, 1140
- Crushing**
 Cost, 1130, 1172
 Proportion of size outputs, 1173-1181
 Weights of different sizes, 1182
- Sampling, 754**
- Sizes**
 Bituminous concrete, 493, 1383
 macadam, 446, 1383
 Concrete (Cement), 456, 1383
 Macadam foundations, 429, 1383
 Waterbound macadam, 440, 1383
- Suitability**
 Concrete, 740, 1383
 Pavements
 Bituminous concrete, 492, 1383
 " macadam, 440, 1383
 Concrete, 456, 1383
 Macadam foundations, 429, 441, 1383
 Waterbound macadam, 440, 1383
- Tests**
 Abrasion, 706
 Absorption, 707
 Hardness, 706
 Specific gravity, 707, 741
 Toughness, 707
 Voids, 741
- Stone Block Pavement**
 Cost data, 1147
 Crowns, 124, 173, 515, 960
 Current practice, 515
 Description, 515
 Failures, 428
 Foundation (Design), 421, 426, 515, 960
 Life of, 65, 535
 Limitations of use, 425, 515, 960
 Specifications, 1481

INDEX

- Stone Block Pavement**
 Suitability of pavement (General), 515, 968
 Yearly cost, 65, 519-544
- Stone Fills**
 Use of, 436
 Ratio cut to fill, 995
 Slopes, 145
- Stone Masonry**
 Cost, 766
- Stoneway (see Macadam)**
 Depths on different soils, 391, 969
 Widths, 130, 968
- Streams**
 Channel improvements, 181
 Flow of water in
 Floods, 186, 1021
 Velocity of flow, 195
 Scour, 211
 Backwater head, 196, 1026
- Streets (Details)**
 Car Tracks, 175-177
 Crowns, 173, 967
 Curbs, 174
 Pavements (see Pavement desired)
 Sidewalks, 174, 634, 1006
 Widths, 165-172
 Sewers, 691-695
 Manholes, 695
 Catchbasins, 690
 Water pipe details, 693
- Strength of Materials**
 Beams, safe loads, 1028, 1074, 1076
 Columns, " " 1078
 Slabs, " " 1072
 Working stresses different materials, 203, 1033
- Strength of Pavement**
 Design of
 Flexible pavements, 366-392, 969
 Rigid " 366-428, 960
- Stresses in Materials**
 Design (Allowable), 1033
 Temperature, 1063
 Ultimate, 1033
- Sub Base Courses (see Foundations and bottom courses)**
 Amounts of material, 430-442, 1133-1138
 Cost data, 430-438, 662, 1132-1138
 Depth required, 390, 969-960
 Description, 430-438
 Fillers, 430-438, 441, 715, 1168
 Inspection, 1291
 Specifications, 1484
- Subgrade, Preparation of, 1290**
- Subgrade Tester, 1300**
- Sulphite Liquor (Glutrin)**
 Specification, 1403
- Sun (Solar meridian), 927-932**
- Sunstroke (Treatment), 1721**
- Superelevation at Curves**
 Runoff to normal crown, 129
- Superstructures of Bridges (see Bridges)**
- Supplies**
 Office, 1103
 Survey, 831
- Surface Measures, Units and Conversion, 1573**
- Surveys (General)**
 Accuracy required (see Accuracy)
 Cost of, 747, 749, 840, 893
 Curve data, 865-884
 Equipment, 782, 818, 831, 894-904, 938
Methods
 Adjustment of instruments 852
 Base lines (Location), 831, 904, 905
 Bridges, 942
 Cross-sections, 833, 909
 Curves (Tables and problems), 864-892
 Drainage data, 835, 911
 Land surveys, 840
 Levels, 833
 Magnetic variation, 799
 Materials, sampling, 752, 911
 Meridian determination, 912-932
 Stadia work 844, 932-939, 1105
 Topography, 836, 911
 Traffic reports, 31, 837
 Organization, 831, 893
 Preliminary investigations, 749-830
 Speed of work, 840, 893, 1105
- T Beam Bridges (see also Bridges)**
 Cost, 310, 769, 1160
 Economic use, 205, 1005
 Examples of, 252
 Quantities, 252-256, 759
 Suitability of, 205, 1005
- Tangents**
 of 1° curves (Table), 858
 Logarithmic, 1653
 Natural, 1693
 Offsets for staking curves, 907
- Tar (see Bitumens)**
- Tarvia (see Bitumens)**
- Taxation**
 Effect on general design, 4, 16, 17
 Distribution of for
 Construction, 17
 Maintenance, 17
 Railroad Xing protection, 601
 Reconstruction, 17
 General taxes, 17
 Vehicle taxes, 17
- Team Traffic**
 Effect on design, 84
 Alignment, 117
 Grades, 86
 Pavement surfaces, 101, 425, 968

INDEX

- Team Traffic**
 Importance of in design, 26, 84
 Loads drawn, 86-93
 Volume of, 26, 84
- Telford Base**
 Cost, 433
 Depth, 389-391, 959
 Design, 389, 434
 Inspection, 433
 Materials
 Amounts, 434
 Suitability, 434
 Specifications, 434
- Temperature**
 Asphaltic mixtures, 1326
 Coefficient of expansion, 498, 1063
 Effect on design of pavements, 367
 " " volume of bitumen, 754
 Protection of concrete, 1309, 1529
 Stresses, 1053
 Units of measure, 1573
- Templets**
 Pavement construction, 1304
 Plotting cross sections, 962, 969
- Tension** (Modulus of rupture)
 Definition, 396
 Values for concrete
 Bridges, 656
 Pavements, 397
 Reinforcement effect, 400
- Tests of Materials**
Bitumens
 Ductility, 729
 Evaporation, 729
 Flash, 727
 Melting point, 732
 Penetration, 728
 Significance of tests, 723
 Solubility, 730
 Specific gravity, 727
Brick
 Abrasion (Rattler), 716
 Absorption, 741
 Size variation in, 716
Cement (Portland), 735
Concrete
 Sampling, 743
 Slump, 744
Gravel
 Abrasion, 742
 Loam content, 738
 Shale " 743
 Voids, 741
 Weight (Specific gravity), 741
Sand
 Hardness, 739
 Loam content, 737
 Organic impurities, 738
 Voids, 741
 Weight, 741
Stone
 Abrasion, 706
 Hardness, 706
 Toughness, 707
 Voids, 741
 Wear, 706
 Weight, 741
- Tests of Materials**
Water
 Acid, 739
 Alkali, 739
 Organic impurities, 738
Test Piles (*see* Transit)
Theodilite (*see* Transit)
Theoretical Design (Pavements)
 Fundamental assumptions
 Macadam, 366-392
 Rigid, 366-428
 Limitations of, 390, 392
 Value of, 392, 425
Thickness of Pavements (*see* Depth of pavements)
 Macadam types, 391, 959
 Rigid " 426, 960
 Over trenches, 417, 420
- Tile**
 Underdrains, 338
 Vitrified pipe (*see also* Vitrified pipe)
 Sewers (*see* Sewers)
- Timber** (General)
 Amount in logs, 798
 Strength of
 Design stresses, 1037
 Beams, 1076
 Columns, 1078
- Timber Bridges** (*see also* Bridges)
 Costs, 797, 798
 Design tables, 1076
 Examples of, 294-309
 Quantities, 294-309, 798
 Suitability, 180
- Timber Culverts**
 Examples of, 214
 Cost of, 797
- Time** (Conversion of)
 Determination of local mean time, 930
 Mean time local, 915
 Standard time zones, U. S., 914
 Sidereal, 926
- Time of Mixing**
 Bituminous concrete, 326
 Cement
 Effect on strength, 475, 486
 specifications, 462, 1276, 1471, 1512
- Tires** (Wagon and automobile)
 Allowable load per inch width, 370
 Effect of width on tractive resistance, 88
 Effect of condition on impact, 370
- Toe Pressure** (Foundations)
 Allowable, 208, 1051
 Computation of, 1047
- Toe Walls**, 685
- Top Courses** (*see* Respective pavement desired)
- Topeka Mix** (*see* Bituminous concrete)
- Topography**
 Field methods, 836, 911
 Office " 848
- Toughness** (Test for), 707
- Tracks** (Railroad)
 Clearances, 642

INDEX

- Tracks (Railroad)**
 Cost of, 662
 Cross sections, 643
 Gauge, 643
 Pavement between rails (Crossings), 609-611
 Protection of, 599-675
 Street car construction, 175, 176
Traction Engineer
 Widths, 130
Tractive Resistance of Wagons
 Friction, 87
 Grade, 87
 Pavement surface, 90
Tractive Power (Horses), 86
Traffic Data (General)
 Accidents (*see* Accidents), 33, 601, 606
 Classification for, 6-9, 46, 634, 959
 Range of, 38
 Regulation of
 Load, 28, 370
 Speed, 28, 37, 370
 Requirements (General), 26
 Safety of (*see* Safety provisions)
 Speed of, 37
 Volume of and road capacity, (28-33) 635, 1005
 Census data, 28
 Fluctuation in intensity, 30
 Effect on design, 6-9, 28, 385, 391, 426, 634, 1005
 Present, 31
 Future (Estimates of), 32, 203, 633, 1005
Vehicles
 Cost of operation
 General costs, 80, 98
 Pavement effect on, 11, 68
 Grades effect on, 12, 100
 Clearances, 130
 Loads, 6, 8, 200
 Types
 Automobiles (*see* Automobiles)
 Horse (*see* Horse traffic)
Traffic Data (Effect on design details)
 Alignment, 6, 8, 113-121, 634, 950
 Bridges, 6, 8, 202, 203, 633, 1005
 Grades, 6, 8, 105, 634, 949
 Pavement
 Strength and type, 6, 8, 40-48, 391, 426, 634, 959-960
 Width, 6, 8, 130, 634, 958
 Roadway sections
 Ditches, 6, 8, 142
 Widths, 6, 8, 130, 634, 951
 Shoulders, 6, 8, 130, 634, 951
Trails (Alaskan dog), 361
Transit
 Adjustments of, 858
Transition Curves
 Practical method, 125
Traverse Computations (Land surveys), 1094
- Trenches**
 Depth of pavement over, 417, 420
 Sewer (Details), 691
 Water (), 693
Trestles (Highway)
 Cost of, 656, 667
 Examples of
 Concrete, 308, 656
 Timber, 303, 307
 Use of
 Economic conditions, 656, 645
Triangles (Solutions of, trigonometric) 1578
Trigonometric Formulae, 1578
Trigonometric Functions
 Logarithmic, 1653
 Natural, 1693-1628
Trucks (*see* Automobiles)
Truss Bridges (*see* Bridges)
 Cost, 314, 1151
 Quantities, 313, 652, 760
 Suitability (Limits), 205
Turnouts (Mountain roads), 6, 164
Turnpike Sections
 Examples, 167, 788
 Quantities, 786
 Specifications, 1444
Underdrains, 338
 Cost, 661, 765, 768
 Design, 338
 Examples
 Bridge, 241
 Roadway, 338, 439
Unloading Materials, 1159-1161
 Cost of
 Cement, 1161
 Sand, 1161
 Steel, 1161
 Stone, 1159
Utilization of Old Structures
 Bridges, 180, 210, 1013
 Pavements, 579-598
 Value of, 180, 210, 579-598
Value (General) (10-16)
 Highways
 Direct, 7, 9, 10, 79
 Indirect, 4
 Engineering design
 Alternate designs, 747, 943
 Construction cost reductions, 50, 54, 747
Variation (Magnetic meridian), 799
Vehicles (*see also* Automobiles)
 Clearances, 130, 204
 Dimensions, 130, 200
 Length (Effect on pavement width on curves), 116
 Weight, 202, 370
 Wheel loads, 202, 370, 1039
 Width, 130
 Volume of traffic (Road capacity), 28, 633, 1005
Velocity and Time Distance Table, 616
Velocity Head
 Backwater head, 196, 1026
Velocity of Stream Flow
 Formulae, 195

INDEX

Velocity of Stream Flow

- Tables of
 - Channels, 195
 - Pipes, 194, 337
- Scouring action, 211, 335
- Self cleansing velocity
 - Culverts, 196
 - Sewers, 338
 - Underdrains, 340

Vertical Curves

- Effect on construction cost, 110-112
 - " " sight distance, 110-112, 965
- Formulae for, 966
- Minimum length, 110-112, 634, 965
- Use of (Proper and limits), 110-112, 634, 964
- Graphic methods, 1106
- Radii of, 968

Vialog Records (Roughness), 63, 547

Vitrified Pipe

- Capacity of, 194, 335, 1082
- Cost
 - Culverts, 213, 797, 1148
 - Sewers, 669, 1149
- Culverts, 217, 1084
- Dimensions, 217, 1084
- Sewers, 691
- Specifications, 1571
- Weights, 217, 1084

Voids

- Tests for, 741
- Effect on strength of concrete, 489

Volatilization (Test), 729

Volumes (Solids and liquids)

- Earthwork computations, 971-993
- Formulae, 1576
- Units of measure, 1573

Volume of Traffic

- Census Data
 - Fluctuation in volume
 - Hourly, 30
 - Daily, 30
 - Weekly, 30
 - Yearly, 30
- Classification for design, 6-9, 46, 633, 959
- Effect on design, 6, 8, 130, 202, 203, 391, 426, 633, 1006
- Present volume, 31
- Future volume (Estimating), 32, 203, 632-634, 1006
- Road Capacity, 28, 633, 1005

Wagon Loads (Teams)

- On different grades, 90-93
- Mountain freighting loads, 92

Walls

- Retaining walls
 - Cost, 668
 - Design, 1043
 - Examples, 676-684
- Toe walls
 - Examples of, 685
- Wall Sections (Mountain roads)
 - Examples, 171, 792
 - Quantities, 798

Warrenite (see Bituminous concrete)

Warning Signs

- Examples of, 612, 613, 687-696
- Location of, 607-613, 687
- Use of, 6-9, 610, 687

Water

Amounts required

- Padding macadam, 441, 1172
- Concrete (Structural), 490, 1092
- Concrete pavements, 461, 1092
- Effect of, on strength, 490, 1276

Flow of

Channels (Streams)

- Floods, 186, 1021

Velocity, 195

Capacity, 195

Pipes

- Capacity, 194, 335, 1251
- Velocity, 194
- Velocity head, 1251

Velocity

- Minimum self cleansing, 196, 338
- Scour velocities, 211, 335
- Tests for, 739
- Weight of, 1038

Water Pipes (Cast iron)

- Cost, 661, 675
- Dimension and weights, 1079

Trenches

- Details, 693
- Depth of pavement over, 417, 420
- Velocity head, 1251

Waterbound Macadam

- Construction methods, 1296, 1454

Costs

- Detail data, 1156-1178
- Estimate forms, 1140
- General comparative data, 65, 438

Design

- Current practice, 389
- Recommended practice, 440, 959
- Theoretical, 336-391

Durability of surface, 65, 531

Economic limitations of use, 6-9,

- 40-48, 438, 962

Equipment for construction, 1243

Failures (Common causes), 428

Foundation courses, 429-441

Inspection details

- Culverts and bridges, 1273

Grading, 1268

Pavement, 1291

Maintenance

- Cost, 65, 519-544
- Methods, 552-564

Materials

- Amounts required, 441, 1140

Specifications for, 1383

Suitability of, 440, 1383

Tests for, 705

Reconstruction of

- Cost, 65, 579
- Methods, 579-598

Specifications, 1454

Suitability of pavement (General), 40, 428, 438

INDEX

- Waterway Area**
Bridges, 186, 1081
Culverts, 186, 1081
- Wear** (*see also* Specific material)
Abrasion tests, 706, 716
French coefficient of, 706, 710
- Weight** (Units of measure), 1573
- Weights**
Bridge dead loads, 1038, 1547
" steel, 310, 760
- Materials**
Bitumen, 1388 (Specific gravity)
Concrete, 1038
Crushed stone, 1038
Gravel, 1038
Sand, 1038
Steel, 1038
Stone, 1038
Timber, 1038
Water, 1038
- Pipes**
Cast iron, 1079
Corrugated metal, 1080
Reinforced concrete, 1083
Vitrified, 217, 1084
- Reinforcement** (Steel bars), 1061
Wires, 1056
- Weight of Vehicles** (*see* Loads)
- Wheel Base** (Length)
Effect on rear wheel encroachment, 116
Effect on pavement width, 130
Trucks, 1039
- Wheel Loads**
Impact
Bridges, 202, 1040
Pavements, 372
Recommended design loads
Bridge, 202, 1039
Pavements, 373
Vehicles
Military ordinance, 202
- Wheel Loads, Vehicles**
Regulation of, 28, 370
Trucks, 370, 202
- Width of Pavements and Roadways**
At bridges, 6, 8, 203, 633, 1006
" curves, 130, 958
" railroad crossings, 609
" tangents (Normal widths), 6, 8, 130, 634, 958
Changing widths (Length of runoff)
At bridges, 133
" curves, 133
" railroad Xings, 133
Streets (City and village), 165
- Width of Right of Way**, 6, 8, 177
- Wire** (Gauges and weights), 1054-1059
- Wood Block Pavement**
Description, 515
Specifications, 1479
Typical sections, 515
- Wooden Guide Rail**
Cost, 661, 1156, 1216
Examples, 676
Resetting, 1222
- Working Stresses of Materials**, 203, 1033
- Wrought Iron**
Weight of, 1038
- Yardage of Earthwork**
Computation of, 971-993
- Yearly Charges** (*see also* Annual charges)
Bridges (Maintenance of), 210
Camp equipment, 902
Contractors equipment, 1238-1268
Pavements (*see also* Each pavement)
Maintenance, 65, 519-544
Renewal, 65, 579-597
Survey equipment, 894

DATE OF ISSUE

This book must be returned within 3, 7, 14 days of its issue. A fine of ONE ANNA per day will be charged if the book is overdue.

--	--

