

Birla Central Library

PILANI (Jaipur State)

Engg College Branch

Class No :- 693

Book No :- WS3D

Accession No :- 32192

**THE DESIGN OF MASONRY STRUCTURES
AND FOUNDATIONS**

*The quality of the materials used in the manufacture
of this book is governed by continued postwar shortages.*

**THE DESIGN
OF
MASONRY STRUCTURES
AND
FOUNDATIONS**

BY

CLEMENT C. WILLIAMS, C. E.

Dean of the College of Engineering, University of Iowa; Member American Society of Civil Engineers; Member American Railway Engineering Association; Member Society for the Promotion of Engineering Education

**SECOND EDITION
SEVENTH IMPRESSION**

McGRAW-HILL BOOK COMPANY, INC.

NEW YORK AND LONDON

1930

COPYRIGHT, 1922, 1930, BY THE
MCGRAW-HILL BOOK COMPANY, INC.

PRINTED IN THE UNITED STATES OF AMERICA

COMPOSITION BY THE MAPLE PRESS COMPANY, YORK, PA.
PRINTED AND BOUND BY COMAC PRESS, INC., BROOKLYN, N. Y.

PREFACE TO THE SECOND EDITION

In this edition, the new material includes a treatment of those phases of the subject wherein development since the first issue has been most pronounced, and also a revision of other material with a view to a more satisfactory presentation. Instances of the former type of change are found in the treatment of plain concrete, of arch dams, and of foundations, while the latter is exemplified in the chapter on retaining walls, where a simpler and more practical analysis replaces the classic treatment of Coulomb. It is hoped that these changes will enhance the usefulness of the book as a classroom text.

C. C. W.

IOWA CITY, IOWA.
March, 1930.

PREFACE TO THE FIRST EDITION

Due to investigations, both analytical and experimental, that have been made in recent years of the properties of masonry materials, the forces to which masonry structures are subjected, and the behavior of such structures, masonry design and construction have largely passed from the status of an art to that of a science, much as did bridge design after the invention of methods for calculating stresses in truss members. The extensive use of concrete with the studies that have been made to improve its quality and to secure economy in its use, and the development of reinforced concrete, a masonry material capable of sustaining tensile strains and requiring a stress analysis in order to proportion the steel, have contributed largely to this changed status in the design of masonry structures. This scientific understanding of masonry design has widened the use of masonry to include many structures for which other materials formerly were used exclusively, although for the most part, notwithstanding their diversity, these structures can be grouped about a comparatively few representative types.

The soft and pleasing hues and outlines of masonry structures as well as their durability have appealed to builders from time immemorial, and masonry still offers the best means of building artistically and strongly with the economy that results from permanence. Moreover, there is an increasing demand in the design of engineering structures to secure not only stability and economy but something of elegance, grace and beauty in addition. Since good architectural treatment can be secured with but slight if any increase in the cost, it is appropriate that this phase of design should be given special attention in planning masonry structures.

The present volume was prepared with a view to furnishing a textbook embodying these ideas. An attempt has been made to offer a mode of analyzing forces and calculating resulting stresses and to indicate an acceptable method of design. Extended discussion of moot questions and of variations in design are purposely avoided with the belief that these are of interest to the

practicing engineer rather than of use in the class room. An effort has been made to keep in mind the aesthetic features of design in the selection of illustrative examples and to mention briefly the underlying principles of good architectural treatment whenever they could be formulated, although no more could be accomplished in this direction, perhaps, than to call attention to the desirability of giving thought to this important phase of design.

A knowledge of mechanics on the part of the reader is assumed. No attempt was made to treat reinforced concrete completely, the brief chapter on this topic being for reference and to provide for those readers who have not previously pursued a course in this subject. The study of the design of masonry structures should preferably be preceded by a course in the mechanics of reinforced concrete.

A brief historical review of masonry materials and construction was included with some recent patent litigation in mind as well as for its intrinsic interest. It is believed that the chapter on built up masonry and the one on plain concrete will serve to give the student the essential facts and principles involved, although the treatment is brief in each case. The consideration of foundations was reserved until after the loads that the superstructures transmit to the foundations had been studied. The arrangement and also the material included as the result of several years teaching the subject as well as some years practical experience in design and construction.

C. C. W.

LAWRENCE, KAN.
January, 1922.

CONTENTS

	PAGE
PREFACE TO THE SECOND EDITION.	v
PREFACE TO THE FIRST EDITION.	vii
CHAPTER I. GENERAL PRINCIPLES.	1
Historical development of masonry construction.—Structures.—Materials.—Factors affecting design.—Adequacy.—Economy.—Aesthetics.	
CHAPTER II. MASONRY LAID IN MORTAR.	23
Elements of stone masonry.—Building stones.—Classification of stone masonry.—Laying stone masonry.—Strength.—Stone bearing blocks.—Costs.—Brick masonry.—Manner of laying.—Strength.—Corbeling.—Terra cotta.—Stucco.	
CHAPTER III. PLAIN CONCRETE	62
Nature of concrete.—Cements.—Aggregates.—Methods of proportioning.—Strength and other properties of concrete.—Effect of various factors on the properties of concrete.—Expansion and contraction.—Waterproofing concrete.	
CHAPTER IV. REINFORCED CONCRETE	120
General principles.—Derivation of formulas.—Beams.—Columns.—Slabs.—Allowable stresses.—Practical design.	
CHAPTER V. MASONRY ARCHES	150
Determination of form of arch ring.—Analysis of stresses.—Loading for maximum stress.—Design of an arch.—Arches with elastic piers.—Arch abutment.—Groined arches.—Architectural treatment of arch bridges.	
CHAPTER VI. DAMS AND SEA WALLS.	221
Forces acting on a dam.—Conditions of stability.—Design of section.—Design of overflow dams.—Dam foundations.—Single arch dams.—Multiple arch dams.—Rock fill and core-wall earth dams.—Architectural treatment of dams.—Breakwaters and sea walls.	
CHAPTER VII. RETAINING WALLS AND QUAY WALLS.	272
Nature of materials retained.—Forces acting on a retaining wall.—Theory of pressures.—Design of section.—Effect of cohesion.—Types of wall sections.—Retaining grillage and slope walls.—Relative economy.—Architectural treatment of walls.—Quay walls.	

	PAGE
CHAPTER VIII. BRIDGE ABUTMENTS AND PIERS.	304
Functions of a bridge abutment.—Elements of design.—Forces acting.—Stability of an abutment.—Types of abutments.—Relative economy. Forces acting on a bridge pier.—Stability.—Hollow piers.—Relative economy.—Appearance.	
CHAPTER IX. CONCRETE VIADUCTS AND TRESTLES.	344
Types of masonry bridges.—Loads on bridges.—Girder bridges.—Three hinged arch bridges.—Slab bridges.—Trestles.—Stresses in trestle frames.—Cantilever concrete bridges.—Waterproofing bridge floors.	
CHAPTER X. CULVERTS AND UNDERGROUND CONDUITS.	373
Nature of loads and pressures.—Water way required.—Distribution of pressure through earth.—Stresses in pipe conduits.—Stresses in box culverts.—Rectangular culverts.—Arch culverts.—Stresses in a large conduit of curved section.	
CHAPTER XI. BINS AND CHIMNEYS.	395
Nature of pressures in granular materials.—Shallow bins.—Deep bins.—Janssen's theory of pressures.—Interspace bins.—Design of foundation slab.—Design of silos.—Forces acting on a chimney.—Design of brick chimneys.—Design of reinforced concrete chimneys.	
CHAPTER XII. FORMS AND CONSTRUCTION	433
General requirements.—Action of concrete in forms.—Typical forms.—Steel forms.—Movable forms.—Arch centers.—Costs of form work.—Construction methods and economy.	
CHAPTER XIII. FOUNDATIONS ON DRY GROUND.	467
Classification of soils.—Bearing capacity of soils.—Tests.—Modes of failure.—Investigations of foundation sites.—Wall and column footings.—Grillages.—Pile foundations.—Pile driving.—Supporting capacities of piles.—Concrete piles.—Open well foundations.—Costs.	
CHAPTER XIV. OPEN FOUNDATIONS UNDER WATER	525
Cofferdams.—Sheet piling.—Open caissons.—Solidifying aquiferous strata.—Costs.	
CHAPTER XV. FOUNDATIONS UNDER WATER. PNEUMATIC PROCESS.	542
General principles.—Diving.—Pneumatic cylinders.—Pneumatic caisson.—Design of caisson.—Details of caisson.—Launching, sinking and sealing the caisson.—Pneumatic caissons under buildings.—Physiological and pathological effects of compressed air. Costs.	
APPENDIX A. SPECIFICATIONS FOR CEMENT	584
APPENDIX B. SPECIFICATIONS FOR STONE MASONRY	591
INDEX.	597

DESIGN OF MASONRY STRUCTURES AND FOUNDATIONS

CHAPTER I

GENERAL PRINCIPLES

Introduction.—Masonry structures are those built of stone, or of stone-like (petrous), materials. In a primitive form, they were among the earliest types of structures erected by man, and the development from the earliest and crudest *dolmens* to the magnificent masonry edifices and bridges of the present day has been one of slow stages.

The enduring character of masonry structures, the relative simplicity of the processes involved, the pleasing outlines usually obtained, together with the almost universal availability of the materials and the consequent moderate cost, render masonry construction one of the most important of the civil engineer's activities. Moreover, the importance of masonry construction is likely to be enhanced in the future by the growing scarcity of other structural materials, notably steel and timber, and the fact that the ingredients of concrete are almost unlimited in their raw state.

The processes involved directly in the design of masonry structures require a familiarity with the properties of masonry materials and the behavior of the structural elements to be used, a knowledge of the loads to be imposed, the stresses induced thereby and the method of proportioning the parts, and judgment in the principles of good architectural form.

The choice of type of structure, like reconnaissance for a railroad or an irrigation project, is of fundamental importance and requires the exercise of the engineer's best judgment, whereas, after the choice is made, the remainder of the design is largely based on fixed laws of mechanics and of costs. It will frequently happen, of course, that the choice of type cannot be made until after a detailed study of the relative stability, adequacy and costs of several different types has been made, in which event judgment

will need to be exercised in assigning proper weight to the merits of the various types considered. In all of these respects, advantages of masonry structures commend this type of construction to the consideration of the engineer.

Historical Development of the Elements of Masonry Construction.—Perhaps the earliest elements of masonry construction were columns and slabs of stone. Even in prehistoric times, the prototypes of our masonry structures were found in the crude *dolmens* and *cromlechs* of barbarous man. These consisted of unshaped stones set as columns and partial walls and covered with a slab or slabs of stone without any attempt at attaching one to the other. Mortar was, of course, unknown, but piles of stone with huge natural slabs of stone spanning the intervals are to be found in the ruins at Maidstone and Stonehenge, England, and at various other places in Europe. Gradually these simple elements of support and cover were improved.

The stone masonry column was used by practically all of the early peoples, although it was developed chiefly by the Greeks, and the beautiful stone columns erected by them, copied in some cases doubtless from similar timber structures and suggested by various circumstances of that time, gave rise to the *orders of architecture*, the term "order" referring to the manner of proportioning and decorating the column. The Egyptian, copying in stone the bulging bundle of reeds that had been used as supports in early reed houses, gave another form of column.

The earliest device in stone construction for covering or bridging the span between supporting columns was the stone slab or beam, and the subsequent progress in masonry construction has resulted chiefly in man's ability to improve his method of spanning the interval between supports. *Inclined blocks*, forming triangular-headed openings over doorways and other spaces were employed in many instances. *Corbel arches*, formed by laying successive horizontal layers projecting one over the preceding one until the apex is reached, were employed by the early Persians, Assyrians and Greeks. This form of construction gradually developed into the pointed arch and later into the true arch, which was used on a small scale by these peoples as well as by the Greeks. However, it remained for the Romans to contribute the arch and dome on a large scale. Groined, cloister and other intersection arches are the product of later Roman builders and of the Middle Ages. The pointed arches, or gables, are chiefly of the Middle Age period.

The Chinese made use of the true arch at a very early time also. Probably the oldest known arch is one found in 1893 in the ruins of Babylonia, the estimated date of construction being 4000 B.C. It was constructed of well-baked plano-convex bricks laid as voussoirs with clay mortar. It has a span of 20 in. and a rise of 13 in., and is elliptical in form.¹

The practice of using lime and lime mortar as binding agents for stones and bricks used in construction is of great antiquity, just when the custom began being unknown. Evidences of the early use of lime mortar may be observed in the ruins of Europe, Asia, Africa, Mexico and Peru. One of the earliest examples of the use of mortar in masonry construction is found in the Pyramids of Egypt, where the mortar used was similar to that in use at the present time. That the Ancients knew nothing of the essential character of lime and of mortar is evident from a perusal of the explanation given by Vitruvius² of the action of lime, in which he says:

“The reason why lime makes a solid structure on being combined with water and sand seems to be this: that rocks, like all other bodies, are composed of four elements. Those which contain a larger proportion of air are soft; of water, are tough from the moisture; of earth, hard; and of fire, more brittle. Therefore, if limestone, without being burned, is merely pounded up and mixed with sand and so put into the work, the mass does not solidify nor can it hold together. But if the stone is first thrown into the kiln, it loses its property of solidity by exposure to the great heat of the fire, and so with its strength burned out and exhausted it is left with its pores open and empty. Hence, the moisture and air in the body of the stone being burned out and set free, and only a residuum of heat left in it, if the stone is then immersed in water, the moisture, before the water can feel the influence of the fire, makes its way into the open pores; then the stone begins to get hot, and finally, after it cools off, the heat is rejected from the body of the lime.

Consequently, limestone when taken out of the kiln cannot be as heavy as when it is thrown in, but on being weighed, though its bulk is the same as before, it is found to have lost about a third of its weight owing to the boiling out of the water. Therefore, its pores being thus opened and its texture rendered loose, it readily mixes with sand, and hence, the two materials cohere as they dry, unite with the rubble, and make a solid structure.”

¹ M. A. HOWE, “A Treatise on Arches,” p. xiii.

² MARCUS VITRUVIUS POLLIO, a Roman architect and engineer, who lived during the reign of Caesar Augustus, wrote a treatise on architecture, “De Architectura,” covering the practice of that time. M. H. MORGAN, Translation.

Etruscan masonry walls and other structures laid at Rome, Florence and other Italian cities contemporaneously with Roman building were composed of cut stone masonry without mortar, this being a distinguishing characteristic in the ruins at the present time. The use of lime mortar was a decided step in advance over the bedding of stone in clay, as had been the custom by many of the ancient peoples.

The Romans discovered a way to improve lime and to give it the ability to set up or harden under water, and even manufactured an hydraulic cement similar to the natural cement of the present day. Vitruvius, the foremost architect of imperial Rome says in his Ten Books on Architecture (Book II, Ch. 6) "There is also a kind of powder which from natural causes produces astonishing results. It is found in the neighborhood of Baiæ and in the country belonging to the towns about Mt. Vesuvius. This substance, when mixed with lime and rubble, not only lends strength to buildings of other kinds, but even when piers of it are constructed in the sea, they set hard under water." From certain formations, chiefly in Tuscany, the Romans obtained a volcanic stone (tufa) which, when calcined and powdered, made a natural cement. The author observed mortar of this type in structures at Rome erected a century or more B. C., although the mortar may have been placed there in re-pointing. In building the Los Angeles aqueduct about a decade ago, a tufa cement was employed,¹ and experiments made at the time showed that powdered tufa mixed with lime gave a cement that would set under water and probably resembled the cement used by the Romans of the Republic.

However, it remained for John Smeaton, an English engineer, to discover in 1756 after an extended series of experiments that the lime made from the clayey limestone would harden under water and that a true hydraulic cement could be made by an argillaceous admixture. This material he used in the construction of the famous Eddystone Lighthouse in 1757, which "after being buffeted by the storms of eighty years, the Eddystone stands unmoved as the rock it is built on, a proud monument to its great author."² To an extent, Smeaton's exploit was a rediscovery of a principle that was known in a measure to the Romans, but had not been utilized in Western Europe. The

¹ *Trans. Am. Soc. C. E.*, vol. 76, p. 528.

² *Proc. Inst. Civil Engineers*, vol. 1.

Roman cement was in no sense a "lost art," for there has been no break in the continuity of its use up to modern times.

In 1810, Edgar Dobbs of Southwick, England, obtained a patent for the manufacture of artificial Roman cement by mixing carbonate of lime and clay, molding into bricks and burning. In 1813, Vicat began the manufacture of artificial cement in France as did also James Frost in England in 1822. In 1824, Joseph Aspdin, a bricklayer of Leeds, took out a patent on an improved cement by combining limestone with clay and then burning and grinding. This he called "Portland Cement" because when it hardened it produced a yellowish-gray mass resembling the stone from the famous quarries at Portland, England.

Canvass White, the engineer in charge of the construction of the Erie Canal, began the manufacture of natural cement near Fayetteville, N. Y. in 1818. Later, in 1828, a large plant was built at Rosendale, N. Y. for the manufacture of this kind of cement, and for a while, Rosendale cement became synonymous with natural cement in America.

Since the middle of the last century, various improvements in the processes of cement manufacture have been instituted which have greatly lessened the cost of the product, particularly with regard to portland cement, thus rendering hydraulic cement one of the most available building materials. First England led in the production of cement, then Germany, but since the beginning of the present century, the United States has surpassed all other countries.

Perhaps the most significant development in masonry construction was the introduction of reinforced concrete, by which masonry could be made to withstand tensile stresses comparable with its compressive strength. The first authentic record of the use of reinforced concrete was at the World's Fair at Paris in 1855, when a small rowboat built by M. Lambot of mortar reinforced with wire netting was on exhibition. However, iron bars were used at least a century earlier by architects in Italy for reinforcing the molded statuary in parks and gardens (e.g. statuary groups in Ville d'Este at Tivoli). In 1865, Francois Coignet explained the principles of reinforcing beams, slabs, arches, etc. and in 1869 took out a patent on the process. In the same year, F. Joseph Monier took out patents covering many of the details of this new form of construction, and he has sometimes been called the "father" of reinforced concrete. He was a gardener and

used the device for decreasing the thickness of walls, reservoirs, etc. by reinforcing them with a trellis of iron.

While the French and German engineers were developing Monier's method of reinforcement, American engineers began a more scientific study of the new process, and W. E. Ward, who began placing rods in the bottom of his beams and slabs in 1875, was probably one of the first to get the correct conception of the function of the steel. Various systems of reinforcement were developed by different engineers to which the names of the inventors have been attached.

The studies that probably have done the most to place reinforced concrete construction on a scientific basis were the investigations made at the University of Illinois, University of Wisconsin and other laboratories, for they have revealed the character and behavior of beams, columns and slabs, and reduced the principles involved to formulas and laws that can be applied in practical design.

The development of the masonry arch has been one of the notable achievements in engineering. Until the last quarter of the last century, in the main the arch had been built empirically, although various theories had been proposed which purported to explain the nature of arch action. Indeed, arches of considerable length had been built in this empirical fashion, such as the highway arch at Trezzo, Italy, with a span of 251 ft. built in 1377, the Claix, France, highway bridge, built in 1611 with a span of 150 ft., and the Maidenhead railway bridge built in 1838 with a span of 128 ft.

The *Elastic Theory* of arch action, developed at the close of the last century, is one of the most notable contributions to the design of masonry structures. This theory, developed chiefly through the contributions of British, German, and French engineers, was first applied to steel arches and later to fixed masonry arches, in which application various American as well as foreign engineers contributed. The elastic theory brought confidence in the design of fixed arches with a resultant economy in design and a wider application to the construction of bridges, dams, conduits, and other structures.

It is not necessary in this brief paragraph to point out the contributions to the science of masonry construction made by the many bold-spirited engineers who led the way in constructing the many structures of record size, and of those who rendered

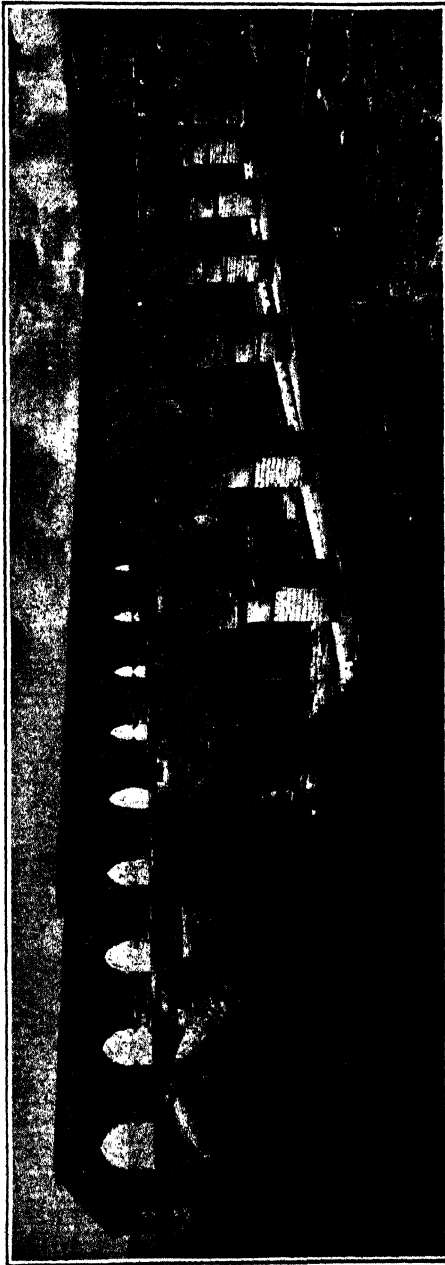

FIG. 1.—Pont du Gard, near Nîmes, France.

possible the splendid achievements in engineering by developing foundation processes that would furnish support adequate to the loads that were unavoidable in the successful carrying out of such construction. Enough has been said, perhaps, to indicate the gradual growth of masonry construction processes and to show the gradual emergence of the science from the empirical art, an evolution that is entirely analogous to that of nearly every other phase of engineering science.

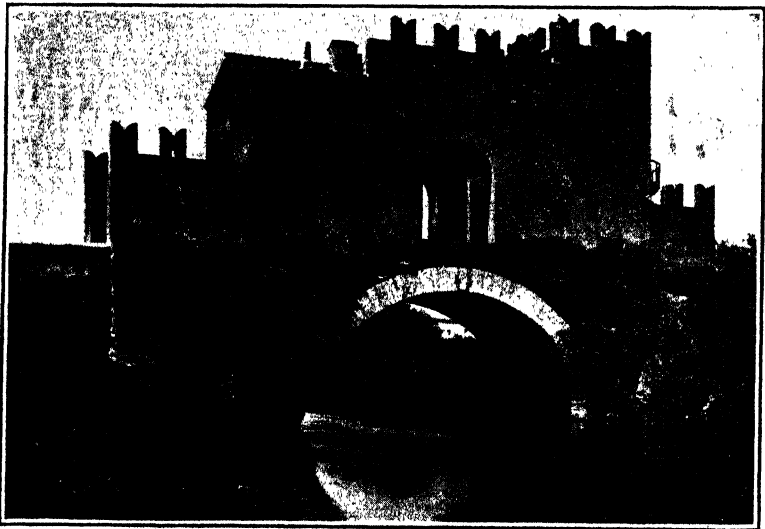

FIG. 2.—An Old Roman Bridge over a Branch of the Tiber River.

Historic Masonry Structures.—The permanence of masonry construction is illustrated in the many structures remaining from the days of the Greeks and Romans, who were primarily masonry builders. Figure 1 shows the famous Pont du Gard, an aqueduct built across the Gard river near Nimes, France, about 17 miles from Avignon. It consists of three tiers of arches, the total height being about 161 ft. and the length about 884 ft. It was built about 15 B.C. and was laid without mortar, although the aqueduct itself is lined with cement mortar, which is still very hard and in fair condition. The channel, which is located above the top tier of arches, is about $2\frac{1}{2}$ by 5 ft. in cross section and is covered with flat stones about 3 by 12 ft. in size and 14 in. thick.

A well preserved cement concrete bridge along the famous

Amalfi Drive in Italy, near Naples, built in about the sixth century A.D. well illustrates the durability of this type of construction.

The arch ring of the bridge shown in Fig. 2, a bridge over a branch of the Tiber near Rome is nearly 2,000 years old, although the superstructure is of a later date, about 1475.

Figure 3 shows the Cloaca Maxima, or Great Sewer, built about 700 B.C. which still drains the area between the Palatine and Capitoline Hills occupied in part by the old Roman Forum.



FIG. 3.—The Cloaca Maxima.

It is about $10\frac{1}{2}$ ft. wide and 14 ft. high, although nearly submerged at present by the deposit along the shore of the Tiber. The arch consists of three rings of "peperino" voussoirs carefully shaped and the remainder is built of tufa and peperino.

The permanence of the brick masonry built by the Romans is illustrated in Fig. 4 which shows a corridor of the Palace of Caligula built 37 A.D. These bricks were burned in kilns (a device invented by the Romans) similar to those in use today and were comparable in quality to modern bricks.

Factors Affecting the Design of Structures.—A structure is well designed if it meets the needs of the situation com-

10 DESIGN OF MASONRY STRUCTURES AND FOUNDATIONS

pletely at a minimum cost. In order that it may do this, all factors and conditions affecting the design must be taken into consideration. As indicated in a previous paragraph, not only the loadings to which the structure will be immediately subjected must be considered, but the function of the structure as related to the primary project of which it is a part, and the possible changes in conditions at a future time, should be considered as well.



FIG. 4.—Corridor in the Palace of Caligula.

In general, the choice of type of structure as well as the general features of the design will be determined by the following considerations:

1. Adequacy
 - (a) Stability
 - (b) Performance of function
2. Economy
 - (a) Initial cost
 - (b) Relative permanence
 - (c) Maintenance cost
3. Legal requirements
 - (a) Federal
 - (b) State
 - (c) Municipal
4. Aesthetics
 - (a) Harmony
 - (b) Proportions
 - (c) Ornamentation

Which of these primary factors is most important will depend upon the circumstances in any particular case. Usually stability

will be of primary importance, but where human life is not at stake and possible loss resulting from failure is measurable in dollars, designing for extreme conditions may not be desirable because of the greater cost involved. The possible loss would perhaps not pay for the added cost of construction required to secure complete stability. On the other hand, where a failure would result in loss of life, absolute stability should be made the paramount consideration. In setting off expense against architectural treatment a wider variance of opinion may arise.

Adequacy.—In general, any structure should be designed so as to be stable under the loads and forces to which it may be subjected with a reasonable margin, or factor of safety. This factor of safety is chiefly an “ignorance coefficient” and is intended to provide for the unknown features of the loadings and forces to which the structure may be subjected and also for the variability in the quality of the structural materials used. What this factor should be depends upon circumstances; the greater certainty with which the factors of design are known, the more nearly may the resisting capacity be made equal to the forces encountered. The conditions of stability for different types of masonry structures will constitute the bulk of the succeeding chapters, and the appropriate margin of safety will be discussed in each case.

A structure should be adequate to perform the function required of it, in addition to being stable under the loads to which it is subjected. Masonry structures seldom constitute a project in themselves but are usually a secondary part of a larger project designed for some economic use. Thus, a dam may be a part of a water supply, irrigation system, or river improvement; a retaining wall may support an earth fill on which a factory carrying heavy machinery may rest; a bridge may be a part of a highway or a railway; a bin may be a part of a large storage plant for grain, coal, ore or crushed stone; a chimney is always a subsidiary part of an industrial plant of some sort; and foundations are inherently a subsidiary part of some principal structure. The design of masonry structures should contemplate, therefore, not only the immediate loading and other conditions, but should take into consideration the complete relationship between the structure and the primary project of which it is a contributing part in order that it may perform properly the function required of it in the realization of the purpose of the primary project.

Whether a structure should be designed for the most severe conditions that may possibly come upon it depends upon the circumstances. Where human life is at stake, of course, nothing should be lacking to make a structure as secure as possible, but frequently a failure or partial failure would involve nothing more than a money or economic loss in the event that it should occur. In such a case, there is a limit to the amount that can be spent to provide for the extreme contingency, which may never happen. In general, from a strictly economic point of view, if L represents the loss that would occur in the event that the extreme conditions should occur, and $1/N$, the probability of its occurrence, then L/N represents the total outlay that would be justified in preventing the loss by providing for the extreme conditions.

The interest on the fixed investment where provision is made for extreme conditions may be so great as to render extreme conservatism unwise. For example, \$1 at 6 per cent compound interest amounts to \$18.42 in 50 years and \$339.30 in 100 years, hence, to provide for a condition that will occur in 50 years, the investment of \$1 in the initial cost must save \$18.42 at the time the contingency occurs, or \$339.30 in the case of a contingency occurring in 100 years. Thus if loads are to be doubled in 50 years, the investment of \$1,000 could be made at the time of initial construction as easily as \$18,420 at the end of 50 years, according to this basis. However, the added depreciation and maintenance of the structure during the 50 years would greatly alter the above numerical relation, and therefore, only the general reasoning holds true.

Because of the durability of masonry structures, possible future changes in the conditions affecting design should be taken into consideration. These changes may be either physical or economic, the latter being usually related to the function of the major project of which the masonry structure forms a part. For example, the design of a culvert or bridge abutment for a railroad, which would not admit of an extension for a second track would be a serious error when a study of conditions would indicate the necessity of a second track in the near future.

Permanence of Masonry Structures.—When properly designed, to provide for both physical and economic conditions, both of the present and of the future, masonry structures constitute the most permanent type of construction that an engineer can build. Yet an erroneous impression is sometimes created by ascribing

the term *permanent* to masonry or to any other type of construction, because other considerations than that of durability enter into the account. The failures of dams, retaining walls, reinforced concrete buildings, conduits, etc. indicate that one cause of a lack of permanence is the lack of knowledge concerning the behavior of the materials and more particularly concerning the character and magnitude of the forces and other conditions to which the structure may be subjected.

Another factor enters to limit the life of a structure, and that is the fact that a structure built for existing conditions may become obsolete in type or inadequate in capacity. A bridge may be required to carry heavy traction engines or other loads which were not contemplated when it was built; a retaining wall may have to support a live load on the embankment that was not provided for in the design, etc. A dam may not be needed in a certain place because the need for impounded water at that place may have ceased; bins, chimneys, etc. may cease to be needed where they are built, and owing to the impracticability of moving them, their life is limited, although they may be in unimpaired physical condition. The author assisted in the removal of a stone arch railroad bridge which was unimpaired so far as its physical condition was concerned, but it had become inadequate to carry the increased traffic required of it.

In estimating the life of a structure, therefore, the factor of permanence should be used with caution. While the expected life of a structure as determined by the durability might be measured in centuries, a study of the life histories of masonry structures indicates that not more than 30 to 50 years should be assigned to many masonry structures when comparing their permanency with other types of construction.

While it is true that the term "permanent structure" may be misleading, as indicated above, it is also a fact that masonry structures as a class are the most permanent of all so far as permanency is dependent upon deterioration of materials, or resistance to erosion and fire. Where deterioration is the only factor to be considered in determining the life of a structure, we may say that masonry structures last indefinitely, for many of those built in medieval, and even in ancient times, are either in a fair state of preservation at the present time, or would have been had they been properly maintained. While 10 to 15 years is about the average length of useful life of timber structures, 15 to 30 years

that of steel, 30 to 75 years may be rationally assigned to the life of masonry structures in estimating relative economy. However, in this connection, attention should be called to the effect of climatic conditions on permanence, as exemplified in the comparatively rapid deterioration in a few years of the obelisk in the humid climate of New York following its removal to Central Park after it had stood for several milleniums in Egypt. Instances of this same situation may be found in the deterioration of Bunker Hill monument, a granite structure, and in the Houses of Parliament, built of stone recommended by the best authorities of the time, due to the adverse climatic conditions of those localities.

Maintenance of Masonry Structures.—In general, the maintenance costs for masonry structures are lower than for any other class of construction. The materials of masonry are not subject to rust nor decay; neither fungi, borers nor bacteria act on them; they consist for the most part of stable chemical compounds and therefore are not readily altered by chemical action; they do not require painting or other protective coating; the fire hazard is reduced to a minimum if not obviated entirely. About the only sources of deterioration in masonry structures, where they are well constructed, are erosion by water or sand, disintegration by frost action and abrasion by traffic where they are subjected to such wear. Brickwork and stone masonry require repointing occasionally, coping stones sometimes become displaced, and efflorescence may need to be scrubbed off at times, but the total of these is comparatively small.

While it is the practice in America to clean masonry structures occasionally, it is the custom quite generally in European countries to permit discoloration to continue on the ground that the appearance of the structure is mellowed and improved thereby, and it is doubtless true that the British Museum, Notre Dame and other structures are more beautiful than if they presented a glistening fresh masonry appearance. Whether such structures are kept scrubbed clean or not, the cost of maintenance is not high.

A mason with two helpers should clean and point about 60 to 75 sq. ft. per hour with a cost of materials of perhaps half a cent per square foot. Even unskilled workmen can scrub with a wire brush and acid efflorescence or other discoloration from masonry surfaces at the rate of 25 to 30 sq. ft. per man per hour.

Economy of Design.—The relative economy of different types of structures is not determined by comparing their first costs, but by comparing the total annual costs of the various types. The total annual cost includes three items,

1. Interest on the initial cost
2. Maintenance charge
3. An annuity which at the end of the life of the structure will produce a sum sufficient to reproduce the structure.

Thus, if C is the total annual cost, I , the initial cost (or reproduction cost), r the rate of interest, M the annual maintenance cost including repairs and renewals, A the annuity which will amount to a sum at the end of the life of the structure sufficient to reproduce the structure, the annual cost will be

$$C = Ir + M + A$$

The annuity, A , is the amount that will have to be put out at compound interest annually to produce the original cost, or rather the reproduction cost in most cases, at the end of the natural life of the structure and amounts to $\frac{Ir}{(r+1)^N - 1}$ where N is the length of life of the structure in years. This expression is obtained as follows: Let $R = r + 1$,

The amount at the end of the first year is A

The amount at the end of the second year is $A + AR$

The amount at the end of the third year is $A + AR + AR^2$

The amount at the end of the fourth year is $A + AR^2 + AR^3$

The amount at the end of the N th year is $A + AR + AR^2 + AR^3 + \dots + AR^{N-1}$

$$I = A + AR + AR^2 + \dots + AR^{N-1} \quad (1)$$

$$IR = AR + AR^2 + AR^3 + \dots + AR^N \quad (2)$$

Subtracting (1) from (2),

$$I(R - 1) = AR^N - A,$$

whence,

$$A = \frac{I(R - 1)}{R^N - 1} \quad \text{or,} \quad A = \frac{Ir}{(r + 1)^N - 1}$$

Tables giving values of the annuity, A , applicable to ordinary conditions, can be found in various engineering handbooks.

The initial cost of a structure includes not only the direct outlay

of funds but interest charges during construction usually averaged as half the total cost over the construction period, and the loss resulting from the unavailability of the structure during construction. The relative importance of these items obviously depends on circumstances, such as the facilities for construction, the urgency of need for the structure, etc., but in general, masonry structures will be constructed more slowly than steel structures. Damages to abutting property and to other parties who may be inconvenienced during construction should also be charged against initial cost, the latter consideration applying chiefly to other commercial interests such as other railroads and shipping. Insurance during construction also constitutes a proper charge to the initial cost of a structure, and so does contractor's profit, the amount of which items is so variable as to preclude extended discussion in this connection.

In matters pertaining to the economy of design, attention should be given to a judicious proportioning of labor and materials costs. Complicated form work, additional excavation, or difficult placing of material may so add to labor costs as to more than counterbalance any saving in materials that may be effected by fine points in design. On the other hand, thought on the part of the designer may save many man-hours of labor and cubic yards of material in the field and thus produce a net saving in the cost of construction.

Economy of design as affected by the details of design will be discussed in connection with the various classes of structures treated in the subsequent chapters.

Economy of Construction.—Economy of construction depends largely upon four factors, viz., (1) organization of the working force, (2) system in laying out the work, (3) skilful handling of labor, and (4) economical handling of materials.

Care should be exercised in forming the organization of a construction force in order that it may be most effective. The function and limits of authority of each superintendent and foreman and of all assistants should be as completely defined as possible and this definition of the province of each should be understood by everyone concerned. In a large organization especially, much loss of effort and of morale results from not knowing where to go nor whom to address for an authoritative decision. A diagrammatic scheme or chart of the organization should be made up which will show the relationships of depart-

ments, superintendents, foremen, etc. and these should be posted or distributed so that all concerned may be fully informed.

Before construction is begun, a complete program or schedule of the work should be formulated providing for the dates of beginning and finishing each operation and portion of the work, the number of employees that will be required, schedule of the arrival of materials, etc. This schedule should be formulated with the utmost accuracy practicable and then adhered to entirely, unless some totally unforeseeable event should occur to disarrange it. It should be posted or made available to everyone in authority on the work.

Much has been written about the efficient handling of labor and only a word can be said here to call attention to the importance of giving this phase of construction the most careful thought. It may be taken as axiomatic that laborers cannot nor will not work efficiently if they are overworked, underfed, poorly housed, their families inadequately provided for, if they are neglected in the case of sickness or injury, and do not have reasonably agreeable surroundings while at work and during leisure hours as well. Niggardliness in these regards as well as in wage rates seldom results in economy, for what is saved in wages is lost in labor turnover. When it is realized that it costs \$50 or more as a minimum to let an experienced workman go and to train another, the importance of keeping the labor turnover to the lowest proportions possible becomes apparent.

Perhaps in no other respect will systematic planning bring economy to a greater degree than in the handling of materials. Before any materials begin to arrive on the site of the work, a comprehensive scheme of storage and handling should be formed and this should be adhered to throughout the progress of the work. Form lumber and construction timbers should be systematically piled, reinforcing steel should be classified and placed on racks with easy access; aggregate, sand and cement should be placed so as to be conveniently transported to the mixer. Systematic handling of materials will minimize waste and thereby reduce cost of construction. Provision for convenient inspection should be made.

The use of gasoline engines, electric motors, or horse power should be substituted for man power wherever possible, for the former will perform work at a small fraction of the cost of the same by mere man power. The use of cranes, hoists, power

loaders, conveyors, trucks, etc., on work of some magnitude will almost always be found economical. Power machinery is, thus, economically used in handling concrete materials and the mixed concrete, in preparing forms, in cutting stone, and in conveying stone, brick, and mortar. The employment of a central mixing plant for concrete on large work is generally economical.

Legal Requirements Affecting Design.—In the design of any structure, the possible features necessary to meet legal requirements should be carefully considered. This applies particularly to structures along navigable streams and to a less extent to construction on any stream of water. Obstructions to streams which interfere with the normal carrying capacity of the stream bed may bring damages to owners whose property may be inundated by backwater, and structures are legally required to be adequate to care for normal freshets, although perhaps not for extraordinary floods. Any construction along navigable streams must have the approval of the War Department. No structure should be so placed as to divert the stream against a bank and cause cutting, else damage claims may result.

Legal complications are particularly likely to arise in construction in cities where obstruction of traffic, failure to give lateral support during excavation for foundations, damage to adjacent property, etc., are avoided only with difficulty in most cases.

Aesthetics of Design.—Masonry structures are especially well adapted to aesthetic treatment in their design. Much as a bird with its feathers, because of the harmony and graceful continuity of outlines, is more beautiful than a plucked bird, or a body with flesh is more sightly than a skeleton, so masonry structures, because of the fullness of contour, are more pleasing in appearance than angular frames of steel or of timber. Probably the continual observance of rounded outlines formed by erosion on the earth's surface, of the natural curved shapes of the bodies of animals and of stems, leaves and petals of plants, has so accustomed the human eye to this standard of form that angularity appears unsightly and ugly. Therefore, while there are no fixed canons of taste and beauty, those designs are generally most pleasing that are in harmony with Nature's outlines.

Usually good architectural treatment of structures is entirely compatible with strength and economy of construction and can be obtained by giving attention to the matter in the course of

design, without appreciable increase in the total cost. In those cases where special treatment and finish may be desired in order to improve the appearance of a structure, not more than 2 to 5 per cent will be added to the cost required of a strictly utilitarian structure built merely to perform the function desired, and expenditure of such an amount is justifiable, especially where the structure involved will be subjected to the public gaze.

On the other hand, so called architectural treatment is often overdone. Not infrequently one sees a railroad station, a water-works pump house, or a car barn built after the fashion of a Greek (or pseudo-Greek) temple, a Gothic cathedral, or a Spanish mission house. While the building itself may be more pleasing to the eye than a severely plain structure, when taken in connection with the purpose for which it was designed, its appearance becomes oppressive in the extreme. Many of the older bridges of Europe are ornamented with statuary and allegorical figures which have no logical connection whatever with the purpose of the structure and therefore weary one rather than please. Excessive ornamentation, therefore, is not only in bad taste, but if unrelated to the nature of the structure, becomes a source of chagrin rather than of pleasure.

As observed above, no general rules can be formulated that can be followed infallibly in securing good architectural treatment. However, although the primary factor in securing good treatment is proper proportioning a judicious use of curved fillets and other devices to obliterate angles and corners, securing continuity of outline by means of arches and curved beams, breaking up monotonous plane surfaces by paneling, finishing facades with parapets, corbels or other device, and other variations and schemes of relief, and a careful study of the lines of the structure to avoid confusion and to secure simplicity, will be found applicable to structures that are too commonly built with unpleasing effect. Indeed, with good proportions given, attention to such details may raise a structure from the plane of mediocrity, if not positive unsightliness, to one of grace and beauty.

Principles of Good Design.—The following general principles of composition in design as formulated by J. B. Robinson,¹ John Ruskin and others, are suggestive in securing a pleasing appearance. They are listed here in outline only, as an extended

¹ J. B. ROBINSON, "Architectural Composition."

exposition with examples would be required to explain the significance of each.

1. *Decisiveness and Frankness.*—The structure should be either symmetrical or decidedly unsymmetrical, that is, not undecided. Asymmetrical structures should have the lines of perspective pronounced. Panels should either be square or decidedly oblong. A series of features should be exactly in rows or decidedly out of row.

2. *Character.*—That is, the structure should show the purpose for which it was constructed.

3. *Sincerity and Truth.*—Ruskin gives as the three chief deceits in construction as (a) the suggestion of modes of support other than the true ones, (b) the painting of surfaces to represent some other material than the real one, (c) the use of cast or machine molded ornaments.

4. *Simplicity.*—A structure should be comprehensible at a glance and should not contain details understood only by the initiated.

5. *Unity of Lines.*—There should be a unity of lines. Either horizontal or vertical lines should be accentuated. A medley of lines running in various directions distracts the eye, for the eye naturally seeks to find a way through the maze.

6. *Structural lines* close together give an impression of delicacy, whereas, lines more widely spaced give an idea of robustness and strength. The former gives an impression of artificiality while the latter is more rustic.

7. *Breaking up the monotony* of large plain surfaces by corbeling or other device rests the eye and improves the shadow effect. Heavy cornices, corbels and other projections with the resulting deep shadow effects give the impression of strength and of ruggedness.

8. *Grace of outline* should be sought rather than the heaviness of mediaeval fortifications.

9. *A structure should fit* into its surroundings of landscape and existing structures. In general, nature's outlines are pleasing and should be taken into account and changed only after very careful consideration. For example, a delicately ornamented masonry bridge in the rugged surroundings of the Rocky mountains, where a bold and massive structure is demanded, would be as inappropriate as a plain arch bridge would be in a viaduct over a city street or in a city park where refinement is expected.

Harmony with neighboring structures is scarcely less important than with natural setting.

10. *The parts of a structure* should bear proper proportion to the whole. Primary masses should be visibly connected and should have a logical relation to each other.

11. *Ornamentation* should be used sparingly. Ruskin said: "Decorate construction without constructing decoration." Ornament should not seem to be added to a structure for the sake of ornament, but should be an integral purposeful part of the structure. Features of ornament should be of sufficient size to be seen at the distance from which they will be viewed.

12. *Special arrangements of colors* should be used cautiously. Strong colors are likely to prove unsatisfactory. Harmony of color is more important than is any single color feature.

The introduction of concrete has radically affected architectural design. F. L. Ackerman, Fellow, Am. Inst. Arch., interestingly points out¹ that, just as the early passenger coach and automobile designers were hampered in their ideas of form by the impression that what they were building was a substitute for horse-drawn vehicles and should be fashioned after them, so designers of concrete structures have had to outgrow the handicap of the feeling that concrete is a substitute for wood or stone. He quotes Beresford Pite, F. R. I. B. A., in the same vein eloquently as follows:²

"The door is opened. The designer is no longer in a stonework prison. The realization of the possibility of the deliverance from ideal proportions established in masonry by the substitution of reinforced concrete is the taking of a very considerable step in the path of architectural progress. The dead hand of the past has been lifted from architecture: Renaissance is no longer its aim. We are marching to a dawn; but it is not of the long-set sun of classical precedent—it is the light of an entirely new science of building, that glorious adventure is to be sought."

Mr. Ackerman further says:

"We must not overlook the fact that the traditional divisions of architectural composition were derived from properties of the materials used. And the traditional forms of architecture with which we are familiar grew out of the necessity of acknowledging such things as the limiting dimensions of materials available, convenient size, shape, and

¹ *Proc. Am. Concrete Inst.*, vol. 23, p. 257.

² *Ibid.*, p. 267.

weight to handle under handicraft technique, hardness, durability, limiting strength. These played a definite part in giving form and character to whatever was built."

He then points out the essentially new character of concrete and its possibilities as a plastic moldable material, and continues:

"To state the broad outline of the theory of form building we have: The form should be composed of simple planes such as would enclose the volumes required by our structural theory and as dictated by our general concept of what should constitute the mass as a whole. That is to say, our mass would be conceived in terms of simple planes. This gives us obviously something quite different from architectural examples previously referred to.

"Our simple masses may be modified in silhouette and in surface treatment in an endless variety of ways and for reasons that have little or no bearing upon the structural theory from which we derived our masses. Refinement and embellishment fall within the scope of concrete the same as other materials. We may properly introduce lines, secondary planes, and ornamentation. . . . And so whatever we do to achieve variety and interest must commend itself as a perfectly rational procedure with respect to the building itself.

"Without going into the details of form building, we may mention a few steps which would constitute a rational procedure. By secondary forms built into the angles of our preparatory structure, we may produce chamfers of endless variety and detail. Thus, the silhouette of piers may be modified and shaped to our aims. In the same way, the enrichment of openings—doors, windows, rectangular and arched—may be secured. These secondary forms in no wise complicate the construction of our primary form; nor do they weaken it. They strengthen the form and at the same time eliminate the sharp arrisses from the structure."

In conclusion, the desirability of making a careful study of a proposed structure relative to its surroundings may be urged. An architectural rendering may be made showing the structure sketched in its setting. A very effective device for use in this connection in showing a structure in its proposed setting is to photograph the landscape, draw in the proposed structure on the print using the perspective of the camera, and then re-photograph the whole. Remarkably realistic effects can be secured in this manner. By such means as above mentioned the features that are out of harmony with the surroundings can be detected and corrected.

CHAPTER II

MASONRY LAID IN MORTAR

Introduction.—Masonry consisting of natural stone or brick laid in mortar was formerly synonymous with the term masonry, but in recent years, the use of concrete has overshadowed the older type to such an extent that concrete has almost become synonymous with masonry instead. However, in many instances natural stone, brick or cement block construction may have a proper place in the engineer's consideration. Where suitable stone is near at hand, stone masonry may be more economical than concrete, and where special architectural effects are required, it may be desirable, even though more expensive.

To a comparatively limited extent in America, but to a very great extent in England and some other European countries, brick masonry is used for bridge abutments and piers, for arch bridges in highway and railway construction and retaining walls, as well as for buildings, and in many instances may be very properly considered by the engineer as an alternative with concrete or with stone masonry. One eminent engineer stated that he could not see the economy of breaking up stone in order to cement it together again in construction. However, the facility with which hand labor is replaced by machine labor in handling concrete usually makes concrete masonry the more economical.

The relative merits of the different kinds of masonry depend on the circumstances of each individual case and no general statement of the superiority of one kind over another can be made that will be universally applicable.

Mortar.—Mortar for use in masonry construction consists of sand or finely crushed rock mixed with a cementing paste which hardens in time. The cementing paste may be either lime paste or hydraulic cement paste, the latter being almost exclusively used at the present time. The proportions commonly used are 1:2 or 1:3 for lime or portland cement and about 1:1 or 1:2 for natural cement. After the cementing paste has set up and

hardened, the mortar becomes essentially an artificial sandstone with a calcareous binder. The characteristics of sand and of hydraulic cement will be taken up in a succeeding chapter on cement concrete, and only a brief statement of the properties of lime mortar will be given here.

Lime.—Lime is manufactured by calcining limestone at high heat (925° C.), the character of the product depending upon the composition of the natural stone. Pure limestone would be calcium carbonate (CaCO_3). Except as the mineral calcite, it seldom is found in this pure form, but has various impurities, such as magnesium carbonate, silica (SiO_2), alumina (Al_2O_3), or iron oxide (Fe_2O_3).

Where the impurities do not exceed about 10 per cent, the product is sold as "quick lime" or "pure lime" or "high calcium lime." Quick lime is calcium oxide (CaO) and when treated with water forms calcium hydroxide, which on exposure to air takes on carbon dioxide thereby returning to the form of calcium carbonate. The process of forming the hydroxide is known as "slaking," and is accompanied by the liberation of heat.

Magnesian limestones are composed of calcium and magnesium carbonates in various proportions and the resulting lime has variable characteristics accordingly. When the proportions are equal, the limestone is called dolomite ($\text{CaCO}_3 \cdot \text{MgCO}_3$). Lime made from magnesian limestones is called "magnesian lime," the term being applied where the magnesia amounts to more than 5 per cent, although it usually runs considerably higher than this proportion. Magnesian lime slakes more slowly, sets more rapidly and forms a stronger mortar than does quick lime.

When the other ingredients mentioned above are found in lime to a considerable extent, the latter takes on the property of setting up with water even in the absence of air and the material becomes hydraulic lime, or hydraulic cement, depending on the proportions, which cements will be considered in a subsequent chapter.

Gypsum Cements.—In addition to the limes, there is a series of cements derived from gypsum, calcium sulphate (CaSO_4), the chief of which is plaster of paris. When gypsum is heated, water of hydration is given off, leaving the anhydrous sulphate; then when water is added, it rehydrates and forms gypsum again, a substance with a certain degree of strength and hardness. Various other plasters are made from gypsum, but they depend essentially on this same property.

Strength of Mortar.—With a given cement and sand, the strength of mortar depends on the richness, density and consistency of the mixture.

1. Other factors remaining constant, the richer the mixture, the stronger the mortar.

2. Other factors remaining constant, the denser the mixture, the stronger the mortar.

3. Other factors remaining constant, a plastic consistency produces a mortar of greatest strength.

4. The adhesive strength of mortar varies with the absorption of the surface to which it is applied.¹

The density, and hence the strength, of a mortar is dependent largely upon the gradation of the sand. Sand with approximately a uniform gradation but having an excess of coarse particles yields the densest and therefore the strongest mortar. See Fig. 12. Very fine sand and sand of uniform size generally yield a weak mortar. Mortars gain strength rapidly for the first 3 days, then more slowly up to about 6 months, and then either remain practically constant or decrease slightly.

Hydrated lime up to about 10 or 15 per cent increases the strength of a lean mortar and facilitates spreading the mortar in a bed. A small amount of clay, under about 7 per cent, has little or no effect on the strength of mortar, and may actually increase the strength of a lean mortar. The presence of mica in sand is deleterious, 10 per cent reducing the strength of the mortar about one third.² Any organic matter present decreases the strength of the mortar and may cause disintegration.

Re-gaging or re-tempering mortar, i.e. adding water and mixing after initial set has begun, does not materially decrease the strength of portland cement mortar, if done within two hours, but does greatly weaken natural cement mortar.

A. STONE MASONRY

Elements of Stone Masonry.—The strength, durability and other properties of stone masonry depend on four elements, viz., the stone, the mortar, the class of masonry and the workmanship in laying. In general, masonry should be laid so that these elements affect the final result consistently and no one of them constitutes the "weakest part." With lime mortar, the

¹ *Proc. Am. Soc. for Testing Materials*, vol. 8, p. 529.

² *Engineering News*, Feb. 6, 1908.

strength will depend usually upon the mortar, but frequently with hydraulic cement mortar, the stone may be so inferior as to limit the strength of the whole, and not infrequently poor workmanship will produce poor results even with good materials. Particularly in rubble and other classes of masonry in which the mortar constitutes a considerable part of the whole volume, the mortar and the workmanship will be the determining factors. In any case, the importance of these elements should be well understood and the design and construction carried on with due regard to the effect that they may have on the finished work.

Classification of Building Stones.—Building stones are classified according to their mineralogical constituents into three groups: (1) *argillaceous*, or those that have alumina compounds such as clay, shale and slate for predominating elements; (2) *calcareous*, including those whose chief constituent is the carbonate of calcium, or lime, such as limestone, or marble; (3) *siliceous*, consisting of those rocks whose chief constituent is silica or quartz, e.g., granite, quartzite, sandstone, etc.

With reference to their geological formation, rocks are classified as (1) igneous, (2) sedimentary and (3) metamorphic. Igneous rocks are those which were formed by the solidification of molten or plastic rock substance; they may be wholly or partially crystalline, as granite, dacite, etc., or they may be entirely free from crystals, as obsidian. This class includes two principal groups, of value in building construction, although there are others of less value: (1) The granites and related stones such as rhyolite, syenite, and others, and (2) the group frequently called trap rock by engineers, which group comprises several geologic classes, including basalt, gabbro, diabase, dacite, andesite, etc. The rocks in this latter group are not widely used owing to the difficulty of working them. In addition to these, there are rocks of the igneous class such as serpentine, peridotite, and others that are frequently used for ornamental purposes, for veneering walls and columns, etc. but they are not sufficiently strong or durable to justify their use where they will be exposed to the weather.

Sedimentary rocks comprise those that have been formed from previously existing rocks and materials, and have been brought to their present form and position by various agencies, such as water, wind, life, chemical precipitation, etc. They may be classified as:

1. Sand and gravel, or arenaceous, rocks—sandstone
2. Clay rock, or argillaceous—shale, soapstone
3. Lime, or calcareous rock—limestone, dolomite, chalk
4. Siliceous—flint, chert
5. Rocks chiefly chemical precipitates—travertine, onyx.

Metamorphic rocks are those that have been formed from previously existing rocks chiefly by pressure and heat being applied due to changes within the earth's surface.

Properties of Building Stones.—The qualities that may be desired in good building stone depend upon the character of the structure in which the stone is to be used and the conditions to which it will be exposed. The properties commonly required are (1) durability, (2) availability, (3) strength, (4) uniformity, (5) texture, (6) color, (7) susceptibility to polish. The order of the relative importance of these properties depends upon the use to be made of the stone. Generally for the loads that come upon it, stone has ample strength and durability, hence, availability affecting cheapness will most commonly be a controlling factor, although under peculiar conditions either durability or appearance may have prime consideration.

Durability.—All stones when exposed to the weather are subject to decay. Some stones which seem very durable in their natural beds prove susceptible to comparatively rapid deterioration when taken to other conditions of climate and exposure. Thus, Cleopatra's Needle, that had stood the mild climatic conditions of Egypt unimpaired for centuries, has shown marked signs of disintegration since being brought to Central Park in New York in 1880; and the Parliament Houses in London were constructed of a magnesium limestone which the leading authorities of that day pronounced durable, yet subjected to the gases and damp atmosphere of London, it has rapidly deteriorated. The life of building stones varies from a few years to centuries.

The agencies which may destroy building stones are (1) chemical disintegration, (2) freezing of water in the interstitial space and in crevices, (3) expansion of crystallizing salts in such spaces, (4) erosion due to water, wind and ice, (5) abrasion under wear, (6) expansion and contraction due to temperature changes, (7) heat from fire.

Chemical disintegration may result from weathering of certain elements, such as the crumbling of granite due to the decomposition of the feldspar constituent; from the dissolving of

constituents in dilute acids, e.g. the dissolving of limestone by carbonic acid or sulphuric acid in water, or the action of gaseous acids resulting from the combustion of coal, etc. When a more resistant material is cemented together by one readily yielding to the attack of acid or other agency, of course the stone crumbles when the cementing material is destroyed. A dolomitic limestone for a similar reason is generally more durable than a pure limestone because it does not yield so readily to the attack of acids. There is no reliable test of general application by which the resistance of stone to chemical action may be determined. A careful study of the constituent minerals and their probable action when exposed to the conditions surrounding the proposed structure is the safest guide in this respect. Observations on the behavior of the stone in question when subjected to similar conditions are also desirable where they can be made.

Frost deterioration results when water enters the interstitial spaces and crevices of a rock and freezes, thereby exerting a disruptive force. Other things being equal, the stone having the lowest water absorption will be the least affected by frost action, hence, the absorptive capacity of a stone is roughly a measure of its resistance to frost action. The following data show about average percentages of absorption.

	PER CENT
Granite.....	0.001 to 0.4
Sandstone.....	2 to 3
Limestone.....	4 to 5
Marble.....	0.01 to 0.6
Slate	0.01 to 0.4

The laboratory test most commonly used to determine the frost resistance of a stone consists of subjecting prepared specimens that have been carefully weighed to alternate freezing and thawing by means of freezing mixtures and observing the effects. The effects may be (a) the formation of cracks, (b) the detaching of grains from the surface causing loss of weight, and (c) loss of strength when subjected to crushing tests. An artificial simulation of the freezing and thawing test known as Brard's test consists of boiling carefully weighed specimens in a solution of sodium sulphate and then allowing this salt to crystallize in the pore space of the stone causing an expansive action similar to that of freezing. Brard's test is usually more severe than the actual freezing and thawing test and is less reliable.

Disintegration due to crystallization of soluble salts is very closely akin to the effects of freezing and thawing. In the western parts of the United States and elsewhere, the effect of alkali salts (sodium sulphate and sodium carbonate) is very marked in this respect, causing the foundations of structures to spall and scale off.

Resistance to erosion and abrasion is dependent largely upon the toughness and the hardness of the stone, both of which properties are capable of fairly satisfactory determination by standardized tests. While these tests need not be described here, it should be noted that the toughness test is measured by the resistance to a blow delivered under standard conditions and hardness by a standardized abrasion test. Stones subject to the wear of traffic such as door sills, floor slabs, etc., should have high value in this respect.

Expansion and contraction due to temperature changes may cause failure of stone masonry when adequate provision for such movement is not provided for, although utter failure from this cause is rare. Tests made at the Watertown Arsenal show the following values of the coefficient of thermal expansion of building stones:

Limestone.....	0.000,00375
Marble.....	0.000,00361 to 0.000,00562
Sandstone.....	0.000,00501 to 0.000,00526
Slate.....	0.000,00500
Granite.....	0.000,00311 to 0.000,00408

Fire resistance of masonry depends upon the nature of the stone used in construction, disintegration from exposure to fire temperatures being due to unequal expansion of heated exterior and cooler interior, spalling of heated surfaces from application of water, or by the calcining of some of the calcareous constituents. Because lime rocks are calcined at about 850° F., they are disintegrated at high heat, although below this temperature, they resist destruction from heat better than granitic stone. Professor W. E. McCourt concluded¹ from a series of tests on New York building stones that their order of refractoriness was in the order of sandstone, fine grained granite, limestone, coarse grained granite, gneiss and marble.

The *availability* of a building stone depends upon several factors, chief of which are (1) a wide range of occurrence, (2)

¹ U. S. Geol. Survey Bull. 370.

proximity of quarries to the site of construction, (3) ease of quarrying, (4) convenient transportation facilities, (5) ease of shaping and finishing. Local stones should always be investigated before stones from far distant quarries are resorted to, for by this procedure the cost of the structure may be greatly affected. The author has observed many instances of shipping stone from New England, Ohio, or elsewhere in the eastern part of the United States to the western region, when equally good stones were available locally had the architect or the engineer taken the trouble to investigate the situation.

Granitic and porphyritic stones are usually the most difficult to quarry while limestone is generally the easiest because of its stratification. Quartzite sandstone is nearly as difficult to work as granite. In general, stratified rock is more easily quarried and worked than the igneous unstratified, especially if the laminae are comparatively thin, and those formations are more easily worked where the strata are horizontal or nearly so than where the strata are steeply dipping.

A rock in its natural bed usually contains water, known as "quarry sap," which will evaporate while seasoning thereby increasing the hardness of the stone. Such stone should be worked while "green" because of the greater ease of cutting.

Strength and Weight.—A wide variation in the strength of building stones is to be expected, the strength of any one class being far from a definite quantity. In this respect, the sandstones probably exhibit the widest range of variation. Table I shows values of average strength, moduli of elasticity and weights of the chief classes of building stones. In making a test of the compressive strength of a stone, the shape of the test specimen has an appreciable effect on the results observed. Thus a specimen having the lateral dimension greater than the vertical shows greater strength than a cube, and a cube in turn shows greater strength than a prism having a vertical dimension two or three times the lateral. This difference arises from the mode of failure. Inasmuch as stone is weaker in tension and in shear than in compression, the failure is a combination of shear on diagonal planes and of tension at right angles to the applied load, and these latter stresses are relatively greater in the prism.

Most stones, particularly sandstones, also show a greater strength when tested with their natural bedding plane at right angles to the direction of application of the load than when

tested on edge. Tool-dressed specimens usually show less strength than sawed specimens, and stones saturated with water are not so strong as dry stone. As a general rule, for any class of stone, the densest and heaviest stones are the strongest.

Tests made on the building stones of Colorado under the author's direction indicated that the modulus of elasticity of certain stones increased with the load applied, contrary to the behavior of most structural materials. This property appeared to be particularly true with the crystalline stones, such as marble. Repeated applications of the stress, however, tended to destroy this relationship and to establish a constant modulus of elasticity within the elastic limit.

TABLE I.—STRENGTH AND WEIGHT OF BUILDING STONES
(Strength in pounds per square inch)

Stone	Weight, lb. per cu. ft.	Appar- ent sp. gr.	Compressive strength	Shear strength	Modulus of rupture	Modulus of elasticity
Granite.....	165	2.7	2,500- 38,000	1,700- 2,800	1,000- 3,000	2,000,000- 12,000,000
Sandstone.....	145	2.3	1,200- 25,000	1,100- 2,100	500- 3,000	1,000,000- 6,000,000
Limestone.....	156	2.6	3,000- 30,000	300- 2,500	2,500,000- 10,000,000
Marble.....	165	2.7	11,000- 25,000	1,100- 1,500	500- 2,500	3,000,000- 12,000,000
Trap.....	175	2.8	10,000- 24,000
Slate.....	175	2.8	14,000- 30,000	7,000- 11,000	5,000,000 20,000,000

The *apparent specific gravity* of a stone is the ratio of the weight of a given volume of the stone to an equal volume of water. In order to obtain the apparent specific gravity, the specimen should be dipped in hot paraffin before immersing. The *true specific gravity* of a stone is the specific gravity of the stone material or substance. It can only be found accurately by pulverizing the stone and finding the specific gravity of the stone particles in a specific gravity flask as for cement. If the stone is weighed dry and then again in water after it has been immersed long enough to become thoroughly saturated, an approximate value of the true specific gravity can be obtained by dividing the former weight by the difference in these weights.

The porosity can be calculated after the true specific gravity is

obtained by computing the weight of a measured volume having the true specific gravity of the stone, subtracting the observed weight of this volume from the computed weight if solid and dividing this difference by the computed weight.

Uniformity of Stone.—In order that a stone may be acceptable for building purposes, it is important that the quarry should be uniform in the character and quality of the stone furnished. It is not an infrequent occurrence to see a building that shows the effect of a lack of uniformity of stone, either as to color or texture, even though the stone was obtained all from the same quarry. This situation is especially likely to arise when additions are made.

Texture.—The texture of a stone refers to the grain, and may be described as coarse, medium or fine, regular or irregular. Sometimes other terms are used, particularly by geologists, such as *eye-grained*, meaning composed of large enough grains to be seen with the unaided eye, *lens-grained*, that is, requiring a lens in order to determine the grain, *porphyritic*, signifying that the rock consists of large grains in a finer grained ground-mass or magma.

Marbles vary in texture from the fine grained statuary marbles of Italy and Alabama to those so coarse grained as to be unsuitable for much architectural work. Sandstones may vary from a fine grain to a very coarse grain approaching a conglomerate. Fine grained stones are usually denser and more durable than coarse grained, this being particularly applicable to the granites. For ornamental work, a fine grained stone is almost essential.

Color.—The color of a stone for building purposes is important, and particularly the ability to retain its color unchanged. Whether a building has a dark gloomy appearance or a warm cheery aspect depends to a considerable extent upon the color of the stone selected for its construction. Red, grey and dark granites are available in nearly all shades. Limestone is usually white or grey, but owing to the admixture of iron and other impurities, it may be of almost any color. The chief coloring constituent of building stones is iron, which may be present in chemical composition with other elements, as in mica, hornblende or augite, or as free oxides and sulphides distributed in minute particles throughout the mass. The free oxides impart a brownish hue, the sulphides a bluish or greyish cast.

The chemical composition of the iron also determines the stabil-

ity of its color. The sulphide, carbonate, and protoxides are liable to oxidation thereby causing stains and other discoloration on exposure. The sesqui-oxide, on the other hand, is of stable composition and the resulting color is durable. Iron sulphide, etc., if in small particles and distributed throughout the mass, will not cause objectionable discoloration of stones for ordinary building purposes, but, if the particles are large, the staining will be uneven and unsightly. Generally, therefore, the red colors may be accepted as unchangeable. Marbles and other limestones are particularly susceptible to stain from iron content. The mottled marbles that are used so much for interior decoration are the result of the deposition of successive layers of rock from solutions containing various coloring impurities, chiefly of a carbonaceous nature.

Staining of Stone Masonry.—Stains on stone masonry may result from decomposition of certain mineral constituents, such as iron oxides and sulphides, the growth of algae, and from constituents of cement mortars used in joints.

A characteristic brown stain of certain limestones seems to result¹ from water dissolving alkali (sodium and potassium compounds) from the cement of the mortar, and these alkali solutions partially dissolving the organic matter remaining from the small shell-covered animals (foraminifera, etc.) whose remains compose the body of the stone. These alkaline solutions carry the dissolved organic matter to the surface where it is deposited upon evaporation.

Prevention of staining is generally more effective than cure. Care in the selection of the cement for mortar and the exclusion of percolating water are the most beneficial precautions. This stain, when exposed to the weather, naturally washes away in a few months and does not seem to be harmful to the building except to mar the appearance of the masonry when new. The stain can be scrubbed off with hot water or steam, but the process is expensive and usually not warranted.

Rust stains from iron brackets and other attachments can best be prevented by protecting against rust. Strong acids for removal of such stains should be used with caution, lest the stonework be injured.

When limestone is in contact with wet hardwood, a brown stain frequently results due to the absorption of tannic acid from

¹ *Univ. Purdue, Eng. Exp. Sta., Bull. 33.*

the wood. For this reason, sawdust or excelsior for shipping cut stone should be from pine timber rather than from hardwood.

Susceptibility to Polish.—The readiness with which a stone may be polished and the permanency of the polish depend chiefly on the texture and the character of the mineral constituents. A stone consisting of the same mineral throughout, or of different minerals of the same degree of hardness admits of a better polish than one consisting of minerals of varying hardness. Quartz, feldspar and calcite take good polish, while hornblende, mica and augite are difficult to polish. The fine grained marbles are capable of taking an excellent polish, as are serpentine, and some of the fine grained limestones.

Stone Tools.—Stone working is an art of ancient origin and various tools have been developed to facilitate the shaping of the stone. With a view to promoting uniformity in specifications and other literature pertaining to masonry, a committee of the American Society of Civil Engineers formulated definitions and nomenclature of terms and a classification of masonry construction that have become practically standard.¹ The following description of hand tools is extracted from that report.

The *Double Face Hammer* is a heavy tool weighing about 20 to 30 lbs. and is used for roughly shaping the stones as they come from the quarry. The *Single Face Hammer* is similar except that it is lighter and one face is made similar to an ax or wedge. The *Cavil* has one hammer face and one pyramidal pointed end. The *Pick* is also used for roughly shaping stones. The *Ax* or *Pean Hammer* has two opposite cutting edges, and the *Tooth Ax* is similar except that the two edges are serrated.

The following tools are used to give a finish to the surface of stones. The *Bush Hammer* has a face 2 to 4 in. square and is much used in surfacing; the *Patent Hammer* is a double headed tool so formed as to hold at each end a set of thin wide chisels. The *Crandall* is a malleable iron bar containing a slot 3 in. long in which double ended points are held in place by means of a key. The *Point* is a round or octagonal bar of steel about 12 in. long when new, and is struck with a mallet to put a final finish on a stone or to prepare the surface for some other tool. The *Pitching Chisel* is used for making a well defined edge to the face of a stone by striking off with it under the blows of a mallet the face

¹ *Trans. Am. Soc. C. E.*, vol. 6, p. 297: see also. I. O. BAKER, "Treatise on Masonry Construction."

of the stone along a scribed line to which the chisel is applied. The *Chisel*, *Tooth Chisel* and *Splitting Chisel* do not require special description; they are used chiefly in making a *draft* around the edge of the face of a stone and for cleaving stones along planes of stratification. The *Plug and Feathers* is used for splitting unstratified stone by insertion in a drilled hole.

Power tools are of comparatively recent development and include pneumatic hammers and chisels of various types, pneumatic surfacing and finishing tools, saws, groovers, planers,

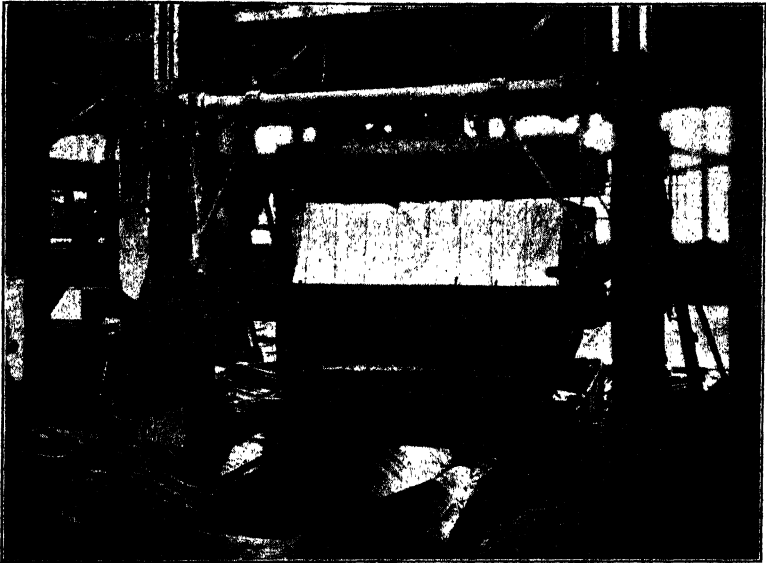

FIG. 5(a).—Power operated stone saw.

rubbing beds, etc., a description of which may be found in a dealer's catalog.

Cut stone is most commonly prepared by power machinery under modern conditions. Figure¹ 5(a) shows a gang saw in operation, the rate of cutting being 1 to 2 in. per hour. Figure 5(b) shows a shaper cutting moldings of marble. In sawing granite with a circular steel saw using removable teeth and steel shot, the rate of progress may be 40 sq. ft. of surface cut per hour.² Recently, especially hard cutting tools have been introduced which have greatly increased the rate of cutting.

¹ Courtesy, Georgia Marble Co.

² *Engineering and Contracting*, vol. 65, p. 118.

Stone Cutting.—All stones used in building are divided into three classes according to the finish of the surface, viz.,

1. Rough stones that are used as they come from the quarry.
2. Stones roughly squared and dressed.
3. Stones accurately squared and finely dressed.

In practice, the lines of demarkation between these classes are not distinctly marked, one class merging into the next.

Square stones may be *quarry faced*, *pitch faced*, or *drafted stones*.

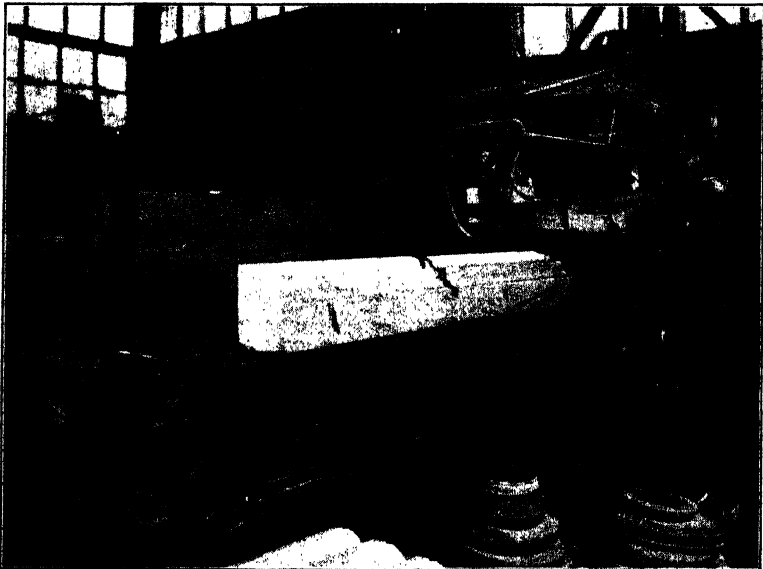

FIG. 5(b).—Stone cutting by machinery.

Cut stones include all those that are accurately squared with smoothly dressed beds and joints. They may be *rough pointed*, *fine pointed*, *crandalled*, *axed*, *patent hammered*, *tooth axed*, *bush hammered*, *rubbed*, or *diamond paneled* according to the tool used in the dressing. *Sawed stone* is also of frequent occurrence in masonry construction.

The art of making the drawings, patterns, bevels, etc. in cutting *dimension stone*, i.e. stones whose dimensions have been fixed in advance, is called *stereotomy* and involves chiefly the principles of projections and descriptive geometry in its application. The drawings are usually made to a large scale and the dimensions of each stone, in the case of high class ashlar masonry,

are determined by scaling from the drawings or by calculations. Each stone is then given a construction marking, similar to the erection markings on structural steel members, so that when the stones are laid in place there may be a perfect fit. Owing to the obsolescent state of the art, so far as most engineering work is concerned, a detailed treatment of the processes involved is not required in this connection, the reader being referred to special books on the subject for a complete presentation.

Classification of Masonry.—While there is some diversity in the use of terms referring to stone masonry, the classification given below is the one most generally recognized.¹

Ashlar or cut stone masonry is composed of cut stones which have their joints carefully dressed to planes so that the joints do not exceed $\frac{1}{2}$ in. in thickness. In high grade dimension stone work, the joints do not exceed $\frac{1}{8}$ in. in thickness. Ashlar masonry is almost always *range*, that is, the stones are of the same height and are laid in courses, but it may be *broken range* if two or more stones replace a large one in the course, or it may be *random*, if the courses are not preserved at all.

Squared stone masonry applies to masonry where the joints are between $\frac{1}{2}$ and 1 in. in thickness, and obviously consists of stones less accurately dressed than in the case of ashlar. The terms, *range*, *broken range* and *random* apply as in ashlar.

Rubble masonry consists of unsquared stones, the faces being left as they come from the quarry and the irregularities being made up by filling with mortar. Rubble may be either *coursed* or *uncoursed*.

Dry masonry consists of stones laid without mortar, and includes slope-wall masonry, stone paving and riprap. Slope-wall masonry consists of stones of fairly regular shapes hand laid to protect a sloping bank; stone paving consists of stones laid with a fairly smooth surface to protect the bed of a stream, usually; riprap consists of stones of various shapes and sizes placed for the protection of the banks of a stream, a bridge pier, or other structure.

Masonry Definitions.—The following definitions taken chiefly from the Manual of the American Railway Engineering Association p. 249 ff. are descriptive of terms used in masonry specifications:

¹ *Trans. Am. Soc. C. E.*, vol. 6, p. 303.

Arris.—The external edge formed by two surfaces, whether plane or curved, meeting each other.

Backing.—That portion of a masonry wall built in the rear of the face, usually a cheaper class of masonry and bonded to the face.

Batter.—The slope or inclination of the face or back of a wall from a vertical plane.

Bed.—The top or bottom of a stone. *Natural bed*.—The surface of a stone parallel to its stratification. *Course bed*.—Stone, brick, mortar or other material in position upon which other material is to be placed.

Bond.—In stone or brick masonry, the mechanical disposition of stone, brick or other blocks by overlapping to break joints.

Build.—A vertical joint.

Centering.—A temporary support used in arch construction. (Also called centers.)

Clamp.—An instrument for lifting stone, so designed that its grip is increased as the load is applied.

Coping.—A top course of stone or of other building blocks, or of concrete to shelter the masonry from the weather.

Course.—Each separate layer in stone, brick or other masonry.

Cramps.—Bars of iron having their ends turned at right angles to the body of the bar in order to enter holes in the faces of adjacent stones to hold them in place.

Dowels.—Straight metal bars used to connect two sections of masonry. Also, a two-piece instrument for lifting stones.

Draft.—A margin on the surface of a stone cut approximately to the width of the chisel.

Flush.—(adj.) Having the surface even with the adjoining surface. (verb) To fill, or to bring to a level.

Footing.—A bottom course.

Grout.—A mortar of liquid consistency.

Header.—A stone having its greatest dimension at right angles to the face of the wall in which it rests.

Lewis.—A four piece instrument for lifting stone.

Lock.—Any special device or method of construction used to secure a bond in masonry.

Parapet.—A wall or barrier on the edge of an elevated structure for the purpose of protection or ornament.

Pitch.—To square a stone.

Pointing.—Filling joints or defects in the face of a masonry wall.

Quoin.—A corner stone in a wall.

Ring stones.—The end stones or voussoirs of an arch.

Spall.—A chip of stone broken from a large block.

Stretcher.—A stone or other block with its longest dimension parallel to the face of the wall in which it rests.

Laying Stone Masonry.—The workmanship in laying stone masonry is quite as important a factor in the production of good results as are the materials and should receive therefore very careful attention in the preparation of masonry specifications and in

the construction. Professor I. O. Baker gives the following rules¹ for laying stone masonry, the observance of which should be adhered to carefully.

1. The larger stones should be used in the foundation courses to give the greatest strength and to lessen the danger of unequal settlement.

2. A stone should be laid on its broadest face, since then there is better opportunity to fill the spaces between the stones.

3. For the sake of appearance, the larger stones should be placed in the lower courses, the thickness of the stones gradually diminishing towards the top of the wall.

4. Stratified stones should be laid on their natural bed because in that position they are stronger and more durable.

5. The courses of the masonry should be perpendicular to the direction of the pressure it is to withstand.

6. To bind a wall together laterally, a stone in any course should break joints or overlap the stone in the course below.

7. To bind the wall together transversely, there should be a considerable number of headers extending from the front to the back of the wall, or from the outside of the wall into the interior of thick walls.

8. The surface of all porous stones should be moistened before being bedded in order to prevent the stone from absorbing the water of the mortar and thereby rendering the latter friable.

9. The spaces between the back ends of adjoining stones should be as small as practicable, and these spaces and the joints between the stones should be completely filled with mortar.

10. If it is necessary to remove a stone after it has been placed upon the mortar bed, it should be lifted clear and re-set, as attempting to slide it is likely to loosen stones already laid and thereby destroy the adhesion.

11. An unseasoned stone should not be laid in a wall if there is any likelihood of its being frozen before it becomes seasoned.

12. Masonry should not be laid in freezing weather unless unavoidable. Where laying in cold weather can not be avoided, cement mortar should be used and the work protected and other precautions taken, as for pouring concrete in freezing weather. (See p. 458.)

A neglect of one or more of the above rules has frequently caused failure and the importance of observing them should be emphasized.

Stone masonry is usually *pointed up* after the wall is laid. That is, the mortar is not brought to the face while the stone is being put into place, but after the courses are laid, usually after the structure is finished otherwise, the joints are cleared out for a depth of about an inch and then filled as compactly as possible with mortar, the projecting mortar being struck off or finished as *flush*, *grooved* or *beaded*.

¹ I. O. BAKER, "Treatise on Masonry Construction," p. 282.

The quantity of mortar required in any volume of stone masonry obviously depends upon the class of masonry, that is, upon the thickness of the joints. It averages about 10 per cent of the total volume for good ashlar, 15 per cent for squared stone and 20 to 35 per cent for rubble.

A modification of Fuller's formula for quantities (see p. 102) may be used for estimating the quantities of cement and sand required to make any given quantity of mortar of any proportions. Thus, where C is the number of barrels of cement required per cubic yard of mortar and S the number of cubic yards of sand per cubic yard of mortar, and 1:s, the proportions of cement and sand,

$$C = 7.5/(1 + 0.7s), \text{ and } S = C \times s \times 4/27$$

For lime mortar, about one barrel weighing 200 lb. is required for one cubic yard of mortar of 1:3 proportions, which are the usual proportions employed.

Strength of Stone Masonry.—The loads to which stone masonry may be subjected may give rise to compressive, shear and transverse flexure stresses, compressive being of most frequent occurrence. In spanning an opening, in the projections of footings, corbels, etc., masonry is required to sustain flexural and shear stresses.

The strength of masonry depends primarily upon the mortar used and unless the stone has less strength than the mortar, the crushing strength of the stone has little influence on the strength of the built-up masonry. Obviously, also, the character of the masonry, the size and regularity of the stone, the care in laying and other factors will affect the ability to withstand strains. In ashlar and other squared stone masonry, the safe load is much less than the ultimate strength, for after the mortar gives way, and the stones crack, the stones will still support additional loads before complete failure. No satisfactory tests have been made to determine the strength of stone masonry, but Professor I. O. Baker¹ has compiled a list of structures with the existing pressures indicated. In these, the pressures range from 400 to 600 lbs. per square inch on good ashlar. Table II² shows the allowable working stresses in tons per square foot (1 ton per square foot

¹ I. O. BAKER, "Treatise on Masonry Construction," p. 294.

² "Am. Civil Engineers' Pocket Book," p. 578.

equals approximately 14 lb. per square inch) according to the building laws of several American cities.

With the ordinary range of pier or column lengths, the compressive strength is probably not appreciably affected by column action, although no definite tests have been performed to establish this belief.

TABLE II.—ALLOWABLE PRESSURES ON STONE MASONRY IN AMERICAN CITIES
(In tons per square foot)

Kind of masonry	New York, 1906	Wash'n, 1909	Boston, 1909	Cleveland, 1907	Baltimore, 1908
Granite ashlar.....	73-173	72-173	60	9-20	72-173
Gneiss ashlar.....	94	94	..	9-20	..
Limestone ashlar.....	50-166	50-166	40	9-20	72
Marble ashlar.....	43-86	43-86	40	9-20	..
Sandstone ashlar.....	29-115	29-115	30	9-20	..
Rubble, natural cement... ..	8	8	..	7-9	7
Rubble, portland cement... ..	10	10	..	10-12	9
Rubble, lime.....	5	5	..	4-6	4

The allowable shear stress in stone masonry should not be assumed higher than perhaps one-fourth of the compressive stress where the stress is true punching shear and not affected by diagonal tension. Stone masonry is very weak in tension, about 5 lb. per square inch being a conservative working stress where lime mortar is used, 15 lb. per square inch with portland cement mortar. Where stone masonry is required to withstand tension, as in spanning an opening, special care should be exercised in laying.

Stone Bearing Blocks.—The ends of trusses, beams and columns are frequently set on large flat stones in order to spread the load over a larger area of the supporting material. Such stones are called bearing blocks, although the latter term is general and may be applied to blocks or slabs of wood, metal or of reinforced concrete when used similarly. The block is subjected as a beam or as a plate, depending upon conditions, to transverse flexure and to compression. If the superimposed load is centrally placed, then the reacting pressure on the block is uniform, but if it is eccentric, the reacting pressure on the block will vary from one edge of the block to the other. Obviously, where the

bearing block is built solidly into the wall, the flexural stress is not so great as where the edges are free, but it is well to design a bearing block for free edge conditions in most cases, for such may practically obtain due to shrinkage and other causes. The flexural stresses should be investigated along diagonal as well as median lines of the bearing block, for the stresses along the latter may be the greater in some instances. In fact, Bach found from experiment that rectangular plates usually break along a diagonal.

According to the theory of true stress, the actual or equivalent simple stress, that is Ee (E being the modulus of elasticity and e

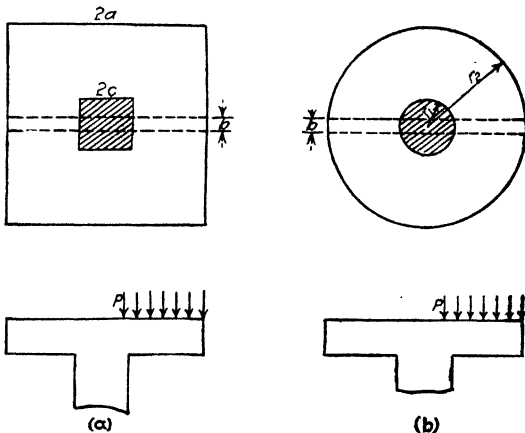

FIG. 6.—Diagram of bearing blocks.

the unit deformation), is less than the apparent stress calculated by considering a strip as a beam. An exact solution of the stresses based on true stresses and Poisson's ratio as proposed by Grashof is complicated, hence, an approximate solution based on apparent stresses will be used in this discussion.

In Fig. 6 (a), let P be the load per unit area. The load on a strip b wide outside the bearing area is $b(a - c)P$. The reaction along the end of the strip of width b is $b(4a^2 - 4c^2)P/8c$, or, $(a^2 - c^2)Pb/2c$.

The difference between the load and the reaction is borne by shear along the edge of the strip, which shear may be assumed to be uniformly distributed, and hence, would equal

$$Pb(a - c) - Pb(a^2 - c^2)/2c, \quad \text{or} \quad Pb \frac{(2ac - a^2 - c^2)}{2c}$$

This quantity will always be negative, indicating that there is a downward load equal to this amount which will make the moment in the strip greater than if the strip were considered as cantilever beam by itself. Assuming this downward load uniformly distributed, the moment will be

$$M = -\frac{1}{2}Pb(a-c)^2 - Pb\left(\frac{a^2 - 2ac + c^2}{2c}\right)\left(\frac{a-c}{2}\right) = -\frac{1}{2}Pb(a-c)^2\left(\frac{a+c}{2c}\right).$$

For any value of a greater than c , it is obvious that this moment will be greater than for the simple cantilever.

For a circular block supporting a cylindrical column, a similar process of reasoning may be followed. Let r_2 be the radius of the plate and r_1 the radius of the column.

In Fig. 6 (b), the load on the strip of width b is $Pb(r_2 - r_1)$ and the reaction on a width b at the support is $\frac{r_2^2 - r_1^2}{2r_1}Pb$; hence, the reaction to be taken by shear on the sides of the strip is $\left[\frac{r_2^2 - r_1^2}{2r_1} - (r_2 - r_1)\right]Pb$, or $\frac{(r_2 - r_1)^2}{2r_1}Pb$, which is negative or downward. The moment $M = -\frac{1}{2}Pb(r_2 - r_1)^2\left[1 + \frac{2(r_2 - r_1)}{3r_1}\right] = -\frac{1}{2}Pb\frac{(r_2 - r_1)^2(2r_2 + r_1)}{3r_1}$, which is greater numerically than $-\frac{1}{2}Pb(r_2 - r_1)^2$, the moment of the load on the strip itself.

Door and window sills, lintels, etc. are likely to break under a load due to settlement, and for this reason, the masonry should not be laid solidly against the sill at the middle, lest the sill become center bound and too great a moment at that point result.

Stone Columns and Pillars.—When the height of a masonry column greatly exceeds its lateral dimension, the allowable unit bearing pressure should be decreased. Tests indicate that the strength of built-up masonry columns is affected by the ability of the individual blocks to resist transverse breaking, which fact would suggest the use of large deep blocks so far as practicable in such work. A column formula for stone columns sometimes used is

$$P = \frac{S}{1 + c\frac{L^2}{D^2}}$$

Where P is the allowable load per unit area on the column, S the allowable unit compression on a prism of the masonry, L the length in inches, D the least lateral dimension in inches, and c a coefficient equal to about $\frac{1}{600}$.

Stone pillars are seldom used in modern work except for purposes of architectural embellishment, and then such pillars seldom support any considerable load except their own weight. Care should be exercised to have the bearing surfaces of the sections of such pillars flat and at right angles to the axis. It is a practice common among masons to cut the bearing surfaces concave in order to obtain a more perfectly fitting bearing. This practice is likely to cause the edge to spall. On the other hand if the surfaces are convex, the column may be split.

Stone Veneer.—Because of increasing cost of cut-stone masonry, stone veneer over concrete or brick walls has come into use. It is important that such veneer be rigidly clamped to the main wall in order to withstand stress of wind, of earth vibrations, and of fire. Such stone veneer can best be attached to the main wall by anchoring staples in the wall permitting them to project beyond the face of the wall. Staples in the mortar of the courses of the stone veneer are laid hooked through the wall staples. A continuous $\frac{1}{4}$ -in. bent rod lying in the joints of the veneer with the bends passing through the wall staples affords a secure anchorage in the veneer masonry. Lone ties of veneer to the back wall should be spaced not farther than 1.0 ft. vertically and 2.0 ft. horizontally.

Stone or brick veneer laid monolithically with the concrete will in most cases eventually split loose from concrete walls due to the shrinkage of concrete. The stone or brick do not shrink or expand appreciably with changes in moisture, while concrete shrinks considerably while setting and expands somewhat when wet. Where such veneer is laid integrally with fresh concrete walls, provision should be made for contraction points in the veneer.

B. BRICK MASONRY

Definitions.—In order to facilitate the discussion of brick masonry, it may be advantageous to define certain materials and terms used.

A *kiln* is a furnace in which bricks are burned.

Fire bricks are bricks made from essentially pure kaolin or clay, or a mixture of pure clay and sand, and are used wherever the wall is to be subjected to high temperatures.

Soft mud bricks are made from clay mixed in a *pug mill* and pressed into molds under a plunger.

Stiff mud bricks are made by forcing a plastic clay through a die in a continuous bar and cutting off the blocks of the desired size by a moving wire reel. Most stiff mud bricks are *side cut* although *end cut* bricks are still made to a limited extent. The drying and burning processes are essentially the same regardless of the manner of molding.

Dry clay, or pressed bricks are molded under a plunger of clay containing but little moisture. They are very smooth and uniform in size and shape, and are much used for exterior finish or veneer of buildings.

Repressed bricks are made by subjecting stiff mud bricks to heavy pressure in a mold before burning.

Arch bricks are those taken from the top or side of the kiln. This class, as well as the next two, is applicable only where the old style clamp kiln is used.

Body bricks are those taken from the interior of the kiln next after the arch bricks. They are the No. 1 grade of bricks, being the best quality in the kiln.

Salmon or soft bricks are those taken from the kiln farthest from the fire and are underburned and consequently soft.

Vitrified bricks are those that have been subjected to heat of sufficient intensity to cause partial or complete fusion of the silicates present. Only certain kinds of clays will make good vitrified bricks.

Compass bricks have one edge shorter than the other and are used in walls having sharp curves.

Feather edge bricks have one edge thinner than the other and are used in arches.

Sand lime bricks are made from a mixture of sand and lime (about 16:1 proportions), molded under pressure and cured under steam at 125 lb. pressure.

Cement bricks are cement-mortar blocks of brick size.

Ornamental face bricks are made from special clays or by adding various coatings before burning in order to obtain the color desired.

Terra cotta (cooked earth) is a clay product consisting of hollow blocks of various shapes and sizes, ranging from simple rectangular blocks to elaborately molded designs used for ornamental purposes. In order to render the blocks light, the clay is sometimes mixed with sawdust or with chopped straw before burning, which burns out and leaves the block porous. This product is commonly termed *terra cotta lumber*, since it can be sawed, nailed to, etc.

Parge or parget (verb), to lay on mortar.

Fur (verb), to hang a plaster coat from a wall by means of wood or metal strips so that an air space intervenes.

Requisites of Good Building Brick.—Clay bricks are commonly burned in the old style kiln from which the product varies greatly according to the distance of the brick from the fire during burning. The modern *continuous kiln*, however, consisting of two long parallel tunnels connected at the ends, yields a much

more uniform product and permits *green* bricks to be introduced and burned bricks to be removed without discontinuing the fire. After burning in any kiln the bricks should be slowly cooled, or annealed, otherwise they will be brittle.

Where the clay from which the bricks are formed contains considerable quantities of lime, the latter is calcined in the burning and later when the bricks are exposed to the weather, this lime in slaking expands and chips or spalls the brick. Consequently, the clay or shale for making bricks should be free from limestone fragments.

Vitrification of brick is partly a physical and partly a chemical process. It is essentially a process of fusion of the silicates in which they become fluid to an extent and fill the interstitial space of the structure formed by the more refractory materials, thereby cementing the mass together. Vitrification occurs at about 1,600° F. and is distinguished from fusion in that, in the latter process, the entire mass becomes plastic while in vitrification, the granules forming the more refractory structure remain rigid and the interstitial spaces are filled by the fused silicates. The physical manifestation of vitrification lies chiefly in increased density and hardness and decreased absorption.

The essentials of a good building brick are (1) uniformity of size, form and color, (2) strength and (3) low absorption. The size of commercial bricks is not standardized, although the sizes adopted by the National Brick Manufacturers' Assn. are $8\frac{1}{4}$ by 4 by $2\frac{1}{4}$ in. for common brick, $8\frac{1}{2}$ by 4 by $2\frac{1}{2}$ for paving brick, $8\frac{3}{8}$ by 4 by $2\frac{3}{8}$ for pressed, and 12 by 4 by $1\frac{1}{2}$ for Roman brick. English bricks are $8\frac{3}{4}$ by $4\frac{3}{4}$ by $2\frac{3}{4}$ in. Bricks warped in burning should be rejected by the engineer because of the difficulty in laying and the weakness of construction resulting where they are used. The color of bricks depends chiefly upon the constituents of the clay from which they are made, the red color of the common bricks being caused by the presence of iron. However, the color of bricks made from any particular clay is indicative of the thoroughness of burning, the darker colors indicating well burned brick.

The strength of brick depends upon the character of the clay or shale from which it is made and the skill used in the manufacture. The compressive strength of brick laid flatwise ranges from 2,000 to 12,000 lb. per square inch, although very poor brick may be below this limit and very good brick above. Well burned

brick is about three times as strong as underburned brick from the same material. Bricks tested edgewise and endwise gave 80 and 60 per cent respectively as great strengths as when tested flatwise. Brick soaked in water gave about 85 per cent as great strength as when dry. The modulus of rupture ranges from 10 to 20 per cent of the crushing strength, while the tensile strength is about 10 per cent and the shearing strength about one third of the compressive strength. Sand lime brick tested at Watertown Arsenal gave a compressive strength of 6,400 to 7,500 lb. per square inch.

The absorption of brick depends upon the clay used, the skill of manufacture and the thoroughness of burning. In general, the better brick has a low absorption, although there are exceptions to this rule. Soft mud and salmon brick sometimes absorb as high as 20 to 30 per cent of water, while good body brick absorb about 0.5 to 5.0 per cent.

The specific gravity of brick varies from about 1.5 to 2.2, depending upon the materials from which it is made and the degree of compression and the burning in the manufacture. Brick masonry weighs about 115 to 145 lb. per cubic foot.

Method of Laying Brick Masonry.—Brick masonry is laid with joints about $\frac{1}{4}$ to $\frac{1}{2}$ in. thick for common brick and about $\frac{1}{8}$ in. for pressed brick. The function of the mortar is to fill the space between the bricks and to eliminate the effects of unevenness and secure uniformity of distribution of the pressures so far as possible. Where cement mortar of good quality is used, thick joints are not objectionable so far as strength is concerned but they may impair the appearance of the wall.

It is always best to dip bricks that are especially porous in water before laying in order that they may not absorb the water from the mortar thereby rendering it friable. The bricks should be pressed firmly into place so that the mortar will form an even bed and be squeezed into the interstices between the bricks. The best results are obtained when the bricks are laid with a *shove joint*, i.e., the brick is laid slightly away from its final position and shoved into place. However, to specify "filled" or "shove" joints will add appreciably to the cost of the work and this additional expenditure is not always justified. The joints should be filled by *slushing* in the mortar from the trowel, the tendency on the part of masons being to use too little mortar by merely "buttering" the ends thereby leaving joints only partially filled.

The following precautions should be followed in laying brick masonry in order to secure good results:

1. Lay the brick in a full bed of mortar.
2. Shove the brick into place and apply sufficient pressure to bed firmly.
3. Keep all leads and corners plumb.
4. Slush the joints full of mortar.
5. Use good mortar.
6. Put in plenty of headers.
7. Wet all brick before laying, especially if dry and porous.
8. Strike all exposed joints neatly.

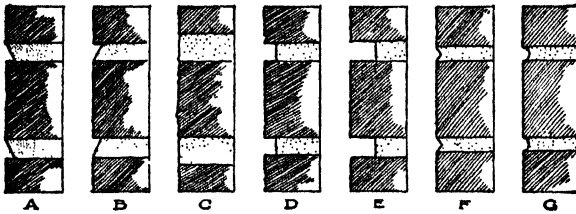

FIG. 7(a).—Methods of pointing brick masonry.

The *bond* of brickwork is the arrangement of courses for binding the wall together longitudinally and transversely. It consists essentially of the arrangement of *stretchers* and *headers*, i.e., bricks parallel and perpendicular respectively to the face

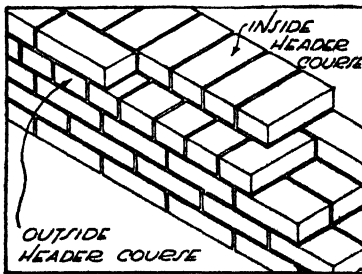

FIG. 7(b).—Manner of laying brick with common bond.

of the wall. For the strongest construction, every third course should be headers, and in all high class work, at least one course in five should be headers. *Common bond* consists of one course of headers to four to seven of stretchers; in *English bond*, headers and stretchers are laid in alternate courses; in *Flemish bond*, every alternate brick is a header. In thick walls, the headers should be lapped and carried through the wall from face to back.

In *running bond*, the face of the wall consists entirely of stretchers which break joints at the middle. Owing to the absence of headers, running bond is lacking in strength.

In Fig. 7(a) are shown the various ways of finishing the joints, as (A) struck joint, (B) weathered joint, (C) flush of plain joint, (D) raked joint, (E) stripped joint, (F) "V" joint, (G) concave joint.

Figure 7(b) shows the manner of laying a 12 in. wall with common bond.

TABLE III.- TESTS OF BRICK COLUMNS. AVERAGE VALUES¹

Characteristics of columns	Av. load lb./sq. in.	Ratio str. of col. to str. of brick	Str. of mortar, lb./sq. in.	Ratio str. of col. to mortar
Shale Building Brick				
1. Well laid, 1-3 portland cement mortar, 67 days.....	3,365	0.31	2,870	1.17
2. Well laid, 1-3 portland cement mortar, 6 months.....	3,950	0.37
3. Well laid, 1-3 portland cement mortar, eccentrically loaded, 68 days.....	2,800	0.26
4. Poorly laid, 1-3 portland cement mortar, 67 days.....	2,920	0.27	2,870	1.05
5. Well laid, 1-5 portland cement mortar, 65 days.....	2,225	0.21	1,710	1.30
6. Well laid, 1-3 natural cement mortar, 67 days.....	1,750	0.16	305	5.75
7. Well laid, 1-2 lime mortar, 66 days.....	1,450	0.14
Underburned Clay Brick				
8. Well laid, 1-3 portland cement mortar, 63 days.....	1,060	0.27	2,870	0.37

¹ *Univ. of Illinois, Eng. Exp. Sta. Bull. 27.*

Strength of Brick Masonry.—The strength of brick masonry depends upon the quality of the brick, the kind of mortar used, and the manner of laying the brick. With good cement mortar, the adhesion of the mortar to the brick should be sufficient to break the brick in failure. The relative strengths of brick masonry as affected by the mortar were as follows in tests made at the Watertown Arsenal.¹

¹ "Tests of Metals, etc.," 1884.

Mortar	Per cent of strength of brick	Per cent of strength with neat cement mortar
Neat portland cement mortar.....	30	100
1 portland cement to 2 sand.....	27	90
1 portland cement to 3 sand.....	24	80
1 natural cement to 2 sand.....	18	60
1 natural cement to 3 sand.....	13	45

Table III shows the results of a number of tests of brick columns as to crushing strength, the effect of mortar and the quality of the brick. A committee of architects and engineers of Chicago, in 1908, recommended the following values of safe bearing strength for the building laws of that city.¹

	LB. PER SQ. IN.
Paving brick with 1:3 portland cement mortar.....	350
Brick with strength of 5,000 lb. per square inch ditto mortar...	250
Brick, 2,500 lb. per sq. in., ditto mortar.....	200
Brick, 1,800 lb. per sq. in., ditto mortar.....	175
Brick, ditto with 1:3 natural cement mortar.....	150
Brick, ditto with lime and cement mortar.....	125
Brick, ditto with lime mortar.....	100

These values are very conservative in view of the tests that have been made and the pressures that are commonly known to exist in structures.

Tests made at the Watertown Arsenal showed brick columns to have a modulus of elasticity of 1,000,000, to 6,000,000 lb. per square inch. Observations and tests do not indicate any appreciable effect of slenderness of brick piers for slenderness ratios between 4 and 20,² although practice limits this ratio to about 10.

Corbeling Action of Brick Masonry.—A corbel is a piece of stone, brick, wood or other material that has one end imbedded in a wall while the other end projects beyond the face of the wall. Its structural use is to furnish support to members above it, and it may consist of one integral block or a unit composed of several blocks. The structural behavior is essentially that of a cantilever, its strength being determined by its resistance in shear and

¹ "Am. Civil Engineers' Pocket Book," p. 523.

² *Bur. Standards, Building Code Committee, Rept., p. 36.*

flexure. The stresses induced in a wall due to a load placed on a corbel are not capable of exact determination, but the plausible assumption as to the stress distribution is a uniformly varying stress from the face of the wall to the depth of embedment.

When brick masonry is laid on a lintel over a window or other opening, the brickwork above will be self-supporting to a certain



FIG. 8.—Jack arch.

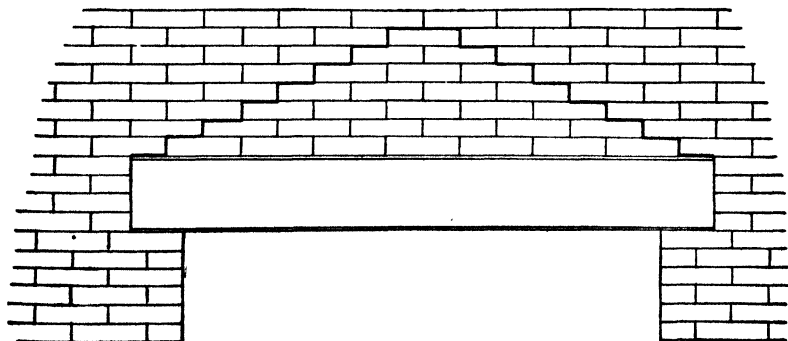

FIG. 9.—Masonry supported by a lintel.

extent due to the *corbeling action* of the brick. Sometimes a stone lintel is relieved by building an arch in the wall over the opening, in which case the lintel supports only the part of the wall filled in between the lintel and the arch, called the *tympa-num*. A flat or "jack" arch, Fig. 8, is weak and should not be used unsupported for spans exceeding 2 ft. When, however, the full pressure of the superimposed masonry is not relieved, the question as to the amount of the load that is borne by the lintel must

be determined. The line of separation between the bricks that are self-supporting by corbeling action and those that are supported by the lintel is illustrated in Fig. 9, the portion below the heavy line being carried by the lintel. With brick of ordinary size, this line would have approximately a 2:1 slope, making the height of the triangle one fourth of the span. However, it is customary by some engineers to allow from one-half to two-thirds the span as the height of this triangle.

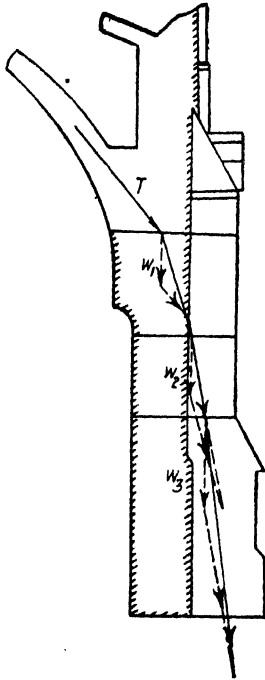

FIG. 10.—Line of thrust in a buttressed wall.

The modulus of rupture of brick masonry in transverse flexure is small, tests made at the University of Illinois showing about 90 lb. per square inch for 1:3 portland cement mortar and the shear strength is about 5 per cent of the compressive strength of the brick.

Buttressed Walls.—In large buildings such as churches, armories, gymnasias, etc. where the walls are of considerable height unsupported laterally by floors, and where they support roof trusses which may bring some outward thrust on the walls, it is not uncommon practice to build buttresses along the exterior face of the wall opposite the support of each truss. Such buttresses must be carefully bonded into the wall masonry so that they will act as an integral part of the wall and not as a separate pilaster or column. The determination of the pressures and resultant stresses involves

merely the successive combination of the forces acting, beginning at the top with the thrust, T , from the roof truss or arch and going down to the bottom, combining with the weights, W_1 , W_2 , etc., of the segments of the buttress, as illustrated in Fig. 10. The reaction of the roof truss must first be determined in amount and direction by the usual methods.

Brick Columns.—Brick piers and columns may be used satisfactorily where they sustain central loads and are not subjected to bending moment from any source that will produce any considerable amount of tension in the masonry. Tests made on

two large piers, about 4 ft. square, at Watertown Arsenal, indicate that large brick piers give essentially the same unit strength as small ones. Piers with bricks on edge and carefully broken joints gave 57 per cent more strength than with the bricks laid flatwise and less carefully constructed joints. Tests made at the University of Illinois showed¹ that stresses caused by eccentric loads were essentially as indicated by the theoretical formula (for piers of rectangular cross section): $S = \frac{P}{A} (1 \pm 6e/d)$ where

S is the stress in the extreme fibre, P the load applied, A the area of the cross section, e the eccentricity of the load, and d the lateral dimension in the direction of the eccentricity. Even a small amount of eccentricity, such as may be caused by the deflection of a beam or slab supported on the pier, may result in greatly increased stresses.

In 1916, a school house at Roxbury, Mass., failed and an investigation into the causes of the failure indicated¹ that the deflection of the reinforced concrete slabs which were supported by the piers resulted in the failure of the latter, due probably to the eccentricity caused by the deflection. Tension in brick masonry should not in general be depended upon to aid in withstanding flexural stresses, and where necessary to allow tensile stress to obtain, not more than 20 to 25 lb. per square inch should be counted on even under the most favorable conditions, for the modulus of rupture does not exceed 100 lb. per square inch.²

Reinforced Brick Masonry.—Lintels over doorways and other openings may be made of brickwork reinforced with steel rods or bands suitably placed between courses of the brick similar to reinforcement in concrete beams. Web reinforcement is necessary for shear stresses and, in general, the theory of reinforced concrete applies to reinforced brickwork.³ The limiting working stresses in the brickwork, as indicated by the tests made at the University of Missouri, may be taken at 500 lb. per square inch compression, 80 lb. per square inch shear, when web reinforcement is used. The modulus of elasticity of brickwork is about 2,000,000 lb. per square inch. The data on strength of reinforced brickwork are meagre, however, and, until this form of

¹ *Univ. of Illinois, Eng. Exp. Sta., Bull.* 27.

² *Engineering Record*, Sept. 2, 1916.

³ *Univ. Missouri, Eng. Exp. Sta., Bull.* 37, p. 29.

masonry is more adequately studied, designs involving its use should be on conservative assumptions.

Brick and stone walls, because of their deficient flexural strength, have been vulnerable to the effects of winds and earthquakes. It is probable that steel reinforcement in brick walls would add greatly to their strength, although no such use has come to the author's attention. Placed at the first mortar joint inside the wall, the effective depth of such reinforcement would be approximately two-thirds the thickness in a 12-in. wall.

Thickness of Bearing Walls.—The minimum thickness of an exterior brick wall is a debatable matter, but the concensus of opinion seems to indicate that an 8-in. wall may be properly used, although many building codes specify 12 in.¹ Unless supported laterally by floors and partition walls, even a 12-in. wall will not withstand a wind approaching tornado velocities, hence, the ability to resist wind is not a deciding factor. Brick walls, because of their inability to sustain flexural stress must be secured by supplementary framing of steel or timber.

The resistance to fire of a 12-in. wall is not enough greater than that of an 8-in. wall to warrant specifying the former as a minimum thickness.²

For one and two story buildings, the 8-in. wall is widely used, but for more than two stories, thicker walls should be required.

Joists and other members joining to brick walls should be so attached that if they should fall, due to an interior fire, the wall will not be destroyed.

Brick Fire Walls.—A fire wall must be sufficiently thick to prevent communication of ignition temperatures. Experiments in the Bureau of Standards³ indicate that an 8-in. brick wall, supported at each story, with no combustible members framed into them, will serve as reliable fire stops. Ignition temperatures were attained in about 1½ hours through a 4-in. wall exposed to a fire of usual intensity. An 8-in. hollow wall was less effective than a solid wall. Fire walls deflected 1 to 5 in. when exposed to a fire test. Lime mortar disintegrated badly under heat action. The practice of building fire walls independently through a structure is no longer followed, but, with steel and reinforced concrete framed buildings, the firewall is supported at each story by the building framework.

¹ *Bur. Standards, Building Code Committee, Rept.*, p. 33, 1922.

² *Ibid.*, p. 45.

³ *Building Code Committee, Rept. 1925*, p. 26.

To prevent a fire from lapping around the ends of a fire wall, no openings should be placed in exterior walls within 5 ft. of their junction with fire walls.

A fire wall should, of course, have no unprotected openings and they should have sufficient stability to stand intact when subject to conditions of a fire. Walls of sand lime and of concrete brick transmit heat more slowly than walls of ordinary brick.

Measurement of Masonry.—In estimating the cost of stone masonry, the actual volume in cubic yards should be calculated, deducting all openings, and the cost figured on the stone, the mortar, and the labor. A stone mason with a helper will lay about 0.5 cu. yd. of rubble masonry per hour in walls 1.5 to 3 ft. thick. On cut stone work, one mason with four helpers will lay about 0.5 cu. yd. per hour.

Stone masonry is frequently paid for by the perch, which is usually $16\frac{1}{2}$ cu. ft., although in some localities it is 22 cu. ft. and in others $24\frac{3}{4}$ cu. ft. The linear perch being $5\frac{1}{2}$ yd., the first conception of the perch is a volume of wall 1 perch long, 1 ft. thick and 1 ft. high, while the last is a volume 1 perch long, $1\frac{1}{2}$ ft. thick and 1 ft. high. It is common practice when the perch is used as the unit of measurement not to deduct for openings less than 70 sq. ft., although local usage will govern, unless the specifications are explicit with regard to the units to be used.

Likewise, in estimating brick work, the best procedure is to calculate actual volumes in cubic yards and figure costs from the materials and labor required. It is customary to allow one hod carrier for one brick mason, although, on heavy work, the number of hod carriers may be economically increased to six for every five masons. One mason with one hod carrier can lay about 1,000 bricks in 8 hours in ordinary walls, but the amount may vary from 500 in difficult work to 2,000 in plain unbroken walls. One thousand brick ($8\frac{1}{4}$ by 4 by $2\frac{1}{4}$ in.) with $\frac{1}{2}$ -in. joints will lay about $2\frac{1}{2}$ cu. yds. of masonry wall. The wastage in fitting bricks will vary from 2 per cent for good grades to 5 per cent for inferior grades of brick. Walls are commonly figured as solid where openings are not greater than 80 sq. ft.

Efflorescence.—Efflorescence is the whitish deposit of salts which frequently appears on brick and other masonry due to the evaporation of the water containing these salts in solution. These salts may dissolve out of the mortar or they may come up

by capillarity from the ground. As the water evaporates at the surface, the salts crystallize usually and form the whitish deposit. Any salts that may be present may be thus deposited, although the most common ones are the sulphates, carbonates and chlorides of sodium, potassium and magnesium. The chief effect of efflorescence is to disfigure the wall surface, although the crystallization of the salts may tend to disintegrate the brick surface due to expansion in the pores of the brick.

Efflorescence can be prevented by using materials containing a minimum of soluble salts and by making the masonry waterproof. Since most of the efflorescence is derived from the mortar, care should be exercised to secure a mortar free from these salts. In waterproofing masonry, "Sylvester's Washes" have been used with good results. These consist of two washes or solutions for covering the surface of the walls, the first composed of castile soap ($\frac{3}{4}$ lb. to the gal. of water) and the second of alum ($\frac{1}{2}$ lb. to the gal. of water), the first being applied on the dry wall followed by the second 24 hours later. Coating the surface of the masonry below the ground with a waterproof paint will also have a beneficial effect.

Efflorescence will usually disappear in time, being washed away by rain water and blown away by the wind. It can be removed by scrubbing with a wire brush and dilute muriatic acid, one part commercial muriatic acid to five of water.

C. HOLLOW BLOCKS AND STUCCO

Concrete Building Blocks.—Concrete blocks are made in the improved processes by subjecting a mixture of wet concrete composed of fine materials to a pressure so that a dense, hard, artificial stone results. With a well graded aggregate, the proportions of one cement to five or six of well graded fine aggregate is satisfactory for many purposes, but a 1:4 mixture should be used where greater strength is required. The blocks can be made somewhat more impervious by adding hydrated lime to the mixture, satisfactory proportions being $1\frac{1}{2}$ cement, $\frac{1}{2}$ hydrated lime and 6 aggregate.

In the manufacture of concrete blocks, a moderately wet mixture seems to give better results than a dry consistency. By one process, in which a high pressure is placed on the blocks, the latter are removed to the curing racks immediately after

molding, where they are allowed to attain their final hardness in a moist condition under a continuous spray. Blocks made from a dry mixture are likely to be friable and porous.

The recommended practice for concrete stone and building blocks of the American Concrete Institute¹ specifies that the ideal aggregate shall be clean, coarse, hard, and durable, free from dust, soft, flat or elongated particles, loam, organic, or other deleterious matter. The fine aggregate should consist of sand or stone screenings, preferably of a silicious material, graded from fine to coarse, passing when dry a $\frac{1}{4}$ -in. screen and having not more than 20 per cent passing a 50-mesh screen nor more than 6 per cent passing the 100-mesh screen. The coarse aggregate should consist of gravel or crushed stone retained on a $\frac{1}{4}$ -in. screen and having no particle larger than one-half the minimum thickness of the block. Where coloring is to be used, only durable mineral ingredients should be employed and they should be considered as so much aggregate in proportioning the materials.

Concrete blocks should be cured by protecting them from the direct rays of the sun and from strong air currents for at least seven days. During this period they should be sprinkled at intervals to prevent undue drying. After seven days, they may be removed to the storage yard, but they should not be used before they are at least 21 days old.

The compressive strength of hollow concrete blocks should average not less at 28 days than 1,000 lb. per square inch on the gross section as it would be laid in the wall, and should not fall below 700 lb. per square inch in any particular test. This will require a much higher strength in the net section of the block, since the gross section includes about 20 to 50 per cent of hollow space (usually about 30 per cent). The per cent absorption should not exceed 5 per cent. The processes of manufacture vary so widely that data on specific tests are of but little value, but the above specified figures represent average results for good materials.² Usually, however, concrete blocks are employed where high strength is of secondary importance, other qualities such as dampproofing, low thermal conductivity, low maintenance costs, fireproofing, etc. being the determining factors in making the choice of the materials.

¹ *Proc. Amer. Concrete Inst.*, vol. 8, p. 703.

² *U. S. Bureau of Standards, Bull.* 58.

Masonry of concrete blocks should be laid similarly to that constructed of brick or stone, care being exercised to secure adequate bond, good joints and bedding.

One of the chief objections to concrete blocks as a substitute for natural stone is the monotonous appearance of the wall due to the uniformity of the blocks. Concrete blocks should not be molded to simulate other forms of masonry, such as pitched stone, for such practice violates the essential element of good architecture, namely sincerity and truth. Concrete has a character of its own which should be utilized in the design of structures where this material is employed. A proper choice of aggregates for facing, such as variegated granites and marbles, etc., with some form of treatment of the surface in order to bring out this character produces very pleasing results. The surface treatments most commonly employed are *brushing* and *scrubbing*, *acid wash*, *water spraying*, *grinding* and *tooling*.

Brushing and scrubbing is done with either a stiff fiber or a wire brush while the concrete is green but sufficiently hard to prevent the particles from being dislodged. Acid wash is accomplished by washing with dilute muriatic acid applied with an ordinary scrubbing brush, and then thoroughly rinsed, thus producing an etching effect. Water spraying is done with a fine spray or "fog nozzle," the spray being applied as soon as the blocks are formed. The washing should be carefully done to avoid removing the surface material. Tooling is done by chipping, pointing, chiseling, bush hammering, etc., as in the case of natural stone.

By these methods, concrete blocks can be made to yield a very satisfactory building material at a reasonable cost. The cost of treatment varies so greatly with conditions that it is impracticable to give any cost data that will be at all significant.

Where stucco or plaster is to be placed on concrete blocks, the surface should be corrugated in order to secure a good bond. Previously to applying the stucco, the joints should be raked out and the surface of the blocks brushed free from loose particles and then wet down and should be moist when the stucco is applied.

Terra Cotta Masonry.—Terra cotta is a clay product made in a manner similar to that used in making brick and tile, except that a finer and more homogeneous clay mixture is used. Special colors are obtained by the use of clays of special composition,

a mottled effect being secured by piling these special clays in layers and cutting them down.

Two different types of products are made and classed as terra cotta, viz., decorative terra cotta and terra cotta building blocks, or terra cotta lumber. The former consists of very dense hard tile used for architectural purposes, and is generally given a dull finish by the application of a coating before burning. The second class of terra cotta is structurally the more important, not being intended at all for ornamental purposes but for structural uses only. It is classed as porous, semi-porous and dense, the first two containing about 30 and 20 per cent respectively of sawdust or finely chopped straw in the raw clay mixture before burning, which is turned out in the kiln. Practically all terra cotta lumber is made with walls about $\frac{3}{4}$ to 1 in. thick. The compressive strength for the porous and semi-porous terra cotta averages about 3,000 to 5,000 lb. per square inch on the net section, while the dense terra cotta averages about 5,000 to 6,000 lb. per square inch, and about 80 per cent as much on the gross section.¹

In laying terra cotta masonry, care should be exercised to have the adjoining tile walls and partitions butt fairly and solidly against each other. The mortar joints should not be over $\frac{3}{8}$ in. thick and are made with the same grade of mortar and in the same general manner as for brick masonry. The blocks are sometimes laid with the ducts or hollow spaces running vertically, but the better practice is to lay the ducts horizontally.

Tests of terra cotta columns made at the University of Illinois gave strengths of 2,700 to 3,700 lb. per square inch on the gross section, and a modulus of elasticity of 2,000,000 to 3,000,000 lb. per square inch. The tests showed no appreciable difference in strength due to a difference in size of columns, and a general behavior under eccentric loads similar to that of brick columns, the actual stresses corresponding closely to those calculated by the theoretical formulas. The columns in which the richer mortar was used developed the greater strength.

Terra cotta blocks for finished outside surfaces have a characteristic tendency to unevenness, so that for masonry work where appearance is an important consideration, rigid inspection must be followed and a large percentage of rejection expected.

¹ *Univ. of Illinois, Eng. Exp. Sta., Bull. 27.*

Building tiles of terra cotta are widely used for fireproofing. Tests show that a tile wall 8 to 12 in. thick will resist an ordinary fire 2 to 6 hours.¹

Stucco.—Stucco consists of a plaster of cement or gypsum combined with sand, fine gravel, or stone chips placed on some surface. Usually stucco is placed on hollow building tile or on a steel mesh, either wire or expanded metal. In general, stucco is most suitable for plain walls, since stuccoed cornices, copings and other angular projections are likely to crack and to deteriorate more rapidly than are plain surfaces.

The chief difficulty arising from stucco walls is the crazing or map cracking of the surface. Lean mixtures have been used successfully to prevent this defect, but the additional work required because of the lack of plasticity made the construction expensive.² The contraction which produces this cracking is chiefly in the cement, hence, minimizing the cement content is desirable. A careful gradation of the aggregate which will permit the leanest practicable mixture should be obtained. Practical proportions are 1:3 to 1:4½. Hydrated lime up to 20 per cent of the volume of the cement can be used advantageously. Stucco should be kept moist by spraying with a "fog nozzle" for at least 24 hours after placing.

Various modes of finishing stucco have been used. A *stippled* finish is effected by troweling smooth and patting lightly with a coarse brush. A *sand sprayed* finish may be secured by swishing on with a broom a covering of grout consisting of equal parts of cement and sand. A *spatter dash* finish is accomplished by throwing a mixture of cement and sand or screenings (about 1:3) against the surface until it appears to be uniformly placed. *Pebble dash* is accomplished by throwing fine clean pebbles against the green surface until they are imbedded in the surface. They should be distributed uniformly, by means of a trowel, where necessary, but no troweling should be done after the pebbles are in place. Where special aggregates are used, a surface of *exposed aggregates* may be obtained by scrubbing the surface with a stiff brush and water within 24 hours after the stucco is placed. In the event the stucco has hardened, weak muriatic acid may be used instead of water in scrubbing.

¹ *Proc. Am. Soc. Testing Materials*, vol. 27, p. 387.

² *Proc. Amer. Concrete Inst.*, vol. 16, p. 73.

Special coloring of stucco may be secured by selecting colored aggregates or by the introduction of some mineral pigment. Where colored aggregates are used, brushing of the finished surface will be required to bring out the color effects.

When it is required that any of the above finishes should be made with colored mortar not more than 10 per cent of the weight of portland cement should be added to the mortar in the form of finely ground mineral coloring matter.

TABLE IV. --TABLE OF COLORS TO BE USED IN PORTLAND CEMENT STUCCO

Color desired	Commercial names of color for use in cement	Pounds of color required for each bag of cement to secure	
		Light shade	Medium shade
Grays, blue-black and black.	Germantown lampblack.	½	1
	Carbon black.....	½	1
	Black oxide of manganese	1	2
Blue shade.....	Ultramarine blue.....	5	10
Brownish-red to dull brick red	Red oxide of iron.....	5	10
Bright red to vermilion.....	Mineral turkey red.....	5	10
Red sandstone to purplish-red	Indian red.....	5	10
Brown to reddish-brown.....	Metallic brown (oxide)..	5	10
Buff, colonial tint and yellow.	Yellow ochre.....	5	10
Green shade.....	Chromium oxide.....	5	10

A predetermined weight of color should be added dry to each batch of dry fine aggregate before the cement is added. The color and fine aggregate should be mixed together and then the cement mixed in. The whole should then be thoroughly mixed dry by shoveling from one pile to another through a ¼-in. mesh wire screen until the entire batch is of uniform color. Water should then be added to bring the mortar to a proper plastering consistency.

CHAPTER III

PLAIN CONCRETE

Nature of Concrete.—Hydraulic cement concrete is an artificial stone consisting of fragments of natural stone or of other material cemented together by means of hydraulic cement paste. In order to secure a concrete of maximum density and strength with given materials and proportions, it is necessary to secure a proper gradation of the fragments of stone, and to accomplish this, the fragments are commonly classed according to size of particles as (*a*) coarse aggregate, consisting of particles larger than about $\frac{1}{4}$ in. and (*b*) fine aggregate, consisting of particles finer than about $\frac{1}{4}$ in. As a matter of fact, practically, coarse aggregate as obtained almost always contains a considerable amount of fine aggregate, and the fine aggregate usually contains some coarse particles. However, the division is a convenient one and will be preserved in the present discussion. The elements which enter into the making of concrete are, then, (1) hydraulic cement, (2) water, (3) fine aggregate, (4) coarse aggregate, (5) proper proportioning, and (6) skill in fabrication.

The coarse aggregate may consist of crushed rock, gravel, or other suitable material while the fine aggregate may be sand or finely crushed rock such as stone screenings. Theoretically, the cement paste coats the grains of the fine aggregate making a mortar and this mortar is used in sufficient amount to fill the voids or interstitial space of the coarse aggregate. If there were no overlapping of sizes between the fine and coarse aggregate, concrete might properly be considered as a rubble consisting of irregular fragments of stone with the interstitial spaces filled with mortar. However, under practical conditions, the coarse aggregate contains a considerable amount of fine particles which enter into the mortar matrix and thereby alter the character of the mortar which results from mixing the cement paste and fine aggregate. The entire mass forms an artificial stone much as conglomerates, granites or other natural composite stones are formed, except that in the latter, silica, iron oxide, or other sub-

stances form the cementing material instead of hydraulic cement paste.

The factors which affect the quality of concrete are (1) the quality of the cement, (2) the character and gradation of the aggregates, (3) the proportions of cement to aggregates, (4) the amount of water used, and (5) the skill of workmanship in the fabrication.

Concrete is not a material manufactured under conditions of nice laboratory control as is steel, bronze, and most other engineering materials and owing to the fact that its fabrication appears simple and unscientific, much concrete that has been used has been of poor quality. As a matter of fact, with concrete as with most materials, intelligent skill in fabrication yields large returns in quality of the product. Within comparatively recent years, indeed, studies in the properties of the ingredients, in proportioning, and in the manner of mixing have changed the process from one of merely handling the materials by unskilled labor to a procedure of craftsmanship, and have changed the product when thus fabricated from a more or less haphazard combination of a certain dry powder with water and whatever sand and stone happened to be at hand, to a scientifically wrought engineering material requiring scientific knowledge for its successful manipulation, whose properties can be pre-determined with a fair degree of precision, having given the properties of the ingredients.

Hydraulic Cements.—Hydraulic cements are so called because of their property of setting and hardening under water in the absence of air, as distinguished from lime, which hardens only in the presence of air, as explained in the last chapter. In either case, a new substance is formed as the material hardens, in the case of lime air being essential to the formation of this new substance, i.e., calcium carbonate, while in the case of the hydraulic cements, water alone with the active ingredients of the cement is sufficient to form the new stone-like substance.

The behavior of the different cements depends largely upon the character and composition of the raw materials from which they are made, the chief factor being the amount of argillaceous and siliceous material contained, i.e., the amount of alumina (Al_2O_3) and silica (SiO_2), these constituting more than 20 per cent in hydraulic cement, between 20 and 10 per cent for hydraulic lime, and less than 10 per cent for quick lime. The remainder

of the composition is chiefly calcareous in any case, the raw material consisting chiefly of limestone. Hydraulic lime thus lies between quick lime and hydraulic cement in its composition, and may be expected to be intermediate in its behavior, as in fact it is. These three cementing substances may, therefore, be roughly characterized in outline as follows:

Quick lime

1. Contains less than 10 per cent argillaceous material.
2. Slakes with water but does not set under water.

Hydraulic lime

1. Contains between 10 and 20 per cent argillaceous material.
2. Both slakes and sets with water.

Hydraulic cement

1. Contains 20 to 35 per cent argillaceous material.
2. Sets but does not slake with water.

Hydraulic cements include portland, natural, slag and pozzuolan cements, the most important of which is portland cement.

Portland Cement.—Portland cement is manufactured by grinding a carefully adjusted mixture of limestone and argillaceous material to a powder, burning it to a clinker and then grinding this clinker to fine powder, usually adding a small amount of gypsum for retarding the time of setting. The chief difference between portland and natural cements is that in the former the raw ingredients are artificially proportioned whereas in the latter, the raw materials are used as they occur in the natural beds. In appearance, portland cement is a mauve or steel grey while natural cement varies from yellow to buff. The specific gravity of portland cement is about 3.10 to 3.15 while that of natural cement is about 2.75 to 3.00. Natural cement yields a mortar and a concrete roughly about two-thirds as strong as those from portland cement.

The elemental composition of portland cement is approximately as follows:

	PER CENT
Silica (SiO ₂).....	19 to 25
Alumina (Al ₂ O ₃).....	6 to 8.5
Iron (Fe ₂ O ₃).....	2.3 to 3.3
Sulphuric acid (SO ₃).....	1.3 to 1.5
Magnesia (MgO).....	0.5 to 3.0
Lime (CaO).....	60 to 63

The principal constituents of a perfectly burned cement clinker would be as follows:¹

¹ U. S. Bureau of Standards, *Tech. Papers 43 and 78.*

	PER CENT
Tricalcium silicate ($3\text{CaO}\cdot\text{SiO}_2$).....	36
Dicalcium silicate ($2\text{CaO}\cdot\text{SiO}_2$).....	33
Tricalcium aluminate ($3\text{CaO}\cdot\text{Al}_2\text{O}_3$).....	21
Minor constituents (Fe_2O_3 , MgO , CaO , SiO_2 , etc.).....	10
	—
	100

When the above substances are mixed together in their pure state, a cement essentially similar to portland cement results. The tricalcium silicate is apparently the most active and important factor in giving cementing strength, for in general, a slight preponderance of this substance improves the strength of the cement, and when used alone, it possesses all of the essential properties of portland cement, except that it is less plastic and sets too rapidly to be used alone. Dicalcium silicate sets more slowly and is of much less strength value. Underburning of cement causes a diminution of the former and an increase of the latter ingredient. In general, the best cements contain about equal proportions of the two ingredients.

The setting and hardening of cement is due to the hydration and crystallization of the chief constituents, tricalcium aluminate, tricalcium silicate and dicalcium silicate, and certain other minor constituents, all of which exist in an amorphous, dehydrated condition in the dry cement before water is added. When water is added to these substances to the extent of forming a saturated solution, these substances form an amorphous gel or colloidal mass at first, which later crystallizes, and the interlacing of the crystals including a certain amount of amorphous material, binds the whole together into a rocklike substance as the materials harden. An excess of water retards or tends to prevent crystallization because crystallization occurs best in a saturated solution. Messrs. Klein and Phillips¹ thus summarize the setting action of cement:

“The hydration of cements is thus brought about by the formation of amorphous hydrated tricalcium aluminate with or without amorphous alumina, the aluminate later crystallizing. At the same time sulphoaluminate ($3\text{CaO}\cdot\text{Al}_2\text{O}_3\cdot 3\text{CaSO}_4\cdot 36\frac{1}{2}\text{H}_2\text{O}$) crystals are formed, and low burned or finely ground lime is hydrated. The formation of the above compounds begins within a short time after the cement is gauged. The next compound to react is tricalcium silicate. Its hydration may begin within 24 hours and it is generally completed within 7 days.

¹ U. S. Bureau of Standards, Bull. 43.

Between 7 and 28 days the amorphous aluminate commences to crystallize and beta-orthosilicate begins to hydrate. Although the latter is the chief constituent of American portland cements, it is the least reactive compound. The early strength (24 hours) of cements is probably due to the hydration of free lime and the aluminates. The increase in strength between 24 hours and 7 days depends upon the hydration of tricalcium silicate, although the further hydration of aluminates may contribute somewhat. The increase between 7 and 28 days is due to the hydration of beta-calcium orthosilicate, but here are encountered opposing forces, in the hydration of any high burned free lime present and the crystallization of the aluminate. It is to this hydration that the falling off of strength between 7 and 28 days of very high burned high limed cements is due, whereas the decrease shown by the high alumina cements is due to the crystallization of the aluminate."

The *initial set*, so called and distinguished more or less arbitrarily by standard tests, marks a fairly definite stage in the hydration of cement and is probably due to the initial hydration of the aluminate, while the *final set*, distinguished by other arbitrarily fixed tests, marks a stage somewhat further advanced in the hydration and crystallization of the aluminate and the early stages of hydration of the tricalcium silicate. These tests are arbitrary and do not correspond to definite stages of chemical or crystallizing action, but rather constitute a measure of the rate of activity of the cement, indicating a slow or rapid setting cement.

Tests of Cement.—Tests of cement include both chemical and physical.

Chemical:

1. Loss on ignition,
2. Insoluble residue,
3. Amount of sulphuric anhydride,
4. The magnesia content;

Physical:

1. Fineness, or sieve analysis,
2. Water required to produce normal consistency,
3. Soundness, or constancy of volume in setting,
4. Time of setting, or rate of activity in setting,
5. Tensile strength of mortar briquettes,
6. Specific gravity.

The chemical tests give a good indication of the probable behavior of the cement when used in mortar or in concrete, but their significance is not absolutely invariable.

The fineness test indicates the thoroughness of grinding, as only the finest impalpable dust has any cementing value.

The normal consistency is a plastic consistency that can be recognized and secured in the laboratory, and is defined in terms of the tests used to determine it.

The presence of an undue amount of unslaked lime, of sulphides and other substances may cause cement to expand, crack, warp or disintegrate, hence, the test for soundness. This is a very important test.

The time of setting should be such that the cement will not set up before the concrete is in place nor should it be unduly delayed.

The tensile strength of mortar briquettes is taken as an index of the adhesive strength of the cement, and indicates the strength of the mortar or of the paste made from the cement.

The specific gravity of cement in a general way indicates the thoroughness of burning and presence of adulteration, if the other characteristics of the cement are known. Its indication is not absolute by any means.

The standard tests for properties of cement are given in Appendix A and need not be further discussed here.

Early Strength Cement.—The time required for concrete to set up and harden represents direct loss to the owner in delayed use of the structure and loss to the contractor in additional form and equipment cost. A quick-setting cement which yields high early strength of concrete is, therefore, economically desirable, provided the cost of such cement is not so great as to offset the gains from expediting construction.

Several high early strength cements have been put on the market. These have been commonly termed "high alumina" or "aluminous" cements. They differ from portland cements somewhat in chemical composition. While both portland and aluminous cements are mixtures of various compounds, the active principle of portland cement consists chiefly of bicalcium silicate ($2\text{CaO}.\text{SiO}_2$) and tricalcium silicate ($3\text{CaO}.\text{SiO}_2$), while that of aluminous cements is probably monocalcium aluminate ($\text{Al}_2\text{O}_3\text{-CaO}$).

The monocalcium aluminate upon hydration is transformed into bicalcium aluminate, thus,¹ $2(\text{Al}_2\text{O}_3\text{CaO}) + 10\text{H}_2\text{O} = \text{Al}_2\text{O}_3\text{2CaO}.\text{7H}_2\text{O} + \text{Al}_2\text{O}_3\text{3H}_2\text{O}$. According to this equation, aluminous cement absorbs about 88 per cent of the weight of the

¹ *Concrete* (Mill Section), vol. 30, p. 107, June 1927.

alumina, requiring about twice as much water for hydration as does portland cement, or about 40 per cent of the weight of the cement. Because of the large amount of water used, aluminous cement mortar and concrete should be mixed rather wet and kept wet during curing because water deficiency causes marked reduction in strength.

Aluminous cement makes a denser mortar than portland cement, which, consequently, resists decomposition in sulphate and alkaline waters better and is more resistant to disintegration from freezing and thawing.

Aluminous cements must be distinguished from accelerated portland cements, several of which are on the market. The latter are manufactured by the use of high lime and silica content, fine raw grinding, hard burning, and fine finished grinding. They are frequently termed "supercements" and show an early strength much higher (100 per cent in some cases) than ordinary portland cement. Rapid hardening portland cements are somewhat cheaper than aluminous cements, the cost of manufacture being less.

Rapid setting should not be confused with rapid hardening. Aluminous cements actually are relatively slow setting but attain hardness rapidly after set. There are quick-setting cements available for use where water is to be excluded and for sea work when work must set up between tides.

To what extent aluminous cements may replace standard portland cements cannot be predicted. At present, their high cost and more rapid deterioration while stored, owing to more rapid hydration on exposure to moist air, seriously hinder a more extensive use. It is probable, however, that as manufacturing processes improve and knowledge of its properties increases, aluminous cement will be more widely used. Cements that will yield a strength twice that of the concrete now commonly used may be expected, and they will doubtlessly be found economical for many types of structures.

Other Hydraulic Cements.—As stated above, natural cement is manufactured similarly to portland cement, except that the raw materials are less accurately proportioned. It can be economically used in walls and other mass structures where weight is a more important consideration than strength, although in recent years, there is scarcely enough difference in the prices to warrant the extensive use of the natural cement.

Slag cement is manufactured by grinding basic blast furnace slag with carefully slacked lime and is essentially similar to portland cement. The slag to be used for making cement is quenched while in the molten condition in order to preserve the constituents which have cementing value, for slag that is allowed to cool slowly loses nearly all of its cementing properties. Slag cement is likely to run high in sulphur content, notwithstanding the fact that the process of quenching the slag removes a considerable amount of the sulphur in the original slag. Slag cement can usually be recognized by its bluish color and its light weight, its specific gravity being about 2.60 to 2.85. Slag cement is required to meet essentially the same specifications as portland cement, although it is likely to be unsound due to an excess of free lime and the presence of sulphides.

Pozzuolan cement is a term frequently applied to slag cement, but it is more properly applied to cement made in a similar manner by grinding volcanic scoria or other volcanic cinder with dry hydrated lime similarly to the method used in the manufacture of slag cement. This is essentially the same as the cement used by the Romans when they mixed volcanic ash and tufa with the lime thus giving it hydraulic properties.

Effect of Storage on Cement.—Professor D. A. Abrams of Lewis Institute made an extended series of tests¹ to determine the effect of storage on the properties of cement, both as to the time and the conditions of storage. Figure 11 shows typical results of the effect of storage on the strength of concrete made from stored cement, and corresponding results were obtained with reference to the effect on the strength of mortar.

The tests included three lots of cement kept in storage for periods up to two years, and were stored in three different conditions, (A) in the laboratory, representing optimum conditions of storage, (B) in the basement, representing somewhat less satisfactory conditions, and (C) storage in a shed, which would represent good field conditions of storage on construction. Professor Abrams' summary includes the following conclusions:

1. Compression tests of concrete and of mortar showed a deterioration in strength with storage of cement for all samples, for all conditions and periods of storage and for all test ages. The deterioration was greatest for samples stored in the yard and least for samples stored in the laboratory.

The basement storage was nearly as deleterious as out of doors. The deterioration was greater during the first three months than in any sub-

¹ *Structural Mils. Research Lab., Lewis Inst., Bull. 6.*

sequent three months period, and the deterioration was most marked in the 7 day test.

2. The effect of storage of cement on the strength of concrete or mortar is largely a question of the age at which the concrete or mortar is tested. The average concrete strength with cement stored in the shed in the yard when tested at 7 days (for all periods of storage) was 64 per cent of the strength when received from the warehouse; at 28 days 71 per cent; at 6 months,

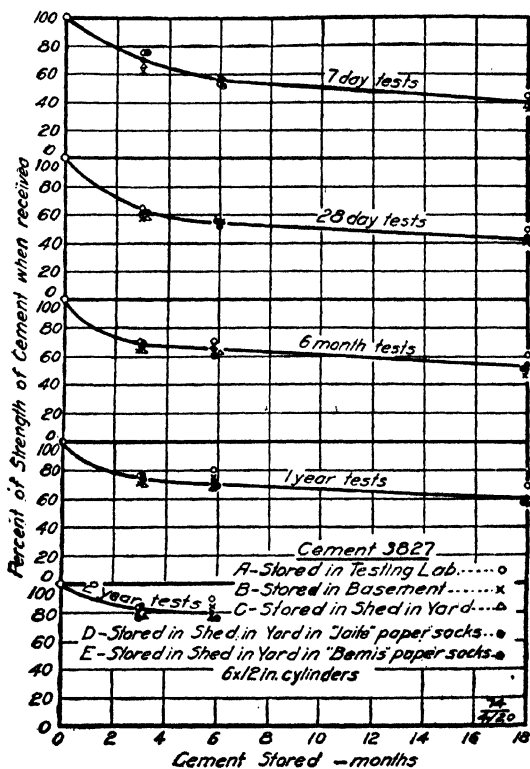

FIG. 11.—Effect of storage of cement on the strength of concrete.

78 per cent; at 1 year, 82 per cent; and at 2 years, 85 per cent. A somewhat similar relation is found for the other conditions of storage. It is a matter of utmost importance to note that the strength is not permanently reduced to the low values of the 7- and 28-day tests.

3. For periods up to 1½ years, there was no marked difference in the quality of cement stored in cloth and in paper sacks. Only a slight advantage was found from protecting cement in cloth sacks by thin layers of cement or of hydrated lime, the gain not justifying the cost of the process.

4. The difference in results from the different condition of storage was not sufficiently great to indicate possibilities of improving conditions of storage to marked degree in this climate.

5. Storage of cement prolongs the time of initial and of final setting. The normal consistency was only slightly affected by storage.

6. The deterioration of cement in storage appears to be due to the absorption of atmospheric moisture, causing partial hydration, which exhibits itself in reducing the early strength of concrete and in prolonging the time of setting.

In the above tests, lumps coarser than a 20 screen were generally discarded. At the end of 1 year, the cement showed about 12 per cent lumps while at the end of 2 years, it showed 30 to 75 per cent lumps. Concrete made entirely from lumps showed a strength at 7 days and two months of 40 to 50 per cent of the other cement from the same sacks.

Chemically, the chief effects appear to have been an increase in carbon dioxide, in moisture content some 500 per cent and in the loss on ignition about 200 per cent.

Owing to the less exposure, it is probable that bulk cement would deteriorate less during storage than does cement in bags.

Cement should be stored in a weather-tight building with the floor raised not less than 1 ft. from the ground and the cement should not be piled against the sides of temporary store houses but instead, a space of at least 1 ft. should be left on all sides to prevent contact with moisture from the sides.

Voids in Aggregates.—The void or interstitial space in aggregates has an important influence on the strength and other physical properties of concrete as well as upon the cost per unit volume, for to make good concrete the voids must be filled, hence, it is desirable to examine into the nature and conditions affecting void space.

In a mass of spheres of equal diameter, the voids between the spheres, or the total interstitial space, amount approximately to 26 per cent of the total volume, shown as follows: If n is the number of spheres in one tier and t the number of tiers, then the volume of the spheres is $\frac{4}{3}\pi r^3 nt$, r being the radius of a sphere. The volume of the including space is $2\sqrt{3}r^2n \times \frac{2}{3}\sqrt{6}rt$, and the ratio of these two quantities is 0.74. That is, the voids are 26 per cent of the total containing space.

However, even perfect spheres would have a larger percentage of voids than this theoretical amount because they would not be perfectly piled together. Fragments of stone or of sand that are essentially of uniform size have likewise a larger percentage of voids than this amount, although in a mass of irregular fragments

of approximately uniform size, the percentage of voids remains nearly constant regardless of the actual size. The percentage of voids is greater for angular than for rounded fragments.

When particles of graded sizes are mixed together, the smaller particles fill the interstices between the larger and consequently the percentage of void space is reduced. The densest mixture, i.e. the one with least void space, is formed by a mixture of such proportions that the finer particles just fill the interstitial space of the sizes next larger. The proportions which accomplish such a mixture of greatest density will be discussed in a subsequent paragraph.

The most convenient method of determining the voids in fine aggregate is to pour a *measured volume* of the aggregate into a graduated cylinder partially filled with water and observe the increase in the height of the water level. The difference in the heights of the water surface before and after introducing the aggregate indicates the volume of the water displaced, or the volume of the aggregate particles. The difference between this and the original volume of the aggregate represents the actual void space, which may readily be expressed as a percentage of the original volume. The same method may be used for coarse aggregate if a large graduate is available, but usually the preferable procedure is to determine the specific gravity of the material by the Jolly balance or other method, calculate the weight of a known volume if it were solid, then observe the actual weight of this volume and take the difference, which represents the voids, and this divided by the calculated weight gives the proportion of voids to the total volume.

In general voids should be determined in the aggregate loose rather than shaken together because such condition more nearly represents actual field conditions.

The voids in sand vary from 25 per cent in well graded sand to 45 per cent in sands more uniform in size and those having an excess of fine and intermediate particles. The voids in coarse aggregate average about as follows:

	PER CENT
Granite.....	38 to 46
Trap rock.....	47 to 51
Limestone.....	32 to 50
Gravel.....	22 to 40

There does not seem to be any definite relation between the percentage of voids and a "uniformity coefficient," or "finess

modulus," the voids depending almost entirely upon the gradation of the sizes.

Fine Aggregate.—Fine aggregate usually consists of sand, but it may be crushed stone or stone screenings, or artificially prepared material. Next to the cement, the fine aggregate is probably the most important ingredient in determining the strength of concrete, consequently the sand or other fine aggregate used should be carefully examined.

Three classes of sand may be mentioned according to the source from which it is derived, (1) pit or bank sand, (2) river sand and (3) sea sand. The first usually has an angular grain and frequently contains a good deal of clay, iron oxide, etc., and may require washing. It is usually of glacial origin and the grains are usually of quartz, but may be of limestone or other material. River sand is obtained from sand bars along the stream or by dredging from the bottom of the river bed, excellent sand being frequently obtained from this source. Sea sand is usually very fine grained, more uniform in size of grain and commonly contains alkaline salts. While it is impossible to formulate an inflexible specification for sand such as will always give good results and be universally and exclusively applicable yet certain qualities may be mentioned that will enhance the quality of the concrete and should be secured when practicable and when high grade construction is sought. Four properties should be listed in this category, viz., size of grains, gradation of size of grains, durability of the substance and the absence of impurities.

In general, sand should be coarse. Test made by René Feret¹ and others² show that sands composed chiefly of coarse grains, (about 80 per cent between $\frac{1}{4}$ and $\frac{1}{20}$ in. in diameter) and the remainder of fine grains (less than $\frac{1}{40}$ in.) with practically no grains of intermediate size yielded the strongest mortars, and tests made at the University of Kansas under the author's direction indicated the same conclusion. However, tests made by the Bureau of Standards led to the conclusion³ "the straight line gradation may be said to be the ideal gradation . . . but that the proportion passing the coarser screens should not be too low." Coarse sand with comparatively little fine material is

¹ *Annales des Ponts et Chaussées*, vol. 2, p. 164.

² *Engineering News-Record*, Nov. 27, 1918.

³ *U. S. Bureau of Standards, Tech. Paper 56*, p. 25.

superior for concrete, although a fine sea sand with 99 per cent passing a 50-mesh screen has given satisfactory concrete. It is possible that other characteristics of sand exercise such an influence on the strength of concrete that the effects of different gradations on the strength of concrete are obscured. The Joint Committee specified that not more than 30 per cent should pass a 50-mesh screen. A coarse sand containing only a small proportion of fine particles is frequently termed "torpedo sand."

Tests made by E. E. Paul under the author's direction indicated the average results on 1:3 mortar briquettes at 28 days as stated, with 15 per cent fine and 85 per cent coarse yielding the strongest mortar. Uniformly graded sand gave a strength about 4 per cent less than the mix 15 per cent fine and 85 per cent coarse.

The gradation of an aggregate is expressed by the equation,¹

$$p = 100 \left(\frac{d}{D} \right)^n$$

where p is the per cent passing any screen of size d in., D is the diameter of the largest particles in the aggregate, and n is an exponent. When $n = 1$, the curve of gradation is a straight line; when $n = 0.5$, the curve is a parabola.

Older specifications designated that the sand should be "sharp," i.e., have angular grains, but experiments have quite completely demonstrated that sand with angular grains does not yield a stronger mortar than one with rounded grains.

In order that a sand may be durable and strong, the minerals of which it is composed should be hard and tough. Silica sand is preferable in this respect, although sand consisting of fragments from any hard trap rock will suffice, and much glacial drift sand, such as that found at many points in Ohio, consisting chiefly of limestone particles, yields a strong mortar. It is essential only that the strength of the particles shall be as great as or greater than that of the cement matrix in which they are placed. Sands consisting largely of grains of feldspar, mica, hornblende, augite, etc. are less satisfactory than those of harder and more durable materials, mica being particularly objectionable, 10 per cent mica reducing the strength of 1:3 mortar about 40 per cent.

Absolutely clean sand is practically impossible to obtain and a limited amount of impurities must usually be expected. The effect of impurities in sand on concrete depends very largely on the character rather than the amount of the impurities. Mineral

¹ *Univ. of Illinois, Eng. Exp. Sta., Bull. 137.*

matter in sand, such as clay, in small quantities may not impair the quality of the concrete but in fact, may even improve a lean mortar or concrete by effecting a better distribution of the cement paste. Organic impurities, on the other hand, such as vegetable loam, will always seriously diminish the strength of concrete, as small a percentage of organic matter as 0.5 per cent having been found to reduce the strength of mortar about 20 per cent.¹ Vegetable matter seems to coat the sand grains and thus diminish the adhesion. Therefore, while clay may ordinarily be admitted

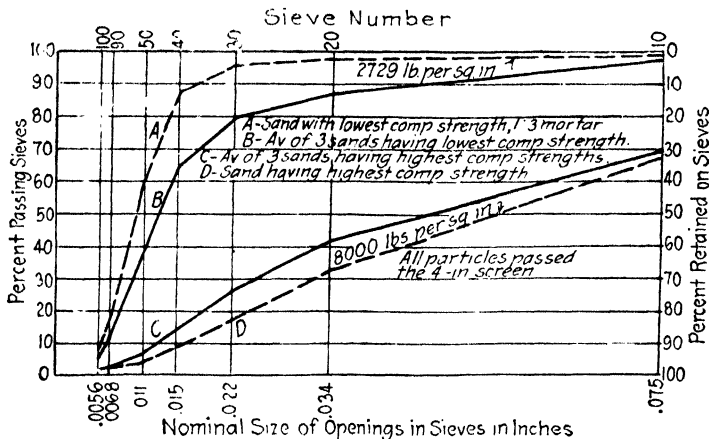

FIG. 12.—Effect of gradation of sand on the strength of mortar.

up to perhaps 7 per cent without objectionable results, all organic matter should be rigidly avoided.

Impurities in sand may be removed by washing, but this is an expensive process and should not be required unless the character and the amount of the impurities are such as to be really harmful. While for high grade work, washing a dirty sand is worth all that it costs, washing a sand does not always improve it, for washing may remove too much of the fine material which is required to secure a good distribution of the cement paste.

Tests of Sand.—The tests most commonly applied to sand for use as fine aggregate are (a) Sieve analysis to determine the size of particles and the gradation, (b) the mortar test and (c) the cleanness test.

¹ *Engineering-Contracting*, vol. 43, p. 403.

Sand weighs from 80 to 120 lb. per cubic foot, averaging about 100 lb. Dry well graded sand weighs about 120 lb. per cubic foot, while moist sand will weigh about 5 to 8 per cent less.

A sieve analysis is made by using a succession of sizes of sieves determining the percentages of the original sample passing and retained on each size. A sieve analysis curve is then plotted with per cents passing (or per cents retained) as ordinates and sizes of sieves as abscissas. Figure 12 shows analyses of sands and the average of sands giving the highest and lowest compressive strengths of the series. The sieves most commonly used for making the sieve analysis test (used by the Bureau of Standards) are 8-in. hand sieves as follows:

Mesher per inch.	4	6	8	10	16	20	30	40	60	100	200
Size of holes,	0.25	0.13	0.096	0.073	0.042	0.034	0.020	0.015	0.009	0.0055	0.0026

A test frequently required for sand to ascertain its entire usefulness in mortar or in concrete is the mortar test, and consists in comparing the strength of briquettes made from the sand in question with that of briquettes made with standard sand¹ using the same proportions. However, the mortar test is by no means a certain indication of good fine aggregate, particularly when the standard proportions of 1:3 are used in making the test, for tests made under the direction of the author² show that sand or screenings containing considerable fine material may give a strong 1:3 mortar but a relatively weak concrete. Where the mortar test is used, therefore, the proportions should be similar to those to be used in the concrete mixture.

For determining the clay content, the most practical method is to wash out the silt on a 100-mesh screen, as follows: After slowly drying the sample to avoid baking lumps, about 200 g. are carefully weighed out and then washed on a 100-mesh screen under a gentle stream of water until the water runs essentially clear, and then dried and re-weighed, the loss in weight representing the silt content. The silt can be estimated also by allowing the wash water after elutriation to stand in a graduated cylinder the volume of sediment being measured at the bottom. A rough approximation can be made by counting the proportion passing an 80-mesh sieve as silt. If as much as 10 per cent clay is present

¹ Note.—“Standard sand” means a silica sand obtained from Ottawa, Ill., washed and screened to pass a 20 screen and be retained on a 30 screen.

² *Engineering News-Record*, May 22, 1919.

in sand (an amount that should not be exceeded), the sand if damp will adhere and remain molded in the form of the palm of the hand when squeezed.

Two tests for organic impurities have been used, viz., (1) the colorimetric test and (2) the loss on ignition test. The colorimetric test consists in adding a 3 per cent solution of sodium hydroxide¹ to a sample of sand and after shaking allowing it to stand. If the supernatant liquid is clear or light yellow, the sand does not contain an appreciable amount of organic matter; but if it is dark red to black, it probably contains a harmful amount of organic matter.

The loss on ignition test is performed by drying and weighing a sample and then subjecting it to high heat in a crucible and determining the loss. Obviously sand of unstable composition may suffer losses other than those due to the presence of organic matter.

Stone Screenings.—When natural sand is not available for use as fine aggregate, crushed stone screenings passing a $\frac{1}{4}$ -in. or $\frac{3}{8}$ -in. screen may be used instead. Laboratory tests on mortar made from carefully prepared screenings indicate that even greater strength may be secured from screenings than from sand. Precaution should be taken, however, to see that the screenings are free from an excess of fine material or dust. Tests conducted under the author's direction on an extensive project on which limestone screenings from some of the best quarries were used in making concrete showed that commercial screenings cannot be depended upon to afford a satisfactory fine aggregate for concrete as rich as 1:6 or richer, owing to the large amount of dust contained in the screenings. This was true notwithstanding the fact that 1:3 mortar briquettes made from these screenings showed high strength. The difficulty arises from the fact that all of the clay in the native bed of stone is concentrated in the screenings.

However, for mass construction where high strength is not so essential, commercial screenings may be used satisfactorily, and in the absence of a suitable sand, crushed stone may be prepared from a suitable rock, even though the rock is not flinty in its hardness. In fact, a hard quartzite or trap rock may grind away the crusher so rapidly that the preparation of artificial sand in this manner may be impracticable. Brick dust, crushed marble

¹ *Report Committee C, Am. Soc. for Testing Materials*, vol. 17, p. 382.

and fine cherts may be used under certain conditions as fine aggregate, but with rather indifferent success.

Coarse Aggregate.—The purpose of the coarse aggregate is to form the body of the artificial stone, or concrete. Various materials have been used as coarse aggregate, such as crushed stone, gravel, slag, cinders, coke, brick fragments, shells and some specially prepared granulated material of fused clay or shale, the lighter substances being employed in floor, roof or other construction where it is desired to keep the weight to a minimum.

The relative value of gravel and broken stone as aggregates has been a much debated question. Neither material as a class

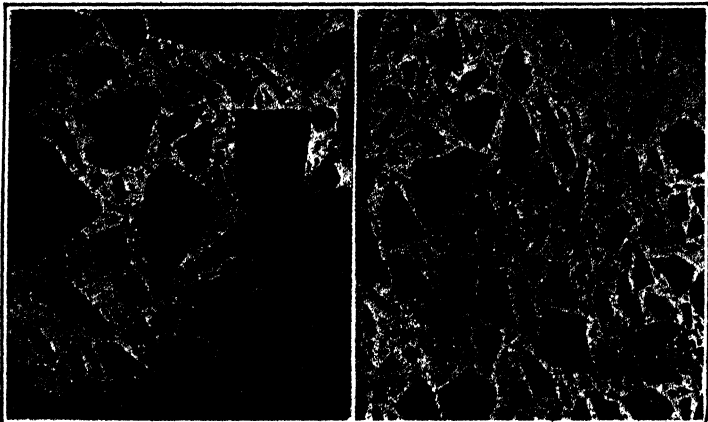

FIG. 13.—Sections through concrete.

can be said to be superior to the other, for the range of strength of the concrete with either is greater than any apparent difference between the two. In general it is probable that better concrete will be secured with crushed stone of good quality than with gravel because of the greater freedom from deleterious matter, although results of tests can be found that seem to indicate that gravel is the superior material.

Crushed rock may be obtained from almost any natural rock that is of reasonable strength and not decomposed. It is desirable that the natural rock shall have sufficient strength to develop the full strength of the mortar matrix in which it is to be imbedded, but strength of the coarse aggregate in excess of this amount cannot be utilized in concrete and usually is not worth

any additional cost. The fragments of crushed stone should be cuboidal in shape and not flat or splintery. Figure 13, from Bulletin No. 58, Bureau of Standards shows the increased density of concrete from cubical fragments owing to the mortar forcing or wedging the fragments apart. Trap rocks, limestone, granites, conglomerates, hard sandstone, and marble yield good aggregate, their value being about in the order named.

The size of broken stone is measured by the diameter of the ring that the fragment will pass. Formerly, the maximum size used rarely exceeded 2½ to 3 in., but recently it has become the practice to use large pudding stones for plain concrete in thick masses because of the economy effected, and tests indicate that the use of such large stones increases the strength of the concrete.¹ Large aggregates decrease the surface area and hence give a better distribution of the cement mortar. For mass work, aggregate graded up to 6 or 8 in. may be economically used. "Pudding stones" for heavy mass work as large as two men can move (or larger if they can be handled) may be used. Such stones should be structurally sound, clean and free from surface disintegration, and placed far enough apart to permit complete imbedment in the concrete matrix. They should not be closer together nor closer to an exterior surface than about 6 in. Concrete composed to a considerable degree of such stones is called "Cyclopean" concrete.

The size of aggregate should be governed by the character of the work, the largest stones being such as can be properly placed with reference to the thickness of the wall, position of any reinforcing steel, etc. For normal reinforced concrete construction, the stone should seldom exceed 1 in. in diameter on account of the difficulty in placing around the reinforcing steel. In fact many engineers prefer ¾-in. stone, and it is doubtful if for highly reinforced construction any economy is effected by using stone coarser than ¾ in.

Blast furnace slag has been quite extensively used as coarse aggregate with good results. It should be free from dirt, should be non-porous and sound, and should be well seasoned in order that unstable chemical compounds may be eliminated. Before a slag is used, it should be examined carefully to insure its chemical composition and stability lest its disintegration affect the concrete and acid products react with the steel in the case of rein-

¹ U. S. Bureau of Standards, *Tech. Paper 58*, p. 63.

forced concrete. The Joint Committee declined to sanction the use of slag as an aggregate, particularly for reinforced concrete.

Cinders for coarse aggregate should consist of hard vitreous clinker free from ashes or unburned coal. Cinders are suitable only where lightness of the concrete is a controlling desideratum and the concrete is not intended to carry appreciable load. Coke may sometimes be used as aggregate under similar conditions.

There are several specially prepared proprietary aggregates on the market of varying merit. Most of these are manufactured by burning clay or shale and are intended to replace both the fine and coarse aggregate. From some of them, concrete can be made comparable in strength with normal concrete and in weight with cinder concrete.

Gradation of coarse aggregate from fine to coarse is an important property, since a gradation of sizes yields the densest and strongest concrete. The minimum size is commonly recognized as that retained on a $\frac{1}{4}$ -in. screen, although many commercial concerns use the $\frac{3}{8}$ -in. screen as the minimum. The maximum size of particle, as shown above, varies with the character of the work under construction, large size aggregate being economically used for mass work.

Other qualities being equal, flinty rock with an impervious smooth surface probably does not produce so strong a concrete as an aggregate with a somewhat porous and grained surface. However, this effect is usually more than counterbalanced by the greater shearing and flexural strength of the flints, as tests made by the author indicate. In these tests, the flint aggregates gave a concrete of higher strength than did the limestone with which it was being compared.

The character of the surface has a marked effect on the amount of water required to produce a workable mix, a porous stone requiring considerably more water than does an impervious aggregate. This fact makes it impossible to use a predetermined percentage of water in the mixing and requires the proper amount of water to be determined by observation in each case.

Units Used in Proportioning.—Ordinarily, the cement and aggregates are measured in bulk loose, although sometimes weighed. The former practice is preferable for two reasons: In the first place, measurement by volume is the more convenient. In the second place, the proportioning is chiefly a function of void space in the aggregates, which is a matter of volume. That is,

a stone with a specific gravity 2.75 would weigh 22 per cent more per cubic foot than one with a specific gravity 2.25, yet the voids in the two might be the same.

Since 1 cu. ft. of stone, of sand, of gravel, and of cement weigh approximately 100 lb., the practice of proportioning by volumes loose has become widely adopted and this practice probably gives more uniform results than would gross weight. If proportions were based on absolute volumes of particles, however, more uniform concrete would doubtless result, but this refinement is generally impracticable.

General Principles of Proportioning Concrete.—Concrete is in reality an artificial conglomerate stone in which the mineral ingredients are made to adhere by virtue of the cement paste. Its qualities are directly affected by the character of the aggregate and it is obviously not capable of refined control in its manufacture, because of unavoidable lack of uniformity in its composition and manipulation. At best, there are variations from batch to batch of aggregates which appear to be uniform and corresponding variations occur in the mixing and placing. The strength and other properties are not predictable with refinement, therefore, even under the best conditions.

Under careful laboratory control, the strength of concrete should be uniform within ± 10 per cent from the average; under good field construction conditions, the strength may be expected to vary ± 20 per cent, and, under inferior control, the average may be ± 35 per cent from the mean. A very succinct summary of these principles may be quoted from a discussion by Prof. A. N. Talbot.¹

“1. The cement and mixing water may be considered together to form a paste; this paste becomes the glue which holds the particles of the aggregate together.

2. The volume of the paste is approximately equal to the sum of the volume of the particles of cement and the volume of the mixing water.

3. The strength given by this paste is dependent upon its concentration—the more dilute the paste, the lower its strength; the less dilute, the greater its strength.

4. The paste coats or covers the particles of the aggregates partially or wholly and also goes to fill the voids of the aggregate partially or wholly. Full coating of the surface and complete filling of the voids are not usually obtained.

¹ *Proc. Am. Ry. Eng. Assn.*, vol. 20, p. 905.

5. The coating or layer of paste over the particles forms the lubricating material which makes the mass workable; that is, makes it mobile and easily placed to fill a space compactly.

6. The requisite mobility or plasticity is obtained only when there is sufficient paste to give a thickness of film or layer of paste over the surface of the particles of the aggregate and between the particles sufficient to lubricate these particles.

7. Increase in mobility may be obtained by increasing the thickness of the layer of paste; this may be accomplished by adding water (resulting in a weaker paste) or by adding cement, up to a certain point (resulting in a stronger paste).

8. Factors contributing to the strength of concrete are then, the amount of cement, the amount of mixing water, the amount of voids in the combination of fine and coarse aggregate, and the area of the surface of the aggregate.

9. For a given kind of aggregate the strength of the concrete is largely dependent upon the strength of the cement paste used in the mix, which forms the gluing material between the particles of the aggregate.

10. For the same amount of cement and same voids in the aggregate, that aggregate (or combination of fine and coarse aggregates) will give the higher strength which has the smaller total area of surface of particles, since it will require the less amount of paste to produce the requisite mobility and this amount of paste will be secured with a smaller amount of water; this paste being less dilute will therefore be stronger. The relative surface area of different aggregates or combination of aggregates may readily be obtained by means of a surface modulus that may be calculated from the screen analysis of the aggregate.

11. For the same amount of cement and the same surface of the aggregate, that aggregate will give the higher strength which has the less voids, since additional pore space will require a larger quantity of paste and therefore a more dilute paste.

12. Any element which carries with it a dilution of the cement paste may in general be expected to weaken the concrete—smaller amounts of cement, the use of additional mixing water to secure mobility of the mass, increased surface of the aggregate, and increased voids in the aggregate all operate to lower the strength of the product.

13. In varying the gradation of the aggregate a point will be reached, however, when the advantages in the reduction of surface of particles is offset by increasing difficulty in securing a mobile mass, the voids are greatly increased, the mix is not workable, and less strength is developed in the concrete. For a given aggregate and a given amount of cement, a decrease in the amount of mixing water below that necessary to produce a sufficient paste to occupy most of the voids and to provide the lubricating layer will give a mix deficient in mobility and lower in strength."

From various experiments, too extensive to be described here, five conclusions may be drawn which may be stated as laws for proportioning concrete:

1. Other conditions, such as the ratio of fine to coarse aggregate, the character of materials, the surface area of the aggregates, and the water content, remaining constant, the strength of concrete increases with the amount of cement used.

2. Other conditions remaining constant, within the range of practical workability, the strength of concrete varies inversely with the water-cement ratio.

3. Other conditions, such as those mentioned in (1) and the proportion of cement to aggregate remaining constant, the strength and durability of concrete increases with the density of the mixture.

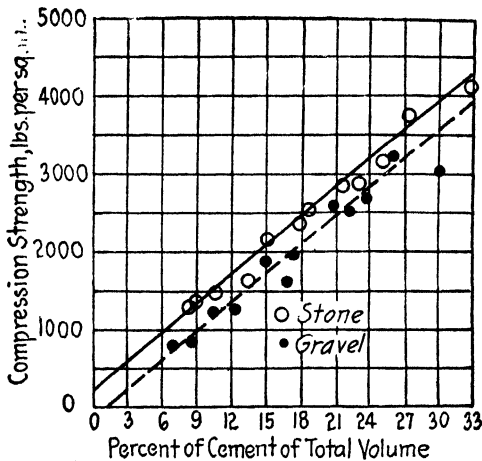

FIG. 14.—Relation between the compressive strength of concrete and the proportion of cement used.

4. Other conditions remaining constant, the strength of concrete varies with the ratio between the volume of cement and the total interstitial space in the aggregates, that is, the ratio between the volume of the cement and the void space in the concrete plus the space occupied by the cement in the concrete, or, $c/(v + c)$.

5. Other conditions remaining constant, including character of surface and percentage of voids, the aggregates with a minimum of surface area of particles will yield the strongest concrete.

The first law stated above is illustrated in Fig. 14,¹ the second in Fig. 17, the third in Fig. 15² and the fourth in Fig. 16.³

¹ I. O. BAKER, "Treatise on Masonry Construction," p. 140.

² U. S. Bureau of Standards, Bull. 58, pp. 58-9.

³ Univ. of Illinois, Eng. Exp. Sta., Bull. 137, p. 32.

Obviously the objects to be sought under No. 5 are incompatible with those required by No. 3 for large spheres of uniform size

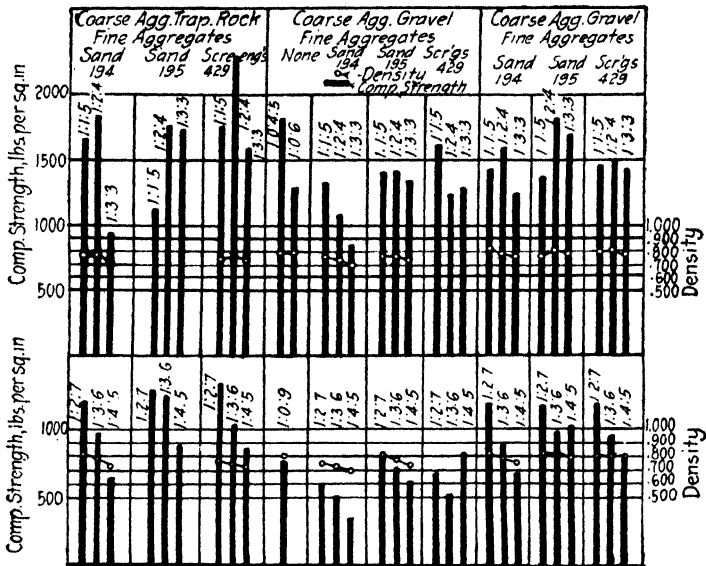

FIG. 15.—Relation between strength and density of concrete.

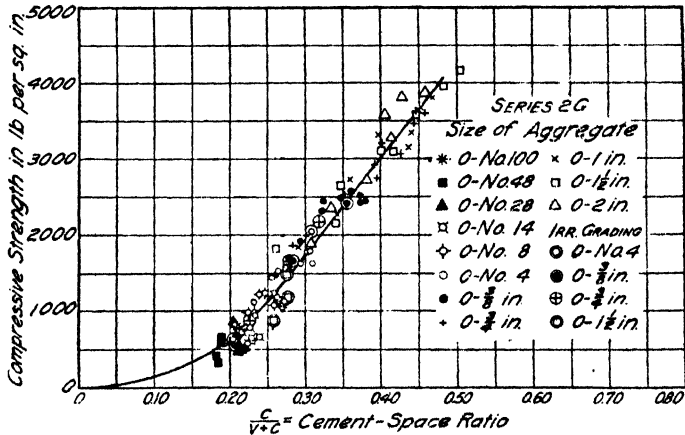

FIG. 16.—Relation between strength of concrete and cement space ratio.

would give a minimum of surface area but a relatively large void space, while a well graded aggregate from fine to coarse will yield a large superficial area of particles but relatively a smaller

void space. This fact may account for the variation observed by the Bureau of Standards and others that the gradation of maximum density does not always yield the strongest concrete, although it always yields a relatively strong concrete.

The determination of the amount of cement to be used per unit volume, or in other words the richness in the mixture, is chiefly a question of economics, depending upon the character of the structure contemplated, and not one of mechanics. With first class materials and workmanship in fabrication, strengths of concrete 100 per cent in excess of those given in Table V may be obtained, while with inferior materials and inferior fabrication,

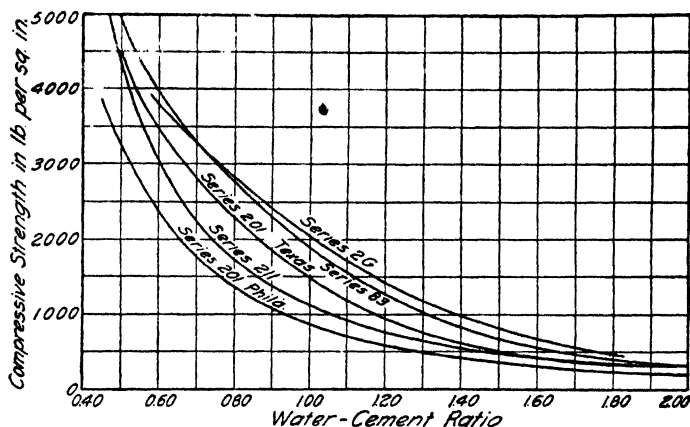

Fig. 17.—Relation between strength of concrete and the amount of water used.

concrete which may appear acceptable may have strengths of not more than 50 per cent of these values. Tests reported by the Bureau of Standards of 1:2:4 concrete showed variations as follows: limestone, range 213 per cent; granite, range 29 per cent; gravel, range, 354 per cent.¹ For 1:3:6 concrete, limestone and granite showed a variation of about 300 per cent. The test period was four weeks and represented 18 limestones, 11 gravels and 3 granites.

With a close control of the fabrication, it is possible to predict within a relatively small margin the strength of the concrete resulting from any given materials and degree of richness, but care is required to do so. In general, it is better to use the rather conservative values of Table V in practical design,

¹ U. S. Bureau of Standards, Bull. 58, p. 37.

although where conditions require extraordinary strength, it may be secured as indicated above by using proper precautions as to materials and workmanship.

Proportion of Cement.—The cement is the most expensive ingredient in concrete and it is uneconomical to use a greater amount than is required to furnish the necessary strength and imperviousness to meet the conditions at hand. The aggregate is a diluent and cheapens the resulting concrete when it is increased in amount. Proportions are usually stated as a ratio, as 1:6, meaning one part cement by volume (measured loose) to six parts of total aggregate (fine and coarse), or as 1:2:4, meaning one volume of cement to 2 volumes of sand to 4 volumes of coarse aggregate, all by volume measured loose. In practice, one bag of cement, net weight 94 pounds, is taken as one cubic foot, four of which are counted as one barrel.

The following general statements of proportions to be used are illustrative rather than complete or absolute, although they do represent good average practice, normal workability being assumed:

- 1:2 For concrete floors subject to heavy abrasive wear.
- 1:3 For sidewalk surfaces and water-tight structures.
- 1:4 For highly reinforced work requiring extraordinary strength.
- 1:5 For highly reinforced concrete, columns, etc.; also used commonly for concrete pavements.
- 1:6 For ordinary reinforced beams, columns, bin walls, slabs and other structural parts; a very common standard for building construction, sewers, conduits, etc.
- 1:7½ For machine foundations, reinforced retaining walls, and other heavy work, thin foundation walls bearing comparatively light loads.
- 1:9 For mass work not subject to heavy stresses carrying stationary loads, such as bridge piers and abutments (below the bridge seat), retaining walls, etc.
- 1:12 For very massive work where little strength or imperviousness is required and where large stones are used in the coarse aggregate.

The judgment of the engineer will have to be largely relied upon to determine the economic percentage of cement to be used, governed by the principle that for constant conditions of aggregates, and fabrication, the more cement the better the concrete and at the same time the greater the cost. Good engineering judgment will not incur additional cost to obtain a better grade of concrete than is required by the circumstances nor will it admit of con-

crete that is inadequate to meet the requirements. In other words, the concrete should be designed to suit the use for which it is intended, and the problem is essentially, *first to determine the character of the concrete required with respect to strength, imperviousness, resistance to abrasion, etc., and then to obtain that grade of concrete at the least cost.*

With the proper proportion of cement determined to furnish the grade of concrete desired for the particular construction in view, the choice of the relative proportions of the aggregates is a matter of fairly exact determination, depending chiefly upon the mechanical properties of the aggregates themselves.

The principle that with other conditions remaining constant the densest mixture is the strongest gives the clue to the selection of the proportions, namely, the proportions should be such that the resulting mixture will be of maximum density. While experiments have shown exceptions to this rule,¹ yet in every case the densest mixture is nearly the strongest if not absolutely the strongest, and the rule is, therefore, a reliable one to follow in practical proportioning.

The practical problem is how to choose the proportions of the ingredients so that the resulting mixture will have the maximum density. Several methods have been used to a greater or less extent to accomplish this purpose which will be briefly outlined in the following paragraphs.

Proportioning by Arbitrary Assignment.—Making a concrete with a given proportion of cement consists essentially in making a mortar of the desired richness and then filling the voids of the coarse aggregate with that mortar. This principle, while roughly correct, is deficient in two respects, (1) there is always present a certain amount of fine material in the coarse aggregate which alters the proportions of the mortar, and (2) when the mortar is mixed with the coarse aggregate, it wedges the particles of the latter apart, thereby requiring more mortar to fill the voids than would be indicated by the apparent volume of the voids in the loose rock.

On an average, crushed rock is assumed for this purpose to contain about 45 per cent voids, which because of the wedging action of the mortar require a volume of 50 per cent of the loose stone to fill, and thus half as much sand is used as stone, e.g., 1:2:4, 1:3:6 mixtures, the cement being assumed to form a

¹ U. S. Bureau of Standards, *Tech. Paper 58*, p. 92.

paste around the sand grains and not appreciably to increase the volume of the sand. This process gives fairly good results for crusher run stone and well graded gravel, but at best is but an unscientific rule-of-thumb method, and cannot be expected to give as satisfactory and economical results as proportions designed in accordance with the peculiar properties of the aggregates to be used, and in many cases, it actually yields decidedly inferior concrete.

Moreover, when this mode of specifying is used, frequently no adequate restriction is made with regard to the consistency or the amount of mixing water, *without which, proportions have little significance with respect to strength.*

Proportioning by Void Determination.—If the percentage of void space should remain unchanged after the mortar is added, it would be a simple matter to determine the percentage of voids and to use enough mortar of a desired richness to fill those voids, but, as explained above, the void space is not constant and therefore this method is not accurate. The amount of increase of the voids due to the wedging action of the mortar amounts to 10 to 20 per cent, being greater for well graded material than for material of uniform size. For gravel and crusher run stone, the amount of mortar used should be about 1.15 times the volume of the voids, while for crushed stone of uniformly large size, the mortar may be made practically equal to the void space or increased but slightly. Viewed in this manner, concrete is essentially a combination of mortar and coarse aggregate. This method of proportioning is a step more reliable than the preceding one, the approximation lying in a generalized figure for the increase in voids instead of an average value for the voids themselves.

The proportion of mortar of desired richness which is necessary to fill the voids of a given coarse aggregate may be determined by direct trial with fairly satisfactory results. The voids are filled when the mortar flushes to the surface as the mixture is tamped into a vessel. For example, if a 1:2 mortar were to be used and 0.44 cu. ft. of this mortar were required to fill the voids in making a cubic foot of concrete, assuming the volume of the mortar equal to the volume of the sand, the proportions should be 1:2:4½.

Proportioning by Mechanical Analyses.—In this method, it is assumed that with a given gradation of the aggregates, the

void space is essentially constant and that there is a certain mechanical analysis curve representing a gradation of the sizes which gives the maximum density of mix and hence the strongest concrete. The maximum density curve devised by W. B. Fuller and J. L. Davis¹ from an extensive series of investigations consists of an ellipse (plotted as shown presently) over the portion of the mixture corresponding to the fine aggregate and the cement

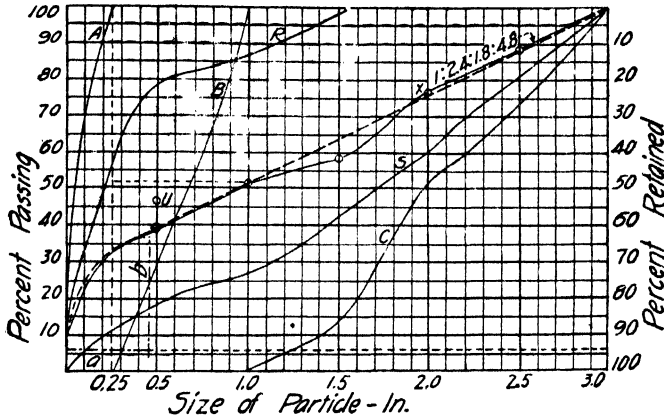

FIG. 18.—Sieve analysis curves and curve of maximum density.

and a straight line over the portion corresponding to the coarse aggregate. This curve of maximum density is illustrated in

Material	Semi-Axes	
	a-in.	b-%
Crushed stone and sand.....	0.150D	30.4
Gravel and sand.....	0.164D	28.6
Crushed stone and screenings.....	0.174D	30.8

NOTE.—An ellipse is conveniently plotted by the trammel point method, as follows: Lay off on the edge of a strip of cardboard from the left end, *O*, distances equal to the semi-horizontal and semi-vertical axes and mark these points *A* and *B* respectively. Turn the cardboard so that the point *B* is always on the horizontal axis and the point *A* is always on the vertical axis, and then the point *O* will describe an ellipse. A number of positions of *O* having thus been plotted, the curve can be drawn with an irregular curve.

¹ *Trans. Am. Soc. C. E.*, vol. 59, p. 144.

Fig. 18 the ordinate to the curve including the cement in each case. The quadrant of the ellipse is plotted on the 7 per cent line as the x-axis and on a y-axis that is a distant from the vertical axis of co-ordinates. The axes of the elliptical quadrant are as shown on p. 89, D being the diameter of the largest particle.

While tests made by the Bureau of Standards indicate that it is impossible to devise a single curve that will represent the maximum density of all aggregates and that each particular aggregate has its own maximum density curve, yet tests show that this general curve gives good results even if not the maximum in every case. It is probably impossible to make any general rule that will be universally applicable in giving absolutely maximum results in every case where the material is as variable as are concrete aggregates.

To illustrate the use of this maximum density curve, take for example a crushed stone screened to the sizes 0-0.25, 0.25-1.00, and 1.00-3.00 curves A, B and C , Fig. 18. Combining the sizes according to this curve would give 48 per cent of the 1.00-3.00 size, 34 per cent of the 0.25 size (including the cement) and 18 per cent of the intermediate size. Inasmuch as the 34 per cent includes the cement, for 1:9 mixture, since 10 per cent of the whole is cement, 24 per cent should be taken from the sand. The actual curve of the combined mixture can be plotted by calculating the points, any point, X , having $10 + 24 + 18 + 0.52 \times 48 = 77$ per cent as its ordinate.

The mix of maximum density can be obtained by "trial proportions" by ascertaining the weight of a pailful of a series of mixtures of varying proportions, keeping the consistency constant. The pailful which is the heaviest is the densest mixture.

Where the sieve analysis curves overlap, as in the case of combining a coarse gravel with a fine gravel which is to take the place of sand, a slightly different procedure is required. This case is illustrated in Curves R and S . The method followed is to try out various proportions, but instead of actually measuring the densities of the resulting mixtures as in the case of proportioning by trial, the relative densities are tested by a comparison with the maximum density curve. For a 1:6 mixture, for example, $1:1\frac{1}{2}:4\frac{1}{2}$, $1:1\frac{3}{4}:4\frac{1}{4}$, $1:2:4$, $1:2\frac{1}{4}:3\frac{3}{4}$, $1:2\frac{1}{2}:3\frac{1}{2}$ might be used and the curve for each mixture calculated, and the curve nearest the maximum density curve would represent the best proportions. For example, to obtain a point on a curve for the

1:2:4 proportions corresponding to the 0.5 in. size, the ordinate would be obtained as follows:

	PER CENT
$\frac{1}{4}$ of 100 per cent	= 14.3
$\frac{2}{4}$ of 79 per cent	= 22.6
$\frac{3}{4}$ of 18 per cent	= 10.3
	47.2

That is, the ordinate to the curve at this size would be 47.2 per cent.

Manifestly, it is needless to secure a theoretical refinement in proportioning which practical methods of mixing and the varying character of the materials will not permit to be realized in practice.

Proportioning by Water-cement Ratio.—Investigations conducted by D. A. Abrams at Lewis Institute resulted in a method of proportioning by means of the water-cement ratio. Originally, this ratio was stated in terms of the ratio of the volume of water to the volume of the loose cement, but, more recently, the custom has gained favor of expressing the ratio in terms of the gallons of water per sack of cement, a *w/c* of 1.0 being $7\frac{1}{2}$ gal. per bag. Mr. Abrams' tests showed the important relation between the water-cement ratio and the strength of the concrete. See Fig. 19. That the water-cement relation is not an exact law but represents a general tendency is shown by Fig. 17.¹ This figure contains the curve of Mr. Abrams' tests, Series 83, tests made at the University of Illinois, 2G and 211, as well as some other tests. It is obvious that the relationship is not an exact one and that many other factors than water-cement ratio and workability, such as gradation of aggregates, workmanship, and conditions of curing, particularly temperature, affect the strength of concrete.

The assumption upon which this method of proportioning is based is that, for a constant workability, the strength is governed entirely by the water-cement ratio. Workability is measured preferably by means of a penetration test or the flow table, although the slump test has been widely used in the field to measure consistency as an index of workability. From the plotted curve, Mr. Abrams derived the equation $S = 14,000/7^x$ or $\log S = 4.148 - 0.845x$. Variations as much as ± 30 per cent may be expected from the value of strength thus calculated, depending upon the aggregates and other conditions.

¹ *Univ. of Illinois, Eng. Exp. Sta., Bull. 137, p. 75.*

The procedure in this method is to determine, from such information as Fig. 19, the water-cement ratio that will give the desired strength, duly taking into account the water entrained in the aggregates by making frequent observations on the same, and then determine, by trial, the economic proportions of aggregates which, when mixed with paste having this water-cement ratio, will give the desired workability. It is important in using the water-cement ratio methods that bulking of aggregates and the amount of latent moisture be taken fully into account.

The size of course aggregate has considerable influence on the strength and other properties of concrete even though the proportions and workability be kept constant. Thus, with

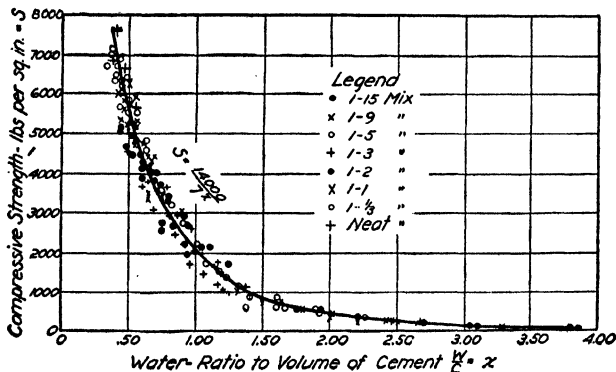

FIG. 19.—Relation between water-cement ratio and strength of concrete.

aggregate graded from $\frac{1}{4}$ - $1\frac{1}{2}$ in., the strength may be a third greater than with aggregate $\frac{1}{4}$ - $\frac{3}{4}$ in., using the same proportions and workability.

The water-cement ratio tends to yield an over-sanded concrete in practice because the presence of excess fine aggregate promotes workability. The result is that there is a danger of securing a less dense or more permeable concrete with consequent greater tendency to weather under freezing action.

Because also of the lack of precision in determining a definite standard of workability, a considerable variation in quality of concrete may result, since workability along with water-cement ratio is a primary factor in quality control.

Other Methods.—Many other methods have been proposed. Professor Abrams first proposed the “fineness modulus” as a basis of proportioning. This modulus, defined as the “sum of

the ordinates under the sieve analysis curve divided by 100," is in reality a gradation modulus and when properly interpreted gives results corresponding to the maximum density curve. The sieves used by him are from the Tyler standard series: 100, 48, 28, 14, 4, $\frac{3}{8}$, $\frac{3}{4}$, and $1\frac{1}{2}$. Each sieve has a clear opening just double the width of the preceding one, and the curve is plotted with *per cents coarser* than each sieve instead of *per cents passing*, as in the previous article. Thus, a well graded torpedo sand will have a fineness modulus of 3.00, while a fine drift sand will give a modulus as low as 1.50; a well graded coarse aggregate, $\frac{1}{4}$ - $1\frac{1}{2}$ in., will give a modulus of about 7.00, while a mixture in proper proportions for a 1:4 mix will have a modulus

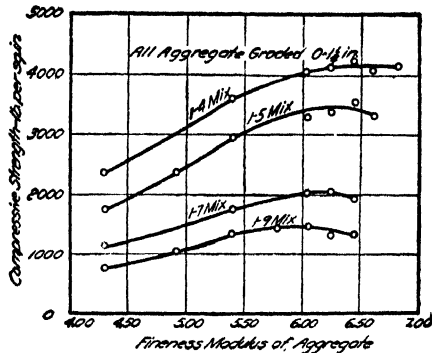

FIG. 20.—Relation between fineness modulus and strength of concrete.

of about 5.80. Figure 20 shows the relation between the fineness modulus and the compressive strength.

Professor Abrams' experiments caused him to conclude that the "water-cement ratio" is a determining factor in fixing the strength of concrete so long as a workable mix is used. Figure 19 taken from Bulletin No. 1 of the Structural Research Laboratory of Lewis Institute summarizes his results, the dry mixes being omitted since only "workable" mixes were plotted.

This method of proportioning consists essentially in selecting the proper fineness modulus for the desired mixture from Fig. 21, calculating the fineness moduli for the aggregates at hand, and then calculating the proper percentage of each aggregate from the formula:

$$P_f = \frac{C - M}{C - F}$$

where P_f is the proportion of the fine aggregate in the total mixture of aggregates,

C is the fineness modulus of the coarse aggregate used,

F is the fineness modulus of the fine aggregate used,

M is the fineness modulus of the final aggregate mixture from diagram.

The values in Fig. 21 are for rounded gravel and sand; for crushed stone, slag, pebbles with flat particles, and for stone screenings as fine aggregate, these values should be reduced by 0.25. Certain other refinements are given by Professor Abrams which need not be set down here.

For example, given a gravel graded from 0-1½ in., having a fineness modulus of 7.2 and a sand graded 0-¼ in., with a fineness

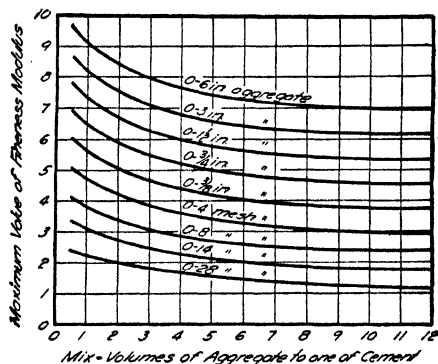

FIG. 21.—Maximum permissible value of fineness modulus.

modulus of 2.4. For a 1:6 mix, Fig. 21 shows a desirable fineness modulus for the mixture of 5.6. Then the proportion of sand is $p_f = (7.2 - 5.6) \div (7.2 - 2.4) = 0.33$. Out of a total of 6 parts of aggregate, therefore, the fine aggregate should constitute two parts. Hence, the mixture should be 1:2:4.

L. N. Edwards devised a mode¹ of proportioning by means of the surface areas of the aggregates, the principle being that, other factors remaining constant, the aggregates with a minimum of surface area gave the greatest strength. While the principle is correct, owing to the fact that the relationship is of minor consequence and conflicts at times with the density relationship, it does not furnish so satisfactory and reliable a method of pro-

¹ *Proc. Am. Soc. Testing Materials*, p. 235, 1918.

portioning as does a more fundamental relationship, such as maximum density or water-cement ratio.

Many other methods have been suggested and used, but the principles of maximum density, mortar voids, and water-cement ratio are the most practical, and are all involved necessarily in any sound procedure of proportioning.

Design of Mixture for a Desired 28-day Strength.—As shown in Fig. 16, the strength at basic water content of concrete varies with the ratio between the absolute volume of the cement and the void space plus the cement space, i.e., $\frac{c}{v+c}$. This relation is expressed by the equation $S = 32,000\left(\frac{c}{v+c}\right)^{2.5}$.

Through all practical ranges this relation is a direct one, the equation of the line being $S_b = 12,500\frac{c}{v+c} - 2,000$ for concrete mixed with basic water content and tested at 28 days. From a study of the effect of water on concrete, a relationship similar to that shown in Fig. 17 is obtained and may be expressed algebraically as follows:

$$S = S_b/2.5^x$$

x being the ratio between W_c , the excess water used and W_b , the water at basic water content. Hence, the equation of strength of concrete at 28 days may be written conveniently and with consistent accuracy,

$$S_{28} = \left(12,500\frac{c}{v+c} - 2,000\right)/2.5^x$$

The constants of the above formula are predicated on the average curing temperature of approximately 70° F. and upon cement that will give a tensile test in 1:3 mortar of 320 lb. per square inch. Better or poorer cement will affect the results in direct proportion to the quality, and the strength will vary also approximately with the cube root of the average curing temperature.¹

The basic water content may be taken practically as that which gives a slump test of about $\frac{1}{8}$ in. for coarse aggregates (2 in.) and $\frac{3}{4}$ in. for smaller aggregates (1 in.).

¹ *Engineering News-Record*, vol. 102, p. 179.

The first step, therefore, in determining the proportions for a desired strength concrete at a given consistency is to determine the actual voids in a unit volume of the concrete of a given mixture. The voids will obviously be the gross volume of the concrete minus the absolute volumes of the coarse aggregates, the fine aggregates, the cement and water. (Cement and water equals the volume of the paste.) The proportion of solids in cement, sand, or stone is found by calculating the ratio of the weight of a cubic foot of the material to the weight of solid. An example will illustrate the principle.

If 1 cu. ft. of cement loose weighs 94 lb., its weight solid being 62.4 times 3.12 or 194.5 lb., it would contain 94/194.5 or 0.483 cu. ft. solid particles. For sand weighing 106 lb. per cubic foot and having a specific gravity of the particles of 2.75, the weight solid would be 62.4 × 2.75 or 171.5 lb.; it would contain 106/171.5, or 0.617 cu. ft. solid particles. Stone weighing 103 lb. per cubic foot and having a specific gravity 2.65 would weigh solid 62.4 × 2.65 or 165 lb. and would contain 103/165 or 0.623 cu. ft. solid particles. For a 1:2:4 concrete the absolute volume is indicated in the following table:

Material	Loose volume, cu. ft.	Absolute volume, cu. ft.
Stone.....	1.0	0.623
Sand.....	0.5	0.308
Cement.....	0.25	0.121
Water.....	0.06	0.060
Total.....	1.112

If this mixture occupies 1.280 cu. ft., the voids are $(1.280 - 1.112) \div 1.280 = 0.131$ of the whole. Assuming that the desired consistency of the concrete is obtained by adding 25 per cent more water than basic content, the strength would be $(12,500 \frac{0.121}{0.121 + 0.131} - 2,000) / 2.5^{0.25} = 3,190$ lb. per square inch. By successive trials, the proportion of cement for given aggregates may be determined that will yield a concrete of desired strength.

Water for Concrete and Consistency.—Water for making concrete should be free from oil, acid, alkali, and organic matter. A

small amount on inorganic silt or clay which may make the water appear turbid does not appear to be seriously injurious. The temperature of the water has no appreciable effect on the strength of the concrete.

The amount of water used in mixing has a very marked effect on the quality of the concrete, an excess of water beyond that required to give a workable mix greatly reducing the strength of the concrete. See Fig. 17. A supersaturated solution of the colloidal parts of the cement making a gel is necessary to permit crystallization, and an excess of water delays this crystallization and hinders the interlacing of the crystals thereby reducing the strength of the resulting concrete or mortar.

The consistency of concrete is variously described, as: "dry" when just enough water has been added to make the cement adhere, "moist" when it has the appearance of damp earth, "plastic" when the maximum amount of water has been added that will permit the forms to be removed immediately, "quaking" when water will flush to the surface on tamping, "mushy" when it will flow sluggishly and can be readily spaded into forms, "fluid" when it is watery and flows readily, "sloppy" or "wet" when there is a decided excess of water.

Dry and plastic concretes must be tamped into place, while the wetter consistencies facilitate the handling, are more easily worked into place and give a smoother surface when forms are removed. "Mushy" or "fluid" consistencies are almost imperative for highly reinforced work, but the use of "wet" or "sloppy" mixtures should not be tolerated, as the strength of the resulting concrete may be only a small fraction of what it would be if properly put in place. For example, the Bureau of Standards found that 3 per cent more water than the amount required for maximum strength decreased the strength 50 per cent. The injurious effect of too much water cannot be too much emphasized. The desired fluidity of the mixture can be secured with the proper amount of water and additional mixing in the mixer, as will be seen in the next article.

The most practical test for the consistency of concrete is the "slump test." A smooth iron frustrum of a cone 12 in. in height 8 in. in diameter at the bottom and 4 in. in diameter at the top, is filled with the concrete tamped in place. The frustrum of the cone is then lifted directly vertically and the "slump" or decrease in height from the original height is measured. "Dry" concrete

will give a slump of 0- $\frac{1}{2}$ in., plastic about 1 in., mushy about 8 in. and "wet" mixtures more than 8 in. A good workable mix for reinforced construction should have a slump of about 4 to 6 in.

Consistency and workability are not synonymous, although similar, qualities. Consistency is an absolute quality independent of the character of the aggregates, while workability depends largely upon the character of the aggregates as well as the water-cement ratio of the paste. Plasticity, flowability, and mobility are terms sometimes applied to this property.

Workability is measured in the laboratory most successfully by the "flow table." This consists of a circular steel plate 30 in. in diameter mounted horizontally so that a cam on a horizontal shaft will raise and suddenly drop the table $\frac{1}{2}$ -in. The concrete to be tested is placed in a conical mold 6 in. high and 11 in. in diameter at the center of the plate and, after removal of the mold, dropped a standard number of times (usually fifteen) by turning the horizontal shaft. The percentage of the average diameter of the area occupied by the concrete at the conclusion of the test to the original diameter measures the workability. Thus, a slump of 0 to 9 in. corresponds in general to flows of 120 to 250, a 6-in. slump corresponding to a flow of about 200.

There is no definite relation between slump and water-cement ratio because of the variability of proportions and of aggregates, which directly affect workability. Where the quality of the concrete is specified by the water-cement ratio, the amount of water should range from about 5 $\frac{1}{2}$ gal. per bag of cement for dense impervious concrete to 7 $\frac{1}{2}$ gal. for footings and heavy piers, the same workability being assumed. For reinforced concrete members, 6 $\frac{3}{4}$ to 7 gal. should be used.

Mixing Concrete.—Concrete may be mixed by hand on a mixing board with shovels, but machine mixing is preferable for large work because it is more economical and yields better concrete. Under normal circumstances, therefore, only batch machine mixing should be allowed. In any case it is important that the ingredients be accurately measured in order that the proportions may be reliably determined. Where the materials are wheeled to the mixer, wheelbarrows are usually taken as the unit of measurement. A measuring tank for the water should be attached to the mixer.

There is a great variety of concrete mixers on the market, but the more successful ones consist essentially of a rotating drum with scoop-like projections inside which carry the ingredients near to the top of the drum and drop them to the lower side as the drum rotates on its axis. This action churns and kneads the ingredients together into an intimate mixture, which produces better results than merely stirring. These mixers should rotate at 18 to 20 r.p.m. for best results and economy, a small variation in speed having no appreciable effect on the character of the concrete.

The time of mixing is important. The mixing should continue a full minute after all ingredients, including the water, are in the mixer before discharging is begun. There is not much gain in strength by mixing for a longer period than 1 to 1 $\frac{1}{4}$ min. if the mixer rotates at approximately the above speed. Tests by the Bureau of Public Roads¹ seemed to indicate that, in approved mixers, neither strength nor uniformity were improved by mixing over 45 sec. For mixers rotating at slower speeds, the time of mixing should be extended. Additional mixing secures flowability or fluidity of the concrete without impairing its strength as does the addition of water. Some batch mixers are provided with a timing device which automatically discharges the concrete at the end of the interval for which it is set.

Field Control of Proportions.—Specified proportions for materials usually contemplate gross volume measured loose, the whole theory of proportioning being based on volumes of solids and voids. The amount of absolute volume of solids varies considerably in aggregates, even though loose volumes are kept constant. This is particularly true in the sand because of the bulking due to the initial moisture content, which is difficult to control. Likewise, the amount of water in concrete, being the sum of the initial moisture and of the added water, is likely to vary greatly unless special precautions are taken.

A cubic foot of dry sand may weigh 106 lb., whereas a cubic foot of loose moist sand may weigh only 85 lb. after the water has been driven off. That is, sand may "bulk" or occupy 5 to 30 per cent more space when containing 4 or 5 per cent by weight of water than when dry. Sand used in this condition, therefore, introduces a corresponding error in the proportioning. This bulking effect increases with the fineness of the sand. For an

¹ *Public Roads*, vol. 9, p. 111.

ordinary fairly coarse sand, about 50 per cent between $\frac{1}{4}$ and $\frac{1}{10}$ in., the greatest increase in volume will be about 15 per cent for 5 per cent moisture, while, for a fine sand, all smaller than $\frac{1}{10}$ in. and about 50 per cent smaller than a 30 screen, the bulking may be as much as 30 per cent.

One of the most useful methods for controlling this factor, particularly on large jobs, is by means of inundation. By flooding the sand and then drawing off the water, the sand is reduced to a definite amount per cubic foot and the moisture is likewise made definite so that the very important water content can be regulated with precision.

An inundator is available on the market which measures the sand in an excess water tank so that the amount of sand and of water can be accurately known, and this excess water tank discharges directly into the concrete mixer. The amount of water in the sand is the total volume of the sand multiplied by the percentage of void space.

The control of proportioning requires so many elaborate facilities that there is a great advantage in mixing concrete on large works at a central mixing plant. Bins for storage, conveyors for handling, water supply, and other essentials can be best arranged at a central mixing plant. Mixed concrete can be hauled successfully in special dump trucks, and, with high elevator towers, concrete can be spouted over a large structure from one point. Field control is generally most readily accomplished, therefore, by means of a central mixing plant.

Placing Concrete in Forms.—The setting up or hardening of concrete begins very soon after the water is added, hence, concrete should be placed immediately in the forms. It should be deposited in layers of uniform depth all around the form, unless for some special reason, the work is being built up in sections. Where plastic concrete is being put in place, as in foundations, machine bases, etc., it should be tamped as it is placed. Mushy and fluid concrete should be “spaded” as it is placed. This is accomplished by pushing a straight shovel or hoe down along the side against the forms and pressing the coarse aggregate back and allowing the finer matrix to flow against the forms in order that a smooth surface may result when the latter are removed.

Before the concrete is placed, the forms should be thoroughly wet down, or oiled, in order that the concrete may not stick to the lumber. Where the forms are built up in sections to be

reused oiling is frequently found to be the more convenient. All shavings, blocks, and debris should be removed before placing concrete in the forms and all "spreaders" and other bracing should be removed as the concrete rises in the forms.

When it is necessary to stop work before the forms are filled, as at night, the top of the concrete deposited should be left rough and clean in order to secure a bond to that subsequently placed. Before resuming work, the surface should be scrubbed if "laitance" or other foreign matter is present, thoroughly wet down, and preferably washed with a cement grout. By "caulking" the concrete already in place down against the forms before placing fresh concrete, unsightly juncture markings may be avoided.

When concrete is being deposited, the inspector should be careful to see that the ingredients do not become segregated in any batch, the coarse material going one place and the matrix another. This is a danger particularly inherent in the spouting method of construction and should be guarded against. In general better results are obtained if the concrete is spouted into a receptacle and then dumped into the forms rather than being spouted directly into the forms.

Curing Concrete after Deposition.—As previously shown, the hardening of concrete is not a drying out process, but a chemical action, for the consummation of which, water is absolutely essential. Allowing excessive evaporation, therefore, after the concrete is placed by leaving the surface unprotected will greatly impair its quality. Particularly in hot dry weather it is necessary to keep the surfaces covered until hardening is well along. When temperatures are not extremely high, in the humid regions, sprinkling the surface by means of a hose, if frequently done, will suffice.

Tests made by Professor Abrams¹ showed that "concrete stored for 4 months in damp sand and tested damp is 2½ to 3 times as strong as similar concrete which has been exposed to room atmosphere for the same period. Protecting the concrete from drying out for only 10 days gives an increase in strength of about 75 per cent for the dryer mixes." The necessity of having sufficient water present to secure proper curing constitutes an argument against the use of dry mixtures for exposed work. The strength of concrete also is affected by the temperature

¹ *Structural Mils. Research Lab., Lewis Inst., Bull. 2, p. 17.*

during the curing period, varying about as the cube root of the average temperature.

Quantity of Materials Required.—The amount of cement per unit volume varies directly with the proportion of cement and inversely with the sum of the ingredients, i.e., as $\frac{c}{c+s+g}$. The cubic feet (bags) of cement per cubic foot of concrete is $\frac{1.55c}{c+s+g}$, the number 1.55 being empirical. Hence, the number of cubic yards of stone required for 1 cu. yd. of concrete of 1:s:g mix will be $\frac{1.55}{1+s+g} \times g$ and of sand $\frac{1.55}{1+s+g} \times s$. A convenient form of this empirical rule, devised by W. B. Fuller, is

$$C = \frac{11}{c+s+g}$$

$$S = C \times s \times 3.8/27$$

$$G = C \times g \times 3.8/27$$

where C is the number of barrels of cement per cubic yard of concrete,

S is the number of cubic yards of sand required for one cubic yard of concrete,

G is the number of cubic yards of stone or gravel required for one cubic yard of concrete,

$c:s:g$ represents the proportions of cement, sand and stone, as, e.g., 1:2:4.

For well-graded aggregates, this rule gives results somewhat too high, the additional allowance being for waste. It is predicated on average materials and all materials being measured loose.

The quantities may be calculated with greater refinement from the absolute volumes of the ingredients. For example, take the conditions of the case on p. 96 where 1.0 cu. ft. stone, 0.5 cu. ft. sand, 0.25 cu. ft. cement, 0.06 cu. ft. of water, and 0.131 voids, make 1.280 cu. ft. of concrete. It is obvious that 1/1.28 cu. ft. or 0.782 cu. ft. of stone will be required per cubic foot of concrete, and for the 1:2:4, proportions used, 0.391 cu. ft. of sand and 0.196 cu. ft. of cement. From these data, the quantities for any given volume of concrete can be readily calculated. Extensive tables have been prepared for estimating quantities, but it does not seem necessary to include any such tables here.

Strength and Elastic Properties of Concrete.—The strength and elastic properties of concrete depend very largely upon the manner of fabrication and the treatment after molding. Allowing freshly deposited concrete to be exposed to dry atmosphere, thereby permitting excessive evaporation of the water from the surface, may reduce the strength as much as 40 per cent, while proper methods of fabrication may increase the strength as much as 25 to 100 per cent. The strength and elastic properties of concrete vary with its age, as illustrated in Fig. 22. The strength

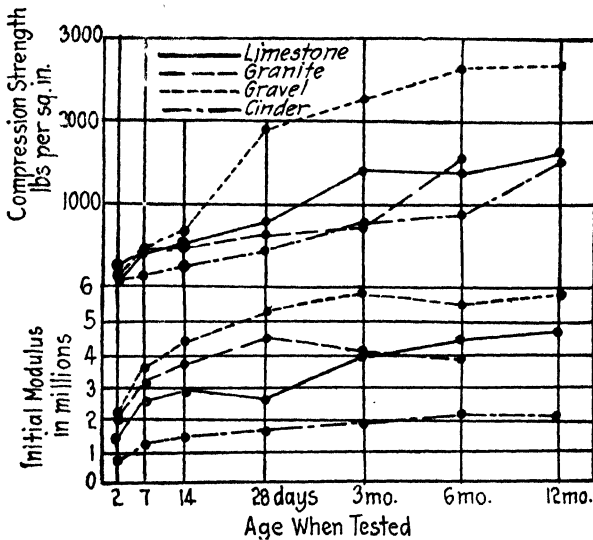

FIG. 22.—Effect of age on the properties of concrete.

at 28 days in terms of the strength at 7 days may be satisfactorily calculated by the formula

$$S_{28} = S_7 + 30\sqrt{S_{28}}$$

In selecting the permissible working stresses in concrete, the designer should be governed by the ultimate compressive strength of the concrete under consideration. Table V¹ gives the average compressive strengths of different grades of concrete recommended by the Joint Committee, although for special conditions using special materials and methods, these strengths might be increased by as much as perhaps 100 per cent.

¹ *Trans. Am. Soc. C. E.*, vol. 81, p. 1143.

TABLE V.—COMPRESSIVE STRENGTH OF CONCRETE

Aggregate	Mixture, workable mix				
	1:3	1:4½	1:6	1:7½	1:9
Granite, trap rock.....	3,300	2,800	2,200	1,800	1,400
Gravel, limestone, or hard sandstone.....	3,000	2,500	2,000	1,600	1,300
Soft limestone and sandstone....	2,200	1,800	1,500	1,200	1,000
Cinders.....	800	700	600	500	400

Slag concrete may be expected to show about the same strength as gravel concrete, and coke breeze concrete about two-thirds that of broken stone.

The tensile strength of concrete is usually not of great importance, yet at times it may be desirable to take advantage of the tensile strength in the design of structures. Tests made at the Massachusetts Institute of Technology show the values of the tensile strength given in Table VI.¹

TABLE VI.—TENSILE STRENGTH OF CONCRETE

Proportions, workable mix	Tensile strength at 28 days	
	Lbs. per sq. in.	Per cent of compressive strength
1:1:2	210	6.4
1:1½:3	175	7.0
1:2:4	140	8.0
1:2½:5	110	9.0

The direct shearing strength of concrete may be a determining factor in design under certain circumstances. Values as determined at the University of Illinois were as follows:

Proportions, workable mix	Shearing strength lbs. per sq. in.	Ratio of shear to compressive strength
1:2:4	1,418	0.44
1:3:6	1,250	0.57

¹ Univ. of Illinois Eng. Exp. Sta., Bull. 8.

Tests by punching through plates gave shear strengths varying from 37 to 90 per cent of the compressive strength.

Diagonal shear (diagonal tension) and bond strengths will be discussed in Chap. IV.

Figure 23 shows stress-strain diagrams of concrete of proportion varying from 1:3 to 1:10 and illustrates the variation of the modulus of elasticity with the stress. Table VII gives average values of the modulus of elasticity for different mixtures at working stresses and Fig. 24¹ shows the variation for sand and pebble concrete of the modulus with respect to the amount of cement used and the age.

TABLE VII.—MODULUS OF ELASTICITY OF CONCRETE
3 Months

Proportions	Initial tangent mod.		At 1,000 lb. per sq. in.	
	Limestone	Pebbles	Limestone	Pebbles
1:9	3,870,000	3,000,000	2,500,000	2,200,000
1:6	5,800,000	5,000,000	4,520,000	4,380,000
1:5	5,900,000	5,500,000	4,610,000	4,700,000
1:4	7,600,000	5,900,000	5,890,000	4,700,000

Stanton Walker gives the following equations² as the relation between modulus of elasticity and compressive strengths:

$$E_i = 40,000S^{0.6}$$

$$E_w = 84,300S^{0.47}$$

where E_i is the initial modulus of elasticity, E_w , the modulus at one quarter of the compressive strength, and S , the compressive strength.

While the data of Table VII seem to indicate that concrete of broken stone has a larger modulus of elasticity than that of gravel, such may not always be the case, and variations must be counted on.

When subjected to a load for a considerable period of time, concrete seems to flow, probably by a readjustment of the crystallization, so that the initial modulus of elasticity is decreased in effect, and stresses that would be produced by such prolonged and gradual strains as those due to shrinkage and temperature

¹ *Structural Mils. Research Lab., Bull. 5.*

² *Structural Mils. Research Lab., Bull. 5, p. 65.*

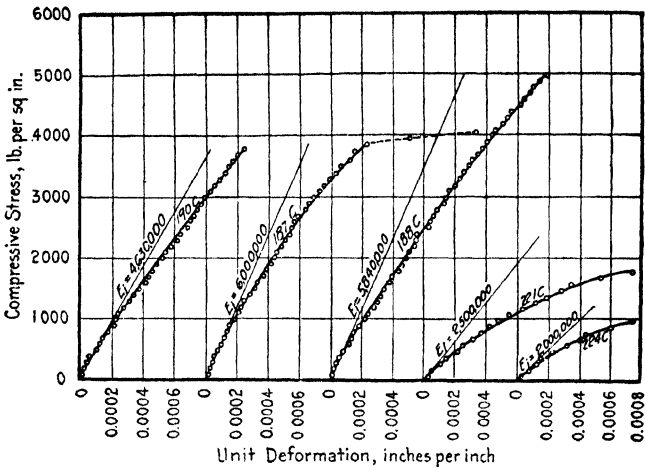

FIG. 23.—Stress-strain diagrams for concrete.

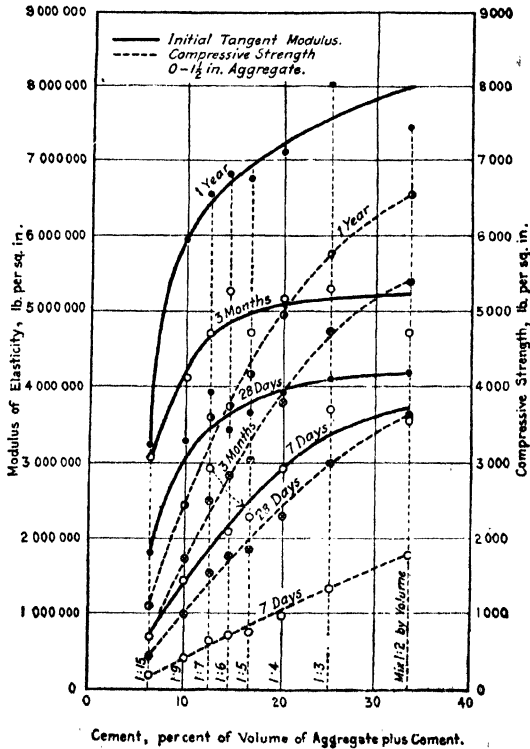

FIG. 24.—Effect of proportions and age on properties of concrete.

changes are mitigated to a considerable extent, this time yield of the concrete throwing a larger proportion of the stress into the reinforcing steel.¹ Poisson's ratio for 1:6 concrete varies from about 0.10 at low stresses to about 0.18 at stresses near the ultimate strength.

Concrete can scarcely be said to have an elastic limit, for it shows permanent set under comparatively light loads. It will fail by fatigue even though the stress does not exceed one half the ultimate strength.

The weight of concrete depends upon the specific gravity of the aggregates and the density of the mix and, hence, upon the consistency. Table VIII taken from Bulletin 58 of the Bureau of Standards shows the effect of various factors on the weight of concrete.

Fatigue of Concrete.—Concrete, like most engineering materials, has an endurance limit and will fail by fatigue, even though the stresses do not approach the ultimate strength. Tests made at Purdue University² indicate an endurance limit for mortar beams at 55 per cent of their ultimate strength under static load. Tests made by the Illinois Division of Highways³ indicated that for 1:2:3½ and 1:3:5 concrete, a load 50 per cent of the ultimate might be repeated indefinitely without failure, that 60 per cent loads would cause failure in 30,000 repetitions, and a 70 per cent load would cause failure in 5,000 repetitions.

In general, the endurance limit seems to increase with the richness of the mixture, and wet concrete has a lower endurance limit than dry.

Concrete under repeated loads which exceed normal working stresses seems to suffer loss of rigidity, although such rigidity is recovered in part after a lapse of time. For example, a 1:2:3 concrete gave a modulus of elasticity of 3,870,000 lb. per square inch the first application of loads up to 2,400 lb. per square inch, while, for successive applications, the results were 3,340,000, 3,240,000, and 3,140,000, respectively. However, a fifth application made one year later gave 3,440,000 lb. per square inch.⁴

Plastic Flow under Stress.—That concrete, even when carefully made, is slightly plastic and will flow under stress has long

¹ *Trans. Am. Soc. C. E.*, vol. 80, p. 1747 ff.

² *Eng. Exp. Sta., Bull.* 24, p. 49.

³ *Proc. Am. Soc. Testing Materials*, p. 408, 1922.

⁴ *Public Roads*, vol. 9, p. 181, November, 1928.

TABLE VIII.—VARIATION IN WEIGHT PER CUBIC FOOT OF CONCRETE WITH VARIATION IN CONSISTENCY, PERCENTAGE OF CEMENT, AND "DENSITY"

Proportions by volume	Weight per cubic foot of gravel and sand, mushy consistency	Proportions by volume, coarse aggregate 1:2:4,	Weight per cubic foot			Proportions by volume	Stone and sand	
			Fluid consistency	Mushy consistency	Quaking consistency		Weight per cubic foot	"Density"
1:1 :2	147	Cinder 507	115.2	114.9	113.1	1:0½:5½	153	0.838
1:1½:3	145	Granite 175	147.6	147.7	148.9	1:1 :5	150	.826
1:2 :4	144	Gravel 501	139.6	142.7	144.5	1:2 :4	146	.789
1:2½:5	143	Limestone 500	144.7	145.9	147.8	1:3 :3	140	.745
1:3 :6	142	1:1 :8	152	.842
1:4 :8	140	1:2 :7	151	.818
						1:3 :6	145	.788
						1:4 :5	140	.751

been known, but comparatively few quantitative studies have been made on the phenomenon. Indeed, steel and other engineering materials exhibit this same property of being plastic under a stress somewhat less than the elastic limit when applied over a period of years. This property, therefore, should not give rise to a lack of confidence in concrete.

As a result of this plastic flow, beams and slabs carrying loads have been observed to deflect permanently and columns acquire

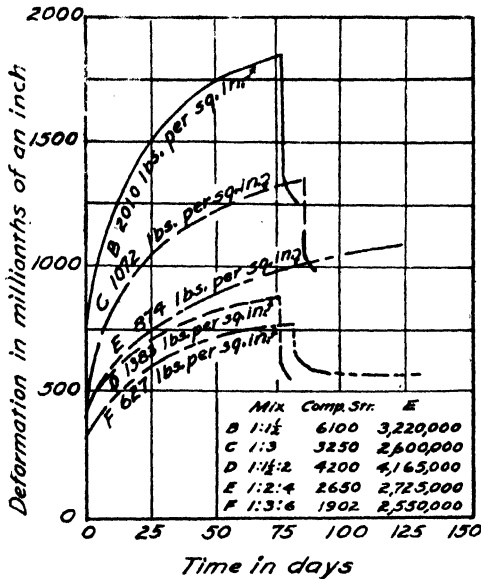

FIG. 25.—Plastic flow of concrete under stress.

a permanent shortening. Concrete has been found to fail under a continuous load of less than the ordinary maximum.

From a number of sources,¹ the following characteristics of plastic flow may be formulated:

1. The amount of the flow varies as some power of the unit stress, being larger for higher stresses.
2. The flow varies inversely with the modulus of elasticity.
3. The older the concrete at the time of loading, the less rapid the rate of flow.

¹ *Proc. Am. Concrete Inst.*, vol. 12, p. 302; vol. 13, p. 99; vol. 15, p. 137; vol. 17, p. 161; vol. 24, p. 203; *Proc. Am. Soc. Testing Materials* vol. 20, p. 233.

4. Concrete from well graded aggregates has a less plastic flow than poorly graded aggregates, the consistency of mix and other factors remaining the same.

5. The flow varies as some fractional power of the time, being most rapid when the load is first applied.

6. The flow apparently continues for a period of about one year.

Some of these relationships are illustrated in Fig. 25.

The test data, chiefly by Professors Davis and Shank,¹ available indicate that the flow per unit length equals approximately $\frac{f_c^{1.5} T^{0.25}}{30E_c}$ where T is the time in days, f_c the stress applied, and E_c the modulus of elasticity.

Abrasive Resistance of Concrete.—In floors, pavements and other places where concrete is subjected to wear, special precautions should be taken to secure high abrasive resistance. This is done by using a hard well graded aggregate with a rich mix. The wear has to be borne by the aggregate and unless it is hard, the resistance of the concrete will be low, since the cement matrix has a low resistance to wear. A plastic consistency should be used and then the surface should be “floated” or otherwise kneaded to drive off any excess water and secure maximum density. Too wet concrete should be avoided, yet at the same time the concrete should be cured under such conditions as will prevent too early drying.

Professor D. A. Abrams has reported the following relation between the wear and the compressive strength of concrete, although the character of the aggregates may lead to variations in this relationship.

$$S \cdot W^x = K,$$

where S is the compressive strength of the concrete and W is the wear in inches depth caused by the Talbot-Jones abrasion rattler, the value of x being about 1.07 for 1:5 concrete. These observations indicate that in general, the same factors promote resistance to wear that improve compressive strength.

Expansion and Contraction of Concrete.—Concrete expands and contracts with changes of temperature as does other materials, its coefficient of expansion per degree Fahrenheit being about as follows:

1:1½:3 concrete	0.000,0068
1:2:4	0.000,0065
1:3:6	0.000,0054
1:2 to 1:4 mortar	0.000,0060

¹ *Proc. Am. Concrete Inst.*, vol. 24.

Concrete also contracts in setting up, the coefficient of contraction for 1:2:4 concrete being about 0.0003, or 0.03 per cent at 28 days and about 0.05 per cent at 6 months.

The source of the shrinkage is in the gel of colloidal aluminous material in the cement paste, hence anything that increases the amount of this gel increases the shrinkage. The coefficient of shrinkage varies approximately with the proportion of cement used in the concrete; it varies also with different cements. This shrinkage due to setting and hardening may cause considerable initial stress in steel reinforcement as will be seen in the next chapter.

The contraction of concrete due to temperature changes and to hardening necessitates the placing of expansion (contraction) joints at intervals in order to prevent the promiscuous cracking of the surface and to prevent undue stresses and even rupture of the structure resulting from such contraction, for it is obvious that the contraction effect is cumulative over any monolithic section, unless cracking occurs.

The coefficient of thermal expansion and contraction being known, the other factor required in order to calculate the total contraction is the range of temperature to which the structure will be subjected. Observations made at the Arrowrock dam¹ indicate the following conclusions:

(a) The internal temperatures of large masses of concrete deposited in summer during the setting up period and immediately thereafter is about 90° to 95° F. That is, the concrete sets up and begins to harden at about that temperature.

(b) In the case of concrete 1 ft. from the surface, there is a daily variation of about 2° when the temperature variation is about 50°; at 2 ft. from the surface the daily variation was about 1° and at 3.5 ft., it was zero under the same conditions.

(c) The seasonal variation is about 32° when the variation in the mean daily temperature is about 75°.

In investigations made at Iowa State College,² the temperature of setting was found to reach 96° to 108° inside an arch abutment, and the lowest winter temperature was found to be 15° F.

From these observations, it would appear that the maximum range of temperature may be as high as 75° to 90°, depending

¹ *Trans. Am. Soc. C. E.*, vol. 79, p. 1226.

² *Iowa State College, Eng. Exp. Sta., Bull.* 30.

upon the massiveness of the structure and the maximum range of seasonal variation.

Bonding New to Old Concrete.—Frequently in extensions of structures, it becomes necessary to bond new concrete to that already in place. Unless special care is exercised, this bonding will not be successful, because of the deteriorated condition of the old surface and also to the tendency of the old concrete to absorb water from the new. The old surface should be thoroughly cleaned with wire brushes, roughened with a pick and all loose particles brushed away. Live steam at high pressure has been found effective in cleaning a concrete surface. After cleaning, the surface should be drenched with water until it is thoroughly wet. It should then be sprinkled with dry cement or coated with rich cement mortar, and then the fresh concrete should be deposited immediately. Where care is exercised, new concrete can be bonded to old in this manner so as to have a strength of about two thirds of monolithically placed concrete, otherwise it will have a strength not more than about one fifth as great.¹

Finishing Concrete Surfaces.—The cheapest and most generally applied finish of concrete is obtained by "spading," that is by pushing the coarse aggregate particles back from the forms with a straight hoe or other similar instrument. This procedure should be followed, as a matter of fact, whether special finish is to be applied or not. This process if properly done will prevent the appearance of the coarse aggregate at the surface of the finished work. Of course, the forms should be tight, otherwise the matrix will leak out and leave rough spots where the coarse aggregate shows, commonly called "honeycomb" concrete. With a spaded finish at best, the form marks remain on the surface, and some special treatment is necessary after the forms are removed to give the surface a smooth uniform appearance. Some of the special finishes commonly applied to concrete surfaces after the forms are removed are mentioned below without describing the processes in detail.

Faced concrete is obtained by working a layer about one inch thick of specially prepared mortar with an aggregate usually less than $\frac{3}{8}$ in. in diameter against the forms while the concrete is being deposited. This is usually done by means of "slip plates." It is important that the special layer shall constitute

¹ *Engineering News-Record*, July 31, 1919.

an integral part of the concrete, otherwise it may crack loose. When faced concrete is placed on stairs, floors, etc. and troweled smooth, the finish is sometimes termed *granolithic*.

Washed or *Scrubbed* finish is accomplished by scrubbing the surface while still green as soon as the forms are removed with stiff wire or fibre brushes and water, or in some cases with dilute hydrochloric acid (1 part commercial hydrochloric acid to 2½ parts water). This process removes form marks and gives a pleasing appearance. The cost is about 4 to 9 cents per square foot.

A *Rubbed* finish is obtained by rubbing with a carborundum block (No. 8 carborundum block giving good results), cement bricks, or wooden floats. The rubbing is best done with an electric driven machine. This process removes the prints of the forms, joint marks, and because of its relative cheapness is frequently employed. The cost usually amounts to 4 or 5 cents per square foot.

A *Float* finish is really a modification of a rubbed finish, and is effected, after all rough spots are pointed up, by giving the surface a brush coat of grout consisting of one part cement to one part sand, and afterward rubbing with a wood float. This is an inexpensive and satisfactory finish.

Sand blast finish is made by means of a sand blast about 10 to 15 days after the concrete is placed.

A *Tooled* finish is accomplished by means of various kinds of stone cutting tools, such as *points*, *tooth ax*, *bush hammer*, or *crandall*. (See Chap. II.) Bush hammered panels on an abutment of the N. Y. C. & St. L. R. R. cost about 12 cents per square foot, which is somewhat higher than an average cost.¹

A *Terrazzo* finish is obtained by making a 1:2.5 concrete using crushed marble or quartz pebbles under ½-in. size and free from dust. This mixture is applied about 1 in. thick and, when hard, ground smooth with a surfacing machine.

Action of Sea Water and Alkali on Concrete.—The disintegration of concrete surfaces when exposed to the action of alkali salts of soils or to the salts of sea water has caused considerable study to be made of the matter. When sodium sulphate, magnesium sulphate, chloride salts, and others are taken into the concrete in solution by capillarity from the soil and deposited near the free surface due to the evaporation of the water of solution

¹ *Proc. Amer. Ry. Eng. Assn.*, vol. 18, p. 840.

from the surface, the salts crystallize and in doing so expand and flake off the surface of the concrete. To minimize this effect, the concrete should be as dense and non-porous as possible. In Colorado and other western states, this action is very marked, the author having observed the surface disintegrated to a height of five feet from the ground.

The preservation of concrete exposed to sea water likewise depends upon securing a dense concrete and maintaining an unbroken surface of the structure by using sufficient reinforcement to prevent cracks where necessary, for the action is essentially the same as that described above for alkali. It appears from investigations by the Bureau of Standards¹ that the chemical composition of the cement has very little if any influence on the action of sea water or of alkali. The failure of the Santa Monica pier at Los Angeles was apparently due to the corrosion of the reinforcing steel resulting from the use of a pervious concrete. An impervious concrete is the only safeguard against disintegration from sea water. Structures built of impermeable concrete withstand the action of alkali and of sea water satisfactorily.

Water-proofing Concrete.—The U. S. Bureau of Standards conducted an extensive series of investigations into the various methods of water-proofing concrete and the following paragraph is largely abstracted from Bulletin No. 3.

Portland cement mortar and concrete can be made practically water tight or impermeable to hydrostatic heads up to 40 ft. without the use of any so called "integral" water-proofing materials; but in order to obtain such impermeable mortar or concrete good aggregates and care in fabricating the concrete must be used. The consistency of the mixture should be wet enough so that the concrete can be puddled and pockets should be avoided. The addition of any of the so called "integral" water-proofing compounds will not compensate for lean mixtures, for poor materials, nor for poor workmanship. Hydrated lime in small percentages and lean mixtures increases impermeability and has little effect on strength. Being of constant volume, it increases imperviousness without increasing the shrinkage effects of richer concrete. The same expenditure necessary for these water-proofing compounds will produce more impermeable concrete if expended for better materials and for a richer mix.

¹ U. S. Bureau of Standards, *Bull.* 12, p. 101.

The water-proofing compounds are of two general classes, (a) a dust like filler, frequently similar to portland cement but rich in aluminates, to be mixed with the cement, and (b) certain resinous or gelatinous materials which are assumed to be water repellent, such as soaps, oils, etc. As stated above, the use of any such fillers is of doubtful value or economy.

The only satisfactory mode of water-proofing or damp-proofing concrete is by covering the concrete with a bituminous coating of some sort, such as asphalt mastic or tar. This is usually applied in the form of a membrane consisting of tarred or asphalted felt, alternate layers of asphalt and burlap or canvas.

In applying a bituminous membrane, the surface should be carefully cleaned and all pockets filled with cement mortar. A primer coat is applied and allowed to dry and then a coat of hot asphalt is mopped on the surface about $\frac{1}{8}$ in. thick. While the asphalt is still hot, the burlap is laid transverse to the slope, when the concrete surface is on a slope, allowing each strip to overlap the previous one about two thirds the width. The burlap should be pressed into the asphalt and mopped with hot asphalt. Joints of the burlap should be lapped six inches. This is then mopped with hot asphalt forming a layer about $\frac{1}{8}$ in. thick, and the membrane is then covered with a mortar-protecting coat, consisting of about an inch of cement mortar reinforced with expanded metal. This is essentially the method used by the C. M. & St. P. R. R. with satisfactory results, although somewhat expensive.

Thermal Conductivity of Concrete.—When concrete is used for ice houses and other refrigeration structures, as well as for fireproofing, its resistance to the transmission of heat is an important consideration. The thermal conductivity of concrete depends upon its density, the denser the concrete the higher the conductivity. In general, the flow of heat through concrete is about twice as great as through brick and eight times as great as through wood.¹

Concrete covering has been extensively used for fire-proofing. The chief difficulty encountered in this use is that of preventing spalling of the concrete. For light fires, almost any concrete is fire-proof, but for serious conflagrations, most concrete spalls badly. This is particularly true of concrete made of siliceous gravels and sand. For this reason, concrete made of

¹ *Univ. of Illinois, Eng. Exp. Sta., Bull. 102, p. 40.*

limestone, trap rock and blast furnace slag is better than quartz gravel and sand for fire-proofing. The recommendations of the American Concrete Institute committee on fire-proofing are as follows:¹

"1. That in concrete columns where four-hour protection is required, protective material not less than 2 in. in thickness shall be provided over the steel. In columns in which a high percentage of steel is used, increasing the importance of affording ample protection, the thickness of the protective material shall be $2\frac{1}{2}$ inches for four hour protection, and special care shall be given to the accurate placing of the steel in the forms to avoid inadequate protection on any side.

2. That for fire resistive construction, limestone, trap rock, blast furnace slag, well burned clay and gravels composed largely of limestone pebbles be given preference over highly silicious gravels. •

3. That where highly silicious gravel aggregate is to be used, in columns without hooping and with no special safeguards, round columns be given preference over rectangular ones.

4. That where highly silicious gravel aggregate is to be used, all columns, but especially rectangular columns and round columns with spiral reinforcement, be safeguarded by one of the following expedients:

(a) Placing expanded metal or other high weight large mesh reinforcement in the outer concrete to prevent the loss of protective concrete by spalling.

(b) Giving columns additional protection of approximately 1 inch of cement plaster, either on metal lath or reinforced with light expanded metal or other suitable material."

Pre-cast Concrete Units.—Pre-cast concrete units for ornamental and architectural designs are being used extensively at present and promise to be even more widely used in the future. Pre-cast units are used for balustrades, pylons, basins, columns, pilasters, posts, etc. The proportions used are about 1:1:2 $\frac{1}{4}$, or perhaps a 1:3 mixture of cement and aggregate, the latter being graded to secure the greatest density. The forms may be made of plaster, glue, wood or iron according to the adaptability of these materials to the character of the work. Forms must be cleaned after each use and kept in first class condition. The sand should be a good grade of torpedo sand passing a $\frac{1}{4}$ -in. screen with perhaps not more than 15 per cent passing a 50 mesh screen. The coarse aggregate should pass a $\frac{1}{2}$ -in. screen and have the usual requisites of durability, etc. All molded or pre-cast concrete units must be cured by keeping

¹ *Proc. Amer. Concrete Inst.*, 1920.

under shelter and sprinkling, or covering with moist canvas, in order to prevent checking due to too rapid drying.

Art marble is a cement concrete product made with marble fragments $\frac{1}{4}$ to $\frac{3}{8}$ in. in diameter for aggregate and used extensively for floor tile, trim, wainscoting, stairs, and ornamental purposes. After curing, the surface is ground on a large machine or in place with a rotary grinder, and then rubbed with grit stone until it is smooth and polished. When similarly made with stone other than marble, the product is called *art stone*. When well made, art stone is a satisfactory building material but not infrequently disintegrates under wear, if the proportions and consistency are not carefully controlled in the mixing.

Durability of Concrete.—The principal agencies tending to disintegrate concrete are

1. Corrosion
2. Freezing
3. Decomposition
4. Shrinkage cracks.

And the inherent sources of disintegration are

1. Inferior materials
2. Too much mixing water
3. Allowing laitance to accumulate
4. Improper curing.

Corrosion of concrete results from the dissolving of certain of the compounds of the cement paste. What these compounds are is a debated question. Probably, in many cases, calcium carbonate is an important one. The solubility of calcium carbonate depends upon the absence of other salts and the hydrogen-ion concentration. Rainwater, being free from alkalinity and having a high hydrogen-ion concentration, acts as a solvent. The resistance to the entrance of water and of CO_2 is dependent upon the density of the concrete and, hence, an excess of mixing water or other defective manipulation which lowers the density of concrete will lower the resistance to corrosion.

In a like manner, when water enters concrete and freezes, the pressure from the expanding ice breaks and disintegrates the surface. Again, density of concrete or other device which will exclude water is the obvious remedy.

Disintegration by decomposition results from lack of stability in the compounds of the cement. The manifestations of such action may be dusting and scaling on exposed surfaces and a loss of coherence due to lack of cementing power of the paste after the changes occur.

A frequently encountered form of disintegration is branched crackings or crazings. It is caused chiefly by unequal shrinkage between surface and interior during setting and hardening. The surface sets and dries more quickly than does the interior and hence shrinks, causing hair cracks or "crazing" to a depth at which the strength is sufficient to withstand the shrinkage. Initial surface crazing usually does not exceed $\frac{1}{16}$ in. The amount of crazing is affected greatly by the temperature and humidity of the atmosphere, increasing with higher temperatures and decreasing with higher humidities.

Portland cement is partly crystalline and partly colloidal, the latter element expanding and contracting with the moisture content, while the former remains constant in volume. On hydration, the colloidal material forms a gel which, like all colloidal gels, expands and contracts with changes in moisture. That this colloidal element persists in hardened concrete is evident from the fact that old concrete expands and contracts with changes in moisture.

These hair cracks may be invisible when first formed but they admit water, thus expanding the material nearer the surface and tending to extend the cracks into the interior. Also, when subjected to freezing and thawing, the water intruded in these cracks expands and tends to disintegrate the adjacent concrete and to deepen the cracks. The hair cracks gradually develop into structural cracks of considerable depth and eventually complete disintegration results.

Such crazing and resultant disintegration seldom can occur in a member subjected to normal working compressive stresses, because the applied stress overcomes the tendency to crack and, hence, incipient disintegration is impossible. This source of disintegration chiefly occurs in members not subject to compression, such as pylons, balustrades, and steps.

The most effective treatment to prevent crazing is to secure uniform moisture in the concrete during curing by keeping the surface wet. After curing is entirely complete, subsequent expansion and contraction due to moisture changes is less likely

to cause cracking, because the small difference in shrinkage stress at any plane is insufficient to crack the concrete. Hair cracking is more pronounced in rich than in lean mixtures.

In the attainment of a specified strength, or in the attainment of a high strength, engineers have been lulled into a sense of security and led to neglect the more important objective, durability. Indeed, a specified strength under present methods of control is not difficult to attain, just as the standard specifications of strength of cement mortar are not difficult to attain. Permanence or durability, on the other hand, is difficult to attain. It demands the best skill and attention of the engineer to achieve it. To do so, emphasis must be shifted from compressive strength to those factors that affect durability, namely, density, permeability, and shrinkage.

Concrete surfaces that have deteriorated can be repaired by cutting away all material affected and replacing with fresh concrete. Precautions for bonding new to old concrete (p. 112) should be followed; in addition, steel bar anchors should be set in the old material so as to project into the new concrete and thus make the bond more secure. Several water-proofing compounds are available on the market which, when applied to concrete surfaces, prevent the entrance of water to a certain extent and thereby tend to prevent surface deterioration. They serve as protective coatings similarly to paint on timber.

CHAPTER IV

REINFORCED CONCRETE

Introduction.—The development of a masonry material in reinforced concrete capable of withstanding tensile stresses has had a marked influence on the design and adaptability of masonry structures because it has permitted the construction of thin walls, slender columns and thin slabs combining the durability of stone and the strength of steel. The development of reinforced concrete has been chiefly in the present century, although it was begun during the last quarter of the last century. In this brief chapter, no more can be attempted than a summary of principles and formulas governing the design of structures, leaving the reader to find a more extended discussion in special treatises on the subject.

The theory of reinforced concrete is fairly well established in most respects, hence a description of tests or other argumentation need not be offered in this connection, and many principles will be stated rather dogmatically even though moot questions may be touched upon.

Nature of Reinforced Concrete.—Concrete is weak in tension, hence, in order to use it where flexural stress will be encountered, steel can be introduced to advantage to withstand the tensile stress, since the bond between concrete and steel is sufficient to transmit the resulting shear stresses. Steel is sometimes introduced to withstand compressive stresses also, but not so frequently, for ordinarily compressive strength can be obtained more economically in the concrete itself. Only where the member is to be kept at a small cross section can reinforcing steel be used advantageously in compression. The essential feature of reinforced concrete is, therefore, the ability of the steel and concrete to act in conjunction with each other so that each material will withstand the kind of stress to which it is best adapted. Where compression bars are imbedded in concrete, they receive lateral support from the concrete and, hence, contribute their full compressive strength whereas, if they were unsupported laterally,

they would have but little compressive strength owing to their flexibility.

The common theory of reinforced concrete assumes elastic action of the materials and perfect bond between concrete and steel, although it is well known that the modulus of elasticity of concrete is not constant and that the bond is not always perfect. With these two assumptions, the theory is rational for the most part. The principal structural elements are (1) rectangular beams, (2) T-beams, (3) beams reinforced for tension and compression, (4) columns, (5) flat slabs, and (6) arches, the last being treated in a special chapter.

Notation.—The nomenclature of reinforced concrete formulas has become practically standard and universal. The notation adopted by the Joint Committee¹ was as follows:

1.—*Rectangular Beams.*

The following notation is recommended:

f_s = tensile unit stress in steel,

f_c = compressive unit stress in concrete,

E_s = modulus of elasticity of steel,

E_c = modulus of elasticity of concrete,

$$n = \frac{E_s}{E_c},$$

M = moment of resistance, or bending moment in general,

A = steel area,

b = breadth of beam,

d = depth of beam to center of steel,

k = ratio of depth of neutral axis to effective depth d ,

z = depth of resultant compression below top,

j = ratio of lever arm of resisting couple to depth d ,

jd = $d - z$ = arm of resisting couple,

● p = steel ratio (not percentage).

2.—*T-Beams.*

b = width of flange,

b' = width of stem,

t = thickness of flange.

¹ *Trans. Am. Soc. C. E.*, vol. 81 p. 1148, ff.

NOTE: A Joint Committee comprised of members of the American Society of Civil Engineers, the American Railway Engineering Association, the American Society for Testing Materials, the Portland Cement Association, and the American Concrete Institute, was formed to report on approved practice in concrete and reinforced concrete, which is herein referred to as the Joint Committee.

3.—*Beams Reinforced for Compression.*

- A' = area of compressive steel,
 p' = steel ratio for compressive steel,
 f'_s = compressive unit stress in steel,
 C = total compressive stress in concrete,
 C' = total compressive stress in steel,
 d' = depth to center of compressive steel,
 z = depth to resultant of C and C' .

4.—*Shear and Bond.*

- V = total shear,
 V' = total shear producing stress in reinforcement,
 v = shearing unit stress,
 u = bond stress per unit area of bar,
 o = circumference or perimeter of bar,
 Σ_o = sum of the perimeters of all bars.

5.—*Columns.*

- A = total net area,
 A_s = area of longitudinal steel,
 A_c = area of concrete,
 P = total safe load.

Rectangular Beams.—*Tension, Compression and Shear.*—A rectangular reinforced concrete beam is subject to six different kinds of stress while carrying a load which produces bending moment:

- (A) *Tension* in the steel at the bottom, T ;
 (B) *Compression* in the concrete at the top, C ;
 (C) *Shear* at the ends due to the preaction, R ;
 (D) *Longitudinal shear* along planes parallel to neutral surface;
 (E) *Diagonal tension* along any plane AB resulting from a combination of direct tension and shear;
 (F) *Bond stress* on the surface of the steel resulting from the transmission of the increment of moment (shear) from the concrete to the tensile steel.

It is important that the student get these actions clearly in mind at the outset, for in order that a beam be properly designed, it must be sufficiently strong in each of these six respects to withstand the stresses encountered. Although, as a matter of fact, direct shear at the end or longitudinal shear is seldom a critical consideration (except in short beams), each of these aspects must be investigated and provided for in the design of a beam.

It is obvious, since the resisting moment, the moment of the resisting couple $C-T$, Fig. 26, must equal the bending moment in order to have equilibrium, that,

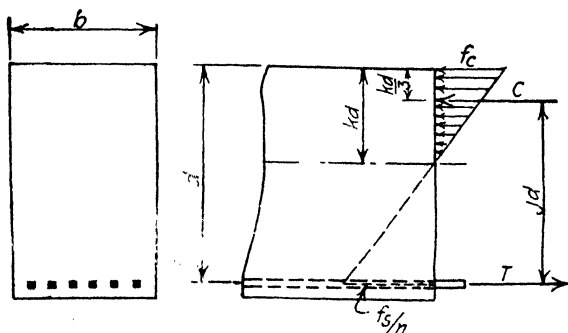

FIG. 26.—Stress distribution in a reinforced concrete beam according to the "straight line" theory.

$$M = f_s A_s j d, \text{ or } M = \frac{1}{2} k j b d^2 f_c. \quad (1)$$

In order to render these equations usable, it is necessary to determine values of k and j . Assuming a straight line variation of stress from the neutral surface within working stresses,

$$\frac{f_s}{n f_c} = \frac{d - kd}{kd} = \frac{1 - k}{k}, \quad (2)$$

$$f_s A_s = \frac{1}{2} f_c b k d, \text{ or } f_s p b d = \frac{1}{2} f_c b k d. \quad (3)$$

Solving for k from (2) and (3).

$$k = \sqrt{2pn + (pn)^2} - pn. \quad (4)$$

This formula gives k as a function of p and n and is independent of the size of the beam. Figure 27 gives values of k in terms of p for n equal to 10, 12, 15 and 18. Obviously $j = 1 - \frac{k}{3}$. Ordinarily k may be taken as $\frac{3}{8}$ and j as $\frac{7}{8}$ with sufficiently accurate results.

For definite working stresses in the concrete and the steel, from Eq. (2)

$$k = \frac{1}{1 + \frac{f_s}{n f_c}}$$

a formula most convenient for design.

For $f_s = 16,000$ and $f_c = 650$, or for $f_s = 18,000$, and $f_c = 750$, $k = 0.38$ or approximately $\frac{3}{8}$.

The Joint Committee recommends the following values of n :

- (a) $n = 40$, when the strength of concrete is taken as not more than 800 lb. per square inch.
- (b) $n = 15$, when the strength of concrete is taken between 800 and 2,200 lb. per square inch.
- (c) $n = 12$, when the strength of concrete is taken between 2,200 and 2,900 lb. per square inch.
- (d) $n = 10$, when the strength of concrete is taken greater than 2,900 lb. per square inch.

From Eq. (1) the stresses in the concrete and steel can be readily computed. See (A) and (B) above. For example, if a

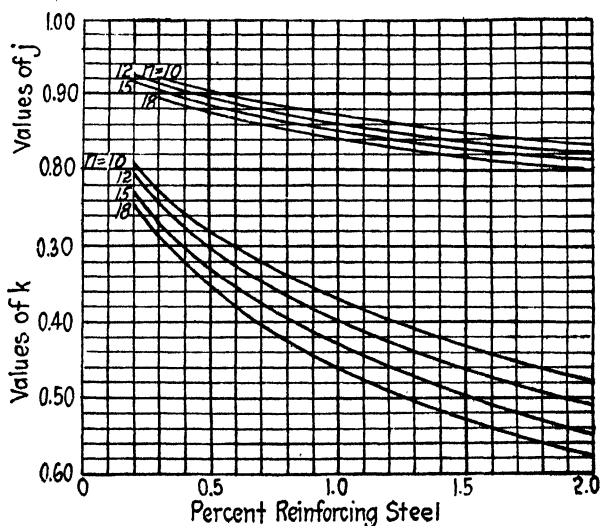

FIG. 27.—Diagram for values of k and j .

beam 14 in. wide and 16 in. effective depth to the steel with four $\frac{3}{4}$ -in. steel rods sustains a bending moment of 480,000 lb.-in., the stress in the steel will be $480,000 \div \left(4 \times 0.56 \times \frac{7}{8} \times 16\right) = 15,300$ lb. per square inch; and the stress in the concrete will be $480,000 \div \left(\frac{1}{2} \times 14 \times 16^2 \times \frac{3}{8} \times \frac{7}{8}\right) = 816$ lb. per square inch. (Assuming $k = \frac{3}{8}$).

Eliminating k between equations (2) and (3) and solving for p ,

$$p = \frac{0.5}{\frac{f_s}{f_c} \left(\frac{f_s}{nf_c} + 1 \right)}, \quad (5)$$

a formula which gives the proper percentage of steel to use for various working stresses in the concrete and steel.

The direct shear stress is V/bjd , the value of which is usually small in practice.

When the stresses involved are increased up to the point of rupture, the linear variation of stress does not apply and formula (4) is in error for these conditions. Assuming the stress to vary as the abscissas of a parabola with the origin at the top fibre, a similar analysis gives a corresponding formula,

$$k = \sqrt{3pn + (2\sqrt{3}pn)^2} - \frac{3}{2}pn \text{ and } j = 1 - \frac{3}{8}k. \quad (4a)$$

Diagonal Tension.—After providing for the direct tension compression and shear, the next step is to investigate the diagonal tension in the concrete resulting from the combination of shear and tension.

In a homogeneous beam, it is shown in works on mechanics of materials that the maximum stress at any point results from a combination of the direct tensile or compressive stress and the shear, and the direction of this resultant stress is at an angle with the direct stress, Fig. 28 (a). Specifically, if S_t is the direct tensile stress in the lower fibre at any point and S_s is the shear at that point, then the maximum tensile stress at that point, S_m , is

$$S_m = \frac{1}{2}S_t + \sqrt{\left(\frac{1}{2}S_t\right)^2 + S_s^2}$$

and S_m acts at an angle θ with the direction of the tensile stress given by the formula, $\tan 2\theta = 2S_s/S_t$, which is always 45° at the neutral surface. In a similar manner, diagonal compression occurs in the portion of the beam above the neutral surface, but it is seldom, if ever, that diagonal compression is significant.

This stress, S_m , acting on a diagonal plane, Fig. 28 (b), tends to cause the concrete to rupture along this plane, and such rupture can be prevented (a) by bending up the ends of some of the tensile reinforcing bars at an angle of 30° to 45° , which may not be required toward the end of the beam, as shown, or (b), by

placing vertical bars, called stirrups, across the plane of weakness as shown, or by both methods.

These stresses are frequently called "web stresses," and this arrangement of stirrups is termed "web reinforcement," because of the similarity in function to the web of a girder or truss. A beam without web reinforcement will fail whenever the web stress exceeds the tensile strength of the concrete.

The behavior of web stresses in reinforced beams is so complex that a rigorous analysis is impracticable, hence, a more or less empirical statement of principles established by partial analysis, justified by experiment and commonly accepted will suffice.

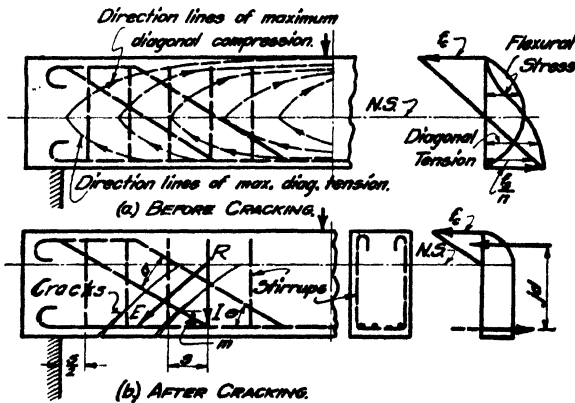

FIG. 28.—Diagonal tension in a simple beam.

When a beam is subjected to flexure and shear under a system of loads and a reaction as shown in Fig. 28, the diagonal tension stresses are borne, before the concrete is cracked, by the concrete and steel in proportion to their moduli of elasticity. Actual measurements on stirrups show them, at times, to be in compression in the upper portion of the beam, and the tension in the lower portion to be slight. After the initial cracking (invisible to the eye), the tension in the concrete disappears and the beam takes on a character similar to a Howe truss, the vertical member, R I, being in tension sustaining the vertical shear and the inclined lug of concrete, RE, being in compression. The necessity of having the stirrups anchored at both ends is obvious.

Before cracking, bent up bars are the more effective inasmuch as they lie more nearly in the direction of maximum stress, and, even after cracking when both inclined and vertical reinforce-

ment exists, the inclined steel, if adequate, probably carries most of the stress until the shear displacement brings the vertical steel into play. After cracking, if there are no diagonal bars present, the stress divides into its two components, vertical shear carried by the stirrups, and longitudinal tension carried by the tensile steel. Where both vertical and inclined bars are present, the distribution of stress between the two systems is indeterminate, the former acting as verticals in a quasi-Howe truss and the latter as diagonals in a quasi-Warren truss. In this case, the shear at any section may be divided between the two systems in proportion to the area of steel cut by a 45° section.

Where the entire vertical shear is borne by vertical stirrups, the *maximum* inclination of the crack in the concrete is assumed to be 45°, in which case there will be jd/s stirrups to sustain the stress that would be borne in diagonal tension along the plane of the crack if the beam were homogeneous, the vertical component of the stress being the vertical shear at the midpoint of the crack. The pull in any one stirrup is therefore $\frac{V \cdot s}{jd}$ and the unit stress $f_v = \frac{Vs}{A_v \cdot jd}$, A_v being the cross-sectional area of one stirrup. The spacing may be determined by the equation $s = \frac{A_v f_v jd}{V}$. The maximum spacing of vertical stirrups is commonly placed at approximately one half jd , or about $0.45 d$, and for inclined stirrups at $\frac{45 d}{\theta + 10}$, θ being the angle of inclination in degrees.

Where the stress is borne entirely by bent up bars spaced s apart along the beam, the distance, a , between the inclined bars will be $s \cdot \sin \theta$. Assuming the maximum slope of the crack at 45°, $a = m(1 + \cot \theta) \sin \theta$ or $m(\sin \theta + \cos \theta)$, whence

$$m = \frac{s}{(\sin \theta + \cos \theta)}$$

The minimum number of bars cut by any crack will be $\frac{jd}{m}$ or $\frac{jd(\sin \theta + \cos \theta)}{s}$ and the stress in one bar will be

$$f_v = \frac{V \cdot s \cdot jd}{A_v (\sin \theta + \cos \theta) j \cdot d}$$

Assuming the distribution of shear above the neutral surface after initial cracking of the concrete to be a parabola, the total

area of the shear diagram is approximately $jd \cdot v$, hence the average shear stress, $v = \frac{V}{b \cdot jd}$.

Where the tension bars are bent up to withstand the web stresses wholly or in part, care should be exercised that the bars remaining be sufficient to sustain the moment stress. The following excerpt from the report of the Joint Committee represents approved practice in the design of web reinforcement.

“Sufficient bond resistance between the concrete and stirrups or diagonals should be provided in the compression area of the beam. The longitudinal spacing of vertical stirrups should not exceed one half the depth of the beam, and that for inclined members should not exceed three fourths the depth of beam.

“Bending of longitudinal reinforcing bars at an angle across the web of the beam may be considered as adding to diagonal tension resistance for a horizontal distance from the point of bending equal to three-fourths the depth of beam. Where the bending is made at two or more points, the distance between the points of bending should not exceed three-fourths the depth of the beam. In the case of a restrained beam, the effect of bending up a bar at the bottom of the beam in resisting diagonal tension may not be taken as extending beyond a section at the point of inflection, and the effect of bending down a bar in the region of negative moment may be taken as extending from the point of bending down of the bar nearest the support to a section not more than three fourths the depth of the beam beyond the point of bending down of bar farthest from the support, but not beyond the point of inflection. In case stirrups are used in the beam away from the region in which the bent bars are considered effective, a stirrup should be placed not farther than a distance equal to one-fourth the depth of the beam from the limiting sections defined above. In case the web resistance required through the region of bent bars is greater than that furnished by the bent bars, sufficient additional web reinforcement in the form of stirrups or attached diagonals should be provided. The higher resistance to diagonal tension stresses given by unit frames having the stirrups and the bent-up bars securely connected together both longitudinally and laterally is worthy of recognition. It is necessary that a limit be placed on the amount of shear that may be allowed in a beam; for when web reinforcement sufficiently efficient to give very high web resistance is used, at the higher stresses the concrete in the beam becomes checked and cracked in such a way as to endanger its durability as well as its strength.

“The section to be taken as the critical section in the calculation of shearing stresses will generally be the one having the maximum vertical shear, though experiments show that the section at which diagonal

tension failures occur is not just at the support, even though the shear at the latter point be much greater.

"In the case of restrained beams, the first stirrup or the point of bending down of bar should be placed not farther than one half the depth of beam away from the face of the support."

Bond Stress.—The bond stress on the longitudinal bars results from the transferring of the increment of moment from the concrete to the steel. The derivative of the moment with respect to the distance along the beam being equal to the vertical shear, as proved in treatises on mechanics, $dM = dT \cdot jd = V dx$. Hence the increment in tension in 1 in. of length of the bar,

which is the total bond stress, is $\frac{V}{jd}$ and

$$u \cdot \Sigma_o \cdot jd = V, \text{ or } u = V / \Sigma_o \cdot jd \quad (1)$$

In short beams, bond stress may be the determining or critical factor in the strength of the beam, and may be the determining factor in proportioning the longitudinal steel.

Where high bond stress is required, deformed bars may be used advantageously. Where it is impracticable to secure sufficient bond area, end anchorage may be accomplished by bending the ends of the bar, preferably through 180° as a 90° bend is not so effective. The diameter of end bends must generally be eight to twelve times the diameter of the bar in order to develop the elastic limit of the bars.¹

The lateral spacing of bars should not be less than three diameters from center to center, nor should the distance from the side of the beam to the center of the nearest bar be less than two diameters. The clear spacing between two layers of bars should not be less than 1 in. These provisions are necessary in order that the bond on the under side of the bar may be effective in transmitting moment.

T-Beams.—In certain circumstances, beams designed in the shape of a T are economical where bond and diagonal tension stresses do not run high. Particularly in the design of floors, the supporting beams are frequently built integrally with the floor slab and the compressive strength of the latter is available in determining the strength of the beam. The width, b , Fig. 29, of the floor slab that may be considered to act as the flange of the

¹ *Proc. Am. Concrete Inst.*, vol. 24, p. 240, 1928.

beam should not be considered more than one-fourth the span, nor should the overhanging width on either side exceed three times the thickness of the slab.

If the neutral surface falls within the flange, the formulas for rectangular beams apply in general. If the neutral surface falls below the flange in the stem, special formulas must be

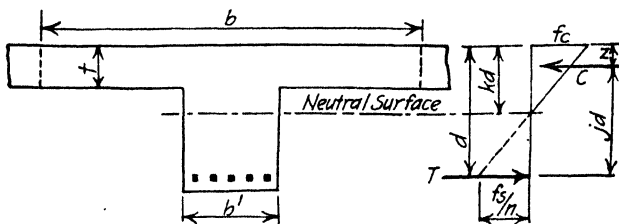

FIG. 29.—Stress distribution in a T-beam.

devised. Where the compression in the stem or web is neglected, the following derivation applies:

$$\frac{f_s}{nf_c} = \frac{1 - k}{k} \quad (1)$$

$$f_s \cdot A = f_c \left(1 - \frac{t}{2kd}\right) bt, \text{ whence} \quad (2)$$

$$kd = \frac{2ndA_s + bt^2}{2nA_s + 2bt}, \text{ gives the position of the neutral surface.} \quad (3)$$

$$z = \frac{3kd - 2t}{2kd - t} \cdot \frac{t}{3} \quad (4)$$

$$jd = d - z, \text{ gives the arm of the resisting couple.} \quad (5)$$

$$f_s = M/A_s \cdot jd \quad (6)$$

$$f_c = \frac{M \cdot kd}{bt \left(kd - \frac{t}{2}\right) jd} = \frac{f_s}{n} \cdot \frac{k}{1 - k} \quad (7)$$

The following formulas take into account the compression in the stem and are recommended where the flange is small compared with the stem. The derivation is long and is not given here.

Position of neutral axis,

$$kd = \sqrt{\frac{2ndA + (b - b')t^2}{b'} + \left(\frac{nA + (b - b')t}{b'}\right)^2} - \frac{nA + (b - b')t}{b'} \quad (8)$$

Position of resultant compression,

$$z = \frac{\left(kdt^2 - \frac{2}{3}t^3\right)b + \left[(kd - t)\left(t + \frac{1}{3}(kd - t)\right)\right]b'}{t(2kd - t)b + (kd - t)^2b'} \quad (9)$$

Arm of resisting couple, $jd = d - z$

$$\text{Fiber stresses, } f_s = \frac{M}{Ajd} \quad (10)$$

$$f_c = \frac{2Mkd}{[(2kd - t)bt + (kd - t)^2b']jd} \quad (11)$$

Beams Reinforced for Compression.—Assuming the straight line variation of stress as before, Fig. 30,

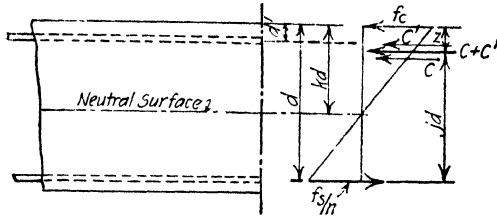

FIG. 30.—Stress distribution in a beam reinforced for tension and compression.

$$f_s/nf_c = (1 - k)/k \quad (1)$$

$$kbf_c/2 + bdp'f_s = bdpf_s, \quad (2)$$

from which

$$p = \frac{k^2}{2n(1 - k)} + p' \frac{k - \frac{d'}{d}}{1 - k} \quad (3)$$

and solving for k

$$k = \sqrt{2n\left(p + p' \frac{d'}{d}\right) + n^2(p + p')^2} - n(p + p') \quad (4)$$

Position of resultant compression,

$$z = \frac{\frac{1}{3}k^3d + 2p'nd'\left(k - \frac{d'}{d}\right)}{k^2 + 2p'n\left(k - \frac{d'}{d}\right)} \quad (5)$$

Arm of resisting couple,

$$jd = d - z$$

Fiber stresses,

$$f_c = \frac{6M}{bd^2 \left[3k - k^2 + \frac{6p'n}{k} \left(k - \frac{d'}{d} \right) \left(1 - \frac{d'}{d} \right) \right]} \quad (6)$$

$$f_s = \frac{M}{pjbd^2} = nf_c \frac{1 - k}{k} \quad (7)$$

$$f_s' = nf_c \frac{k - d'}{k} \quad (8)$$

Diagonal tension and bond stresses must be provided for in beams reinforced for compression in the same manner as in ordinary rectangular beams.

Beams Subject to Both Flexure and Axial Compression.—Frequently, reinforced concrete beams are subjected not only to

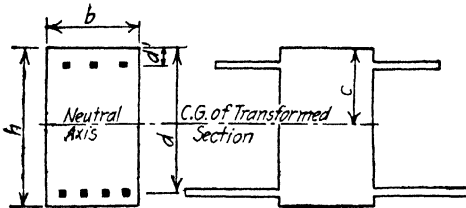

FIG. 31.—Transformed section of a reinforced concrete beam.

flexure but to an axial thrust as well. In order to analyze the stresses arising in this case, it is convenient to reduce the section to an equivalent homogeneous section by considering the steel to be replaced by concrete lying at the same distance from the neutral surface and having equal resistance. Such a section is called a transformed section. See Fig. 31.

The total area of the transformed section is

$$A = bh + n(A + A')$$

and the moment of inertia of the section is

$$I_t = I_c + nI_s$$

where I_c and I_s are the moments of inertia of the concrete and the steel areas respectively.

When the stress consists of compression only over the entire areas of the section, letting N be the total axial thrust,

$$\begin{aligned} f_c &= N/A_t + Mc/I_t, \\ f_s &= nN/A_t + nM(c - d')/I_t, \\ f_s' &= nN/A_t - nM(d - c)/I_t, \end{aligned}$$

These formulas with the sign changed to negative would apply, of course, where there was a small amount of tension on one side so long as the tension did not exceed the tensile strength of the concrete. Where the tension is greater, formulas may be readily found for the solution in any treatise on reinforced concrete.

Continuous Reinforced Concrete Beams and Slabs.—It is not customary to allow the full effect of the principle of continuity in designing continuous reinforced concrete beams and slabs reinforced principally in one direction owing chiefly to the liability of supports to settle and to the difficulty in securing conditions of continuity in fact. It is the custom to ascribe to the moment expression arbitrary coefficients which are partly the result of analysis and partly experimental. The following paragraph from the Report of the Joint Committee¹ shows prevailing practice in this respect:

“Beams and slabs of equal spans built to act integrally with beams, girders, or other slightly restraining supports and carrying uniformly distributed loads shall be designed for the following moments at critical sections:

- (a) Beams and slabs of one span,
Maximum positive moment near center,

$$M = \frac{wl^2}{8} \quad (12)$$

- (b) Beams and slabs continuous for two spans only,
1. Maximum positive moment near center,

$$M = \frac{wl^2}{10} \quad (13)$$

2. Negative moment over interior support,

$$M = \frac{wl^2}{8} \quad (14)$$

- (c) Beams and slabs continuous for more than two spans,
1. Maximum positive moment near center and negative moment at support of interior spans,

$$M = \frac{wl^2}{12} \quad (15)$$

2. Maximum positive moment near centers of end spans and negative moment at first interior support,

$$M = \frac{wl^2}{10} \quad (16)$$

¹*Proc. Am. Soc. Testing Materials*, vol. 24, p. 342, 1924.

(d) Negative moment at end supports for Cases (a), (b), and (c) of this Section,

$$M = \text{not less than } \frac{wl^2}{16} \quad (16a)$$

“Beams and slabs built into brick or masonry walls in a manner which develops partial end restraint shall be designed for a negative moment, at the support, of

$$M = \text{not less than } \frac{wl^2}{16} \quad (17)$$

“Beams and slabs of equal spans freely supported and assumed to carry uniformly distributed loads shall be designed for the moments specified, except that no reinforcement for negative moment need be provided at end supports where effective measures are taken to prevent end restraint. The span shall be taken as defined for freely supported beams.

“For spans of unusual length, more exact calculations should be made. Special consideration is also required in the case of concentrated loads.

“Even if the center of the span is designed for a greater bending moment than is called for by (a) or (b), the negative moment at the support should not be taken as less than the values there given.

“Where beams are reinforced on the compression side, the steel may be assumed to carry its proportion of stress, in accordance with the ratio of the moduli of elasticity. In the case of cantilever and continuous beams, tensile and compressive reinforcement over supports must extend sufficiently beyond the support and beyond the point of inflection to develop the requisite bond strength.”

Haunched Beams.—The beams of reinforced concrete frames are frequently deepened by large fillets where they join columns, or “haunched.” These haunches increase the stiffness of the beams at the support, causing a greater proportion of the total bending moment to be carried by a larger relative negative resisting moment at the supports. An exact solution of stress distribution, taking into consideration the variable moment of inertia, is complicated. In the familiar equation for the slope of a beam $d^2y/dx^2 = M/EI$, I must be expressed as a function of x , to admit algebraic solution, where I is not constant. When I is not a simple function of x due to an irregularity, as at the haunch, graphical methods are more convenient than algebraic.¹

¹ ARTHUR MORLEY, “Strength of Materials,” p. 188.

Professor Hardy Cross shows¹ that, within the range of practical sizes of haunches, the increase in end moment is essentially proportional to the increase in side area of the beam due to the haunches. Professor Cross found that over a range of increased side areas up to 20 per cent, the error of this approximate rule did not exceed 3 per cent for either a straight or curved (parabolic) haunch.

Columns.—Reinforced concrete columns may be reinforced in one or more of four ways: (a) by placing longitudinal bars the entire length of the columns merely tied together, (b) by placing hoops, bands, or spirals along the length of the columns together with longitudinal bars, (c) by using structural shapes sufficiently rigid to have strength as a column, (d) by a combination of (a) and (b).

The general effect of closely spaced hooping is greatly to increase the "toughness" of the column and its ultimate strength, but hooping has little effect on its behavior within the limit of elasticity. It thus renders the concrete a safer and more reliable material, and should permit the use of a somewhat higher working stress. The beneficial effects of "toughening" are adequately provided by a modern amount of hooping, a larger amount serving mainly to increase the ultimate strength and the possible deformation before ultimate failure.²

The Joint Committee specification is: "The spiral reinforcement shall be not less than one-fourth ($\frac{1}{4}$) the volume of the longitudinal reinforcement; it shall consist of evenly spaced continuous spirals held firmly in place and true to line by at least three vertical spacer bars. The spacing of the spirals shall be not greater than one-sixth ($\frac{1}{6}$) of the diameter of the core and in no case more than 3 in."

Composite columns of structural steel and concrete in which the steel forms a column by itself, should be designed with caution. To classify this type as a concrete column reinforced with structural steel is hardly permissible, as the steel will generally take the greater part of the load. When this type of column is used, the concrete should not be relied on to tie the steel units together or to transmit stresses from one unit to another. The

¹ *Proc. Am. Concrete Inst.*, p. 9, January, 1929. The reader is referred to Professor Cross' paper for an excellent discussion of reinforced concrete design.

² For a theoretical analysis and discussion of spirally reinforced columns, see *Trans. Am. Soc. C. E.* Vol. 90, pp. 379-443.

units should be adequately tied together by tie-plates or lattice bars, which, together with other details, such as splices, etc., should be designed in conformity with standard practice for structural steel. The concrete may exert a beneficial effect in restraining the steel from lateral deflection, and also in increasing the carrying capacity of the column. The proportion of load to be carried by the concrete will depend on the form of the column and the method of construction. Generally, for high percentages of steel, the concrete will develop relatively low unit stresses, and caution should be used in placing dependence on the concrete. The unit stress in the steel should not exceed $f_s = 18,000 - 70 \frac{h}{R}$, R being the least radius of gyration of the steel core.

Columns constitute the weakest part of a building, ordinarily, because of deficient strength in shear; hence, shear on oblique sections should be carefully investigated in column design. In general, rodded columns unless tied with hoops or spirals closely spaced, are unreliable.

For a column of cross section, A , and longitudinal bars for reinforcement, a load P is distributed to the concrete and the steel in proportion to their respective rigidities.

Assuming a distribution of stress proportional to the moduli of elasticity:

$$P = f_c[A(1 + (n - 1)p)] \quad (1)$$

$$f_s = n f_c \quad (2)$$

Columns are frequently subjected to combined compression and bending arising one or both of two conditions: (1) where moment is transmitted to the column from a beam or slab built continuously with the column as a rigid frame, and (2) where an eccentric load is placed on the column. The bending stresses are seldom sufficiently great to produce tension, hence, the stress distribution may be treated by means of the transformed section as in any member subject to combined compression and flexure. (See p. 132.)

Longitudinal steel bars in columns are usually lapped if they are small, while bars 1 in. or more in diameter are butted by means of pipe sleeves, the ends of the bars having been milled for even bearing.

The shrinkage of concrete due to the setting of cement induces a certain initial compression in the steel of reinforced concrete

columns which may increase the stress in the steel somewhat over that given by the above formula.

Where columns are to support beams or slabs built monolithically, the concrete in the column forms should be allowed to settle at least four hours before the adjoining members are poured in order that there may be no separation or cracking due to this settlement.

Temperature and Shrinkage Stresses.—Inasmuch as steel and concrete have practically the same coefficient of thermal expansion, if reinforced concrete members are free to expand and contract, temperature changes will not cause appreciable stress in either steel or concrete. However, in long walls and in restrained members, temperature changes give rise to large stresses and unless steel is placed near the exposed surfaces to distribute the contraction, large and unsightly cracks will occur. By placing the proper amount of reinforcing steel near the exposed surfaces, the shrinkage may be so distributed that the cracks will be so fine as to be unnoticeable.

Where one side of a wall is to be subject to a considerably higher temperature than the other, as in the case of a chimney or flue duct, the reinforcing steel should obviously be placed on the cooler side of the wall.

Since complete failure of the structure is not involved, the steel may be calculated at elastic limit stress. The tensile strength of concrete in this connection may be taken at 100 lb. per square inch. Thus a square foot of concrete would require $144 \times 100/40,000 = 0.36$ sq. in. of steel, or 0.25 per cent, to crack the concrete and thus distribute the contraction. It is customary to use about 0.2 to 0.3 per cent of steel for temperature reinforcement, which seems to be ample.

Since there is no change in the length of the reinforcing steel to correspond with the change in the concrete due to setting, shrinkage of the concrete while hardening definitely sets up stresses in the steel as may be shown theoretically and experimentally.

Let C = coefficient of contraction of concrete,

f_s = compressive stress in the steel caused by the shrinkage,

f_c = tensile stress in the concrete caused by the shrinkage,

then the net contraction per unit of length in terms of the concrete stress is $C - f_c/E_c$, and in terms of the steel stress is f_s/E_s .

These expressions are equal, and for equilibrium,

$$f_c = pf_s, \text{ whence } f_s = CE_s/(1 + pn), \text{ and } f_c = CE_c \frac{pn}{1 + pn}.$$

Tests made at the University of Kansas by the author indicate that where the coefficient of contraction of plain concrete is used for C , namely 0.0005, the actual stresses in the steel are only about half as large as the above formula would indicate. Evidently, a part of the shrinkage occurs before the concrete is sufficiently hard to grip the steel, and perhaps also there is some adjustment of stress due to flow of the concrete. The author found stresses as high as 7,000 lb. per square inch in 1:2:3 concrete, 6,000 in 1:2:4, and 4,600 in 1:3:6 concrete with approximately 1.0 per cent reinforcement. Investigations at the University of Illinois¹ showed even higher stresses, the stress in the concrete of 1:2:4 mix exceeding the ultimate tensile strength when the reinforcement was greater than 1.5 per cent. The coefficient of shrinkage varies with the richness of the mix from about 0.0003 for a 1:10 to about 0.0005 for a 1:3 mix.

The coefficient of actual shrinkage of reinforced concrete may be readily shown theoretically to be $\frac{C}{1 + pn}$, and experiments made by the author gave approximately the theoretical values. A considerable portion of the shrinkage occurs before the concrete is sufficiently hard to grip the reinforcing steel with a bond strength that will stress the steel, hence observed stresses from shrinkage are less than calculated from coefficients of shrinkage.

Reinforced Concrete Slabs.—Two general types of construction have been employed in laying floors and similar flat structures, (a) practically square panel slabs supported on beams or girders on all four sides, the reinforcing usually being continuous over the supports, the slabs usually being built monolithically with the girders, and (b) so called "flat slabs," reinforced in two or more directions, resting on columns with expanded capitals, a type of construction of recent development and possessing many advantages.

Slabs Supported on Girders.—The type of construction much used consists of girders between columns and beams between the girders with a slab built monolithically with the girders and beams.

¹ Univ. of Ill. Eng. Exp. Sta., Bull. 126.

A rigorous analysis of the stresses in the girders and slab built in this manner is practically impossible, for the reinforcing in the slab extends in both directions and moreover the girders and beams themselves do not constitute rigid supports but are more or less flexible. In view of the difficulties involved, it is customary to assume the beams and girders to be rigid supports and the load carried on the panel to vary with the distance from the center of the panel. This variation is sometimes assumed as parabolic and sometimes as linear. In a square panel, the proportion of the unit load, w , at the middle carried by each system of

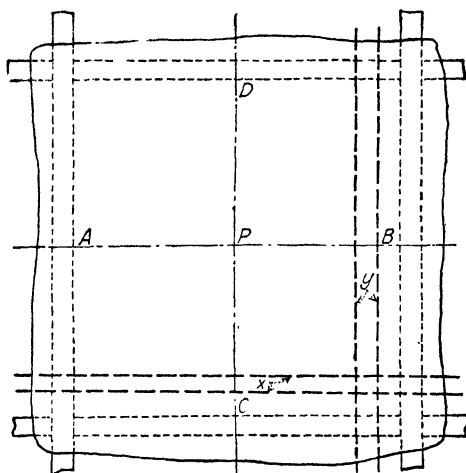

FIG. 32(a).—Beam and girder construction.

reinforcing bars, if the systems of bars were equal in both directions, would be $w/2$. This is assumed to vary from a value $w/2$ at P , Fig. 32(a), for each system of reinforcing to 0 for that system at the edge. That is, the bars, x , in one direction would carry $w/2$ lb. per square foot at P and 0 lb. per square foot at C , while bars, y , would carry $w/2$ at the center and w lbs. per square foot at C .

Where panels are rectangles of unequal sides, if the length of one side is as much as one fifth longer than the other, the load is carried chiefly by the transverse reinforcement and there is very little advantage in placing reinforcing bars in the longer direction.

Flat Slabs.—The continuous flat slab reinforced in two or more directions resting on columns with expanded capitals and without beams or girders is a recent type of construction and has many

advantages. Figure 33 shows the appearance of the completed floor, in a similar building, except that it has "drop panels."

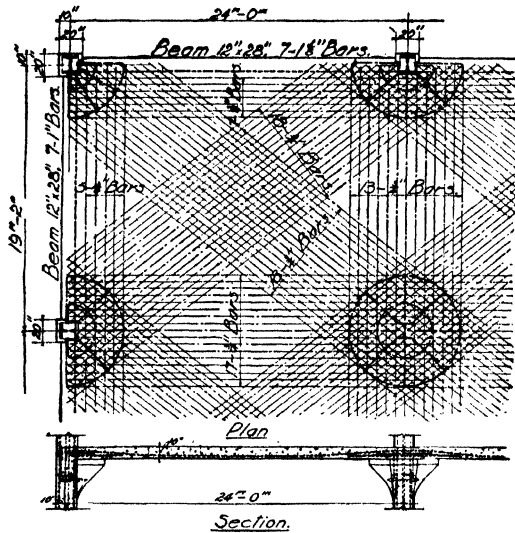

FIG. 32(b).—Four-way reinforcement in a slab.

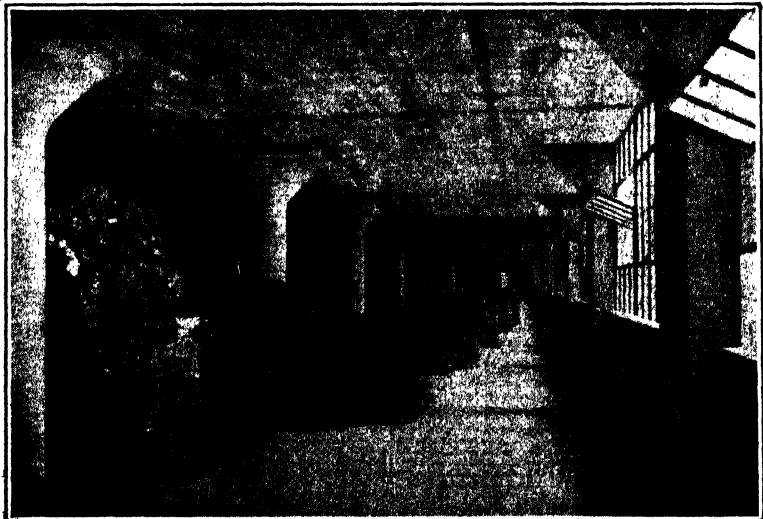

FIG. 33.—Flat slab warehouse floor with drop panels.

This is a typical building although the manner of placing the reinforcement varies widely.

The behavior of the stresses in this type of construction, as in the slab and girder type, is too complex to admit of rigorous analysis, although many purporting to be rigorous have been proposed. The report of the Joint Committee gives a mode of procedure which is well on the side of safety and is readily adapted to practical design. Much of the following discussion is abstracted from that report.

The Joint Committee recommends that the diameter of the capital should be not less than 0.20 times the panel length center to center of columns, and suggests 0.225 times the panel length as being preferable. In one type of construction, called the "dropped panel" or "depressed panel" construction, the slab is thickened over an area surrounding the column capital. For this type, it is recommended that the dropped panel be not less than 0.40 times the panel length center to center of columns.

The following formulas for minimum thickness of slab are recommended as general rules of design where the diameter of the column capital is not less than one-fifth the panel length.

Let t = total thickness of slab in inches

l = panel length in feet

r = radius of capital

w = sum of live and dead loads in pounds per square foot.

For a slab without dropped panels,

$$\text{minimum } t = 0.024l\sqrt{w} + 1\frac{1}{2}$$

For a slab with dropped panels,

$$\text{minimum } t = 0.02l\sqrt{w} + 1$$

For a dropped panel whose width is 0.40 times the panel length,

$$\text{minimum } t = 0.03l\sqrt{w} + 1\frac{1}{2}$$

In no case should the slab thickness be less than 6 in., nor the thickness of a floor slab be less than $\frac{1}{32}$ of the panel length, nor that of a roof slab be less than $\frac{1}{40}$ the panel length.

In designing flat slabs, the stresses at four locations must be provided for:

1. Stress in concrete and in steel over the column capital due to negative bending moment.
2. Stress in concrete and in steel in the central part of the slab due to positive bending moment.
3. Shear around the edge of the column capital.
4. Diagonal tension in the capital.

Bending and Resisting Moments and Shears in Slab for Uniform Loads.—If a vertical section of a slab be taken midway between columns and another parallel to that section through the center line of the columns but skirting the periphery of the capitals, Fig. 34(a), the moment of the couple formed by the external load on the half panel, exclusive of that over the capital, and the resultant of the external shear or reaction at the support may be found by ordinary static analysis. It will be noted that the edges of the area here considered are along lines of zero shear, except around the column capitals. This moment of the external

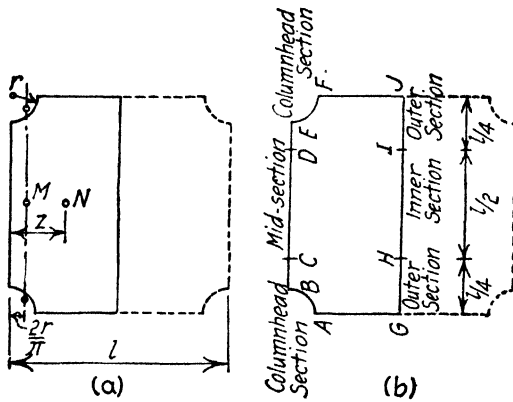

FIG. 34.—Diagram of a flat slab panel.

forces acting on half of the panel will be resisted by the numerical sum of (a), the positive resisting moment of the internal stresses along the panel midway between columns, and (b), the negative resisting moment of the internal stresses at the end of the panel, the components of moments at the curved portion parallel to the edges being considered. The following analysis shows the amount of this total moment, but the division between positive and negative is indeterminate. See Fig. 34.

$$\text{The load on the half panel} = w \left(\frac{l^2}{2} - \frac{\pi r^2}{2} \right).$$

The distance, z , to the center of gravity of the load is found as follows:

$$\text{Moment of rectangle} = \frac{l^2}{2} \times \frac{l}{4} = \frac{l^3}{8}$$

$$\text{Moment of quadrant} = \frac{\pi r^2}{2} \times \frac{4r}{3\pi} = \frac{2r^3}{3}$$

$$\begin{aligned} \text{Difference} &= \frac{l^3}{8} - \frac{2r^3}{3} \\ z &= \frac{\frac{l^3}{8} - \frac{2r^3}{3}}{\frac{l^2}{2} - \frac{\pi r^2}{2}} \end{aligned} \tag{1}$$

The distance to the center of gravity of shear on the periphery of the capitals is $\frac{2r}{\pi}$

$$\text{The moment arm} = \frac{\frac{l^3}{8} - \frac{2r^3}{3}}{\frac{l^2}{2} - \frac{\pi r^2}{2}} - \frac{2r}{\pi} \tag{2}$$

The moment at the center line of columns is

$$M_0 = \left(\frac{l^3}{8} - \frac{2r^3}{3} - \frac{2r}{\pi} \left(\frac{l^2}{2} - \frac{\pi r^2}{2} \right) \right) w \tag{3}$$

$$\begin{aligned} &= \frac{w}{8} \left(l^3 - \frac{16r^3}{3} - \frac{8rl^2}{\pi} + 8r^3 \right), \text{ substituting } c = 2r \\ &= \frac{wl}{8} \left(l^2 - \frac{4}{3}cl + \frac{c^3}{3l} \right) \end{aligned} \tag{4}$$

which does not differ appreciably from

$$M_0 = \frac{wl}{8} \left(l - \frac{2}{3}c \right)^2 \tag{5}$$

for practical values of l and c . From test data, the Joint Committee deduced that provision for 72 per cent of this theoretical moment is adequate, making the coefficient 0.09 instead of $\frac{1}{8}$.

In oblong panels similar formulas may be devised.

Let l_1 = one side of the panel

l_2 = the other side of the panel

M_x = the numerical sum of the positive and negative moments in the direction parallel to l_2

M_y = the numerical sum of the positive and negative moments in the direction parallel to l_1

Then $M_x = \frac{1}{8} wl_2 (l_1 - \frac{2}{3}c)^2$

$M_y = \frac{1}{8} wl_1 (l_2 - \frac{2}{3}c)^2$

As stated previously, the division of this moment between positive and negative is indeterminate. However, with the

reinforcing bars placed according to any reasonable assumption, because of the principle of least work and its corollary that a load is divided between two or more systems in proportion to their rigidities, the distribution between positive and negative moment will depend upon the reinforcement.

Systems of Reinforcement.—There are four modes of placing the reinforcement in flat slabs of this type, viz., (1) the two-way, (2) the four-way, (3) the three-way, and (4) the circumferential systems.

In the two-way system, the panels are rectangular (ordinarily square), and the reinforcement is laid rectangularly in bands or zones. Tests as well as theory indicate that moment is not uniformly distributed along any section, but that the moment is more intense across a strip over the column capitals than it is in an intermediate strip. For convenience in design, therefore, the slab is separated into two strips in each direction, the column strip $0.25l$ in width, and a middle strip, $0.5l$ in width. See Fig. 34. The moment assigned to each of these strips is indicated in Table IX, the number of bars in each direction being determined by the requirements for positive moment.

In the four-way system, Fig. 32 (b), reinforcement is laid in the column strips as in the two-way, and then bars are laid diagonally both ways over the columns to carry the moments assigned to the middle strips. These bands are usually about the width of the column capitals. The number of bars is determined by the positive moment as before from Table IX.

The moments in the middle strips are sustained by the diagonal bands. Since the section of positive bending moment in a middle strip cuts the two diagonal bands at an angle, the area of the steel that would be required if laid perpendicular to the section must be divided by the cosine of the angle that the steel bands make with the longer side of the strip. This angle in square panels being 45 degrees, the divisor should be 0.707. Taking A as the area of steel required if the steel were parallel to the column row, then the area of steel required in each diagonal band would be $\frac{A}{2 \times 0.707}$ or $0.71A$.

Also in the column strips over the capitals, the total effective steel is that lying in the column strips plus that in the diagonal strips multiplied by the cosine of the angle of inclination of the diagonal to the column strip. Thus in square panels, the

effective steel for negative reinforcement is $A_1 + 2 \times 0.707A_2$, where A_1 and A_2 are the areas of the steel in the column and the diagonal strips respectively.

The moment coefficients of Table IX are for proportioning the steel. The compressive stresses in the bottom of the slab, and especially in the bottom of the drop, are larger than these moments would indicate, because in this table, the theoretical moment has been modified according to test results. Moreover, the compressive stress on the diagonal section is the resultant of the two rectangular moments, and should be calculated accordingly. In deep drops, the compression at the column capital is largely sustained by the concrete in the drop owing to its greater distance from the neutral axis.

The number of bars required in the rectangular strip and in the diagonal strip is determined from the positive bending moment in each case, and sufficient short bars are placed over the capital to supply the additional area required for the negative moment. In both the two-way and the four-way systems, the reinforcement consists of long bars bent down at the points of inflection and of straight bars as needed. The arrangement varies widely with different designers. The critical section for shear is usually at the edge of the column capital. Ordinarily it is better to choose a thickness of slab that will keep the shear stresses within those allowable for plain concrete than to introduce stirrups for web strengthening.

Flat slab floors have the advantage over beam and girder construction that they are economical in depth. Thus a building of this type need not be so high in order to yield the same net usable space between ceilings and floors as when built with beam and girder construction, and the resultant saving in cost may be considerable. Whether or not drop panels should be used will depend upon the character of the building. So far as construction is concerned, drop panels will usually be found economical, but they may so seriously impair the convenience and utility of the building that they would be undesirable.

In the three way system (patented), the columns are placed at the apices of equilateral triangles and the reinforcement is laid over the column capitals along the sides of such triangles.

In the circumferential system (patented), the main reinforcement radiates from the columns and is connected with bars laid in rings concentric with the column and extending beyond the

capital. In addition, some bars are laid rectangularly between columns similar to the four-way system.

The Joint Committee recommends the distribution of the moment according to Table IX.

TABLE IX.—MOMENTS TO BE USED IN DESIGN OF FLAT SLABS¹

Strip	Flat slabs without dropped panels		Flat slabs with dropped panels	
	Negative	Positive	Negative	Positive
Slabs with two-way reinforcement				
Column strip.....	0.23 M_0	0.11 M_0	0.25 M_0	0.10 M_0
Two-column strips.....	0.46 M_0	0.22 M_0	0.50 M_0	0.20 M_0
Middle strip.....	0.16 M_0	0.16 M_0	0.15 M_0	0.15 M_0
Slabs with four-way reinforcement				
Column strip.....	0.25 M_0	0.10 M_0	0.27 M_0	0.095 M_0
Two-column strips.....	0.50 M_0	0.20 M_0	0.54 M_0	0.190 M_0
Middle strip.....	0.10 M_0	0.20 M_0	0.08 M_0	0.190 M_0

¹ These are approximately the values which would be obtained by considering one-third ($\frac{1}{3}$) of the total moment, M_0 , as positive and two-thirds ($\frac{2}{3}$) of it as negative moment.

Working Stresses.—The Joint Committee recommended the following working stresses in design of reinforced concrete structures, where f'_c is the 28-day strength of the concrete:

DIRECT STRESS IN CONCRETE

Direct Compression:

(a) Columns the length of which does not exceed $40R$:

1. With spirals.....varies with amount of longitudinal reinforcement..... $300 + (0.10 + 4P)f'_c$.
2. Longitudinal reinforcement and lateral ties... (See p. 136.)

(b) Long columns, $\frac{h}{R} > 40$ $\frac{P'}{P} = 1.33 - \frac{h}{120R}$

(c) Piers and pedestals..... $0.25f'_c$

Compression in Extreme Fiber:

(a) Extreme fiber stress in flexure..... $0.40f'_c$.

(b) Extreme fiber stress in flexure adjacent to supports of continuous beams..... $0.45f'_c$.

Tension:

In concrete members..... None

SHEARING STRESSES IN CONCRETE

Longitudinal Bars without Special Anchorage:

(a) Beams without web reinforcement.....	0.02f'
(b) Beams with stirrups or bent-up bars or combination of the two.....	0.06f'

Longitudinal Bars Having Special Anchorage:

(a) Beams without web reinforcement.....	0.02f'
(b) Beams with stirrups or bent-up bars or a combination of the two.....	0.12f'

Flat Slabs:

Shear at distance, <i>d</i> , from capital or dropped panel.....	0.03f'
--	--------

Footings:

(a) Longitudinal bars without special anchorage.....	0.02f'
(b) Longitudinal bars having special anchorage.....	0.03f'

STRESSES IN REINFORCEMENT

Tension in Steel:

<i>(a) Billet-steel bars:</i>	
1. Structural steel grade.....	16,000 lb. per square inch
2. Intermediate grade.....	18,000 lb. per square inch
3. Hard grade.....	18,000 lb. per square inch
<i>(b) Rail-steel bars.....</i>	18,000 lb. per square inch
<i>(c) Structural steel.....</i>	16,000 lb. per square inch
<i>(d) Cold-drawn steel wire:</i>	
1. Spirals.....	Stress not calculated
2. Elsewhere.....	18,000 lb. per square inch

Bond between Concrete and Reinforcement:

(a) Beams and slabs, plain bars.....	0.04f'
(b) Beams and slabs, deformed bars.....	0.05f'
(c) Footings, plain bars, one-way.....	0.04f'
(d) Footings, deformed bars, one-way.....	0.05f'
(e) Footings, bars, two-ways...Secs. (c) or (d) reduced by 25 per cent.	

Practical Design.—In practical design, many diagrams and charts have been devised which greatly facilitate calculations, a few typical ones being illustrated below.

Referring to Formula (1) p. 123, it is evident that

$$f_s p j = \frac{1}{2} f_s k j = \frac{M}{b d^2} \tag{1}$$

and
$$d = c \sqrt{\frac{M}{b}} \tag{2}$$

For
$$f_c = 650, d = 0.096 \sqrt{\frac{M}{b}} \tag{3}$$

This quantity M/bd^2 is called the "coefficient of resistance." The diagram shown in Fig. 39(C) gives values of the first two

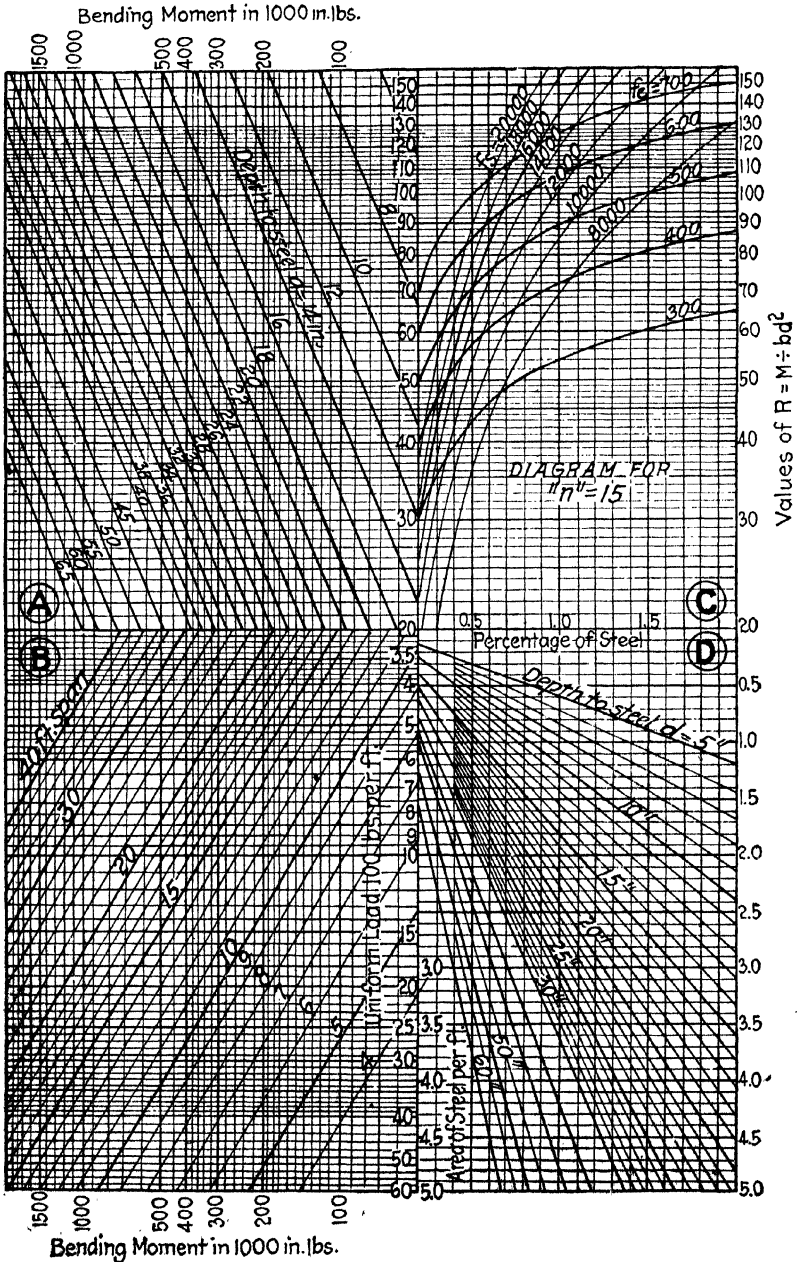

Fig. 35.—Diagrams for design of reinforced concrete beams.

members of equation (1) for various unit stresses and percentages of steel, and hence values of the last member as well. The use of these diagrams will appear from the two following examples, in which n is taken as 15.

1. Given a beam 12 in. wide and 16 in. effective depth with four $\frac{3}{4}$ -in. square bars (1.17 per cent reinforcement). What bending moment will it sustain if the working stresses are to be 600 and 16,000 lb. per square inch for concrete and steel respectively.

Find 1.17 per cent and trace vertically until the first of 600 or 16,000 curves is crossed. Since the 600 curve is met first, the stress in the concrete will govern with this percentage of reinforcement. Trace now horizontally and find $M/bd^2 = 112$. Then $112 \times 12 \times 16^2 = 247,000$ lb.-in., the moment that it will carry.

2. Design a beam with the above unit stresses to carry a bending moment of 628,000 lb.-in.

Find the intersection of the 600 and 16,000 lb. curves which gives $M/bd^2 = 95$, and a percentage of steel of 0.7 per cent. $628,000 \div 95 = 6,610 = bd^2$. Making b approximately $\frac{2}{3}d$ gives $d = 21\frac{1}{2}$ in. and $b = 14$ in., with 2.11 sq. in. of steel, or say four $\frac{3}{4}$ -in. square rods.

In Fig. 35, diagram (B) gives values of the bending moment ($M = 1.5wt^2$) for various uniform loads and spans. Diagram (A) gives the relation between coefficients of resistance ($M/12d^2$) and bending moments for various effective depths. Diagram (C) has been explained. Diagram (D) gives areas of steel per foot of width of beams for various depths of beams having various percentages of reinforcement.

For practical designing, the use of such diagrams is to be commended as greatly facilitating the calculations and hence lessening the expense. Various handbooks on reinforced concrete offer a great variety of these diagrams covering almost every phase of design and the reader is referred to such works for the same.

CHAPTER V

MASONRY ARCHES

Terms Used in Arch Masonry.—The following terms are in current usage in the literature on arches, and, although some variations in usage exist, the definitions given are believed to be most generally accepted.

The *arch ring*, *arch rib*, or *arch barrel* is the curved masonry which carries, or is assumed to carry, the load.

The *arch axis* is the median line of the arch ring; the axis of the arch barrel is the axis of the cylinder of curvature at the crown.

The *span* is the horizontal distance between the faces of the abutments; mathematically used, it is the distance between the ends of the arch axis at the skewbacks.

The *soffit* is the under surface of the arch rib or barrel.

The *back* of the arch is the outside of the arch rib.

The *crown* is the apex of the arch ring; in calculations, it refers to the apex of the arch axis.

The *skewback* is the inclined surface on which the arch ring joins, or is assumed to join, the abutment.

The *springing line* is the line where the skewback cuts the soffit; in calculations, the term commonly refers to the intersection of the arch axis with the skewback.

The *rise* is the height of the crown above the level of the springing; in calculations, it refers to the height of the apex of the arch axis above the level of springing of the arch axis.

The *intrados* (French: *intra*, *inside* + *dos*, *back*) is the lower curved surface of the arch; used mathematically, it is the intersection of the soffit with the vertical face of the arch rib. Intrados and soffit are sometimes used interchangeably, although the former usually refers to the curvature and the latter to the surface.

The *extrados* (French: *extra*, *outside* + *dos*, *back*) is the upper or exterior curved surface of the arch; mathematically, the term signifies the intersection of the exterior surface of the arch ring with the vertical face of the arch rib.

The *spandrel* is the space between the extrados of the arch and the roadway. This space may be occupied by *spandrel arches* or columns, in which case it is termed *open spandrel*, or it may be filled solidly, in which case it is termed *filled spandrel*.

A *vousoir* is a wedge-shaped stone forming a part of the arch ring of stone arches. The *keystone* is the vousoir at the crown of the arch. The vousoirs are called *ringstones*.

A *fixed arch* is one whose skewback is fixed as to position and inclination. *Three hinged arches* are those with hinges at the springing line and at the crown.

Two hinged arches are those with hinges at the springing line.

A *segmental arch* is one consisting of a portion of a cylinder whose intrados is less than a semicircle. If it is a complete semi-cylinder, it is called a *full centered arch*. Arches may be *elliptical*, *parabolic*, etc.

A *right arch* is one whose ends are in planes at right angles with the axis, and a *skew arch* is one whose end planes make an oblique angle with the axis.

A *pointed arch* is one whose intrados consists of segments of a circle whose tangents intersect at the crown at an angle less than 180° .

The *tympanum* is the space between the level of the springing line and the intrados of the arch.

Nature of an Arch.—An arch ring is essentially a curved beam fixed at both ends. Whereas vertical loads on a straight fixed beam cause two classes of stress, namely, moment and shear, vertical loads on an arch cause not only moment and shear, but also direct thrust in the arch, because vertical loads have components along the arch axis. Any section of an arch ring is, therefore, ordinarily subject to moment, shear, and thrust. Obviously, the flatter the arch the more nearly will the stress distribution resemble that of a straight fixed beam.

If the arch were hinged at the center so that only shear could be transferred past the crown, the structure would be essentially two cantilevers, or a "one-hinged arch." It is apparent, therefore, that the rigidity at the crown must be sufficient to transmit positive moment through the crown to be resisted, partly as negative moment in the other half of the arch in order to have true arch action.

In order to have pure arch action, three conditions must be fulfilled with reference to the arch ring. (1) The length of the span must remain constant, (2) the elevation of the ends must remain unchanged, and (3) the inclination of the skewback must be fixed. These mean that all changes in displacement and slope must occur between the springing lines and that a displacement in one direction must be accommodated by a counter displacement in the other between these planes. The significance of these conditions will become apparent later. They apply, of course, only to fixed or hingeless arches, the only type to be considered in this chapter.

The essential difference between an arch and a beam is that moment stresses resulting directly from loads, theoretically at

least, could be eliminated by choosing the form of arch so that the resultant thrust would pass through the centers of gravity of the sections of the arch ring. The horizontal crown thrust (under symmetrical loads) combined with the superimposed load on the first segment or voussoir gives the resultant thrust a deflection downward, and the load on the next segment combined with this resultant gives a still greater deflection, and so on. If the arch ring were made to follow this curved line of thrust exactly, the direct loading would produce only compressive and shear stresses in the arch ring, thereby eliminating flexural stresses.

In the design of a fixed masonry arch, the procedure consists in making an approximate design by empirical formulas and then in investigating this design to make a more exact design.

Method of Procedure in Design.—Inasmuch as the loads and the stresses depend directly upon the form of the arch ring, and the form of the arch ring in turn depends upon the loads to be carried, an arch is designed necessarily by more or less indirect methods. That is, the form and dimensions of the arch ring cannot be made an explicit function of the loads. However, corresponding indirect methods are employed in the design of beams, trusses, etc. The design consists essentially of three steps, (1) an approximate design by empirical formulas, (2) an investigation of the approximate design, and (3) such modifications of the approximate design as may be indicated by this investigation.

The preliminary approximate design consists of two steps, (a) determining the form of the arch ring and (b) determining the thickness of the arch ring at the crown.

Determining the Form of the Arch Ring.—In many cases, the form of the arch ring is largely fixed by certain local conditions, such as the height of clearance over other railways, the maximum waterway for a given span, etc. For example, since an elliptical arch will give the maximum waterway for a given span, the necessity of providing ample waterway may practically compel the choice of an elliptical arch. However, where freedom is allowed in the choice of arch form, economy will generally be the governing factor, and in general, economy will mean a minimum amount of masonry, unless the complicated form work should render the forms and falsework unduly expensive.

The selection of the *rise ratio*, i.e., the ratio of the *rise* to the *span*, has much to do with the economy of the arch. The flatter

the arch, in general, the greater the thrust on the abutments, the greater the stresses due to loads, temperature and shrinkage, and consequently, the greater the cost. However, the rise ratio will usually be determined by the height of waterway required, the relative elevations of the foundations and the roadway to be carried, or by a consideration of both factors.

Having determined the rise ratio, the most economical type results from a consideration of stress distribution, as explained hereafter, although other considerations than economy may cause a choice of some different form.

If all the loads on the arch were fixed loads, the arch ring could be designed to follow the form of the funicular or equilibrium polygon for such loads and the line of thrust would be normal to the section of the arch ring at any point and would pass through the center of gravity of the section and hence would produce only compression in the arch ring, so far as the direct loading stress was concerned. For example, if the load were uniformly distributed across the span, the equilibrium polygon would be a parabola. Hence, if in that case the arch ring were given the shape of a parabola, compressive stresses only would result. The equilibrium polygon for any given loading is called the *linear arch* if the number of sides of the polygon is made infinite.

Obviously the shape of this linear arch depends upon the distribution of the loading. Thus for normal loads as for water pressure, the arch should be circular; for a uniformly distributed load, it should be parabolic, and for any other condition of loading there is a definite curve for the arch ring that will make the resultant pass through the centers of gravity of the sections of the arch ring. A linear arch is, therefore, like an inverted cable for a suspension bridge, the stresses being compression instead of tension as in the latter, and the equilibrium polygon being a "stick" polygon rather than a "string" polygon. Owing to the fact that the load varies over the spandrels and is not normal to the arch ring, a simple circular arch ring cannot be used generally to advantage because the line of pressure cannot be made to fit the arch ring. Neither can a simple parabolic arch be made to follow the funicular polygon, because it is impractical to distribute the dead load uniformly on account of the additional load coming from the spandrels. Elliptical, "basket-handle," three and five centered, or other regular forms will usually require more

masonry in the arch ring and also in the abutments than one designed to follow the funicular polygon.

In the following discussion, positive moment will refer to the moment which tends to cause compression in the upper fibers of the arch ring and negative moment, that which tends to cause compression in the lower fibers.

It can be shown theoretically, and practical results have demonstrated, that the most economical arch for relatively large rise ratios follows the equilibrium or funicular polygon for the

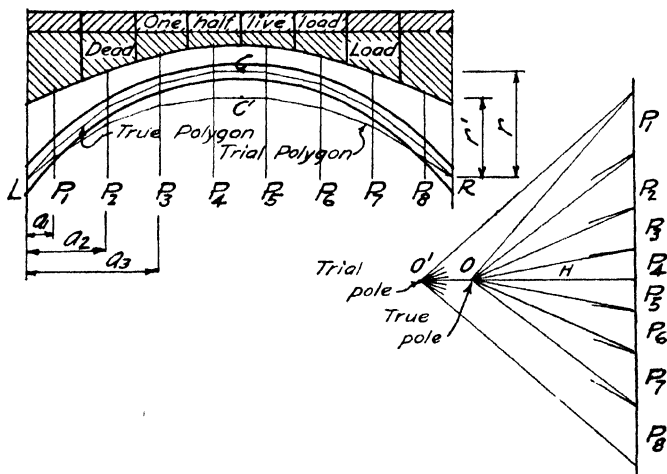

FIG. 36.—Loading and equilibrium polygon for economic arch.

dead load plus one half the live load distributed over the entire span. In such an arch the positive moments caused by combined dead and live loads at any section will approximately equal the combined negative moment for that section. See Fig. 36.

However, for arches of relatively small rise ratio (less than about $\frac{1}{5}$), better results can be had by making the arch follow the funicular polygon for the dead load only, or for the dead load plus a small fraction of the live load uniformly distributed, because temperature and arch shortening stresses will be relatively high, and they will be counteracted to a degree by the live load. In the majority of cases, however, the arch ring laid out for the dead-plus-half-live load will not differ greatly from that laid out to

follow the funicular polygon for the dead load only, particularly for a heavy dead load as compared to the live load.

On the basis of laying the arch to the funicular polygon for the dead load only, Victor H. Cochrane¹ has derived the following approximate formulas for the form of arch ring for average conditions:

For open spandrel arches, $y = \frac{8rL}{6 + 5r}(3c^2 + 10c^4r)$

For filled spandrel arches, $y = \frac{4rL}{1 + 3r}(c^2 + 24c^5r)$

Where y = the ordinate from crown to any point on the arch ring

c = the ratio of the x -coordinate of this point to the span

r = the rise ratio

L = the span.

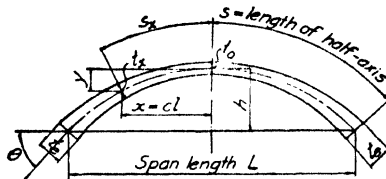

FIG. 37.—Coordinates of an arch rib.

The linear arch for the dead load plus one-half the live load (or any other fixed loads) can be drawn at once by passing a funicular polygon for the given loads through the three known points, the springings and the crown. Graphically, the procedure is as follows: Draw the loads P_1, P_2, P_3 , etc., in position with reference to the springings, L and R . Lay off the load line and, with a pole O' and pole distance H' selected at random, draw the force polygon and the corresponding funicular polygon $LC'R$. Since $H'r'$ is the moment of the forces at the springing, $H'r'/r$ is the true pole distance (Fig. 36).

The true pole distance, or the crown thrust, can be calculated directly from the fact that the sum of moments of all forces acting on one-half the arch equals zero, since it is assumed that the funicular polygon is to pass through the center of the skew-back producing zero moment at that point. That is, $(P_1a_1 + P_2a_2 + P_3a_3 + \dots)/R = H$.

¹ *Proc. Eng. Soc. of W. Pa.*, vol. 32, p. 659.

Thickness of the Arch Ring.—*Thickness at the Crown.* After selecting the rise ratio and the general form of arch ring, the next step is to determine approximately the thickness of the arch ring, first at the crown and then at other points. From a study of existing arches and also of his own designs, F. F. Weld¹ devised the following empirical formula for the thickness of the crown of an arch

$$t'_c = \sqrt{L} + 0.1L + 0.005W_l + 0.0025w_c$$

TABLE X.—VALUES OF COEFFICIENT *K* FOR HIGHWAY AND RAILWAY BRIDGES

<i>R/L</i>	Span in feet										
	20		30		40		50		60	120	150
	Hy.	Ry.	Hy.	Ry.	Hy.	Ry.	Hy.	Ry.	Highway or railway		
1:4	0.16	0.26	0.25	0.36	0.35	0.41	0.42	0.44	0.46	0.58	0.64
1:5	0.20	0.32	0.30	0.42	0.40	0.48	0.49	0.52	0.54	0.66	0.72
1:6	0.24	0.38	0.35	0.49	0.45	0.55	0.55	0.57	0.59	0.71	0.77
1:7	0.27	0.46	0.39	0.56	0.50	0.59	0.60	0.61	0.63	0.75	0.81
1:8	0.31	0.55	0.44	0.62	0.55	0.64	0.64	0.65	0.67	0.79	0.85

where *L* is the length of span in feet, *W_l* is the live load in pounds per square foot, *w_c* is the dead load at the crown in pounds per square foot, and *t'_c* is the depth of crown in inches. For railroad bridges, add 50 per cent to the equivalent live load for impact. The thickness at the quarter points should be 1.25*t_c* to 1.50*t_c* depending upon the curve of the intrados.

This formula does not take into consideration the rise ratio of the arch nor the strength of the materials used in its construction. Below is given a rational formula derived by J. P. Schwada² which takes into consideration these factors:

$$t_c = \frac{L^2}{57.6(R-d)f_c K} \left(\frac{B}{20} + R + 8d + 6F + \frac{w}{20} \right)$$

where *t_c* = depth of the crown in feet.

L = span in feet.

R = rise in feet.

F = fill at the crown in feet.

¹ *Engineering Record*, Nov. 4, 1905.

² *Engineering News*, Nov. 9, 1916.

B = weight of track and ballast or of pavement in pounds per square foot.

w = uniform live load in pounds per square foot.

f_c = unit stress in arch ring in pounds per square inch.

K = ratio of stress at crown (average) to stress f_c .

Table X gives values of the coefficient K for use in this formula for various spans and rise ratios for highway and railway bridges.

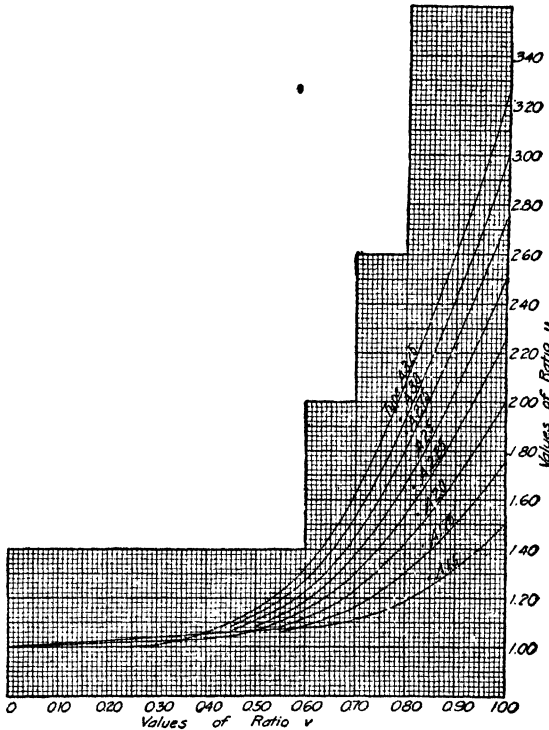

FIG. 38.—Diagram for thickness of typical arch rings.

Mr. Schwada's formula gives reliable results and is convenient to use, particularly if placed in the form of a graphic chart.

Thickness of the Haunch.—After determining tentatively the thickness of the crown, the next step is to proportion the arch in the haunch. Victor H. Cochrane¹ from a study of comparative designs of arches of the linear arch form prepared the diagram of Fig. 38, which gives the relative thickness of the arch at any

¹ Proc. Eng. Soc. of W. Pa., vol. 32, p. 663.

proportional distance from the crown on the arch ring towards the springing line. The term u is the ratio of the thickness at any point in the haunch to the thickness at the crown, and v is the ratio of the distance along the arch ring to the point considered to the total length from the crown to the springing line. Type A2.0, etc., means an arch whose thickness at the springing is 2.0 times that at the crown.

The use of the values given by Fig. 38 will cause a slight excess of thickness in the haunch between the crown and the quarter point, which is employed to enhance the appearance of the arch, as it improves the gracefulness of outline over that which follows strictly the requirements of stresses. The flatter the arch, i.e., the less the rise ratio, the greater will be the portion having essentially the same thickness as the crown, and the thicker will be the arch at the springing.

In full centered arches of stone masonry, the arch ring has commonly been of uniform depth, although not infrequently with a ratio t_s/t_c of 1.25 to 2.0, and plain concrete arches have followed similar lines. In reinforced concrete arches, the ratio t_s/t_c varies from 1.5 for high-rise ratios to 2.5 for arches of low-rise ratio. Economy is served in long-span arches by keeping the crown thickness a minimum, the minimum limit being the thickness required to sustain the crown thrust and shear. On the other hand, moments from temperature and rib shortening are increased by any thickening at the springing.

For thrust only, assuming no moment and a constant unit compressive stress, the depth of the arch ring should increase toward the springing so that the vertical projection of the section would be constant, that is, $t \cos \theta = t_c$, where θ is the angle between the tangent at the point considered and the tangent at the crown. With the arch axis following the funicular polygon for the dead load only, the live load alone causes moment (except for changes in rib length). The areas under the influence lines measure the maximum moments due to a uniform load on the designated portions of the span, and these are found to be approximately four times as great at the springing as at the crown (Cf. pp. 191 and 194). If the resistance to moment varies with the cube of the depth, the depth at the springing should be approximately 1.6 that at the crown to care for the moment.

Obviously there is no rational method of determining the relative thickness at the haunch and at the crown, or at least, the

relationship is too complex for analysis. Many arches have been built with the thickness at springing more than three times that at the crown, this ratio amounting to 9.0 or more in some instances, but such proportions are scarcely justifiable. For arches carrying heavy live loads the ratio t_s/t_c should be larger than for arches carrying relatively light live loads. Additional thickness at the springing causes increased stresses due to temperature changes and to rib shortening.

The stresses in an arch are influenced to a greater degree by the form of the arch curve than by variations in depth of the arch ring. By a careful study of the form of the arch ring, it can be varied from the funicular polygon at certain points so as to cause the moments due to loads to counteract the moments due to rib shortening. In smaller arches, it is doubtful if the feasible accuracy in construction warrants this refinement, although on large structures it is a practical procedure.

Tests made under the direction of the Committee in Concrete and Reinforced Concrete Arches indicate that there is no danger of buckling of arch ribs where the slenderness ratio of unsupported length to width does not exceed 30.¹

Loads on a Masonry Arch.—The loads to which a masonry arch may be subjected vary widely because of the variety of uses to which this type of structure is put, e.g., in bridges, buildings, dams, monuments, foundations and other structures. The positions of the live load which produce maximum stresses at the crown and at the springing are shown in Fig. 39,² and the arch should be investigated for each of these conditions of loading at least. The positions of loads for maximum stress at any point are apparent from a study of the influence diagrams, Figs. 48–55. For example, a unit load placed within the middle quarter of the arch causes positive crown moment, while a unit load placed elsewhere causes negative crown moment; hence, when the middle quarter only is loaded, maximum crown moment occurs.

¹Proc. Am. Soc. C. E., March, 1929.

²Proc. Eng. Soc. of W. Pa., vol. 32, p. 683.

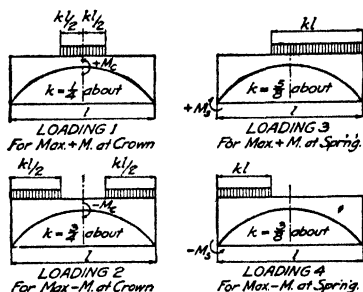

FIG. 39.—Position of live loads for maximum stresses.

For the loadings to which arch bridges may be subjected, see Chap. IX.

Stresses in Arch Rib.—The stresses in an arch rib, as previously indicated, consist of direct compression, flexure and shear, and result from four sources as follows:

1. *Loads, dead and live*, on the structure producing
 - (a) Thrust or direct compression
 - (b) Moment or flexure
 - (c) Shear
2. *Temperature change*, producing
 - (a) Compression or tension at the crown
 - (b) Flexure
3. *Shrinkage due to setting and hardening*, producing
 - (a) Tension at the crown
 - (b) Flexure
4. *Shortening of arch rib under thrust* caused by loads, producing
 - (a) Tension at the crown
 - (b) Flexure.

Each of these stresses must be investigated separately and the combination ascertained which produces the maximum total stress. Moment stresses are, in general, the most severe in an arch.

The stresses are statically indeterminate, but by making use of the elastic properties of the materials, the stresses become determinate. The resulting method of procedure is called the "Elastic Theory" of arches and is applicable to masonry arches constructed of materials capable of sustaining tensile stress, and to any masonry arch so long as the line of thrust is kept within the middle third of the section of the arch rib so that no net tensile stress actually exists at any section. A number of methods have been devised for applying the elastic theory, each having its merits. The method used in this chapter is believed to be most easily grasped by students. Tests on arches have shown that measured stresses agree closely with the elastic theory.

Stresses in Curved Beams.—A hingeless arch acts essentially as a curved beam fixed at both ends. Owing to the fact that the projected length is not the same as the curved length and that transverse loads produce direct compression, the principles involved are different from those pertaining to straight beams.

As previously stated, there are three conditions requisite for a fixed arch, as for a fixed beam, viz., (a) the inclination of the neutral surface at the abutments must remain unchanged, i.e.,

the total change in inclination between springing lines must equal zero; (b) the length of span must remain unchanged; and (c) the elevation at the springing line must remain constant. The method of procedure consists in investigating these three conditions.

In Fig. 40(a) let ds be an increment of length of the arch ring and $d\phi$ represent the angular change in the inclination of the section normal to the neutral surface in the length ds , due to stress. Then the stress at a distance z from the neutral surface is $S_z = E \cdot z \cdot d\phi/ds$. The total moment of these stresses over the entire section about the neutral axis is

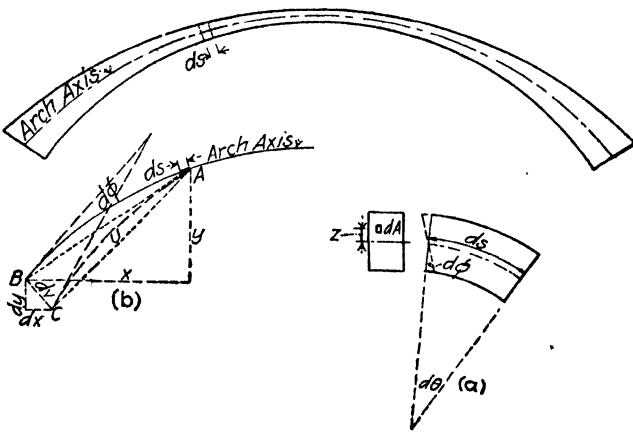

FIG. 40.—Elastic deformation of a curved beam.

$$M = \int S_z \cdot dA \cdot z = \int E \cdot z \cdot dA \cdot \frac{d\phi}{ds} \cdot z = E \cdot \frac{d\phi}{ds} \int z^2 \cdot dA = EI \cdot \frac{d\phi}{ds} \quad (1)$$

Let Fig. 40(b) represent a portion of a curved fixed beam or an arch, BA being the unstrained position and CA the strained position of this same portion due to the distortion of the differential segment ds , if the point B were free to move.

From (1), we have for the total increment of change in inclination

$$\Delta\phi = \int_A^B \frac{M \cdot ds}{EI} \quad (2)$$

In Fig. 40 (b), $dy/dv = x/u$, or $\frac{dy}{u \cdot d\phi} = \frac{x}{u}$

and $dx/dv = y/u$, or $\frac{dx}{u \cdot d\phi} = \frac{y}{u}$

whence $dy = x \cdot d\phi$, and $dx = -y \cdot d\phi$.

The total change in coordinates is¹

$$\Delta x = - \int_A^B y \cdot d\phi = - \int_A^B \frac{My \cdot ds}{EI} \quad (3)$$

$$\Delta y = \int_A^B x \cdot d\phi = \int_A^B \frac{Mx \cdot ds}{EI} \quad (4)$$

These equations are fundamental and form the basis of the elastic analysis of fixed arches; together with the equations of static equilibrium, they enable one to calculate the stresses at any point in the arch ring. Since by the principles stated above, the total change in the inclination of the section perpendicular to the neutral surface equals zero, and likewise the total change in the coordinates is zero, because the abutments are fixed, there results

$$\begin{aligned} \Delta\phi &= 0 \\ \Delta x &= 0 \\ \Delta y &= 0. \end{aligned} \quad (5)$$

If, by a method to be explained presently, the arch ring is divided into segments of varying lengths increasing towards the springing line so that ds/I is a constant quantity for each segment, or increment of s , it is obvious that

$$\frac{ds}{E_c I} \Sigma M = 0, \text{ or } \Sigma M = 0, \quad (6)$$

$$\frac{ds}{E_c I} \Sigma M \cdot y = 0, \text{ or } \Sigma M \cdot y = 0, \quad (7)$$

$$\frac{ds}{E_c I} \Sigma M \cdot x = 0, \text{ or } \Sigma M \cdot x = 0. \quad (8)$$

Stresses Due to Loads.²—The stresses produced by loads on an arch consist of compression, shear and moment. In Fig. 41, assume the loads applied to a symmetrical arch as shown. The arch ring is divided into an even number of segments of variable lengths such that ds/I is constant (by a method to be explained later), and the center of gravity of the loads on each segment indicated. Assuming the thrust, shear and moment at the crown replaced by external forces, one half of the arch may

¹ JOHNSON, BRYAN and TURNEAURE, "Modern Frame Structures," vol. 2, p. 114.

² For an excellent treatment of the elastic theory of the arch, the reader is referred to TURNEAURE and MAUER, "Principles of Reinforced Concrete Construction," from which the present article was largely taken.

be considered as removed and the remaining half may be considered as a cantilever under the forces applied as shown.

Let H_c , V_c and M_c represent the thrust, shear and moment respectively at the crown;

N , V and M , the thrust, shear and moment at any other section along the arch ring;

I for the section be equal to $I_c + nI_s$, I_c and I_s being the moments of inertia for the concrete and steel sections respectively;

x , y be the coordinates of any point considered;

n_s be the number of divisions or segments into which the half arch ring is divided.

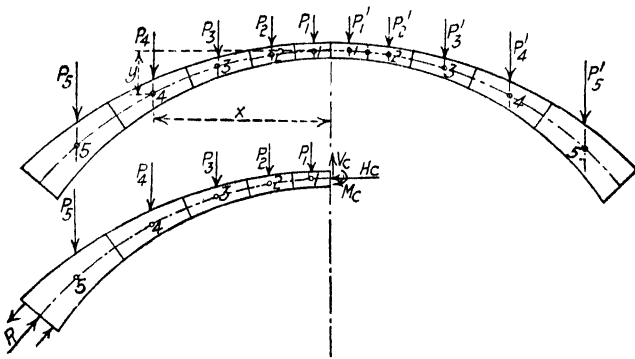

FIG. 41. Loads and forces on an elastic arch ring.

Using the subscript r and l to indicate quantities on the right or left, respectively, and m to represent the moment in the half arch acting as a cantilever, and taking summations across the entire arch, and referring to Eq. (5),

$$\sum M_l x - \sum M_r x = 0 \tag{1}$$

$$\sum M_l y + \sum M_r y = 0 \tag{2}$$

$$\sum M_l + \sum M_r = 0 \tag{3}$$

$$M_l = m_l + M_c + H_c y + V_c x, \text{ and} \tag{4}$$

$$M_r = m_r + M_c + H_c y - V_c x \tag{5}$$

In this discussion, moments which tend to cause compression in the upper fibers are considered positive and those which tend to cause compression in the lower fibers are considered negative.

Substituting values of M_l and M_r from (4) and (5) in (1), (2) and (3) and collecting terms,

$$\Sigma m_l x - \Sigma m_r x + 2V_c \Sigma x^2 = 0 \quad (6)$$

$$\Sigma m_l y + \Sigma m_r y + 2M_c \Sigma y + 2H_c \Sigma y^2 = 0 \quad (7)$$

$$\Sigma m_l + \Sigma m_r + 2\Sigma M_c + 2H_c \Sigma y = 0 \quad (8)$$

Eliminating M_c between (7) and (8), since $\Sigma M_c = n_s M_c$

$$M_c = -\frac{\Sigma m_l y + \Sigma m_r y + 2H_c \Sigma y^2}{2\Sigma y} = -\frac{\Sigma m y + 2H_c \Sigma y^2}{2\Sigma y} \quad (9)$$

$$M_c = -\frac{\Sigma m_l + \Sigma m_r + 2H_c \Sigma y}{2n_s} = -\frac{\Sigma m + 2H_c \Sigma y}{2n_s} \quad (10)$$

Equating and solving for H ,

$$H_c = \frac{n_s \Sigma (m_l + m_r) y - \Sigma (m_l + m_r) \Sigma y}{2[(\Sigma y)^2 - n_s \Sigma y^2]} = \frac{n_s \Sigma m y - \Sigma m \Sigma y}{2[(\Sigma y)^2 - n_s \Sigma y^2]} \quad (11)$$

From (6)

$$V_c = \frac{\Sigma (m_r - m_l) x}{2\Sigma x^2} \quad (12)$$

Equations (10), (11) and (12) are applicable to elastic arches of any form and from them the thrust, shear and moment at the crown can readily be calculated. With these quantities known for the crown section (or for any other section) the thrust, shear and moment for any other point become readily calculable by simple statics. The thrust at any point is the resultant of the crown thrust and the loads up to that point. The shear is given by the equation.

$$V = V_c + \Sigma P, \quad (13)$$

P being the intermediate loads.

The moment at any point on the left cantilever is given by the statical equation,

$$M = M_c + H_c \cdot y + V_c \cdot x + m_l \quad (14)$$

and for any point on the right cantilever by

$$M = M_c + H_c \cdot y - V_c \cdot x + m_r \quad (15)$$

Care must be exercised to give the proper sign to the moments of the loads on the cantilever. The summations above are for half of the arch ring.

Stresses Due to Temperature Changes.—The stresses resulting from temperature changes consist of tension or compression and moment. If an arch were entirely free to move concentrically, i.e., not restrained at the abutments, changes in temperature would not induce stress, but owing to the fact that the abutments are fixed, a change in the length of the arch ring has an effect similar to that which would result if the arch ring were kept constant in length and the abutments were moved horizontally, as indicated by the dotted lines in Fig. 42. Thus a drop in temperature, which would correspond to a pulling of the abutments apart, would cause positive moment in the arch ring and tension at the crown, and a rise in temperature, which would

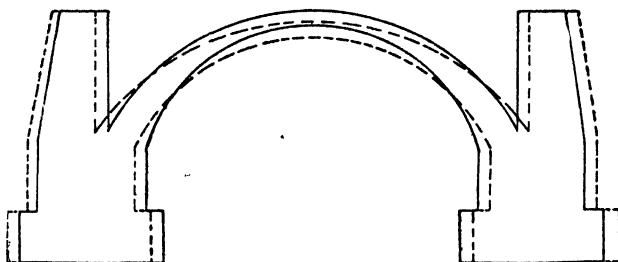

FIG. 42.—Effect of temperature drop on an elastic arch.

correspond to a pushing of the abutments together would cause negative moment and compression at the crown.

As the temperature increases, the crown of the arch rises and negative moment results with a thrust in the arch at the crown. The total expansion (change in span) that would occur if the arch were free to expand would be cTL , c being the coefficient of thermal expansion, T the temperature change in degrees, and L the span length. Hence, from (3) p. 162.

$$\Delta x = \Sigma M_t y \frac{ds}{E_c I} = cLT/2 \quad (1)$$

Since the total change in inclination of the normal to the neutral surface is zero,

$$\Delta \phi = \Sigma M_t \frac{ds}{E_c I} = 0, \text{ or } \Sigma M_t = 0 \text{ (} ds/E_c I \text{ being constant).} \quad (2)$$

Since there are no external loads,

$$M_t = M_c + H_c \cdot y \quad (3)$$

Substituting this value of M_l in (1)

$$M_c \Sigma y + H_c \Sigma y^2 = \frac{cTL \cdot E_c I}{2ds} \quad (4)$$

Substituting in (2), (remembering $\Sigma M_c = n_s M_c$)

$$M_c = -\frac{H_c \Sigma y}{n_s} \quad (5)$$

Substituting this value of M_c in (4)

$$-\frac{H_c (\Sigma y)^2}{n_s} + H_c \Sigma y^2 = cTL \frac{E_c I}{2ds} \quad (6)$$

Whence

$$H_c = \frac{cTL \cdot n_s}{2[n_s \Sigma y^2 - (\Sigma y)^2]} \cdot \frac{E_c I}{ds} \quad (7)$$

From equations (5) and (7), the moment and thrust at the crown can be readily calculated for any change in temperature, and with these determined, from (3) the moment at any point can be computed.

The modulus E_c must be expressed in pounds per square foot when L and y are in feet, or if the former is in terms of square inches, the latter must be reduced to inches.

Since there are no external loads applied, the compression on any section due to temperature change will be the component of the crown thrust (horizontal for symmetrical arches) perpendicular to that section.

It will be observed that since the crown thrust and the crown moment vary inversely as $[n_s \Sigma y^2 - (\Sigma y)^2]$, the stresses due to temperature will be decreased by an increase of the rise of the arch, and vice versa, other conditions remaining constant.

How great a range of temperature should be provided for in the calculation of temperature stresses as being effective in an arch is somewhat indefinite. Experiments made at Iowa State College on spandrel filled arches¹ indicate that the range of effective internal temperature in an arch ring is about 75 per cent of the mean seasonal atmospheric variation, amounting to about 80° for climates comparable with that of Iowa. For open spandrel arches, the range of temperature should be a somewhat higher percentage of the atmospheric variation. When concrete sets up, its temperature rises to about that of summer conditions, hence it is reasonable to suppose that concrete hardens at a rather

¹ Iowa State College, Eng. Exp. Sta., Bull. 30.

high temperature. Consequently any change in temperature should be considered chiefly as a *drop* instead of a variation consisting of half drop and half rise from a mean as is the custom. While the customary 40° F. variation each way from the temperature of no stress will suffice for ordinary conditions, it is probable that, for open spandrel arches particularly, a drop of 50° and a rise of 30° from the temperature of no stress would be better. This view is substantiated by the fact that cracks have appeared on the under side of arches designed for an equal range of temperature from a mean. A specification sometimes used for spandrel filled arches provides for a drop of 30° and a rise of 15° from the temperature of no stress.

That the thickness of the arch ring has some effect on the range of temperature appears from the results obtained at Iowa State College previously mentioned. The expression, $90^\circ - 0.53d$, is given as representing the range from the climatic conditions of Iowa, where d is the distance in inches from the exposed surface to the point considered.

Stresses Due to Shrinkage of Concrete.—Shrinkage of concrete due to setting produces tension at the crown and positive moment in the arch ring, just as would a fall in temperature. The stresses resulting from this shortening of the arch ring may be calculated in a manner similar to that given above for a drop in temperature. Substituting $C_s L$ for cTL in equation (7), p. 166,

$$H_c = -\frac{C_s L n_s E_c}{2[n_s \Sigma y^2 - (\Sigma y)^2]} \cdot \frac{I}{ds} \quad (1)$$

$$M_c = -\frac{H_c \Sigma y}{n_s} \quad (2)$$

$$M = M_c + H_c \cdot y \quad (3)$$

the summations being for half the arch ring.

The coefficient of linear shrinkage of plain concrete is about 0.0003 for 1:9 concrete and 0.0005 for 1:3 concrete.

The stresses in the steel and in the concrete produced locally by the shrinkage of the latter may be computed as for any reinforced concrete members as shown on p. 138.

The stresses incurred by seasonal temperature change and by shrinkage are doubtless relieved to a considerable extent by the "flow" of the concrete, although not enough is known about this property of concrete to justify taking it into consideration in the design of structures.

Stresses Due to Rib Shortening from Thrust.—When loads are placed on an arch, compression is set up in the arch ring causing a shortening of the latter. This shortening produces, as secondary stresses, tension at the crown and moment in the arch ring in the same manner as does a shortening of the rib due to shrinkage, or to a drop in temperature. The amount of these effects may be calculated in a manner similar to that of the preceding article, if the compressive stresses are known. The shortening of the span of the arch rib is $f'_c L/E_c$, where f'_c is the average stress in the concrete over the arch ring. Following the same procedure as above,

$$H_c = -\frac{f'_c L n_s}{2[n_s \Sigma y^2 - (\Sigma y)^2]} \cdot \frac{I}{ds} \quad (1)$$

$$M_c = -\frac{H_c \Sigma y}{n_s} \quad (2)$$

$$M = M_c + H_c \cdot y \quad (3)$$

The value of f'_c to be used above is uncertain as it varies over the length of the arch ring. A more reliable result might be obtained by calculating the actual shortening of the arch ring by summing up the shortening of the segments using the particular stress for each segment, but this is a refinement that is scarcely justified. Hence, the average stress is indicated in the above formula.

Deflection of the Crown.—The deflection of the crown caused by loads on the arch consists of three elements, namely, (a) that resulting from flexure, (b) that resulting from rib shortening under thrust, and (c) that due to shear. By substituting the general expression for moment, $M_c + H_c y + V_c x + m$, in Eq. (4) p. 162, the deflection from flexure may be obtained as $\frac{ds}{E_c I} (M_c \Sigma x + H_c \Sigma xy + V_c x^2 + \Sigma mx)$.

The crown movement from thrust is the vertical component of the rib shortening and is $\frac{1}{E_c} \sum_0^l f'_c ds \cdot \sin \varphi$, φ being the angle of the tangent at any point with the tangent at the crown and f'_c the stress in the concrete due to thrust. This would equal approximately $\frac{f'_a R}{E_c}$, f'_a being the average compressive stress due to thrust.

Likewise, the movement from shear is the vertical component of the radial shear movement and is $\frac{1}{E'_c} \sum_0^l f_r ds \cdot \cos \varphi$. This would equal approximately $\frac{L}{2} \frac{f'_v}{E'_c}$, f'_v being the average shear stress. E'_c , the shear modulus of elasticity, from mechanics equals $E_c \frac{m}{2(m+1)}$ where m is Poissons ratio, which is about 8 for 1:6 concrete molded at mushy consistency.

The total deflection caused by loads is, therefore, approximately

$$\Delta y = \frac{ds}{E_c I} (M_c \Sigma x + H_c \Sigma xy + V_c \Sigma x^2 + \Sigma mx) + \frac{f_a R}{E_c} + \frac{f_v}{E'_c} \cdot \frac{L}{2}$$

The movement of the crown resulting from temperature change consists of two elements, namely, (a) that which would occur in a member having a length equal to the rise of the arch, i.e., the vertical projection, and (b) that which results from a change in length of the arch keeping the abutments fixed. The former is obviously cTR and the latter may be determined by calculating the value of Δy from the equation $\Delta y = \int \frac{M x ds}{EI}$. By substituting the crown thrust and moment from Eqs. (5) and (7) p. 166 in Eq. (1) above, the crown movement attributable to the latter element (b) is

$$\frac{cTL}{2} \frac{(n_s \Sigma xy - \Sigma x \Sigma y)}{n_s \Sigma y^2 - (\Sigma y)^2}$$

and the total crown movement from temperature is

$$\Delta y = cTR + \frac{cTL}{2} \frac{(n_s \Sigma xy - \Sigma x \Sigma y)}{n_s \Sigma y^2 - (\Sigma y)^2}$$

Deflection of the crown resulting from shrinkage may be found in a similar manner.

$$\Delta y = C_s R + \frac{C_s L}{2} \frac{(n_s \Sigma xy - \Sigma x \Sigma y)}{n_s \Sigma y^2 - (\Sigma y)^2}$$

Effect of Abutment Movement on Arch Behavior.—The abutments and the piers of continuous arches may settle and rotate if placed on compressible soil owing to uneven soil pressures. With a knowledge of the properties of the soil, the amount of such movement can be estimated for a given condition of loading. See p. 489. The effect on stresses in the arch may

be calculated by a procedure similar to that for temperature. Three possible cases may arise: (1) when there is a horizontal movement of an abutment, (2) when there is a vertical settlement, and (3) when there is a rotation.

In case (1) let Δx be the horizontal movement of the left abutment of an arch with span L and rise R . Proceeding as for temperature change, making $\frac{ds}{E_c I} \Sigma My = \Delta x$, values of crown functions are derived

$$V_c = 0$$

$$H_c = \frac{n_s \Delta x}{2[n_s \Sigma y^2 - (\Sigma y)^2]} \cdot \frac{E_c I}{ds}$$

$$M_c = -\frac{\Delta x \cdot \Sigma y}{2[n_s \Sigma y^2 - (\Sigma y)^2]} \cdot \frac{E_c I}{ds}$$

In case (2), let Δy be the vertical settlement of the left abutment. Then $\frac{ds}{E_c I} \Sigma Mx = \Delta y$, $\frac{ds}{E_c I} \Sigma My = 0$, and $\frac{ds}{E_c I} \Sigma M = 0$.

Whence $H_c = 0$, $M_c = 0$, and $V_c = \frac{\Delta y}{\Sigma x^2} \cdot \frac{E_c I}{2ds}$

In case (3), let $\Delta\phi$ be the angle of rotation of the left abutment, assumed in a clockwise direction. The total movement of the crown of the left half arch will be $\frac{\Delta\phi L}{2}$ in the vertical direction (downward) and $R\Delta\phi$ in the horizontal direction (to the right).

Eqs. (6), (7) and (8) p. 162 become $\frac{ds}{E_c I} \Sigma Mx = \frac{L}{2} \Delta\phi$,

$\frac{ds}{E_c I} \Sigma My = R\Delta\phi$, and $\frac{ds}{E_c I} \Sigma M = \Delta\phi$. Substituting the values of M_l and M_r as before, m_l and m_r being zero,

$$2V_c \Sigma x^2 = \frac{L\Delta\phi}{2} \cdot \frac{EI}{ds} \tag{6}$$

$$2M_c \Sigma y + 2H_c \Sigma y^2 = R\Delta\phi \frac{EI}{ds} \tag{7}$$

$$2M_c + 2H_c \Sigma y = \Delta\phi \frac{EI}{ds} \tag{8}$$

Whence,

$$V_c = \frac{L\Delta\phi}{2\Sigma x^2} \cdot \frac{EI}{2ds}$$

$$H_c = \frac{[n_s R - \Sigma y]}{[n_s \Sigma y^2 - (\Sigma y)^2]} \cdot \frac{\Delta\phi EI}{2ds}$$

$$M_c = \frac{[\Sigma y^2 - R\Sigma y]}{n_s \Sigma y^2 - (\Sigma y)^2} \cdot \frac{\Delta\phi EI}{2ds}$$

In the event of all three movements occurring simultaneously, the above values of the crown stresses should be added.

Determination of Maximum Stresses.—The maximum stresses that may occur in an arch result from the combination of all of the above factors, i.e., loads, temperature and rib shortening, for they act independently and may act simultaneously. These factors can all be reduced to two actions, however, the moment M and the normal thrust at any section N ; and the maximum stress might be obtained by the well known equation

$$f_c = N/A + Mc/I$$

if the values of N and M were computed for each section.

The position of the live load should be chosen so as to give the maximum stresses that may be expected to be produced at any point under consideration. In the vast majority of cases, the crown and the springing line will be the critical sections, i.e., the stresses at these sections will be the maximum. Figure 39 shows the position of live load to produce maximum moments at the crown and at the springing. In open spandrel arches, it is sometimes better to determine the positions of live load for maximum moment, the most convenient method of doing this being by means of influence lines.

While the computations might be made as indicated above, the process is greatly facilitated by means of the graphic force diagram for the arch. The equilibrium polygon should be begun at the crown, the position of the crown thrust being obtained by solving for the moment arm of the force producing the moment. That is, the thrust will be M_c/H_c above the center of the crown if M_c is positive and below the center if negative.

These methods will be illustrated presently by an example.

Steel Reinforcement in an Arch.—The amount of reinforcing steel placed in arch rings is largely arbitrary, the function of the steel being to reduce the stresses in the concrete and to provide tensile strength in the event that tension should occur at any section. Since the reinforcement is usually placed symmetrically at the top and bottom of the section, the amount of reinforcement may vary through a considerable range without any appreciable effect on the elastic behavior of the arch, because the position of the neutral axis is not materially shifted. No economy results from the use of a large amount of reinforcement.

It is common practice to use an amount of steel equal to about 1 per cent of the area of the arch section at the crown, and this amount is retained throughout the length of the arch rib. The shear stresses are probably never so large as to make web reinforcement necessary.

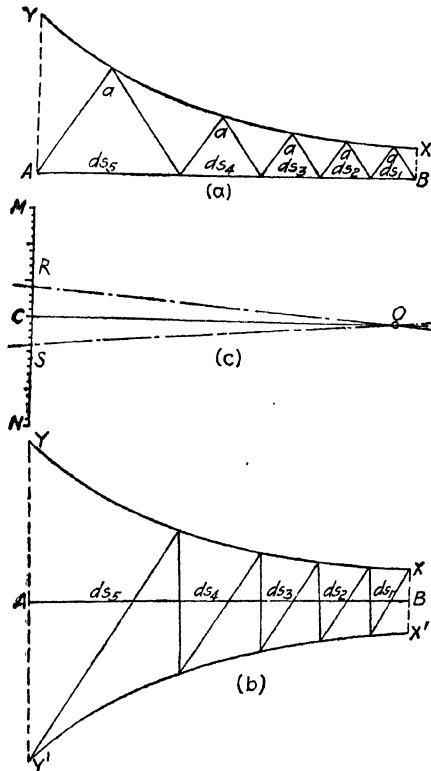

FIG. 43.—Dividing an arch ring by graphical methods to make $\frac{ds}{I}$ constant.

Dividing the Arch Ring to Make $\frac{ds}{I}$ Constant.—In the preceding discussion, ds was at first considered as an infinitesimal increment but for practical uses it must be taken as a finite increment. As has been seen, the use of the preceding formulas is predicated on, or at least facilitated by, choosing the length of ds so as to make $\frac{ds}{I}$ a constant quantity, although this procedure is not necessary.¹ Inasmuch as the thickness of the arch ring

¹ For the procedure where $\frac{ds}{I}$ is not made constant, see J. A. L. WADDELL, "Bridge Engineering," p. 865.

usually increases toward the springing and the I for the section increases as the cube of the depth, it is necessary to increase the length of the sections near the springing to a considerable extent.

The most convenient method of doing this is by the graphical process illustrated in Fig. 43. The half arch length is developed, that is, it is measured by dividers or otherwise and laid off as a straight line AB . At a number of points along the arch, the depths are measured and the I 's computed for these sections. These values of I are laid off at right angles to AB and the I -curve, XY , drawn as shown. Beginning at the large end, n_s triangles are drawn with equal angles a , in such a manner that the last side of the last triangle comes even at the end of the axis, B . The divisions of the axis AB are then such that ds/I , where I is for a section at approximately the middle of the segment, is constant.

A convenient mode of doing this is to erect a scale MN as shown in (c) and fix a point O at a convenient distance from the center C . By laying a straight edge in successive positions OR and OS , alternating equal distances above and below C , these equal angles can readily be constructed by means of a triangle placed above the straight edge, reversing the triangle when the straight edge is below C . The correct angle a can be found in this manner by trial.

Another method is shown in (b), where the I -curve is laid off both above and below the developed axis, in which case all diagonal lines are drawn at the same inclination.

In a reinforced concrete arch ring, the divisions should be such that ds/I should be constant, where I is the moment of inertia of the transformed section, or equal to $I_c + n \cdot I_s$, and this quantity should be used in plotting the diagram for finding the arch divisions.

Unsymmetrical Arches.—In a series of arches, the end spans may be unsymmetrical owing to the juncture of one end with a pier and the other with the abutment. Unless the arch is decidedly unsymmetrical, the analysis given in the preceding pages will suffice, but where the springing of one end is considerably lower than at the other, or the dissymmetry is otherwise marked, the summations should be made for the entire arch instead of for half of it as before, the entire arch ring being divided into segments so that ds/I is constant. This situation may arise where the piers in the stream bed are made high in order to provide the necessary waterway.

Explicit formulas for determining H_c , V_c and M_c are impracticable, recourse being had to implicit functions in which the coefficients of these terms can be evaluated by tabulation of known quantities, and then these equations solved simultaneously. Taking the origin of coordinates at the section corresponding to the crown, i.e., at the section between the two middle segments, the following equations can be derived:

From Eqs. (1), (2), (3), (4) and (5), p. 162, using the subscripts l and r to indicate quantities on the left and right respectively, the following equations are derived for stresses at the crown due to loads:

$$(\Sigma_{lx} - \Sigma_{rx})M_c + (\Sigma_{lxy} - \Sigma_{rxy})H_c + \Sigma x^2 V_c = \Sigma mx - \Sigma_l mx \quad (1)$$

$$\Sigma y M_c + \Sigma y^2 H_c + (\Sigma_{lxy} - \Sigma_{rxy})V_c = -\Sigma my \quad (2)$$

$$2n_s M_c + H_c \Sigma y + (\Sigma_{lx} - \Sigma_{rx})V_c = -\Sigma m \quad (3)$$

Unless otherwise indicated, the summations are for the entire arch ring.

The corresponding relations for stresses at the crown due to temperature changes are given by the following equations:

$$(\Sigma_{lx} - \Sigma_{rx})M_c + (\Sigma_{lxy} - \Sigma_{rxy})H_c + V_c \Sigma x^2 = 0 \quad (4)$$

$$(\Sigma_{ly} + \Sigma_{ry})M_c + H_c \Sigma y^2 + (\Sigma_{lxy} - \Sigma_{rxy})V_c = \frac{E_c I}{ds} \cdot cTL \quad (5)$$

$$2n_s M_c + H_c \Sigma y + (\Sigma_{lx} - \Sigma_{rx})V_c = 0 \quad (6)$$

Corresponding equations could be written for crown stresses due to shortening of the arch from shrinkage by using $C_s L$ instead of cTL in the fifth equation, and equations for stresses resulting from shortening of the arch rib due to thrust might be written in a corresponding manner.

Elastic Center Method.—As previously stated, there are various methods in use in utilizing the elastic theory of an arch to accomplish the determination of the stresses. Most of these are aimed at reducing the labor of the calculations in solving the equations. Owing to the lack of precision arising from using the long segment adjacent to the abutment, many engineers prefer to divide the arch rib into segments of equal length or segments whose horizontal projections are equal. The computations may be simplified by choosing the origin of coordinates at the elastic center, i.e., at the center of gravity of the elastic units $\frac{ds}{I}$ (frequently called elastic weights).

For a symmetrical arch, the position of the elastic center with reference to the left spring as the origin is

$$\bar{x} = \frac{L}{2}, \bar{y} = \frac{\sum_0^L \frac{ds}{I} y}{\sum_0^L \frac{ds}{I}}$$

and the equations for moment, thrust, and shear can be obtained, referred to the elastic center, by substituting $y + \bar{y}$ for y , and $x + \bar{x}$ for x .

Obviously, when the origin is taken at this point, all quantities in the equations involving $\int \frac{ds}{EI} x$, $\int \frac{ds}{EI} y$, and $\int \frac{ds}{EI} xy$ will become zero, thus simplifying the procedure. With the shifting of the coordinates, the reactions are assumed to act on a bracket

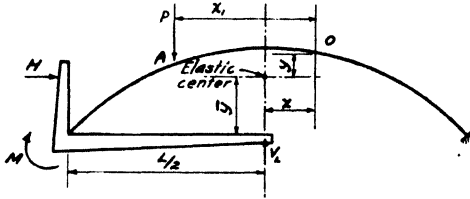

FIG. 44.—Elastic center as origin.

attached rigidly to the left end, as shown in Fig. 44,¹ so that they act through the new origin, or the "elastic center." Such an arrangement changes the value of the moment at the left end.

Let M'_L be this new value. Then $M'_L = M_L - H\bar{y} + V_L \cdot \frac{L}{2}$.

The equation for moment at any section due to reactions is $M = M' + V_L x - Hy$. The Δx due to thrust is $H \int \frac{\cos \varphi dx}{EA}$, A being the cross-section at any point, and φ the angle between the tangent and the horizontal.

Substituting in Eqs. 6, 7 and 8, p. 162, assuming abutments rigid and not considering moment due to rib shortening:

$$\Delta x = \int_L^R (M'y + V_L xy - Hy^2) \frac{ds}{EI} - P \int_A^R x'y \frac{ds}{EI} - H \int_L^R \frac{\cos \varphi dx}{EA} = 0$$

¹ See paper by C. S. WHITNEY, *Trans. Am. Soc. C. E.*, vol. 88, p. 931, for a more complete exposition of this method.

$$\Delta y = \int_L^R (M'x + V_L x^2 - Hxy) \frac{ds}{EI} - P \int_A^R x'x \frac{ds}{EI} = 0$$

$$\Delta \varphi = \int_L^R (M' + V_L x - Hy) \frac{ds}{EI} - P \int_A^R x' \frac{ds}{EI} = 0$$

Whence, since

$$\int_L^R x \frac{ds}{EI} = 0, \int_L^R y \frac{ds}{EI} = 0, \text{ and } \int_L^R xy \frac{ds}{EI} = 0$$

$$H = - \frac{P \int_A^R x'y \frac{ds}{EI}}{\int_L^R y^2 \frac{ds}{EI} + \int_L^R \frac{\cos \varphi dx}{EA}}$$

$$V_L = \frac{P \int_A^R x'x \frac{ds}{EI}}{\int_L^R x^2 \frac{ds}{EI}}$$

$$M_{L'} = \frac{P \int_A^R x' \frac{ds}{EI}}{\int_L^R \frac{ds}{EI}}$$

The effect of rib shortening produces a moment and crown tension the same as if the abutments were separated a distance Δx , which may be found as follows:

The stress due to thrust is $\frac{T}{A}$; $\Delta ds = -\frac{T ds}{EA}$ and $\Delta dx = -\frac{T ds}{EA} \cos \varphi$, φ being the angle between the tangent and the horizontal. Whence, the total horizontal displacement of the arch due to rib shortening is $-\int_L^R \frac{T ds}{EA} \cos \varphi$.

Since

$$ds \cos \varphi = dx, \text{ and } T = H \cos \varphi, \Delta x = - \int_L^R \frac{RH \cos \varphi}{EA} dx$$

Therefore,

$$\Delta x = \int_L^R My \frac{ds}{EI} + \int_L^R \frac{RH \cos \varphi}{EA} dx$$

Substituting the value of M as before

$$\int_L^R (M'y + V_L xy - H_s y^2) \frac{ds}{EI} + \int_L^R \frac{RH_s \cos \varphi}{EA} dx = - \int_L^R \frac{H \cos \varphi dx}{EA}$$

H_s being the crown tension due to shortening, and H being the crown thrust due to loads. Whence, for rib shortening

$$H_s = - \frac{H_c \int_L^R \frac{\cos \varphi dx}{EA}}{\int_L^R y^2 \frac{ds}{EI} + \int_L^R \frac{\cos \varphi dx}{EA}}$$

For temperature changes a similar procedure gives

$$H_t = \frac{cTL}{\int_L^R y^2 \frac{ds}{EI} + \int_L^R \frac{\cos \varphi dx}{EA}}$$

Effect of Superstructure on the Behavior of the Arch.—

The design of arches has usually been based on the assumption that the arch ring carries all of the load transmitted to it by the spandrel walls, piers, or fill, although much uncertainty exists as to the soundness of this assumption.

Where spandrel retaining walls for earth fill are built monolithic with the arch, as is the custom, it seems inevitable that such walls should affect the elastic behavior of the arch rib by stiffening the haunches to a considerable extent. To what extent the resistance to raising of an earth fill would increase the load on an arch during a rise in temperature is conjectural.

Some studies have been made on the effect of deck and spandrel piers on the behavior of an arch which indicate that this effect may be considerable.¹ The Committee on Concrete and Reinforced Concrete Arches of the Am. Soc. C. E. found that the superstructure of an open spandrel arch in general reduces the deformation of the arch rib, the amount of the deformation depending upon the degree of continuity of the floor system and the character of the spandrel piers. Expansion and contraction of the deck slab under some conditions transmit through spandrel piers a local moment of considerable although not serious magnitude to the arch ring. Professor W. M. Wilson² found in the high arch at Danville, Ill., stresses as high as 38 lb. per square inch due to rotation of spandrel piers. To prevent this condition, care should be exercised in the design of expansion joints in the deck. Where the middle section of the deck constitutes a saddle monolithic with the arch rib, expansion joints immediately

¹ *Univ. of Illinois, Eng. Exp. Sta., Bull. 174.*

² *Univ. of Illinois, Eng. Exp. Sta., Bull. 174, p. 55.*

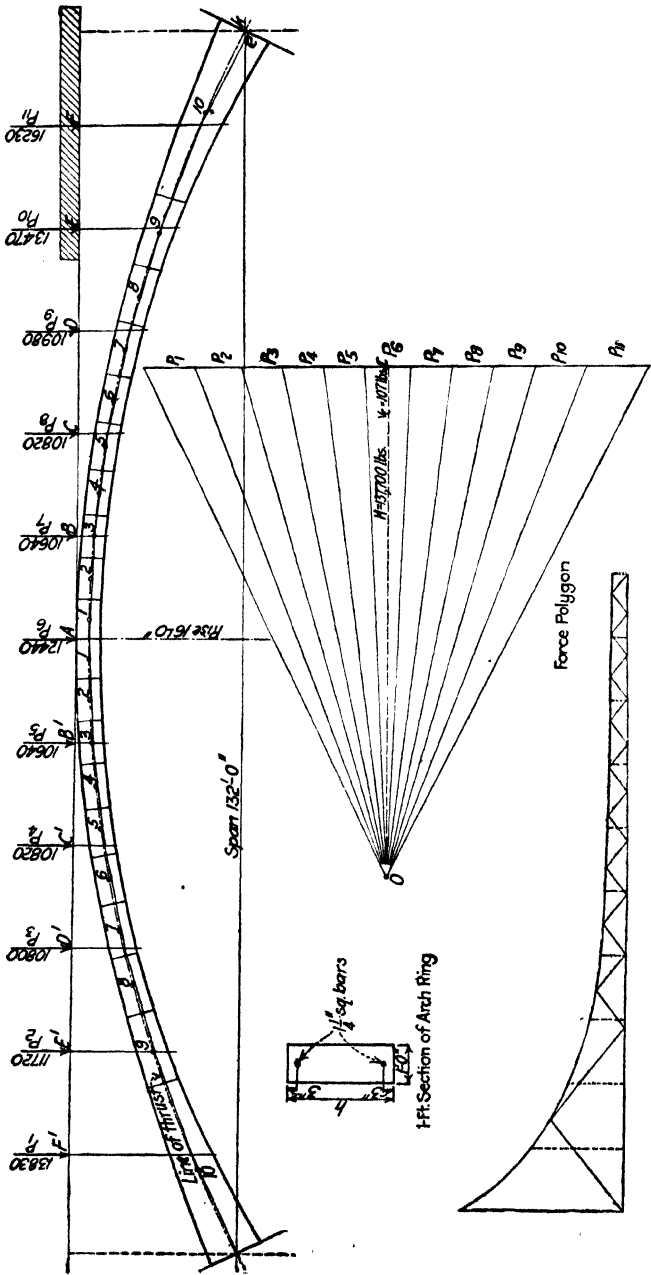

FIG. 45.—Stress analysis of a masonry arch.

adjacent to the saddle seem to be disadvantageous,¹ in that they are not only ineffective but, owing to crown movement, make a rougher roadway. Unless the expansion joints are effective, the arch rib, deck, and spandrel piers act to an extent as an open web truss with the deck as the upper chord taking much of the compression, and the arch as a curved lower chord tending to take the tension. Of course, such action is limited to the ability of the spandrel piers to transmit shear by flexure to the deck and to the arch.

Problem 1. Algebraic and Graphical Analysis of Stresses in a Fixed Masonry Arch.—The arch ring shown in Fig. 45 represents a section 1 ft. long of an arch barrel loaded so that this 1 ft. section is subjected to the loads shown. The arch has a span of 132 ft. and a rise of 16 ft. The thickness at the crown is 2 ft. 6 in. and at the springing, 5 ft. 7½ in. The arch is reinforced with 1¼ in. square steel rods 12 in. on centers. Take *n* as 15. The loads are carried on spandrel piers spaced (as shown) 11 ft. 1½ in. apart, the live load being added to the dead loads on the piers. The loads here shown are vertical, but the procedure would not differ radically if the loads were inclined.

The arch ring is first divided so that *ds/I* is constant by the method previously explained. Inasmuch as this is a reinforced arch, the transformed section must be used in calculating *I*, by means of the equation, $I_t = I_c + nI_s$.

The data for plotting the curve of *I_t* are given in Table XI.

TABLE XI.—CALCULATION OF *I_t*

Point	<i>d</i>	$\frac{d^3}{12}$	$0.325\left(\frac{d}{2} - \frac{1}{4}\right)^2$	$I_t = \frac{d^3}{12} + 0.325\left(\frac{d}{2} - \frac{1}{4}\right)^2$
Crown	2.50	1.302	0.325	1.627
1	2.55	1.382	0.341	1.723
2	2.58	1.438	0.352	1.790
3	2.65	1.550	0.372	1.922
4	2.71	1.658	0.393	2.051
5	2.85	1.929	0.450	2.379
6	2.97	2.183	0.492	2.695
7	3.31	3.022	0.646	3.668
8	3.89	4.905	0.928	5.833
9	4.62	8.218	1.278	9.496
10	5.62	14.796	2.130	16.926

¹*Loc. cit.*, p. 65.

The data for the calculation of the thrust, shear and moment at the crown are given in Table XII.

To illustrate the method of computation of the cantilever moments, m , the moment at Point 4 is $-6220 \times 15.90 - 10,640 \times 4.78 = -149,850$ lb-ft.

TABLE XII.—CALCULATION OF H_c , V_c AND M_c

Point	x	y	x^2	y^2	m_l	m_r	$(m_l + m_r)y$	$(m_r - m_l)x$
1	2.15	0.1	4.6	0.01	- 13,380	- 13,380	- 2,680	0
2	6.65	0.2	44.2	0.04	- 41,400	- 41,400	- 16,560	0
3	11.20	0.5	125.4	0.25	- 69,700	- 69,700	- 69,700	0
4	15.90	1.0	252.8	1.00	- 149,800	- 149,800	- 299,600	0
5	20.90	1.7	436.8	2.90	- 234,100	- 234,100	- 797,000	0
6	25.90	2.5	670.8	6.25	- 358,100	- 358,100	- 1,790,500	0
7	31.40	3.7	985.9	13.70	- 510,500	- 510,500	- 3,777,700	0
8	37.30	5.2	1391.3	27.00	- 715,600	- 716,800	- 7,448,500	- 44,760
9	44.30	7.2	1,962.5	51.80	- 985,300	- 988,000	-14,207,800	- 119,610
10	57.10	12.0	3,260.4	144.00	-1,645,040	-1,676,300	-39,856,100	-1,784,950
Σ	34.1	9.134.7	246.95		-4,722,920	-4,758,080	-68,266,140	-1,950,520

$$\Sigma m = \Sigma m_l + \Sigma m_r = -9,481,000$$

$$H_c = \frac{10 \times (-68,266,140) + 9,481,000 \times 34.1}{2[1,165 - 10 \times 246.9]} = 137,700 \text{ lbs.}$$

$$V_c = \frac{-1,950,500}{2 \times 9,134.7} = -107 \text{ lbs.}$$

$$M_c = -\frac{-9,481,000 + 2 \times 137,700 \times 34.1}{2 \times 10} = 4,500 \text{ lb.-ft.}$$

Substituting in equations (10), (11), and (12), p. 164, H_c , V_c and M_c are obtained as shown.

To calculate the moment at any other point, the general equation, $M = M_c + H_c y \pm V_c x + m$, is used. For example, the moment at the right springing is found as follows:

$$M_s = +4,500 + 137,700 \times 16 + 107 \times 66 - 6,220 \times 66 - 10,640 \times 54.88 - 10,820 \times 43.76 - 10,980 \times 32.64 - 13,470 \times 21.52 - 16,230 \times 10.40 = -72,400 \text{ lb.-ft.}$$

The thrust at the springing line is calculated by the composition of the crown thrust with the loads on the right half of the arch. Thus, $\sqrt{68,250^2 + 137,700^2} = 154,000$ lbs., and this thrust makes an angle of $\tan^{-1} \frac{137,700}{68,250} = 63^\circ 37'$ with the vertical.

The graphical method of calculating the thrust and moment at any point is simple and somewhat more rapid. It is done by constructing the ordinary force and funicular polygons as shown in Fig. 45. The load line is laid off in the usual manner and the position of the crown, C , indicated. Where there is a load at the crown, half of it is considered borne by each half of the arch. The shear, V_c , is laid off from C , downward if negative and upward if positive. The pole distance is then laid off perpendicularly equal to the crown thrust, H_c , and the rays of the force polygon drawn in the usual manner, and these give the thrusts at the various sections. The eccentricity of the thrust can be scaled between the axis of the arch and the string of the funicular polygon, and this eccentricity multiplied by the thrust at that point gives the moment. Thus in Fig. 45, the eccentricity at the right springing, ek , scaled -0.47 ft., and the thrust is 154,000 lbs., which multiplied together give a moment of $-72,100$ lb.-ft.

After the thrust and moment are calculated at any point, the unit stresses can be computed by the ordinary principles of mechanics. Thus at the right springing, the component of the thrust normal to the skewback is 153,700 lbs., and the stress at the right springing is

$$f_c = N/A + Mu/I_t = \frac{153,700}{857} + \frac{868,800 \times 33.75}{343,400}$$

$$= 264 \text{ lb. per square inch.}$$

$$f_s = n \left(\frac{N}{A} + \frac{Md'}{I_t} \right) = 15 \left(\frac{153,700}{857} + \frac{868,800 \times 30.75}{343,400} \right)$$

$$= 3,860 \text{ lb. per square inch.}$$

Stresses Due to Temperature Change.—The stresses due to a change in temperature may be found as follows, assuming a drop of 40° F.

$$H_c = \frac{EI}{ds} \cdot \frac{cTLn_s}{2[n_s \Sigma y^2 - (\Sigma y)^2]} \left(\frac{I}{ds} = 0.382 \right)$$

$$= -288,000,000 \times 0.382 \times \frac{0.000006 \times 40 \times 132 \times 10}{2[10 \times 246.9 - (34.1)^2]}$$

$$= -13,300 \text{ lbs.}$$

$$M_c = -\frac{H_c \Sigma y}{n_s} = -\frac{-13,300 \times 34.1}{10} = +45,300 \text{ lb.-ft.}$$

The moment at any other point is found by $M_1 = M_c + H_c y$. Thus, the moment at the springing is $+45,300 - 13,300 \times 16 = -167,500$ lb.-ft.

The stress due to temperature would be calculated in a manner similar to that used for calculating stresses due to loads.

For ascertaining the positive moment at the springing, a rise of temperature should be considered.

Stresses Due to Shrinkage of Concrete.—The stresses due to shrinkage of the concrete are obtained by using Eq. (1), p. 167. Assume a coefficient of shrinkage of reinforced concrete with about 1.0 per cent reinforcement equal to 0.0003.

$$\begin{aligned}
 H_c &= \frac{EI}{ds} \cdot \frac{C_s Ln_s}{2[n_s \Sigma y^2 - (\Sigma y)^2]} \\
 &= -288,000,000 \times 0.382 \times \frac{0.0003 \times 132 \times 10}{2[10 \times 246.9 - (34.1)^2]} \\
 &= -16,700 \text{ lbs.} \\
 M_c &= -\frac{H_c \Sigma y}{n} = -\frac{-16,700 \times 34.1}{10} = +57,000 \text{ lb.-ft.}
 \end{aligned}$$

The moment at any point is $M = M_c + H_c y$.

The moment at the springing is

$$M_s = +57,000 - 16,700 \times 16 = -210,000 \text{ lb.-ft.}$$

The stresses are calculated as before.

The stress due to shrinkage is very uncertain because much of the shrinkage is accommodated without affecting the arch where the arch is erected in segments, hence, some engineers neglect it entirely.

The coefficient of shrinkage of concrete with about 1.0 per cent reinforcement is about 0.0003, although for plain concrete it is about 0.0005.

Stress Due to Rib Shortening Under Thrust.—Each section of the arch is subjected to a compressive stress, hence it will be shortened and a crown tension and moment will result as previously explained. The amount of this shortening depends on the *average* unit stress in the arch ring. Assume this average unit stress as 250 lbs. per square inch (36,000 lb. per square foot), and substitute in Eq. (1), p. 168.

$$\begin{aligned}
 H_c &= -\frac{I}{ds} \cdot \frac{f' L n_s}{2[n_s \Sigma y^2 - (\Sigma y)^2]} \\
 &= -0.382 \cdot \frac{36,000 \times 132 \times 10}{2,610} = -6,960 \text{ lb.} \\
 M_c &= -\frac{-6,960 \times 34.1}{10} = +23,750 \text{ lb.-ft.}
 \end{aligned}$$

The moment at any point is $M_c + H_c y$. Thus the moment at the springing is

$$M_s = + 23,750 - 6,960 \times 16 = - 87,610 \text{ lb.-ft.}$$

Problem 2. Graphical Method of Analysis by Influence Lines.

The above problem will now be solved by the use of influence lines, a method which has much to commend it where a variety of loadings is to be considered.

An influence line or diagram represents the variation of moment, shear, stress, or some other function at any particular point due to the placing of loads of unity at other points. For an exposition of the properties of influence lines, the reader is referred to various works on structural engineering, but their application to arches may be readily understood from the following illustration.

The arch is laid out, and values of H_c , V_c and M_c are calculated for a load of unity placed at the successive load points as in the preceding problem. The quantities required for these calculations are shown in Table XIII. These computations are made by substituting in Equations (10), (11) and (12), p. 151, as in the previous example.

For a load at A , to illustrate,

$$H_c = \frac{10(-1,437) - (-252.8) \times 34.1}{2[(34.1)^2 - 10 \times 246.9]} = 2.21 \text{ lbs.}$$

$$V_c = \frac{-9,134.7}{2 \times 9,134.7} = -0.50$$

$$M_c = -\frac{-252.8 + 2 \times 2.21 \times 34.1}{2 \times 10} = +5.10 \text{ lb.-ft.}$$

$$\text{The eccentricity at the crown} = \frac{+5.10}{2.21} = +2.30 \text{ ft.}$$

In a similar manner, H_c , V_c , M_c and e are calculated and tabulated below.

Unit load at	H_c	V_c	M_c	e
<i>A</i>	2.21	-0.50	+5.10	+2.30
<i>B</i>	2.02	-0.35	+0.87	+0.43
<i>C</i>	1.57	-0.21	-1.10	-0.70
<i>D</i>	0.96	-0.11	-1.34	-1.40
<i>E</i>	0.42	-0.04	-0.80	-1.90
<i>F</i>	0.05	-0.0049	-0.096	-1.94

184 DESIGN OF MASONRY STRUCTURES AND FOUNDATIONS

TABLE XIII.—CALCULATION OF H_c , V_c AND M_c FOR UNIT LOADS AT VARIOUS POINTS

Point	x	y	x^2	y^2	Load at A; $x_1 = 0$		
					m_r	$m_r \cdot y$	$m_r \cdot x$
1	2.15	0.1	4.6	0.01	- 2.2	- 0.2	- 4.6
2	6.65	0.2	44.2	0.04	6.6	1.3	44.2
3	11.20	0.5	125.4	0.25	11.2	5.6	125.4
4	15.90	1.0	252.8	1.00	15.9	15.5	252.8
5	20.90	1.7	436.8	2.90	20.9	35.6	436.8
6	25.90	2.5	670.8	6.25	25.4	64.8	670.8
7	31.40	3.7	985.9	13.70	31.4	116.2	985.9
8	37.30	5.2	1,391.3	27.00	37.3	193.8	1,391.3
9	44.30	7.2	1,962.5	51.80	44.3	318.8	1,962.5
10	57.10	12.0	3,260.4	144.00	57.1	685.2	3,260.4
Σ	34.1	9,134.7	246.95	-252.8	-1,437.0	-9,134.7

Point	Load at B; $x_1 = 11.12$			Load at C; $x_1 = 22.24$		
	m_r	$m_r \cdot y$	$m_r \cdot x$	m_r	$m_r \cdot y$	$m_r \cdot x$
4	- 4.8	- 4.8	- 76.3			
5	9.8	16.6	204.7			
6	14.8	37.0	383.0	- 3.7	- 9.2	- 95.0
7	20.3	75.1	637.0	9.2	33.9	288.0
8	26.2	136.2	977.0	15.1	78.1	560.0
9	33.2	240.0	1,470.0	22.1	159.0	980.0
10	46.0	552.0	2,630.0	39.4	419.0	1,990.0
Σ	-155.1	-1,061.7	-6,378.0	-84.9	-699.2	-3,913.9

	Load at D; $x_1 = 33.36$			Load at E; $x_1 = 44.48$		
	m_r	$m_r \cdot y$	$m_r \cdot x$	m_r	$m_r \cdot y$	$m_r \cdot x$
8	- 3.9	- 20.3	- 145.0			
9	10.9	78.5	483.0			
10	23.7	284.0	1,353.0	-12.6	-152.0	-721.0
Σ	-38.5	-382.8	-1,981.0	-12.6	-152.0	-721.0

	Load at F; $x_1 = 55.60$		
	m_r	$m_r \cdot y$	$m_r \cdot x$
10	-1.5	-18.0	-85.6

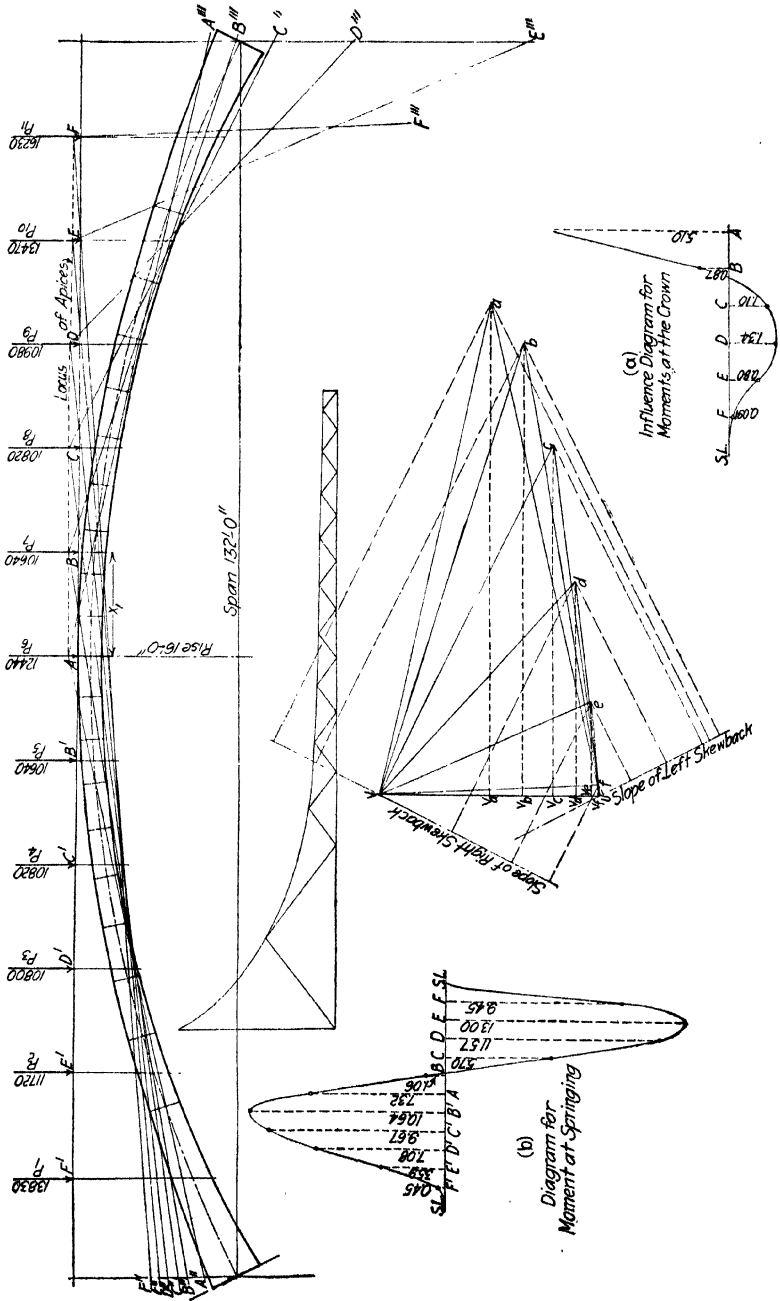

After the crown thrusts, shears, moments, and the eccentricities of the thrusts have been computed, the force polygons are constructed on a unit load line as shown, Fig. 46. The various shears are laid off from the bottom, the pole distances laid off equal to H_c for each case, and the rays of the force polygon drawn. The eccentricities are measured up (or down where negative) from the middle of the crown and the two thrust lines of the equilibrium polygon drawn parallel to the corresponding rays of the force polygon.

To find the thrust and moment at the right springing for the loading shown, calculate these functions for unit loads in these positions and then multiply these functions for unit loads by the actual loads and the total sum is the function desired for the given loading. The thrust normal to the section is obtained by resolving the resulting thrust into the normal and parallel components, the latter representing the shear at the point. The manner of performing the operation is indicated in Table XIV.

TABLE XIV.—MOMENTS AND THRUSTS AT THE RIGHT SPRINGING

Point	Ecc. dist. e	For unit loads			For loads given			
		Thrust	Normal component	Moment	Loads	Thrust	+moments	-moments
<i>A</i>	+ 3.25	2.25	2.20	+ 7.32	12,440	27,300	91,000	
<i>B</i>	+ 0.50	2.12	2.10	+ 1.06	10,640	22,600	11,300	
<i>C</i>	- 3.25	1.75	1.75	- 5.70	10,820	18,800	61,700
<i>D</i>	- 8.90	1.30	1.25	-11.57	10,980	13,700	127,100
<i>E</i>	-12.40	1.05	0.79	-13.00	13,470	10,700	175,000
<i>F</i>	- 9.45	1.00	0.48	- 9.45	16,230	7,800	153,300
<i>B'</i>	+ 5.20	2.05	1.95	+10.64	10,640	20,800	113,000	
<i>C'</i>	+ 6.20	1.56	1.50	+ 9.67	10,820	16,400	104,600	
<i>D'</i>	+ 7.30	0.97	0.91	+ 7.08	10,800	9,700	76,500	
<i>E'</i>	+ 8.55	0.42	0.39	+ 3.59	11,720	4,600	42,100	
<i>F'</i>	+ 9.15	0.05	0.05	+ 0.45	13,830	700	6,200	
Σ	153,100	+444,700	-517,100

$$M_s = +444,700 - 517,100 = -72,400 \text{ lb.-ft.}$$

This quantity checks with that previously obtained by other methods.

If the moments at the crown and at the springing are plotted as ordinates from an axis, the resulting figure is an influence diagram which shows the variations of the moments as a unit

load moves across the bridge. Figure 46 (a) shows such a diagram for moments at the crown and Fig. 46 (b) shows a similar diagram for moments at the springing. Similar diagrams could be plotted for shears and for thrusts due to unit loads on the arch. These diagrams may be used for any similar arch and their use will be referred to again presently.

Problem 3. Analysis of an Unsymmetrical Arch.—The following problem¹ illustrates the application of the preceding method to an unsymmetrical arch. The stresses in the bridge were figured for dead loads only and for a temperature variation of 40° F. each way from the temperature of no stress. The arch is a spandrel filled bridge and the loads were considered as concentrated at 2-ft. intervals on the right and at 2½-ft. intervals on the left.

The arch has a span of 45 ft., a crown depth of 9 in. and a depth at the springing of 18 in. The reinforcement consists of 5/8-in. round bars spaced 12 in. centers, some of which were bent up as shown.

The quantities for calculating H_c , V_c and M_c are given in Table XV.

Substituting in Eqs. (1), (2) and (3) from p. 163

$$(\Sigma ix - \Sigma, x)M_c + (\Sigma ixy - \Sigma, xy)H_c + (\Sigma x^2)V_c = \Sigma m, x - \Sigma m, ix \quad (4)$$

$$(\Sigma y)M_c + (\Sigma y^2)H_c + (\Sigma ixy - \Sigma, rxy)V_c = -\Sigma my \quad (5)$$

$$2n_s M_c + H_c \Sigma y + \Sigma ix + \Sigma, r)V_c = -\Sigma m \quad (6)$$

$$8.12M_c + 94.05H_c + 1,620.08V_c = 1,128,703 \quad (7)$$

$$21.23M_c + 69.52H_c + 94.05V_c = 928,984 \quad (8)$$

$$16 M_c + 21.23H_c + 812.0V_c = 270,887 \quad (9)$$

Whence,

$$H_c = 13,992 \text{ lbs.}$$

$$V_c = -108 \text{ lbs.}$$

$$M_c = -1,580 \text{ lb.-ft.}$$

Substituting in Eqs. (4), (5), and (6) p. 174, the thrust, shear and moment at the crown due to temperature drop of 40° may be computed.

$$\begin{aligned} 8.12M_c + 94.05H_c + 1620.08V_c &= 0 \\ 21.23M_c + 69.52H_c + 94.05V_c &= 92,783 \\ 16M_c + 21.23H_c + 812V_c &= 0 \end{aligned}$$

¹ Iowa State College, Eng. Exp. Sta., Bull. 30.

TABLE XV.—QUANTITIES FOR AN UNSYMMETRICAL ARCH

Point	x				y				x ²				y ²				mx				my				
	rt		lft		rt		lft		rt		lft		rt		lft		m _r x		m _l x		m _r y		m _l y		
	rt	lft	rt	lft	rt	lft	rt	lft	rt	lft	rt	lft	rt	lft	rt	lft	m _r x	m _l x	m _r y	m _l y	rt	lft	m _r y	m _l y	
1	0.91	0.01	0.00	0.83	0.83	0.000	0.000	0.000	0.000	0.000	0.000	0.000	0.000	0.01	0.00	0	0	0.00	0.00	0.00	0.00	0	0	0	0
2	2.75	2.79	0.10	0.08	7.56	7.78	0.010	0.006	0.078	0.073	0.078	0.073	0.078	1.039	955	2,626	2,899	0.27	0.22	0.27	0.22	95	83	95	83
3	4.60	4.70	0.28	0.27	21.16	22.09	0.078	0.073	0.360	0.360	0.360	0.360	3,009	2,929	13,473	14,142	14,142	1.29	1.29	1.29	1.27	820	812	820	812
4	6.46	6.61	0.52	0.60	41.73	43.69	0.270	0.360	0.689	0.689	0.689	0.689	5,996	5,996	38,734	39,429	39,429	3.36	3.36	3.36	3.36	3,118	3,579	3,118	3,579
5	8.29	8.69	0.83	1.03	68.72	75.52	0.689	1.061	1.690	1.690	1.690	1.690	10,490	10,252	84,989	91,158	91,158	6.88	6.88	6.88	6.88	8,509	10,805	8,509	10,805
6	10.19	11.21	1.30	1.69	103.84	125.66	1.690	2.856	3.686	3.686	3.686	3.686	18,450	16,126	164,324	206,825	206,825	13.25	13.25	13.25	13.25	20,964	31,181	20,964	31,181
7	12.40	14.70	1.92	2.86	153.76	216.09	3.686	8.180	13.104	13.104	13.104	13.104	34,603	25,046	310,570	508,664	508,664	23.81	23.81	23.81	23.81	48,088	98,965	48,088	98,965
8	16.95	21.06	3.62	6.12	287.30	443.52	13.104	37.454	52.208	52.208	52.208	52.208	83,819	52,208	884,926	1,765,228	1,765,228	61.36	61.36	61.36	61.36	128,891	188,993	128,891	188,993
Σ	62.55	70.67	8.58	12.65	684.90	935.18	49.527	113.512	157.375	157.375	157.375	157.375	499,642	345,110	23,282,700	587,658,397	587,658,397	110.23	110.23	110.23	110.23	204,282,700	587,658,397	204,282,700	587,658,397

Whence

$$\begin{aligned}
 H_c &= 2,504 \text{ lbs.} \\
 V_c &= -129 \text{ lbs.} \\
 M_c &= -3,257 \text{ lb.-ft.}
 \end{aligned}$$

The thrust, shear and moment at any other point due to temperature change may be found by the procedure previously

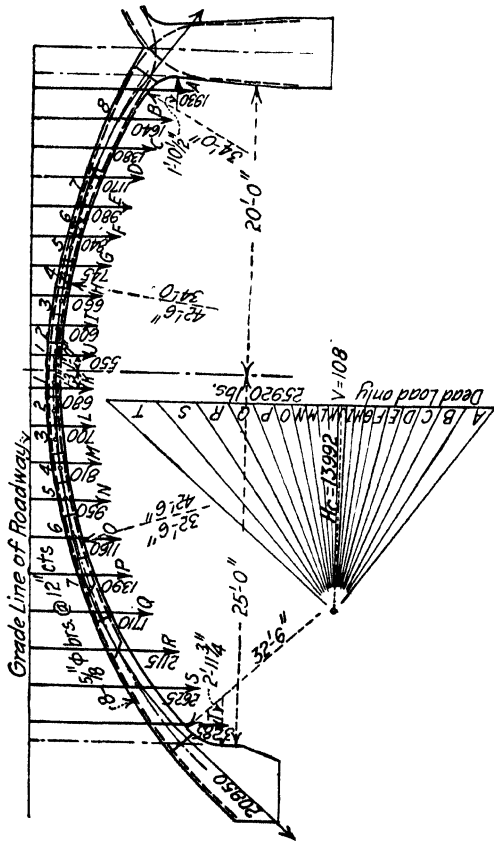

Fig. 47.—Analysis of an unsymmetrical arch.

explained, either graphically with the force and funicular polygons or algebraically by composition of forces and by the general moment equation

$$M = M_c + H_c y \pm V_c x + m$$

Influence Diagrams for Thrusts, Shears and Moments at Crown and Springing.—The diagrams of Figs. 48-55 prepared

by Victor H. Cochrane,¹ are influence diagrams for thrusts, shears, and moments at the crown and at the springing for both open spandrel and filled spandrel arches of the types indicated.

Types $A_{1.5}$, $A_{2.0}$, etc. mean arches having a thickness at the springing 1.5, 2.0 etc., times the crown thickness, and kl is the distance from the left springing to the position of the unit load.

These diagrams give approximate values of these functions at the crown and springing for a unit load at any point on the arch and are applicable to any arch whose axis follows the equilibrium polygon for the dead load plus half the live load.

The manner of using these diagrams is obvious. With the type of arch selected or given, i.e., the relative thickness at springing and at crown, the values of thrust, shear and moment at the crown and springing are taken from the appropriate diagram for unit loads at the various loading points and then the corresponding thrusts, shears, and moments computed for the given loads at these points by direct multiplication.

Determining Maximum Stresses.—By the methods previously explained, the stresses due to loads under the various conditions, to temperature change, to shrinkage and to arch shortening under thrust can be computed. It is then necessary to select such practical combinations of these stresses as will produce the maximum total stress. The maximum stress due to loads will occur near the point of maximum moment usually, although not at that point in general.

The maximum stress should be determined at three points, viz., the crown, the haunch and the springing, although usually the determination of the maximum stresses at the crown and at the springing will suffice.

Figure 39 shows the positions of the live load that usually give the maximum stresses at the crown and at the springing. However, by means of influence diagrams, the exact loading which will produce the maximum stress at any point can readily be determined.

Arch Bridges with Elastic Piers.—Where arch bridges of several spans are supported by relatively thin piers and the arches firmly tied to the piers, the elasticity of the piers should be taken into consideration in calculating the stresses in the arches. In this type of construction, the piers contain less concrete and at the same time provide greater waterway for any given pier

¹ *Proc. Eng. Soc., of W. Pa.*, vol. 32, p. 672, ff.

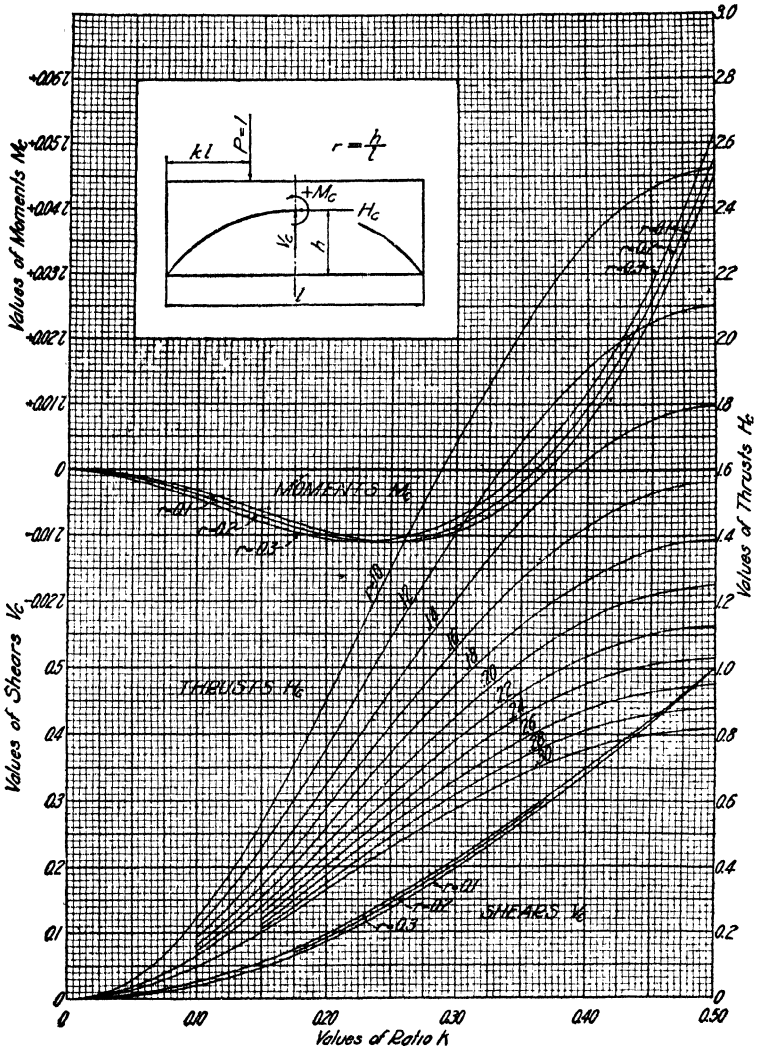

FIG. 48.—Influence lines for moments, thrusts and shears at crown; open spandrel arch, type $A_{1.5}$.

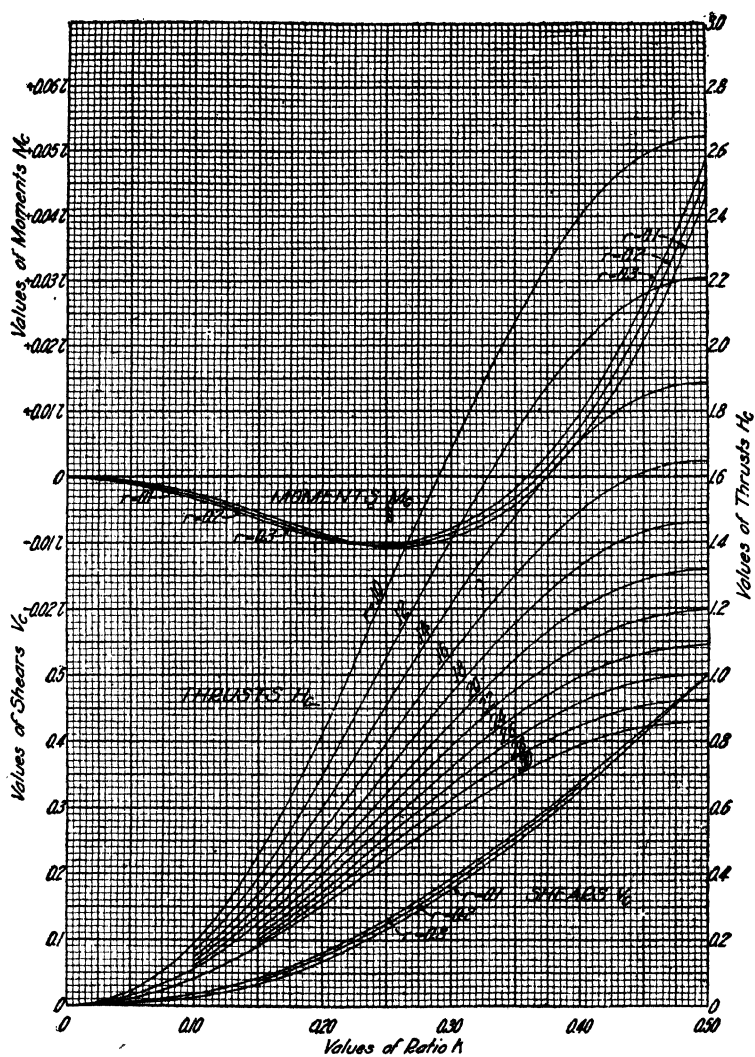

FIG. 49.—Influence lines for moments, thrusts and shears at the crown; open spandrel arch, type A_{2.0}.

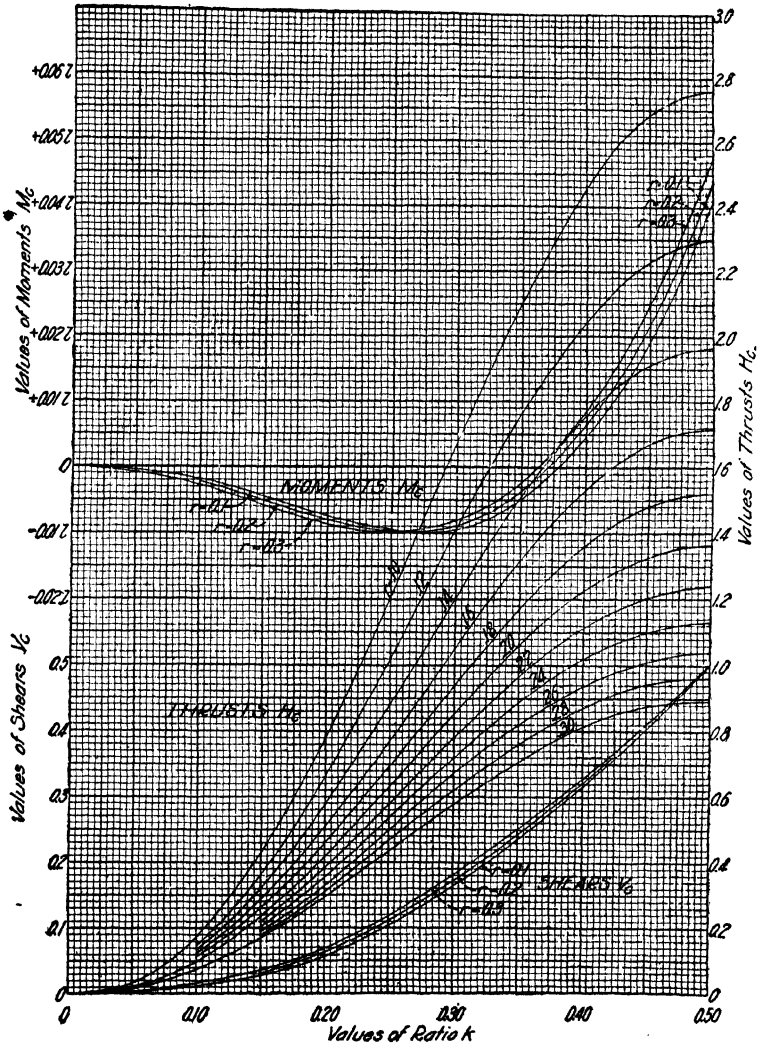

FIG. 50.—Influence lines for moments, thrusts and shears at the crown; open spandrel arch, type A_{2.6}.

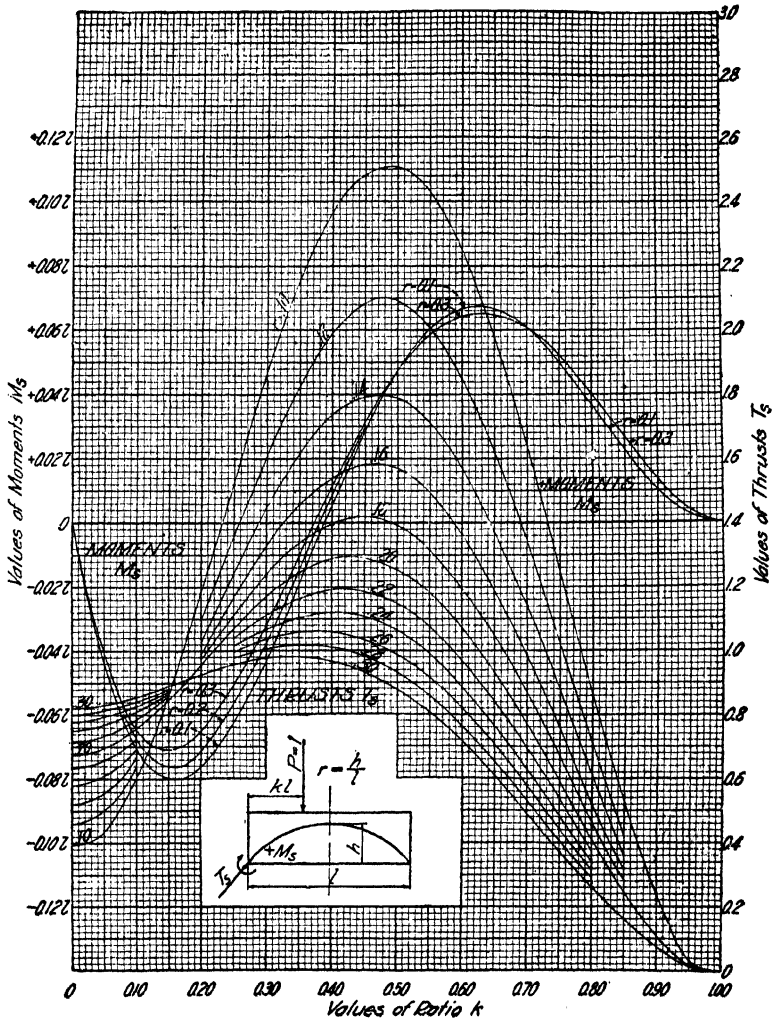

FIG. 51.—Influence lines for moments and thrusts at springing; open spandrel arch, type A1.5.

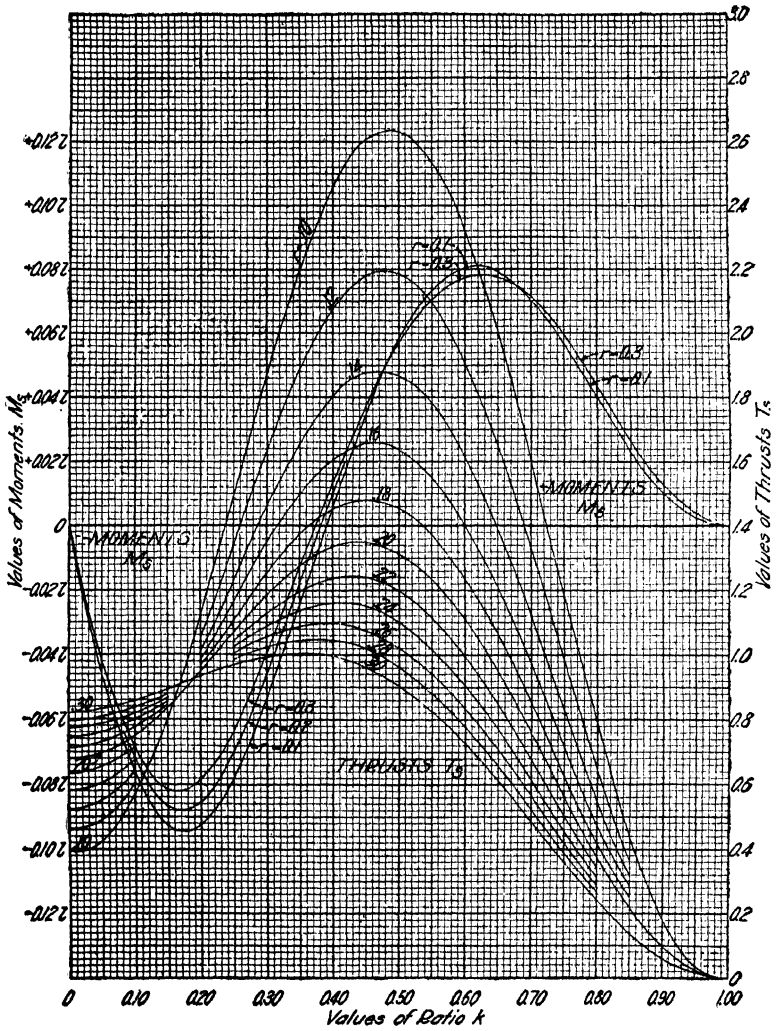

FIG. 52.—Influence lines for moments and thrusts at springing; open spandrel arch, type $A_{2,0}$.

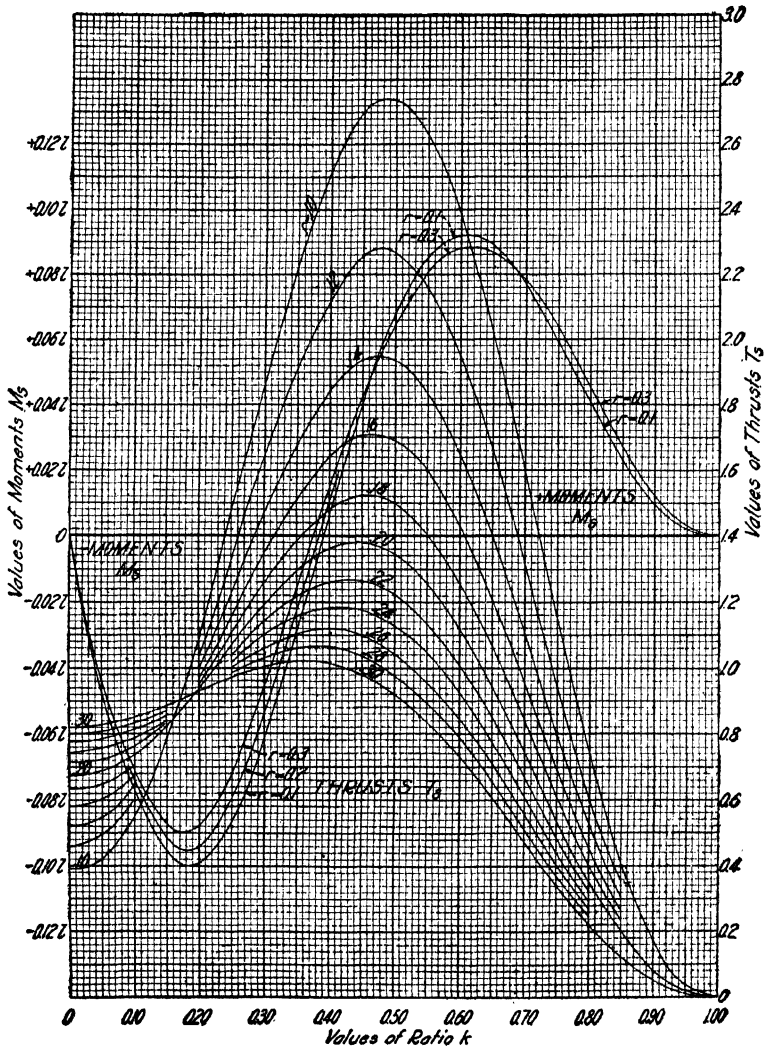

FIG. 53.—Influence lines for moments and thrusts at springing; open spandrel arch, type A_{2.5}.

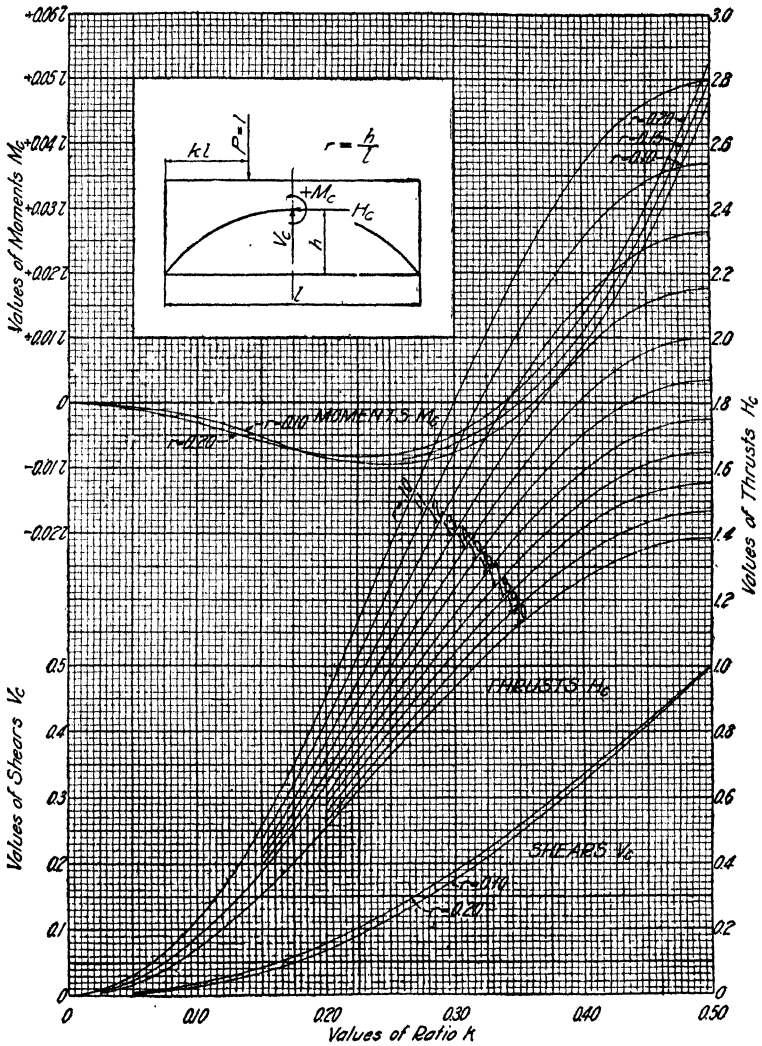

FIG. 54.—Influence lines for moments, thrusts and shears at crown; filled spandrel arch, type A_{2.0}.

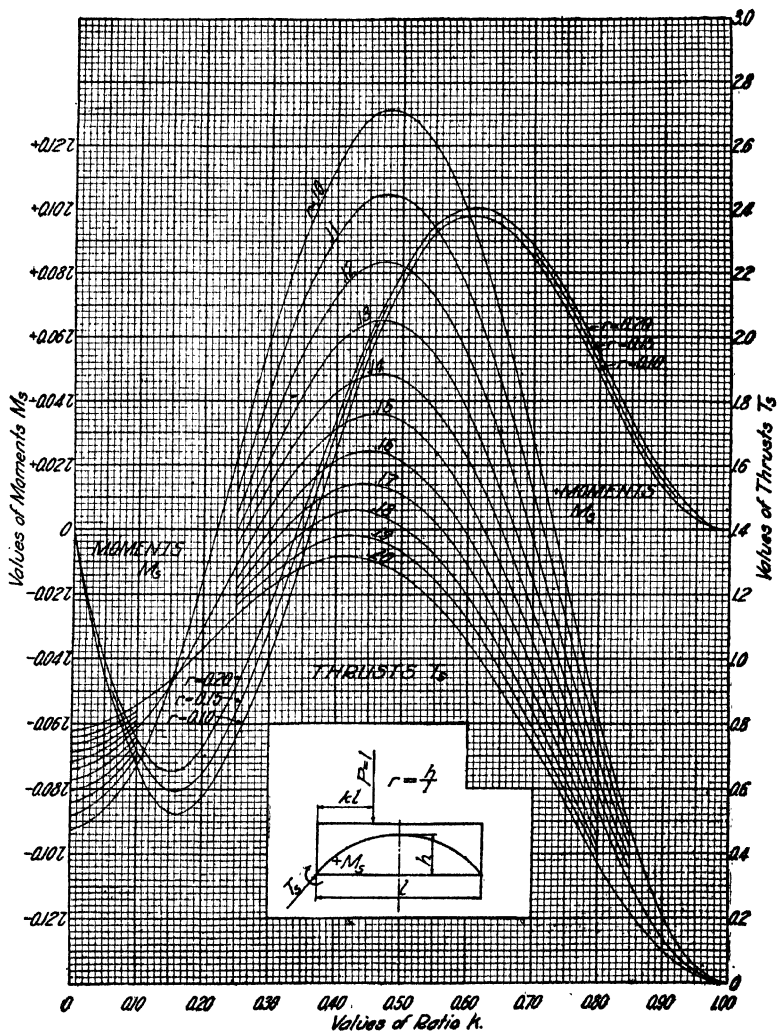

FIG. 55.—Influence lines for moments and thrusts at springing; filled spandrel arch, type A_{2.0}.

spacing. Although some additional concrete may be required in the arches to provide for the stresses resulting from elasticity of the piers, yet on the whole, if the piers are high, there will be an economy of construction. Arches with thin elastic piers have been used to a considerable extent within recent years and they offer some advantages where a considerable height of waterway or other space is required beneath the arches.

Where the piers are extremely thin and the arches of very low rise ratio, the arches become little more than continuous beams supported at the piers, but where the rise is considerable and the reinforcement properly placed over the pier, an economy of design

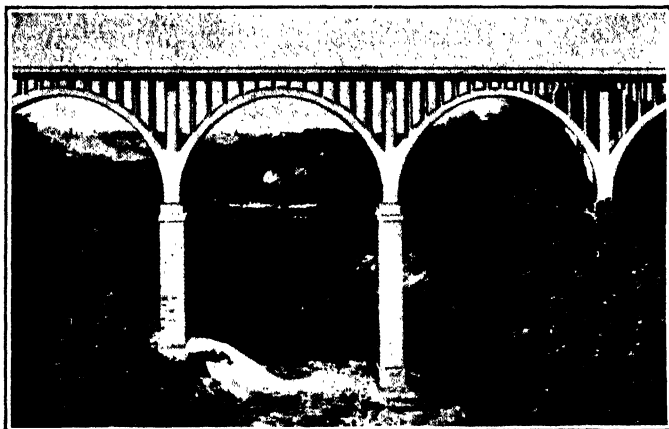

FIG. 56.—Arch with thin piers at Akron, Ohio.

may be effected. This type is illustrated in the North Howard St. Bridge¹ across Cuyahoga River at Akron, Ohio. See Fig. 56.

The bridge is 781 ft. 9 in. long, made up of five main arch spans 127 ft. center to center of piers and an approach at each end, of column and girder construction. It is 190 ft. high from bed of stream to grade.

In the case of two adjacent spans on a slender elastic pier, so long as the two spans are symmetrically loaded, the conditions of fixed ends obtain. When, however, a live load is placed on one span and not on the other, the horizontal thrust at the pier for the one becomes greater than the corresponding thrust from the other, and this disparity of horizontal thrust increases with the disparity of the loadings.

¹ *Engineering News*, Oct. 21, 1915.

While a rigorous analysis is rather arduous and complicated, since the stresses in each arch are affected by the loads and stresses of all the others, an approximate solution of simple application suffices for all ordinary cases.¹

The pier is essentially a cantilever subjected to a horizontal thrust at the top equal to the difference between the horizontal components of the thrusts T_l and T_r , which is approximately the same as the difference between the crown thrusts for all ordinary cases. Thus in Fig. 57, if a live load is placed on the middle span, the piers are deflected as shown, increasing the crown thrusts and the negative moments (numerically) in the outer spans and increasing the positive moments in the middle

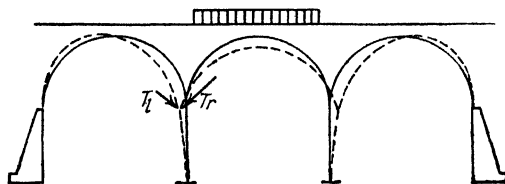

Fig. 57. Deformation of arches with elastic piers.

span and decreasing the negative moments (numerically). The vertical movement as well as the angular deflection of the skew-back are small and are neglected in this approximate analysis.

The deflection of the top of the pier is then

$$\Delta x = (H'_c - H_c) \frac{h^3}{3E_c I_p} \quad (1)$$

where H'_c and H_c represent the thrusts of the loaded and the unloaded spans respectively calculated in the ordinary manner for fixed arches; h , the height of pier above fixed base, I_p the moment of inertia of the pier cross section. Substituting the values of H'_c and H_c from p.164, the horizontal movement of the top of the pier would be approximately,

$$\Delta x = \left[\frac{n'_s \Sigma m' y' - \Sigma m' \Sigma y'}{2[(\Sigma y')^2 - n'_s \Sigma y'^2]} - \frac{n_s \Sigma m y - \Sigma m \Sigma y}{2[(\Sigma y)^2 - n_s \Sigma y^2]} \right] \frac{h^3}{3E_c I_p} = u \quad (2)$$

where u equals this horizontal movement of the top of the pier, n'_s , m' and y' refer to the loaded span, and n , m and y , to the unloaded span. As in the case of temperature change, the result-

¹ J. MELAN, "Plain and Reinforced Concrete Arches" (Tr. by D. B. Steinman), p. 86.

ing increment of crown thrust would be due to this movement.

$$\Delta H''_c = \frac{\frac{EI}{n_s \frac{ds}{ds}} u}{2[n_s \Sigma y^2 - (\Sigma y)^2]} \quad (3)$$

This quantity would be added to the crown thrust of the unloaded span and subtracted from that of the loaded span.

An average value of I_p , the moment of inertia of the pier section, should be selected, as the relative precision of the method does not justify the use of a variable I_p .

For symmetrical arches, the crown thrust due to loads would be approximately

$$H_c = \frac{n_s \Sigma my - \Sigma m \Sigma y - n_s \frac{EI}{ds} \cdot u}{2[(\Sigma y)^2 - n_s \Sigma y^2]} \quad \text{for the loaded span,} \quad (4)$$

and

$$H_c = \frac{n_s \Sigma my - \Sigma m \Sigma y + n_s \frac{EI}{ds} \cdot u}{2[(\Sigma y)^2 - n_s \Sigma y^2]} \quad \text{for the unloaded span.} \quad (5)$$

Obviously for the conditions assumed, i.e., for no change in the vertical position nor in the inclination of the skewback, the value of V_c would not change with a small horizontal movement of the top of pier. The maximum effect will be for the condition of loading which produces the maximum difference in the crown thrusts when calculated as for fixed abutments. No change would be made in the formulas (9), (14) and (15) for moments except that the values of H_c would be used as obtained from formulas (4) and (5) above.

Several methods of securing a rigorous analysis of the stresses in arches with elastic piers have been proposed, but they are all too long and complicated to be intelligibly presented in the space available in the present text.¹

Design of Spandrels.—In a filled spandrel arch, the spandrel walls must be designed as retaining walls. These are usually

¹ Some of these may be referred to for those readers who desire a more extended treatment: J. MELAN, "Plain and Reinforced Concrete Arches" (tr. by D. B. Steinman), p. 71 ff.; article by S. MOREELL, *Proc. W. Soc. Eng.*, April, 1917; paper by A. C. JANNI, *Trans. Am. Soc. C. E.*, vol. 88, p. 1142; discussion by PROF. HARDY CROSS, p. 1196; paper by C. S. WHITNEY, *Trans. Am. Soc. C. E.*, vol. 90, p. 1194. The two latter are especially useful.

of gravity type, if not too high, or of counterfort and curtain wall type if so high that the gravity walls would bring undue load upon the arch. High gravity walls cause an appreciable increase in the dead load coming on the arch, and any type of wall introduces transverse moment in the arch ring. See Chap. VII.

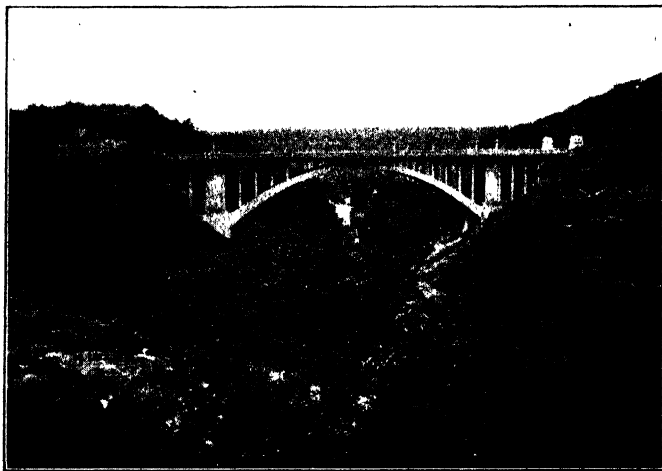

FIG. 58.—Beechwood Boulevard viaduct, showing spandrel piers.

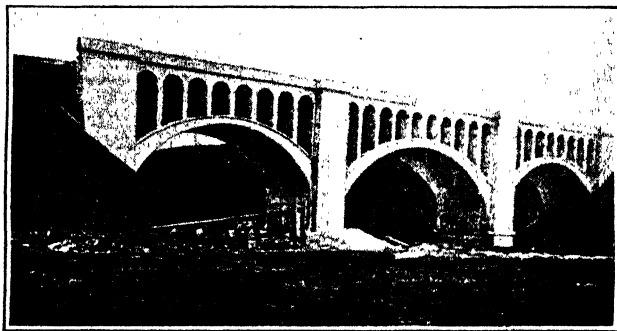

FIG. 59.—Vermilion River bridge showing spandrel arches.

In open spandrel construction, two types are to be found, (1) pier and girder carrying the roadway slab, and (2) spandrel arches carrying the roadway slab. The former is illustrated in the Beechwood Boulevard viaduct¹ in a residential district of

¹ Courtesy, Mr. John D. Stevenson, Chief Engineer, Bureau of Bridges and Structures, the designer, who received the Fowler award for its excellence in architectural treatment.

Pittsburgh, Pa. This affords very pleasing lines (Fig. 58). The latter type is illustrated in the Vermilion River bridge of the C. C. C. & St. L. R. R. shown in Fig. 59. Sometimes the latter type is simulated by building the transverse spandrel walls and slabs with curved fillets which thereby are made to appear as arches, as in the Brighton Viaduct at Cleveland.¹ Fig. 60. Spandrel arches should be designed as arches with elastic piers generally, but the unmodified elastic theory is often used for this purpose with apparently satisfactory results. For the design of slabs and thin piers see Chap. IX.

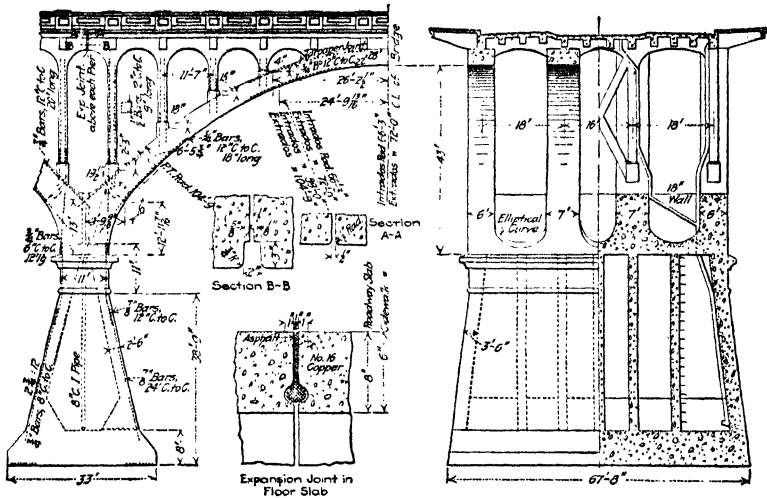

FIG. 60.—Brighton viaduct, Cleveland.

Expansion and contraction joints must be provided in spandrel side walls and in spandrel arches and trestles. For short spans, expansion joints over the springing lines of the arches will suffice, but for long spans, expansion joints should be provided about every 100 ft. in order to keep the movement at any joint under about $\frac{1}{2}$ in. Where a rigid pavement rests on the roadway, expansion joints in the pavement must also be provided at the same section. Details of an expansion joint are shown in Fig. 60.

Effect of Method of Construction on Design.—In the construction of arches, care must be exercised (a) in order that unusual strains may not come upon the arch while the masonry is yet

¹ *Engineering News*, Sept. 9, 1915.

green, (b) to prevent unsymmetrical loading of the arch centers (forms) thereby causing deformation of the latter, and (c) to bring the construction joints in the most advantageous places. The abutments and piers are usually poured somewhat above the springing line leaving a construction joint at the skewback.

Two methods of construction are in common use. (1) In short arch spans, the arch rib is poured in ribs 3 to 5 ft. wide

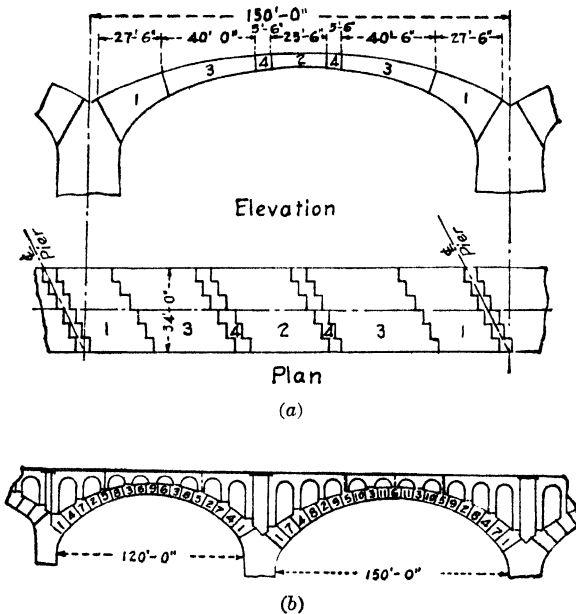

FIG. 61.—Order of placing masonry in arch rings.

extending across the entire span in order that the entire rib may be poured continuously. The arch is carried up from the springing lines simultaneously in order that the loads on the arch centers may be symmetrical. If the centering is of the ordinary timber or steel type, it may be desirable to place a temporary load at the crown in order to prevent the latter from rising due to the loads on the haunches.

(2) The other mode of constructing arches is commonly used for long spans, 60 ft. or longer. It consists in pouring segments or blocks symmetrically placed over the forms in such a manner that the arch centers may not be distorted, construction joints

being placed at the ends of these sections normal to the arch ring. A method used in the Delaware River viaduct of the D. L. & W. R. R. is shown in Fig. 61(a), while another scheme is indicated in (b). Construction joints not normal to the arch ring should be avoided because the thrust in the arch ring under load might cause shearing along an oblique construction joint.

In designing an arch ring, it is necessary to keep in mind, therefore, the proposed method of erection in order that features may not be introduced in the design that will be incompatible with the construction.

Some engineers follow the practice of leaving the arch hinged at the springing lines and at the crown during construction and while the concrete is hardening and then filling the hinges with concrete after the dead load is entirely on the bridge and shrinkage is practically complete. This procedure is followed with a view to obviating stresses due to flexure under dead load and to shrinkage of the arch rib, as well as those that might result from yielding of arch centers, although the efficacy of the method has not been established.

Abutments and Piers.—The design of abutments for arch bridges does not differ fundamentally from the design of any bridge abutment. See Chap. VIII. An abutment for an arch bridge is subject to the following forces for both dead load and live load conditions: (1) the reaction of the arch, (2) its own weight, (3) the weight of the earth fill, the roadway, etc. above the abutment, (4) the pressure of the earth back of the abutment, and (5) the reaction of the foundation. A typical analysis of an arch bridge abutment is indicated in Fig. 62. An arch abutment should be investigated for the three conditions of loading, viz., (a) dead load plus live load on the half span opposite the abutment, (b) dead and live load over the entire span, and (c) dead load plus live load on the half span adjacent to the abutment. T_1 is the thrust for condition (a), T_2 for condition (b) and T_3 for condition (c). E is the earth pressure and W is the total vertical load including the weight of the abutment and the superimposed loads. Where the ledge of rock on which the abutment rests rises above the base of the abutment, the bottom face resting on the foundation should be perpendicular to the resultant thrust rather than horizontal as shown.

Piers for arch bridges should be designed to be stable for erecting conditions when one span is in place and the adjacent

span missing. Otherwise piers for arches do not differ fundamentally from piers for truss bridges. The reinforcement from the arch ring should extend sufficiently into the pier to develop adequate bond strength.

Piers of special massiveness, sometimes called "abutment piers," are placed by some engineers at every fourth or fifth span to give stability in the event that one arch span should fail.

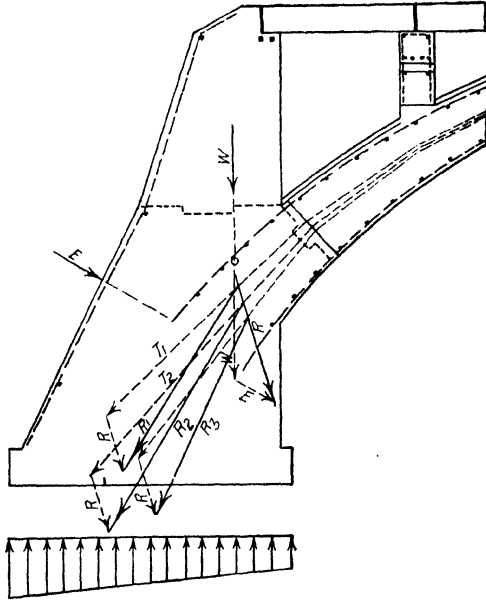

FIG. 62.—Forces acting on an arch abutment.

The General Form of Arch.—The arch ring for fixed arch bridges may take one of three forms, viz., (a) it may be a cylindrical barrel, (b) it may consist of two or more ribs, or (c) it may consist of ribs serving as trusses with the floor hung therefrom.

The cylindrical form of arch is perhaps most common and is illustrated in Vermilion River bridge, Fig. 59. For a comparatively narrow roadway, this form is the most economical, although with reinforced concrete as the material of construction, there is usually an excess of strength over that actually required when the minimum practical thickness of arch ring is used.

The separation of the arch ring into ribs is economical usually for a wide roadway with a long span and having areas of con-

centrated loads, as for example, under a railroad consisting of several tracks, when a rib can be placed under each track. Separation into ribs effects a considerable saving of material and weight under such circumstances. This type of construction is illustrated in Saskatchewan River bridge, Fig. 68.

When the waterway required necessitates a high bridge and the position of the roadway cannot readily be elevated, the so-called "rainbow arch," or through arch has been used to advantage. This type of bridge is illustrated in the Carmi, Ill., bridge, Fig. 63.¹ The roadway may be placed at any elevation between the crown and springing, depending upon conditions.

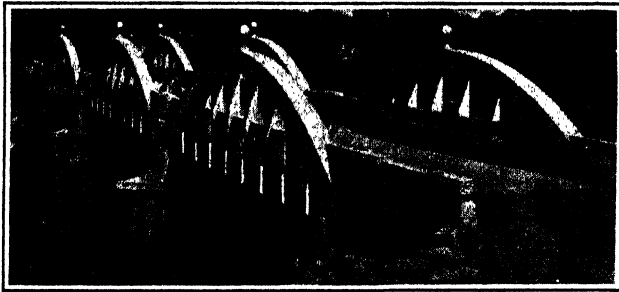

FIG. 63.—Rainbow arch at Carmi, Illinois.

The Carmi bridge has three arch spans of 90 ft. between piers, with a rise of 18 ft. and a radius of 65 ft. 3 in. on the under side. It has an 18-ft. roadway and 6-ft. sidewalk between the arches. The bridge is high, with its deck 43 ft. above the bed of the stream. The Little Wabash River is subject to very sudden rises, the water level rising sometimes 40 ft. in three days after a heavy rain. The rainbow type of through-arch span is of particular advantage under such conditions, as it gives a maximum clearance for the waterway and does not cause such obstruction (to drift and water) as would be caused by a deck-arch span. This bridge was built in 1916 and cost about \$21,960.

Economy in Design.—In comparing an arch bridge with other types with respect to economy, the first cost, the cost of maintenance, and the relative durability of the structures must be taken into account as explained on p. 15.

Two primary items enter into the first cost, viz., foundations and superstructure. Where solid rock is near the surface,

¹ *Engineering News*, Feb. 5, 1917.

the foundations of an arch bridge may be cheaper than for a girder or truss bridge. Where rock is not readily available, the foundations of an arch bridge will generally be the greater, partly because of the larger bearing area required but also because of the requirement of greater rigidity for the arch. Discussion of the relative economy of alternate types of bridges cannot be undertaken here.

Economy of design in arch bridges is affected by various factors, such as,

1. Minimum quantity of masonry:
 - (a) Primarily, of high unit cost masonry, such as in the arch ring and spandrel walls.
 - (b) Secondly, of low unit cost masonry such as piers.
2. Least cost of construction:
 - (a) Foundations.
 - (b) Falsework and forms.
 - (c) Convenience in handling materials.
 - (d) Minimizing time of construction.
 - (e) Judicious use of power and of machines instead of hand labor.

The quantity of masonry in the arch and in the spandrels will, in general, be lessened by any increase in the rise ratio up to about $\frac{1}{3}$. The rise may be increased by bringing the crown as near as practicable to the roadway and by lowering the springing lines. Elevating the roadway in order to increase the rise will not ordinarily result in economy. Open spandrels are usually more economical than filled spandrels.

In the case of multiple span arch bridges, the economic length of span (determining the number of spans) depends primarily upon the character of the foundations and on the loads to be carried. If the foundations are expensive, the spans should be lengthened, while on good rock foundations near the surface, economy will result from shorter spans. In general, light loads make long spans economical, while heavy loads make shorter spans the more economical. Economic span length cannot be stated in a formula; it can be ascertained only from estimates carefully made of structures using different span lengths.

Falsework and arch centers should be designed so as to offer the least possible hazard to damage from floods and at the same time support the fresh masonry without any considerable deformation. The design of the forms and falsework is affected by the structural features of the arch to some extent and should

be taken into account, for therein lie possibilities of substantial economy.

Aesthetic Treatment of Arch Bridges.—The masonry arch, properly designed, has probably the most pleasing appearance of all engineering structures. However care must be exercised in order to secure the maximum of beauty, otherwise an inherently beautiful structure may be rendered unsightly by unskilled treatment. Some of the most frequent violations of good aesthetic design in arches may be briefly mentioned.

1. *Lack of Harmony with Surroundings.*—In the first place, an arch should be built only on a site suited to this type of con-

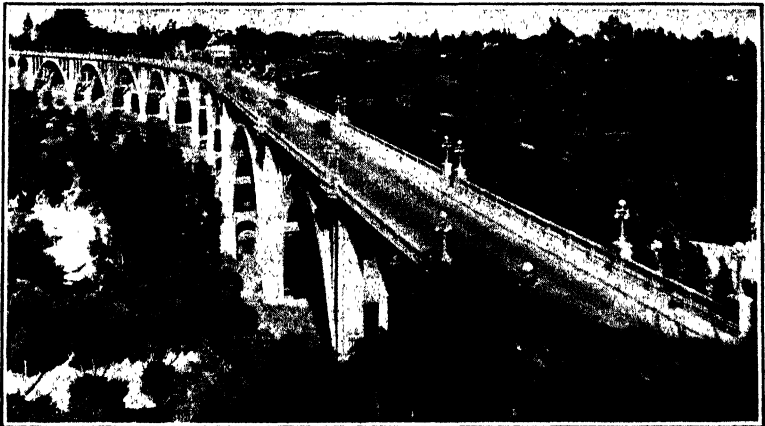

FIG. 64.—Arroyo Seco bridge at Pasadena, California.

struction. An arch is adapted to a stream with steep banks but appears artificial if abutments and high fills must be built above flat shores. Thus an arch is admirably suited to a canyon or the Royal Gorge, but an arch bridge springing from the level shores of the East River, New York, would seem unnatural and labored. In the second place, the type of arch and details should be in harmony with the surroundings. Between the massive rock walls of a Colorado canyon a massive arch is in keeping, while across a wide ravine in level territory, a more slender type of structure with more graceful details would be preferable.

An arch should seem to spring from the ground, hence an arch with low rise ratio giving the impression of ruggedness fits admirably into the landscape of a mountain stream bridge, while a slender graceful arch with a large rise ratio is more

suitable for crossing a comparatively shallow ravine as in the Arroyo-Seco viaduct at Pasadena, Cal., Fig. 64.¹ However, the abutments should not be lacking in any case but should be fully in sight, otherwise the question of adequate support will naturally rise to the mind as one views the bridge.

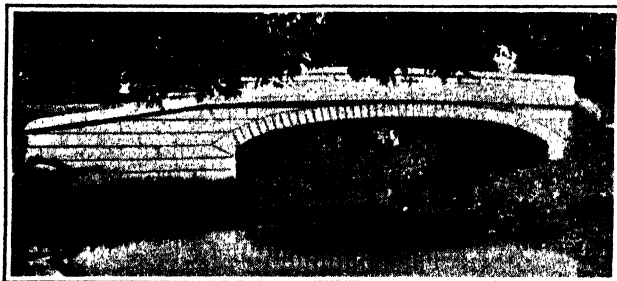

FIG. 65.—Little Eagle River bridge.

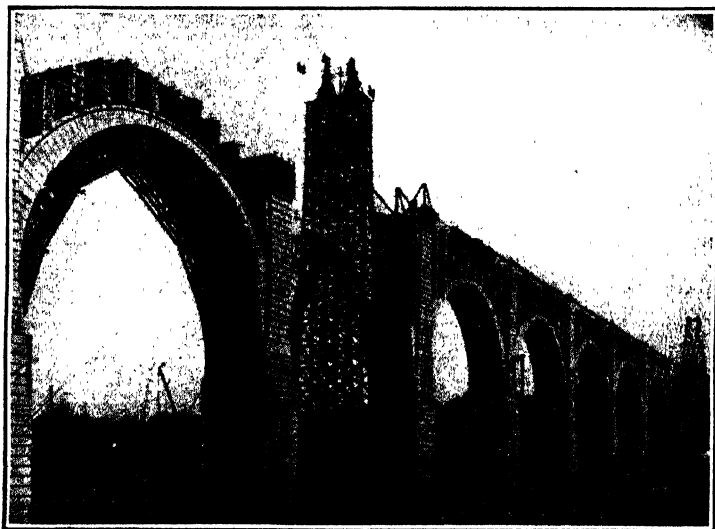

FIG. 66.—Tunkhannock viaduct. D. L. & W. R. R.

2. *Lack of Symmetry.*—This fault may arise from a lack of symmetry of the spans in the case of a series of arches or from dissimilar abutments in the case of a single span. The 30-ft. arch over the Little Eagle River at Agusta, Ind., Fig. 65, illustrates the lack of symmetry in abutments.

¹ Courtesy of Harrington, Howard & Ash, Consulting Engineers, Kansas City, Mo.

3. *Disparity or Rise Ratios*, such as joining a full centered arch with segmental or elliptical arches in the same series. This fault arises most frequently from joining approach spans of one type to a main span of quite another type.

4. *Combining Arch Spans with Girder Approaches* usually produces unsatisfactory results.

5. *Lack of Harmony in Details*.—Small and insignificant railing, coping or other detail is placed on a massive arch, or heavy details are placed on a slender arch. Massive details should accompany a massive main arch and light details should be used with a light arch. The Tunkhannock viaduct of the

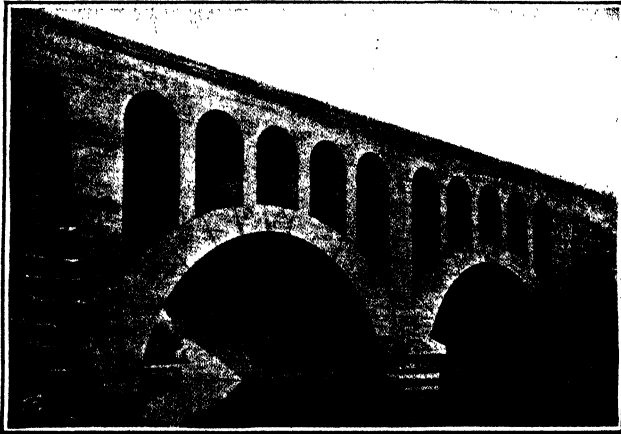

FIG. 67.—Angola bridge, L. S. & M. S. R. R.

D. L. & W. R. R., Fig. 66, is an example of a structure that is massive throughout.

6. *Poor Proportions*.—An arch may be made to look clumsy and awkward by a lack of good proportioning and no amount of ornamentation will relieve the defect. In general, the proportions of details and of parts should diminish from the ground to the roadway. The crown of the arch should come near to the roadway and the selection of rise ratio should be made such as to accomplish this end, for both economy and appearance are promoted thereby. Compare Fig. 67 and Fig. 68.

7. *Lack of Good Shadow Effects*.—Inadequate coping and insignificant pilasters and other details mar a structure because of failure to relieve the monotony. Where the roadway can be

made to extend over the spandrel walls, the shadow effects are improved. See Saskatchewan River bridge, Fig. 68.

The elements capable of treatment in an arch bridge are the arch ring, abutments, piers, spandrel walls, coping and railing or parapet. In general, these should be in harmony and proportion to the entire structure. The appearance of the arch may be made or marred by the attention or lack of attention given to these features. If these features do not stand out definitely, the structure will have a weak indecisive character, while on the other hand they may be made so prominent as to dominate the appearance of the structure and to jar one's sense of proportion.

The Arch Ring.—The arch ring is the supporting member and therefore should definitely appear as such by being distinguishable

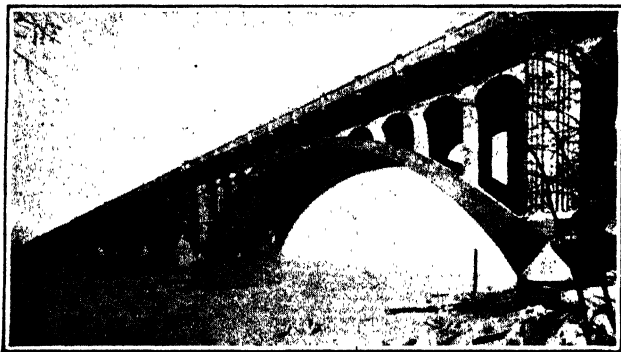

FIG. 68.—Saskatchewan River Bridge.

in its outline. In open spandrel arches, the arch ring needs no accentuation, but in filled arches it does. This may be accomplished by allowing it to project slightly, by scoring the spandrel wall along the top of the ring, by placing a slightly projecting cornice at the top of the arch ring, or by leaving the arch ring smooth and giving a rough finish to the spandrel walls above. Scoring the arch ring to give it the appearance of stone, although frequently done by good engineers, is of doubtful propriety, because its artificiality violates the law of sincerity and truth.

Piers and Abutments.—The piers and abutments should appear adequate in mass to perform the functions required of them. They should preferably extend beyond the face of the arch rib, the abutments into wings and the piers into breakwaters. Round nosed piers with a graceful “starling” or “cocked-hat” coping

usually give a good appearance as well as effective action as a breakwater. (See Chap. VIII.) There should be a coping over the projecting end of the pier, but if this coping is extended around to the sides of the pier under the springing lines, the effect is displeasing. In general, the cutwater, or starling, should be extended up past the springing of the arches. See Fig. 136.

The piers should extend as pilasters above the springing to the roadway and should appear at the face to be essentially continuous with the pier itself, although this portion may be of much lighter construction. Sometimes a small bay or retreat is placed on this pilaster at the level of the roadway, but such construction breaks the line of the railing and is not to be commended generally.

The Spandrel Walls.—Where spandrel walls present large surfaces, the monotony may be relieved by depressed panels. Raised panels do not give good results because the shadow effects are reversed. On a filled spandrel wall with a railing, there should be a coping of significant proportions at the level of the roadway, since one axiom of good architecture is that the lines of the exterior should reveal the interior structure. This coping should be continuous around the pilasters above the piers. If properly proportioned, it throws pleasing shadows on the face of the spandrel wall and relieves the monotony.

In general, figured designs, intricate scoring, and other excessive ornamentation of spandrel walls do not give pleasing effects. Depressed paneling, or slight scoring, particularly if vertical, may be satisfactory, but little beyond that should be attempted.

Parapet or Railing.—The parapet or railing consists of the *plinth* or base, the *coping* at the top, and the *dado* or intermediate web. The plinth and coping should be approximately of the same width, the latter being somewhat narrower, following the law of superposition. The plinth should appear adequate in its proportions to serve as a base. The dado, whether solid or open-work, should be treated with care. Where the dado consists of a balustrade, the balusters should be carefully proportioned with a base, a shaft and a capital well defined. (Compare designs of Fig. 69.) The dado is frequently made solid with depressed panels giving pleasing results.

The railing should be in proper proportion to the arch. A light iron pipe railing on top of a massive concrete arch gives one the

sense of flimsiness and inadequacy, although on a light foot bridge, a pipe railing may be entirely satisfactory.

Giving the railing a flare at the ends where the conditions are appropriate for such treatment gives the sense of facility in entering onto the bridge and yields a satisfactory result. The railing should seem to join to the earth at the ends of the arch or to have a definite ending in a newel post or other device. The railing should have a camber following that of the roadway, but this camber should end with the springing of the arch and the railing should be level over the abutment.

The railing marks the upper line of the bridge and its continuity

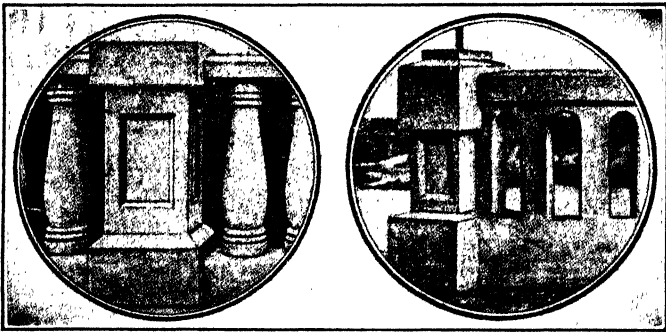

FIG. 69.—Types of balustrades.

should be guarded with care, and intermediate posts, retreats, etc. that would break that continuity should be used with caution.

Lamp posts placed on the railing and on the end posts should be substantial in appearance and simple in outline. Heavy pylons at the end of a bridge are of doubtful aesthetic value, although they have been much employed in Europe. Excessive ornamentation with statuary, etc. as in the Victor Emanuel and St. Angelo bridges at Rome has very little to commend it from an artistic viewpoint. Where a bridge is erected as a memorial, such decoration may be admissible, but even then should be used sparingly.

Example of Arch Design.—Plates I and II give details of two spans of the Illinois Central R. R. arch bridge¹ over the Kankakee river, on the design of which the author was engaged. The bridge consists of five spans and was designed to carry heavy railroad traffic on a double track line. Owing to the high price of steel

¹ Courtesy of S. F. GREAR, Chief Draftsman.

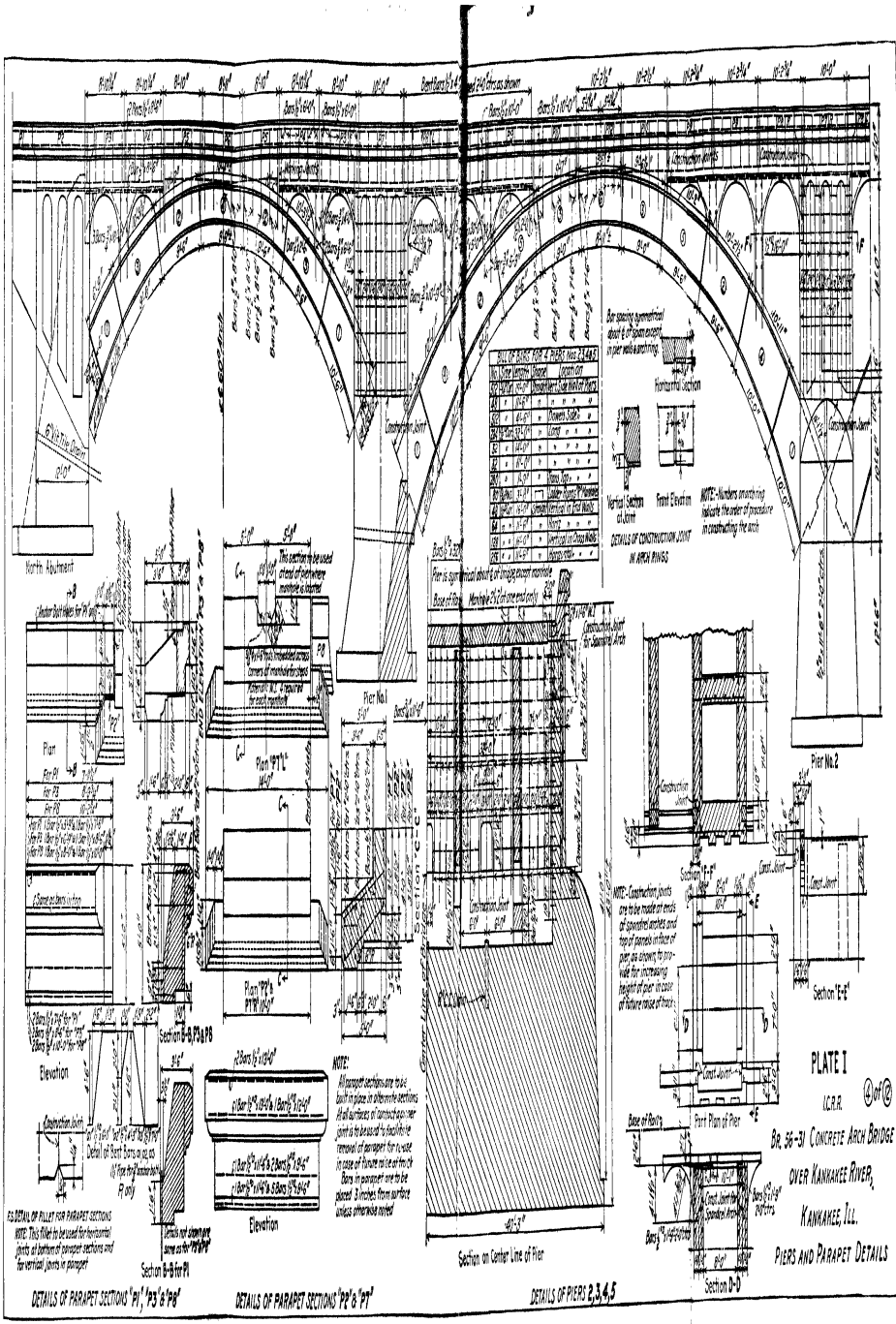

NO.	DESCRIPTION	QUANTITY	UNIT
1	1/2" x 1/2" x 1/2" (3) 1/2" x 1/2" x 1/2"	100	CU YD
2	1/2" x 1/2" x 1/2" (3) 1/2" x 1/2" x 1/2"	100	CU YD
3	1/2" x 1/2" x 1/2" (3) 1/2" x 1/2" x 1/2"	100	CU YD
4	1/2" x 1/2" x 1/2" (3) 1/2" x 1/2" x 1/2"	100	CU YD
5	1/2" x 1/2" x 1/2" (3) 1/2" x 1/2" x 1/2"	100	CU YD
6	1/2" x 1/2" x 1/2" (3) 1/2" x 1/2" x 1/2"	100	CU YD
7	1/2" x 1/2" x 1/2" (3) 1/2" x 1/2" x 1/2"	100	CU YD
8	1/2" x 1/2" x 1/2" (3) 1/2" x 1/2" x 1/2"	100	CU YD
9	1/2" x 1/2" x 1/2" (3) 1/2" x 1/2" x 1/2"	100	CU YD
10	1/2" x 1/2" x 1/2" (3) 1/2" x 1/2" x 1/2"	100	CU YD
11	1/2" x 1/2" x 1/2" (3) 1/2" x 1/2" x 1/2"	100	CU YD
12	1/2" x 1/2" x 1/2" (3) 1/2" x 1/2" x 1/2"	100	CU YD
13	1/2" x 1/2" x 1/2" (3) 1/2" x 1/2" x 1/2"	100	CU YD
14	1/2" x 1/2" x 1/2" (3) 1/2" x 1/2" x 1/2"	100	CU YD
15	1/2" x 1/2" x 1/2" (3) 1/2" x 1/2" x 1/2"	100	CU YD
16	1/2" x 1/2" x 1/2" (3) 1/2" x 1/2" x 1/2"	100	CU YD
17	1/2" x 1/2" x 1/2" (3) 1/2" x 1/2" x 1/2"	100	CU YD
18	1/2" x 1/2" x 1/2" (3) 1/2" x 1/2" x 1/2"	100	CU YD
19	1/2" x 1/2" x 1/2" (3) 1/2" x 1/2" x 1/2"	100	CU YD
20	1/2" x 1/2" x 1/2" (3) 1/2" x 1/2" x 1/2"	100	CU YD
21	1/2" x 1/2" x 1/2" (3) 1/2" x 1/2" x 1/2"	100	CU YD
22	1/2" x 1/2" x 1/2" (3) 1/2" x 1/2" x 1/2"	100	CU YD
23	1/2" x 1/2" x 1/2" (3) 1/2" x 1/2" x 1/2"	100	CU YD
24	1/2" x 1/2" x 1/2" (3) 1/2" x 1/2" x 1/2"	100	CU YD
25	1/2" x 1/2" x 1/2" (3) 1/2" x 1/2" x 1/2"	100	CU YD
26	1/2" x 1/2" x 1/2" (3) 1/2" x 1/2" x 1/2"	100	CU YD
27	1/2" x 1/2" x 1/2" (3) 1/2" x 1/2" x 1/2"	100	CU YD
28	1/2" x 1/2" x 1/2" (3) 1/2" x 1/2" x 1/2"	100	CU YD
29	1/2" x 1/2" x 1/2" (3) 1/2" x 1/2" x 1/2"	100	CU YD
30	1/2" x 1/2" x 1/2" (3) 1/2" x 1/2" x 1/2"	100	CU YD
31	1/2" x 1/2" x 1/2" (3) 1/2" x 1/2" x 1/2"	100	CU YD
32	1/2" x 1/2" x 1/2" (3) 1/2" x 1/2" x 1/2"	100	CU YD
33	1/2" x 1/2" x 1/2" (3) 1/2" x 1/2" x 1/2"	100	CU YD
34	1/2" x 1/2" x 1/2" (3) 1/2" x 1/2" x 1/2"	100	CU YD
35	1/2" x 1/2" x 1/2" (3) 1/2" x 1/2" x 1/2"	100	CU YD
36	1/2" x 1/2" x 1/2" (3) 1/2" x 1/2" x 1/2"	100	CU YD
37	1/2" x 1/2" x 1/2" (3) 1/2" x 1/2" x 1/2"	100	CU YD
38	1/2" x 1/2" x 1/2" (3) 1/2" x 1/2" x 1/2"	100	CU YD
39	1/2" x 1/2" x 1/2" (3) 1/2" x 1/2" x 1/2"	100	CU YD
40	1/2" x 1/2" x 1/2" (3) 1/2" x 1/2" x 1/2"	100	CU YD
41	1/2" x 1/2" x 1/2" (3) 1/2" x 1/2" x 1/2"	100	CU YD
42	1/2" x 1/2" x 1/2" (3) 1/2" x 1/2" x 1/2"	100	CU YD
43	1/2" x 1/2" x 1/2" (3) 1/2" x 1/2" x 1/2"	100	CU YD
44	1/2" x 1/2" x 1/2" (3) 1/2" x 1/2" x 1/2"	100	CU YD
45	1/2" x 1/2" x 1/2" (3) 1/2" x 1/2" x 1/2"	100	CU YD
46	1/2" x 1/2" x 1/2" (3) 1/2" x 1/2" x 1/2"	100	CU YD
47	1/2" x 1/2" x 1/2" (3) 1/2" x 1/2" x 1/2"	100	CU YD
48	1/2" x 1/2" x 1/2" (3) 1/2" x 1/2" x 1/2"	100	CU YD
49	1/2" x 1/2" x 1/2" (3) 1/2" x 1/2" x 1/2"	100	CU YD
50	1/2" x 1/2" x 1/2" (3) 1/2" x 1/2" x 1/2"	100	CU YD

Be symmetry geometrical about & P in elevation in pier wall abutting

Horizontal section

Vertical Section at Joint

DETAILS OF CONSTRUCTION JOINT IN ARCH BRIDGE

NOTE - Members shown indicate the order of procedure in constructing the arch

DETAILS OF PIER FOR PARAPET SECTIONS

NOTE: This detail to be used for horizontal joints at bottom of parapet sections and for vertical joints in parapet

NOTE: All parapet sections are to be built in place in alternate sections. All surfaces of concrete parapet joint in the base of the parapet form to use in case of future repair are to be placed 3 inches from surface unless otherwise noted

NOTE - Construction joints are to be made at ends of panels marked and top of panels in face of pier as shown to provide for increasing height of pier in case of future raise of truss

PLATE I
I.C.R.
Br. 56-31 CONCRETE ARCH BRIDGE
OVER KANKAKEE RIVER,
KANKAKEE, ILL.
PIERS AND PARAPET DETAILS

DETAILS OF PARAPET SECTIONS 'P1' 'P3' & 'P4'

DETAILS OF PARAPET SECTIONS 'P2' & 'P7'

DETAILS OF PIERS 2, 3 & 4, 5

existing at that time (1916), an effort was made to minimize the amount of steel used. Since the structure was to be within the city of Kankakee, the design attempted good architectural treatment.

Groined Arches.—The groined arch has been so widely used for reservoir and filter roofs in water purification works and for roofs generally and is so well adapted to such use that some mention should be made of it in this connection. The groined arch is essentially an intersection arch being formed by the intersection of barrel arches with their axes in the same plane. The economy of the groined arch over beam and slab construction for such structures as those mentioned above has been amply demonstrated and it has been generally used in the floors of these structures as well as in the roof. The usual form for roofs consists in the intersection of semi-elliptical surfaces for the intrados and of parabolic surfaces for the extrados. For floors, the surface is usually parabolic. This form offers a maximum amount of head-room with the requisite strength and economy. In estimates by T. H. Wiggin¹ for the Pittsburgh filters, groined arch construction cost about half as much as beam and slab construction. While brick was formerly used to a considerable extent, groined arches are now made almost universally of concrete, usually plain, although frequently reinforced lightly.

The calculation of stresses in groined arches is subject to so much uncertainty that such a calculation can be made only for rough checking, and the design is necessarily empirical following precedent. Three different modes of analyzing the stresses in a groined arch have been proposed, and each has a modicum of plausibility.

1. The roof is considered as a series of cantilever or umbrella structures supported at the piers and meeting along the crowns of the arches. Where there is considerable thickness of masonry capable of taking tension over the supports, this cantilever action doubtless exists, for at the Albany filters, made of plain concrete, the arches actually opened along the crowns due to temperature changes, and yet the structure stood and carried its load.

2. The roof is considered as a series of barrel arches with the loaded area rhomboid in plan abutting on the piers and cut along the groin lines. In support of this theory, it is pointed out that

¹ *Proc. Amer. Concrete Inst.*, vol. 6, p. 216.

in practice, due to the sequence of construction, particularly in filter floors, the arches are so separated by construction joints.

3. The roof is considered as a series of barrel arches, the full centered arch of approximately the width of the pier carrying part of the load and that portion of the load which goes to the groins being carried by the diagonal arch along the groin lines. See Fig. 70(a). In some structures, the roof is thickened along

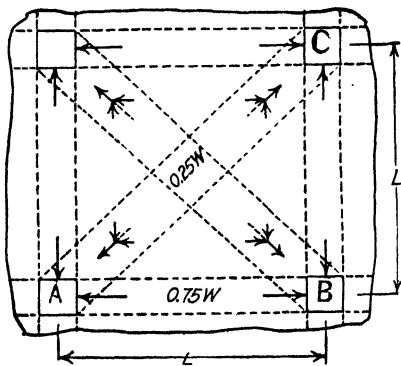

FIG. 70(a).—Assumed stress distribution in a groined arch.

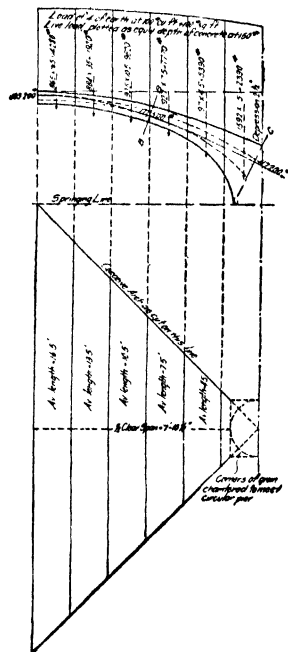

FIG. 70(b).—Stresses in a groined arch.

the groin lines to care for these stresses. The stresses going to the groin lines at right angles to the axis of the barrel form a resultant, R , acting in the diagonal or groin arch. For the same deflection, the thickness of the arches being the same, assuming the deflections of similar arches under similar loadings to vary as the cubes of their spans, the main arch AB would carry about 2.8 times as much load as the diagonal arch AC , for square panels. That is, about 75 per cent of the panel load should be considered as being carried by the main arch AB and about 25 per cent by the diagonal arch BC . The logical width to assign to this diagonal arch

would be the width of the pier, or perhaps the diagonal of the pier.

On the basis of either of these assumptions, the stresses become calculable, although it is impossible to prove one of them more

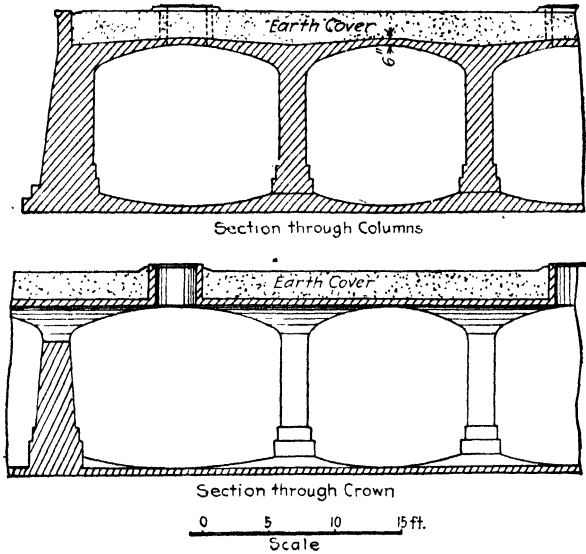

FIG. 71.—Section through groined arches at Washington.

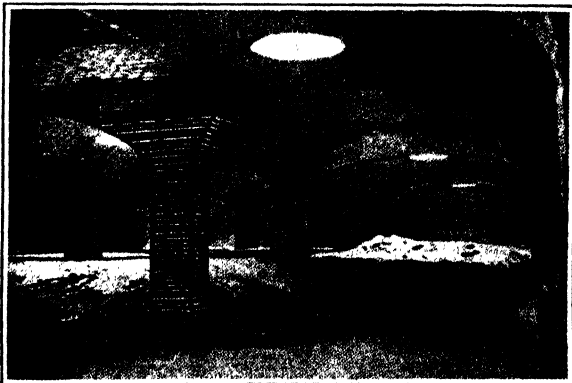

FIG. 72.—Interior view of groined arch cover over filter of Ashland, Wis.

applicable and probable than the others. Where the panels are poured continuously, it is probable that the third assumption more truly applies. Even at best, the calculation of the stresses is subject to much uncertainty and indefiniteness. Figure 70(b)

TABLE XVI.—DATA RELATING TO GROINED ARCHES WHICH HAVE BEEN BUILT IN THE UNITED STATES AND CANADA

Date completed	Location	Total area in acres	Depth of earth cover	Concrete mixture	Groined arches			Piers	
					Span	Rise	Crown	Size	Depression above
1903	Yonkers, N. Y.	0.06	4' 0"	1:2 0:5	10' 6"	1' 6"	6"	17" X 17"	93 1/4"
1903	Watertown, N. Y.	0.40	2' 0"	1:2 0:5	10' 0"	1' 6"	6"	18" X 18"	10"
1909	Providence, R. I.	10.00	2' 0"	1:2 1/2:5	10' 3"	1' 6"	6"	20" X 20"	15"
1903	Ithaca, N. Y.	0.25	2' 0"	1:2 1/2:4 1/2	10' 6"	1' 6"	6"	18" X 18"	10 1/4"
1912	Grand Rapids, Mich.	0.22	none	1:2:4	10' 6"	2' 0"	9"	24" X 24"	none
1909	New Orleans, La.	3.74	1' 0"	1:2 1/2:5 1/2	10' 8"	2' 6"	6"	16" X 16"	...
1907	Cincinnati, O.	1.05	none	1:2 1/2:5	11' X 9 1/2'	2' 6"	8"	21" X 21"	none
1909	Springfield, Mass.	3 12	2' 0"	1:3 1:5.3	11' 4"	2' 0"	6"	20" X 20"	15"
1911	Toronto, Ont.	2 23	2' 0"	1:2 1/2:4 1/2	11' 4"	2' 0"	6"	20" X 20"	14"
1911	Toronto, Ont.	10.08	2' 0"	1:2 1/2:4 1/2	11' 4"	2' 6"	6"	20" X 20"	14"
1910	Owen Sound, Ont.	0.49	11' 6"	2' 6"	6"	18" X 18"	14"
1905	New Milford, N. J.	0.25	none	1:2 1/2:5	11 1/2' X 9 1/2'	2' 6"	8"	24" X 24"	none
1903	Washington, D. C.	5.18	2' 0"	1:3 1:5.3	11' 10"	2' 6"	6"	22" X 22"	17"
1908	Columbus, O.	0.53	none	1:2 1/2:3 1/2	12' X 9 1/2'	2' 6"	8"	24" X 24"	none
1913	Minneapolis, Minn.	0.38	none	1:2:4	12' X 11'	3' 0"	9"	26" X 26"	none
1899	Albany, N. Y.	5.74	2' 0"	1:3:5	11' 11"	2' 6"	6"	21" X 21"	6"
1897	Wellesley, Mass.	0.12	2' 0"	1:2 1/2:4 1/2	12' 0"	2' 6"	6"	24" X 24"	none
1900	Superior, Wis.	0.59	2' 0"	1:3:5	12' 0"	2' 6"	6"	20" X 20"	6"
1903	Brookline, Mass.	1.4	1' 6"	1:2:4	12' 0"	2' 6"	6"	20" X 20"	none
1910	Wilmington, Del.	2.11	none	1:3:5	12' 0"	3' 0"	9"	24" X 24"	none
1905	Milford, N. J.	0.10	none	1:2 1/2:5	12' X 11 3/4'	2' 6"	8"	24" X 24"	none
1913	Montreal, P. Q.	0.65	none	1:2 1/2:5	12' X 10 1/4'	3' 0"	8"	30" X 30"	none
1913	Montreal, P. Q.	1.35	3' 0"	1:2 1/2:5	12' X 10 3/4'	3' 0"	8"	30" X 30"	none
1913	Montreal, P. Q.	0.23	3' 0"	1:2 1/2:5	12' X 10 1/4'	3' 0"	8"	30" X 30"	21"
1913	Montreal, P. Q.	0.53	none	1:2 1/2:5	12' X 10 1/4'	3' 0"	9"	30" X 30"	none

1899	Clinton, Mass.....	0.18	4' 6"	1:2½:4	12' 1"	2' 6"	12"	30"×30"	none
1903	Washington, D. C.....	23.72	2' 0"	1:3:1.5:3	12' 2"	2' 6"	6"	22"×22"	17"
1909	Yonkers, N. Y.....	1.55	2' 0"	1:3:5	12' 2"	2' 6"	6"	22"×22"
1899	Concord, Mass.....	0.06	2' 6"	1:2:5	12' 9"	3' 0"	6"	24"×24"	none
1912	Roland Park, Md.....	0.34	2' 0"	1:2½:5¼	13' 0"	2' 8"	6"	20"×20"	18"
1907	Philadelphia, Pa.....	16.50	2' 0"	1:3:5	13' 2"	3' 0"	6"	22"×22"	21"
1907	Lawrence, Mass.....	0.74	3' 0"	1:3:5	13' 2"	2' 9"	6"	22"×22"	20"
1908	Pittsburgh, Pa.....	46.0	3' 0"	1:3:5	13' 2"	3' 0"	6"	22"×22"	21"
1910	Pittsburgh, Pa.....	10.0	2' 3"	1:3:5	13' 2"	3' 0"	6"	20" dia.	21"
1904	Philadelphia, Pa.....	13.23	2' 0"	1:3:5	13' 5"	3' 0"	6"	22"×22"	21"
1913	Baltimore, Md.....	2.78	2' 0"	1:2½:5	13' 6"	3' 0"	6"	18"×18"	21"
1912	Philadelphia, Pa.....	17.2	none	1:2½:5	13' 6"	3' 9"	10"	30"×30"	none
1902	Natick, Mass.....	1.02	2' 0"	1:2½:4½	13' 6"	2' 9"	6"	20"×20"	none
1912	Grand Rapids, Mich.....	0.57	1' 6"	1:2:4	13' 10"	3' 0"	6"	14"×14"	22"
1902	Philadelphia, Pa.....								
1902	Lower Roxborough.....	2.69	2' 0"	1:3:5	14' 0"	3' 0"	6"	22"×22"	21"
1902	Lower Roxborough.....	0.70	2' 0"	1:3:5	14' 0"	3' 0"	6"	22"×22"	21"
1903	Upper Roxborough.....	5.58	2' 0"	1:3:5	14' 0"	3' 0"	6"	22"×22"	21"
1903	Upper Roxborough.....	1.74	2' 0"	1:3:5	14' 0"	3' 0"	6"	22"×22"	21"
1904	Belmont.....	3.48	2' 0"	1:3:5	14' 0"	3' 0"	6"	22"×22"	21"
1907	Torresdale.....	24.75	2' 0"	1:3:5	14' 0"	3' 0"	6"	22"×22"	21"
1907	Torresdale.....	7.50	2' 0"	1:3:5	14' 0"	3' 0"	6"	22"×22"	21"
1907	Torresdale.....	10.53	2' 6"	1:3:5	14' 0"	3' 0"	6"	22"×22"	21"
1902	Milford, Mass.....	0.25	1' 6"	1:3:5	14' 0"	3' 0"	6"	24"×24"	18"
1909	Springfield, Mass.....	2.12	2' 0"	1:3:1.5:3	14' 0"	2' 9"	6"	24"×24"	18"
1908	Columbus, O.....	1.63	2' 4"	1:2½:5½	15' 2"	3' 2"	6"	20"×20"	23"
1905	Washington, D. C.....	2.28	2' 0"	1:3:1.5:3	15' 6"	3' 6"	6"	30"×30"	25"
1905	Ashland, Wis.....	0.50	2' 0"	1:2½:5	15' 9"	3' 6"	6"	28"×28"	none
1908	Pittsburgh, Pa.....	6.36	3' 0"	1:3:5	15' 9"	4' 0"	6"	27" dia.	26"
1896	Somersworth, N. H.....	0.50	2' 6"	1:2½:5	16' 0"	4' 0"	6"	34"×34"	none
1913	Minneapolis, Minn.....	7.65	2' 0"	1:2:4	16' 4"	3' 6"	6"	20"×20"	24"
1913	Montreal, P. Q.....	6.9	3' 0"	1:2½:5	17' 0"	4' 3"	5"	21"×21"	24"

shows the results of the calculation of stresses in the Pittsburgh filters based on assumption (2),¹ i.e., assuming the arches cut along the groin lines.

Owing to the indeterminate character of the stresses existing in groined arches, it is necessary to follow precedent to a considerable extent in the design of such structures. Table XVI, taken from the Annual Report of the Water Board of Baltimore, gives data on a number of groined arches that have been constructed and have given satisfaction. Figure 71 shows sections through the groined arches over the filters at Washington, D. C., and Fig. 72 gives an interior view of the groined arches over the filter basins at Ashland, Wis.²

¹ *Engineering and Contracting*, Apr. 6, 1910.

² *Trans. Am. Soc. C. E.*, vol. 43.

CHAPTER VI

DAMS AND SEA WALLS

Introduction.—Dams are constructed for (1) impounding water, (2) diverting water, (3) raising the level of streams to aid navigation or for other purpose and (4) retention of water for flood control. They are built of various materials, chief of which are earth, loose rock, timber, steel, and masonry including stone, plain concrete and reinforced concrete masonry, as well as of various combinations of these materials.

A dam may be a plain gravity type, i.e., its stability depending upon its weight only, or it may be built up structurally as an arch or otherwise, in which case its stability does not depend upon its weight alone.

A *breakwater* is a wall or other obstruction to waves built to protect a shore or a harbor. Breakwaters are built of loose rock, timber, masonry, or combinations of these materials.

The forces to which these structures are subjected and the principles underlying their design will be presented in the following pages.

Prior to 1853, dams were built empirically altogether, but in that year, De Sazilly, a French engineer,¹ explained the nature of the forces to which a dam is subjected, and since that time, the design of dams has been reduced to a scientific procedure. Edward Wegmann in 1884 made a series of studies for the Quaker Bridge dam near the mouth of the Croton river (which was afterward built a mile farther up the stream and named the new Croton dam), and these studies have probably advanced the science of dam design more than any other one contribution. Previous to that date, the highest dam was 184 ft., near St. Etienne, France, but Mr. Wegmann's studies contemplated a dam near 300 ft. high, and since that time, dams have been built to much greater heights. Table XVII gives the height and base of a few notable plain gravity dams (arch dams have been built recently to exceed these heights):

¹ *Annales des Ponts et Chaussées*, vol. 2.

TABLE XVII.—DIMENSIONS OF GRAVITY DAMS

Dam	Date	Dimensions, ft.			Material
		Height	Base	Top	
Boyd's Corners.....	1872	78	57	8.5	Conc. and stone face
San Mateo.....	1887	170	176		
Titicus.....	1895	109	75	21	Conc. and stone face
Wachusett.....	1906	205	187	22.5	Rubble
New Croton.....	1907	238	185	18	Stone masonry
Barker's Meadow....	1909	175	124	16	Concrete
Kensico.....	1910	250	228	28	Concrete
Ashokan.....	1913	220	190	2.6	Concrete

In the design of a masonry dam, the following factors should be considered: (a) Stability, (b) Imperviousness, (c) Economy, and sometimes (d) Appearance.

Forces Acting on a Dam.—The forces acting on a dam are:

1. Pressure of the water:
 - (a) Horizontal,
 - (b) Downward on back slopes,
 - (c) Upward or buoyant,
2. Ice pressure,
3. Wind pressure,
4. Wave action,
5. Pressure of the earth at the bottom and at the ends where the dam extends into the earth,
6. Gravity, or weight of the dam,
7. Reaction of the foundation,
8. Reaction at the ends.

The first four of these include the forces which tend to overturn the dam, (except the downward pressure of the water on the back), while the last four are those which tend to resist the former and to give the structure stability. These forces must of necessity be in equilibrium. The exact amount and the point of application, of each of these forces, with the exception of the horizontal water pressure, are indeterminate, hence, the design of a dam is a matter of approximation to a great extent and not a matter of close precision. Moreover, the conditions as affected by the site are seldom the same in two instances, hence, the design in each case must be considered with reference to the peculiar conditions attendant on that situation.

Horizontal Pressure of Water.—By well known principles of hydraulics, the unit pressure on a submerged surface at any point is

$$p = wh$$

where p is the pressure in pounds per square foot, w is the weight in lbs. per cubic foot of water (62.4 for fresh water at 32° F. and about 64.2 for ocean water) h is the depth in feet to the point in question.

If A is the width of any surface extending from the top of the water to a depth H , the total pressure is

$$P = \frac{1}{2}wAH^2$$

and on any submerged rectangular surface, the pressure is

$P = \frac{1}{2}wA(H_1^2 - H_2^2)$ where H_1 and H_2 are the depths to the bottom and the top of the surface respectively.

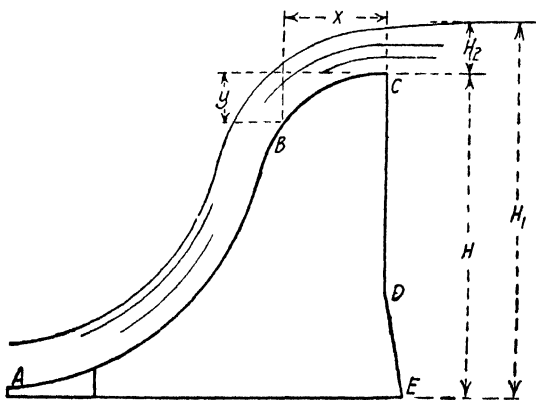

FIG. 73.—Head on an overflow dam.

The center of pressure can be readily calculated, the resultant for a rectangular surface passing through the center of gravity of the trapezoid whose bases are respectively the pressure at the bottom and at the top of the surface considered. For any surface

$$x = I/S$$

where x is the distance from the intersection of the plane with the surface of the water, I and S are the moment of inertia and the statical moment respectively of the plane about that intersection. On a rectangular strip such as is commonly under con-

sideration, the center of pressure is at a distance from the bottom of $H/3$ where H is the depth of the water.

In an overflow dam as shown in Fig. 73, if the curve of the downstream face is such that a particle of water with an initial velocity of $\sqrt{2gH_2}$ would pass clear over the crest, (i.e., if the ordinate to the curve is as great as or greater than indicated by the equation, $y = x^2/4H_2$) the weight of the water on the crest should not be counted as a vertical force acting on the dam, but if the inclination of the downstream surface is less than this, the water on the crest will exert a force downward on the dam varying with the flatness of the crest.

In general, the water on the lower face of an overflow dam does not exert much pressure on the dam, the only pressure being the reaction required to deflect the course of the water and in well designed overflow dams, this is negligible. However, if the water does not flow over the dam "nappe free," that is with a free access of air beneath the sheet of water, a partial vacuum may be formed which will exert a "pull" on the downward face of the dam tending to overturn the structure, the possible maximum value of which would be the horizontal impulse of the sheet of water.

Inasmuch as the water in the cross section of the channel above the dam is diverted upward nearly at right angles when it strikes the dam, a horizontal force nearly equal to the pressure due to the velocity head in the channel above the dam should be counted as acting on the structure. The center of pressure of this force is approximately at half the depth, the mean velocity being at about 0.6 the depth from the surface. This pressure head equals $v^2/2g$, where v is the velocity of the water. Thus if the velocity of approach is 0.5 ft. per second, this pressure would amount to 0.24 lb. per square foot. Obviously the pressures from this source will be small.

The collection of silt above the dam may increase the pressure on the dam considerably. The pressure from silt should be calculated as the pressure of a fluid having a specific gravity of about 1.6, for it is essentially in a fluid state in many cases.

The pressure on the lower face from water in the lower pool should be calculated as for water in the upper pool. Due to overflow, however, the pressure from water in the lower pool may be almost entirely prevented, hence, this action should not generally be counted on in calculating the stability of the structure.

Uplift Due to Intrusive Water.—If the foundation or any horizontal plane of a dam is permeable so that water under hydrostatic head may enter, a vertical uplift will result, which may be a force of considerable magnitude tending to overturn the dam. Care should be exercised, therefore, to make the foundation as nearly impervious as possible in order to minimize this force. Obviously, the amount of this force depends upon the permeability of the dam, for full hydrostatic pressure is not exerted through water in a capillary state, while, on the other hand, if the water

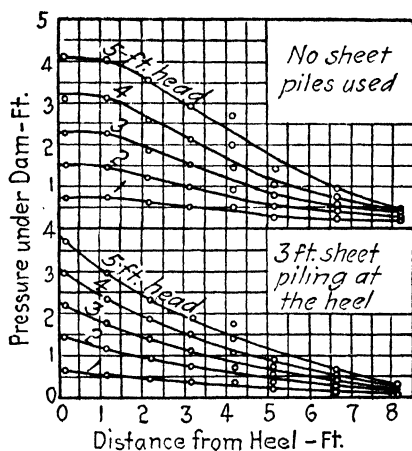

FIG. 74.—Hydrostatic pressure under a model dam.

enters as a connected sheet, the full hydrostatic force will occur.

Obviously the proportion of the full hydrostatic head that is effective in producing upward pressure on the dam depends upon the character of the foundation, and very few observations have been made to determine the behavior of this pressure. Figure 74¹ shows the variation under a model dam whose base was 8.25 ft. long resting on sand. The pressures were observed also with sheet piling 3 ft. long at the heel and 1.5 ft. long at the toe. The effect of sheet piling in reducing the intensity of pressure is noticeable from the results.

The exact amount of this pressure and the location of its center of pressure are matters of considerable uncertainty, for they vary with the local conditions. In view of this fact, the character of the foundations at each dam site should be studied in order to

¹ *Trans. Am. Soc. C. E.*, vol. 80, p. 445.

ascertain as accurately as possible the facts in each case. If the foundation is solid rock without seams or faults, concrete will adhere perfectly and the effect of intrusive water may be avoided entirely. At the Keokuk dam, for instance, (an overflow dam about 45 ft. high) holes were bored in the foundations to a depth of 35 ft. after the rock had been removed to what was apparently solid foundation. Besides serving as a test for seams of mud or other fault material, these holes were used as a test of the imperviousness of the rock by attaching an air line to them carrying 100 lb. air pressure. If no air leaked into the neighboring holes, the foundations were assumed to be satisfactory. In this case, no allowance was made for the upward pressure of intrusive water.

As the opposite extreme condition, if the foundation is of gravel or other porous material, or is seamy, and a pool exists below the dam (which would be the case with an overflow dam) conservative design would require that the full hydrostatic effect of the water should be counted upon, varying from somewhat less than the head in the pool above to the head in the pool below. If there is to be no pool below, the pressure at the toe will be zero and will vary uniformly to a certain fraction of the head in the upper pool. The proportion of effective area may vary from zero for solid rock as in the case at Keokuk to perhaps 0.7 or more for seamy rock or otherwise unfavorable foundation. The amount of this effective area is a matter about which there is a difference of opinion and the judgment of the engineer will have to be relied upon in estimating it. Table XVIII gives the percentage of theoretical uplift adopted in the design of various dams.

TABLE XVIII.—EFFECTIVE HEAD UNDER DAMS

Dam	Foundation	Head, ft.	Per cent effective,
Wachusett.....	Schist, granite	205	66
Cross River.....	Seamy gneiss	153	66
Elephant Butte.....	Coarse sandstone	264	33
Olive Bridge.....	Seamy rock	130	66
Kensico.....	Gneiss, schist, limestone	160	66
Scioto.....	Seamy limestone	52	66
Keokuk.....	Solid limestone	42	0

Tests¹ indicate that the hydrostatic pressure generally does not exceed three fourths of the theoretical pressure, although these tests were too meagre to justify a definite conclusion.

One method that has been extensively used for estimating the proportional pressure at any point is by the "line of creep" theory. It assumes that the pressure is reduced in proportion to the distance the water must travel in reaching the point considered, and that the water follows the surface of contact of the

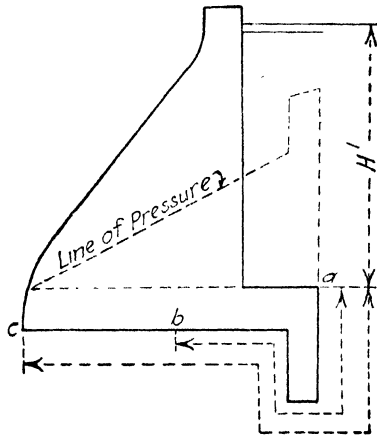

FIG. 75. Line of creep theory of hydrostatic pressure under a dam.

dam with the foundation. That is, if the pressure is reduced a certain amount, H' , in the dam from heel to toe, the reduction at any point will be $\frac{ab}{ac} H'$ in Fig. 75. However, observations at Island Park dam² indicate that the actual pressure does not always follow the "line of creep" theory. Observations³ on the Maquoketa River dam indicate that the "line of creep" theory gives conservative results; and at the Island Park dam at Dayton, where there was a mud blanket on the reservoir bottom, the observed pressure was below that given by this theory.

Obviously, the pressure at any point in the dam will be only such a head as will force the internal water to an exit at the toe,

¹ *Engineering News*, July 31, 1913; *Proc. Am. Soc. C. E.*, vol. 40, p. 955.

² *Engineering News-Record*, May 20, 1920.

³ *Proc. Am. Soc. C. E.*, vol. 54, p. 1357.

into a drain or elsewhere. From this axiomatic statement, it follows that if the lower portion of the dam foundation is porous so that the water can escape readily, or if the lower portion is well underdrained, the hydrostatic pressure will be much reduced from what it would be if the dam foundation is homogeneous.

In practical design, therefore, so far as hydrostatic pressure from intrusive water is concerned, the dam should consist as nearly as possible of an impervious upper face and a body, or lower portion, which supports that upper face and permits the ready egress of any water that may percolate into the dam. By the construction of a cut-off wall, by extra dense masonry, or by other device, the water should be kept out of the dam so far as possible, but since all water can not be entirely excluded, any water that gets into the dam should be conducted away as rapidly as possible. The construction of a cut-off wall is perhaps one of the most effective devices for accomplishing this purpose. A layer of silt against the heel of the dam has been found effective also.

In this connection, the effect of horizontal construction joints should be noted. Storms and various interruptions are likely to cause seams; some methods of construction permit the use of a wet concrete from which laitance $\frac{1}{2}$ in. thick or more may collect and form a permeable bed into which the water may intrude; in either case, a large internal pressure may result. Care should be exercised, therefore, to break up the continuity of the horizontal seams so as to prevent the entrance of a sheet of water.

Drainage of dam foundations will always be advantageous, even where conditions are the most favorable. In many dams recently built, large inspection galleries have been placed in the body of the structure into which entrance is readily made from the top or from the ends.

Wave Action.—The chief effect of waves so far as the design of dams is concerned is to increase the effective head on the dam to the extent of the height of the wave. Usually this increase in pressure is not large. The height of waves may be estimated from a formula given by Thomas Stevenson, a noted Scotch harbor engineer, which is

$$h = 1.5\sqrt{F} + (2.5 - \sqrt[4]{F})$$

in which h is the height of wave in feet and F is the "fetch" or the

longest line of exposure of the surface of the water to the wind expressed in miles. This formula was derived from observations under windy conditions and gives rather large results.

Unless the waves break due to shallowness of approach, there is very little impact effect, and in masonry dam design, the impact effect may be practically neglected. However, in the design of breakwaters the impact effect of waves is of great importance.

The amount of water impinging on a square foot of surface per second due to the approach of a wave is wv/g , w being the weight of a cubic foot of water and v the velocity in feet per second. According to the principle of impulse and momentum, the force of impact would be wv^2/g , since this amount of momentum is destroyed in one second. Major Gaillard gives the following formula for the velocity of waves in shallow water¹

$$v = \sqrt{g(d + \frac{3}{4}h)}$$

where d is the depth of the water and h the height of the wave, and considers the velocity of the crest of a breaking wave as 30 per cent greater than the general velocity of the wave. The depth at which waves break has been found to vary from $1.7h$ to $2.7h$. Dr. Brysson Cunningham² concludes a valuable discussion on the subject by proposing the formula for the pressure of waves due to impact

$$p = 3.2gh$$

p being the pressure in pounds per square foot, h the height of wave in feet, g the acceleration of a body due to gravity.

The effect of waves in disintegrating a surface is very marked because of water ram. Cavities in a breakwater or other structure may become filled with water having a small entry way to the outside. Waves producing a pressure in this entry way have their pressure multiplied in proportion to the area of the cavity inside, producing a disruptive force of considerable magnitude. It is highly important from these considerations to construct the face free from crevices or other cavities into which the waves may force the water.

Ice Pressure.—Ice expands with a decrease in temperature, hence, when a reservoir is covered with ice, the dam is subject

¹ *U. S. Army Engineers, Professional Papers*, 31, 1904.

² BRYSSON CUNNINGHAM, "Harbour Engineering," p. 175.

to a thrust due to its expansion. Where ice is enclosed so that the pressure is confined, as in a globe or vessel, this pressure is enormous, being sufficient to burst most materials. However, such conditions do not obtain in a reservoir, for the ice may expand upward into the air and laterally along the sloping shores. This pressure would probably never amount to the crushing strength of ice, viz., 100 to 1,000 lbs. per square inch, unless the ice should be floating and exert its pressure by impact, or should be in practically a confined condition. The following is quoted from a discussion on the subject by C. L. Harrison¹ as covering the conditions where ice pressure need not be provided for:

"1. For the ordinary storage reservoir with sloping banks, in climates where the maximum thickness of ice is 6 in. or less,—for dams with a southern exposure, this limit may be placed at 1 ft.

"2. For reservoirs which are filled during the flood season and from which all the stored water is drawn off each year during the low water season. This would include even the large reservoirs on the head waters of the Mississippi River, where the ice has a thickness of more than 4 ft. and the atmospheric temperatures reach 50° below zero.

"3. For storage reservoirs where water will be drawn off each year during the winter to a level where the dam is strong enough to resist the ice pressure.

"4. For reservoirs where the contour of the ground at high water level is such that the expansive force of the ice will not reach the dam."

TABLE XIX.—ALLOWANCE FOR ICE PRESSURE IN DAM DESIGN

Dam	Location	Pressure lbs. per linear ft.
Wachusett.....	Boston	47,000
Olive Bridge.....	Catskills	47,000
Kensico.....	New York	47,000
Croton Falls.....	New York	30,000
Cross River.....	New York	24,000
New Croton.....	New York	none
Scioto.....	Columbus	34,000

The data of Table XIX indicates the amount of ice pressure allowed in a number of instances of dam design.

The reason for the smaller allowance for the Cross River and Croton Falls dams was that the local conditions of topography were such that the full ice pressure would not reach the dam.

¹ *Trans. Am. Soc. C. E.*, vol. 75, p. 219.

Ice flows cannot exert great pressure on a non-overflow dam because of the low velocity of approach, and, moreover, the ice is usually soft under such conditions. While the pressure on overflow dams may be more, it probably is less than that due to the expansive force.

Wind Pressure.—For the condition of reservoir full, the effect of wind pressure would scarcely ever need to be taken into account unless the dam projects to an unusual height above the water. With the reservoir empty, the effect of wind pressure on the face of the dam should be considered in computing the pressure at the heel and in the design of the back of the dam.

Weight of a Dam.—The weight of a dam may be computed if the specific weight of the masonry is known. The data of Table XX indicate the weights of masonry commonly used in dams.

TABLE XX.—WEIGHT OF MASONRY IN DAMS

Class of masonry	Weight, lbs. per cu. ft.
Ashlar	
Granite.....	165
Limestone.....	160
Sandstone.....	140
Rubble	
Granite.....	155
Limestone.....	150
Sandstone.....	130
Concrete	
Trap aggregate.....	150—160
Gravel.....	140—160
Granite.....	145—160
Limestone.....	145—150
Sandstone.....	130—140
Reinforced concrete.....	add 6 per cent to above

The method of finding the position of the center of gravity will be indicated at another place.

Pressure of the Earth.—Masonry dams are almost necessarily set on rock foundations and as a consequence, it is usually necessary to sink the dam to a considerable depth below ground level. As a result, the earth exerts a pressure against the lower part of the dam. For example, the Croton Falls dam extends

55 ft. into the earth and the Olive Bridge dam extends about the same distance. The method of calculating the pressures from the surrounding earth will be explained in the next chapter under retaining walls.

Reaction of the Foundation.—Let ΣP be the resultant of all horizontal forces and ΣW the resultant of all vertical downward forces and R the resultant of these. These forces cause a reaction R' in the foundation which must be equal and opposite to R in order that the dam may be in equilibrium. If e represents the eccentricity of the resultant R and V the vertical component, that is, the distance from the middle of the base to the point where R passes through the base, then the pressure at the toe and heel of the dam are given by the familiar formula from mechanics

$$p = \frac{V}{b} \left(1 \pm \frac{6e}{b} \right) \tag{1}$$

the plus sign applying to the toe and the minus to the heel. This condition is represented in Fig. 76 (a) and (b) and is pre-

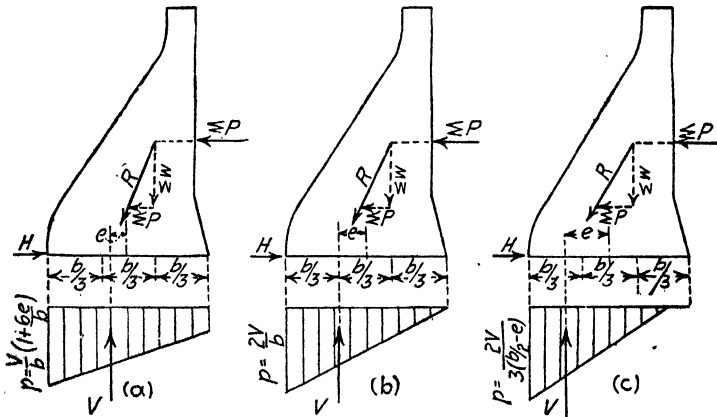

FIG. 76.—Pressure distribution under a dam.

indicated on an elastic reaction of the foundation. An elastic reaction probably obtains only where the foundation is solid rock and the masonry does not sustain high unit stresses.

The equation given above is applicable so long as the resultant falls within the kern or middle third of the base, or so long as

there is only compression in the masonry, and also if the masonry and its connection with the foundation is capable of taking tension at the heel. However, the strength of masonry in tension and the adhesion to the foundation are so uncertain that it is not safe to assume any tensile strength whatever at the heel of the dam. The maximum stress under this condition must be calculated on the basis of a redistribution of the stresses in the reaction in which the bearing is over an area having a width less than the width of the dam. The point at which the resultant cuts the base and, hence, e , can be ascertained. The maximum pressure as illustrated in Fig. 85 (c) is

$$p = \frac{2V}{3(b/2 - e)} \quad (2)$$

since the length of the base over which the stress is distributed is $3(b/2 - e)$, the center of gravity of a triangle being at one-third the height, and area one-half the product of the base and altitude.

Conditions of Stability of Dams.—Three conditions must be fulfilled before a masonry dam may be stable:

1. It shall not *slide* (a) along any plane or joint in the dam, (b) nor along the plane of the foundation, (c) nor along any seam in the foundation.

2. It shall not *overturn* (a) about any horizontal plane or joint in the dam, (b) nor about the plane of the foundation, (c) nor about any bedding plane in the foundation.

3. The *stresses* in the masonry shall not exceed safe limits: (a) in compression at the toe or at any plane in the dam nor (b) in shear or diagonal shear along a vertical section in the downstream slope.

In order that a dam may not slide at any horizontal plane it is necessary that the weight of the superimposed material multiplied by the coefficient of friction shall be equal to or greater than the horizontal forces tending to slide the portion of the dam above that plane. Sliding is the most common mode of failure of masonry dams, either at the base or at a horizontal seam in the rock on which the structure rests. The buoyant effect of intrusive water is especially serious in this connection. The coefficients of friction for various materials are as follows:

TABLE XXI.—COEFFICIENTS OF FRICTION OF VARIOUS MASONRY MATERIALS

Material	Coefficient
Granite (roughly worked) on gravel and sand (wet).....	0.41
Pine (sawed) on gravel and sand (wet).....	0.41
Granite (roughly worked) on sand (dry).....	0.65
Granite (roughly worked) on sand (wet).....	0.47
Masonry on clayey gravel.....	0.58
Masonry on dry clay.....	0.51
Masonry on moist clay.....	0.33
Point dressed granite (medium) on like granite.....	0.70
Point dressed granite (medium) on common brickwork.....	0.63
Point dressed granite (medium) on smooth concrete.....	0.62
Fine cut granite (medium) on like granite.....	0.58
Dressed hard limestone (medium) on like limestone.....	0.58
Dressed hard limestone (medium) on brickwork.....	0.60
Beton blocks (pressed) on like beton blocks.....	0.66
Common bricks on common bricks.....	0.64
Common bricks on hard dressed limestone.....	0.60

The factor of safety against sliding will be the ratio of the total resisting force to the total sliding force. When the dam is safe against overturning and against crushing of the masonry at the toe, it will usually be safe against sliding on any plane. However, several dams have failed by sliding on the foundation owing to the buoyant effect or vertical uplift of the water under the dam.

For stability against overturning, the moment of the resisting forces about the toe of the dam should be greater than the moment of the overturning forces about that same point. The factor of safety against overturning will be the ratio of these two moments.

Quality of Masonry Required.—A dam of built up stone masonry almost always leaks some when first constructed but generally this leakage diminishes with time as the silt from the water tends to clog the pores of the masonry. In a few cases, masonry dams have been coated with a rich concrete or mortar over the back in order to increase the imperviousness. This has been accomplished advantageously in a few instances by means of the "cement gun."

Concrete as rich as 1:9 or richer will prove sufficiently impervious for a gravity dam, as the porous spaces usually fill up with

silt from the water and magnesian and other salts transferred from other parts of the structure. However, it is seldom that the downstream face of a high masonry dam is dry or free from small seeps. These, fortunately, are of little consequence.

For thin arch dams, the quality of the concrete should be much better than for gravity dams. Usually a 1:6 or a 1:7½ mixture properly graded will be necessary to secure the requisite imperviousness. The stresses are generally kept rather low so that such concrete is amply strong to sustain the loads coming upon the structure. The mixture should be of a mushy consistency and care should be exercised to avoid "honeycombed" concrete due to the leaking of the matrix through the forms while placing the concrete.

Imperviousness and Drainage.—Although it is impracticable to make a dam absolutely impervious, it should be as nearly impervious as can be conveniently attained. A dam properly consists of two elements, (a) the upper portion or back of the dam, in the design and construction of which special attention should be given to rendering it impervious, and (b) the support or downstream body of the dam. These two portions are not built as structural entities, of course, but in function, the distinction should be kept in mind.

Dams may leak through construction joints, through the junction with the foundation or around the ends. Leaks through the foundation itself or through permeable strata underlying the reservoir frequently occur, but usually these are not due to any fault in the dam itself, although the entire project may be at fault in that a proper site was not selected. Unless the leakage is considerable, the escape of water through the body of a masonry dam is not serious.

The use of dense masonry in the upper portion of the dam and the building of a cutoff wall at the heel are perhaps the best devices for preventing leakage.

Drainage of the foundation of a dam is important, especially where there is a likelihood of considerable water seeping under the dam. With sufficient care in constructing the cut-off wall and the installation of adequate drainage, the effect of the uplift pressure of intrusive water can be practically eliminated. Figure 77 is the design of the Lower Otay dam as recommended by M. M. O'Shaughnessy,¹ City Engineer of San Francisco, and

¹ *Engineering Record*, Aug. 12, 1916.

illustrates a complete drainage system under a high masonry dam.

Design of Section for a Gravity Dam.—The economical section of a dam is the one that fulfills the above requirements for

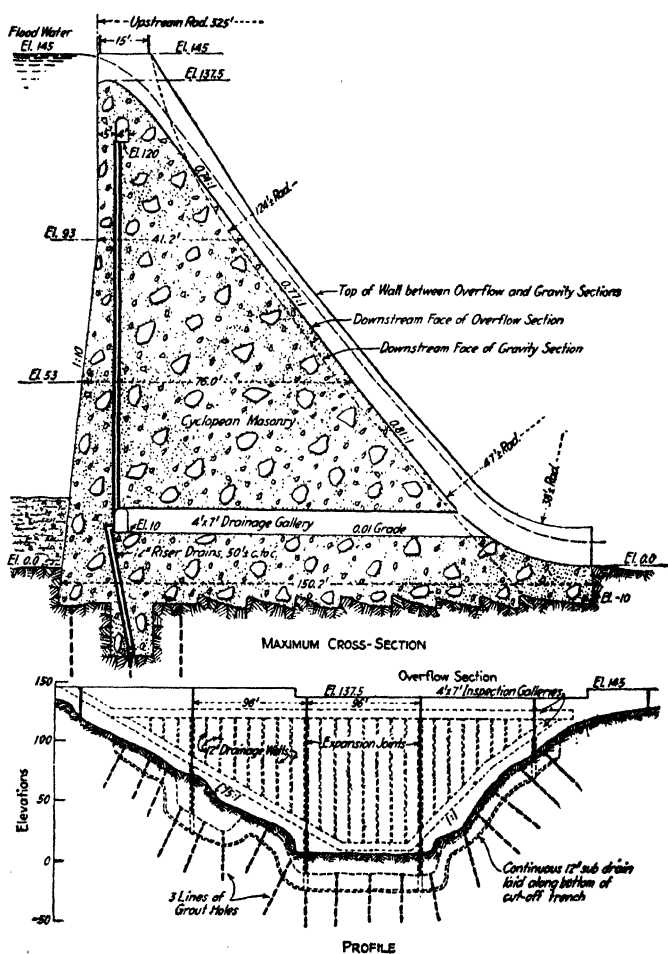

Fig. 77.—Section of the lower Otay dam (proposed).

stability and imperviousness at a minimum cost. Generally, the economic section will be the one that is stable and contains the minimum quantity of masonry, although owing to peculiarities in the foundation and to the variation in the costs of different

kinds of masonry, this may not always be true. Theoretical considerations¹ indicate that the economical top width of masonry gravity dams is about 14 to 17 per cent of the average height, although 10 per cent is the figure most commonly used. However, the top width will frequently be governed by other considerations, such as the resistance to ice pressure, the presence of

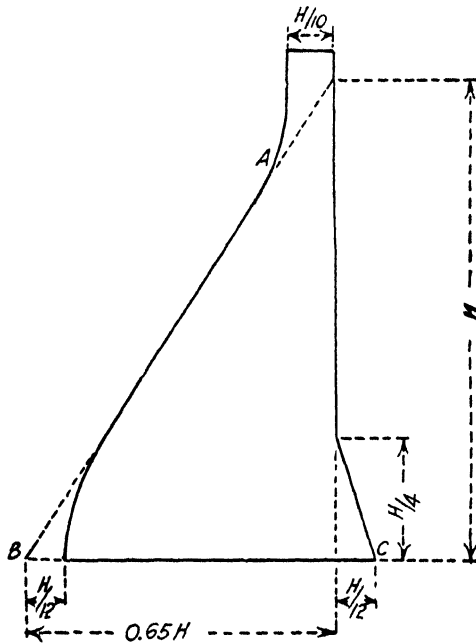

FIG. 78.—Approximate section for a gravity dam.

a roadway on top of the dam, etc. With the top width given, the outline of the face and of the back is then selected to conduce to economy. Equations for economical profile with curved face and back have been devised, but owing to the variability of conditions, they are of little general value. Low non-overflow dams are usually of trapezoidal section, and overflow dams should have an ogee curve on the downstream face. In any case, the condition should be satisfied that there shall be no tension in the masonry at the heel when the reservoir is full.

Dams over 40 ft. in height are built more economically if the lower side or face is in the form of a curve or of broken line. An

¹ *Trans. Am. Soc. C. E.*, vol. 80, p. 723.

approximate outline of cross section can be formed by a triangle whose base is 0.65 of the height and adding a trapezoidal portion at the top having a width of $H/10$ to provide for ice and wave action, and a triangular portion at the heel with a height of $H/4$ and width of $H/12$ to provide for conditions of reservoir empty. See Fig. 78. Such an outline, rounded off somewhat at the toe so that the amount cut off is about $H/12$, and filled in to an even curve at A , gives a fairly close approximation to the theoretical section and may serve satisfactorily in making preliminary investigations and estimates.

It is impossible to formulate general equations for the determination of the shape of a dam. The only feasible procedure is to design the dam, section by section, beginning at the top and testing each section for stability according to the principles previously explained.

Edward Wegmann, C. E., derived certain algebraic equations¹ to facilitate the determination of the length of any joint of a dam, or in other words, the thickness at any level, and these are extracted below. Let W' be the weight of masonry resting on this section, w the specific weight of the masonry, and d the depth of water to the section considered.

Referring to Fig. 79, $x = u + v + n$

$$H \cdot d/3 = M = Wv, \text{ whence, } v = M/W$$

$$W = W' + \left(\frac{l+x}{2}\right)hw \quad \text{whence,}$$

$$v = \frac{M}{W' + \left(\frac{l+x}{2}\right)hw} \quad \text{and}$$

$$x = u + \frac{H \cdot \frac{d}{3}}{W' + \left(\frac{l+x}{2}\right)hw} + n.$$

In the upper portions of the profile where the pressure in the masonry is not large, u and n will be determined by the condition that each should equal $x/3$. When, however, the pressures in the masonry reach their allowable limits, the values of u and n will have to be determined by the equations derived from the trapezoidal distribution of pressures

$$u = 2x/3 - px^2/6W \text{ and } n = 2x/3 - qx^2/6W.$$

¹ EDWARD WEGMANN, "Design and Construction of Dams," p. 17.

in which p and q are the allowable compressive stresses at the face and back of the dam respectively. Inasmuch as the top width is in excess of the actual needs for withstanding the hydraulic pressure, the sides are continued vertical until one of the limiting conditions is reached. It is customary to investigate the section in trapezoidal segments 10 ft. in depth and then make the faces curved by drawing the average outline. Mr. Wegmann's equations do not take into account the upward effect of intrusive water, hence, they should be modified where the hydrostatic upward pressure must be taken into account.

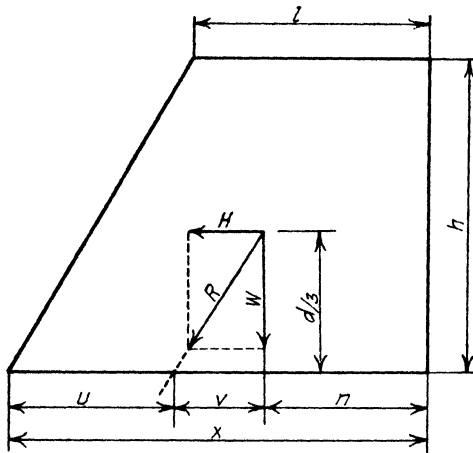

FIG. 79.—Calculation of section of a gravity dam.

Stresses in a Dam.—A graphical method of studying stresses and stress distribution in a dam is illustrated in Fig. 80, which represents a section of the dam 1 ft. long. In this case, the dam is divided into five segments, the center of gravity G_1, G_2 , etc. of the portion above each division line determined and the pressure of the water P_1, P_2 , etc. for the various heights computed. The pressures, P_1, P_2 , etc., are laid off horizontally and the weights W_1, W_2 , etc., are laid off vertically from O . Diagonal lines are then drawn completing the triangle of forces for each succeeding portion of the dam and lines drawn parallel to these through the intersection of the gravity lines with the forces, P , etc., to ascertain where the resultants cut the sections. In a similar manner, the wind pressures are computed for the entire dam and laid off on the other side of the load line and the results drawn similarly.

It is obvious that wind pressures do not greatly affect the stability of a dam. The loads P_1, P_2 , etc. should consist not only of the water pressures, but should include pressure from ice, silt and waves. In the event that flashboards are to be used on top of the dam, the added head should be taken into account. Strictly, the last pressure, P_5 , should be inclined to be perpendicular to the back of the dam; it represents only the horizontal component as drawn.

It is desirable for good design that the resultant of loads and pressures should fall within the middle third of the section in each case, as previously stated.

The limit of the middle third zone is indicated on the section. In this case, it is obvious that the width of the dam in all sections

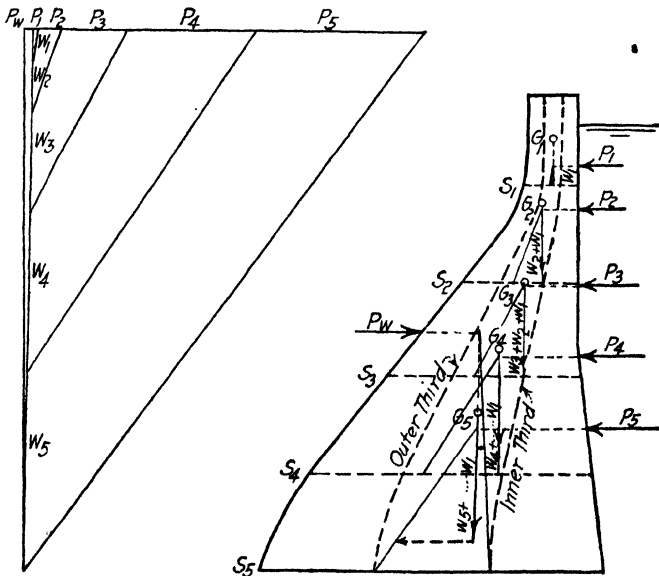

FIG. 80.—Graphical analysis of stresses in a gravity dam.

above the lowest could be decreased somewhat and still allow the resultant to fall within the kern. The direct stresses at the toe of any section can readily be calculated by the general formula, $S = W(1 + 6e/b)/b$ where e is the eccentricity of the resultant where it cuts the base, W , the total superimposed

weight of the section and b the width of base at the section considered.

This formula gives the direct crushing stress at the toe and at the heel, but the maximum stress would result from a combination of this compression stress with the horizontal shear stress at that point according to the familiar formula

$$S = \frac{1}{2}S_c + \sqrt{\frac{1}{4}S_c^2 + S_s^2}$$

S_c being the direct compressive stress and S_s the shear stress.

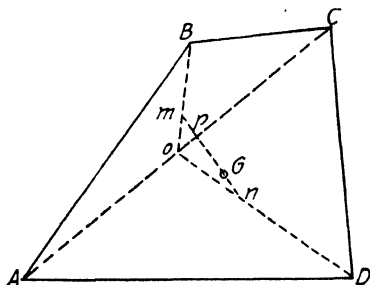

FIG. 81.

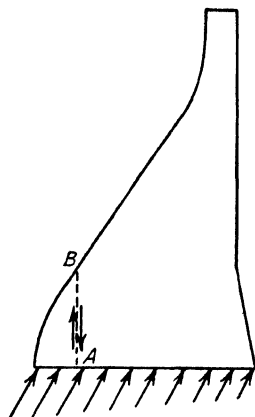

FIG. 82.

FIG. 82.—Shear stresses in a masonry dam.

The shear along any plane AB , Fig. 82, should be investigated as well as the flexural stress along such plane. The reaction of the foundation at the toe may cause the dam to rupture along this plane unless the toe of the dam is made sufficiently thick to withstand such stresses.

Expansion and Contraction in a Dam.—Unless provision is made to allow for the expansion and contraction of a concrete dam, cracks will occur due to temperature changes and due to the shrinkage of the concrete. These follow the planes of least

FOOTNOTE.—The center of gravity of a quadrilateral is readily found by graphics as follows: Draw the diagonal AC dividing the quadrilateral into two triangles. Find the centers of gravity of each of these by drawing the median lines Bo and Do and marking their third points m and n . The center of gravity of the quadrilateral is at G , a distance mp from n , Fig. 81.

resistance in an irregular fashion, marring the appearance of the structure and permitting some leakage, although the latter is usually not serious.

Observations¹ on temperature changes in such structures indicate that the internal temperatures follow closely the seasonal variations in temperature but not the daily variations. From rather incomplete observations, Thaddeus Merriman deduced the total range of temperature Fahrenheit, to be $135^\circ/3\sqrt[3]{D}$, D being the distance in feet from the nearest face of the dam to the point in question and 135° being the total range in atmospheric temperature.

Reinforcement at the top of the Cross River and Croton Falls dams apparently had very little effect on the formation of tem-

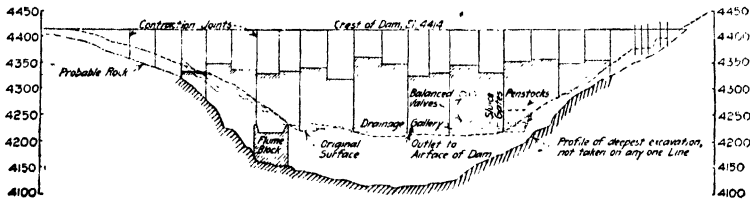

FIG. 83.—Contraction joints in Elephant Butte dam.

perature cracks. Recent practice favors the introduction of expansion joints at intervals of 40 to 80 ft., 50 ft. being the most common practice. Expansion joints should be placed between buttresses and the face slab in reinforced concrete dams.

The usual type of contraction joint consists of a triangular or trapezoidal notch or "keyway" in one face of the joint which is allowed to fill with concrete when the adjacent section is poured. However, before the adjoining section is poured, the entire surface of the section including the keyway is heavily painted with tar or asphalt. In a large dam many such notches or keyways are placed in one joint so that the water in passing through may have as devious a route as possible and hence deposit any sediment, which will aid in rendering the joint watertight.

The introduction of expansion joints marks a step in advance in dam construction, for it not only avoids the random appearance of cracks, but greatly facilitates construction in allowing the dam to be built in alternate sections. In the Elephant Butte dam only alternate contraction joints extended to the base

¹ *Trans. Am. Soc. C. E.*, vol. 61, p. 399; vol. 79, p. 1226.

from the top of the dam. See Fig. 84.¹ From Fig. 83, it is obvious how the introduction of contraction joints permits a dam to be constructed in sections.

Single Arch Dams.—An arch dam is one that does not depend solely upon gravity or the weight of the dam section for its stability, but is arched in plan between the sides of the gorge so that the pressure of the water against the dam is transmitted directly to the sidewalls by arch action. Where the walls of the ravine or canyon are steep and of solid rock, and the gorge is

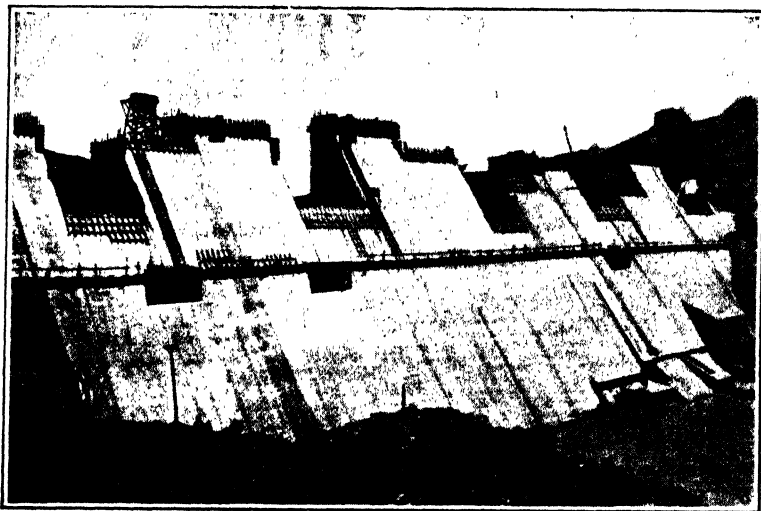

FIG. 84.—Elephant Butte dam during construction.

narrow, the conditions are favorable for the construction of a single arch dam.

The exact solution of the stresses existing in an arch dam is very uncertain and indeterminate, except as it is based on certain assumptions. The chief indeterminate factor is the division of resisting forces between ordinary gravity dam action, vertical beam action and the arch action. With any assumed division of the load, the problem becomes determinate and relatively simple. In some cases, where the side walls are very steep and solid and the gorge very narrow, the assignment of nearly all of the load to arch action is justified, whereas under less favorable circumstances, a less proportion should be assigned to arch action.

¹ *Engineering News*, Sept. 30, 1915.

The tendency is to assume more and more of the pressure of the water to be borne by the arch and less by the gravity of the section. Several dams have been built where the entire load is borne by the arch to the side abutments.

Under the action of normal pressure which exists in water or other fluid, an arch ring at any given height is ideally loaded and the calculations are comparatively simple, if the section is assumed to act as a simple arch. With a circular arch plan, the stress at any elevation in the dam may be taken as that of a cylinder subjected to uniform normal external pressure, or,

$$S = RP/T = 62.3 RH/T$$

where S is the compressive stress in the masonry in pounds per square foot, R the radius of curvature of the upper surface in feet, P the pressure on the upper face per square foot, T the thickness of the dam in feet at that point, and H the head of water in feet at the point considered.

The cylinder formula is defective as a basis for the design of thick arch dams because thick arches do not behave as cylinders and because the stresses caused by shortening of the arch rib from thrust and temperature, which may be of considerable magnitude, are not taken into account. These factors cause tension on the extrados side near the abutments and on the intrados side at the crown.

For a given deflection, since both the arch element and the cantilever element must have the same deflection, the distribution of load to the two elements could be readily enough determined, but, owing to the varying length of the arch element, this division of load would not be the same for any two points. Also, where the bottom of the canyon is irregular, the cantilever element being of variable height would carry a variable portion of the load, leaving a non-uniform water load to be carried by the arch. The shape of the canyon is, therefore, an essential element in a rigid analysis of the problem.

The method of dividing the load between cantilever and arch elements most commonly followed is to calculate the division of the load for one or more cantilever elements and the corresponding arch elements, giving to both the same deflection; e.g., a trapezoidal cantilever section 1 ft. wide on the extrados side at the crown of the arch and a series of horizontal arch elements

1 ft. wide from the top to bottom of the arch. The tentative loads required to produce assumed common deflection in the two elements can be calculated, and the given water load divided proportional to these tentative loads.

Unless the base of the arch is embedded securely in solid rock, cantilever action is discontinued after a small deflection, and the load is borne entirely by the arch elements. Some engineers, therefore, follow the custom of designing the dam to carry full load as an arch. In the test of the Stevenson Creek Dam, the Committee of the Am. Soc. C. E. report¹ that for heads above 20 ft. (on a dam designed to fail at 60 ft.) the load shifted from the vertical to the horizontal elements; the dam cracked from the foundation on the upstream side when the reservoir was half full. Inasmuch as the condition of reservoir full is the critical condition for design, it would seem that the practice of considering all the load as carried by the arch elements is probably justified under ordinary conditions. Assigning part of the load to the cantilever or vertical element by any rational method ordinarily results in a non-uniform residual load on the arch, which for economy would require a non-circular arch. The effect of swelling of the saturated concrete at the extrados also increases the uncertainty with regard to the distribution of load to vertical and horizontal elements. With the present information, it is doubtful, therefore, if, for the condition of reservoir full and ordinary type of juncture with foundations, the assumption that any considerable part of the water load is carried by the cantilever element² is practical. The Am. Soc. C. E. Committee found in the test of the Stevenson Creek model dam (60 ft. high):

“In all cases, the bending load on the upper vertical element was positive in the upper part of the dam; that is, the upper portion of the vertical element, instead of carrying load, was resting on the arch element, which at any elevation in the upper part of the dam was, therefore, carrying more than the total water pressure applied at that elevation. For nearly all sections . . . the load on the vertical ele-

¹ *Proc. Am. Soc. C. E.*, p. 186, May, 1928.

² See Committee on Arch Dams, *Rept., Proc. Am. Soc. C. E.*, May, 1928; also, F. A. NOETZLI, Gravity and Arch Action in Curved Dams, *Trans. Am. Soc. C. E.*, vol. 84, p. 1; WM. CAIN, The Circular Arch under Normal Load, vol. 85, p. 233; B. F. JACOBSEN, Stresses in Thick Arches of Dams, vol. 90, p. 475; C. H. HOWELL, Analysis of Arch Dams by Trial Load Method, *Proc. Am. Soc. C. E.*, January, 1928.

ments changed from positive to negative somewhere between 40 and 35 ft. elevations from the bottom. As shown, the region of positive load on the upper part of the vertical elements extended from the center line to at least 30 ft. from the center line, and possibly farther. The load carried by the vertical element was approximately the same, regardless of location, up to a distance of 30 ft. from the vertical center line."

The following analysis is taken largely from the discussion by Prof. William Cain¹. Figure 85 (b) represents a half elemen-

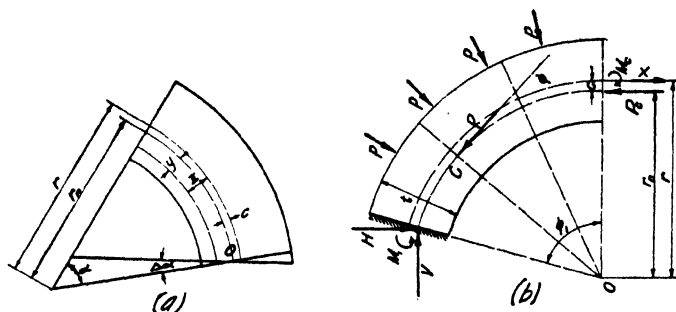

FIG. 85.—Elementary section of an arch dam.

tary arch 1 ft. thick, subjected to water pressure; X is the supplementary crown force required for equilibrium.

r_e , r_i , and r_n are the radii of the extrados, intrados, and neutral surface, respectively

p is the unit pressure on the dam

P , M , and S are, respectively, the thrust, moment, and shear at any point

$$X = pr_e - P_c \quad (1)$$

The internal work due to these stresses is, from the mechanics of materials² (dl being equal to $r d\varphi$), the work of flexure plus the work in direct compression plus the work in shear.

$$W_i = \frac{r_n}{2E_c I} \int_0^{\varphi_1} M^2 d\varphi + \frac{r_n}{2E_c t} \int_0^{\varphi_1} P^2 d\varphi + \frac{r}{2E_c t} \int_0^{\varphi_1} S^2 d\varphi \quad (2)$$

W_i being the internal elastic work for the half arch.

Let E'_c , the shear modulus of elasticity, equal kE_c .

$$\text{Where Poissons ratio is } \frac{1}{7}, k = \frac{m}{2(m+1)} = 0.44 \quad (3)$$

¹ *Trans. Am. Soc. C. E.*, vol. 90, p. 522.

² G. F. SWAIN, "Strength of Materials," pp. 135, 204-5, McGraw-Hill Book Company, Inc.

By the theorem of Castigliano¹ that the partial derivative of elastic work with respect to any external force gives the displacement corresponding to that force, it is possible to solve for the unknown X :

$$P = pr_e - X \cos \varphi = pr_e - (pr_e - P_c) \cos \varphi \quad (4)$$

$$M = M_c + Xr_n(1 - \cos \varphi) = M_c + r_n(pr_e - P_c)(1 - \cos \varphi) \quad (5)$$

$$S = X \sin \varphi = (pr_e - P_c) \sin \varphi \quad (6)$$

The partial derivatives of these functions with respect to M_c and P_c are

$$\begin{aligned} \frac{\delta M}{\delta M_c} &= 1; \quad \frac{\delta M}{\delta P_c} = -r(1 - \cos \varphi); \quad \frac{\delta P}{\delta M_c} = 0; \quad \frac{\delta P}{\delta P_c} = \cos \varphi; \\ \frac{\delta S}{\delta M_c} &= 0; \quad \frac{\delta S}{\delta P_c} = -\sin \varphi \end{aligned} \quad (7)$$

The shear at the crown being zero, it is necessary to determine only M_c and P_c . The rotation of the crown section being zero, $\frac{\delta W_i}{\delta M_c} = 0$; and the displacement of the crown in the direction of P_c being zero, $\frac{\delta W_i}{\delta P_c} = 0$.

Taking successive partial derivatives of (2)

$$\frac{\delta W_i}{\delta M_c} = 0 = \frac{r_n}{2E_c I} \int_0^{\varphi_1} M \frac{\delta M}{\delta M_c} d\varphi; \text{ whence, } \int_0^{\varphi_1} M d\varphi = 0 \quad (8)$$

Substituting from (5)

$$\int_0^{\varphi_1} [M_c + Xr_n(1 - \cos \varphi)] d\varphi = 0; \quad \text{whence, } M_c \varphi_1 + Xr_n(\varphi_1 - \sin \varphi_1) = 0 \quad (9)$$

From $\frac{\delta W_i}{\delta P_c} = 0$,

$$\frac{r_n}{I} \int_0^{\varphi_1} M \frac{\delta M}{\delta P_c} d\varphi + \frac{r_n}{t} \int_0^{\varphi_1} P \frac{\delta P}{\delta P_c} d\varphi + \frac{r}{kt} \int_0^{\varphi_1} S \frac{\delta S}{\delta P_c} d\varphi = 0 \quad (10)$$

Substituting values from (7)

$$\begin{aligned} -\frac{r_n}{I} \int_0^{\varphi_1} M(1 - \cos \varphi) d\varphi + \frac{r_n}{t} \int_0^{\varphi_1} P \cos \varphi d\varphi - \\ \frac{r}{kt} \int_0^{\varphi_1} S \sin \varphi d\varphi = 0 \end{aligned} \quad (11)$$

¹ TIMOSHENKO and LESSELLS, "Applied Elasticity," p. 119.

Substituting from (4), (5), and (6) remembering that $\int_0^{\varphi} M d\varphi = 0$,

$$\frac{r_n}{I} \int_0^{\varphi_1} [M_c + X r_n (1 - \cos \varphi)] \cos \varphi d\varphi + \frac{r_n}{t} \int_0^{\varphi_1} (p r_e - X \cos \varphi) \cos \varphi d\varphi - \frac{r}{k t} \int_0^{\varphi_1} X \sin^2 \varphi d\varphi = 0.$$

Integrating

$$\begin{aligned} \frac{r_n}{I} \left[M_c \sin \varphi_1 + X r_n \left(\sin \varphi_1 - \frac{\varphi_1}{2} - \frac{1}{4} \sin 2\varphi_1 \right) \right] + \\ \frac{r_n}{t} \left[p r_e \sin \varphi_1 - X \left(\frac{\varphi_1}{2} + \frac{1}{4} \sin 2\varphi_1 \right) \right] - \\ \frac{r X}{k t} \left(\frac{\varphi_1}{2} - \frac{1}{4} \sin 2\varphi_1 \right) = 0 \quad (12) \end{aligned}$$

Letting $I_n = A^2 t$, $k = 0.44$, eliminating M_c between (9) and (12) and solving for X

$$X = \frac{p r_e}{D} 2 \sin \varphi_1 \frac{A^2}{r_n^2} \quad (13)$$

Where

$$D = \left(\varphi_1 + \frac{1}{2} \sin 2\varphi_1 \right) \left(1 + \frac{A^2}{r_n^2} \right) - \frac{1 - \cos 2\varphi_1}{\varphi_1} + 2.28 \frac{r A^2}{r_n^3} \left(\varphi_1 - \frac{1}{2} \sin 2\varphi_1 \right)$$

From (9)

$$M_c = - X r_n \left(1 - \frac{\sin \varphi_1}{\varphi_1} \right) \quad (14)$$

To find the value of c or of r_n , let Fig. 85(a) represent a section of the elementary arch under a strain, with the radial section turned through an angle $\Delta\alpha$. Let y be the distance from the neutral surface to any point. Then the unit stress on the fibre at y distance is $\frac{E y \Delta\alpha}{(r_n - y)\alpha}$. The area of the fibre is dy times 1 and the moment of all stresses about the neutral axis is zero.

$$M = \frac{E \Delta\alpha}{\alpha} \int_{-(\frac{t}{2}+c)}^{\frac{t}{2}-c} \frac{y dy}{r_n - y} = 0$$

or,

$$\int_{-(\frac{t}{2}+c)}^{\frac{t}{2}-c} \frac{y dy}{r_n - y} = 0$$

Changing the variable

$$\int_{-\frac{t}{2}}^{+\frac{t}{2}} \frac{z - c}{r - z} dz = \int_{-\frac{t}{2}}^{+\frac{t}{2}} \frac{z - r + r}{r - z} r_n dz = 0$$

Whence

$$r_n = \frac{t}{\log \frac{r_c}{r_i}}$$

Knowing r_n , X may be calculated from (13), and M_c from (14). Stresses at other points can be calculated by statics in the usual way.

To find the effect of temperature change, let H be the crown thrust due to a rise in temperature, c , the coefficient of expansion and T the temperature change in degrees. Let W_i be the internal work for the entire arch. In this case, $P_e = V = 0$, and $P_c = H$.

Then $M = M_c - Hr_n(1 - \cos \varphi)$, $P = H \cos \varphi$ and $S = -H \sin \varphi$. Proceeding as before, making $\frac{\delta W_i}{\delta H} = 2cTr_n \sin \varphi$, the increase in span caused by the change in temperature,

$$H = \frac{2 \sin \varphi_1}{D} \left(E_c c T \frac{A^2}{r_n^2 t} \right)$$

where D is as above.

The crown moment may be obtained from (14)

$$M_c = Hr_n \left(1 - \frac{\sin \varphi_1}{\varphi_1} \right)$$

These formulas are for a free rise in an arch not restrained by cantilever action. For a fall in temperature, the direction of H would be reversed. The effect of shrinkage and rib shortening may be treated in a similar manner.

The analysis of arch dams embodies so many uncertainties and a rigorous treatment is so complicated that a more extended discussion is not warranted in this text. The excellent papers by B. F. Jacobson and by Wm. Cain are commended for a more complete presentation. Studies of the behavior of celluloid models has been found to yield results of practical value, and this method is especially commended for estimating deflections under load.

The above analysis does not distinguish between the moment of inertia about the middle axis and that about the neutral axis. Professor Cain shows in his analysis that the resulting error is negligible.

Yielding of foundations and abutments of an arch dam affect the behavior of the structure. This influence is equivalent to a replacement of the elastic foundation by an extension of the structure to an imaginary rigid foundation. Dr. Frederick Vogt¹ states that the yielding of rock foundations under the cantilever is equivalent to extending the cantilever $0.45t$ to an unyielding foundation. Yielding of the abutments has the same effect as a drop in temperature. In long arch dams this effect would be small, but in narrow canyons the effect may be considerable.

In several instances gravity dams have been built arched in plan. If proper vertical, radial expansion joints are not provided, such a dam is likely to develop vertical contraction cracks due to shortening of the arch. In fact, owing to the stresses arising from any shortening of the arch, an arched gravity dam may prove less satisfactory and more liable to leaking through cracks than a straight dam of the same section with proper expansion joints. In addition, a larger volume of masonry at a higher unit cost will be required for the arch gravity dam than for a straight dam of the same section. Inasmuch as incipient gravity failure must occur virtually before arch action can come into operation, there seems little justification for curving gravity dams under ordinary circumstances. However, the propriety of arching gravity dams is a much debated matter.

Details of Design of Single Arch Dams.—The arch angle most commonly used for single arch dams is about 90° to 120° , although theoretically the least masonry will be required where the angle is about $133\frac{1}{2}^\circ$. That this is so is shown as follows by L. R. Jorgensen, M. Am. Soc. C. E.²

Let w be the width of span

A be the area of a cross section of the dam

R_m be the mean radius

θ be the central angle of the dam.

Volume = $A \times R_m \times \theta = KR^2_m \times \theta$, since $A = KR_m$

$$= K \times \left(\frac{w}{2 \sin \frac{\theta}{2}} \right)^2 \times \theta$$

Differentiating and equating to 0, $\theta =$ approximately $133\frac{1}{2}^\circ$.

¹ *Trans. Am. Soc. C. E.*, vol. 90, p. 555.

² *Trans. Am. Soc. C. E.*, vol. 78, p. 689.

The rock abutments should be excavated to be at right angles to the line of thrust at the junction with the canyon walls in

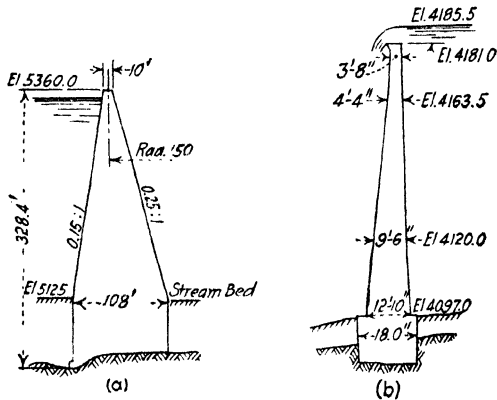

FIG. 86.—Sections of arch dams (a) Shoshone, (b) Huacal.

TABLE XXIII.—CHARACTERISTICS OF TYPICAL ARCH DAMS

Name of dam	Location	Year built	Maximum height, ft.	Length, ft.	Upstream radius, ft.	Thick-ness		Cylinder stress, lb. per sq. in.	Reference
						Top ft.	Base, ft.		
Upper Otay.....	Calif.	1900	84	350	359	4	14	940	E. WEGMANN, p. 220
Clear Creek.....	Wash.	1913	90	400	123	..	9	400	<i>Trans. Am. Soc. C. E.</i> , vol. 83, p. 574
East Canyon.....	Utah	1916	190	290	99-78	6	26	174	
Malibu Lake.....	Calif.	1922	35	160	135	..	7.5	275	<i>Water Works</i> , June, 1925
Upper Hubbard....	Mont.	1923	131	503	220-188	..	24	400	
Morman Flat.....	Ariz.	1923	216	416	193-108	8	22	458	<i>Engineering News-Record</i> , May 13, 1926
Cushman Lake.....	Wash.	1925	280	1,110	210-163	2	45	250	<i>Engineering News-Record</i> , Apr. 4, 1927
Pacoima.....	Calif.	1926	380	600	330-171	8	96	300	<i>Trans. Am. Soc. C. E.</i> , vol. 90, p. 584
Horse Mesa.....	Ariz.	1926	305	810	Variable	..	57	150	WEGMANN
Fruita.....	Colo.	1924	56	117	60	..	7.5	300	
Medlow.....	Wales, N. S.	1906	65	113	90	..	9	186	
Carfino.....	Italy	1914	125	77	..	23	181	
Amsteg.....	Switzerland	1922	100	216	66-46	..	11.5	174	

order to prevent sliding. Figure 86 (a) is a cross section of the Shoshone arch dam built by the U. S. Reclamation Service and (b) is the Huacal dam designed by H. Hawgood,¹ M. Am. Soc. C. E. The former represents conservative design and the latter is a design in which the arch is assumed to carry the entire water pressure. So far as the author is aware, there has never been a failure of an arch dam and it is probable that engineers will become more and more confident of the safety of this type of structure even when no allowance whatever is made for gravity

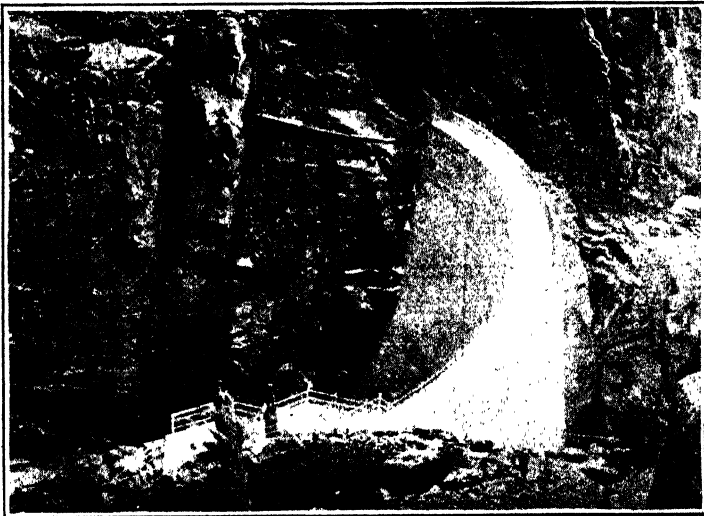

FIG. 87.—Shoshone arch dam.

and cantilever action and the entire load is taken by the arch. Figure 87 is a picture of the setting of the Shoshone dam. Table XXIIA, taken chiefly from the report of the Am. Soc. C. E. Committee on Arch Dam Investigation, gives the characteristics of a number of arch dams that have been built.

L. R. Jorgensen points out in his article referred to above that there is a theoretical economy in making the central angle of a dam constant. Most ravines in which dams are built are narrow at the bottom in sort of V-shape, hence if the same radius is employed for the bottom of the dam that is used at the top, the bottom portion is little more than a straight sector. In the constant angle arch dam, however, the radius is decreased toward

¹ *Trans. Am. Soc. C. E.*, vol. 78, p. 564.

the bottom and the central angle retained practically constant. Figure 88 shows a cross section and the dimensions of the Salmon River dam, which is designed with a constant central angle.

Multiple Arch Dams.—In recent years, multiple arch dams are being built with greater frequency. Figure 89 shows a front and a back view of Lake Hodges dam near Los Angeles and illustrates this type of structure.

Inasmuch as the circular section, as usually built, is not parallel to the surface of the water, the arch ring of unit length

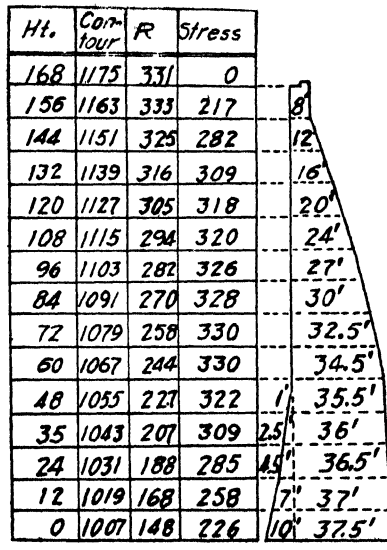

FIG. 88.—Section of Salmon River constant angle arch dam.

is under varying depths and consequently is subject to a varying load. The calculation of the stresses in such an arch can be readily made by means of the principles explained for an elastic arch and need not be explained in detail here. In Fig. 90, consider a section at right angles to the cylinder. The weight of this segment, W , is borne partly, P , by the reaction of the masonry below and partly, N , by the reaction of the arch, hence, only a portion of the weight of the segment, $W \cos \theta$, will be borne by the arch ring. Reinforcing is usually placed in multiple arch dams to provide for temperature changes, as the stresses resulting from the water pressure will probably never produce tensile stress in the arch.

The design of a multiple arch dam consists in designing the structure so that (a) it will be safe against external forces with respect to sliding and overturning, and (b) it will be safe against internal rupture under the stresses set up. The former aspects of the problem are essentially the same as for a gravity dam. In the latter aspect, it is necessary to consider (1) the arch and (2) the buttress and arch as a cantilever beam.

The design of the arch need not be considered in detail, since it can be designed by principles already explained. It should be designed for loads with reservoir full and for rib shortening due to thrust and to temperature change. The latter is frequently large in mountainous regions where multiple arch dams are commonly built.

TABLE XXII B.—TYPICAL MULTIPLE ARCH DAMS

Name	Location	Year built	Height, ft.	Length, ft.	Space of abutments	Slope, degrees	Radius, ft.	Central angle, degrees	Thick-ness	
									Top	Base
Mountain Dell.....	Utah	1916 to 1924	150	560	35	50	19.7	133	1.3	4.8
Lake Eleanor.....	Calif.	1917	70	800	40	50	23	120	1.3	4.0
Palmdale.....	Calif.	1923	175	648	24	45	15.7	100	1.3	4.3
Florence Lake.....	Calif.	1925	150	3,300	50	48	27.5	156	1.5	4.5
Lake Lure.....	Calif.	1925	122	574	41	45	23.1	130	1.0	3.7
Lake Pleasant.....	Ariz.	1926	256	1,975	60	47	24.0	96	1.5	5.5
Southerland.....	Calif.	1927	160	1,100	60	45	33.0	130	1.5	6.3
Coolidge.....	Ariz.	1928	250	910	180	Vari- able	Vari- able	Vari- able	4.0	20.1
Big Dalton.....	Calif.	1928	165	480	60	48	27.0	140	2.0	5.5
Tirso.....	Italy	1923	239	930	49.2	57	26.6	180	1.6	5.5

The buttresses present the greatest difficulty in design, owing to the uncertainty with regard to the stress distribution and to the fact that they contain the bulk of the masonry, and that in them lie the possibilities of economy. If the buttresses can be keyed into solid rock, they will develop the shear strength of the concrete, otherwise only friction can be counted on to prevent sliding.

In calculating stresses in the buttresses, a buttress and the two adjacent half arches are considered as a unit, constituting a cantilever beam roughly triangular in elevation. The ordinary

formulas for flexure are predicated on a section at right angles to the neutral axis; hence, they do not apply directly to an arch dam unit where the horizontal plane makes an angle with the neutral axis. This fact can be taken into consideration in the calculations, although the discrepancy is usually small. Owing to the relatively high shearing stresses in such a short cantilever, the ordinary formulas for flexural stress are only approximate and correction for this factor may well be made.¹

Particular attention should be given the effect of combined stresses. The buttress is subjected to a heavy shear as well as a compression and a flexural stress, and these yield serious

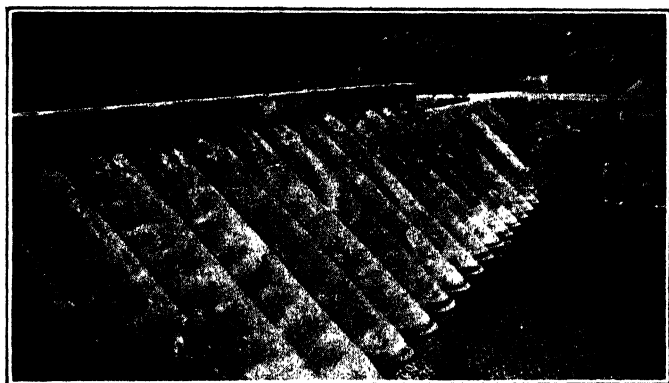

FIG. 89A.—Lake Hodges multiple arch dam. Upstream face.

diagonal tension stresses. Cracks have occurred in the buttresses of the Lake Hodges dam apparently as the result of excessive diagonal tension.²

As improvements are made in the analysis and design of the buttresses, the heights to which multiple arch dams may be built will be increased. Recent developments include the introduction of the H-section and the cellular section,³ which afford abutments of adequate column strength with economy of material.

In deciding on the arch span, the following points should be kept in mind: (1) the amount of concrete in the buttresses is practically independent of the length of span of the arches; (2) the span length should be constant throughout the structure in

¹ *Trans. Am. Soc. C. E.*, vol. 75, p. 932.

² *Trans. Am. Soc. C. E.*, vol. 87, p. 311.

³ *Trans. Am. Soc. C. E.*, vol. 87, pp. 342-370.

order to minimize the form expense; (3) short span arches require less concrete than long spans, although they may not be cheaper because of the greater expense of placing concrete in thin sections

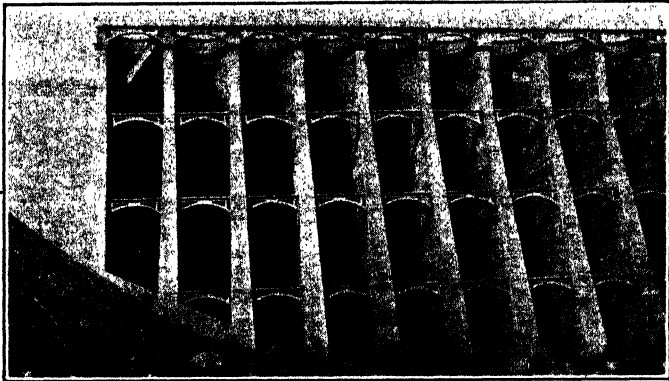

FIG. 89B.—Same. Downstream face.

and because of complications of form work; (4) a certain minimum thickness of concrete is required for imperviousness.

Based on these considerations, the most economical limits for the arch span will be found to vary from 25 to 50 ft., the latter span being applicable to heights around 100 ft. The most economical arch angle is $133\frac{1}{2}^\circ$, but variations of 15° either way

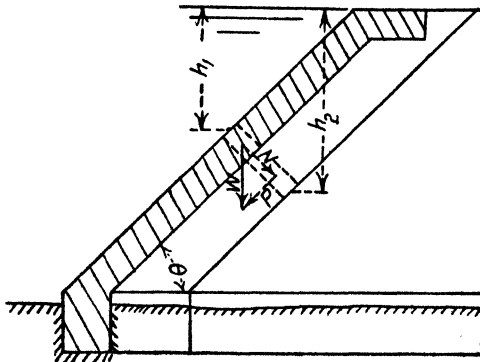

FIG. 90.—Stress distribution in a multiple arch dam.

from this figure do not greatly affect the cost. The economical slope, i.e., for minimum volume of concrete, is about 50° with the horizontal for the greater heights and about 60° for lower dams.

A preliminary or trial thickness of the arch can be found by the simple formula, $t = PR/S_a$, where t is the thickness in feet for any depth, P the water pressure in pounds per square foot, R the radius of the upstream face and S_a the average working

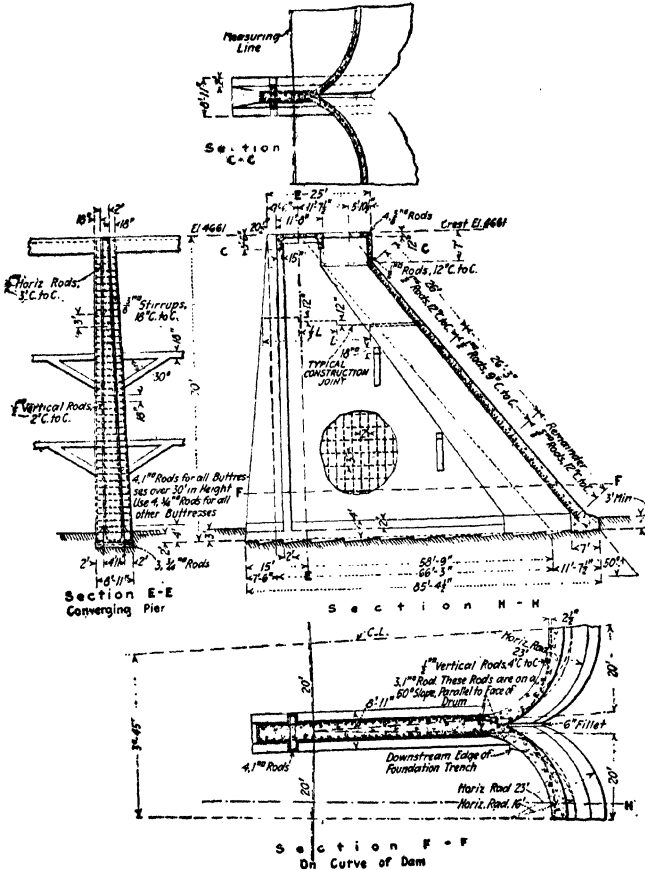

FIG. 91.—Details of Lake Eleanor multiple arch dam.

compressive stress in pounds per square foot. It will usually be found necessary to increase the thickness in order to secure water tightness, and a practical thickness will have to be provided for the top to care for ice, debris, etc. Freezing is especially severe on thin arch dams in cold climates, as illustrated in the Gem Lake dam.¹

¹ *Engineering News-Record*, Sept. 3, 1925.

Table XXIIB gives data with regard to some typical multiple arch dams and Fig. 91 shows details of the Eleanor Lake dam¹ of the Hetch Hetchy (San Francisco) water supply project.

Hollow Reinforced Concrete Dams.—Hollow reinforced concrete dams of various forms have been built with a view to utilizing the weight of the water on the upstream slope to effect stability. The usual type is that of a slab laid on buttresses as exemplified by the Jordan River dam, Vancouver, B. C.² This dam is 126 ft. high and 891 ft. long, 306 ft. of which constitutes a spillway. The buttresses are 18 ft. centers and are 12 in. thick at the top and 3 ft. 6 in. at the bottom. The deck slabs vary in thickness from 15 in. at the top to 4 ft. 7 in. at the bottom. The horizontal reinforcement consists of $\frac{7}{8}$ in. square bars on 4 in. centers in the lower portion and $4\frac{1}{2}$ in. above the 45-ft. level.

Overflow Dams, Wiers and Spillways.—Two considerations arise in connection with overflow dams that do not apply in the non-overflow type: (1) The effect of the falling water and (2) the design of the crest for the desired discharge capacity. Only the former phase of the subject will be briefly treated here, as the other is a question of practical hydraulics and without the scope of the present volume.³

To provide for the overflow of water it is desirable (1) to make the slope of the downstream face conform to the natural path of the water in order that impact may be reduced to a minimum, and (2) to provide some protection for the toe of the dam either by a water cushion or by an apron. The proper shape of the lower face would be a parabola at the upper portion, which should reverse into a circular arc at the bottom (with perhaps a straight portion between), and this circular arc should end tangent to the apron, provided no water cushion is employed. Where there is no straight portion between the curves, this form of a reverse curve is called an ogee curve, and for low dams usually consists of two circular arcs reversing as above described.

If a particle of water passes over the crest of the weir with an initial velocity of v_i , Fig. 73, the equation of its path will be

$$y = \frac{gx^2}{2v_i^2}$$

¹ *Engineering News-Record*, Sept. 4, 1919.

² *Eng. Rec.*, Jan. 17, 1914.

³ See *Water Supply and Irrigation Paper* 200 for the results of experiments and a full treatment of this matter.

As the sheet of water passes down the slope, it becomes thinner because of the fact that the velocity increases and the width remains constant. It is probably not necessary to enter into any great refinement in the design of the shape of this surface owing to the variability of the stream's path under wind pressure and due to various other influences. In Fig. 77¹ is illustrated the shape of the spillway in the lower Otay dam as designed.

Miscellaneous Types of Dams.— In addition to the types of dams previously described, there are several which can scarcely

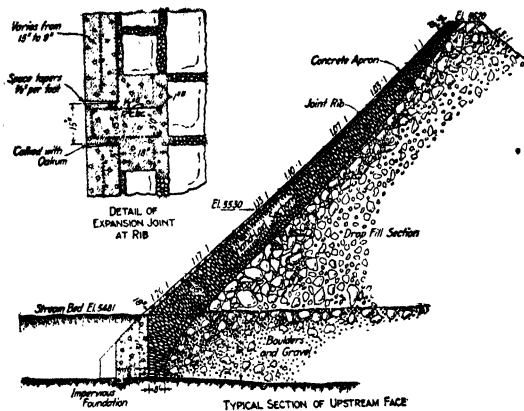

FIG. 92.—Rock fill dam on Stanislaus River.

be classed as masonry dams, hence, only brief mention will be made of them, although they have been widely used.

A *rock fill* dam is made by placing loose rock with more or less care to form the body or support and rendering it as nearly impervious as practicable by placing a concrete face over it, or a concrete corewall through the center, the former being the better practice. Figure 92² shows the Strawberry dam on Stanislaus river and illustrates an approved mode of constructing a rock fill dam. Obviously, the design is empirical and need not be discussed in detail here.

Earth fill dams with masonry corewalls have been built to a considerable extent in the western part of the United States and are frequently found economical where masonry materials are not readily available and the foundations are not suitable to masonry construction. Figure 93 illustrates this type of dam

¹ *Engineering Record*, Aug. 12, 1916.

² *Engineering Record*, Aug. 26, 1916.

in process of construction, being the Pleasant Valley Irrigation dam near North Yakima, Washington.

A *timber crib* dam is constructed by building a timber crib and filling it with stones, thus anchoring it to its foundation. Such dams are sometimes used as diversion weirs and at times for raising the level of streams for navigation.

Dam Foundations.—Perhaps there is no other class of engineering structures whose success is so dependent upon the quality

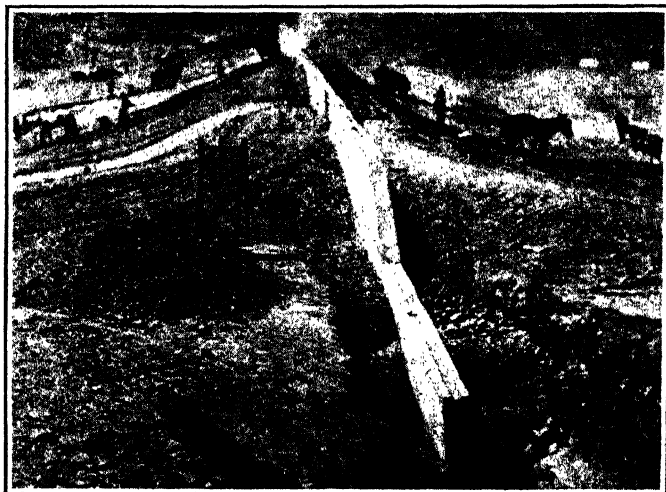

FIG. 93.—Earth fill dam with core wall.

of the foundations, than are masonry dams. Masonry dams should rest on solid rock if at all possible, although a few have been set on piles and on loose rock. However, when placed on such inferior foundations, the section of the dam should be designed accordingly with sufficient allowance for the uplift of the water beneath the dam.

Usually the exposed surface of ledge rock is so weathered that considerable excavation into the rock is necessary before a satisfactory foundation is obtained. Not only should this weathered and friable rock be removed, but the surface of the rock should be clean and free from clay, etc., in order that the masonry may adhere to the best advantage. Thorough washing with clear water from a nozzle is effective in preparing the surface. All springs in the foundation should be sealed with mortar

or concrete, or provision made for piping away the water. Thorough drainage of dam foundations is of primary importance, where the foundation is not solid rock.

Where the foundation rock is seamy and otherwise unsatisfactory to a depth too great to be removed, it is necessary to construct a cutoff wall to such depth as will render the leakage of water so small as to be unobjectionable. Two methods have been used in the construction of such a cutoff wall, (1) by a trench along the heel of the dam which is filled with concrete, and (2) by forcing cement grout under pressure into the foundation rock through drilled holes. The former method is much the more efficacious where it can be constructed at reasonable cost owing to the presence of satisfactory rock at no great depth. The process need not be described in detail, although attention should be called to the danger of unduly and injuriously shattering the rock in the main part of the foundation by the blasting in the cutoff trench.

The procedure in grouting a cutoff wall has been described in several excellent articles¹ and need not be given in detail here. The process consists, in brief, of drilling about two rows of holes about 3 in. in diameter from 3 to 15 ft. apart in the rows, the rows being about 3 to 6 ft. apart and forcing cement grout into these holes and allowing it to penetrate the crevices thus rendering the rock impervious. These holes can be driven to a depth of 50 ft. or so and the grouting done at much less expense than that involved in the construction of a trench and cutoff wall of the usual type. Each hole should be grouted immediately after it is drilled and before other holes are drilled in that vicinity in order that the grout may not escape into the neighboring holes. The process of grouting has not been proved entirely effective by experience and should be used only supplementary to more reliable processes. The chief difficulty is that the grout follows crevices offering the least resistance and does not fill the small seams and voids that will permit leakage of water.

It sometimes occurs that a masonry dam has to be built on loose rock, hardpan, gravel, or other material than bed rock, and the engineer will have to exercise extreme care to assure the success of the structure. Such a structure should be limited in

¹ See articles in *Trans. Am. Soc. C. E.*, vol. 78, *Engineering News*, Apr. 3, 1913, *Engineering Record*, Dec. 12, 1914, and *Engineering News-Record*, June 28, 1917.

height and every precaution possible taken to exclude and drain water from the foundation. Driving interlocking steel sheet piling as a cutoff at the heel is perhaps the most effective device together with thorough underdrainage. The velocity of underflow varies inversely with the length of "enforced percolation" or the distance of creep, which is the total distance water must travel from the heel of the dam to the point in question. For example, the enforced percolation under sheet piling would be twice the depth, i.e., down one side and up the other. W. B. Bligh,¹ an engineer of wide experience, recommends that this enforced percolation should be 5 to 18 times the head on the dam, depending on the perviousness of the soil, in order to prevent harmful velocity of underflow. The larger figure is for fine sand or silt and the lower for clay, shale, or a mixture of clay and boulders. The construction of an upstream apron with shallow cutoff walls connected integrally with the dam, is perhaps next to sheet piling, the most effective means of securing a large enforced percolation and hence the stability of a dam on porous foundations.

Although it may not be possible always to secure ideal ledge rock for foundations so that the engineer may be compelled to set a dam on porous materials, effort expended to secure the best foundations practicable will usually be well spent, for a study by the author of practically all failures of dams recorded in technical literature, some 300 in all, demonstrated that the most prolific source of failure by far was insecure foundations.

Investigation of the Dam Site.—The character of the dam site will largely control the design of the dam itself, hence a careful investigation should be made of the site before determining the type of structure to be built. The principal features that the engineer should consider are:

1. Availability of rock foundation:
 - (a) Does the rock extend over the entire site;
 - (b) Is the rock continuous with the surrounding formations or is it separated by faults;
 - (c) Will the rock present sustain the pressures required of it;
 - (d) Is the rock solid or is it seamy to the extent that serious leakage will occur through it;
 - (e) Total depth of the rock bed;
 - (f) Depth of overlying material to be removed before solid rock is exposed.

¹ *Engineering News*, Dec. 29, 1910.

2. Features that will further determine the type of dam:
 - (a) Possibility of arch dam—steep solid canyon walls—shape of the gorge, etc.;
 - (b) Possibility of rock fill dam—loose rock easily available from heights above site, etc.;
 - (c) Possibility of sluicing an earth dam—availability of suitable material at proper elevation above site—availability of water supply, etc.
3. Materials to be used in construction:
 - (a) Availability of coarse and fine aggregates and water for concrete;
 - (b) Availability of suitable stone for built up masonry;
 - (c) Transportation facilities for cement and other materials not locally available;
 - (d) Available power for operating machinery.

Borings should be made covering the entire site to establish the nature of the foundations and careful logs should be kept of such borings. After these are completed, they should be plotted into cross sections showing the probable distribution of strata as shown in Fig. 94.¹ For further discussion on foundations, see Chap. XIII, XIV and XV.

Factors Affecting the Cost of a Dam.—The cost of a dam will depend upon a number of factors, chief of which may be mentioned:

1. The location of the site
2. The nature of the site
3. The availability of local materials
4. The availability of a labor market
5. The availability of power, electric lines, coal, etc.
6. Transportation facilities
7. The methods used in construction.

If the dam is being built at a location in a mountain canyon far removed from any city or railroad, where no wagon road exists and all materials and labor have to be brought to the site with great difficulty, the conditions are unfavorable for a low cost, while if the site is near a city on a railroad with a good market for materials and labor, with good highways for local haulage, and with cheap power available, the conditions are most favorable.

The chief materials used in dam construction are cement, sand, stone, lumber, steel, water pipe, fuel, explosives, repairs, and operating machinery (mixers, conveyors, etc.). In a few instances, cement rock has been found available near the site for

¹Taken from C. W. SMITH, "Construction of Masonry Dams."

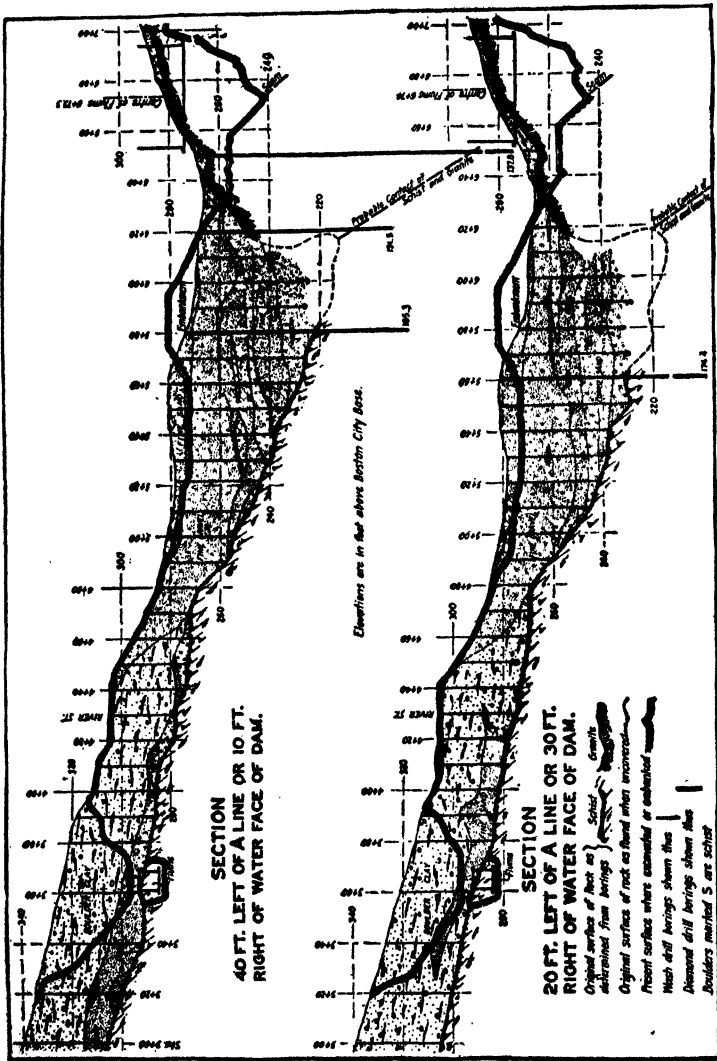

FIG. 94.—Foundation section under Wachusett dam.

making cement or hydraulic lime and the necessity of transporting cement thus avoided. Where sand is not to be had near the site, the feasibility of crushing a local rock into fine aggregate may have to be considered in comparison with shipping sand. Obviously, it would be a mistake, to construct a masonry dam where the stone is not locally available; and where stone is near by the ease with which it may be quarried and prepared will have a marked effect on the cost of the structure. The cost of the other items depends chiefly upon the facilities of transportation.

The method of procedure best adapted to low cost of construction will be that which most completely substitutes machine power for man power. This element is the chief factor in causing concrete dams to be cheaper than built up masonry dams, in that the concrete can be placed almost entirely by machine power and manual labor reduced to a minimum. Moreover, modern methods of depositing concrete which eliminate derricks from the top of the dam so far as practicable lessen the cost and expedite the work.

The availability of cheap power under modern methods of construction will have a great influence on the cost of construction. Where coal is near at hand, or electric power from nearby lines can be purchased cheaply, or where hydraulic power can be cheaply developed, the conditions are most favorable. Electric power is generally the most convenient as well as the most economical form of power for use in dam construction.

Architectural Treatment of Masonry Dams.—Where a masonry dam, as well as any other engineering structure, is located near centers of population and will inevitably be viewed daily by many people, it is desirable that it be treated in such a way architecturally that it will add to the landscape rather than detract from the surroundings. A high masonry dam for impounding water is usually impressive because of its mass, yet breaking up the monotony of its plain face may add greatly to its sightliness. The following excerpt taken from an article on "The Architecture of the Kensico Dam," by Alfred D. Flinn¹ contains many of the essential principles involved in the improvement of the appearance of a masonry dam:

"After visiting a number of masonry dams, the architects remarked that all these dams lacked a definite, visible base, that few had satisfactory cornices or entablatures, that architectural composition had been

¹ *Engineering News*, Sept. 2, 1915.

neglected, and that in most of these structures there was little to give scale—no feature of readily appreciated size with which the beholder could measure the main structure and gain some adequate apprehension of its magnitude. Architecturally, then, the problem of Kensico dam may be stated as the securing by means of suitable composition and embellishment of an adequate expression of the strength, magnitude, importance and dignity of this great mass of masonry, and the water-supply system of which it is a part, in harmony with its purpose and its elemental structural character.

“The long, lofty, straight, level line of the dam’s top as viewed from downstream, the equal of which is not to be found in any other kind of

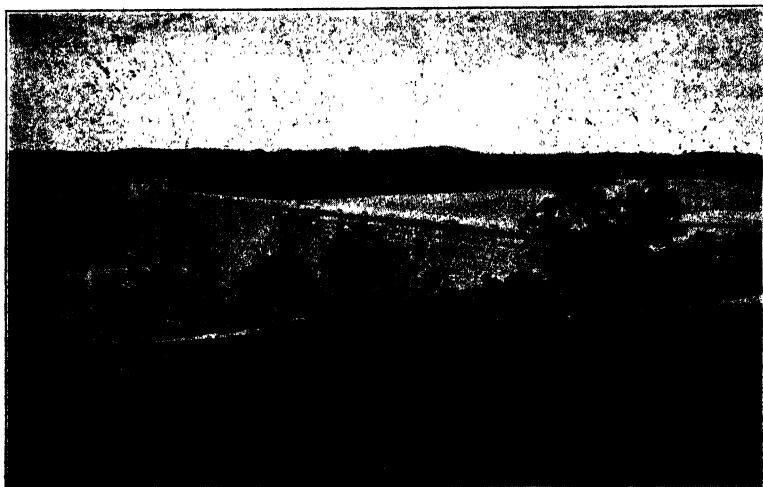

FIG. 95.—Architectural treatment of Kensico dam.¹

masonry structure, has been preserved unbroken, but is strongly terminated by massive circular pavilions of cut granite, which will serve also as shelters for visitors. Between the pavilions extend stone parapets of very simple design, about 3 ft. high, bounding the roadway. From these pavilions beautiful views can be enjoyed across the reservoir and the surrounding hill country. In the base of each pavilion storage space is available for tools and materials. On the upstream side of the dam, steps and ramps lead down to the water surface from these pavilions. The roadway on top of the dam is to be paved with vitrified brick blocks.

“For a base in the architectural composition of the downstream face of the dam a paved, level terrace has been provided, 30 ft. wide and 1,025 ft. long across the valley bottom, and continued up the hill slopes by

¹ Courtesy, Mr. Thaddeus Merriman, Chief Engineer, Board of Water Supply.

ramps 20 ft. wide terminating at the circular pavilions marking the ends of the top of the dam. The terrace pavement is 10 ft. above the ground immediately in front of it and is supported by a massive cut-stone wall. Beneath the terrace are a valve chamber and storage spaces. The downstream face of the dam is naturally divided into three parts—the central portion of uniform height and two triangular wings on the hill-sides. This division is emphasized architecturally by placing a pylon at each end of the central portion, with two small square pavilions at the foot of each pylon, on the terrace, and steps leading down to the ground level, between these pavilions.

“Since the contraction joints are an evident structural feature, they were made also a dominant motif in the architectural composition, as

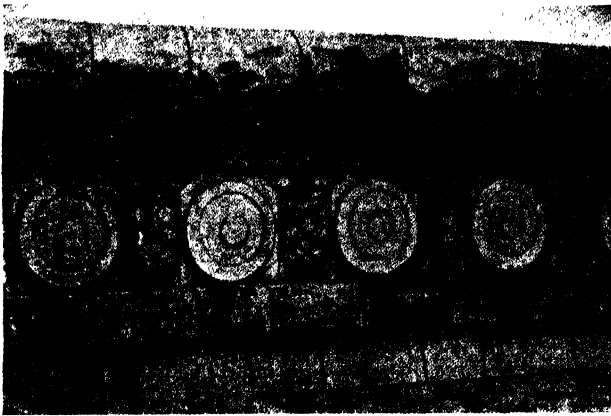

FIG. 96.—Entablature near the top of Kensico dam.

will be at once observed when looking at the dam or pictures of it (see Fig. 95). A broad, rusticated band of large, very roughly cut stones marks one edge of each contraction joint. The space between adjacent bands naturally becomes a panel, bounded top and bottom by the entablature and the base, or terrace. Around the margin of each panel is a narrow border of relatively smoothly cut stones, while the field is composed of “roughly squared” stone masonry, relieved and controlled by square cut-stone headers projecting slightly and arranged in a diamond pattern. One notable characteristic of the masonry facing is the coarseness and simplicity of the stone cutting; another is the very large size of many of the stones, and the third is the strong contrasts in the stone.

“In the torus of the entablature all stones are 4 ft. high; many are 5 to 8 ft. long, and weigh 9 to 14 tons each. The frieze is 6 ft. 6 in. high, in one course, and most of its stones weigh 10 to 14 tons or more. See Fig. 96. Only sufficient carving of the crudest sort has been done on

these frieze stones to develop the very simple design. At the bottom of each rusticated band is a kneeler made up of five stones, weighing together 51 tons. In the panel fields no stones have exposed faces less than 12 sq. ft. in area, and at least 50 per cent. of the exposed face of the roughly squared stone masonry in the dam consists of stones each having a face area greater than 6 sq. ft. In general, as many stones as possible are as large as it is practicable to handle. To give further boldness and suggestion of strength to the masonry, most of the joints are wide and are recessed. The struggle has been to secure a general surface texture which would not seem too smooth and flat, and consequently uninteresting when beheld from a point remote enough to afford a comprehensive view.

“Fortunately, the local gneissoid granite, which for economic reasons was used for the concrete and cyclopean masonry, proved to be a beautiful stone for the architectural features. Its grain varies from that of a straight-banded gneiss through curly and knotted varieties to that of a true, massive granite. Large pegmatite intrusions are frequent. In color the range is from light gray to strong pink, with green, black and white streaks and areas, due to different mineralogical ingredients, and deep russets and browns on seam faces. Of all these characters of the stone the architects have skillfully taken advantage, although in so doing they have sturdily disregarded the older conceptions of good engineering masonry, for which it was commonly specified that the stone should be uniform in color and texture and in which very narrow joints were regarded as necessary.

“There appear, therefore, as original elements in the architectural design of this dam: (1) The division of the wall into panels by bands of rusticated stone indicating the contraction, or expansion, joints; (2) the substitution of an adequate treatment for the usual ‘cornices’; (3) the provision of a base and ramps which receive the flanking hills; (4) the introduction of smaller structures, treated as integral parts of the design of the dam; (5) the pools, or artificial water below the dam; (6) the foreground layout which also is connected intimately with the design of the wall itself; and (7) the planting of the foreground in such a manner as to give the best effect and to require the least expense to maintain.”

Sea Walls.—A *breakwater*, sometimes called a *mole* or *jetty*, is a structure built to protect a harbor from the action of the sea. Its function is to break up the heavy waves and to prevent their doing damage to the shipping in the harbor or to structures on the land. The chief destructive agencies acting against a breakwater are the buoyant effect of the sea water, the washing of the moving water, and the impact of the waves.

There are two principle types of breakwaters, namely (a) the mound type and (b) the wall type. The former consists simply of a wall of rock dumped from scows into place until the surface of the water is reached and then laid with somewhat more care above the surface. The latter usually consists of a masonry

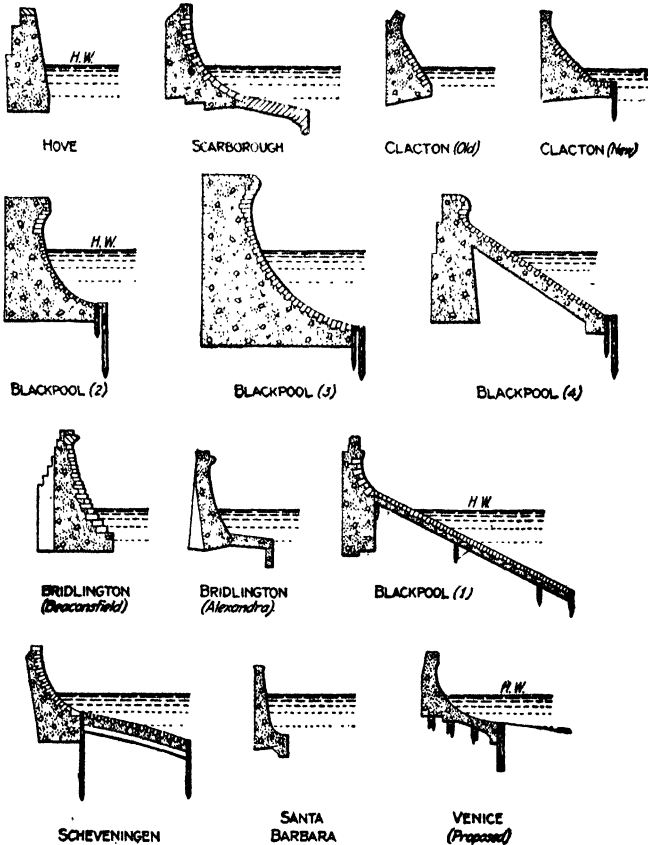

FIG. 97.—Sections of existing sea walls.

wall resting on a mound of stone formed as above, although it may rest on concrete piling or other support. On account of the tendency of the waves to strike the wall and fall back on the mound, thus loosening the stones of the latter, the wall should either be well above the high water line or else it should begin at least 20 ft. below low water in order that the superstructure may not be undermined. A breakwater should preferably be

located obliquely to the line of action of the waves in order to diminish the overturning effect of the latter.

A *sea wall* proper is a wall placed along a sandy shore for the protection of the shore and the structures located thereon. The destructive forces acting on a sea wall are impact of the waves and the undermining influence of the washing of the water. A sea wall usually has connected with it as a more or less integral part, a *groin* or sloping revetment of masonry for the further protection of the sandy beach.

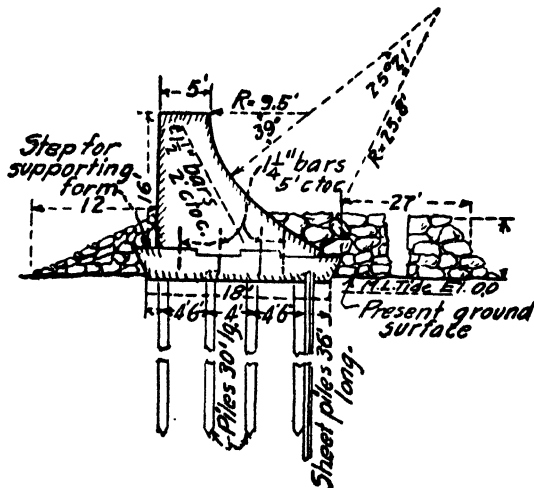

FIG. 98.—Section of sea wall at Galveston.

Owing to the fact that the design of sea walls is largely empirical, there have been many different types constructed, several of which are illustrated in Fig. 97¹

The impact of waves to which sea walls are subjected results from “translatory” waves as distinguished from “oscillatory” waves. The waves in mid-ocean are oscillatory, the particles of water scarcely advancing any, if at all. However, when an oscillatory wave comes into shallow water, the bottom is retarded causing the front of the wave to increase in steepness until it overhangs, and then the wave breaks and becomes “translatory.” Waves break when the depth of water becomes about twice the height of the wave. Oscillatory waves in mid-ocean probably never exceed 50 ft. in height, while breaking waves have been known to exceed twice that height.

¹ *Engineering Record*, Jan. 29, 1916.

The dynamic effect of high waves at breaking is much more than the mere hydrostatic pressure of the water, for waves traveling at 41 ft. per second corresponding to a pressure head of 1,622 lbs. per square foot, have been known to exert an impact of 6,000 lbs. per square foot.¹ Few observations have been made on the force exerted by the breaking of waves against a surface, but in general, it has been demonstrated to be lessened by curving the face of the sea wall so that the force of the wave is the more gradually dissipated. Figure 98 shows a section of the sea wall built at Galveston in 1919.

¹ WM. SHIELD, "Principles and Practice of Harbor Construction," p. 41.

CHAPTER VII

RETAINING WALLS AND QUAY WALLS

Introduction.—A *retaining wall* is a wall built to retain earth or similar material and is subjected to the lateral pressure of the earth behind it. It is thus distinguished from a *bearing wall*, which is a vertical wall supporting a structure or other load and is subjected primarily to vertical loads.

A *breast wall* is one built to retain an undisturbed bank of earth or of loose rock.

A *retaining grillage* is a grillage built to retain earth deposited behind it.

A *slope wall* is a protective wall constructed at approximately the natural slope of the earth bank retained.

A *quay wall* is a wall built to retain the earth of a dock or quay and at the same time protect the dock or quay against the action of the water, which consists of pressure and abrasion.

There is probably no other type of engineering structure that has been the subject of more discussion and controversy than have retaining walls with respect to their principles of design. Some engineers have contended that the factors controlling their design are so indeterminate that it is not worth while to do more than follow precedent and rule of thumb methods in their design, while others have maintained that the forces acting on a retaining wall are as definite as those acting on most engineering structures, such as dams, bridges, buildings, conduits, etc. The truth of the matter doubtless lies somewhere between these extremes, and while the forces acting are somewhat indefinite owing to lack of information concerning the materials retained, yet with certain assumptions concerning the behavior of these materials, the design of a retaining wall becomes a determinate problem, and more satisfactory results are obtained if the wall is designed accordingly. In other words, as in other structures, the best engineering practice requires the reduction of unknown factors to their simplest terms and the introduction of empirical coefficients and estimated terms in lieu of observed or rational factors

to the least possible extent. The indeterminate factors arise from the lack of knowledge regarding the behavior of the materials retained and not with regard to the effect of these forces after they have been ascertained. Moreover, in the design of reinforced concrete retaining walls, in order to proportion the steel properly, it is necessary to determine the stresses in the wall, and in order to know the distribution of pressure on the foundation, it is likewise necessary to know the forces acting.

The present chapter is not an exhaustive treatise on the subject in any sense, but its purpose is rather to indicate the underlying principles and to indicate a practical method of design.

Types of Wall Sections.—Retaining walls may be classified as follows according to the type of wall section employed:

A. *Gravity walls:*

- (a) Plain walls;
 - 1. Back vertical;
 - 2. Back inclined from the fill—plain or stepped;
 - 3. Back inclined toward the fill;
- (b) Buttressed wall;
- (c) Walls with relieving arches;

B. *Reinforced concrete walls:*

- (a) Plain cantilever walls;
- (b) Fillet cantilever walls;
- (c) Counterfort walls;
- (e) Anchored walls.

Gravity walls are those which by the mere inertia of their mass resist the thrust of the retained earth. They may be built of brick, stone or plain concrete.

Reinforced concrete walls, in addition to the mass of the walls themselves, are so designed as to utilize the weight of the earth load on the footing to resist the lateral thrust of the fill. Anchored walls depend to an extent for their stability upon tie rods anchored in the fill, or extending through the fill to a similar wall on the other side.

Stability of Retaining Walls.—The stability of a retaining wall depends upon the nature and magnitude of the forces acting on the wall. Four conditions of loading of a retaining wall may be recognized:

1. The surcharge is zero; that is, the earth is level back from the wall and there is no superimposed load resting on the fill.
2. The surcharge consists of a sloping bank, back and upward from the top of the wall, usually at the angle of natural repose of the material; that is, the angle of surcharge is positive.

3. The retained material has a downward slope from the top of the wall; that is, the angle of surcharge is negative.

4. The surcharge consists of a superimposed load on the fill behind the wall, such as a building, a railroad track with train, a platform, machinery, etc.

The problem of designing a retaining wall, therefore, reduces itself to determining the magnitude, direction and point of application of the forces to which the wall is subjected and the selection of a structure that will hold these forces in equilibrium with the proper factor of safety. These forces may cause the failure of a retaining wall in one or more of four ways:

1. The pressure may cause the wall to slide forward on its base.

2. The pressure behind may cause the wall to overturn by rotating about the toe, due either to insufficient resisting moment or to the failure of the foundation at the toe.

3. The masonry may fail at the toe.

4. The wall may fail due to insufficient strength at a section in flexure or in shear; such section may be either in the body of the wall or in the footing.

The nature of the forces acting and the methods of design to sustain them will now be studied. See Fig. 99.

Nature of Pressures Encountered.—Earth, gravel, sand, etc. and viscous materials occupy a position between perfect liquids on the one hand and perfect solids on the other, so far as the pressures exerted are concerned. Liquids, with negligible internal friction and cohesion, exert a lateral pressure equal to the vertical pressure at any point in the body of the liquid, while solids exert only a downward pressure (so far as practical design is concerned) equal to the weight of the solid. These intermediate materials exert a lateral pressure that is a fractional part of the vertical pressure, and the ratio between the lateral and vertical unit pressures at any point depends upon the character of the material. Soils other than rock belong to this intermediate class of materials, and may be grouped into two classes, *viz.*, cohesive and non-cohesive.

Cohesive soils are those containing more or less clay sufficient to cause the soil to retain its shape as a solid. Their properties depend upon their composition and the amount of water contained and the degree of compactness.

Non-cohesive soils are those so nearly free from clay or other cementitious material that they will not stand vertically unrestrained. Sand and gravel are typical non-cohesive soils.

Naturally, these two classes gradually merge one into the other. Cohesive soils vary from thin mud to hardpan and hard rock. Non-cohesive soils comprise the granular materials and vary from clean dry sand to dense mixtures of sand, gravel, and clay. See Chap. XIII for a further discussion of soils.

Two different forces tend to hold earth in equilibrium, namely, friction and cohesion. Friction is dependent upon the normal pressure and the coefficient of friction between the particles. Generally, friction is considered independent of the area of

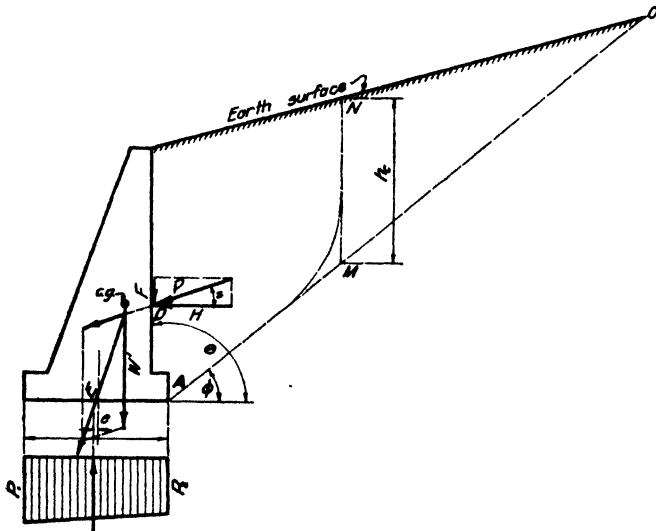

FIG. 99.—Forces acting on a retaining wall.

contact. A material such as dry sand or grain which is devoid of cohesion will not stand vertically when unrestrained but will assume a natural slope of repose equal approximately to the angle of friction between particles. A grain of the material on this slope will obviously be in equilibrium but on the verge of sliding.

Cohesion, on the other hand, results from the cohering of particles because of their own molecular attraction and to surface tension of any entrained water. Cohesion is independent of pressure and depends entirely upon the area of contact and the cohesion per unit area. Cohesive material will stand vertically unrestrained until the downward component along some plane

of rupture is sufficient to overcome the total shear strength (cohesion plus friction) along that plane.

The extent to which cohesion may be taken into account in the design of retaining walls depends upon how serious would be the result of a failure of the wall and the probability of a saturation occurring which would destroy cohesion as a restraining force.

Pressures Exerted by Soils.—Many theories have been proposed for analyzing the stresses in soils and the pressure which soils may exert against a retaining wall. Previous to the latter part of the eighteenth century, the design of retaining walls was entirely empirical. In 1687, Vauban, a French military engineer, formulated rules covering the design of revetments which have exercised a great influence on the design of retaining walls, and, in 1691, Bullet, another French engineer, attempted a theoretical analysis of the problem. Numerous French engineers added improvements until, in 1773, Charles Augustin Coulomb presented his sliding wedge theory. In this, he assumed that there is a wedge of the material which tends to slide and, hence, to cause the pressure of the wall. By allowing the dimensions of the wedge to be variable, he differentiated the equation of equilibrium and found the wedge of maximum thrust. The Coulomb wedge theory, improved later by Prof. J. J. Weyrauch and others, is one of the two classic theories of earth pressure.

The other classic theory is that of Wm. J. M. Rankine, professor of civil engineering and mechanics at the University of Glasgow. Professor Rankine assumed that previous to motion, the particles of granular materials are held by mutual inter-reactions and internal friction just as in a solid, and, therefore, he applied directly the theory of the ellipse of stress taken from the mathematical theory of elasticity devised for solids. The theory assumes a homogeneous incompressible granular mass of indefinite extent, devoid of cohesion, and yields formulas that are in agreement with experimental results for clean dry sand, the material most like the hypothetical material assumed. However, even clean dry sand is compressible, a fact which vitiates Rankine's theory in one respect, namely, that sand gives a downward tangential force due to friction on the back of a retaining wall, whereas Rankine's theory yielded no such downward force. An able historic and critical review of theories of earth pressures is contained in a paper by Dr. Jacob Feld before the

Brooklyn Engineers' Club, January, 1928, and an exposition of the more important theories is well set forth in "Walls, Bins and Grain Elevators" by Professor Milo S. Ketchum. All of these theories are rather complicated and all fall short of universal applicability.

The following theory, which is a modification of an analysis by A. L. Bell,¹ is partly rational and partly experimental; it possesses the merit of simplicity and is believed to be reliable. The three unknowns sought are:

1. The direction of the pressure.
2. The point of application of the pressure.
3. The magnitude of the pressure.

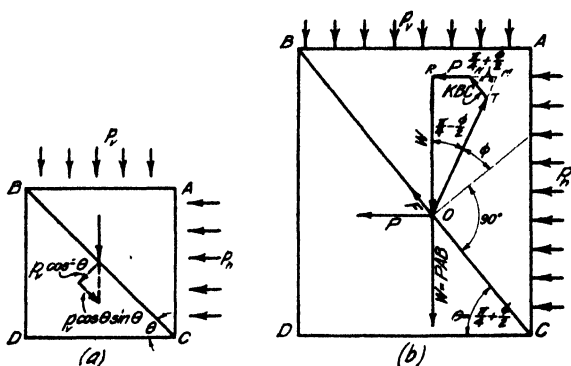

FIG. 100.—Forces acting on a particle of earth.

Experiments by Jacob Feld,² as well as those performed (unpublished) at the University of Kansas (1916), showed that in newly placed fills there is always a tangential downward force along the back of a retaining wall equal essentially to the normal pressure multiplied by the coefficient of friction. In *newly placed material*, the resultant pressure, therefore, always acts at an angle equal to the friction angle with the normal to the back of the wall, regardless of the slope of the wall. In undisturbed material, the pressure would be horizontal for a level surface because there is no movement to develop friction. Since there is no articulation between the wall and the earth, the friction force is the maximum possible tangential component of the

¹ *Proc. Inst. C. E.*, vol. 199.

² *Trans. Am. Soc. C. E.*, vol. 86, p. 1448.

force which the earth exerts on the wall, and this force can be operative only when there is a tendency of the earth, in contact with the wall, to move downward. In new fills only, where settlement is not complete, can there be a frictional force downward. Under all other circumstances, the resultant pressure must be horizontal.

All theories assume, and tests with granular materials agree, that the law of pressure is a linear function, or a direct increase with the depth, and, hence, for horizontal top surface, the pressure is applied at one-third the total depth from the bottom. This total depth may include a surcharge, which will raise the point of application above one-third the height of the wall. This case will be discussed in a subsequent paragraph.

The third quest is the magnitude of the force. The first case discussed will be the elementary one of a vertical back of wall with the fill having a level surface.

Let Fig. 100 (a) represent an elementary prism of earth under vertical and horizontal principal stresses.

Let p_v be the intensity of vertical pressure and p_h the intensity of horizontal pressure.

In Fig. 100 (a), the intensity of the vertical stress on BC is $p_v \cos \theta$.

Let F be the active shearing force along the plane BC . Then, for impending motion, $F = p_v \cos \theta \sin \theta - p_v \cos^2 \theta \tan \varphi$, φ being the limiting angle of internal friction.

Differentiating and equating to 0 in order to find the maximum value of F

$$\frac{dF}{d\theta} = p_v(\cos^2 \theta - \sin^2 \theta) + 2p_v \sin \theta \cos \theta \tan \varphi = 0$$

whence $\theta = \left(\frac{\pi}{4} + \frac{\varphi}{2}\right)$, the value of the angle for maximum tendency to slide or for the maximum pressure against an adjoining particle or against a wall.

In Fig. 100 (b), certain forces act on a particle of earth located at some point, O , along the back of a wall retaining a fill. Let the dimensions of this prismatic particle be AB , BD , and 1. $W(= p_v AB)$ is the weight of earth acting on an area $AB \times 1$, $P(= p_h AC)$ is the unknown horizontal component of the force acting on the wall due to the earth pressure, C is the force of cohesion = $K \cdot BC$ where K is the cohesion in pounds per square

foot, OT is the pressure of the wall on the particle acting at the friction angle, φ , with the normal.

$$P = RM - NM$$

$$= W \tan\left(\frac{\pi}{4} - \frac{\varphi}{2}\right) - 2K \cdot BC \cos\left(\frac{\pi}{4} + \frac{\varphi}{2}\right)$$

Divide by AC , and remembering $W = p_v AB$

$$\frac{P}{AC} = p_v \frac{AB}{AC} \tan\left(\frac{\pi}{4} - \frac{\varphi}{2}\right) - 2K \frac{BC}{AC} \cos\left(\frac{\pi}{4} + \frac{\varphi}{2}\right)$$

or

$$p_h = p_v \tan^2\left(\frac{\pi}{4} - \frac{\varphi}{2}\right) - 2K \tan\left(\frac{\pi}{4} - \frac{\varphi}{2}\right)$$

or

$$p_h = p_v \frac{1 - \sin \varphi}{1 + \sin \varphi} - 2K \sqrt{\frac{1 - \sin \varphi}{1 + \sin \varphi}} \quad (1)$$

Since $P_v = wh$, the total horizontal pressure (Fig. 99)

$$H = \frac{1}{2} wh^2 \frac{1 - \sin \varphi}{1 + \sin \varphi} - 2Kh \sqrt{\frac{1 - \sin \varphi}{1 + \sin \varphi}} \quad (2)$$

Assuming that the earth bank will stand vertically without a retaining wall to a height h_c , or, in other words, within a height h_c , there will be no active pressure on the wall, and hence,

$$h_c = \frac{2K}{w} \sqrt{\frac{1 + \sin \varphi}{1 - \sin \varphi}} \quad (3)$$

TABLE XXIII.—FRICTION AND COHESION FACTORS

Soil	Weight, lb. per cu. ft.	Angle of repose, degrees	Friction angle, degrees	Cohesion lb. per sq. ft.
Loam, top soil.....	90	37	25	200
Puddle clay, saturated.....	90	5	0	50
Yellow clay, moist.....	100	37	13	250
Sandy clay, moist.....	110	37	13	120
Blue clay.....	135	37	24	300
Stiff clay.....	120	40	21	350
Very stiff clay.....	130	40	25	500
Clean sand or gravel.....	100	33½	33½	0
Sand, with some clay, dry.....	100	37	33	100
Disintegrated rock, soft.....	110	37		
Disintegrated rock, hard.....	100	45		
Cinders.....	45	33½		

The angle of friction herein is the actual angle of internal friction and not the angle of repose, which includes the effect of cohesion. When cohesion is absent, the angle of friction becomes the angle of repose and the expression is the same as that developed by Rankine. Equation (1) gives the intensity of the horizontal pressure on a vertical wall, when the surface of the soil is vertical. This tangential component (in new fill) is Pf where f is the coefficient of friction with the back of the wall.

Cohesion should not be considered for fills; for natural banks where it will not be destroyed by water or shock, K may be taken at one-half the average values in Table XXIII.

In calculating the stability of a wall, conservative design neglects this tangential frictional force owing to the uncertainty of its existence in consolidated fills. Indeed, under freezing conditions on a vertical wall, it might even be reversed, a condition which renders a vertical back undesirable.

Tests made by the Bureau of Public Roads¹ indicated that the pressure of earth fill against a retaining wall is affected greatly by the amount of moisture present. For a clayey earth, the pressure was that of an equivalent fluid weighing 44 lb. per cubic foot for dry conditions to 54 lb. per cubic foot following a 2.9-in. rain, corresponding to friction angles of 23° and 17°, respectively. On dry clayey loam, the equivalent fluid pressure was 23 lbs. for dry material when first placed. For hydraulic fill of clay the equivalent fluid pressure was 84.5 lbs. per cubic foot, corresponding to an internal friction angle of 4° 50'.

Effect of Surcharge.—Three conditions arise of a surcharged fill, namely (1) where the surcharge is of a uniform depth, (2) where the surcharge slopes up at some angle, δ , and (3) where the surface slopes down at some angle from the horizontal.

When the earth is filled level above the top of the retaining wall, the effective depth is merely increased by that height of the surcharge, as shown in Fig. 101 (a).

Where the earth slopes up from the back of the wall, an equivalent level surcharge is ascertained. That there is an equivalent level surcharge is indicated by the fact that, when observed pressures are plotted against the tangent of the angle of surcharge, the curve is parabolic, which is the curve of increased depth.

The effect of surcharge may be assumed to decrease directly with the distance from the wall and to vanish at the point where

¹ *Public Roads*, p. 102, July, 1925.

the slope of repose cuts the horizontal at the top of the wall. Experiments show that the pressure is transmitted downward within 1:1 slopes. See p. 475. The equivalent level surcharge may, therefore, be found as follows:

The differential weight, Fig. 101 (b), at the back of the wall is $w dx \cdot x \cdot \tan \delta$, causing a lateral pressure against the wall of $Kw \tan \delta x \cdot \frac{m-x}{m} dx$, where $BR = m$. The total pressure is $Kw \tan \delta \int_0^m x \left(\frac{m-x}{m} \right) dx$. Let $RS = b$. Integrating, the total pressure against the wall due to the triangular prism is $\frac{1}{6} K w m b$.

In a level surcharge of height b , the pressure is in a similar manner $\frac{1}{2} K w m b$. Therefore, the height of the equivalent level surcharge is $b/3$ or $\frac{1}{3} h \cot \varphi \tan \delta$, where φ is the angle of repose of the material.

TABLE XXIV.—COMPARISON OF CALCULATED WITH OBSERVED PRESSURES UNDER SLOPING SURCHARGE

Surcharge, angle	Equivalent surcharge h'	Equivalent height h ft.	H pounds	
			Observed	Calculated
-25°0'	0.8	5.2	210	212
-11°20'	0.5	5.5	229	236
0	0.0	6.0	282	282
+11°20'	0.6	6.6	336	342
+25°0'	1.4	7.4	416	430
+34°0'	2.0	8.0	501	503

When the earth fill slopes down from the wall, a similar procedure gives an equivalent depth of fill. Fig. 101 (c). This gives the equivalent surcharge as $\frac{1}{3} \cdot \frac{h \tan \delta}{\tan \delta + \tan \varphi}$, which is negative and should therefore be subtracted (arithmetically) from the maximum depth of earth to obtain the equivalent depth of earth for calculations.

Walls with Sloping Back.—Two conditions of walls with sloping back arise (a) where the slope is from the fill (either plain or stepped), and (b) where the slope is toward the fill.

Where the slope is away from the fill, the pressure is calculated as on a vertical back, and the portion of the earth resting on the

wall is considered a part of the wall, giving virtually a composite wall of two different materials, Fig. 102 (a) and (b). In general, it is desirable to design a retaining wall with the back sloping away from the fill to prevent the heaving, due to frost, from tending to tilt the wall.

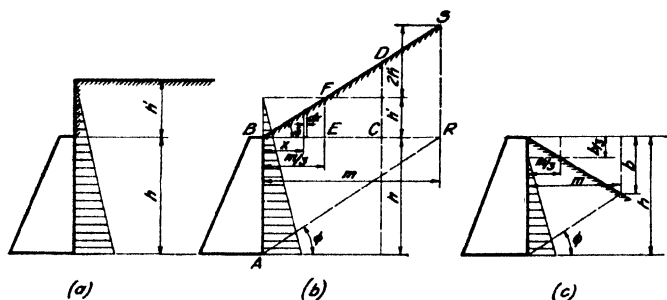

FIG. 101.—Retaining wall with surcharge.

Where the wall slopes toward the fill, as in Fig. 102 (c), the pressure on AB is less than it would be on its projection, BC , because of the presence of a prism of earth ABC between the plane BC and the wall. This decrease in the pressure may be assumed to be in proportion to the mass of this triangular prism,

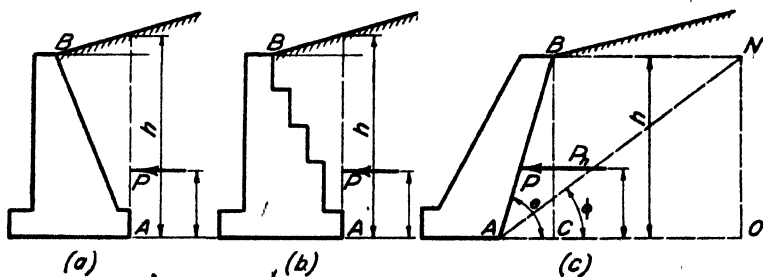

FIG. 102.—Effect of sloping back.

and it amounts to the entire pressure when $\theta = \phi$. The mass is proportional to AC since the height remains constant and equal to h . Therefore, where $ON = BC$ the proportional decrease will be AC/AO , or $\cot \theta / \cot \phi$, and the pressure on the wall in terms of P_1 , the pressure BC , will be

$$P = P_1 \left(1 - \frac{\cot \theta}{\cot \phi} \right)$$

The resultant pressure acts at the centroid of the effective pressure on the wall, *i.e.*, at the center of gravity of the trapezoid or of the triangle of pressure.

Reliability of Retaining Wall Theory.—The analysis of this procedure is not perfect, but it is fairly rational and the results agree with all experimental values with which the author is familiar. Table XXIV shows values for sand obtained by Dr. Feld¹ compared with calculated results. The assumptions are as reasonable as those of the classical theories, and, if lacking in elegance, they gain in simplicity and, the author believes, in reliability.

Few attempts have been made to observe the magnitude of earth pressures on retaining walls of full size, but many experiments have been made on model walls retaining such materials as sand, and in general these experiments corroborate the results of the theoretical analysis insofar as they are applicable. Carefully conducted experiments at the University of Kansas in 1916–17 using dry sand behind a retaining board with a reliable apparatus for determining the magnitude, direction and point of application of the resultant thrust, gave results in close accord with those obtained from the theoretical formulas. Being thus substantiated by tests, it is believed that the theory of retaining walls as above set forth is reliable within the range of ordinary accuracy of design of engineering structures.

The slope of the surface of rupture of a bank of earth, as is well known, is not usually a plane, but is a curved surface tangent approximately to the theoretical plane at the bottom and concave upward following roughly the broken plane *AMN*, Fig. 99. The explanation of this phenomenon is that the cohesion is not entirely destroyed, and as shown in a previous paragraph, the actual thrust is less than the maximum which the material as a granular mass was capable of producing.

In Vol. X of the Proceedings of the American Railway Engineering Association may be found some observations on failures of retaining walls that are very instructive. So far as calculations can be made from the meagre data given, the results sustain the theoretical analysis of retaining walls.

Retaining Wall with a Loaded Fill.—In many instances, the fill behind a wall may be required to sustain a superimposed load, such as a railroad track and train, a building with heavy

¹ *Trans. Am. Soc. C. E.*, vol. 86, p. 1475.

floor loads, or a highway load. Impact from moving loads is probably not an important factor since there is no cumulative vibration through an earth fill. It is, therefore, customary to consider only the direct load and to consider it as spread over a reasonable area. For example, the weight of a locomotive on a track should be considered as spread over about the width of the ballast where the latter is of adequate depth, a spread of 14 ft. being recommended by the American Railway Engineering Association. A single concentrated wheel load is considered usually as distributed over three ties along the track.

Experiments (see p. 475) on the distribution of pressures through sand at the University of Illinois and at Pennsylvania

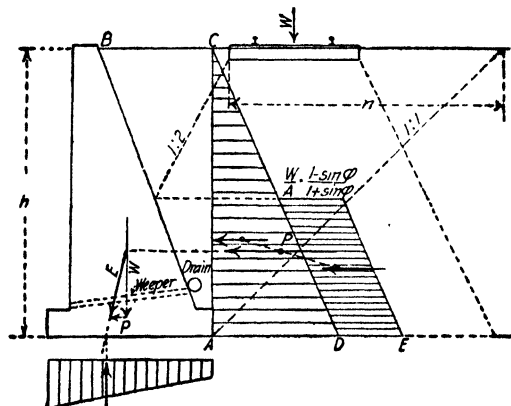

FIG. 103.—Pressure on a retaining wall due to loaded fill.

State College indicate that a 1:2 line is practically the limit of the zone of vertical pressures, and consequently, would mark the limit of the zone of lateral pressures. The distribution of pressure for a superimposed load would therefore be as indicated in Fig. 103, where the unit lateral pressure AD is caused by the fill and DE by the superimposed load. The American Railway Engineering Association recommends as standard practice¹ that a 1:1 line be considered as the limit of pressure distribution, that is, a load farther from a vertical at the back of the footing than the height of the wall shall not be included as a load on the wall. The Association also recommends that the live load be considered as effective for intermediate positions in proportion to the ratio n/h , where n is the distance from the edge of the

¹ Amer. Ry. Eng. Assn., Supplement to Manual, 1917, p. 48.

track to the point where a slope of 1:1 intersects the ground surface. As stated above, however, experiments do not indicate a greater spread of the pressure than the boundary of a 1:2 slope.

Calculating the Stability of a Retaining Wall.—In order that a retaining wall may be stable against sliding, the total weight of the wall and the fill resting thereon multiplied by the coefficient of friction for the material composing the foundation must be greater than the horizontal component of the earth thrust (this is neglecting the friction of the fill on the back of the wall). These coefficients are given for dams on p. 234 and apply to retaining walls as well.

Where a considerable amount of earth lies in front of the wall, the passive resistance of this earth may be added to the frictional force tending to prevent sliding. This resistance may be taken

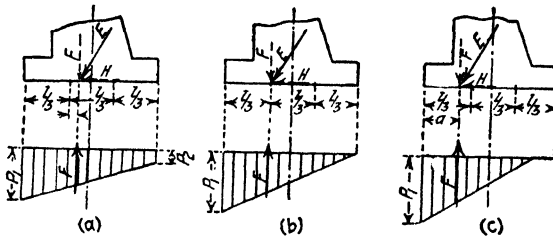

FIG. 104.—Distribution of pressure under a retaining wall.

as a reasonable bearing capacity multiplied by the area of wall abutting the earth.

Where there is special danger of sliding, as in the case of a wall set on a slippery clay or shale stratum, a trench should be dug in the foundation bed, thereby causing a projection of the wall to extend into the solid stratum. See Fig. 116.

A wall is stable against overturning about the toe when the resisting moment of the weight of the wall and of the earth carried by the wall, and of any other force such as ties that tend to resist overturning, is greater than the overturning moment of the earth thrust about the toe. This statement is predicated on the supposition that the wall will not crush at the toe nor the foundation give way at the toe. In order that this supposition may be correct, the pressure or compression at the toe must not exceed safe values when calculated as explained below.

The pressure on the foundation is distributed as shown in Fig. 104, according as the resultant of the earth pressure and

the total weight of wall and earth resting thereon cuts the base (a) within the middle third of the base, (b) at the edge of the middle third or (c) without the middle third. If it falls without the base and no provision is made for tension at the heel, of course, the wall will overturn.

$$\text{In case (a) } p_1 = \frac{F}{l} \left(1 + \frac{6e}{l} \right) \text{ and } p_2 = \frac{F}{l} \left(1 - \frac{6e}{l} \right)$$

$$\text{In case (b) } p_1 = \frac{2F}{l} \text{ and } p_2 = 0$$

$$\text{In case (c) } p_1 = \frac{2F}{3a} \text{ and } p_2 = 0$$

The maximum pressure at the toe should not exceed the safe bearing capacity of the foundation on which the wall is placed. For bearing capacities of soils see p. 470. If the foundation is soft, the wall should be designed so that the resultant will fall at the center of the base if practicable. On solid rock, the resultant might fall outside the middle third without harm, although conservative design keeps the resultant within the middle third. With the resultant at the edge of the middle third, the factor of safety (the ratio between the resisting moment and the overturning moment about the toe) ranges from 3.0 for a rectangular section to 2.0 for a triangular section.

Contraction Joints.—As in other structures, expansion and contraction of retaining walls must be provided for. In plain walls, contraction joints are employed to localize the contraction cracks to definite vertical planes where they may be rendered least objectionable. In plain concrete walls, contraction joints are commonly placed 32 to 48 ft. apart, although in thick walls, they may be placed 60 ft. apart, the exact interval depending on convenience of construction as affected by the length of form lumber used.

A contraction joint is usually formed by making a trapezoidal groove about 6 by 8 in. in cross section from top to bottom down the middle of the end of one section, and after that section has set up, pouring the next section against it, thus forming a sort of tongue-and-groove joint. This tongue-and-groove holds the wall in alignment in the event of uneven settlement and yet the joint may separate considerably. On a 48-ft. section, allowing 0.0005 as the coefficient of contraction due to shrinkage, and 0.000,006 as the coefficient of thermal contraction and 100° range

in temperature, the maximum contraction would be somewhat more than $\frac{1}{2}$ in. The edges of contraction joints should be chamfered off by nailing triangular strips in the corners of the forms before the concrete is poured.

In reinforced concrete walls, contraction joints are sometimes provided in a similar manner, but more frequently, the walls are reinforced for temperature change. Sometimes an amount is used sufficient to distribute the cracks, allowing a tensile strength of the concrete of 200 lb. per square inch. This is usually more than necessary and an amount of steel area equal to 0.2 to 0.3 per cent of the area of the concrete has been found sufficient. This should be placed near the face of the wall.

Drainage of Retaining Walls.—The importance of adequately draining the fill behind retaining walls can scarcely be over-emphasized in promoting the economy of design. The presence of water decreases the angle of internal friction and tends to destroy cohesion, both of which effects tend to increase the pressure on the wall and at the same time to decrease its resisting capacity.

Drainage is effected by inserting "weep holes" consisting of 3- or 4-in. drain tiles through the wall about 15 to 20 ft. apart and by piling crushed stone, gravel, cinders, or similar material around the weeper at the back. The D. L. & W. R. R. turns up the inner end of the weeper by means of an elbow and a column of loose stone is placed above the opening of the elbow extending to the top of the fill.

Where considerable quantities of water are to be expected, a drain tile placed along the back of the wall at such a height as to permit them to discharge into the weepers adds greatly to the efficacy of the drainage. Crushed stone or gravel placed along the back of the wall above the weepers will serve a similar purpose.

Design of the Wall Section.—The design of the section of a retaining wall should take into account the following factors: (1) The wall should be stable, according to the standards previously outlined, (2) it should be an economical section for both the wall and the footing, and (3) particularly where exposed to public view, the wall should have good architectural treatment.

The usual procedure in the design of a gravity section is to select a section either from walls previously used under similar conditions or by some rule of thumb design and then investigate the section selected and modify according to the results of the

calculations. Empirical rules in common use are to make the base width above the footing $0.45h$ for gravity walls of no surcharge, $0.70h$ for inclined surcharge at angle of repose, and $0.65h$ for fill carrying a railway track. The weight of the earth on the back of the wall is more effective in promoting stability when the back is stepped, but convenience of construction causes it more often to be given a uniform batter.

A convenient formula¹ for bottom width of a gravity wall of trapezoidal cross section, having the top width t and the batter of the face, n , given or assumed, is $B = n + t + m$. Where

$$m = \frac{1}{2}(\sqrt{M^2 + 4N} - M) \text{ in which}$$

$$M = \frac{chn + 2e(h + 2h')(n + t)}{e(h + h')}$$

$$N = \frac{h[erh(h + 3h') - c(n^2 + 3nt + t^2)]}{e(h + h')}$$

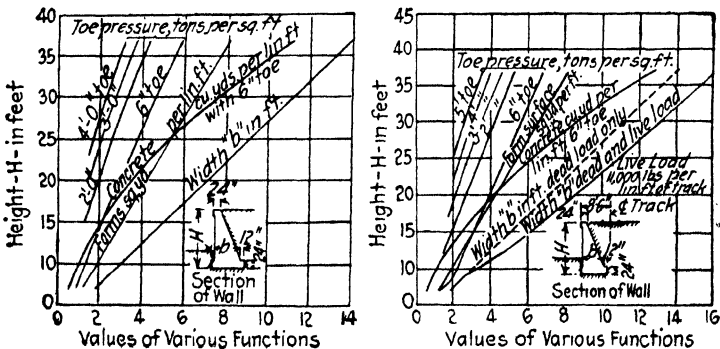

FIG. 105.—Chart for preliminary design of gravity retaining walls.

e being the weight of earth and c the weight of concrete per cubic foot, h' the equivalent height of surcharge to include any load on the fill, r the ratio of lateral to vertical pressure, $\frac{1 - \sin \phi}{1 + \sin \phi}$, and the other nomenclature as before.

Figure 105 is a chart devised by S. H. Smith² for a gravity retaining wall with level surcharge, which is of value in preliminary estimates and designs.

An approximate relation between the length of base and the height of a reinforced concrete wall of cantilever or counterfort

¹ Article by T. A. SMITH, *Engineering Record*, Nov. 4, 1916.

² *Engineering News-Record*, July 5, 1917.

type can be made by equating the overturning moment of the thrust of the earth and the reaction of the foundation about the point where the vertical through the center of gravity cuts the base, assuming the reaction to act through the outer third point. When the toe slab beyond the face of the wall is one third the total length of base, the section gives maximum economy, but

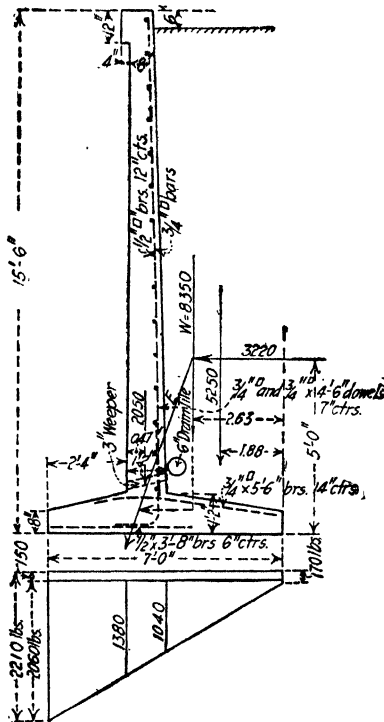

FIG. 106.—Section of a cantilever retaining wall.

there is very little difference in this respect for a variation between one-sixth and one-half of the total length.

The toe and heel slabs as well as the main wall are designed as cantilever beams for moment, shear and bond, and in the main wall, the element of direct compression should be combined with the moment, although in general this factor will not be large. The main wall should also be reinforced to withstand temperature changes without undue cracking.

A counterfort wall consists essentially of a reinforced concrete slab tied rigidly at the points of support to the counterforts and

at the bottom to the footing. The slab instead of acting as a cantilever from the footing, acts as a continuous slab or beam over the counterforts as supports. The slab is designed as a beam between the counterforts taking into account the increase of pressure towards the bottom. Instead of the full effect of continuity being allowed, however, a coefficient of moment of $\frac{1}{10}$ or $\frac{1}{12}$ is commonly used. The wall slab is commonly made of uniform thickness and the spacing of the bars varied to provide for the increased earth thrust at the bottom, the number of changes of spacing being made small to simplify construction.

The footing slab back of the wall likewise, instead of being a cantilever, is a continuous slab between the counterforts, sup-

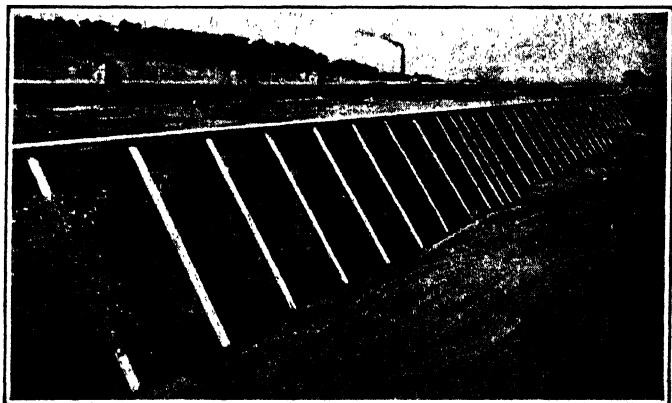

FIG. 107.—Rear view of counterfort retaining wall.

ported on one edge by the wall. However, where the footing slab extends in front of the wall, as it usually does, this projection should be designed as a cantilever as in the case of a T-wall, and then the load or foundation reaction may be considered as carried by a cantilever back of the wall for a width of about one-fifth the total, and the remainder designed as a slab between counterforts. The exact distribution of the load is, of course, indeterminate.

The counterforts are essentially cantilever beams fixed at the bottom and carrying the earth thrust on the wall slab. For economy of material, they should be spaced $(2.5 + 0.2h)$ ft. apart. They are usually about 6 to 8 in. thick for practical construction. The counterforts should be adequately anchored to the footing and tied to the wall slab. The method of tying the counterfort to the base and to the wall should include the bending

the ends of the steel in the counterfort around the steel in the footing and wall slabs, for sufficient bond cannot be secured to anchor the counterfort to the slabs adequately otherwise. Figure 107 shows a counterfort wall 25 ft. high built around the settling basins at Chain of Rocks, St. Louis, and Fig. 108 illustrates the

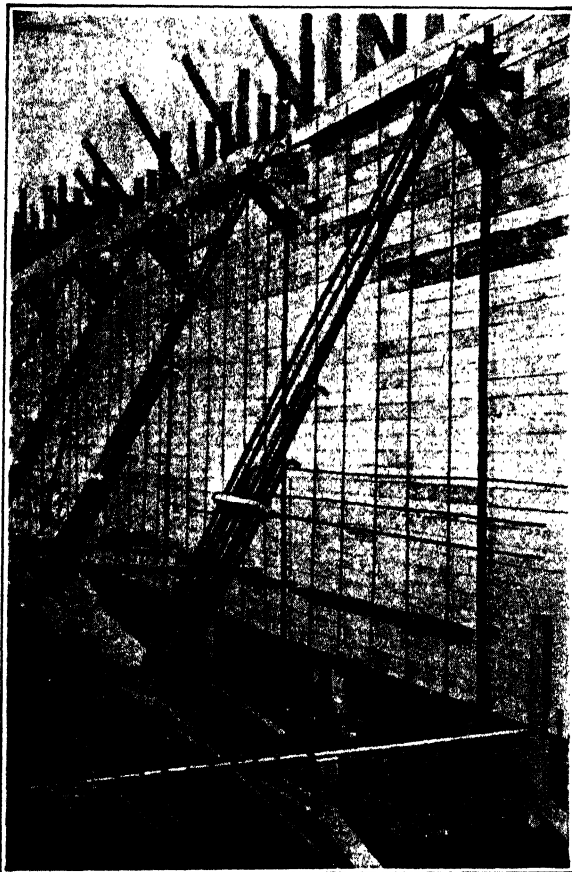

FIG. 108.—Reinforcement in counterfort retaining wall.

manner of placing the steel in the counterforts of the D. L. & W. R. R. retaining wall at Buffalo. Figure 109 gives the details of a cellular wall of the C. M. & St. P. R. R.

Example of Design of Cantilever Retaining Wall.—Suppose it is desired to design a reinforced cantilever wall to sustain an earth fill 15.0 ft. high, the surface being level. The foundation

is to be hardpan soil with a bearing capacity of 6 tons per square foot.

The height of the wall will be taken at 15.5 ft. in order that the earth may be 6 in. below the top. The pressure of the earth will be $0.143wh^2$, or $0.143 \times 100 \times 15^2 = 3,220$ lbs., acting 5 ft.

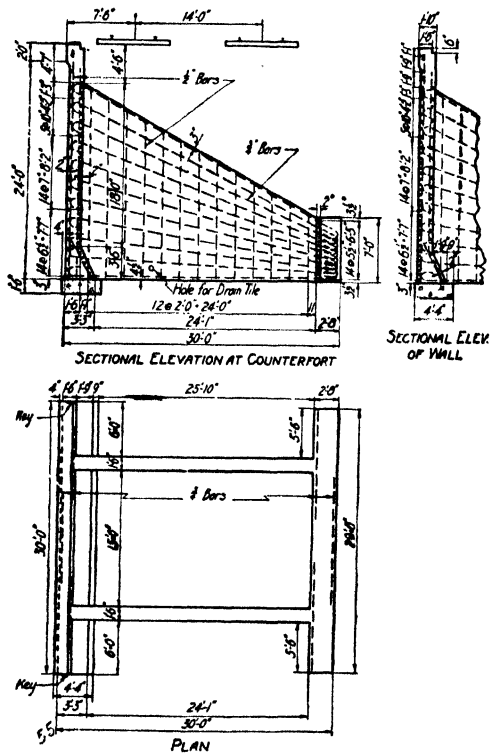

FIG. 109.—Cellular retaining wall of C. M. & St. P. Ry.

above the bottom. The toe distance in front of the wall will be taken as one-third the base, b . The weight of the earth prism on the footing and of the wall is approximately $\frac{2}{3} \times b \times 15 \times 100 = 1,000b$ lbs. It acts a distance of $b/3$ from the heel and $b/3$ distance from the point where the resultant cuts the base, assuming the latter to cut the base at the outer third point. Equating the approximate moments about this point, $1,000b \times b/3 = 3,220 \times 5$, whence $b = 7.0$ ft. approx. Assume the footing 1 ft. thick for preliminary estimating.

The wall will sustain a moment at the bottom of $0.143 \times 100 \times 14^2 \times 4.67 = 13,200$ lb.-ft. or 158,400 lb.-in. The weight of the wall itself will give approximately 20 lbs. per square inch compression. Since 650 lbs. is the working stress in concrete, the thickness should be chosen for 630 lbs. per square inch. Using Eq. (3), p. 147, with this modification, the wall is 11.5 effective depth. Adding 2.5 in. to cover the steel makes the wall 14.0 in. thick at the bottom. A minimum practical width at the top is 8 in.

The weight of the wall will be 2,050 lbs. per lineal foot and its center of mass is 0.47 ft. from the face. The weight of the earth on the heel is 5,250 lbs. and its center of mass 1.88 ft. from the heel. The weight of the footing (assumed as 1 ft. thick) is 1,050 lbs. The resultant of all vertical forces, 8,350 lbs., acts 4.37 ft. from the toe. Combining the thrust and this vertical resultant, gives a resultant which cuts the base 2.50 ft. from the toe or 2 in. inside the middle third of the base.

The pressure at the toe and heel will be respectively,

$$p_1 = \frac{8,350}{7} \left(1 + \frac{6 \times 1.0}{7} \right) = 2,210 \text{ lbs. per square foot.}$$

$$p_2 = \frac{8,350}{7} \left(1 - \frac{6 \times 1.0}{7} \right) = 170 \text{ lbs. per square foot.}$$

The moment at the base of the main wall is 158,400 lb.-in.

$$\text{Area of steel required} = \frac{158,400}{16,000 \times \frac{7}{8} \times 11.5} = 0.98 \text{ sq. in. per}$$

foot; this would require $\frac{3}{4}$ -in. square bars spaced 7-in. centers. At a point 10.5 ft. from the top of the wall, only 0.40 sq. in. is required, hence alternate bars only need be extended above this height. At a point 8.5 ft. from the top, only 0.22 sq. in. is required, hence only every third bar need be extended above this height. While the pressure would not require any rods to be carried to the top of the wall, yet to avoid breaking under impact from blows, every third bar will be extended to within 3 in. of the top of the wall.

Since the weight of the footing slab is approximately 150 lbs. per square foot the net upward pressure producing moment in the footing slab is found by subtracting this weight as shown.

The center of gravity of the upward pressure on the toe slab is $\frac{2.33(1,380 + 2 \times 2,060)}{3(1,380 + 2,060)} = 1.24$ ft. from the face of the wall.

The moment is $1,720 + 2.33 \times 1.24 = 4,980$ lb.-ft. or $59,760$ lb.-in.

$$A_s = \frac{59,760}{16,000 \times \frac{7}{8} \times 9.0} = 0.48 \text{ sq. in. per foot, 9 in. being the}$$

effective depth. To satisfy this requirement, $\frac{3}{4}$ -in. square bars 13 in. centers will suffice, or $\frac{1}{2}$ -in. square bars 6 in. centers, the choice depending on bond requirement.

The shear at the face of the wall is $1,720 \times 2.33 = 4,010$ lbs.

$$\text{The bond stress } f_o = \frac{v}{\Sigma o \cdot jd} = \frac{4,010 \times \frac{13}{2}}{3 \times \frac{7}{8} \times 9} = 184 \text{ lbs. per square}$$

inch for the $\frac{3}{4}$ -in. bars. The $\frac{1}{2}$ -in. bars at 6 in. centers give 127 lbs. per square inch bond stress. The beam will be increased to 14 in. in depth in order to reduce the bond stress on $\frac{1}{2}$ -in. bars and the shear stress in the section in conformity to the specifications. (See p. 147.) These bars should extend 18 in. back of the face of the wall in order that the embedment may be 36 diameters, hence, the bars will be 3 ft. 8 in. long.

The shear 1 ft. from the toe is approx. 2,000 lbs. $2,000/40 = 50$ sq. in. required. The effective depth at this point need be only 5 in. which added to the 3 in. below the steel makes the slab 8 in. thick at the toe.

The moment in the heel slab will be $5,250 \times 1.62 - 530 \times 3.5 \times 1.18 = 6,330$ lb.-ft. or $75,960$ lb.-in.

$A_s = 75,960 \div (16,000 \times \frac{7}{8} \times 11.5) = 0.47$ sq. in. To provide for this moment, $\frac{3}{4}$ -in. square bars spaced 14 in. centers will suffice. These should extend 27 in. beyond the back of the wall to secure sufficient embedment, hence, these bars will be 5 ft. 6 in. long. Shear and bond conform to specifications.

To provide for temperature change and shrinkage, 0.2 per cent of steel will be placed longitudinally in the wall, or $0.002 \times 1,920 = 3.8$ sq. in., or $\frac{1}{2}$ -in. bars, at 12 in. centers.

The upright bars in the wall should be embedded 36 diameters or 27 in., to effect which the bars will have to be bent back along the footing as shown in Fig. 106. To facilitate construction in avoiding the projecting of the long unsupported bars when the footing is being placed, dowels are sometimes placed in the base and allowed to overlap the upright bars, which are placed later. This is not necessary, however, as the long bars can readily be supported while the footing is being poured.

Making the depth of coping in inches equal to the exposed height of wall, gives a 12-in. coping as shown. In the absence of

specific conditions governing drainage, a 6-in. drain tile will be placed back of the wall discharging through 3-in. weepers spaced 16 ft. apart.

Quay and Reservoir Walls.—A quay wall is one built to provide deep water in which boats in dock, lock or harbor may approach the shore loading pier. Its function is to form a basin for the water on the one side and to retain the earth with any superimposed load on the other. It differs from an ordinary retaining wall in that a portion of the earth back of the wall is saturated and takes on different properties from what it would have in the dry state, and in that the wall is subject to the buoyant effect of the water when the basin is full.

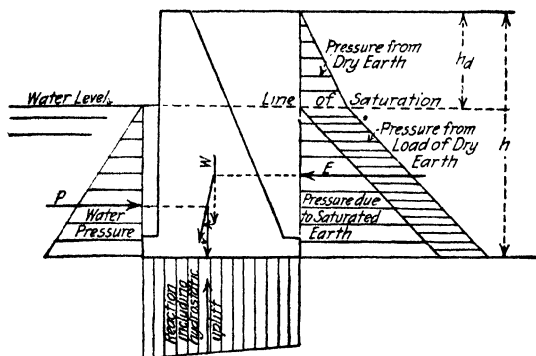

FIG. 110.—Forces acting on a quay wall.

The problem resolves itself into a wall with the earth below the plane of saturation carrying a superimposed load of the dry earth above together with any loads that may lie on the surface. The wall should be investigated for the conditions of basin full and basin empty in the event that the basin will ever actually be empty in fact. The solution of the problem does not differ in principle from that of the ordinary retaining wall, except that the properties of saturated earth will have to be used. Fluid mud is frequently dumped from scows behind quay wall, during the construction of the dock. Figure 110 shows the character of the forces acting on such a wall. The pressure of a backfill of sand and mud at the Hudson River bridge was less than hydrostatic pressure for corresponding heads.¹ Where boats are likely to strike the wall, of course it should be designed to provide for such impact.

¹ *Engineering News-Record*, vol. 101, p. 235, 1928.

Dock walls are sometimes built up partly of cribbing or on piles below the ground as illustrated in the wall of the Dominion Government wharf at Vancouver, Fig. 111. These cribs were

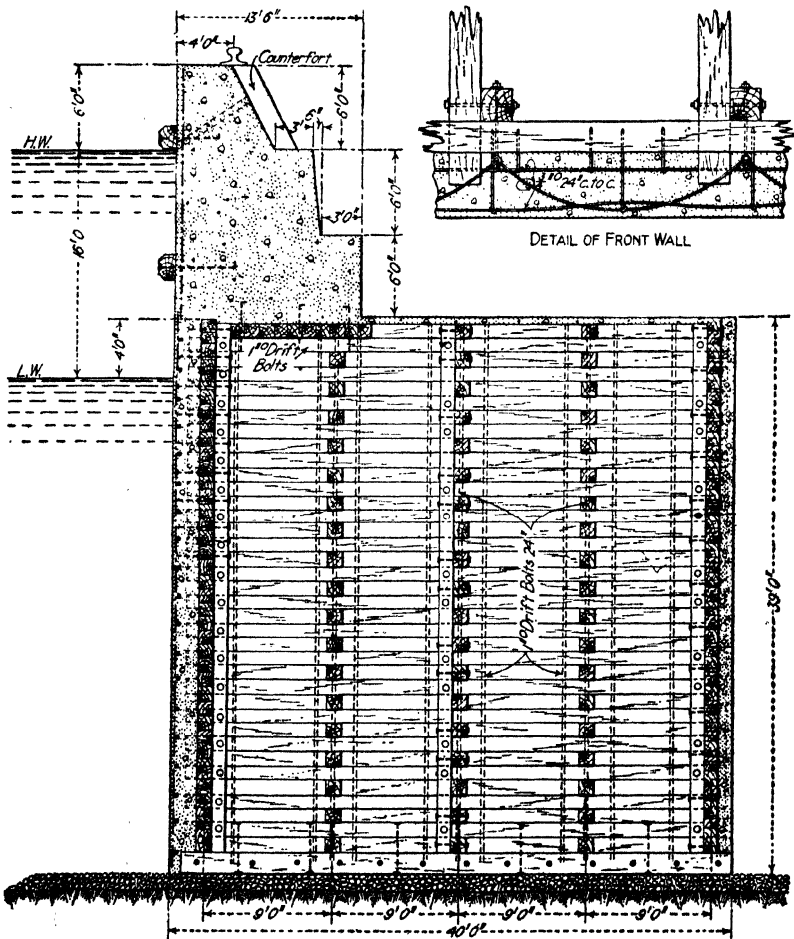

FIG. 111.—Section of Vancouver dock wall.

built to a height of 10 ft. on ways, then launched and finished in place. The back fill consisted of sand and clay dredged from the harbor.¹

¹ *Engineering Record*, July 22, 1916.

Walls for circular reservoirs of small diameter may be built as cylinders sustaining a normal external pressure. Walls for reservoirs of other shapes should be built with an independently stable section. Figure 112 shows a cross section of the reservoir wall at Webb City, Mo., and the analysis of forces acting.

For walls of this sort, a rich concrete mixture is required. In the case of walls exposed to sea water, an impervious concrete should be used, otherwise the entrance of sea water will disintegrate the structure and attack any reinforcing or other steel

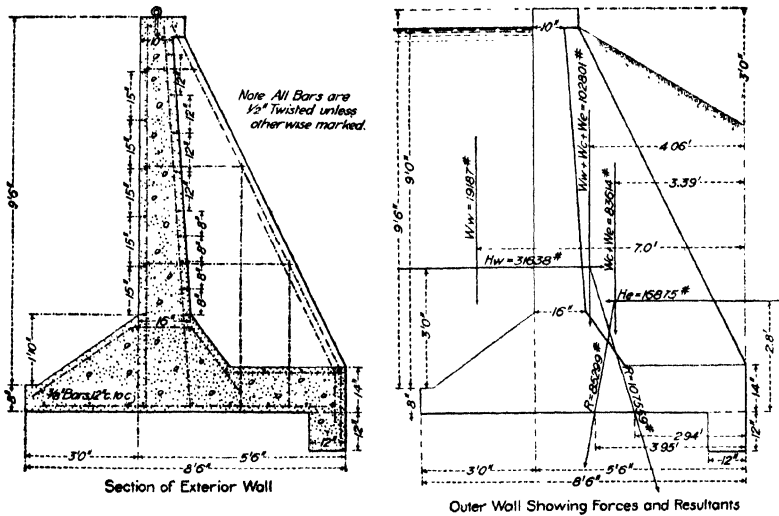

FIG. 112.—Section of reservoir wall at Webb City, Mo.

that may be encountered. For reservoir walls, an impervious wall is required to prevent the leakage of water from the inside and in the case of municipal supplies, to prevent the pollution from the outside.

Slope Walls and Retaining Grillages.—Slope walls are concrete or built-up masonry walls laid either dry or with mortar on approximately the natural slope of the bank of earth retained. Their purpose is to protect the bank from erosion and to assist in holding the earth in place, particularly at the bottom of the slope. Slope walls are frequently laid on slopes that are subject to the waves of a body of water to prevent scour and wash. Concrete slope walls are frequently used as linings for reservoirs,

and as such, are cheaper than vertical retaining walls where available space is not a controlling factor.

Concrete of plastic consistency can be laid on a $1\frac{1}{2}$:1 slope without forms, and a dry mix can be laid on a $1\frac{1}{4}$:1 slope without forms, where a plank is laid on the freshly deposited concrete temporarily to hold it in place. Concrete of mushy consistency cannot be used on slope walls without forms because of its tendency to flow. Even where an outer form must be built for a slope wall, as on a 1:1 slope, a comparatively thin wall can be built of concrete, which will be cheaper than the ordinary type of retaining wall, unless the space that the slope occupies is too valuable.

Several railroads have used retaining grillages in recent years instead of solid retaining walls and have found them much cheaper than the latter. The retaining grillage shown in Fig. 113, which was built by the C. R. I. & P. R. R. in track elevation work, was built of reinforced concrete stretchers 8 ft. long, and headers 6 ft. long, the front batter being 1:12. The cost is stated¹ to have been about one-fifth that of a retaining wall of the same height.

Relative Economy of Retaining Wall Types.—The cost of a concrete retaining wall, aside from overhead charges, depends upon (a) the amount of excavation for the footing, (b) the cost of forms, including both material and labor, (c) the amount of concrete, (d) the amount of steel reinforcement, (e) the labor of placing. Beside the ordinary charge of overhead expense, the delay in the use of the wall, the loss of time in the use of equipment, and other losses that may result from the choice of a type of slow construction should be considered.

The type of wall that is most economical is the one that will render the total of these costs a minimum, and these costs obviously depend upon the unit prices of labor, materials and excavation. Theoretical savings in concrete are frequently lost in the expense of complicated forms and difficult placing of the concrete, particularly where high priced labor is used. No general rules or definite statements can be formulated as to the relative economy of the different types of walls, that will always apply, but the most economical form can only be selected with certainty after making careful estimates of the various types under the conditions to be met.

¹ *Engineering Record*, Sept. 16, 1916.

The following statements, however, may be considered as approximately true for average conditions. Counterfort walls are not economical for heights under 20 ft. Gravity walls are economical for low walls, say up to 10 or 12 ft. Reinforced concrete walls are economical for heights of 12 or 15 ft. and over, the cantilever type being used up to 20 ft. Highly reinforced footings for gravity walls are seldom economical, although the saving in excavation may render them so in some instances. A fillet wall is seldom economical on account of the extra cost of building the forms at different slopes and the additional cost of

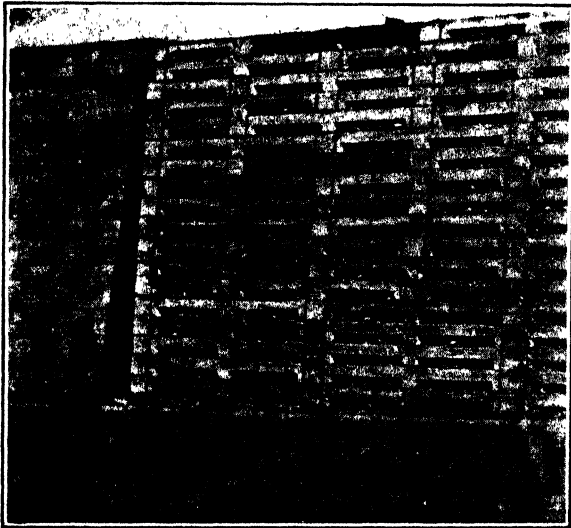

FIG. 113.—A retaining grillage.

placing the concrete. A compromise wall, i.e., a light gravity wall lightly reinforced, with a reinforced footing may be found economical in some instances for heights of about 10 to 15 ft. Breast walls leaning towards the earth bank are economical where no back form need be built, but where a back form is required, a wall leaning toward the bank is seldom economical notwithstanding it may require less material than other types. Where the space is available, retaining walls with a heavily battered face are economical. Buttressed retaining walls are never economical and have no justification except for architectural appearance in some locations. Retaining walls with

relieving arches at the back, although they have been built to some extent in the past, have no merit to justify their adoption.

There are practically no patents on retaining walls that need to hamper freedom in design, inasmuch as nearly all patent claims have been declared invalid. Where patent claims do exist, however, royalty charges should be added to the cost of the patented type.

Architectural Treatment of Retaining Walls.—For track elevation purposes or other construction in cities where sightliness is an important factor in the design of retaining walls, some effort should be made to relieve the monotony of plain wall surfaces. This can usually be accomplished without undue cost by (a)

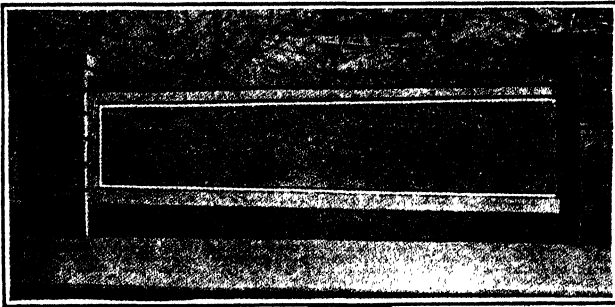

FIG. 114.—Paneled retaining wall.

use of a coping, (b) scoring the surface, (c) paneling, (d) buttressing, and (e) treatment of the concrete surface.

The depth of a coping should bear a proper relation to the height of the wall exposed to view and if skilfully designed will greatly improve the appearance of the wall. Making the depth of the coping in inches approximately equal the exposed height in feet usually gives satisfactory results except for extremely low or extremely high walls. Low walls (below about 4 ft.) do not require a coping and on high walls making a coping deeper than 30 in. adds nothing and may detract from the appearance.

Scoring is accomplished by nailing triangular strips on the inside of the form when the concrete is poured. Scoring may properly run horizontally or vertically, but preferably the former. Rather deep grooves widely spaced give more pleasing results than insignificant grooves placed close together. Cross grooves are confusing and should not be used generally, but where they

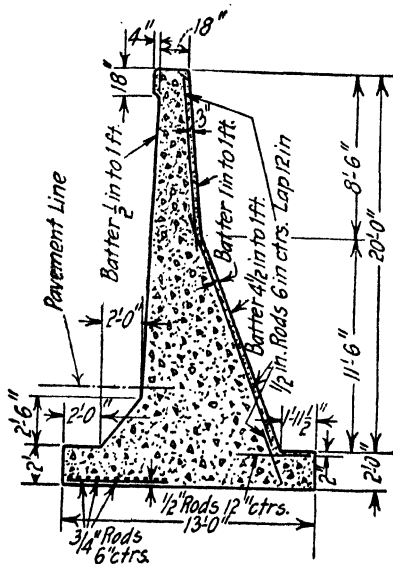

FIG. 115.—Section of a fillet retaining wall.

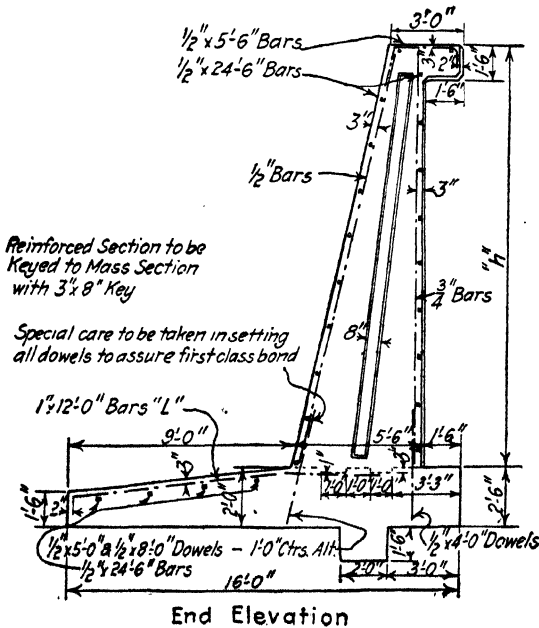

FIG. 116.—Compromise section of a retaining wall of the C. M. & St. P. Ry.

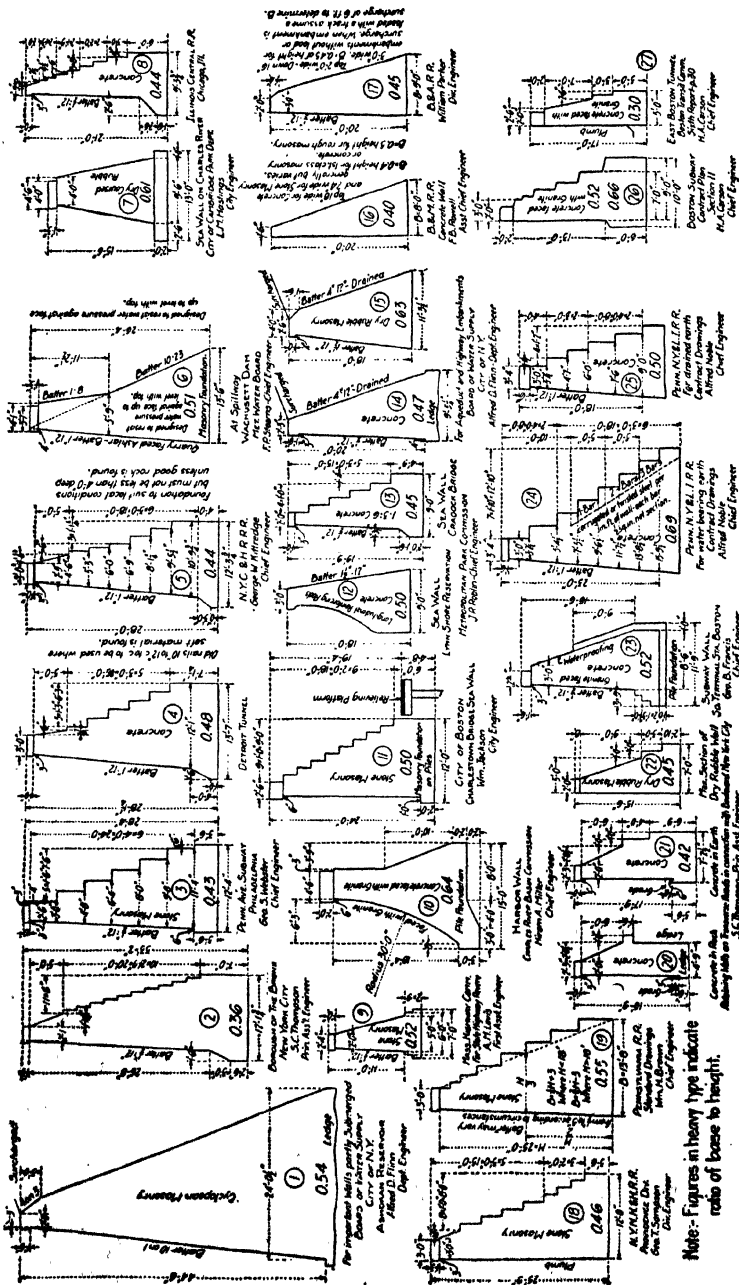

Fig. 117.—Various sections of gravity retaining walls.

Note: Figures in heavy type indicate ratio of base to height.

are employed, they should be much lighter than the primary grooves.

Paneling is more expensive than scoring and must be done with care to be effective. Either horizontal or vertical lines should be accentuated. Paneling must show a definite plan, for a haphazard arrangement is likely to impair rather than improve the appearance of the wall. Figure 114 shows the mode of paneling on a retaining wall in Meridian Park, Washington,¹ where the aesthetic requirements were unusual. This is a low wall varying from 7 to 10 ft. in height. For high walls, the panels are commonly placed with their longer dimension vertical. An offset forming a visible base on the face of a wall usually improves the appearance.

Building false buttresses in front of concrete walls violates the first principle of good architecture, namely, that of sincerity, in that the pseudo-buttress pretends to possess structural value but does not. Buttress walls of stone masonry have been used to rather good advantage at times.

For various modes of treating concrete surfaces, see p. 112.

Examples of Retaining Walls.—Owing to the variety of factors that may influence the shape of a retaining wall, it is not surprising that a large variety of shapes have been devised. Figure 115 is a fillet section of a retaining wall built by the Burlington R. R. and Fig. 116 is a compromise section of the C. M. & St. P. Ry. built by extending the fillet to the top in order to avoid complicated forms.

Figure 117, taken from Professor Milo S. Ketchum's treatise, "Walls, Bins, and Grain Elevators," shows a group of gravity walls, and illustrates well the variety of forms that have been used.

¹ *Engineering News*, Dec. 23, 1915.

CHAPTER VIII

BRIDGE ABUTMENTS AND PIERS

A. ABUTMENTS

Functions of a Bridge Abutment.—The substructure of a bridge consists of the abutments and piers together with their foundations. A bridge abutment is a structure whose function is to support the end of the bridge span and to retain the earth embankment carrying the roadway. A railroad bridge abutment, in addition, must provide support for the track as it passes from the earth roadbed on the approach embankment on to the bridge floor, and to withstand the traction forces to which it may be subjected. An abutment for a railroad bridge should also be designed to prevent disaster in the event of derailment of a train as it approaches the bridge. When the bridge is over a stream, the abutment should prevent scouring the embankment, and in any case, the abutment should be designed to provide adequate drainage of the fill behind it.

The parts of an abutment are (1) the footing, (2) the body, (3) the bridge seat, (4) the back wall and (5) the wing walls. The footing must be spread over sufficient area so that the pressure on the soil may not exceed its bearing capacity. The body of the abutment must have sufficient area and strength to support the bridge and to withstand the various forces transmitted to it from the bridge span and from the fill back of the abutment. The bridge seat must have sufficient area to accommodate the shoe or bearing plates of the truss or girder. The back-wall prevents the earth from slipping or falling forward on to the bridge seat and must be sufficiently strong to retain the fill above the level of the bridge seat with its superimposed load. The wing walls are extended out to such a distance and at such a height and angle as to retain the side slopes of the embankment and to prevent scour from the stream.

The problem of designing a bridge abutment is to provide for these various functions adequately and economically, and the

following pages will present briefly an analysis of the factors involved.

Types of Bridge Abutments.—Early abutments were nothing more than a mass of stone masonry laid at the stream edge to support the end of the bridge above the water, and as a result, abutments were uniformly alike for early bridges. As engineering skill and knowledge advanced, as the requirements became more varied and as new building materials were introduced, e.g. reinforced concrete, various types have been introduced to meet the varying needs with a view to economy and appearance. Abutments may be classified as follows:

1. *Pile* abutments
2. *Steel cylinder* abutments
3. *Mass* abutments of built up or plain concrete masonry
 - (a) Wing abutments
 - (b) U-abutments
 - (c) Pier abutments
 - (d) T-abutments
4. *Reinforced concrete* abutments
 - (a) Counterfort wing abutments
 - (b) U-abutments
 - (c) Arch abutments
 - (d) Trestle abutments
 - (e) Cellular abutments.

The choice of type of abutment depends upon the foundation and other conditions of the site, the height, and other factors affecting the relative economy.

Stability of an Abutment.—In the present discussion, abutments for railroad bridges will be chiefly considered owing to their greater complexity of design. The forces acting on an abutment are the weight of the end of the bridge span with any load that it may carry, the traction force of the train, the pressure from the earth fill and the surcharge, the weight of the abutment, centrifugal and wind forces acting on the bridge span and transmitted to the abutment, and the reaction of the foundation. As in the case of a dam or a retaining wall, an abutment must be stable against sliding and overturning and against failure within the structure itself. It must be stable with and without the bridge in place. See Fig. 118.

The method of calculating the pressure from the earth fill and its surcharge was explained in the previous chapter, being the same for an abutment as for a retaining wall. The pressure from the

live load surcharge under a railroad track is distributed laterally over a width limited by lines with a slope of 1:2 running outward from either end of the ties or from the edge of the ballast. Figure

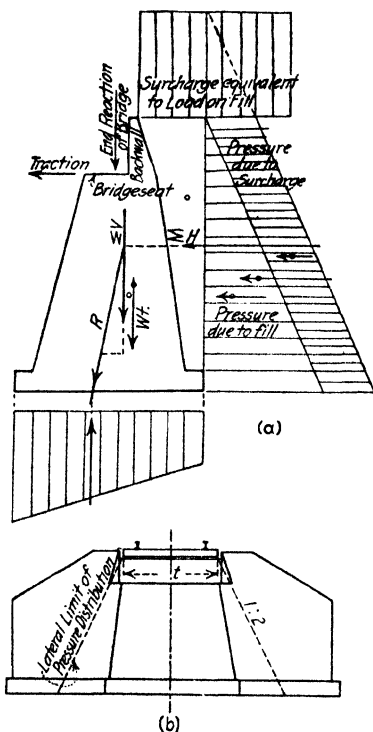

FIG. 118.—Forces acting on a bridge abutment.

118(b) shows this distribution of load. It is not customary to consider an impact effect from moving loads since any vibration is supposed to be entirely dissipated through the embankment. In calculating the pressure on the wall, it is good practice to consider the load of the track and train as spread over a width of 10 ft. at the bottom of the ballast for a single track road, where the ballast is of standard depth.

The traction force results from the train applying the brakes while passing over the bridge, or to a lesser extent in the locomotive accelerating its train, tending to push the bridge longitudinally. A train is decelerated, of course, when the brakes are set, by the horizontal component of the reaction of the track against the wheels and that portion of the

train that is on the bridge communicates this horizontal force to the substructure through the bridge superstructure. The total amount of this traction force equals the weight of the train on the bridge multiplied by the friction per pound developed between the track and the wheels. It is commonly assumed that this force equals the weight multiplied by a friction factor of 0.2; for long spans (over 250 ft.), a coefficient of 0.1 is more commonly used because of the improbability of all the wheels acting at a maximum grip simultaneously.

This tractive force is sustained by (a) being transmitted along the track producing tension in the rails back of the train and compression forward, and (b) being transmitted to the sub-

structure of the bridge; the proportion withstood by each of these resistances is entirely indeterminate. The portion of the traction force sustained by tension and compression in the rails is limited probably to the frictional resistance to slipping between the rails and the angle bars at the joints. Each joint has been found capable of sustaining 30,000 to 70,000 lb. equivalent to about 4,000 lb. per square inch in the rail section. The amount of the tractive force carried by the track would, therefore, be limited to about 120,000 to 280,000 lb. or the total traction of Cooper's E50 loading on a 120- to 280-ft. span. It is probable, owing to the fact that the resistance of the rails is more direct and rigid than the reaction of the substructure through the bearing and frame of the superstructure, that most of the traction force is carried by the rails up to this limit. Many of the more conservative engineers, however, assign the entire traction force to the substructure and design it accordingly.

Owing to the greater rigidity of the abutments as compared with the piers, the portion of the traction force that is sustained by the substructure, is probably divided between the abutments and piers with the larger proportion to the former where the number of piers is not greater than the number of abutments and the bridge spans are attached with equal rigidity in each case. For spans of any considerable length, one end is fixed and the other rests on rollers or rockers to permit expansion and contraction. The traction force of such a span that is carried by the substructure should obviously be assigned to the abutment or pier supporting the fixed end.

The live load is commonly equated to an equivalent surcharge of earth. Thus with the track and train producing a load of 6,000 lb. per linear foot of track considered as spread laterally over a width of 10 ft., the equivalent surcharge is 6 ft., assuming the earth fill to weigh 100 lbs. per cubic foot.

The amount of centrifugal and wind forces will be considered later in their application to piers. (See p. 324.)

The stability of an abutment is investigated essentially as in the case of a retaining wall, the wings being in reality only retaining walls, and for that reason, an extended discussion here is not necessary. The body of the abutment and the wings should, in general, be made stable independent of each other, although straight short wings are sometimes tied to the body and the stability of the whole structure considered as a unit. No

horizontal restraint is considered to be afforded by the superstructure. In investigating the stability of an abutment a section 1 ft. long is usually considered, but conditions may necessitate the calculations being made on the whole abutment as a unit.

When the abutment rests on piles, the resultant pressure should fall well within the piles and properly should cut the base at the center of gravity of the pile foundation for the condition of maximum severity. (See p. 515.)

Mass Abutments.—Mass abutments are designed to resist the forces acting upon them by the inertia of their own weight. They include wing wall abutments, either straight or at an angle, U-abutments, T-abutments and pier abutments without wings. Figure 119 is a plan of a plain mass abutment.¹

The angle that the wings make with the body of the abutment may vary from 0° to 90°; at the former extreme, the abutment becomes one with straight wing walls and at the latter, it becomes a U-abutment. The angle is selected to meet the peculiar conditions of the site. Straight wing walls are always cheaper to construct and are generally used on small structures where there is little likelihood of scouring from the stream. Angle wings are used to prevent scour, the usual angle being 15° to 30°, the larger angle corresponding to the wider spread of the stream in high water, and the smaller, to a more confined channel. Angle wings facilitate the passage of drift and debris. The top slope of the wing wall may be either stepped or sloped, the latter being more common in concrete construction and the former in built-up masonry.

U-abutments are frequently used where the approach to the bridge is a long embankment, the earth fill being allowed to spill down past the wings as shown in Fig. 120. T-abutments were formerly used to a considerable extent, but exist now only in the older structures.

The back wall must be designed to withstand the pressure of the earth behind it with the load carried thereon. It may frequently be economically designed with reinforcing rods extending from the body of the abutment in order to diminish the thickness. Moreover, where the structure is being erected under traffic, to facilitate construction of the track and bridge steel work, the back is built last, in which case these reinforcing bars

¹*Proc. Am. Ry. Eng. Assn.*, vol. 13, p. 1092.

may serve as dowels to attach the back wall to the bridge seat. The C. M. & St. P. R. R. uses a backwall with a removable top, which is inserted in slots in the top of the base of the backwall and at the sides. This is to facilitate construction under traffic.

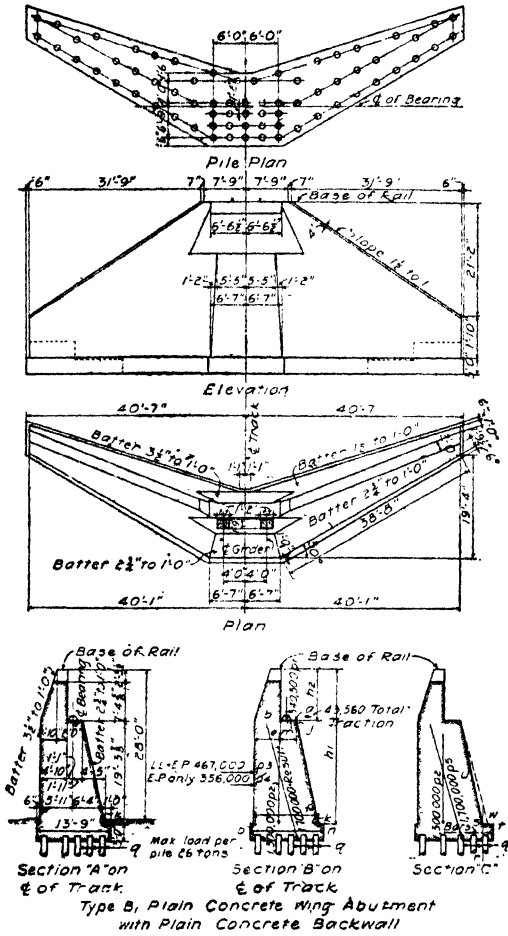

FIG. 119.—Details of a mass bridge abutment of C. M. & St. P. Ry.

Whether an abutment should be vertical on the face or inclined backwards depends upon the circumstances. In the case of a viaduct over a street or in other circumstances where the span is fixed and vertical sides are required, the front of the abutment

must be vertical. At a stream crossing, a saving can sometimes be effected by giving the face a batter so that the load of the bridge superstructure may fall over the center of the foundation, or even back of it, and thus serve to equalize the pressures on the foundation. However, in general, it will not pay to lengthen the bridge span in order to accomplish this result. Hence, in order to afford the required waterway or clear span between abutments, the batter may be made larger at the bottom below ground.

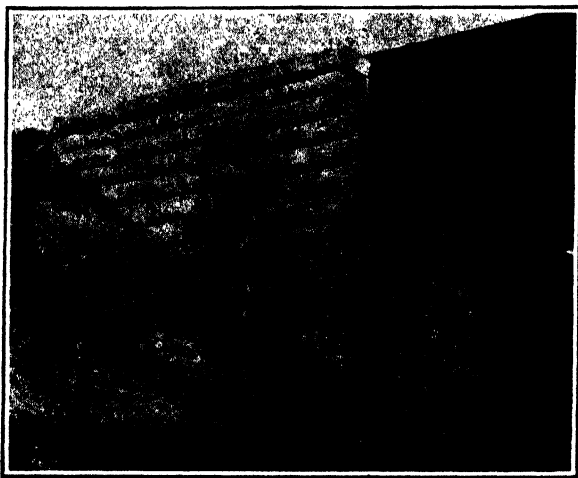

FIG. 120.—Masonry U-abutment.

Reinforced Concrete Abutments.¹—For high abutments, reinforced concrete construction is more economical than plain masonry structures, the choice of type being dependent on the conditions of scour, whether the earth may spill forward or not, and the height.

The counterfort type, Figs. 121 and 122, consists of a footing slab spread sufficiently to provide adequate bearing area, a curtain wall anchored to the counterforts, a bridge seat reinforced over the spans between the counterforts, and the backwall also anchored to the counterforts. This type is rather more expensive than plain concrete mass abutments for heights less than about 30 ft.

¹ Many of the illustrations of reinforced concrete abutments used herein are taken from the excellent monograph by J. H. PRIOR, "Bridge Abutments," in *Proc. Amer. Ry. Eng. Assn.*, vol. 13.

The reinforced concrete U-abutment, Fig. 123, consists essentially of the footing under the front curtain wall, the bridge seat reinforced as a slab over the span between the side walls and resting also on the front curtain wall, the back wall resting on the bridge seat and tied to the side walls, and lastly the side walls tied together by means of reinforced concrete ties through the fill. This is an economical type for fills of 25 to 30 ft. in height where

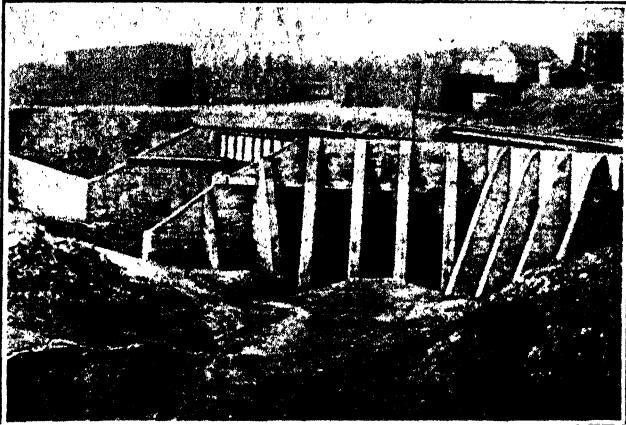

FIG. 121.—Counterfort abutment, K. C. M. & O. R. R.

there is no danger of scour from the stream. With a heavier pier at the front in place of the thin curtain wall, this type of abutment may be advantageously used in the construction of arch bridges. In calculating the stability against overturning, the weight of the side walls, the weight of the earth on the footings of the side walls and friction of the earth on the side walls may be included in the forces contributing to the resisting moment.

Where a deck of reinforced concrete slabs is laid on the side walls, arch openings may be left in the side walls, thus effecting a saving of material. Figure 124 shows such an abutment after the fill is in place. The beams over these openings are designed as fixed beams, the openings being arches in appearance only. Where the earth spills forward on both the inside and the outside of the side walls, the lateral pressure from the earth is almost entirely eliminated.

For greater heights, where the spilling forward of the earth is not objectionable, the reinforced concrete trestle type is econom-

ical. Figure 125 is a photograph of the abutment built by the C. M. & St. P. R. R.¹ over the Lind Coulee in Washington. It is 77 ft. high, contains 900 cu. yds. of concrete and 103,000 lbs. of

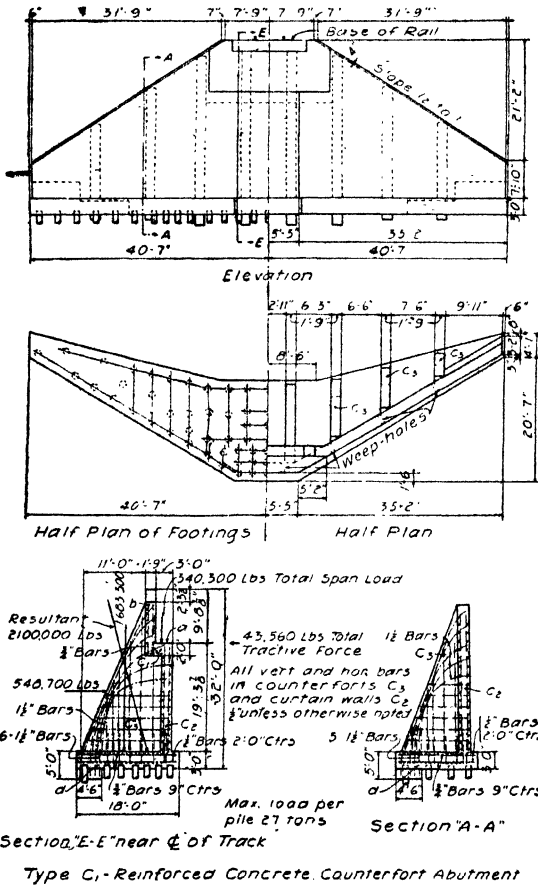

FIG. 122.—Details of a counterfort abutment, C. M. & St. P. Ry.

steel, and brings a soil pressure on the gravel foundation of $3\frac{1}{2}$ to $4\frac{1}{2}$ tons per square foot.

Cellular abutments consist of a heavy front wall or body to withstand the thrust or load from the bridge, and a cellular or box construction back of this wall to retain the fill and support the roadway, the weight of this fill assisting in stabilizing the abutment, the entire weight of the cells and the fill being considered in calculating the stability. They are used in the design

¹ *Engineering Record*, Sept. 26, 1914.

of reinforced concrete arches of long span. The weight of the earth in the abutment resists negative moment at the skewback, while the passive resistance of the embankment under the cells

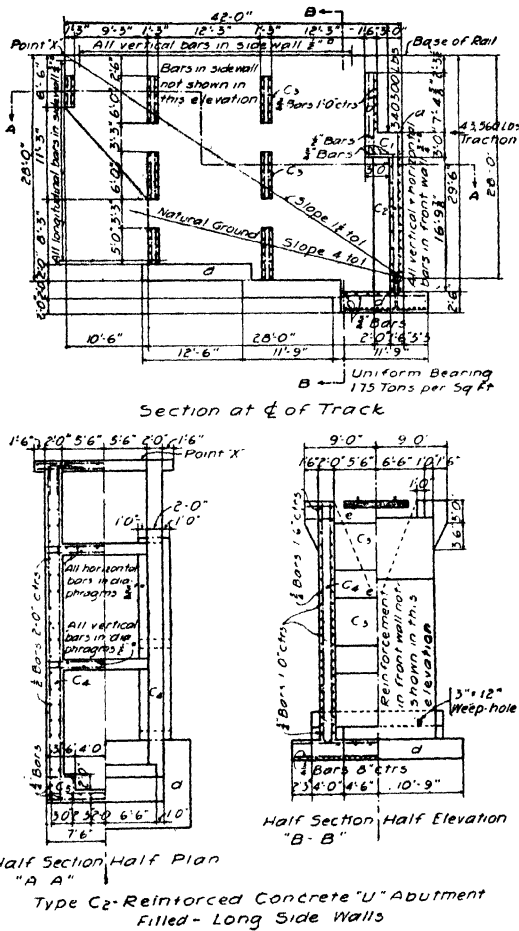

FIG. 123.—Details of a reinforced concrete U-abutment, C. M. & St. P. Ry.

resists positive moment. Figure 126 illustrates an abutment of this type resting on a shaft sunk to gravel and boulders by the pneumatic caisson process, being the abutment of the 132-ft. arch over the Kansas River at Lawrence.

General Dimensions.—The dimensions of a bridge abutment in addition to securing stability to the structure must accommo-



FIG. 124.—U-abutment with open side walls.

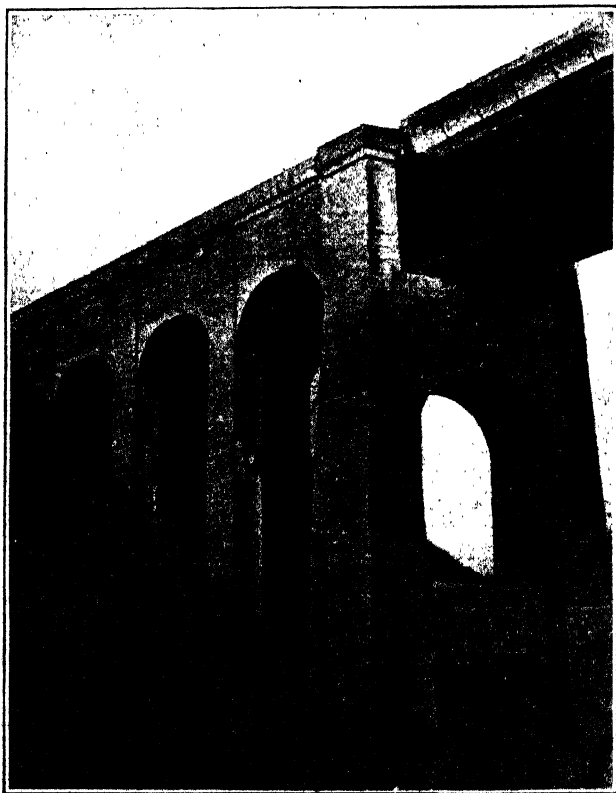

FIG. 125.—Trestle abutment, C. M. & St. P. Ry.

date the superstructure of the bridge and otherwise meet the needs of the situation. The width of the bridge seat must be adequate to provide for the bridge bearing plates or pedestals under the ends of the trusses or girders, with a clearance of about

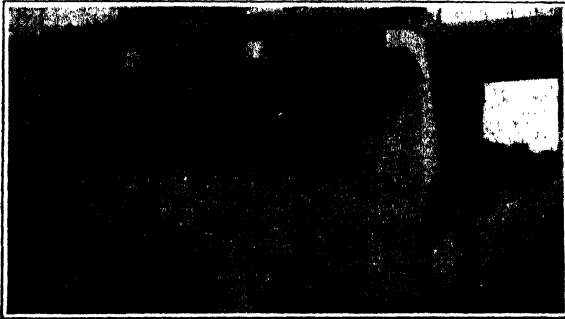

FIG. 126.—Cellular abutment for highway arch bridge at Lawrence, Kansas.

4 in. between the back wall and a deck girder and about 6 in. between the back wall and a truss, and the edge of the bearing plates should not be nearer than 1 ft. from the edge of the masonry. At the roller end of a span, the movement of about 1 in. per 100 ft.

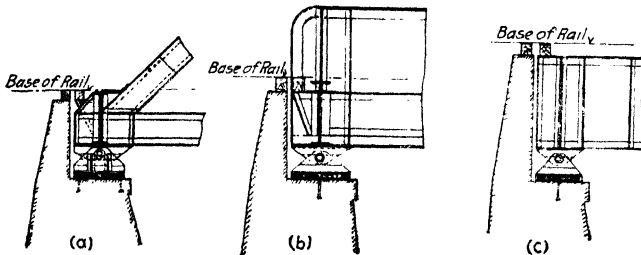

FIG. 127.—Position of superstructure on an abutment.

of span each way from a mean position should be provided for in good practice. The top of the back wall should reach to the base of the ties, and some roads permit it to extend up between two ties slightly. Where deck slabs carry a ballasted track on the bridge, the back wall is made to fit the shape of the slab so that there is no break in the continuity of the ballast. The height of the back wall above the bridge seat, is dependent, therefore, on the kind of bridge superstructure, differing for trusses, deck girders, through girders, and for ballasted and open deck bridges.

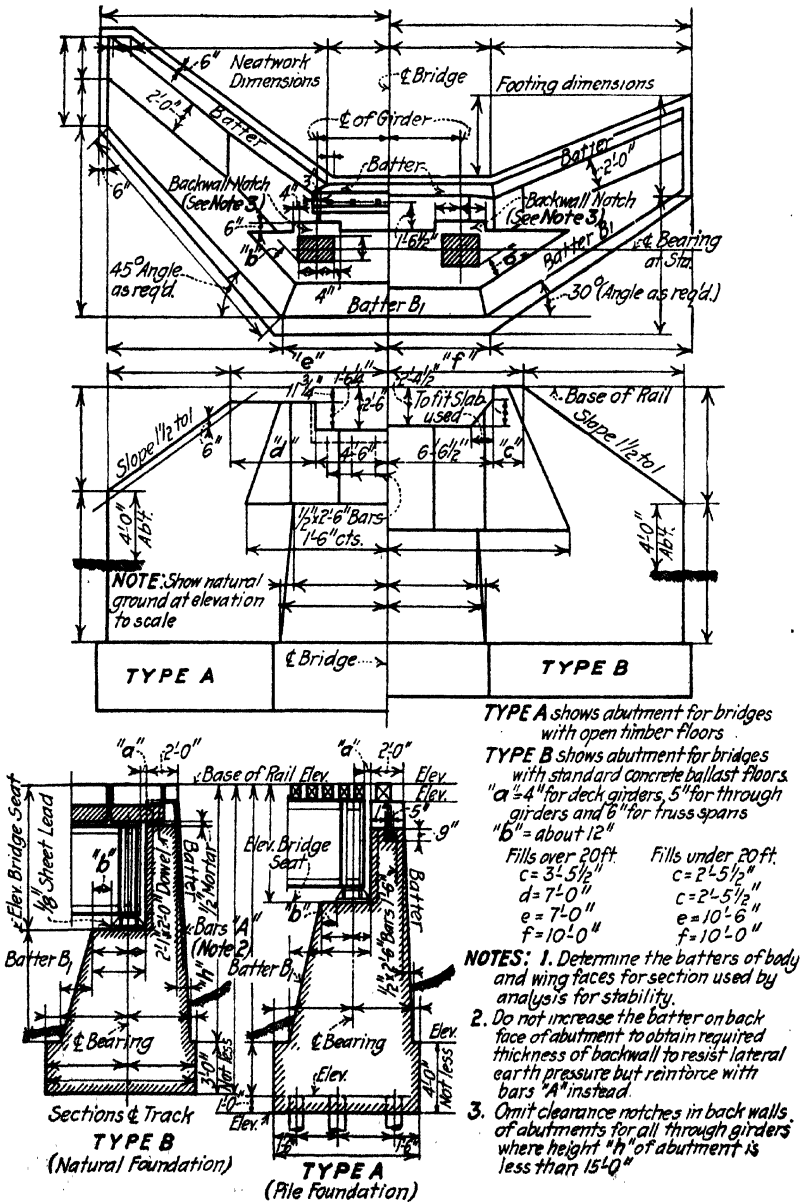

FIG. 128.—Standard bridge abutment of C. M. & St. P. Ry.

Figure 127 illustrates the mode of placing the superstructure on the abutment, (a) being for a through truss, (b) for a through girder and (c) for a deck girder bridge.

Batters on the front or back of abutments should not exceed about 4 in. to 1 ft. because of the difficulty in anchoring the forms so as to prevent their rising due to the buoyancy of the fresh concrete.

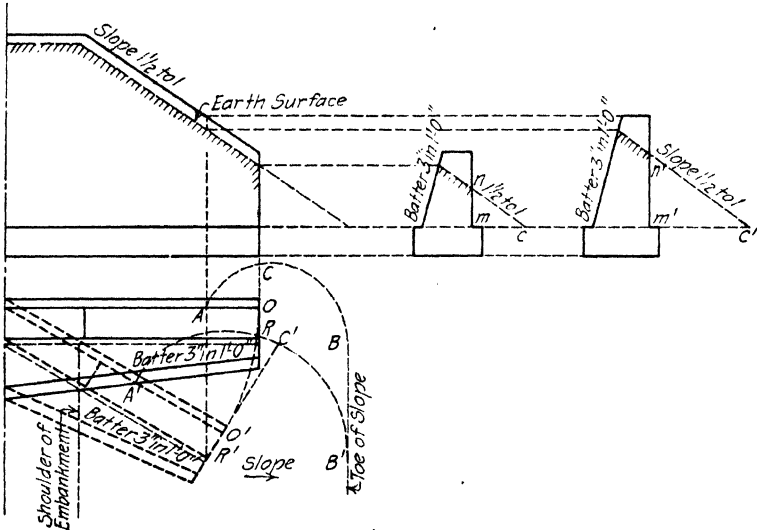

FIG. 129.—Disposition of the earth slopes at the end of a wing wall.

An abutment is preferably dimensioned on the drawings using the center line of track and the bottom line of the face of the body as axes to which dimensions of controlling details should be referenced. Figure 128 is the standard instruction sheet for detailing mass abutments on the C. M. & St. P. R. R. and illustrates a proper method of dimensioning.

Wing Walls.—The purpose of the wing walls is to retain the side slopes of the embankment. The cross section is designed so that it will be stable against the pressure of the earth behind it, and is designed essentially as a retaining wall. The top of the wing wall should extend level past the shoulder of the embankment and then it should slope downward at the natural angle of repose of the earth in the embankment. This top slope may be either stepped or inclined.

The embankment slope will spill, or "tail," around the end of the wing wall as shown at *ABC*, Fig. 129, and due consideration should be given to the full cone of earth as it spills from the highest point of retention. It should not be allowed to spill farther than the conditions surrounding the abutment will warrant, while, on the other hand, it may properly spill as far as it will without harm, for any unnecessary length of wall adds to the cost of the structure. Obviously it would be uneconomical and impractical to prevent any earth from spilling in front of the wall, hence a practical compromise is adopted, usually about 4 ft. for the end height. Figure 137 illustrates the method of studying the disposition of the earth about the end of the wing for any angle of inclination of the wall. $OA = 1.5mn$ and $O'A' = 1.5m'n'$.

The slope of the top of the wing wall will obviously depend upon the angle of the wing as well as on the natural slope of the embankment, the true slope being $s/\cos A$, where s is the slope of the embankment at right angles to the track, and A is the angle of the wing with the normal to the track.

In skew bridges, the wing wall at the slack end can be turned at right angles to the embankment with a decided economy, and improvement in appearance. At the acute end, the slope of the wing wall if straight will be $s/\sin \theta$, θ being the angle of skew. Figure 130 illustrates a typical skew abutment of the C. M. & St. P. R. R.¹

Where wing walls of a mass abutment make an angle of 45° or less with the face of the abutment, they should be separated therefrom by a keyed construction joint at or near the apex of the angle.

Relative Economy.—Various factors enter into the cost of a bridge abutment, and that type of abutment will be the cheapest which renders the sum of these elements a minimum, assuming, of course that the various types perform their functions equally well. These factors are (a) the cost of the masonry in the body walls above the footing, (b) the cost of the masonry in the footing, (c) cost of forms, (d) cost of excavation. The abutment containing a minimum amount of masonry is not necessarily the cheapest because the character of the masonry may cause the unit cost to be high. Sometimes it is economical to use reinforced concrete footings instead of plain concrete on account of

¹ Courtesy C. N. BAINBRIDGE, Engineer of Design.

the additional excavation that deeper plain footings may require.

Possible extensions that may be required for double track or other reason should be kept in mind where such extension is probable and the original design made with a view to facilitating such an extension. For example, straight wing walls can be incorporated in the body of an extension to an abutment, hence they offer an opportunity for cheaper extension than do wings at an angle.

In the paper previously referred to, J. H. Prior made an extensive study of the costs of different types of abutments and Fig. 131 (a), (b), and (c) taken from that paper indicate the relative costs of the various factors entering for a mass wing wall abutment, a reinforced concrete abutment and a trestle abutment respectively and Fig. 132 shows the total costs of the various types. The conclusion may be drawn that in general, mass abutments are economical for heights up to 15 ft. or less, between 15 and 35 ft. a form of reinforced concrete abutment should be used of the cantilever type, and for heights greater than 35 ft., the trestle abutment is the most economical. These limits apply only to railway bridges; for highway bridges, the lower limit for each type should be perhaps not more than 0.8 of the above limits, because of the lighter superimposed loads carried.

Highway Bridge Abutments.—The principles governing the design of highway bridge abutments are essentially similar to those discussed above for railway bridges except that the live load to be provided for is less. Traction forces may generally be neglected and the problem of conducting the roadway onto the bridge is simpler. Because of less stringent grade restrictions, highway bridge abutments are not likely to be so high as many railroad abutments. Figure 133 shows the standard truss bridge abutment of the Iowa State Highway Commission for heights between 20 and 30 ft. The top of wing walls is usually 12 in. or less and the construction is lighter in every respect than for railway construction.

B. BRIDGE PIERS

Forces Acting on a Bridge Pier.—The function of a bridge pier is to support the intermediate ends of bridge spans with a minimum obstruction to the stream. The possible forces acting

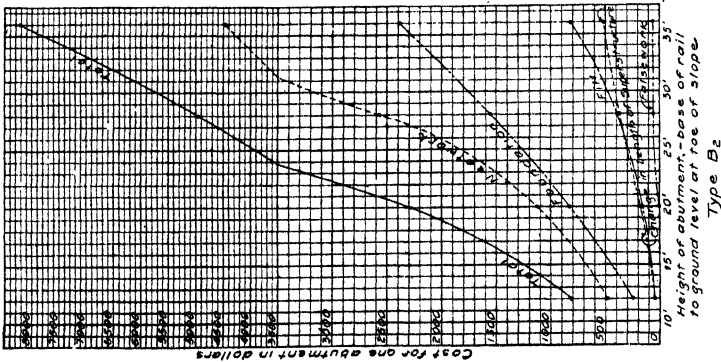
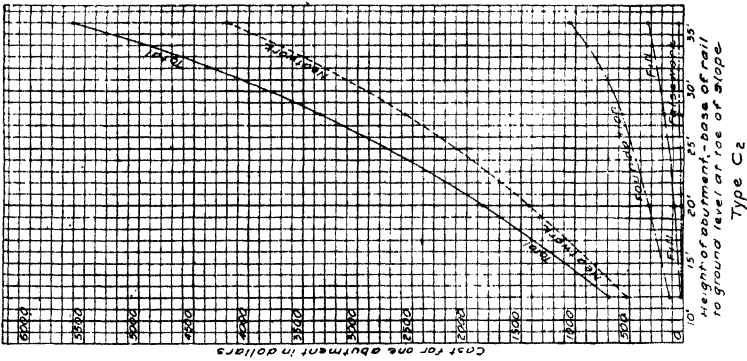
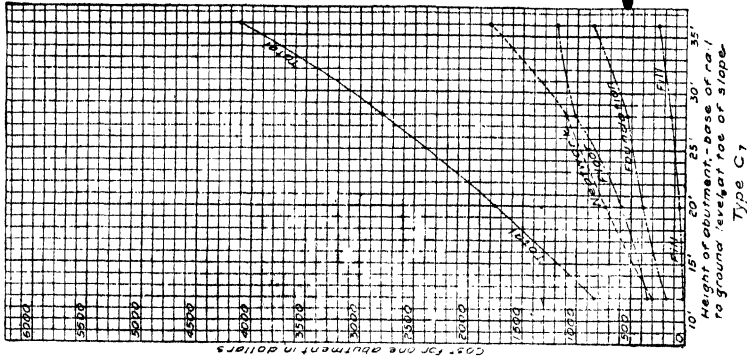

FIG. 131.—Elements of cost of bridge abutments.

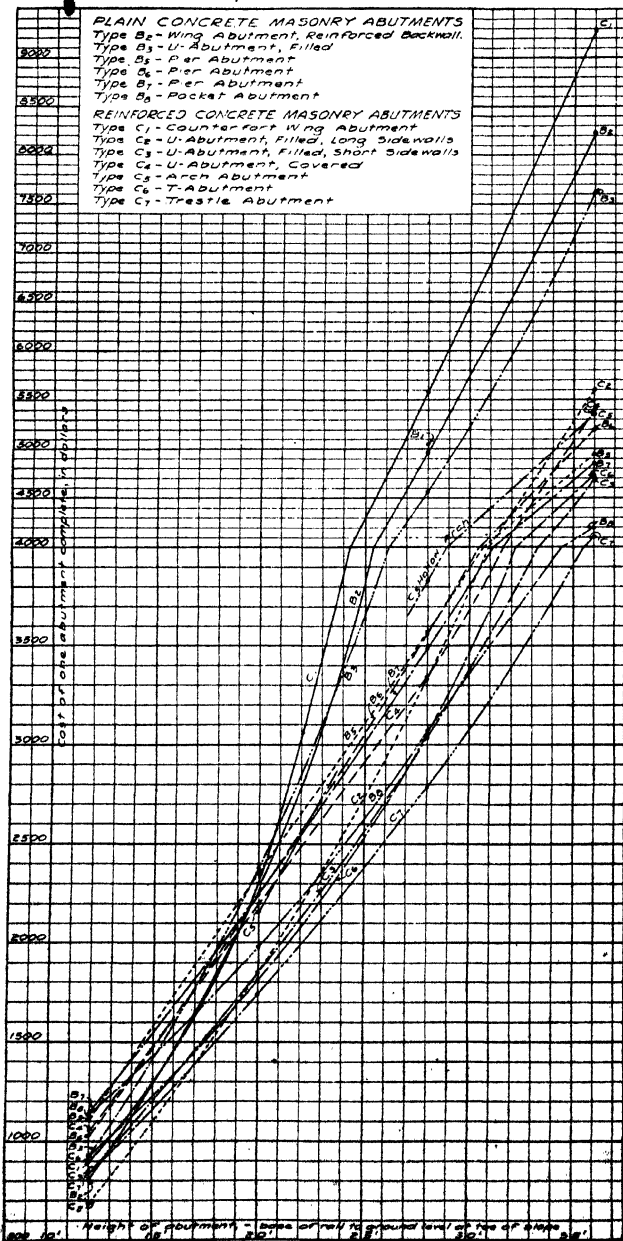

Diagram Showing Total Cost of Abutments of Various Heights

Fig. 132.—Relative costs of railway bridge abutments of various types.

		DESIGNING DATA											
		H	20	21	22	23	24	25	26	27	28	29	30
Height of Abutment	A	8.0	7.0	7.4	7.7	8.0	8.4	8.8	9.2	9.6	10.0	10.4	10.8
Width of Base	B	2.4	2.5	2.6	2.7	2.8	2.9	3.0	3.1	3.2	3.3	3.4	3.5
Minimum Spacing between	C	2.6	2.7	2.8	2.9	3.0	3.1	3.2	3.3	3.4	3.5	3.6	3.7
Reinforcing Bars	D	2.6	2.7	2.8	2.9	3.0	3.1	3.2	3.3	3.4	3.5	3.6	3.7
Minimum Spacing	E	2.6	2.7	2.8	2.9	3.0	3.1	3.2	3.3	3.4	3.5	3.6	3.7
Maximum Spacing	F	5.3	5.9	6.3	6.7	7.1	7.5	7.9	8.4	8.8	9.2	9.6	10.0
Minimum Spacing	G	2.6	2.7	2.8	2.9	3.0	3.1	3.2	3.3	3.4	3.5	3.6	3.7
Maximum Spacing	H	5.3	5.9	6.3	6.7	7.1	7.5	7.9	8.4	8.8	9.2	9.6	10.0
Minimum Spacing	I	2.6	2.7	2.8	2.9	3.0	3.1	3.2	3.3	3.4	3.5	3.6	3.7
Maximum Spacing	J	5.3	5.9	6.3	6.7	7.1	7.5	7.9	8.4	8.8	9.2	9.6	10.0
Minimum Spacing	K	2.6	2.7	2.8	2.9	3.0	3.1	3.2	3.3	3.4	3.5	3.6	3.7
Maximum Spacing	L	5.3	5.9	6.3	6.7	7.1	7.5	7.9	8.4	8.8	9.2	9.6	10.0
Minimum Spacing	M	2.6	2.7	2.8	2.9	3.0	3.1	3.2	3.3	3.4	3.5	3.6	3.7
Maximum Spacing	N	5.3	5.9	6.3	6.7	7.1	7.5	7.9	8.4	8.8	9.2	9.6	10.0
Minimum Spacing	O	2.6	2.7	2.8	2.9	3.0	3.1	3.2	3.3	3.4	3.5	3.6	3.7
Maximum Spacing	P	5.3	5.9	6.3	6.7	7.1	7.5	7.9	8.4	8.8	9.2	9.6	10.0
Minimum Spacing	Q	2.6	2.7	2.8	2.9	3.0	3.1	3.2	3.3	3.4	3.5	3.6	3.7
Maximum Spacing	R	5.3	5.9	6.3	6.7	7.1	7.5	7.9	8.4	8.8	9.2	9.6	10.0
Minimum Spacing	S	2.6	2.7	2.8	2.9	3.0	3.1	3.2	3.3	3.4	3.5	3.6	3.7
Maximum Spacing	T	5.3	5.9	6.3	6.7	7.1	7.5	7.9	8.4	8.8	9.2	9.6	10.0
Minimum Spacing	U	2.6	2.7	2.8	2.9	3.0	3.1	3.2	3.3	3.4	3.5	3.6	3.7
Maximum Spacing	V	5.3	5.9	6.3	6.7	7.1	7.5	7.9	8.4	8.8	9.2	9.6	10.0
Minimum Spacing	W	2.6	2.7	2.8	2.9	3.0	3.1	3.2	3.3	3.4	3.5	3.6	3.7
Maximum Spacing	X	5.3	5.9	6.3	6.7	7.1	7.5	7.9	8.4	8.8	9.2	9.6	10.0
Minimum Spacing	Y	2.6	2.7	2.8	2.9	3.0	3.1	3.2	3.3	3.4	3.5	3.6	3.7
Maximum Spacing	Z	5.3	5.9	6.3	6.7	7.1	7.5	7.9	8.4	8.8	9.2	9.6	10.0

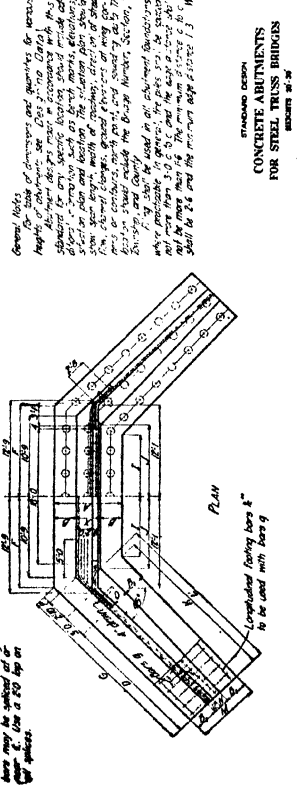
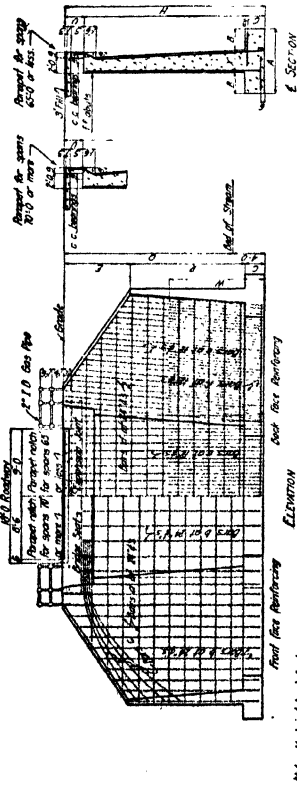

FIG. 133.—Details of a highway bridge abutment of the Iowa Highway Commission.

General Notes:
 1. The base of abutments and piers for spans 20.0 or more shall be reinforced with concrete to a depth of 2.0 feet below the base of the structure.
 2. The base of abutments and piers for spans 6.50 or less shall be reinforced with concrete to a depth of 1.0 foot below the base of the structure.
 3. The reinforcement shall be placed in a grid pattern with a spacing of 12 inches.
 4. The reinforcement shall be placed in a grid pattern with a spacing of 12 inches.
 5. The reinforcement shall be placed in a grid pattern with a spacing of 12 inches.
 6. The reinforcement shall be placed in a grid pattern with a spacing of 12 inches.
 7. The reinforcement shall be placed in a grid pattern with a spacing of 12 inches.
 8. The reinforcement shall be placed in a grid pattern with a spacing of 12 inches.
 9. The reinforcement shall be placed in a grid pattern with a spacing of 12 inches.
 10. The reinforcement shall be placed in a grid pattern with a spacing of 12 inches.



STANDARD DESIGN
 CONCRETE ABUTMENTS
 FOR STEEL TRUSS BRIDGES
 IOWA HIGHWAY COMMISSION
 REINFORCED FOR SPANS 20.0 OR MORE
 REINFORCED FOR SPANS 6.50 OR LESS
 Length of Span 20.0-34.7
 Length of Abutment 6.50-10.0
 Height of Abutment 8.0-10.8
 Width of Base 2.4-3.5
 Width of Top 10.0-10.8

on a bridge pier are (a) the end load of the two adjacent bridge spans, (b) the wind load acting on the pier, on the superstructure and on the moving load, (c) the traction forces due to the live load, (d) the impact of floating debris and ice, (e) the pressure of the stream of water and of solid ice, (f) forces resulting from the expansion and contraction of the superstructure, (g) the weight of the pier itself and (h) the reaction of the foundation. Where water can enter under a pier, an additional force, namely the buoyant force or uplift of intrusive water, should be considered as in the case of dams.

The end load or reaction of the bridge spans includes the weight of the trusses or girders and floor, the roadway and track, and the maximum live load that can properly be considered as carried to the pier.

The wind load for railway bridges is specified by the American Railway Engineering Association as 30 lbs. per square foot on the projected area of the superstructure, plus 400 lbs. per linear foot for the pressure on the train, applied 7 ft. above the rail. An allowance of 30 lbs. per square foot on the pier itself should also be made.

The pressure of the water depends upon the shape of the end of the pier being greatest for a flat ended pier. The pressure of the water in lbs. per square foot is given by the formula $P = k \cdot w \cdot \frac{V^2}{2g}$, in which w is the weight of the water per cubic foot (62.3 lbs. for fresh water), V is the velocity of the stream in ft. per second., and k is a factor depending on the shape and proportions of the pier, being $1\frac{1}{3}$ for square ends, $\frac{1}{2}$ for angle ends where the angle is 30° or less, and $\frac{2}{3}$ for circular piers. The mean velocity is about 0.6 the depth measured from the surface and the center of pressure at about half the depth.

The effect of ice on bridge piers, which may be of serious magnitude in streams in cold climates, results from ice in two forms, (a) as cake ice floating down stream at the surface of the water to be crushed or split by the nose of the pier, and (b) ice gorges piling up against the nose of the pier back of floating logs or other debris.

In the first case, the impact of the ice is usually not great and the effect is largely that of abrasion. With a nose protection of steel, cakes of ice cleave or crush without exerting any considerable force on the pier.

In the second case, ice gorges back of floating debris may bring a considerable force against a pier because of the pressure of the current on the ice. However, a log's strength in cross bending as a double cantilever beam, if, balanced over a pier nose, it holds back an ice gorge, would limit such a pressure. In northern climates, ice-breaking noses at about 45° angle are commonly used, which allow the ice to slide upon the slope and break under its own weight.

The amount of traction force transmitted to the substructure of a bridge was discussed under abutments. Where the fixed end of a truss or girder span rests on a pier, and the other end is on rockers, the pier will be required to sustain the full amount of the traction considered as transmitted to the substructure. In the case of a double track structure, traction forces on one track only need be considered at one time because traction due to acceleration is small. However, for a bridge on a steep grade where brakes may be set in one direction and heavy pulling in the other, traction should be allowed on both tracks, that on the second track being considered as the actual grade resistance at 20 lbs. per ton of train multiplied by the per cent of grade. Traction forces are not considered on highway bridge piers.

The centrifugal force where the bridge is located on a curve is, from mechanics, $WV^2/32.2R$, where W is the weight of the train on the track tributary to the pier, V , the velocity in ft. per second, and R the radius of the curve in feet. This force is commonly considered as effective at the top of the rail and is calculated for a speed of $60 - 2\frac{1}{2}D$ miles per hour, D being the degree of curve. In reality, the force acts, of course, through the center of gravity of the train, which is about 6 or 7 ft. above the top of rail.

The longitudinal force resulting from the expansion and contraction of the span may equal one-half the weight of the superstructure multiplied by the coefficient of friction, but where proper rollers or rockers are provided, it is a small fraction of this maximum frictional force.

Impact is not usually considered as being effective on bridge piers.

Stability of a Bridge Pier.—A bridge pier should be stable against the forces acting upon it with respect to (1) sliding down stream, (2) sliding in the direction of the axis of the bridge, (3) overturning about the downstream toe, (4) overturning about

one side of the footing; and (5) the maximum pressure at a side and at the downstream end should not exceed the allowable bearing pressure, and (6) the shaft of the pier and the footing should be stable against failures due to internal stresses.

The reaction of the end span due to live load will be eccentric when one span is loaded and the other is not. The maximum soil pressure is found as before, for rectangular footings, by the formula $\frac{W}{A}(1 + \frac{6e}{d})$, W being the total load, A the area of the base, e the eccentricity of the resultant load, and d the dimension

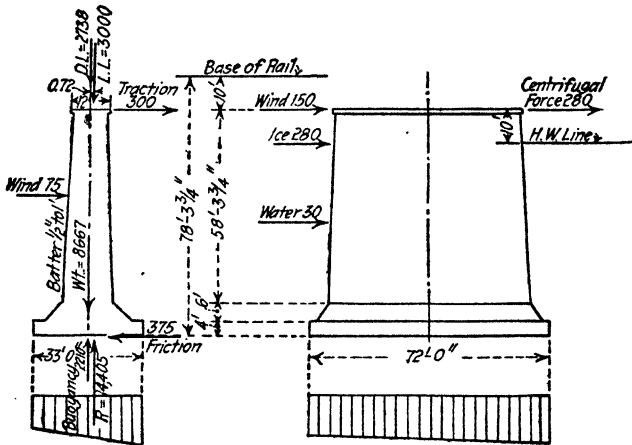

FIG. 134.—Forces acting on a bridge pier.

at right angles to the edge at which pressure is being computed. Figure 134 shows a bridge pier with the forces acting, or which under certain circumstances may act upon it, expressed in kips. Obviously these can not all act simultaneously and in calculating the soil pressure at the side or at the end, only those forces that may act simultaneously should be considered. This pier is under an Illinois Central R. R. bridge over the Tennessee River, and most of the quantities were taken from an article by W. M. Torrance in Engineering News, Vol. 53, p. 548.

Design of Pier for Waterway Requirements.—In the design of a bridge pier, as well as in the case of almost any other structure that is to be placed in a stream, one of the chief considerations is the effect on the behavior of the stream. The importance of designing such structures so that they will not seriously

diminish the carrying capacity of the stream bed should be given due weight. Two effects may result from the building of a pier in mid-stream, viz., (1) the stream may be deflected so as to change the existing relation between the cutting and the filling banks of the stream, which effect should be cared for in such a manner that harm to existing structures cannot result, and (2) the flow may be so obstructed that the carrying capacity of the stream bed will be reduced, causing an increase in the height of the water level.

When a pier is set at an angle to the thread of the current, it tends to deflect the stream in some cases so as to cut into the bank with resulting injury to structures thereon, or perhaps to the embankment of the railroad itself. While this situation does not often arise, it should be given proper consideration.

Where possible, a bridge should be placed across a stream at a comparatively straight stretch in order to minimize the difficulties in placing the piers parallel to the direction of the current. When the bridge is not at right angles to the stream, the piers must be set askew with the bridge in order that the piers may parallel the stream. Where the bridge crosses at a bend in the stream, obviously the difficulties of satisfactorily locating the piers are increased.

The effect of bridge piers in obstructing the current is important, for the piers may cause an increase in the height of the backwater which may result in serious overflow of property, railroads being frequently defendants in suits for damages from this source. No exact solution of the height of backwater curve exists, although many have been proposed. The Eytelwein formula for backwater is perhaps as reliable as any, which is,

$$y = \frac{V^2}{2g} \left[\frac{W^2}{m^2 w^2} - \frac{h^2}{(h + y)^2} \right]$$

in which y = the height of backwater in feet;

V = velocity of the stream in ft. per second in the approach channel;

W = the full width of the approach channel in feet;

w = the contracted width between piers;

h = the normal depth of the stream below the piers;

m = a coefficient of contraction, 0.70 for square headed piers, 0.90 for rounded piers, and 0.95 for acute angle-nosed piers.

Obviously the above equation must be solved by trial since it is not an explicit function. The effect on the discharge of a properly shaped tail of the pier is neglected in this formula, a matter of considerable importance.

Experiments performed at the University of Michigan¹ indicated the following conclusions:

1. The best practical form of a pier nose is either the half round or half elliptical, these shapes giving better discharge efficiencies than the pointed nose.
2. The best practical form for the tail of a pier is the half rounded.
3. The 90° angled nose is not satisfactory, the angle for best efficiencies being 45° or less.

The above conclusions are corroborated essentially in a more elaborate series of experiments being conducted by F. A. Nagler and D. L. Yarnell at the University of Iowa. A pier nose with convex arcs either of an ellipse or of a circle is a practical and efficient form.

Where a pointed cutwater is used, the shoulders should be rounded to avoid eddying, for the eddying caused by angles results in a loss of much of the advantage of a rounded or pointed cutwater. Where the axis of the pier makes only a slight angle with the stream, the effect of a skew pier can be approximated by making the nose unsymmetrical as in type *C*, Fig. 135(*b*), which is a type of pier used by the C. M. & St. P. R. R. Where there is a possibility of damage from floating ice and debris, an angle iron can be placed at the point of the nose of the cutwater, or a rail embedded as shown in Fig. 135(*b*).

Where the cutwater projects beyond the main body of the pier and is discontinued above the high water line, it is frequently called a "starling" and the coping of the starling is commonly termed a "cocked hat." The cocked hat or coping should extend over the starling only. See Fig. 136. Where severe conditions of floating ice are to be expected as in the northern climate, the cutwater is given a slope of perhaps 45° between the elevations of high and low water and it may be protected with iron rails or plates, bolted to the masonry.

Dimensions of Bridge Piers.—The dimensions of a bridge pier are determined by the nature and elevation of the structure to be carried and by the clearances required under the bridge. The height of a pier carrying an overhead crossing must be such

¹Paper by F. A. NAGLER, *Trans. Amer. Soc. C. E.*, vol. 82, p. 334.

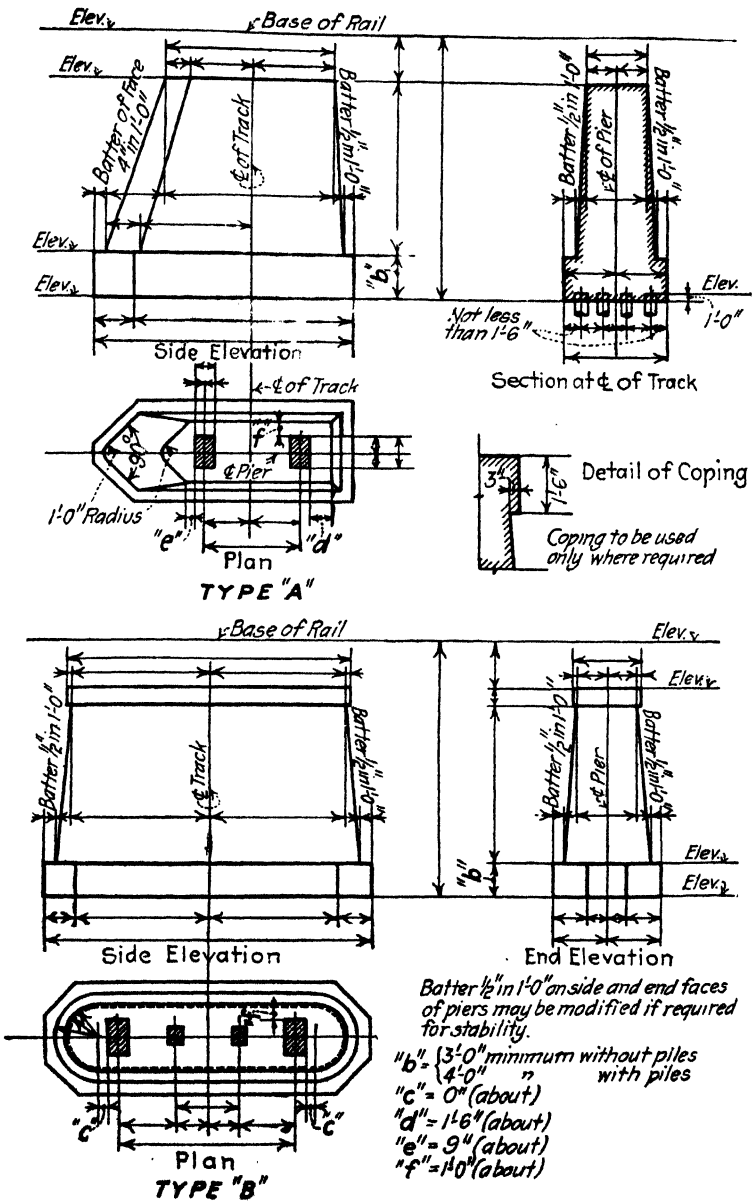

FIG. 135(a).—Standard mass bridge piers of C. M. & St. P. Ry.

that the lowest point of the superstructure ("low steel" or "low masonry") shall be at least equal to the specified clearance above the other track—22 ft. above top of rail is specified by the American Railway Engineering Association. The height of a pier for a stream is sometimes fixed by the necessary height of the roadway over the stream, otherwise its minimum height should be such as to keep the bottom of the superstructure well above high water so that drift, etc. may not lodge against the structure and also so that the total waterway may be ample to pass the maximum flood. Ten feet clearance above high water will usually suffice to pass drift and ice.

The width of the top of a bridge pier should be such as to afford sufficient clearance on the outside of the bridge pedestal.

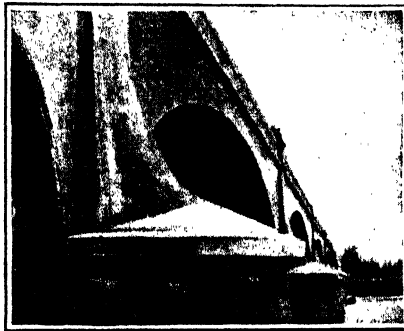

FIG. 136.—Cocked hat starting.

The C. M. & St. P. R. R. requires 1 ft. clearance on the side and $1\frac{1}{2}$ ft. on the ends beyond the edge of the pedestal. In the case of a viaduct over yard tracks where it is necessary to reduce the pier width to a minimum, these clearances can be practically eliminated.

The length of a pier is dependent upon the lateral spacing of the trusses or girders of the superstructure. The economic spacing for lateral rigidity of through trusses is about $\frac{1}{20}$ to $\frac{1}{18}$ of the span. Clearance requirements usually determine the spacing of through girders, making it usually about $14\frac{1}{2}$ ft. center to center for single railway track. Deck girders are commonly spaced 6 to 8 ft. center to center for spans less than 60 ft. and for spans greater than this at about $\frac{1}{10}$ the span. The dimensions of bearing plates and castings depend upon the load to be carried for a safe unit compressive stress on the

masonry and upon the type of structure. These plates are about 1-ft 9 in. by 2 ft. 0 in. for the abutment bearing of a deck girder of spans up to 50 ft., and 1 ft. 9 in. by 3 ft. 10 in. for the pier bearing, and 1 ft. 11 in. by 3 ft. 9 in. for 90 ft. girders on the C. M. & St. P. R. R., which are representative of average practice. J. E. Greiner, Mem. Am. Soc. C. E., specifies that the length under the coping shall not be less than the distance out to out of the pedestals plus one and a quarter times the width.

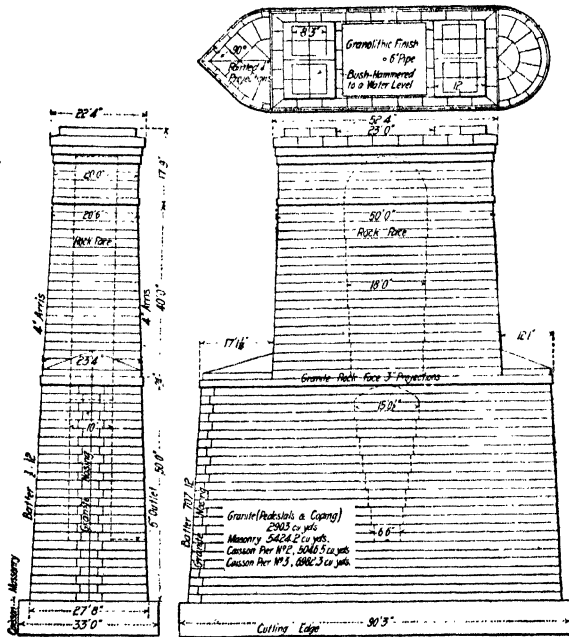

FIG. 137.—Hollow pier of the municipal bridge of St. Louis.

The batter of the sides of a bridge pier is made such as to accomplish the necessary spread to the foundation to secure adequate bearing area. Where the piers are on rock or other solid foundations, for tall piers, a minimum batter of $\frac{1}{4}$ or $\frac{3}{16}$ in. to the foot may be given for the sake of appearance.

Hollow and Divided Piers.—The unit bearing stress over a solid pier is usually very low, hence high bridge piers are frequently built hollow or divided above the high water line in order to save masonry. Reinforced concrete hollow piers have been built to some extent but the economy of this type has not

been demonstrated. The piers of the Municipal bridge at St. Louis over the Mississippi are hollow, the open space in the middle of the pier constituting approximately one-fifth of the total area of the horizontal cross section. See Fig. 137.¹ The cost of the four piers was about \$470,000, or about \$12 per cu. yd.

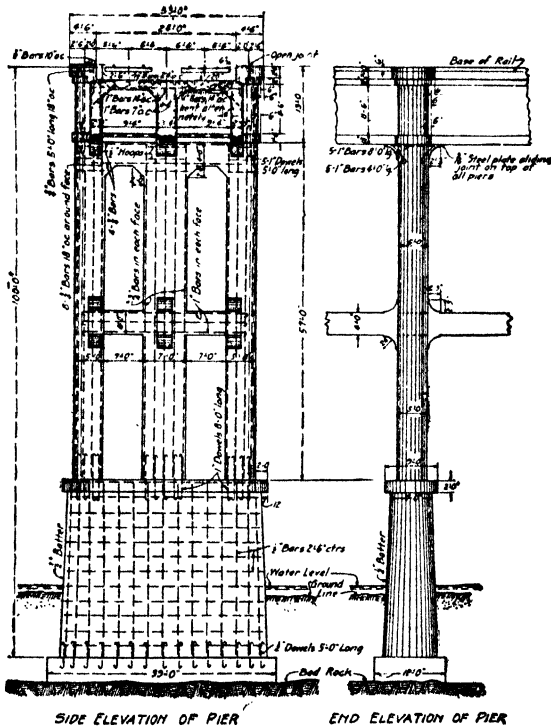

FIG. 138.—Divided reinforced concrete pier.

Where a pier consists of slender reinforced concrete columns above the base which are framed together rigidly at the top, the pier takes on the character of a rigid frame and should be investigated as such. Piers of this sort have been used considerably in recent years and for trestle and viaduct construction they may be advantageously employed. Figure 138² shows a reinforced concrete pier for a 50 ft. reinforced girder span over the Big Thicketty Creek carrying the Southern R. R.

¹ *Engineering News*, Mar. 16, 1911.

² *Proc. Amer. Ry. Eng. Assn.*, vol. 23, No. 238, p. 74.

To divide a pier decreases the cubature of the masonry but increases the amount of forms and the cost of placing the masonry. No general statement can be made as to the height at which divided piers are economical because of the variation in the prices of the elements involved.

Usually the top of the pier is framed across but in some instances, the pedestals of the superstructure rest directly on single extensions of the parts of the pier.

Piers for Movable Bridges.—The chief type of pier for movable bridges is the circular pivot pier for swing bridges, the piers for other types of movable bridges not differing essentially from the piers for fixed bridges. Moreover, the swing or draw bridge is apparently an obsolescent type of structure, hence, very little attention need be devoted to pivot piers in this connection.

Circular pivot piers for swing bridges are necessarily large in plan to provide sufficient space for the bearings, particularly for rim bearing bridges. In order to save masonry and to lessen the load on foundations pivot piers are usually built hollow with a reinforced concrete top. The load during the swinging of the bridge is practically balanced, hence the nature of the stresses does not differ materially from those in piers for fixed spans.

Piers and abutments for rolling lift and for vertical lift bridges must be designed for wind pressures when the bridge is open and for kinetic reactions in operating the bridge.

Movable bridges are constructed over navigable streams, hence, the first requirement is that the substructure shall interfere as little as possible with navigation. To this end, the bridge should be located wherever practicable on a straight stretch of the stream in order to make a minimum span suffice. Authority and approval must be obtained from the War Department for any bridge or alteration of a bridge substructure over a navigable stream.

Trestle Piers.—Trestle piers must be designed to support their loads and sustain the longitudinal forces to which they are subject, including traction and temperature thrusts. Piers for reinforced concrete slab trestles are usually slender reinforced concrete shafts about 2 ft. to 2 ft. 6 in. thick and as long as the slabs are wide so that there is no projection beyond the slabs. Slender piers have a tendency to split under the longitudinal forces to which they are subjected, and for this reason they

ance of large plain surfaces by paneling, scoring, or other device will greatly improve the appearance in some circumstances, as in the East Boulevard bridge at Cleveland,¹ Fig. 140. The use of pylons at the ends of girders is another device that has been used advantageously. A more formal and elaborate treatment

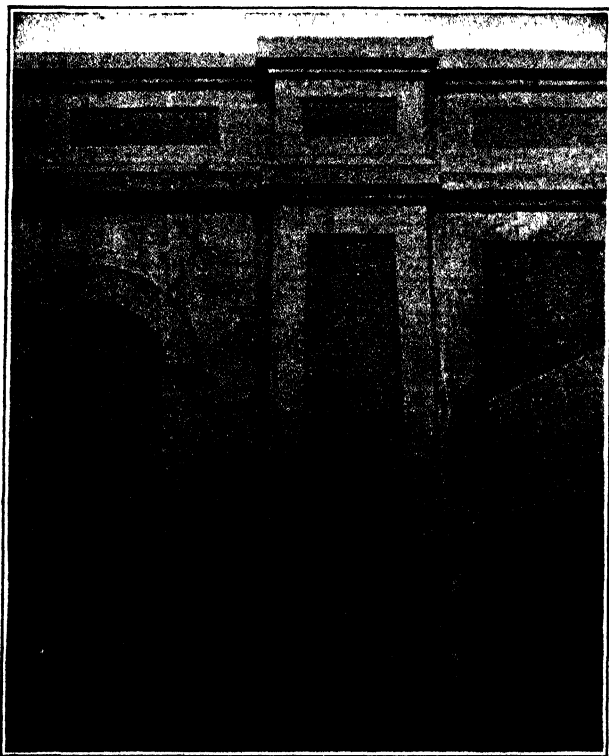

FIG. 140.—Paneled bridge abutment.

of bridge abutments is illustrated in the bridge over the main drive in Forest Park, St. Louis, shown in Fig. 141.

The chief device used to relieve the monotony of tall bridge piers is building a wide coping with a corbel below it at the top of the pier. On tall piers, a corbel projection is sometimes placed at about half the height, or the coping above the starting is continued around the entire body of the pier. In track elevation

¹ *Proc. Amer. Ry. Eng. Assn.*, vol. 18, p. 844.

work, the Illinois Central R. R. uses piers consisting of a row of concrete columns cast in place with good effect.

European engineers are prone to decorate their bridge piers with some manner of design as in the case of the Hammersmith bridge over the Thames in London and the bridge over the Amstel in Amsterdam, (a) and (b), Fig. 142. Although in the latter

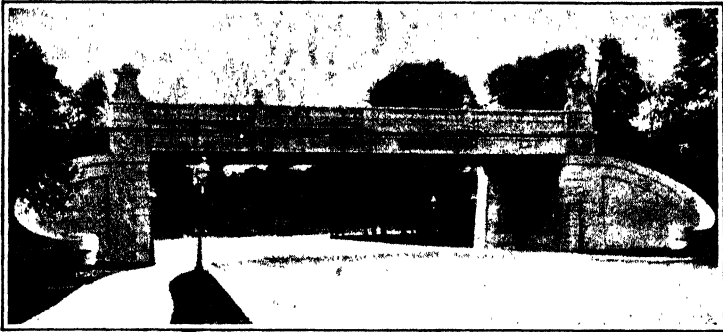

FIG. 141.—Wabash R. R. bridge in Forest Park.

case the shaping of the piers into the form of the prow of a boat is somewhat appropriate where canal traffic is so prevalent, it is doubtful if elaborately fashioned piers make as good an appearance as do the simple lines of the ordinary mass pier. Certainly,

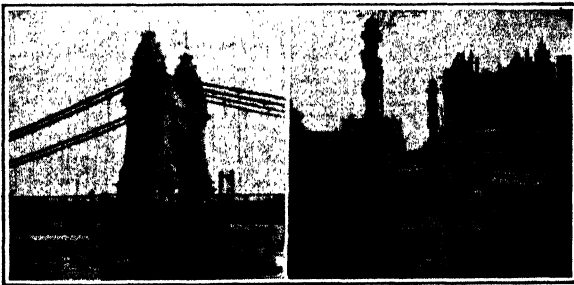

FIG. 142.—Architectural treatment of bridge piers. Hammersmith Bridge, London, and bridge over Amstel, Amsterdam.

the starting of a bridge pier is not an appropriate place for statuary, such as one finds on so many European bridges.

Too frequently when a special architect is engaged to treat the design of a large bridge, he overdoes the decoration of the piers and abutments. For example, the ornate towers of the Tower Bridge, in London, which are the work of a famous archi-

tect, Sir Horace Jones, compare unfavorably with the stately massiveness of the towers of the Brooklyn Bridge, which follow the simple lines used by the designing engineer. To quote Walter Shaw Sparrow, the artist and pontist on the architecture of the Tower Bridge will indicate the dangers of over-ornamentation of bridge piers. "What anachronism could be sillier than that which united the principle of metal suspension to an architecture cribbed partly from the Middle Ages and partly from the French Renaissance? The many small windows, the peaked roofing, the absurdly impudent little turrets, the biscuit-like aspect of the meretricious masonry, the desperate effort to be 'artistic'

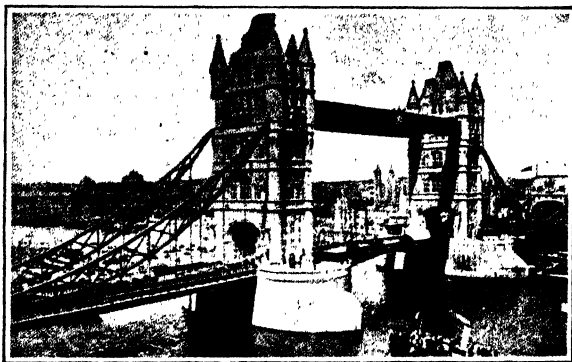

FIG. 143.—Piers of Tower bridge, London.

at any cost: all this, you know, is at standing odds with the contemporary parts of the unhistoric bridge, parts huge in scale, but so commercial that there is not a vestige of military forethought anywhere. It is mere perishable bulk."¹

Many of the bridges of Europe mark the point of military struggles, being on the sites of brave defense and heroic onslaught, hence massive towers resembling in character the fortifications used in those historic days may not be inappropriate for those bridges, such as the one over the Rhine at Worms, but to copy such features in the designs intended for the pacific associations of most American landscapes seems to the author to border on the grotesque.

A bridge is a portion of a highway and should conduct the traveller across the stream with as little inconvenience and with as pleasant associations as possible, hence, dark and forbidding

¹ A Book on Bridges, by Frank Brangwyn, p. 327.

towers, covered bridges, etc. are out of place. Pleasure travel on highways is marred by features that obstruct the view of the

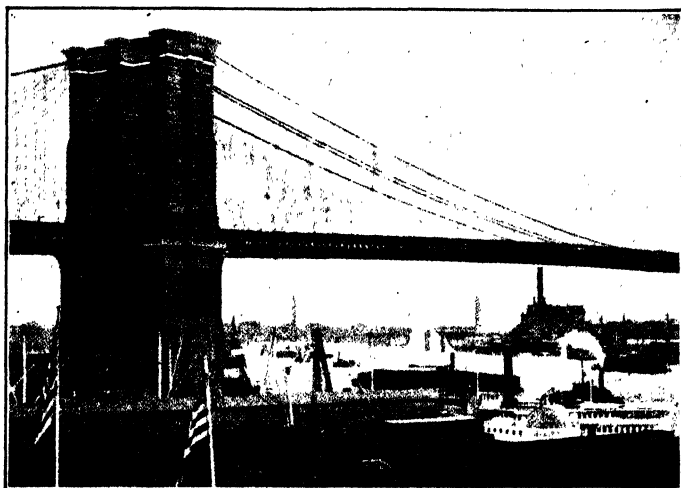

FIG. 144.—Pier of Brooklyn bridge.

natural landscape. Particularly is this true at bridge crossings where the natural scenery is likely to be the most attractive. For this reason, attempts at elaborate decoration of piers and

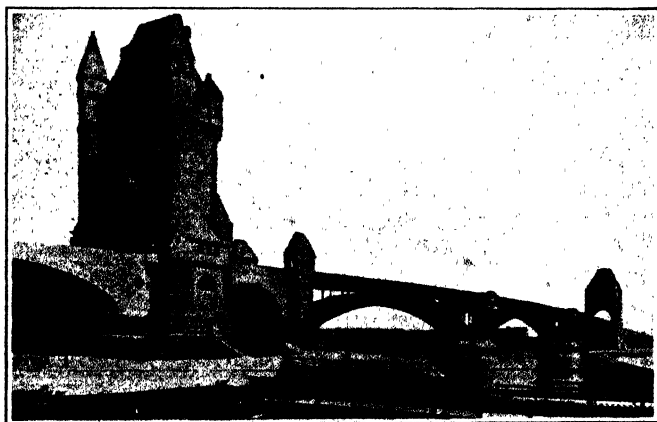

FIG. 145.—Piers of Worms highway bridge over the Rhine.

abutments, especially above the deck of the bridge, are usually in poor taste and may become oppressive in the extreme.

Bridges are frequently memorial in their character and the masonry offers the chief opportunity to express the monumentality of such a structure. In such a case, the style of the piers should be in keeping with the historic associations as well as with the landscape, and the piers may then be made to rise above the deck as a memorial or triumphal arch if so desired, but under ordinary circumstances, such treatment is out of place.

Where a large river divides a city and the view of the river is impressive while crossing the bridge, as at New York, London, Paris, Budapest, Rome and other places, considerable attention should be given to make the bridges worthy of their surroundings. A great river should have a great bridge spanning it at any point, but particularly in an urban district such as above mentioned.

Surveys for Bridge Piers.—In the location of bridge piers in a river of considerable depth and width where the measurements cannot be made directly, recourse must be had to triangulation. Base lines must be established on both shores of such length and position that the angles shall not be far from 45° . This necessitates making the base line, if approximately at right angles to the axis of the structure, essentially as long as the total span to be measured. All monuments should be of a permanent character, carefully set and referenced in order to prevent loss by flood or other causes. Base lines should be measured with accurately standardized tapes, preferably 500 ft. long, and corrected for temperature and sag. All angles should be measured by repetition with perhaps ten readings with telescope normal and an equal number with telescope reversed.

In the case of the McKinley bridge¹ at St. Louis across the Mississippi, the piers were located by triangulation from both ends of the base lines, the sights being taken simultaneously. It was necessary to establish reference points to a pile cluster or other permanent object in order that the alignment of the caisson might be checked with facility during sinking.

Figure 146² shows the triangulation for the location of the piers for the Quebec bridge, the two main piers of which are 1,800 ft. apart. The north base line was measured and checked four times with great care. The triangles were adjusted for elevations and all other corrections made with utmost precision.

¹ *Engineering News*, Jan. 6, 1910.

² *Report of Government Board of Engineers*, 1919.

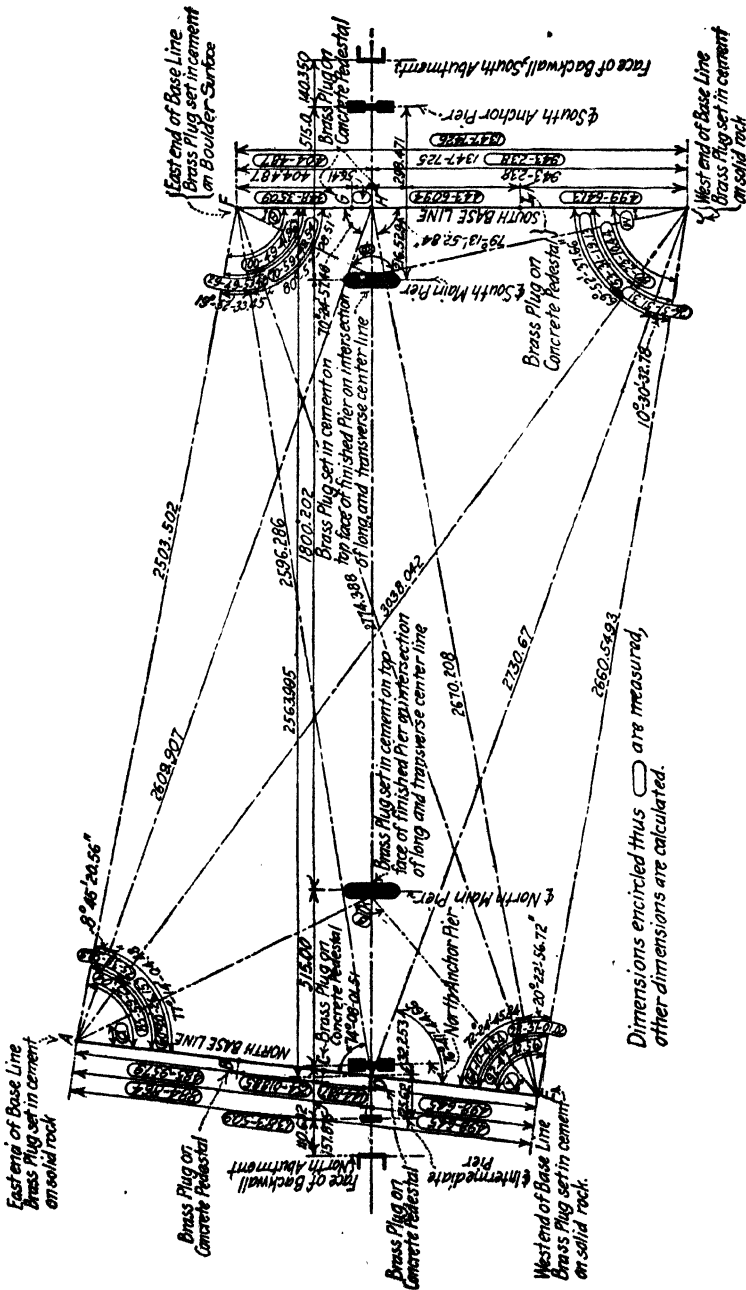

FIG. 146.—Triangulation survey for locating piers of the Quebec bridge.

Generally the triangulation lines from the base lines will not be the axes of the piers or of the caisson cribs, but will make an angle with the latter. The intersection of the triangulation lines at the center of the crib of the caisson can be found in the usual manner and the crib centered accordingly. The angles that the axes should make with the triangulation lines having previously been computed from the known azimuths of the base lines and the piers, the crib can be oriented accordingly. The intersection of the triangulation lines with the edges of the crib should be marked for reference so that movements of the crib from the desired position or angle can be readily checked and corrected.

Too much emphasis cannot well be put on the importance of accuracy in making the triangulation surveys for bridge piers in wide streams. The location of each point should be fixed by triangulation from both base lines, the one being used as a check on the results from the other. For good work, the allowable error in the checks should be within about 1:50,000, although an allowable error of perhaps twice this amount might be permitted in some instances. To secure such accuracy, it will be found necessary to measure the base lines about five times each and to repeat the angles perhaps 20 times and take the mean of the measurements.

The elevations on the cribs are obtained in the usual manner with a good engineer's level or a precise level, the elevations being checked from different set ups.

Location of Piers in Navigable Streams.—Certain streams of the United States have been declared navigable by Congress and any structures built over them must conform to the requirements of the War Department. Many of these streams carry little or no traffic as waterways, yet provision must be made for the passage of boats if required. When a bridge is to be located over a navigable stream, application must be made to the Secretary of War for permission and the following information must be furnished with the application:¹

1. A copy of or a reference to the law of the state, either general or special, authorizing the construction of the bridge.

2. Drawings in triplicate showing the general plan of the bridge, length and height of spans, width of draw openings, position of piers, abutments, etc., and any other features that may affect navigation of the stream.

¹ Paper by C. E. SMITH, *Proc. Amer. Ry. Eng. Assn.*, vol. 14, p. 185 of Appendix.

3. A map in triplicate showing the location of the bridge, giving for the distance of one mile above and one-half mile below the site such data in regard to low and high water, direction and strength of currents, soundings, existing bridges, and such other information as may be necessary to enable the Secretary of War to determine the suitable location.

The most important considerations to which the War Department will give attention are:

(a) The location of the crossing relative to current behavior and to river traffic requirements.

(b) The location of the movable span of the bridge relative to the position of the thread of the current or deep water-way channel.

(c) The clear width of channel opening.

The War Department endeavors to locate bridges on a long straight reach of the river in order that the likelihood of shifting of the position of the main channel or of cutting banks at the site may be reduced to a minimum. However, in many instances it is impossible to find a satisfactory site for the bridge and some scheme of shore protection may have to be resorted to, and modifications of the structure made to suit the available site.

Not only must the completed structure not interfere with river traffic, but the construction falsework must also be so arranged as not to interfere. After construction is complete, all piles, coffer-dams, etc. must be removed in order to prevent injury to passing boats.

After the War Department has approved the plans, Congress passes an act authorizing the construction of the bridge. In case action cannot be readily obtained due to adjournment or other reason, the War Department will sometimes issue a temporary permit to proceed.

CHAPTER IX

CONCRETE VIADUCTS AND TRESTLES

Introduction.—With the introduction of reinforced concrete a type of masonry bridge construction has been developed in the way of viaducts and trestles that has proved satisfactory from the viewpoint of economy, stability and appearance. Moreover, the advancing price of steel structures would indicate a still more extended use of this type of structure. Because of their inherent unsightliness, steel truss and girder bridges are not suited to many locations and even where the span is of such length as to necessitate a steel structure, steel arches are gaining in favor. Reinforced concrete bridges are also supplanting timber bridges for highway use, because the location of the highways is becoming more definitely fixed thereby justifying the more permanent construction.

Concrete bridges may be classified as follows:

1. *Girder bridges*
 - (a) Deck girders
 - (b) Through girders
2. *Slab trestles*
 - (a) On abutments and piers
 - (b) On pile bents
 - (c) On frame bents
3. *Cantilever bridges*
4. *Concrete truss bridges*
5. *Arch bridges*
 - (a) Fixed arch
 - (b) Two-hinged
 - (c) Three-hinged

Fixed masonry arches were discussed in a separate chapter because of the more complicated nature of the stresses and because of the fact that the arch is a structural member of more general application than merely to bridges. Owing to the infrequency of its application to masonry construction, the two-

hinged arch will not be discussed here. The design of the other types will be briefly discussed in the present chapter.

Unyielding foundations for abutments and piers are essential to the successful use of a fixed arch, hence when such stable foundations are not available, some other type of structure becomes necessary. In many instances the aesthetic requirements render a steel skeleton structure undesirable, hence a bridge of one of the types under consideration in the present chapter affords the most feasible solution. Moreover, the economic advantages may lie with the concrete structure rather than with the steel bridge because of the longer life of the former and the lower maintenance, no painting being required.

Loads on Masonry Bridges.—Whenever practicable, special investigation should be made to ascertain the loads to which a bridge will be subjected rather than to design the structure on the basis of general data and assumptions, for dead loads may vary as much as 25 to 40 per cent from general figures due to differences in specific weights of fill, type of roadway, the drainage, etc. However, where no specific information is available, the general data of Table XXV, taken largely from the 1916 Report of the Committee on Bridges and Culverts of the American Concrete Institute, may serve.

TABLE XXV.—WEIGHTS OF SOILS

Material	Weight per cu. ft.	
	Damp	Saturated
Black top soil.....	94	105
Sandy clay.....	106	115
Blue clay.....	114	118
Yellow clay.....	121	123
Clayey sand.....	123	132

In the absence of special observations or of specified loadings, the following general weights may be used.

Class A Bridges.—City Bridges and Bridges on Main Thoroughfares Leading Therefrom.

Concentrated Live Load.—A motor truck of the following dimensions and weights:

Total weight.....	50,000 lb.
Weight on rear axle.....	33,000 lb.
Distance between axles.....	10 ft.
Width of tread of rear axles.....	24 in.
Distance between centers of rear wheels.....	6 ft.
Roadway space occupied:	
Width.....	10 ft.
Length.....	30 to 36 ft.

For city bridges in areas of heavy traffic, such trucks may follow in a continuous string, while outside the limits of heavy traffic, the probability of more than two trucks being on the bridge at one time is exceedingly remote.

The following alternate uniform live load is recommended:

Span, feet....	under 80	80-100	100-125	125-150	150-200	over 200
Loads, lbs.						
per sq. ft. . .	125	110	100	90	85	80

It is further recommended that the above uniform live loading be assumed to occupy all or such portion of the roadway area not occupied by the motor truck loading as is necessary for maximum stresses.

Sidewalk loading will rarely exceed 90 lbs. per square foot.

Class B Bridges.—Ordinary Highway Bridges. The minimum requirements for ordinary highway traffic should probably be within the following limits:

Concentrated Live Load.—A traction engine or motor truck within the following limits:

Total weight.....	30,000-36,000 lb.
Concentration on rear wheels.....	66 $\frac{2}{3}$ per cent
Distance between axles.....	10-12 ft.
Distance between rear wheels.....	5 ft.-6 $\frac{1}{2}$ ft.
Width of tread of rear wheels.....	20-24 in.

Only one such vehicle need be considered on a single span at one time. The floor area occupied by the above live load may be taken as 10 ft. in width.

The alternate uniform live loading on Class B spans of varying lengths may safely be assumed as follows:

Span, feet....	under 80	80-100	100-125	125-150	150-200	over 200
Load, lb. per						
sq. ft.....	100	90	80	75	65	60

Class E-1 Bridges.—Bridges Carrying Ordinary Electric Railway Traffic. It is recommended that these bridges should

be designed to carry a concentrated live load on the following dimensions and weights:

Total weight.....	100,000 lb.
Number of wheels (on two trucks).....	8
Spacing of wheels c. to c.....	7 ft.
Spacing of trucks c. to c.....	20 ft
Each axle load distributed over three ties.	

Railway Bridges.—Cooper's loadings are commonly adopted for design of railway arches, although it is customary to assume an equivalent uniform load for the design of the main arch. It may be desirable to use the wheel concentrations in designing the spandrel arches or slabs. A uniform load of 700 lb. per square foot is frequently assumed for spans over 80 ft. long while 1,000 lb. may be necessary for shorter spans. As in the case of highway bridges, it is exceedingly important that the exact loading be determined wherever possible and this used instead of general loading data. Impact on spandrel filled arches usually need not be considered for the main arch where there is a filling of one foot or more at the crown but should be for open spandrel arches of short span, and for the spandrel piers and slabs. A similar remark applies to tractive forces. Where impact is to be considered, in open spandrel arches, the following impact formula may be used:

$$I = \frac{100}{L + 300} \text{ for highway bridges, and}$$

$$I = \frac{0.8 \text{ Live Load}}{\text{Live Load} + \text{Dead Load}} \text{ for railroad bridges}^1$$

Wind load is taken as 30 lb. per square foot, of projected area, and on railroad bridges, as 300 lb. per linear foot considered as live load on the loaded portion, acting 7 ft. above the base of rail. Except in regions of heavy snows in northern latitudes, snow load need not be considered.

The live load coming on a bridge varies widely with the location of the structure. Owing to the permanent character of masonry arch bridges, it is advisable to use a relatively high allowable live loading in the design owing to the tendency of loads to increase. The positions of live load for maximum stresses are shown in Fig. 44 and the arch should be investigated

¹ "Specifications," C. M. & St. P. R. R.

They have been used also in railway construction, but to a more limited extent. The floor slab is usually built monolithically with the girders affording a T-beam type of construction. In general with the loads given, the design of girder bridges does not involve any principles different from those explained in preceding chapters.

The chief advantages of the deck girder type of bridge are, (1) the slab is built monolithically with the girders thereby effecting the economy of the T-beam, (2) the roadway can be extended out over the girders, thereby permitting the piers to be made shorter than would be the case with a through girder, (3) a slight settlement of the piers or abutments is not so serious as in

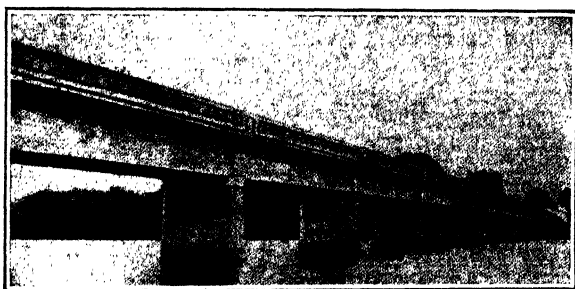

FIG. 148.—Concrete deck girder bridge of Moline, Ill.

the case of a fixed arch. Frequently deck girder bridges are built as continuous girders, although instead of allowing for the full effect of continuity in calculating the bending moment, many engineers use $\frac{1}{10}wl^2$ arbitrarily.

Figure 147 shows details of the standard deck girder bridge of the Iowa State Highway Commission and Fig. 148 is a picture of the deck girder bridge over the Rock River near Moline, Illinois. This latter structure consists of eleven 69-ft. spans. The bridge has a total camber of 2 ft., which is less than that commonly given to girder bridges, a common specification being 0.05 in. per foot of span, yet this amount of camber appears to be sufficient. The girders are $7\frac{1}{2}$ by 3 ft. and are spaced 10 ft. on centers and carry a roadway slab 20 ft. wide, the latter projecting about 4 ft. beyond the girders. Some of the piers rest on solid rock while others rest on piles. This latter fact made the choice of the fixed arch type of bridge inadvisable. Expansion is provided for by placing a cast iron rocker resting on a milled

steel plate under one end of each girder. There is a space of 2 in. between the ends of the girders over the piers.

Through Girder Bridges.—Through reinforced concrete girder bridges are used advantageously for highway work for the same lengths of span as noted for deck girder bridges, viz., 24 to 60 ft. They are particularly adapted to sites where the roadway is narrow and where clearance for waterway will not permit the use of deck girders. They are not economical for roadways wider than about 20 ft. because for greater widths cross floor

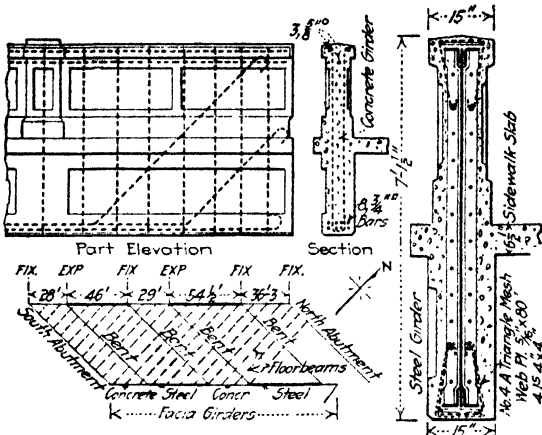

FIG. 150.—Steel girder encased in concrete.

beams must be used to support the floor, although cross floor beams are sometimes used for this width. In fact, the chief difficulty encountered in the design of this type of structure is securing a satisfactory connection between the floor slab and the girders.

Figure 149 is the standard 40-ft. through girder bridge of the Wisconsin State Highway Commission.

Where several spans are required, some of which are too long to admit of the economic use of through reinforced concrete girders of the usual type, steel plate girders encased in concrete may be employed advantageously, as in the case in the Vandevanter Ave. viaduct at St. Louis. See Fig. 150.¹

Slab or Trestle Bridges.—Reinforced concrete slab bridges may be used advantageously for spans of about 12 to 24 ft. and

¹ *Engineering News*, July, 1915.

are sometimes built up to 30 ft. although the girder type will usually be found the more economical for spans above 24 ft. The slab carries the load directly to the abutments and piers, the railing not being designed to carry any load. The slab may

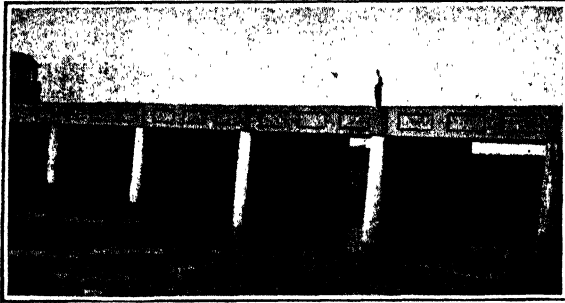

FIG. 151.—Reinforced concrete railroad trestle.

be carried on abutments and thin piers or on trestle bents, either pile or frame. The first is illustrated in the C. B. & Q. R. R. trestle,¹ Fig. 151, and the last two in the 14,000-ft. Yolo By-Pass causeway over the Sacramento Valley, Fig. 152.

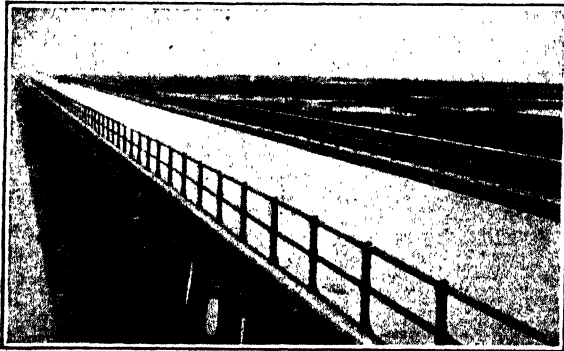

FIG. 152.—Reinforced concrete highway trestle.

In highway trestles, the slab is usually built as a unit because it is commonly built in place, but in railway trestles, the slab is usually built for half the width of roadway and is pre-cast. Figure 153 shows the details of the standard slab bridge of the Iowa State Highway Commission and Fig. 154 shows the 15-ft.

¹ *Engineering News*, Feb. 3, 1916.

trestle bridge of the Kansas City Southern R. R.¹ The practice of pre-casting the slabs greatly facilitates the construction of

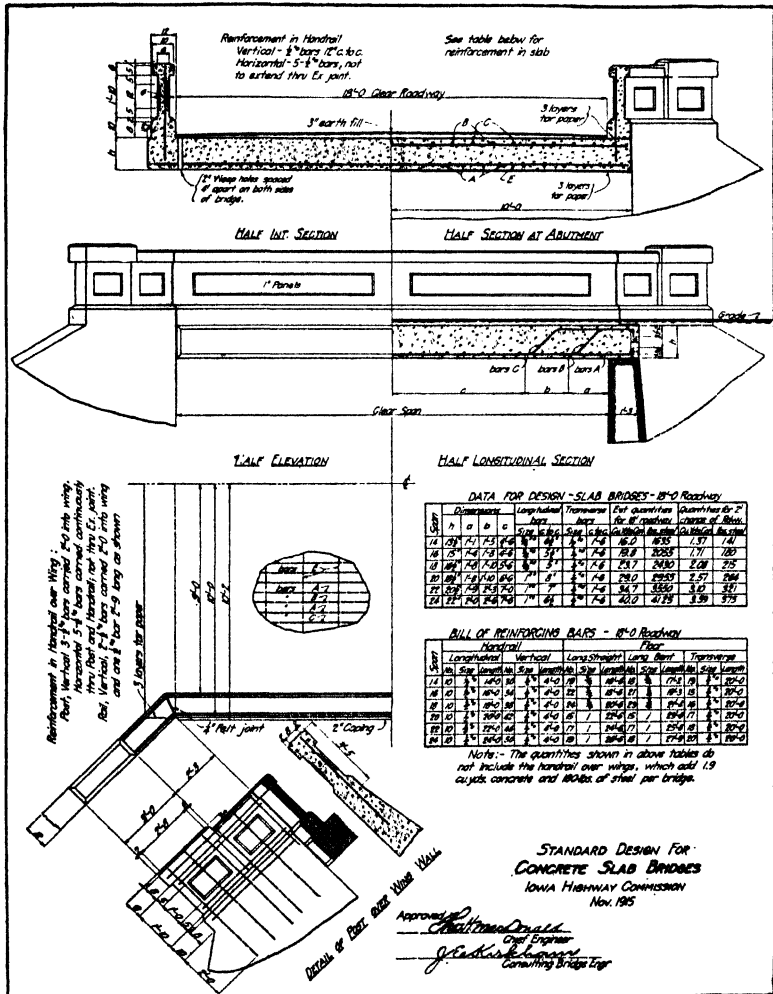

FIG. 153.—Reinforced concrete slab bridge of the Iowa Highway Commission.

bridges under traffic, as they can be quickly swung into place with a locomotive crane after the piers have been completed.

Design of the Slab.—The slabs are essentially reinforced concrete beams and are designed as such, being usually 6½ to 7

¹ Univ. of Colo. Journal of Engineering, vol. 12, No. 4, p. 29.

ft. wide for railroad bridges and the full width of roadway for highway bridges. With a load on the slab at any point, the width that may be considered as effective in contributing to the

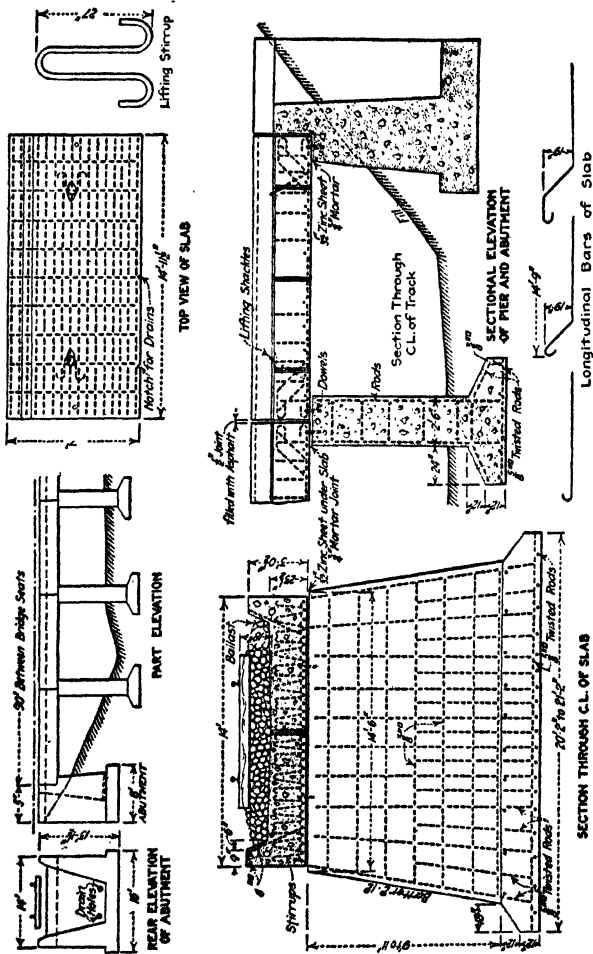

FIG. 154.—Reinforced concrete slab trestle of the K. C. S. R. R.

support of the load may be taken as $0.6L + 1.7$ ft., where the total width is greater than $1\frac{1}{3}L + 4$ ft., L being the span in feet, according to tests made by the Ohio State Highway Commission, or, perhaps with a greater precision, as $4x/3 + d$, where x is the

distance from the load to the nearest support and d is the width at right angles to the support over which the load is applied.¹

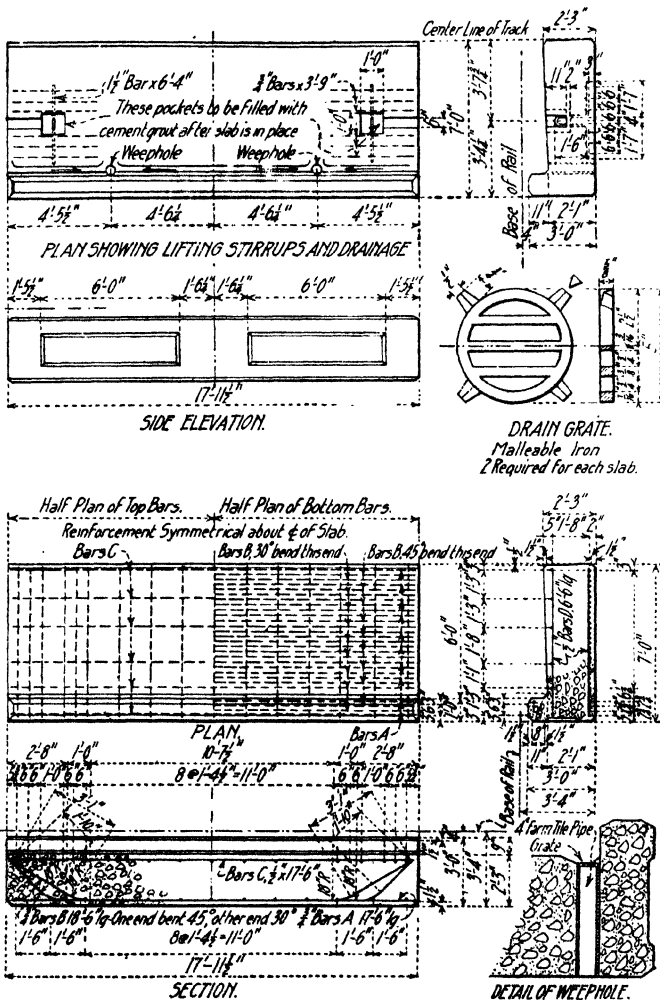

FIG. 155.—Reinforced concrete trestle slab of the Illinois Central R. R.

In the design of slabs for railroad bridges, the practice of allowing impact on slabs varies on different roads. Most roads use less than that given by the usual formula $\frac{L}{L + 300}$, about half

¹ Proc. Am. Soc. for Testing Materials, vol. 13.

of them using 50 per cent of that amount and the remainder various percentages between 50 and 100.¹ Inasmuch as vibration is the chief factor in causing impact and vibration is much less in a concrete slab than in a steel floor, it is scarcely necessary to allow as much as for steel structures, the 50 per cent figure being probably sufficient.

Care must be exercised to provide sufficient shear reinforcement in the slabs, and where a part of the tension bars are bent up, it is important that adequate imbedment of the ends be arranged to insure safe bond. Figure 155² shows details of the standard trestle slab of the Illinois Central R. R.

In multiple span structures, one end of the slab is usually fixed and the other arranged to slide. The C. M. & St. P. R. R. uses zinc plates under the sliding end of the slab and sets the fixed end in mortar, a method that has been found satisfactory.

Pile Trestle Bents.—Reinforced concrete pile trestles are constructed by driving reinforced concrete piles either with a hammer or by means of a water jet and then building a concrete cap to the bent in place, allowing the heads of the piles to project into the latter about 1 to 2 ft. Figure 156 shows the pile trestle bent of the C. B. & Q. R. R.³

Pre-cast concrete piles are used for trestles and their design is empirical entirely and varies on different railroads. For details of reinforced concrete piles, see p. 515. Deck slabs are also frequently pre-cast and swung into place by derricks or cranes.

Uniform section piles are well adapted to conditions where the pile is to act as a column resting on a hard stratum, while tapered piles are more satisfactory where skin friction will constitute the more important factor in the bearing capacity of the piles. Concrete piles can be manufactured and driven up to 40 feet in length.

The concrete for piles should be as rich as a 1:6 mixture at least with a well graded aggregate, the largest particle of which should not exceed $\frac{3}{4}$ in. The "cage," or unit reinforcement, usually consists of longitudinal rods wound around with about No. 14 B.w.g. wire. The forms are built up with only the top side of the octagon open, and the concrete, a mushy consistency, is rammed into place. Provision is usually made for placing a cap on the top for protection during driving.

¹ *Proc. Amer. Ry. Eng. Assn.*, vol. 20, p. 943 ff.

² *Univ. of Colo. Journal of Engineering*, vol. 12, No. 4, p. 25.

³ *Univ. of Colo. Journal of Engineering*, vol. 12, No. 4, p. 28.

Frame Trestle Bents.—Frame trestle bents of reinforced concrete for moderate heights are usually cheaper than steel trestles in first cost and do not require painting. For greater heights, the indeterminate character of the stresses involved in the design renders their use less advantageous. A good example

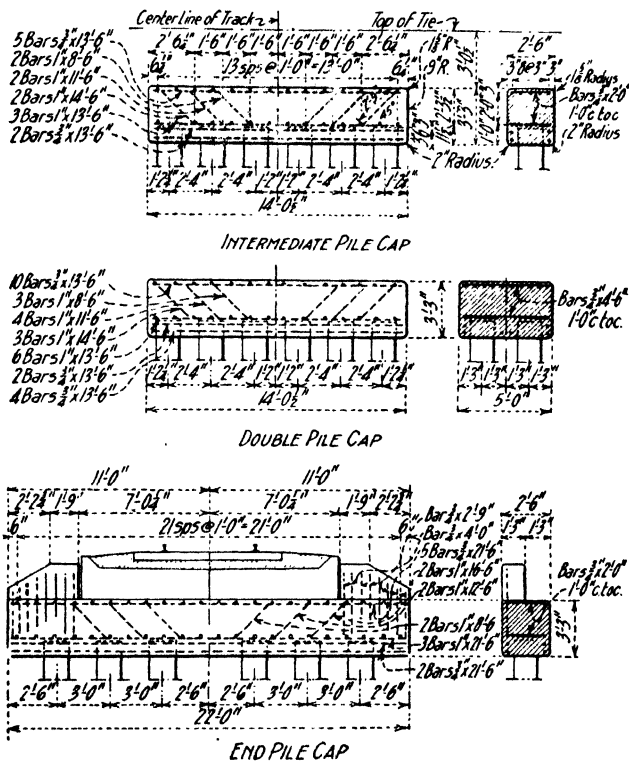

NOTES: Where dimensions are not given see corresponding dimensions of intermediate cap. All bars are square corrugated. Bearing surface of caps covered with sheet zinc grouted in place when slabs are set. Concrete 1:2:4 mixture.

STANDARD PILE CAPS
CONCRETE PILE TRESTLE
C. B. & Q. R. R.

FIG. 156.—Reinforced concrete pile trestle bent of the C. B. & Q. R. R.

of this type of structure is the Richmond viaduct of the Richmond and Chesapeake Bay Electric R. R. This viaduct is 2,800 ft. long and varies from 18 to 70 ft. in height. The viaduct was designed to carry a 75-ton car on four wheeled trucks 33 ft. apart, with 50 per cent allowance for impact. The longitudinal thrust was taken as 20 per cent. of the live load.

Stresses in Reinforced Concrete Trestle Frames.—In a reinforced concrete trestle frame built up with rigid joints and having quadrilateral panels, the stresses are statically indeterminate. These stresses may be determined by the principle of least work,¹ by the method of slope deflection,² or by the principle of displacements as explained herein. The stresses for direct loads and for wind may be computed separately and independently and the results added algebraically. The following solution employs the latter method as explained in "Modern Framed Structures," Part II, by Johnson, Bryan & Turneaure.³

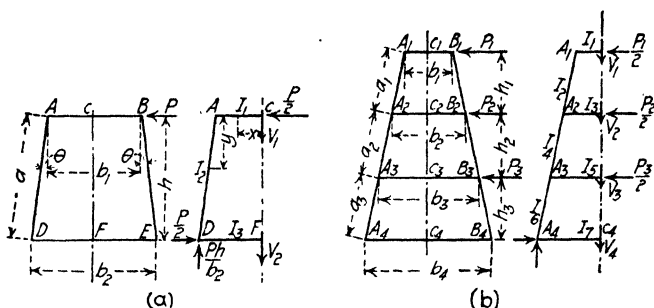

FIG. 157.—Stress analysis of a trestle frame.

Single Story Frame Bent.—Let Fig. 157 (a) represent a rigid quadrangular symmetrical frame with wind pressure, P , at the top considered as being borne equally between the two sides. Let I_1 , I_2 , and I_3 be the moments of inertia of the transformed sections of the members as shown. Consider the left half of the frame, and replace the action of the other half by V_1 and V_2 .

Since the frame is symmetrical, the center points of the members AB and DE are points of inflection, and the deflection of C relative to F will be zero, or in other words, the sum of the deflections between C and F will be zero.

$$\text{The deflection, } \Delta = \int \frac{M_x ds}{EI}; \text{ for } CA \int_0^{b_1} \frac{V_1 x^2 dx}{I_1} = \frac{V_1 b_1^3}{24I_1}$$

Likewise, the deflection for FD is $-\frac{V_2 b_2^3}{24I_3}$. For AD , the moment

¹ *Univ. of Illinois Eng. Exp. Sta., Bull. 107.*

² *Univ. of Illinois Eng. Exp. Sta., Bull. 108.*

³ JOHNSON, BRYAN and TURNEAURE, "Modern Framed Structures," Part II, p. 398 ff.

$M = V_1x - \frac{Py}{2}$; also $ds = \frac{2a}{b_2 - b_1} dx$, and $y = \left(x - \frac{b_1}{2}\right) \cot \theta = \frac{h}{b_2 - b_1} (2x - b_1)$. Hence for AD ,

$$\int \frac{Mxdx}{I} = \frac{2V_1a}{(b_2 - b_1)I_2} \int_{b_1}^{b_2} x^2 dx - \frac{Pha}{(b_2 - b_1)^2 I_2} \int_{b_1}^{b_2} (2x^2 - b_1x) dx = \frac{V_1a(b_2^3 + b_1b_2 + b_2^2)}{12I_2} - \frac{Pha(2b_2 + b_1)}{24I_2}$$

Equating the total deflection to zero,

$$\frac{V_1a(b_2^3 + b_1b_2 + b_2^2)}{I_2} + \frac{V_1b_1^3}{2I_1} - \frac{V_2b_2^3}{2I_3} = \frac{Pha(2b_2 + b_1)}{2I_2} \quad (1)$$

From static equilibrium,

$$V_1 + V_2 = \frac{Ph}{b_2}$$

Equations (1) and (2) enable one to solve for V_1 and V_2 , and with these known, the other forces can readily be determined.

Multiple Story Trestle Frames.—The mode of procedure for a trestle bent of several stories is similar to that for one story. See Fig. 157 (b). As in the previous article, the value of

$$\int \frac{Mxdx}{I}$$

for A_1A_2 is $\frac{V_1a_1(b_1^2 + b_1b_2 + b_2^2)}{12I_3} - \frac{P_1h_1a_1(2b_2 + b_1)}{24I_2}$

and for the top story, the deflection is the same as in Eq. (1) above.

For the second story, the integrals for C_2A_2 and C_3A_3 are $V_2b_2^3/24I_3$ and $-V_3b_3^3/24I_5$ respectively. For A_2A_3 , the effect of V_1 and V_2 is the same as if their sum were applied at C_2 , since they act in the same vertical line. Also, the effect of $P_1/2$ and $P_2/2$ on A_2A_3 is the same as if $\frac{P_1 + P_2}{2}$ were applied at C_2 together with a constant moment $P_1h_1/2$. The constant moment $P_1h_1/2$ applied to A_2A_3 is at an average distance of $x = (b_2 + b_3)/4$ from C_2 , hence the integral

$$\int \frac{Mxdx}{I} = \frac{P_1h_1a_2(b_2 + b_3)}{8I_4}$$

Making these substitutions in Eq. (1) of the preceding article,

$$\frac{(V_1 + V_2)a_2(b_2^2 + b_2b_3 + b_3^2)}{I_4} + \frac{V_2b_2^3}{2I_3} - \frac{V_3b_3^3}{2I_5} = \frac{(P_1 + P_2)h_2a_2(2b_3 + b_2) + 3P_1h_1a_2(b_2 + b_3)}{2I_4}$$

From static moments $V_1 + V_2 + V_3 = \frac{P_1(h_1 + h_2) + P_2h_2}{b_3}$

For additional stories the procedure may be continued in a similar manner. For the next story, the equation becomes

$$\frac{(V_1 + V_2 + V_3)a_3(b_3^2 + b_3b_4 + b_4^2)}{I_6} + \frac{V_3b_3^3}{2I_5} - \frac{V_4b_4^3}{2I_7} = \frac{(P_1 + P_2 + P_3)h_3a_3(2b_4 + b_3) + 3[P_1(h_1 + h_2) + P_2h_2]a_3(b_3 + b_4)}{2I_6}$$

and $V_1 + V_2 + V_3 + V_4 = \frac{P_1(h_1 + h_2 + h_3) + P_2(h_2 + h_3) + P_3h_3}{b_5}$

From these equations V_1, V_2, V_3 , etc. can be determined and with these quantities known, the entire structure becomes determinate.

In the application of this solution, the moments of inertia of the transformed sections must be used.

If the columns are rigidly fixed at the bottom, the effect is the same as if the moment of inertia of the lower strut were infinity, hence, in such case, the term having this quantity in the denominator would become zero.

Reinforced Concrete Truss Bridges.—In a few instances, reinforced concrete truss bridges have been built, usually with a curved upper chord so that the structure assumes some of the characteristics of a two-hinged arch, or of the ordinary curved chord truss with riveted connections. In general, this type of bridge has less to commend it than the other types of concrete bridges, but where a reinforced concrete bridge is to be built over a long span and the foundations are not such as would warrant the erection of an arch, or where the waterway requirement cannot be easily provided for by the use of an arch, its use may be justified.

Figure 158 is a picture of a reinforced concrete truss bridge over the Mahoning River near Sebring, Ohio. The upper chord of this bridge was designed as a two-hinged arch and the tension in the lower chord was obtained by the equation.

$$\frac{\Sigma Myds - H\Sigma y^2ds}{EJ} = \frac{HL}{A_eE} \quad (\text{See p. 361})$$

where M is the moment of external forces about the center of a ds division, ds the length of one of the equal divisions into which the arch rib was divided, y the distance from the center of the bottom chord steel to the center of the ds division, L the length of bottom chord steel subject to stretch, I the moment of inertia of the arch rib, and the other terms have their usual significance.¹ The two

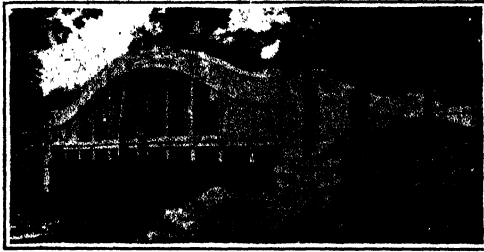

FIG. 158.—Reinforced concrete truss bridge.

end panels were considered as a girder and the web designed to take the shear. The details of a bridge of similar design are shown in the Canadian Engineer for April 3, 1919.

Cantilever Bridges of Reinforced Concrete.—An economical type of reinforced concrete bridge for highways and one that is capable of good architectural treatment is the balanced cantilever bridge. It will adjust itself to a slight unevenness of settlement of foundations with much less serious results than will a fixed arch and yet it may be made to simulate a fixed arch very closely in outline. The piers are designed to withstand the bending moment when the cantilever on one side only is loaded and the footing is also designed to carry the load when it is thus eccentrically placed. Inasmuch as uneven settlement of piers disturbs the stress distribution but slightly in this type of struc-

¹ FOOT-NOTE. The general equation for the horizontal reaction of a two-hinged arch is:

$$\int_A^B \frac{Myds}{EI} - H \int_A^B \frac{y^2 ds}{EI} - \frac{Hl \cos \alpha'}{EA_c} + cTl = 0$$

Where α is the inclination of the arch axis at the springing and L is length of the arch axis, A_c the area of cross section of the arch at the crown.

Omitting the temperature effect and taking $l \cos \alpha'$ equal to L ,

$$\int_A^B \frac{Myds}{EI} - H \int_A^B \frac{y^2 ds}{EI} = \frac{HL}{EA_c}$$

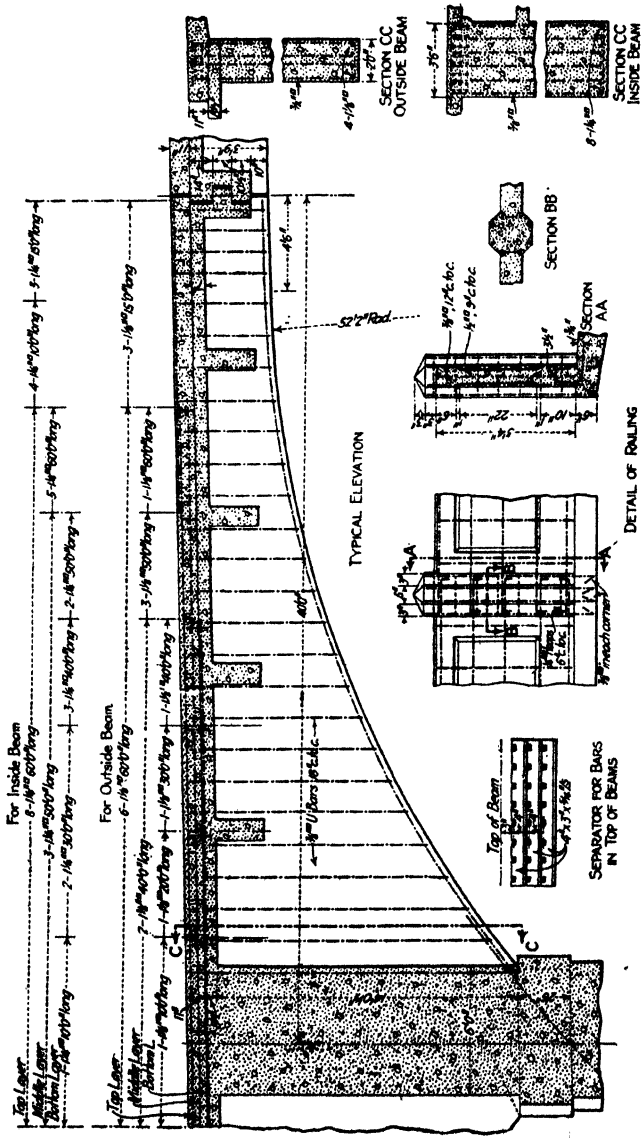

FIG. 159.—Cantilever arm of the Hopple St. Viaduct, Cincinnati.

ture, it is adapted to locations where the piers will not rest on solid rock.

Figure 159 presents the manner of reinforcing the cantilever arms in the Hopple Street viaduct at Cincinnati.¹ The cantilever beam was designed for a moving load consisting of two 40-ton electric cars entrain 25 per cent added for impact. The roadway slab was designed for 600 lb. per square foot and the cantilever sidewalk for 100 lb. per square foot. The piers and footings were designed for a full live load on one side only.

The Risorgimento bridge² over the Tiber at Rome with a span of 328 ft. and arch ring 8 in. thick at the crown is an interesting example of a structure on the border line between a cantilever and an arch. The total depth of deck and arch at the crown is 2 ft. 9 in. Each abutment rests on a "compressor" foundation and is anchored by a shoreward counterfort extension about 70 ft. long, filled with compacted earth. The haunches are of box construction with interior ribs 8 in. thick.

Three-hinged Masonry Arch Bridges.—Owing to the fact that the stresses in a fixed masonry arch are not statically determinate and also due to the fact that any settlement of abutments or piers introduces serious and unknown stresses in the arch ring, many engineers choose for certain locations to build bridges of arch ribs of the three-hinged type, i. e., at the crown and at the springing. Such a structure is statically determinate and offers a very satisfactory solution of the problem where the foundations are not on solid strata. The hinges constitute an expensive item in the construction and also a feature that must be carefully designed if trouble is to be avoided.

Where one load is placed on one half of the arch (which load might be the resultant of any number of loads), the reactions may be found as in Fig. 160. The two reactions and the load, being a system of three forces, must be concurrent in order to be in equilibrium. Also, since the moment at the hinge is zero, the reaction of the hinge of the unloaded side must pass through the center hinge. These conditions give the directions of the reactions and by laying off the load line equal to P , and drawing the rays parallel to these reactions, their amount can be determined. If a load is placed on each half, the reactions can be found for

¹ *Engineering Record*, Sept. 23, 1916.

² *Engineering*, Dec. 1, 1911.

each load separately and the resultants obtained by the parallelogram of forces.

Algebraically, the reactions are found as for a simple beam, i.e., from the equations of equilibrium:

$$V_A + V_B - \Sigma P = 0 \quad (1)$$

$$H_A - H_B = 0 \quad (2)$$

Taking moments about the left hinge

$$V_B L - H_B d - \Sigma P a = 0 \quad (3)$$

the summation being for the left half only. Taking moments about the crown,

$$H_A r - V_A L_l + \Sigma P(L_l - a) = 0 \quad (4)$$

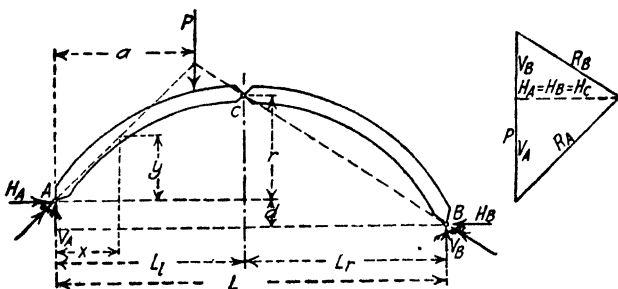

FIG. 160.—Reactions for a three-hinged arch.

the summation being for the left half only. Obviously, the crown thrust is equal to the horizontal reactions.

After the reactions are determined, the moment, shear and thrust at any point can readily be determined as in simple beams, since the moment at the hinges is zero. With these quantities determined, the stresses at any point may be calculated by the equation $S = N/A \pm Mc/I$, N being the normal thrust at the section considered, and the other nomenclature as before.

For symmetrical arches with the end hinges at the same elevation, the entire procedure in the calculation of the stresses becomes very simple.

For an approximate design, in order to estimate the weight of the proposed structure in the calculation of the stresses, the crown thickness, t_c may be taken at somewhat less than for a fixed arch, the thickness at the lower hinge at $1.25t_c$, and at the middle of the haunch at $1.5t_c$. However, by making the arch approximately

of the same outline as the fixed arch and concealing the hinges in the masonry, the graceful outline of the fixed arch may be

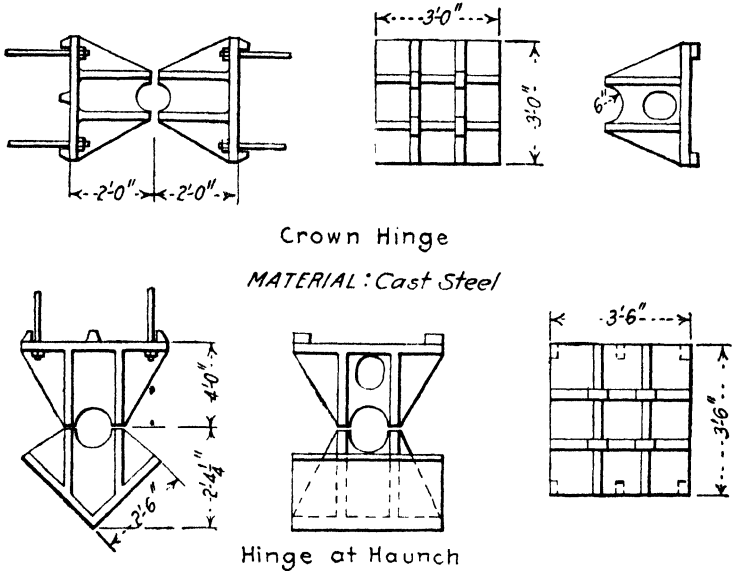

FIG. 161.—Hinges for a three-hinged masonry arch.

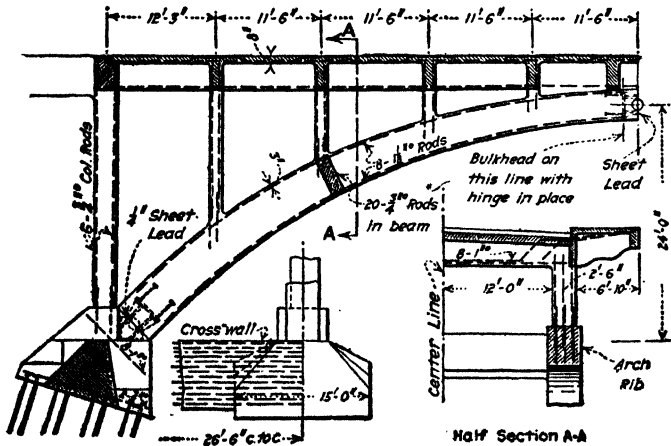

FIG. 162.—Three-hinged reinforced concrete arch.

obtained. One of the chief objections to the three-hinged arch is that its unnatural proportions render it unsightly, the middle of

the arch rib being required by theory to be thicker than at either end, hence a waste of material is involved when more pleasing outlines are adopted.

A common type of hinge is shown in Fig. 161, although a variety of types are in use. One casting is molded in the abutment and the other attached to the arch rib. The chief element of uncertainty in the calculation of stresses in a three-hinged arch arises from the fact that the hinge is not smooth and that under conditions of rusting, there may be considerable moment transmitted through the hinge. Figure 162 shows details of the Fourth Street viaduct at Paducah, Ky. and illustrates the use of the three-hinged type of construction. It is common practice to place three or four arch ribs under the ordinary roadway, although for narrow roadways, two may be sufficient.

Pier and Slab Frame Bridges.—For short and moderate length spans, economy is claimed for rigid frame bridges as compared to ordinary girder spans because of the utilization of the passive resistance of the earth back of the abutments. Figure 163 shows a type of rigid frame bridge used at Bronx Parkway, New York. In this case, the saving was estimated at \$5,000 over a girder or arch structure.¹

The design of such a structure is uncertain with respect to stress analysis and is complicated by the varying moment of inertia of the section. If the footings are assumed to remain fixed, the solution can be made similar to the method shown on p. 388 or approximations can be made by analogies to fixed beams. In any event, arbitrary assumptions must be made with reference to the nature of the reactions. If the piers are assumed as hinged at the bottom, the general expression for horizontal reaction at the bottom of the end pier is

$$H = \frac{\int \frac{M' y ds}{I}}{\int \frac{y^2 ds}{I}}$$

as for a two hinged arch, where M' is the moment of a vertical load on the frame.² The integrations (summations) are made

¹ *Engineering News-Record*, vol. 90, p. 75; vol. 93, p. 150; vol. 95, p. 16; vol. 96, p. 686.

² JOHNSON, BRYAN, and TURNEAURE, vol. 2, "Modern Framed Structures," p. 391.

generally provided for in the design, particularly for short spans. In a continuous girder bridge of inverted T-section with curved lower flange, built across the Platte River at Douglas, Wyo.,¹ the spans are 94, 95, and 94 ft., respectively. This bridge

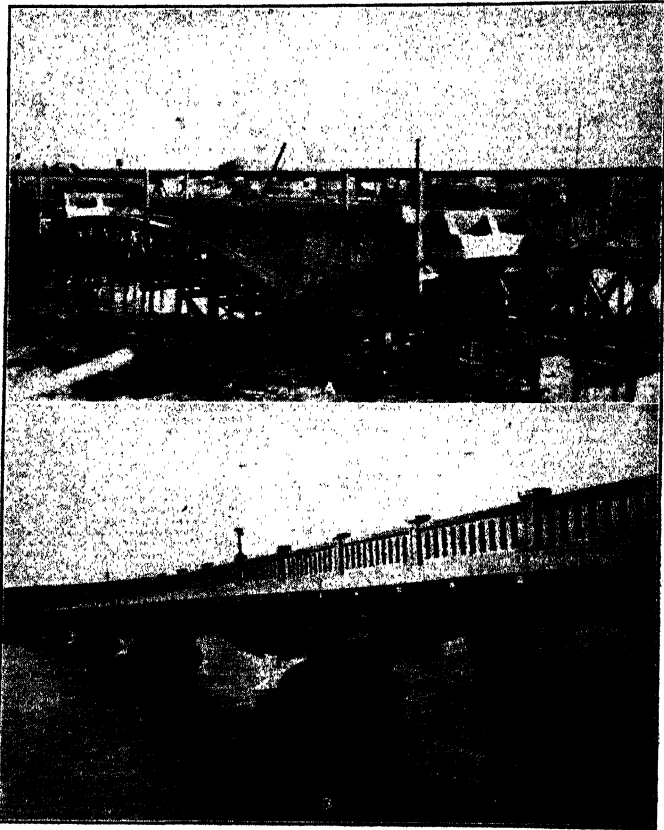

FIG. 164.—Platte river bridge at Douglas, Wyoming.

is in reality a cantilever bridge with a suspended simple slab, because expansion joints were placed at the points of contraflexure. Figure 164 (a)² shows the mode of erection and (b) shows the completed structure. The structure is reported to have cost about 20 per cent less than one of simple girders.

¹ *Engineering News-Record*, vol. 95, p. 722.

² Courtesy, Mr. J. F. Seiler, formerly Bridge Engineer.

A uniform section of girder is used in many cases, as, for example, in the bridge of the Cincinnati Rapid Transit over Reading road¹ (spans $40\frac{1}{2}$, $70\frac{1}{2}$, $40\frac{1}{2}$ ft.), where the girders are $9\frac{1}{2}$ ft. deep. Obviously, a uniform girder section simplifies stress calculations, although the appearance may be less pleasing. The economy from less material obtained in the variable section may be lost to an extent in the added cost of construction.

The obvious economies of material result from three conditions: (1) The greatest moment to be resisted is less than in a simple beam. (2) The average bending moment throughout is less than in simple beams. (3) The greatest moment occurs at the support where additional material can be used to resist it most advantageously.

Stress calculations offer little difficulty, particularly for essentially uniform sections of girders. In this case, reactions and moments may be calculated readily by the theorem of three moments or other method. When the section and its moment of inertia vary, however, the procedure is more complex. The calculations may be made algebraically or by semigraphical methods.

In a continuous beam, the deflection at any point is given by the expression $\Delta = \int_0^l \frac{Mdx}{EI}m$, as shown from principles of internal work² where m is the moment of a unit load placed at the point where the deflection is desired. In a two span continuous beam ABC, the deflection at A is zero, hence

$$\int_A^C \frac{Mdx}{EI}m = 0$$

m being the moment due to a reaction of unity at R_1 .³ The moment, M , may be considered as of two parts, that due to loads with the support removed, M' , and that due to the reaction, R_1 , equal to R_1m . Therefore

$$\int_A^C \frac{M'dx}{EI}m + R_1 \int_A^C \frac{m^2dx}{EI} = 0 \quad (1)$$

¹ *Engineering News-Record*, vol. 94, p. 576.

² G. F. SWAIN, "Strength of Materials," p. 217.

³ JOHNSON, BRYAN and TURNEAURE, "Modern Framed Structures," vol. 2, p. 37.

whence

$$R_1 = - \frac{\int_A^C \frac{M'm}{I} dx}{\int_A^C \frac{m^2 dx}{I}} \quad (2)$$

Dividing the girders into sections of such length that dx/I will be constant, which can be conveniently done as for an arch, simplifies calculations.

For the usual case of three symmetrical spans uniformly loaded, this equation, together with the equations of statics, permits the reactions to be determined, since $R_1 = R_4$ and $R_2 = R_3$. For the general case, two equations must be formed from the conditions of zero deflections at two supports and solved simultaneously to determine the reactions.

A convenient semigraphical method of determining the reactions is given by J. F. Seiler¹ based on Maxwell's theorem of reciprocal deflections and the use of influence lines. The elastic curve of the beam is obtained from area moments by plotting the M/I diagram, considering this as load and plotting a moment diagram. This latter is the elastic curve and is also the influence line for the deflection at a support. For non-uniform loadings, especially, the method has much to commend it.

Waterproofing Bridge Floors.—In viaducts over city streets and in some other instances, it is necessary to waterproof the floors of the bridges in order to protect the passage beneath. The most effective method of accomplishing this is by means of a bituminous membrane composed of layers of burlap, felt or other fabric impregnated with bitumen, either tar or asphalt. Such a membrane should be elastic in order to accommodate itself to the expansion and contraction of the structure and it should be tough to resist injury and should not crack of its own accord. The waterproofing membrane should be protected by a covering of cement mortar in order that it may not be injured by the handling and placing of ballast or other materials above it. Figure 165 shows the method of waterproofing bridge floors recommended by the Committee on Masonry of the Am. Railway Engineering Assn.²

¹ *Engineering News-Record*, vol. 95, p. 722; see also *Engineering News-Record*, vol. 94, p. 886, for a solution by I. Duberstein.

² *Proc. Amer. Ry. Eng. Assn.*, vol. 15, p. 531.

The following conclusions were adopted by the Committee:

“1. Watertight concrete may be obtained by proper design, reinforcing the concrete against cracks due to expansion and contraction, using the proper proportions of cement and graded aggregates to secure the filling of voids and employing proper workmanship and close supervision.

2. Membrane waterproofing, of either asphalt or pure coal-tar pitch in connection with felts and burlaps, with proper number of layers, good materials and workmanship and good working conditions, is recommended as good practice for waterproofing masonry, concrete and bridge floors.

3. Permanent and direct drainage of bridge floors is essential to secure good results in waterproofing.

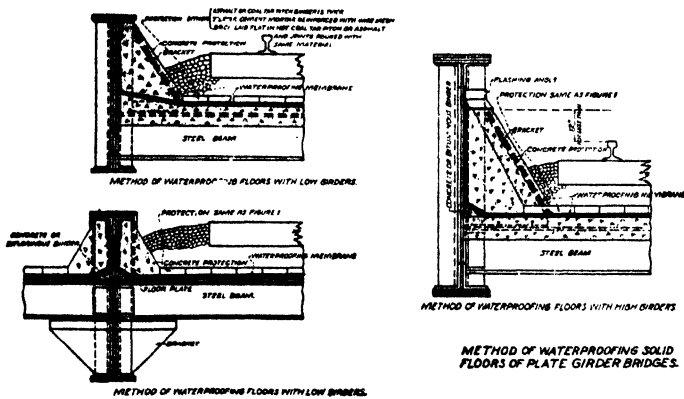

Fig. 165.—Methods of water-proofing bridge floors.

4. Integral methods of waterproofing concrete have given some good results. Special care is required to properly proportion the concrete, mix thoroughly and deposit properly so as to have the void-filling compounds do the required duty; if this is neglected, the value of the compounds is lost and their waterproofing effect destroyed. Careful tests should be made to ascertain the proper proportions and effectiveness of such compounds.

Integral compounds should be used with caution, ascertaining their chemical action on the concrete as well as their effect on its strength; as a general rule, integral compounds are not recommended, since the same results as to watertightness can be obtained by adding a small percentage of cement and properly grading the aggregate.

5. Surface coatings, such as cement mortar, asphalt or bituminous mastic, if properly applied to masonry reinforced against cracks pro-

duced by settlement, expansion and contraction, may be successfully used for waterproofing arches, abutments, retaining walls, reservoirs and similar structures; for important work under high pressure of water these cannot be recommended for all conditions.

6. Surface brush coatings, such as oil paints and varnishes, are not considered reliable or lasting for waterproofing of masonry.”

CHAPTER X

CULVERTS AND UNDERGROUND CONDUITS

General Conditions.—A culvert is a structure built through an earth roadway embankment crossing a ravine to permit the passage of the natural water course and to prevent the accumulation of water above the embankment. Timber trestles and bridges are frequently replaced by an earth embankment containing a culvert. Obviously there are two factors involved in the design of a culvert, viz., (1) the size of the opening required to carry the water from the drainage area above the opening in order that there may be no injury to the embankment nor to adjacent real estate by flooding due to backwater, and (2) the structure should be stable under the loads to which it is subject.

The exact requirements of both of these conditions are indeterminate with any degree of nicety, but estimates have to be made under the guidance of experience and judgment to a considerable extent. However, observation of past practice indicates the limits of safe procedure, and fortunately great refinement in these matters is not necessary.

Area of Waterway Required.—Successful design requires that sufficient waterway be provided to pass the maximum flood flow that is likely to occur frequently although perhaps not the maximum that may ever occur. That is, the opening should accommodate the maximum flood that might be expected to occur in perhaps each 25-year period but not the maximum that would occur in a century, it being cheaper to sustain the loss due to this rare flood than to provide for it in the original structure. Whether the flood to be provided for should be the maximum in 25 years, in 50 years or in a century will obviously depend upon the character and extent of the damage likely to occur from the unaccommodated flood. The damage to inundated woodland would be small and such land might be flooded every 10 years or so, while the damage to city property would be so great that perhaps the maximum recorded flood should be provided for in the design, and there would be a complete range of conditions between these limits so that the engineer's judgment will have to be exercised in making the decision.

The amount of flow through a culvert depends on about six principal factors; namely, (1) the area to be drained, (2) the intensity and duration of the rainfall, (3) the shape of the drainage area, (4) the character of the slopes, (5) the character of the soil and of the vegetation, and (6) climatic conditions.

The flood flow increases with the area drained but not in direct proportion, because the precipitation is not uniform over large areas, and moreover, that rain which falls on the lower portions of the area escapes before that from the more remote portions of the watershed reach the culvert opening. Observations indicate that the run-off varies with the one-half or three-fourth power of the area for the humid regions and average rolling topography.

Obviously the run-off would increase with the amount of precipitation, both with the intensity and with the duration. Heavy precipitation is not confined to the humid regions, for floods of extreme intensity are of frequent occurrence in the arid districts. The rainfall of maximum intensity through a period equal to that required for water falling on the most remote portions of the watershed to reach the culvert will be the rainfall that will produce the maximum flood discharge because of the cumulative effect.

The shape of the area also has a direct influence on the flood height. A long narrow valley, which allows the water falling on the lower portion to run off before that on the upper portion reaches the culvert does not yield so great a flood height as a fan-shaped watershed, which would deliver water at the outlet from all portions at once.

Steep slopes likewise yield a larger flow from a given precipitation than does a rolling country, and the latter yields a greater run-off, in turn, than does an area consisting of prairie or plains.

The character of the soil and of the culture affects the yield of a watershed in that impervious rocky soil causes the water to collect in rivulets the more readily and to reach the natural water courses. Cultivated land allows a smaller percentage of run-off than does waste or wooded land. Contrary to a belief widely held, forests do not appreciably affect flood conditions, although they may influence the regular flow. For a similar reason, frozen soil yields a greater percentage of run-off than does soil that is not rendered impervious by being frozen.

The run-off might be estimated and the size of the water-way selected to provide for this flow, but it is simpler to estimate the

area of the water-way directly from the area of the watershed, since the solution of the problem does not admit of great refinement in either case. Various formulas have been proposed as an aid to the engineer's judgment, but it should be remembered that they are to serve as an aid only and should not replace his judgment. A comparison of the various formulas proposed¹ indicates that the one devised by Professor A. N. Talbot in general gives the most reliable results. It is

$$a = C \cdot A^{\frac{1}{2}}$$

in which, a is the area of the required water-way in square feet, A the area of the watershed in acres, and C is a coefficient varying from $\frac{1}{6}$ to 1. For steep and rocky ground with conditions of vegetation, shape of drainage area, etc. favorable to a maximum discharge, C is $\frac{2}{3}$ to 1; for rolling agricultural country subject to floods at times of melting snow with length of valley about three times the width, C is about $\frac{1}{3}$; in districts not affected by snow where the valley is several times as long as wide, $\frac{1}{5}$ or $\frac{1}{6}$ or less may be used. C should be increased for steep side slopes, especially if the upper part of the valley has a much greater fall than does the channel at the culvert.

The carrying capacity of a culvert is decreased somewhat when the height of the water reaches the soffit of the culvert because of the well known principle that the increasing of the wetted perimeter decreases the carrying capacity. This fact causes culverts to flood, or be "drowned," at times when their carrying capacity is slightly exceeded. When a pond forms above the culvert, the latter discharges under a head, the discharge capacity in this circumstance being $Ka\sqrt{2gH}$, in which a is the area of the culvert and H the head on the center of the culvert opening, and K is a coefficient of discharge. The value of K is about 0.6 for square ended culverts and about 0.95 for culverts with bell or rounded entrance.²

For box culverts flowing partially full, the discharge in second-feet is $2.70LH^{1.5}$ for square cornered entrance and $2.85LH^{1.5}$ where L is the width in feet and H the height in feet of the water above the culvert floor.³

The extent to which water may be allowed to head up against an embankment above a culvert depends upon the nature of the embankment and the arrangement at the end of the culvert as well as on the probable damage that would result to property

¹ *Proc. Amer. Ry. Eng. Assn.*, vol. 8.

² *Engineering Record*, Mar. 16, 1911.

³ *Studies in Engineering, Univ. Iowa, Bull.* 1.

owners above. With a stable embankment, excessive floods may be taken care of in this way, usually without serious harm to the embankment. Moreover, it may be cheaper to repair the embankment at times than to sustain the heavier fixed charge incurred in constructing a larger culvert that would carry the maximum flood without backwater damage. Unless negligence is proved, it has been held by the courts that a railroad is not liable for damage from extraordinary floods, although it will be held for damage from floods that might have been foreseen by prudent men, where the flood results from insufficient waterway. This rule applies only where the railroad did not obtain its right of way from the plaintiff, for it is assumed that such damage would be included in the damages awarded the grantor when the land was taken.

Distribution Through Earth of Pressures from Superimposed Loads.—The portion of the culvert which carries the load of the roadway and the live load will be determined by the extent to which the earth fill distributes the load laterally. Experiments made at the University of Illinois¹ and at Pennsylvania State College² on sand show that the load is distributed within an area bounded by lines sloping 1:2 from the area of application. The intensity of pressure is maximum at the center of application and decreases to zero at the edge of the zone of pressure. See Fig. 219. Assuming that this law of pressure holds good for earths as well as for sand, the load should be considered as distributed over a length of culvert equal approximately to $w + \frac{1}{2}d$, where w is the width of the area over which the load is applied at the surface and d is the depth of the fill, for the pressure may be considered practically uniform over this length of culvert. If the barrel of the culvert is constructed continuously instead of in sections, the load may be considered as borne by a somewhat greater length than this, which from analogy to slabs may be estimated at about 0.6 the span of the culvert. On this assumption, the length over which the load would be distributed would be $w + \frac{1}{2}d + 0.6s$, s being the span of the culvert in feet.

The bearing on the footings and floor arches and struts is considered as uniformly distributed and they are designed accordingly. They are, of course, only inverted beam members with the side walls of the culvert forming the supports and the upward pressure of the earth the loading. The track load may be considered as uniformly distributed over a zone of the footing

¹ *Engineering Record*, Jan. 22, 1916.

² *Engineering Record*, May 30, 1914.

bounded by lines diverging from the area of application at a slope of 1:4 through the earth and 1:2 through the masonry. See Fig. 167.

In newly placed fills, the load on a culvert or a conduit may actually exceed the weight of earth directly over the structure, owing to the fact that the earth at sides of the culvert settles to a greater or less extent, causing the rigid masonry of the culvert to support more than the earth directly above. Tests¹ made under the direction of the A. n. Ry. Eng. Assn. Committee on Roadway indicated that the total pressure on a rigid masonry culvert or conduit may be as much as 1.6 times the weight of the superimposed earth, while on a flexible pipe culvert which was not subject to the additional weight due to friction at the sides, the pressure on the culvert does not exceed the weight of earth above. This circumstance accounts for the not infrequent breakage of vitrified pipe in new fills. However, this increment of load in settling is generally not serious because the design is made for earth at maximum density. This fact would ordinarily provide for this small additional load, and, moreover, this additional dead load is not simultaneous with the live load. A culvert should be designed to carry the entire embankment directly above it.

In shallow fills, the culvert or conduit should be designed to carry also any superimposed load. Tests at Iowa State College² indicate that through bridging action of the earth, the effect of superimposed loads disappears at depths greater than about twice the span of the culvert.

Impact in highway culverts seems to be practically negligible, also, for depths of embankment over the culvert greater than about twice the span.³ Railroads commonly make an impact allowance of $LL/(LL + DL)$ where the track rests directly on the masonry and about 50 per cent of this amount for well ballasted track. Where there is earth in addition to ballast, the impact may be further diminished by considering the earth above the culvert as dead load in the foregoing formula.⁴

Slab Culvert of Rectangular Cross Section.—Where the top slab of a culvert of rectangular cross section is built monolithically with the side walls, the top span is usually designed as a beam with a length equal to the clear span. The specification

¹ *Proc. Am. Ry. Eng. Assn.*, vol. 27.

² *Eng. Exp. Sta., Bull.* 79, p. 15.

³ *Ibid.*, p. 36.

⁴ *Proc. Am. Ry. Eng. Assn.*, vol. 20, p. 943; vol. 25, p. 666.

of the Joint Committee as to the span length to be taken is as follows:

“The span length for beams and slabs simply supported should be taken as the distance center to center of the supports, but need not be taken to exceed the clear span plus the depth of the beam or slab. For continuous or restrained beams built monolithically into the supports, the span length may be taken as the clear distance between the faces of the supports. Brackets

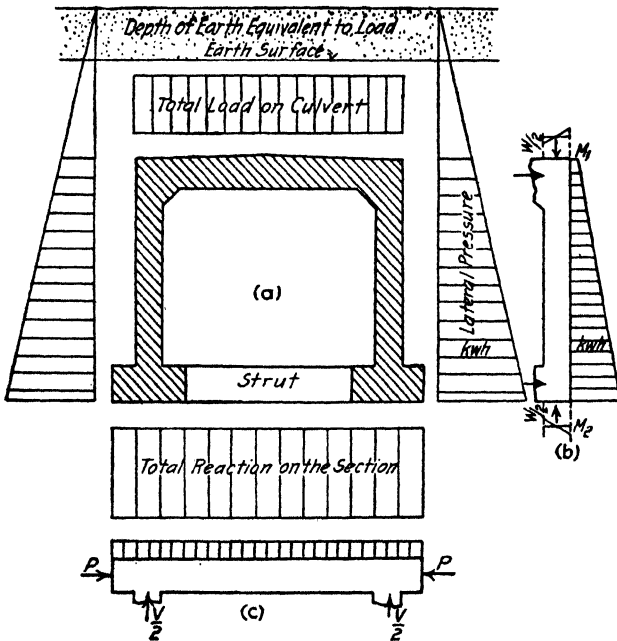

FIG. 166.—Forces acting on a rectangular culvert.

should not be considered as reducing the clear span in the sense here intended, except that when brackets which make an angle of 45° or more with the axis of a restrained beam are built monolithically with the beam, the span may be measured from the section where the combined depth of beam and bracket is at least one-third more than the depth of the beam.”

Tests made at the University of Kansas under the author's direction, indicate that where the restrained beam is built monolithically with the support, the center of pressure at the support is about 0.3 to 0.2 of the width of the support from the face of

the latter. In some cases, brackets served to bring the center of pressure to the face of the support or slightly beyond.

The side walls are designed as slabs resisting the lateral thrust of the earth and restrained at the top and bottom, and also supporting the weight of the top slab and its superimposed load of fill and live load. The unit lateral pressure is taken as $\frac{1 - \sin \phi}{1 + \sin \phi} wh$, or kwh , w being the weight of the fill per cubic foot and h the depth of the fill to the point considered. For small culverts at considerable depth the error would not be large if the pressure were considered as uniform over the sides and the center of pressure at half the height of the side wall. Figure 166 illustrates the forces acting on a culvert cross section and on the side wall as a separate member.

In reinforced concrete culverts, longitudinal reinforcement is provided to prevent unsightly cracks, such as might lead to deterioration of the concrete, due to temperature changes and to shrinkage. The amount of this steel may be somewhat less than the amount of ordinary temperature reinforcement owing to the protection afforded by the surrounding earth. About 0.15 per cent of the cross section of the concrete will suffice. This should be placed near the exposed face of the side walls.

Where the footings are joined by transverse struts built monolithically with the footing, such a strut sustains the reaction of the foundation in the proportion that its area bears to the total footing area. A footing strut then is subject to the forces shown at (c). The force P equals the earth pressure on the side wall over the area tributary to the strut, or in other words, the bottom reaction of the side wall for a width equal to the spacing of the struts. The frictional force, F , in the absence of struts will equal $W' f$, where W' is the weight on the side wall over a length equal to the spacing of the struts and f is the coefficient of friction between the masonry and the foundation. This represents the maximum value of F for obviously it could never be greater than P . In the event that the maximum possible value of F is equal to or greater than P , then a transverse strut is not actually required. A comparatively low value should be assigned to f because of the lubricating effect of water and infiltrated clay. See p. 234.

In detailing the plans for a culvert, it is desirable to show the following: (1) a longitudinal sectional elevation along the

center line of the culvert; (2) a complete plan of the culvert if unsymmetrical, or half plan if symmetrical; (3) a complete plan of footings if unsymmetrical, or half plan if symmetrical; (4) a half cross section at the center line of track, a half section at parapet, and such other sections as may be required to show the reinforcement; (5) an end view, or half end view, if symmetrical. Figure 175 shows the standard form of rectangular culvert of the C. M. & St. P. R. R.

The relation between the width and depth of a culvert opening is arbitrary. A square section has the maximum area for a given perimeter. However, to prevent the accumulation of water at the entrance, it is customary to make the span somewhat greater than the height. On the other hand, owing to the greater pressures on the top and bottom slabs, it would be economical of material to make the height greater than the width. For an opening giving a constant discharging capacity when flowing full and a minimum of masonry, the height should be approximately 1.18 times the width. In expressing the dimensions of a culvert, the span is usually given first, thus an 8 ft. by 6 ft. culvert means one with an 8 ft. span and a 6 ft. height inside dimensions.

The design of a highway culvert is similar to that of a railway culvert except that the details are lighter owing to the lighter loads to be carried. Fills over highway culverts are seldom comparable in depth to those over railways culverts, and frequently the fill is almost entirely lacking.

The wingwalls may be either at right angles to the culvert, form a straight continuation of the sidewalls, or they may flare at an angle with the sidewalls. The first or the last arrangement of wings will usually be found the most satisfactory, the choice depending chiefly upon the disposition of the side drainage. Where the span exceeds about 12 ft., it is customary to use a slab bridge rather than a monolithic culvert for a highway crossing.

Stresses in Pipes Due to External Loads.¹—External loads produce direct compressive stresses and bending moment in the pipe section. The external loads consist of the weight of the superimposed earth in the trench and the upward pressure from the bottom equal to it, the lateral pressures of the earth, and the weight of any loads which may be placed over the trench, such

¹ *Univ. of Illinois Eng. Exp. Sta., Bull. 22, p. 4.*

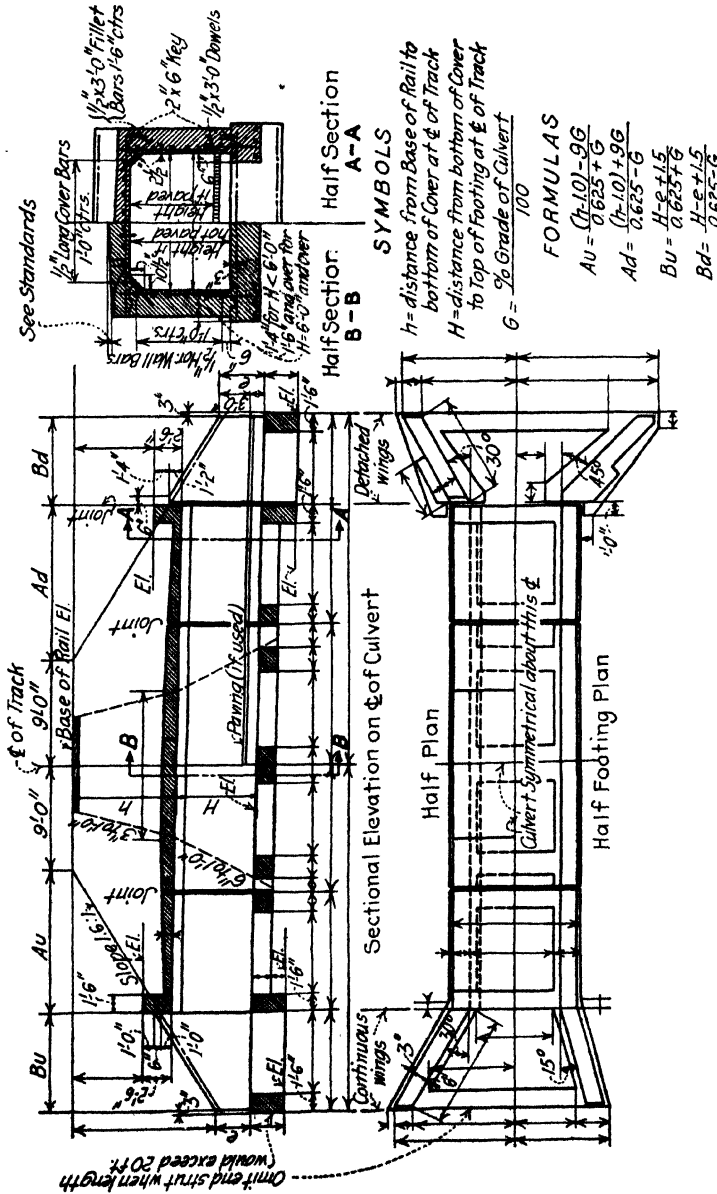

Fig. 167.—Layout of rectangular culvert, C. M. & St. P. Ry.

as loads on the street surface, buildings, loads passing over a railroad track, etc.

Let r = the radius of the pipe, and d the diameter

w = the load on a unit area

M_A = the moment at A

M_B = the moment at B

M = the moment at any point

ϕ = central angle for any segment of arc AC

θ = the angular change of the normal section due to the load

R = radius of curvature of the elastic curve.

Case I. Concentrated load. Figure 168 (a) shows a section of a pipe sustaining a concentrated load P , and (c) shows a seg-

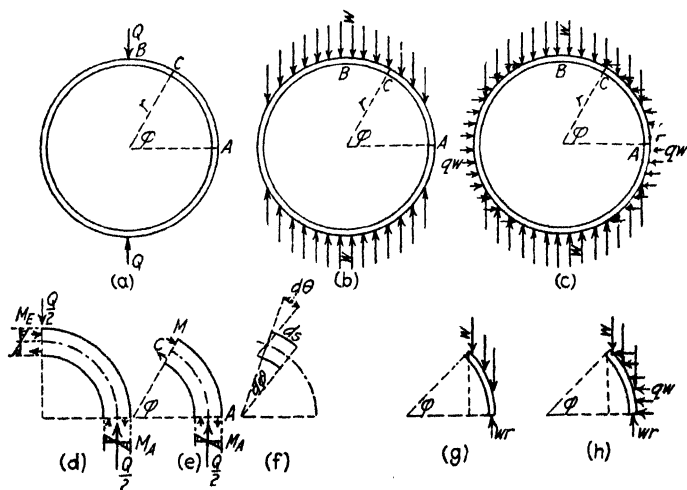

FIG. 168.—Stresses in a pipe conduit due to external loads.

ment somewhat enlarged. The moment at any point, C , may be found as follows:

$$M = \frac{1}{2} Qr (1 - \cos \phi) - M_A \quad (1)$$

From mechanics,

$$\frac{M}{EI} = \frac{1}{R} = \frac{d\theta}{ds}$$

Since $ds = rd\phi$,

$$\frac{M}{EI} = \frac{d\theta}{rd\phi} \text{ or } \frac{d\theta}{d\phi} = \frac{Mr}{EI} \quad (2)$$

The angle $d\theta$ is the resulting change in the direction of the normal due to the bending moment; r remains practically constant.

Then $\frac{d\theta}{d\varphi}$ represents the φ -rate of change of direction of the normal.

It is evident that

$$\int_0^\pi \frac{d\theta}{d\varphi} = 0 = \int_{M_A}^{M_B} \frac{M r}{EI} \text{ or } \int_{M_A}^{M_B} M r = 0 \tag{3}$$

or substituting,

$$\int_0^\pi \frac{Q r^2}{2} (1 - \cos \varphi) d\varphi - \int_0^\pi M_A r d\varphi = 0 \tag{4}$$

Whence,

$$\frac{Q r}{2} (\pi - 1) - M_A \frac{\pi}{2} = 0, \text{ or } M_A = .091 Q d \tag{5}$$

Substituting this value of M_A and making $\varphi = 90^\circ$

$$M_B = \frac{Q d}{4} - .091 Q d = .159 Q d \tag{6}$$

Case II. Distributed vertical load. In Fig. 168 (b), a section of a pipe is shown carrying a distributed load and at (g) a segment with a central angle ϕ . Following the reasoning of Case I, there results,

$$\int_0^\pi \frac{d\theta}{d\varphi} = \int_{M_A}^{M_B} M r = 0$$

Since $\frac{d\theta}{d\varphi}$ measures the rate of angular change of the normal to the elastic curve and the total change from A to B is zero, because the tangents at A and B do not change from their original positions, the integral of this quantity between the limits is 0.

The moment at any point, C , is

$$M = w r^2 (1 - \cos \varphi) - \frac{1}{2} w r^2 (1 - \cos \varphi)^2 - M_A \tag{8}$$

But the total change being zero, we have

$$\int_0^\pi M = 0$$

since E , I and r are constant.

$$\int_0^\pi w r^2 (1 - \cos \varphi) d\varphi - \int_0^\pi \frac{1}{2} w r^2 (1 - \cos \varphi)^2 d\varphi - \int_0^\pi M_A d\varphi = 0 \tag{9}$$

or

$$\int_0^{\frac{\pi}{2}} \frac{1}{2} wr^2(1 - \cos^2 \varphi) d\varphi - \int_0^{\frac{\pi}{2}} M_A d\varphi = 0$$

Whence, $M_A = \frac{1}{4} wr^2$ and since $M_A = -M_B$,

$$M_A = -M_B = \frac{1}{16} Wd$$

Case III. Distributed vertical load and a distributed horizontal load. Figure 168 (c) and (h).

By analogy the moment due to the lateral pressure is

$$M_B = -M_A = \frac{1}{4} qwr^2$$

Hence, the combined moment is

$$\frac{1}{4} wr^2 - \frac{1}{4} qwr^2 = \frac{1}{4} wr^2(1 - q) = \frac{1}{16} Wd(1 - q)$$

Stresses in Pipes Resulting from External Loads.—Owing to the fact that the ring sustains a direct compression at the sides, the effect of bending at these points is somewhat modified by increasing the compressive stress and decreasing the tensile. Consequently the bending will affect the ring most severely at the top. The stress at the top due to a concentrated load is

$$S_B = \frac{0.954Qd}{t^2} = \frac{Qd}{t^2}$$

practically, and at the sides $S_A = \frac{Q}{2t} \pm \frac{0.546Qd}{t^2}$

Due to vertical distributed loads only, $S_B = \frac{3}{8} \frac{Wd}{t^2}$

and at the sides $S_A = \frac{W}{2t} \pm \frac{3}{8} \frac{Wd}{t^2}$

Due to both vertical and horizontal loads

$$S_B = \frac{qW}{2t} \pm \frac{3}{8} \frac{Wd}{t^2} (1 - q)$$

and at the sides $S_A = \frac{W}{2t} \pm \frac{3}{8} \frac{Wd}{t^2} (1 - q)$

From the analysis of the preceding paragraphs, the bending moment and stresses at any intermediate point can be determined.

Small Box Culverts and Conduits.—A section of a rigid box culvert has essentially the same properties as a curved beam. That is, the sum of the displacements on the left side equals the sum of those on the right. See p. 161.

Let M_c = the moment at the section at the middle of the top.

H_c = the thrust at the section at the middle of the top.

V_c = the shear at the section at the middle of the top.

M'_l and M'_r = the moments due to loads on the left and right respectively.

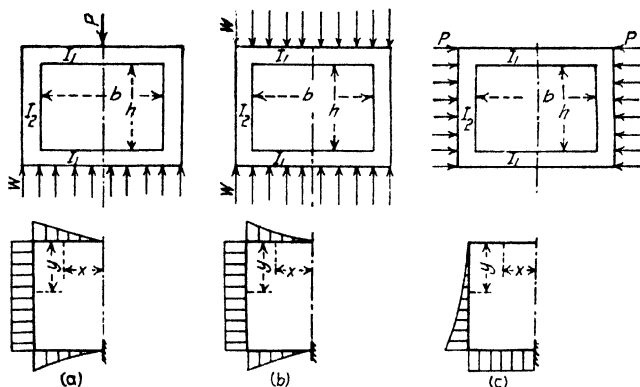

FIG. 169.—Moments of loads on a half section of box culvert.

x and y = the co-ordinates of the section referred to the origin at the middle of the top.

The y -displacement,
$$\Delta y = \int \frac{M_l x ds}{EI} = \int \frac{M_r x ds}{EI} \tag{1}$$

The x -displacement,
$$\Delta x = \int \frac{M_l y ds}{EI} = - \int \frac{M_r y ds}{EI} \tag{2}$$

The angular displacement $\Delta \varphi = \int \frac{M_l ds}{EI} = - \int \frac{M_r ds}{EI} \tag{3}$

For the left side, $M_l = M'_l + M_c + H_c y - V_c x \tag{4}$

For the right side, $M_r = M'_r + M_c + H_c y + V_c x \tag{5}$

Substituting in the above equations and reducing¹,

$$H_c = \frac{\int_0^s ds \int_0^s \frac{M'_l y ds}{I} - \int_0^s y ds \int_0^s \frac{M'_r ds}{I}}{2 \left[\left(\int_0^s \frac{y ds}{I} \right)^2 - \int_0^s \frac{ds}{I} \int_0^s \frac{y^2 ds}{I} \right]} \tag{6}$$

¹ JOHNSON, BRYAN and TURNEAURE, "Stresses in Framed Structures," Vol. 2, p. 386. HOOL and JOHNSON, "Concrete Engineers' Handbook," p. 787.

$$V_c = \frac{\int \frac{M' x ds}{I} - \int \frac{M' x ds}{I}}{2 \int \frac{x^2 ds}{I}} \quad (7)$$

$$M_c = - \frac{\int \frac{M' ds}{I} + 2H_c \int \frac{y ds}{I}}{2 \int \frac{ds}{I}} \quad (8)$$

The symbol \int_1 indicates the summation is for the half of the frame only. The half frame is considered as fixed at the middle of the bottom.

Case I. Load P at the center. See Fig. 169 (a).

$$\text{For the top, } M' = -\frac{P}{2} x;$$

$$\text{for the side, } M' = -\frac{Pb}{4};$$

$$\text{for the bottom, } M' = -\frac{w}{2} (b-x)^2 - \frac{P}{2} x.$$

$$\begin{aligned} \text{Whence } \int \frac{M' y ds}{I} &= \frac{2}{I_1} \int_0^b \left[-\frac{w}{2} (b-x)^2 - \frac{P}{2} x \right] h dx + \frac{2}{I_2} \int_0^h -\frac{Pb}{4} y dy \\ &= -\frac{Pbh^2}{6I_1} - \frac{Pbh^2}{4I_2}. \end{aligned}$$

$$\begin{aligned} \int \frac{M' ds}{I} &= \frac{2}{I_1} \int_0^b \left[-\frac{w}{2} (b-x)^2 - \frac{P}{2} x \right] dx + \frac{2}{I_2} \int_0^h -\frac{Pb}{4} dy \\ &\quad + \frac{2}{I_1} \int_0^b \left(-\frac{P}{2} x \right) dx \\ &= -\frac{7}{24} \frac{Pb^2}{I_1} - \frac{Pbh}{2I_2} \end{aligned}$$

$$\int \frac{y ds}{I} = \frac{1}{I_1} \int_0^b h dx + \frac{1}{I_2} \int_0^h y dy = \left(\frac{b}{I_1} + \frac{h}{I_2} \right) \frac{h}{2}$$

$$\int \frac{y^2 ds}{I} = \frac{1}{I_1} \int_0^b h^2 dx + \frac{1}{I_2} \int_0^h y^2 dy = \frac{h^2}{6} \left(\frac{3b}{I_1} + \frac{2h}{I_2} \right)$$

Substituting these values in (6)

$$H_c = \frac{\left(\frac{b}{I_1} + \frac{h}{I_2}\right)\left(-\frac{Phb^2}{6I_1} - \frac{Pbh^2}{4I_2}\right) - \frac{h}{2}\left(\frac{b}{I_1} + \frac{h}{I_2}\right)\left(-\frac{7Pb^2}{24I_1} - \frac{Pbh}{2I_2}\right)}{2\left[\frac{h^2}{4}\left(\frac{b}{I_1} + \frac{h}{I_2}\right)^2 - \left(\frac{b}{I_1} + \frac{h}{I_2}\right) \cdot \frac{h^2}{6}\left(\frac{3b}{I_1} + \frac{2h}{I_2}\right)\right]}$$

$$= \frac{\frac{Pb^2}{48I_1}}{\frac{bh}{2I_1} + \frac{h^2}{6I_2}} = \frac{1}{8} P \frac{R^2}{S + 3R} \text{ in which } R = \frac{b}{h} \text{ and } S = \frac{I_1}{I_2}$$

$$M_c = -\frac{-\frac{7Pb^2}{24SI_2} - \frac{Pbh}{2I_2} + \frac{1}{4} \frac{PR^2}{S + 3R} \cdot \frac{h}{2}\left(\frac{b}{SI_2} + \frac{h}{I_2}\right)}{2\left[\frac{b}{SI_2} + \frac{h}{I_2}\right]}$$

$$\frac{Pb}{24} \frac{6S^2 + 20RS + 9R^2}{(S + R)(S + 3R)}$$

Case II. Uniform load w on top and bottom. See Fig. 169

(b). For the top, $M' = -\frac{wx^2}{2}$; for the side, $M' = -\frac{wb^2}{8}$; for

the bottom, $M' = -\frac{w}{2}\left(\frac{b}{2} - x\right)^2 + \frac{wb^2}{8} - \frac{wbx}{2}$.

$$\int \frac{M'y ds}{I} = \frac{2}{I_1} \int_0^b \left[-\frac{w}{2}\left(\frac{b}{2} - x\right)^2 + \frac{wb^2}{8} - \frac{wbx}{2} \right] h dx + \frac{2}{I_2} \int_0^h -\frac{wb^2}{8} y dy$$

$$= -\frac{wb^3h}{24I_1} - \frac{wb^2h^2}{8I_2}$$

$$\int \frac{M'ds}{I} = \frac{2}{I_1} \int_0^b \left[-\frac{w}{2}\left(\frac{b}{2} - x\right)^2 + \frac{wb}{2}\left(\frac{b}{4} - x\right) \right] dx + \frac{2}{I_2} \int_0^h -\frac{wb^2}{8} dy + \frac{2}{I_1} \int_0^b -\frac{wx^2}{2} dx$$

$$= -\frac{wb^3}{12I_1} - \frac{wb^2h}{4I_2}$$

$$H_c = \frac{\left(\frac{b}{I_1} + \frac{h}{I_2}\right)\left(-\frac{wb^3h}{24I_1} - \frac{wb^2h^2}{8I_2}\right) - \frac{h}{2}\left(\frac{b}{I_1} + \frac{h}{I_2}\right)\left(-\frac{wb^3}{12I_1} - \frac{wb^2h}{4I_2}\right)}{2\left[\frac{h^2}{4}\left(\frac{b}{I_1} + \frac{h}{I_2}\right)^2 - \left(\frac{b}{I_1} + \frac{h}{I_2}\right) \cdot \frac{h^2}{6}\left(\frac{3b}{I_1} + \frac{2h}{I_2}\right)\right]}$$

¹ HOOL and JOHNSON, "Concrete Engineers' Handbook," p. 788.

= 0, as may have been anticipated.

$$M_c = \frac{-wb^3}{12I_1} - \frac{wb^2h}{4I_2} = \frac{wb^2}{24} \frac{R + 3S}{R + S}$$

Case III. Loads on the sides. For the top, $M' = 0$; for the side, $M' = -\frac{Py^2}{2}$; for the bottom, $M' = -\frac{Ph^2}{2}$.

Proceeding as before, $H_c = \frac{Ph}{2}$, and $M_c = -\frac{Ph^2}{12} \frac{S}{R + S}$.

Having calculated the moment and thrust at the middle of the top for the conditions given, the moment and thrust at any other point may be calculated by Eq. (4). For conditions involving all three cases, the moment or thrust due to a combined concentrated load, distributed load and side pressure may be readily obtained by adding *algebraically* the corresponding functions for the separate cases.

The passive pressures at the sides doubtless exert some tendency to restrain the top slab, hence, the moments calculated as above are probably somewhat greater than the moments actually existing.

Large Culverts and Conduits of Curved Section.—In large conduits of curved cross section with a comparatively thin arch and a heavy invert resting on solid rock, the stresses may be calculated by the principles already explained for the elastic arch, the arch being considered as fixed at its junction with the invert. This method would apply only of course, where there is not a construction joint at this section but a rigid monolithic junction. The loads being symmetrical, the formulas become

$$H_c = \frac{n_s \Sigma my}{(\Sigma y)^2} - \frac{\Sigma m \Sigma y}{n_s \Sigma y^2}$$

$$V_c = 0$$

$$M_c = -\frac{\Sigma m_i + H_c \Sigma y}{n_s}$$

$$M = M_c + m + H_c \cdot y.$$

The procedure is identical with that explained in Chap. V, hence, a further discussion is unnecessary in this connection. Figure 171 illustrates a sewer constructed in the manner here contemplated.

Where a conduit has a comparatively light invert and is con-

structed on yielding soil, the procedure previously explained for curved beams and arches is readily adapted to the determination of the stresses. The procedure is similar to that used in the elastic arch mentioned above, except that the summations must be made from the crown to the middle of the invert, for the summation must be for the entire section, and because of symmetry, the half section suffices. The procedure can best be explained by an example.

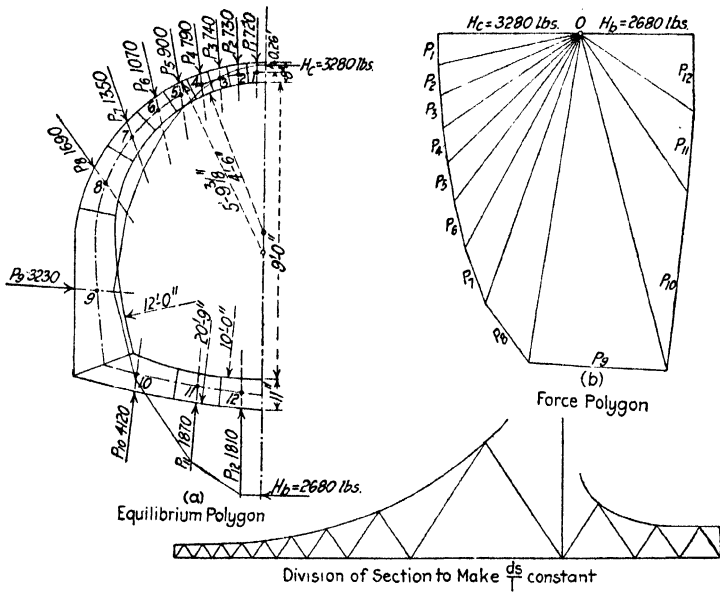

FIG. 170.—Analysis of stresses in a large conduit of curved section.

Take the conduit shown in Fig. 170, sustaining an equivalent depth of earth of 12 ft., including the equated superimposed load. The angle of repose is taken as 30°; the horizontal unit pressure is taken as $\frac{1 - \sin \phi}{1 + \sin \phi} wh$, or $wh/3$. Earth is assumed to weigh 100 lbs. per cubic foot.

The conduit section is divided into 12 segments so that ds/I is constant as was done for the elastic arch. The resultant loads on the extrados of the section are shown. The quantities for determining H_c and M_c are given in Table XXVI. The pro-

cedure is the same as for the fixed arch, care being exercised to preserve the proper signs in the calculations. For example, $m_{11} = -720(2.00 - 0.29) - 730(2.00 - 0.87) - 740(2.00 - 1.42) - 770(2.00 - 1.96) - 890(2.00 - 2.60) - 1,060(2.00 - 3.29) - 1,260(2.00 - 4.04) - 1360(2.00 - 4.85) - 230(2.00 - 5.06) - (-4,090)(2.00 - 3.80) - 50 \times 9.46 - 60 \times 9.33 - 100 \times 9.11 - 150 \times 8.72 - 260 \times 8.34 - 460 \times 7.54 - 1,000 \times 6.14 - 3,210 \times 2.92 - 450 \times 0.37 = -25,430$ lb.-ft.

After calculating the crown thrust, H_c , and its eccentricity, e , H_c is drawn a distance, e , up from the center of the crown, since e is positive, and the equilibrium polygon drawn in the usual manner by laying off the load line of the force polygon, measuring the pole distance equal to H_c , drawing the rays of the force polygon, and finally drawing the lines of the equilibrium polygon parallel to their corresponding rays.

The moment at any point can be computed either by the equation $M = M_c + H_c \cdot y + m$, or by scaling the ordinate to the equilibrium polygon and multiplying it by the component of the thrust at that point that is perpendicular to the section. The stresses at any point can be computed in the usual manner from the moment and thrust at that point. The stresses in this case are such that steel reinforcement would have to be employed.

TABLE XXVI.—ANALYSIS OF CONDUIT SECTION

Point	y	y^2	x	Loads		m	$m \cdot y$
				V. comp.	H. comp.		
1	0.00	0.000	0.29	720	0	0	0
2	0.08	0.006	0.87	730	50	-420	-40
3	0.21	0.044	1.42	740	60	-1,220	-260
4	0.43	0.185	1.96	770	100	-2,430	-1,050
5	0.72	0.518	2.60	890	150	-4,390	-3,160
6	1.20	1.440	3.29	1,060	260	-7,200	-8,640
7	2.00	4.000	4.04	1,260	460	-11,340	-22,680
8	3.40	11.560	4.85	1,360	1,000	-17,890	-60,840
9	6.62	43.820	5.06	230	3,210	-27,180	-189,780
10	9.17	84.090	3.80	-4,090	450	-30,340	-278,220
11	9.54	91.010	2.00	-1,860	150	-25,430	-242,600
12	9.71	94.280	0.64	-1,810	80	-28,980	-232,650
Σ	43.08	330.953	0000	5,960	-151,780	-1,039,920

$$H_c = \frac{12(-1,039,920) - (-151,780)(43.08)}{1856 - 12 \times 330.95} = 3280 \text{ lbs.}$$

$$M_c = -\frac{-1,51780 + 3,280 \times 43.08}{12} = +870 \text{ lb. ft.}$$

$$e = \frac{870}{3,280} = +0.26 \text{ ft.}$$

Examples of Culvert and Conduit Sections.—Figure 171 shows a cross section of a large intercepting sewer built in Chicago in 1915 to serve the Calumet district.¹ The section was built monolithically and was reinforced with steel rods through soft swampy ground, but not reinforced in firm soil.

In the design of a reinforced concrete culvert or conduit, an assumed percentage of reinforcement must be used in calcula-

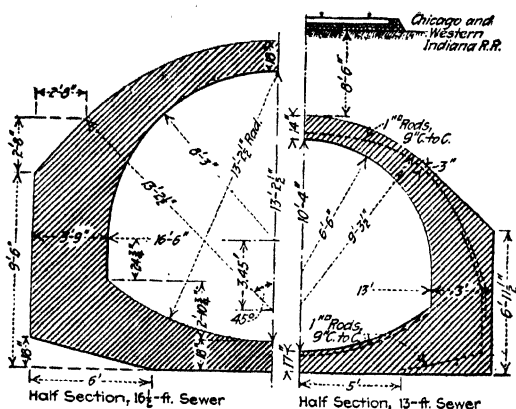

FIG. 171.—Details of section of a large concrete sewer.

tions of the stresses by the method explained above. A comparison with existing designs for similar conditions may be the best guide as to the proper amount to assume, but it will usually be between 0.5 and 1.2 per cent, the former for a well shaped section in firm ground and the latter for conduits in swampy earth.

A certain amount of longitudinal reinforcement is desirable in reinforced concrete sewers to prevent cracks due to temperature changes and shrinkage of the concrete. This will usually require 0.2 to 0.3 per cent of steel. In plain concrete conduits, it is advisable to provide contraction joints about every 32 ft. in order to localize the contraction cracks in one and then provide against leakage at that joint by the use of a joint filler of mastic.

Figure 172 shows a cross section of a 10 ft. by 6 ft. rectangular culvert of the C. M. & St. P. R. R. for fills 10 to 13 ft. and fills 24 to 40 ft. over the footing. This section was not designed

¹ *Engineering News*, Dec. 23, 1915.

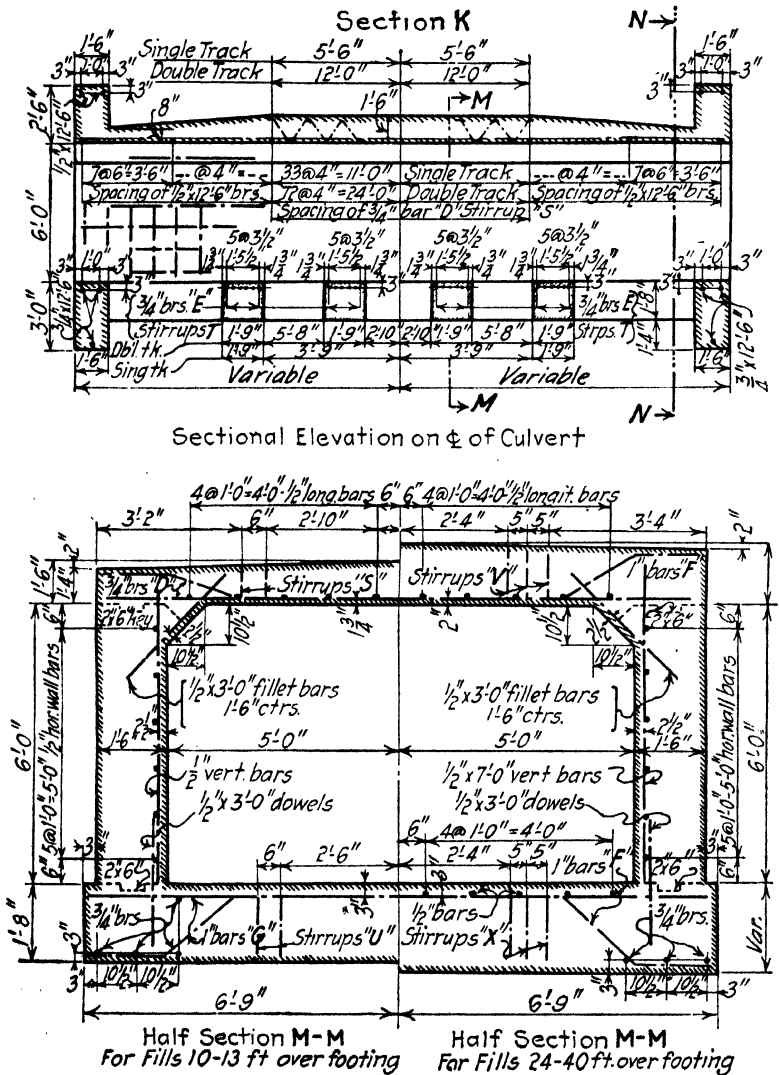

FIG. 172.—Details of a standard rectangular culvert of C. M. & St. P. Ry.

as a monolithic frame, but rather the top, bottom and sides were considered as simple slabs.

A section through the standard 8-ft. arch culvert of the C. M. & St. P. R. R. is given in Fig. 173. This section was designed as a fixed arch between the supports on the footing. The struts in the bottom were designed essentially as simple beams with the load acting upward.

Figure 174 is the standard 6 ft. by 6 ft. culvert of the Iowa Highway Commission and represents good highway practice.

CHAPTER XI

BINS AND CHIMNEYS

Introduction.—The purpose of the present chapter is to offer a brief study of the conditions and elements which affect the design of bins and related structures as types rather than to describe the details of design and construction or the accessory facilities required in handling grain, or other material that may be stored in them. The principles involved have a wider and more general application than in the design of the particular structures considered, hence, the treatment takes on the nature of a study of principles underlying the design of structures of a group rather than the design of any one particular class.

Various materials have been employed in the construction of grain bins, such as timber, steel, brick, special blocks and staves, and monolithic concrete. Owing to the adaptability to withstand the stresses occurring in the structure, protection against fire hazard, the entrance of vermin, and dampness, some form of masonry construction is most commonly used in modern practice. Since 1900, reinforced concrete is the most generally used material, although special blocks banded with steel are being employed to a considerable extent.

Nature of Materials Stored in Bins.—The materials stored in bins are parti-fluid in their behavior in that they will flow, although sluggishly, due to friction between particles, and in that a vertical pressure applied to the top surface causes a horizontal pressure to be exerted against the sides of the containing structure. These materials may be classified as (1) pulverulent, (2) granular, (3) fragmental, and (4) plastic. For a perfect fluid, the ratio of the lateral to the vertical pressure at any point due to the weight of the material or to a superimposed load is unity, while for the materials under consideration this ratio is less than unity, the exact value depending on the materials.

Experimental studies by the author on the behavior of these parti-fluid materials using portland cement, sand and wheat, crushed rock and clay as types indicate some of their properties.

Pulverulent materials except when very dry tend to cake and cohere. When being drawn from a bin, they frequently stand with a nearly vertical face for a time and then sweep down with a force as much as two times the static pressure of an equal head. They transmit a horizontal pressure which is a proper fraction of the vertical pressure at any point. Vertical pressures are transmitted almost directly downward and there is no upward component of pressure at any point. Cement, gypsum, powdered coal, and flour are typical pulverulent materials. Pulverulent materials will cake into a solid under pressure. For example, dry portland cement will cake into a solid when subjected to 85 to 100 lb. per square inch pressure.

Granular materials, such as sand, fine gravel, wheat, shelled corn, rye and other similar grains, ashes and fine cinders, have been studied extensively. Their fluid behavior is similar to that of the preceding class; a vertical pressure causes a horizontal pressure that is a fraction of the vertical intensity; vertical pressures spread pyramidally through a mass of the material; and there is no upward component of pressure at a point. Dry granular materials do not cake under pressure.

Fragmental materials include crushed rock, ore, coal, coke, slag, coarse gravel, and coarse cinders. They differ chiefly in their behavior in that the larger fragments interlock, being in contact at two or more points some distance apart. The spread of pressure from a vertical load is at a somewhat wider angle than for granular materials, and the ratio of lateral to vertical pressure at any point is less than for the foregoing groups.

Plastic materials frequently placed in bins are clay, tar, asphalt, cotton and flax seed, ensilage, and sawdust. Such materials more nearly resemble fluids in behavior than the preceding classes. The ratio of lateral to vertical pressure is usually greater and internal friction less than in the preceding group. The sluggishness of flow is due more to cohesion and less to friction. Plastic materials contrary to the behavior of the preceding groups transmit an upward component of pressure

at any point. Plastic materials are virtually pulverulent materials mixed with some liquid, e.g., earth dust with water. Plastic materials will cake or form a solid under high pressure when the lubricating fluid is squeezed out.

Many experiments have been made on the behavior of granular materials, especially grain, sand and cement, in bins, and a few observations on fragmental and plastic materials, although the latter are comparatively meagre. For an excellent resume of these experimental investigations, the reader is referred to the authoritative work, "The Design of Walls, Bins and Grain Elevators" by Milo S. Ketchum.

The essential characteristics of granular and fragmental materials are the friction and interlocking between the particles, by virtue of which the material may be heaped or piled up at a certain "angle of repose" whereas perfect fluids spread out in a thin sheet, and the inequality of lateral and vertical pressures at any point in the body of the material.

Forces Acting on a Bin.—The forces acting on a bin include the weight of the structure itself, the weight of the material contained, carried partly by the bottom and partly through friction by the sides, the force exerted by the material while in motion either while discharging or in a slide, the pressure of the wind and the reaction of the foundation.

On a cylindrical surface, the pressure of the wind is two-thirds that on a flat surface equal to the projected surface, hence, where 30 lb. per square foot is the value assigned to a flat surface (the usual value), only 20 lb. per square foot of projected area should be used for a cylindrical surface. Observations indicate that the pressure due to wind does not greatly exceed this value for velocities of 100 miles per hour or less.

Granular and fragmental materials do not exert a pressure upward nor will they flow upward from a horizontal orifice, even though that orifice be under a considerable head. This property is, of course, distinctively different from the corresponding behavior of fluids.

Because of the friction and the interlocking action of the particles of granular and fragmental materials and the friction on

the sides of the bin, the weight of materials in deep bins is largely borne by the sides of the bin directly and does not come upon the bottom. This weight is supported by the sides as actually as if a portion of the contents were in a box and placed on top of the structure. When the depth of the bin is about $2\frac{1}{2}$ times the

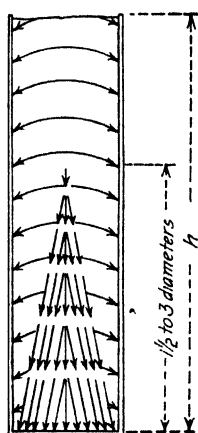

FIG. 175.—Distribution of pressure in a deep bin.

diameter or greater, the material wedges or arches against the sides so that the weight of the contents above that depth is carried almost entirely on the sides. This condition is illustrated diagrammatically in Fig. 175, the lengths of the arrows roughly indicating the portion of the weight carried to the bottom and to the sides respectively. After the depth of about $2\frac{1}{2}$ diameters (this height depending upon the character of the material and the nature of the bin wall), the addition of grain or weight on the grain does not increase either the vertical or the horizontal pressure at the bottom of the bin. For crushed rock, experiments by the author indicate that this arching effect occurs at about $1\frac{1}{2}$ to 2 times the lateral dimension.

Action of Materials in Shallow Bins.—The term shallow bin, as used in the present discussion, refers to a bin having a depth somewhat less than the width so that the plane of rupture cuts the free surface of the filling inside the bin wall inclosure. While many refinements are sometimes made in calculations, it is believed that the following simplified theory will yield results that are reasonable and conservative.

In the ordinary shallow bins, the procedure in calculating the forces to which the sides are subjected is similar to that followed in computing the pressure on a retaining wall. Where the side walls are inclined, either wholly or in part, the forces acting on the inclined portion may be considered as the resultant of the horizontal pressures on its vertical projection and the vertical load on its horizontal projection, as shown in Fig. 176. The horizontal unit pressure on a given surface may be obtained from the equation for conjugate pressure, $p = \frac{1 - \sin \phi}{1 + \sin \phi} \cdot wh$, in which w is the weight of the material in lbs. per cu. ft. and ϕ is

the angle of internal friction, or the angle of repose. Table XXVII gives values of w and ϕ for various materials.

The load supported by the bottom of the bin is the weight of the material directly above the portion of the bottom considered and equals the load on its projected area.

Where the material in the bin has a surcharge, either positive or negative, the procedure is similar to that for the corresponding cases of a retaining wall. This condition frequently arises from the prevailing methods of depositing materials in bins.

Pressures in Deep Bins.—The term *deep bins* as used in this connection refers to bins having a depth equal to or greater than the diameter. The following theoretical analysis of pressures due to granular materials in deep bins, deduced by H. A. Janssen,¹ gives a general formula for the pressures, the essential validity

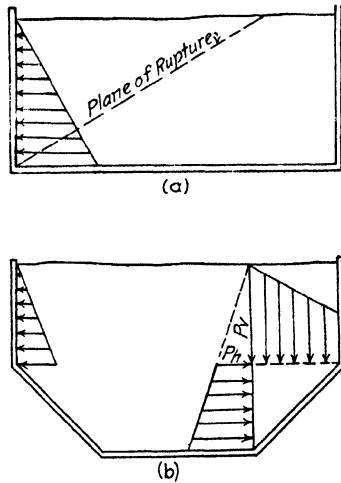

FIG. 176.—Distribution of pressures in a shallow bin.

TABLE XXVII.—ANGLE OF REPOSE AND WEIGHT OF VARIOUS MATERIALS

Material	ϕ in degrees	Weight, lbs. per cu. ft.
Bituminous coal.....	35	47-55
Coal slack.....	37	52-53
Anthracite.....	27	52
Coke.....	45	25-32
Sand.....	24	90-100
Ashes.....	40	30-40
Cinders.....	45	45
Gravel.....	37	100-110
Crushed rock.....	37	90-100
Iron ore.....	40	150-200
Cement.....	38	96-105

¹ MILO S. KETCHUM, "The Design of Walls, Bins and Grain Elevators," p. 307; *Z. Ver. deut. Ing.*, p. 1045, 1895.

of which has been attested to by the results of numerous experiments:

Let f and f' = the coefficient of friction between the particles or grains, and between the grain and bin wall respectively

w = the weight per cubic foot of the material

V = the vertical pressure at any point

L = the lateral pressure at any point

$k = L/V$

A = area of the horizontal cross section of the bin

U = the perimeter of the bin inside

$R = A/U$

Y = distance from top surface of the contents to the point considered.

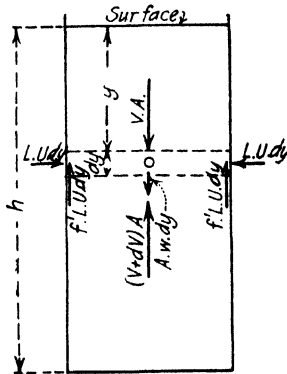

FIG. 177.—Analysis of pressure in a deep bin.

In Fig. 177, the differential volume of grain of thickness dy (may be arched instead of flat) is held in equilibrium under the forces acting upon it. That is

$$VA - (V + dV)A + Aw dy - f' \cdot LU \cdot dy = 0$$

whence $dV = \left(w - f' \frac{LU}{A} \right) dy = \left(w - f' \frac{kV}{R} \right) dy$, or

$$\frac{dV}{w - f' \cdot kV/R} = dy$$

Integrating, $\log (w - f' \cdot kV/R) = - \frac{f'k}{R} y + C$.

When $y=0$, $V = 0$, and hence $C = \log w$.

$$\log \left(\frac{w - f' \cdot k V / R}{w} \right) = - \frac{f' k}{R} y$$

or,
$$\frac{w - \frac{f' \cdot k V}{R}}{w} = \epsilon^{-\frac{f' k}{R} y}$$

Solving for V ,
$$V = \frac{Rw}{f' k} \left(1 - \epsilon^{-\frac{f' k}{R} y} \right)$$

and
$$L = k \cdot V = \frac{Rw}{f'} \left(1 - \epsilon^{-\frac{f' k y}{R}} \right).$$

$\epsilon = 2.71828$ and $\log_{10} \epsilon = 0.434294$.

Experiments show k to be about 0.40 to 0.60 for wheat, rye or flax, and f' for these grains to be about 0.40 to 0.43 making $f' \cdot k$ equal to 0.20 to 0.25 as an average figure. Table XXVIII gives the values of the coefficient of friction found by Wilfred Airy. Figure 178 gives values of the lateral pressure for wheat according to the above equation for various diameters of bins.

TABLE XXVIII.—COEFFICIENTS OF FRICTION OF VARIOUS GRAINS

Kind	Weight of cubic foot loosely filled into measure	Coefficient of friction				
		Grain on grain	Grain on rough board	Grain on smooth board	Grain on iron	Grain on cement
	<i>Pounds</i>					
Wheat.....	49	0.466	0.412	0.361	0.414	0.444
Barley.....	39	.507	.424	.325	.376	.452
Oats.....	28	.532	.450	.369	.412	.466
Corn.....	44	.521	.344	.308	.374	.423
Beans.....	46	.616	.435	.322	.366	.442
Peas.....	50	.472	.287	.268	.263	.296
Tares.....	49	.554	.424	.359	.364	.394
Flaxseed.....	41	.456	.407	.308	.339	.414

Example: What will be the pressure and the stresses at the bottom in the Canadian Pacific R. R. elevator listed on p. 385?

$R = (\pi \times 15^2) \div 2\pi \times 15 = 7.5$. w for wheat is 48 lbs. Assume $f' = 0.4$ and $k = 0.5$

$$V = \frac{7.5 \times 48}{0.5 \times 0.4} \left(1 - \epsilon^{-\frac{0.20 \times 90}{7.5}} \right)$$

$$= 1,800 \left(1 - \frac{1}{e^{2.4}} \right) = 1,640 \text{ lbs. per square foot.}$$

The total load carried on the bottom is $1,640 \times 3.14 \times 15^2 = 1,160,000$ lbs. The total weight of the grain in the bin is $48 \times 90 \times 15^2 \times 3.14 = 3,060,000$ lbs. The weight carried on the walls is $3,060,000 - 1,160,000 = 1,900,000$ lbs.

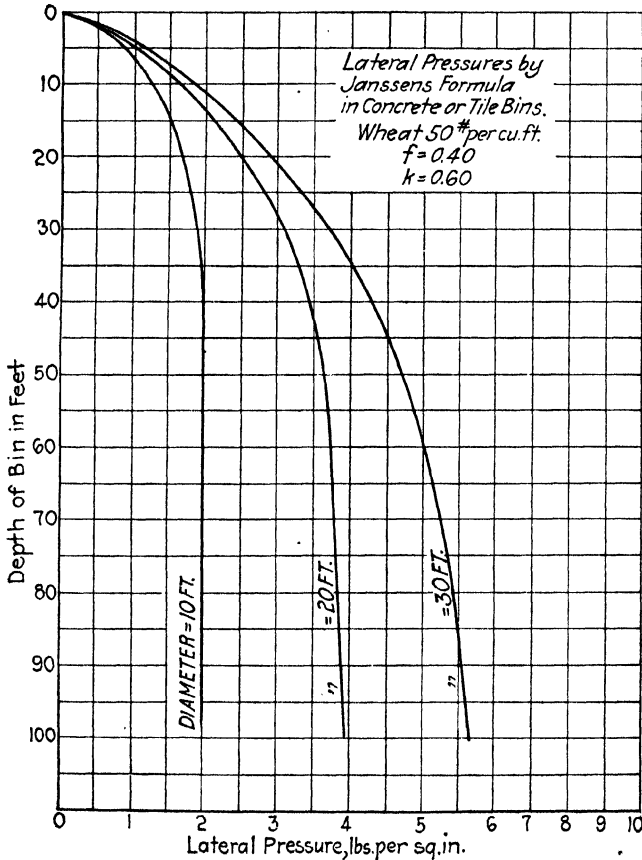

FIG. 178.—Chart of lateral pressures of wheat in bins.

The thickness of the wall is 9 in. and the compression area is $369 \times 3.14 \times 9 = 10,440$ sq. in. The compression stress is therefore $1,900,000 \div 10,440 = 182$ lbs. per square inch.

$L = 0.50V$ or 820 lbs. per square foot.

If the section had been unreinforced, the tension in the concrete would be $820 \times 30 \div 2 \times 9 \times 12 = 115$ lbs. per square inch. The reinforcement actually used consisted of two 2 in. by $\frac{1}{4}$ in. bars, or 1.0 sq. in.

per foot of height. The stress in the steel is therefore, assuming the steel to take the entire stress, $820 \times 30 \div 2 = 12,300$ lbs. per square inch.

Experimental Investigation of Pressures.—Experiments have been conducted by numerous observers to determine the behavior of grain in bins, both for full size and for model size bins, the pressures being measured by placing a pressure gage of some sort in the sides and bottom. Figure 179 shows the results of experiments by Eckhardt Lufft¹ on a commercial size bin 23 ft. 10 in. in diameter and 55 ft. high, the diagram giving the observed lateral pressures. Tests by Milo S. Ketchum, H. T. Bovey, J. Pleissner, Max Tolz and by the author have given similar results. The following conclusions summarize the behavior of grain in bins:

1. The lateral pressure is less than the vertical pressure at any point, the ratio between the two depending on the grain and on the depth.

2. After a depth of about $2\frac{1}{2}$ or 3 diameters is reached, the pressures increase very little with additional depth due to the arching, doming or wedging action of the grain against the sides of the bin.

3. The pressures from moving grain are slightly greater than for grain at rest, about 5 to 10 per cent greater according to Jamieson's and Bovey's experiments, but greater than this according to the experiments of others.

4. Pressures are greater while a bin is being filled than while the grain is at rest.

5. Pressures on the side opposite a side discharge gate are increased due to the eccentricity of the discharge. Some observers state that eccentricity of discharge may increase the pressure opposite the gate to three or four times the static pressure. Experiments by the author gave somewhat less increase than this, but certain failures apparently due to this factor indicate a considerable increase due to eccentric discharge.

Cotton seed behaves more as a plastic material than as a granular one. Inasmuch as cotton seed is commonly stored in shallow bins, the pressures vary with the depth. Figure 180

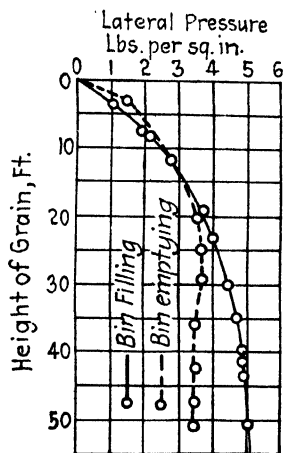

FIG. 179.—Observed lateral pressures of wheat in a bin.

¹ *Engineering News*, vol. 52, p. 531.

gives the results of tests¹ to determine the horizontal pressure in a cotton seed bin. Weight of the seed loose was 22.4 lbs. per cubic foot, packed, 33.6 lbs. per cubic foot. Angle of repose was $38^{\circ} 40'$. These tests were made in a full size bin so that wall friction did not affect the results.

Stresses in Clustered Bins.—Thus far, the discussion of stresses in bins has been with reference to bins built in single units, but it is customary to construct the bins of a large grain storage plant in clusters. In such clusters, where the individual

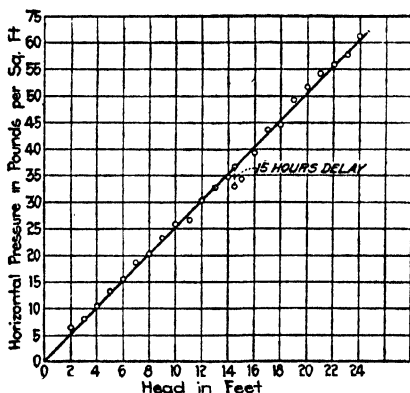

FIG. 180.—Observed lateral pressure of cotton seed in a bin.

bins are circular in plan, it is customary to use not only the annular space inside the bins, but the irregular interspaces are used for storage as well. This latter situation introduces stresses of quite a different character from those induced by grain inside the bins. That is, the lateral pressure on the outside of the circular bin in the interspace will cause a moment in the annulus of the circular bin if the latter is empty so that no counterpressure exists. The most severe condition would occur when one interspace bin is filled and the surrounding bins are empty.

Bins are usually built tangent to each other but are sometimes spread in order more nearly to equalize the capacities of the main and interspace bins and also the pressures exerted. In calculating the pressures by Janssen's equation, the value of the mean depth, A/U , must be calculated. See Fig. 181. Where the bins are of the same size, the area of the square is D^2 , D being the diameter of the bin; the area of the four quadrants is

¹ *Engineering News*, Nov. 18, 1915.

$3.14D^2/4$; hence the area of the interspace is $0.215D^2$. The length of the perimeter to the point of tangency is $3.14D$, and to the point of practical juncture, is about $2.44D$; hence, $A/U = 0.215D^2/2.44D$ or $0.088D$. For the space at the side between the bins and the tangent side wall, the area of the rectangle is $D^2/2$ and of the quadrants, $3.14D^2/8$. Subtracting, the area of the interspace is $0.107D^2$. The actual perimeter is $1.57D + D =$

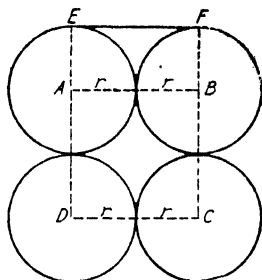

FIG. 181.

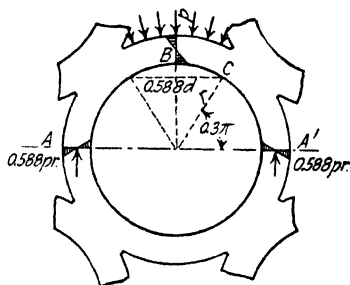

FIG. 182.

FIG. 181.—Area of an interspace bin.

FIG. 182.—Moments due to grain in an interspace bin.

$2.57D$. The practical perimeter is about $2.00D$, making A/U equal to $0.050D$.

In the Canadian Pacific elevator mentioned above, R would be $0.088D = 0.088 \times 30 = 2.64$ ft.

$$V = \frac{2.64 \times 48}{0.4 \times 0.5} \left(1 - e^{-\frac{0.20 \times 90}{2.64}} \right) = 634 \left(1 - \frac{1}{e^{6.8}} \right) = 630 \text{ lbs.}$$

$$L = kV = 0.5 \times 630 = 315 \text{ lbs. per sq. ft.}$$

The actual distribution of pressure over the arc is uncertain, Fig. 182, but it is probably not far wrong to assume the pressure equally distributed over a fifth of the circumference. With this assumption, the moments in the ring are found as follows:

When the bins are merely tangent to each other with a light plain concrete filler or a pedestal at the junction and are not rigidly attached, the moments may be found as in the case of a thin pipe, p. 382. In Fig. 182, let p be the external pressure on the arc in lbs. per square foot. It is assumed that the tangents to the circle at A and B do not change direction, an assumption that is exactly true for B and approximately true for A , since the loads and reactions are symmetrical.

According to the principles of stresses in rings, p. 383,

$$\int_A^B M \cdot r = 0, \text{ or since } r \text{ is practically constant, } \int_A^B M = 0. \quad (1)$$

$$M_{AC} = 0.588pr^2(1 - \cos \phi) - M_A$$

$$M_{CB} = 0.588pr^2(1 - \cos \phi) - \frac{1}{2}pr^2(\cos 54^\circ - \cos \phi)^2 - M_A$$

Substituting in (1) and simplifying, $M_A = 0.19 pr^2$, and

$$M_B = 0.588pr^2 - 0.19pr^2 - 0.588pr^2/2 = 0.224pr^2.$$

Where the bins are rigidly attached, the stresses due to pressures resulting from grain in the interspace bin are indeterminate unless the degree of fixity at the points of contact is known, and even then it is not entirely determinate. If the arc subjected to the pressure of the grain is assumed to be essentially fixed at the points of contact and the pressure assumed as equally distributed over the arc, the pressure would be calculated as in an arch dam, viz. by the formula, $S = pr/T$, T being the thickness of the bin wall. Thus in the Canadian Pacific elevator, on this basis, the stress would be $(315 \times 15) \div (9 \times 12) = 26$ lbs. per square inch. Obviously the stress where the bins are rigidly anchored to each other would be small in any case. Had the bins not been rigidly anchored to each other, there would have been a moment of $0.19 pr^2$, or $0.19 \times 315 \times 15^2 \times 12 = 190,500$ lb. in., which would have caused the stresses to exceed the allowable stresses. From this example, the advantage of rigidly anchoring the bins together becomes apparent.

An interesting failure of a reinforced concrete wheat bin due to improper design for pressures when the interspace bins were filled occurred at the Peavy elevator at Duluth in 1900.¹ The bins were 104 ft. high and $33\frac{1}{2}$ ft. in diameter. The walls were 12 in. thick reinforced with $1\frac{1}{2}$ by $\frac{3}{8}$ -in. bars 6 in. on centers. One of the interspace bins had been filled with wheat nearly to the top when the walls of two of the circular bins were forced in at the points corresponding to B , Fig. 182, and were broken outward at the point corresponding to A . The bins were not anchored to each other but were connected by a straight wall 6 ft. long and 12 in. thick. Stresses calculated as indicated above exceeded the strength of the materials and failure should reasonably have been expected.

¹ *Engineering News*, Dec. 27, 1900.

It is exceedingly important to have an unyielding foundation where bins are built in clusters lest the settlement of the bins be uneven and a rupture occur between the cells. To accomplish this, the entire cluster is frequently placed on a reinforced concrete mat. Where a uniform foundation can not be obtained, it is preferable to build the bins as separate units.

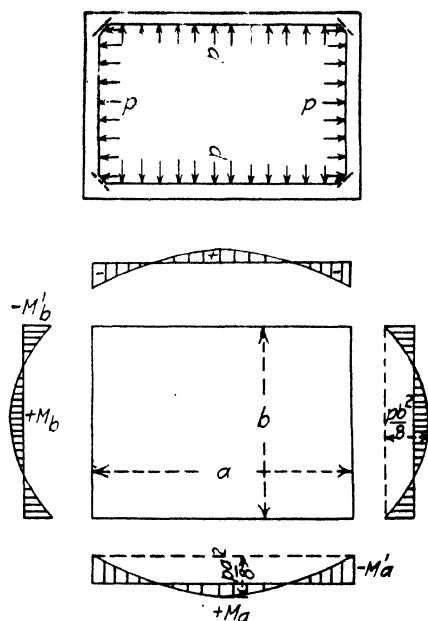

FIG. 183.—Moments in a rectangular bin.

Stresses in Rectangular Bins.—In a manner similar to that employed in the case of culverts, (p. 385), the moment at the middle of the sides can be determined for a rectangular bin subjected to internal pressure. It is assumed that the corners are rigidly reinforced sufficient to transmit negative moment from one side to the other.

Since the frame is rigid, Eq. (6) p. 385 applies, and the procedure is exactly the same as for a rectangular culvert, except that the pressure is internal instead of external and the unit pressures on the two sides are equal. The moment at the middle of the side is, therefore, the sum of the moments for Cases II and III, or

$$M_a = \frac{pa^2}{24} \left(\frac{R + 3S}{R + S} \right) - \frac{pb^2}{12} \left(\frac{S}{R + S} \right)$$

$$= \frac{p}{24} \left(\frac{a^2R + 3a^2S - 2b^2S}{R + S} \right)$$

where $R = a/b$ and $S = I_a/I_b$. In a square bin, R and S each equals 1, hence, for a square bin,

$M_a = \frac{pa^2}{24}$, and the negative moment at the corners equals $-pa^2/8 + pa^2/24 = -pa^2/12$.

Where rectangular bins are built in clusters and the corners rigidly reinforced, the moments may be reversed from those in the case above considered, the condition of maximum moment being when the bin under consideration is empty and all the surrounding bins are full. The stresses will be somewhat less than the above method would give, but being statically indeterminate, a solution will not be offered here. They may be determined by principles of least work or by the slope deflection method.¹

General Dimensions of Bins.—So far as the character of the stresses encountered are concerned, circular bins are the most satisfactory, since bending moments in the sides are very largely eliminated, but they are not so conveniently constructed as are rectangular bins, nor are they so economical of space. However, because of the adaptability of the circular bin to the nature of the stresses encountered, this type has been growing in favor. Bins rectangular in cross section are usually square rather than oblong.

The relation between the height and the diameter of a grain storage bin to give maximum economy cannot be determined analytically. The criterion of economy is the minimum cost per bushel for storage of the grain. The factors entering into the cost of storage so far as they might be affected by the dimensions of the bins are:

A. *Fixed charges:*

1. Cost of real estate occupied;
2. Cost of construction of bins;

B. *Operating charges:*

1. Maintenance;
2. Elevating and handling the grain.

The cost of the land occupied will vary directly with the area

¹ *Univ. of Illinois Eng. Exp. Sta., Bulls. 107 and 108.*

or with the diameter of the bins and inversely with the height for a given capacity. For a cluster of bins where the interspace bins are used, the capacity for a given floor area will be about constant regardless of the relation between height and diameter. For practical considerations in convenience of construction, a 7-in. wall is about a minimum thickness for circular bins, and a wall of this thickness will suffice, if properly reinforced, for any height up to 160 ft for bins of practical diameters, it being assumed that where the interspace bins are used, the bins are rigidly anchored to each other at the points of juncture. The total weight of reinforcing in the walls varies approximately with the square of the diameter. A practical average relation is to make the height 5 to 6 times the diameter of grain storage bins. Table XXIX gives the essential dimensions of a number of bins for storage of grain.

Cement bins are rarely built higher than 50 or 60 ft., on account of the weight of the contents, which makes the securing of a satisfactory foundation difficult. The cement bins of the Universal Portland Cement Co. at Duluth, Minn. are 33 ft. in diameter and 50 ft. high each having a capacity of 10,300 bbl. while the interspace bins have a capacity of 2,200 bbl. each. The bin walls are 9 in. thick except where they join, being 12 in. thick at these points, and the intermediate space filled 5 ft. on either side of the point of tangency. These bins were designed for an internal pressure of 25 lbs. per square foot. Cement bins are liable to severe strains due to "sweeps" or "slips" of the contents when perhaps a considerable fraction of the contents slides with great force against the sides. Tests made under the author's direction indicate that the pressures resulting from these sweeps may be two to three times the static pressures. In these experiments, sand, wheat and cement were used. The dynamic pressure apparently varies with the height of descent, amounting to about 2 to $2\frac{1}{2}$ times the static pressure when the height of descent was approximately equal to the width of the bin.

Details of Reinforcement.—In single bins, and in clustered bins where the adjacent bins are anchored rigidly together, the circumferential reinforcement may be placed in the middle of the wall because the stresses to be sustained are practically pure tension from the grain in the circular bin or pure compression from the grain in the interspace bin. Where clustered bins are not rigidly attached to each other but are connected by a short

TABLE XXIX.—DATA ON GRAIN STORAGE BINS

Owner	Location	Shape	Height, ft.	Inside diameter, ft.	Thickness of wall, inches	Material	Foundation
A. T. & S. F. R. R.	Chicago	Circular	80.0	23 0	7	Reinforced Concrete	Piles
Canadian Pac. R. R.	Port Arthur	Circular	90.0	30.0	9	Concrete	50 ft. piles
Canadian Nor. R. R.	Port Arthur	Circular	83 0	19.75	7½	Tile	Piles
Gt. Northern R. R.	Superior	Circular	110 0	19 6	7	Concrete	55 ft. piles to rock
Grand Trunk R. R.	Ft. William	Circular	79.0	12 0	8	Concrete	60 ft. piles to rock
Grand Trunk R. R.	Ft. William	Circular	95.0	23 75	8	Concrete	
Grand Trunk R. R.	Tiffin	Circular	86.0	24 0	8	Concrete	
Warehouse & Elev. Co.	Girard, Pa.	Circular	74.5	13 0	7	Concrete	
Spencer Kellogg Co.	Buffalo	Circular	85 0	27.0	8	Concrete	
Ocean Steamship Co.	New Orleans	Circular	85.0	15 25	8	Concrete	
Girard Pt. W. & E. Co.	Girard Pt., Pa.	Circular	96.0	15.0	7	Concrete	4 ft. mat on piers
Noblesville Milling Co.	Noblesville, Ind.	Circular	90.0	25.0	7	Concrete	
Interstate Elev. Co.	Chicago	Circular	73.0	18.5	7	Concrete	
Canadian Pac. R. R.	Winnipeg	Circular	92 0	14.3	6	Concrete	Blue clay, failed
F. C. Ayres Co.	Denver	Rectangular	70.0	13 × 14.3	8	Concrete	Shale
Harbor Comm.	Montreal	Rectangular	86.0	8	Concrete	
B. & O. R. R.	Baltimore	Rectangular	76.0	6 5 × 7 5	6	Concrete	
Grand Trunk R. R.	Montreal	Rectangular	86.0	8	Concrete	

Reinforced

wall, the reinforcement should consist of circumferential rods or bands placed both near the outside of the wall and near the inside in order to withstand the moments induced by grain in the interspace bins.

The stresses in the sides due to vertical weight are not large, hence very little or no vertical reinforcement is required to sustain the load. A few large vertical rods ($1\frac{1}{4}$ inch) need to be placed in the wall to which the jacks may be applied for raising the forms during construction, inasmuch as nearly all bins are constructed by means of sliding forms. Also, since the structure is free to expand, a minimum amount of longitudinal steel will take care of any temperature stresses.

Where one wall joins another, whether straight or curved, care should be exercised to form a firm junction by hooking the reinforcement of the abutting wall over that of the continuous wall, or if at a corner, by properly lapping the reinforcing rods. Unless this precaution is taken, the junction may be ruptured by the pressure of the grain. One such failure due to insufficient reinforcement at the junction came to the author's observation, where a straight outside wall was tangent to two bins and the bonding reinforcement was lacking. The excess pressure against the outside wall was doubtless due to a discharge gate in the short wall opposite, the outside tangent wall pulling away from the circular bins.

Foundation Base.—Usually a cluster of grain bins is placed on a solid reinforced concrete mat or slab which serves to prevent uneven settlement and to bind the entire cluster together into one unit. This mat or base must be designed to sustain the reaction of the foundation when only such a portion of the bins are filled as will produce maximum moment. Two cases arise for consideration one of which may produce maximum negative moment and the other maximum positive moment. (1) When a certain portion of the bins at the middle of the mat are filled and the ends of the mat act as a cantilever, Fig. 184 (a), the maximum negative moment occurs, and (2) when a certain portion of the bins at the ends are filled and those in the middle are empty, the maximum positive moment occurs, Fig. 184 (b).

In case (1), if the live or grain load per foot of length is w when the bins are filled, and x is the length of the portion of filled bins, the total load on the slab is wx , the reaction per foot of length is wx/L , and the moment in the cantilever is

$$M = -\frac{1}{2} \frac{wx}{L} \left(\frac{L-x}{2} \right)^2$$

$$dM/dx = -\frac{1}{8} \frac{w}{L} (L^2 - 4Lx + 3x^2)$$

Equating to zero and solving for x , $x = L/3$ for the maximum negative moment. The value of this maximum negative moment is $-wL^2/54$.

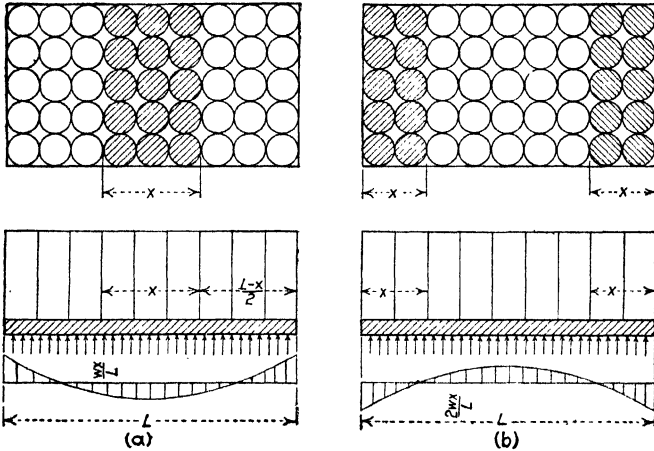

FIG. 184.—Moments in slab under a bin cluster.

In case (2), the reaction per foot is $2wx/L$, and the moment, considering the slab as partially restrained,

$$M = \frac{1}{10} \frac{2wx}{L} (L - 2x)^2$$

Differentiating, equating to zero and solving, $x = L/6$ and the value of this maximum positive moment is $4wL^2/270$. The negative moment, $-wL^2/54$, will determine the maximum amount of steel in the bottom of the slab and the positive moment $4wL^2/270$ will determine the amount of steel at the middle of the top of the slab. The moment at any other section of the slab may be calculated in a similar manner, determining the condition of maximum severity for that section by loading successive rows of bins. This procedure must be followed for both the length and the width of the slab, resulting in a recticulate mesh of steel in both the top and the bottom of the slab.

In the Canadian Pacific Elevator at Winnipeg (Transcona), a 12-in. slab forms the bottom of the bins beneath which there are

conveyor tunnels 7 ft. high, separated by walls 16 in. thick. Under these there is a 2-ft. reinforced mat of concrete. In 1915, the foundation gave way¹ at one side allowing the entire structure to tilt to an angle of $26^{\circ} 53'$ with the vertical, but the mat held the bin so that the entire cluster could be righted by means of jacks without serious loss.

Examples of Bins.—The grain elevator at Girard Point, Pa.,² capacity 1,000,000 bushels, is a good illustration of circular

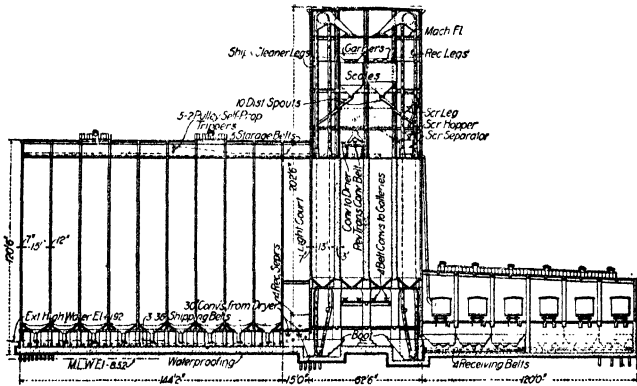

FIG. 185.—Section through Girard Point grain elevator.

concrete grain bins. Figure 185 shows a longitudinal section through the storage bins, the working house and the track-shed.

To the east of the working house and connected to it by a concrete tunnel and bridge is a storage annex consisting of fifty-four 13,000-bu. reinforced-concrete circular tanks with a basement and cupola. The tanks rest on a 4-ft. concrete mattress laid over a pier foundation. In the basement are three 36-in. shipping-conveyor belts, draw-off spouts and belt loaders for each tank and interspace. The circular storage tanks are 15 ft. inside diameter, 96 ft. high and have 7-in. walls. The forty interspaces have a capacity of about 3,300 bu. each. Over the tanks is a concrete floor for the 82 by 144-ft. cupola, in which are placed the storage belt conveyors, each provided with a two-pulley self-propelling, double-discharge tripper.

¹ *Trans. Am. Soc. C. E.*, vol. 80, p. 799.

² *Engineering Record*, Jan. 10, 1914.

Foundations for all buildings were waterproofed by the *membrane method* by applying six plies of waterproof felt cemented together with pitch compound. The waterproofing was laid on a 9-in. slab of concrete deposited on top of the piles, between which earth was tamped even with their cutoff tops. The waterproof membrane was brought out beyond the area of the concrete slab a sufficient amount to allow for joining into the walls. As soon as the waterproof membrane was laid a protection layer of cement mortar $\frac{1}{2}$ in. thick was placed on top. For the outside walls a 4-in. brick wall, laid in cement, was placed and capped with steel angles bolted to the concrete walls after the waterproof contractor had finished his work, which, according to specifications, was to be guaranteed for a period of ten years.

Under the foundation are 6,000 timber piles, 65 ft. long, driven to a gravel stratum on 2 ft. 3-in. centers both ways, with the exception that under the trackshed they are driven on 5-ft. centers. Tests were made on these piles, which were designed to carry 15 tons each, by loading three sets of four with pig iron up to 60 tons each. The settlement was only a fraction of an inch, although the loads were left in place several months.

The circular storage tanks rest on four concrete piers, $2\frac{1}{2}$ ft. thick and 8 ft. high, placed in rectangular positions on the concrete mattress. These piers are in rows at right angles, $5\frac{1}{2}$ ft. long in one direction and 8 ft. in the other. This permits space for the hoppers at the bottoms, which are laid on a slope of 10 to 12, with a 2-in. thickness of concrete over a filling of sand or cinders in which a small amount of cement is used.

The contact point between bins is 12 in. thick and extends 3 ft. either way from the tangent point. Steel hoop bands, varying from $1\frac{3}{4}$ by $\frac{3}{8}$ in. at the bottom to 1 by $1\frac{1}{8}$ in. at the top, are laid 12 in. center to center vertically in the center of the wall in two lengths, so as to have a lap of $3\frac{1}{2}$ ft. Four $\frac{1}{2}$ -in. round vertical rods are provided for each tank on which the hollow screwjacks raised the moving forms and platforms. Eight other vertical rods were also provided for the purpose of reinforcing the walls.

A sand bin holding 8,200 cu. ft., built by the United Railways of St. Louis¹ is shown in Fig. 186.

In the design of the bin a fluid pressure at 100 lb. per cu. ft. was used in computing the side and bottom reinforcement. The

¹ *Engineering Record*, Mar. 16, 1912.

circular beam between the posts at the bottom of the bin was designed to hold four-tenths of the total sand load, but the conical bottom was designed for full load. The vertical side walls of the bin are 7 in. thick, and the ring reinforcement increases from $\frac{3}{8}$ -in. square bars 12 in. on centers at the top to $\frac{3}{4}$ -in. square bars $6\frac{1}{2}$ in. on centers at the bottom. Vertical temperature rods are $\frac{1}{2}$ -in. square bars 18 in. apart. The



FIG. 186.—A reinforced concrete sand bin.

conical bottom is 9 in. thick with ring reinforcement varying from $\frac{3}{4}$ -in. square bars $6\frac{1}{2}$ in. apart to $\frac{5}{8}$ -in. bars 9 in. apart. The radial reinforcement in the bottom consists of one hundred and twenty $\frac{3}{4}$ -in. square bars, thirty of which run to the opening at the bottom, while the others stop at the $\frac{1}{4}$, $\frac{1}{2}$ and $\frac{3}{4}$ points. The circular beam is reinforced with eleven 1-in. square bars, seven of which are at the bottom. The roof was made 9 in. thick with reinforcement running both ways. The columns are 24 in. thick with $\frac{1}{4}$ -in. square hoops 12 in. apart and eight $\frac{3}{4}$ -in. square vertical bars; the opposite center bars are tied together with No. 12 wire and all vertical bars are embedded about 40 diameters in the circular beam and also in the ring foundations.

Silos.—Silage, or ensilage, consists of chopped green corn fodder, or other green forage crops which are placed in a silo for preservation in a relatively green condition. The process is comparable to the canning of green vegetables. Silage is chopped

into bits about an inch long and blown into the silo where it is compacted by tamping thereby forcing out the air. A thin layer of the contents at the top decomposes but this layer forms a seal for the remainder.

Silos are almost universally circular in plan and are commonly built of tile, concrete blocks, staves, or of reinforced concrete, and they should be water and vermin proof and as nearly air tight as practicable. The stresses in a silo can be calculated by the principles already explained. Silage weighs about 33 lbs. per cubic foot and exerts a lateral pressure of about 0.33 of the

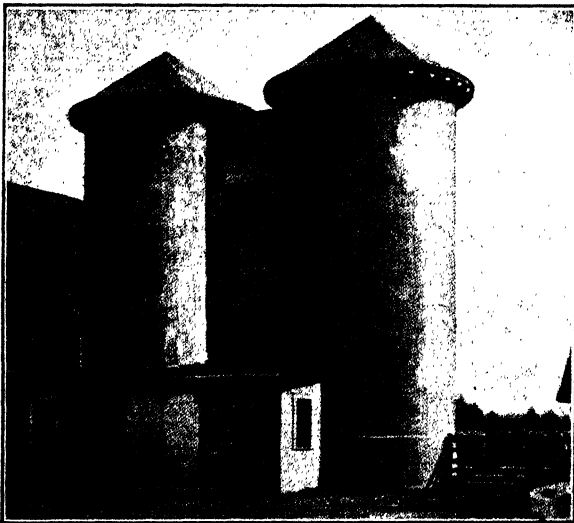

FIG. 187.—Reinforced concrete twin silos.

vertical pressure at any point. Experiments by Professor F. H. King at the University of Wisconsin showed a lateral pressure of 11 lbs. per foot of depth.

The silo should be smooth on the inside so that the silage will settle uniformly and not leave air pockets along the walls. The walls should prevent the silage from freezing as much as possible because frozen silage quickly decomposes and may injure the stock that eats it. The silo should be set about $3\frac{1}{2}$ to 5 ft. in the ground to insure getting it below frost line, and the foundation should be thoroughly drained in order that water may not enter the bottom of the tank. A continuous, or an intermittent door is placed in one side of the silo and a chute placed along this

opening from bottom to top into which the silage is thrown as it is removed from the tank. Figure 187 shows twin silos with a well lighted chute between the two units.

Where an intermittent door is used, the rods passing through the ties between the openings will be sufficient to give the necessary tensile strength to prevent bursting or spreading of the door. However, where a continuous door is used it is essential that heavy rods be used to tie the two sides of the opening together. These should be attached firmly to the reinforcing steel of the sides of the silo either by hooking around the vertical rods at each side of the door or by proper embedment. They should not be closer than about 2 ft. apart to avoid undue restricting of the doorway.

Table XXX¹ gives the spacing of reinforcement for average silos. A small amount of vertical reinforcing is required to which the circumferential bars may be attached. This will consist of $\frac{1}{2}$ -in. bars spaced about 30 in. apart.

TABLE XXX.—SPACING OF HORIZONTAL REINFORCING BARS FOR SILOS OF VARIOUS INSIDE DIAMETERS

Distance in feet down from top of silo	8 Ft. diameter	10 Ft. diameter	12 Ft. diameter	14 Ft. diameter	16 Ft. diameter	18 Ft. diameter	20 Ft. diameter
	$\frac{1}{4}$ Inch bars	$\frac{1}{4}$ Inch bars	$\frac{3}{8}$ Inch bars	$\frac{1}{2}$ Inch bars	$\frac{1}{2}$ Inch bars	$\frac{1}{2}$ Inch bars	$\frac{1}{2}$ Inch bars
Top to 5 ft....	24 in.	24 in.	24 in.	24 in.	24 in.	24 in.	24 in.
5 ft. to 10 ft.	15 $\frac{1}{2}$ in.	12 in.	24 in.	24 in.	24 in.	24 in.	24 in.
10 ft. to 15 ft.	10 $\frac{1}{2}$ in.	8 $\frac{1}{2}$ in.	16 in.	24 in.	20 in.	19 in.	17 in.
15 ft. to 20 ft.	7 $\frac{1}{2}$ in.	6 $\frac{1}{2}$ in.	12 in.	18 in.	16 in.	14 in.	12 in.
20 ft. to 25 ft.	6 in.	5 in.	9 $\frac{1}{2}$ in.	14 in.	12 $\frac{1}{4}$ in.	11 in.	10 in.
25 ft. to 30 ft.	5 in.	4 in.	8 in.	12 in.	10 $\frac{1}{2}$ in.	9 $\frac{1}{2}$ in.	8 $\frac{1}{2}$ in.
30 ft. to 35 ft.	3 $\frac{1}{2}$ in.	7 in.	10 $\frac{1}{2}$ in.	9 in.	8 in.	7 $\frac{1}{2}$ in.
35 ft. to 40 ft.	3 in.	6 in.	9 in.	8 in.	7 in.	6 $\frac{1}{2}$ in.
40 ft. to 45 ft.	5 in.	8 in.	7 in.	6 in.	5 $\frac{1}{2}$ in.
45 ft. to 50 ft.	4 $\frac{1}{2}$ in.	7 in.	6 $\frac{1}{2}$ in.	5 $\frac{1}{2}$ in.	5 in.

In determining the size of a silo required, the following may be considered as the average daily ration for stock: Dairy cattle 30 to 50 lbs. per head; fattening beef cattle 20 to 30 lbs.; sheep, 3 to 5 lbs.

CHIMNEYS

General Considerations.—The term chimney is commonly used to refer to a masonry structure and stack to mean a steel

¹ Portland Cement Assn., Bull. 71.

structure designed to serve as a flue to eliminate furnace gases. However, the two terms are used interchangeably by many.

A chimney is constructed to a considerable height in order to create draft for the furnace and in order also to deliver the gases at a height which will prevent nuisance. Because of the height and the small base, the design of a masonry chimney presents some peculiar problems. In the present discussion, no attempt will be made to discuss the arrangement of the flue, the height required to produce a certain draft, the diameter necessary for a desired velocity of gases, nor any of the other functional requirements, the structural features only being considered. For a discussion of the functional design of a chimney, the reader is referred to *Steam Power Plant Engineering* by G. F. Gebhardt, p. 279 ff. It may be stated, however, that almost any desired draft can be obtained by various combinations of height and diameter, and care should be exercised to secure the most economical proportions, taking into account the greater unit costs at the greater heights.

Forces Acting on a Chimney.—The chief forces, in addition to gravity and foundation reaction, which affect the design of a chimney are wind pressures and temperature effects. Wind pressure has been shown by experiments to vary with the square of the velocity, or equal to kV^2 , where V is the velocity in miles per hour and k a coefficient, equal to about 0.003, the pressure being in pounds per square foot on a flat area. The pressure on cylindrical surfaces is by mechanics equal to two-thirds that on a flat surface and on a cylindrical chimney may be taken as $0.002V^2$, or about 20 lb. per square foot for a wind of 100 miles per hour, which would be a maximum condition. Chimneys designed for this figure have withstood the most severe gales.

Pressures due to wind are positive on the windward side over an arc of about 70° , or 0.6 of the projected circumference, and negative on the remainder of the circumference, the lowest (greatest negative) pressure occurs about 80° from the point of maximum pressure and the negative pressure on the leeward side is about half the positive pressure on the windward¹.

The heat of the gases within a chimney cause an extreme of temperature variation in the chimney walls, and where materials are of such a nature as to be damaged by expansion and contraction, precautions must be taken to obviate such damage.

¹ *Proc. Am. Concrete Inst.*, vol. 23, p. 124.

The flue gases escaping into a chimney at a well designed plant, usually have a temperature of about 500° to 700° F., being hotter at the breeching and cooler at the top with the temperature dropping about 40° per 100 ft. of height in masonry chimneys.

Chimneys are either of single or double shell construction, the latter being the more common. The inner shell or lining consists of a fire-brick wall built separately from the outer shell and extending through part or the whole of the height. The space between the two shells is to prevent the extreme range of temperature being effective in the outer shell.

The actual difference in temperature between the inner and the outer surface of a chimney wall depends upon (a) the differ-

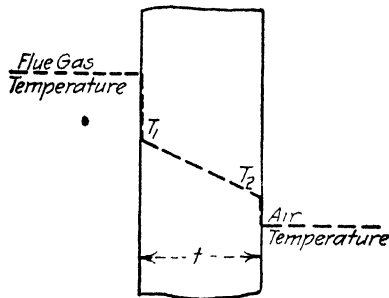

FIG. 188.—Temperature drop in a chimney wall.

ence in temperature between the gases and the surrounding air, (b) the coefficient of thermal absorption of the surface of the chimney material, (c) the coefficient of thermal conductivity of the chimney material, and (d) the coefficient of emissivity or radiation from the outer surface.

The character of the temperature drop is indicated in Fig. 188. Of the total drop in temperature, a considerable proportion occurs at the inner and the outer surfaces. The actual drop in temperature through the wall, or the thermal gradient, $\frac{T_1 - T_2}{t}$.

is the factor which affects the structural design of the chimney, T_1 and T_2 being the temperatures of the chimney surfaces. The radiation of the outer surface varies as the fourth power of the temperature, hence, the actual difference in the inside and the outside of the masonry is not so great as is sometimes supposed. The temperature drop through a concrete chimney wall is shown

by tests¹ to be practically a straight line with a gradient of about 20 to 26° F. per inch of thickness above the top of the lining and about 8° F. per inch for sections below the top of lining.

Although the actual difference in temperature of the outside and the inside of the chimney wall may be considerably less than the difference in the temperature of the gases and of air outside, the fact remains that there will always be a difference in these temperatures because masonry is a poor conductor of heat relatively and has a fairly high rate of emissivity at the outside. The effect is, of course, that the chimney cracks on the cool side because of the tension induced by the expansion of the hotter side, unless reinforcing is placed in the wall of sufficient amount to prevent the cracking. The situation is analogous to a glass bottle into which hot water is poured causing the inside to expand and the consequent cracking of the outside. Brick or tile masonry is capable of making such adjustment at the joints that the cracks do not become serious. Where the inner shell is built up only a portion of the height of the chimney, cracking is likely to occur at the top of the inner shell.

Stresses Due to Earthquake Shocks.—On the western coast of the United States and elsewhere, earthquake shocks of sufficient magnitude to wreck buildings and chimneys sometimes occur. The effect of an earthquake shock is to cause the foundation or base of the chimney to be quickly moved horizontally, the rate of acceleration depending upon the severity of the shock. Slight tremors result from an acceleration of 1 to 2 ft. per second², while an acceleration of 13 ft. per second² in soft loose ground was observed at San Francisco and 5 ft. per second² on firm ground.² It is probable that chimneys located in such regions should be designed for an acceleration of 5 to 6 ft. per second².

The equivalent force resulting from this acceleration is $Wa/32.2$, where W is the weight of the chimney and a the rate of acceleration. The amount due to this acceleration of the base is $Wax_1/32.2$, where x_1 is the distance from the base to the center of gravity of the portion of the chimney above the section considered and W is the weight of that portion. J. G. Mingle, Engineer for the Rust Engineering Company, recommends that

¹ *Proc. Am. Concrete Inst.*, vol. 23, p. 119.

² *Engineering Record*, Jan. 10, 1914.

the rate of acceleration be taken as 7 to 9 ft. per second².¹ The reinforcement required to withstand this moment may be found in the same manner as for wind moment.

Owing to the fact that the period of earthquakes is about 1 sec. and the period of tall chimneys is about 2½ to 3 sec., a cumulative effect occurs at about the upper and lower third points which causes a characteristic failure at about those points. At these nodal points, the moment would approach twice that resulting from the direct inertia force.

Brick Chimneys.—Brick chimneys are built of common brick or of special radial brick, which are usually perforated and molded to different sizes suitable for use in various diameters of chimneys. The thickness at the top should not be less than the length of a brick as a minimum and may be taken as $4 + 0.05D$ in., where D is the diameter of the chimney in inches. The thickness increases regularly by offsets towards the bottom, these offsets being at intervals of 15 to 25 ft. The batter commonly used for brick chimneys is 1:30 to 1:36.

It is impracticable to design a chimney so that during maximum wind pressure, the resultant will fall within the kern area of the section, that is, so that there may be no tension on the windward side of the chimney. The following formulas for maximum tensile and compressive stresses devised by Professor G. Lang² have been used by the author in the design of brick chimneys with satisfactory results.

Tension:

$$S = 18.5 + 0.056L \text{ for single shell chimneys;}$$

$$S = 21.3 + 0.056L \text{ for chimneys with a complete lining;}$$

Compression:

$$S = 71 + 0.65L \text{ for single shell chimneys;}$$

$$S = 85 + 0.65L \text{ for chimneys with a full complete lining;}$$

in which S is the allowable stress in lbs. per sq. in. and L is the distance from the top of the chimney to the section considered. The allowable working stress is made to vary with the distance from the top because of conditions occurring during construction. The age of the mortar, and consequently its strength, varies with the distance from the top during construction in a large chimney, and for this reason, the allowable stresses are

¹ *Proc. Amer. Concrete Inst.*, vol. 14, p. 278.

² *Engineering Record*, July 27, 1901.

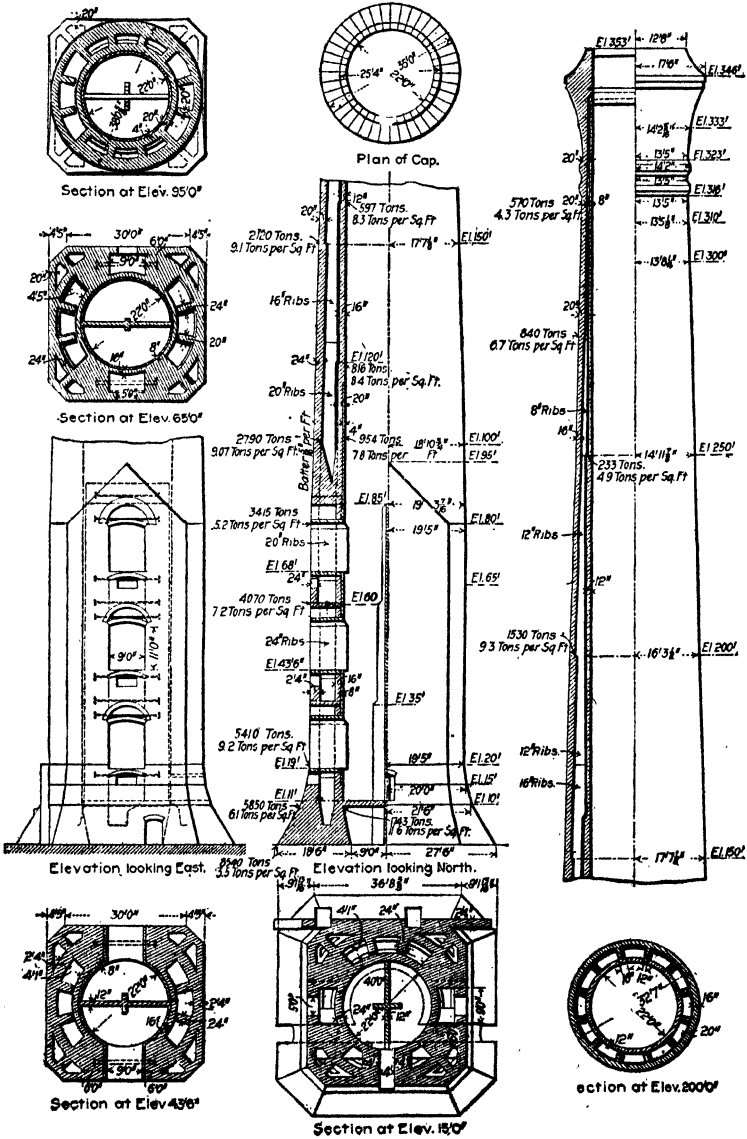

FIG. 189.—Details of a chimney of common brick.

increased with the distance from the top of the chimney. For small chimneys that may be completed in a few days, there would be no reason for this distinction. With first class cement mortar, the above values are doubtless very conservative, particularly for the compressive stresses.

The stresses in the chimney may be calculated in the usual manner by means of the combined stress equation,

$$S = W/A \pm Mc/I$$

Calculations for stability must be made at intervals where section is changed at offsets. Figure 189 shows the general

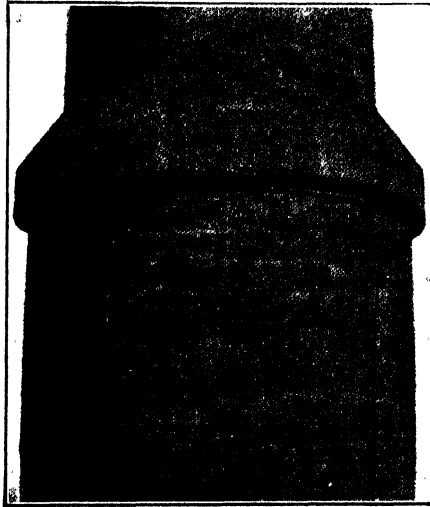

FIG. 190.—Temperature cracks in a concrete chimney.

dimensions of a 353-ft. chimney built of common brick by the Metropolitan Street R. R. Company at 95th Street, New York.¹ The chimney rests on piles driven into sand and clay.

Whether the lining of fire-brick should extend clear to the top depends upon the temperature of the flue gases. Where the escaping gases are at high temperature, approved practice would carry the lining to the top.

Reinforced Concrete Chimneys.—In recent years, the use of reinforced concrete for the construction of chimneys has become common practice. Notwithstanding the appearance of defects

¹ *Engineering Record*, Dec. 17, 1898.

in many of these structures, it is believed that this material may be used for chimneys with satisfactory results if proper precautions are taken in the design and construction. The chief defects lie in the cracking of the concrete due to temperature effects, as illustrated in Fig. 190. However, by proper reinforcement and methods of construction, these cracks can be so diminished that they are not seriously objectionable. The design of a reinforced concrete chimney, therefore, resolves itself into the

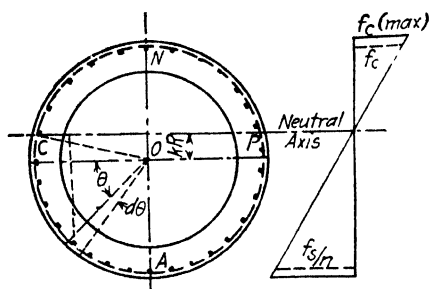

FIG. 191.—Stresses in a reinforced concrete chimney.

design against wind pressure and the design against temperature cracks.

Stresses Due to Wind.

The magnitude of wind pressure has been discussed at another place (see p. 418) and need not be repeated in this connection. The determination of the stresses in a

reinforced concrete chimney by rigorous analysis is complicated and an entirely satisfactory solution of the problem has not been accomplished as yet, all existing solutions involving certain approximations. However, the following solution, taken largely from "Concrete Engineers' Handbook," by Hool & Johnson, p. 816 ff., is comparatively simple and yields satisfactory results.

In Fig. 191, let

R = the radius of the chimney to the reinforcing steel, (approximately to the middle of the wall)

t = the thickness of the wall

p = the proportion of reinforcement, A_s/A_c

P = the wind pressure in lbs. per square foot of projected area

kR = distance from the center to the neutral axis.

The moment of the transformed area of the tensile steel CAP about the neutral axis is

$$2nptR^2 \int_{-\sin^{-1}k}^{\frac{\pi}{2}} (\sin \theta + k) d\theta = 2nptR^2 \left[\frac{k\pi}{2} + \sqrt{1 - k^2} + k \sin^{-1}k \right]$$

and the moment of the compressive area, *CND*, with the transformed steel area, is

$$2R^2t \left[1 + (n - 1)p \right] \int_{\sin^{-1}k}^{\frac{\pi}{2}} (\sin \theta - k) d\theta = 2R^2t \left[1 + (n - 1)p \right] \left[k \sin^{-1}k + \sqrt{1 - k^2} - \frac{k\pi}{2} \right]$$

These moments balance about the neutral axis, since the latter passes through the center of gravity of the transformed section, hence,

$$p = \frac{k \sin^{-1}k + \sqrt{1 - k^2} - \frac{k\pi}{2}}{k \sin^{-1}k + \sqrt{1 - k^2} - \frac{k\pi}{2} + k\pi n}$$

Figure 192 has a curve at the top which gives this relation between *p* and *k* for *n* = 15, as expressed by the above formula.

The moment of inertia for the transformed section is

$$R^2t \left\{ (1 - p) \left[(1 + 2k^2) \left(\frac{\pi}{2} - \sin^{-1}k \right) - 3k\sqrt{1 - k^2} \right] + \pi p n (1 + 2k^2) \right\}$$

The stresses in the steel and in the concrete may be calculated by the formulas

$$f_s = \frac{Mc_s}{I}, f_{s'} = \frac{Mc_s'}{I}, f_c = \frac{Mc_c}{I}$$

in which, *f_c*, *f_s*, and *f_{s'}* are the stresses in the concrete, the tensile steel and the compressive steel respectively at the distance *R* from the center;

c_c is the distance from the neutral axis to the extreme fiber of the concrete in compression and *R* from the center

c_s is the distance from the neutral axis to the extreme fiber of the steel in tension

$$c_s = Rn(1 + k), c_s' = Rn(1 - k) \text{ and } c_c = R(1 - k)$$

Since *f_c* is the stress in the concrete, practically at the center of the chimney wall, the maximum stress will be greater than *f_c*,

namely, $f_c(\text{max.}) = f_c \left(1 + \frac{t}{2R(1 - k)} \right)$. This percentage of increase in stress is plotted in the second diagram of Fig. 192.

The relation between the percentage of reinforcement and the allowable bending moment for $n = 15$ is shown in the third diagram of Fig. 192.¹ Stresses due to moment only are given in this diagram, the compressive stresses due to the weight of the structure itself will have to be added to these to obtain the actual compressive stress for any given case. The compressive

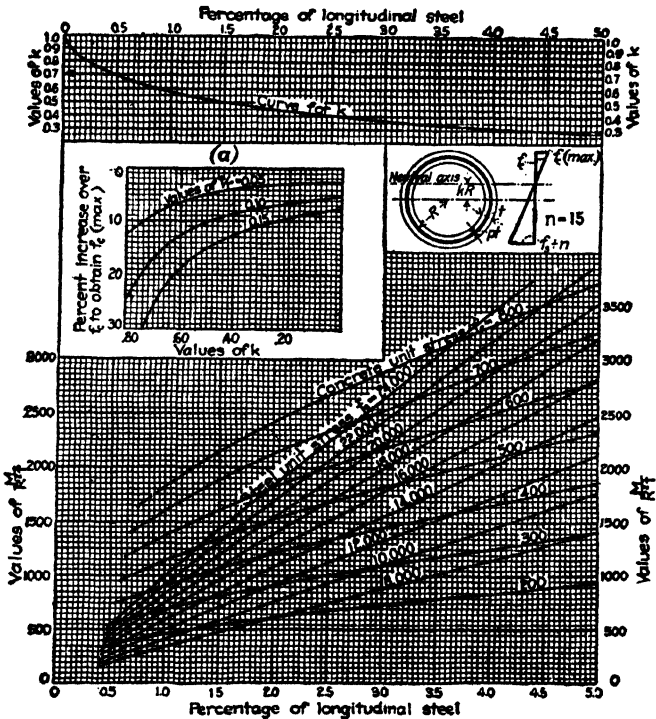

Fig. 192.—Diagram for designing a reinforced concrete chimney.

stress due to the weight of a concrete chimney is approximately 1 lb. per square inch for each foot of height.

Thus if the allowable stress in the concrete in a chimney 200 ft. high and 10 ft. in diameter is 650 lbs. per square inch, leaving 450 lbs. per square inch available for moment stress and the allowable stress in the steel is 14,000 lbs. per square inch, $M/R^2t = 1,750$. The bending moment due to wind pressure of 20 lbs. per square foot projected area is 48,000,000 lb.-in., whence $t = 48,000,000$

¹ HOOL and JOHNSON, "Concrete Engineers' Handbook," p. 816.

$\div (1,750 \times 60^2) = 7\frac{3}{4}$ in. approximately and the reinforcement is 3.4 per cent. With 2.5 per cent reinforcement steel, $M/R^2t = 1,350$ and $t = 10$ in. approximately.

Owing to the thinness of the chimney walls, the longitudinal shear should be investigated, which may be serious on account of cracking of the walls. The transverse shear will practically never be serious.

Since from mechanics, the increment of moment equals the total shear at the section multiplied by the increment of distance, $dM = V \cdot dy = PyD \cdot dy$, y being the distance from the top to the section considered. The increment of moment equals the longitudinal shear over the length dy multiplied by the effective depth (the distance between centers of tensile and compressive stress), or $V_h \cdot jD = PyD \cdot dy$. Taking dy as unity, or 1 ft., $V_h = Py/j$.

Since j is practically constant and equal to 0.78, $V_h = 1.28Py$, and the longitudinal shear stress per square inch is $\frac{1.28Py}{2 \times 12t}$.

Temperature Reinforcement.—Owing to the higher temperature of the inner portion of the chimney shell, the expansion of that portion is greater than for the outside, consequently, unless properly reinforced the outside will crack both vertically and horizontally, and at best, the results are not always satisfactory in this respect. See Fig. 190. A theoretical determination of the proper amount of temperature reinforcement is difficult and uncertain because of the lack of knowledge regarding the behavior of concrete under such conditions. Over-reinforcement theoretically causes high compressive stresses in the concrete, and under reinforcement may allow the concrete to crack objectionably.

The difference in temperature of the concrete at the outside and the inside of the shell requires both vertical and circumferential reinforcement. Theoretically the amount of reinforcement should diminish towards the top owing to the decrease in temperature, but from present information, it is impossible to determine the extent of this difference. Ordinarily, the vertical reinforcement required to resist wind moment if placed near the outside of the chimney wall will suffice for vertical temperature reinforcement, and experience indicates that about 0.3 to 0.4 per cent circumferential reinforcement will yield satisfactory results. It is desirable to make the walls as thin as practicable

in order to minimize the difference in temperature between the outside and inside surfaces of the chimney.

Chimney Base.—The base of a chimney must be of sufficient size to provide adequate bearing area in order that the bearing capacity of the soil or of the foundation may not be exceeded. Owing to the increase of pressure at the edge of the base due to the wind moment on the chimney, it will be found necessary to make the area of the base about 2.5 times the area required to support the weight of the chimney itself with the given soil bearing capacity.

Having determined the size of the base, it is then necessary to calculate the stresses occurring in it. The base of a chimney should be either circular or octagonal, for the distribution of soil pressure under a square base is unsatisfactory because the pressure is likely to be excessive at the corners. Moreover, the reinforcement of a square base is more difficult to arrange than for a more nearly circular form.

When the resultant pressure falls within the kern of the base, the pressures at the edges may be readily calculated by the equation, $p = W/A \pm Mc/I$, where W is the weight of the chimney, A is the area of the base, M is the moment of the wind on the shaft

about the base, c is half the diameter, and I is the moment of inertia of the base.

However, usually the resultant of the weight and wind pressure falls without the kern, as shown in Fig. 193. Let p_1 be the unit pressure at the outer edge for a circular base, then the pressure at a distance x from the center is $p_1 \frac{R(1-k) + x}{R(2-k)}$, and the reaction over a differential area is

$$dP = 2p_1 \frac{R(1-k) + x}{R(2-k)} \sqrt{R^2 - x^2} dx$$

and the moment of this reaction about the neutral axis is

$$dM = 2p_1 \frac{[R(1-k) + x]^2}{R(2-k)} \sqrt{R^2 - x^2} dx$$

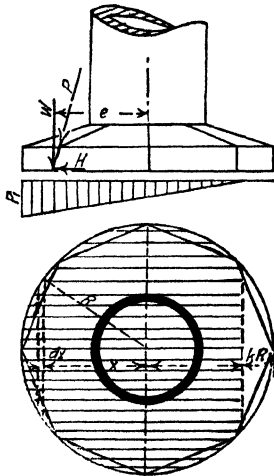

FIG. 193.—Soil pressure under a chimney base.

From which the following equations may be derived

$$W = \frac{2p_1}{R(2-k)} \int_{-R(1-k)}^R [R(1-k) + x] \sqrt{R^2 - x^2} dx \quad (1)$$

$$W\{e + R(1-k)\} =$$

$$\frac{2p_1}{R(2-k)} \int_{-R(1-k)}^R [R(1-k) + x]^2 \sqrt{R^2 - x^2} dx \quad (2)$$

The integrals of these equations are not reducible to simple explicit functions. Following Turneure and Maurer,¹ a graphical relationship is given in Fig. 194. The maximum pressure for a circular base is given by the equation $p_1 = mW/A$, in which A is the area of the circular base and m is a coefficient obtained from the diagram. Where the base is square, the maximum toe pressure on one side may be obtained by the formula

$$p_1 = \frac{2W}{3(L/2 - e)}$$

The chimney should be securely anchored to the base by extending the vertical reinforcement into the base so as to secure adequate bond. Where at least forty diameters of the bar can not be obtained as embedment by extending the bars directly, they should be hooked to the reinforcement at the bottom of the base.

The shear strength of the base should be investigated as well as its strength in flexure, and the edge of the base made of sufficient thickness to withstand the shear to which it may be subjected. This requirement will necessitate a base about 3 ft. thick at the edge for a 100 ft. chimney and about 7 ft. thick for a 300 ft. chimney.

The positive moment at the center of the base due to the direct weight of the chimney will usually be relatively small, but

¹ TURNEAURE and MAURER, "Principles of Reinforced Concrete Construction," p. 424.

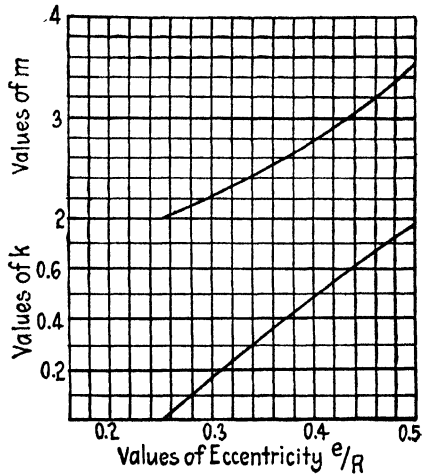

FIG. 194.—Diagram for calculating soil pressure under a chimney.

in a thin base under a chimney of large diameter, it should be investigated. The stress in a bearing plate may be calculated as explained on p. 42.

Materials for Chimneys.—Brick chimneys are sometimes built of common brick, but more frequently high chimneys are constructed of radial brick of special design. In either case, the brick should be of good quality, well burned, and having a specific gravity of at least 2.0. They should be uniform in size and color and have a crushing strength of not less than 4,000 lbs. per square inch.

The mortar for a brick chimney should consist of about $\frac{1}{4}$ part hydrated lime, $\frac{3}{4}$ part portland cement and 3 parts sand. The sand should be a fairly coarse sand screened to remove particles coarser than $\frac{1}{4}$ in. Mortar for the lining should consist of cement, sand and fire clay.

For a concrete chimney, it is preferable to use aggregates other than quartz rocks because these spall when heated. Limestone may be calcined by high heat, hence, a trap rock is desirable when it can be obtained.

Since a chimney is particularly susceptible to lightning, it is important that suitable lightning protectors should be provided. For a diameter of 5 ft., two points at the top should be provided, and one additional point for each 2 ft. additional diameter. The points should be $\frac{3}{4}$ by 8 in. copper rod with a $1\frac{1}{2}$ in. platinum coated tip. These points should be attached to a ring of twisted copper cable of not less than seven strands of No. 10 wire attached around the top at the outer edge, and a similar copper cable should reach from this ring to the ground, extending to a copper plate embedded well below ground water in the ground. This "ground" should be constructed while the foundation is being placed.

Figure 195 shows the type of reinforced concrete chimney built by the Weber Chimney Co. of Chicago. A square base is used containing a rectangular and diagonal net of steel.

Architectural Treatment of Chimneys.—From their nature, chimneys are not handsome structures, particularly when emitting a cloud of black smoke. However, considerable may be done to improve the sightliness of these structures by giving attention to the detail. It is probably generally accepted that the shaft should be tapering, although the amount of taper will necessarily depend upon the conditions to be met. Paneling

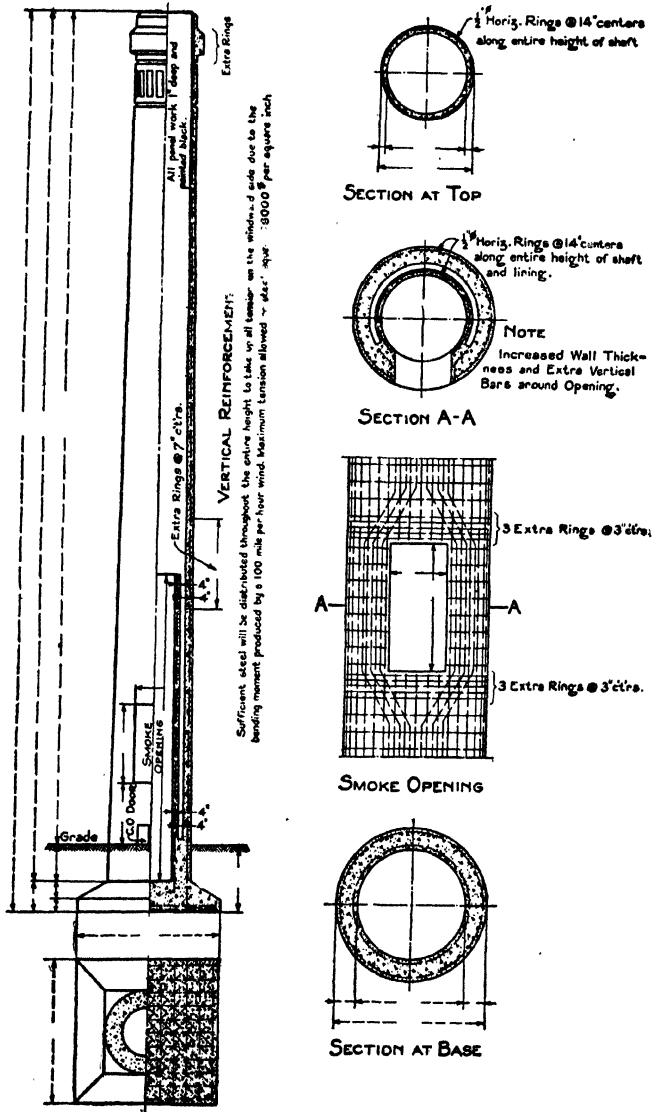

FIG. 195.—Reinforced concrete chimney built by the Weber Chimney Co.

and projecting arches are devices that are frequently used in brick chimneys, while fluting is sometimes employed in concrete chimneys.

At the Windsor Street power house, Montreal, the stack was given special treatment by an architect with a view to improving its appearance. The body of the chimneys is of buff brick with a panel course of gray terra cotta blocks spanned by arches of the same material. Above these arches and near the top is a projecting course of the same gray terra cotta, the entire effect being to relieve the monotony of the uniform circular shaft. The chimneys at the heating plant of Yale University afford another example of notably successful architectural treatment at a location where plain shafts would have been offensive among buildings of unusual beauty and charm.

The enlarged top of a chimney may take one of various forms, but it should bear some suitable proportion to the size of the entire structure.

As in other engineering structures, excessive ornamentation in a chimney is objectionable, yet attention given to the form and color of a chimney may yield a rich return in appearance with little if any additional cost.

CHAPTER XII

FORMS AND CONSTRUCTION

Introduction.—Falsework is a general term and may be defined as a temporary structure whose function is to aid in the erection of a permanent structure. Forms for concrete are special types of falsework for molding concrete masonry structures. Falsework used in the support of stone or brick masonry structures during construction are frequently referred to as centers, a term applicable especially to the falsework used in the construction of masonry arches and conduits.

Considerations of economy in construction require careful attention to be given to the design of forms and falsework because this item constitutes a considerable portion of the total cost of masonry structures. Large construction companies design and detail their forms and falsework with almost as much care as is used in the design of the primary structure. The form sections and other parts are framed at a central mill and yard and then given erection markings in a manner similar to those used in the construction of steel structures. This procedure yields great economy over the older one of leaving the design and assembling of the forms to the wasteful methods of foremen and carpenters in the field.

Elements Affecting the Design of Forms.—Various factors enter into the design of forms, among which may be mentioned the following items:

1. The forms should be rigid and stable under the weight of the concrete;
2. The interior surface should be adapted to forming a good concrete surface, requiring,
 - (a) Smoothness of form surface,
 - (b) Properly formed corners and angles;
3. Tightness to prevent leakage of matrix;
4. Ease of stripping after the concrete has set;
5. Provision for re-use;
6. Economy,
 - (a) Joists and girts should be in as few lengths as possible to save time in sorting,

- (b) Stock sizes of timbers should be used,
- (c) Sectional units should be as large as can be easily handled,
- (d) Panels should be made of an even number of board widths, so far as practicable.

Two considerations enter into the mechanics of form design, viz., stability and economy. Since the structure is of a temporary nature, high unit stresses may be used in the design, provided that resulting deflections, bulging and twisting, or other deformations are not so great as to mar the appearance of the finished structure. Forms should be designed not only for ultimate stability, therefore, but with a view to producing an even smooth surface.

The loads to which concrete forms are subjected consist of the weight of the supported concrete, the pressure of the wet concrete when freshly deposited, the buoyancy of wet concrete, the weight of staging, runways, and platforms for mixing and transporting the concrete in "buggies" or otherwise, etc.

Pressure of Wet Concrete on Forms.—The pressure exerted by freshly deposited concrete against forms depends primarily upon the consistency of the concrete. Dry or plastic concrete

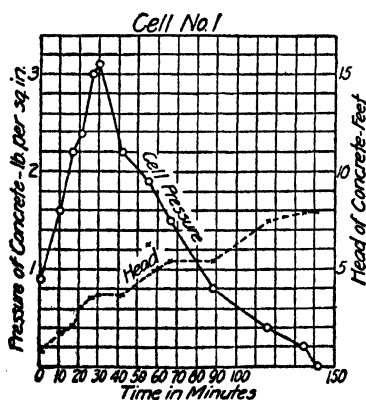

FIG. 196.—Effect of time on the pressure of concrete on forms.

behaves similarly to any other plastic material and exerts a lateral pressure that is only a fraction of the vertical pressure, while mushy and wet concrete gives pressures that approach fluid pressure for a liquid of similar specific gravity to concrete. Tests made by the Aberthaw Construction Company¹ and by Professor A. B. McDaniel at the University of Illinois² indicate that wet concrete of a rich mixture while being deposited exerts a pressure equivalent to that of a fluid weighing 140 to 150 lbs. per cubic foot. Tests made by the Bureau of Standards³ indicate the equivalent pressure of a liquid weighing 124 lbs. per cubic foot.

¹ *Concrete-Cement Age*, Oct., 1913.

² *Concrete*, May, 1917.

³ U. S. Bureau of Standards, *Tech. Paper 175*.

The greater time required in pouring, the more viscous the material becomes and the less the pressure exerted because the concrete begins to set up and when the initial set occurs, the pressure rapidly falls off as indicated in Fig. 196. From the tests of the Bureau of Standards, the conclusion may be drawn that the greatest pressure head that may be considered will not be greater than a depth that can be poured in about 40 minutes.

The pressure in pounds per square foot from a plastic or dry mix of concrete may be calculated by the formula $\frac{1 - \sin \phi}{1 + \sin \phi} wh$, w being the weight per cubic foot, h the effective head in feet, and ϕ the angle of repose, which varies from 10° for mushy concrete and 20° for plastic to 30° for dry concrete.

Buoyant Effect of Wet Concrete.—Where any portion of the forms are immersed in the concrete, the latter exerts a considerable buoyant force tending to float or lift that portion of the forms. The amount of this force is dependent upon the consistency of the concrete and slope of the exposed surface.

Where the exposed surface is horizontal and the buoyant effect is directly upward, the intensity of the buoyant pressure in lbs. per square foot may be calculated by the expression $\left(\frac{1 - \sin \phi}{1 + \sin \phi}\right)^2 wh$, w being the specific weight per cubic foot, h the head of the fresh concrete that may be considered effective and ϕ the angle of repose of the concrete, varying as above from 10° for mushy concrete to 30° for dry concrete. A very wet concrete will give practically full fluid buoyancy.

In small pier forms, where the sides are given a heavy batter, trouble may be experienced in the rising of the forms, the buoyancy being effective over the projected area of the batter. Where the forms are battered more than 4 in. per foot, it becomes very difficult to anchor the forms down so as to prevent their rising when the concrete is deposited. In a similar manner, a concrete bin with sloping sides which has an internal form with sloping sides presents a difficulty in anchorage of the forms.

Lumber for Forms.—The ideal lumber for formwork should be light and strong, and obtainable at a low price per thousand feet. The kind that will actually be used, will vary with the locality since this factor largely governs the cost. White pine, spruce, southern pine and Douglas fir are the most satisfactory and most commonly used. Hemlock splits too easily to be satisfactory

form lumber. The lumber should be free from imperfections, such as wind shakes, waness, large knots. Planed lumber for sheathing is necessary where a smooth surface is desired, and generally will be found economical because of the greater facility in framing and stripping. For braces and other supports, a cheaper grade of unplanned lumber may be used so long as it is sound. Forms are required to sustain great weight at times and many serious accidents have occurred due to insufficient supports.

In work where unusual finish is desired, tongue-and-grooved lumber may be used for sheathing, which will effectively prevent leakage of the matrix of the concrete. Beveled edge stock has the advantage that when the lumber swells after being wet, the edges compress against each other and thus make a tight joint.

It is seldom economical to re-work second hand form lumber owing to the presence of nails that have to be pulled, and to the coating of dry mortar that has adhered to the forms, which dulls and injures tools. The cost of labor and equipment for making forms of second hand lumber will be about twice that for new lumber.

Table XXXI gives the board feet in various sizes and length of lumber for use in forms and falsework. Lumber is sold by the feet board measure (f.b.m.), usually at so much per thousand feet. One board foot may be defined as a board 1 ft. square and 1 in. thick. Thus, a board $1\frac{1}{2}$ in. by 10 in. by 16 ft. contains $1\frac{1}{2} \times 10 \times 16$ or 240 board feet.

Bracing Concrete Forms.—Forms for concrete should be braced with two objectives in view; first, to make the form rigid within itself by firm tying with rods or wires and by internal bracing, and second, the form as a whole should be securely anchored to the ground or to other parts of the main structure to prevent movement of the entire form. The devices used to accomplish the former may be called *bracing* and those for the latter, *anchorage* or *shoring*.

Bracing consists of ties, such as wires, rods, girdles, and "spreaders," or short struts for holding the wall forms apart until the concrete is poured. (It is necessary of course to remove the spreaders from the forms as the concrete rises in the latter during pouring.) A variety of patented clamps and other devices for holding forms and reinforcing steel in place are on the market which aid in the placing of forms and facilitate the removal of the former. The function of the bracing is to with-

TABLE XXXI.—BOARD FEET IN VARIOUS SIZES AND LENGTHS OF LUMBER

Size of timber in inches	Length of piece in feet							
	10	12	14	16	18	20	22	24
1 × 2	13 ² / ₃	2	23 ² / ₃	23 ² / ₃	3	31 ² / ₃	33 ² / ₃	4
1 × 3	23 ² / ₃	3	33 ² / ₃	4	43 ² / ₃	5	53 ² / ₃	6
1 × 4	33 ² / ₃	4	43 ² / ₃	53 ² / ₃	6	63 ² / ₃	73 ² / ₃	8
1 × 5	43 ² / ₃	5	53 ² / ₃	63 ² / ₃	73 ² / ₃	83 ² / ₃	93 ² / ₃	10
1 × 6	5	6	7	8	9	10	11	12
1 × 8	63 ² / ₃	8	93 ² / ₃	103 ² / ₃	12	133 ² / ₃	143 ² / ₃	16
1 × 10	83 ² / ₃	10	113 ² / ₃	133 ² / ₃	15	163 ² / ₃	183 ² / ₃	20
1 × 12	10	12	14	16	18	20	22	24
1 × 14	113 ² / ₃	14	163 ² / ₃	183 ² / ₃	21	233 ² / ₃	253 ² / ₃	28
1 × 16	133 ² / ₃	16	183 ² / ₃	213 ² / ₃	24	263 ² / ₃	293 ² / ₃	32
1 × 20	163 ² / ₃	20	233 ² / ₃	263 ² / ₃	30	333 ² / ₃	363 ² / ₃	40
1 1/2 × 4	5	6	7	8	9	10	11	12
1 1/2 × 6	73 ² / ₃	9	103 ² / ₃	12	133 ² / ₃	15	163 ² / ₃	18
1 1/2 × 8	10	12	14	16	18	20	22	24
1 1/2 × 10	123 ² / ₃	15	173 ² / ₃	20	223 ² / ₃	25	273 ² / ₃	30
1 1/2 × 12	15	18	21	24	27	30	33	36
2 × 4	63 ² / ₃	8	93 ² / ₃	103 ² / ₃	12	133 ² / ₃	143 ² / ₃	16
2 × 6	10	12	14	16	18	20	22	24
2 × 8	133 ² / ₃	16	183 ² / ₃	213 ² / ₃	24	263 ² / ₃	293 ² / ₃	32
2 × 10	163 ² / ₃	20	233 ² / ₃	263 ² / ₃	30	333 ² / ₃	363 ² / ₃	40
2 × 12	20	24	28	32	36	40	44	48
2 × 14	233 ² / ₃	28	323 ² / ₃	373 ² / ₃	42	463 ² / ₃	513 ² / ₃	56
2 × 16	263 ² / ₃	32	373 ² / ₃	423 ² / ₃	48	533 ² / ₃	583 ² / ₃	64
2 1/2 × 12	25	30	35	40	45	50	55	60
2 1/2 × 14	293 ² / ₃	35	403 ² / ₃	463 ² / ₃	523 ² / ₃	583 ² / ₃	643 ² / ₃	70
2 1/2 × 16	333 ² / ₃	40	463 ² / ₃	533 ² / ₃	60	663 ² / ₃	733 ² / ₃	80
3 × 6	15	18	21	24	27	30	33	36
3 × 8	20	24	28	32	36	40	44	48
3 × 10	25	30	35	40	45	50	55	60
3 × 12	30	36	42	48	54	60	66	72
3 × 14	35	42	49	56	63	70	77	84
3 × 16	40	48	56	64	72	80	88	96
4 × 4	133 ² / ₃	16	183 ² / ₃	213 ² / ₃	24	263 ² / ₃	293 ² / ₃	32
4 × 6	20	24	28	32	36	40	44	48
4 × 8	263 ² / ₃	32	373 ² / ₃	423 ² / ₃	48	533 ² / ₃	583 ² / ₃	64
4 × 10	333 ² / ₃	40	463 ² / ₃	533 ² / ₃	60	663 ² / ₃	733 ² / ₃	80
4 × 12	40	48	56	64	72	80	88	96
4 × 14	463 ² / ₃	56	653 ² / ₃	743 ² / ₃	84	933 ² / ₃	1023 ² / ₃	112
6 × 6	30	36	42	48	54	60	66	72
6 × 8	40	48	56	64	72	80	88	96
6 × 10	50	60	70	80	90	100	110	120
6 × 12	60	72	84	96	108	120	132	144
6 × 14	70	84	98	112	126	140	154	168
6 × 16	80	96	112	128	144	160	176	192
8 × 8	533 ² / ₃	64	743 ² / ₃	853 ² / ₃	96	1063 ² / ₃	1173 ² / ₃	128
8 × 10	663 ² / ₃	80	933 ² / ₃	1063 ² / ₃	120	1333 ² / ₃	1463 ² / ₃	160
8 × 12	80	96	112	128	144	160	176	192

stand the forces such as internal pressure tending to cause deformation of the forms by bulging or spreading.

Anchorage or shoring consists chiefly of braces or struts extending to stakes driven into the ground, to firm members of the finished portions of the structure, to other buildings, or to solid objects. These should be placed so that their attachment will injure the forms as little as possible and so that they may be readily removed when the concrete has set up.

Composition of Forms.—Forms for concrete construction in general consist of vertical or horizontal studs of dimension timbers, usually 2 by 4 in., or 2 by 6 in. stock, lined with lagging or sheathing of 1 to 1½ in. stock, the whole being held on the outside by longitudinal girts. The particular arrangement of these component parts depends upon the character and shape of the structure being built. By giving careful attention to the method of form construction in connection with the design of the structure, a considerable saving may be effected in the spacing of panels, avoiding difficult features, and adopting uniform details.

In the early years of concrete construction, the forms were built up in place by the field forces, but now approved practice requires that they be framed in sections at a central plant, and then the sections are commonly bolted together in the field. Forms for low walls and for minor work are still constructed *in situ* more advantageously. In either case, the building of the forms will be made more economical generally if form plans are prepared, and in the construction of large and complicated structures, careful design and plans of forms are quite essential.

The thickness of lumber used for forms varies with the conditions to which it is subjected. For short spans between supports, such as floor slabs and wall forms, 1-in. stock is commonly used; for columns, either 1 in. or 1¼ in. is used, according to the spacing of the column yokes; for beam sides and bottoms, 2-in. stock is preferable, although 1½-in. is sometimes used. Dressed lumber is about ⅛ to ¼ under the commercial size of the rough lumber. Shores and supports for forms usually consist of 3 by 4, 4 by 4 or 2 by 4 in. studding. Timbers as large as 4 by 6, 6 by 8 or 8, by 10 in. may be used to shore up forms where the masses of concrete to be supported are exceptionally heavy.

Lubrication of Forms.—Unless the inside surface of forms is wetted or lubricated in some manner before the concrete is poured, the latter will adhere to the forms and thus produce a disfigured surface after the forms have been stripped and at the

same time diminish the value of the forms for re-use. If the forms are to remain on the concrete until the latter is thoroughly hard, wetting the forms with water from a hose just before the concrete is poured will suffice, but if the forms are to be re-used sectionally as soon as the concrete becomes self-supporting, it is desirable to use some other lubricant.

A good coating material should be thin enough to spread easily and uniformly and at the same time fill the grain and the pores of the wood. Crude oil or petroline is a satisfactory coating for forms, although various other substances may be used. Oiled forms should not be used when the concrete surface is to be plastered because an oiled surface hinders the adhesion of the plaster.

The use of oil as a lubricant will usually pay for itself in the reduced cost of removing the forms and in the greater ease of finishing the concrete surface. The expense in coating the forms with oil that may be economically justified will depend upon the character of the work. Where panels are to be used repeatedly thorough coating will be found economical, but where from the nature of the work, the forms can be used but once, such care in this respect is not justified.

Examples of Concrete Forms.—While the particular type of forms to be used on any piece of work must be determined by local conditions, yet typical arrangements for various representative or elemental structures may assist the student in seeing the relation between the finished structure and the forms that produce it.

Column Forms.—Rectangular and octagonal columns are usually made of wood with the boards vertical braced by means of yokes. Round columns are almost always molded in steel forms. There should always be a clean-out hole left at the bottom of a column form because the shavings, sawdust, etc. will almost always collect at the bottom of the column form when the forms for girders, beams and slabs are swept out preparatory to the pouring of the concrete. This clean-out hole should be of sufficient size to permit the thorough cleaning and inspection of the bottom of the column form before the concrete is poured.

In some instances it is more convenient to assemble three sides of the column form leaving the fourth out until after the reinforcement is in place, a procedure that is usually necessary when the reinforcing is more than one story high. Under other

conditions, especially for small columns, it is more convenient to assemble the column form complete and place it at one operation.

Figure 197¹ shows some of the common types of column forms. The sheathing consists of 1¼-in. stock, T. & G. D2S, and the yokes are 4 by 4 in. pine. The bolts are ½ or ⅝ in.; a smaller size while giving ample tensile strength will be bent too easily in handling. Special forms of yokes are extensively used.

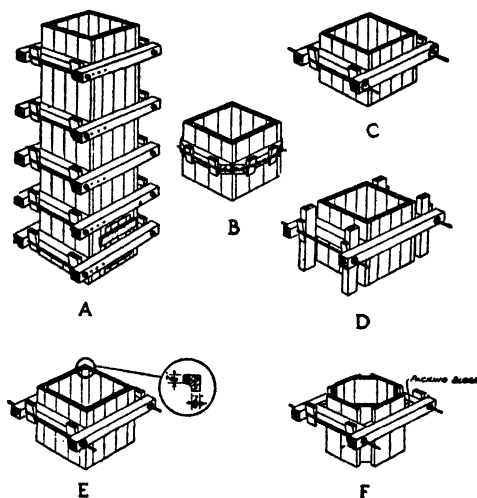

FIG. 197.—Typical column forms.

Table XXXII gives the spacing of yokes for rectangular columns for various heights using 1¼-in. stock for sheathing. To find the spacing for a column 24 in. by 30 in., 14 ft. high, trace across on the 14-ft. line to the column headed 30 in., which gives 7 in. as the proper spacing for the bottom yokes, 8 in. for the next three, 9 in., 10 in. etc., in order up the column form.

Steel forms for round columns are obtainable from certain firms who rent to users, the charge being based chiefly on the length of time the forms are in use.

Beam Forms.—The manner of constructing forms for beams depends upon the character of the building and the manner of removing the forms. Where the forms are to be removed all in one piece after the concrete has set up, as may be the case if the entire forms can be left in place until the concrete is fully hard,

¹ "Handbook of Concrete Construction," Atlas Portland Cement Co.

TABLE XXXII.—SPACING OF COLUMN YOKES

Height	Largest Dimension of Column in Inches							
	16"	18"	20"	24"	28"	30"	32"	36"
1'								
2'	3"	29"	27"	23"	20"	20"	19"	17"
3'	3"	28"	26"	23"	20"	20"	19"	17"
4'	3"	28"	26"	23"	20"	20"	19"	17"
5'	3"	28"	26"	23"	20"	20"	19"	17"
6'	30"	28"	26"	22"	18"	18"	17"	15"
7'	30"	26"	24"	22"	18"	18"	17"	15"
8'		26"	24"	22"	18"	18"	17"	15"
9'		26"	24"	22"	18"	18"	17"	15"
10'	29"	20"	19"	16"	13"	12"	10"	8"
11'	29"	20"	19"	16"	13"	12"	10"	8"
12'	21"	18"	16"	14"	11"	9"	8"	7"
13'	20"	18"	16"	14"	11"	9"	8"	7"
14'	20"	16"	15"	13"	10"	9"	8"	7"
15'	18"	13"	12"	10"	9"	8"	7"	6"
16'	15"	13"	11"	9"	8"	7"	6"	5"
17'	14"	12"	11"	9"	8"	7"	6"	5"
18'	13"	12"	10"	9"	8"	7"	6"	5"
19'	13"	11"	10"	9"	8"	7"	6"	5"
20'	13"	11"	9"	8"	7"	6"	5"	4"

the forms must be structurally strong enough to stand the stripping, removal and re-erection. In such cases, the lumber is usually of 2-in. stock throughout. Figure 198 shows beam, girder and slab forms designed to be removed as a unit.

The more common procedure, however, is to leave the bottoms of the beam and girder forms in place in order to support the green concrete until it is sufficiently hard to withstand the load coming upon it. In this case, the bottoms are made of 2-in. lumber but the sides may be of lighter stock. Figure 199 shows forms for beams, girder and slabs designed for leaving the bottoms in place when the sides are removed. The forms for the beams and girders are essentially similar, except that the girder forms are weaker owing to the notches in the sides for

receiving the ends of the beams, and hence, are somewhat more difficult to handle without breaking.

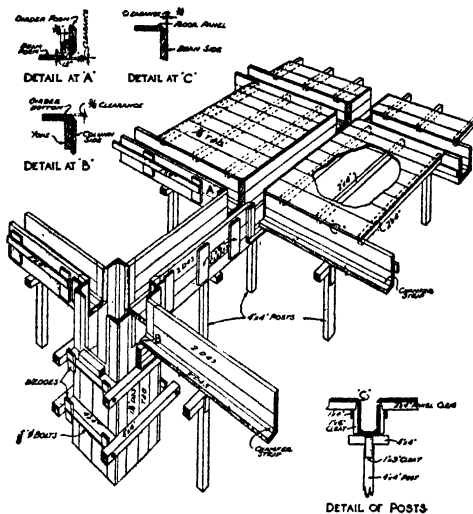

FIG. 198.—Beam and girder forms, bottom attached.

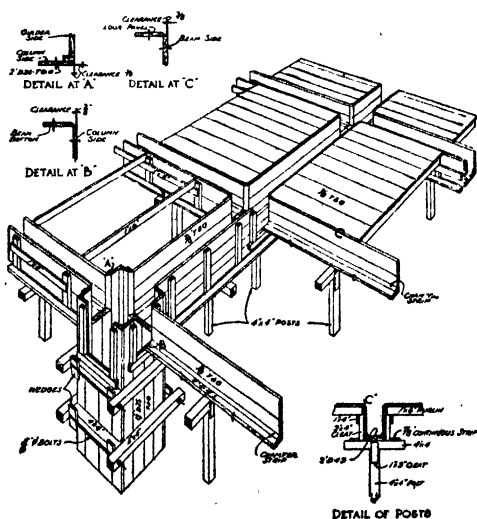

FIG. 199.—Beam and girder forms, bottom detached.

Wall Forms.—Wall forms are usually made up in panels using 1 in. or $\frac{7}{8}$ in. sheathing fastened together with cleats. Figure

200 shows a typical wall form. The two sides are tied together with wires or with bolts and held at the proper space with short

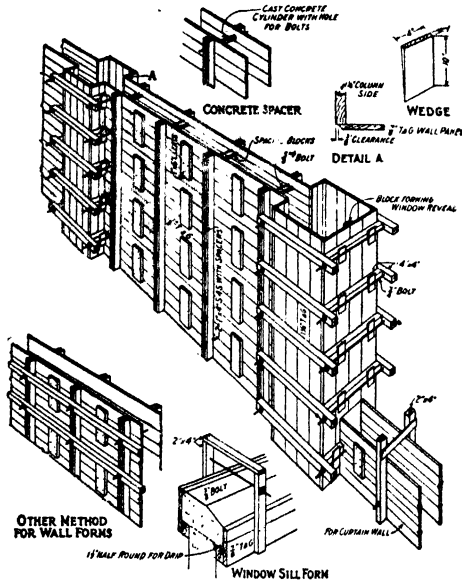

FIG. 200.—Typical wall forms.

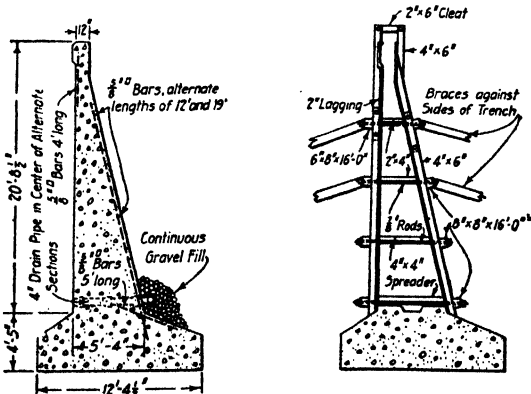

FIG. 201.—Retaining wall form, Miami Conservancy District.

wood spreaders. These spreaders must be knocked out and removed as the concrete rises in the form while being poured. Large plain walls are frequently built with sliding forms, which will be described in a subsequent paragraph.

To facilitate stripping of forms, it is very important that the ends of sheathing at a re-entrant angle shall not project into the concrete after it is poured. If the ends are cut back slightly, the stripping of the forms will be facilitated and the appearance of the structure will not be marred.

Wall forms are sometimes stiffened by bolting additional 2 by 4, or 4 by 4 in. braces to the upright standards which hold the sheathing. When the forms are built in sections, the standards at the edge of the sections, usually consisting of 2 by 4 in. studding, are flush with the edge of the sheathing and bolted to the corresponding standards of the adjacent sections.

Retaining Wall Forms.—Forms for retaining walls are usually built in sections with a view to re-use. It is important that the bracing be rigid and that the shoring be securely attached to rigid stakes or other stable support. Figure 201¹ is the form used by the Miami Conservancy District at Dayton, Ohio. The footing form, (not shown) was the ordinary built-in-place type; the wall forms are movable sections held apart by spreaders and tied together with bolts. The sections were 16 ft. long, corresponding to the sections of the wall, and were swung forward by means of a derrick. The sections were divided horizontally into halves to facilitate handling and to permit the use at other places.

Figure 202² is the retaining wall form used by the C. B. & Q. R. R. to construct the fillet type of reinforced concrete wall shown in Fig. 115. Figure 203³ shows the form for the Webb City, Mo., reservoir wall.

The C. R. I. & P. R. R. is reported⁴ to have effected a saving of about 70 per cent in the cost of erection of large retaining walls by the use of movable forms over the cost with forms built in place; as well as a saving of 75 per cent in time. The wall was built in alternate sections to facilitate construction.

Conduit Forms.—Conduit forms consist of two parts, the outside form and the inside collapsible form or center. Various devices have been arranged to facilitate the handling of such forms, particularly for circular sections. Figure 204 shows the form for a large storm sewer at Louisville, Ky., and Fig. 205

¹ *Engineering-Contracting*, Mar. 24, 1920.

² *Proc. W. Soc. of Engineers*, vol. 12, p. 349.

³ *Engineering Record*, May 11, 1912.

⁴ *Engineering Record*, Aug. 15, 1914.

shows another type of collapsible center that has been used advantageously.

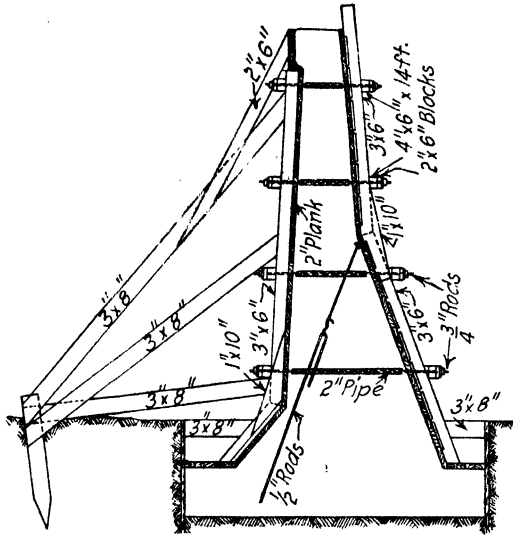
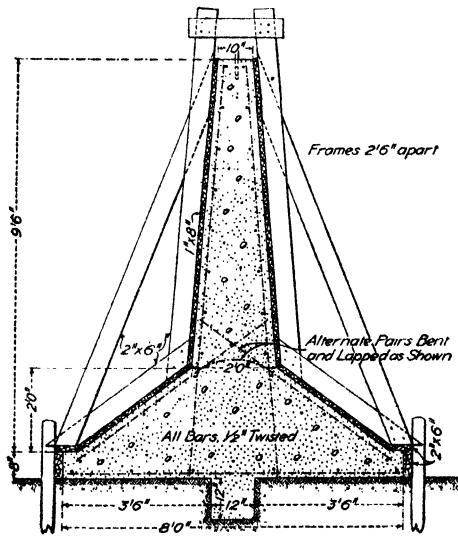

FIG. 202.—Retaining wall form, C. B. & Q. R. R.



Forms and Reinforcing of Division Wall

FIG. 203.—Reservoir wall form.

Sliding Forms.—In the construction of certain classes of structures involving large areas of unbroken walls, sliding forms

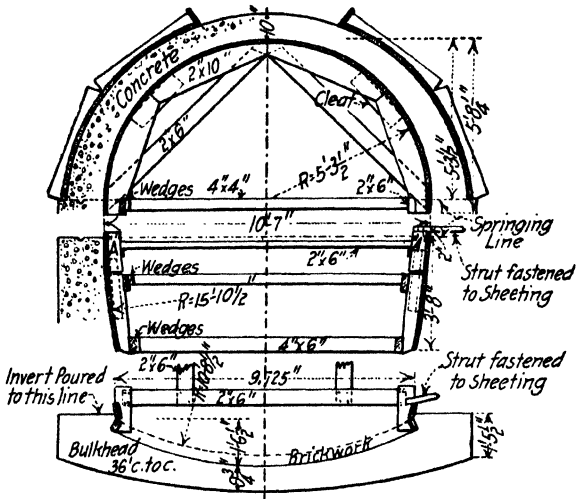

FIG. 204.—Forms for a large concrete sewer.

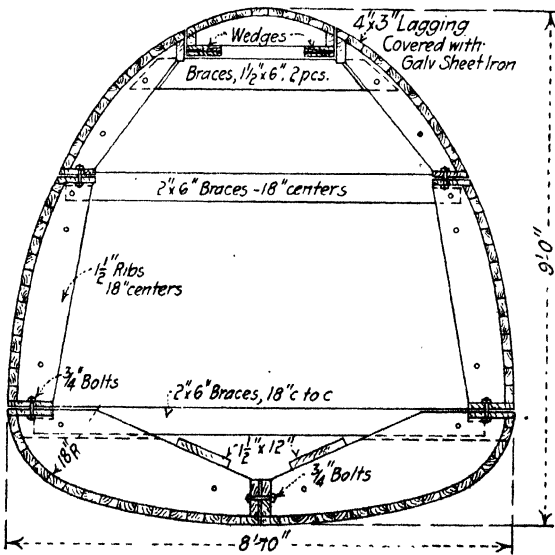

FIG. 205.—Collapsible center for a conduit.

may be used advantageously and are commonly used for these conditions. Grain elevators, chimneys, silos, tanks, and similar structures are well adapted to this method of construction. The forms are raised by means of special jacks attached to the

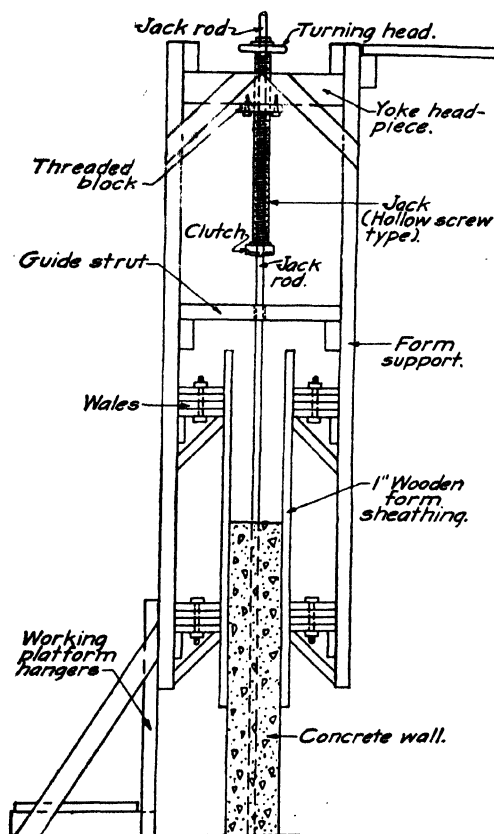

FIG. 206.—Sliding forms for a wall.

vertical reinforcing rods, as the concrete is poured and attains its initial set although formerly the jacks were attached to gas pipe extending up through the wall for this purpose. The jacking rods are spliced by means of a gas-pipe sleeve about 6 in. long. The jack rods are chosen of various lengths to avoid the jacks' reaching the tops of all at one time.

The forms consist of ordinary sheathing and extend down on the hardened wall past the junction with the fresh concrete. The concrete is poured at such a rate that at the bottom of the

form section, which is perhaps 4 to 6 ft. high, the concrete is about 24 hours old, while that at the top is fresh. The forms are raised about one foot at a time. It is preferable to pour the concrete continuously throughout the 24 hours in order that the concrete may not adhere to the forms and a more uniform result may be obtained. Figure 206 shows the use of sliding forms in the construction of a concrete grain elevator.

There are several different types of jacks in use for this purpose, the more successful ones being of the jack screw type. A sufficient number of jacks are attached to the forms so that when the turning heads are twisted the forms are raised steadily all the way round. A common type of jack consists of a hollow screw fitted at the top with a turning head and at the bottom with a clutch for gripping the vertical jacking rods imbedded in the concrete. The jacking rod passes up through the center of the jack which engages the yoke of the forms, so that when the turning head is operated the yoke is moved up, thus lifting the forms with it.

Special care must be exercised to have the forms level at the start and also to avoid raising the deposited concrete at the first lift of the form. The surfaces are finished from the working platform by means of wood floats as fast as the concrete is exposed. Openings in walls are formed by placing temporary bulkheads in the form.

Storage bins at Cedar Rapids, Iowa, 25 ft. diameter and 100 ft. high were poured in 19 days by means of sliding forms.

Steel Forms.—On large construction where the same structural units appear many times and on plain surfaces of great area, form units may be made up for repeated use. For example, in floor and column construction in buildings, conduits, large retaining walls, dams, and other walls of large unbroken surface, sectional forms for repeated use are economical. In such cases, steel forms, which can be rented from commercial firms or bought outright, may be used advantageously. Figures 207 and 208¹ show typical uses of steel forms. The rental of steel forms runs from 6 to 12 cents per square foot, depending upon the weight and complexity, and the erecting, stripping, and handling amount to 7 to 18 cents per square foot. Hence, it is necessary to be

¹ Courtesy, Blaw-Knox Co., Pittsburgh.

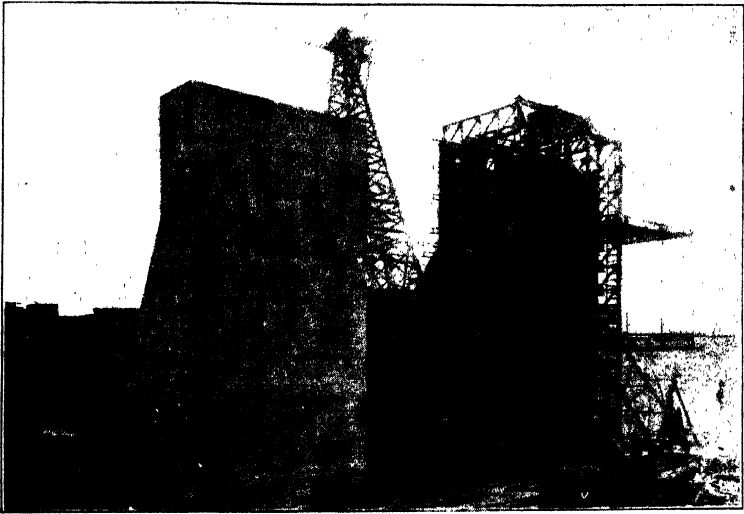

FIG. 207.—Heavy steel forms for walls on lock at Lockport, Ill.

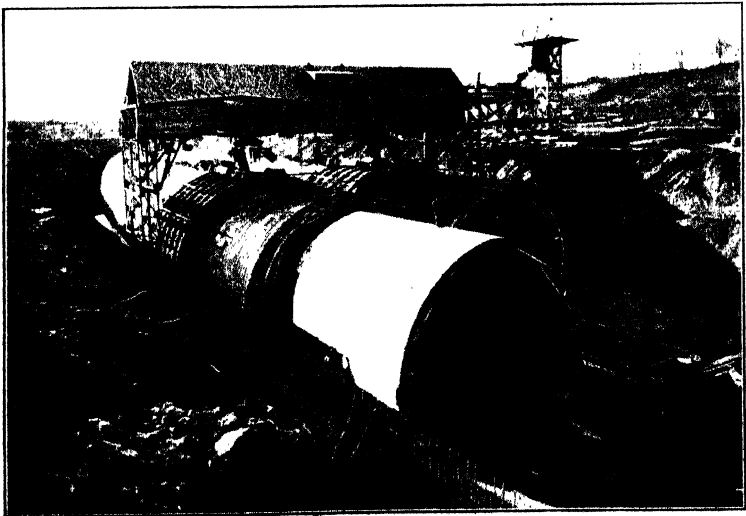

FIG. 208.—Telescopic conduit forms of steel, River des Peres, St. Louis.

able to use them about six times in order that they may be more economical than wooden forms.

Cost of Forms —The proportion of the whole cost of a structure chargeable to forms varies with the type of structure and the intricacy of the form work. In any case, the forms constitute a considerable item of the total cost and justify therefore much care in their design. The cost of forms depends on

- (a) The cost of lumber;
- (b) The cost of labor;
- (c) The method of handling form work;
- (d) The character of the structure;
- (e) The number of times the lumber may be re-used, in the case of wood forms.

Three different methods are in use for estimating the cost of forms, viz., (1) the cost per cubic yard of concrete, (2) the cost per thousand feet b.m. of lumber used, and (3) the cost per square yard of form or concrete area. Neither one of these methods furnishes a unit of form cost with which the cost will vary in direct proportion for all structures. The three methods of estimating should be used as checks on each other.

The cost of forms per cubic yard of concrete varies greatly depending upon whether the structure is of mass concrete or reinforced concrete consisting of small members. The forms for a mass dam or plain retaining wall would obviously be much less per cubic yard than they would be for a reinforced concrete building consisting of beams and slab members. Moreover, the cost varies with the size of the member even when the relative proportions are unchanged. For example, the forms for a 20-in. square column will be less per cubic yard of concrete than they will be for a 12-in. column. From the above considerations, it is obvious that the cubic yard of concrete does not furnish a satisfactory unit basis for estimating the cost of forms, except in work of a given class.

The cost of forms per thousand feet of lumber b.m. may be used as a unit of cost in estimating form work, although this cost will vary greatly with the character of the work and the number of times the lumber can be used. Where costs for framing and for erecting are kept separate, estimates of form work may be made with fair reliability as follows:

M.b.m. lumber new at \$.....per M
Framing same at \$..... per M.....
Erecting same at \$..... per M.....
Stripping and removing at \$..... per M.....
Erecting.....M.b.m 2nd time at \$... per M
Total cost per M.....

Framing comparatively simple wall forms requires about eight hours work for one carpenter and one helper per 1,000 feet b.m. Tearing down such forms requires about five hours for one laborer per 1,000 ft. b.m. Complicated wall, floor and girder forms will require about twice the above time for the carpenters and about the same time for common labor in performing the corresponding operations.

The cost of forms more nearly varies with the area of the concrete or form surface than with the yardage of concrete, although, as before stated, the cost depends largely upon the nature of the work and the skill with which it is handled. The following figures show form costs of the Aberthaw Construction Co. in terms of form areas:¹

LABOR COST IN CENTS PER SQUARE FOOT OF FORM SURFACE

	Flat Slabs	Walls	Girders	Beams	Columns
Framing.....	1.25	1.25	1.75	1.75	2.50
Erecting.....	2.50	4.50	3.25	3.25	5.33
Stripping.....	0.70	0.70	1.00	1.00	1.00
Total.....	4 to 5	6 to 7	5 to 6	5 to 6	8 to 9

The above figures are based on wages as follows:

Carpenter foreman, \$30 to \$40 per week

Stripping gang, \$24 per week

Mill men, 50 cents per hour

Asst. mill men, 35 cents per hour

Labor, 30 cents per hour.

These costs are 25 to 40 per cent less than where form work is not carefully planned and systematically executed and are proportionately less than would obtain under advanced wages.

Standardized forms built to be used repeatedly in sections yield economies on large structures. In fact, the extent to which re-use is practicable is a primary factor in the cost of forms.

¹ *Concrete*, Aug., 1918.

Arch Centers.—The supporting falsework for masonry arches is commonly called the “centering” or the “centers.” Arch centering may be constructed in a number of ways, the mode of construction best adapted depending on the type and span of the arch being erected, the character of the crossing, the number of spans, etc. The types of arch centers most commonly used are pile bents as illustrated in the 190-ft. span of the Alaman-dares River bridge¹ Fig. 209, (2) frame bents as illustrated in a 102-ft. spans of the same bridge, (3) wood truss supported on tower bents, (4) frame bents supported on steel trusses as



FIG. 209.—Pile bents used as centering.

illustrated in the 281-ft. Monroe Street bridge at Spokane,² Fig. 210, and in the Kansas River bridge at Lawrence, Kansas, and (5) steel arches, usually of the three hinged type, as used in 123 to 181-ft. spans of the Detroit-Superior viaduct and for the Tunkhannock viaduct of the Lackawanna R. R. Fig. 66.³ Steel arch centers usually rest on a special projecting ledge on the piers.

The primary requisites of masonry arch centering are (1) rigidity, (2) minimum amount of material, (3) ease of erection, (4) simplicity in arrangement for “striking” or removing the centers without injury to the masonry, (5) possibility of repeated use.

Usually it is good economy to build arch forms and centers with complete assurance of rigidity even at the expense of additional material and labor, for lack of rigidity may not only cause trouble in the placing of the concrete but it may seriously

¹ *Trans. Am. Soc. C. E.*, vol. 74, p. 215

² *Engineering News*, May 4, 1911.

³ *Engineering News*, Sept. 2, 1915.

alter the distribution of stresses in the completed arch by altering the curve of the arch ring. Timber trusses of any considerable length are lacking in rigidity and hence are seldom

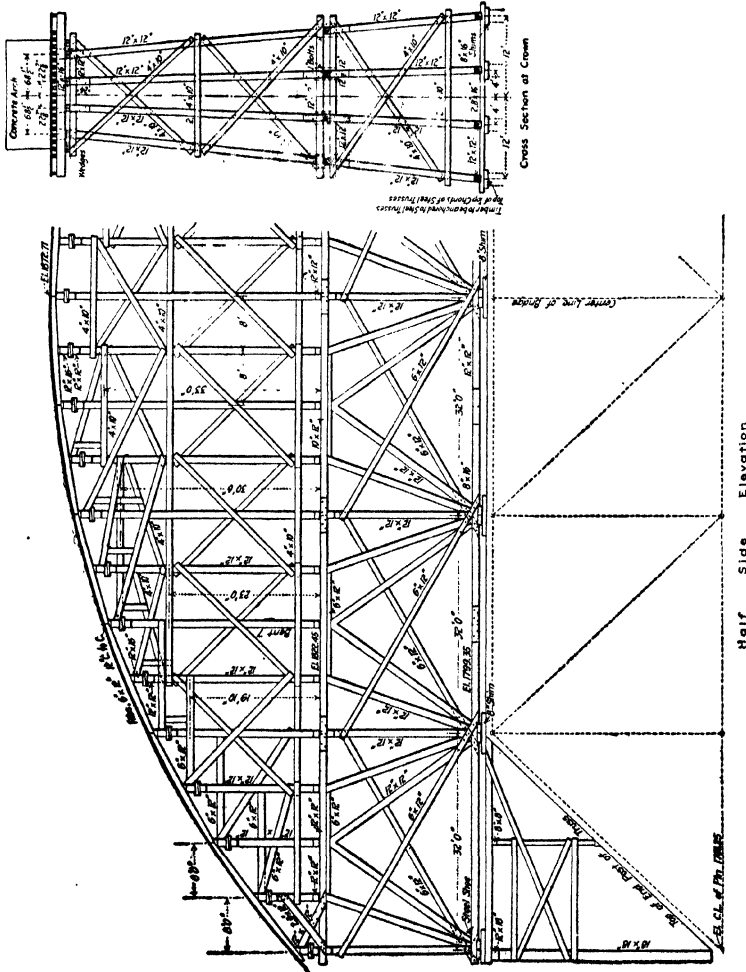

Fig. 210.—Timber centers on a steel truss.

employed. An allowance of $\frac{1}{2}$ to $1\frac{1}{2}$ inches is sometimes made for settlement at the crown when the masonry is put in place with a further allowance of perhaps $\frac{1}{2}$ inch when the centers are struck and the arch is permitted to carry the dead load. However, so great a settlement as this should not occur if the centers

are properly designed. As stated in another place (p. 204), some engineers virtually hinge their arches until all settlement and shrinkage have occurred and then fill the hinges with concrete in order that the settlement may not induce strains not provided for in the design.

In the case of single arch spans, timber centering is commonly used and is usually the most economical, but for bridges consisting of many spans of similar length, steel centers may be used to advantage. For arches high above the stream bed, particularly where pile driving is difficult or where timber falsework is likely to be carried away by flood or ice, steel centers of the three hinged type are advantageous. The deflection of steel arch

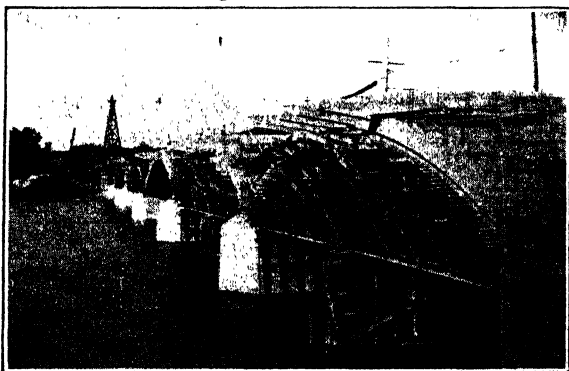

FIG. 211.—Timber centers on steel trusses used in constructing Lawrence, Kansas, bridge.

forms of the three hinged type is less than for the usual timber forms or for steel trusses with horizontal chords. The chief difficulty in the use of steel forms arises from the expansion and contraction due to temperature changes.

The device most commonly utilized for lowering arch centers consists of wedges inserted beneath the posts or framework which support the segments to which the lagging is attached. However, sand boxes, or cylinders filled with sand are sometimes used to support the end of steel falsework in the erection of large arches. The chief disadvantages of the use of sand boxes is that the sand compresses as the weight comes upon it thus increasing the depression of the falsework, and also that the arch centers are difficult to raise in making minor adjustments to elevation. When sand is used, it should be kept dry because wet sand is much more compressible than dry sand, and more-

over, the release of the sand through holes at the bottom of the boxes can be more readily effected with dry sand. Centers

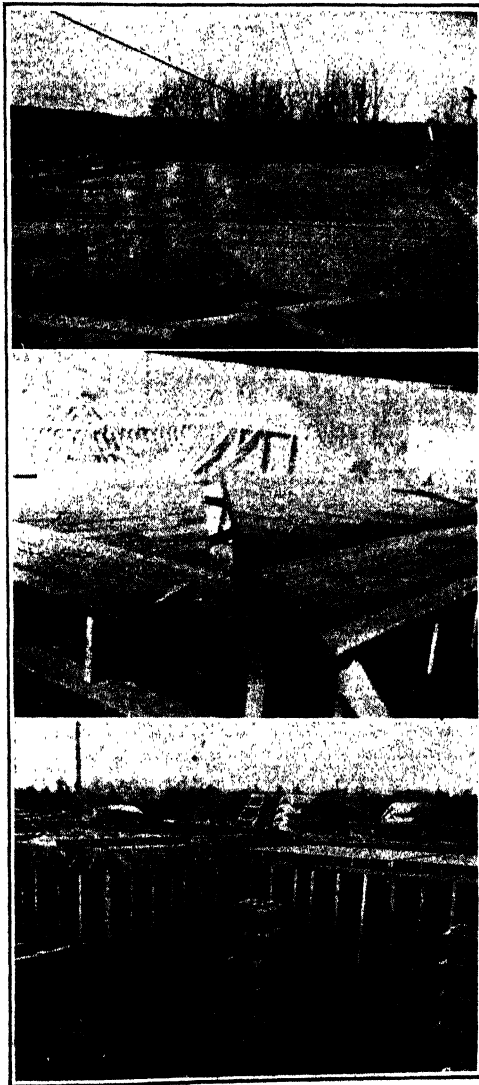

FIG. 212.—Forms for groined arches at Whitinsville, Mass. Showing method of construction.

consisting of three hinged steel arches are frequently struck by means of a toggle at the center hinge.

For groined arches, steel forms are advantageously used because of the possibility of repeated use. Fig. 212¹ shows the construction of wooden forms for groined arches over water filters at Whitinsville, Mass. built in 1919 by Metcalf and Eddy, Consulting Engineers.

Removal of Forms.—The length of time that forms should remain on concrete depends chiefly upon (1) the temperature and humidity of the air, (2) the nature of the structure and (3) the ratio of dead to live load. It should be increased for low temperatures and lack of humidity and for highly reinforced members and for members sustaining a high ratio of dead to live load. Forms in place retain heat and moisture and, hence, improve the conditions of curing. The following statements represent average practice as to the time forms should be left in place, the lower figure being for summer temperatures and the upper for cold weather: Mass concrete, 2–5 days; thin walls and columns, 3–12 days; beams and slabs, 10–28 days; long span arches, 21–28 days. For hot dry climates, these limits should be increased 25 to 50 per cent.

Conveying to Forms.—The means adopted for conveying the mixed concrete to forms should be such as to secure its deposition without segregation of aggregates and within such time that no deterioration results from initial setting. To this end, concrete should be placed within an hour after mixing. Ordinary concrete has been conveyed 3 miles in rear-dump autotrucks without deterioration. The prevailing methods for conveying mixed concrete are:

1. In hopper cars on tracks which pass directly over the forms so that the concrete is dumped directly or from short chutes
2. By chutting down inclined troughs from an elevator tower.
3. In buckets to be handled by derricks or cranes.
4. In buckets to be taken to the forms over cableways.
5. By belt conveyors, singly or in trains.

Conveying in hopper cars is best adapted to long dams or other long narrow structures, the central plant being at one end. Where a stiff concrete is specified, this method is most advantageous.

Chuting is used almost universally for buildings and structures where the elevator tower can be erected and the central plant placed at about the center of operations. The concrete is

¹ Courtesy Metcalf & Eddy, Consulting Engineers, Boston, Mass.

preferable chuted to a hopper and wheeled in carts to the forms. Chutes should not be permitted to have a slope less than 35° with the horizontal and care should be exercised to prevent segregation of materials. See Fig. 213.

Where derricks are used, either the stiff leg or guyed type is satisfactory, although the latter is generally preferable because of less interference with operations

Handling concrete by cable ways is sometimes used on dams and long bridges, although the method is generally less economical and less expeditious than other methods.

Belt conveyors were used on the Merchandise Mart in Chicago for transporting concrete materials and also for conveying the

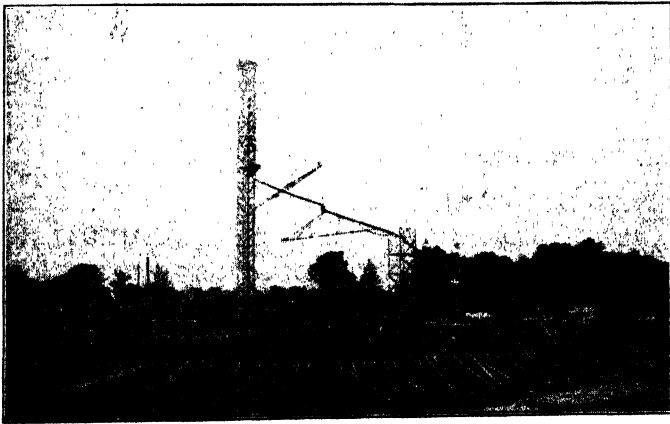

FIG. 213.—Plant for chuting concrete at hospital building, University of Iowa.

mixed concrete to forms. These were in units 40 ft. long, each with its own electric motor, and the units were placed in trains. The belt speed was 250 ft. per minute and each train could handle 1 cu. yd. per minute. The system of conveying was adopted as being the most flexible and rapid, as causing the least interference with other operations, and as requiring the smallest labor force.¹

A process of recent invention should be mentioned here because of its peculiar adaptability in covering or masking surfaces with a relatively thin layer of concrete. This is a proprietary process and is known as the Cement Gun process. Briefly, it consists of projecting the concrete ingredients, a fine aggregate being used,

¹ *Engineering News-Record*, Sept. 12, 1929.

together with the necessary water from a nozzle under air pressure against the surface to be covered with such velocity that the material adheres to the surface. Usually the surface is previously covered with a wire or other mesh reinforcing, which decreases the "rebound" or lost through a portion of the material failing to adhere and falling down. This "rebound" consists almost entirely of sand and amounts to 15 to 35 per cent of the amount delivered by the nozzle. This sand is gathered up and used over again in the mixer. The process is much used in masking girder bridges, timber walls, coating masonry walls, lining leaking reservoirs, etc. The product is strong and has a low per cent of

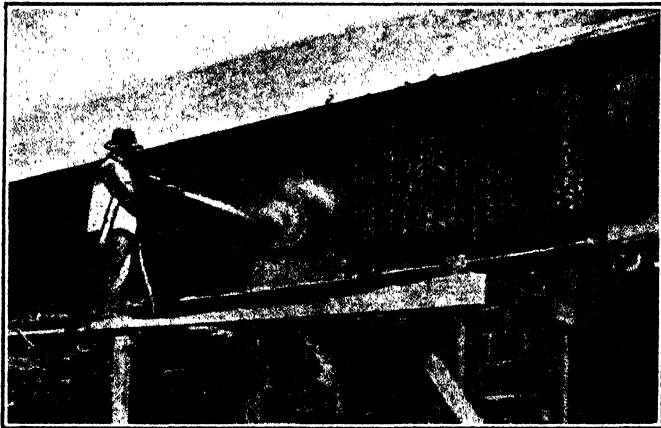

FIG. 214.—Covering a steel girder with concrete by means of a "cement gun."

absorption. The material thus deposited is essentially a mortar and tests have shown it to have qualities superior in general to mortar or concrete mixed and placed in the usual methods. The cost of the process varies with conditions of the work. Figure 214 illustrates the method of application to a steel girder.

Placing Concrete in Freezing Weather.—Cold temperatures delay the setting up of concrete while heat or steam hastens the process. The effect of cold weather becomes especially marked below 50° F. Whenever it is necessary to deposit concrete in freezing weather, the aggregates and the water should be heated by contact with steam pipes. The cement, since it constitutes a small proportion of the total and is difficult to handle, need not be heated. Concrete should have a temperature of not less than

about 60° F. when deposited, regardless of the temperature of the atmosphere.

Alternate freezing and thawing while setting will almost completely destroy the strength of concrete, while if frozen but once and allowed to set up and harden completely after thawing out, the harm done is minimized. If the concrete is allowed to set up, even though it does not completely harden before freezing, the harm is not so serious. For this reason, in freezing weather, the materials should be heated, the heat hastening the setting and at the same time giving sufficient time for setting to occur. The work should be protected by covering with straw, canvas, or otherwise for at least 48 hours after the concrete is deposited. The setting of cement generates some heat, and by heating the materials, concreting may be successfully carried on in cold weather if the concrete is covered immediately after depositing, particularly if the work is in a sheltered position, such as in a partially inclosed building. Frozen lumps in the aggregates should be carefully avoided.

Tests reported by K. H. Talbot¹ show that 1:2:4 concrete kept at 10° F. until 7 days before testing and then at 40° to 60° F., showed only 36 per cent of the strength of corresponding specimens kept at about 68° F. all the time. Specimens kept above salamanders in an inclosed space were 2.4 times as strong at 8 days as those exposed under a cover of tar paper, and 2.0 times as strong at 40 days.

The use of common salt in the mixing water to prevent freezing is not recommended, although it has been frequently so used. While salt thus used lowers the freezing temperature, it also retards the setting of the cement when speedy setting is most desired. If added in an amount that appreciably affects the freezing temperature, say 10 per cent of the weight of the water, it has a deleterious effect on the strength of the concrete. Its use in reinforced concrete is particularly objectionable because of its corroding effect on the steel. Essentially the same objections apply to calcium chloride as to sodium chloride, only that the corrosion effect on reinforcing steel is more serious.²

Depositing Concrete under Water.—When concrete has to be deposited under water, it should not be dropped through the water but should be carried to its place by means of buckets, in

¹ *Proc. Ohio Eng. Soc.*, 1913-14, p. 151.

² *Engineering News-Record*, May 13, 1920.

bags or through a *tremie*. If such precautions are not taken, the cement will wash out of the concrete and impair its strength. The use of a tremie is probably the most satisfactory method. A tremie consists of a spout or conduit 6 to 14 in. in diameter with a funnel shaped top into which the concrete is poured. The bottom of the tremie rests directly on the mass of concrete already deposited, or slightly projects into it, so that the concrete does not drop through the conduit but runs through slowly, and inasmuch as the tube is entirely filled with concrete all the time, the water is excluded. The concrete oozes out at the bottom causing a minimum of disturbance.

When concrete is deposited in paper bags under water, the bags should not be ruptured until after they are in place, when the paper softens and the concrete forms a more or less continuous mass.

Where concrete is dropped through water, or where an excess of water is used in the mixing, *laitance* usually forms and must be carefully scrubbed off at construction joints, otherwise a plane of weakness will be formed. *Laitance* consists of fine particles from the cement and much of the dust and dirt from the aggregates, which together with the foam on the surface of the water above the concrete forms this milky appearing substance, hence its name. *Laitance* is deleterious and should be avoided, and if it forms, it should be carefully scrubbed off free surfaces before depositing more concrete. Chemically, *laitance* has much the same composition as cement, but it is entirely devoid of any cementitious properties.

Construction Plant.—When the construction project is not scattered over too large an area, a central mixing plant with facilities for transporting the concrete will always be economical and most effective in yielding uniformity of concrete. A central plant also facilitates handling the concrete materials, especially in cold water. A central mixing plant should be located on the natural route of travel for the materials on their way to the plant and topographic features should be utilized to minimize cost of elevating and conveying.

The capacity of the central mixing plant will be determined by the maximum draft that will be made upon it, a fact to be determined by a study of the schedule chart. However, the size and type of equipment available may properly affect the capacity of the plant unless the project is of such size as to

warrant the purchase of new equipment. One cubic yard of mixer capacity for each 5,000 cu. yd. to be placed per month will ordinarily be ample. In general, it is desirable to have duplicate units rather than one large unit. Mixers of 1- and 2-yd. capacity are in common use, although mixers up to 4 cu. yd. have been used on large mass projects.

The plant should be provided with such facilities for handling and proportioning the materials. Automatic measuring devices

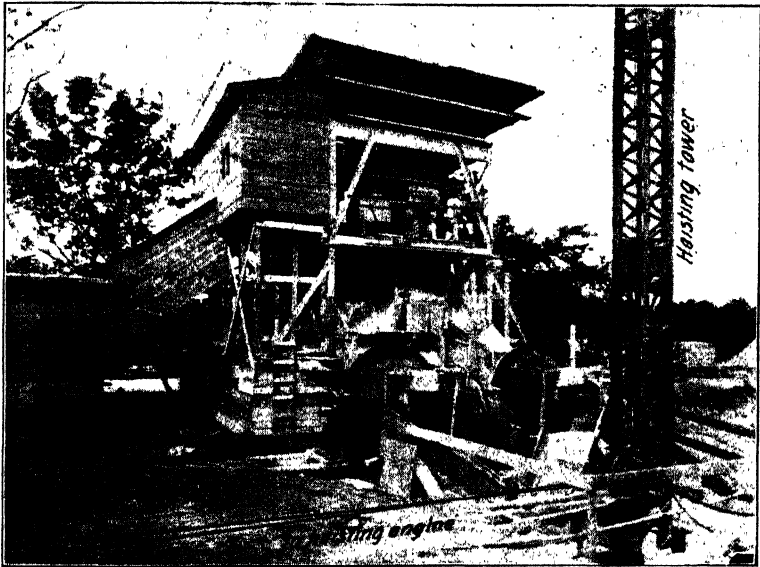

FIG. 215.—A central mixing plant showing inundator marked I.

are desirable. Where feasible, the use of cement in bulk is economical in that it avoids bag loss and expense.

Naturally, the coarse aggregate should be placed nearest the mixer because of the greater bulk to be handled. Figure 215¹ shows a modern central mixing plant.

Construction Schedule.—Before beginning a piece of construction of considerable magnitude, a progress schedule should be laid out which will indicate the expected progress at successive dates, usually at the end of each week. The quantities of materials required at successive dates should be estimated and an ordering schedule made up. Plotting a graph for each of the materials,

¹ Courtesy, Blaw-Knox Co., Pittsburgh, Pa.

for the employees, and for funds required at successive dates gives a comprehensive view of the project and facilitates the checking of progress.

Painting Concrete.—Recently, the custom of painting concrete surfaces has increased owing to a desire to relieve the rather dull color of natural surfaces. In painting, care must be exercised in the treatment of the surface and the selection of colors. Dr. Maximilian Toch¹ gives the following instructions: First, the surface should be washed with zinc sulphate 4 lb. to the gallon, or preferably a fluosilicate of magnesium and zinc, about 1 lb. per gallon of water. As soon as dry, the surface should be brushed to remove surface crystals. The concrete is then filled with a resin filler of the cement filler type.

As to colors, Dr. Toch recommends the following pigments: *green*, chromium oxide; *yellow*, ochre, raw sienna, and lemon, golden or bronze cadmium; *red*, ferric oxide; *blue*, cobalt and ultramarine blue; *black*, lamp black and graphite; *white*, lithopone, zinc white, and titanium white; *brown*, umber and sienna; *violet*, mixture of madder lake and cobalt blue.

Masonry Inspection.—The owner of a structure being built under contract usually employs an engineer in the capacity of "masonry inspector" or "concrete inspector," whose duty it is to see that the work is executed in accordance with the plans and specifications. This work is so frequently performed by young engineers that a brief discussion of the masonry inspector's duties is appropriate in this connection.

The masonry inspector should at once familiarize himself with the plans and specifications governing the work and with city ordinances bearing on it, if there are such, and should be always on the work whenever any operations are in progress, constantly on watch to detect any departure from the plans and specifications.

The inspector has authority to forbid the use of materials not conforming to specifications and order defective materials removed from the site; he also may halt the work whenever the workmanship is not in accord with specifications. He should report any such irregularity at once to his superior.

The inspector should check over excavation and see that it is down to the level specified. If the excavation is to go to

¹ *Concrete*, p. 31, September, 1928.

rock, he should see that the rock is entirely uncovered and cleaned as specified.

When piles are to be driven, the inspector should see that the piles conform to specifications as to diameter, length, peeling, straightness, and kind of wood. He should keep record of the piles driven and note the penetration under the last five blows of every fifth pile. He should also record the weight and type of pile driver and the height of drop. He should note the length of cut off when piles are cut off.

The inspector should inspect and identify each lot of material upon its receipt and keep careful watch of aggregates to insure that they conform to specifications, and that they are so stored as not to become foul. He should secure all needed samples for testing and record complete information concerning each sample taken.

With regard to reinforcing steel, the inspector should see that all bars are clean, free from mill scale and rust, or any other coatings that might impair bond. He should see that the reinforcement conforms to plans as to section, angle, and radius of bends and length. He must see that the reinforcement is placed in the forms according to plans, and that they are rigidly secured in place in the forms by means of spacers and ties.

Before any concrete is poured, the inspector should carefully examine the forms to see that (a) they conform to plans, (b) that they are clean and free from chips, shavings, and other debris (most likely to collect at the bottom of column forms), (c) that they are oiled or wetted as specified, (d) that they do not bulge or sag; that all wiring, bolts, sleeves, flashings, etc., are in place.

In regard to mixing and placing the concrete, the inspector should (a) check the capacity of the measuring devices, (b) check the amount of cement used per batch, (c) observe the consistency of the concrete frequently, (d) check the time of mixing frequently, (e) check proportions systematically.

He should see to it that the manner of conveying and placing is in accord with the specifications and that segregation of aggregates does not occur; that the concrete is properly placed around reinforcing bars; that the concrete is adequately spaded along the forms; that the construction joints are made as specified and that undue delays do not occur which may virtually result in planes of separation; that in beginning a new pouring, all

laitance is removed and the surface cleaned; when concreting in cold weather, that all provisions for heating materials and protecting deposited concrete are fulfilled.

The inspector should see that the forms are not removed before the time specified and that the surface and corners are not marred in their removal. He should require that any defects in the surface be repaired promptly, as specified, and that any projecting wires, nails be properly removed. He should see that all surfaces are pointed and finished in accordance with specifications.

The inspector should record and report daily (a) the portions of the work in progress, (b) the names of contractors at work, (c) the installation of contractors' equipment, (d) the size of the labor force, number of teams, etc., in use, (e) materials received, (f) amount and location of concrete placed, time of beginning and of completion of placing concrete, (g) samples taken and tests made, (h) forms removed, (i) weather conditions, (j) materials rejected and disposition of rejected material, (k) any special instructions given to contractor or any significant conversations with him. He would do well to keep a diary in which he makes memoranda of his daily activities and conversations, for, in the event of litigation, he may be required to testify when the accuracy of his memory will be important.

Costs of Reinforced Concrete Work.—The elements entering into the cost of reinforced concrete work may be analyzed as follows for typical construction:

1. *Concrete:*

- (a) Materials, including initial cost and cost of transportation, and cost of tests and inspection,
- (b) Mixing and placing,
- (c) The plant required;

2. *Forms and Falsework:*

- (a) Materials,
- (b) Labor in erection,
- (c) Labor in removal;

3. *Steel reinforcement:*

- (a) Cost of steel and of transportation,
- (b) Cost of bending,
- (c) Cost of placing in forms;

4. *Finish of exposed surfaces:*

- (a) Materials,
- (b) Labor.

The cost of materials varies so widely that average figures mean little, hence, the current market prices must be consulted. In general, the cost of concrete is estimated in terms of the cubic yard as the unit, but the cost per cubic yard for highly reinforced beams, girders and slabs may be ten times as great as for plain concrete or for lightly reinforced concrete. Again the unit cost varies with the size of the job, being smaller for large than for minor work.

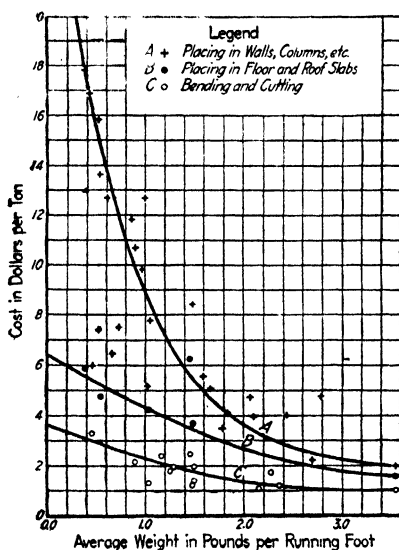

FIG. 216.—Effect of weight of bars upon cost of placing steel reinforcement.

The cost of steel reinforcement varies with the season, the location and other conditions. The cost is usually estimated in terms of tons in place, and the cost of placing is commonly estimated in terms of cents per ton. However, the cost per ton for placing varies with the complexity of the reinforcement and with the size of bars used. Figure 216¹ shows the effect of the weight of bars per running foot on the cost of bending and placing.

The cost of oiling forms depends upon the price of oil. One gallon of oil will cover about 160 sq. ft. of forms two coats, and one workman will apply about 2 to 2½ gal. per hour.

¹ *Engineering Record*, Aug. 26, 1916.

The cost of placing concrete varies widely with conditions of plant, wages, and nature of the work. In general, the labor and handling will comprise somewhat more than half the total cost, and therein lies the economy of high-strength concrete in most reinforced construction, for the handling cost is less with first-class concrete than it is with inferior concrete.

CHAPTER XIII

FOUNDATIONS ON DRY GROUND

Introduction.—By foundation is meant that portion of a structure whose function is to secure adequate support on the earth for carrying the main structure with its superimposed loads. According to the nature of the processes involved in construction, foundations may be divided into two classes; (a) foundations on essentially dry earth where no special provision need be made for excluding water other than a moderate amount of pumping, (sometimes called *ordinary* foundations) and (b), those below the water surface either in a body of water or below the natural water table in porous soils near the edge of a body of water where special provision must be made for the exclusion of water. The latter class may be divided into two types, namely, (1) open foundations subject to the natural atmospheric pressure and (2) pneumatic foundations, where a higher air pressure is used under an inclosed structure for excluding the water.

In any case, the purpose of the foundation is to secure an adequate bearing on the earth, and this is accomplished by excavating down to an earth stratum which has sufficient bearing capacity to sustain the loads coming upon the loaded area without undue settlement. The foundation is usually spread over an area greater than the base of the primary structure in order to distribute the load to an area sufficient to sustain the total load with an allowable soil pressure. Obviously there are three primary problems involved in the design of foundations, viz., (1) the bearing capacity of various soils or earth strata, (2) methods of spreading the foundation to secure sufficient area of bearing, and (3) methods of sinking the foundation to an earth stratum that will have sufficient bearing capacity to sustain the loads with a practical spread of the foundation.

Earth Surface Formations.—Geology has shown that the earth consists of various rock formations covered with a mantle of unconsolidated products of rock disintegration, called the

regolith, or more commonly, the soil, although agriculturists use the term soil in a somewhat different sense. The rock formations consist of one large irregular mass roughly in the shape of a sphere consisting of unstratified granite-like materials, the irregularities rising high in the air as mountains at places, and the indentations between the irregularities being occupied by various strata of limestone, sandstone, shale, slate, etc. Over the whole, except in mountainous areas, is the mantle, or regolith, of unconsolidated materials varying in thickness from nothing where the central core of igneous rock is exposed in the mountainous regions to several thousand feet in valley regions. This regolith has been formed by various agencies and is the result not only of rock decomposition directly but of rock transportation as well. The main agencies of rock decomposition are heat, freezing, water action, wind, and attrition by movement, while the main agencies of transportation are water, wind, glacial ice, and gravity. The stratified layers of sandstone, limestone, etc. are the result of segregating and collecting this material over an area and consolidating it under pressure from superimposed material.

According to the mode of formation, soils may be classified as follows:¹

1. *Sedimentary:*

- (a) Residual deposits: Residuary gravels, sands and clays, wacke, laterite, terra rosa, etc.;
- (b) Cumulose deposits: Peat, muck, swamp soils, muskeag, etc.

2. *Transported:*

- (a) Colluvial: Talus and cliff debris and material of avalanches;
- (b) Alluvial: Modern alluvium, marsh deposits, clays, etc.;
- (c) Aeolian: Wind blown material, sand dunes, adobe and loess, in part;
- (d) Glacial deposits: Morainal material, drumlins, eskers, etc.

Colluvial deposits include the heterogeneous masses of rock waste that have accumulated by the action of gravity, while alluvial deposits having been formed by running water are usually definitely stratified. In general, only residual deposits or glacial deposits may be expected to have sufficient bearing capacity for heavy foundations.

According to texture, soils may be classified as *sand*, *sandy loam*, and *clay*. Loam is a mixture of sand, clay and a varying

¹ H. RIES and T. L. WATSON, "Engineering Geology," p. 241.

amount of organic matter. *Gumbo* is a dark colored, very sticky, highly plastic clay, occurring abundantly in the central and southern parts of the United States. *Adobe* is a sandy, calcareous clay occurring in the southwestern part of the United States. *Loess* is a clay-like material that is largely siliceous and calcareous in its composition, which occurs in thick beds in many places and is characterized by its vertical cleavage causing it to form steep precipitous cliffs. *Herdpan* is a rather loosely used term, but is most commonly applied to a very dense heterogeneous mass of clay, sand and gravel of glacial drift origin. *Quicksand* is a condition of soil rather than a type of soil. Any fine granular soil carrying water under a head is called quicksand because of its tendency to flow from under a superimposed load.

Supporting Capacity of Earth Formations.—The supporting capacity of various earth formations varies from several hundred tons per square foot for solid rock in deep beds to practically nothing for saturated silt, and it depends upon (a) the character of the formation, (b) the bedding and stratification of this particular formation and (c) the degree of saturation of this formation with water.

The general character of earth formations was recalled in the preceding paragraph. Flood plains and alluvial deposits generally are non-homogeneous in their composition and need to be studied with care in order to determine the proper bearing to be assigned to them. Their bearing capacity will generally be determined by the most porous material contained in their make-up. Glacial deposits may vary from pockets of small size to formations covering a wide area, and their extent must be studied when such formations are utilized as foundation beds. Thin strata of rock, especially when badly fissured, afford very little better foundation bed than does the stratum beneath the rock. Solid rock should mean a solid unfissured stratum not less than 10 or 12 feet thick. Muck and peat soils (cumulose), such as are found in Louisiana and other southern states almost inevitably settle when subjected to load and foundations should be built on such with caution.

The present condition of the soil should be taken into consideration, and its probable behavior when exposed to the weather, if it is to be exposed, for many formations such as some shales, clays, etc., disintegrate and are changed in their properties when so exposed.

The influence on the plasticity of soil depends upon the texture of the latter. The amount of water present is about as follows for different degrees of moisture.¹

	PER CENT [†]
Dry.....	0-5
Damp.....	5-10
Moist.....	10-15
Wet.....	15-25
Saturated.....	25-35
Fluid.....	35-

Table XXXIII taken from the Progress Report of the Committee on Bearing Value of Soils of the Am. Soc. C. E., 1920, gives the practice in various cities of the U. S. and Fig. 217 from

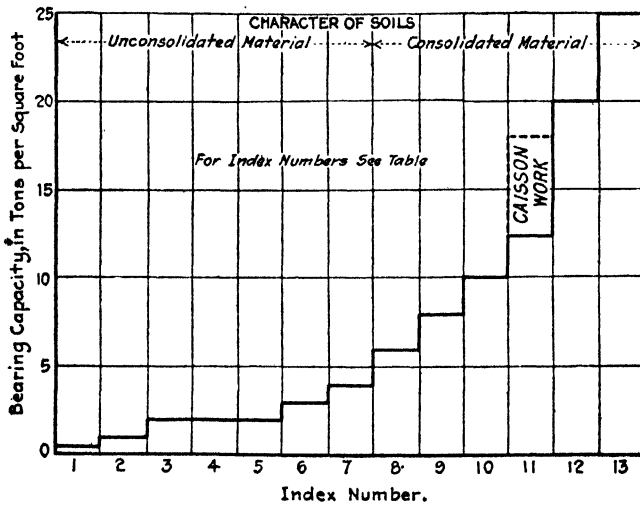

FIG. 217.—Chart for allowable soil pressures.

the same report gives allowable bearing values of soils with index numbers listed in Table XXXIII. Practically no settlement should be expected to occur in foundations loaded within the range of the pressures cited.

While no settlement of foundations at all is desirable, yet in many cases where the settlement is uniform, it occurs without serious harm. Buildings in Chicago resting on “floating” foundations on clay have sunk from 8 to 30 in.² without serious

¹ Proc. Am. Soc. C. E., Report, Committee on Bearing Value of Soils, March, 1916.

² Engineering Record, July 29, 1905.

TABLE XXXIII.—ALLOWED BEARING VALUES ON SOILS AT VARIOUS CITIES, IN TONS PER SQUARE FOOT

Index number	Index number
1. Quicksand and alluvial soil.	8. Coarse gravel, stratified stone and clay, or rock inferior to best brick masonry.
2. Soft clay.	9. Gravel and sand well cemented.
3. Wet clay and soft wet sand.	10. Good hardpan or hard shale.
4. Moderately dry clay, and fine sand, clean and dry.	11. Good hardpan or hard shale unexposed to air, frost or water
5. Clay and sand in alternate layers.	12. Very hard native bed-rock
6. Firm and dry loam or clay, or hard dry clay or fine sand.	13. Rock under caisson
7. Compact coarse sand, stiff gravel, or natural earth.	

City	Index number												
	1	2	3	4	5	6	7	8	9	10	11	12	13
Albany		1			2	3	4						
Atlanta		1			2	2-3	3-4						
Baltimore		1			2	3	4	6		12-18	20		24
Bridgeport		1			2	3	4						
Buffalo							3½						
Chicago			1½	1¾ to 2¼	2½	2½							
Cincinnati				2	4	4	4.5	8					
Cleveland	½	1		2	4	3		8	6	8	10		
Columbus	½	1		2	4	4	5	8			15		25
Denver		1		2		3	5						
Detroit					2	3	4						
Grand Rapids				3			4, 6						
Jersey City		1			2	3	4						
Kansas City		1			2	3	4						
Los Angeles		1		3		3	4						
Louisville				2½		2½	4						
Lowell	½	1		2			4	8					
Memphis	½	1		2		3	4	8					
Milwaukee	½	1	2			3	4	5		6		20	
Minneapolis		1			2	3	4						
Newark		1			2	3	4						
New Bedford		1			2	3	4						
New Haven							4						
New Orleans		½						By tests					
New York		1			2	3	4						
Oakland		1			2	3	4	6		10		20	
Omaha						4							
Paterson		1			2	3	4						
Philadelphia							3½		6				
Providence	½-1	2-3		2-4	3-5		4-6		8-10		10-15	25-50	
Richmond		1	2			3	4						
Rochester		1	2			3	6			10			
Rochester		1	2		2	3	4	6		10		20	
San Francisco		1							6	8			
Seattle			1	2		4			6	8			
Seattle				2		3	4	8		10		20	
Spokane		1											
St. Louis						3							
St. Paul		1			2	3	4, 6						
St. Paul		1			2	3	4						
Syracuse													
Toledo	½	1		2		4	4						
Washington		1			2	3	4						

1 Sandy loam.
 1 Under caisson.

injury to the structure because the integrity of the foundations was not impaired by the settlement. Most of the settlement occurs from dead load during construction as the dead load is gradually applied, and as this initial settlement causes the surrounding soil to be more resistant, a lower allowable unit load should be used in structures or parts of structures which take live load early. For example, the columns at the stairs of the Masonic Temple in Chicago received their load after the remainder of the structure had taken its initial settlement and consequently the settlement in these stair towers was small compared with the columns under other parts, a fact which deranged the connections to a considerable extent. Obviously the amount of settlement of foundations allowable will depend upon the character of building, the amount permissible for a cathedral or similar structure containing highly ornamental masonry being decidedly less than for a steel highway bridge.

Characteristics Affecting Soil Behavior.—What physical properties of soil most affect its behavior under load is a question, although many experimental investigations have been conducted to ascertain the answer. The chief factor involved is obviously the relation between the volume compressibility and the load applied, and numerous elements affect this relationship.

The two factors most commonly used in classic discussions are internal friction and cohesion between particles. Both of these have been previously considered. The Committee on Bearing Value of Soils for Foundations concluded¹ that the frictional theory of earth resistance (Rankine and Coulomb) is inadequate as a basis for codification of soil behavior and that such a codification "must be based on a theory of elastic equilibrium with frictional equilibrium as a limiting state determining the limiting discontinuities of the field." This is not a new view, because Rankine's theory of soil pressures was taken almost bodily from the mathematical theory of elasticity and his assumptions so limit his theory.

One factor which seems to affect the bearing behavior of soils is the colloidal content, or ultrafine material, particularly the clay and humus. The chief influence lies in the increased impermeability or capacity for holding water and their great shrinkage upon drying. Humus is the product of the decomposition of vegetable matter and may vary in soils from nothing up

¹ *Proc. Am. Soc. C. E.*, August, 1920.

to nearly 100 per cent, as in peat. It has a tendency to lubricate or to diminish internal friction between the larger grains of the soil.

This committee¹ devoted much study to the influence of colloidal content of earths upon their behavior under pressure and found the strength of loam and clay specimens increased with the percentage of colloids contained. Probably the influence of the colloidal content is reflected in its effect upon the permeability and the effect upon the extent to which the entrained water is held as capillary moisture and the rapidity with which the water and air can be expelled under pressure.

Dr. Chas. T. Terzaghi,² Mem. Am. Soc. C. E., states that the chief characteristics affecting the settlement of unconsolidated soils under pressure are (1) the relative proportion of scale-like (mica) particles present, (2) the permeability of the soil which controls the rate at which entrained water will escape under pressure and consequently the rate of change of volume, and (3) the cohesive strength of the soil. While these properties are mutually interdependent to a considerable extent and the experimental evidence does not indicate that they completely account for soil behavior, they may be accepted as important factors.

At present, the factors which affect the supporting capacity of soil have not been entirely determined and none have been evaluated as to the magnitude of their influence.

Soil Deformability.—Soils in foundations may be classed roughly as granular, plastic, and solid, and, within a certain range, these all behave like a partially elastic solid. Granular soils are sand and gravel; plastic soils are compressible clay, silt, and mixtures of sand, gravel, and clay; hard soils are shale and rock.

In granular soils, the particles react on each other through friction, and, until the friction is exceeded, they resist elastically much as does any solid. When a load is applied, aside from a slight surface adjustment of particles, the mass is essentially a porous solid, and the deformation, until the particles suffer displacement, is entirely *an elastic deformation of the particles* and is recoverable when the load is released.

Figure 218, from results of observations by H. T. Heald, a graduate student under the author's direction, shows the com-

¹ *Proc. Am. Soc. C. E.*, May, 1925.

² *Trans. Am. Soc. C. E.*, vol. 93, p. 297 ff.

pression and the proportion of resilience of two typical soils when a load is alternately imposed and released. With greater load, the particles become displaced relative to each other with a resulting deformation of the mass that is not recoverable.

Plastic soils show a similar characteristic to a very slight (negligible) extent. A very minute portion of the compression is elastic and recoverable, but nearly all of any considerable deformation is plastic and not recoverable.

In either class of soils, the deformation varies roughly with the pressure until a yield or fluidity point is reached, when the

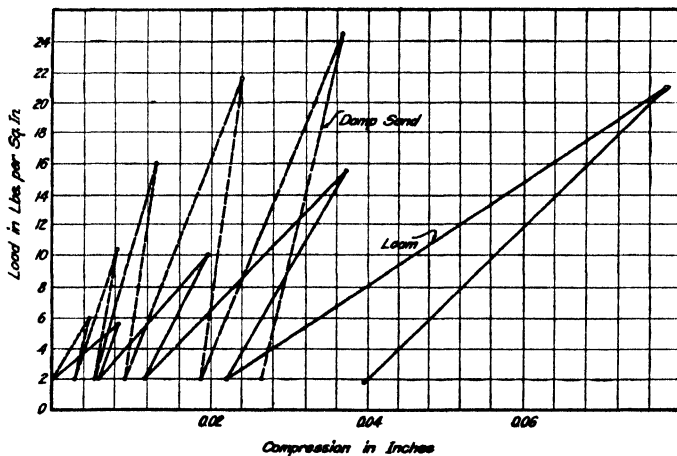

FIG. 218.—Elastic and plastic deformation of soil.

bearing surface settles rapidly without any proportionate increase in the superimposed load. This point of fluidity is roughly analogous to the yield point of more rigid materials.

Within the range of elasticity, soils behave as elastic solids; beyond that range, plastic conditions obtain. In the plastic range, deformation continues under a load until a sufficient area becomes involved to cause internal friction to restore equilibrium. A deformed plastic material has essentially the same properties as before deformation.

Spread of Pressure through Soils.—When a load is applied on a footing over an area, there occurs some settlement (partly elastic, partly plastic) which, by means of shear along the periphery, is distributed to an ever increasing area with the depth. If the angle of inclination or rate of spread is α , and the side of

the footing (assumed square for convenience) is b , the area over which the load is distributed at any depth, d , is $(b + 2d \tan \alpha)^2$; hence, when the load is applied over a small area at the surface, the intensity of pressure decreases approximately as the square of the depth in the soil below the footing. The angle α is dependent upon the angle of internal friction.

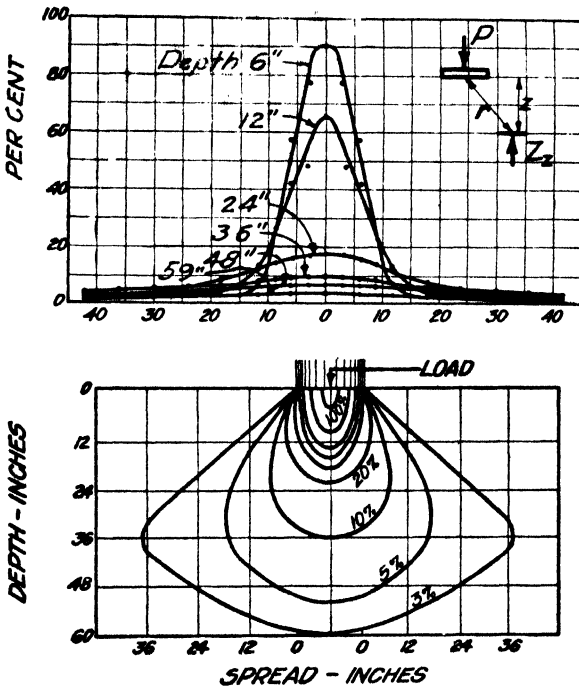

FIG. 219.—Spread of pressure in soil under load.

Figure 219 is drawn compositely representing results of experiments at Pennsylvania State College¹ and at the University of Illinois.² Lazarus White, Mem. Am. Soc. C. E., applied the vivid term “bulb of pressure”³ to the volume of the soil thus affected in sustaining the superimposed load. The curves below represent percentages of the average bearing pressure, W/A .

¹ *Engineering Record*, vol. 71, p. 330.

² *Engineering Record*, vol. 73, p. 106.

³ *Trans. Am. Soc. C. E.*, vol. 93, p. 335.

Boussinesq¹ concluded that on elastic soils the rate of spread of the pressure might be expressed by the equation

$$Z_z = \frac{3Pz^3}{2\pi r^5}$$

where P is the intensity of the pressure applied, Z_z the intensity of the vertical pressure at a depth z , and r the slant distance to the point considered. Investigations at Iowa State College² indicate that this formula yields results closely agreeing to observed values for a granular material such as gravel. For earth embankment, this equation seemed to have little significance.

The load is spread over the soil in such a bulb of pressure until the intensity of pressure is reduced to that which is within the elastic deformation range of the soil, when equilibrium is restored. Let p be the unit pressure at a depth h that the soil will sustain elastically; b be the side of the footing (assumed square); r the rate of spread of the lines of zero pressure; y , the depth to any plane considered, and C be the modulus of compressibility.

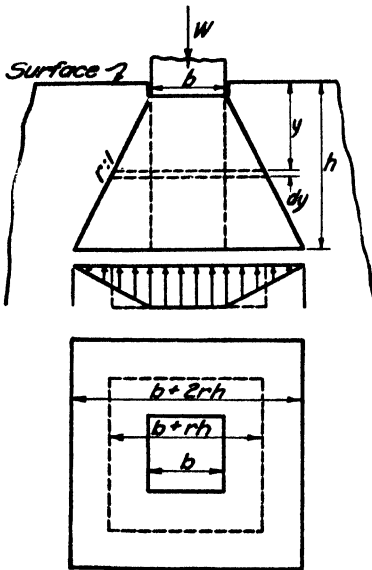

FIG. 220.—Resistance of soil to deformation.

Figure 220. Roughly, the deformation will be as if the pressure at any depth were distributed over a square whose side

is $b + ry$. The intensity of pressure, w , at any depth y is $\frac{W}{(b + ry)^2}$

and the deformation in a distance dy is $\frac{Wdy}{C(b + ry)^2}$; and the total

deformation in the depth h is $\frac{W}{C} \int_0^h \frac{dy}{(b + ry)^2}$, or $\frac{Wh}{C(b^2 + brh)}$.

This expression shows that the deformation varies inversely with the perimeter as well as with the area. Where $y = h$, neglecting

¹ "Applications des Potentiels," Paris, 1885.

² Eng. Exp. Sta., Bull. 79.

the weight of the soil itself, $h = \frac{b}{r} \left(\sqrt{\frac{w_0}{p}} - 1 \right)$. Observations show h to be about 5 ft. for sand for small depressions of the surface.

Thus an elementary analysis indicates that the supporting capacity of soil depends upon two factors: (1) the bearing area and (2) the perimeter of the bearing surface. Hence, it may be said that

$$W = Ap + Lf$$

Where W is the load that can be safely applied; A , the bearing area; p , the supporting capacity per square foot in compression for a given deformation; L the length of the perimeter, and f the supporting capacity in shear per foot around the perimeter.

The relative values of the terms Ap and Lf depend upon whether the soil is more rigid in direct compression or in shear. In a 5:1 sand-clay soil p was found to be about 500 lb. per square foot and f about 160 lb. per linear foot, while in clay alone, p was about 100 lb. per square foot and f about 400 lb. per linear foot for a very small compression.

Further experimental observations are needed to ascertain the relative values of shear and direct compression resistance of soils. The rather meagre data at hand indicate the following values of P/f for depressions up to about $\frac{1}{2}$ in.: 2 for sand, 1 for stiff yellow clay, 2 to 3 for plastic yellow clay or for sandy clay, and 4 to 8 for plastic blue clay. It appears from tests that P varies directly with the depression of the soil and f with approximately the fourth root of the depression, as might be expected from analogous properties of elastic solids.

The supporting capacity of a footing, may, therefore, be considered as varying with the area of the base of the "bulb of pressure" or as $A + L \frac{hr}{2}$. For soils with a small angle of internal friction, r is small, causing the supporting capacity to vary nearly as the area A , while in a soil like sand with a larger angle of friction, r is relatively large, and, hence, for small areas, the perimeter L may be a dominant factor in the bearing capacity.

Variation of Pressure Intensity under a Loaded Surface.—Observations indicate that, contrary to the usual assumption, the intensity of pressure may vary for light pressures under a given footing. The average pressure P/A is commonly assumed

The maximum pressure $S' = r'u' = \frac{aeq}{4(a+b)}$ (1)

The maximum pressure $S_1 = et = e \cdot \frac{q}{a} \cdot b$

whence

$$qe = \frac{aS_1}{b}$$

Substituting in (1)

$$S' = \frac{a^2S_1}{4b(a+b)} \cdot r\left(\frac{a}{2}\right) = \frac{b(a+b)S}{S_1}$$
 (2)

Since the curve of pressure can readily be shown to be a parabola, we have $\frac{b(a+b)}{S_1}$ as the parameter of a parabola of the form $y^2 = 2px$; $S' = \frac{a^2}{8p}$.

Moving the origin to the right¹ a distance S'

$$y^2 = 2p(x - S') = 2px + \frac{a^2}{4}$$

$$D = 2 \int_0^{\frac{a}{2}} x dy = 2 \int_0^{\frac{a}{2}} \frac{4y^2 - a^2}{8p} dy = \frac{a^3}{12p}, \text{ or } \frac{a^3S_1}{6b(a+b)}$$
 (3)

$$Z = \int_{\frac{a}{2}}^{\frac{a}{2}+b} x dy = \frac{1}{8p} \int_{\frac{a}{2}}^{\frac{a}{2}+b} \frac{4y^2 - a^2}{8p} dy = \frac{S_1b(3a+2b)}{6(a+b)}$$
 (4)

The moment of Z about D is

$$M = \int_{\frac{a}{2}}^{\frac{a}{2}+b} xy dy = \frac{bS_1(a+b)}{4}$$

$$z = \frac{M}{Z} = \frac{3(a+b)^2}{2(3a+2b)}$$

Let d be the width of the member embedded.

Equating moments about D

$$P\left(c + \frac{a}{2}\right) = \frac{S_1db}{4}(a+b) = \frac{S_1d}{4}(A-a)A$$

whence

$$a = \frac{A^2S_1d - 4Pc}{2P + AS_1d}$$
 (5)

Since

$$\Sigma H = 0$$

$$P + \frac{S_1bd(3a+2b)}{6(a+b)} - \frac{a^3S_1d}{6b(a+b)} = 0$$
 (6)

¹ *Beton u. Eisen*, p. 226, 1911.

Whence from (5) and (6)

$$b = \frac{2P(A+2c)}{2P+S_1Ad}$$

and

$$S_1 = \frac{12Pc}{A^2d} + \frac{6P}{Ad} \quad (7)$$

From (7) the earth pressure at the bottom of the member can be calculated, and then S' can be calculated from (2).

Where a round pole is placed in homogeneous, plastic ground, it can be shown that the unit of pressure at the middle element is approximately 1.56 times the average on the projected surface or on a flat surface with a width equal to the diameter of the pole.

Explorations and Tests.—The importance of making a thorough exploration of the foundation site cannot be over-emphasized. Inadequate information in this respect may result in increased cost of the structure if not in its ultimate failure. For example, in boring with a core drill in what seemed to be solid bed rock in examining the site of a high bridge pier, on which the author was engaged, an extensive mine opening was discovered beneath the site which maps had not revealed, and it was deemed advisable to fill this opening with concrete before founding the pier. In another case, a bridge pier was placed on what seemed to be hardpan, and after the bridge was completed the pier sank into the river causing the loss of two bridge spans and of several lives. Investigation revealed the fact that the hardpan was merely a thin stratum overlying a soft clay. A bridge over Claverack Creek, N. Y. failed¹ when the piers rested on a cemented sand and gravel bed 7 to 20 ft. thick overlying a stratum of very unstable clay about 100 ft. thick. A cement plant about 100 yd. away three years previously had settled due to this same stratum of soft clay. Another instance of subsidence of bridge piers at another location resulted from the presence of a 10-ft. layer of peat 35 ft. below the surface.

Numerous other instances of failure of structures resulting from an inadequate study of foundation might be cited, but enough has been said to call attention to the importance of making a thorough investigation of the foundations under important structures.

Methods of Making Explorations.—Examination of a foundation site should be made to ascertain (a) the nature and (b)

¹ *Engineering News-Record*, Mar. 28, 1918.

the extent of the earth formations that will probably constitute the foundation bed. There are several methods of procedure, chief of which are (1) driving test rods, (2) boring with an auger, (3) drilling test holes, (4) core drilling, (5) making wash borings, (6) digging test pits, (7) driving test piles, and (8) applying test loads.

A test rod usually consists of a solid rod or of gas pipe 1 to 1½ in. in diameter driven by means of a maul and turned under each blow by means of a pipe wrench. Very meagre information is obtainable by this method, although if driven successively over the entire area of the foundation bed, it may reveal the presence of soft strata. Obstructions such as boulders, logs, etc. may give an erroneous impression of what is to be encountered. The method is, therefore, very unreliable.

An ordinary wood auger, 2 to 2½ in. in diameter, welded to a section of gas pipe to which other sections may be screwed, may be used in making borings. The handle is a rod about 2 ft. long with a ring at the middle which will pass over the couplings and which may be fixed by means of set screws, or it may be a section with a T-coupling at the middle to be screwed to the top of the uppermost section. A tripod or head-frame with a block and chain is desirable for lifting the auger from the hole. The auger must be lifted every few turns, at which times it brings up samples of the material being penetrated for examination and record. Borings of this sort can be made as deep as 50 or 75 ft. at about 35 cents per foot,¹ and the method has been used for borings 100 ft. deep. A special form of earth auger which may be used for depths up to about 50 ft. advantageously consists of two cutters at the bottom and a cylindrical portion above, the cutting portion being about 10 in. long. The cutters draw the instrument into the ground and the cylindrical portion retains the sample of the material penetrated.

Test holes are sometimes driven much as wells are driven, the material being lifted out by means of a sand bucket. The hole may be lined with steel casing where the depth is great or where sand or other fluid material is penetrated. The possible depth and the cost of such test holes depend greatly upon the materials encountered. At Milwaukee, with a nest of pipes varying from 4 to 10 in. in diameter, a hole was driven 115 ft. at a cost of \$2.25 per foot.

¹ *Canadian Engineer*, vol. 29, p. 321.

Wash borings are put down with a drill bit and drill rod similar to those used in drilling wells, with the exception that the drill stem is a hollow pipe down which water can be forced by means of a force pump. The water escapes through openings in the bottom of the drill bit and washes the spoil or debris up to the top of the hole through the space between the drill stem and the casing. The casing consists ordinarily of steel or iron pipe and is sunk by rotating and jarring by means of a block at the top of the hole attached to a derrick. Holes can be sunk in this manner through loam, clay, hardpan, sand, gravel or shale, the cost varying from \$0.25 to \$1.00 per foot depending upon the character of the material penetrated and the depth of hole. Rock drilling requires special details.

Core drilling through rock may be done with a diamond core drill, water being forced down through the drill stem to wash out the spoil, much as in the case of wash borings. The cost of a 2-in. core usually varies from about \$2.00 to \$4.00 per foot. Several rock drills are on the market which are considerably cheaper than diamond drills and for most purposes these serve practically as well, although for very hard rock, the diamond drill will be found economical.

Test pits are dug either circular or square and are usually about 4 or 5 ft. in diameter. Where circular, the lining consists of sections 3 to 5 ft. long braced by iron bands in semi-circular segments, as in the method of sinking open wells for concrete pier foundations; when rectangular, they are lined with lagging and square-set bracing as in any vertical shaft. The cost of such test pits depends upon the character of the materials penetrated; one, sunk under the author's direction, proved very expensive because of the presence of quicksand which forced its way in from beneath about as fast as it could be removed. In another case, rectangular pits proved to be relatively cheap because the materials penetrated were such as not to exert heavy lateral pressure on the lining.

Where it is impracticable to sink such test pits below the level of the foundation bed, it is usually desirable to make further exploration to a greater depth by means of bored holes in the bottom of the test pits. The obvious advantage of the open pit as a source of information is that the density and the arrangement of the various strata can be readily observed. In an extensive foundation over a fairly uniform geological formation,

a single open pit may be very useful in interpreting the results of auger borings or other simpler examinations.

Besides an examination of the extent and character of the earth formations under a foundation, direct observations are commonly made on the supporting capacity of the soils. Where a pile foundation is contemplated, test piles may be driven. As the test pile is driven, careful record is made on the penetration under the last five blows and the supporting capacity computed by the Engineering News pile formula (see p. 518). Then a platform is placed on the pile and loaded until it sinks, or until the load is considerably in excess of the proposed bearing load. Test piles are sometimes driven to a greater depth than the ordinary bearing piles with a view to ascertaining information concerning the lower earth strata.

Actual test loads are applied by loading a platform supported by a single leg and observing the amount of settlement. Since the supporting capacity per square foot depends upon the area loaded, it is desirable to use a standard mode of testing. A 12 by 12 in. timber has been so generally used for the supporting or bearing timber that this size may be said to be accepted practice. The bottom of the bearing timber should rest on the stratum at the bottom of the excavation on which the foundation may be expected to be placed, and should remain 60 to 72 hours, observations on settlement being taken at intervals. See Fig. 222. A convenient mode of loading the platform consists of using old cement bags filled with gravel weighing 100 lb. each. Figure

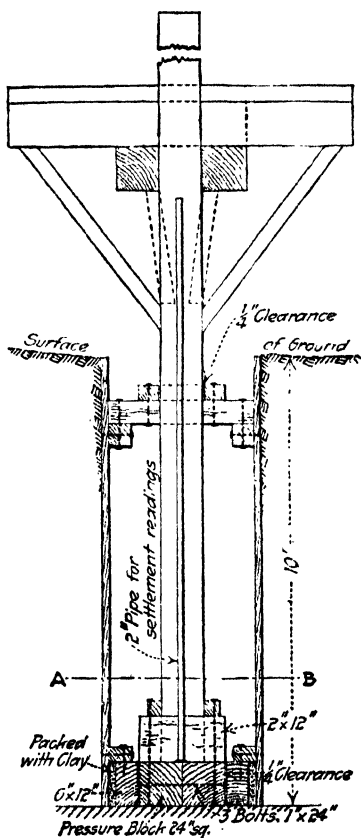

FIG. 222.—Frame for applying a test load to soils.

223(a)¹ shows the rate of settlement with time, in a typical soil bearing test. For a given load, the settlement gradually increases with time until equilibrium is established by the enlargement of the "bulb of pressure." See p. 475. Figure 224² shows typical test graphs grouped according to soil characteristics. The similarity of the graphs of each group is significant. The log of a hole bored adjacent to the test area shows the soil strata on which the test was made. These tests were from widely scattered locations. The logs are abbreviated thus: *Bk.* (black),

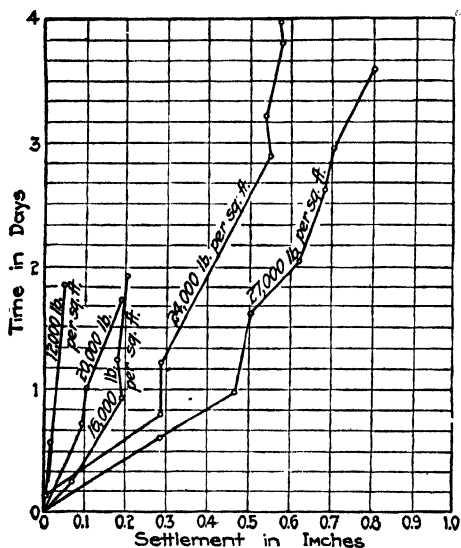

FIG. 223(a).—Typical rate of settlement of a test load.

Bl. (blue), *Bn.* (brown), *Y.* (yellow), *L.* (loam), *C.* (clay), *S.* (sand), *Sy.* (sandy), *M.* (mud), *W.* (water or wet).

After the explorations have been completed, typical cross sections of the site showing the relative positions and extent of the various strata should be plotted. See Fig. 94. Samples of the materials penetrated in washed borings placed in glass cylinders with the thickness of the layers made to scale and in proper sequence afford a valuable visual record of the results. Accurate technical descriptions of the materials penetrated should be kept rather than loose general descriptions involving vague and unscientific field terms.

¹ *Engineereng News*, Sept. 30, 1915.

² Courtesy, Robert W. Hunt Co., Testing Engineers, Chicago.

Interpretation of Soil Bearing Tests.—After a test on the bearing capacity of the foundation has been completed, there is no definite procedure in interpreting the results so as to indicate the proper bearing value to use in design. Under any moderate load, the test will show some settlement, and this settlement is

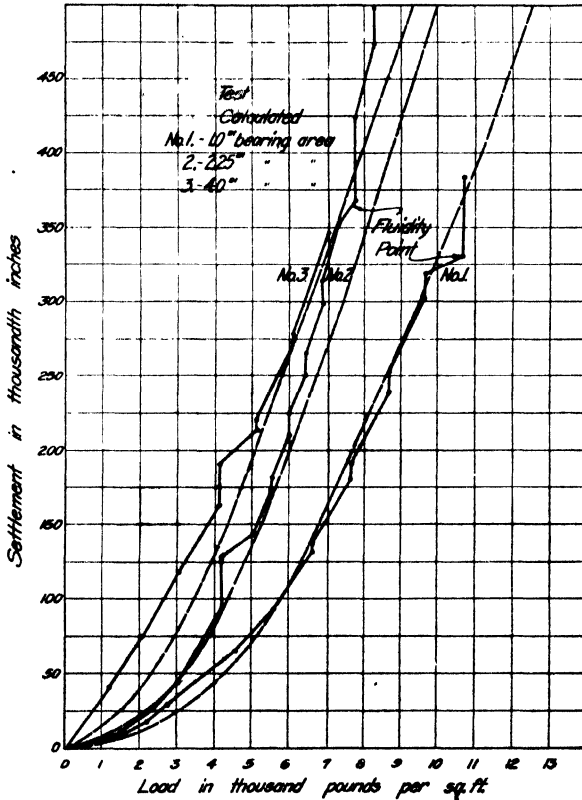

FIG. 223(b).—Observed and calculated settlements under test areas of different sizes.

attained gradually over a period of one to three days at the end of which the test load comes to rest. At this point, the compression of the soil has been communicated to such a depth and a sufficiently large "bulb of pressure" has been formed to bring the intensity of pressure within the elastic strength of the soil.

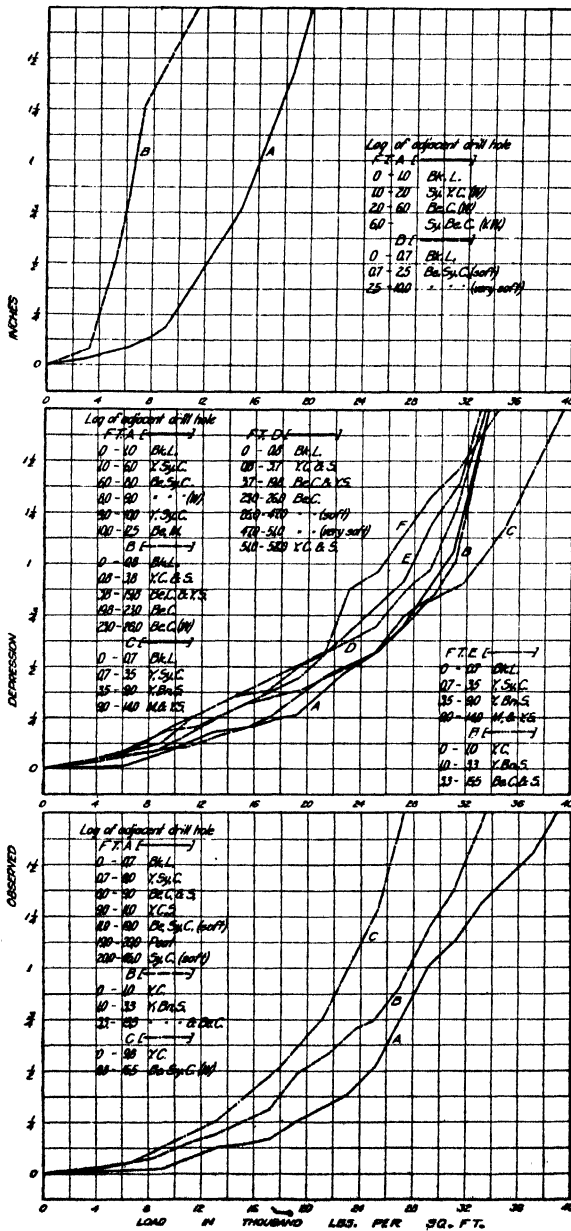

FIG. 224(a).—Test graphs of various soils.

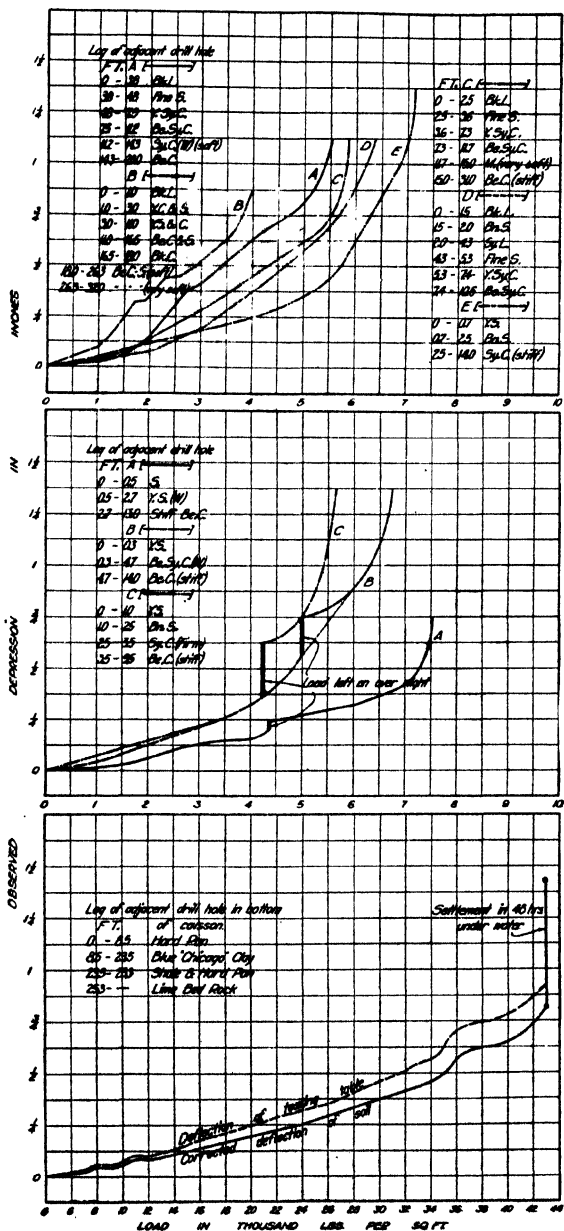

FIG. 224(b).—Test graphs of various soils.

As shown on p. 477, the supporting capacity of a footing does not vary with its area but varies as a function of the area and a function of the perimeter. That is, the supporting capacity equals $pA + fL$, and which of these terms will be the larger depends upon the soil and upon the size of the area. For example, if $p = 3,500$ lb. per square foot and $f = 1,500$ lb. per linear foot for 0.3 in. depression, a bearing post of 1 sq. ft. area would support $3,500 \times 4 + 1,500$ or 9,500 lb., while one 10 ft. sq. would support $100 \times 3,500 + 40 \times 1,500$ or 410,000 lb. instead of $100 \times 9,500$ or 950,000 lb., as would be the case if the supporting capacity varied directly with the area only.

The effect of the shear around the perimeter has led to some confusion and caused some to draw the conclusion from small scale tests that the supporting capacity varies with the square root of the area. In soils where the shear value of the soil is large, it is obvious that for small test areas the perimeter or linear dimension of the area will predominate, whereas for the comparable areas of practical design, the supporting capacity actually varies more nearly with the area than with the linear dimension. A comparison of a few cases will readily show this to be true.

Of the two elements, p varies almost directly with the depth of settlement in sand and dry clay soils, whereas f , on the other hand, remains fairly independent of the amount of settlement, varying, if at all, with some low power of the settlement; in cases studied, it varied about as the fourth root.

If these elements were determined, it would be possible to predict the bearing capacity of a larger area from the results of a small area test. Thus, using the data of the above test for a 0.3-in. penetration under a 12-in. square post, a footing 8-ft. square might be expected to sustain with a 0.5-in. penetration, $3,600 \times \sqrt[5]{\frac{5}{3}} \times 64 + 1,500 \sqrt[4]{\frac{5}{3}} \times 32 = 432,000$ lb., or approximately 5,400 lb. per square foot. The broken lines of Fig. 223(b), which were plotted from values calculated in this manner, agree closely with observed results up to the point of fluidity.

A safe design bearing load should be well under the bearing at which yield or fluidity occurs, but, in many tests, a point of fluidity is not sufficiently definite to serve as a basis of procedure. Moreover, the seriousness of settlement also affects the choice. In some instances, all settlement must be avoided as nearly as

possible, while, in others, some settlement is not serious. In one case, a footing loaded 4 tons per square foot has shown no settlement although the test load settled 0.1-in. under 4 tons. In general, a structure will probably show no appreciable settlement under a loading equal to the test load for $\frac{1}{8}$ in. settlement. Cases for which data (unpublished) are available in which no appreciable settlement has occurred are given below:

Soil material	Test load, tons per square foot	Test settlement, inches	Design load tons per square foot
Sand.....	6.5	0.5	3.2
Sand.....	7.0	0.2	4.0
Compact yellow clay.....	20.0	0.4	3.0
Gumbo.....	3.0	0.2	1.5
Loam.....	0.7	0.5	0.32

The 1921 tentative report of the Am. Soc. C. E. Committee on Bearing Power of Soils stated that “the bearing value of soil should be limited to one-half the value shown by the compression diagram between the point where the soil is merely compacted and that where displacement begins.”

Movement of a Structure Caused by Unequal Settlement.—

Unequal settlement may cause a structure to lean considerably out of plumb as well as to be displaced vertically. In one six story building inspected by the author, a foundation settlement had not only lowered the building several inches, but had caused the top to lean over on the adjacent lot some eight inches and to interfere with the building thereon. An abutment for a bridge may lean so much from unequal settlement

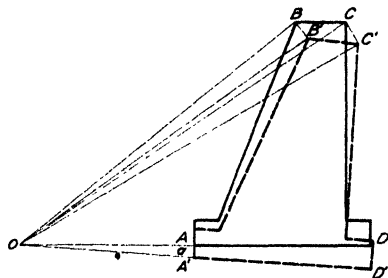

FIG. 225.—Movement of a structure caused by settlement.

as to push a steel span off its roller expansion bearing or seriously to disturb the stress distribution of an arch.

Where a structure settles unevenly, it rotates about an instantaneous axis, as shown in Fig. 225. If one side settles DD' and the other AA' , then the instantaneous axis at O is found

by drawing lines DAO and $D'A'O$, and the movement of any other point C is found by rotating OC through an angle COC' equal to DOD' .

In a homogenous soil, the amounts that the soil will compress DD' and AA' are practically proportional to the soil pressures, and if the modulus of compressibility (load per square inch per inch of compression) is known, the settlement can be calculated. This modulus can be readily obtained from bearing tests.

Effect of Depth.—Soils at great depth have a greater bearing capacity owing to their greater compaction under the overburden of earth. Tests made at Antwerp under a quay wall indicated that the supporting capacity increased according to the following formula: $P = 0.68k + 0.014kh^1$ where k is a soil constant, 1.5 for aluvium, 4.5 for compact sand, 5.0 for sand and gravel and for hard clay, and 8.5 for bedded gravel. P is the allowable bearing in tons per square foot and h is the depth in feet below the surface.

Professor C. T. Morris² found that, under about 112 ft. of earth, a bearing test with a 5 by 5-in. plate on heavy clay or hardpan showed less than 0.1 in. settlement up to 60 to 80 tons per square foot. The soil yielded, however, at this load. Tests on 8-in. cubes cut from this soil averaged a crushing strength of about 31 per cent of the test loads. A loading was adopted not to exceed 35 per cent of the yield test load, nor to exceed 25 tons per square foot in any case.

At the Metropolis bridge, tests on fine sand at the bottom of the caisson at 90 ft. depth gave a test bearing of 20 tons per square foot. The allowable bearing pressure adopted was 6.5 tons per square foot.

Types of Foundations on Dry Soil.—With respect to the mode of bearing on the earth and the mode of increasing the bearing area, foundations constructed on dry earth may be classified as:

- A. *Direct*, or unenlarged bearing;
- B. *Spread* foundations:
 - (a) With footings,
 - (b) On grillage;
- C. *Floating* foundations
 - (a) Mat or slab,
 - (b) Beam and slab,

¹ *Engineering and Contracting*, Mar. 16, 1921.

² *Engineering News-Record*, Jan. 21, 1926.

- (c) Inverted arch and slab,
- (d) Groined arch;
- D. *Open well*, or pier foundations:
 - (a) Sheet piling,
 - (b) Sectional lagging;
- E. *Compacted soil* foundations:
 - (a) Timber compacting piles,
 - (b) Sand and stone piles,
 - (c) Concrete ingots cast in depressions
 - (d) Cupping process;
- F. *Pile* foundations:
 - (a) Timber piles,
 - (b) Concrete piles,
 - (c) Miscellaneous.

Where a wall or column rests on solid rock, no enlargement at the bottom is necessary, since the bed of rock is as strong or stronger than the masonry of the structure itself, although a slight spreading may be desirable on account of inferior concrete at the bottom. Where, however, the foundation does not rest directly on solid bed rock, it is almost always necessary to enlarge the bearing area by some form of foundation construction in order to secure adequate supporting capacity, except in the case of very light structures. The above types of foundations will be briefly discussed in the following paragraphs.

Spread Footings.—Spread footings may be used under either walls or columns and may be either of plain masonry or of reinforced concrete. The problem is to enlarge the base sufficiently to secure sufficient bearing area to carry the superimposed load without exceeding safe bearing values on the soil or safe working stresses in the masonry of the footing.

As stated previously, the bearing capacity of any earth stratum depends upon the character of the formation, the extent of the bed, and the depth below the surface. If a foundation bed is compressible and the soil is displaced by being pushed to one side causing a bulging of the earth at the side, it is obvious that its bearing capacity will depend upon the depth of the bed below the surface of the ground. If the weight of the wall, W , causes a unit pressure, p , downward, this will cause a lateral pressure of $\frac{1 - \sin \phi}{1 + \sin \phi}p$, or kp , which acting on a particle of earth at the side will cause a vertical pressure tending to lift the earth at the side equal to $\left(\frac{1 - \sin \phi}{1 + \sin \phi}\right)^2 p$, or k^2p . For exact equi-

librium, this must equal $w x$, where w is the unit weight of the earth and x is the depth of the foundation bed. From this relation, $x = \left(\frac{1 - \sin \phi}{1 + \sin \phi} \right)^2 \frac{p}{w}$.

Wall Footings.—In the case of wall footings, Fig. 226(a), the footings act merely as a cantilever beam with the load acting upward and the support at the middle. It is commonly assumed that the bearing is uniformly distributed over the bearing area, although owing to the deflection of the footing, the bearing may be somewhat greater at the middle than at the edges.

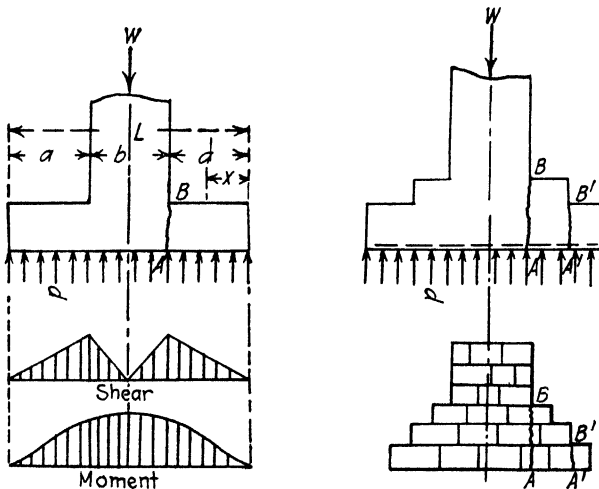

FIG. 226(a).—Diagrams of wall footings.

However, since this deflection in a masonry footing would be very small and until considerable compression of soil has occurred, the bearing capacity is not greatly increased, it is probable that the assumption of uniform bearing is sufficiently accurate. Therefore, the unit bearing where the load is centrally placed may be taken as $p = W/A$, where W is the total load and A is the bearing area.

The moment at the section AB in a strip 1 ft. wide is $\frac{1}{2} p a^2$, or in general, the moment is $\frac{1}{2} p x^2$, x being the distance from the edge of the footing to the section in question. The shear stress along the section AB is $pa/12d$ pounds per square inch. The maximum diagonal stress should be determined by the

formula $S_m = S_t/2 + (\frac{1}{4}S_t^2 + S_s^2)^{1/2}$, in which S_t is the direct tensile stress due to flexure, and S_s is the direct shear stress.

In the case of reinforced concrete wall footings, the diagonal shear should be investigated as in any beam, and the bond also should be similarly investigated, for in such short members, shear or bond may be the determining factor in proportioning the reinforcement. Comparatively small reinforcing bars can be used to advantage in order to increase the bond area. Tests by Professor A. N. Talbot¹ indicate that vertical stirrups are not very efficacious in resisting diagonal tension in such short beams. His tests show that in general, the critical section may be taken at the face of the wall where the section is uniform, but it may be at one of the stepped sections where the footing is stepped. The ordinary unit working stresses may be safely used in the design of footings.

Column Footings.—The distribution of stresses in a column footing is indeterminate, the footing acting generally as a plate carrying a uniformly distributed load and supported at the center. The moment of the earth pressure against the area $ABCD$, Fig. 226(b), is

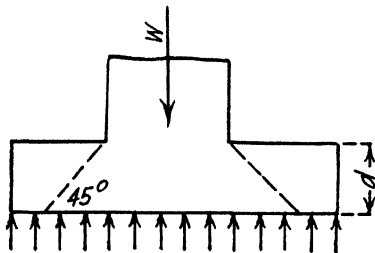
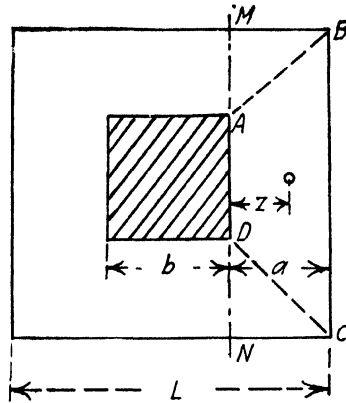

FIG. 226(b).—Diagram of column footing.

$$M = \frac{W}{4} \left(\frac{L^2 - b^2}{L^2} \right) z; z = \frac{b + 2L}{b + L} \frac{a}{3}$$

Whence,

$$M = \frac{W}{4} \left(\frac{L^2 - b^2}{L^2} \right) \left(\frac{b + 2L}{b + L} \right) \left(\frac{L - b}{6} \right) = \frac{W}{24} \left(\frac{L - b}{L} \right)^2 (b + 2L)$$

¹ Univ. of Illinois Eng. Exp. Sta., Bull. 67.

W being the total load on the column and z the distance to the center of gravity of the area $ABCD$.

Tests made at the University of Illinois indicate¹ that the moment at the critical section is given by the formula

$$M = (\frac{1}{2}ba^2 + 0.6a^3)p$$

in which p is the uniform upward pressure in pounds per square foot. The location of the section which resists this moment is conjectural to a certain extent. Professor A. N. Talbot has formulated the following rule as a basis of calculation.² "As a basis applicable when the spacing of the bars is uniform or does not vary far from this, the resisting moment of the footing in each of the two directions may be based on the amount of steel in a width of beam equal to the width of the pier (column) plus twice the depth of the footing to the reinforcement, plus one half the remainder of the width of the footing, and the use of this amount of steel will determine the maximum steel stress." Expressed as a formula, the equivalent beam width according to this rule is

$$L' = b + 2d + \frac{1}{2}(L - b - 2d).$$

If reinforcing bars are placed parallel to the sides forming a reticulate mesh, the arrangement is spoken of as "two-way" reinforcement, while if in addition bars are placed on both diagonals, it is called "four-way" reinforcement.

Bond stresses in ordinary two-way reinforced footings are calculated as in ordinary reinforced concrete beams, and should always be investigated carefully, for, as in the case of wall footings, bond stress may be the controlling factor in proportioning the steel. Tests made at the University of Illinois, referred to above, showed that column footings failed around a frustrum of a cone or pyramid, depending on the shape of the column, as indicated in Fig. 226(b), hence, it is logical to take the critical shear area at a section at a distance from the face of the column equal to the depth of the footing, the external load being considered as that outside the base of such a frustrum. The unit vertical shear for a square column becomes

$$f_v = \frac{[L^2 - (b + 2d)^2]p}{4(b + 2d)jd}$$

¹ *Univ. of Illinois Eng. Exp. Sta., Bull. 67.*

² *Ibid.* p. 22.

Where columns are placed at the edge of property so that the adjacent property cannot be encroached upon, the footing is usually made continuous with that of the next interior column so that the resultant of the two column loadings will coincide with the center of gravity of the reaction on the footing, and the reinforcement designed accordingly.

The dimensions of a trapezoidal footing slab which will have its center of gravity at a fixed point under the center of gravity loads may be readily found by taking moments in the usual way about one end.

Where three or more columns rest on a single slab footing, the moments and shears may be determined by the theorem of three moments or by other methods applicable to continuous beams, considering the earth reaction as a uniformly distributed upward load and the columns as the reactions. Actually, the bearing is not perfectly uniform owing to the elastic deflection of the slab, but, in all ordinary cases, the lack of uniformity is negligible.

Instead of stepping the footing to follow moment and shear requirements, many designers give them a uniform slope. Obviously, the ordinary principles applicable to a beam of uniform section do not apply to a sloped footing. A slope is theoretically conceivable which would make the moment stress in the steel and bond stress constant throughout the length.

In a section of such a footing, $C = T = M/jd$, where both M and jd are variables.

Differentiating

$$dT = \frac{jd \cdot dM - M \cdot d(jd)}{(jd)^2} \tag{1}$$

Dividing by dx

$$\frac{dT}{dx} = \frac{1}{jd} \cdot \frac{dM}{dx} - \frac{M}{(jd)^2} \cdot \frac{d(jd)}{dx} \tag{2}$$

$\frac{dT}{dx}$ is the bond stress at any section and dM/dx is the shear, and

$\frac{d(jd)}{dx}$ is $j \tan \alpha$.

Since $M/jd^2 = T/jd$, the bond is $\frac{dT}{dx} = \frac{V}{jd} - \frac{T}{jd} \tan \alpha$, or

$$f_0 \Sigma_0 = \frac{V - Tj \tan \alpha}{jd} \tag{3}$$

From Eq. (3), the unit bond stress, f_0 , can be calculated.

permanently immersed, as in the case of the Auditorium at Chicago.

Steel grillages constructed of I-beams or of built-up girders and filled with concrete have been extensively used. Figure 227(a) shows details of the grillages and the foundation plan of the L. C. Smith 35-story office building at Seattle,¹ concerning which the following details are of interest.

"The foundations rest on soil composed of sand, gravel and clay in strata of varying thicknesses. Borings indicated that this alternate stratification extended to an indefinite distance below the street. The foundations were proportioned for a load of 5,500 lb. per square foot, dead load only being considered. On the north side of the building the columns are carried on pairs of cantilever plate girders extending over three column points. Underneath the girders is a single tier of 24 or 20-in. I-beams. This construction was necessary to provide for the required foundations without extending over the lot line and still keep the center of gravity of the foundations concentric with the center of gravity of load. Underneath the bottoms of the grillage beams there is a concrete bed 12 in. thick. The grillage beams and girders are filled between and encased in solid concrete. In two cases behind the elevators where the space was not sufficient for two girders, a single 60-in. grillage girder is used with one tier of beams beneath. The top flange of this girder is supported laterally by braces to the tops of grillage beams."

Figure 227(b) shows the grillage under the Woolworth building² at New York. The piers of this building are mostly circular varying from 6½ to 18 ft. in diameter. For the smaller piers, only two tiers of beams were required, but for the larger piers four tiers of beams were needed.

A steel grillage of this sort is commonly designed as a cantilever, each beam considered as carrying its proportionate part of the load. The soil pressure is usually assumed as uniform over the length of the beams, but owing to the deflections of the beams, it is probably somewhat greater than the average under the column and diminishes towards the edge of the grillage. The concrete is not considered as taking any stress, its function being merely to protect the steel against corrosion.

¹ *Engineering Record*, July 6, 1912.

² *Engineering Record*, July 5, 1913.

In Chicago, buildings placed on grillages are expected to settle owing to the plasticity of the soil, and consequently it has been the custom to set the buildings some 5 to 8 in. above the desired elevation; this amount of settlement has not been realized in some instances and has been exceeded in others.

Floating Foundations.—Floating foundation is a term applied to practically monolithic foundations built under an entire structure, which, with the advent of reinforced concrete, have been used widely for construction on soils of more or less plastic nature. Floating foundations have been constructed as slabs or mats, a combination of beams and slabs, inverted barrel arches and slabs, and as inverted groined arches. The last

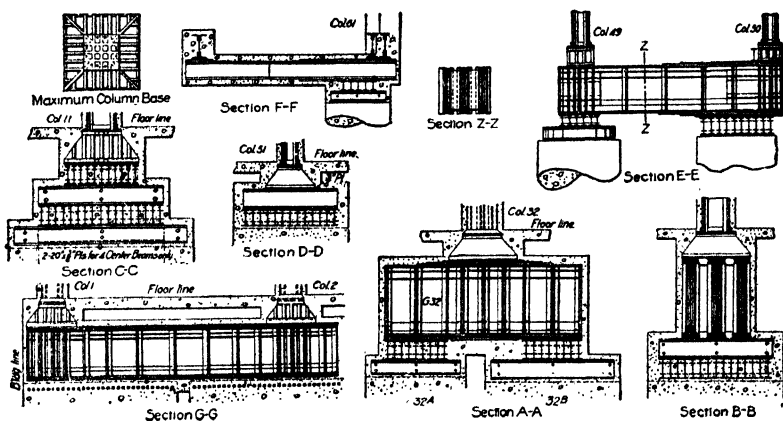

FIG. 227(b).—Grillage foundation of the Woolworth Building, New York.

named type has been especially adaptable for use under covered water storage reservoirs.

The obvious advantage of floating foundations is that if uneven settlement occurs, which is rendered less probable by this type of foundation, serious injury to the structure does not result. At Winnipeg, a million bushel grain elevator, constructed on a floating foundation of beams and slabs, when about three-fourths filled with wheat, tipped to an angle of 26° with the vertical due to the subsidence of one side of the foundation bed. The grain was removed and the structure righted by means of jacks without serious loss and with comparatively low expense. Such an incident would manifestly have been impossible if the foundation had been separate for each bin instead of a monolithic mat under the entire structure.

A plain slab or mat is merely an inverted flat slab on which the earth reaction or pressure constitutes the load and the columns the supports, hence, the principles of flat slab design (p. 138) are applicable in this type of structure as well. Care should be exercised to provide sufficient shear strength around the column footings as around the capitals in ordinary slab design.

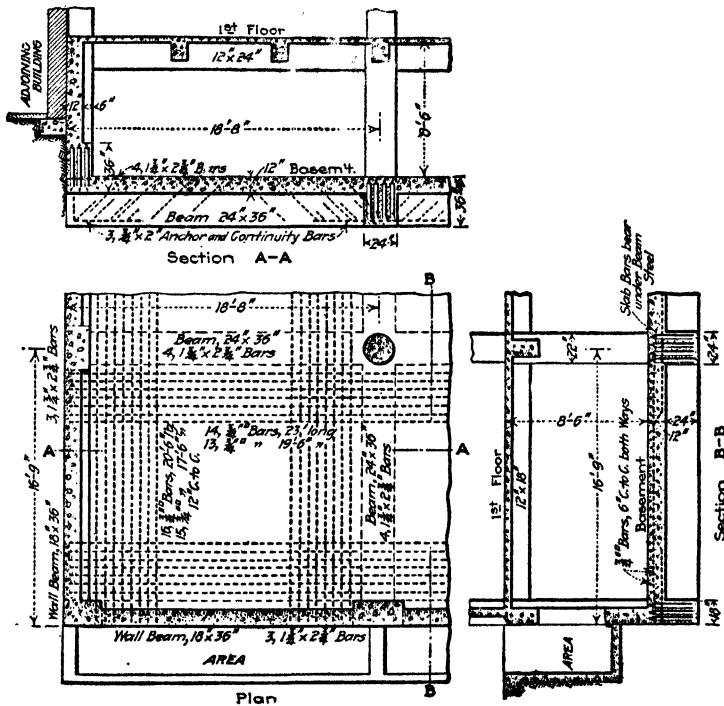

FIG. 228.—Floating foundation under the Farr & Bailey Manufacturing Co. Building, Camden, N. J.

A twelve-story building at Minneapolis was constructed on such a mat on loam and fine unstable sand. The mat was 108 by 162 ft. in plan and 5 ft. thick at the outside and 4 ft. thick under interior columns with four way reinforcement at the top and bottom. Pedestals 12 ft. square and 2 ft. thick supported the columns.

Figure 228¹ illustrates a foundation consisting of a slab and beams where the beams are placed beneath the slab, the latter

¹ *Engineering News-Record*, Nov. 1, 1917.

servicing as a floor, and Fig. 229¹ shows a slab and beam foundation where the slab is beneath the beams. This latter is the more logical arrangement since the slab acts at the flange of the T-beams, although it requires a second slab to be constructed for a floor. The former building is located at Camden, N. J. on soft water-bearing soil and the latter at Chicago on stiff blue clay estimated to support two tons per square foot.

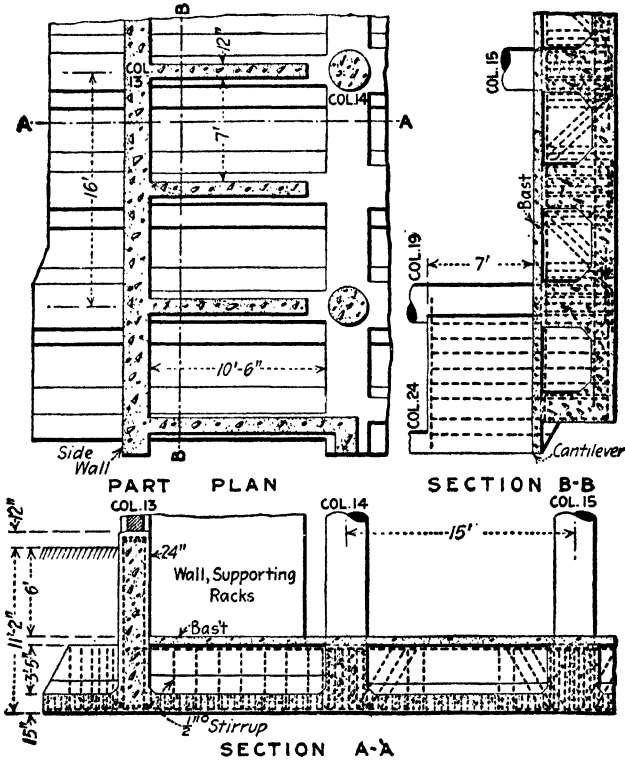

FIG. 229.—Floating foundation under the Felt & Tarrant Building.

Figure 230² illustrates a foundation composed of inverted arches and a slab under an eight-story building in New York resting on unstable sand, the soil pressure being 3.4 tons per square foot. The advantages claimed for this type of foundation are its simplicity and its low cost, the cost being estimated at 25 per cent lower than for a steel grillage in the same place.

¹ *Ibid.*

² *Engineering News*, Dec. 28, 1911.

In this instance, reinforcing steel for negative moment was placed under the columns in order to take advantage of the cantilever action in the event of a failure of the arch. The arches run in both directions as shown and are 12 in. thick at the crown and 42 in. under the columns. The extrados of the arches was made flat in order to give an even bearing on the soil.

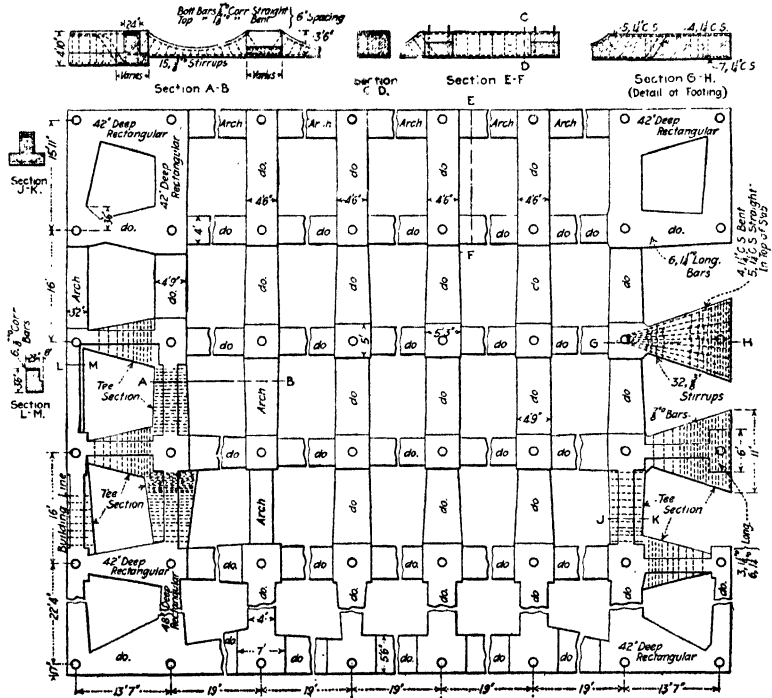

FIG. 230.—Reinforced concrete arch foundation under a warehouse, New York.

Inverted groined arches are frequently used as foundations under filters and covered water storage reservoirs. They are commonly built in alternate blocks to facilitate construction.

Compacted Soil Foundations.—In Continental European countries especially, satisfactory foundations on compressible soil have been constructed in several instances by mechanically compacting the soil over the area on which the structure is to rest. Several methods have been employed to accomplish the compacting of the soil, chief of which are (a) by forcing stone, gravel or sand into holes driven into the ground by dropping a

conical weight, (b) by driving short timber piles into the ground and thus solidifying a top layer into sort of a mat, (c) by forming short concrete piles or pedestals in holes driven into the ground usually by dropping a conical weight as above, (d) the cupping process.

The theory of the compacting of the soil is that the water and air are driven out from between the particles thus making the earth layer a solid crust. The procedure in the first method is to drop a weight of about 5,000 lb. and 4 ft. in diameter down leads much as in the case of a pile driver¹ until a hole is forced into the ground 10 to 20 ft. deep. Crushed stone, sand or gravel is then rammed into the hole by means of a flat bottom weight dropped in a similar manner. In Europe foundations for buildings and bridges of considerable magnitude have been built in this manner and on very difficult soils. The Canal du Nord was carried across a peat marsh in the valley of the Somme in this manner, the piles being about 16 ft. apart.

Driving short wooden piles into compressible soil compacts it to such an extent that its bearing capacity is greatly increased and in the past, such a scheme has been used at times in foundation work. Owing to the decay of the piles, however, as well as to other inherent defects in this scheme, the method is not one to be recommended.

In a manner similar to that outlined above for compacting soil by means of sand or stone forced into holes, concrete pedestals have been placed in the ground to increase the bearing. This method of compressing the soil, when properly used, has given good results. The process shades into the construction of concrete bearing piles by patented methods that will be described in a subsequent paragraph.

The compressol foundation is of this type. A conical block of about 2 tons weight and $2\frac{1}{2}$ to 3 ft. diameter, is dropped through a height of about 25 ft., thereby ramming holes 25 to 50 ft. deep in the soil. These holes, being 8 to 12 ft. on centers, compact the soil over the foundation area and increase its impermeability. They are rammed full of concrete immediately after they are formed, thereby further compacting the soil, since the volume of the concrete introduced may be as much as three times the original volume of the hole. The structure is then founded on these concrete pedestals. This type of foundation

¹ *Cassier's Engineering Monthly*, Aug., 1916.

has been rather widely used in Europe and it is said to have advantages in the compressible soils to which it is adapted.

Cupping or restraining the soil by driving interlocking sheet piles around the foundation, or by encircling it with a steel or a reinforced concrete cylinder, or other restraining device, may serve to increase the bearing capacity of the soil. A steel cylinder may be driven around the footing of a column; a reinforced concrete annulus is placed by excavating a circular trench about the foundation and then placing the reinforced concrete.

Open Well or Pier Foundations.—Sinking open wells under columns down to solid rock or other firm stratum and then filling with concrete forming piers for the support of column loads

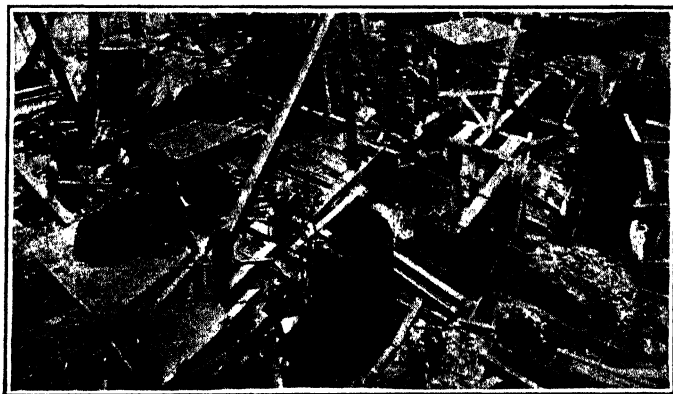

FIG. 231.—Open well foundation.

is a method much used in building construction. Two methods of sinking the wells are in common use, one by driving sheet piling, either wood or steel, and the other by lining successive sections of about 4 or 5 ft. with circular lagging braced by iron bands. Figure 231 is a photograph of the construction by means of steel sheet piling in the Kinney Building at Newark, N. J., and Fig. 232 shows the arrangement of wood sheet piles for the Railway Exchange Building at St. Louis.¹

The second method, sometimes referred to as the Chicago method, because of its extensive use in that city, consists in excavating a well about 5 ft. deep, inserting a section of the lagging, excavating another 5 ft., inserting the next section of lagging, etc. until the desired depth is reached. This method unmodified cannot be successfully used through quicksand, but

¹ H. S. JACOBY and R. P. DAVIS, "Foundations of Bridges and Buildings," p. 367.

through stiff clay and silt, or firm sand, the method is advantageous. The wells must be about 4 ft. in diameter at least in order to permit men to work in the excavation and it is usually

found that 6 or 8 ft. diameter is a practical maximum, hence, the diameter of the wells is about 4 to 6 ft., although sometimes as large as 8 to 10 ft.

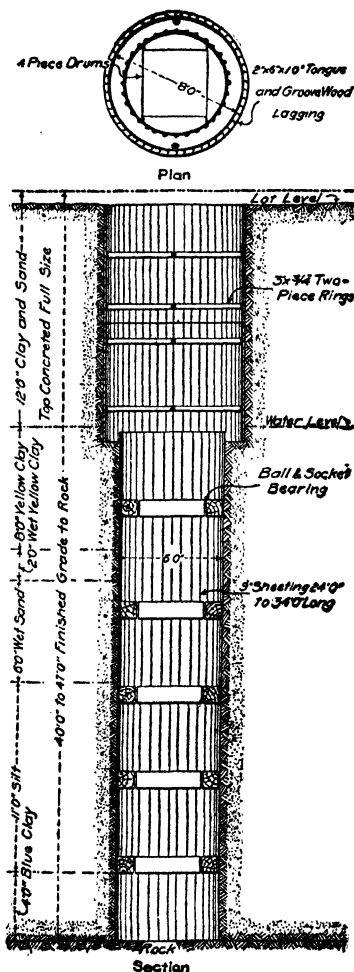

FIG. 232.—Open well for pier under the Railway Exchange Building, St. Louis.

When the wells are excavated to bed rock, the bottom is thoroughly cleaned and made ready for the concrete. Usually the bottom is belled out to about twice the diameter where the pier rests on hardpan, or other material than rock, the slope of this enlargement being not less than 45° . In Chicago, seven tons per square foot is allowable for piers resting on hardpan, and 30 tons where resting on rock. The cost of excavating these open wells in Chicago has usually been about \$12.00 to \$16.00 per lineal foot.

The chief advantages of this type of construction are that the resulting foundation is firm and without settlement; it is rapidly constructed and much of the work can be done without discontinuing the use of existing structures, the derricks being set up in the basement; the permanence of the work; and the reasonable cost. It is practically the accepted procedure for foundations under high buildings

of the steel cage or skeleton type.

Designing Loads for Foundations.—The proper load for which a foundation should be designed is a much debated matter, and

in fact, a hard and fast rule cannot be well adopted that is of general application. While each part of the superstructure should be designed for the maximum stress that will come upon that member, which condition usually involves full loads on the adjacent panels or parts, it is extremely improbable that full load will ever be over the entire structure at one time. This is particularly true in the case of a high building, for while each floor must be designed for full load on that floor, or certain panels must be designed for full load, it is not probable that all floors will be fully loaded at one time. However, in the case of warehouses, this condition might obtain, hence judgment must be used in estimating what part of full load may exist at one time, or in other words, what part of full load for the entire structure should be used in the design of the foundation.

For bridge foundations, the combination of live load, traction, earth pressure, ice pressure, wind pressure, etc. that will give maximum earth pressures should be considered, provided it is physically possible or probable that they can all occur simultaneously.

In high buildings, the question of proportional load on the foundation is a subject of great diversity of opinion, particularly where the foundations may be expected to settle somewhat, as in the case of spread or floating foundations on compressible soils. In these cases where settlement is expected, the problem is to adjust the bearing on the soil so that the settlement may be uniform in order that there may not be undue strains in the superstructure, cracks, etc. It is a matter of common observation that the settlement is caused chiefly by the dead load, for it is the load first applied and also it constitutes the major portion of the total load, and furthermore, because settlement is dependent upon the time that the load is applied and the dead load is constantly applied, while the live load is more or less transient or intermittent. Therefore, in assigning proportional load, the dead load should have a greater influence than does the live load. In some instances, e.g., the Masonic Temple at Chicago, the settlement during erection was so uneven that some of the steel work would not fit together until some members had been altered several inches in length. It is as important, therefore, in such cases not to make some parts of the foundation too large as it is not to make them too small.

The practice among engineers is to design the foundation for the dead load plus a certain proportion of the live load, frequently taken arbitrarily as 50 per cent. However, it is the better practice to allow the ratio of the probable live load (i.e., the actual load that will probably come upon the building) to the dead load to control the proportion of the live load to be used in the design of the foundations. The method used by C. C. Schneider, M. Am. Soc. C. E.¹ may be represented by the formula:

$$A = D/Br$$

in which A is the area required, D the dead load, B the allowable soil pressure and r the ratio between the dead load and the total load coming on the foundation at the footing where the ratio of the live to the dead load is greatest. This footing is selected as the basis for design because it is, in a sense, an index of the probability of the occurrence of full load. It will be observed that the design of any particular footing depends primarily upon the dead load.

Daniel E. Moran, M. Soc. C. E., employs a similar rule² except that it is based on the dead load plus half the live load:

$$A = \frac{D + 0.5L}{Br}$$

L being the live load, r the ratio $(D' + 0.5L')/(D' + L')$ in which D' and L' are the dead and live load respectively on the footing where the ratio of live to dead load is greatest.

Other engineers have formulated rules for their own use, but the above rules are typical and have been widely and successfully used. The actual results do not differ greatly for the two methods above cited.

Impact is not generally considered as being effective in designing foundations because it results chiefly from vibrations and the vibrations of the superstructure are entirely dissipated before the stresses transmitted reach the foundation.

The area of a footing may be more rationally proportioned by the formula $A = \frac{D}{B} + \frac{L}{cB}$, where c is a coefficient which varies with the character of the live load, being about 4 for people,

¹ C. C. SCHNEIDER, "General Specifications for Structural Work for Buildings."

² *Engineering News*, Apr. 3, 1913.

2 for merchandise, 1 for electrical and other quiet machines, and $\frac{2}{3}$ to $\frac{1}{2}$ for machines with heavy rotating parts.

The live loads for designing foundations are taken as those used in designing the columns resting thereon and are ordinarily much less than the sum of all loads at the maximum assumed intensity over the superstructure.

Pile Foundations.—In Fig. 223 is shown a pile foundation after the piles have been driven but not sawed off to grade. Piles driven to support a structure in this manner are called bearing piles or foundation piles to distinguish them from trestle piles or sheet piles. Such a foundation has proved effective under a great variety of conditions where soil of sufficient sup-

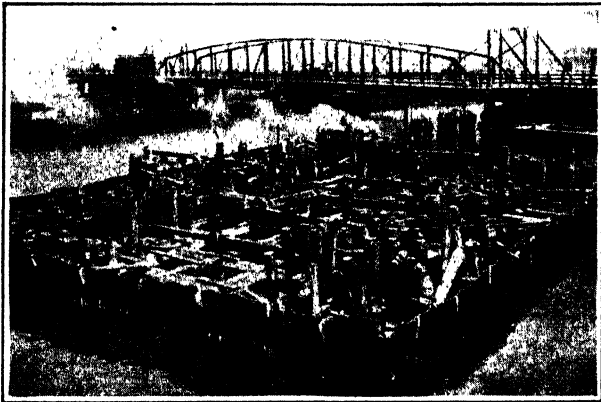

FIG. 233.—Pile foundation, 92nd St. bridge, Chicago.

porting capacity is not to be found within reasonable distance from the surface. Where the piles are permanently under water they will last indefinitely.

The number of piles, the spacing and position depend entirely upon the loads to be carried. Piles may be of timber, concrete, or specially designed steel shafts. The piles are ordinarily assumed to carry the entire superimposed load, since they are more rigid than the soil between them.

Timber Piles.—Timber piles have been used almost exclusively in the past in foundation work, but with the growing scarcity of timber and the cheapening of concrete, reinforced concrete piles are coming to be extensively used. Timber piles will last for centuries if permanently below the water level and protected from borers, but they decay in about 10 to 15 years, depending

upon the kind of timber and the climatic conditions, if alternately exposed to air and water.

The first grade of piles specified by the American Railway Engineering Association includes white, burr and post oak, longlead pine, Douglas fir, tamarack, eastern white and red cedar, chestnut, western clear redwood and cypress. These specifications further require:¹

“Piles shall be cut from sound trees; shall be close grained and solid; free from defects, such as injurious ring shakes, large and unsound or loose knots, or decayed spots, which may impair their strength or durability. In eastern United States, red or white cedar with a small amount of heart rot at the butt which does not materially impair the strength of the pile will be allowed.

“Piles must be butt cut above the ground swell and have a uniform taper from butt to tip. Short bends will not be allowed. A line drawn from the center of butt to the center of tip shall lie within the body of the pile.

“Unless otherwise allowed, piles must be cut when the sap is down. Piles must be peeled soon after cutting. All knots shall be trimmed close to the body of the pile.

“The minimum diameter at the tips of round piles shall be 9 in. for lengths not exceeding 50 ft., and 7 in. for lengths over 50 ft. The minimum diameter at one quarter length from the butt shall be 12 in. and the maximum diameter at the butt shall be 20 in.”

The second grade includes all other oaks not in the first grade, sycamore, sweet, black and tupelo gum, maple, elm, hickory, Norway pine, or any sound timber that will stand driving. The requirements for tip, butt, taper and straightness are the same as for grade one. Unless otherwise specified, piles of this grade need not be peeled. This grade of piles in general should not be used in permanent work but rather for falsework or in relatively less important foundations.

Bearing piles are usually about 20 to 30 ft. long, although in swampy and some other regions, greater lengths may be required. The length should preferably be determined from the results of soil borings, and should be selected so that the tip shall penetrate slightly into a hard stratum. Piles are driven with the small end or tip downward because of the greater facility in driving and because of the greater supporting capacity when thus driven.

¹ *Manual Amer. Ry. Eng. Assn.*, p. 235.

Timber piles, in addition to being subject to ordinary decay, are attacked by certain borers when located in salt water, chief of which are the teredo or shipworm, (head at *a*), and the limnoria or wood louse, Fig. 234.¹ The former, as a free-swimming mollusk about the size of a pinhead, becomes attached to a timber, bores through the surface, and then begins to grow, boring with its shell at its head and leaving its tail at the entrance for the circulation of water through its body. It attains the size of about six to eight inches long. The limnoria is about the size of a grain of rice. These borers are active chiefly within a few feet of the surface or between tide levels, and their borings may remove such a large proportion of the timber that little

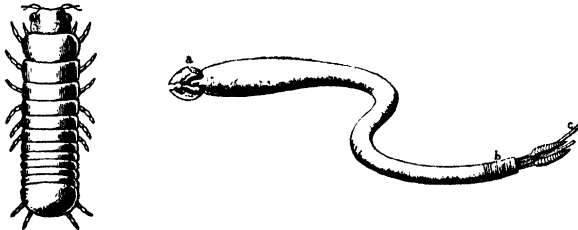

FIG. 234.— Wood borers, *Limnoria* and *Teredo*.

strength may remain. Impregnation with creosote of open grain timber like loblolly pine tends to prevent attack by marine borers but this method is ineffective for close grained timbers. Where piles are not exposed to the water directly, they are not attacked. Soft timbers last only six months to a year in warm climates when attacked by borers.

Pile Driving.—Piles may be driven by means of a pile driver or by means of a water jet, the former being used through ordinary soils and the latter through sand, gravel or small boulders when a large quantity of water is near at hand to be thus used. Pile drivers may be classed as:

1. *Drop hammers*
 - (a) Land or spool roller type
 - (b) Track type
2. *Steam hammers*
 - (a) Single acting
 - (b) Double acting.

Figure 235 shows in outline the spool roller type and Fig. 236 the track type of pile driver of the C. M. & St. P. R. R. indicating

¹ *Forest Service Bull.* 128.

the general dimensions. In the drop hammer type, the weight of hammer is about 2,000 to 4,000 lb. and drops about 25 ft. for

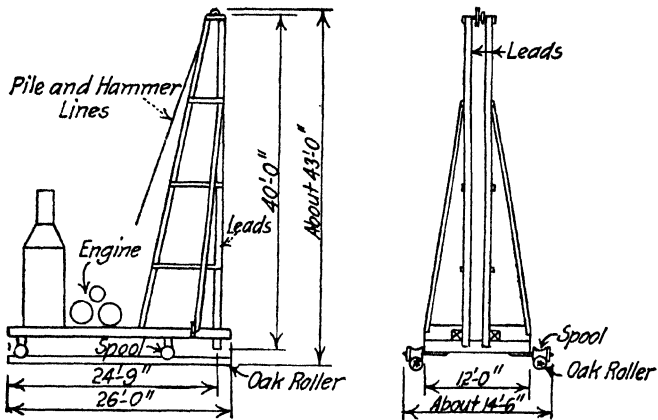

FIG. 235.—Spool roller pile driver, C. M. & St. P. Ry.

the lighter and 10 ft. for the heavier hammers. Some observations seem to indicate that not much is gained by a drop exceeding 10 ft. The effectiveness and efficiency of the drop hammer depends very largely upon the skill of the operator in his ability to take advantage of the rebound of the hammer when lifting it.

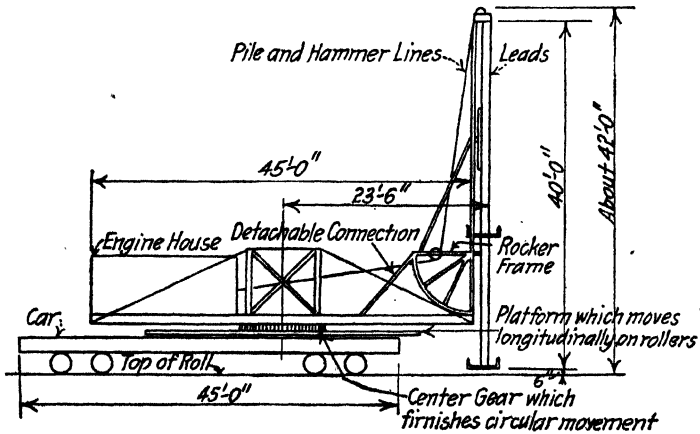

FIG. 236.—Track pile driver, C. M. & St. P. Ry.

Where piles have to be driven between or below existing structures, necessitating the use of a follower, a clearance of 9

or 10 in. must be allowed. With swinging leads, piles can be driven at a batter when necessary. With the above track pile driver, piles cannot be driven at a distance from the center line of track greater than 23 ft. 6 in. The track type would obviously be used where the work can be reached from the railroad track because of the greater convenience of this type, and the land type will be used where the work is remote from the track. By means of extension leads, piles can readily be driven at the bottom of an excavation with either type of driver.

The older types of steam hammers were single acting, that is, the steam acted on the piston only in raising the hammer from the pile, but the more recent types are double acting, the steam forcing the hammer downward against the pile as well as raising it. Figure 237 (a) shows the Warrington hammer, which is a good illustration of the former and (b) shows the Goubert hammer which is a good example of the latter type. The steam pile driver has so many advantages over the drop hammer that it has supplanted the latter to a very great extent except in the case of temporary or pioneer construction where a steam hammer is not available. It does not

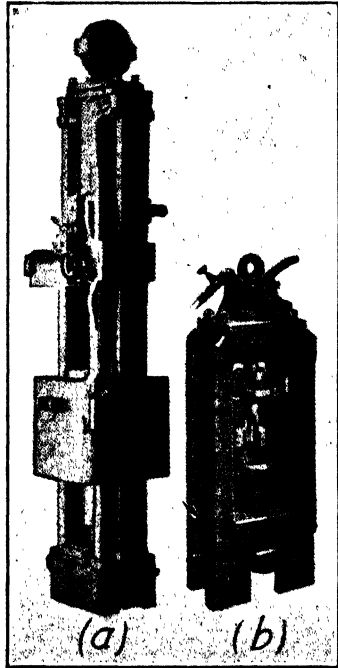

FIG. 237.—Steam pile drivers.

broom or otherwise injure the pile to so great an extent, it will drive about 50 per cent more piles per day, it requires fewer men to operate it, the pile is driven with less vibration and consequently with less injury to adjacent foundations and structures, and the driving is usually done at less cost notwithstanding the greater cost of the steam hammer. Drop hammers operate at about 5 or 6 blows per minute while steam hammers strike about 60 per minute for a single acting and 120 per minute for a double acting hammer. Table XXXIV gives the weights and dimensions of the principal makes of steam pile driving hammers.

512 DESIGN OF MASONRY STRUCTURES AND FOUNDATIONS

TABLE XXXIV.—WEIGHTS AND DIMENSIONS OF PILE DRIVING HAMMERS

Size number	Total net weight, lbs.	Weight of ram, lbs.	Dimensions over all			Cylinder				Comp. air, free air cu. ft. per min.	Size of hose, in.	Distance between jaws, in.	Width of jaws, in.	Duty, size of piles or piling hammer will drive	
			Height, in.	Width, in.	Depth, in.	Diam., in.	Stroke, in.	Strokes per min.	Steam boiler required h.p.						
WARRINGTON STEAM PILE HAMMERS															
Manufactured by Vulcan Iron Works, Chicago, Ill.															
0	16,000	7,500	180	16½	48	50	60	2½	26	9½				Heavy concrete piles	
*1	10,150	5,000	159	13½	42	60	40	2	20	8½				16" sq. or rd. piles	
1	9,850	5,000	156	13½	42	60	40	2	20	8½				16" sq. or rd. piles	
*2	6,800	3,000	144	10½	36	70	25	1½	19	7½				13" sq. or rd. piles	
2	6,500	3,000	138	10½	36	70	25	1½	19	7½				13" sq. or rd. piles	
3	3,800	1,800	114	8	30	80	18	1¼	18	6½				10" sq. or rd. piles	
4	1,350	550	84	4	24	80	8	1	14	4½				4" X 12" sheeting	
5	800		68	10	4	7½	125	10	1	10				3" X 12" sheeting	
UNION PILE HAMMERS															
Manufactured by Union Iron Works, Hoboken, N. J.															
0	12,100	2,560	118	20	10½	24	100	50	750	2	28			8½	Heavy concrete piles
1	8,000	1,548	94	28	18	9½	21	110	30	600	1½	28		8½	18" sq. or rd. piles
2	5,500	890	81	25	15	7½	16	130	18	300	1¼	25		6½	14" sq. or rd. piles
3	4,500	663	74	23	13	6½	14	135	15	200	1¼	23		5½	10" sq. or rd. piles
4	2,500	363	60	20	11	5½	12	150	10	150	1	20		4½	6" X 12" sheeting
5	1,400	214	47	17	9	4½	9	200	8	100	1	17		4½	4" X 12" sheeting
6	850	129	40	14	8	3½	7	250	5	60	¾	14		3½	2" X 12" sheeting
7	365	70	31	10	6	2½	5	300	3	40	¾	10		3½	1" X 6" sheeting
8	135	53	31	10	6	2½	5	300	3	40	¾	10		3½	1" X 6" sheeting
GOUBERT STEAM PILE DRIVING HAMMERS															
Manufactured by A. A. Goubert, New York, N. Y.															
3	5,000	1,500	76	29	17	8	14	140	50	570	2	24		8½	18" sq. or rd. piles
2	3,400	800	62	24	14	6½	10	160	25	300	1½	22		6½	12" sq. or rd. piles
1	950	200	43	16	10½	4	8	200	10	120	1¼	16		4"	sheeting
NATIONAL STEAM PILE HAMMERS															
Manufactured by National Hoisting Engine Co., Harrison, N. J.															
1	8,000	1,500	94	26	26	9	16	115	35	600	2	26		8½	Med. concrete and 18" sq. or rd. piles
2	5,500	1,025	81	24	24	7½	12	150	25	300	1½	24		6½	14" sq. or rd. piles
3	3,500	575	73	20	17½	6	10	170	15	200	1¼	20		5½	6" X 12" sheeting
4	1,500	310	60	16	16	4½	9	200	10	150	1	16		4½	4" X 12" sheeting
5	800	145	46	14½	13½	3½	7	250	5	75	¾	14½		3½	3" X 12" sheeting
McKIERNAN-TERRY PILE HAMMERS															
Manufactured by McKiernan-Terry Drill Co., New York, N. Y.															
9	7,500	1,250	78	21	15	12	200	60	600	2	21	6½ to 10		18"	sq. or rd. piles
8	6,300	1,050	75	21	14	10½	210	50	500	1½	21	6½ to 10		16"	sq. or rd. piles
7	5,000	800	73	21	16	12½	9½	225	35	350	1½	21		6½ to 8½	14" sq. or rd. piles
6	2,900	400	64	15	15	9½	8½	275	25	275	1¼	15		5½ to 7½	6" X 12" sheeting
5	1,500	200	56	11	11	7	7	300	20	200	1¼	11		4½	4" X 12" sheeting
3	640	68	58	9	9½	3½	5½	300	15	150	1	9		3"	X 12" sheeting
2	400	47	44	7½	6½	4½	5½	450	10	125	¾	7½		3"	X 8" sheeting
1	145	21	43	8	6	2½	3½	500	10	100	¾	8		2"	X 10" sheeting
INGERSOLL-RAND SHEET PILE DRIVER															
Manufactured by Ingersoll-Rand Co., New York, N. Y.															
G1	1,200	200	80	11½	11	4	7½	300	10	110	1¼	11		4"	X 12" sheeting

The butt of the pile must be cut square before driving is begun, otherwise the blow on the projecting portion will split the top of the pile. Rings of steel about $\frac{1}{2}$ by 3 in. are placed over the top of the pile sometimes, the latter being trimmed to fit, to prevent brooming. After driving, this ring is removed by means of a canthook, one ring serving for 50 to 300 piles. A more common device for protecting the butt of the pile consists of a cast block fitting over the head of the pile.

Where piles are to be driven through sand or gravel by means of a hammer, they should be pointed somewhat, the diameter of the "point" being 4 to 6 in. and its plane at right angles to the axis of the pile otherwise difficulty will be encountered in guiding the pile. Where specially hard strata are to be penetrated, iron or steel points should be used. In driving to depths greater than the length of one pile, the pile must be spliced. This is done by fishplate splices spiked to the sides.

Care must be exercised to avoid overdriving of piles causing them to shatter beneath the surface of the ground. Striking a log or boulder is likely to cause the destruction of a pile in this manner. Overdriving is indicated by the bouncing of the hammer or by the "kicking" of the pile. Where a pile is thus injured, its supporting capacity is almost entirely destroyed.

An underwater pile driver, using compressed air, drove 50 ft. piles 65 ft. below water at Portland, Ore.¹

Sinking of piles by means of a water jet has been done advantageously in sand, gravel or similar soil. The method is particularly applicable to reinforced concrete piles. The process consists in displacing material under the point of the pile by means of one or more water jets. The water is conducted to the jet at the point of the pile by a gas pipe and the water rising along the side of the pile carries up the displaced material, the pile sinking of its own weight or under light blows from the hammer. Water pressure of 100 to 200 lbs. per square inch is needed; the pipe down the side of the pile leading to the jet is about 2 in. in diameter and drawn to a jet about $\frac{1}{2}$ to $\frac{3}{4}$ in. in diameter. The process requires about 50 to 250 gal. per minute. Piles driven in this manner are said to have a greater bearing capacity than those driven by the hammer owing to the settling of the earth around the pile.

¹ *Engineering News-Record*, July 9, 1925.

After piles are driven, they are sawed off at a given elevation and the foundation footings placed directly thereon, the heads of the piles projecting into the concrete about 6 to 12 in. The engineer in charge of pile driving should carefully inspect the piles previous to driving to see that they meet the specifications and after they are driven to discover injured piles. During driving a complete record should be kept covering the following points: (a) location and number of pile, (b) dimensions of pile, (c) kind of wood, (d) total penetration, (e) the average drop of hammer and the average penetration under the last five blows and the penetration under the last blow, (f) the kind of soil, and (g) the amount of cut-off. While it is desirable to keep this record for all piles driven, this is inconvenient and the author has found the record kept for about every fifth pile satisfactory.

Spacing of Piles.—Piles to be effective should not be so closely spaced that the earth included between them loses its supporting capacity. The supporting capacity of a group of piles can actually be diminished by driving additional piles if such additional piles cause the group to act as a unit instead of each pile acting separately, because the friction of the periphery of the group will be less than the sum of the peripheries of the piles taken separately. A minimum effective spacing is frequently stated to be about 3 ft. for piles of ordinary size, or perhaps three diameters center to center. Piles have been driven slightly closer than this in some instances but it is probable that the same bearing could have been obtained with fewer piles.

In the design of the spacing, it is important to have a uniform bearing on all the piles so that in the event of any settlement occurring it may be uniform and cause a minimum of damage. Special care must be exercised to secure uniformity of bearing for continuous structures. To accomplish this result, the resultant of the superimposed loads should coincide with the resultant of the resistance of the piles when the piles are considered as uniformly resistant. A convenient method of spacing piles accordingly is to draw vertical lines dividing the soil pressure diagram under a cross section of the structure into a number of equal trapezoidal areas corresponding to the number of piles in the cross section and place a pile at the center of gravity of each of these equal areas. Figure 119 shows piles so spaced.

The bending moment at the edge of the wall will be Pa/s per foot of wall, where P is the bearing per pile and s the longitudinal

spacing of the piles and a is the distance from the edge of the wall to the center of bearing of the piles beyond the edge. Where the footing is reinforced, the steel should not be placed nearer than about 3 in. of the top of the piles in order to secure complete bond and to avoid the irregularities of the tops of the piles. Shear at the edge of the wall should be investigated.

Piles are commonly arranged in rows with the positions staggered where necessary to secure the minimum spacing allowed. Concrete is poured over the pile tops after the latter have been cut off to grade, the piles projecting into the concrete somewhat.

In the case of eccentricity of the superimposed loads, the maximum and minimum bearing on the piles, i.e., the maximum falling on the one nearest the toe and the minimum at the heel, is given by the formula for combined compression and direct stress, which reduces to

$$p = W/n \pm W \cdot e \cdot z / \Sigma x^2$$

where W is the total load, n the number of piles, e the eccentricity of the resultant at the foundation, z the distance from the centroidal axis to the pile in question and x is the distance from this axis to any pile, referred to the axis of the piles.

Concrete Piles.—With the growing scarcity of suitable timber of wood piles, concrete piles are coming into extended use. According to the manner of molding, concrete piles are divided into two classes, viz., pre-cast piles and cast-in-place piles, particular forms of either group being patented. The pre-cast piles are always reinforced and are driven much as are timber piles with either a hammer or a water jet, while the latter group are mainly of plain concrete.

Pre-cast concrete piles are usually octagonal in cross-section with a diameter of about 7 in. at the small end and a taper of $\frac{1}{2}$ -in. per foot and are usually from 20 to 40 ft. long, although lengths up to 75 ft. have been used. They are usually made of a 1:5 or a 1:6 mixture and are cast in a horizontal position. After curing under a sprinkling system for 30 days they are ready for use. Figure 238¹ shows the essential features of the concrete piles as used by several railroads. The steel reinforcement is intended to resist the strains due to handling the pile and in driving. A special cap is commonly used while driving to prevent the shattering of the head of the pile. The reinforcement

¹ *Univ. of Colo. Journal of Engineering*, vol. 12, No. 4, p. 31.

amounts to 4.25 lbs. per linear foot in the C. B. & Q. pile, 12.5 in the Illinois Central and 17.5 lbs. in the C. M. & St. P. R. R. pile.

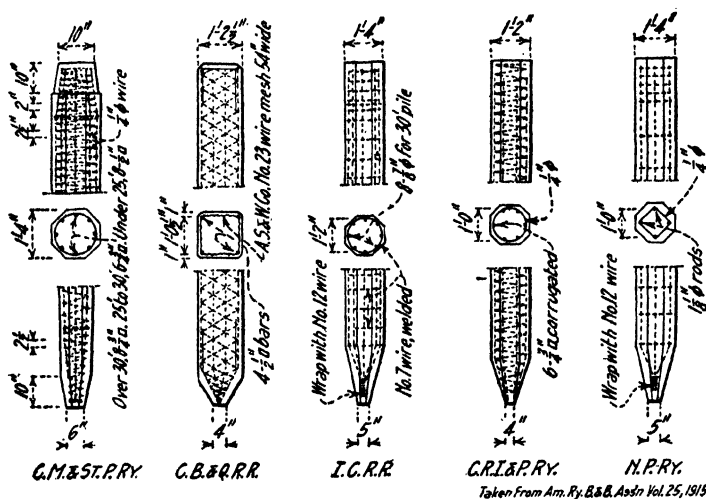

FIG. 238.—Details of reinforced concrete piles.

The reinforcement consists of a "cage" or unit made up of longitudinal bars with hoops or spiral winding. Very long piles should have extra reinforcement in the middle half of their length to withstand the additional strains due to deflection while driving.

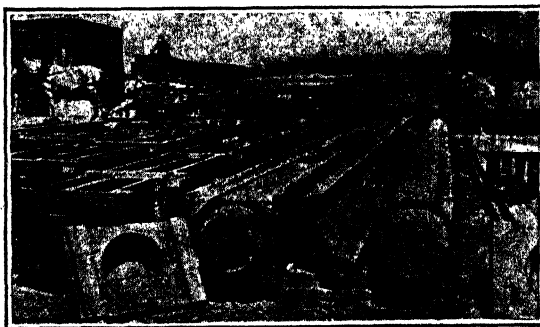

FIG. 239.—Precast concrete piles.

Concrete piles are best driven with a steam hammer using a wooden follower or cap to break the shattering effect of the blow.

If the top crumbles so that the longitudinal bars receive the blow, the bars will buckle and shatter the pile. In driving 30 to 35-ft. piles in Tennessee on the Illinois Central R. R., 136 to 1,978 blows were required per pile with 26 to 832 blows to drive the last foot.

Where reinforced concrete piles are to be sunk with a water jet, special provision is made by placing a pipe down the center of the pile while it is being cast, an elbow with a short piece of pipe being placed near the top for a hose connection to be used in forcing water to the point of the pile. Of course this provision is not necessary as it is possible to sink piles in the usual manner with the jet pipe outside the pile, but the inside pipe is a convenience.

The cast-in-place piles in most common use are the Raymond, the "Simplex" and the "Pedestal" pile. The first is formed by driving a tapered sheet shell or casing of 18 to 20 gauge with the aid of a collapsible core, withdrawing the core and filling with concrete. Sometimes longitudinal reinforcement is introduced before placing the concrete and frequently a spiral wire reinforcement is required to stiffen the casing. In general, this type of pile has been satisfactory.

The "Simplex" pile is formed by driving a steel case with a special "jaw" to close the bottom, then filling the case with concrete and withdrawing the case as the cavity is filled. A ram is commonly used to insure the complete filling of the hole. It is claimed for the pile that the roughness of the sides resulting from the process of casting produces a maximum frictional resistance along the sides. Piles 30 to 45 ft. in length have been successfully cast in this manner.

The "Pedestal" pile is formed by driving a casing and core into the ground, the core extending some 4 or 5 ft. below the casing. The core is then withdrawn and the bottom of the hole filled with concrete which is severely rammed until the soil is pressed away forming an enlarged cavity filled with concrete. Afterward the shaft of the pile is formed by filling the casing with concrete. It is claimed that the enlarged base or pedestal greatly adds to the supporting capacity of the pile.

Supporting Capacity of Piles.—In considering the supporting capacity of piles, two fairly distinct conditions arise, namely, (1) when the pile rests at the bottom on shale or some other stratum which has a high supporting capacity causing the pile

to act as a column supported by the earth at the sides and (2) when there is no hard stratum at the bottom of the pile and its supporting capacity is dependent chiefly on the frictional resistance along the sides. Many observations have been made and many formulas proposed for the bearing capacity of piles and the reader is referred to the extensive literature on the subject for a complete discussion, the present treatment consisting merely of formulas most commonly used.

Where piles are driven, the Engineering News formula is widely accepted and has been observed to be fairly in accord with practical results. For a drop hammer, the formula is

$$P = \frac{2Wh}{s + 1}$$

in which P is the safe supporting capacity of the pile, W is the weight of the hammer, h is the height of fall in feet, s is the penetration under the last blow in inches. The formula is derived by equating the energy of the hammer to the work done by a load P (with a factor of safety of 6) that would sink the pile an amount equal to the penetration under the last blow. The term in the denominator is arbitrarily increased by 1 to avoid the absurdity of having an infinite load capacity when the penetration is zero, as when the pile is driven to "refusal."

For a steam hammer the formula is given the form

$$P = \frac{2Wh}{s + 0.1}$$

when the drop of the hammer is free without the aid of steam pressure in the cylinder. Where the steam is active against the piston in forcing the hammer down, the formula is

$$P = \frac{2(W + Ap)h}{s + 0.1}$$

in which A is the area of the piston in square inches, and p the steam pressure in pounds per square inch.

For concrete piles, in order to provide for the inertia of the heavy piles by taking into account the weight of the latter, the corresponding formulas for steam hammer have been proposed as follows:

$$P = \frac{2Wh}{s + 0.1 \frac{w}{W}}$$

and

$$P = \frac{2(W + Ap)h}{s + 0.1\frac{w}{W}}$$

in which w is the weight of the pile and the other nomenclature as above. These give somewhat more conservative values than does the Engineering News formula unmodified.

In the design of a foundation, the penetration that will be used in the above formulas will be that obtained from test piles or that provided for in the specifications. It must be borne in mind of course that the formulas are only approximate and refinement in calculation is not justified.

The validity of the Engineering News formulas has been much questioned and discussed. Dr. Charles T. Terzaghi¹ states that it may be expected to be fairly reliable in sandy and otherwise pervious soils, but that it will give results too low for clay and otherwise impervious soils. It gives erratic results for small penetrations. The supporting capacity per pile is doubtless affected by the spacing of the piles also, because of mutual interference, so that a bearing test on a single pile may not be reliable. The supporting capacity as determined by any method based on a single pile should be reduced practically in proportion as the spacing is less than the radius of the cylinder of influence for a single pile.

Granted that no pile formula is universally applicable with precision, it is probable that the Engineering News formula with its accumulated pertinent data is as satisfactory as any yet proposed. When test piles can be driven, more reliable information can be obtained than from any possible formula.

In the cases of piles cast in place and of those driven by means of a water jet, the experience with the hammer in producing penetration is not available in estimating supporting capacity. A formula with empirical coefficients is sometimes used under such circumstances as follows:

$$P = B \cdot A + F \cdot S$$

in which P is the load the pile will carry in pounds, B the bearing capacity of the soil at the bottom of the pile, A the area of the bottom of the pile, F the frictional resistance in pounds per

¹ *Trans. Am. Soc. C. E.*, vol. 93, p. 282.

square foot, sometimes referred to as skin friction, and S is the superficial area of the pile in square feet.

The frictional factor, F , is the most indefinite term in the formula, the observations made to determine this factor being inevitably uncertain. However, from various sources the following averages may be taken for depths commonly reached by piles; the classes of soil being rather indefinite and overlapping:

Soil	Frictional resistance, lbs. per sq. ft.
Silt and soft mud.....	50 to 100
Silt compacted.	120 to 350
Clay and sand.....	400 to 800
Sand with some clay.....	500 to 1,000
Sand and gravel.....	600 to 1,800

The frictional resistance or "skin friction" is about 50 per cent more at depths of 100 ft. than at depths of 25 ft., and it varies in general with the depth. It is obvious from the above discussion that the bearing capacity of piles depends primarily upon the character of the soil and upon the length of the pile. Wet soils in general will not support as great loads as dry soils.

The maximum load that a group of piles can be expected to carry is the bearing capacity of the over-all area inclosed by the group at their point plus the skin friction around the periphery of the group. Thus, piles driven in soft alluvium at $2\frac{1}{2}$ ft. centers would have approximately $5\frac{1}{2}$ sq. ft. of area per pile. If the alluvium will bear only 1 ton per square foot at the elevation of the point of the pile, a single pile will not carry more than $5\frac{1}{2}$ tons, except that the entire group may gain a small amount of support from skin friction at the periphery. The piles merely transfer the load from their head to a plane at their point and cannot increase the supporting capacity of the stratum at their point. The supporting capacity of piles can be increased by bolting or spiking lugs or strips to the sides.

Sometimes the load resistance of pile heads imbedded in concrete can be utilized advantageously. Experiments¹ have shown this resistance to be 50 to 85 lbs. per square inch of surface.

Cost of Pile Foundations.—The procedure and conditions connected with construction of pile foundations are so extremely

¹ *Trans. Am. Soc. C. E.*, vol. 86, p. 268.

variable that reliable data on costs can scarcely be given. The cost of piles delivered depends on whether local timber is available for use or not, upon price standing, cost of cutting and cost of transportation. The cost of timber piles in place for ordinary lengths averages about as follows:

	Cost per lin. ft.	Cost per pile
Piles delivered.....	\$0.20 to \$0.35	\$6.00 to \$ 9.00
Handling and sharpening.....		.30 to .50
Driving.....	.15 to .40	3.00 to 12.00
Sawing off.....		.20 to .50
Total per pile.....		\$9.50 to \$22.00

The following analysis of cost¹ shows the items involved in the cost of driving, being the record of 519 piles about 24 ft. long, or 10,056 linear feet, at the construction of a bridge in New York.

Item	Cost
Freight.....	\$ 74.40
Unloading and loading, plant and team hire.....	41.50
Cost of barge.....	81.85
Oil and grease.....	9.95
Bolts and nails.....	6.32
Blacksmithing.....	27.65
Repairs to pile driver plant.....	17.35
Rope for hammer.....	37.65
Coal, 30 tons at \$4.50.....	135.00
Labor.....	799.35
Superintendence and overhead.....	300.00
Interest on investment.....	9.00
Depreciation of plant.....	15.00
Total.....	\$1,555.02
Salvage of barge.....	40.00
	\$1,515.02
Total cost per linear foot.....	\$.15

While this cost is unusually low, the analysis of the cost is typical.

¹ *Engineering News*, Aug. 26, 1916.

Reinforced concrete piles cost considerably more than timber piles, both for the piles themselves and for the driving. The following figures illustrate the cost for a job in Nebraska in 1916.¹

	Per lin. ft.	Per pile
Materials.....	\$0.61	\$27.31
Labor.....	.17	7.69
Driving.....	.22	8.84
Total.....	1.00	\$43.84

In the Proc. American Railway Engineering Association, Vol. 16, p. 824 some data are given with regard to the cost of concrete piles; the average was about \$1.10 per linear foot in place, the range being from \$0.94 to \$1.60.

In previous years, miscellaneous types of piles, such as steel screw piles, and disc piles have been used, but their use has been nearly, if not entirely, discontinued, hence, special mention of them need not be made here.

Removal of Water.—In most foundations that are extended to considerable depth, some water is likely to be encountered even though the foundation is essentially on dry ground. This condition may arise from three possible sources, (1) rain, (2) normal ground water, and (3) springs.

Where foundations cover a considerable area, rain water is likely to cause trouble. The best method of caring for this is to provide a sump at the low point of the foundation, drain the water from all the area into this sump, and then pump from this sump into a natural or an artificial water course. Effort and funds will be well spent in securing satisfactory drainage, and in the case of an extensive foundation, a sump partially lined with timber may be constructed profitably, especially where the work is to last over a considerable period of time.

Steam pulsometer pumps are very convenient for removing water from the sump and are fairly efficient. Centrifugal pumps are also frequently used, but the installation is somewhat more complicated than with the pulsometer. Where steam power is not available, centrifugal pumps can be run by an electric motor conveniently. Special pumping units consisting of a gasoline

¹ *Engineering and Contracting*, July, 26, 1916.

engine and pump on the same frame are available on the market and are extremely valuable for this purpose.

Supporting Existing Structures During Reconstruction of Foundations.—In a large proportion of the cases of construction that arise, existing structures must be supported while the new construction of foundations is in progress. Three typical schemes of procedure, or devices, are utilized to accomplish this

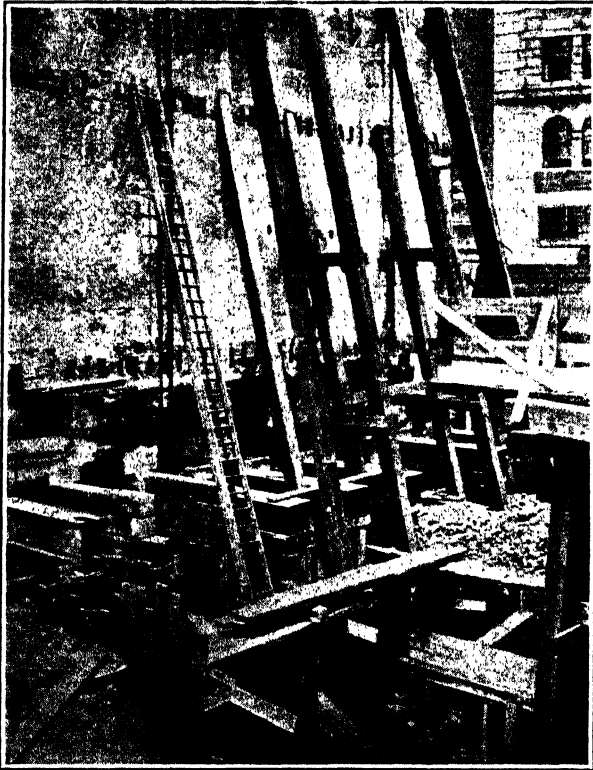

FIG. 240.—Shores and needle beams.

end, viz., (a) *shores* or *pushers*, (b) *needle beams* and (c) *underpinning*.

Figure 240¹ illustrates the method of supporting a brick wall by means of shores. The process consists simply of inserting shores or props into notches in sufficient number to carry the load. Jack screws may be placed at the bottom of such shores to raise the wall when desired.

¹ JACOBY AND DAVIS, "Foundations of Bridges and Buildings," p. 502.

TABLE XXXV.—LIMITS FOR FOUNDATION METHODS

		Min. depth, Ft.	Economic max. depth, Ft.	Max. possible depth, Ft.
1	Earth bank cofferdam.....	1	6 to 7	8 to 10
2	Log crib cofferdam.....	4	14 to 16	20 to 25
3	Sheet pile cofferdam.....	5	14 to 16	25 to 30
4	Removable box cofferdam.....	5	10 to 12	15 to 20
5	Cribs and tubes.....	5	18 to 20	20 to 30
6	Open dredge caisson.....	20	80 to 90	250
7	Diving bell caisson.....	10	40 to 60	80
8	Pneumatic caisson.....	20	70 to 80	110
9	Comb. dr. and pn. caisson.....	20	90 to 100	110+
10	Ballmatic caisson.....	60	80 to 90	250
11	Freezing process.....	25	40 to 80	125
12	Grouting process.....	10	30 to 60	125

The choice of type for subaqueous foundations depends upon a number of factors, among which may be mentioned:

1. Magnitude and character of loads to be carried;
2. Depth to rock or other suitable bearing stratum;
3. Depth of water;
4. Character of soil to be penetrated;
5. Cost.

In certain cases, the character of the load to be carried, as in the case of an isolated tower, is such that a small amount of settlement may do no harm, hence, it is needless to incur great expenditure to secure an unyielding foundation for such a structure. On the other hand, in the case of large bridges, particularly the cantilever and arch types, and of high buildings, settlement might lead to disaster.

Coffer-dams.—A coffer-dam is an enclosure constructed to exclude water from the area of operations during construction. In character, it may vary from a simple dike of earth, bags of sand, or other simple construction to a rather complicated structure of timber or of steel. Earth coffer-dams have been successfully used for depths of 4 or 5 ft. where the current is not swift, and steel sheet piling coffer-dams have been used for depths up to 50 ft. Earth coffer-dams are sometimes reinforced with facines or brush.

In order to be satisfactory, a coffer-dam should have four

requisites: (1) It should be strong enough to withstand the pressures due to water, mud and floating debris; (2) it should be sufficiently flexible that a small obstruction can be passed during the process of excavation without destroying the structure; (3) it should be as nearly watertight as practicable, although some pumping must always be expected; and (4) the cost should be reasonably low, for the structure being inherently of a temporary nature, any expense incurred in the construction that cannot be recovered in salvage will be lost.

The type of coffer-dam to be selected depends upon the conditions surrounding the work. The most economical coffer-dam is the one which makes the total cost of the structure a minimum; that is, the initial cost, plus the cost of maintaining it, plus the cost of pumping the water out, less the salvage value, should be a minimum.

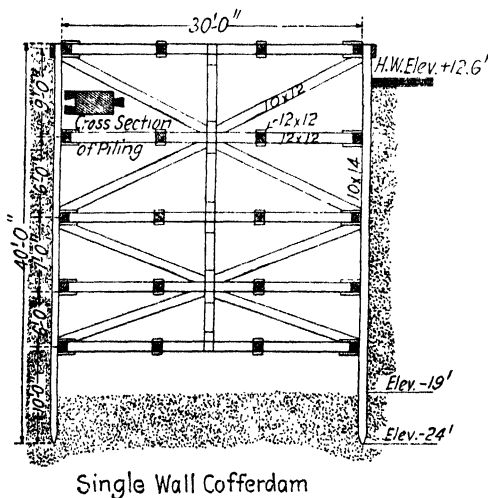
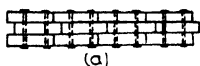

FIG. 241.—Internal traming of a timber cofferdam.

Sheet Pile Cofferdams.—Sheet piles may be of either timber, steel or reinforced concrete, although the practicability of the last has not been demonstrated by their limited application to date. Sheet pile cofferdams may be either of single wall or double wall type.

Timber sheet piles are usually about 3 to 4 in. thick and 10 or 12 in. wide and can be obtained in almost any length up to 40 ft. When used in a coffer-dam, they may be supported inside by a

row of piles driven parallel to the wall with wales attached outside against which the sheet piles are driven or by internal framing similar to that shown in Fig. 241, this latter being the preferable type. Where pressures of considerable magnitude are expected, only clear straight grained sheet piling should be used. The author has seen complete failures of coffer-dams built of



(a)

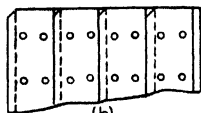

(b)

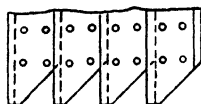

(c)

FIG. 242.—Wakefield sheet piling.

common or inferior timber for sheet piles where the use of first quality timber at the same site brought success. Fir, Douglas fir, yellow pine and hemlock are most commonly used as sheet piles.

Timber sheet piles may be driven singly, or planks may be bolted together in triple lap to form a tongue-and-groove effect as in Fig. 242. This latter arrangement is commonly called the Wakefield sheet pile, although the patent rights have expired. Wakefield piles are stronger and stand driving better than do piles of single timbers, chiefly because imperfections such as

knots and cross grain do not extend through the three planks. Right angle corners may be turned with Wakefield piling by spiking a tongue to the side of one pile and driving the next one at right angles along this tongue. The bottom of each pile is beveled towards the one already driven in order to force it to stay tight against the latter. The groove should always be driven down over the tongue, for if the pile with the groove exposed should be already in the ground, the groove would become filled with earth and the insertion of the tongue would be made with difficulty.

Steel Sheet Piling.—Steel sheet piling consisting of rolled shapes with an interlocking device is made in a variety of forms by different manufacturers and forms a stronger and more nearly watertight coffer-dam than does timber sheet piling. Figure 233 shows a 58 by 78-ft. coffer-dam at 92nd Street bridge in the Chicago River under a head of 23 ft. The sheet piling were braced internally by wales and cross struts, the piling being driven through the spaces in the framing. Figure 243 shows a circular coffer-dam of Lackawanna steel piling surrounding a circular pier under a head of 20 ft. of water.

Figure 244 shows a telescoped coffer-dam of steel sheet piling

for a deep foundation under a pier of the Tunkhannock viaduct of the Lackawanna R. R. The total depth of the coffer-dam was about 75 ft., the outer coffer-dam extending about half this



FIG. 243.—Steel sheet piling coffer-dam.

depth and the inner coffer-dam the remainder. The inner row of sheet piles was driven to their full depth, the inclosed material excavated and the bracing placed. Then the outer row was



FIG. 244.—Telescoped sheet piling coffer-dam.

driven 4 ft. 8 in. outside the inner and the space between the two rows excavated and the outer row braced above the tops of the inner piling. The inner row was then again driven to full

depth and the excavation completed, the waling and braces on the outside row being placed as the driving proceeded.

Table XXXVI gives the properties of some of the common types of steel sheet piles.

TABLE XXXVI.—PROPERTIES OF STEEL SHEET PILES

Manufacturer	Type of web	Size, in.	Weight, lbs. per ft.	Least rad. of gyration, in.	Section modulus, in. ³
Lackawanna Steel Co.	Straight	7 × 1/4	12.54	0.37	0.57
	Straight	12 3/4 × 3/8	37.19	0.76	4.04
	Straight	12 3/4 × 1/2	42.50	0.73	4.12
	Flanged	15 × 7/16	60.00	1.01	5.73
	Arched	14 × 3/8	40.83	1.15	7.61
	Arched	15 × 7/16	46.50	1.29	11.80
Carnegie Steel Co.	U. S.	9	16.00	0.56	1.13
	U. S.	12 1/2	38.00	0.87	4.30
	U. S.	12 1/2	43.00	0.85	4.53
	Friestedt	12	33.00	1.30	6.84
	Friestedt	12	38.00	1.37	9.62
	Friestedt	15	38.00	1.51	11.74
	Friestedt	15	44.00	1.59	14.88
	Symmetrical	10	28.00	1.10	3.64
	Symmetrical	12	34.00	1.31	6.63
	Symmetrical	15	39.00	1.52	11.44
Symmetrical	15	45.00	1.60	14.55	

The loads to which a sheet pile coffer-dam is subject consist of the pressure of the water and earth outside, similar to that on a dam or retaining wall, and the blows that may come from the floating debris, impact of barges, etc. The former can be estimated in a manner similar to that employed for quay walls.

Usually sheet piling can be used more than once if care is exercised in the pulling. Three or four times represents perhaps about the average re-use of steel sheet piles. Various devices are available for pulling the piles with a minimum of injury to the piles. A block-and-tackle attached to a lever is commonly used for pulling piles, and sometimes an inverted steam pile driver is used advantageously for this purpose. The facility of pulling varies greatly, the daily average being about 30 to 50.

Cellular Cofferdams.—For open foundations of greater depth, surrounded by water, cellular coffer-dams are frequently

used. The cells are formed of sheet piling and filled with puddle. Where these cells are of considerable depth, the internal pressure from the puddle may need to be taken into consideration lest it pull the piles apart. A cellular coffer-dam was used in raising the Battleship "*Maine*" in the Havana harbor under a head of 37 ft. of water and 21 to 23 ft. of soft harbor bottom. The cells were circular and were 50 ft. in diameter.

Puddle Coffers-dams.—Coffer-dams for considerable depth, over about 20 ft., are made with a double row of sheet piling or a double wall of cribbing, and the space between the two walls filled with puddle of clay and gravel. With either timber or steel sheet piles, it is necessary to tie the two rows of piles together to enable them to withstand the pressure resulting from the fill or puddle. In the case of timber piles, this is accomplished by placing tie rods between wales running along the outside of the piles. In the case of steel piles, tie rods may be attached directly to the piles.

The distance between the two rows of piles varies with the pressure to which they may be subjected and the embedment in the bottom. Single rows of piling are sufficiently watertight usually for heads of water up to 20 ft., but for greater depths than this puddling is commonly necessary, and for great depths, the walls must be a considerable distance apart, and are ordinarily connected by dividing walls forming cells.

The material best suited for puddle is a mixture of clay, sand and gravel, with an excess of clay over that required to fill the voids of the coarser material. Sand alone is too permeable to be satisfactory and clay washes so rapidly when a leak is once started that it is unsatisfactory. On the other hand, a mixture of clay, sand and gravel readily settles into the cavity when a leak is started and stops the flow.

Design of Coffers-dams.—The design of coffer-dams does not admit of definite analysis because of the many unknown and indeterminate factors in the problem, such as floating debris, ice, uncertain external pressures, etc. The pressure from the water and earth outside can be calculated with a precision that depends entirely upon the definiteness with which the properties of the surrounding materials are known; likewise, the pressure resulting from the puddle depends entirely upon the composition and the fluidity of the puddle. The character of the external pressures on a single wall coffer-dam is indicated in Fig. 245.

An equation which shows the proper spacing of wales for various conditions is derived by F. R. Sweeny,¹ Engineer for The Foundation Company, Pittsburgh, as follows:

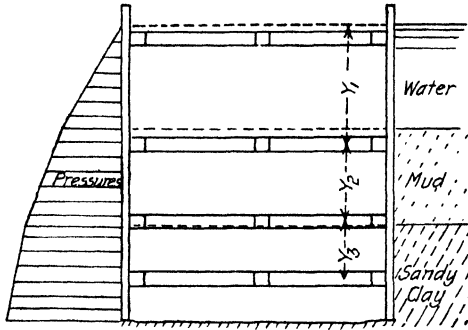

FIG. 245.—External pressures on a cofferdam.

Let w = the weight of the material outside the sheeting per cu. ft.

k = the ratio of horizontal to vertical pressure

S = the span of wales in feet

L = the span of sheeting in feet

n = the number of wales from top, not counting the top one

$D_1, D_2 \dots D_n$ = distances in feet to the respective wales

b and d = width and depth of wales respectively

h = the depth to the point under consideration

f = safe stress in wale in lbs. per square inch

W = the allowable load on a wale of span S

The total load on one panel equals $\frac{1}{2}wkh^2S$, distributed over n wales. The allowable load on one wale is $fbd^2/9S$, hence,

$$n = \frac{\frac{1}{2}wkh^2S}{\frac{fbd^2}{9S}} = \frac{4.5wkh^2S^2}{fbd^2}, \text{ or } h = \sqrt{\frac{fbd^2n}{4.5wkS^2}} \quad (1)$$

Taking moments about the surface,

$$n \cdot W \cdot \times \frac{2}{3} \sqrt{\frac{fbd^2n}{4.5wkS^2}} = WD_1 + WD_2 + \dots + WD_n$$

Solving for D_n

$$D_n = \frac{2}{3} \sqrt{\frac{fbd^2n^3}{4.5wkS^2}} - (D_1 + D_2 + \dots + D_{n-1})$$

¹ *Engineering News-Record*, Apr. 10, 1919.

and substituting the value of D_{n-1}

$$D_n = \frac{2}{3} \sqrt{\frac{fbd^2n^3}{4.5wkS^2}} - \frac{2}{3} \sqrt{\frac{fbd^2(n-1)^3}{4.5wkS^2}}$$

$$= 0.314 \frac{d}{S} \sqrt{\frac{fb}{wk}} [\sqrt{n^3} - \sqrt{(n-1)^3}]$$

This equation expresses the distance down to the successive wales. Figure 246 shows the graphical solution of this equation where the material is water for a fiber stress of 1,500 lb. per square inch. To obtain the spacing of wales for other materials, it is necessary to multiply by the factors shown in Table XXXVII the top surface being assumed as level:

TABLE XXXVII.—SPACING OF WALES IN COFFER-DAMS

Material	Unit weight, lbs. per cu. ft.	Ratio k	Coefficients for different soils at fiber stress		
			1,000	1,500	2,000
Water.....	62.5	1.00	0.816	1.00	1.15
Clay, wet.....	130.0	0.59	0.736	0.902	1.04
Clay, damp.....	120.0	0.16	1.47	1.80	2.08
Clay, dry.....	110.0	0.41	0.95	1.18	1.36
Sand, wet.....	120.0	0.33	1.02	1.25	1.44
Sand, damp.....	110.0	0.21	1.34	1.65	1.90
Sand, dry.....	100.0	0.27	1.24	1.52	1.76
Loam, wet.....	110.0	0.33	1.07	1.31	1.51
Loam, damp.....	90.0	0.16	1.70	2.08	2.40
Loam, dry.....	80.0	0.21	1.57	1.92	2.22
Alluvium.....	90.0	0.50	0.96	1.18	1.36
Gravel, graded.....	120.0	0.21	1.28	1.58	1.82
Ashes.....	40.0	0.21	2.23	2.73	3.16

The exigencies of construction usually determine the spacing of braces and hence, the span of the wales. However, the minimum amount of timber f.b.m. is secured with a span about 4 ft. for 8 by 8 in. wales and about 10 ft. for 12 by 12 in. wales. This economic criterion, however, will seldom be applicable. It is customary to allow nothing for the value of continuity but to calculate the members as simple beam spans.

Coffer-dams usually fail by "blows," or the forcing of material beneath the edge. To secure watertightness is particularly difficult where a coffer-dam rests on rock. Small leaks can some-

Theoretically, the depth to which an open caisson can be sunk is limited only by the possibilities of forcing the caisson down, although the practicality of its use is limited because of the interference of logs, boulders, etc. under the cutting edge. Where there is not much earth overlying rock, open caissons

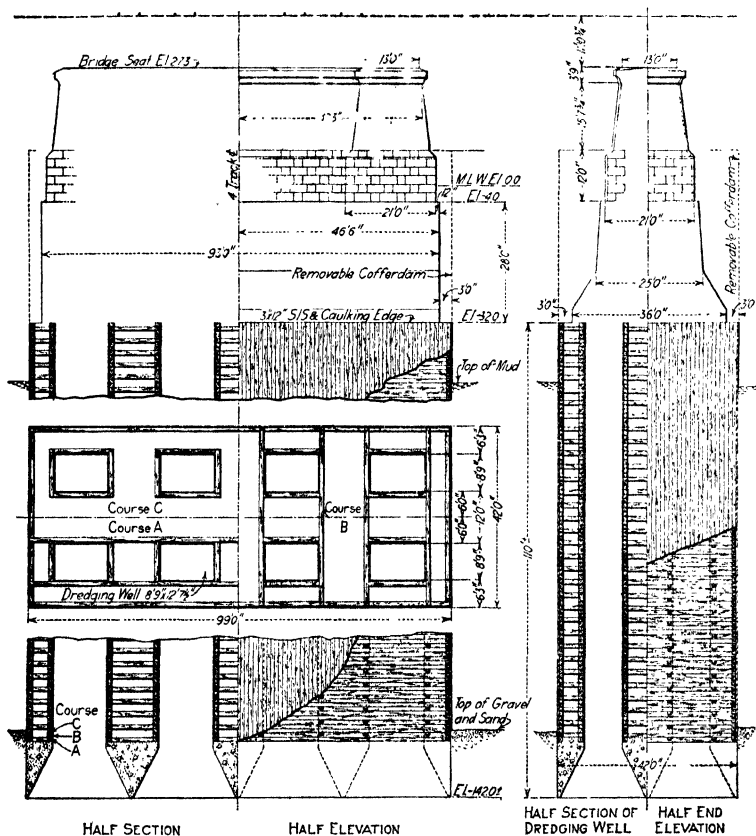

FIG. 247.—Open caisson for the New London bridge.

may be used advantageously, but with the improvement of method in the use of pneumatic caissons, they are not so widely used as formerly. For depths exceeding about 110 or 115 ft., the limit of the pneumatic caisson foundation, the open caisson becomes a necessity. In the case of the N. Y. C. & H. R. R. R. bridge over the Thames River at New London,

Conn., the total depth of one of the piers was 142 ft., and at the Fraser River bridge at New Westminster, B. C., the depth was 135 ft. through silt and sand. The depths at which open caissons may be used, therefore, vary from shallow to the deepest to which foundations have been sunk, although most commonly, the method in recent years has proved most useful for depths greater than the limit for pneumatic foundations. However, the open caisson is still frequently used for comparatively shallow foundations of 50 ft. and under.

The advantage of the open caisson method of sinking foundations lies in the fact that all work is done above water, while the disadvantage results from the fact that the site of the foundation is never unwatered, and hence, cannot be cleaned carefully before the concrete is deposited, and also, since the concrete must be deposited under water, the quality of the concrete may be impaired. The chief difficulties encountered are (1) that logs, boulders, and other obstructions are struck by the cutting edge and are frequently difficult to dislodge, and (2) that due to the lack of uniformity of materials encountered, the caisson sinks unevenly and is, as a consequence, difficult to guide.

Some of the points to be kept in mind in the design of an open caisson are:

1. Since the sinking is not under close control, the caisson should be large enough in plan to allow a slight shifting of the pier from a perfectly central position with respect to the caisson.
2. The dredging wells should be so distributed that the excavation can be of such sequence as to guide the caisson in sinking. Instead of a single row of wells on the center line, a distribution nearer the edge is preferable, as illustrated in Fig. 247,¹ which shows the Thames River bridge of the N. Y. N. H. & H. R. R. at New London, Conn.
3. Steel frame cutting edges filled with concrete, not only serve their purpose well as cutting edges, but they add stability while launching, and prevent listing.
4. Jetting pipes should be placed in such position that they will not interfere with the dredging.

Cylinder Caissons.—Bridge substructure frequently is built by means of steel cylinders being sunk to a solid foundation bed, dredging out the inclosed material, and then filling with concrete. These cylinders consist of steel plates, usually 5 ft. wide between rivet lines, and are riveted together in the field as the cylinders are sunk, the sinking being accomplished by weighting.

¹ *Engineering Record*, Dec. 16, 1916.

The material inside the cylinder is sometimes removed by hand, sometimes by pumping with a centrifugal pump, where it is a soft silt, and sometimes by dredging with a small orange peel dredge bucket. Where the cylinders are not sunk to a sufficiently solid stratum to secure adequate bearing, piles may be driven in the bottom.

An interesting example of this mode of securing a foundation is found in the construction of the Ft. William bridge of the Grand Trunk R. R. in Ontario. The first pier consisted of the steel cylinder 31 ft. in diameter, sunk to bed rock under a head of 60 ft. and filled with concrete. The cylinder was composed of $\frac{1}{2}$ in. steel plates 10 ft. long and 5 ft. wide, riveted together in the field, double riveted with $\frac{3}{4}$ -in. rivets on vertical seams, and single riveted on horizontal seams. Five courses had been riveted up when the shell touched bottom, and the weight was sufficient to cause the shell to sink about a foot into the bottom. By attaching jacks to piling that had already been driven, the shell was forced down to a total penetration of 7 ft. After the material had been pumped out, a "blow" occurred, allowing the cylinder to fill. It was then forced down by weighting with 175 tons of steel rails for another 5 ft. Even then, it was impossible to pump out the water, whereupon, a form was constructed inside the shell and hung from the top, leaving an opening for dredging through the middle, and into this form, concrete was placed. The spoil was then dredged out and the cylinder with its thick concrete lining sank gradually to bedrock. It was then sealed at the bottom by depositing a foot of concrete under water at the bottom. The water was then pumped out, the opening filled with concrete, and the pier completed. The project was begun with a view to using the cylinder as a coffer-dam and unwatering the site, but when dredging was resorted to, the cylinder became virtually an open caisson.

Where the steel cylinders project above the water surface and form the bridge seat, it is desirable to have them properly braced laterally by frames between the cylinders and riveted to the latter. Cast iron cylinders have been used in some instances, but experience has shown that they are unsatisfactory, particularly for the lower sections because of their brittleness.² Economy in weighting the cylinder to cause the sinking may be

¹ *Trans. Am. Soc. C. E.*, vol. 62, p. 113.

² *Proc. Inst. of Civil Engineers*, vol. 103, p. 135.

effected by building a double wall so that part of the permanent masonry can be used for this purpose.

The depth to which steel cylinders may be sunk depends upon the character of the materials penetrated. Caissons for the Omaha bridge over the Missouri River were sunk to a depth of about 100 ft. below water level, the material being 50 ft. of sand and clay, and 60 ft. of gravel and sand. Eight-foot cylinders for the Atchafalaya bridge at Morgan City, La., were sunk to a depth of 120 ft. below water level and 70 to 115 ft. below mud line. Records indicate the skin friction on metal caissons to be about 80 to 200 lbs. per square foot.

Cylinder caissons have sometimes been built of reinforced concrete with satisfactory results. The caisson at Penhorn viaduct in Jersey City was built in 20-ft. sections and the caisson was sunk this distance before another section was built, each section being allowed to harden six days before sinking. The average rate of sinking was $6\frac{1}{2}$ ft. per day, the minimum being $1\frac{1}{2}$ ft. In the foundation of the lumber dock at Balboa, C. Z., the sections 6-ft. in diameter were cast separately in 5-ft. lengths and added as the caisson sank, the junction being made with dowels.

Box Caissons.—A box caisson consists of a watertight box with a bottom sunk in place by weighting. When it is constructed of timber, the walls are usually of the crib type of construction. Recent practice, however, seems to favor reinforced concrete because of its greater permanence and its freedom from injury by marine borers. Box caissons are most frequently used in the construction of breakwaters, jetties, wharves, etc. because of the difficulty in securing a bearing by other means in most sites for such structures, although the method has been employed frequently in constructing light bridge piers. Where an adequate bearing on good sand or gravel beds can be obtained at the bottom of the water, box caissons afford an economical means of constructing piers. As it is impracticable to sink box caissons through soil of any kind, the bearing stratum must be essentially at the bottom of the water.

Three types of bearing may be used: (1) the caisson may rest on a natural bed of sand or gravel at the bottom of the water, (2) it may be placed on piles driven and sawed off at the bottom of the water, or (3) it may be placed on an *enrockment* or pile of rocks placed under water on the natural bed.

Where there is likely to be heavy scour due to the swift current of a stream, obviously this mode of construction is not practical. It is, therefore, best adapted to use along beaches of lakes, etc., where there is no current and where a suitable bed of gravel or of sand forms the lake bottom.

The stresses in a reinforced box caisson result chiefly from (1) the water pressure on the outside, (2) flexure resulting from uneven foundation bed, as where the caisson is supported only at the ends or at the middle. The pressure of the water on the outside is maximum as the caisson plunges into the water from the ways and is approximately $wv^2/32.2$ lbs. per square foot where w is the weight of the water per cu. ft. and v is the velocity of the caisson in ft. per second.

Reinforced concrete caissons may be launched when the concrete is only 10 days old, hence, unit compressive stresses should be kept low. The velocity of the caisson as it strikes the water will depend upon the slope of the ways; a caisson will slide down timber ways without binding if the latter have a 10:1 slope. Usually, if the walls are designed for the pressure of the water at launching, they will sustain other pressures, although all other contingencies should be investigated.

W. V. Judson, M. Am. Soc. C. E., gives the following directions for the design of reinforced concrete box caissons:¹

“Assume a reasonable thickness for the wall dependent upon the flotation desired, etc., say from 12 to 16 in. Consider the wall as a series of discontinuous beams, one above the other, each with a distributed load corresponding to the water pressure. Take the span in the clear without allowance for filling in the corners where the walls meet. . . . The vertical rods add somewhat to the strength of the walls and reinforce against diagonal tension when the caisson is considered as a single beam.

“The steel in the bottom is determined as in the case of the wall. If the caisson is to rest on piles, the principal reinforcement usually runs longitudinally to support the filling from one pile to another. For use on an enrockment, the principal rods are ordinarily placed transversely.”

Solidifying Aquiferous Formations.—In quicksand and in certain other water-bearing soils of a sandy nature, foundations may be sunk by solidifying the soil. Two processes have been

¹ *Engineering News*, July 8, 1909.

used to a limited extent for effecting the solidification, viz., the freezing process and the grouting process.

The freezing process, invented by F. H. Poetch in 1883, consists in driving return pipes into the soil and circulating a freezing mixture through them until the soil is congealed. The method has been used chiefly in sinking shafts through quicksand and has been used in one instance for a depth of 816 ft. However, the process has never proven sufficiently practical to cause it to come into general use.

The grouting process consists essentially of forcing hydraulic cement grout into the soil and allowing it to set up thus forming a weak concrete.¹ In sand, a fairly good bearing capacity may thus be secured in addition to solidifying the soil sufficiently to facilitate excavation. The procedure is to drive perforated pipes, drawn to a point at the ends, into the soil and to pump the grout into the soil by this means. The lack of uniformity of distribution of the grout in the soil is the chief obstacle in the way of securing satisfactory results by this means. As in the freezing process, the feasibility of the grouting process has not been demonstrated to be reliably of general application.

Costs of Open Sub-aqueous Foundations.—The costs of cofferdams and open caissons are so variable that the best mode of making an estimate of a proposed structure is to analyze the elements of cost, the chief of which may be classed somewhat as follows:

Materials:

Timbers, Y.P.....	f.b.m.	@
Sheet piles.....	f.b.m.	@
Bolts, nuts and washers.....	lb.	@
Rods, drift bolts.....	lb.	@
Boat spikes and nails.....	lb.	@
Dynamite.....	lb.	@

Labor:

Framing.....	f.b.m.	@
Handling materials.....	f.b.m.	@
Driving sheet piles.....	ft.	@
Removing sheathing.....	f.b.m.	@
Placing puddle.....	cu. yd.	@
Excavation.....	cu. yd.	@

¹ *Trans. Am. Soc. C. E.*, vol. 29, p. 639 and *Engineering News*, May 8, 1913.

Plant charge:

Pile driver.....	days	@.....
Fuel.....	tons	@.....
Oil.....	gal.	@.....
Repairs.....		@.....%
Pumps.....	days	@.....
Dredge.....	days	@.....
Pipe.....	ft.	@.....
Hose.....	ft.	@.....
Installing plant.....	days	@.....
Removing plant.....	days	@.....
<hr/>			
Total plant charge.....		
Less salvage value.....		
<hr/>			

Plant charge against this job.....

General expense:

Superintendence.....	@.....%
----------------------	---------	-------

The costs of these elements are so extremely variable that specific figures are practically valueless. A pile driver will drive about 50 to 100 ft. of steel piles of average size per hour and perhaps 50 to 200 ft. of timber piles per hour under average conditions of soil.

CHAPTER XV

FOUNDATIONS UNDER WATER, PNEUMATIC PROCESS

Introduction.—The pneumatic process of sinking foundations of various kinds has been developed chiefly since the middle of the last century, being first used in sinking *pneumatic piles*, or iron cylinders, at Rochester, England in 1851, and in America in about 1855 on the Pedee River in North Carolina. The first pneumatic caisson was designed and built by William Sooy Smith¹ 1865–8 at the Waugoshance lighthouse at the western entrance of the straights of Mackinac, although he had previously designed one for the Frying Pan Shoals in 1860 which was not built.

The pneumatic process in general is based on the principle that when a vessel is inverted in water, the water does not rise to occupy the entire space in the vessel owing to the presence of the air inclosed. The space under the vessel above the surface of the water occupied by air may be occupied by men while doing work, it being only necessary to renew the air for breathing. However, if additional pressure is induced by pumping additional air into the chamber beneath the vessel, the water may be driven out entirely down to the edge of the vessel, and if the vessel rests on the bottom of a river or other body of water, a man might stand on the bottom of the stream under the vessel and work without interference by water. This principle was first utilized in diving bells, which were nothing more than an inverted steel cylinder closed at the upper end with an air hose attached. The pneumatic pile was next used, which consisted in extending the cylinder above the surface of the water with an air lock part way down by which men might enter and leave and materials might be removed.

The pneumatic caisson which grew out of this is a large inverted box with a bottom (top) sufficiently strong to permit the building of a coffer-dam and a masonry pier on it after the caisson has been sunk to a solid stratum.

¹ *Trans. Am. Soc. C. E.*, vol. 2, p. 441.

Developments from this elemental form have been largely in the way of economic construction, improvement in accessories, skill in handling the caisson, and in the safety of men employed. At the present time, the pneumatic process is applied to sinking foundation, with the following types of structures or devices:

1. Diving apparatus,
2. Pneumatic cylinders,
3. Pneumatic stationary caissons,
4. Pneumatic drop caisson.

Diving.—Diving in shallow depths and for very brief periods of time can be accomplished by a good diver without any special apparatus, but where the depth is considerable, or where the work to be done requires more time than a few seconds, it is necessary to provide special diving apparatus.

The diving bell was an early invention being used by Smeaton in an improved form as early as 1778 in submarine construction. The principle of the diving bell is that of an inverted glass tumbler in a basin of water, the water rising only part way in the tumbler owing to the presence of the air. Thus James B. Eads improvised a diving bell from an inverted barrel for use along the Mississippi river, the barrel being properly weighted to insure its sinking in an upright position. Air is pumped into the diving bell by a hose connection and light was formerly admitted through glass windows.

The diving bell is an obsolete device in engineering work and would not be mentioned in this connection except for the fact

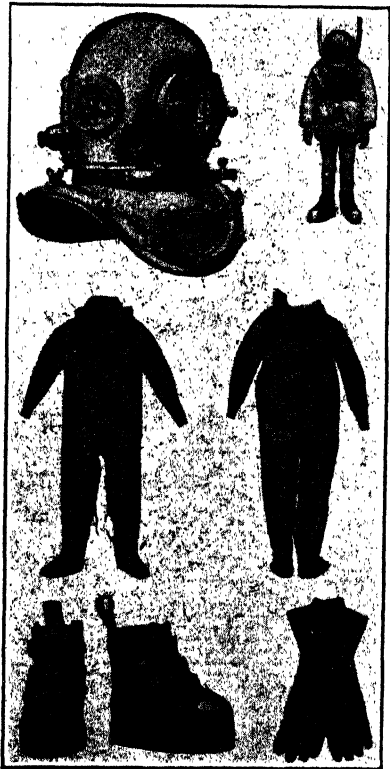

FIG. 248.—Divers' suit.

that it represents the simplest application of the identical principle used in the pneumatic caisson to be described later.

A modern diving suit consists of a waterproof suit with a metal helmet to which the suit is attached so as to exclude the water. Air is pumped into the helmet from the surface and escapes from the helmet so that the diver has a circulation of fresh air for breathing. He is, however, subjected to the full hydrostatic pressure of the water corresponding to the depth at which he may be working. The maximum practical depth for working in such a suit is about 180 to 200 ft., although suits have been devised which during the trial tests have permitted going to greater depths. Figure 248 shows the parts and an assembled diving suit and needs no comment. The helmet has telephone connection as well as air.

Pneumatic Cylinders.—Pneumatic cylinders were an early development of the diving bell. The steel cylinders, composed of plates $\frac{3}{8}$ to $\frac{1}{2}$ -in. thick are about 6 to 9 ft. in diameter and have two diaphragms, each containing a door, about 7 or 8 ft. apart, which form the air lock. The cylinder may be forced downward either by slacking off the air beneath or by weighting at the top.

The Columbia River bridge at Trail, B. C.¹ rests on piers founded on pneumatic cylinders as shown in Fig. 249. Each cylinder is 6 ft. in diameter at the top and 9 ft. at the bottom, the two cylinders for each pier being filled with concrete and joined to each other by a concrete web 2 ft. thick incased in steel and extending from low to high water line. The lower 61 ft. of the cylinder consists of a double shell, the inner cylinder being three feet in diameter and splayed out at the bottom to meet the outer shell in the cutting edge.

The cylinders of the Atchafalaya bridge of the Texas & Pacific R. R.² consisted of a double shell, the outer diameter being 8 ft. and the inner 5 ft., the latter being splayed out to the cutting edge at the bottom as described above, and the space between the two cylinders being filled with concrete. These cylinders were put down to replace old cast iron cylindrical piers sunk in 1882 by the open dredging process, which had been broken off by the sliding of the inclined strata of blue clay forming the river bottom. The old cast iron cylinders had extended 120 ft. below high water and stubs of these old cylinders were encountered

¹ *Engineering News*, Dec. 5, 1912.

² *Engineering Record*, Apr. 8, 1899.

just where the clay stratum joined the sand, showing that the sliding had occurred at that plane. Old railroad rails were stood on end between the shells of the caisson to add sufficient weight to sink the cylinders. These cylinder caissons were 135 ft. in length and were sunk 120 ft. below high water, a depth probably exceeding any other recorded use of compressed air in foundation work.

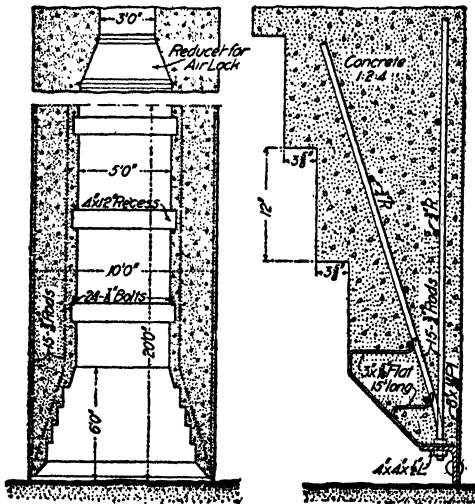

FIG. 250.—Reinforced concrete pneumatic cylinders for the Bronx viaduct.

Cylindrical caissons are sometimes built of reinforced concrete as shown in Fig. 250,¹ which is a section through the reinforced concrete cylindrical caisson used in the Bronx viaduct of the New York Connecting R. R. The caissons were 10 to 18 ft. in diameter and were sunk to a maximum depth of 55 ft. While passing through clay, the open dredging process of excavating was used and while sinking through sand, the pneumatic process was used.

The chief advantage of cylindrical caissons is that they can be readily converted from open dredging cylinders to pneumatic cylinders by the insertion of an air lock in the event that quicksand or other obstacles are encountered.

Stationary Caissons.—In the sinking of a subsurface chamber on shore near a body of water, such as a waterworks intake, a

¹ *Engineering Record*, Sept. 20, 1913.

stationary pneumatic caisson can be utilized to advantage. A stationary caisson consists of an inverted box, usually of reinforced concrete with the outside of the bottom placed at the elevation desired in the finished structure and the sides extending down into the soil. Air is pumped into the box and the soil beneath removed through air-locks in the usual manner, but instead of the caisson being lowered as the excavation proceeds, the walls are underpinned and extended. When the desired elevation is reached for the bottom of the chamber as governed

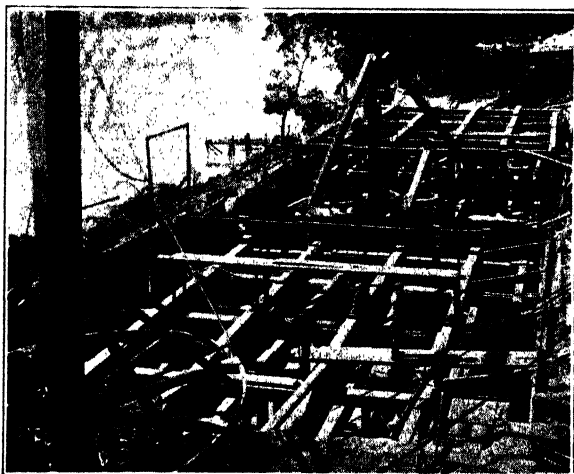

FIG. 251.—Stationary pneumatic caisson.

by-bearing capacity of the soil and by other conditions, such as the elevation of the water in the case of waterworks intake, the caisson is floored and the necessary cross walls, columns, etc. put in place.

The caisson is originally built by constructing the walls in an open trench and excavating the enclosed soil with a dredge bucket or by other means until strata are reached requiring the application of air to keep out the water. A reinforced concrete slab roof is then placed on the walls in which an air-lock, air pipe and blow-out pipe are inserted, air pressure applied, and the work proceeds under compressed air. It is necessary to weight down the caisson by piling earth or other material on the roof in order to prevent the caisson from rising because of the pressure of the air beneath.

Figure 251 shows a stationary caisson used in the construction of a waterworks intake on which the author was engaged. Single sheet piles were driven at first but owing to the presence of quicksand somewhat below the level of the water in the river, air had to be used. Concrete walls were built and roofed over as above described, air applied, and the walls extended to the desired depth. The figure shows the air-lock on suction chamber No. 1 in place after that chamber had been completed. The caissons were put down in the above symmetrical order with a view to balancing the external lateral pressures from the earth.

Drop Caissons.—A pneumatic drop caisson is the type commonly meant when the term pneumatic caisson is used. It consists in principle of an inverted box with sides and roof strong enough to sustain the pier masonry above and a coffer-dam built on this roof to exclude the water while the masonry is being placed. The space beneath the "box," which is usually about 6 or 7 ft. high, constitutes the working chamber and is subject to the air pressure; the roof of the working chamber is reinforced by the "crib" above it in a timber caisson, and the coffer-dam is erected above the crib. The caisson is commonly built on shore, floated into position, grounded, air applied, and the spoil excavated and removed from the working chamber as the caisson sinks. The crib gives rigidity to the caisson and when filled with masonry furnishes much of the weight required to sink the caisson. The coffer-dam serves to exclude the water from the construction area above the crib and is extended upward as the caisson sinks, being kept at all times well above the water surface.

In recent years, the pneumatic caisson method of sinking foundations has been so well developed that, where a considerable amount of earth is to be penetrated, for depths below water level between 30 and 110 ft., it is one of the favorite modes of procedure on the part of foundation contractors. Figure 252 shows a view in the working chamber of a pneumatic caisson¹ constructed of steel, a modern development. The caisson rests on jacks prior to the application of compressed air.

¹ *Bur. Mines, Tech. Paper 285*, by EDWARD LEVY, a valuable discussion of the subject.

Design of a Drop Caisson.—The design of a pneumatic caisson comprises (1) the determining of the dimensions of the caisson in plan and altitude, (2) the design of the roof, walls, cutting edge, crib and coffer-dam to withstand the forces to which they may be subject, (3) the determining of the weight necessary to sink the caisson, (4) the calculation of the flotation depth required for launching and floating to position and providing for the same, and (6) the investigation of the stability of the pier founded thereon.

The caisson should be strong enough to support its weight and that of the superimposed load while sinking. The three

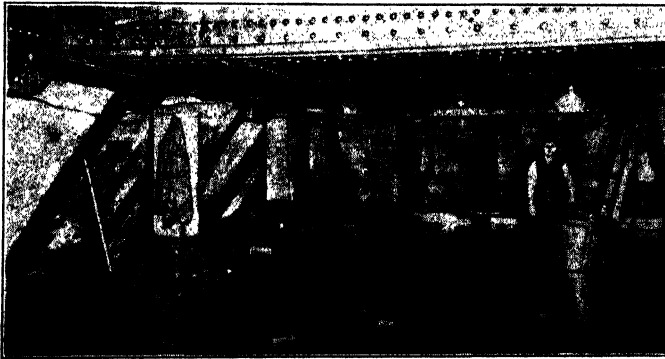

FIG. 252.—Inside the working chamber ready to begin sinking.

most severe conditions to which the caisson may be subjected while sinking are (1) "bridging" between two obstructions or hard strata at the ends with soft material between, in which case the caisson acts as a simple beam supported at the ends; (2) "hogging" an obstruction or resistant material at the middle with soft soil under the ends, in which case the caisson acts as a double cantilever; and (3) the caisson strikes obstructions or resistant material at diagonally opposite corners. Obviously, the analysis of stresses for these conditions is indeterminate and can be made only approximately.

The area of the caisson will be determined by the bearing capacity of the soil stratum upon which the caisson is to rest and the total load to be carried where the caisson is founded on a stratum of limited bearing capacity. The maximum pressure on the foundation bed equals the total weight of pier, caisson, concrete filling in the working chamber (see p. 572), etc., the

superimposed weight of water, earth, and the dead and live load from the superstructure, less the skin friction on the sides of the caisson and less the buoyant effect of displaced water and other materials. The practice of allowing full value to the buoyant effect of water displaced is justified where the foundation bed is only slightly below the bottom of the main body of water or where the hydrostatic force of the water might be effective upward, as where the bed is permeable sand, gravel, etc., but frequently the foundation bed is so far below the bottom of the water basin that the hydrostatic pressure may be somewhat dissipated and probably is not effective to the full extent, especially where the caisson is ultimately founded on an impervious stratum of rock. It is common practice also to deduct the weight of the earth displaced from the loads.

As an illustration of such a calculation, the following data are taken from Pier No. 1 of the Harahan bridge near Memphis:¹

Weight of timber, iron, etc., of caisson.....	10,110 tons	
Weight of concrete in working chamber.....	1,180	
Weight of pier masonry.....	7,780	
Total weight of pier.....	19,070	
Weight of superimposed earth.....	1,810	
Weight of superimposed water.....	0	
Dead load from superstructure.....	5,670	
Live load from superstructure.....	3,870	
Total load.....	30,420	30,420
Deduct for skin friction at 400 lbs. per sq. ft.....	2,850	
Deduct for buoyant effect of water.....	5,310	
Deduct for earth displaced.....	8,110	
Total deduction.....	16,270	16,270
Net effective.....		14,150 tons

This pier rested on a hard clay bed which was estimated to have a bearing capacity of 5 tons per square foot, hence the required area is $14,150 \div 5 = 2,830$ sq. ft. A caisson 40 by 80 ft. was actually used, giving a bearing of 4.4 tons per square foot.

Samples of the clay from the working chamber when tested in cubes gave a bearing strength of 100 lbs. per square inch or 7.2 tons per square foot, and since the clay would sustain a much greater load in a confined bed than when in the form of unsupported cubes, the allowed bearing was conservative. Likewise, on another pier under the same bridge, the skin friction was

¹ RALPH MODJESKI, Consulting Engineer, *Report*, p. 7.

observed to be about 800 lbs. per square foot, hence the allowance of 400 lbs. was conservative.

Soil at the depths reached by pneumatic caissons have a greater supporting capacity than have similar soils at the surface owing to the influence of lateral pressures. Tests made at the Metropolis bridge showed a bearing capacity of 20 tons on well bedded fine sand with practically no settlement.

Where the caisson is to rest on a stratum of rock or other material having greater compressive strength than the caisson masonry itself, the size will be determined either by the strength of the caisson, or by other considerations.

Where neither the bearing on the foundation bed nor on the caisson itself is the limiting factor in determining the size of the caisson, the dimensions of the plan will be determined by the size of the pier or other structure which will rest upon the caisson. In case of a bridge pier, the dimensions of the bridge seat will be fixed by the general requirements of the superstructure; allowing then for the batter of the sides of the pier, and the offset at the top of the caisson, the general dimensions will be fixed. It is usually desirable to make the caisson somewhat larger than the exact requirements of the base of the pier would indicate in order to allow for some deviation from the exact position in sinking. The caissons at Havre de Grace bridge over the Susquehanna River were 3 ft. larger on all sides than the first masonry course of the pier. The actual deviation was less than 18 in. although the caissons were sunk over 90 ft. An allowance of from 6 to 12 in. is common for deviation from true in the sinking of a caisson.

The height of the caisson will obviously depend upon the depth to the desired bearing stratum. It is essential that complete information be secured by borings as to the character of the stratum on which the structure will finally rest before the caisson can be designed. The height will necessarily be the distance from this stratum up to an elevation well above the surface of the water in order that waves, etc. may not interfere.

The Cutting Edge.—Opinion and practice differ among engineers as to the best design of the cutting edge. Two types of cutting edge are in general use, viz., (a) the sharp edge, Fig. 254 and (b) the blunt edge, Fig. 253. The arguments in favor of the sharp edge are (1) that no excavation under the cutting edge is necessary to cause the caisson to sink, and (2) air does not

readily escape under the edge because the thin edge penetrates the soil and seals the junction to an extent. The disadvantages are (1) the edge may bend when logs, boulders or other obstacles are encountered, and (2) the edge does not have sufficient bearing area to support the caisson if one side strikes a soft stratum and additional bearing must be provided for such a contingency. Obviously the blunt edge obviates the objectionable features of the sharp edge but at the same time it does not possess its merits. However, in most soils, a sharp edge is not necessary and engineers generally have favored the blunt edge.

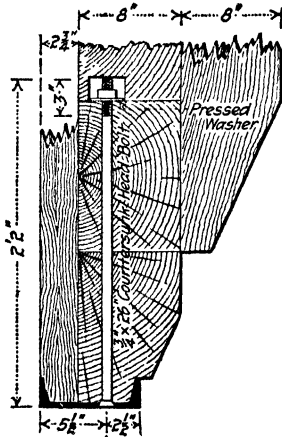

FIG. 253.—Detail of blunt cutting edge for a caisson.

The sharp edge is formed generally of steel plates or of plate and angles and additional bearing area is secured by attaching a bent plate on the sloping roof. In the other form of cutting edge, no additional bearing area is required. The amount of this bearing area should be sufficient to furnish support to the caisson on the material being excavated equivalent to a reasonable drop in the air pressure inside so that when the air is slacked off the caisson will sink.

A blunt cutting edge is frequently formed by chamfering the bottom timber to fit into a channel, the size of which should be dependent upon the load to be supported as indicated above; it is usually about a 6 or 8-in. channel. Instead of a channel, a tough plank of hickory or oak may be used. In either case, the channel or plank should extend to the outside of the sheathing.

Caisson Walls.—The walls of a pneumatic caisson begin at the cutting edge and extend continuously to the top of the cofferdam, although the type of construction may vary considerably. Naturally, the heaviest strains occur in the walls of the working chamber, requiring the heaviest bracing in that region. The walls of the caisson must have sufficient strength to support the caisson and the pier.

Two general types of walls for the working chamber are used, one in which the inside of the wall is vertical, the wall being braced by struts at intervals, as shown in Fig. 255, and the other

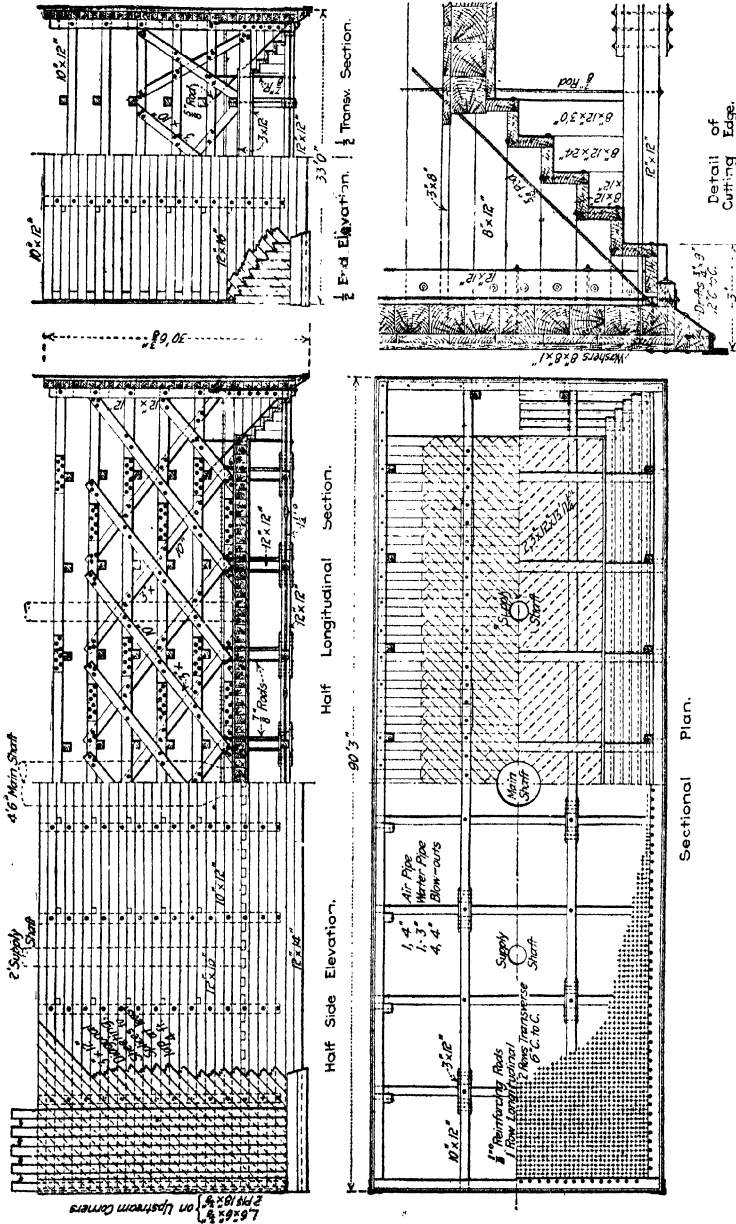

FIG. 254.—Details of a pneumatic caisson for the municipal bridge, St. Louis.

in which the inclined struts with the sheathing forms a sloping roof, Fig. 254. The former provides more headroom and consequently facilitates the removal of the spoil from under the cutting edge, but the latter is somewhat more rigid. In several cases

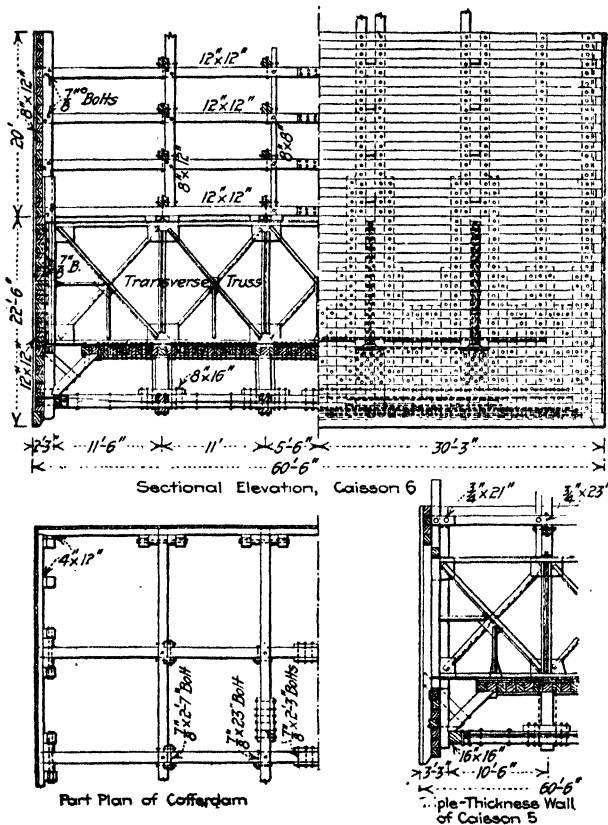

FIG. 255.—Details of the Metropolis bridge caisson.

the walls of caissons have failed by buckling inward, hence, adequate strength in this respect is important.

The pressure on the walls in pounds per square foot is given by the formula

$$p = (wh + w'h') \frac{1 - \sin \phi}{1 + \sin \phi}$$

where h' is the depth below the bottom of the water and h the depth of the water in feet, w' the weight of the earth and w the

weight of the water in pounds per cubic foot, and ϕ the angle of repose of the earth materials, varying from 0° to perhaps 33° , about 15° being an average value for silt in a wet condition. If the silt is fine and thoroughly saturated, the value of ϕ should be taken as 0° . The pressure on the walls at launching will be $\frac{wv^2}{32.2}$ v being the velocity in feet per second with which the caisson strikes the water

The specifications for the Manhattan bridge over East River, New York,¹ represent good practice in regard to the details of construction of timber caissons, although timber caissons are practically obsolete:

"All outside timbers to the launching height shall be drift bolted with 1 by 30 in. drift bolts, started in each course and staggered, and spaced 3 ft. center to center. From this point (launching height) to the top, all horizontal wall timbers shall have 1 by 30 in. drift bolts 4 ft. center to center and staggered. The pitch of the stagger shall be varied with the courses below so as to secure an equal distribution. The outside sheathing of these walls shall be of two courses of 3 by 12 in. tongue-and-groove sheathing fastened with $\frac{3}{8}$ by 7 in. boat spikes, the first course to be laid longitudinally and the second vertically. All timbers shall lap at least 6 ft.

"Bulkheads shall be drift bolted as for the walls below the launching height with 3 by 12 in. sheathing. The bottom and top courses shall be framed into the walls by dovetailing . . .

"The outside seams of horizontal wall timbers and all chamber seams in vertical wall timbers and roof timbers and in roof and wall lining shall be caulked with two threads of cotton and followed with four threads of oakum, the several threads to be thoroughly driven home, and all points, so far as practicable, to be served with hot pitch."

The outside walls of the caisson should be vertical, although formerly some engineers built their caissons with a batter inward at the top. This latter practice was found to cause difficulty in guiding the caisson. The friction sheathing is always placed vertical, although other layers of sheathing are commonly placed diagonally at about 45° .

Roof of Working Chamber.—The working chamber is 6 or 7 ft. high and since the excavation is commonly kept below the cutting edge, there is ample head room for men to work. The roof of the working chamber must be sufficiently strong to support the weight of the filling in the cribbing and of the pier,

¹ *Engineering News*, Nov. 27, 1902.

and sufficiently air tight to prevent serious leakage of air. Formerly, when the filling in the crib and the pier were stone masonry and the roof was of timber, the latter was made very thick because it was estimated that the roof would be subject to very heavy loads and severe bending strains. The roof of the caisson under the Brooklyn bridge was 22 ft. thick and consisted of a solid mass of 12 by 12 in. timbers. With the introduction of concrete in building piers, the pier is assumed to be self-supporting after reaching a moderate height. In fact reinforcement is placed in the concrete immediately over the roof to make it strong enough to sustain the loads.

Where stone masonry is used, it is customary to consider all the masonry in a triangular prism whose sides make an angle of 60° with the horizontal as supported by the timber roof, and where reinforced concrete is used above the timber roof, the maximum load that will be sustained by the timber roof in addition to the weight of the roof itself will be the green concrete before it has time to set up. In comparatively small caissons a reinforced concrete or timber roof can readily be made that will support the superimposed load but in large caissons, the difficulty increases. Timber trusses extending down into the working chamber are commonly used as illustrated in the Municipal bridge at St. Louis, Fig. 254.¹ In the Metropolis bridge, steel trusses were used immediately above the roof on account of the large size of the caissons. See Fig. 255.²

While the static loads coming on the roof consist chiefly of the weight necessary to be placed there to sink the caisson, a considerable allowance must be made to provide for shocks, the chief source of which is from sudden sinking and the consequent stopping which causes an impact on the roof. A common allowance is 100 per cent of the static load to provide for such shocks. Careful investigation should be made to see that the shear and bearing strengths are adequate where the roof joins the side walls. Where the wall of the working chamber is V-shaped and concrete filled in and made continuous with the roof slab so that the concrete in the wall takes the bearing directly, no difficulty of securing sufficient shear area occurs.

The Crib.—The crib is the portion of the caisson, as it is commonly built, immediately above the roof of the working

¹ *Engineering News*, Mar. 16, 1911.

² *Engineering News*, Mar. 22, 1917.

chamber. Its purpose is to give rigidity to the caisson, to facilitate the floating into position, where the caisson is not built *in situ*, and to serve as the initial coffer-dam in sinking, and when filled with concrete, to furnish most of the weight required in

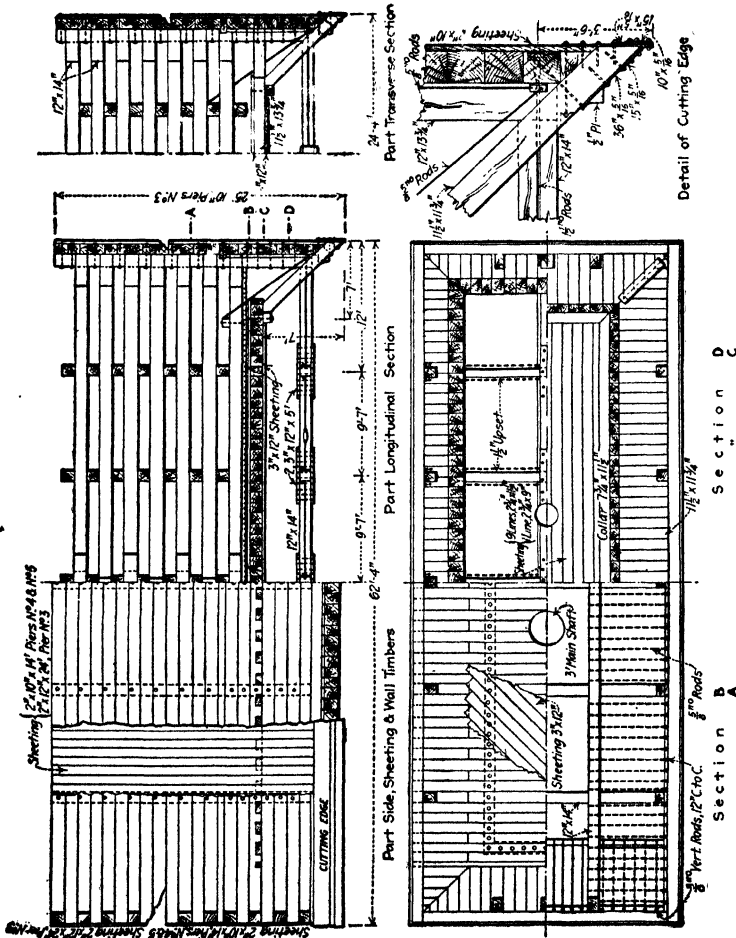

FIG. 256.—Details of pneumatic caisson for the Union Pacific R. R. bridge at St. Joseph.

sinking. Where there is not much water, the crib is sometimes omitted and the pier begun directly on the top of the roof of the working chamber, the masonry of the pier being sufficient to sink the caisson.

The adjustment of the weight (see subsequent paragraph) required to sink the caisson is effected by filling all or a portion of the crib with concrete, and in this way, the weight can be varied through a considerable range.

The walls of the crib are built similar to the walls of the working chamber and usually consist of either 12 by 12 or 6 by 12 in. timbers drift bolted together and framed and drift bolted at the corners. The crib itself may consist of a grillage of timbers in alternate tiers laid at right angles to those of the adjacent tiers and spaced in the tiers about 8 to 10 ft. apart as in Fig. 256 which shows the caisson for the pier of the Union Pacific R. R. bridge at St. Joseph.¹ In other cases, the timbers are spaced some distance apart vertically and are then essentially like the bracing of the coffer-dam. The ends of the timbers are framed into the caisson sometimes with halved joints and sometimes by dove-tailing the full size timbers, the latter being the stronger method. Where there is a reinforced concrete slab above the roof, the reinforcement is placed immediately above the roof timbers as shown in Fig. 256.

The Cofferdam.—The crib is an integral part of the caisson and serves as a form for the concrete above the roof of the working chamber, the concrete filling the entire area of the crib. However, to minimize the obstruction to the stream flow where the pier is in a running stream and to prevent decay, the cribbing is discontinued somewhat below the bottom of the stream bed and the pier with battered sides extends from there up. In order to build the pier thus, it is necessary to provide a coffer-dam on the top of the crib. This is accomplished by extending the crib walls, somewhat modified owing to the diminished pressures, and placing bracing inside as needed. These braces usually consist of 6 by 8 in. timbers and are removed as the pier is built upward and the sides of the coffer-dam braced directly against the finished portion of the pier. The coffer-dam is removed entirely after the pier is completed. The relation between the coffer-dam, crib and working chamber is illustrated in the pivot pier caisson of the Missouri River bridge of the Union Pacific R. R. at St. Joseph, Mo., Fig. 257.

Air Locks.—Employees make entrance and exit and materials are removed from the working chamber by means of shafts which are sealed by air locks. The air lock usually consists of an

¹*Engineering News-Record*, Oct. 25, 1917.

enlarged section of the shaft, fitted with an air tight door at the top and one at the bottom so arranged that the pressure from inside will hold either shut when the other is open. Sometimes, when an elevator is used in the shaft, the air lock for men consists of a double chamber one beside the other. Figure 258

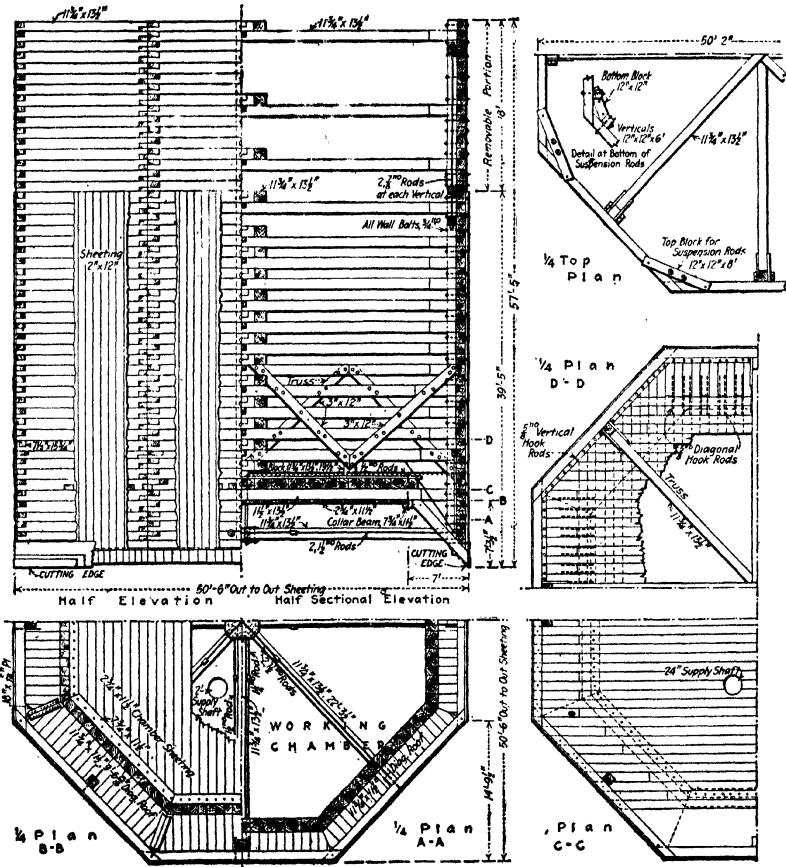

FIG. 257.—Pneumatic caisson for the pivot pier of the Union Pacific R. R. bridge at St. Joseph.

illustrates the manner of passing a bucket through an air lock, and Fig. 259 shows a picture of an air lock ready to receive the bucket. The shaft for men is usually about 2 1/2 to 3 ft. in diameter, although sometimes as large as 6 ft., and consists of a riveted steel pipe of about 3/8-in. plates. When the shaft for

removing spoil is separate, it is usually about 2 ft. in diameter. Where the depth is not great, men usually enter and leave by means of a ladder, although for greater depths, an elevator may be used advantageously. Spoil that cannot be blown out (see p. 571) is removed by means of a bucket and cable through a shaft.

The air lock for men is placed at the top of the shaft in order that men may take refuge temporarily in the shaft in the event

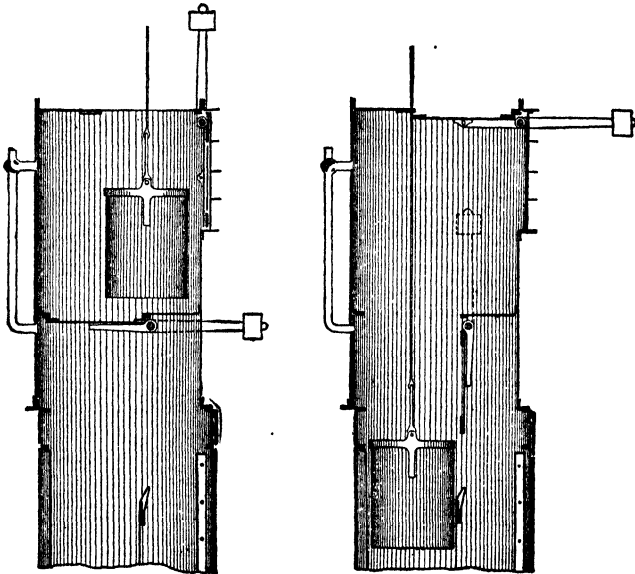

FIG. 258.—Diagram showing the passage of a bucket through an air lock.

of an accident which may allow water to enter the working chamber.

When the shaft needs to be extended, a valve or gate is closed at the bottom in the working chamber to prevent the escape of air, the air lock is unbolted from the shaft, the new section bolted in place and the air lock replaced on top of the added section.

Some contractors use collapsible steel pipe so that it can be removed leaving a shaft molded through the concrete, and thus effect a saving where the caissons are sunk to a considerable depth. In this case, the junction of the steel pipe to the concrete shaft can be made air tight by means of packing and mortar.

The section of the steel pipe at the bottom of the shaft is not removed because it must be especially equipped with an air valve, etc. to prevent the escape of air while changing the air lock.

Flotation of the Caisson.—In most cases, the caisson is built on shore some distance from the pier site and floated into place. The displacement of the caisson must be carefully calculated from its estimated weight and the depth of displacement so adjusted that no difficulty may be encountered in launching and floating into place. For example, a caisson weighing 1,562,000 lbs. will require a displacement of 25,090 cu. ft. in fresh water and perhaps 24,800 cu. ft. in salt water. If this caisson is 70 by 28 feet in plan, it would sink $25,090/70 \times 28 = 12.8$ ft. in fresh water, if the bottom of the working chamber is floored temporarily and caulked to effect flotation. If the working chamber is not so floored and used as displacement, the depth of sinking will be practically the height of the working chamber greater than this figure. The coffer-dam, of course, will have to be extended above the crib sufficiently to insure adequate displacement to effect flotation.

It is essential that the weight of the caisson be calculated with considerable accuracy in order that its flotation may be properly forecast. The position of the center of gravity and the center of flotation must be calculated and arranged with the former well below the latter and directly under it in order that the caisson may keep an even keel as a ship while it is being towed into position.

Launching and Locating the Caisson.—Caissons may be constructed (a) on ways along the shore, launched much as a ship is launched and towed into position, (b) on pile supports over the proposed site of the pier and lowered into position with long screw rods, (c) in a dry dock and floated by the admission of water, (d) between two barges, and floated into position and

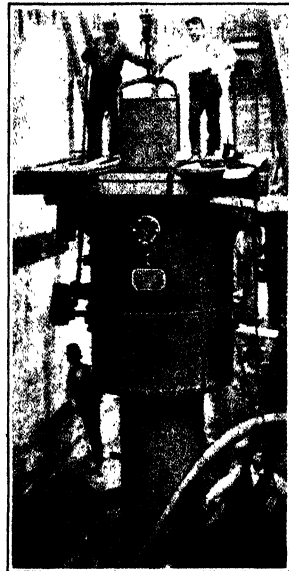

FIG. 259.—Exterior view of an air lock.

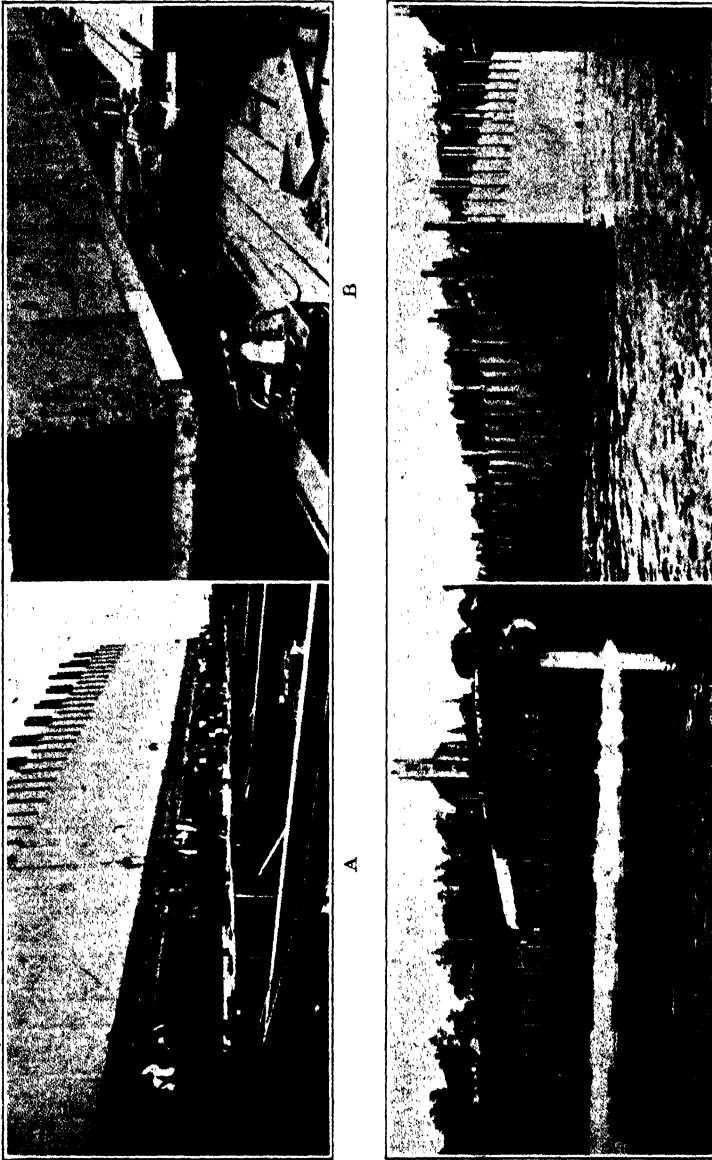

FIG. 260.—Launching and floating the Quebec bridge caisson.

lowered, (c) on a barge and launched by tipping the barge, or (f) on a pontoon and launched by sinking the pontoon from beneath either by filling water ballast tanks or by dividing the pontoon and withdrawing the two halves.

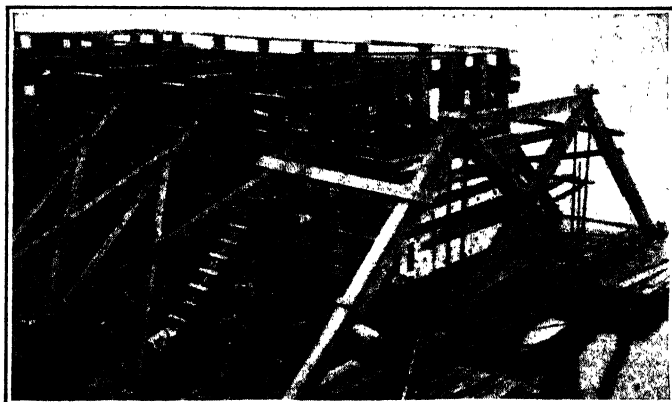

FIG. 261.—Caisson supported by barges.

Figure 260¹ shows the successive stages of launching a caisson from ways for the Quebec bridge, with jacks, blocking, etc. in place. The launchways had a grade of 10.94 per cent and the start was given by means of jacks.

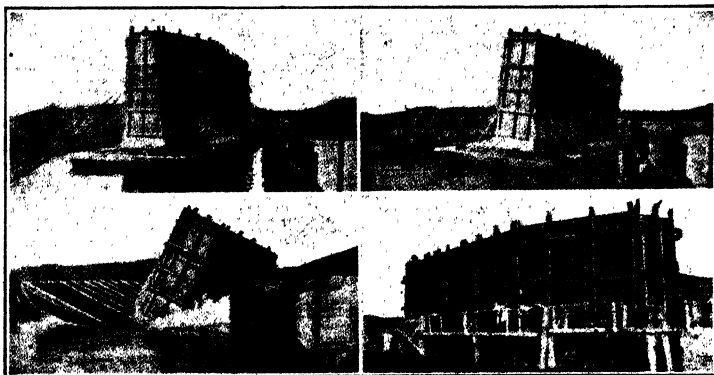

FIG. 262.—Launching from a scow.

When a caisson is supported on piles, it is built between two pile clusters or rows and rests directly on beams slung by means of stirrups of lowering bolts from the piles. The cutting edge

¹ *Report of the Government Board of Engineers.*

is above the water surface so that men can work in the working chamber, and when the caisson is to be lowered, the long lowering screws or bolts are slacked off and the caisson gradually lowered into the water. When the caisson is built in dry dock, the latter is usually a temporary affair and the procedure is similar to the placing of a boat in dry dock and then floating by the admission of water. Figure 261¹ shows the caisson for the Willamette River bridge floating between two barges ready to be floated into place.

Figure 262² shows a series of pictures of launching a pier caisson of the Jones bridge from a scow at Manila, P. I., concerning which the following details are of interest.

"The caisson was 100 ft. long, 35 ft. wide and 36 ft. high. The walls of the lower portion of the caisson for a height of 14 ft. were battered and constructed of reinforced concrete 1 ft. thick, while the remaining height was unbattered and built of double timber sheathing and one thickness of tarred paper. Three feet above the lower edge of the caisson was a 4-in. calked plank floor supported by inverted timber trusses, which in turn rested on timber sills bolted to the upper edge of the concrete walls. The floor and trusses were designed to withstand water pressure during flotation. The scow upon which the caisson was built was divided longitudinally by a bulkhead, so that water could be admitted into one side and cause the scow to list. Between the scow deck and the caisson were pairs of skids that were well greased just before launching.

After the piles were driven and cut off, the scow with the caisson was towed to a position below the proposed pier location, and the valves on the midstream side of the scow were opened. The only lines used were those necessary to keep the caisson from floating downstream and to tow it into place after launching. Twenty-three minutes after opening the valves, when the list was about 15°, the caisson slid smoothly into the water, reaching a maximum angle of inclination, due to the momentum of the slide, of about 45°. As was anticipated, just as soon as the caisson began to slide, the scow tipped quickly and was pushed from underneath with considerable force, as shown in one of the views. Due to the low center of gravity, the caisson righted itself with long easy rolls and finally rested on an even keel at an immersed depth of 8.5 ft."

Figure 263 shows the pontoon used in launching the large caissons of the Metropolis bridge over the Ohio River, the following description of which is taken from the *Engineering Record*, vol. 74, p. 150:

¹ JACOBY and DAVIS, "Foundations of Bridges and Buildings," p. 316.

² *Engineering News-Record*, May 17, 1917.

"The pontoon is 66 ft. 9 in. by 120 ft. 10 in. and is 9 ft. 6 in. deep. The largest caisson built in it was 60 ft. 6 in. by 110 ft. 6 in., the portion constructed before launching weighing $67\frac{1}{2}$ tons. On account of the unequal distribution of the load, the pontoon is given transverse stiffness by heavy timber beams on 4-ft. centers. Each of these is made of four 8 by 16-in. timbers bolted together and spliced with steel plates. Under these beams are longitudinal rows of 12 by 12-in. timbers on 4-ft. centers. The pontoon contains 183,120 ft. b m. of lumber and, allowing for the iron used in its construction, has a net buoyancy of 195 tons. The whole pontoon must, of course, be filled with water to reduce the buoyancy to this figure. This is done just before launching the caisson by removing a wooden gate, made in two pieces, which covers a number of 4-in. holes in the side of the pontoon. The gate is first unbolted and tem-

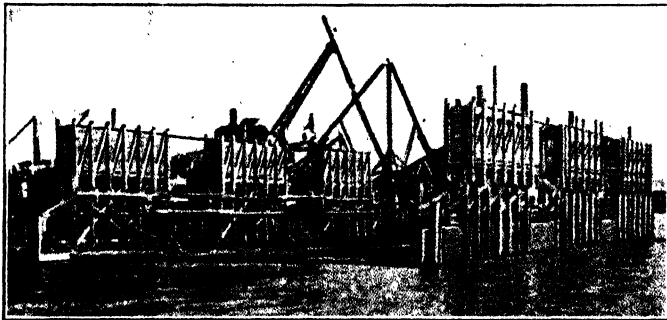

FIG. 263.—Pontoon for launching a caisson.

porarily shored, and comes to the surface when the shores are removed. When the pontoon is raised after a launching, the emptying of the ballast tanks brings these holes above water so that the gate can be replaced.

On a deck of 3-in. plank laid between the transverse timber beams is loaded sufficient gravel to weigh 130 tons submerged. This reduces the buoyancy to a point which allows the pontoon to be sunk free of the caisson being launched when the water boxes are about half full. Each of the six boxes weighs 2 tons, is $23\frac{1}{2}$ ft. long, 3 ft. wide and 7 ft. 8 in. high. Each has a capacity of 17 tons of water, but not more than 9 tons per box is required."

Where the water is deep and comparatively still, sometimes an artificial mound of earth or sand in bags is placed on the site in order to reduce the depth of water through which the caisson must be sunk before being landed. However, flood conditions in streams must be taken into consideration, lest a caisson landed on such an artificial pile be swept away by a rise in the stream. At

the Havre de Grace bridge in Maryland, the caissons were sunk through 60 ft. of water.

An ingenious device for sinking caissons under unusual depths of water was employed in the construction of the Suisun bridge.¹ The depth to rock was about 140 feet and the water was about 60 feet deep. A circular steel shell 80 feet in diameter was lowered from falsework supported on piles around the site of the pier. The shell was allowed to penetrate the mud of the bottom to effect a seal and was then unwatered to within 12 feet of the water surface and after some of the soft mud inside had been removed, was filled to the water level with sand. The caissons were then placed on this "sand island" and sunk by open dredging. The shell above natural ground level was then removed and used on other piers. The highest pier was 214¹/₂ feet from foundation to top. The process proved to be entirely successful.

When being moved into place, the caisson is located at the approximate site while still floating and moored to pile clusters, and then concreting is begun and continued until the caisson is landed on the bottom of the river bed. After landing at the bottom of the water, an excess of air is turned in, lifting the caisson, and then it is located exactly on the center lines of the proposed structure. The locations are made by observations from the ends of the base lines, platforms being built at the ends of the caisson for the exact points, with which, points on the caisson are made to correspond by moving the caisson into line.

The caisson may be aligned by tackle attached to pile clusters. Where the configuration of the stream bed is such that the earth on one side of the caisson is banked much higher than on the other, difficulty is likely to be encountered in preventing the excess lateral thrust from the high bank from moving the caisson out of position. It is customary to allow for this pressure in such circumstances by landing the caisson somewhat out of position toward the bank and allowing this pressure to move it into place as sinking proceeds. The amount of this allowance must be determined by the engineer's judgment. In one of the piers of the Harahan bridge at Memphis, 6 in. was allowed, and it proved to be just right, the caisson coming exactly into

¹The details of the method were furnished by M. F. Clements, *Mem. Am. Soc. C. E.*, consulting engineer, who invented the system.

position, while at another pier at the same bridge, 18 in. was allowed and it proved to be too much, and only with considerable difficulty was the caisson forced to the desired position.¹ An open caisson on which the author was engaged was forced nearly 1 ft. by a high bank on one side in going to a depth of about 40 ft. The amount of such an allowance should, therefore, generally not exceed 6 to 12 in.

Mats of willow weaving, or baps of sand are frequently placed over the site of the caisson. In swift currents to prevent scouring of the river bed, and consequent uneven bearing as the caisson is landed. Then the caisson is sunk through this artificial bed.

Where the site of the pier is covered with mud and there is little or no current, this mud can be dredged out before the caisson is landed in place much more cheaply than it can be brought out of the working chamber afterward.

In the event that the caisson settles somewhat out of the desired position, it can be easily floated again and shifted by pumping an excess of air into the working chamber.

Sinking the Caisson.—After the caisson is in place, it is weighted down by filling the pockets provided for that purpose with rocks, or by other means, so that the caisson will not rise, and then air is pumped into the working chamber. As soon as the working chamber is laid dry, men enter through the air locks and begin removing the spoil, and the sinking begins.

The ground at the center of the working chamber is usually excavated somewhat lower than under the cutting edge, and the slopes run up from this low point at the center to the cutting edge. The material is taken out through the air lock or blown out, as described later. The caisson itself is at all times balanced between the downward and the upward forces acting upon it, one of the latter being the air pressure beneath. In order to drive the caisson downward, therefore, after excavating up to or even under the cutting edge, it is only necessary to slack off the air pressure in the working chamber somewhat, and the excess of downward forces drives the caisson down. Water jets may be provided to diminish skin friction on the side when necessary. Slacking the pressure 1 lb. per square inch would be equivalent approximately to a layer of 1 ft. of concrete over the entire caisson. Varying the rate of building up the pier masonry constitutes an additional means of controlling the sinking.

¹ Report of RALPH MODJESKI, Consulting Engineer in Charge.

direction, by excavating under the high side of the cutting edge, this tendency can be corrected. By allowing the spoil that has been removed to pile up against one wall, outside, the caisson may be forced over laterally; and by attaching taut cables, a similar result may be attained. At Sibley, Mo. one of the caissons of the bridge over the Mississippi River was forced some 4 ft. laterally in a descent of about the same amount, by placing inclined posts against the roof of the working chamber and removing the air pressure and allowing the water to fill the work-

TABLE XXXVIII.—VALUES OF SKIN FRICTION ON CAISSONS

Type of Caisson	Method of sinking	Materials penetrated	Skin friction, lbs per sq. ft.	Depth below low water, feet	Area of base, sq. ft.
Cast iron.....	Open excavation	Gravel, clay	240	60	125
Cast iron.....	Open excavation	Sand, clay	250	75	225
Cast iron.....	Open excavation	Sand	250	60	125
Wrought iron.....	Open excavation	Sand, clay	285	140	1,000
Cast iron.....	Open excavation	Sand, clay, gravel	300	100	125
Cast iron.....	Open excavation	Sand	325	60	125
Cast iron.....	Open excavation	Silt	350	60	125
Steel construction....	Open excavation	Silt, sand, clay	375	55	190
Cast iron.....	Open excavation	Silt, mud, clay	390	75	100
Timber construction....	Open excavation	Sand	450	30	1,300
Steel construction....	Open excavation	Silt, clay	450	60	700
Steel construction....	Open excavation	Silt, clay, sand	450	60	1,200
Steel construction....	Open excavation	Mud, sand	450	65	1,300
Steel construction....	Open excavation	Clay	450	75	1,500
Iron construction....	Open excavation	Sand, gravel, clay	480	65	200
Cast iron.....	Open excavation	Clay	500	60	125
Steel construction....	Open excavation	Clay	700	65	1,300
Masonry.....	Pneumatic	Sand, mud	205	40	75
Timber.....	Pneumatic	Clay	250	35	800
Steel construction....	Pneumatic	Clay, sand	275	60	150
Timber construction....	Pneumatic	Silt, sand, mud	310	75	2,550
Timber construction....	Pneumatic	Sand, clay, gravel	350	100	1,200
Timber construction....	Pneumatic	Sand, clay boulders	400	48	1,925
Timber construction....	Pneumatic	Clay, sand, gravel	400	95	4,500
Timber construction....	Pneumatic	Sand, gravel, clay	425	55	1,300
Steel construction....	Pneumatic	Sand, boulders	450	68	2,700
Timber.....	Pneumatic	Silt, clay, gravel	500	75	1,800
Iron cylinder.....	Pneumatic	Sand, shale	525	60	1,200
Timber construction....	Pneumatic	Sand,	540	75	1,700
Timber.....	Pneumatic	Sand, clay	600	75	1,400
Timber construction....	Pneumatic	Sand, gravel, clay	650	80	2,000
Timber construction....	Pneumatic	Sand	650	90	1,200
Timber construction....	Pneumatic	Sand, boulders	650	101	2,100
Timber construction....	Pneumatic	Silt, sand, clay	900	54	1,700

ing chamber. The inflowing water loosened the soil and the inclined posts forced the caisson over as it sank.

In a few instances, where caissons have tipped, they have been righted by attaching cables and tackle and pulling them into position, excavating under the high side of the cutting edge at the same time. Where one side encounters a soft stratum and the other remains on a hard ledge, such tilting is likely to occur.

Operations are usually carried on day and night, the length of the shifts depending upon the depth attained, as noted later. The rate of progress varies greatly, of course, with the character of the material encountered, amounting to only a fraction of an inch per day in some cases, while in others, 3 to 8 ft. For small cylindrical caissons under buildings, much higher rates have been obtained, even exceeding a foot an hour. In most instances, $\frac{1}{2}$ ft. per day, would perhaps represent average progress. A careful record should be kept of the progress made, of pressures, materials encountered, weight of caisson, and all other factors which might throw light on subsequent foundation construction. Figure 264¹ shows a progress chart of one of the C. & N. W. R. R. bridge caissons at Kinzie Street Chicago over the Chicago river.

The frictional resistance to sinking varies with the depth sunk and the character of the materials penetrated. Table XXXVIII² gives values of skin friction on a number of pneumatic caissons. Skin friction on a concrete pier as determined by a full size

TABLE XXXIX.—DEPTHS BELOW WATER SURFACE IN PNEUMATIC CAISSONS

Structure	Maximum depth, feet	Gauge pressure, lbs. per sq. in.
Municipal, bridge, St. Louis.....	113.0	50
Arch bridge, St. Louis.....	109.7	
Memphis bridge, Memphis.....	106.4	
Williamsburg bridge, New York.....	107.5	
Mine shaft, Deerwood, Minn.....	123.0	52
Brooklyn bridge, New York.....	78.0	
Broadway bridge, Portland.....	101.0	
Northern Pacific bridge, Vancouver.....	80.0	
Harahan bridge, Memphis.....	107.0	48
Metropolis bridge, Metropolis, Ill.....	113.2	51

¹ *Engineering News*, Nov. 24, 1910.

² *Trans. Am. Soc. C. E.*, vol. 62, p. 133.

test of the Chicago Union Station was found to be 700 lb. per square foot.¹

The maximum depth reached in some notable pneumatic caissons is indicated in Table XXXIX.

Excavating the Spoil.—Boulders and other heavy material requiring removal must be taken out through the air locks. Frequently light blasting may have to be resorted to in order to reduce materials to such state that they can thus be removed; that such blasting can be carried on without serious danger of a blowout has been amply demonstrated. Boulders may be carried down by excavating around them, when not too numerous, and concreted in as a part of the filling of the working chamber when the work is complete.

Sand and silt may be removed by buckets through air locks, but usually they are most conveniently blown out by air pressure. A small sump pit is formed in the bottom of the excavation into which the water is drained; a flexible hose, usually about 4 in. in diameter, attached to a blowout pipe leading to the exterior, has its free end in this sump. The "sand hogs," as the men are called who do this work, shovel the sand and silt into this sump and the air pressure forces it out through the blowout pipe. When not in use, the blowout pipe is closed by a valve in the working chamber. The exterior discharge of the blowout pipe is horizontal and special devices must be used at the elbow where the vertical pipe turns to the horizontal to prevent the rapid wearing out of the bend. Usually a cap of specially resistant metal which can readily be replaced is used for this purpose. The dry blowout is most satisfactory for pressures between 20 and 75 ft. For less pressures, the material is not rapidly removed and for greater pressures, the difficulty of maintaining approximately uniform pressures in the working chamber increases the likelihood of a blowout and makes foggy and otherwise difficult working conditions.

In some instances, special devices for pumping out sand and silt have been used, such as the mud and sand pump. The principle involved is that of the ejector, frequently used in pumping sand at filter basins.

Stiff clay and mud are usually more conveniently removed by means of buckets through some simple type of air lock than in

¹*Journal W. Soc. Eng.* vol. 29, p. 41, 1625.

any other way. In some cases, the bucket of spoil is hoisted up the chute by the air pressure acting on the bucket as a piston.

Sealing the Caisson.—After the cutting edge has reached the stratum on which the caisson is finally to rest, the caisson is “sealed” by cleaning the floor of the working chamber and filling the working chamber and the shafts with concrete. This is an exceedingly important part of the work, and extreme care should be exercised to see that it is properly done. Formerly a dry mixture of concrete was used, which was tamped in by workmen, but more recently a dry mix has been used only under the edges and under the cross beams, being rammed into place. After this dry concrete is in place, wet concrete is poured in to fill the chamber. In this manner, the labor and the time required for sealing are greatly decreased. Where a caisson lands on a stratum of rock with a dip, as soon as the cutting edge strikes the high side, the low side is underpinned with timbers to keep the caisson evenly supported, the excavation is completed to solid rock and the working chamber sealed in the usual manner.

Concrete for sealing may be carried in buckets through air locks, but the work on large caissons is expedited by arranging a special trap or dump bucket which discharges at intervals into the working chamber. Care must be taken to insure the complete filling of the working chamber after the concrete has taken permanent set. The coefficient of shrinkage due to setting is about 0.0005, hence, a layer of concrete 6 ft. thick would shrink about 0.003 ft. or about 0.04 in. When very wet concrete is used, due to the escape of excess water, the shrinkage has been observed to result in $1\frac{1}{2}$ to $3\frac{1}{4}$ in. between the concrete and the roof. To prevent this, it is well to fill the working chamber within about 12 in. of the top and allow this to stand 24 hours until the shrinkage has been accomplished and then fill the remaining space with a comparatively dry concrete.

Pneumatic Caisson Foundations Under Buildings.—Pneumatic caissons or cylinders are frequently used under buildings for the purpose of sinking columnar piers to bed rock, where the excavation must be carried through water bearing strata. Figure 265¹ shows the work on the foundations of the Municipal Building at New York, work on several caissons being in progress. The foundations consisted partly of cylindrical caissons $6\frac{1}{2}$ to $8\frac{1}{2}$ ft. in diameter, and partly of rectangular caissons of vary-

¹ *Engineering News*, Sept. 17, 1910.

ing size up to 26 ft. by 31 ft., the size and type depending upon the loads to be carried and the soil conditions encountered. Some of the caissons rested on rock with a bearing of 15 tons per sq. ft. and some on sand with a bearing of 6 tons per sq. ft., the depth for the former being about 40 ft. and for the latter 114 ft. as a maximum. Six to eight caissons were in progress of sinking at any one time, the average time of sinking

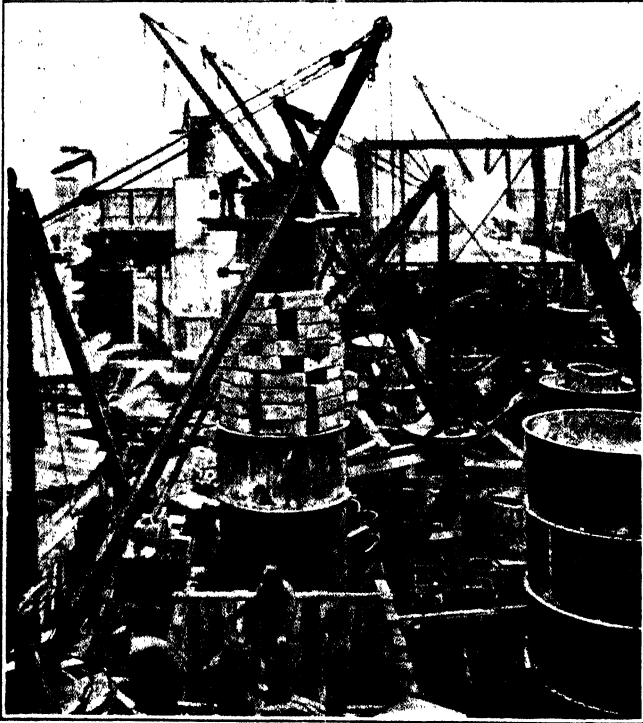

FIG. 265.—Pneumatic caisson under the Municipal Building, New York, N. Y.

being about one month. The maximum pressure regularly used was 48 lbs. per sq. in. Iron weighting was used on most of the caissons.

Caissons similar to those described above were used in the construction of the foundations of the Singer Building, New York,¹ where the piers were sunk 70 to 90 ft. to a solid stratum of shale or hardpan above rock. Figure 266 is a diagrammatic sketch of the type of caisson used. The following details of the plant used

¹ *Trans. Am. Soc. C. E.*, vol. 63, p. 1.

in the Singer Building foundations are of interest and are fairly typical of this class of work.

“The hoisting plant consisted of a four-boom derrick and two stiff-leg derricks, with five Lidgerwood double-drum engines, 3 ft. 7 in. by 10 in.

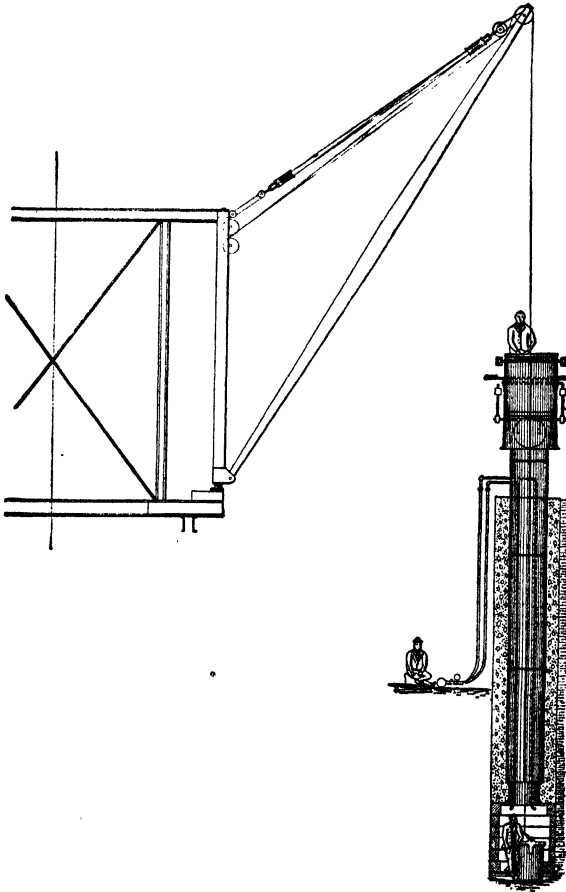

FIG. 266.—Diagrammatic sketch of section through a cylinder caisson under the Singer Building, New York.

and two, $8\frac{1}{4}$ by 10 in., and one Lambert, $7\frac{1}{2}$ by 10 in.; in addition, there were four Rawson and Morrison boom-swinging gears.

“A platform was built on the level of the sidewalk about 15 ft. above the excavation. The lot was excavated to about the water level before commencing the caisson work proper. The derrick, which was built so that carts could run under it on the street level, was about 30 ft. square, with four masts 30 ft. high and 50-ft. booms.

"The compressor plant consisted of one Rand straight-line compressor of 14-in. steam cylinder by 18-in. air cylinder by 22-in. stroke, capable of pumping 1,294 cu. ft. of free air per minute, theoretical rated capacity, and one McKiernan 22-in. steam cylinder, 26-in. air cylinder and 24-in. stroke compressor, capable of pumping 1,474 cu. ft. of free air per minute with a speed of 100 rev. per min. Twin air receivers were used, each 41 in. in diameter, coupled, and 15 ft. 9 in. long. There was also a 14-in. air cooler, 14 ft. long."

Costs of Pneumatic Foundations.—The cost of pneumatic caissons is too variable to permit average figures being given that would be at all reliable in making an estimate. The introduction of reinforced concrete in the construction of caissons makes the construction somewhat cheaper than timber construction would be following the older designs, but the most accurate mode of estimating the probable cost of a pneumatic foundation is to estimate the costs of the separate items, the chief of which may be grouped as shown below:

Materials:

- Timber
- Rods
- Bolts, nuts and washers
- Boat spikes, lag screws and drift bolts
- Oakum
- Pitch
- Pipe for shaft
- Steel plate and angles for cutting edge
- Miscellaneous

Labor:

- Framing
- Handling materials
- Caulking
- Launching
- Grounding
- Excavating
- Removing coffer-dam
- Sealing caisson
- Placing masonry
- Miscellaneous

Plant charge less salvage:

- Engine
- Compressors
- Air tanks
- Pumps
- Air locks
- Hose

Pipe
 Jack screws
 Engine and compressor house
 Fuel and oil
 Installing and removing plant
General expense:
 Superintendence.

Usually the cost of pneumatic caissons is stated in terms of cubic yards below the water as a unit of quantity, but the cost per cubic yard varies widely with the conditions of sinking and of labor. The cost per cubic yard below the top of the crib has ranged from about \$10 to \$30 per cubic yard, averaging perhaps about \$20. However, an average figure from so wide a range of variation is of no value in forecasting the probable cost of a proposed foundation, hence a careful estimate made item by item as above suggested is the only recourse, unless data are at hand showing costs of similar work under similar conditions.

Physiological and Pathological Effects of Compressed Air on Caisson Workers.—Due to the more concentrated form of the air in a caisson, oxidation is more rapid, hence, generally men evince greater energy than when working in the open. Candles or torches burn more rapidly for a similar reason. However, the effect on the normal functioning of the organs of the body seems to be slight if not entirely negligible. Perspiration is perhaps more profuse than in the open, although this is possibly due to the increased temperature quite as much as to the air pressure. Upon entrance into the chamber, or while in the air lock, pressure on the ear drums may become unpleasant, although swallowing or holding the nose and blowing will in almost every case equalize the pressure on the outside and inside of the ear drums by forcing air from the nasal passage through the eustachian tubes.

The pallor of the skin on entering compression noticed by some observers probably is the result of fright rather than any physiological effect of compressed air. There seems to be no evidence to substantiate the claim that compression (aside from fright) alters the volume or rate of pulse or of respiration, nor blood pressure nor the amount of urine or of sweat production. In some instances, the pulse was slowed from 70 to 65. The profuse sweating results from increased temperatures. There is a noticeable change in the quality of the voice to a nasal intonation and a general exhilaration. The appetite may be affected and

thus the vitality of the men diminished, making them susceptible to various disease attacks in addition to caisson disease itself. The caisson should be well ventilated, therefore, and the humidity, as indicated by a wet bulb thermometer, kept as low as practicable.

The pathological effects are much more serious than the physiological and may be grouped into three classes:

1. The increased liability to contracting colds and pneumonia;
2. The direct effect of pressure on the ears and the respiratory organs, spoken of as being "plugged," or "blocked;"
3. Caisson disease, "the bends," or aemia, which varies greatly in its severity;
4. Remote pathological effects.

The compression of the air in the caisson raises the temperature and permits men to work thinly or partially clad, and when they emerge from the caisson they frequently do not add sufficient clothing to protect them adequately and the exposure leads to colds and pneumonia. Temperatures in one of the air locks at the Metropolis bridge ran as high as 125° F. due to the great pressure and the frequent concreting.

For a more extended discussion of caisson disease than the present one, the reader is referred to the paper by Henry Japp, with the discussions.¹

Symptoms and Causes of Caisson Disease.—The symptoms² of caisson disease are vertigo, neuralgic or rheumatic pains of an intermittent paroxysmal character, chiefly in the legs and of varying severity, prostration and unconsciousness. In the worst cases, these pains are so violent as to completely unnerve strong men. The sensation is that of the flesh being torn apart and loose from the bones, causing men to double up and writhe with agony, hence the popular name of "bends" given to the disease. Vomiting usually accompanies the attack, and almost always pains in the stomach. In many cases, paralysis, partial or complete, results, varying in severity from a feeling of numbness to a complete loss of feeling and of muscular control, hence the name "diver's palsy," sometimes applied to the disease. Dizziness, or vertigo, or the "staggers," headache, double vision, incoherence of speech, paralysis of the bowels and of the bladder, labored breathing, or "the chokes" due to bubbles of gas forced

¹ *Trans. Am. Soc. C. E.*, vol. 65.

² *Engineering News*, Sept. 5, 1901.

through the pulmonary arteries, and sometimes prostration and unconsciousness are concomitants. Paralysis may last from a few hours to several weeks or months. Itching caused by the formation of bubbles in the fat of the sub-cutaneous tissues is frequently observed. Death resulting directly from caisson disease usually occurs within a few hours after the attack, although death may result indirectly from complications or sequelæ several days or months subsequent to the attack.

The cause of caisson disease, or aremia, is the formation of bubbles of air or of nitrogen, in the circulatory system, which may clog the circulation or, on expanding, may rupture the blood vessels, particularly the capillaries and the veins. The formation of these bubbles is due to the fact that the blood of the caisson worker has become saturated with gases at the high pressure, and on emergence from the caisson, the external pressure being reduced, these dissolved gases expand producing bubbles or beads in the blood. Post mortems have shown that the formation of beads of air is most noticeable in the venous circulation. The period of onset varies greatly, of course, usually early, that is within a few minutes, and is seldom delayed over three hours.

A dog quickly decompressed from $9\frac{1}{2}$ atmospheres died instantly. Investigation showed air in all the tissues and in the blood and in the spinal cord. Frogs placed under compressed air show air bubbles in the vessels of the web of the foot. The conclusion is accepted by everyone that the release of air, and more particularly nitrogen bubbles, in the blood and tissues is the cause of caisson disease.

Air bubbles in such unyielding tissues as the ligaments, faciæ, periosteum, etc., cause "bends" of less severity and certain other organs may give rise to no symptoms whatever; air embolism of the arteries of the spinal cord is commonly the cause of paralysis of the lower limbs, while embolism of the cerebral vessels may cause paralysis of one limb, or of one complete side, or may cause complete loss of understanding, or may result in blindness or loss of other senses.

The remote effects of working in compressed air are usually sequelæ of caisson disease in conjunction with alcoholism or some other extraneous factor. Those reported by Dr. Bassae¹ are inflammation of the spinal cord with the accompanying

¹ *International Congress on Hygiene and Demography*, vol. 3.

physical effects, inflammation of joints producing deformation, particularly of the hip, and brittleness of the bones.

The susceptibility to caisson disease increases with each attack and the symptoms become more severe with each succeeding attack. Lack of nervous control in the limbs sometimes results following repeated attacks. In a few instances, acute mania has resulted, the subject being designated as a "degenerate, liar, sodomist, and quarrelsome fellow."

Prevention and Treatment of Caisson Disease.—Two general precautions are employed to prevent caisson disease among workers, viz., (1) the employment of only those suited to this kind of work, and (2) the regulation of conditions of working, such as length of shift, time of decompression in the air lock, mode of living, etc., so that the danger may be minimized.

Only comparatively young men of sound body and clean habits of living should be employed. Men addicted to alcohol are likely to succumb easily; fat men are not suitable as the fatty tissues absorb about five times as much gas as does the blood, and as the rate of absorption is slow, the rate of desaturation is correspondingly slow. Men with strong hearts and good circulation, and relatively low blood pressure should be employed, for the desaturation occurs much more rapidly if the circulation is good. A thorough physical examination by a competent physician should be the basis of accepting men for caisson work. The men should never go into the caisson with an empty stomach, and should dress warmly on coming out.

The chief elements to be observed in working conditions are the period of compression during entrance, the length of shift spent in the working chamber, the period of rest between shifts, adequate ventilation of the working chamber, and last and most important, the time of decompression when leaving the working chamber. The time required for compression is brief, and beyond the requirements for physical comfort, does not require special attention, 1.5 to 2 lb. increase in pressure per minute being conservative practice. Dr. Haldane found that the blood becomes 50 per cent saturated in five minutes and completely saturated in 40 min. in those tissues and parts where the circulation is rapid, while other parts lacking the copious supply of blood become 50 per cent saturated in $1\frac{1}{4}$ hours and 100 per cent saturated in 4 hours.

As to the length of shift and rest period between shifts, practice indicates that the periods prescribed by the New York law are conservative. Usually the continual pumping of air into the chamber with the usual escape of air provides sufficient ventilation, but in some instances, the air becomes foul and special means of ventilation should be provided. Poor ventilation due to the decrease in the air space during the sealing of the working chamber is likely to cause attacks of caisson disease. The chief need of ventilation is in the air lock, where, due to the changing air pressure during compression, the atmosphere is cold and foggy. The French Law of 1908 requires 21.2 cu. ft. per man to be provided in the air lock for depths to 66 ft., and not less than 24.7 cu. ft. per man for depths above this. A small amount of ozone pumped into the chamber sweetens the air and removes the musty odor. Electric lighting rather than oil lights should be used in order to avoid the soot from the lights. Cooling the air greatly improves the working conditions.

The main difficulty arises in decompression, for it is impracticable to allow as much time for decompression as certain physiological experiments indicate as being desirable. Two modes of procedure are followed, one employing a uniform rate of decompression, and the other, a stage decompression, rapid at first and then more slowly. The total time allotted is not greatly different in the two modes.

In decompressing uniformly, the time allotted by different engineers varies. For depths less than 50 ft., little difficulty is encountered, but for greater depths special care must be exercised. German practice is about $1\frac{1}{3}$ min. per pound of pressure, while others allow only $\frac{1}{2}$ to 1 min. per pound. Older practice commonly allowed about 2 to 4 hours working shifts for pressures between 30 and 50 lb., and 20 min. to an hour for decompression. For lower pressures, the shift is not shortened from that used under normal atmospheric pressure and the time of decompression varies from 5 to 15 min. The provisions of the New York law are as follows:

Gauge pressure in lbs. per sq. in.	10	15	20	25	30	36	40	50
Minutes in decompression.	1	2	5	10	12	15	20	25

Gauge pressure in lbs. per sq. in.	0-21	22-30	31-35	36-40	41-45	45-50
Total hours per day in caisson.	8	6	4	3	2	1½
Number of shifts.	2	2	2	2	2	2
Length of shift in hours. (min.)	3	2	1½	1	¾
Minimum time between shifts, hrs.	½	1	2	3	4	5

This law is open to criticism perhaps in that it requires too many shifts and therefore too many decompressions. A longer period of working with only one shift per day is believed by some to be a more satisfactory arrangement, and the evidence from practice would indicate such to be the case.¹

The French Government regulations² for compressed air work require that a physician examine all men and any intoxicated workman must be kept away from the work at least 24 hours. In compression, the time shall be at least 4 min. to raise from 14 to 28 lbs. per square inch above atmospheric pressure, and at least 5 min. for each additional 14 lbs. The time employed in decompression shall not be less than: 20 min. for each 14 lbs. down to 42 lbs., 15 min. for each 14 lbs. between 42 and 28, and 10 min. for each 14 lbs. below 28 lbs. If the pressure does not exceed 14 lbs., the time required to reduce to zero may be 5 min.

The French law further requires that the height of the working chamber shall be such that men can stand upright in it. The quantity of air shall not be less than 1,400 cu. ft. per hour per man, and the carbon dioxide shall not exceed 1 part per 1,000. In the event that the pumping of air is stopped, all men must depart after a period of 10 min. Firing blasts without removing the workmen is prohibited. In summer the lock shall be protected by awnings to prevent greater heat. Where more than 20 are in the chamber, communication by telephone must be established with the outside. Electric lighting shall be used in

¹ *Trans. Am. Soc. C. E.*, vol. 65, p. 10 and 27.

² *Engineering News*, Dec. 30, 1909.

lock, shaft and chamber. The working chamber shall be supplied with a tank of oxygen under pressure for an emergency.

The length of shift is restricted as follows:

Below 28 lbs.....	8 hours
28-35 lbs.....	7
35-42 lbs.....	6
42-49 lbs.....	5
49-56 lbs.....	4

The stage decompression method as developed by Dr. J. S. Haldane is based on the theory, which is supported by many experiments, that bubbles of gas are not released in the blood where the saturation or pressure in the blood does not exceed the external pressure by more than 19 lbs. per square inch gauge, or 34 lbs. absolute, hence, the pressure can be diminished quickly by that amount in about 3 min., and then more slowly for the remainder of the time, allowing the rate of decrease in pressure to correspond with the rate of desaturation of the blood; or, in other words, keeping the difference between air pressure in the blood and on the outside constant at about 19 lbs., allowing men finally to emerge with 19 lbs. air pressure in their blood. Dr. Haldane recommends from 2 to 9 min. per pound of pressure after the initial stage, depending upon the length of time the men have been in the working chamber and the intensity of the air pressure. This practice is stated by Henry Japp¹ and others to be needlessly conservative. Mr. Japp allowed the pressure to be reduced 27 lb. in the initial stage of 3 to 9 min. and allowed 1½ to 2 min. per pound for the remainder of the decompression, allowing the men to emerge finally with an air pressure in the blood of about 27 lb. This inequality of pressures expedites the desaturation of the blood. Mr. Japp reports this arrangement to have been found satisfactory on work at New York where pressures ran as high as 50 lb.

In general, slow decompression is the most effective means of preventing caisson disease, and engineers are beginning to adopt this method always for deep work. Whether the shorter shifts with more than one shift per day are more advantageous than one longer shift per day with the single decompression is still open to question. The difficulty arises out of the decompression, hence, other things being equal, it is desirable to minimize the number of decompressions, although perhaps saturation is not so

¹ *Trans. Am. Soc. C. E.*, vol. 65, p. 18.

complete for the shorter shifts, for apparently complete saturation does not occur until after an immersion of three hours or more. At the Metropolis bridge, men worked $3\frac{1}{4}$ -hour shifts under 51 lbs. per square inch and decompressed without serious trouble. Dr. Haldane's stage decompression has been used successfully up to 92.4 lbs. per square inch.

The only effective treatment of caisson disease is recompression and then slower decompression. If this is done before the air embolism has had opportunity to rupture the blood vessels, a cure can almost always be effected, otherwise recompression is of little value. Dr. E. W. Moir has devised¹ a recompression tank or chamber which is kept available outside the caisson, in which affected men may be placed and recompressed, and then decompressed at sufficiently low rate to insure safety. Its use reduced the death rate from 25 per cent to 1 per cent on the Hudson River tunnel, and to 0.19 per cent on the East River tunnels. In compressed air work where there is any likelihood of caisson disease, that is, where men have to work for any considerable period under pressure exceeding about 30 lbs. per square inch, a recompression chamber should be provided for emergency use.

Poisonous Gases in Caissons.—In sinking Pier V of the Harahan bridge at Memphis, a poisonous gas was encountered which caused nine men to lose their lives in the main shaft above the air lock. The gang going in to relieve the one in the working chamber were overcome and apparently killed almost instantly. The men in the working chamber felt no ill effects. No definite evidence was available as to the origin or the nature of the gas that had accumulated at the bottom of the shaft, but Mr. Modjeski, the Consulting Engineer in Charge, supposed it to be carbon monoxide resulting from the combustion of methane.²

In the foundations under the Harlem River, such poisonous gases were encountered as to cause much trouble with caisson disease even at light pressures.³

¹ *Trans. Am. Soc. C. E.*, vol. 65, p. 5.

² *Report of RALPH MODJESKI, Consulting Engineer in Charge* p. 8.

³ *Engineering News*, Nov. 7, 1912.

APPENDIX A

STANDARD SPECIFICATIONS AND TESTS FOR PORTLAND CEMENT

These specifications were approved Mar. 31, 1922, as "American Standard" by the American Engineering Standards Committee (Illustrations and clauses relating to chemical tests omitted)

SPECIFICATIONS

1. Definition.—Portland cement is the product obtained by finely pulverizing clinker produced by calcining to incipient fusion an intimate and properly proportioned mixture of argillaceous and calcareous materials, with no additions subsequent to calcination excepting water and calcined or uncalcined gypsum.

I. CHEMICAL PROPERTIES

- 2. Chemical Limits.**—The following limits shall not be exceeded:
- | | |
|--|------|
| Loss on ignition, per cent. | 4.00 |
| Insoluble residue, per cent. | 0.85 |
| Sulfuric anhydride (SO ₃), per cent. | 2.00 |
| Magnesia (MgO), per cent. | 5.00 |

II. PHYSICAL PROPERTIES

3. Specific Gravity.—The specific gravity of cement shall be not less than 3.10 (3.07 for white Portland cement). Should the test of cement as received fall below this requirement a second test may be made upon an ignited sample. The specific gravity test will not be made unless specifically ordered.

4. Fineness.—The residue on a standard No. 200 sieve shall not exceed 22 per cent by weight.

5. Soundness.—A pat of neat cement shall remain firm and hard, and show no signs of distortion, cracking, checking, or disintegration in the steam test for soundness.

6. Time of Setting.—The cement shall not develop initial set in less than 45 minutes when the Vicat needle is used or 60 minutes when the Gillmore needle is used. Final set shall be attained within 10 hours.

7. Tensile Strength.—The average tensile strength in pounds per square inch of not less than three standard mortar briquettes (see Section 50) composed of one part cement and three parts standard sand, by weight, shall be equal to or higher than the following:

Age at test, days	Storage of briquettes	Tensile strength, lb. per sq. in.
7	1 day in moist air, 6 days in water.	200
28	1 day in moist air, 27 days in water.	300

8. The average tensile strength of standard mortar at 28 days shall be higher than the strength at 7 days.

III. PACKAGES, MARKING AND STORAGE

9. **Packages and Marking.**—The cement shall be delivered in suitable bags or barrels with the brand and name of the manufacturer plainly marked thereon, unless shipped in bulk. A bag shall contain 94 lb. net. A barrel shall contain 376 lb. net.

10. **Storage.**—The cement shall be stored in such a manner as to permit easy access for proper inspection and identification of each shipment, and in a suitable weather-tight building which will protect the cement from dampness.

IV. INSPECTION

11. **Inspection.**—Every facility shall be provided the purchaser for careful sampling and inspection at either the mill or at the site of the work, as may be specified by the purchaser. At least 10 days from the time of sampling shall be allowed for the completion of the 7-day test, and at least 31 days shall be allowed for the completion of the 28-day test. The cement shall be tested in accordance with the methods hereinafter prescribed. The 28-day test shall be waived only when specifically so ordered.

V. REJECTION

12. **Rejection.**—The cement may be rejected if it fails to meet any of the requirements of these specifications.

13. Cement shall not be rejected on account of failure to meet the fineness requirement if upon retest after drying at 100° C. for one hour it meets this requirement.

14. Cement failing to meet the test for soundness in steam may be accepted if it passes a retest using a new sample at any time within 28 days thereafter.

15. Packages varying more than 5 per cent from the specified weight may be rejected; and if the average weight of packages in any shipment, as shown by weighing 50 packages taken at random, is less than that specified, the entire shipment may be rejected.

STANDARD PHYSICAL TESTS FOR PORTLAND CEMENT

VIII. DETERMINATION OF SPECIFIC GRAVITY

28. **Apparatus.**—The determination of specific gravity shall be made with a standardized Le Chatelier apparatus. This apparatus is standardized

by the United States Bureau of Standards. Kerosene free from water, or benzine not lighter than 62° Baumé, shall be used in making this determination.

29. Method.—The flask shall be filled with either of these liquids to a point on the stem between zero and one cubic centimeter, and 64 g. of cement, of the same temperature as the liquid, shall be slowly introduced, taking care that the cement does not adhere to the inside of the flask above the liquid and to free the cement from air by rolling the flask in an inclined position. After all the cement is introduced, the level of the liquid will rise to some division of the graduated neck; the difference between readings is the volume displaced by 64 g. of the cement.

The specific gravity shall then be obtained from the formula

$$\text{Specific gravity} = \frac{\text{Weight of cement (g.)}}{\text{Displaced volume (cc.)}}$$

30. The flask, during the operation, shall be kept immersed in water, in order to avoid variations in the temperature of the liquid in the flask, which shall not exceed 0°.5 C. The results of repeated tests should agree within 0.01.

31. The determination of specific gravity shall be made on the cement as received; if it falls below 3.10, a second determination shall be made after igniting the sample as described in Section 20.

IX. DETERMINATION OF FINENESS

32. Apparatus.—Wire cloth for standard sieves for cement shall be woven (not twilled) from brass, bronze, or other suitable wire, and mounted without distortion on frames not less than 1½ in. below the top of the frame. The sieve frames shall be circular, approximately 8 in. in diameter, and may be provided with a pan and cover.

33. A standard No. 200 sieve is one having nominally an 0.0029-in. opening and 200 wires per inch standardized by the U. S. Bureau of Standards, and conforming to the following requirements:

The No. 200 sieve should have 200 wires per inch, and the number of wires in any whole inch shall not be outside the limits of 192 to 208. No opening between adjacent parallel wires shall be more than 0.0050 in. in width. The diameter of the wire should be 0.0021 in. and the average diameter shall not be outside the limits 0.0019 to 0.0023 in. The value of the sieve as determined by sieving tests made in conformity with the standard specification for these tests on a standardized cement which gives a residue of 25 to 20 per cent on the No. 200 sieve, or on other similarly graded material, shall not show a variation of more than 1.5 per cent above or below the standards maintained at the Bureau of Standards.

34. Method.—The test shall be made with 50 g. of cement. The sieve shall be thoroughly clean and dry. The cement shall be placed on the No. 200 sieve, with pan and cover attached, if desired, and shall be held in one hand in a slightly inclined position so that the sample will be well distributed over the sieve, at the same time gently striking the side about 150 times per minute against the palm of the other hand on the up stroke. The sieve shall be turned every 25 strokes about one-sixth of a revolution in the

same direction. The operation shall continue until not more than 0.05 g. passes through in one minute of continuous sieving. The fineness shall be determined from the weight of the residue on the sieve expressed as a percentage of the weight of the original sample.

35. Mechanical sieving devices may be used, but the cement shall not be rejected if it meets the fineness requirement when tested by the hand method described in Section 34.

X. MIXING CEMENT PASTE AND MORTARS

36. Method.—The quantity of dry material to be mixed at one time shall not exceed 1,000 g. nor be less than 500 g. The proportions of cement or cement and sand shall be stated by weight in grams of the dry materials; the quantity of water shall be expressed in cubic centimeters (1 cc. of water = 1 g.). The dry materials shall be weighed, placed upon a non-absorbent surface, thoroughly mixed dry if sand is used, and a crater formed in the center, into which the proper percentage of clean water shall be poured; the material on the outer edge shall be turned into the crater by the aid of a trowel. After an interval of $\frac{1}{2}$ min. for the absorption of the water the operation shall be completed by continuous, vigorous mixing, squeezing and kneading with the hands for at least one minute.¹ During the operation of mixing the hands should be protected by rubber gloves.

37. The temperature of the room and the mixing water shall be maintained as nearly as practicable at 21° C. (70° F.).

XI. NORMAL CONSISTENCY

38. Apparatus.—The Vicat apparatus consists of a frame *A* bearing a movable rod *B*, weighing 300 g., one end *C* being 1 cm. in diameter for a distance of 6 cm., the other having a removable needle *D*, 1 mm. in diameter, 6 cm. long. The rod is reversible, and can be held in any desired position by a screw *E*, and has midway between the ends a mark *F* which moves under a scale (graduated to millimeters) attached to the frame *A*. The paste is held in a conical, hard-rubber ring *G*, 7 cm. in diameter at the base, 4 cm. high, resting on a glass plate *H* about 10 cm. square.

39. Method.—In making the determination, 500 g. of cement, with a measured quantity of water, shall be kneaded into a paste, as described in Section 36, and quickly formed into a ball with the hands, completing the operation by tossing it six times from one hand to the other, maintained about 6 in. apart; the ball resting in the palm of one hand shall be pressed into the larger end of the rubber ring held in the other hand, completely filling the ring with paste; the excess at the larger end shall then be removed by a single movement of the palm of the hand; the ring shall then be placed on its larger end on a glass plate and the excess paste at the smaller end sliced off at the top of the ring by a single oblique stroke of a trowel held at a slight angle with the top of the ring. During these operations

¹ In order to secure uniformity in the results of tests for the time of setting and tensile strength the manner of mixing above described should be carefully followed. At least one minute is necessary to obtain the desired plasticity which is not appreciably affected by continuing the mixing for several minutes. The exact time necessary is dependent upon the personal equation of the operator. The error in mixing should be on the side of over mixing.

care shall be taken not to compress the paste. The paste confined in the ring, resting on the plate, shall be placed under the rod, the larger end of which shall be brought in contact with the surface of the paste; the scale shall be then read, and the rod quickly released. The paste shall be of normal consistency when the rod settles to a point 10 mm. below the original surface in $\frac{1}{2}$ min. after being released. The apparatus shall be free from all vibrations during the test. Trial pastes shall be made with varying percentages of water until the normal consistency is obtained. The amount of water required shall be expressed in percentage by weight of the dry cement.

40. The consistency of standard mortar shall depend on the amount of water required to produce a paste of normal consistency from the same sample of cement. Having determined the normal consistency of the sample, the consistency of standard mortar made from the same sample shall be as indicated in Table I, the values being in percentage of the combined dry weights of the cement and standard sand.

TABLE I.—PERCENTAGE OF WATER FOR STANDARD MORTARS

Percentage of water for neat cement paste of normal consistency	Percentage of water for one cement, three standard Ottawa sand	Percentage of water for neat cement paste of normal consistency	Percentage of water for one cement, three standard Ottawa sand
15	9.0	23	10.3
16	9.2	24	10.5
17	9.3	25	10.7
18	9.5	26	10.8
19	9.7	27	11.0
20	9.8	28	11.2
21	10.0	29	11.3
22	10.2	30	11.5

XII. DETERMINATION OF SOUNDNESS¹

41. **Apparatus.**—A steam apparatus, which can be maintained at a temperature between 98 and 100° C. (a number of such being available), is recommended. The capacity of this apparatus may be increased by using a rack for holding the pats in a vertical or inclined position.

42. **Method.**—A pat from cement paste of normal consistency about 3 in. in diameter, $\frac{1}{2}$ in. thick at the center, and tapering to a thin edge, shall be made on clean glass plates about 4 in. square, and stored in moist air for 24 hours. In molding the pat, the cement paste shall first be flattened on the glass and the pat then formed by drawing the trowel from the outer edge toward the center.

¹ Unsoundness is usually manifested by change in volume which causes distortion, cracking, checking or disintegration.

Pats improperly made or exposed to drying may develop what are known as shrinkage cracks within the first 24 hours and are not an indication of unsoundness.

The failure of the pats to remain on the glass or the cracking of the glass to which the pats are attached does not necessarily indicate unsoundness.

43. The pat shall then be placed in an atmosphere of steam at a temperature between 98 and 100° C. upon a suitable support 1 in. above boiling water for 5 hours.

44. Should the pat leave the plate, distortion may be detected best with a straight edge applied to the surface which was in contact with the plate.

XIII. DETERMINATION OF TIME OF SETTING

45. The following are alternate methods, either of which may be used as ordered:

46. Vicat Apparatus.—The time of setting shall be determined with the Vicat apparatus described in Section 38.

47. Vicat Method.—A paste of normal consistency shall be molded in the hard-rubber ring *G* as described in Section 39, and placed under the rod *B*, the smaller end of which shall then be carefully brought in contact with the surface of the paste, and the rod quickly released. The initial set shall be said to have occurred when the needle ceases to pass a point 5 mm. above the glass plate in $\frac{1}{2}$ min. after being released; and the final set, when the needle does not sink visibly into the paste. The test pieces shall be kept in moist air during the test. This may be accomplished by placing them on a rack over water contained in a pan and covered by a damp cloth, kept from contact with them by means of a wire screen; or they may be stored in a moist closet. Care shall be taken to keep the needle clean, as the collection of cement on the sides of the needle retards the penetration, while cement on the point may increase the penetration. The time of setting is affected not only by the percentage and temperatures of the water used and the amount of kneading the paste receives, but by the temperature and humidity of the air, and its determination is therefore only approximate.

48. Gillmore Needles.—The time of setting shall be determined by the Gillmore needles. The Gillmore needles should preferably be mounted.

49. Gillmore Method.—The time of setting shall be determined as follows: A pat of neat cement paste about 3 in. in diameter and $\frac{1}{2}$ in. in thickness with a flat top, mixed to a normal consistency, shall be kept in moist air at a temperature maintained as nearly as practicable at 21° C. (70° F.). The cement shall be considered to have acquired its initial set when the pat will bear, without appreciable indentation, the Gillmore needle $\frac{1}{2}$ in. in diameter, loaded to weigh $\frac{1}{4}$ lb. The final set has been acquired when the pat will bear without appreciable indentation, the Gillmore needle $\frac{1}{2}$ in. in diameter, loaded to weigh 1 lb. In making the test, the needles shall be held in a vertical position and applied lightly to the surface of the pat.

XIV. TENSION TESTS

50. Form of Test Piece.—The standard form of test piece shall be used. The molds shall be made of non-corroding metal and have sufficient material in the sides to prevent spreading during molding. Gang molds when used shall be of the approved type. Molds shall be wiped with an oily cloth before using.

51. Standard Sand.—The sand to be used shall be natural sand from Ottawa, Ill., screened to pass a No. 20 sieve and retained on a No. 30 sieve.

This sand may be obtained from the Ottawa Silica Co., at a cost of three cents per pound, f. o. b. cars, Ottawa, Ill.

52. This sand, having passed the No. 20 sieve, shall be considered standard when not more than 5 g. pass the No. 30 sieve after one minute continuous sieving of a 500-g. sample.

53. The sieves shall conform to the following specifications:

The No. 20 sieve shall have between 19.5 and 20.5 wires per whole inch of the warp wires and between 19.5 and 20.5 wires per whole inch of the shoot wires. The diameter of the wire should be 0.0165 in. and the average diameter shall not be outside the limits of 0.0160 and 0.0170 in.

The No. 30 sieve shall have between 29.5 and 30.5 wires per whole inch of the warp wires and between 28.5 and 31.5 wires per whole inch of the shoot wires. The diameter of the wire should be 0.0110 in. and the average diameter shall not be outside the limits 0.0105 to 0.0115 in.

54. Molding.—Immediately after mixing, the standard mortar shall be placed in the molds, pressed in firmly with the thumbs and smoothed off with a trowel without ramming. Additional mortar shall be heaped above the mold and smoothed off with a trowel; the trowel shall be drawn over the mold in such a manner as to exert a moderate pressure on the material. The mold shall then be turned over and the operation of heaping, thumbing and smoothing off repeated.

55. Testing.—Tests shall be made with any standard machine. The briquettes shall be tested as soon as they are removed from the water. The bearing surfaces of the clips and briquettes shall be free from grains of sand or dirt. The briquettes shall be carefully centered and the load applied continuously at the rate of 600 lb. per minute.

56. Testing machines should be frequently calibrated in order to determine their accuracy.

57. Faulty Briquettes.—Briquettes that are manifestly faulty, or which give strengths differing more than 15 per cent from the average value of all test pieces made from the same sample and broken at the same period, shall not be considered in determining the tensile strength.

XV. STORAGE OF TEST PIECES

58. Apparatus.—The moist closet may consist of a soapstone, slate or concrete box, or a wooden box lined with metal. If a wooden box is used, the interior should be covered with felt or broad wicking kept wet. The bottom of the moist closet should be covered with water. The interior of the closet should be provided with non-absorbent shelves on which to place the test pieces, the shelves being so arranged that they may be withdrawn readily.

59. Methods.—Unless otherwise specified all test pieces, immediately after molding, shall be placed in the moist closet for from 20 to 24 hours.

60. The briquettes shall be kept in molds on glass plates in the moist closet for at least 20 hours. After 24 hours in moist air the briquettes shall be immersed in clean water in storage tanks of non-corroding material.

61. The air and water shall be maintained as nearly as practicable at a temperature of 21° C. (70° F.).

APPENDIX B

SPECIFICATIONS FOR STONE MASONRY *

GENERAL

Standard Specifications.

1. The requirements for cement and concrete shall be those adopted by the American Railway Engineering Association.

GENERAL REQUIREMENTS

Stone.

2. Stone shall be of and shall be sound, hard and durable,
(State kind)

able, of approved quality and shape, free from holes, seams, drys or other imperfections.

Mortar.

3. Mortar shall be mixed in a suitable box, or in a machine mixer, preferably of the batch type, and shall be kept free from foreign matter. The size of the batch and the proportions and the consistency shall be as directed by the Engineer. When mixed by hand the sand and cement shall be mixed dry, the requisite amount of water then added and the mixing continued until the cement is uniformly distributed and the mass is uniform in color and homogeneous.

Laying.

4. The arrangement of courses and bond shall be as indicated on the drawings, or as directed by the Engineer. Stone shall be laid to exact lines and levels, to give the required bond and thickness of mortar in beds and joints.

5. Stone shall be cleansed and dampened before laying.

6. Stone shall be well bonded, laid on its natural bed and solidly settled into place in a full bed of mortar.

7. Stone shall not be dropped on or dragged over the wall, but shall be placed without jarring stones already laid.

8. Heavy hammering shall not be allowed on the wall after a course is laid.

9. Stone becoming loose after the mortar is set shall be relaid with fresh mortar.

10. Stone shall not be laid in freezing weather, unless authorized by the Engineer. If laid, the stone shall be first freed from ice, snow or frost by warming. The sand and water used in the mortar shall be heated.

* Manual American Railway Engineering Association.

Pointing.

11. Before the mortar has set in beds and joints, it shall be removed to a depth of not less than $1\frac{1}{2}$ inches. Pointing shall not be done until the wall is complete and mortar set; nor when frost is in the stone.

12. Mortar for pointing shall consist of equal parts of sand, sieved to meet the requirements, and portland cement. In pointing, the joints shall be wet, and filled with mortar, pounded in with a "set-in" or calking tool and finished with a beading tool the width of a joint, used with a straight-edge.

BRIDGE AND RETAINING WALL MASONRY—ASHLAR STONE

13. The stone shall be large and well-proportioned. The thickness of the courses shall diminish regularly from bottom to top. The maximum thickness shall not be more than twice the minimum thickness and no course shall be less than 12 inches thick.

Dressing.

14. Beds and builds shall be square with each other and dressed true and out of wind. They shall be fine-pointed, so that the mortar layer shall not be more than $\frac{3}{8}$ -inch thick when the stone is laid. Hollow beds shall not be permitted.

15. Joints in face stone shall be full to the square for a depth equal to at least one-half the height of the course, but in no case less than 10 inches. The backs shall be roughly scabbled to avoid overhang.

Face or Surface.

16. Exposed surfaces of the face stone, where not otherwise specified, shall be rock faced with edges pitched to the true lines and exact batter. The face shall not project more than three inches beyond the pitch line.

17. Chisel drafts, not less than $1\frac{1}{2}$ inches wide, shall be cut at exterior edges and shall be neat and accurate.

18. Holes for stone hooks shall not be permitted to show in exposed dressed surfaces. Such stone shall be handled with clams, keys, lewis or dowels.

Stretchers.

19. Stretchers shall not be less in length than $2\frac{1}{2}$ times their thickness, with an average width of bed at least $1\frac{1}{4}$ times their thickness.

Headers.

20. Headers shall not be less in length than $2\frac{1}{2}$ times their thickness, shall occupy one-fifth of the face of the wall and shall not be less in width than $1\frac{1}{4}$ times their thickness.

21. Headers shall hold in heart of wall the same size shown in face, so arranged that a header in a superior course shall not be laid over a joint, and a joint shall not occur over a header; the same disposition shall occur in back of wall.

22. Headers in face and back of wall shall interlock when thickness of wall will admit.

23. Where the wall is 3 ft. thick or less, the face stone shall pass entirely through. Backing shall not be permitted.

Backing.

¹24(a). At least one-half of the backing stone shall be of the same size as the face stone and be roughly squared; the remainder of backing stone shall be large, well-shaped and roughly bedded and jointed. Bed joints shall not exceed one inch. Vertical joints in back of wall shall not exceed two inches. The interior vertical joints shall not exceed four inches.

Voids shall be thoroughly filled with ^{concrete} spalls, fully bedded in cement mortar.

¹24(b). Backing shall be of ^{concrete} headers and stretchers, as specified in paragraphs 19 and 20, and heart of wall filled with concrete.

25. Where the wall will not admit of such arrangement, stone not less than four ft. long shall be placed transversely in heart of wall to bond the opposite sides.

26. Where stone is backed with two courses, neither course shall be less than nine inches thick.

Bond.

27. Bond of stone in face, back and heart of wall shall be at least one-half the thickness, but not less than 10 inches. Backing stones shall be laid to break joints with the face stone and with one another.

Coping.

28. Coping stone shall be full size throughout, of dimensions indicated on the drawings.

29. Beds, joints and top shall be fine-pointed.

30. Location of joints shall be determined by the position of the bed plates, as indicated on the drawings.

Locks.

31. Where required, coping stones, stones in steps of abutment wings and stones on piers and ice-breakers shall be fastened together with iron cramps or dowels in the position indicated on the drawings.

Ice Breakers.

32. In large piers with ice-breakers, the face of the stones forming the ice-breakers shall have a two-inch tooled margin draft all around, and shall be dressed off between to a minimum surface with a point or pick. The beds and vertical joints shall be pick-dressed the full width of the stones, so as not to exceed one-quarter of an inch in width. The backs of the stones shall be scabbled off so as to form square and vertical joints with the backing. The courses shall be arranged as shown in detail plans.

¹ Paragraphs 24(a) and 24(b) are so arranged that either may be eliminated according to requirements.

Trestle Piers.

33. Small piers carrying columns shall have backing of precisely the same thickness as the face stones, with beds dressed with the same care. The vertical joints shall be square, and shall not exceed half an inch in width. Such piers shall be built wholly of dimension stones, and the courses shall be arranged as shown in detailed plans. The footings shall in all cases be of concrete, reinforced, if necessary.

BRIDGE AND RETAINING WALL MASONRY—BLOCK RUBBLE

34. The stone shall be roughly squared, and may be laid in irregular courses. Beds shall be parallel, roughly dressed, and the stone laid horizontal to the wall. Face joints shall not be more than one inch thick. Bottom stone shall be large, selected flat stone.

35. The wall shall be compactly laid, having at least one-fifth the surface of back and face headers arranged to interlock, having all voids in the heart of the wall thoroughly filled with concrete.
suitable stones and spalls, fully bedded in cement mortar.

ARCH MASONRY—ASHLAR STONE

Falsework.

36. The contractor shall provide and erect falsework for the temporary support of arch centers. This may be of any preferred design, subject to approval, but shall be of ample strength and stiffness to safely, and without undue deformation, carry the whole load of completed arch. The contractor shall be entirely responsible for the stability of the falsework and for any damage that may result from overloading, wind, flood, back-water, logs, ice, fire or other cause. Should piling be necessary, the Railway Company may, at its option, drive the piles at the cost of the contractor.

Centers.

37. The contractor shall provide and erect centers strongly framed and braced longitudinally and transversely, the upper surface conforming accurately to the curve of the intrados of the arch, after making proper allowance for settlement under load. The lagging shall consist of two-inch by three-inch dressed plank laid transversely along the joints of the voussoir. Arch centers may be of any preferred design (subject to approval). At the ends, and in large arches at the intermediate posts, the centers shall be supported on sills or plates, provided with sand boxes, folding oak or other hardwood wedges, or both. Centers shall not be unequally or eccentrically loaded, and great care shall be taken in striking the arch centers to insure a slow and even subsidence, and to avoid unequal stresses. They shall not be struck without the express permission of the Engineer.

38. Voussoirs or ring stones shall be full size throughout and dressed true to templet, and shall have bond not less than width on intrados.

Dressing.

39. Joints of voussoirs and intrados shall be fine-pointed. Mortar joints shall not exceed $\frac{1}{4}$ -inch.

Face or Surface.

40. Exposed surface of the ring stone shall be ^{fine-pointed.} rock-faced with a marginal draft.

41. Number of courses and depth of voussoirs shall be indicated on the drawings.

42. Voussoirs shall be placed in the order indicated on the drawings.

Backing.

43. Backing shall consist of ^{concrete.} large stone, shaped to fit the arch bonded to the spandrel and laid in full bed of mortar.

44. Extrados shall be grouted and finished with $1\frac{1}{2}$ -inch coat of mortar applied evenly for a finishing coat, upon which, when required, shall be placed a covering of approved waterproofing material. (For information on waterproofing, see page 371.)

Bench Walls, Piers, Spandrels, Etc.

45. Bench walls, piers, spandrels, parapets, wing walls and copings shall be built under the specifications for Bridge and Retaining Wall Masonry—Ashlar Stone, as far as applicable.

ARCH MASONRY—BLOCK RUBBLE

Dressing.

46. Voussoirs or ring stones shall be full size throughout, and shall have bond not less than width on intrados.

47. Beds shall be roughly dressed to bring them to radial planes.

48. Mortar joints shall not exceed one inch.

Face or Surface.

49. Exposed surfaces of ring stones shall be rock-faced, and edges pitched to true lines.

50. Voussoirs shall be placed in the order indicated on the drawings.

Backing.

51. Backing shall consist of ^{concrete.} large stone, shaped to fit the arch, bonded to the spandrel, and laid in full bed of mortar.

52. Extrados shall be grouted and finished with $1\frac{1}{2}$ -inch coat of mortar applied evenly for a finishing coat, upon which, when required, shall be placed a covering of approved waterproofing material. (For information on waterproofing, see page 371.)

Bench Walls, Piers, Spandrels, Etc.

53. Bench walls, piers, spandrels, parapets, wing walls and copings shall be built under the specifications for Bridge and Retaining Wall Masonry—Block Rubble, as far as applicable.

CULVERT MASONRY

54. Culvert Masonry shall be laid in cement mortar. Character of stone and quality of work shall be the same as specified for Bridge and Retaining Wall Masonry—Block Rubble.

Side Walls.

55. One-half the top stones of the side walls shall extend entirely across the wall.

Cover Stones.

56. Cover stones shall be sound and strong and of thickness indicated on the drawings.

57. End walls shall be covered with suitable coping, as indicated on the drawings.

DRY MASONRY

58. Dry Masonry shall include dry retaining walls and slope walls.

Retaining Walls.

59. Retaining Walls and Dry Masonry shall include all walls in which stone laid without mortar is used for retaining embankments or for similar purposes. Flat stones at least $1\frac{1}{2}$ times as wide as thick shall be used.

60. Bed and joint shall be roughly squared.

61. Bed and face joints shall not exceed one inch. Vertical joints at back two inches and interior joints three inches.

62. Stone of different sizes shall be evenly distributed over entire face of wall, generally keeping the larger stone in lower part of wall.

63. The work shall be well-bonded, and shall present a reasonably true, and even surface, free from holes or projections.

Slope Walls.

64. Slope walls shall be built of such thickness and slope as indicated on plans or by the Engineer. Stone used in this construction must reach entirely through the wall. Stone shall be placed at right angles to the

INDEX

A

Abrams, D. A., 69
Abutments, arch, 205
 bridge, 304
 cellular, 312
 counterfort, 310
 cost of, 321
 types, 319
Ackermann, F. L., 21
Adobe, 469
Aesthetics of design, 18
Aggregates, 73, 74, 78
Air lock, 558
Alkali, effect on concrete, 114
Amalfi Drive bridge, 9
Angle of repose, 399
Angola bridge, 211
Arch centers, 452
Arch dams, 246, 250
Arch ring, 212
Arches, analysis, 160
 construction, 203
 deflection, 168
 economy in design, 207
 effect of settlement, 169
 on elastic piers, 190
 linear, 155
 masonry, 150
 reinforcement, 171
 three hinged, 363
 unsymmetrical, 173
Arris, 38
Arroyo Seco bridge, 209
Art marble, 117
Art stone, 117
Ashlar, definition, 37
Atchafalaya bridge, 538, 544

B

Baker, Prof. I. O., 39
Balustrade, 214

Beams, with axial loads, 132
 curved, 160
 rectangular, 122
 reinforced for compression, 131
Bearing blocks, 41
Bearing tests on soil, 483
Bearing walls, 54
Belt conveyors, 457
"Bends," 577
Bent, reinforced concrete, 357
Bin failure, 410
Bins, 399, 404, 406
 cement, 409
 sand, 414
Bond, in masonry, 48
 old to new concrete, 112
 stress, 129
Boussinesq formula, 476
Bracing forms, 436
Brard's test, 28
Breakwater, 221, 268
Breast wall, 272, 299
Breuchaud method, 524
Brick columns, 49
Brick masonry, definitions, 44
 laying, 47
 reinforced, 53
 strength, 49
Bricks, sizes and strength, 46
Bridges, cantilever, 361
 concrete, 344
 continuous, 367
 railway, 347
 slab frame, 366
"Bridging," 549
Bronx viaduct, 546
Building blocks, concrete, 56
Building stones, 27
Bulb of pressure, 475
Bulking effect of sand, 99
Bunker Hill monument, 14

- Buoyant effect of intrusive water, 435
- Bushhammer, 34
- Buttressed walls, 52
- C
- Cain, Prof. William, 246
- Caisson disease, 577, 579
- Caissons, cylinder, 536
- design, 549
- drop, 548
- flotation, 561
- open, 534
- pneumatic, 542
- sealing, 572
- sinking, 567
- stationary, 546
- Caligula, palace of, 9
- Cement, accelerated, 68
- aluminous, 67
- compositions of, 64
- gun, 547
- hydraulic, 63, 68
- natural, 68
- portland, 64
- pozzuolan, 69
- proportion of, 86
- slag, 69
- specific gravity, 64
- specifications, 584
- storage of, 69
- tests, 66
- Cement-space ratio, 84
- Centering, 38
- Chimneys, architectural treatment, 430
- brick, 421
- reinforced concrete, 423
- stresses in, 424
- "Chokes," caisson disease, 577
- Cleopatra's needle, 27
- Cloaca maxima, 9
- Cochrane, V. H., 190
- "Cocked hat" on pier, 328
- Coefficient of resistance, 147
- Coffer-dams, 526
- caisson, 558
- cellular, 530
- Cohesion, 275, 279
- Coignet, Francois, 5
- Colloidal content of soil, 472
- Colorado, building stones, 31
- Colorimetric test, 77
- Colors for masonry, 21, 61
- Columbia River bridge, 544
- Column footings, 494
- Columns, brick, 52
- concrete, 135
- stone, 43
- Compacted soil foundations, 502
- Compressol foundations, 502
- Compromise section, 303
- Concrete, 62
- abrasive resistance, 110
- consistency, 96
- construction costs, 464
- depositing under water, 459
- durability of, 117
- expansion and contraction, 110
- fatigue of, 107
- finishing surfaces, 112
- materials required, 102
- modulus of elasticity, 105
- plastic flow, 107, 167
- repairs, 119
- strength of, 81, 103, 105
- temperatures in, 111
- Conduits, 388
- Construction plant, 460
- Construction schedule, 461
- Continuous beams and slabs, 133
- Contraction joints, 286
- Conveying concrete, 456
- Coping, definition, 38
- Corbeling action, 50
- Core drilling, 482
- Cost, factors affecting, 15
- Cotton-seed, pressures of, 404
- Coulomb, C. A., 276
- Cover stones, 596
- Cramps, definition, 38
- Crandall, 34
- Crazing effects, 60, 118
- Crib of caisson, 556
- Cromlechs, 2
- Cross, Prof. Hardy, 135

Culverts, 373
 box, 385
 rectangular, 377
 Curing of concrete, 101
 Cut-off wall, 261
 Cutwater on piers, 328

D

Dado, 213
 Dam, approximate section, 237
 architectural treatment, 265
 Dams, arch, 253
 cost of, 263
 earth, 259
 history of, 221
 hollow, 258
 overflow, 224, 258
 rock-fill, 259
 site for, 262
 stresses in, 239
 Density, 89
 Design, factors affecting, 10
 principles of good, 19
 Diagonal tension, 125
 Disintegration of concrete, 29
 "Diver's palsey," 577
 Diving, 543
 Dobbs, Edgar, 5
 Dolmens, 2
 Draft, definition, 38
 Dropped panel, 141

E

Eads, James B., 543
 Earth pressures, 276, 376
 Earthquake shocks, 420
 Eddystone lighthouse, 4
 Efflorescence, 55
 Elastic center method, 174
 Elastic piers, 190
 Elastic theory of arch, 6, 160
 Enforced percolation, 262
 Engineering News formula, 518
 Enrockment, 538
 Enrosion, resistance to, 29
 Etruscan masonry, 4
 Expansion of masonry, 29

Expansion joints, 177, 242
 Extradados, 150
 Eytelwein formula, 327

F

Falsework, 433
 Fatigue of concrete, 107
 Feld, Jacob, 276
 Feret, René, 73
 Fineness of cement, 586
 Fineness modulus, 93
 Fire brick wall, 419
 Fire resistance of masonry, 29
 Fire-proofing, 116
 Float finish, 113
 Flow table test, 98
 Fog nozzle, 58
 Footings, 491
 Forms, arch, 452
 beam, 440
 column, 439
 conduit, 444
 cost of, 450
 design, 433
 groined arch, 456
 movable, 445
 removal of, 456
 retaining wall, 444
 steel, 448
 wall, 442
 Ft. William bridge, 537
 Foundations, 467
 compacted soil, 501
 cost, 520, 540, 575
 dam, 259
 explorations for, 480
 failures, 480
 floating, 470, 498
 groined arch, 501
 inverted arch, 500
 limits, 526
 loads on, 504
 pile, 507
 pneumatic, 542
 types, 490
 Four-way reinforcement, 144
 Fowler, C. E., 525
 Fragmental materials, 396

600 DESIGN OF MASONRY STRUCTURES AND FOUNDATIONS

- Frame, trestle, 357 J
 Fraser River bridge, 536
 Freezing, effect on concrete, 459
 process, 540
 weather, construction in, 458
 Frost deterioration, 28
 Fuller's rule, 40, 102
 Fur, definition, 45
- G**
- Gases in caissons, 583
 Gillmore needles, 589
 Girder bridges, 348
 Gradation of aggregates, 80
 Granolithic finish, 113
 Granular materials, 396
 Grillage, 496
 Groin, shore protection, 270
 Groined arch, 215, 501
 Grouting process, 540
 Gumbo, 469
 Gypsum cements, 24
- H**
- Haldane, Dr. J. S., 582
 Harahan bridge, 550, 566
 Hardpan, 469
 Haunched beams, 134
 Havre de Grace bridge, 551, 566
 Header, definition, 38
 Hinges for arches, 365
 History of masonry, 2, 8
 "Hogging," 549
 "Honeycomb" concrete, 112
 Hopple Street viaduct, 362
 Huacal dam, 252
 Hydrostatic pressure, 225
- I**
- Ice breakers, 593
 pressure, 229, 325
 Impact, 347, 377
 Influence diagrams, 189
 Intrados, defined, 160
 Inundator, 100
- Jack arch, 51
 Janssen, H. A., 399
 Japp, Henry, 582
 Jetty, 268
 Joints, 49
 Judson, W. V., 539
- K**
- Kensico dam, 265
 Keokuk dam, 226
 Ketchum, Prof. M. S., 277, 379
 Kiln, continuous, 45
 Kinzie Street bridge, 570
- L**
- Laitance, 460
 Lake Eleanor dam, 257
 Lake Hodges dam, 253
 Lambot, M., 5
 Lamp posts, 214
 Legal requirements, 18
 Lewis, definition, 38
 Lime, 3, 24, 64
 Limnoria, 509
 Line of creep, 227
 Lintel, 51
 Little Eagle River bridge, 210
 Loading, arch, 154
 bridge, 349
 foundation, 504
 Lubrication of forms, 438
 Lumber for forms, 435
- M**
- McCourt, Prof. W. E., 29
 Magnesian lime, 24
 "Maine" cofferdam, 531
 Maintenance, 14
 Manhattan bridge, 555
 Manila, P. I., bridge, 564
 Masonic Temple, settlement, 472
 Masonry, classification, 37
 definitions, 1, 37
 inspection, 462

Masonry, measurement of, 55
 rate of laying, 55
 Mat foundation, 498
 Metropolis bridge, 490, 556, 564
 Mixers, capacity of, 461
 Mixing concrete, 98
 Modjeski, Ralph, 583
 Moir recompression chamber, 583
 Molds, cement, 589
 Mole, 268
 Monier, Joseph, 5
 Mortar, 23, 25, 40
 Multiple arch dams, 256
 Municipal bridge, 556
 Municipal Building, New York, 572

N

Nagler, Prof. F. A., 328
 Nappe-free wiers, 224
 Navigable streams, 342
 Needle beams, 523
 Normal consistency, 587

O

Oil for forms, 439
 Orders of architecture, 2
 Ornamentation, 21
 Otay dam, 236

P

Painting concrete, 119, 462
 Paneling, 303
 Parapet, 38, 213
 Parge, parget, 45
 Parliament houses, 27
 Parti-fluids, 396
 Peavy elevator failure, 406
 Pedestal pile, 517
 Penhorn viaduct, 538
 Permanence, of concrete, 117
 factor in design, 12
 Piers, 320
 and abutments, 212
 arch, 205
 hollow, 503
 movable bridge, 334
 stability of, 325

Pile drivers, 512
 driving, 509
 foundations, 507
 spacing, 514
 supporting capacity, 517
 Piles, 507, 515
 Pipe, stresses in, 380
 Pite, Beresford, 21
 Pivot piers, 334
 Plastic materials, 396
 Plinth, 213
 Plug and feathers, 35
 Pneumatic caisson, 542
 Poetch process, 540
 Point, a tool, 34
 Pointing masonry, 38, 39, 592
 Poissons ratio, 107
 Pont du Gard, 8
 Pozzuolan cement, 69
 Pre-cast units, 116
 Pressures in bins, 403
 in caissons, 581
 of concrete, 434
 of earth, 276, 474
 Proportions, field control, 99
 Proportioning concrete, 80, 81, 87,
 88, 91, 92, 95
 Pudding stones, 79
 Puddle coffer-dams, 531
 Pulverulent materials, 396

Q

Quarrying, 30
 Quay wall, 272, 295
 Quebec bridge caisson, 563
 Quicksand, 469
 Quoin, definition, 38

R

Rainbow arch, 207
 Rankine, W. J. M., 276
 Refractoriness of stone, 29
 Reinforced concrete, 120
 working stresses, 146
 Reinforcement, cost of, 463
 Reservoir walls, 295
 Retaining grillage, 297

- Retaining wall, 272
 - architectural treatment, 300
 - cellular, 292
 - design, 287
 - drainage, 287
 - pressures on, 274
 - types, 273, 298
 - Rib-shortening, 168, 174, 176, 182
 - Rise ratio, 152
 - Robinson, J. B., 19
 - Roman masonry, 4
 - Rosendale cement, 5
 - Roxbury school house failure, 53
 - Rubble, 37
 - Ruskin, John, 19
- S
- St. Joseph bridge, 558
 - Salmon River dam, 253
 - Sand, standard, 589
 - tests of, 75
 - torpedo, 74
 - "Sand hogs," 571
 - Sand line brick, 47
 - Sand piles, 501
 - Schwada, Joseph, 157
 - Scouring, 300
 - Screenings, 77
 - Sea walls, 268, 270
 - Sea water, action on concrete, 113
 - Settlement, uneven, 489
 - Sheet piles, 527
 - Shores, 523
 - Shoshone dam, 252
 - Shove-joint, 47
 - Shrinkage stresses, 137, 167
 - Sibley, Mo., bridge, 569
 - Silos, 415
 - Silt, pressure on dam, 224
 - Simplex piles, 517
 - Singer Building foundation, 573
 - Skin friction, 569
 - Slabs, bridge, 353
 - on girders, 138
 - reinforced concrete, 144
 - stresses in, 142
 - Slag aggregate, 79
 - Slope walls, 297
 - Slump test, 97
 - Smeaton, John, 4
 - Soil, bearing values, 471
 - borings, 481
 - characteristics, 472, 473, 484
 - classification, 468
 - friction, 520
 - lateral support, 478
 - pressures, 276
 - resistance, 476
 - Solid rock, 469
 - Spall, 38
 - Spandrel, design, 201
 - walls, 213
 - Sparrow, W. S., 338
 - Specific gravity, 31, 586
 - Spillways, 258
 - Spreaders, 436
 - Stack, 417
 - Stage decompression, 582
 - Staining of stone, 33
 - Standard sand, 589
 - Starling, 328
 - Stereotomy, 36
 - Stevenson Creek dam, 245
 - Stirrups, 128
 - Stone, properties of, 31
 - Stone cutting, 36
 - Stone machinery, 35
 - masonry, 25, 40, 591
 - polish of, 34
 - texture of, 32
 - tools, 34
 - Stonehenge, Eng., 2
 - Stucco, 60
 - Surcharge, effect of, 280
 - Surface area of aggregates, 94
 - Surveys for piers, 340
 - Sylvester's washes, 56
- T
- T-abutments, 308
 - T-beams, 129
 - Talbot, Prof. A. N., 81, 375
 - Temperature stresses, 137, 167, 427
 - Teredo, 507
 - Terra cotta, 45, 58, 59
 - Terrazzo, 113

- Terzaghi, C. T., 473, 519
 Thermal conductivity, 115, 419
 Thompson method, 524
 Tower Bridge, 337
 Transformed area, 132
 Tremie, 460
 Trestle bridges, 351
 Trestles, 356, 357
 Tunkhannock viaduct, 210, 529
 Two-way reinforcement, 144
 Tympanum, 51, 151
- U
- U-abutments, 308
 Underpinning, 523
 Union Station, foundations, 571
 Unity in design, 20
 University of Kansas experiments,
 277
- V
- Veneer, 44
 Vicat apparatus, 587
 Vitrification, 46
 Vitruvius, 3
 Voids in aggregates, 71
 in concrete, 96
 Voussoir, defined, 150
- W
- Wakefield sheet piles, 528
 Wales, 533
 Walls, brick, 54
 War Department requirements, 343
 Ward, W. E., 6
 Wash borings, 482
 Water jet, 513
 Water-cement ratio, 85
 Water-proofing masonry, 115, 370,
 414
 Waterway, 326, 373
 Wave action, 228, 270
 Web stresses, 126
 Wegmann, Edward, 221, 238
 Weld formula, 156
 White, Canvass, 5
 Willamette River bridge, 564
 Wind pressure, 418
 Wing walls, 308, 317
 Workability, 98
 Working stresses, 146
- Y
- Yokes for columns, 440
 Yolo By-Pass bridge, 352

